

FOR MANUFACTURERS



WORKSHOP RECEIPTS

FIFTH SERIES

DIAMOND CUTTING. TOBACCO PIPES.
LABORATORY APPARATUS. TAPS.
COPYING. TYPING AND SPLICING
FILTERING. TACKLE.
FIREPROOFING. VELOCIPEDES.
MAGIC LANTERNS. REPAIRING BOOKS
METAL WORK. NETTING.
PERCOLATION. WALKING STICKS
ILLUMINATING AGENTS. BOAT BUILDING.

&c. &c. &c.

SCIENTIFIC AMATEURS

ELECTRIC LIGHTING.

GROMPTON & CO., LIMITED,
Electric Light & Power Engineers,
MANSION HOUSE BUILDINGS, LONDON, E.C.

MANUFACTURERS OF
Dynamamos, Lamps, Measuring Instruments, Switches,
Patent Underground Mains, and all accessories
for Electric Lighting.

ELECTRO MOTORS FOR ELECTRIC TRACTION.

DYNAMOS FOR SMELTING AND PLATING.

ELECTRIC CRANES FOR ALL PURPOSES.

CONTRACTS FOR TOWN LIGHTING ON ANY SCALE.

Estimates, Catalogues, and all information free.

GROMPTON & CO., LIMITED,
MANSION HOUSE BUILDINGS, LONDON, E.C.
Works: CHELMSFORD.

WOODHOUSE & RAWSON,

UNITED LIMITED,

Electrical Engineers and
Contractors,

AND
MANUFACTURERS

OF
ELECTRICAL
APPARATUS.

“ B ”

Catalogue
(4th Edition),
250 Pages,
350 Woodcuts.

Contains prices
and particulars of all
classes of Electrical
Apparatus for House
Lighting, Telephone
and Telegraph Con-
tractors, &c., in-
cluding Engines,
Dynamos, Ac-
cumulators,

Switches,
Fittings,
&c.

Price
1/-



HEAD
OFFICES,
88,

QUEEN VICTORIA ST.,
LONDON, E.C.

SHOW ROOMS, &c.,
30, CANNON ST., LONDON, E.C.,

AND,
41, PICCADILLY, BRADFORD.

WORKS,
WEST KENSINGTON HALL, LONDON, W.,
AND
Cornbrook Telegraph Works, Manchester.

Branch Offices and Agencies throughout the world.

ELECTRICAL LIGHTING

APPARATUS

“ A ”

Catalogue,
150 Pages,
250 Woodcuts.
Contains prices
and particulars of
all classes of Elec-
trical Apparatus for
Domestic, Experi-
mental, and Labo-
ratory use, such as
Pushes, Bells,
Indicators, Bat-
teries, Hand
Dynamos,
&c.

Price
1/-

PHOSPHOR BRONZE

**FOR BEARINGS, SLIDE VALVES, PUMPS AND
MACHINERY PARTS.**

Supplied in Ingots and Castings to Pattern or Drawings.

Beware of all Imitations, and specify the COG-WHEEL BRAND of

THE PHOSPHOR BRONZE CO.,
LIMITED,

**87, SUMNER ST., SOUTHWARK,
LONDON, S.E.**

13 & 22, Litherland Alley, LIVERPOOL;
Salem Street, ETRURIA, NORTH STAFFORDSHIRE.

ALL INGOTS BEAR THE COMPANY'S NAME, COG WHEEL TRADE MARK,
AND THE NUMBER OF ALLOY.

MANUFACTURERS OF
ROLLED BRASS of all kinds; BRASS WIRE and RODS
COPPER WIRE (BEST HIGH CONDUCTIVITY
and ORDINARY).

BRITISH & FOREIGN PATENTS, DESIGNS, TRADE MARKS.

PROVISIONAL PROTECTION FROM £2 2s.

MESSRS. WEATHERDON & CO. (Patent Agents, established in Chancery Lane, 1849) will, upon application of Inventors, give the lowest possible charge for completing British Patents.

FOREIGN & COLONIAL PATENTS.

MESSRS. WEATHERDON & CO. offer special reasonable terms for procuring Foreign Patents, and being represented in all Countries by old-established Agents, Inventors can rely upon the work being done in a competent manner.

DESIGNS, TRADE MARKS, AND COPYRIGHTS REGISTERED.

OPPOSITIONS AND APPEALS CONDUCTED.

DRAWINGS OF ALL KINDS PREPARED.

CIRCULAR AND ADVICE GRATIS ON APPLICATION—

B. F. WEATHERDON & CO.,

REGISTERED PATENT AGENTS,

11 & 12, SOUTHAMPTON BUILDINGS,
CHANCERY LANE, LONDON, W.C.

ESTABLISHED 1849.

[Interleaf before Title.]

ROWNSON, DREW, & CO.,

ENGINEERS & MANUFACTURERS OF CONSTRUCTIONAL IRONWORK.

BRIDGES, ROOFS, GIRDERS,
ROLLED JOISTS, FLITCH PLATES,
COLUMNS & STANCHEONS,
TANKS, SASHES, IRON BUILDINGS.

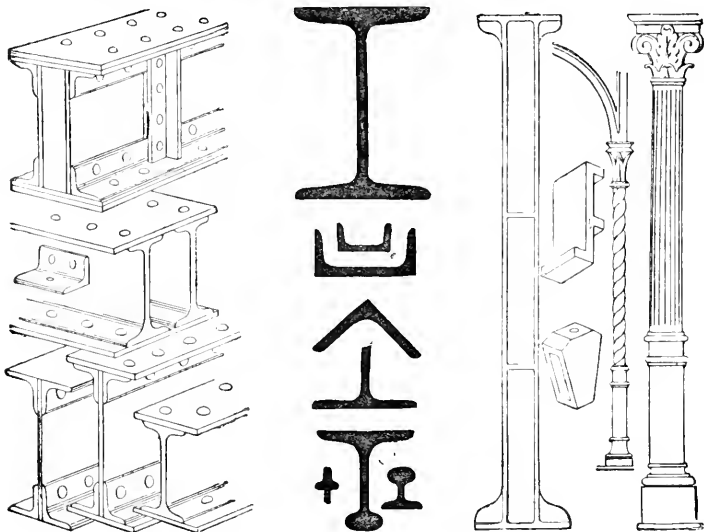

OFFICES AND WAREHOUSES:

225, Upper Thames Street, and 113, Queen Victoria Street, E.C.

WORKS AND IRON STORES:

Prince's Wharf, Commercial Road, Lambeth, S.E.

Telegrams, "ROWNSON, LONDON."

Telephone, No. 1901.

WORKSHOP RECEIPTS.

(FIFTH SERIES.)

WORKSHOP RECEIPTS.

(FIFTH SERIES.)



E. & F. N. SPON, 125, STRAND, LONDON.

NEW YORK: 12, CORTLANDT STREET.

1892.

“DURO METAL.”

REGISTERED TRADE MARK.

ALLOY.

A.—A very dense Bronze, well adapted for heavy Fly-Wheel Bearings, but specially for Railway Carriage and Truck Bearings.

B.—This mixture is most suitable, and is now largely used, for the Bearings of Hot Neck Rolls in Ironworks, and other Mills.

These alloys have now been in use for some years, and have given great satisfaction in all parts of the World. They were originally introduced by us with a view to providing a good Bearing Metal cheaper than our No. XI. “**Phosphor Bronze,**” and at the same time much superior to Gun Metals and Brass.

Foreign Buyers and others, when indenting, are requested, in order to prevent imposition and error, to specify that the Ingots required by them shall bear the registered trade title, “**Duro Metal,**” and also the Company’s General Trade Mark, a “**Cog Wheel**” bearing the Company’s name.

Supplied in Ingots and Castings by the SOLE PROPRIETORS—

THE PHOSPHOR BRONZE CO.,

LIMITED,

Chief Office and Foundry—

87, SUMNER ST., SOUTHWARK, LONDON, S.E.

Branch Foundries—

13 and 22, LITHERLAND ALLEY, LIVERPOOL.

SALEM STREET, ETRURIA, NORTH STAFFORDSHIRE.

[Interleaf before Preface]

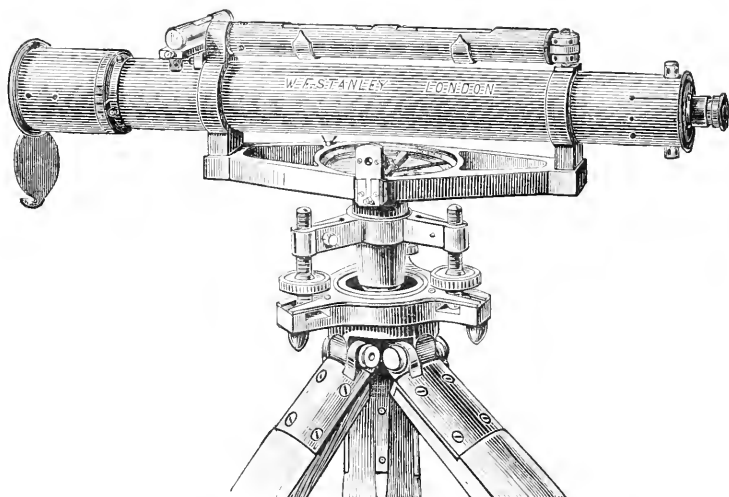

W. F. STANLEY,
MANUFACTURING OPTICIAN.

Mathematical, Drawing, and Surveying Instrument
Maker,

Contractor to H.M. Government, also for India and Colonies.

*Theodolites, Sextants, Levels, Compasses, and every Description of Instrument
and Material for Field and Office,*

OF THE FIRST QUALITY, HIGHEST FINISH, AND MOST MODERATE PRICE.

Manufactured for the most part by **Self-Acting Machinery.**

MEDALS—*International Exhibitions, 1862 and 1873.*

GOLD MEDAL, *Inventions Exhibition, 1885.*

ENGINE DIVIDER TO THE TRADE.

GOODS SHIPPED WITH GREATEST CARE.

Mathematical, Microscopic, Photographic, and Electrical Catalogues,
Post Free.

STANLEY,
GREAT TURNSTILE, HOLBORN, W.C., LONDON.

STEAM OPTICAL WORKS AT SOUTH NORWOOD.

Registered Telegraphic Cipher Address — "TURNSTILE, LONDON."

INTRODUCTION.

WITH the spread of technical education, which is such a feature in the present century, scarcely a household but has its more or less pretentious workshop, in which the mechanical and scientific tastes of the boys can be developed and made useful. No better way of keeping idle hands from mischief can be imagined, and there is always a charm about home-made knickknacks, and a satisfaction in doing one's own repairs about the dwelling, that quite atone for any little defects that a professional eye might discover. As aid books to such industrious amateurs, and by no means to be despised even by the trained mechanic, **WORKSHOP RECEIPTS** have enjoyed a wide reputation for close on a quarter of a century. Of handy size, well indexed, and fully illustrated, they comprise in themselves a complete technical library at a very low cost. In adding a **FIFTH** volume, the range of subjects has been widened, and the information conveyed in earlier volumes has been supplemented by the results of most recent investigations and experiments, thus bringing the whole series well up to date. In the matter of illustrations this last addition to their number is specially liberal.

THE
PHOSPHOR BRONZE CO.,
LIMITED.

LONDON, BIRMINGHAM, LIVERPOOL,
and ETRURIA.

SOLE MAKERS OF THE FOLLOWING SPECIALITIES.

PHOSPHOR BRONZE, "Cog Wheel" and "Vulcan"
Brands.

"DURO METAL" (*Registered Title*). For Roll Bearings,
Wagon Brasses, &c.

PHOSPHOR TIN, "Cog Wheel" Brand. The best made.

PLASTIC METAL, "Cog Wheel" Brand. The best in
the market.

"PHOSPHOR" WHITE BRASS. Qualities I. & II.

BABBITT'S METAL. "Vulcan" Brand. Qualities I.,
II., III., IV.

WEILLER'S PATENT SILICIUM BRONZE
ELECTRICAL WIRE. For Overhead Lines.

Please apply for Circulars containing full particulars to the

COMPANY'S HEAD OFFICE,

87, SUMNER ST., SOUTHWARK, LONDON, S.E.

[To face end of Preface.]

THE
PHOSPHOR BRONZE CO.,
LIMITED.

87, SUMNER ST., SOUTHWARK, LONDON, S.E.

ROLLING AND WIRE MILLS—
BAGOT STREET, BIRMINGHAM.

Branch Foundries at LIVERPOOL and ETRURIA, Stoke-on-Trent.

SOLE MAKERS OF THE "COG WHEEL" BRAND PHOSPHOR
BRONZE INGOTS AND CASTINGS,

Spring and Electric Wire, Rods, Seamless Tubes,
Sheets, Doctor Blades, Cycle Spokes, &c.



This Trade Mark, a "Cog Wheel," bearing
the Company's name, has been registered
in every civilized country.

SOLE PROPRIETORS OF THE
BRITISH, INDIAN, AND COLONIAL PATENTS,
FOR

SILICIUM BRONZE ELECTRICAL WIRE,

Qualities A, B, and C (see Circulars and Price Lists).

*For Overhead Telegraph and Telephone Lines, &c., as used by the chief Railway
and Telephone Companies throughout the World.*

HIGH CONDUCTIVITY. GREAT TENSILE STRENGTH. RESISTANCE TO
CORROSION. PRACTICAL INDESTRUCTIBILITY.

PAMPHLETS AND CIRCULARS ON APPLICATION

NALDER BROS. & CO.,

ENGINEERS, ELECTRICIANS, & SCIENTIFIC
INSTRUMENT MAKERS,

MANUFACTURERS OF

Every description of Electrical and other Scientific Measuring Instruments, such as Thomson Reflecting and other Galvanometers, Resistance Coils, Wheatstone Bridges, Standard Cells, Condensers, Standards of Self Induction, Ammeters, and Voltmeters. Also, Measuring Machines, Micrometers, Spherometers, Optical Benches, and Special Instruments for all purposes.

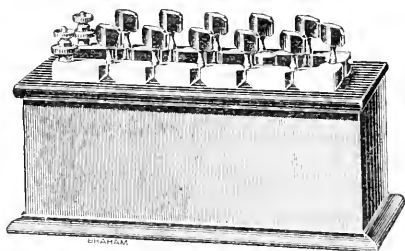
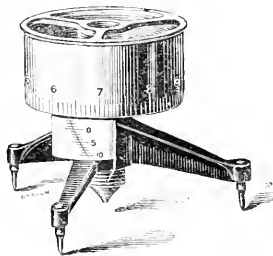
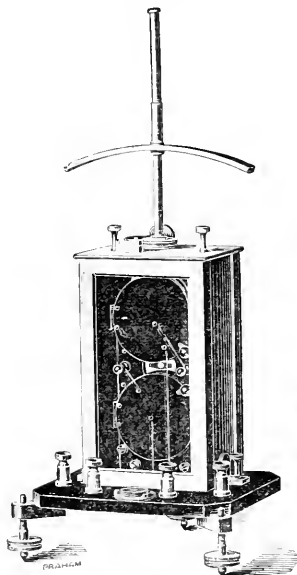

NALDER BROS. & CO.,

132, HORSEFERRY ROAD, WESTMINSTER,
LONDON, S.W.

REGISTERED TELEGRAPH ADDRESS—
"SECOHM, LONDON."

TELEPHONE No. 3120

PATENTS,
DESIGNS & TRADE MARKS.

BERNHARD DUKES,

TEL. ADDRESS :
APPLICANT,
LONDON.

226, *High Holborn,*
London, W.C.,

Attends to all business relating to
PATENTS, DESIGNS, & TRADE MARKS.

ATTENDANCE IN THE PROVINCES.

Please mention this Book when applying.

CONTENTS.

	PAGE		PAGE
DIAMOND CUTTING AND		CORROSION AND PROTEC-	
POLISHING	1	TION OF METAL SUR-	
LABELS	4	FACES	283
LABORATORY APPARATUS	6	PUMPS AND SIPHONS ..	301
CEMENTS AND LUTES ..	13	WATERPROOFING	311
COOLING	19	GLASS MANIPULATING ..	313
COPYING	22	MODELLING AND PLASTER	
DESICCATING	32	CASTING	321
DISTILLING	42	STEREOTYPING	332
EVAPORATING	45	TOBACCO PIPES	355
ILLUMINATING AGENTS ..	48	TAPS	366
FILTERING	53	TYING AND SPLICING ..	368
EXPLOSIVES	65	TACKLE	377
FIREPROOFING	67	VELOCIPEDES	380
INK	82	REPAIRING BOOKS	381
LACQUERS	89	NETTING	384
MAGIC LANTERNS	95	WALKING STICKS	397
ELECTRICS	125	BOAT BUILDING	407
METAL WORK	219	ANEMOMETERS	411
MUSICAL INSTRUMENTS ..	262	ANGLES, MEASURING ..	413
PACKING AND STORING ..	262	BAROMETERS	414
PERCOLATION	269	CAMERA LUCIDA	427
PRESERVING	270	DENDROMETERS	430

WORKSHOP RECEIPTS.

FIFTH SERIES.

DIAMOND CUTTING AND POLISHING.

VERY little is known by the mechanic, of the real process of transforming a rough and apparently worthless-looking pebble into a stone of the greatest brilliancy and lustre. The change wrought in the stone as it passes through the cutter's and the polisher's hands is the result of a tedious, difficult, and dirty process. It is remarkable that the purest diamond, though perfectly colourless, when reduced to powder, is always of a black or black-gray colour. In all the operations through which a diamond passes the utmost skill and judgment are required, every detail, even from the preparation of the tools to the finishing whirl of the polishing wheel, demanding a thorough acquaintance with the nature of the stone. As scarcely two stones are alike in shape, it necessarily follows that a different treatment, more or less varied according to circumstances, is required in polishing each stone. Thus, the excellence of workmanship depends entirely upon the good judgment and skill of the polisher. It is in some cases years before a man can be entrusted with valuable stones, and the difficulties which an apprentice experiences in learning his trade are so many that it is not surprising that, unlike other mechanical pursuits, the supply of labour is scarcely ever above that of the demand. The slightest error on the part of the operator may utterly destroy the value of a stone, hence men of known experience and skill are always

in request. The wages of a diamond polisher are far above those of any other mechanical pursuit, ordinary polishers and cutters earning when in full work from 8*l.* to 10*l.* a week. But as each workman is paid per carat and not a weekly wage (except the apprentices or lads), a man's income generally depends upon his industry and energy.

The art of diamond cutting was almost a secret, or very little understood till the year 1476, when one Berghem, a resident of Bruges, introduced the practice of using diamond powder for forming and polishing the facets. Holland for many years enjoyed the entire monopoly of the trade, and to this day Amsterdam is the great centre of the industry. And although this monopoly has for some years been broken by the establishment in London and elsewhere of workshops, yet Holland still continues to supply both the workmen and their tools. The latter are somewhat roughly made, and might be largely improved upon, although there can be no question of their adaptability to the work. It is owing no doubt to the small demand in England for the machinery and implements for this special industry which has caused the total neglect in their manufacture by English mechanics. At present the demand would certainly not pay for their manufacture, but the attention of practical men might well be turned to the improvement of the appliances used by diamond cutters and polishers. While Holland and the Dutch have kept the trade in their own hands, it is the Dutch Jews that Holland has to thank

for this exclusive industry. The trade is almost entirely in the hands of this industrious people. It is owing to their characteristic energy and perseverance that the trade has so largely developed. To be a good workman one must be steady, doggedly persevering, temperate, industrious, and painstaking, and these qualifications are generally found among the descendants of the ancient race. They are therefore well adapted by nature for the tedious process of diamond polishing, and they have contrived to keep it in their hands for centuries. Hatton Garden appears to be not only the centre of the London trade, but also the mart for the sale and purchase of the finished gems.

The first process is what is called "cutting" the stone — albeit this cutting is really rubbing. When in its rough state, the stone presents a rugged appearance, shapeless, and full of sharp angularities. It is the cutter's work to reduce the indefinable pebble to something like shape and form, and thus render the work of polishing easier and more expeditious. Should the diamond possess flaws—that is, spots which militate against its commercial value—recourse is had to cleaving, in which operation these flaws are removed without decreasing to any considerable extent the size or value of the stone. Cleaving is effected by means of a small knife tapped lightly with a hammer. To successfully cleave a diamond the utmost care is necessary, and the cleaver must be thoroughly acquainted with the fibre of the stone. To an outsider there is no such thing as a fibre to a diamond; to the cleaver there is, and unless the knife is placed in one certain position the whole stone is likely to be spoilt. The diamond is, by means of a certain kind of cement, which rapidly hardens when cooling, fixed to the end of a stick termed the "snyder's" or cutter's stock (Fig. 1). This stock is fastened in a sort of vice, and the cleaver, placing his knife on the edge containing the flaw, gives it a gentle tap with a hammer, and the piece is at once divided in a similar way to the

cleaving of slate. But it is only when a stone contains these flaws that cleaving is resorted to, so that practically the first operation is that of cutting. This is effected by placing two stones to be cut each in a snyder's stock, as before described, with the rough edges of the stone to be cut so fixed that the edge of the one may easily be rubbed against the edge of the other. This is a very laborious and tiring work, and the cutter is compelled to wear thick leather gloves. Even this precaution does not prevent the rapid growth of corns on the hands and fingers. The rubbing is done over a small brass box A (Fig. 2), which has a double bottom, the one above being pierced with numberless minute holes, through which the powder as deposited from the rubbing falls into the lower box. This powder is carefully preserved, and, mixed with the finest Lucca oil in the proportion of 30 drops of oil to the carat of powder, is afterwards used to polish the stones. In order to facilitate the work, the cutter rests the two stocks against two pins B, which act as a sort of fulcrum. When all the rugged irregularities of form have been removed by the cutter, the stone is handed to another workman, who proceeds to fix it by means of molten lead in an instrument called the "dop," which is in form similar to the acorn. To the cup is attached a length of thick but remarkably pliable copper wire, specially prepared in Holland for this purpose (Fig. 3). The cup being filled with lead, the diamond is inserted at the apex of the little mound of lead in the position required by the polisher. The height and size of the mould depends upon the nature of the stone, some requiring a high and well-defined apex, others almost a globe. The dop is handed to the polisher, who proceeds to place it in the tongue (Fig. 4). The wheel upon which the stones are polished or ground is the ordinary lapidary's wheel, but much more care is required in its preparation. There is a class of workmen who do nothing else but prepare the wheels for the polisher.

A large variety of stones are required to reduce the surface of the wheel to the requisite fineness, and all these stones are imported, as well as every-

rapidly. The tongue is fixed by means of two iron uprights in its proper position, and the surface of the diamond to be polished is kept pressing against

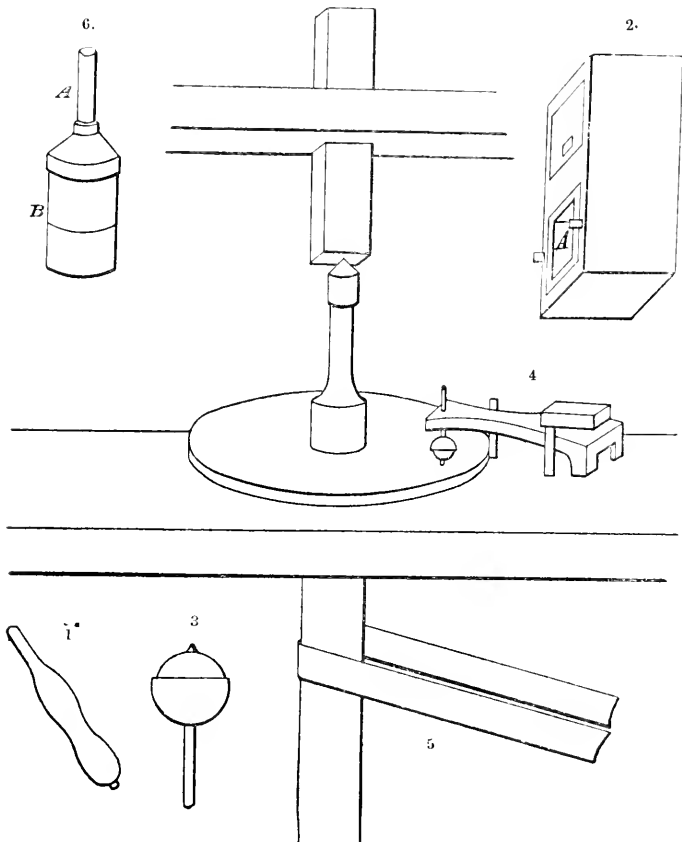

Diamond cutting.

thing else connected with the trade, from Holland. In fixing the wheels, the most perfect balance is required, as the slightest vibration may destroy a diamond. The wheel is turned very

the rotary wheel by means of a leaden weight placed on the broad surface of the tongue (Fig. 4). Before setting the stone on the wheel, the polisher applies to the diamond a small drop of the

powder and oil well mixed. The dust procured by the cutting is never sufficient for the polisher's use; consequently stones of a very inferior quality, and of no commercial value as gems, are first ground to powder in the "meteer" or grinder (Fig. 6). This consists of a metal mortar A and a ramrod-like pestle B, which, when worked up and down in the same way as a churn, gradually reduces the stones to powder. The powder is thoroughly incorporated with the oil, and presents a thick black sticky appearance. But the powder, owing to its heavy weight, sinks rapidly, and it is only by constant stirring that the mixture is kept ready for use. The dop is so placed on the wheel that the part to be polished comes directly in contact with its surface. The revolving wheel gradually—very gradually indeed—wears away the surface in contact with it, and the polisher must use his judgment as to the size and form of the facet he wishes to produce, which, of course, depends upon the size of the stone. In all, the stone has to be polished on 62 surfaces—that is, there are on the largest as well as on the smallest diamond 62 facets. The facets are known as the table or top, the outlet or bottom, hooks or corners, sides, ends, end facets, and verstelletje or stars. The wheel, or, as it is termed in Dutch, the "skyf," has to be continually repolished and ground, for although the wheel grinds the diamond, the diamond *en réchauffe* grinds the stone, consequently in time the surface of the plate is reduced to uneven rings. As a rule, a polisher has four stones in hand at once, and great care is taken in keeping the stones perfectly cool. The period of completion varies with the size of the diamond, some large stones taking weeks to polish. But the same care must be taken with small as with large stones. As no two stones are precisely of the same dimensions, it follows that the sizes of the facets also vary. It will be seen what care and judgment is required in polishing each surface to its requisite shape, size, and angle. The utmost care and skill are

also required in placing the dop to its exact angle, so that the skyf produces the proper facet. In fact, in each branch of the trade every workman must be, and is, well up in his work. Thus the lads who fill in the dops with lead, handle with their naked fingers, with the utmost *sang froid*, the hot liquid while even in a molten condition. The dust produced by the action of the wheel closely resembles soot—in fact, it is nothing but carbon. When the stone leaves the polisher's hands it is a bright, glowing, sparkling gem, and only requires setting in the article it is intended for.

LABELS.

Bottle Labels.—(1) Ordinary glazed paper, preferably of a citron-yellow colour, is wiped over with a damp sponge, and then again allowed to dry. The ink used for writing the labels is prepared from 3 parts extract of logwood and 1 of bichromate of potassium, dissolved in 30 of water. After standing until it has become clear, the liquid is decanted from the sediment, and 2 parts gum arabic are then added. When the writing has become dry, the label is affixed to the receptacle by means of a glue-paste, prepared by pouring a boiling solution of carpenters' glue into a cold prepared paste made from wheat-flour and water. When the label has become dry, it is brushed over twice with the same glue-paste, the second application being delayed until the first is dry. Finally the label is varnished over with damar varnish containing 10 per cent. of Canada balsam. (R. Triest.)

(2) Affix a common paper label and let it dry; then heat the label (by a Bunsen burner of very small flame) till it will just melt paraffin rubbed on it. The label is absolutely protected, and looks as if it were enamelled on the glass. If the neck and lip of the bottle and the stopper are similarly treated, a perfect airtight joint is secured and the stopper never sets, while liquids can be

poured out without running down the sides.

(3) Brush the paper labels with thin size, and afterwards with the ordinary photographers' spirit varnish, or with common white hard varnish, applied before the fire. Or you can paint the name direct on the glass with Bate's black (a superior kind of Brunswick black), sold by the photo. dealers. A simple waterproof cement for labels is made by stirring linseed-oil into hot glue, 1 part oil to 3 or 4 of glue, which should, of course, be previously soaked and dissolved in water to about the consistency used by carpenters.

(4) Paper labels, attached in the usual manner, and, when dry, varnished over with 2 or 3 coats of good copal varnish, will be found to resist almost all chemicals except liquor potassæ and liquor sodæ.

(5) Glass Labels.—When, as will sometimes occur in sudden change of weather, or from age, glass bottle-labels drop off, leaving the resinous layer, together with the lettering, adherent to the bottle, they may again be fastened by painting the glass and label with concentrated solution of white shellac, and holding the glass in place for a few days by means of an elastic band.

(6) Removal of Encaustic Letters.—The signatures, letters, numbers, &c., upon porcelain vessels may be removed without injury to the glazing, by protracted polishing with a piece of pumice moistened with concentrated hydrochloric acid. The removal is facilitated by previously exposing the signatures to the vapours of hydrochloric acid.

(7) Label Varnish.—One of the best label varnishes is the following:—

Sandarac (in coarse powder)	100 parts.
Mastic	40 "
Copaiba	15 "
Venice turpentine	30 "
Oil of turpentine	40 "
Alcohol	90 "
Absolute alcohol	90 "

Macerate until solution is effected.

(8) Writing on Glass with Common

or Indian Inks. — Warm the glass to 120–140° F., until vapour is no longer deposited. Then bathe the surface with the following varnish, moving the plate as when applying collodion in photographic work. The varnish consists of 80 grams 95 per cent. alcohol, 5 grams mastic in sheets, and 8 grams damar. The solution is made in a firmly-corked bottle on the water-bath, and then filtered. This varnish is very hard, brilliant, and transparent. Drawings in common or Indian ink can be made on this surface; after completion, a thin layer of gum is added. This method can be used for marking bottles, designs for projecting on a screen, or for photographic purposes.

(9) A liquid for etching on glass has recently been introduced into commerce, and can be used with an ordinary pen. It consists of hydrofluoric acid, ammonium fluoride, and oxalic acid, and is thickened with barium sulphate. A better ink is obtained as follows: Equal parts of the double hydrogen ammonium fluoride and dried precipitated barium sulphate are ground together in a porcelain mortar. The mixture is then treated in a platinum, lead, or gutta-percha dish with fuming hydrofluoric acid, until the latter ceases to react. (*Diagn. Polyt.*)

Plant Labels.—(1) In transplanting spring shoots, as well as in sowing seeds, the gardener often feels the need of a convenient label, that will withstand the rain and not get soiled with the mud. A writer in the German *Diamond* recommends the use of glass tubes, in which the paper labels can be slipped, and the tube corked or sealed. The tubes should be 8 in. long, and have an interior diameter of $\frac{1}{2}$ in., and be made of quite thick glass. For house plants and conservatories, elegant labels can be made from wider and shorter tubes, open at both ends, one being closed with a cork, from which the label is suspended by a thread or wire passed through the cork, the other end being used to hang the tube on a branch of the tree or shrub.

(2) To Fasten Labels on Metal.—

The following composition is recommended:—

Mucilage of tragacanth	10 parts.
Honey	10 "
Flour	1 "

(3) Attaching Labels to Tin, Zinc, or Glass.—Water-glass (solution of silicate of soda) is recommended as a very good adhesive for this purpose, particularly if the articles are subsequently liable to be exposed to heat. Metallic surfaces should first be rubbed with emery paper before applying the paste; the label is then pressed on with the hand. (*Drog. Zeit.*)

(4) Writing on Metals.—Take 1 lb. nitric acid and 1 oz. muriatic acid. Mix and shake well together, and it is ready for use. Cover the plate you wish to mark with melted beeswax; when cold, write your inscription plainly in the wax clear to the metal with a sharp instrument. Then apply the mixed acids with a feather, carefully filling each letter. Let it remain 1–10 hours, according to the appearance desired, throw on water, which stops the process, and remove the wax.

LABORATORY APPARATUS.

Liebig Condenser.—This condenser (Fig. 7) is much more compact, and is equally as effective as the ordinary form. Much valuable space is saved, which the chemist may use to better advantage. *a* is a tube about $2\frac{3}{4}$ in. diameter, and 20–24 in. long. *b* is a tube $1\frac{3}{4}$ in. diameter, closed at the upper end. This tube is fitted to the large tube by a thick heavy cork soaked in melted paraffin. The tube *c*, which reaches nearly to the bottom of the condenser, serves as an inlet for cold water, and *f* the outlet for the heated water. The tube *c*, connected with the flask *g*, carries the hot vapours to the condenser, where they are condensed and delivered by the tube *d* to any suitable receiver. The tube *e*, which is connected with a cork to the condenser,

should pass up 2–3 in. beyond the cork to prevent the condensed vapours from passing back into the retort flask.

If properly constructed this condenser is very effective. Very little trouble will be experienced by the vapours condensing in *c*, and running back; so

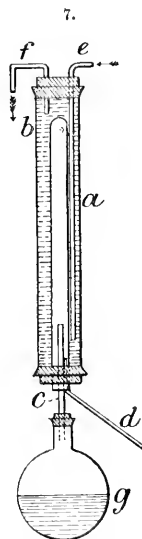

Liebig condenser.

little surface is exposed to the cold atmosphere and cork connection. The vapours condensing in *b* run down the walls of the tube, and are completely delivered by the smaller tube *d*.

This condenser is admirably adapted for the distillation of nearly all liquids of low boiling points, which do not form explosive vapours, to come in contact with the flame under the flask *g*. However, highly volatile liquids like the ethers may be safely distilled by screening the receiver from the heat of the flame, and by connecting with the receiver a safety tube delivering the vapours escaping out of a window, or through a partition into an adjoining room.

I usually employ as a safety connection, in the distillation of highly volatile and combustible liquids, a tube connected with the receiver, the extreme end of which dips under mercury, covered with a layer, 1 in. deep, of oil of a suitable character. This arrangement I have found perfectly safe; any escaping vapours are absorbed by the oil. (Chas. B. Gibson.)

Safety Valve for Extraction Apparatus (Fig. 8).—Used very successfully

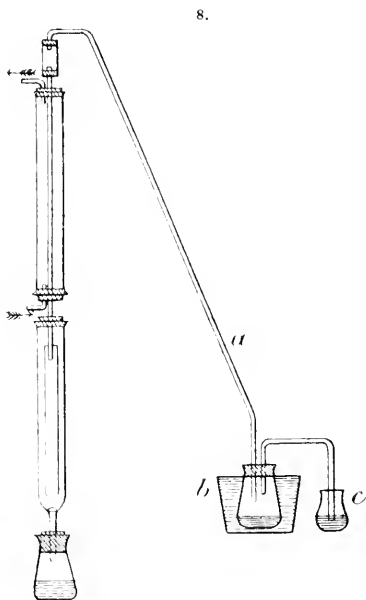

Safety valve for extraction apparatus.

when it is desirable to run the extraction for some hours, at the same time the attention being devoted to other work. The tube *a* is connected with the Liebig as shown, and with the flask *b*, which is loaded with mercury, and immersed in a vessel of cold water. Another tube passes from *b* into *c*, which is partly filled with mercury

and oil. This apparatus is perfectly safe, as any vapours of the ether or benzine, which may not become condensed in the Liebig and flask *b*, will surely be absorbed by the oil in *c*. I have run this apparatus continuously for 24 hours, and have scarcely been able to detect even the smell of ether at *c*. I have no fear of accidents, even with high heat from a Bunsen burner, when these precautions are taken. (Chas. B. Gibson.)

Wire Apparatus for Laboratory Use,—Before the year 1351 everything known as wire was hammered out by hand, but at that date or thereabout the art of wire drawing was invented. Since then the art has been developed and expanded, so that at the present time wire drawing is a leading industry, and we have wire of every size and shape made from all the ductile metals, and used in an infinite number of ways.

It is not my purpose to enter into an extended treatise on wire, but simply bring to the notice of the reader several new as well as some well known forms of laboratory appliances made of wire; and while I am conscious that this subject is by no means exhausted, I believe that the few examples of wire apparatus for the laboratory given in Figs. 9, 10, will not only be found useful, but will prove suggestive of other things equally as good. I have found wire invaluable for these and kindred purposes, and have often made pieces of apparatus in the time that would be required to order or send for them, thus saving a great deal of time, to say nothing of expense, which is no inconsiderable item in matters of this sort.

It is perhaps unnecessary to describe fully in detail each article represented, as an explanation of the manipulations required in forming a single piece will apply to many of the others.

For most of the apparatus shown, some unoxidisable wire should be selected, such as brass or tinned iron, and the tools for forming these articles of wire consist of a pair of cutting pliers, a pair of flat and a pair of round-nosed pliers, a

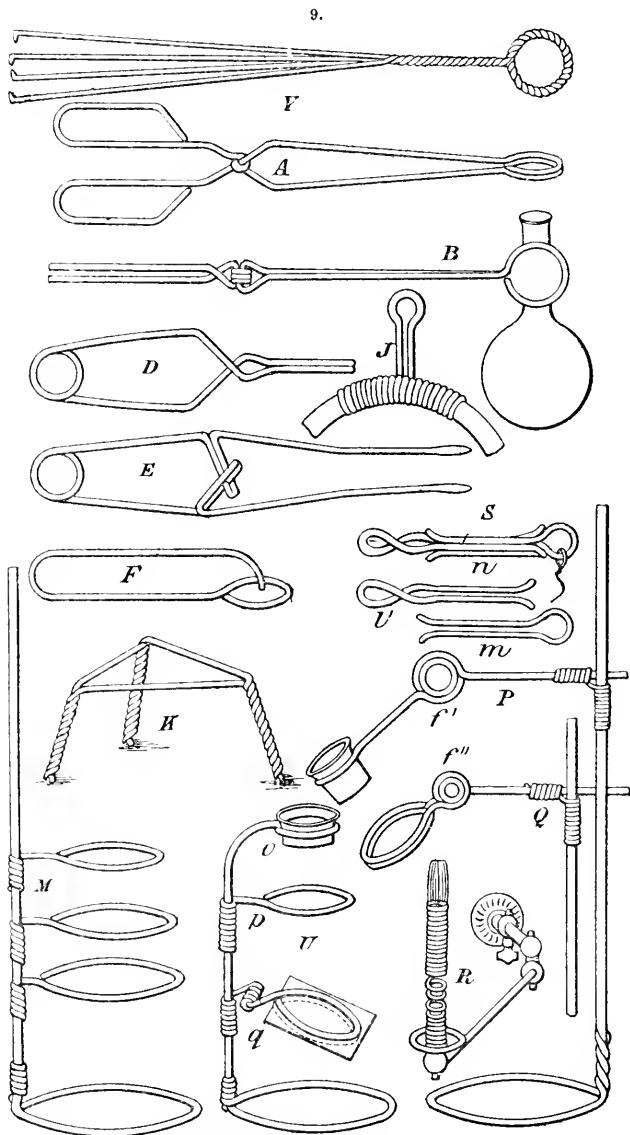

Wire apparatus for laboratory use.

few cylindrical mandrels of wood or metal, made in different sizes, and a small bench vice. Any or all of the articles may be made in different sizes, and of different sizes of wire for different purposes.

A shows a pair of hinged tongs, which are useful for handling coals about the furnace, for holding a coal or piece of pumice for blowpipe work, and for holding large test tubes and flasks, when provided with two notched corks, as shown in B and O. These tongs are made by first winding the wire of one half around the wire of the other half to form the joint, then bending each part at right angles, forming on one end of each half a handle, and upon the other end a ring. By changing the form of the ring end the tongs are adapted to handling crucibles and cupels and other things in a muffle.

C shows a pair of spring tongs, the construction of which will be fully understood without explanation. It may be said, however, that the circular spring at the handle end is formed by wrapping the wire around any round object held in the vice; the rings at the opposite end are formed in the same way. The best way to form good curves in the wires is to bend them around some suitable mandrel or form.

D shows a spring clamp for holding work to be soldered or cemented. It may also be used as a pinch cock.

E represents a pair of tweezers, which should be made of good spring wire flattened at the ends. F is a clamp for mounting microscope slides, and for holding small objects to be cemented or soldered. G is a pinch cock for rubber tubing; its normal position is closed, as in the engraving, but the end *a* is capable of engaging the loop *b*, so as to hold the pinch cock open. H shows a clamp or pinch cock having a wire *c* hooked into an eye in one side, and extending through an eye formed in the other side. This wire is bent at right angles at its outer end to engage a spiral *d*, placed on it and acting as a screw. The open spiral is readily formed by wrapping two wires

parallel to each other on the same mandrel, and then unscrewing one from the other. The handle will of course be formed by aid of pliers. I shows still another form of pinch cock. It is provided with two thumb pieces, which are pressed when it is desired to open the jaws. K is a tripod stand, formed by twisting 3 wires together. This stand is used for supporting various articles, such as a sand bath or evaporating dish, over a gas flame. It is also useful in supporting charcoal in blowpipe work.

L shows a stand adjustable as to height for supporting the beak of a retort, or for holding glass conducting or condensing tubes in an inclined position. The retort or filter stand, represented in M, is shown clearly enough to require no explanation. Should the friction of the spiral on the standard ever become so slight as to permit the rings to slip down, the spirals may be bent laterally, so as to spring tightly against the standard. N shows an adjustable test tube holder, adapted to the standard shown in M, and capable of being turned on a peculiar joint, so as to place the tube in any desired angle. The holder consists of a pair of spring tongs, having eyes for receiving the notched cork, as shown in O. One arm of the tongs is corrugated to retain the clamping ring in any position along the length of the tongs. The construction of the joint by which the tongs are supported from the slide on the standard is clearly shown in O*a*. It consists of two spirals *y* *h*, the spiral *h* being made larger than the spiral *y*, and screwed over it, as shown in O. This holder is very light, strong, and convenient.

P represents a holder for a magnifier, which has a joint, *f*¹, similar to the one just described. The slide *k* is formed of a spiral bent at right angles and offset to admit of the two straight wires passing each other. This holder may be used to advantage by engravers and draughtsmen. Q shows a holder for a microscope condenser, the difference between this and P being that the ring

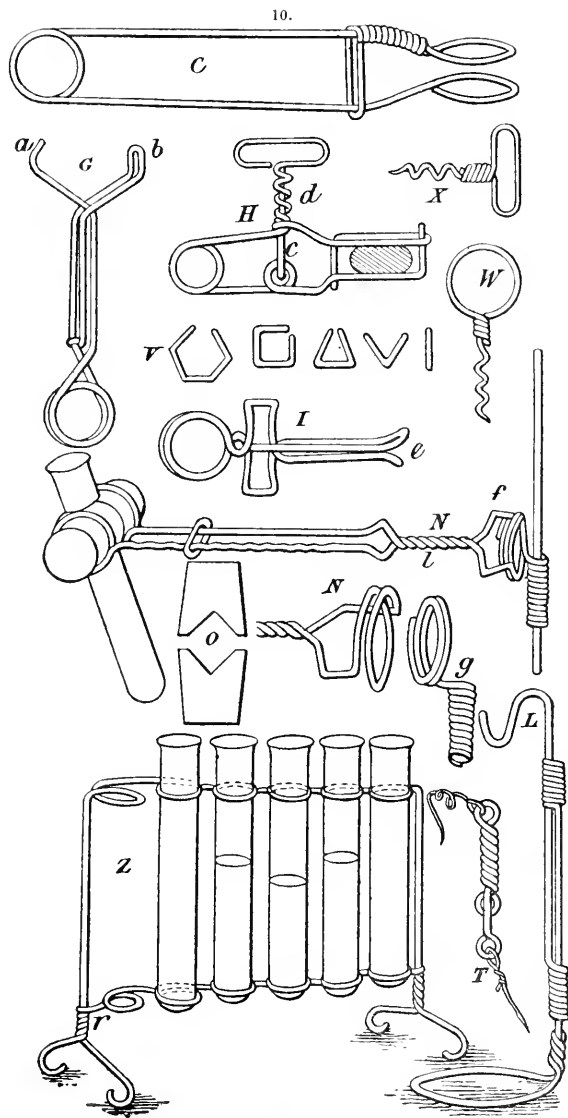

Wire apparatus for laboratory use.

is made double to receive an unmounted lens.

K shows a Bunsen burner, formed of a common burner, having a surrounding tube made of wire wound in a spiral, and drawn apart near the top of the burner to admit the air, which mingles with the gas before it is consumed at the upper end of the spiral.

S represents a connector for electrical wires, which explains itself. The part with a double loop may be attached to a fixed object by means of a screw. Another electrical connector is shown in T, one part of which consists of a spiral having an eye formed at each end for receiving the screws which fasten it to its support, the other part is simply a straight wire having an eye at one end. The connection is made by inserting the straight end in the spiral. To increase the friction of the two parts, either of them may be curved more or less.

A microscope stand is shown in U. The magnifier is supported in the ring *o*. The ring *p* supports the slide, and the double ring *q* receives a piece of looking glass or polished metal, which serves as a reflector.

V shows a set of aluminium grain weights in common use. The straight wire is a 1 gr. weight, the one with a single bend is a 2 gr. weight, the one having two bends and forming a triangle is a 3 gr. weight, and so on. W and X are articles now literally turned out by the million. It is a great convenience to have one of these inexpensive little corkscrews in every cork that is drawn occasionally, thus saving the trouble of frequently inserting and removing the corkscrew. The cork puller shown in Y is old and well known, but none the less useful for removing corks that have been pushed into the bottle, and for holding a cloth

or sponge for cleaning tubes, flasks, &c.

Z shows a stand for test tubes. The wire is formed into series of loops, and twisted together at *r* to form legs. A very useful support for flexible tubes is shown in J. It consists of a wire

11.

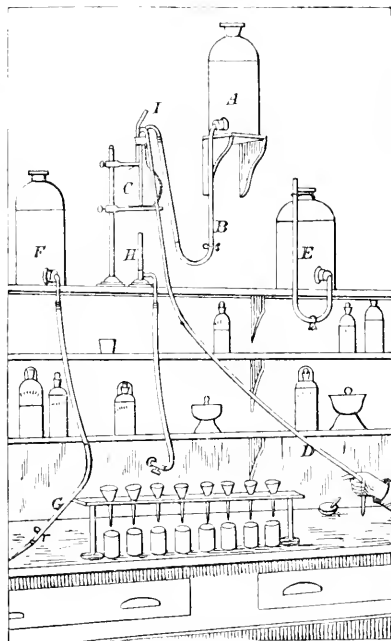

Wash-Bottle.

formed into a loop, and having its ends bent in opposite directions to form spirals. A rubber tube supported by this device cannot bend so short as to injure it. Most of the articles described above may be made to the best advantage from tinned wire, as it possesses sufficient stiffness to spring well, and at the same time is not so stiff as to prevent it from being bent into almost any desired form. Besides this the tin coating protects the wire

from corrosion and gives it a good appearance. (Geo. M. Hopkins.)

Wash-bottle.—By this simple device (Fig. 11) the washing of precipitates and the cleansing of vessels used in the process of analysis, which before required the use of the ordinary wash-bottle, can now be done with much more facility and in a shorter time. It consists essentially of a thin glass flask C, placed about 3 ft. above the level of the working desk, and closed by a 3 hole rubber stopper. Through one of the holes issues a rubber tube D (or glass with rubber connections), descending to the desk and ending in a glass nozzle.

A Bunsen burner H is placed underneath the flask, and the water can be heated when it is so desired. Hot water as well as cold can thus be used in treating precipitates. Other solutions can be employed equally as well as water. (See bottle F.)

The advantages of this system are:

1. The saving of much time and consequent labour attending the use of an ordinary wash-bottle, especially where several analyses are carried on at the same time, the exertions required by the mouth and lungs being thereby avoided.
2. No air exists in the tube, as in an ordinary wash-bottle, and con-

12.

13.

14.

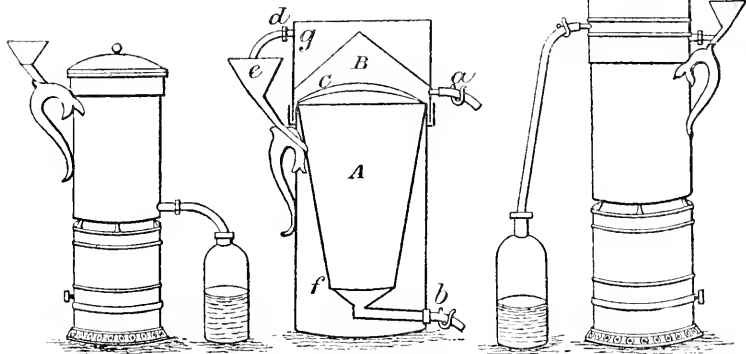

Combined water-bath, percolator, and still.

Connection is made by a second hole in the stopper with a reservoir bottle A, placed above the top of the wash-bottle. In the third hole is placed a glass tube bent at an angle to keep out dust. On filling the flask from the reservoir—the flow being stopped by a pinch cock—the water is started by suction from below, and the stream through the nozzle can be regulated or stopped at will by a pinch cock placed conveniently to the hand, the height of the water flask furnishing the pressure, which is sustained by the siphon.

sequently the full force of the liquid is utilised immediately.

3. When used with a wash solution of ammonia water, no trouble is experienced with free ammonia, which ordinarily is quite hurtful to the mouth and eyes.

The large bottle E with the accompanying tube shows a convenient arrangement for holding any solution and delivering the same. (H. B. Battle.)

Water-Bath, Percolator, and Still Combined.—Figs. 12, 14, show Fenner's combined apparatus which can be used

as a water-bath, a percolator, a still, and evaporator, for making tinctures, fluid extracts, solid extracts, infusions, syrups, &c., and for distilling, evaporating, &c.

CEMENTS AND LUTES.

(ii. 62-111.)

Acid-proof.—(9) See (1). This cement is not at all attacked by hydrochloric, and but very little by nitric acid. When heated it softens but very little. It does not easily dry upon the surface. If this cement is mixed with $\frac{1}{2}$ of its weight of litharge, or minium, it dries up in the course of time, and becomes hard. This is known as "Benicke's Cement."

(10) A luting which will resist acid vapours and chlorine, even at a high temperature, and is thus applicable to chlorine and hydrochloric apparatus, may be prepared by mixing three parts by weight of fine dry clay with one part by weight of the residue left from the distillation of glycerine. This mixture does not lose its plastic properties even at a high temperature, but is not suited for use where it might be exposed to atmospheric changes, since the glycerine which it contains absorbs moisture. Hence it should be prepared immediately before use.

Bottle.—(12) The balsam of Tolu, which has been used for preparing the syrup, has hitherto been utilised only in making a varnish for pills, and it therefore accumulates in course of time to a considerable extent. A composition useful as bottling wax may be prepared by stirring into the melted balsam one-tenth its weight of levigated bole. It sets quickly, with a fine glossy surface, and is less brittle than the wax generally employed. A mixture of residual balsam, amber resin, of each four parts; Venice turpentine, vermilion, of each 1 part; melted together and well stirred, forms sealing-wax of very fair quality.

Cap.—(10) *Soulan's*. Make the following solution:—Purified resin, 7 dr.; ether, 10 dr.; collodion, 15 dr.

Sufficient aniline red. Dissolve the resin in the ether, mix it with the collodion, and colour to taste. All that is necessary to apply the mixture is to dip the cork and the top of the bottle in it, turning it for an instant in the hand while the composition dries. The result is a semi-transparent varnish of pleasing appearance, especially if the cork of the bottle is previously sealed on top with sealing-wax.

Casein.—(7) By heating milk with a little tartaric acid, the casein is coagulated. This casein is then treated with a solution containing six parts of borax to one hundred parts of water and warmed. It speedily dissolves and forms a very tenacious, durable, and inexpensive adhesive medium.

Cutlers'.—(9) 16 oz. rosin, 8 oz. sulphur; melt, and when cool reduce to powder. Mix with this some fine sand or brick dust, and use as stated. (10) Take a portion of a quill, put it into the handle, warm the tang, and insert it into the quill in the handle and press it firmly. This is a simple method, and answers the purpose required very well.

Glass.—(10) Best isinglass, 1 oz., strong acetic acid, 3 oz.; put in a glass bottle, and dissolve by standing in hot water. Will join glass, china, &c., &c. Make the edges of the pieces to be joined hot, and apply the fluid cement. When cold this cement is solid; it must be made hot for use. (11) Equal parts of wheat-flour, finely-powdered glass, and chalk; add half as much brickdust, scraped lint, and white of eggs; mix to a proper consistency with water. This will resist heat. (12) To $\frac{1}{2}$ -pint of milk put a sufficient quantity of vinegar to curdle it, separate the curd from the whey, and mix the whey with the whites of four eggs, shaking the whole well together. When mixed, add a little quicklime, through a sieve, until it acquires the consistency of a paste. This cement dries quickly, and resists the action of fire and water.

Glass to metals.—(11) One of the best cements for uniting glass to other substances is prepared by putting

the very best and purest gum arabic into a small quantity of water, and leaving it till next day, when it should be of the consistence of treacle. Calomel (mercurous chloride or sub-chloride of mercury) is then added in a suitable quantity, enough to make a sticky mass, being well mixed on a glass plate with a spatula. No more is to be made than that required for immediate use. The cement hardens in a few hours, but it is wiser to leave it to itself for a day or two. To ensure success it is necessary to use only the best gum; inferior sorts are absolutely useless. (12) Wiederhold recommends a fusible metal, composed of 4 parts lead, 2 parts tin, and $2\frac{1}{2}$ parts bismuth, which melts at 212° Fahr. The melted metal is poured into the capsule, the glass pressed into it, and then allowed to cool slowly in a warm place. (13) Cailletet describes a process of soldering glass and porcelain to metal. The glass tube to be soldered is first covered with a thin coating of platinum or silver, by treating it with a film of platinum chloride or silver nitrate, and heating to dull red. A ring of copper is next electro-deposited on the platinised tube, which can then be soldered like any ordinary metallic tube. Solderings effected in this manner are said to be very strong. The top of a tube attached to Cailletet's apparatus for liquefying gases terminates in a soldered end and successfully resists pressure over 300 atmospheres.

Glue.—*Dry.* (a) Dry pocket glue is made from 12 parts of glue and 5 parts of sugar. The glue is boiled until entirely dissolved, the sugar is dissolved in the hot glue, and the mass is evaporated until it hardens on cooling. The hard substance dissolves rapidly in lukewarm water, and is an excellent glue for use on paper. (b) Take $\frac{1}{4}$ lb. of very best Scotch glue, melt it in a clean glue pot. When quite dissolved, pour off the clear part into another glue pot, add $\frac{1}{2}$ pint boiling water, well mix. Then add 2 oz. best moist sugar; well mix the whole together, at the same time keeping it quite hot. It may then be cast into moulds, or poured gently on a marble,

or stone, or slab. When nearly set, cut into strips for use. It is ready for use by moistening the strips with the tongue. It should be kept in boxes with a little powdered sugar or starch. This glue will be found both cheap and effective. It is much stronger than paste or gum.

Hot-water pipe joints.—(1)

The best packing for cast-iron socket hot-water pipes is yarn and white and red lead (best white hemp yarn preferred), used in the following manner:—First caulk home about one round of yarn, then put in a ring of red and white lead about $\frac{3}{4}$ -in. diameter, then caulk home another round of yarn, and continue this alternately until the socket is filled up to about $\frac{1}{4}$ in., then finish off with wet iron borings, with a small quantity of sal-ammoniac in it (1 oz. to $\frac{1}{4}$ cwt. is sufficient); let the yarn be in one continuous length from the commencement to finish. Some use all borings and sal-ammoniac, but this is not safe, as the rusting of the borings expands so much that it often bursts the sockets of pipes. (2) 2 parts of ordinary well-dried powdered loam and 1 part of borax are kneaded with the requisite quantity of water to a smooth dough, which must be at once applied to the joints. After exposure to heat, this cement adheres even to smooth surfaces so firmly that it can only be removed with a chisel. (3) Mix 430 parts in weight of white lead, 520 of powdered slate, 5 of chopped hemp, and 45 of linseed oil. The two powders, and the hemp cut into lengths of $\frac{1}{4}$ - $\frac{5}{16}$ in. are mixed, and the linseed oil is gradually added; the mass is kneaded till it has assumed a uniform consistency. This cement is said to keep better than the ordinary red lead cement.

Iron.—(18) A permanent and durable joint can, it is said, be made between rough, cast-iron surfaces by the use of asbestos with sufficient mixed white lead to make a very stiff putty. This will resist any amount of heat, and is unaffected by steam or water. It has been used for mending or closing cracks in cast-iron retorts that were used for the

distillation of oil and gas from cannel coal. The heat being applied to the bottom of retorts and the temperature of iron maintained at a bright red heat, after a time the bottom of the retort would crack, the larger portion of the crack being downward towards the fire. The method employed was to prepare the mixture, and place on top a brick, then place the brick on a bar of iron or shovel and press the cement upward to fill the crack in the iron, holding it for some time until it had penetrated the cavity, and somewhat set. Of course, during this operation, the cap was removed from the retort, so that no pressure of gas or oil forced the cement outward until set. (19) Stir into 1 part of sweet oil and 1 part of molasses, 1 part each of barytes, Venetian red, litharge, and red lead, and $1\frac{1}{2}$ part each of plumbago, Paris white, and yellow ochre. It takes several hours to prepare, but will remain plastic for years.

Labels.—(22) Lehner publishes the following formula for making a liquid paste or glue from starch and acid:—Place 5 lbs. of potato starch in 6 lbs. (3 quarts) of water, and add $\frac{1}{4}$ lb. of pure nitric acid. Keep it in a warm place, stirring frequently for 48 hours. Then boil the mixture until it forms a thick and translucent substance. Dilute with water, if necessary, and filter through a thick cloth. At the same time another paste is made from sugar and gum-arabic. Dissolve 5 lb. gum-arabic and 1 lb. sugar in 5 lb. of water, and add 1 oz. of nitric acid and heat to boiling. Then mix the above with the starch paste. The resultant paste is liquid, does not mould, and dries on paper with a gloss. It is useful for labels, wrappers, and fine bookbinders' use. (23) Paper pasted, gummied, or glued on metal, especially if it has a bright surface, usually comes off on the slightest provocation, leaving the adhesive material on the back of the paper, with a surface bright and slippery as ice. The cheaper description of clock dials are printed on paper and then stuck on zinc; but for years the difficulty was to get the paper and the

metal to adhere. It is, however, said to be now overcome by dipping the metal into a strong and hot solution of washing soda, afterwards rubbing perfectly dry with a clean rag. Onion juice is then applied to the surface of the metal, and the label pasted and fixed in the ordinary way. It is said to be almost impossible to separate paper and metal thus joined. (24) Dissolve 1 oz. gum tragacanth and 4 oz. gum-arabic in 1 pint water; strain, and add 14 grs. thymol suspended in 4 oz. glycerine; finally add water to make 2 pints. This makes a thin paste suitable for labelling bottles, wooden or tin boxes, or for any other purpose paste is ordinarily called for. It makes a good excipient for pill-masses, and does nicely for emulsions. The very small percentage of thymol present is not of any consequence. This paste will keep sweet indefinitely, the thymol preventing fermentation. It will separate on standing, but a single shake will mix it sufficiently for use. (25) 4 oz. rye flour, $\frac{1}{2}$ oz. powdered gum acacia. Rub to a smooth paste with 8 oz. of cold water, strain through a cheese cloth, and pour into 1 pint of boiling water. Continue the heat until thickened to suit. When nearly cold add:—

1 oz. glycerine, 20 drops oil cloves. This is suitable for tin or wooden boxes or bottles, and keeps sweet for a long time. (26) 4 oz. rye flour, 1 pint water, 1 dr. nitric acid, 10 minims carbolic acid, 10 minims oil cloves, 1 oz. glycerine. Mix the flour with the water, strain through a cheese cloth, and add nitric acid. Apply heat until thickened to suit, and add other ingredients when cooling. This is suitable for bottles, tin or wooden boxes, and will not spoil. (27) 8 parts dextrin, 2 parts acetic acid, 2 parts alcohol, 10 parts water. Mix dextrin, water, and acetic acid to a smooth paste, then add the alcohol. This makes a thin paste, and is well suited for labelling bottles and wooden boxes but is not suitable for tin boxes.

Microscopical.—(2) According to Dr. L. Heydenreich of St. Petersburg,

the best cover-glass should be:—1st. Absolutely hermetic, and should not, under any circumstances, require renewal every year. Two or three coats of the cement, applied at short intervals after an object is mounted, should permanently secure and preserve the object. 2nd. It should be as hard as glass, or, if possible, harder. 3rd. It should not crack nor become detached, and should be so solidly adherent as to be less likely to break than the glass to which it is attached; and 4th. It should be insoluble in water or glycerine, or in any liquid used as an immersion medium with objectives. Notwithstanding the large number of cover-glass cements already known and in use, he thinks another should be sought for—one which shall conform to the foregoing requirements. We have commercial varnishes, which are very hard and durable. Some of them, used in the finishing of carriages, are found, after the lapse of a year, to be in the same condition as when first applied. The varnish used on tin pans in albumen factories remains unchanged for a year, although subjected daily, for many hours, to a temperature of 100° R. (257° Fahr.) These and similar varnishes are made of resins, copal, or amber. Of all resins, amber and some kinds of copal are the hardest. Copal varnish is both hard and elastic; amber varnish is harder than copal, but not so elastic, and is, consequently, more brittle; hence, for a cover-glass cement, a mixture composed of both should be used. Only the best and clearest kinds of amber (the opaque pieces contain various kinds of minerals), and only the hardest kind of copal—that is, the East-India or Zanzibar copal—should be selected for cover-glass cements. Zanzibar copal is taken from the earth in flat, disc-shaped pieces, varying in dimensions from the size of a pea to the size of the human hand; is colourless, yellow, or of a dark red-brown colour, and transparent; the surface, rough. Bombay copal comes in larger pieces, is of a yellowish-red colour, has, when broken, a smooth, glassy surface,

and is but very slightly inferior in quality to the copal of Zanzibar. Sierra-Leone copal comes in small, ball-shaped pieces, about 1 in. in diameter, or in pieces resembling drops in shape. All the other kinds are softer than those just described. The best solvent for resin, and the one which possesses the most adhesive quality, is linseed-oil varnish, made of pure, old linseed oil. Neither alcohol, ether, chloroform, nor any other quickly evaporating menstruum should be used. In order to hasten desiccation of the resin, and to obtain for the cement the proper consistency, an ethereal oil which, upon drying, will leave a surface perfectly even, should be added to the mixture; and oil of lavender, either alone or mixed with linseed-oil varnish, is suitable for these purposes. The resins being thus dissolved in linseed-oil varnish until the solution attains the consistency of syrup, oil of lavender should be added until the mixture becomes thin enough to use in mounting microscopical objects—and the cement is finished. The property of adhering to glass is increased in the cement by adding to it a small quantity of cinnabar; but such addition causes it to dry less rapidly. In a week from the time of using it the cement becomes dry, and so firm that the finger-nail will make but a slight impression on it. For months it remains in this condition. At the expiration of a year it is very hard, and has a glassy surface.

So much for the component parts. The preparation of this cement being somewhat difficult it would perhaps be advantageous to buy the varnishes ready made, and then proceed as follows:—taking equal parts of the best, clearest, and hardest amber-varnish and copal-varnish, mix them and heat until all the turpentine has disappeared. This will require a temperature of 100° to 150° R. (257°–370° Fahr.). As soon as all the turpentine has evaporated, remove the dish from the flame, allow it to cool somewhat, and then add oil of lavender to the liquid in proportion of

$\frac{1}{2}$ to 1; mix well, and allow the entire mass to cool thoroughly. The process is terminated by adding from 20 per cent. to 40 per cent. of artificial cinnabar (rosin with cinnabar), which should be very carefully and thoroughly rubbed in. The best method for rubbing in the cinnabar is that employed in the preparation of fine oil-paints. Should the cement when finished be too thick for use, as much oil of lavender as will give the required fluidity may be added. The component parts and their proportions would then be as follows:—

Amber	25	parts
Copal	25	"
Linseed-oil varnish ..	50	"
Oil of lavender	50-60	"
Artificial cinnabar ..	40-60	"

Dr. Heydenreich continues his article by describing the manner in which the cement should be applied, but as his method is the same as that employed in the use of Canada balsam and other cover-glass cements, and, consequently, familiar to all microscopists, it is not necessary to make a note of it. However he advises, in order to secure a perfect mount, that a second ring be made after the first or second week from the time of mounting; and a third, after the first or second month; each additional ring to be slightly wider than the preceding one.

Rubber to metal.—For cementing rubber or guttapercha to metal, Moritz Grossman, in his "Year Book" for 1883, gives the following receipt:—Pulverised shellac, dissolved in ten times its weight of pure ammonia. In three days the mixture will be of the required consistency. The ammonia penetrates the rubber and enables the shellac to take a firm hold, but as it all evaporates in time, the rubber is immovably fastened to the metal, and neither gas nor water will remove it.

Rubber and Guttapercha.—(a) In making a cement one should know pretty thoroughly what is to be expected of it before they could advise upon it. For instance, an ordinary rubber cement will hold on a host of different surfaces and with the best

of success, except where there is continued dampness. For holding to damp walls, or surfaces where there is a constant pressure of moisture there is nothing equal to Jeffrey's marine glue, the formula for which has been published and republished all over the world. It consists of—1 part rubber, 12 parts coal tar, and 2 parts asphaltum. The rubber, after having been massed, is dissolved in the undistilled coal tar, and the asphaltum is then added. This glue, as its name indicates, is oftentimes used for mending articles at sea, or patches, for instance, that are to be laid on surfaces that are to be under water, and it has been found to be a most excellent thing.

(b) Of glass cements there are a great many, rubber as a rule being dissolved in some very volatile solvent and some hard drying gum is added.

(c) A guttapercha cement for leather is obtained by mixing the following. It is used hot. Guttapercha, 100 parts; black pitch or asphaltum, 100 parts; oil of turpentine, 15 parts.

(d) An elastic guttapercha cement especially useful for attaching the soles of boots and shoes, as on account of its great elasticity it is not liable to break or crack when bent. To make it adhere tightly, the surface of the leather is slightly roughened. It is prepared by dissolving 10 parts guttapercha in 100 of benzine. The clear solution from this is then poured into another bottle containing 100 parts linseed oil varnish and well shaken together.

(e) Good rubber cement for sheet rubber, or for attaching rubber material of any description or shape to metal, may be made by softening and dissolving shellac in 10 times its weight of water of ammonia. A transparent mass is thus obtained, which, after keeping 3 or 4 weeks, becomes liquid, and may be used without requiring heat. When applied, it will be found to soften the rubber; but when the ammonia has evaporated, it forms a kind of hard coat, and causes it to become impervious to gases as well as liquids.

(f) Davy's universal cement is made by melting 4 parts common pitch with 4 of guttapercha in an iron vessel, and mixing well. It must be kept fluid, under water, or in a dry, hard state.

(g) A very adhesive cement, especially adapted for leather driving belts, is made by taking bisulphide of carbon 10 parts, oil of turpentine 1 part, and dissolving in this sufficient guttapercha to form a paste. The manner of using this cement is to remove any grease that may be present on the leather by placing on the leather a piece of rag and then rubbing it over with a hot iron. The rag thus absorbs the grease, and the two pieces are then roughened and the cement lightly spread on. The two pieces are then joined, and subjected till dry to a slight pressure.

(h) A solution of guttapercha for shoemakers is made by taking pieces of waste guttapercha, first prepared by soaking in boiling water till soft. It is then cut into small pieces, placed in a vessel, covered with coal tar oil, tightly corked to prevent evaporation, and allowed to stand for 24 hours. It is next melted by standing in hot water till perfectly fluid, and well stirred. Before using it must be warmed as before, by standing in hot water.

(i) A cement for uniting rubber is composed as follows: 100 parts finely chopped rubber, 15 of resin, 10 of shellac; these are dissolved in bisulphide of carbon.

(j) Another rubber cement is made of 15 gr. rubber, 2 oz. chloroform, 4 dr. mastic; first mix the rubber and chloroform together, and when dissolved the mastic is added in powder. It is then allowed to stand by for a week or two before using.

(k) Cement for sticking on leather patches and for attaching rubber soles to boots and shoes is prepared from virgin or native rubber, by cutting it into small pieces or shredding it up; a bottle is filled with this to about 1-10th of its capacity; benzine is then poured on till about $\frac{3}{4}$ full, but be certain that the benzine is free from

oil. It is then kept till thoroughly dissolved, and of a thick consistency. If it turns out too thick or thin, suitable quantities must be added of either material to make as required.

(l) An elastic cement is made by mixing together and allowing to dissolve the following: 4 oz. bisulphide of carbon, 1 oz. fine rubber, 2 dr. isinglass, $\frac{1}{2}$ oz. guttapercha. This cement is used for cementing leather and rubber, and when to be used the leather is roughened and a thin coat of the cement is applied. It is allowed to completely dry, when the two surfaces to be joined are warmed and then placed together and allowed to dry.

(m) Cement used for repairing holes in rubber boots and shoes is made of the following solution: (1) Caoutchouc 10 parts, chloroform 280 parts. This is simply prepared by allowing the caoutchouc to dissolve in the chloroform. (2) Caoutchouc 10 parts, resin 4 parts, gum turpentine 40 parts. For this solution the caoutchouc is shaved into small pieces and melted up with the resin, the turpentine is then added, and all is then dissolved in the oil of turpentine. The two solutions are then mixed together. To repair the shoe with this cement, first wash the hole over with it, then a piece of linen dipped in it is placed over it; as soon as the linen adheres to the sole, the cement is applied as thickly as required. (*Chem. Trade Jl.*)

Stone.—(3). The following metallic cement for repairing broken stone was, according to Professor Brune, of the School of Fine Arts, used in the restoration of the colonnade of the Louvre, of the Pont Neuf, and of the Conservatoire des Arts et Metiers. It consists of a powder and a liquid. The powder:—2 parts by weight of oxide of zinc, 2 of crushed grit, the whole intimately mixed and ground. Ochre in suitable proportions is added as a colouring matter. The liquid:—A saturated solution of zinc in commercial hydrochloric acid, to which is added a quantity by weight, of hydrochlorate of ammonia equal to one-sixth that of the dissolved zinc. This

liquid is diluted with two-thirds of its bulk of water. To use the cement, 1 lb. of the powder is to be mixed with $2\frac{1}{2}$ pints of the liquid. The cement hardens very quickly and is very strong.

COOLING. (iv. 53-87.)

Water.—Freezing Mixtures.—(30)
A liquid invented by Raoul Pictet, of Geneva, for use as a disinfectant, answers well as a freezing mixture for hardening microscopical specimens. Sulphur dioxide and carbon dioxide, having been mixed and cooled, are compressed until they are liquid, and stored in siphons. When liberated, they rapidly evaporate, with great reduction of temperature. By this means mercury may be frozen, and animal or vegetable tissues rendered solid in a few seconds. It is as easily managed and more effective than ether, the odour being the principal objection.

(31) According to Cailletet and Colardeau, flocculent carbonic acid is capable of cooling bodies down to -60° C. at the ordinary pressure of the atmosphere, and down to -76° C. in a vacuum. If the solid carbonic acid is mixed with ether, the temperatures are -77° C. and -103° C. If chloride of methyl is used instead of ether, there is obtained a temperature of -82° C. at the pressure of the atmosphere, and of -106° C. in a vacuum, which is equal to 190° below freezing, or 158° below zero on Fahrenheit's scale.

(32) The most commonly used mixture for obtaining, on a small scale, temperatures between -20° and -40° C. is that of snow and commercial hydrochloric acid. Since diluted sulphuric or nitric acid can be similarly used, it was thereby suggested that one might utilise for this purpose the mixture of equal volumes of strong nitric and sulphuric acid which had been employed in a Grove battery and for which there was little further use. When first made, the mixture of acids has a specific gravity of about 1.63, and when spent about 1.57.

Bachman undertook to ascertain in

what mixture this spent acid can be best employed for obtaining a freezing mixture. The temperature of the atmosphere in which the trials were made ranged from -2° to $+2^{\circ}$ C., and in each instance the acid was brought to the temperature of the air before mixing with the snow. Diluting the acid with differing amounts of water and mixing these with snow, it was found that the undiluted acid and that diluted with one-tenth of the volume of water gave equal diminution of temperature. Any large addition of water lessened the cooling effect. The following results were obtained:—

cc.	grammes	C.
100 acid and	225 snow	gave fall of 31°
100 "	" 285 "	" " " 32°
100 "	" 340 "	" " " 30°
100 HCl	" 200 "	" " " 30°

As there was so little difference in the result when the snow was used within so wide limits, it was found most satisfactory to mix the snow with the acid until it attains the consistency of a thin mush, thus dispensing with all weighing. It is to be noted, as is explained by the above, that when the snow is wet, the temperature to be obtained with it is almost as low as when it is dry, which is far from being the case when hydrochloric acid is used. It will also be seen from the above figures that when working at a temperature near zero, the "spent acids" answer as well as, if not better than hydrochloric acid; but when endeavouring to obtain lower temperatures than -30° C. by previously cooling the acid, it was found that better results were obtained with hydrochloric acid. When snow is not available, there is equal satisfaction in employing shaved ice for this purpose.

By Evaporation of liquids. (a) Pictet's.—Instead of using sulphurous acid, as in his previous machines, Pictet uses mixture of sulphurous acid and carbonic acid, which has received the name of "liquide pictet." The boiling point of this liquid under atmospheric pressure is at -19° C., and at a temperature of

+ 50° C. the pressure of the gas is only half that of pure sulphurous acid. The inventor has some theory, according to which there takes place an actual chemical combination of the molecules of the two gases when they are being liquefied under pressure; and it is due to this property that the work expended in compression is much smaller than in any other working agent. The "liquide pietet" is not inflammable, and can even be used for the extinction of fires. It has the further advantage of leaving a greasy dew upon the surfaces of the cylinder, piston rod, valves, &c., rendering special lubrication unnecessary. The generator consists of a system of seamless copper pipes communicating with a chamber, at the bottom of which the liquid enters, whilst the gas is drawn off from the upper part. The arrangement of pipes is such as to facilitate an efficient circulation throughout the whole of the generator. The pump is provided with check valves; but to avoid the risk of breakage each valve is controlled by two springs, one pressing it down on its seat, and the other acting as a stop when it rises.

(b) Perkins's.—The principle of the apparatus is extremely simple, and can best be illustrated by the well-known lecture experiment intended to show the absorption of heat when liquids of low boiling point are evaporated in vacuum. If of two bulbs which are connected by a pipe, one be filled with a mixture of water and ammonia, and heated, the ammonia will distil over, and may be condensed in the other bulb if this be artificially cooled. Some water will also pass over, but eventually the liquid in the second bulb will be richer in ammonia than that in the first bulb, and if the source of heat be withdrawn, the ammonia will boil over and return to the first bulb, whilst the second bulb will be cooled far below the temperature of the cooling water previously applied.

The construction of the apparatus itself is of the utmost simplicity, and will be readily understood from Fig. 15. There are two horizontal tubes C D

closed at the ends and placed horizontally the one above the other. They are joined by a short vertical tube F at either end, which reaches about half way down into the cavity of the lower tube. This part of the apparatus is called by the inventor the "combiner," because in it the water and ammonia combine again when the ammonia vapour passes over from the "receiver" R through the connecting tube shown on the top. The receiver is also an iron tube, and is placed in the cold room, or in any other position where the effect of the apparatus is required. The combiner and receiver need not be placed in close proximity as shown; there may be any distance between them, so that the combiner, for instance, can be placed in the basement of a building close to the hot-water apparatus if the building be heated on the Perkins system, and the receiver in any other part of the building, but at a slightly higher level. In such cases the lower tube of the combiner is provided with two Perkins's hot-water tubes E, indicated by dotted circles, and the same apparatus which is used to heat the building can be employed for supplying heat to the combiner, the hot water being simply circulated through the tubes E. At Perkins's factory this arrangement is actually in use, the hot water being diverted either into the heating pipes of the factory or into the combiners of his cold air apparatus by a series of stop cocks, which are manipulated once or twice a day by an attendant. Where a heating apparatus is not available, the combiner is heated by gas issuing from the tube B, which is provided with atmospheric burners. The whole apparatus is perfectly sealed, so that no loss of ammonia can occur, the same charge serving over and over again. The process is as follows: The combiner is charged with a mixture of pure ammonia and water, the strength being about that of the ordinary commercial ammonia. After a short application of heat the air is expelled by opening a stop cock, not shown, the escaping gases being led through a water

seal, so as to avoid the unpleasant smell of ammonia. The loss of ammonia in blowing out the apparatus is very trifling, and after this operation is performed the apparatus contains a very small quantity of air, and if left to

surrounding the upper end of the siphon tube, and provided with small holes at the bottom. Owing to the position of these holes, only water can find its way into the short cylinder T, and hence the siphon draws off the water with-

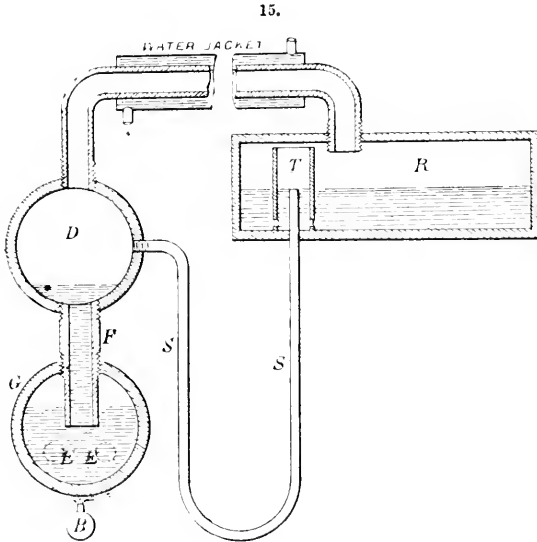

Perkins's cooling apparatus.

itself there would be a vacuum of about 25 in. in it. On applying heat in one form or another to the lower tube of the combiner, the ammonia begins to distil over, and is condensed on the way to the receiver by the action of the water jacket surrounding the connecting tube. A certain amount of water also distils over with the ammonia; but as the specific gravity of ammonia is very much less than that of water, the latter accumulates at the bottom of the receiver, and is conveyed back into the combiner by means of a siphon S, provided with a trap T within the receiver. The construction of the trap will be obvious from our diagram. It consists of a short vertical cylinder

out allowing the ammonia to follow. During the application of heat the pressure in the apparatus rises to 70 lb.-150 lb. per sq. in. at the most, and the temperature within the combiner reaches about 270° F. When, after a few hours' boiling, all the ammonia has distilled over, the source of heat is withdrawn, and the combiner is cooled by an external application of water, which is allowed to flow over its surface. The pressure immediately falls, and finally a vacuum of about 25 in. is produced, after which the ammonia in the receiver begins to boil and distil back into the combiner. In order to promote an intimate mixture of the ammonia which is passing over with

the water left in the combiner, the connecting tubes F project some distance into the cavity of the lower tube C, as already mentioned. By this means the ammonia enters the liquid well within its mass, and is quickly absorbed.

COPYING. (ii. 175-195.)

Chemical Methods.—(37) T. C. Roche gives the following method of making fine blue prints on paper, wood, canvas, &c., and only requires washing to fix properly. First solution: red prussiate of potash, 120 gr.; water, 2 oz. Second solution: ammonio citrate of iron, 2 oz.; water, 140 gr. The solutions should be made separately, and, when dissolved, mixed and filtered; then pour it into a dish, and float plain photographic paper on it for 3 or 4 minutes. When the paper is dyed, it will keep for months. Print in the sun for 8 to 10 minutes; then simply wash the paper under the tap with running water. The result will be a strong blue picture on a white ground. The addition of a little gum arabic water to the above solution, when made, will render the colour of the picture richer and the whites purer.

(38) Channing Whittaker describes an ingenious apparatus of his own contrivance for obtaining prints which shall be free from the defects produced by the printing-frames in common use. In the latter the pressure required to keep the paper in contact with the glass is applied at the periphery of the glass and of the back-board. This causes the centre of the glass to spring, and the contact of the paper and the negative being consequently imperfect, only an imperfect print can be expected.

The ordinary printing-frame used in photography is an excellent one for small negatives, when the back-board is well cushioned with cotton-flannel or woollen blanket, but in large sizes the plate glass is expensive, hard to handle, and liable to be broken by any uneven pressure. The improvement described

is simply the adaptation of an air-cushion in place of a solid pad to ensure the perfect contact of the sensitive paper with the negative. The back-board is in one piece, being clamped to the frame that holds the glass, and is covered by a piece of manila paper coated with shellac varnish. Over this a sheet of the thinnest rubber is laid, and then a single thickness of cotton cloth, the whole being secured at the edges by strap-iron, fastened by bolts to the wooden frame.

The air-cushion is charged by blowing from the lungs. A rubber tube, provided with a glass mouthpiece, leads to a T, one end of which is connected with a nipple introduced through the back-board and the other end of which is connected by a rubber tube with a pressure gauge.

Prints made in this apparatus are entirely free from blue lines, or any blotches or blemishes due to imperfect contact between the negative and the paper. An important addition to the apparatus is that by which it is so adjusted as to have the surface of the glass always at right angles to the direction of the sun's rays. This is secured by providing two adjustments, one by which the glass is rotated in a direction opposite to that of the rotation of the earth, and another in which a secondary axis is mounted on the primary one and at right angles to it, so that it can be rotated to the required position when the sun is either north or south of the equatorial plane.

In addition to this the author gives some notes of experiments on the sensitising liquid, and the proportions for one yielding the best results. When the process was first introduced into America from France, the formula in use was as follows:

Red prussiate of potash, 8 parts; citrate of iron and ammonia, 8 parts; gum arabic, 1 part; water, 80 parts.

Beginning with the proportions—Red prussiate of potash, 10 parts; citrate of iron and ammonia, 1 part; water, 50 parts—different solutions were made up to the proportions: Red prussiate of

potash, 1 part; citrate of iron and ammonia, 10 parts; water, 50 parts.

The plan followed was to coat a sheet with a given solution, and after cutting it into strips to expose them all to direct sunlight and withdraw them one after another at stated intervals, thus giving a different time of exposure to each one.

The conclusion drawn from these experiments was that each mixture would give a deep blue after each exposure, that this would turn to a gray if over-exposed, but that 2-3 minutes' deviation from the proper time of exposure does not materially alter the result. The best formula, he finds, would be: Red prussiate of potash, 2 parts; citrate of iron and ammonia, 3 parts; water, 20 parts.

An excess of the prussiate lengthens the time of exposure, while that of the citrate shortens it.

(39) Below is a formula which Dr. L. H. Laudy of the School of Mines has prepared and long used with excellent results:—

Solution No. 1.—35 grammes (539 grs.) of ferricyanide of potassium dissolved in 230 cubic centimetres (8 oz.) of distilled water.

Solution No. 2.—53 grammes (816 grs.) of citrate of iron and ammonia dissolved in 230 cubic centimetres (8 oz.) of distilled water. These solutions must be kept separate.

When ready to prepare the paper, mix equal parts of Nos. 1 and 2 and apply to the paper either with sponge or soft cloth, and hang up to dry. These operations must be conducted in a dark room. As soon as the paper is dry, place under negative or tracing, and expose to direct sunlight. After printing, place in water and wash thoroughly.

(40) A black process, which will compete for favour with the above blue process, is given in the *Photocopie* of A. Fisch. The process is technically known as heliography, is simple, and inexpensive, while the prints are ink-black, and are made from drawings or positives and negatives. We owe this

process to Poitevin, but it has been slightly improved.

Sensitising Solution.—Dissolve separately:—

1. Gum arabic	0	13 dr.
Water	17	oz. 0
2. Tartaric acid	0	13 dr.
Water	6	oz. 6 dr.
3. Persulphite of iron ..	0	8 dr.
Water	6	oz. 6 dr.

The third solution is poured into the second, well agitated, and then these two solutions united are added to the first, continually stirring. When the mixture is complete, add slowly, still stirring, 100cc. (3 fl. oz. 3 dr.) of liquid acid perchloride of iron at 45° Baumé. Filter into a bottle and keep away from the light. It keeps well for a very long time.

Sensitising the paper.—Here especially it becomes necessary to select a paper that is very strong, well sized, and as little porous as possible. By means of a large brush or sponge apply the sensitising liquid very equally in very thin and smooth coats; then dry as rapidly as possible with heat without exceeding, however, a temperature of 55° C. (131° F.). The paper should dry in obscurity, and be kept away from light and dampness; notwithstanding all these precautions it does not keep well long, and if it is desired to act with some certainty it is better to have a stock to last only a fortnight. Freshly prepared it is better than a few days afterwards. It should be of a yellow colour.

Printing.—The tracing, made with very black ink, is placed in the printing frame, the drawing in direct contact with the plate; then place over it the sensitised paper, the prepared side in contact with the back of the tracing. There is no necessity to make use of photometric bands as the progress of insolation is sufficiently seen on the sensitised paper during the exposure. From yellow that it was it should become perfectly white in the clear portions, that is to say, upon which there is no drawing of the transfer or

positive cliché that is to be copied; this is ascertained by raising from time to time the shutter of the frame. The exposure lasts 10-12 minutes in the sun; in summer less, in winter more. When the exposure is ended remove the print from the frame, and it should show a yellow drawing upon a white ground. If in the sensitising bath a few cubic centimetres of a rather highly concentrated solution of sulphocyanide of potassium have been added, this bath becomes blood-red and colours the paper the same: in this case the print also whitens during exposure, but then the image, instead of being yellow, is red on a white ground. This substance, however, is, if we may so speak, inert, or without any other action; it is very fugitive, and even disappears in a short time in obscurity; it has no other use, therefore, than to render the drawing or the image more visible after exposure.

Developing the Prints.—When the print has been sufficiently exposed it is taken from the pressure-frame and floated for a minute in the following solution, so that the side upon which is the image should alone be in contact with the surface of the liquid, avoiding air bubbles between the two surfaces. Otherwise defects would be found in the print; to ascertain this, raise in succession the four corners. The developing bath is composed as follows:—

Gallic acid (or tannin) ..	31-46 gr.
Oxalic acid	1½ gr.
Water	3¼ oz.

In this bath the orange yellow or red lines are changed into gallate or tannate of iron, and form, consequently, a veritable black writing ink, as permanent as it. The print is then plunged into ordinary water, well rinsed, dried, and the print is now finished. The violet-black lines becomes darker in drying, but unfortunately the ground which appears of a pure white often acquires, in drying, a light violet tint. For prints with half tones this is of no importance; but for the reproduction

of plans, for example, it is very objectionable. By this process we have the satisfaction of obtaining a drawing in black lines similar to the original, and in most cases this is sufficient.

(41) The *Papier Zeitung* gives the following directions for making an improved "graph":—Soak 4 parts of best clear glue in a mixture of 5 parts pure water and 3 parts ammonia (presumably liquor ammonia) until the glue is thoroughly softened. Warm it until the glue is dissolved, and add 3 parts of granulated sugar and 8 parts of glycerine, stirring well and letting it come to the boiling point. While hot, paint it upon clean white blotting paper, with a broad brush, until the blotting paper is thoroughly soaked and a thin coating remains on the surface. Allow it to dry for 2-3 days, and it is then ready for use. The writing or drawing to be copied is done with the usual aniline ink upon writing paper. Before transferring to the blotting paper, wet the latter with a sponge or brush and clean water, and allow it to stand one or two minutes. Place the written side down and stroke out any air bubbles, and submit the whole to gentle pressure for a few moments, remove the written paper, and a number of impressions can then be taken in the ordinary way. When the impressions begin to grow weak, wet the surface of the "graph" again. This "graph" does not require washing off, but simply laying away for 24-36 hours, when the surface will be ready for a new impression.

Mechanical Methods.—(6) Permanently moist copying paper. A perpetually damp copying paper, always ready for use, is described in the Paper Trade Journal. It is prepared by dissolving 1 lb. of chloride of magnesium in a moderate quantity of warm or cold water—about 1 lb. When dissolved, apply this solution with a brush to ordinary copying paper, whether in book form or otherwise, or preferably by means of cloth pads saturated with the liquid, then place these pads between any suitable number of leaves; apply pressure, at first very moderate, until

the absorption by the paper is complete; then remove the cloth pads, and apply with the press a strong pressure; it is then ready for use.

Paper prepared by this process will remain permanently moist under ordinary temperature, and if made dry by an extraordinary heat, will regain its moisture upon being subjected to the common atmosphere.

One advantage of this method is, that the sheets of paper will not adhere to each other, as is frequently the case when the paper is prepared with compounds containing glycerine, &c. The above process is patented.

(7) Any kind of opaque drawing paper in ordinary use may be employed for this purpose, stretched in the usual way over the drawing to be copied or traced. Then, by the aid of a cotton pad, the paper is soaked with benzine. The pad causes the benzine to enter the pores of the paper, rendering the latter more transparent than the finest tracing paper. The most delicate lines and tints show through the paper so treated and may be copied with the greatest ease, for pencil, Indian ink, or water-colours take equally well on the benzinised surface. The paper is neither creased nor torn, remaining whole and supple. Indeed, pencil marks and water-colour tinting last better upon paper treated in this way than on any other kind of tracing paper, the former being rather difficult to remove by rubber. When large drawings are to be dealt with, the benzine treatment is only applied in parts at a time, thus keeping pace with the rapidity of the advancement of the work. When the copy is completed, the benzine rapidly evaporates, and the paper resumes its original white and opaque appearance without betraying the faintest trace of the benzine. If it is desired to fix lead-pencil marks on ordinary drawing or tracing paper this may be done by wetting it with milk and drying in the air.

Zincotypes.—(a) According to Volkner (*Photographic Times*), the original for a heliographic reproduction must be extremely sharp in outline. A

reversed photographic negative upon glass, $\frac{4}{5}$ or $\frac{3}{4}$ the original size, is first made. This reduction renders the lines still sharper and more delicate than in the original. A gelatine solution to which is added sugar, lamp black, alcohol, ammonia, and creosote, is then prepared, and with it a sheet of photographic paper is coated, and laid upon a plate glass carefully levelled. As soon as the gelatine mixture has set, the coated sheets are hung upon cords, and after drying, are kept in a perfectly dry room. The quantity of the pigment is proportional to the character of the original to be reproduced, one-tenth of it being the maximum, one fortieth the minimum, the former for fine and delicate drawings in line manner, the latter for other work. The prepared pigment paper is sensitised in a bichromate of potash bath, 1-15, and laid face down upon a carefully-cleaned plate-glass, and dried in a strong current of air. Immediately before using it the paper is detached from the glass. The exposure under the reversed glass negative is made in an ordinary printing frame, the time adjudged by a Vogel photometer. After printing the pigment paper is taken to the dark room, and in a cold-water bath, transferred to a silvered copper-plate, picture side down. Removed from that bath, the paper is squeezed and dried with blotting paper. After 5 minutes another cold-water bath is used to wash the bichromate from the non-exposed parts. In $\frac{1}{2}$ hour it is taken up, well rinsed, and subjected to a warm water bath of 30° to 35° C. to dissolve the gelatine not acted upon, that is to develop the gelatine relief upon the silvered copper plate. After a short time the water penetrates the pores of the paper, dissolved black gelatine oozes from the film, indicating the beginning of the development; in about 30 minutes the paper is detached, floats upon the surface of the bath, or can be lifted up with ease. The rest of the gelatine is dissolved in a few minutes, and the relief, a copy of the original, appears gradually upon the copper-plate. The development is continued in another

bath of warm distilled water, till all remaining fog or dirt is totally removed from the interstices of the relief, and the picture stands out clear and distinct upon the plate. Finally, it is well rinsed with water and dried spontaneously.

To make this relief plate conductive, powdered graphite is spread over it with tampon and a soft brush; afterwards it is placed on the kathode of a Daniell trough apparatus, and a zinc anode used to accelerate the precipitation of copper. In an hour or less the heliographic relief plate is sufficiently covered, the plate is taken up, cleaned and rinsed, and again placed in the trough. To promote the force of chemical action, caused by the electric current, an iron anode is inserted. After 20–24 days the plate will be of the desired thickness, and is, therefore, then taken from the trough, rinsed with water, and dried; the edges are filed off, and the matrix removed from the matrix. Both plates are well washed. Adhering parts of the gelatine relief are carefully removed.

If the plane of the gelatine relief has been perfectly clean, and free from any tone, the intaglio plate is also smooth, lustrous, and printable. Matt spots are wiped off with oiled flannel and rottenstone; tone and impurities are scraped and burnished; other defects, which but rarely occur, are retouched with needle and graver.

The first impressions made from heliogravure plates are always rough, and retouching them should not be undertaken till a number of prints have been made. They are in every way equal to engraved copper-plates, and with them there is a great, almost incredible, saving of time. Heliogravure plates, maps of the Austrian Empire, made in fifteen years, would have taken generations to engrave. Before large editions are printed galvanoplastic reliefs are taken from the intaglio plate. From them new copies can be made, in case the original should suffer in course of time.

Steel facing.—An important substitute for multiplying copper-plates by

galvanoplasty is to face them with steel. It is used for plates like objects of art, which never require correction. When a copper-plate is placed on the cathode suspended in a solution of sesquichloride of iron, and subjected to the action of the galvanic current, it will in a short time be covered with a delicate and lustrous cuticle of iron, hard as steel. There is no difference seen in the prints taken from plain copper or steel-faced plates. The iron gives the plate an extraordinary durability, and many thousands of prints can be made from it. In case the steel cuticle has been unsound, it can be easily taken off and renewed. The plate is laid in sulphuric acid, diluted so much that it will not attack copper; but it loosens the steel, which blisters and comes off in scales. The plate is again washed before another steel-facing. The process is carried on in a peculiar dark trough, with a 3 cell zinc carbon battery; the electrodes are placed vertically. The suitable iron solution is made by the current. One part of chloride of ammonium is dissolved in 10 parts of water, and in it are placed iron plates, as kathode and anode. When the circuit is closed a chemical action takes place, the chlorine of the chloride of ammonium unites with the iron of the anode, forming sesquichloride, which remains dissolved in the bath. Within 1–2 days the bath assumes a greenish colour, its surface turns red, owing the formation of hydrate of oxide of iron from contact with air, and metallic mirror appears on the kathode. The bath is then sufficiently saturated, and in place of the iron kathode the copper plate to be steeled is inserted. The plate must, of course, be absolutely clean, and is therefore washed in caustic potash, rinsed, and any possibly adhering alkali neutralised with sulphuric acid, washed again and dried. Scamoni, of St. Petersburg, makes very durable plates by first precipitating nickel upon the silvered relief, and then allowing the copper to build up till the desired thickness is reached. His bath is: 45 parts water; 5 sulphate of nickel, and 1 to 1½ of chloride of ammonium.

Photo-chemigraphy.—A plate of zinc or any other metal is coated with a mixture of gum arabic, water, grape sugar, bichromate of potassium, and a few drops of ammonia, and exposed to light under a glass positive. After exposure the plate is removed to the dark room, and etched with a strong solution of perchloride of iron. Strong lines are attacked first and etched deeply, the thin and delicate parts afterwards. The process lasts but 5 minutes, and after cleaning it may be printed from at once. To give the plate more durability it is copper-plated and eventually steel-faced. The copper-plating of zinc cannot be done by electrotypes of the sulphate of copper: the free sulphuric acid will attack the zinc. Instead of it sub-cyanide of copper CuCy (Kupfercyanur) is used. When cyanide of potassium is added in excess to sulphate of copper, the copper electrotype CuCy is formed: $\text{CuSO}_4 + 2\text{KCy} = \text{CuCy} + \text{K}_2\text{SO}_4 + \text{Cy}$. Sulphite of sodium added previously to the cyanide of potassium changes the cyanide into prussic acid, the sulphite of sodium into sulphate: $\text{Cy}_2 + \text{Na}_2\text{SO}_3 + \text{H}_2\text{O} = 2\text{HCy} + \text{Na}_2\text{SO}_4$. Ammonia added to the solution forms, with the prussic acid, cyanide of ammonium NH_4Cy . Two solutions are made, (1) 140 parts sulphate of copper, 840 water; (2) 140–200 cyanide of potassium, 1000 of water, with the addition of sulphite of sodium and ammonia. The solutions are then mixed. The zinc plate to be copper-faced is placed on the kathode. The current is generated by two zinc-carbon elements.

Galvano-caustics.—The electro-negative substance of the electrotype, e. g. the acid of salt, or the chlorine of a chloride, unites chemically with the anode, forming a soluble combination which etches the electrode. Chrom-gelatine paper is exposed under a transparency, inked with roller, and developed; the negative picture is transferred upon a copper-plate which makes the picture metallic-lustrous. The covered parts resist etching. The sulphuric acid liberated by electrotypes combines with the copper; it etches the plate.

In galvanography and stilography the plate is coated with the fatty matter coloured with ochre or lamp-black. A drawing is made upon it with the graving tool, the plates are made conductive by graphite, and by placing them in the trough apparatus a relief is made from that on intaglio plate.

Nature-Printing.—Natural objects like parts of plants, or laces and other open fabrics, are pressed in guttapercha or lead, and galvano-plastic matrices made from them. If lace be the object to be reproduced, it is pasted with gum upon a steel plate, a sheet of lead placed upon it, and subjected to a high pressure. Relief or intaglio plates are made this way; the former answering well for typographic printing.

Type-Printing.—Stereotypes are now substituted by galvano-plastic copper precipitates. The form is impressed in guttapercha, the copper graphited, and, moistened with alcohol, laid in the galvano-plastic apparatus. When the copper is sufficiently thick, the plate is taken up, the reversed side and edges planed off, and backed with ordinary type-metal. Woodcuts similarly treated give galvano-plastic copies from which 70,000 to 80,000 prints can be made.

Plain Copper-plates.—At the time when copper engravings were used exclusively in the Institute, the plates were made by the galvano-plastic process with the aid of a twelve-cell, zinc-silver battery (system Smee). Now such plates are only made for the patrices in heliogravure. The last daguerreotype plates in the American market were also galvano-plastic.

Magneto-electric and Dynamo-electric Machines.—Improvements introduced in the mechanical arts in modern times have also been introduced for the generation of the electric current in electrolytic operations. Magneto-electric and dynamo-electric machines have been substituted for the hydro-electric cell, by which the liberation of injurious gases and interruption of the work is entirely avoided, and more uniform and accurate work obtained. Machines for continuous currents are preferred with

wire twists of considerable diameter, and wire of but little resistance, so as to generate a current great in quantity but of little intensity.

(b) Mantel, director of the stereotype foundry of Dupont's printing house, describes as follows the process of converting a lithographic or copper plate print into a typographic block. The composition to be reproduced is drawn with a crayon or pen upon a lithographic stone, which undergoes all the preparation necessary for a proof upon transfer paper. It is then transferred to a plate of properly planed zinc, which has been washed with a solution of soda or potash and dried with a rag. The transfer is made just as if it were a question of an impression upon stone. Care is taken to see that the fine lines of the drawing are all reproduced, and, if they are satisfactory, gum water, alone or with the addition of a decoction of nutgalls, is passed over the surface of the zinc. The gum combines with the zinc, and renders it proof against the contact of fatty matters.

After the plate has remained under gum for a little while, it is washed and then inked with thick ink by means of a lithographic roller, just as would be done for pulling a proof from stone. Then, by means of a cotton dabber, resin in impalpable powder is dusted over the entire surface—although finely powdered bitumen may likewise be used. This resinous dust adheres to the oily parts, solidifies them, lodges in all the interstices formed where the inking has been slight, and forms a protecting envelope against the penetration of the acid. Care is taken to remove all the superfluous resin.

The edges and bottom of the plate are now covered with lac varnish or a solution of bitumen, after which it is immersed in a bath of water containing 5 per cent. of nitric acid. After remaining in this for 20 minutes, it is taken out and gently rubbed with a piece of soft charcoal—an operation which, by removing the first layer of ink, allows the beginning of the conver-

sion of the drawing into a typographic plate to be seen.

This first biting in is usually very slight. If it has proceeded regularly, a second inking is given before immersing the plate in the bath again for another 20 minutes. Upon being taken out the second time the ink is removed as before, and the plate is examined to see whether the acid has done its duty. Then a third inking is given, and the plate is immersed again for 20–25 minutes.

At every biting in, the strength of the bath is increased 2° – 3° by the acetometer. It is rarely the case that a fourth biting in is necessary. The trough containing the bath is of oak lined with either guttapercha or sheet lead. It is fixed upon a pivot that allows it to be given a continuous rocking motion while the plate is immersed. This agitation is indispensable in order that the acidulated water shall constantly flow over the plate and carry away the salts of zinc that are formed.

The transfer of the drawing from stone to the zinc plate is effected in a lithographic press. Only line drawings are treated by this process.

The zinc plates are prepared by specialists. Moreover, if it be desired to write, draw, or make a transfer upon a zinc plate, it is essential that the latter shall undergo various preparations, such as polishing, scouring, &c. If these operations have been properly performed there will be obtained good typographic plates that it will be only necessary to mount upon wood after the whites have been routed out. Finally, the blisters are removed with a graver, all the inequalities are straightened out, and all the small defects observed are remedied. As for typographic plates derived from an engraving on steel or copper, instead of making a drawing upon stone, the engraving is transferred thereto, and from this is pulled a proof upon India paper, which is transferred to the zinc plate. (*Chronique Industrielle.*)

Mounting Drawings and Tracings.—

One of the most common details in the routine of the drawing-office is the mounting and repairing of tracings and drawings which have either been made on paper too flimsy to stand the wear and tear which they will have to undergo, or which are falling to pieces from the rough treatment which they have received in the shops or elsewhere. Like many other minor details, it often fails to receive the attention which, if paid to it, would be amply repaid. It is usually the first task assigned to a new pupil, who, from ignorance of the materials used, and of the best method of setting about his work, too often "makes a mess of it." To avoid this, and to save the time which it occupies, it is a very common practice to use "tracing-cloth" for all tracings which are likely to be frequently handled and folded. Every one knows the disagreeable nature of this material. From its "greasiness," as compared with ordinary tracing-paper, a "greasiness" which cannot be overcome by ox-gall, it is difficult to make the ink "lie," and, from its non-absorbent qualities, the lines take much longer to dry and are more liable to be smeared. As the ink lies on the surface, the lines are liable to wash, and any colouring that may be necessary has to be applied on the back or wrong side, and any erasure that may be necessary, or any accidental drop of water, leaves a disagreeable white mark. It is no exaggeration to say that three tracings may be made on ordinary tracing-paper in the time required to make two on tracing-cloth. The method which we are about to describe is not only satisfactory, but very easy, and requires only ordinary care, and no special skill.

Let us suppose that we wish to mount a tracing. We take a drawing board, which must be perfectly clean and made without glue in the joints, and lay it on a table, or on trestles, if possible, so that we can get at it from all sides. We then take a stout piece of calico, about an inch larger all round than the tracing to be mounted, and pin it down with a tack at each corner

on another table, which we have previously covered with old newspapers. We then lay the tracing face downwards on the drawing-board, and with a soft sponge wet it thoroughly all over. Then, raising first one half of the tracing and then the other, we flood the board well with clean water. The tracing now lies floating on a thin film of water. Then, taking a moist sponge and commencing at the centre, and working outwards towards the sides in turn, we press the tracing down on to the board, driving the water out at the edges. In the same manner we work out all the water from each corner in turn, always working from the centre to the edges, and taking care to leave no "blobs" of air or water behind us, and wiping off all superfluous moisture from the top or back of the tracing. By viewing it slantwise across the light, it is easy to see if this has been properly done. If it is an old or badly-torn tracing, we can easily fit any detached pieces and, as it were, glue them down in their place on the board with the water. If it is necessary to unite two sheets, we first lay down the larger, if of different size, as above described, and then the other, commencing from the point of junction and working outwards. Then, with a stout brush we spread the paste—which we suppose already prepared—well, and evenly over the calico, beating it thoroughly into the interstices of the cloth and taking care to leave no lumps or superfluous quantity, and, if necessary, picking off any bristles out of the brush, &c. Then, taking it by the corners (this is the only part of the operation in which any assistance is required) and turning it over and holding it at full stretch, we lay it on the tracing, taking care that, as far as possible, every part shall come in contact at the same moment. Once down it must not again be lifted, or it will probably pick up any loose pieces and remove them from their proper positions. Then, with the wet sponge, we proceed to press down the cloth in the same manner as we have previously spread the tracing, driving

all air-bubbles out at the edges and wiping off all superfluous moisture. Then, turning back each corner in succession, as at B_1 , till we can just see the corners of the tracing, we stick in four tacks or drawing-pins, not to hold it down, but merely to mark the corners. A A (Fig. 16) is the board;

16.

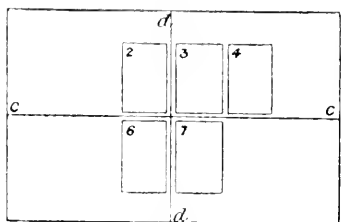
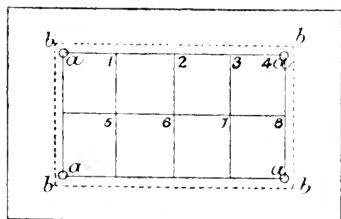
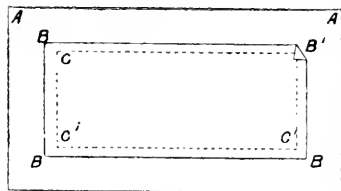

Mounting Drawings.

BB, the cloth; B_1 , one of the corners turned back; CC, the tracing underneath; $C_1 C_1$, tacks at the corners. Then, pressing the corners down again, we set aside to dry. If wanted in a hurry, it may be dried, not too quickly, before the fire, allowing at least two hours for this process; but it is better to allow it to dry slowly and leave it until the next day. When dry, cut

with a sharp knife from tack to tack, and the tracing will fall off. If the paste is good, it will be easier to split the paper than to tear it off the cloth. The remaining strips of cloth may then be torn off the board, and the board washed free from all traces of paste for future use.

It might be supposed that the colouring would run, and the lines be found all blotted and blurred after such rough usage, but such is not the case. Indian yellow, if laid on too thickly, will occasionally run, but not to a serious extent, and heavy lines of Prussian blue would probably be found printed and reproduced on the board, but not blurred or smeared. But the best plan, if a very neat appearance is a *sine qua non*, is to colour the tracing after mounting. The tracing will be found to have a surface for colouring far superior to the best drawing-paper, and as all superfluous ink has been removed by the process, lines and figures may be washed over in the most careless manner without any fear that they will run. Those who know the care required to wash over a heavy dotted line, will fully appreciate the advantage.

The absence of all distortion is a most remarkable feature in tracings mounted as above described, and may be readily tested by applying a straight-edge to any line. Any expansion or contraction is equal in all directions, and may be almost entirely obviated by a careful adaptation of materials. Very thin tracings should not be mounted on very thick cloth, or vice versa. It will also be found that some tracing-papers will expand very much more than others, and, as is well known, will, if left free, contract upon drying to less than their former dimensions. But this tendency is counteracted, not only by the fact that the tracing remains stretched on the board until dry and cut off, but by the fact that the cloth will not contract upon drying, especially if the paste is well beaten into the interstices.

So far we have described the process as applied to thin tracings, but it is equally applicable to torn drawings

upon thick paper and to drawings made on the commoner sorts of drawing-paper when it is not thought worth while to employ the superior qualities which are sold ready mounted on cloth. By soaking old and valueless drawings and tracings in water for a few hours, the cloth may easily be peeled off and used again. If it is desirable to leave a margin wider than that on the unmounted tracing, the cloth may be detached from the board where it adheres at the edges by using an ivory paper-cutter or a feather-edged scale. If small parts of the tracing have been torn out and lost, the cloth will, of course, adhere to the board at these points, and must be carefully detached in the same manner. If desired, stout paper may be used instead of the cloth, though not so good or so easily applied. Of course, white calico must be used, as unbleached cloth shows an unsightly colour through the tracing. If any corrections or erasures should be necessary, we recommend the following plan:—To take out a line, fill a drawing-pen with clean water, and, setting it at a rather coarser pitch than the original line, rule over the line. Let the water lie for a few moments, then dry with blotting-paper, and rub out with soft rubber. By repeating the process once or twice, the line will be perfectly erased. The surface may then be polished with the ivory paper-cutter or with the blade of a knife. To take out a blot or a shade of colour, use a wet brush instead of the drawing-pen. An obstinate blot may be removed by scratching it out with the point of a drawing-pen dipped in clean water, blotting the water off the tracing as often as it gets discoloured. This proceeding, however, will not improve the drawing-pen.

We will next suppose that it is desired to mount a plan or a map (such as a quarter-sheet of the Ordnance Survey) in sections, so as to fold for the pocket or for insertion into a book. These maps usually have a very liberal margin, which, as so much waste paper, is better cut off. Having decided on the final

size, prick the corners through, as at *aaaa* (Fig. 16). Turn it face downwards, and rule lines all round from prick to prick. Then mark it off into the requisite number of squares, which must, of course, be of exactly equal size. Then number the squares in succession before cutting. If this is not done, some comical results will often occur through the sections being mounted in wrong sequence. Then cut it up. It is as well to leave a slight margin, as shown by the dotted lines at *bbbb*, so as to allow the edges to be finally trimmed up with a sharp knife. Then with a blacklead pencil rule two or more lines on the drawing-board at right angles to each other, as *cc*, *dd* (Fig. 16). Then, having soaked each square for about half a minute, lay them one by one on the wetted board, commencing with the centre sections 2, 3, 6, 7, and leaving about $\frac{1}{8}$ in. between each section. When these have been properly placed and stuck down, the others, as 4, will follow. Then apply the pasted cloth as above directed. In removing a map thus mounted in sections from the board, it will be found that in the narrow spaces between the sections it will probably adhere to the board, and the paper-cutter must be used to detach it, care being taken not to "start" the edges, and especially the corners, of each section with the edge of the cutter. If the map is to be attached to a book or case, a margin of cloth must be left on that section which is to be attached. When removed from the board, fold it carefully in the manner which appears most handy (in the above instance, first along the line *cc*, and then along the other lines backwards and forwards alternately), and press it for a short time under a heavy weight. It will afterwards naturally and without difficulty fold in the same manner. In the case of a larger map with three or four rows of sections, first fold all the horizontal and then all the vertical lines, or vice versa, and always in a zigzag form, alternately in and out. The above process, though rather complicated to describe upon

paper, is remarkably easy to put in practice. There is, however, one class of drawings, or rather engravings, to which it is not applicable. We allude to those upon unsized paper, such as is employed for the French Government maps, and for some lithographs. This when wetted, becomes as tender as wet blotting-paper, and is very difficult to handle. We have sometimes employed the following process:—Having arranged the sections, dry or only slightly damped, on the board, we strain the cloth, which must be of an open texture, tightly above them, and then apply glue, as hot and liquid as possible, to the back. This, penetrating the cloth, will produce the required adhesion.

DESICCATING. (iv. 108-119.)

Air Ovens.—(i) The air-bath ordinarily used in chemical laboratories for drying precipitates, for making determinations of water by loss, and for similar purposes, is usually a rather expensive piece of apparatus. The iron or copper closet, with its door, tubulure for thermometer, shelves, stand, &c., works no more satisfactorily because of its somewhat elaborate or difficult construction. In Fig. 17 A, is shown a simple substitute for this apparatus, that as regards simplicity cannot well be excelled, while its other good features certainly operate to commend it. It consists of an inverted flower-pot sustained upon an ordinary tin pan or sand bath, the whole being carried by a tripod or retort stand. The aperture at the top serves to receive a perforated cork, through which a thermometer is passed. An ordinary Bunsen burner is used to heat it. As the sand bath directly over the burner becomes very hot, it is advisable to invert a second smaller sand bath within the first, as shown in B. This prevents too direct a radiation of heat from the hot metal. Upon this the little stand or bent triangle supporting the crucible or watch glass containing the substance to be heated may be placed. The thermometer should be

thrust down through the cork until its bulb is near the substance to be dried, so as to obtain a correct indication of the temperature at that point. The entire arrangement is shown in external view in A.

To place a vessel in it or to remove one, the flower-pot is lifted off the sand baths. It will be observed that its porous nature provides a species of ventilation, while its composition assures it against corrosion. It even protects the plates below to a considerable extent, as drops of water or other fluid cannot run down its sides as it cools.

But convenient as it is in the rôle of air bath for simple drying operations, it will be found more so where drying tubes or retorts have to be manipulated at constant temperature. The flower-pot can be perforated at any place, and holes of any size or shape can be drilled and cut through it with an old knife, file, or other implement. Thus in C it is shown in use for drying a substance at constant temperature in a straight drying tube. The holes to receive this tube can be drilled in a few minutes. The arrangement as shown is of the simplest kind, but if the usual bath was used, it would require a special tubulation to be introduced or contrived for the tube to pass through. Flower-pots cost so little that there need be no hesitation in preparing them for special uses.

In D a U tube is shown as being heated, while in E a retort occupies the bath, and is in use for fractional distillation or other operation requiring a constant temperature. In all cases it is better to use the second bath inverted within the chamber. It conduces greatly to the maintenance of an even temperature throughout the whole space. A hint may also be taken from the heavy drying plate formerly perhaps more used than at present. If for the light metal pans a heavy plate $\frac{1}{2}$ in. or more in thickness is substituted, the temperature will not be subject to as rapid variations, and less difficulty will be experienced in keeping a constant

temperature. The tray furnished with the next large size of pot may be used instead of the sand bath upon which

When the bath is in use for drying substances, its top, which is at a rather low heat, affords an excellent place of

17.

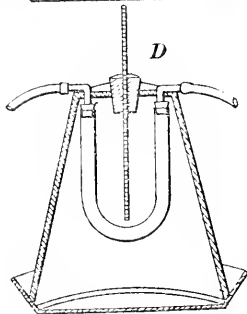
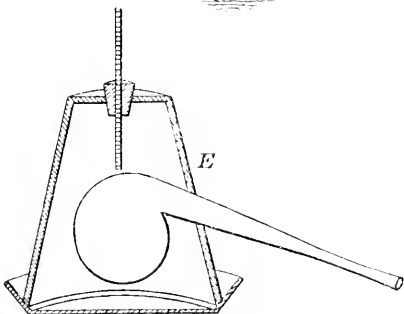
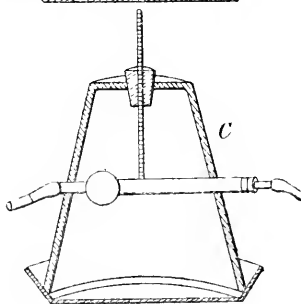
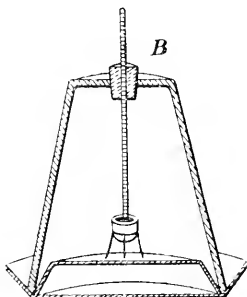
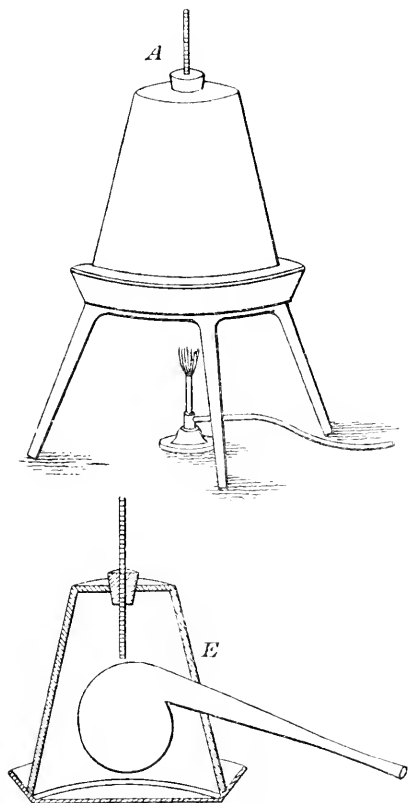

Air ovens.

to rest the inverted flower-pot. This gives an absolutely non-corrodible construction.

drying precipitates wrapt in their filter papers. It acts in two ways. It is generally just hot enough to dry them

with reasonable quickness without danger of spurting, and it also acts by capillarity to absorb the water directly. It represents in the last respect the porous tile or blotting paper—appliances too little appreciated by chemists here. It must be remembered that the drying of a precipitate by evaporation leaves all the impurities of the wash water concentrated therein, while capillary absorption removes a great part of both wash water and its impurities, thus conducing to the accuracy of the work. (T. O'Conor Sloane, Ph D.)

(b) Bearing in mind the universal and indispensable utility of the air-bath to the chemical analyst, one might expect to find much variety and perfection in the design and construction of such an important piece of apparatus. Strange to say, this is not so. I very much doubt if there is to be found any piece of chemical apparatus in the chemist's laboratory that has received less attention, or stands more in need of it.

This fact was forced upon my attention by the great difficulty found in bringing certain hygroscopic substances to a constant weight, and I soon discovered that the attempt was hopeless with the ordinary instrument, the reasons for which were not far to seek. In the first place, in the ordinary bath it is impossible to maintain a uniform temperature throughout the whole of the drying chamber, for, even with the help of a thermostat, though it may be regulated with accuracy for some one special portion, other parts will in all probability be found to be several, indeed many, degrees hotter or colder according to the circumstance, so that to dry a substance, say at 100° C., the bath, though regulated to stand at this point for the spot where the thermometer is placed, is no assurance that the thing to be dried is exposed to the temperature desired, and if the object is of any considerable bulk the probability is that one portion of it may extend into a region that is much below a hundred, and another into a place that is much above a hundred. Naturally

the greatest heat is found near the floor, where the thermometer is never placed, and the least heat at the sides and in the corners, where radiation and stagnation mostly take place; but more especially it is cold in the line of draughts that proceed from the chinks of the door and through the primitive contrivance that is usually provided for ventilation. In these parts the temperature may be very little above that of the external atmosphere. No wonder then that the complete drying of delicate hygroscopic organic substances is found to be so difficult, for before the colder part can be made to give up the last trace of moisture that clings so tenaciously to it, the hotter is over dried and stands the risk of being charred.

In a case like this there is nothing to be got by turning and twisting the thing round so as to expose alternately its various parts to the greater heat. In imagination one can see what occurs; by a process of distillation and condensation the same kind of transference of moisture from the hotter to the colder parts takes place as is seen to occur, for instance, when the attempt is made to dry a damp flask under similar circumstances.

But even this picture by no means exhibits the whole of the perplexing difficulties of tracing and controlling the air currents in an ordinary air-bath. They are so erratic, so fortuitous, so delusive, and subject to such uncontrollable shiftings, that, practically speaking, it is a question whether thorough drying in such a case is possible without destruction of the substance. At all events the chances in favour of it are so slender as not to be relied upon.

Reflecting upon these difficulties, the theory of a perfect method for air-drying suggested two things as indispensable.

1. A constant current of pure dry air brought to the desired degree of temperature before admission into the drying chamber.

2. A regulated source of heat.

Both these conditions to be under perfect control.

I place current first as being the more important item, and the one to which hitherto very little attention appears to have been paid so far, at all events, as regards the temperature of the current when admitted into the drying chamber. As for the source of heat, this has been brought fairly under control by previous experimenters by the use of one or other of the several thermostats, though I was unable to discover one quite suited to the purpose.

the drying to circulate between the jackets before its final admission into the drying chamber, in such a manner as to ensure that its temperature shall be raised to the required degree before it is allowed to come in contact with the thing to be dried. Moreover, as a secondary, but still very important consideration, the inlet of the air-supply is so placed that the air used for drying is kept as distinct as possible from all contact or admixture with the products

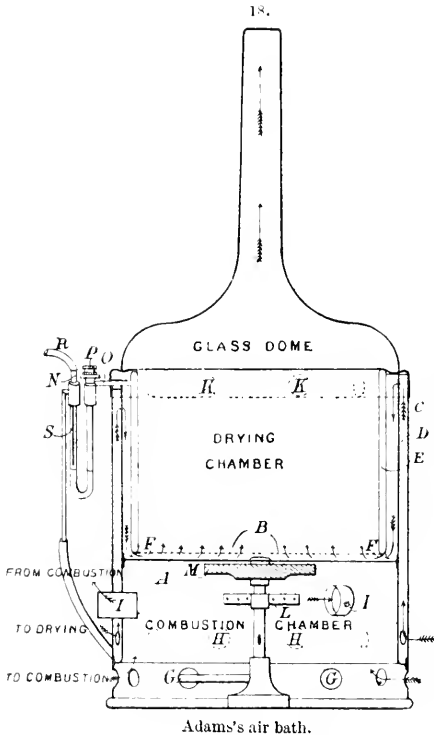

Adams's air bath.

To meet these requirements I have designed the instrument shown in Fig. 18. It consists essentially of a double jacketed cylinder with air passages, so contrived as to compel the air used for

of combustion, such products naturally being loaded with watery vapour and CO_2 . The pure air thus heated before entering the drying chamber is evenly diffused over the whole area of the bottom of the bath, between it and the perforated false bottom which forms the floor of the drying chamber; the air then ascends bodily as a solid cylinder, and escapes by the tall chimney of the domed glass cover. In this way vigorous circulation of dry hot air is constantly maintained, which effects a rapid and uniform drying, such as no ordinary air-bath can accomplish. We will now turn to a consideration of the source of heat and its regulation. This consists of a Bunsen air-burner placed in the cavity under the bottom, but the heat is first received upon a solid disc of metal, separated by a sufficient space from the bottom to prevent the heat of the flame being transmitted direct to the bottom of the bath, the object being to avoid any localisation of the heat. Moreover, the mass of

the metal disc, besides acting as a distributor, also serves as a reservoir of heat and assists in maintaining the equality of temperature, but this equality is chiefly provided for by an entirely new form of

thermostat. It is to be observed that within the two jackets already spoken of is placed an annular copper vessel, which forms the boundary wall of the drying chamber. This is a cylinder composed of two thicknesses of thin sheet copper, enclosing an air-space of 5 mm. wide, 98 cm. circuit, and 22.75 cm. in height. It is securely closed top and bottom, and has a capacity of 1100 cc. This constitutes the heat regulating chamber or thermostat, the cavity of which is connected up to a U tube, having mercury in the bend. Gas is admitted on the other side of the U, and by means of an arrangement, such as is usual in a gas thermostat, depression of the mercury in one limb cuts off the main gas supply, which can then reach the burner by a small bye pass only. By means of a screw at the top of the other limb of the U, air can be admitted into or allowed to escape from the regulator. With the rise or fall of the temperature, and the consequent expansion or contraction of the air contained in the regulator, pressure is exerted or withdrawn from the surface of the mercury, which is thereby forced down the one limb and up the other.

The reference letters indicate as follows:—A, Diaphragm completely separating the drying from the combustion chamber. B, Perforated false bottom. C, Outer jacket. D, Inner jacket. E, Copper regulating chamber or thermostat. F, Baffle plate. G, Apertures in jacket C giving admission to air for combustion. H, Apertures for the passage of air between the jackets for drying. I, One of three apertures for escape of products of combustion. K, Apertures in inner jacket D for passage of drying air. L, Burner. M, Thick metal plate for receiving heat of the flame. N, Mercury U tube. O, And its connection with copper regulator. P, Screw whereby the degree of heat is regulated. R, Gas supply. S, Tube with bye-pass.

I have already mentioned the capacity of this copper regulator is 1100 cc., the coefficient of expansion for one

degree Centigrade being .00367, the alteration of volume for a single degree of temperature at boiling point will be about 3 cubic centimetres (2.95). It is therefore plain we have here a means of regulation of the temperature of extraordinary sensitiveness, and accordingly we find we can command what practically amounts to a fixed temperature at any desired degree, and seeing that the copper regulator entirely surrounds the drying chamber and that the whole of the air employed in the drying process must of necessity sweep both its surfaces, exterior and interior, amounting to nearly half a (.4459) square metre in extent, it follows that no local currents can interfere with the accuracy of its workings. You will agree, I am sure, that this a grand point.

A Page's regulator, or any similar instrument, may be all very well in a still atmosphere, but where a current is concerned it is not unlikely to be at fault and thrown out of working from one cause or another, purely local, such for instance as being shadowed by an object in process of drying, or being placed where there is either an undue amount of current, or too little, or in an eddy. Our arrangement has a further advantage of occupying no space within the drying chamber. Having said this much respecting the principles involved in the design and the mode of construction, let us now pass to a consideration of its performances; but before doing this it will be as well to relate some particulars concerning difficulties encountered in connection with the regulator. When first set in action there was no getting a fixed degree of heat; the thermometer kept steadily mounting, degree by degree without apparent cause. Naturally we looked for some escape of air from the chamber of the regulator, but the closest inspection failed to reveal any point at which escape could take place, and it was only by immersing the copper regulator in water and blowing through the tube attached that enabled us to discover several tiny leaks in the solder.

After these were made good and the test repeated, the thermometer still recorded a constantly increasing temperature. Again and again we went through the process of searching for leaks, but all in vain. Fixity of temperature seemed impossible, when at last I observed some condensation of moisture within the U tube on the regulator side of the mercury. This at once gave the clue to the cause of the rise of temperature. Each time of immersing the regulator in the water, when search was being made for leaks, a small amount of moisture must have gained access into the interior, and this, as the temperature of the bath was raised to boiling point, became converted into steam and mingled with the contained air. So long as this moisture remained at the high temperature of the interior of the regulator, it exerted the vapour tension due to that temperature, but little by little a certain portion found its way into the U tube out of reach of the heat, and thereupon deposited its moisture by condensation on the sides of the tube, producing of course a partial vacuum in the tube and thereby drawing in a fresh supply of hot moist air and steam, so that at last quite a considerable amount collected in the U tube. Now, seeing that 1 cc. of water at 15.5° C. will produce 1696 cc. of steam at 100° at ordinary barometric pressure, there is no need to dwell further upon the cause of our difficulty, or the necessity for keeping the interior of the copper regulator quite dry.

Now, with respect to the performance of this instrument as an air-drying bath, I have directed my experiments to the demonstration of three things:—

I. To show the existence of, and determine the amount of, current passing through the bath.

The passage of the current is roughly but abundantly demonstrated by holding a flame opposite any one of the twelve air inlets; you will observe how the air rushes in. Again, at the outlet the current is manifested by this mica whirling arrangement, which you

observe sails round famously by the impact of the current.

I have attempted to measure the amount of air that passes through the instrument by means of an anemometer, and find that it travels along a chimney whose sectional area = 5.4119 in. at the rate of 204 ft. per minute, from which I calculate that no less than 7.6875 cub. ft. of air pass through the apparatus per minute.

II. The next point of importance was to ascertain that this current was evenly distributed throughout the whole sectional area of the drying chamber.

This equal distribution you will observe was arrived at by making the instrument circular and admitting the air at points placed at equal intervals all round, and by surrounding the lower part of the inner jacket with a curved flange projecting inwards, the object of which is to direct the current horizontally between the true and the false bottom, and so prevent its premature passage through the perforations of the false bottom before having had time to take up heat from the bottom plate, and by thorough mingling and mixing, preventing local inequalities of temperature.

That these designs work well can be demonstrated by the smoke of smouldering brown paper, which shows that the current spreads itself over the whole area; there is no creeping up the sides or centre, it seems to pervade equally the whole space.

III. The final point that we have thought it important to inquire into relates to the vertical distribution of the heat.

At one time I was strongly tempted to head this communication with the title of "A Perfect Air-bath," and should have ventured to do so but for the practical impossibility of obtaining a perfectly equal temperature from top to bottom. For a certain very considerable range it is sufficiently so for all practical purposes, and far more so than it is, or can be, in any ordinary bath. For the convenience, if not the necessity, of the case, the source of heat

is applied to the bottom, and you will remember we have interposed a large mass of metal between the flame and the bottom for the purpose of moderating, storing, and distributing the heat; but, nevertheless, all parts in metallic connection therewith get hot by conduction more in proportion as they are near to the source of heat. They in turn become radiators, and any object placed within near range of their radiation before the air current has had time to take up and distribute the same, gets more than its share of heat. Our experiments show that the useful range is anywhere above 3 in. of the bottom. Below this undoubtedly the temperature increases rapidly, and more so the closer the bottom is approached. About 3 in., and for the whole of the rest of the drying-chamber, the extent of the variation between any two parts does not amount to more than from 1° Centigrade.

In these several ways we have endeavoured to meet the requirements of a theoretically perfect bath. We have contrived an instrument that provides a vigorous current of heated air of definite temperature under perfect control of a self-acting source of heat, and out of reach of contamination by the results of combustion. Taken together, these result are, I submit, satisfactory, and show the instrument to be a substantial improvement on the ordinary air-bath.

As regards regulation of temperature, this is as simple as possible. It can be set at any temperature wished for, from that of the room up to any degree that can be required, in the course of a few minutes. I have only to undo the screw (P) and allow a little of the air contained in the copper chamber to escape, and when the desired temperature is reached, screw it down again; this, by preventing further escape, fixes the temperature at that point. On the other hand, if I want to lower the temperature, I should turn the gas out and allow air to enter the copper chamber until the temperature stands at the desired point. A thermometer

hangs from the chimney, and the temperature can be seen at any moment. The regulation can be accomplished not only exactly but immediately, and moreover, the temperature is absolutely fixed. It may be set going on January 1st and go on to December 31st, and it will not vary. It may do some good to put some asbestos on the upper surface of the diaphragm that divides the drying and combustion chambers. (M. A. Adams, F.R.C.S.)

(c) Chloride of calcium is cheap (being a waste product), easily portable, and when it has absorbed moisture it can be again made fit for use with no more complicated apparatus than an iron pot. Air dried by means of chloride of calcium has, therefore, very naturally come into use for drying purposes. But it is sometimes employed in an unsatisfactory manner, by a mechanical arrangement. The chloride of calcium is alternately exposed to the current of air to be dried, and is then passed into a furnace, in the expectation that moisture will thus be alternately absorbed and expelled. This view seems to be erroneous. Chloride of calcium parts with two-thirds of its water at 392° F., and loses the remaining third at a higher point. Unless the heat is carried to this point, the chloride of calcium does not recover its original capacity of water. If it has been thus heated, it wants sufficient time to enable it to cool down to a temperature below that at which it parts with its moisture. Chloride of calcium, at temperatures above the boiling point of water is a comparatively poor desiccating agent. There is another method in which chloride of calcium may be applied in desiccation, a method often used in the laboratory. The substance to be dried is placed in a vacuum—or even in a closed receiver, filled with air at the ordinary pressure—along with trays of chloride of calcium. In this manner, the moisture evaporating from the material is at once absorbed, and fresh moisture can be given off to take its place.

(d) In Fig. 19 is shown an excellent

apparatus for drying grain, tea, and every kind of agricultural product. The reference letters indicate as follows :—

iron fan, which will draw waste heat from a distance of 50-100 ft. C, Chimney and valve, to carry off smoke when fire is first lighted. c, Thermometer or Pyrometer. D, Feed-hopper, into which the grain is conveyed by an elevator from below, or by a chute from an upper floor. E, Cylinder; when of 18 ft. and upwards, can be made in two lengths, joined in the centre by flanged rings. F, Elevating gear for raising and depressing cylinder. G, Air-duct made of different sections to suit different products. H, Part of the outer shell removed to show the cells in which the grain is carried up and poured out in a continual stream;—the number and pitch of these cells is also varied for various products.

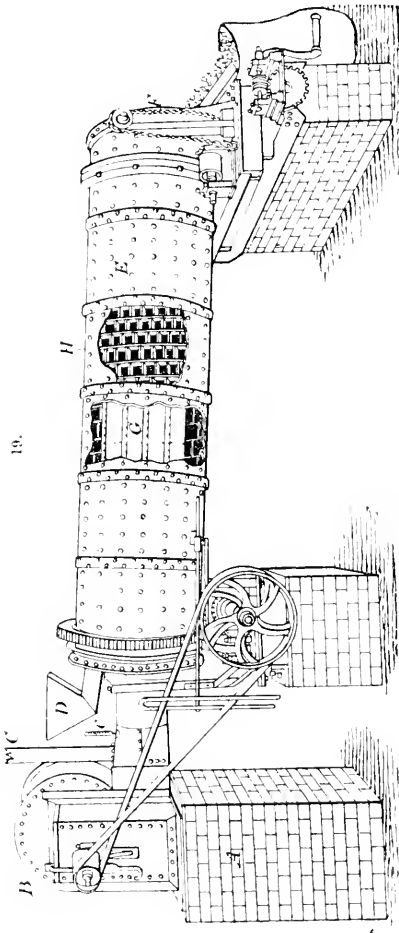

Apparatus for drying grain, tea, &c., &c.

A, Brick box in which coke is burnt, or a flue to convey waste heat from any furnace. B, Compound wrought-

small percentage of hydrogen, be cooled again to the original temperature, it will be capable of taking up as much mois-

(e) The cool air drying machine which we are about to describe, is based upon the principle of drying the air before it in turn is used to dry the material to be operated on; and this drying of the air itself is performed by bringing it into contact with a system of iron tubes heated in a furnace to about 1300° F., when part of the aqueous vapour is dissociated into oxygen and hydrogen. The oxygen attacks the surface of the iron tubes or other pieces of iron, such as nails and filings, placed there for the purpose, and the hydrogen passes away with the rest of the air. If, now, this mixture of dry air, with a

ture as it originally contained. Power is supplied by a Robey undertype steam engine, which works two fans placed under a wooden box, and a number of vertical agitators placed in the drying chamber between the stacks. The air from the fans is forced through a series of vertical tubes placed in a box technically termed the "cooler." After passing the tubes, it is forced through another series of tubes placed in the "furnace," and is there heated to about 1300° F. After passing through the furnace tubes, the air is conducted back to the cooler; but this time it surrounds the outside of the vertical tubes, and flows finally to horizontal flues placed on the ground, which lead into the drying chamber. The air, on coming from the furnace, is cooled by contact with the outside of the tubes, through which fresh air is pushed into the furnace; and the cooler in this manner performs two functions, viz. it heats the air on its way to the furnace, and it cools the air after it has left the furnace. The machine is provided with a second cooler, technically termed the "water cooler;" but this is an addition made merely for the purpose of experimenting. The water cooler is arranged somewhat in the manner of an ordinary surface condenser of a steam engine, with the only difference that, instead of exhaust steam, the air coming from the air cooler is passed through it. This water cooler can be filled more or less with water, and the water can be renewed at a faster or slower rate. By this means, its cooling effect upon the stream of air can be varied so as to obtain the dry air finally at any desired temperature between 150° F. (the temperature to which the air cooler reduces it) and 60° F., or even less if desired. The water cooler is never used in drying machines when not required for experimental purposes; for actual practical work an air cooler alone is used, and its size is so chosen as to reduce the temperature of the air to the desired degree. The goods to be dried are stacked on trolleys and run into the compartment, care being taken to put the heaviest stuff first, because

it requires a longer time to get dry. The agitators are worked from bevel gear overhead, and are placed over the main flues by which the dry air is conveyed to the drying chamber. A hole about 10 in. diam. is cut in the top of the flue below each of the agitators, and the air streaming up through this hole is scattered about by the fans of the agitators, so as to penetrate the interstices left between the stacked goods. In this way the whole of the surface is evenly surrounded by a gentle stream of dry and comparatively cool air. The air, as it passes through the stack, becomes charged with moisture, and if it were not quickly removed, it would impede the further process of drying. To facilitate its removal, exhaust fans are arranged to draw the air through the hollow lining of the walls of the drying chamber, and discharge it into the atmosphere. The whole air contents of the drying chamber, when full, are changed every two minutes. At the time of our visit, we saw in the drying chamber mahogany boards $2\frac{1}{4}$ in. - $3\frac{3}{4}$ in. thick, oak flooring, also some walnut gun stocks, a large pile of billiard cues, and a big parcel of pine deals 12 ft. by 9 in. by 3 in. The best proof that the drying of the wood is effected without warping lies in the fact that billiard cues can be successfully treated. Boards 1 in. thick require to be left in the drying chamber for about a fortnight, 2-in. stuff would be left in a month, and so on in proportion to the thickness for heavier stuff. We may take it that to stack mahogany boards in the open air in order to season the wood in the old way, would cost about 6s. a square, that is, inclusive of ground rent, fire insurance, and interest on the capital lying idle. The timber will in that case take about twelve months to become seasoned. If artificially dried, the process will be completed in a fortnight at a somewhat smaller charge than 6s. per square. Thus the artificial method is not only cheaper, but it has the great advantage of enabling the money to be turned over quickly, instead of lying idle in stacks. (*Industries.*)

Water ovens.—In Fig. 20 is shown

a constant water bath, consisting of a square box A, supported over a Fletcher's solid flame burner. The top of the box, 15×15.5 in., is formed by a brass plate, $\frac{1}{8}$ in. thick, which thus is stiff enough to support a considerable weight

20.

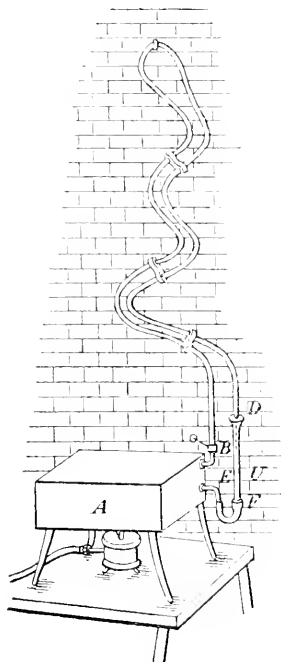

Water oven.

without yielding, the sides and bottom being sheet copper. From the point, B, projects a $\frac{1}{2}$ -in. brass tube, B C, which turns up at a right angle. At E is a stop-cock, which is connected by a thick rubber tube with the glass tube, D F, which is fastened against the adjoining wall. Connected with C by a rubber joint is a $\frac{1}{2}$ -in. block tin tube of 20 ft. length, which extends up the wall in the manner shown to the highest point,

T, and thence returns and ends just over the slightly funnel-shaped top of the glass tube at D. The bath being filled with water to just the level, B b, may be kept constant by boiling for many days without appreciable loss of water, the steam being condensed in its passage up, or, if uncondensed before it reaches the point, T, in its passage down the block tin tube. In flat-bottomed platinum or porcelain capsules, evaporation goes on very rapidly when placed on top of this water-bath. The whole surface of the bath is nickel plated. (*Journal of Analytical Chemistry*.)

MECHANICAL METHODS.—Foremost among mechanical appliances for this purpose ranks the centrifugal machine, or hydro extractor. In principle this apparatus consists of an upright drum, which can be made to revolve with great velocity on a vertical axle. The drum may have its sides constructed of sheet metal, perforated with a multitude of fine holes, of wire gauze properly supported, or of basket work, according to the nature of the substances to be treated. The drum, being charged with material, is set in quick rotation. The water present is thus expelled through the perforated sides in the form of a fine shower. This process is exceedingly well adapted for removing the greater part of the moisture from cloth, yarn, unspun wool, &c.; also from crystalline and granular substances. It is not so well adapted for drying wet powders, pastes, &c., since in such cases a very considerable proportion of the solid matter is projected away along with the liquid, so the holes may get choked up. Thus it has not hitherto been found satisfactory for drying wet sewage mud. Its use requires, further, special modifications where the liquid to be got rid of is not pure water, but holds useful, or hurtful, matters in solution. A recent very simple improvement has considerably extended the use of the hydro extractor. The materials, instead of being put into the drum loose, are enclosed in bags of some suitable material, thus preventing the dispersion of the solids. This method has

been very successfully adopted with butter. It must, however, be remembered that no substance, especially if of organic nature, can be rendered absolutely dry by the use of the hydro extractor.

Another mechanical agency for desiccation is the press, more especially that device known as the filter press, which has proved itself invaluable for separating solids from fluids when the latter largely predominate. This apparatus contains a number of cells, each consisting of a couple of cast iron plates lined, when in use, with suitable cloths. The inner surface of each plate shows a number of ridges. The liquid paste is forced by a pump, or press, into each cell through an aperture, and the water escapes through the cloth, and trickles down between the grooves formed of the ridges to the pipe at the bottom.

In Johnson's press there are several improvements. In the centre of each plate is an aperture, which places a whole series of cells in connection, so that a liquid or paste introduced through one inlet pipe fills the whole series; grooves cut in the plate facilitate the escape of the press liquor to the outlets. The number of ridges is very great. The press cloths are of different kinds, according to the material operated upon. The pressure which may be exerted by means of steam or air ranges from 50 lb. to 100 lb. per sq. inch.

The filter press, like the centrifugal machine, only expels a part of the water in mud, &c.; thus, if a sewage mud contains at the outset 90-95 per cent. of moisture, it may be reduced by the filter press down to 50-60 per cent., according to the time during which the pressure is maintained. It is only in a few cases that hydraulic presses, screw presses, &c., can be employed for desiccation.

By cold.—The concentration of saline and saccharine solutions by the abstraction of surplus water is another branch of desiccating. This is usually performed by means of heat, as described under Evaporating, but may be sometimes advantageously effected by the aid of a low temperature. Thus in

several countries where severe weather predominates common salt is obtained from the ocean by exposing sea-water in shallow reservoirs to the action of the frost. The water becoming frozen separates from the saline bodies which it held in solution, and on being removed in the form of ice the latter can be collected from the bottom of the receptacle; or repeated coatings of ice can be taken from as many freshly admitted supplies of sea-water till the solution reaches a highly concentrated form, needing but little evaporation to afford a crystalline product.

Another direction in which the concentration of solutions by cold is successfully applied is in warmer countries where sugar forms one of the agricultural products. Thus in Ohio the native women were accustomed to expose the syrup as collected in shallow pans to the night air, when the cold would suffice to freeze the water and form a crust of ice over the thereby concentrated syrup below. The bulk of the superfluous water being thus got rid of, very little further concentration by means of fire is needed to produce a solid sugar.

DISTILLING. (iv. 119-143.)

Mercury is now so largely used both in the laboratory and for industrial purposes, such as ore reduction, electric engineering, and so on, that a quick and efficient means of purifying it is a valuable acquisition. An apparatus for this purpose has been devised by J. W. Clark, Demonstrator of Physics in University College, Liverpool, and was recently brought before the Physical Society of London.

The usual processes for purifying mercury are either chemical, such as treatment with dilute sulphuric acid, &c., or mechanical, such as shaking and filtering through wash-leather, or distillation, either *in vacuo* or under the ordinary atmospheric pressure. Of all these methods the best is distillation *in vacuo*.

Prior to distillation it is well to filter

the mercury through a cone of writing paper with a very small orifice at the apex, and to remove the lead or zinc present by chemical means; for the rate of distillation is lowered by these impurities. The presence of 0.0001 part of lead is said by Gmelin Krant to reduce the quantity of mercury distilled in a given time from 67 to 5. Gold, iridium, copper, tin, nickel, cadmium, and arsenic do not influence the rate of distillation.

The distillation of mercury at ordinary pressure is an inconvenient process. The first apparatus for distilling *in vacuo* was probably devised by Weinhold, and others have been designed since by Weber, Shaw, Wright, and others. The arrangement of Clark, however, differs from all these in the important respect of dispensing with an auxiliary Sprengel air pump, and in, so to speak, acting as its own air pump. This is effected by supplying the mercury to be distilled from a movable reservoir in the form of a constant level regulator. On raising this reservoir, Fig. 21, the mercury is supplied to the distiller.

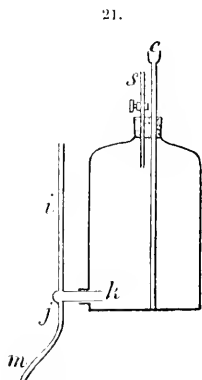

Mercury still.

The distiller is shown in section in Fig. 22, and consists of a lead glass tube *ab* 36 in. long and about $\frac{3}{8}$ in. internal diameter. About 2 in. from its closed

upper end is blown a bulb about 2 in. diameter. The lower end passes through an air-tight cork of rubber, closing the top of the cistern *dc*, and ends at *b*, a little below the tube *f*. The cistern *dc* is made of glass tube 1 in. diameter and 12 in. long, and has two short pieces of "quill" tubing *cf* sealed into it. The lower end is also closed by a cork, through which passes a piece of Sprengel

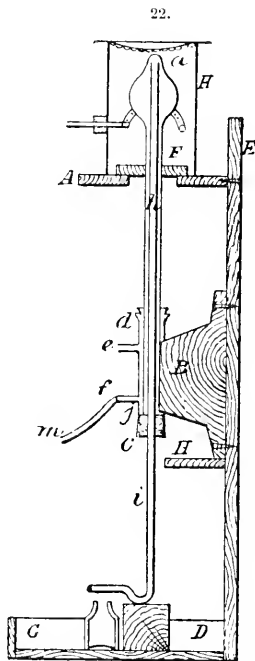

Mercury still.

tube *i* 36 in. long, and having a piece of quill tubing *h* about 24 in. long sealed into the upper end. The top of this tube is nearly in contact with *a*. The internal diameter of the Sprengel tube should not much exceed 1 mm., and the bend of the lower end is best when not much more than 1 in. radius.

The base of the stand is a wooden tray CD, from which rises a board DE, carrying a shelf A E, perforated in the centre with a hole allowing the glass bulb to pass through it. A large cork F is bored with a hole of rather less diameter than the tube *ab*, and the cork is cut in halves. The tube is held in position by twisting a piece of copper wire round the halves of the cork. The cistern is secured by string passing through holes in the projecting piece of wood B. A block of wood serves to support the end of the tube *i*, and a tin cylinder notched round the top, and covered with a flat tin plate, keeps the bulb surrounded with hot air, while a mica window at the side allows the height of the mercury in the bulb to be easily seen. The pipe of the brass ring burner passes through a hole in the tin gas plate, and the ring, slightly larger than the bulb, is perforated on its inside with many holes.

The constant level reservoir is a large glass bottle provided with a tubulure at the side. Similar bottles are now made for the mercury pumps of electric incandescent lamp manufacturers. Into the tubulure passes a glass tube *k* about 3 in. long and $\frac{1}{2}$ in. diameter. Its outer end is closed, and into the upper and under sides are sealed two pieces of quill tubing *lj*. The top of the upper end is open, but the lower *j* is connected with the cistern of the distiller by a narrow piece of rubber tubing *m*, about $3\frac{1}{2}$ ft. long, inclosed in a canvas tube. The "thistle" funnel *t* and small glass stop-cock S are also fitted air tight into the bottle by a rubber tube. The reservoir is placed on an adjustable tablestand on the shelf H.

To set the distiller in action, the stop-cock S of the reservoir is opened, and some mercury is poured through the thistle funnel *t* into the reservoir, while, with a short piece of rubber tubing and glass rod, the tube *e* is closed securely (Fig. 22) at the top by the cistern. Then the reservoir is raised. The mercury gradually rises in the cistern, and by compressing the air in the upper part is forced up the tube *ab*, and then

filling the bulb "sprengels" down the tube *hi*. The reservoir may then be lowered to its stand on H, and the rubber stopper removed from the tube *e*. The reservoir is set in action by attaching a piece of rubber tube to the stop-cock S, and sucking out air until, passing down the tube *l*, it bubbles up through the mercury in the reservoir. Then the stop-cock is closed, and the reservoir is adjusted at such a height in the stand that the mercury is nearly at the top of the bulb in the distiller. Thus set in action, the level of the mercury in the cistern *cd* will be kept constant until almost all the mercury has been distilled.

To start the distillation, the tin plate which covers the cylinder H is removed, and the gas is lighted. A few minutes later sufficient mercury will have distilled over to displace the impure mercury originally present in the narrow Sprengel tube *i*.

The reservoir is replenished with mercury without interrupting the distillation, by placing a screw pinch-cock on the rubber tube leading to the cistern of the distiller, opening the cock S, and pouring the mercury into the reservoir through the funnel *t*. Then a few bubbles of air are sucked out of the reservoir as already described, the stop-cock is closed, and the screw clamp is released from the rubber tube. The level of the mercury in the distiller remains as before.

Such an apparatus as that illustrated will distil about 2 lb. of mercury per hour with an expenditure of very little gas. Zinc, cadmium, magnesium, and other metals may also be distilled by the same plan.

Water.—The arrangement shown in Fig. 23, is one that may readily be adapted to, and is specially suited for, the old fashioned stills which are in frequent use among pharmacists for the purpose of distilling water. The idea is extremely simple, but thoroughly efficient in actual practice. The still is of thin copper, 2 gal. capacity, and the condenser is the usual worm surrounded with cold water. The overflow of warm

water from the condenser is not run into the waste pipe as in the ordinary course, but carried by means of a bent tube A, B, C, to the supply pipe of the still. The bend at B acts as a trap, which prevents the escape of steam. The

dient a still of 2 gal. capacity will yield about 6 gal. per day, a much greater quantity than could ever be obtained under the old system, which required the still to be recharged with cold water every time $1\frac{1}{2}$ gal. had been taken off.

The objection to all such continuous or automatic arrangements is, of course, that the condensed water contains all the free ammonia that may have existed in the water originally, but it is only in cases where the water is exceptionally impure that this disadvantage will become really serious. (T. Maben.)

EVAPORATING.

(iv. 149-171.)

Acids.—Cast iron retorts are now being successfully employed on a

large scale in New York for the final concentration of sulphuric acid. It is found that acid of 65° Bè. does not attack the stills, and no injury appears to result from the deposition of arsenic or other substances. The concentration is carried as far as possible in platinum; the acid is then run into the cast iron stills and concentrated to 98 per cent. H_2SO_4 . It is stated by Mr. Adams, who has recently published a report on the progress made in twenty years in the concentration of sulphuric acid, that a set of iron stills, used in connection with platinum, have been in use in New York for some time with very satisfactory results, as much as 30,000 lb. per day of 98 per cent. acid being turned out.

Quadruple Evaporator.—Example of work done per 24 hours. Much interest has of late been exhibited in multiple evaporation; the following actual statement of facts will therefore be of service:—

Feed liquor:—

Volume 37,200 gal.

Strength.. 3° Tw. = 1.015 Sp. Gr.

Temperature 82° C. = 180° F.

23.

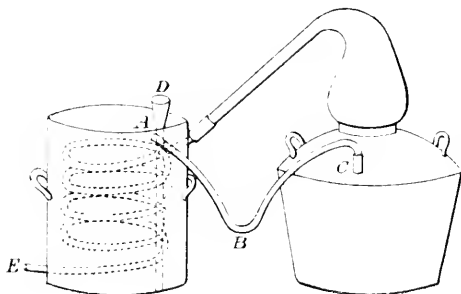

Water still.

advantages of this arrangement are obvious. It is perfectly simple, and can be adapted at no expense. It permits of a continuous supply of hot water to the still, so that the contents of the latter may always be kept boiling rapidly, and as a consequence it condenses the maximum amount of water with the minimum of loss of heat. If the supply of water at D be carefully regulated, it will be found that a continuous current will be passing into the still at a temperature of about 180° F., or, if practice suggest the desirability of running in the water at intervals, this can be easily arranged. It is necessary that the level at A should be two inches or thereabout higher than the level of the bend at C, otherwise there may not be sufficient head to force a free current of water against the pressure of steam. It will also be found that the still should only contain water to the extent of about $\frac{1}{4}$ of its capacity when distillation is commenced, as the water in the condenser becomes heated much more rapidly than the same volume is vapourised. By this expe-

Concentrated liquor:—

Volume 3,360 gal.

Strength.. 45° Tw. = 1·225 Sp. Gr.

Temperature 71° C. = 160° F.

Distilled water:—

Volume 31,290 gal.

Temperature 89° C. = 192° F.

Hot water from vacuum pump:—

Vol. of water used = 174,000 gal.

Temp. of injection = 11° C. = 52° F.

Do. of ejection = 43° C. = 110° F.

The weight of water evaporated is represented by the difference in the weight of concentrated liquid and the feed liquor, thus:—

Weight of feed liquor =

$$37,200 \times 10 \cdot 15 \text{ lb.} = 377,580 \text{ lb.}$$

Weight of feed liquor =

$$3,360 \times 12 \cdot 25 \text{ lb.} = 41,160 \text{ lb.}$$

lb. of water evaporated 336,420 lb.

The amount of steam required in the apparatus to evaporate this weight of water from the temperature of the feed liquor, 82° C. (180° F.), was found to be 5045 lb. per hour, by actual measurement, which included steam for pumps. The exhaust steam from the pumps connected with evaporators may, and indeed is, now exhausted into the first evaporating cylinder to do useful evaporative work. The evaporative efficiency, expressed in lb. of water evaporated from 100° C. (212° F.), and also from the temperature of the feed liquor, may be fairly ascertained as follows:—

a. Evaporative efficiency from 100° C. (212° F.) Per hour.

Total steam used including pumps .. } = 5045 lb.

Less steam required to heat feed liquor from 82° C. to 100° C. .. } = 506·5 lb.

Total steam used to evaporate water from 100° C. = 4538·5 lb.

Water evaporated per hour =

$$\frac{336,320}{24} = 14,013 \text{ lb., and}$$

$$\frac{14,013}{4538 \cdot 5} = 3 \cdot 08 \text{ lb. of water evap-}$$

orated per lb. of steam condensed in first cylinder.

b. Evaporative efficiency from temperature of feed liquor.

$$\frac{14,013}{5,045} = 2 \cdot 772 \text{ lb. of water per lb. of steam.}$$

These results have been expressed in lb. of water evaporated per lb. of steam used, because before we can arrive at the amount of water evaporated *per lb. of coal*, it is necessary to know the weight of steam generated by 1 lb. of coal in the steam boilers which supply the evaporator.

It would appear, then, from the above results, that the efficiency of any multiple evaporator depends on the temperature of the feed liquor, and that by a quadruple effect apparatus, slightly over 3 lb. of water may easily be evaporated for every lb. of steam used, provided the feed liquor be at or very near 100° C.—the boiling point of water. When the temperature falls below this, the efficiency of the apparatus rapidly diminishes also. As above stated, in order to express this efficiency in terms of the coal it is necessary to know how much water 1 lb. of this coal evaporates in the steam boilers, and from this figure the efficiency is easily obtained. Thus, for example, if 1 lb. of coal evaporates 8½ lb. water in steam boilers, we have

(1) $3 \cdot 08 \times 8 \cdot 25 = 25 \cdot 41$ lb. of water evaporated from 100° C. by the multiple evaporator per lb. of coal

(2) $2 \cdot 772 \times 8 \cdot 25 = 22 \cdot 87$ lb. of water evaporated from temperature of feed (82° C.) per lb. of coal.

It will be admitted by all practical men that heat may be measured and reckoned with accuracy if adequate means are adopted for this purpose. The distribution of the heat, therefore, during say 1 hour's work of a multiple evaporator may be arrived at with tolerable certainty. From our own experience the constancy of such results is undoubted, for when once a multiple evaporator is set to work under its proper working condition with respect

to the pressures and volumes and temperature of liquid passed through it, the distribution of the heat which enters the apparatus amongst the various liquids flowing from it, and steam condensed in the condenser, are all practically constant. To quote one case may serve to show the nature of this heat distribution for the individual apparatus under consideration, and in a measure for all similar pieces of apparatus. The distribution or analysis of the heat in the liquids leaving a multiple evaporator has an interest beyond the mere theory of the subject, for by this practical men may arrive at a fair understanding as to how, and to what extent they may make multiple evaporators a valuable adjunct to their necessities in connection with its services as a concentrator of liquids. They yield two abundant supplies of hot water—one distilled, the other natural water used for producing the vacuum. These supplies are inseparable from systems of multiple evaporation. In many cases they are extremely valuable to the manufacturer, more especially the distilled water. Both supplies may for instance be used for feeding steam boilers, in which case the heat they contain is utilised, and may be considered to have a commercial value.

The distilled water, if used for this purpose alone, has the further recommendation of producing no scale. Its volume also is comparatively large, amounting, in fact, to about 85 per cent. of the volume of the weak liquor concentrated, or to that quantity of water required for a set of boilers burning 15–16 tons of coal per 24 hours. On the other hand, the volume of the water used for the condenser is comparatively speaking, very large, and its total consumption for steam raising purposes, excepting in the very largest factories, is quite out of the question. Turning our attention to the distribution of the heat which enters the evaporator among the liquids which leave it, we may employ the following method, which will answer all practical purposes:—

	Cent. lb. units per hour.
Heat entering the apparatus:—	
Weak liquor (feed)	
$377,580 \times 0.9 \times 82$	$= 1,161,021$
24	
Steam (60 lb. press.)	
$5,054 \times 659$	$= 3,330,586$
	<hr/>
	Total = 4,491,607
Heat leaving apparatus:—	
Concentrated liquor	
$41,160 \times 0.6 \times 71$	$= 73,059$
24	
Distilled water	
$31,290 \times 9.7 \times 89$	$= 1,125,527$
24	
Condenser water	
$174,000 \times 10 \times 32$	$= 2,320,000$
24	
	<hr/>
	3,518,586
Heat lost by radiation, &c. = 973,121	
Expressing these results in plainer fashion we find of the total amount of heat entering the apparatus there came out in the	
Concentrated liquor	= 1.6%
Distilled water	= 25.6%
Condenser do.	= 51.6%
Lost by radiation and errors of observation	<hr/>
	= 21.7%
	<hr/>
	99.9

These percentages show clearly that about 75% of the heat entering the apparatus is obtained again in an available form as hot water; that $\frac{1}{3}$ of the heat entered the apparatus in the feed liquor, and $\frac{2}{3}$ as steam. Such calculations inevitably direct the practical man to some of the most telling points in systems of multiple evaporation, and guide the manufacturer in arriving at a correct conclusion as to their real commercial value to him. They also serve to guide the engineer in adapting multiple evaporation to certain manufactures, so as to obtain the maximum economical effect.

The foregoing percentages must not, however, be confounded with the per-

centage amount of heat contained in the distilled and condensed waters expressed in terms of the steam actually used in the evaporator. The percentage recovery on this basis is greater than the foregoing. For example, the amount of heat contained in the distilled water from the above apparatus represented 33·7% of the steam, and that contained in the hot water from the condenser represented 69·6% of the steam used. It is also evident that in either case these percentages may be taken as a direct measure of the fuel saved by employing either of these sources of hot water for steam raising purposes.

The amount of work done, or in other words, the quantity of water evaporated per hour by multiple evaporators will vary according to their construction, and other conditions as to the pressures under which they work. The heating surface of the tubes, through which the liquor passes, has doubtless the most important bearing on this part of the subject. An apparatus containing 2000 sq. ft. of heating surface in the form of thin tubes will, under those working conditions laid down as being essential to successful result, evaporate 6-7 lb. of water per sq. ft.

(*Chem. Trade Jl.*)

ILLUMINATING AGENTS.

The question as to the actual cost to the consumer, everything being included, of the light produced by the various illuminating agents now in use has not yet received a clear and definite answer. Careful attention should therefore be paid to any evidence which is based upon a serious study of the question, so that at least some idea of the truth may be gained. It is for this reason that we reproduce below extracts and tables, taken from a paper presented by C. Rolland, engineer at Mons, to the Society of Engineers of the Liege Institute, and published in the *Revue Universelle des Mines*.

According to this author, "it follows from the examination of these tables that lighting by gas, and even by petro-

leum, is by no means on the point of being replaced by the electric light." These tables establish the fact that under the most favourable conditions for the production of the electric light, that is to say, where spare motive power can be applied to its production, this system of lighting still costs ·0152*d.* per candle power per hour (Table VII.), while gas, costing 1·43*d.* per cub. metre, burnt in the recuperative lamps of Siemens, or still better, of Wenham, gives a light which only costs ·009604*d.* and even only ·006631*d.* per candle power per hour. (Table II.)

PETROLEUM.

The luminous intensity given by a petroleum lamp varies considerably with the quality of the oil employed, and also with the quality, the state of cleanliness, and the cut of the wick. A badly-trimmed wick, or one not cut level, gives, for example, a flame which on one side is too long, and slightly yellow or brown, because the supply of air at that point is insufficient, and on the other side is perhaps too small, the air supply being there in excess. Now, it is well known that under both of these conditions the illuminating power suffers.

The management and regulation of wicks is delicate work, and certainly ought to be included in an estimate of the expense of the lamp.

Another source of expense in using this class of illuminant is that arising from the use of the lamp—repairs, consumption of wicks and chimneys, losses of oil, and waste used for cleaning. (Table I.)

It may be estimated that these sources of expense amount per lamp and hour to—

Expense of lamp ..	·0950 <i>d.</i>
Wicks, chimney, &c.	·0427 <i>d.</i>
	<hr/>
	·1377 <i>d.</i>

Finally, to include the additional trouble connected with the use of this illuminant, such as purchasing the oil, storing oil, risk of fire, &c., we think

TABLE I.—PETROLEUM.

	Chief Types of Lamp.		Actual Expense, 25 per cent. in excess of calculated.
	Angle with Horizon. 0°.	Angle 45°.	
Candle power	40	29·3	..
Consumption of petroleum of best quality, 800 grammes per litre	90 grm.	90	..
Consumption per candle power per hour			
Expense per candle per hour, at 1½ <i>d.</i> per litre	2·25	3·037	3·796
Working expenses per candle per hour	·005396 <i>d.</i>	·006745 <i>d.</i>
Total expenses per candle per hour	·00465 <i>d.</i>	·00465 <i>d.</i>
Total expenses per lamp per hour, 29 candle power at 45°	·010051 <i>d.</i>	·01140 <i>d.</i>
	..	·2973 <i>d.</i>	·33677 <i>d.</i>

that the theoretical price ought to be increased by 25 per cent. It will be observed that the luminous intensity diminishes considerably when the photometric measurement is made at an angle of 45°.

According to the experiments of Heim, the loss of illuminating power is proportional to the diameter of the burner. It is 20 per cent. for burners with an ordinary long flame; about 35 per cent. for the 30 mm. burners used in lamps which give an intense round flame, and amounts to 5 per cent. with 60 mm. burners. It will be possible to compare the luminous intensities of the various systems of lamps and burners at this angle of 45°. The one class giving the maximum intensity at 0° (horizontal rays), the other at 90° (vertical rays).

Moreover, lamps are usually employed under such conditions that their rays are at this angle.

ILLUMINATING GAS.

Column 7 of Table II. gives the expenses of putting down apparatus and mains for candle power per hour, calculated on the following grounds:—

In Belgium the cost of establishing a public burner may be estimated at 12*s.* (for private illumination, stations, rooms, &c., where more elegant appliances are used, the cost may rise to 20*s.* or 27*s.* 9*d.* per burner), and main-

tenance and interest may be taken at 10 per cent. of this amount, say 5*l.* 18*s.* 9*d.* per annum. This cost must be spread over the entire consumption, depending on the number of hours during which it is in use.

Assuming a minimum of 700 hours per annum, and a consumption of 250 litres per hour, it will be found that at 1½*d.* per cub. metre, interest and maintenance must be valued at about 6 per cent. of the value of the gas.

The corresponding expenses for a regenerative Siemens or Wenham lamp, which costs at least 47*s.* 6*d.* for a consumption of 250 litres per hour, may be calculated in the following manner, a saving of 50 % of gas being supposed:—

I.		s.	d.
2 ordinary burners ..	value	2	5
2 secondary tubes	3	2
Piping and main tube (23 <i>s.</i> 9 <i>d.</i> less 5 <i>s.</i> 7 <i>d.</i>)	18	2
		23	9

II.		s.	d.
One complete regenerative burner, giving the same light as the two burners above	47	6
Piping and principal tube	18	2
Secondary tube	1	7
		67	3

The expense of maintenance and interest is found to be 17 %.

TABLE II.—ILLUMINATING GAS.

Type of Burner.	Angle with Horizon.	Candle Power.	Gas per Hour in Cub. Metres.	Consumption of Gas per Candle Power per Hour in Litres.	Value at 1½d. per Cub. Metre.	Working Expenses.	Total Cost per Candle Power per Hour.
Split burner	0 { 45	16.9 17.2	0.251 0.256	14.8 14.9	.021232	.001273	.022505
Argand burner	0 { 45	21.9 19.4	0.239 0.241	10.9 12.4	.01767	.001054	.018724
New Clamond burner	45	21.1	0.190	9	.01282	.00123	.01406
Aver or de Pintsch burner	0 { 45	14.4 10.5	1.0951 0.1037	6.60 9.88	.014079	.001406	.01548
Cardinal or de Brauer burner	45	21.9	0.219	10	.0142	.000902	.0151
Siemens regenerator	0	65.3	0.460	7.05
No. 3	45	46.9	0.456	9.75	.013889	.002356	.01624
Wenham, No. 2	0 { 45 90	28.4 44.5 45.8	0.249 0.257 0.256	8.77 5.77 5.58	.008208	.001396	.009604
Wenham, No. 4.	0 25 45 65 90	99.0 152.0 170.0 200.0 202.0	0.285 0.686 0.677 0.685 0.671	6.92 4.51 3.98 3.42 3.33	.005671	.000959	.009196

We have, therefore, calculated at this rate the expenses tabulated in column 7, Table II., for the illumination given by Siemens or Wenham lamps.

For Clamond and Aver burners we have adopted 10% of the gas consumed as representing the corresponding expenses. The rate of 6% remains for ordinary burners, the cost of which does not exceed 4s.

It must be borne in mind that the numbers should vary inversely with the number of hours during which the burners are employed, since the sources of expense remain almost constant whatever be the consumption of gas.

Before passing to the examination of some other modes of illumination, a word may be said on the subjects of recuperation and intense burners.

TABLE III.—WATER GAS.

Photometric tests of Some's burner.

Consumption per Hour.		Pressure at the Burner.		Candle Power.	Candle Power per Cub. Ft.
cub. ft.	litres.	in.	mm.		
9·66	272·4	2·25	57·15	12·85	1·33
8·31	234·3	2·37	60·19	10·88	1·31
7·90	222·7	2·50	63·50	12·24	1·55
6·70	188·9	1·75	44·45	8·48	1·26
6·70	188·9	1·00	25·40	8·41	1·25
5·58	157·3	3·25	82·55	9·94	1·78
5·10	143·8	4·50	38·10	6·85	1·34
3·96	111·6	2·00	50·80	5·47	1·38
53·91	1519·9			75·14	

Consumption per candle power per hour	20·20 litres.
Price of gas at Frankfort per cub. metre	·712 <i>d.</i>
Cost per candle power per hour	·0142 <i>d.</i>
Working expenses, 10 per cent.	·00142 <i>d.</i>
Total cost per candle power per hour	·01567 <i>d.</i>

TABLE IV.—MAGNESIUM LAMPS.

No. of Ribbons.	Illuminating Power.		Without Reflector.			Total Cost per Candle. Magnesium at 1 <i>s.</i> 6 <i>d.</i> per lb.
	With Reflector.	Without Reflector.	Candle Power per Ribbon.	Consumption per Hour per Ribbon. grm.	Consumption per Hour per Candle. grm.	
1	150	3,200	150	16·7	0·1114	·0418 <i>d.</i>
2	237	5,880	118·7	16·7	0·1410	
4	450	8,000	112·5	16·7	0·1480	
6	700	11,300	117	16·7	0·1415	
8	950	17,000	117	16·7	0·1430	

TABLE V.—ELECTRIC LIGHT—ARC LAMPS.
(Heim.)

	Circuit Lamp of Pieper.	Piette Krizich (Schuckert) Differential Lamp.	Siemens and Halske Differential Lamp.
Diameter of Carbons	6·7 mm. 5·0	1·0 ..	14 ..
Length of Arc	2 " 2	4 .. 4	.. 4·5
Angle with horizon	0° .. 45°	0° .. 45°	0° .. 45°
Candle power	126 .. 377	220 .. 1,420	575 .. 3,830
Electric work in volts ampères	160 .. 153	414 .. 410	918 .. 912
Volts ampères per candle power	1·27 .. 0·405	1·88 .. 0·291	1·60 .. 0·238
Candle power per horse power	433 .. 1360	293 .. 1,890	344 .. 2,310

TABLE VI.—INCANDESCENT LAMPS.
(After Heim.)

Types.	Candle Power.	Electric Work in Volts Ampères.	Volts Ampères per Candle.	Candle per H.P.	Lamps per H.P.
Edison lamp, old model ..	16	72	4·50	122	7·6
" new " ..	16	60	3·75	147	9·2
Swan lamp, old " ..	16	66	4·13	133	8·3
" new " ..	16	56	3·50	157	9·8
Siemens and Halske	16	52	3·25	169	10·6
Bustien (Cannstadt)	16	56	3·50	157	9·8

TABLE VII.—INCANDESCENT LAMPS.

Kind of Installation.	Price per Candle Power per Hour.
Private installation for 200 lamps at least, with special motive power	·0294 <i>d.</i>
When a part of the labour is on hand and an excess of power can be utilised for the production of the light	·0152 <i>d.</i>
Special installation for private lighting	·0446 <i>d.</i>

(Chem. Trade Jl.)

The luminous intensity of a flame increases very rapidly with its temperature, and may be approximately represented by an expression of the form $I = a^t$, when I is the intensity of the flame, and t its temperature. The great increase of intensity obtained by superheating the air may thus be con-

ceived, when it becomes sufficient to sensibly increase the temperature of the flame and so produce a more efficacious combustion. In the Siemens and Wenham lamps the air may be heated to 400°–600°C., but the apparatus soon wears out if the latter temperature be habitually employed.

To render the recuperation rational and efficacious it is essential that the apparatus be so arranged that the air is heated by the products of combustion, and *not simply by the flame of the burner*, for this can only give up part of its heat at the expense of its illuminating power.

It has not been found advantageous to strongly heat the gas itself; on the contrary, deposits are thus formed which rapidly block up the orifices by which it escapes from the burner.

For a given consumption of gas there is a definite supply of air which corresponds to a maximum of luminous intensity. The determination of this quantity is of special importance when ordinary burners with cold air are employed; but even when hot air is supplied it is still important to ascertain exactly the draught which corresponds to a maximum of illuminating power.

Everyone can convince himself of the effect of the draught or volume of air brought into contact with luminous flame on its illuminating power by simply placing a glass chimney on the top of the glass of an Argand burner, so that the height of the chimney is doubled. It will be observed that the flame immediately becomes lower and throws a less powerful light on surrounding objects, although it may itself become whiter. Inversely, the intensity of a flame, which is burning with an excess of air, may be increased by diminishing the supply of the latter. This increase continues until the flame becomes brown towards the top, after which further diminution of the air supply causes a rapid diminution in the brightness of the flame, the combustion then becoming incomplete.

This experiment justifies the conclusion that for burners with cold air the maximum of light corresponds to the minimum of air which permits of complete combustion, and that the yellow flame is more economical than a white flame obtained by means of an excess of cold air.

When the air arrives at the burner heated to 500° C., the influence of the

draught will, of course, not be so great, but it must be remembered that the temperature of the flame expressed in degrees is twice as great as this.

The economy effected by these intense flames, that is to say, flames produced by a large amount of gas, may be explained by the facts that, in the first place, the amount of air immediately surrounding the flame is smaller for an equal volume of flame than in the ordinary burner, and that the loss of heat is thus also rendered smaller; and that in the second place the surfaces and volumes of neighbouring parts of the apparatus so situated as to be capable of absorbing heat from the flame are also smaller in proportion to the gas consumed; finally, a wide flame consists of an interior cone of gas, surrounded by a thicker incandescent layer (which must be traversed by the air) than is the case in a narrow flame burning the same volume of gas.

On account of these various circumstances the temperature of a large flame is appreciably higher than that of a small one, and hence arises its greater illuminating power. This luminous intensity therefore, results from a more effective combustion, which produces an increase in the light radiated from the flame.

FILTERING. (iv. 172-198.)

Water.—(a) A new filter, invented by Dr. William Paulson, of Loughborough, is shown in Fig. 24. It has been designed with a view to use an entirely inorganic, and at the same time a durable and powerful germicide as filtering medium, which, while not a mere strainer, can be easily and cheaply renewed. The basis of the filtering medium is coke, the power of which is increased by a silicate dissolving with a clean surface sufficiently to destroy germs, but not to make the water unpalatable. The method of renewal adopted is to place the filtering-jar in a hot oven ranging from 400° to 600° F., a temperature at which all absorbed impurities are charred. The flat vapid taste of filtered water is obviated by

restoring to it a small proportion of carbonic acid gas. This is done by using as a lid a flat bottle with a straw hole in the side to allow the escape of gas. A small quantity of acid and soda and a

ing disks are superposed, so that several of them operate at one and the same time, and thus give a much larger quantity of filtered water within the

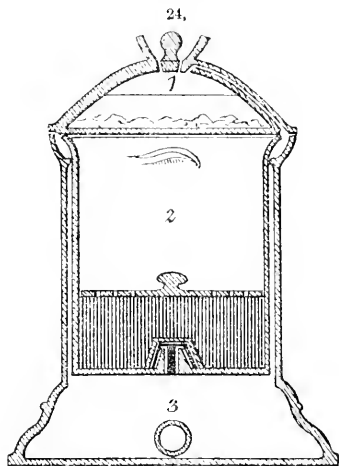

Paulson's filter.

glass of water are then placed in the bottle, and the result is a sparkling and palatable filtered water.

(b) The Johnson filter (Figs. 25, 26) is both mechanical and chemical, and is applicable to both domestic and industrial uses. Fig. 25 shows the domestic style, and Fig. 26 gives the internal arrangement of it. The water enters through the pipe shown at the upper part of the engraving, traverses a disk of prepared carbonised paper, B, and reaches a metallic plate, D, from whence it flows off at E. This plate D, is put in place by means of a screw, F. The disk of filtering paper may be changed with the utmost ease, and the operation may be performed by the most inexperienced domestic. As the entire apparatus is of iron, there is no danger of breakage. The domestic style shown is the smallest sized one. It is constructed in two other styles in which the filter-

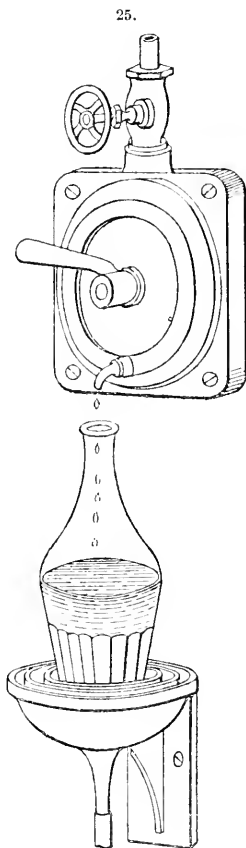

Johnson's filter.

same period. By thus superposing the filtering parts, the inventor has been enabled to construct a large industrial model that is much used in breweries and that is capable of furnishing more

than 130,000 gal. of filtered water per day. In the small apparatus the filtering material is a special paper composed solely of purified cotton fibres and bone-black freed from all phosphates. In the

exact impressions of the grooves in the upper part of the porous vessel and the adjacent faces of the socket and cap of the apparatus. This forms a very tight joint without exerting a stress

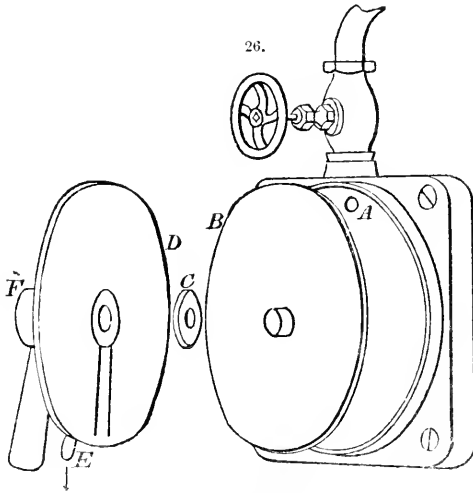

Johnson's filter.

large filters, which resemble barn presses and are managed in the same way, paper is used in conjunction with specially prepared cloth. (*La Nature.*)

(c) The Mallié filter (Figs. 27, 28) utilises the pressure of the city water to force the latter to ooze through porcelain, which retains in its close and imperceptible pores all organic germs. His apparatus consists of a porcelain filter, properly so called, which the water enters under pressure through a tube affixed to a cock. This filter is inclosed in a thick earthen vessel, which is affixed to a metallic support by a bayonet catch, and which serves to protect the porcelain and collect the purified water. The apparatus is made tight through rubber washers of circular or elliptical section, which take the

that might break the neck of the porous vessel. The lower part of the entrance tube is narrowed, and serves as a seat for a conical valve carried by a rod that rests upon the bottom of the filtering vessel. In case of a breakage of the latter, the valve closes. Owing to the automatic operation of this safety apparatus, no accidental flooding and no discharge of unfiltered water is to be feared. The cup constitutes a true reservoir that contains a certain quantity of compressed air, which, thanks to its elasticity, tends to prevent breakages that might occur through the ram strokes of the water under pressure. Besides, the air dissolves in the liquid, and so the latter, on making its exit from the filter, is charged with minute globules of it; hence the name "aeri-

filter" that the inventor has given the apparatus. Since the action of filtration is exerted from within outwardly, salts of various kinds may be put into the interior (so as to obtain artificial mineral waters), or special materials for

exceedingly slow, but the filtrate often passes turbid even through paper of the closest texture. To filter such a fluid, Fresenius advises to dilute with water, add some recently ignited asbestos, and shake the mixture vigorously. After

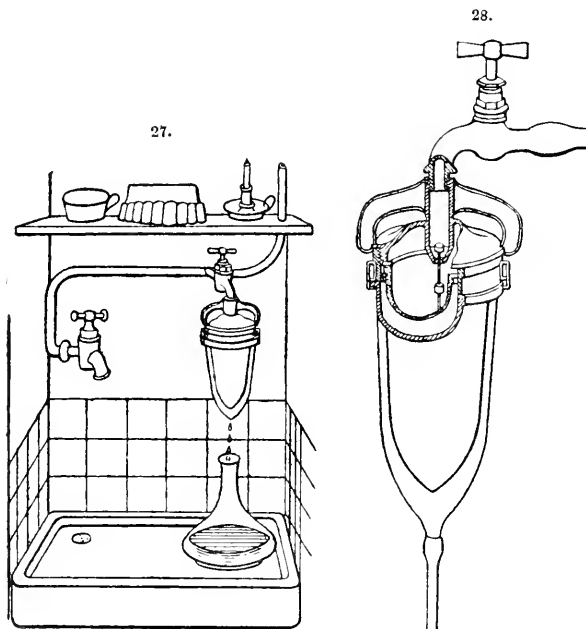

Mallié filter.

decolorising liquids, or, finally, ice (even impure) for cooling the water in summer. A simple apparatus is capable of filtering 9-10 gal. per day, according to the pressure of the water. By modifications in its proportions and construction a larger quantity of water might be filtered.

Laboratory Methods. — (a) Viscid liquids, such as are obtained in processes of artificial digestion, may be filtered, according to Fresenius, by the aid of finely picked asbestos fibre. Not only is the filtration of such fluids

about 12 hours the suspended matters will have subsided, leaving the supernatant liquid perfectly clear. This is to be siphoned off, and the residue to be washed once or twice by decantation, and then passed through a glass funnel the neck of which contains a pellet of asbestos. If the first part of the filtrate runs off cloudy, it is returned to the funnel until it passes clear.

(b) A funnel for filtration in absence of air, is shown in Fig. 29. The funnel has a cylindrical rim 1-2 cm. high, covered with a lid provided in the centre

with a neck. Into this fits a cork and bent glass tube. The funnel is fitted into a filter flask, which has a side tube. By connecting the tube of the funnel with that of the flask by a piece of rubber tubing, the exterior air is excluded.

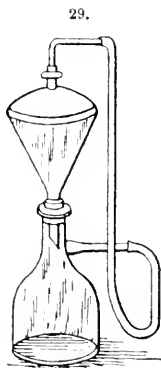

Filtering funnel.

In case a particular gas is required, the funnel is then provided with a double-bored cork. Through one opening the gas is introduced, and it passes out by the other, a connection being made with the filter flask as before.

(c) An apparatus for filtering and drying very oxidisable precipitates is shown in Fig. 30, and is constructed of glass with the exception of the cover C, which is of brass. The tube G, which is connected with the brass tube M by the cork F, is bent over and unites with a small flask containing the precipitate. This small flask has a cork with three holes, one for the tube G, a second for a glass funnel, and the third for a tube connecting with a gas generating apparatus. When all connections are found to be air-tight the tube C is connected with a water pump, and the cock E is opened; the precipitate is drawn over by lowering the tube G into the precipitate in the flask as soon as the apparatus is filled with the indifferent gas. The precipitate collects on the funnel A, and distilled water can be

drawn over to wash the precipitate there, by pouring down the funnel in the small flask. By opening the tap D instead of E, the filtration can proceed

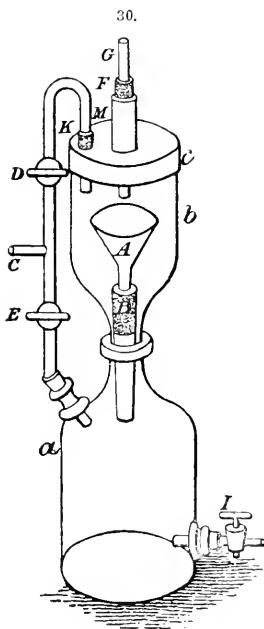

Precipitate filter.

more slowly, and this tap is also useful with very muddy precipitates. To dry the precipitate, the cork K is replaced by another without an opening, the glass tube G is fused off, and the upper part B of the apparatus is removed from the lower part A, and transferred afterwards to a drying oven.

(d) A filter support, which is an improvement on the arrangement for rapid filtration described by Fessenden in (f) below, is shown in Figs. 31-3. It is made from platinum wire, copper wire, or any other suitable material, and bent in the shape shown in Fig. 33. A paper, folded as described by Fessenden,

is pushed in between the wires, *a* and *b*, Fig. 31, which serves the same purpose as the glass rod, that is, to support the inner folds of the filter; whereas the ring, *c f*, supports the outer folds, giving the whole an appearance of a paper formed with two compartments. This may now be placed in a glass funnel, or

being entirely independent of the customary retort-stand. It uses very small circular filters $3\frac{3}{8}$ in. diameter, and yet filters many times faster than the largest heretofore used, doing its work thoroughly, and absolutely without attention, no matter how large the amount to be filtered. It is got ready

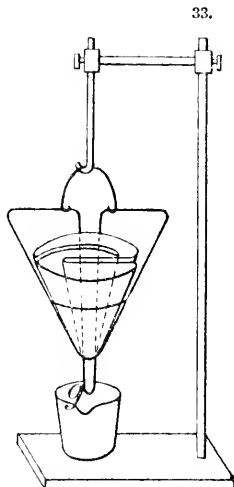
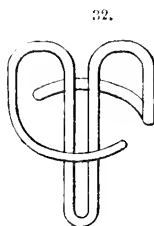
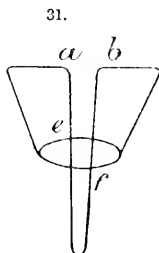

Filter supports.

used alone simply by suspending it over the beaker as in Fig. 32, the liquid following the wire and dripping from the point, *g*. As a means of drying precipitates on the filter, it is far superior to the old way of placing the glass funnel with its filter in the drying oven, as the air has access to the paper from all sides, whereby it dries much more rapidly and thoroughly. For a $7\frac{1}{2}$ -in. filter, a support of $\frac{1}{32}$ -in. platinum wire, with the ring, *c f*, $2\frac{1}{8}$ in. diameter, and the wires, *a* and *b* 3 in. long, gave excellent service. A glass rod bent as indicated by Fig. 33 works very well. (*Chemical News.*)

(*e*) An automatic rapid filter is shown in Fig. 34, which indicates the manner of its operation from a common table,

quicker than the funnel, never breaks the filter-papers, and has no metal contacts. One of its strongest points is in filtering very small quantities as well as large. The former are run through in a moment's time without tedious dropping, as by the funnel.

(*f*) The use of filter pumps, as every chemist is aware, does not, in a very great number of cases, facilitate filtration: first, because a dense layer of the precipitate forms next the paper, which continually requires to be removed, and second, if any considerable pressure is used, particles of the precipitate will pass through. To increase the surface seems to be the better plan. Plaited filters partially effect this, but the precipitate cannot be easily detached

from them, and they are troublesome to prepare. Ribbed funnels, while also an improvement, have only one side of the filter for use, the other side being covered with three thicknesses of filter

34.

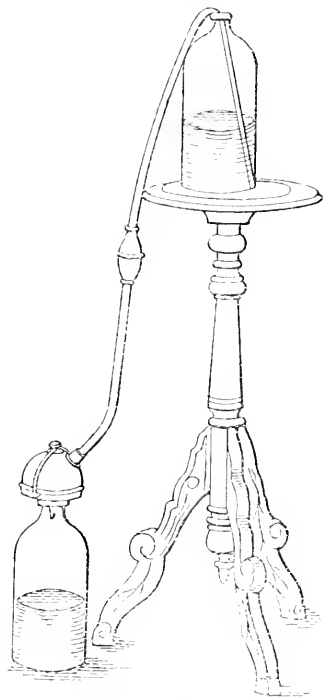

Automatic rapid filter.

paper. The following method (Fig. 35) enables filtrations to be made very rapidly, and in such a manner that the precipitate can be readily removed:—The filter paper is folded three times; folds Nos. 1 and 2 are toward the reader, No. 3 from him. The filter is then gathered (Fig. B), and a piece of glass rod, bent at a very acute angle, is inserted in the cleft of the filter (Figs. C and D), thus giving a filtration surface of nearly four times

the usual one. The filtration being complete, the glass rod is grasped by the projecting ends and lifted from the funnel, bearing the filter upon it. One end of the filter paper is then bent down, and the precipitate is easily washed off (Fig. E). An improvement on this is to use, instead of the glass rod, a plate of glass (Fig. F) ribbed on both sides. This renders the filtration very rapid indeed, and if it were made by the manufacturers of chemical apparatus, would no doubt be used. (R. A. Fessenden.)

(g) The production of a partial vacuum within the vessel receiving the filtrate has long been employed in chemical manipulations for the separation of dense precipitates, and also to save time in the ordinary processes of filtration required in the practice of chemical analysis. There is no reason why, in the absence of a centrifugal machine, the filtering of gelatine emulsions should not be hastened in a similar manner, considering at how small a cost an efficient filter-pump can be manufactured.

A good many vacuum pumps, worked by a flow of water, have from time to time been introduced to the notice of the public, but the majority of them are not completely satisfactory. Bunsen's is perhaps the best; but its production requires the aid of skilled workmanship, and the outfall tube must be at least 32 ft. in length. This altogether forbids its use except upon the upper floor of a building.

The pump to be described was designed by A. P. Smith some years ago. The principle of its construction is based upon that of Giffard's injector. A cistern of water, such as is to be found in every house, is all that is needed for a water supply; but the greater the head of water, the greater the power of the pump. If the water can be laid on from the main supply, nothing further could be desired.

Although a good head of water—and, therefore, pressure—is desirable, it by no means follows that a large quantity of water is required. It is

desirable to attach a screw pinch-cock on the rubber tube which connects the pump with the water supply, so as to govern the quantity flowing through—a condition easily acquired by a little observation and practice.

The construction of the pump offers no difficulty to anyone who can bend a piece of glass tubing, draw out a jet, and bore a hole in a cork; this last is perhaps the most difficult of the three. Procure a glass lamp chimney about

35.

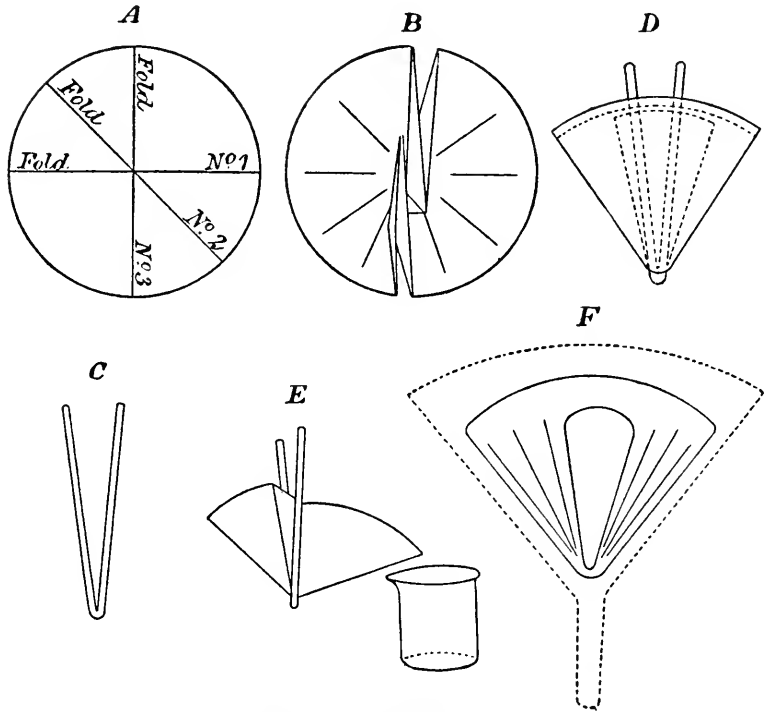

Methods of folding paper filter.

The greater the pressure of water, the greater the power of the pump, which is capable of lifting a column of mercury equal in height to that of the barometer at the time being *minus* the tension of aqueous vapour (the colder the water, therefore, the better). However, the pump will work very well, and lift 15 in. or more of mercury with a head of 10 ft.

23 cm. in length, and some glass tubing of an internal diameter of about 6 mm. Fit two sound corks to the ends of the lamp chimney. Through the centre of the upper cork pass a glass jet with a short nozzle (Fig. 36). Through the lower cork pass another jet, having a long sloping nozzle. The diameter of the holes at the ends of the jets may be about $1\frac{1}{2}$ or 2 mm. (The size really

depends upon the water supply.) Care should be taken that the hole in the

same size. These two jets are placed diametrically opposite each other, and nearly in contact, so that water flowing down may pass smoothly out of one into the other, without striking the edge and spurting off into the chimney glass. A vacuum is produced at this point. This is really easy to accomplish, however difficult it may appear on paper. Adjust an exhaust tube through the upper cork, and, to make the whole affair like an instrument that is intended to work, and not like a model, mount it as in Fig. 37, where A is the pump, B C D the exhaust tube; but at B insert a three-way metal tube, and attach a barometer tube (same tubing as before), which dips into a vessel of mercury. The junctions with the metal tube may be made either by good corks or rubber tied on with wire (the glass tube must project inside the metal tube in any case), and all the junctions well covered with several coats of shellac varnish. The glass tubes may be fixed to a board in the manner shown in Fig. 38, by cutting a groove in a piece of cork, and screwing a strip of tin or brass over the whole.

The final adjustment of the jets can only be made while the water is flowing, and the barometer tube, or the exhaust tube, is dipping under mercury in order to ascertain when the pump is doing its best. When the proper position has been found (generally obtained by twisting the jet, as the point is sure not to be quite central), the corks may be covered with electrical cement, or several applications of shellac varnish.

The filtering bottle requires no special description. Care must be taken to have a sound cork, and it is as well to soak it in melted paraffin to fill up the pores. The rubber which connects the bottle with the exhaust must be as thick as possible, and the ends of the glass tubes must be placed in contact, or the rubber will be flattened by the pressure of the atmosphere, and close the tube. A particular kind of rubber tubing is manufactured specially for such purposes as these, and cannot well be squeezed flat, as it has a diameter of

36.

38.

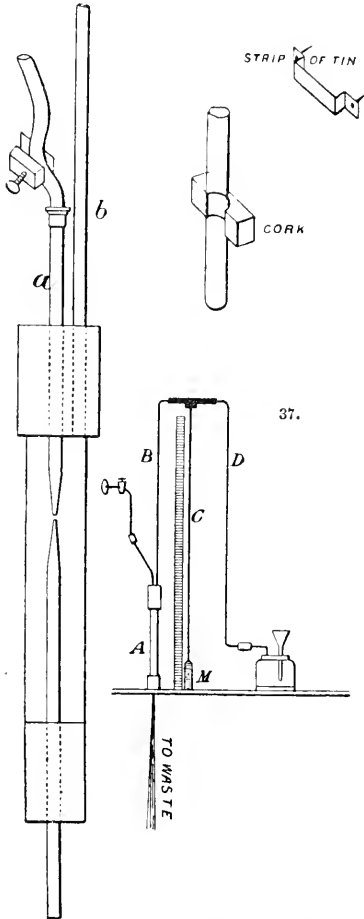

Vacuum pump for hastening filtration.

lower jet is not smaller than that of the upper jet; they ought to be the

2 cm., and a bore of only 4 mm. However, ordinary black rubber tube will do very well for most purposes.—(*Yearbook of Photography.*)

(h) Some precipitates are so exceedingly fine that the best filtering paper is incapable of retaining them. In such cases the difficulty may be overcome by stirring up with the liquid to be filtered a little finely-powdered French chalk (or paper pulp obtained by dissolving filtering paper in aqua regia and reprecipitating in water); this settling on the filter closes the pores of the paper still further, and prevents the passage of the precipitate. When filtering hot liquids which are very acid, or have a high specific gravity, much annoyance may be caused by the repeated breakage of the filtering paper. This can generally be prevented by supporting the apex of the filter on a strip of muslin laid across the funnel, or by using papers which have been steeped in 1.42 nitric acid for a few minutes, washed and dried, whereby the paper is greatly strengthened. For this purpose, also, an extra strong variety of filter paper has been introduced commercially, the peculiarity consisting in a network of linen threads interwoven with the substance of the paper during manufacture.

The ordinary funnel with sides at an angle of 60° is not adapted for very rapid filtration. The long French form, having a length about twice that of the widest diameter, yields much better results, and used in conjunction with a plaited filter paper gives the greatest rapidity of filtration which it is possible to obtain with the simple paper and funnel. Two forms of funnel, each the subject of a patent, have been introduced with the view of lessening the disadvantages of the ordinary 60° funnel. The first is furnished with straight projecting ribs on the interior, which to a great extent keep the paper from close contact with the sides, and this certainly aids filtration considerably. The second is of more recent introduction, and may be described as a funnel of the ordinary shape enclosing

the body of a slightly smaller funnel perforated all over with small holes, and kept from contact with the outer funnel by 8 projecting ribs, the whole being made of earthenware in one piece. The space between the inner and outer bodies of the funnel is closed at the top, and a circular hole is provided in the latter, which may be closed airtight by a stopper. The patentees claim that this funnel may be used for a variety of purposes besides that of ordinary filtration, such as vacuum filtering, washing precipitates automatically, dialysis, &c., besides being a great improvement on the usual pattern. The following is the result of a comparative experiment with the above funnel. Time required to filter 4 pints of liquid,—No. 1. Ordinary funnel, plain filter paper, 50 minutes. No. 2. Patent funnel, plain filter paper, 23 minutes. No. 3. Ordinary funnel, plaited filter paper, 8 minutes. The high price of the above funnel is its chief objection, otherwise it gives very good results.

The most perfect way perhaps of utilising a paper filter is that suggested by Dr. Symes. He makes a linen cone and attaches it at the top to a wooden ring resting on an earthen jar. The linen forms a support for the filter paper, and a suitable cover prevents evaporation.

There is one point to which great importance should be attached in the consideration of this subject, and that is that there is a certain material or combination of material best suited for the filtration of any given liquid, and much time may frequently be saved by carefully noting the filtering medium best adapted to each particular fluid. For instance, a strong infusion of poppy capsules precipitated by rectified spirit filters best through swansdown, liquid extract of bael through paper, a strong infusion of senna precipitated by rectified spirit through flannel, &c., and every liquid which presents any difficulty requires intelligent treatment according to its nature. One combination of filtering materials seems specially adapted

to the filtration of syrups, flannel coated with raw paper pulp. Syrups pass through such a filter with comparative rapidity, and the filtrate is as brilliant as it is possible to obtain it even through paper of the finest texture. The bag should be made of very coarse flannel, and filled with a mixture of paper pulp and water which has previously been boiled until the pulp is quite disintegrated. As the water runs through the bag the pulp is left as a uniform layer on its interior.

There are several methods of assisting filtration by producing a vacuum in the receiving vessel, e. g. with the Bunsen pump; also an arrangement for producing a partial vacuum by connecting the receiving vessel with a bottle full of water placed at a height and communicating with a similar bottle at a lower level. The upper bottle acts as an aspirator, and when empty the positions of the bottles can be reversed and the action rendered continuous. The pressure exerted by a column of liquid may be utilised in two ways, either to force the filtrate through in the usual direction, or to make it pass upward through the filtering medium. In the first case a reservoir is placed at a convenient height, from which proceeds a tube terminating in a ring or collar, to which the filtering bag is securely attached, the height of the reservoir determining the pressure on the contents of the bag. This method is very well suited for thick viscid liquids, which contain but little sediment, and which filter too slowly under ordinary atmospheric pressure. In the second case the filter is attached to the short limb of a siphon, so that the liquid passes in an upward direction through the filter, and herein lies its great advantage, viz. that the solid portion of the liquor, instead of settling on the filter and choking up its pores, tends to move away from it towards the bottom of the vessel.

The apparatus employed for centrifugal filtration consists of a shallow metal box supported horizontally on an axis, and capable of being revolved with great

rapidity by means of suitable gearing. Inside is a similarly shaped but rather smaller box made of perforated metal or gauze, and fitting into the outer case so as to leave a space all round. The inner case is lined with flannel, forming a bag into which the liquid to be filtered is poured. On setting the machine in motion, the liquid is powerfully forced against the sides of the flannel bag; the clear portion then passes through into the annular space between the two cases, and leaves the sediment behind in the bag. A high speed is necessary to obtain good results.

Of the various methods just described none lends itself more readily to the filtration of thick viscous liquids (never ending sources of difficulty when considerable quantities are concerned) than that known as "upward" filtration. In this, advantage is taken of the pressure of the atmosphere by using a long column of liquid to suck the filtrate through. The apparatus usually employed for carrying out this process consists essentially of an inverted open box or cone, over the mouth of which the filtering medium is stretched, the cone being connected at its apex with the short limb of a siphon. The advantages of this arrangement are that by lengthening the siphon leg the rapidity of filtration may be increased to any reasonable extent, and by its position the filtering medium is prevented from becoming choked up with deposit, the sediment tending to move away from the filtering surface rather than to settle upon it. If a liquid containing a suspended precipitate be allowed to rest, a zone at the surface becomes clear in a comparatively short time, whilst that near the bottom still remains turbid. As a comparatively clear liquid filters much more quickly than a thick and muddy one, the position of the filtering cone (which must of necessity be placed near the bottom of the containing vessel) in an upward filtration arrangement is hardly correct, as the filtrate is drawn from a layer of liquid which is much more turbid than that at the surface. The correct position of the filtering cone

is evidently at the surface of the liquid, so that only the clearest portion may have to pass through the filter, and full advantage be taken of the clarifying effect of subsidence.

In order to overcome the difficulties encountered, Bird devised the apparatus shown in Fig. 39 with a view of applying the principle of upward filtration, avoiding exposure to air at any stage of the process, and keeping the filtering medium in the most advantageous position, viz. at the surface of the liquid.

A is a stoneware jar, of about 2 gal. capacity, placed on a shelf at a height of 5-6 ft. above the vessel M. It is secured to a board C of suitable dimensions, perforated by a circular hole q . B is of wood, 3 in. wide, and also perforated by two holes x and r . C, A, and B are securely fastened together by a string or other suitable means. J is the filter proper, and consists of a circular box, closed at the top and open at the bottom, and about $\frac{3}{4}$ in. less in diameter than A. J is divided at the centre by a partition, which thus forms an air-tight chamber in the upper portion. The tube t passes through this chamber and communicates with the lower half of A, its upper end being connected to the glass tube H by rubber tubing. Over the open mouth of J is stretched the filtering medium, consisting of three layers, calico, paper, and flannel, the latter being on the outside. E is a bar of wood to which the glass tubes H and I are firmly attached, J, H, I, E forming a rigid system, partially counterbalanced at its centre of gravity by the weight F through the cord and pulley G, the whole being capable of free motion up and down, so that J rises and falls with the liquid in the interior of A. The tubes H and I work through the holes x , r , and q , which serve as guides. The weight F should be such that when A contains no liquid J just descends freely to the bottom of the jar. K is a piece of rubber tubing connecting I and L, so as to allow of the free motion of I. L is a glass tube passing into the bottle M

and twisted once as shown, near the bottom. A siphon and pinch-cock N, Z,

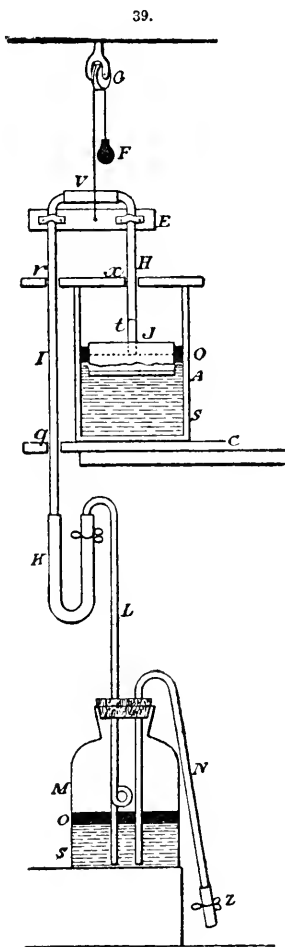

Upward filtration.

are required to draw off the filtrate from M.

If it is desired to start filtration, A is

filled with liquid, when, by the buoyant action of the air chamber in J, aided by the weight F, the filter rises to the surface. A cork is inserted in the bottom of L, and the end of the rubber tube V is removed from I; through V and I, I K L and H J are filled with liquid (preferably bright). The connection at V is again made and secured, and a layer of colourless heavy petroleum oil about $\frac{1}{3}$ in. deep is poured on the two surfaces O of the liquids in A and M. As soon as the end of it is enclosed, filtration commences and goes on continuously. The oil is of course unnecessary in the case of liquids which do not suffer by exposure to air. Glass jars, furnished with stop-cocks at the bottom, may be substituted for the vessels A and M with considerable gain in convenience. All joints must be bound with waxed thread or wire, and thick rubber tubing used, to avoid collapse of its walls and consequent stoppage of the flow; the filter J should also be well varnished with shellac dissolved in methylated spirit. The construction of this filter demands but a small amount of mechanical skill; it works continuously, requires but little attention, and perfectly protects the liquid passing through it from the action of the atmosphere at any stage of the operation.

EXPLOSIVES.

Strengths. — Lieut. Willoughby Walke, of the U.S. Artillery, has recently communicated to the Journal of the American Chemical Society an important paper on the relative strengths of modern high explosives, which is interesting as illustrating the considerable variation in the comparative strengths, not only of different explosives of acknowledged value, but of the same explosive manufactured at different times and under slightly different conditions. C. E. Munroe has already pointed out that the firing point of an explosive is also a very variable number. In his more recent experiments, a thin copper cartridge was placed in a molten

bath of tin or paraffin, the initial temperature noted by a thermometer, and the bath quickly heated until the explosive flashed off, when the temperature marked by the thermometer was again noted. The following table shows some of the results obtained:—

Description of Explosives.	Firing Point in deg. C.
Compressed military gun-cotton.	186-201
Air-dried military gun-cotton	179-186
„ „ „	186-189
„ „ „	137-139
„ „ „	154-161
Gun-cotton dried at 65° C. . .	136-141
Air-dried collodion gun-cotton	186-191
„ „ „	197-199
„ „ „	193-195
„ gun-cotton	192-197
„ „ „	194-197
Hydronitro cellulose	201-213
Nitro-glycerine	203-205
Kieselguhr dynamite, No. 1 . .	197-200
Explosive gelatine	203-209
„ „ camphorated	174-182
Mercury fulminate	175-181
Gunpowder	278-287
Hill's picric powder	273-283
„ „ „	273-290
Forceite, No. 1.	184-200
Atlas powder, 75 per cent. . .	175-185
Emmensite, No. 1	167-184
„ No. 2	165-177
„ No. 3	205-217

Lieut. Willoughby Walke, in his experiments, employed a Quinan pressure gauge for registering the pressures developed by the explosives, in preference to other methods used by the older investigators, as even the *crusher* used by Berthelot gave only approximate results, as shown by Sarau and Vieille. The instrument employed consisted of a heavy block of wood bolted to a cast-iron base, in which were 4 iron guides set around a 4-in. circle. A steel plate is let into the iron block flush with its upper surface, and a ring holds the guides in place at the top. The piston is a cylinder of tempered steel moving freely between the guides, and rests on a plug of lead which is to be compressed.

Composition.—The following table shows the composition of the more important kinds.

Name of Powder.	Sulphur.	Saltpetre.	Sodium Nitrate.	Potassium Chlorate.	Nitro-glycerine.	Gun-cotton.	Charcoal.	Sawdust.	Other Ingredients and Notes.
Bennett	×	×					×		Ordinary powder with 7 per cent of gypsum.
Lannoy	×	×						×	+ starch.
Davey	×	×							+ 27.5 tan.
Pyronome	20		52.5				18		+ 20 lignite.
Oxland	16		85				×		+ 18 dehydrated sodium sulphate.
Robert Dole ..	×	×							
Schwartz (I.) ..	9.2	48.6	26.5				14.7		
" (II.)	9.6	56	18.1				15		
Kup	9	66	8				16		
Budenberg	10	34	40				8		+ 4 lignite + 4 sodium tartrate.
Kellow and Short Spence	10	10	20	10			×		+ 64 tan. + sodium carbonate or starch.
Vynaud		2					22		+ 76 barium nitrate.
Neumeyer		×					×		+ potassium cyanide.
White powder ..				1					+ 1 potassium cyanide + 1 sugar.
Dynamite					78				+ 22 sand.
Dualme					80	20			
Rendrock		40			40				+ 13 cellulose + 7 paraffin.
Giant powder ..	8	40			36		8		
Vulcan	7	48			35		10		
Mica					52				+ 48 mica.
Hercules			1		77				+ 2 cellulose + 20 magnesium carbonate.
Electric					33				Rest unknown.
Dessignolles ..		50							+ 50 potassium picrate + charcoal if used for cannons or small firearms.
Brugères		50							+ 50 ammonium picrate.
Tonite						52.5			+ 47.5 barium nitrate.
Explosive gelatine					89	7			+ 4 camphor.
Atlas A.			2		75			21	+ 2 magnesium carbonate.
" B.			34		50			14	+ 2 magnesium carbonate.
Judson (No 2) ..	13.5		60		20		12.5		
" (No. 3)	16		64		5		15		
Rackarock				77.5	22.5				
Forceite					95	5			
Gelignite		32			56.5	3.5		8	
Pyrolite (I) ..	20	51					1.5	11	+ 6 sodium sulphate.
" (II.)	17	18	1.7					12	+ 77 barium nitrate.
Saxifragine (I.) ..							21		+ 76 "
" (II.)		2					22		+ 23 sugar + 2% potassium cyanide.
American powder		49							+ 2 tannin material.
Erhardt		1		1			4		+ 46 spermaceti + 168.5 antimony sulphide.
Hahn		367.5					18		+ 3 powdered galls.
Horsley				9					+ 2 oil + 5 sodium carbonate.
Spence		20					2	7	+ nitronaphthalene.
Roburite		×							
Carbodynamite ..					90		10		
Meganite			×		×	×			
Fortis	×	×							+ tan.
Cordite or Abel ..					92	8			
Green powder ..				70					+ 20 picric acid + 10 potassium cyanide.

NOTE. × denotes that the amount of ingredient present is unknown. (*Industries.*)

The piston weighs $12\frac{1}{4}$ lb., and the explosive is placed in a parabola-shaped cavity at its top. The shot was also made of tempered steel, 4 in. diameter and 10 in. long, and weighed $34\frac{1}{2}$ lb.

The instrument is worked in the following manner:—The lead plug is placed upon the steel plate, the piston is placed gently upon it, and the shot next lowered upon it. The fuse is lighted, and the charge, in exploding, throws out the shot and compresses the lead plug. The accuracy of the test is based upon the assumption that the lead plugs are of uniform density and homogeneous in structure, and the author, by cutting his plugs from bars of pure lead manufactured from large masses of metal at a high temperature, believes that the error from want of these conditions is reduced to a minimum. The amount of compression is finally expressed in ft. lb. by plotting the actual compressions measured by the Quinan gauge against the work actually done on the lead by known pressures. The author, however, did not plot out his results in this manner, but preferred simply to use the method for determining the relative strengths of the explosives examined, instead of calculating from the observed compressions the absolute pressures exerted. The following table gives a summary of the results obtained, the order of strength being given in numbers, nitro-glycerine having assigned to it the value of 100:—

Name of Explosive.	Compression of Cylinder, In.	Order of Strength.
Explosive gelatine (made by Vouge's process)	0.585 ..	106.17
Hellhoffite	0.585 ..	106.17
Nitro-glycerine (old)	0.551 ..	100.00
Nobel's smokeless powder	0.509 ..	92.38
Nitro-glycerine (fresh)	0.509 ..	92.37
Explosive glycerine (made from above)	0.490 ..	88.93
Gun-cotton (1889)	0.458 ..	83.12
„ (1885)	0.458 ..	83.12
Nitro-glycerine (made by French process)	0.451 ..	81.85

Name of Explosive.	Compression of Cylinder, In.	Order of Strength.
Gun-cotton (laboratory)	0.448 ..	81.31
Dynamite, No. 1	0.448 ..	81.31
Dynamite de Tranzl	0.437 ..	79.31
Emmensite	0.429 ..	77.86
Amide powder	0.385 ..	69.87
Oxonite (from fused picric acid)	0.383 ..	69.51
Tonite	0.376 ..	68.24
Bellite	0.362 ..	65.70
Oxonite (picric acid not fused)	0.354 ..	64.24
Rack-a-rock	0.340 ..	61.71
Atlas powder	0.333 ..	60.43
Ammonia dynamite	0.332 ..	60.25
Volney's powder, No. 1	0.322 ..	58.44
Volney's powder No. 2	0.294 ..	53.18
Melinite	0.280 ..	50.82
Silver fulminate	0.277 ..	50.27
Mercury fulminate	0.275 ..	49.91
Mortar powder (Dupont)	0.155 ..	23.13

(Industries.)

FIREPROOFING. (ii. 289).

Buildings.—In the course of a recent lecture by Dr. Tanner before the Louisville Board of Underwriters, the subject of fires caused by steam pipes and hot-air flues was discussed at considerable length. In the course of his address, Dr. Tanner spoke as follows:

James Braidwood, who was for many years chief of the London Fire Brigade, made the startling statement in 1846 that it was his belief that “by long exposure to heat not exceeding 212° F. timber is brought into such a condition that it will fire without the application of light. The time during which this process will go on until it ends in spontaneous combustion is 8–10 years, so that a fire might be hatching in a man's premises during the whole time of his lease without making any sign.” Among the many instances cited by Braidwood in support of this statement, is one to the effect that a fire in the Bank of England was traced to a stove which was resting on a cast-iron plate

1 in. thick, this in turn resting on concrete $2\frac{1}{2}$ in. thick, which was supported by wooden joists, the joists under the stove igniting. If this is a cause of fire, then the majority of houses heated by means of steam, hot water, and hot air are in constant danger of fire from spontaneous combustion, since the general impression prevails that the pipes and flues for heating can with impunity be placed in contact with timber.

In examining this cause of fires, the first question is whether wood will char at as low a temperature as 212° F. In tearing down houses for the purpose of rebuilding, the timber in contact with the heating pipes and flues has often been found charred. Charcoal is made for certain purposes in the arts at 300° F. As the result of experiments performed in the laboratory, small pieces of white pine heated a few hours in an air bath at a temperature of 300° F., were partially converted into charcoal. Considering these facts, it must be admitted the temperature of 212° F. is sufficient, if applied for a long time, to convert wood into a partially burned charcoal. Accepting this as a fact, the next point to consider is the degree of heat at which charcoal will ignite. Made from the same wood at different temperatures, the product ignites accordingly; that is, if made at a low heat, it fires from a correspondingly low temperature. It has been determined experimentally that charcoal for making powder, when made at 500° F., would fire spontaneously at 680° F., and when wood has been carbonised at 260° F., a temperature of 340° F. only was required for spontaneous ignition. Under certain circumstances, charcoal at a temperature of 500° F. even will ignite when heated to 212° F.

So far the discussion of heating pipes and flues as a cause of spontaneous fires has been upon the false idea that they are never heated beyond 212° F. Under the ordinary pressure of the atmosphere, as when water is heated in the open air, it boils at 212° F., but if it is heated under pressure, the boiling temperature increases accordingly; for instance, water

boiling at a temperature of 212° F. is under a pressure of 147 lb., equal to a column of water 1 in. square and about 30 ft. high; if the pressure is increased to two atmospheres, the temperature required will increase to 249° F., and so on, so that when a steam gauge registers 60 the actual pressure is 75 lb., and the temperature at which the water is boiling as high as 307° F. The higher the house, the greater must be the pressure, and hence the higher the temperature at which the water boils, and it follows that the pipes must heat accordingly, and it is stated that in some systems of hot water heating the pipes have the water started through them at a temperature of 350° F.

By the system of low-pressure steam heating, which is far the most generally used, the pressure is only 5-7 lb. above that of the atmosphere, with a corresponding temperature of 228° to 235° F.

Then, when furnaces are used for heating, the temperature in a flue has been found to be 300° F., at a distance of 50 ft. from the fire. Couple these figures with those given in reference to the heat necessary to produce charcoal and cause its ignition, and it must be admitted that these pipes and flues for heating are responsible for many fires. The application of these facts is as follows: After long exposure, the wood in contact with the heating pipes and flues is changed on the surface to charcoal. During the warm season this charred surface absorbs moisture from the air; then in the fall comes a cold spell and heat is turned on, when the moisture is driven from the pores of the charcoal, leaving it in a condition to readily absorb gases. The cold abates and the heat is lowered; fresh air in abundance then passes into the confined spaces where the pipes are generally placed, rapid absorption of oxygen from the air by the charcoal follows, with heating and spontaneous firing, as already explained.

The body of the timber is heated, and this heat prevents too rapid cooling of the charred surface when the fresh air passes in, otherwise the charcoal would

be placed under circumstances unfavourable to ignition. The experiment of burning iron filings in the flame of a spirit lamp illustrates the influence of division upon the igniting point; now, if the iron is in a pulverulent state, as when made by hydrogen, it will, when freshly made, ignite to a red heat when shaken into the air. Then, if it is true, as stated by an English scientist, that the oxide of iron, if placed in contact with timber and excluded from the air, and aided by a slightly increased temperature, will part with its oxygen and be converted into very finely divided particles of metallic iron, here is another cause of fires from heating pipes. For during the summer the pipes rust, and then when heated the rust is reduced, leaving the metallic iron in the same condition as that made by hydrogen.

The temperature is lowered, fresh air appears, and oxygen is rapidly taken up by the finely divided iron, each particle heating so rapidly as to give a red heat to the mass. As carbon is able to overcome quite strong chemical affinities, and will reduce the oxide under strong heat, theoretically it is possible, and the authorities all tend to prove it. Considering all the points bearing upon hot water and steam pipes, also heating flues, an explanation is found of the great number of fires occurring at the approach of winter, and which are reported as from defective flues, supposed incendiary origin, or causes unknown. Steam pipes packed in sawdust or shavings to retain the heat while steam is conveyed to a distance have given fires. One peculiar and important instance is on record of a fire from steam pipes. In the drying room of a woollen mill, a pine board was placed some 3-4 in. above the steam pipes to prevent wool from falling upon them. A fire followed, and after being put out, a careful examination determined to the satisfaction of all, that the heat of the pipes had distilled the pitch from several knots in the pine board, and this dropping on the pipes had ignited and caused the

fire. The illustration needs no comment, as the lesson is too plain to need pointing out. (Dr. Tanner.)

Fireproof Whitewash.—It is found that a most effective composition for fireproofing exterior surfaces may be formed by slaking a sufficient quantity of freshly burned quicklime of the best grade, and when the slaking is complete there is added such an amount of skim-milk, or water in its absence, as will make a liquid of the consistency of cream. To every 10 gal. of this liquid are added, separately and in powder, stirring constantly, the following ingredients in the order named: 2 lb. alum, 24 oz. subcarbonate of potassium or commercial potash, and 1 lb. common salt. If white paint is desired, no further addition is made to the liquid, though the whiteness is found to be improved by a few oz. plaster of Paris. Lampblack has the effect of giving a number of shades from slate-colour to black. Whatever tint is used, it is incorporated at this stage, and the whole, after being strained through a sieve, is run through a paint-mill. When ready to apply, the paint is heated nearly to the boiling point of water, and is put on in its hot condition. It is found that the addition of a quantity of fine white sand to this composition renders it a valuable covering for roofs and crumbling brick walls, which it serves to protect.

Fireproof Floors.—At a meeting of the Society of Engineers, a paper was read on the above subject by G. M. Lawford. After alluding to the concrete floors and roofs of the Romans, the history of fireproof flooring was briefly traced, showing how the brick arch gradually gave way to the different applications of concrete and wrought iron now in general use. The objects of fireproof flooring were stated to be as follow:—

(a) To divide the building into a complete series of fire-resisting compartments.

(b) To gain strength, and in so doing to avoid lateral thrust on the walls,

and to distribute the weight equally over them.

(c) To render the floors soundproof, as well as fireproof, and

(d) To secure the building from both dry rot and damp.

Detailed descriptions were then given of the following types of construction as instances of modern practice:—

(1) The concrete arch floor, illustrated by Dennett's and Wilkinson's systems.

(2) The flat, or suspended concrete floor, illustrated by Dawnay's, Lindsay's, and Gardner's systems.

(3) The arch block, or American floor, illustrated by the Doulton-Peto system.

(4) The flat brick, or French floor, illustrated by Homan and Rodgers' system.

(5) The solid wooden floor, illustrated by Evans and Swain's system.

Several other systems were briefly described, as having been introduced from time to time with varying success, including those now in vogue in French and American practice.

After contrasting the individual floors, and the different types of construction, the two leading features for consideration were stated to be:—

(1) Which system gave most protection to the iron work supporting the floor?

(2) Which of the different materials employed gave most resistance to fire?

On the first question, the solid wooden floor (Evans and Swain's), requiring no iron work for spans up to 30 ft., was considered to be the best; but next to it, and certainly in advance of the others on this point, was placed the Doulton-Peto floor, the hard burnt clay blocks, with their overlapping bases, forming a most efficient protection to the joist. There was little to choose between the arched and flat concrete floors, as in the former there were comparatively few joists dependent on a plaster covering, while in the latter there were 4 to 6 times

the number of joists, but completely encased in concrete; except in the case of Homan and Rodgers' floor, in which both T-irons and joists depended on a plaster covering. On the second question a comparison was made between concrete in the different forms employed, brick work, terra cotta, and solid wood, and it was stated that for fire-resisting concrete, broken brick was preferable to coke breeze, as the action of intense heat tended to make burnt clay harder still, while coke breeze would calcine and burn away. The flat brick and terra cotta floors were both open to the objection that the floors were constructed in layers of materials differently affected by heat; but the terra cotta floor, giving better protection to the iron work, was entitled to the preference, while the solid wooden floor, though inflammable by nature, would probably give as much resistance as either brick, concrete, or terra cotta floors. A floor of the flat brick type, designed and patented recently by William Lindsay, jun., deserved recognition, as apparently fulfilling the two requirements laid down by the author; but as it had not yet been used, criticism would be premature. It was, however, observed that the cost and weight were less than those of any of the similar floors in the appended table. The conclusion arrived at finally was, that although the floors described were capable of giving great resistance to fire, retarding its action by confinement, and in this way giving greater chances of extinction, a brick arch was the only absolutely "fireproof" floor, and that it would be more correct to describe the others as "fire resisting."

The houses of the fireproof towns of the River Plate are built as follows, the material being brick. Each floor, and the roof (which is flat), is supported by joists of hard wood, about the same distance apart as in this country; across these are laid flat rails of the same, and the spaces between these are bridged over by thin bricks $13\frac{1}{2}$ in. long, their ends resting on the rails;

TABLE GIVING RELATIVE COST, WEIGHT, AND SAFE LOAD OF A FLOOR, 12 FT. BEARING, IN THE DIFFERENT SYSTEMS DESCRIBED ABOVE:—

Arch construction.	Cost per sq. yd.		Weight per sq. ft.			Safe load per sq. ft.	Length of arch.	Span.
	Exclusive of joists.	Inclusive of joists.	Exclusive of joists.	Inclusive of joists.	ft.			
	s. d.	s. d.	lb.	lb.				
Dennet	6 9	9 3	50	54	2	12	10	
Doulton	6 6	9 0	30	34	2	12	6	
Wilkinson	6 0	7 6	50	52	2	12	10	
Flat construction.							Bearing	
						ft.		
Dawney	—	7 0	—	40	2	12	Immaterial.	
Gardner	—	7 0	—	46	2	12	..	
Homan and Rodgers	—	7 0	—	35	2	12	..	
Lindsay	—	7 0	—	44	2	12	..	
Evans and Swain ..	10s. 6d.*	..	20 lb.	..	7	12	..	

* No joists required.

(G. M. LAWFORD).

another layer of bricks is then laid with lime, and generally on this a layer of flat tiles. The roof is exactly the same, but has a slope of about 1 in 30. Then the doors and windows have no boxes, but simply frames, which are set up on building the walls, and built in. There is no lathing, nor wainscot, nor skirting of the bottom of the walls. And all the wood is of the hard and hardish kinds, slow to ignite. Thus the houses are, as already said, absolutely fire-proof. (T. Gibson.)

Theatres.—The points which, in the opinion of the Society of Arts Committee, should be attended to in the construction, &c., of theatres, may be classified as follows:—(a) Structural (including arrangements for heating, and with special reference to exits). (b) Arrangement and treatment of scenery and accessories. (c) Arrangement of illuminating appliances, and stage effects involving the use of gas, pyrotechnic compositions, &c.

(a) Structural.—These are certainly the most important of all. First, the building itself should be constructed in a manner calculated to check the spread of a fire. To this end it should be divided as much as possible by fire-proof partitions, and above all, there should be a division between the stage and the auditorium, extending from the base to the roof. The opening from

the stage in this partition should be defended by a metal screen, or a fire-proof curtain of some sort, though it appears, from the experience of the fire at the Berlin National Theatre, that the iron curtain actually tore down part of the wall, so that this means of protection has its objectionable features. Perhaps the curtain devised by Capt. Shaw, which can, in a very few minutes, be saturated with water, would be effective to this end. There should be an ample water supply, either by reservoirs at sufficient height, or by connection with the street supply—the latter for preference. Hydrants, and other proper fittings, should be provided in abundance. The Committee have had a favourable account of the action, in some warehouses in America, of an arrangement for deluging any part of a building by a shower of water from fixed perforated pipes. Means should be provided for carrying off smoke and heated air, in case of a fire breaking out on the stage or amongst the scenery, so that they may pass away, instead of being, as would now nearly always be the case, drawn into the body of the theatre by the draught usually existing. It is desirable that a theatre should be, as far as possible, separated from adjoining buildings, especially from buildings in which any trade or business is carried on likely to lead to fires. The same

provision is also of importance with regard to exits, it being of the greatest consequence that a theatre should discharge its audience into more than one street, even, if possible, into more than two. The different parts of the theatre should have different exits leading right out to the street, exits bringing streams of persons together being specially dangerous. Such exits should increase in width outwards, and should be free from interruption or impediment of any character. Steps in passages, either ascending or descending, should be avoided, and any other obstruction likely to cause people to fall. All doors should open outwards. Staircases should be properly fitted on both sides with hand-rails. As regards heating, it does not appear that special arrangements are generally adopted for heating theatres, except by means of ordinary fire-grates in refreshment rooms, lobbies, &c. Should the electric light come into general use for lighting theatres, it is possible that they will require to be specially warmed, in which case the usual precautions will have to be employed.

(b) Arrangement and treatment of scenery and accessories.—As regards the scenery and the lighter sort of costumes, there seems to be no doubt that measures ought to be taken to render these uninflammable, or at all events, not easily inflammable. For fabrics, the best material seems to be tungstate of soda, and this has been successfully employed in some theatres. Henderson, at that time the proprietor of the Criterion Theatre, giving evidence before the House of Commons Committee of 1877, said that he used it, and that there was no difficulty in its use as regards new scenery; to old scenery, he said, it could not be applied. There appears to be no reason why the woodwork of scenery should not be treated with silicate of soda, either with or without a lime-wash.

The scenery of some London theatres is now treated with some of the more recently invented preparations, most of which, it is understood, have a silicate

or a borate for their basis. The effect of all such preparations is, that it coats the articles, or, in case of fabrics, the fibres of the articles, with a non-inflammable substance. This does not prevent the evolution of gas from the material when sufficient heat is applied, and the gas thus evolved takes fire, and burns. When the source of external heat is removed no more gas is evolved, and combustion ceases. Thus it may be said that the article will burn when exposed to sufficient heat, but has not, in itself, the power of supporting combustion. One effect of this is, that it is very much more difficult to set such materials on fire, and this alone is sufficient either to prevent the breaking out of fire at all, or to render it much easier to deal with after it has broken out.

(c) Arrangement of illuminating appliances, and of stage effects involving the use of gas, pyrotechnic compositions, &c.—There is not much to be said about the ordinary lighting arrangements. In all theatres they are generally under the control of a special gas-man. It is desirable that precautions should be taken for the ventilation of places in which the meters are fixed, generally underground cellars, to avoid the risks of explosions.

When electrical illumination is employed, the necessary precautions should of course be taken; in fact the rules laid down by the Society of Telegraph Engineers apply equally well to theatres as to other buildings. Whatever system of illumination may be employed, whether gas or electricity, it is absolutely necessary that oil or candle lamps should be fixed up in the passages, and near the doors, so that, in case of the failure of the ordinary lighting arrangements, the audience may not be left in the dark. This is now done in many theatres, and ought to be done in all. Curiously enough, it has happened that these lamps have proved a source of danger, as a theatre in Hungary is reported to have been burnt by one of these "alternative" lamps.

The lighting arrangements for the stage are often very dangerous. The rules which now exist as to the use of naked lights upon the stage ought to be strictly adhered to. All lights should be, and in many theatres are, carefully protected: the footlights should have a grate before them; wooden battens over the stage, carrying rows of gas lights, should never be allowed.

Small accidents have not unfrequently occurred from the careless use of the oxy-hydrogen light. This light, when carefully employed, is perfectly safe, but in the hands of careless or inexperienced persons it is liable to give rise to explosions of a dangerous character. The causes of many of the explosions which have occurred, not only in theatres, but during other exhibitions where the light has been used, have not always been traced, but probably in many cases they are due to the gases having become mixed in one of the bags. A bag in which a little hydrogen remained may have been, by mistake, filled with oxygen, and thus a mixed gas of a very explosive character produced. Another source of these explosions is sudden alteration of pressure upon the bags, by which the mixed gases are drawn back into one of the bags, when a similar result occurs. It would be well if the very simple device were employed of storing the gases, when the ordinary coal-gas mains are not employed, or the oxygen gas when they are, in proper gas-holders and outside the walls of the theatre, laying the gas or gases on in the same way as ordinary illuminating gas is had on.

The use of pyrotechnic compositions is a common source of danger, and it is believed that many of the most serious fires are due to them. Portions of the material are left about after the conclusion of the performance, become ignited, and the result is a fire. Some of these compositions have, moreover, been proved to be capable of spontaneous ignition. Whenever these materials are used—and it would probably be useless to attempt to stop their use—

the greatest precautions ought to be taken. In some places, burning houses have been introduced on the stage. This is certainly a most dangerous practice, and might well be forbidden.

Extinguishing Compounds and Apparatus.—Prof. Silvanus P. Thompson, in a recent lecture, says that nothing but a self-acting or automatic system, which will operate at the right moment and at the very spot, without the intervention of any human hand, will meet the case.

Modern automatic appliances for the prevention and extinction of fire may be grouped under the following heads:—(a) automatic sprinklers; (b) automatic fire-doors; (c) automatic alarms; (d) miscellaneous appliances.

(a) Automatic Sprinklers:—Foremost and most important of modern appliances stands the automatic sprinkler. Briefly, it is a species of self-acting valve connected with a system of water pipes placed in the ceiling of a room, which, on the outbreak of a fire, open and distribute water in a shower of spray exactly at the place where the fire breaks out. It is also usually arranged so that, whenever it is called into operation by the heat, it sounds an alarm bell, and summons aid to the spot. It is both fire extinguisher and fire alarm in one. Concerning it, Edward Atkinson, president of the Boston Manufacturers' Mutual Fire Insurance Company, says, "we consider the automatic sprinkler the most valuable auxiliary appliance, the best fire detector, the watchman who never sleeps, and the device which is least likely to be out of order when needed." The saving effected in New England alone during 8 years by the introduction of sprinklers is calculated to amount to 300,000*l.*, and their use is extending every day. The introduction of sprinklers reduces the risk of conflagration by fire to less than a twentieth part.

The earliest suggestion for the automatic distribution of water in a building appears to have been made in 1806 by John Carey, of London, who took out a patent for "the extinguishment of fires

in gentlemen's apartments and warehouses" by means of rose sprinklers connected by pipes with a rain-water tank. Valves weighted to open, but held back by a combustible cord, were placed near the ceiling, so as to burn and turn on the water. A few years later, Sir Wm. Congreve took out patents for a system of distribution of water by bulbs, roses, or perforated pipes, supplied by water-mains through valves operated from outside. He also proposed to work valves automatically by cords, which were secured with "a cement fusible at 110° F. or less."

In 1852, William Maccaboy proposed a kind of sprinkler, in which the water was distributed by a rotating "mill" like a Hero's engine, covered with a cap of lead, guttapercha, or fusible alloy. Rotating sprinklers have been subsequently patented by Granger, Parmelee, and others.

In 1861, Louis Roughton patented a sprinkler having a rose-head with a neck plugged with a fusible substance, such as fusible alloy, or a mixture of wax, resin, and stearine.

In 1864, Captain A. Stewart Harrison, of the 1st London Engineers, produced an excellent form of automatic sprinkler, which embodied a good many of the principles in the more recent forms. Harrison's sprinkler consisted of a rose, through the perforations of which the water would be forced; but an internal valve held back the water, the valve itself being secured by solder. But it should be noted as an important point that Harrison secured the valve at the lowest point of the sprinkler, outside the rose, by a stem, which passed downwards through the sprinkler.

Another form of sprinkler, introduced by F. W. Whiting, has a conical or hemispherical rosette, covered by a thin metal cap, soldered all round the edge. The water pressure tends to tear the soldered flanges apart.

It may be here remarked that 100 sq. ft., i. e. an area 10 ft. square, forms a convenient unit of reference in connection with the distribution of water by sprinklers.

There were several powerful objections to the methods adopted up till that time. With impure water the perforations of roses or pipes were liable to choke; and in the case of iron pipes, rust produced the same effect. The ingenuity of inventors was called out to meet these difficulties. Harrison countersunk the orifices in his rose; Whiting patented a plan of letting eyelets of brass into the orifices; Burritt devised a method of dislodging sediment or dust, by means of a thimble with a rounded end, which when detached by the melting of the solder, is churned round inside a perforated rose by the action of the water.

A more serious defect was that the water in the sprinkler or pipe, by its near presence to the solder, abstracted the heat and delayed the opening of the valve. This had indeed been positively obviated in the forgotten sprinkler of Harrison, by the interposition of a block of wood between the water-valve and the soldered joint on the stem.

Another defect arose in some cases, where rubber was used as the material of the valve, from the clogging of the valve on its seat. Woodbury, who made a most exhaustive series of tests for the Boston Manufacturers' Mutual Insurance Company, on sprinklers of all kinds, states that it required a pressure of 65 lb. per sq. in. to make some of these valves open.

In 1875, the Boston Manufacturers' Mutual Company issued a pamphlet recommending sprinklers to their clients, although the chief forms to that time were comparatively imperfect. But their use spread rapidly from that date.

In 1874, H. Parmelee introduced a sprinkler which, though now superseded by more sensitive arrangements, did good service, and is still in considerable use. It consisted of a metal cap sealed down with fusible solder over an upright revolving turbine-jet. At a pressure of 10 lb. per sq. in. this sprinkler discharges $1\frac{1}{2}$ cub. ft. of water per minute.

The obvious requisites of a good sprinkler are that the solder should fuse at a low and well-defined temperature, without any appreciable prior

softening; that the mechanism should not be liable to get out of order or stick; that the parts opened by heat should be capable of ready replacement without skilled labour; that there should be no leakage at the valve; and, lastly, that the quantity of solder to be melted should be small, and so placed that it is not cooled by contact with too great a mass of metal, or exposed to the drip of the opening valve.

Now, the Parmelee sprinkler takes a considerable time to open—over two minutes usually—owing to the length of the solder seam, and the mass of metal near it; yet concerning it, Atkinson says:—"The Parmelee sprinkler is

sitive sprinkler, what result may we not expect from the later forms of sensitive types of sprinklers? More than 160,000 of the Parmelee have been used in the States, and several mills have been fitted with them in England.

The sprinkler invented in 1881 by Frederick Grinnell showed a marked advance in many details, and soon superseded the Parmelee. Each sprinkler is calculated to supply an area of 100 ft. The valve, a leaden disc affixed to the centre of a larger disc of brass, is held up against the valve orifice by a system of two curved levers, the lower of which is secured by fusible solder at its lowest point to a light

40.

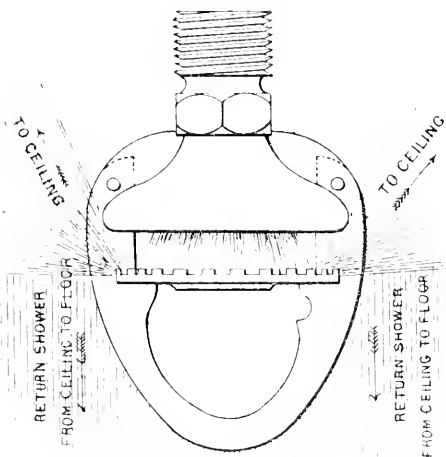

Grinnell sprinkler, open.

41.

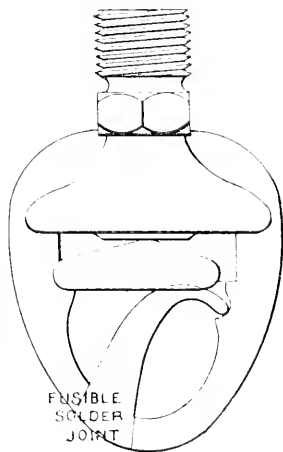

Closed.

shown, by the tests made by Woodbury, to be about the least sensitive head on the list, and the least in capacity of discharge; and yet the whole experience with the Parmelee sprinklers has been a success, the discharge of water has sufficed, and we have no record of a fire getting away from them."

If such is the fact with the least sen-

metal frame (Figs. 40-42). The valve-seat is itself made elastic by the device of fixing it in the centre of a diaphragm of thin, hard metal, perforated for that purpose; and the pressure of the water upon the diaphragm keeps it tight against the valve. The larger disc attached to the valve-disc serves as a deflector. When the solder is melted, the levers fly apart, and the valve and

deflector drop about $\frac{1}{2}$ in., leaving space for the water to escape. It dashes against the disc, which is notched, and slightly dished at its edges, and is then deflected upwards in spray towards the ceiling, whence it falls to the floor.

42.

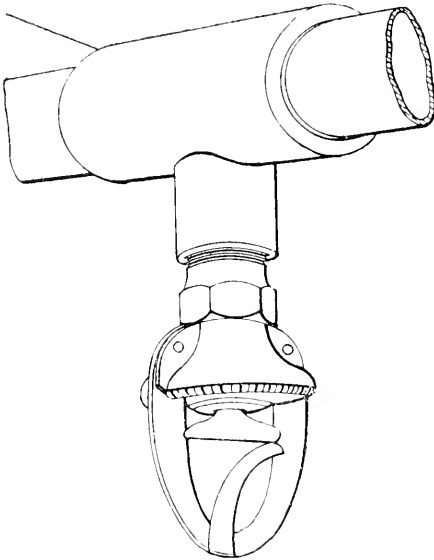

Grinnell sprinkler in position.

When the sprinkler has worked, it requires to be re-soldered. It seldom requires more than 15 seconds to elapse before the levers fly under the influence of a direct flame. With an ascending hot column of air, the sprinkler seldom waits for a whole minute before it works. In the very short time that has elapsed since this invention was introduced, it has entirely superseded the Parmelee. There are now more than 300,000 of these in the States, and more than 30,000 in Great Britain, chiefly in the Lancashire cotton district, but also in a number of factories and warehouses in London.

The success of the sealed Parmelee and the sensitive Grinnell sprinkler have been such as to arouse the emulation of inventors to produce other forms of sprinkler. In the States the sprinklers of Harris, Brown, Bishop, Burritt, Rutherford, and Walworth are more or less known, though in less extensive use than either the Parmelee or Grinnell forms. In the Harris, Brown, and Burritt (sensitive) forms the valve is held up by a soldering which holds up the valve-stem somewhat as in Harrison's original plan. In Rutherford's sprinkler a pair of levers, clamped by a bit of fusible tube, hold up a rubber ball. In the Walworth sprinkler the valve-stem is held up by a cam worked by a lever which is either soldered to the body of the sprinkler, or else clamped by an oval link of fusible metal. This latter device is good in so far as it enables the sprinkler, after working, to be closed up again by merely slipping on another ring without the need for skilled labour or the removal of the sprinkler from the ceiling; but the oval ring of alloy is liable to distension and fracture, as the alloy is somewhat brittle, and will not stand

much tensile stress.

Indeed, the question of alloys must be considered from several points of view, as the most fusible alloy does not necessarily possess the greatest tenacity or the most sharply defined melting point. A piece of Grinnell solder was found to fuse at 165° F.; it was tough and even flexible; whilst a Walworth link which melted at 161° F., was not nearly so tough. Professor Guthrie's "eutectic" alloy, which fuses at 159° F., was not found to be so tough or to have so sharply defined a melting point as some alloys of slightly higher melting point. Of course it is an

advantage, from the point of view of sensitiveness, to work with an alloy that has a very low melting point; but it must not be so low as to risk being melted with the ordinary temperatures at the ceiling of a gas-lit room. Obviously, an electrically-lighted mill may be fitted with sprinklers that are more sensitive than those which can be used in gas-lit mills. Conversely, in drying houses and store-rooms, special solders with higher melting points are preferred.

invention of Sidney Smirke, architect, a valve is used resembling the valve of the Victor system presently to be explained, and the water when admitted by the valve is forced into the narrow annular space between two metal dishes, the upper one of which is capable of adjustment.

Ingenious sprinklers have been invented by Philip Jolin, engineer, of Bristol (Figs. 43, 44.) The form

43.

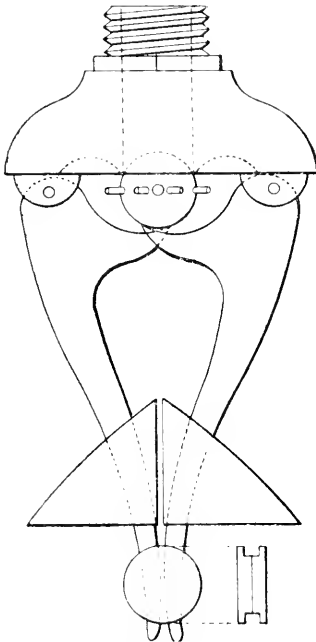

Jolin sprinkler.

44.

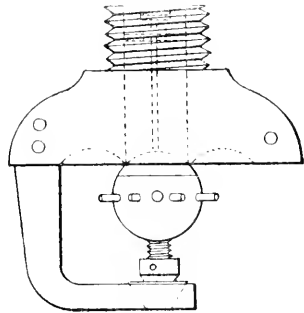

Jolin sprinkler.

Progress in the perfection of the automatic sprinkler has not been confined to the other side of the Atlantic, and in addition to the American forms, there are several English forms well worthy of notice. In one of these, the

which promises best success has a lead-topped ball valve held up against the supply orifice by a pair of springy metal levers, which are clamped below by a fusible clamp. This clamp, which is readily replaced after the sprinkler has worked, is of an ingenious form, in which the solder is relieved of all direct tearing stress. It consists of a button, made in two parts, soldered at the edges right and left, and admitting the ends of the levers by an aperture which passes from top to bottom. This bottom is protected beneath a divided cone, which serves partly as a deflector for the water, partly as a protector to the clamping button, partly as a collector of the ascending hot air. When the lever opens, the valve ball drops a short distance and operates as a deflector. In another form (Fig. 44), a small truncated cone of alloy holds up the deflecting ball to its seat. In yet

another form, the levers are held together by a double link of brass (Fig. 45), the two parts of which are prevented from parting by a wedge of alloy, subjected only to compressing and shearing stresses, not to tensile stresses.



Jolin link.

Closely allied to the automatic sprinkler proper, is the system of sprinkling by perforated pipes through an automatic valve. This system, first made practical by Leonard, has lately come to the front under the name of the "Victor" system. As shown in Figs. 46, 47,

the valve is held up, as in Harrison's plan, by a soldering at the lower end of the stalk, and this soldering

46

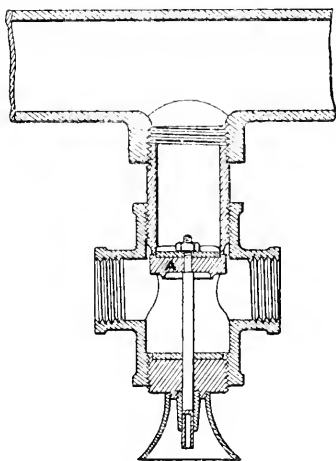

Victor valve, closed.

is surrounded by a collecting cone of metal. On the fall of the valve, the water rushes into the long pipes, and is distributed in jets through its perfora-

tions. One valve suffices for 400-500 sq. ft. of surface protected.

There are several useful adjuncts employed in connection with these appliances. Grinnell fixes in his main pipe, between the supply tank and the

47.

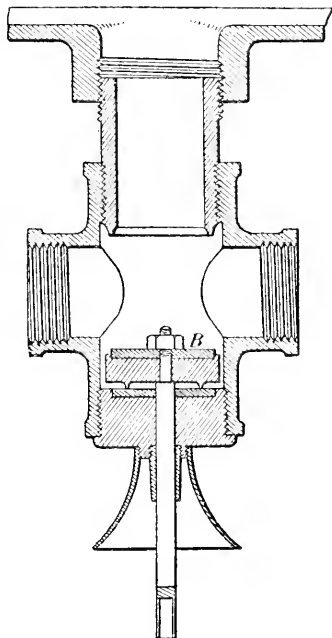

Victor valve, open.

sprinklers, a valve arranged to be moved by the water whenever, on the opening of any sprinkler, the pressure is relieved. This valve then sets a loud gong in motion, and sounds an alarm. Electric alarms are also used in connection with sprinklers.

(b) Automatic Fire-doors.—Fire-doors may be made automatic. The Boston Company have investigated this question by their experts, and have pronounced most emphatically against iron

fire-doors. They say they curl up and keep out the water and men, and allow the fire to spread. They announce the opinion that a well-built wooden door, protected by tin plate on each side, is much better: the wood will not burn, but it becomes charred, holds the tin together, and keeps out fire better than an iron door would. They make it automatic in the following way:—The door is arranged to slide shut on an inclined track, and is kept open by a rod, which is made with a scarf-joint in two parts, united in the centre, inside a copper ferrule or sleeve which nicely fits the two ends of the rod. The joint is shown in Fig. 48. This sleeve is made

(c) Electric Alarms and Devices.—Edward Bright's arrangements for fire alarms are excellent things. There are several more recent: a very good fire alarm, by Martin; another, known

50.



Grinnell link.

as Rowley's; and Grinnell has applied an electric alarm in the form of a fusible link. He introduces somewhere into the electric circuit a little link,

43.

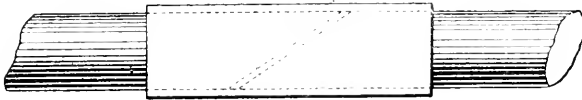

Scarf-jointed rod united by sleeve.

in longitudinal halves, which are secured together with fusible solder. The ends of the rod where they come together are cut at an angle of 45° , and therefore tend to force the sleeve open when the solder melts. One end of the rod is fastened to the door, and the other end to the door-frame. Another device for holding a fire-door open is the fusible link.

The oval link (Fig. 49) used in the Walworth sprinkler is unsuited to stand a tensile stress. The Grinnell link (Fig. 50) is well suited for this purpose; it consists of two links stamped in thin brass, laid over one another so as to overlap throughout $\frac{2}{3}$ of their lengths; they are soldered together, and the central portion is filled up with a bit of copper wire and with solder. These links are introduced into some convenient part of a cord which holds up a weight, the falling of which releases the fire-door.

49.



Waiworth link.

which may be made of a thin strip of alloy, in some place near the ceiling; on melting, it breaks the circuit and rings an electric bell, if it is arranged to work in a closed circuit, and there you have a fire signal of the first order. This is used in England. There is another open circuit system used in connection with small Grinnell installations; it is arranged so that when the heat reaches a catgut band strained inside a copper tube it contracts, and makes contact between two strips of metal which go to an electric bell.

Lorrain's is based upon a system for making an electric contact. It is a little thermostat arrangement, with a strip of two metals soldered together, which, when they are hot, bend and touch a contact screw, making the electric circuit complete. Further, there is an arrangement of an electromagnetic solenoid; it is a coil of wire with an iron core, which is attracted in when the circuit is completed. When that core is attracted in, it bears on a valve, which is intended to perform the

following function:—There is a tank containing sulphuric acid, of course constructed of some acid-proof substance, such as stoneware. The valve allows a little acid to trickle into a lower chamber, where there is already a solution of carbonate of soda, and this generates an enormous amount of carbonic acid, which flies up through pipes, and so, with or without water, will immediately cause a great distribution of spray of carbonic acid (which itself is a splendid extinguisher of fire) all over that part of the factory. There is also a centrifugal arrangement for distributing the water, which is turned on, and is caused to rotate by a small electro-magnet, which is also automatic. And an independent piece of apparatus, quite distinct from the others, is a very strong cylinder charged with compressed carbonic acid, having a valve weighted, but propped up by a little trigger arrangement below. Directly the electric circuit is completed by the arrangement first described, the electro-magnet below the cylinder attracts its armature, lets off the trigger, the weight falls, turns on the valve, and you immediately have carbonic acid either distributed through pipes or led directly into the open air.

(d) *Miscellaneous Appliances.*—One of Jolin's devices to take the place of the Grinnell link is a little button, in which the edges of the brass discs receive the thrust, and take off the stress from the alloy. When it is required for use in a cord to hold up a valve lever or a fire-door, it is provided with a couple of loops to attach it to the cord. It is readily replaceable after the fire has burned out, and would be a little more reliable, perhaps, than the Grinnell link. Another contrivance of Jolin's is an arrangement to make a grenade automatic. The greatest objection to grenades is that they do not throw themselves, and they do not easily break. Jolin wants to make these grenades self-acting when a fire breaks out, therefore he proposes to hang a grenade up in a sort of cage at the top of the room, the cage being pro-

vided with a small button held together with fusible alloy. When that is affected by the ascending hot air, the button bursts open, the cage opens and allows the grenade to fall, and directly the grenade falls, an iron weight follows after it, and breaks it in mid-air and sprinkles the liquid about.

Extinguishing Benzene and Petroleum Fires.—The use of ammonia for this purpose was proposed by a committee of the Polytechnic Society at Munich (see ii. 293). A much cheaper and more easily accessible extinguisher is ordinary ammoniacal gas-liquor of 5°-6° Tw. This was tried with the greatest success to extinguish a fire of a most formidable kind which suddenly broke out in a tar distillery. The heat of the fire causes a large disengagement of carbon dioxide and sulphuretted hydrogen, besides ammoniacal gas and steam. The use of gas-liquor (to be well settled and stored in closed boilers, with suitable piping and forcing power, &c.) has been strongly recommended for extinguishing fires in cotton mills. (Jl. Soc. Chem. Ind.)

Textile Fabrics.—(13) Protochloride of manganese, 33 per cent.; phosphoric acid, 20 per cent.; boric acid or borax, 10 per cent.; chloride of magnesium 12 per cent.; chloride of ammonium or sulphate of magnesia 25 per cent. The materials are immersed for 6-8 hours in this solution at the temperature of ebullition. They quickly become impregnated with double salts, insoluble in water, and the incrustations that are formed effectually protect the materials treated against fire. When exposed to a quick fire, they carbonise, but produce no flame. (Prof. Winckelman.)

Timber.—(9) At the requisition of the Belgian Minister of Public Works, Boudin and Donny, professors at the Ghent University, have conducted a series of experiments and investigations in connection with rendering wood unflammable. The following *resumé* embodies the conclusions at which they arrived.

Although wood cannot practically

be rendered so fireproof as not to be destroyed by heat, it is very possible to deprive it to a considerable extent of the property of catching and communicating fire; and to this end it is sufficient to coat the wood with a suitable composition. It is not, however, sufficient that this composition possesses in a high degree the property of rendering wood unflammable. The treatment must not involve an expense out of proportion with the purpose to which the wood is applied; nor the process be such as to delay the rapid execution of works; nor the substance employed be liable to attack any metal parts which it may be necessary to use with the wood. The process should be of easy application, with a brush, for instance, the only manner in which it can be applied to existing structures. The wood thus coated should present a neat and tidy appearance, and should also be capable of receiving a coat of ordinary paint over the fireproofing composition; nor should one or the other coat be subject to alteration after a moderate lapse of time.

If, instead of coating, injection be employed, certain substances, notably chloride of calcium, should be rigorously excluded, because they would keep the wood constantly damp. The injection method is easily applied to small articles by simple immersion; and it is preferable that the composition or solution be hot, if not boiling. The possible diminution of strength due to all injection processes should also be taken into account, although the results of experiments are not conclusive on this point.

It follows from the above considerations that wood cannot be rendered incombustible, or more strictly speaking non-alterable by heat; but its non-inflammability may, to a considerable extent, be ensured, so as to preserve buildings from a limited and temporary fire, at any rate until assistance arrives. It is, however, hopeless to expect a building encumbered with inflammable substances to pass through such a test uninjured.

The methods of preserving wood against fire are of two kinds: the injection of saline solutions, and the application of a paint or coating. The former appears but little practical; and indeed, short of proof to the contrary, it must be considered dangerous in the case of wood of large dimensions. This system is, however, applicable to small pieces of wood. Of all the substances recommended, a concentrated solution of phosphate of ammonia is undoubtedly the best, the use of this substance, notwithstanding its high price, possessing such great advantages that it should be employed in all cases where expense is no object. In the majority of cases, however, coating with a brush is the only practical solution of the question, and the substances most to be recommended for use in this manner are cyanide of potassium and asbestos paint.

(10) B. Hofl, professor of chemistry at the state college in Jaroslaw in Galicia, has produced in a cheap and easy manner a wood not only unflammable but even incombustible. Following are the excellent qualities of this wood: Incombustibility at high degrees of heat (temperature when glass melts), whereby it neither burns with a flame nor brightly glows, generates no suffocating gases or smoke, and gives out but little heat; a glow on the surface in the open air, as well as in a strong current, without burning or igniting thereby, but extinguishing momentarily. When exposed to great heat for a length of time there remain no ashes, but a compact coal which does not burn. At the same degree of heat zinc sheets melt in seven seconds; slate breaks into pieces, tiles become glazed, and felt for roofs burns with a bright flame. Besides this the last-mentioned roofing materials offer no protection whatever in case of fire breaking out from the inside, because they are fastened upon boards. The chemicals necessary for the production of the incombustible wood consist of the cheapest refuse of industrial establishments. The process of manufacturing is simple and cheap, and may be applied

to all dimensions. Shingles made from it have a pleasing appearance, resemble tiles, are cheaper and safer against fire than felt, zinc sheets, &c., and, since the process preserves the wood, last 25-30 years. (*Gewerbe Zeit.*)

(11) The following treatment of wood is alleged to render it incombustible without any alteration in appearance. Intense heat chars the surface, slowly and without flame, but does not penetrate to any extent, and leaves the fibre intact, whereby in case of fire the firemen would have no occasion to fear that the materials on which they tread would give way beneath them, if this operation had been undergone by the wood composing the staircases, floor, &c. The chemical compound said to produce the result is:—Sulphate of zinc, 55 lb.; potash, 22 lb.; alum, 44 lb.; oxide of manganese, 22 lb.; sulphuric acid of 60° Tw., 22 lb.; water, 54 lb. All the solids are to be poured into an iron boiler containing the water at a temperature of 113° F. As soon as the substances are dissolved, the sulphuric acid to be poured in little by little, until all the substances are completely saturated. For the preparation of the wood it should be placed in a suitable apparatus, and arranged in various sizes (according to the purposes for which it is intended) on iron gratings, care being taken that there is a space of about $\frac{1}{2}$ in. between every two pieces of wood. The chemical compound is then pumped into the apparatus, and as soon as the vacant spaces are filled up, it is boiled for 3 hours. The wood is then taken out and laid on a wooden grating in the open air, after which it is fit for use.

INK. (ii. 325-347.)

Black Writing Ink. A. (h).—The following formula is said to have been in use in 1654, and to have produced an ink of great permanency, if one may judge from manuscript written by the person who is the authority for the formula: $1\frac{1}{2}$ dr. coarse-powdered galls, $1\frac{1}{2}$ dr. sulphate

of iron, 10 dr. gum-arabic, and 1 pint soft water, are to be placed in a bottle, which is to be securely stoppered and placed in the light (sunlight if possible). Stir the contents occasionally until the gum and copperas are dissolved, after which the bottle should be shaken daily. In the course of 4-6 weeks the ink will be fit for use. The addition of 10 drops carbolic acid will prevent the formation of mould.

(i) **Blue-black Writing Fluid.**—Digest together for a fortnight 18 oz. bruised galls, $\frac{1}{2}$ oz. bruised cloves, in 10 wine pints water. Press and filter. Add to the clear liquid 6 oz. sulphate of iron and 2 fl. dr. sulphuric acid, shaking well until solution is effected. Next add 1 oz. indigo paste, and filter if necessary. The ink must be kept in well-corked bottles, and it should be made in vessels of glass or stoneware. (*Can. Phar. J.*)

(k) A good black ink can be made with the following ingredients:—2 lb. galls (in moderately fine powder), $10\frac{1}{2}$ oz. copperas; 10 oz. gum-arabic; $1\frac{1}{2}$ oz. sugar. Water sufficient to make 18 pints. Place the galls in an enamelled vessel, pour on it 6 pints boiling water, and allow it to macerate 2 days; transfer to a glass percolator, in the neck of which is a piece of absorbent cotton, through which allow the liquid portion to drain. When this is accomplished, pack the galls firmly, and displace with sufficient water to produce 2 gal. with that portion of the infusion which first passed. Then dissolve the gum and sugar in 2 pints water; add this and the copperas to the infusion of galls. This, after standing about 12 days, will produce a very superior ink. About 8 drops wood creosote should be added to prevent moulding.

(l) Bruised nutgalls, 12 parts; copperas (slightly calcined), 4 parts; gum arabic, 4 parts; water, 120 parts. Mix them together in a stone bottle, and let them stand for 2-3 weeks, shaking the bottle from time to time. Then pour off the clear liquor, and add a little creosote to prevent mouldiness.

C. (g) pyrogallic acid, 1 part; pulv. gum arabic, 3 parts; ammonia vanadate, 3 parts. These to be mixed in a mortar and sufficient water to be added. This forms an intensely black ink.

Copying Ink. (k) Nigrosine ink may be used for copying, if the gelatin and bichromate are omitted. The following will be good proportions:

Nigrosine	100 grains
Water.. .. .	6 $\frac{1}{4}$ fl. oz.
Glycerin	3 $\frac{3}{4}$ fl. oz.

(l) A better copying ink is obtained by reducing any good iron ink by evaporation, and adding some glycerin:

Black iron ink	10 volumes
Reduce by evaporation to 6
and add	
Glycerin	4 ..

(m) Another good copying ink which is said to yield 3-5 good impressions, is prepared, according to Böttger, as follows:

Extract of logwood	64 parts
Soda	10 ..
Chromate of potassium	2 ..
Glycerin	64 ..
Gum arabic	16 ..
Water	270 ..

Dissolve the extract of logwood, together with the soda in the water, add the glycerin and gum arabic, and finally add the chromate (not bichromate) of potassium dissolved in a very small quantity of boiling water. The ink may be used at once.

(n) For readily transcribing letters without a press.—For the past thirteen years all letters, reports, &c., that I have written have been transcribed into an ordinary thin-paper copying-book with no more effort than is employed in using a piece of blotting paper. It has only been necessary to place the page of writing, note size, letter size, or even foolscap, in the letter-book, and use a leaf of the letter-book just as one would use a leaf of blotting paper. The superfluous ink that would go into blotting paper goes on to the leaf

of the letter-book, and, showing through the thin paper as usual, gives, on the other side of the leaf, a perfect transcript of the letter. Any excess of ink on the page, either of the letter or of the copying paper, is removed by placing a sheet of blotting paper between them and running one's hand firmly over the whole in the ordinary manner.

This ready transcription is accomplished, as will be anticipated, by using ink which dries slowly. Indeed, obviously, the ink must dry sufficiently slowly for the characters at the top of a page of writing to remain wet when the last line is written, while it must dry sufficiently fast to preclude any chance of the copied page being smeared while subsequent pages are being covered. The drying must also be sufficiently rapid to prevent the characters "setting off," as printers term it, from one page to another after folding.

Now to manufacture ink that shall dry at the rate and in the manner just indicated, no matter what the size of the page of writing or how quickly or slowly it be written, no matter whether the air at the time be dry or moist, or the writing paper be unglazed, porous and absorbent, or highly glazed, close and non-absorbent, is impossible. Evaporation proceeds by laws which man can neither suspend nor hasten. Thin up-strokes written with any variety of ink inevitably dry quicker than the thick down-strokes written with the same ink, no matter what the wishes or requirements of the writer. Hence there are defects in my copying ink which are inherent, and, I fear, irremediable. In short, probably no variation in the mode of manufacture of copying ink of this character would result in a writing fluid which could be used by all persons at all times under all circumstances. Still the ink has been of the greatest service to me myself, and should be equally useful to others. In purchasing writing paper, it is easy to avoid the excessively porous or the very highly glazed. On the exceptionally hot days of an exceptionally

hot summer, when all ink dries with exceptional rapidity, it is not difficult to write somewhat more thickly than usual, and thus maintain the wetness of the words until a page is completed ready for copying. In very moist weather when the finished document written with this ink would not dry rapidly, and therefore would be liable to become smeared, it is not impracticable to use a fine pointed pen or to hold your sheet before a fire or over a gas flame for a moment or two. Lastly, the extreme facility with which letters are copied with this ink and the great convenience attached to the advantage of possessing transcripts of letters, etc., are cheaply purchased at the price of a little care and practice in making one's up-strokes and down-strokes pretty much of a thickness.

But I am exaggerating difficulties. Processes, apparently practicable when described, often turn out hopelessly impracticable when applied. Conversely, processes apparently impracticable often admit of ready application. My description of the use of my ink must, I am sure, convey an impression of impracticability. As a matter of fact, however, I use the ink from year's end to year's end without any trouble whatever. The case of this ink is one of those in which unavoidable disadvantages are compensated by an amount of personal carefulness to which one easily becomes habituated. The disadvantages, of course, preclude the introduction of the ink into indiscriminate wholesale and retail trade. The firm of manufacturers that, consulting me respecting copying ink, entertained my suggestion to use such an ink as this, went to the expense of provisionally patenting it, in the hope that before the period of provisional protection elapsed it would be improved sufficiently to render it an ordinary commercial article. They have long abandoned that hope. I, too, have now abandoned it sufficiently to induce me to publish the mode of making and using the ink, in order that at least others may enjoy its use to the extent to which I enjoy

it myself. The ink is really invaluable to me. To pharmacists, retail tradesmen, professional men, private persons and others who desire to keep copies of their letters and writings, but who do not write enough to render worth while the use of a copying-book and copying-press, or the employment of a junior clerk or office boy for press copying, or who may desire to keep a private copying-book, this ink will also prove invaluable. The ink can be made by chemists and druggists, who also might vend the article with no loss of dignity. For the sale of it would be accompanied by one of those little intelligent statements respecting mode of use and attendant conditions which come so naturally from the pharmacist.

I have only to add the process of preparation. The principle of the method consists in dissolving a moderately powerful hygroscopic substance in any ordinary ink. After experimenting on all such substances known to me, I give the preference to glycerine. Reduce, by evaporation, 10 volumes of ink to 6; then add 4 volumes of glycerine. Or manufacture some ink of nearly double strength, and add to any quantity of it nearly an equal quantity of glycerine. (Professor Attfeld.)

Indelible Ink (16).—Triturate $1\frac{3}{4}$ grams aniline black with 60 drops strong hydrochloric acid and 42-43 grams strongest alcohol; then add to it a hot solution of $2\frac{1}{2}$ grams gum-arabic in 170 grams water. This ink attacks steel pens but little. It is not destroyed either by strong mineral acids or by strong lye. If the first alcoholic solution of aniline black be diluted with a solution of $2\frac{1}{2}$ grams shellac (instead of gum-arabic) in 170 grams water, an ink is produced which may be employed for writing on wood, brass, or leather, and which is remarkable for its deep black colour.

Invisible Ink (c).—Finest potato starch, 13.5 kilos., and powdered iodine 1 kilo., are mixed and then rubbed through a sieve, then mixed with 4 litres water and 1 litre rectified spirit. The resulting black

powder is allowed to stand for 14 days, then dried and exposed to the air. The dry powder contains 10 per cent. of iodine. The iodide of starch becomes soluble when heated with stirring in an enamelled saucepan over a gentle fire. As soon as the powder is dry the operation is finished, it then emits a pungent smell. From time to time during the heating it must be ascertained whether the powder has become soluble, by heating some of it with water in an iron spoon. At a strong heat it yields a red solution with loss of iodine. In order to purify the powder and make it thoroughly soluble, of a violet tint in cold water, a concentrated solution is made by heating, so that it shows 7-8°. This solution is allowed to deposit for several days, decanted and precipitated with rectified spirit. The precipitate is strained, and dried in the drying closet. If excess of spirit is used in the precipitation, a gummy matter is thrown down, the presence of which is superfluous. A certain firm claims to be the sole manufacturers of the ink. They advertise that writing executed with it gradually fades away and cannot be restored by any chemical, and state that the time it takes to fade depends on the paper that is used; if written with a perfectly clean steel or quill pen on unglazed paper the evanescence will be more rapid than when written on glazed paper. On some papers it will disappear in a day, whilst on other kinds it will take more than a week. I tried this ink on various sorts of paper, and found the writing quite visible after 6 weeks. It can easily be restored to a jet black by exposing the writing to the fumes of iodine. Perfection has not yet been obtained in the production of this useful ink; there appears to be some chemical either absent or not present in a sufficient quantity to induce a rapid evanescence.

(S. L.)

Marking Ink. (y) Blue.—Mix a sufficient quantity of ultramarine with barytes (sulphate of barium, *blanc fixe*), and water to produce the desired

tint. It may be rendered more permanent by adding some liquid glue (solution of glue in acetic acid) or some starch paste, prepared with the addition of a little wax. (*Chem. and Drug.*)

(z) Dark Blue.—Christian Knab, Munchberg, Bavaria, makes a blue preparation good for marking trunks and boxes, because it readily combines with wood, cloth, etc., and resists the action of the weather. His process is given in the *Deutsche Industrie Zeitung* as follows:—100 lb. of a 30 per cent. fluid extract of logwood are put in a suitable kettle, with 3 qt. alcohol, to which 2 lb. hydrochloric acid has already been added. The mixture is kept at 68° F. and well stirred until thoroughly mixed. Next he dissolves 10 lb. (yellow) chromate of potassium in 30 lb. boiling water, and adds to it 20 lb. of hydrochloric acid, stirring well, and when it has cooled to 86° F., stirs it very slowly into the mixture already in the kettle. The whole is then warmed to about 185° F. The mass, which then becomes an extract, is stirred a short time longer, and to it is added 30 lb. dextrine mixed with 20 lb. fine white earth (*terra alba*), and well stirred through. The mass, when taken from the kettle, is put into a mill where it is thoroughly worked together. It is lastly put into tin boxes, and left standing a long time to dry out.

(aa) Blue.

Silver nitrate	4 gram.
Liq. ammonia	12 "
Sodium carbonate	4 "
Powdered gum-arabic	6 "
Cupric sulphate	20 "
Distilled water	16 "

Dissolve the silver salt in the ammonia, and the soda, gum, and copper salt in the distilled water, and mix the two solutions. (Dorvault.)

(bb) For marking bales.

Shellac	2 oz.
Borax	2 "
Water	25 "
Gum-arabic	2 "
Venetian red, sufficient to colour.	

Boil the borax and shellac in the water until they are dissolved, add the gum-arabic, and withdraw from the fire. When the solution has become cold, complete 25 oz. with water and add Venetian red enough to bring it to a suitable consistency and colour. This ink must be preserved in a glass or earthenware vessel.

Printing Ink. Black (*j*). From Spent Cotton Waste.—The utilisation of waste products, which has made such great progress during the last two decades, has experienced a further development in a department in which we are more especially interested. We refer to the process of C. T. Bastand, 38, Riley Street, Bermondsey, London, by means of which spent cotton waste is made to yield up all the oil and greasy matter contained in it, the latter being subsequently converted into that useful agent of civilisation, printers' ink. Cotton waste, as our readers are aware, is used to clean machinery of all descriptions. When spent—that is to say, used up—it is full of refuse oil and grease. Hitherto, it has been the practice to boil the spent cotton waste in a solution of caustic soda, by which process all the grease is extracted, to wash it, and mix it with new waste, when it is again placed upon the market. The oils and grease are allowed to run to waste.

Bastand proceeds in a very different and at the same time highly remunerative manner. He places the spent cotton waste in a closed cylinder heated by steam by means of an interior coil. He then pumps a solution of bisulphide of carbon into the cylinder containing the waste, upon which the chemical acts, separating the oil and grease. In their combined state, the bisulphide solution and oil are then run by him into another steam-heated cylinder. Here the bisulphide becomes vaporised, and passes thence to condensers, and is finally run into a store tank, to be used over and over again, the loss of bisulphide being almost imperceptible. The cotton waste freed from oil is washed, dried, and sold again.

The far more valuable product obtained, the oil, is run from the second cylinder into tanks, pumped thence into a copper heated by a small portable furnace, running on wheels, and freed from all moisture. It is then pumped into a second copper, where it is converted into the varnish from which printing ink is made. When the varnish has been brought down to its proper consistency, the furnace is withdrawn, and the varnish is taken to the mixing-house, where it is incorporated with the necessary pigments and other ingredients necessary to produce the various shades and qualities of printing ink. When mixed, the crude ink is ground in a French buhrstone mill, and, after grinding, delivered into a machine, in which it is passed between rollers a number of times, according to the quality of ink required. To obtain the lampblack used in the manufacture of printing ink, a portion of the recovered oil is used; and thus what was formerly wasted is converted into the medium which enters so largely into the diffusion of knowledge. (*Chambers's Jl.*)

Stamping Ink (*h*). Indelible.—E. Johanson, St. Petersburg, gives the formula for a convenient ink for marking clothing by means of a stamp: 22 parts carbonate of soda are dissolved in 85 parts glycerine, and triturated with 20 parts gum-arabic. In a small flask are dissolved 11 parts nitrate of silver in 20 parts official water of ammonia. The two solutions are then mixed and heated to boiling. After the liquid has acquired a dark colour, 10 parts Venetian turpentine are stirred into it. The quantity of glycerine may be varied to suit the size of the letters. After stamping, expose to the sun or apply a hot iron. (*Pharm. Rec.*)

(*i*) Polygraphic. — (1) 10 parts "Violet de Paris," 30 parts water (Lebaigne). (2) 1 part "Violet de Paris," 7 parts water, 1 part alcohol (Kwaysser and Husak). (3) 2 parts acetate of rosaniline, 10 parts water, 1 part alcohol (Kwaysser and Husak).

The first two produce a violet, the last a red copy.

(k) An endorsing ink, which does not dry quickly on the pad, and is quickly taken by the paper, can be obtained by the following recipe: Anilin colour in solid form (blue, red, &c.), 16 parts; 80 parts boiling distilled water, 7 parts glycerine, and 3 parts syrup. The colour is dissolved in hot water, and the other ingredients are added whilst agitating. This endorsing ink is said to obtain its good quality by the addition of the syrup. (*Pap. Zeit.*)

Miscellaneous.—*Ink Powder.*—Finely-powdered nut-galls 10 oz., sulphate of zinc (powdered) 2 oz., sulphate of iron (powdered) 4 oz., gum-arabic (powdered) 1 oz.; 1 oz. of this powder when finely sifted, added to about $\frac{1}{2}$ pint of water and well shaken, will form a good ink.

Forgeries.—If a forger has used a different ink to that used by the original writer of the document, his error can be made manifest in the following manner:—Get 9 $\frac{1}{2}$ -oz. or 1-oz. vials, and fill separately with (1) dilute sulphuric acid; (2) concentrated muriatic acid; (3) dilute nitric acid; (4) solution of sulphurous acid; (5) solution of caustic soda; (6) concentrated solution of oxalic acid; (7) solution of chloride of lime; (8) solution of tin crystals; (9) solution of photo-chloride of tin. Take nine quill pens, each one for its particular reagent. Now, with a rule, draw lines crossing original and suspected portions; the difference will show itself at a glance. (*Chem. Rev.*)

To Render Ink Waterproof.—If the ink is prepared with a certain proportion of gelatine, the addition of a little bichromate of potash, followed by exposure to sunlight, has been recommended for rendering the ink so insoluble in water that it will not run or spread when water-colours are used for shading the sides of the lines.

To Restore Faded Ink.—In order to restore faded ink all that is necessary is to moisten the paper with water and brush over the writing with a solution of sulphide of ammonium. The ink

will become black immediately, from the formation of the black sulphide of iron. Of course this means of restoration is not applicable with aniline inks. (*Boston Jl. Chem.*)

Ink Eraser.—A good ink eraser is thus made: Take 1 lb. chloride of lime, thoroughly pulverised, and 4 qt. soft water. The above must be thoroughly shaken when first put together. It is required to stand 24 hours to dissolve the chloride of lime; then strain through a cotton cloth, after which add a teaspoonful of acetic acid to every ounce of the chloride of lime water. The eraser is used by reversing the penholder into the fluid, and applying it, without rubbing, to the word, figure, or blot required to be erased. When the ink has disappeared, absorb the fluid with a blotter, and the paper is immediately ready to write upon again. Chloride of lime has before been used with acids for the purpose as above proposed; but in all previous processes the chloride of lime has been mixed with acids that burn and destroy the paper.

Action of Bleaching Agents upon Writing Ink.—It is well known that ordinary writing is easily removed when it is acted upon by bleaching agents. Advantage is taken of this fact by unscrupulous persons desirous of altering documents, cheques, and banknotes for improper purposes. Hence the number of fugitive inks and supposed untamperable papers in use to meet this difficulty.

A curious and interesting case of supposed fraud came under my notice in the form of a document which was written upon the flyleaf or second page of a sheet of legal paper, the margin of the first page containing the stamp, date, and watermark of a will purporting to have been written about 20 years ago. The document or will was thus written upon paper bearing both on stamp and in watermark a date which gave it the semblance of age. The appearance of the document gave rise to suspicion, and I was asked if it was possible to tell the age of the writing, and if the

writing had been executed at one and the same time, and if so at what time.

This was of course, impossible, as I was not allowed to treat the document itself. I had, therefore, to make experiments upon writings the dates of which I knew.

I selected writing 1 day, 6 months, 12 months, 2 years, 6 years, 14 years, and 22 years old, and exposed these writings to the action of a very dilute solution of ordinary bleaching powder in water. The specific gravity was about 1.001. In 6 minutes the newly written matter had disappeared; in 9-12 minutes the writing of 6 months ago had disappeared; in 20 minutes the writing of 2 years had partly disappeared; in a like time the writing of 6 years ago was not greatly affected; 14 years ago very slightly; and 22 years hardly affected at all (indeed, old writing seems hardly affected by such a weak solution, even after hours' exposure).

Peroxide of hydrogen acts more slowly, but gives more definite results. Other reagents give effects which help (although sometimes in a contrary manner to that I have indicated) to establish the fact that ordinary writing ink, which is a compound of gallic and tannic acids with proto-salts of iron, becomes more stable (presumably by oxidation), and consequently is less or more affected by chemicals which act upon the organic coloring matter of the ink. There are great varieties of writing inks, chromium and vanadium salts being sometimes substituted for the iron salts. There are also black and colored inks prepared from coal tar dyes; but thinking it highly improbable that any documents intended for preservation would be executed in such evanescent inks, I did not investigate their behaviour under such treatment. When ink is thus bleached or apparently removed, most of the iron contained in the compound remains mordanted with the fibres of the paper; consequently, writing so tampered with or dealt with can be restored by the

application of gallic or tannic acid. The writing is thus reproduced almost in its original depth of color. It is delicate work (especially in the civil legal aspect of the case to which I have referred) to determine in a reliable manner the age of any particular writing, and it is necessary that the following precautions be carefully observed:

1. The inks must be those known as ordinary writing inks, prepared from iron and chromium salts and galls.

2. Writing dried by means of blotting paper is naturally more easily removed than writing which is allowed to dry on the surface of the paper; and light writing is somewhat more easily removed than coarse and heavy writing.

3. The bleaching solution must be exceedingly dilute, otherwise the action is so rapid and powerful that both old and new writings are removed almost simultaneously.

4. The action must be carefully watched, so as not to be too long continued. Lastly, very old writing which has become brown by age, although it resists the action of weak solutions of bleaching powder and peroxide of hydrogen, will show signs of giving way almost instantly when acted upon by dilute nitric, hydrochloric, and oxalic acids.

Although I have only made use of a well-known process and materials to obtain the results I have indicated, still I think such a simple means of detection may act as a check to frauds which are becoming only too common. There was a most interesting paper read before the Literary and Philosophical Society of Manchester, in the session of 1879 and 1880, by Mr. W. Thomson, F.R.S.E., which I commend to the study of any one wishful to carry this investigation further than I have been able to do. In it the author gives many curious and interesting facts in connection with the behaviour of writing inks under the influences of various chemical compounds. (R. Irvine.)

LACQUERS. (i. 74-76; iii. 303-335.)

Bottle.—Black Lacquer for Coating Bottles.—Bottles, or other glass vessels, which it is desired to make impervious to light, may be coated according to Ferd. Simand, with a black lacquer prepared in the following manner. Equal parts of asphalt and of boiled linseed-oil are heated for one hour, over a naked fire to about 200° C. (392° F.); then a sufficient quantity of lamp-black, previously triturated with oil of turpentine, is added, to make a mixture, which, when mixed with $\frac{1}{4}$ – $\frac{1}{3}$ its volume of oil of turpentine, will cover well. Usually, one coat is sufficient; in special cases, two coats may be required. Sometimes it is desirable to be able to see the height at which the liquid in the bottle is standing. This may be accomplished, according to the author, by leaving a small round spot on opposite sides uncoated. The bottom of the bottle is likewise left unvarnished. It would be better to leave a very narrow vertical streak, on the side of the bottle usually turned towards the wall, uncoated. This would more readily permit ascertaining at what level the liquid stands. (New Remedies.)

Brass.—(15) When properly lacquered, brass work will retain its colour, and resist the action of the atmosphere for a long time; hence the necessity of always lacquering work which should retain a good appearance. The process is rather difficult to execute properly, especially on large surfaces, where the tyro will find the lacquer continually getting a smeary look. Before applying the lacquer, the brass must be heated to a certain degree, and the difficulty is to know the exact degree best suited to the particular lacquers and materials used, and the effect to be produced; this kind of knowledge cannot be attained but by experience. If you do not feel disposed to prepare the surfaces of your work by means of filing, &c., another plan, far easier and equally effective, though not producing such a workmanlike job, is

the following:—Put the brass work, having previously taken it to pieces as much as possible, into pickle made of nitric acid and water: this will eat away the outer coat, all the corrosion, and all lacquer, leaving a surface of pure brass. The time required to effect this and the strength of the pickle can be soon ascertained by trial. The work must be carried on in the open air, as the fumes given off are very baneful to health. Thoroughly wash the articles to remove all traces of acid, and then dry them in hot sawdust; they will then be ready for lacquering. Use a camel-hair brush to lay on the lacquer with, heat the articles as hot as may be held in the hand; be careful not to touch the bright surface with anything that will stain it, and lay on the lacquer as thinly as possible to prevent smears. If the work is too hot it will burn the lacquer, and if too cold this will not set hard. Small thin articles part with a large proportion of their heat in laying on the lacquer, but bulky work is comparatively unaffected: so small articles must be made somewhat hotter than large before lacquering. Only experience will enable you to judge correctly.

(16) Lacquer is so called because it usually contains gum lac, either shellac or seed lac. Seed lac is the original form of the gum or resin; after being purified it is moulded into thin sheets, like shell, and hence is called shellac. Shellac is frequently bleached so as to become quite white, in which state it forms a colourless solution. Bleached shellac is never as strong as the gum in its natural condition, and unless it be fresh it neither dissolves well in alcohol nor does it preserve any metal to which it may be applied. There are many recipes for good lacquer, but the success of the operator depends quite as much upon skill as upon the particular recipe employed. The metal must be cleaned perfectly from grease and dirt, and in lacquering new work it is always best to lacquer as soon after polishing as possible. Old lacquer may be removed with a strong lye of potash or soda,

after which the work should be well washed in water, dried in fine beech or boxwood sawdust, and polished with whitening applied with a soft brush. The condition of the work, as to cleanliness and polish, is perhaps the most important point in lacquering. The metal should be heated and the lacquer applied evenly with a soft camel-hair brush. A temperature of about that of boiling water will be found right. The solution of lac or varnish is colored to suit the requirements or taste of the user.

(17) A good pale lacquer consists of 3 parts Cape aloes and 1 of turmeric to 1 simple lac varnish. A full yellow contains 4 turmeric and 1 annatto to 1 lac varnish. A gold lacquer, 4 dragon's-blood and 1 turmeric to 1 lac varnish. A red, 32 parts annatto and 8 dragon's-blood to 1 lac varnish. A great deal depends, also, upon the depth of color imparted to the lacquer, and as this may require to be varied, a very good plan is to make up a small stock bottle, holding, say, $\frac{1}{2}$ pint, according to any good recipe, and add as much of it to the varnish as may be required for the desired tint.

(18) Deep Gold Lacquer.—Alcohol, $\frac{1}{2}$ pint; dragon's-blood, 1 dr.; seed lac, $1\frac{1}{2}$ oz.; turmeric, $\frac{1}{4}$ oz. Shake up well for a week, at intervals of, say, a couple of hours; then allow to settle, and decant the clear lacquer; and if at all dirty filter through a tuft of cotton wool. This lacquer may be diluted with a simple solution of shellac in alcohol, and will then give a paler tint.

(19) Bright Gold Lacquer.—(a) Turmeric, 1 oz.; saffron $\frac{1}{4}$ oz.; Spanish annatto, $\frac{1}{4}$ oz.; alcohol 1 pint. Digest at a gentle heat for several days; strain through coarse linen; put the tincture in a bottle and 3 oz. good seed lac coarsely powdered. Let it stand for several days, shaking occasionally. Allow to settle, and use the clear liquid.

(b) 1 oz. annatto and 8 oz. alcohol; mix in a bottle by themselves. Also mix separately 1 oz. gamboge and 8 oz. alcohol. With these mixtures color seed lac varnish to suit yourself. If it

be too red, add gamboge; if too yellow, add annatto; if the color be too deep, add spirit. In this manner you may colour brass of any desired tint.

(20) Pale Gold Lacquer.—Best pale shellac (picked pieces), 8 oz.; sandarac, 2 oz.; turmeric, 8 oz.; annatto, 2 oz.; dragon's-blood, $\frac{1}{4}$ oz.; alcohol, 1 gal. Mix, shake frequently till the gums are dissolved and the color extracted from the colouring matters, and then allow to settle.

(21) 4 oz. shellac and $\frac{1}{4}$ oz. gamboge are dissolved by agitation, without heat, in 24 oz. pure pyro-acetic ether. The solution is allowed to stand until the gummy matters, not taken up by the spirit, subside. The clear liquor is then decanted, and when required for use is mixed with 8 times its quantity of alcohol. In this case the pyro-acetic ether is employed for dissolving the shellac in order to prevent any but the purely resinous portions being taken up, which is almost certain to occur with ordinary alcohol; but if the lacquer were made entirely with pyro-acetic ether, the latter would evaporate too rapidly to allow time for the lacquer to be equally applied. (Workshop Companion.)

Gold Lacquers.—(9) An imitation of Chinese gold lacquer may be prepared by melting 2 parts copal and 1 shellac until thoroughly mixed, and adding 2 parts hot boiled oil. Then remove from the fire and gradually add 10 parts oil of turpentine. To colour, add gum gutta for yellow and dragon's-blood for red, dissolved in turpentine.

(10) Substitute for Gold Bronze.—According to the experiments of Dr. B. W. Gerland, metavanadic acid may be used in the preparation of a substitute for genuine gold bronze. If a solution of sulphate of copper and sal ammoniac is mixed with vanadate of ammonia and cautiously heated, there is obtained a compound of a splendid gold colour, which is deposited from the liquid in the form of gold-coloured spangles. These readily admit of being ground up with gum and varnishes, cover well, do

not change on exposure to the air, and are in every respect equal to gold bronze.

Iron and Steel Lacquers.—

(5) A new preservative of iron and steel has been found in a modification of the well-known Japanese gum lacquer. After many experiments, the preparation has been finally adopted for the imperial Japanese navy. There is a certain difference between the compounds prepared for painting iron and steel and the ordinary lacquer employed for wood, but its principal element is still the gum lacquer. The inventor of the new composition had great difficulty in conquering the tendency of this material to get very hard and then to crack, but, according to the reports, he has succeeded at last. Experience has shown that a ship protected with this variety of lacquer has been able to keep afloat in tropical seas for 3 years—going into dry dock only once instead of 6 times during that time, as usual. A ship of the Russian Pacific squadron has tried the new coating, and the result has been very satisfactory. It is consequently thought that at last a tolerably perfect anti-corrosive coating for iron and steel structures has been discovered, which may render substantial service in the preservation of all descriptions of erections in these materials. The first cost of the preparation is rather high, but it is claimed that the excess of cost is more than compensated by the protection obtained. For ship use it is also asserted that great advantage accrues from the high polish which this lacquer retains while the coating remains perfect, but, on the other hand, fears are expressed that the supply of gum lacquer will be unequal to the demand, if the requirements for these engineering purposes are added to the regular consumption of the article for ornamental joinery and cabinet work. (*Sci. Am.*)

Japanese Lacquer (Urushi).

—Urushi is the milky secretion of *Rhus verniciifera*, and is the material for the well-known Japanese lacquer varnish. The tree is cultivated in many parts of

the country, throughout almost all latitudes, *e.g.*, at Dewa, Aizu, Hiroshima, and in many places about Tokio; the best urushi, however, is obtained at Yoshino. The tree is very similar in aspect to the ordinary wax-tree, and attains the height of 9–12 ft. Trees about 15 years old yield the largest amount of the juice. Two sorts of the juice are generally obtained from a tree, and by different processes. They are distinguished as ordinary “ki-urushi” and “seshime-urushi.”

Ki-urushi (or raw lacquer) is the better of the two, and is collected best in June by making shallow cuttings in the stem of the tree, when it exudes as drops from between the outer and inner barks. A single tree yields on an average about 2½ grammes of this kind of juice. Branches and twigs of the tree, some of which are usually cut down each year, when steeped in water for some months and afterwards warmed in the fire, give out an inferior kind of juice; this is seshime-urushi, which is used as under varnish after being mixed with some drying oil.

The juice is never sent to market in the form in which it comes from the tree, but is usually mixed with more or less of what is called “mokuyiki” (literally wood-juice), *e.g.*, what is ordinarily called Yoshino. Urushi consists of 60 per cent. of the genuine juice with 40 per cent. of mokuyiki, while the inferior quality contains as much as 70 per cent. of the latter substance. Further, in the hands of varnish makers, some quantity of linseed oil is generally added to the already mixed juice, which, if excess is avoided, does not much impair the drying power of urushi.

Different colours are imparted to urushi by the addition of body pigments, such as lamp-black, vermilion, indigo, orpiment, &c.; thus red lacquer is prepared with 20 parts of linseed oil, 70 parts of urushi juice, and about 10 parts of vermilion, etc. Such is a rough yet general account of the extraction and preparation of urushi juice for varnish-making. The pure and unaltered urushi is a thick greyish

fluid of dextrinous consistence, which under the microscope is found to consist of minute globules, some of darker, the others of lighter colour, mixed with small particles of opaque brownish matter, the whole being held mixed in the form of intimate emulsion. It has a characteristic sweetish odour, and specific gravity 1.0020 (20° C.); some specimens, such as that obtained from Hachioji, contained a good deal of bark dust and other impurities, which raise its specific gravity as high as 1.038. If the juice be exposed to moist air in a thin layer at about 20° C., it rapidly darkens in colour and dries up to a lustrous translucent varnish. It contains a small quantity of volatile poison, which acts terribly on some persons, producing a very disagreeable itching.

A peculiar acid, which I now call urushic acid, is the main constituent of the original juice, as well as of the portion soluble in alcohol. The juice also contains a very small quantity of a volatile poisonous body, which also passes into alcoholic solution, being almost completely driven out during the drying of the acid at 105°–110° C. It is a pasty substance of somewhat dark colour, having the characteristic smell of the original juice, readily soluble in benzene, ether, carbon bisulphide, less easily in fusel oil and petroleum of high-boiling point, completely insoluble in water. Its specific gravity taken at 23° C. is 0.9851; it remains unchanged at 160° C., and above 200° C. decomposes slowly with carbonisation. Exposed to the air, it neither dries up, nor shows any sign of change as the original juice does, and in other respects it is a very stable body. From the alcoholic solution of the acid many metallic salts can be produced, most of which are slightly soluble in alcohol, but almost insoluble in water.

Gum is another normal constituent of urushi, and forms 3–8 per cent. of the original juice.

As gum is insoluble in alcohol, it is conveniently separated by treating that portion of the original juice insoluble in alcohol with boiling water, filtering,

and finally evaporating the aqueous solution of gum over the water-bath till the weight of the substance remains constant. In this way a friable light-coloured substance is obtained, tasteless and inodorous; this is the anhydrous gum.

A mixture of gum and urushic acid (and with water) in the proportion in which they exist in the juice, does not undergo any change whatever, even when exposed to the condition most favourable for the drying of the lacquer. Moreover, part of the gum can be extracted in an unchanged state from the once perfectly dried lacquer; and since it exists in the original juice in the form of aqueous solution, it probably serves to keep the constituents of the juice in a state of uniform distribution and intimate emulsion. It may also act as a binding material, and assist the adhering power of the lacquer when laid upon any surface.

The results, so far arrived at, may be summed up in the following statement:—

Urushi juice (lacquer) consists essentially of four substances, viz., urushic acid, gum, water, and a peculiar diastatic matter; and the phenomenon of its drying is due to the oxidation of urushic acid, $C_{14}H_{18}O_2$, into oxyurushic acid, $C_{14}H_{18}O_3$, which takes place by the aid of diastase in the presence of oxygen and moisture. (H. Yoshida.)

Japanning and Japans. (*g*)
Metal.—This is simply the process of laying a coating of varnish, and afterwards drying by artificial heat. This second operation, the baking, is the essential part in japanning. The art was originated in Japan, whence we have derived the name. Many examples of japanning on papier-maché may be seen at fancy repositories where various ornamental nicknacks imported from Japan are on sale. In making this ware the Japanese employ a lacquer which exudes from an indigenous tree. Successive coats are laid on, each one being thoroughly dried in the sun before the application of another. Thus a thick hard coating is made, which may be

smoothed and polished by abrasive materials, though the natural lustre suffices for general requirements. Gilding and other ornamentation is then made to adhere by means of boiled oil. The whole is finally finished by a coat of clear varnish. The above is a rough sketch of the art as practised by the originators, but we have to deal with modern japanning, and confine our observations to its application to metal.

The japanners' oven is a receptacle in which the work is placed when being heated. Usually the heat is applied by means of external flues in which hot air or steam is circulated. By this system the temperature may be regulated to great nicety, the supply of heat being controlled by dampers or stop-cocks. A sheet iron box, encased by another of the same shape, but somewhat larger in size, so that an interspace of an inch or two exists between them, is the most simple form of oven. Heat is applied to the interspace, and thus an even temperature is maintained. A flue must be provided to carry off the vapours which arise from the japan. A doorway, by which to introduce the articles, provided with a tolerably well-fitting door, is, of course, essential. Hooks or wire shelves are provided, by which the work is supported, so that the heat may take effect equally all round. Moisture, dust, and all other extraneous matter must be carefully excluded, so that the japanning may be kept perfectly clean and free from foreign substances. Thermometers are hung in the oven to indicate the precise degree of heat, which is regulated as explained above, to suit the requirements of particular work.

Metals require no special preparation before laying on the japan. After being wrought to the desired shape, and smoothed as much as may be considered advisable, the article has only to be made thoroughly clean to prepare it for japanning. The surface must be quite dry, or the japan will not adhere properly. Wood requires to be primed and otherwise prepared for japanning.

Japan, that is the paint-like material

to be laid on the metal, is made of shellac varnish, with which may be incorporated any pigment necessary to produce a desired colour. Shellac varnish is made by dissolving shellac in alcohol. A better varnish for japanning is made by adding resin and shellac, 2oz. of each, to 1 pint methylated spirit. Any pigment may be added to such varnish to form japan of the colour required. A few formulæ may be useful. Black: Mix lampblack or ivory-black — this latter preferably — with the above varnish. Another black: Melt 1lb. asphaltum, and mix with the same quantity of balsam of capivi, thin the mixture to a workable consistency with hot oil of turpentine. Another black: Mix lampblack with oil of turpentine, and grind smooth on a muller, thin the mixture with copal varnish. White: Flake white, or white lead, ground up with $\frac{1}{10}$ of its weight of starch; this must be thoroughly dried, and mixed with mastic varnish. Yellow: King's yellow is used as the pigment, but the effect is considerably improved by dissolving turmeric in the alcohol before adding the shellac to form the varnish. Various colours are made simply by the incorporation of a suitable pigment in the varnish made as described above.

Tortoiseshell japan is extremely pretty, and comparatively easy to manipulate. The work is first coated with a japan made by boiling 2 pints linseed oil, to which $\frac{1}{4}$ lb. umber has been added, till it becomes thickened; the mixture is then strained and further boiled till it becomes of a pitchy consistency. This is mixed with turpentine to a workable consistency and then applied. On a thoroughly dry coating of this japan lay a quantity of vermilion spots to represent the clear portions of the shell. The vermilion japan is made by adding vermilion to shellac varnish; it should be laid on thinly and dried. The whole surface is then finally coated with a thin layer of the above described brown japan, still further diluted with turpentine. A long course of stoving will

be necessary to thoroughly harden the japanning.

The operation of japanning consists of driving off the solvents of the japan at a high temperature. When the article, covered with a coating of japan, is placed in the oven and submitted to a temperature of about 300 F. and even more, the solvents quickly evaporate.—The residue, a gummy substance, with which is incorporated the colouring matter, is kept liquid by the heat, and in the semi-liquid state forms a smooth coating filling any small inequalities of the surface. The baking process secures a very firm adhesion of the japan to the metal, far superior to that of ordinary varnish or paint. The japan is also made hard, and consequently better able to resist wear. When one coat is dried another is applied and submitted to the action of heat. These operations are repeated, as may be deemed necessary, from one to six times. Each succeeding coat of japan will present a more uniform and glassy surface. The natural flow of the japan generally suffices to produce a good smooth surface, but in some cases a process of polishing is resorted to before the application of the final coat.

The temperature for light-coloured japons must not be sufficiently high to scorch, or the surface will, of course, be discoloured. Dark japons are usually dried at a very high temperature, if the article is not likely to be injured by heat. The final coating of japan is generally a layer of clear varnish, which will add to the lustre of the surface. Practical experience is the best, and, indeed, the only guide by which proficiency in the art of japanning can be attained. (P. N. Hasluck.)

(h) *Wood*.—A lacquer of great elasticity, perfectly supple and not liable to peel off, is made in the following manner:—About 120 lb. oil varnish is heated in one vessel, and 33 lb. quicklime is put into 22 lb. water in another. As soon as the lime causes an effervescence, 55 lb. melted rubber are added. This mixture is stirred, and then poured into the vessel of hot

varnish. The whole is then stirred so as to be thoroughly mixed, then strained and allowed to cool, when it has the appearance of lead. When required for use, it is thinned with the necessary quantity of varnish, and applied with a brush, hot or cold—preferably the former. This lacquer is useful for wood or iron, and for walls; it will also render waterproof cloth, paper, &c.

(i) White is the usual type for Tonbridge ware, &c. Therefore the grain should be filled up with plaster of Paris and glue size. As a matter of course the wood should be white, such as pine, chestnut, lime, or holly. After filling up the grain, well paper the surface, smooth with glass paper; no oil must be used on any account. If the appearance is not satisfactory when papered down, give another coat of glue, size, and plaster of Paris, paper down smooth, then give the article a coat of varnish made as follows:— $\frac{1}{2}$ lb. flake white, $\frac{1}{2}$ gill spirits of turpentine, $\frac{1}{2}$ gill spirit varnish, such as white hard varnish or glaze. (N.B.—It must be borne in mind, as the quality of flake white and the thickness of the varnish vary, the quantity must not be taken as quite exact, but the amateur must be guided by circumstances.) When the first coat is dry, paper down and give another coat; paper down again, give another coat. When quite set give the whole piece of work a coat of white hard varnish, or, if preferable, a coat of glaze. Work done in this style will last for years. Should it at any time get bruised, it may be papered down and revarnished. In grinding colours for coloured work, great care should be taken that the mixture is worked quite smooth, using spirits of turpentine only. Never mix with varnish until the colour has been well mixed with turps, and never mix a greater quantity than will be used at any one time. For colour japanning the following colours are used:—Flake white, red lead, vermilion, Prussian blue, chrome yellow, the various ochres, Vandyke brown, umber, lamp-

black, blue black, drop black. With these any colour may be matched. For black japan a simple plan is to stain the article, or even paint it with lamp black and turps. After the grain is filled up, then varnish it with black japan thinned with turps, after which give the article a coat of white hard varnish, darkened with ivory black, or it may be finished off with a mixture of gold size and ivory black, but must have two coats.

(f) *Trays, Dish Covers, &c.*—Well cleanse the covers from grease by washing in sulphuric acid and water. Rinse in cold water until quite free from acid. Purchase any quantity, say 1 pint, black, brown, yellow, or red japan varnish; pour a small quantity of varnish in a cup. Place the cover in a warm oven until quite hot; remove from the oven, varnish the cover in one direction, using a camel hair brush. When every part required to be varnished is done, place the cover in the oven for 2 or 3 hours. If the article to be varnished is too large for the oven, it should be made quite hot in front of the fire, and same after varnishing, but care must be taken not to allow it to blister, and to keep free from dust and draughts of cold air.

MAGIC LANTERNS.

The Lantern.

(a) *Cheap lantern for gelatine plates.*
—The cost of this lantern is nothing, for every amateur who practises photography has the materials required—viz., a green glass bottle and a jam-pot of white earthenware large enough to admit of the bottle being placed within it. Next cut off the bottom half of the bottle, by first holding the bottle over a candle, and then plunging it into cold water; this will establish a crack which is led round the bottle with a red-hot poker, thus cutting it into two parts; then place the upper portion with the neck into the jam-pot, neck upwards,

and observe how far the neck appears above the jam-pot; this portion blacken with Brunswick or Japan black. Then take the cork belonging to the bottle and cut a piece out of it, like Fig. 51, the cork being placed so that the heat and

51.



52.

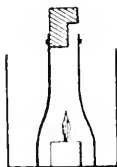

Cheap lantern.

smoke can escape. The lantern is now complete. To use, place a night-light at the bottom of the jar, and the bottle over that (Fig. 52). The light should not be placed within 4ft. of the developing tray, or, if required nearer, a piece of orange paper should be placed over the jar, with a hole cut in it for the neck of the bottle. This light will not fog an extra-rapid plate. A beer bottle will do for the bottle.

(b) *Reflecting lantern.*—A magic-lantern which can be used for showing opaque objects is thus described:—On the inside of each end of the front, and on the inside of each end of the box, is a concave reflector; these are so placed as to concentrate the light upon the picture at the centre of the back of the box. In a tube F, projecting inward from the front, between the mirrors, is arranged a sliding tube G, holding a convex lens H. This tube is moved for focussing by means of a rod J extending up to the top of the back of the box. In the box two lamps or other lights—such as calcium or electric—are placed between the mirrors at each end, as shown in A Fig. 53. Above each light is placed a detachable funnel. The top of the box is curved and the under side is polished to reflect the rays of light. In the top is a ventilating opening provided with a hood to permit the hot air to escape; the supply of air is admitted through the perforated

bottom. The pictures are held in a sliding apparatus moving between two longitudinal grooves B, secured on the outside of the back of the box, and having two apertures, which can be closed by hinged doors. The pictures

For example, if a photographer wishes to show his customer how an enlargement from a carte will look, he simply has to put the carte in the "wonder camera" and "throw it up." Many enlargement scales may be made in

this way. Any photographer may make a "wonder camera" for himself, and what follows will tell him how in a very simple manner:—It consists of a wooden box with a top made of tin or sheet-iron; the chimney is made of the same material. The lens is the same as used upon a camera for making photographs. At the back of the box (as will be seen by reference to Fig. 53 A B C) are two doors placed upon hinges. When the box is in use the door *e* is kept closed. The other door consists of two parts placed at right angles to one another; the object of this is to fill the opening in the door *e* while the pictures are being attached to *c*;

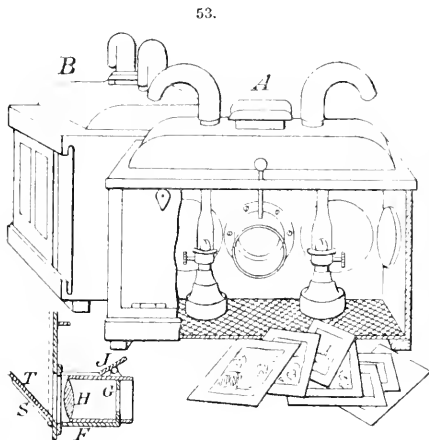

Reflecting lantern.

are held in place by closing the doors, and can be shifted to appear in the opening in the back of the box. The light from the lamps is reflected by the mirrors upon the picture, and from the same through the lens upon a screen or wall. By means of a mirror T on a door S hinged to the front of the box below or at either side of the tube, the light can be reflected upon any desired surface. Any opaque object, such as a photograph, chromo, or drawing, can easily be reflected upon the screen in any desired size, all parts being clear and distinct. The pictures do not become heated sufficiently to injure them, and may remain in the apparatus for hours without being destroyed. (*Scient. Amer.*)

(c) *Wonder camera*.—A "wonder camera" is a sort of magic lantern so contrived as to enable one to use opaque objects for projection upon the screen, instead of glass transparencies.

when *c* is swung into position opposite the lens placed at *b*, *d* is carried to one side. If stereoscopic views are to be shown, a slit may be cut at *e*, through

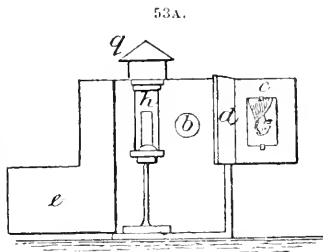

which they may be inserted without opening the box. The door *e* should be cut off a little at the bottom so as to admit air. The light is placed at *h*, as nearly opposite the picture as pos-

sible. It should be a strong light; an argand burner is the best. At the back of the light is a piece of tin bent into the form of a reflector. The light

(d) *Portable lantern.*—A very compact form of magic lantern (Fig. 54) is adapted for all experimental purposes, as well as for the projection of views.

53B.

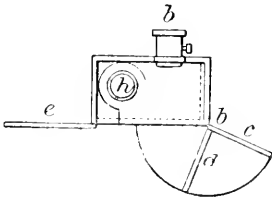

Wonder Camera.

53C.

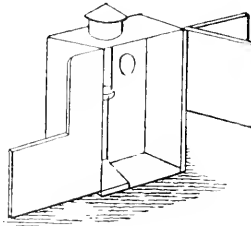

coming from *h* strikes *c*, and is reflected through the lens upon the screen. The plan of the box is represented with the top removed. Dimensions will depend

The best way to give a correct idea will be to take, as example, a $4\frac{1}{2}$ in. condenser lantern, and give the dimensions of the different parts. The size of the condenser settles the question of the measurements of the other parts.

54.

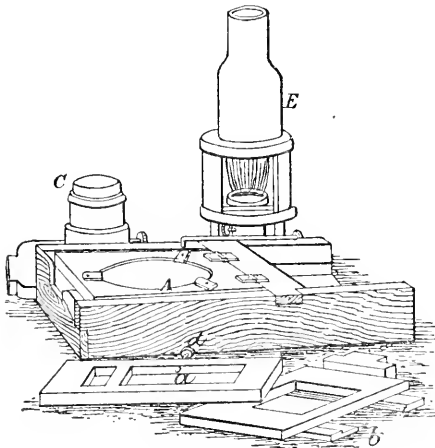

Portable lantern.

upon the focal distance of the lens and height of the light. Care must be used to have the distance from the lens to *c*, when closed, equal to the focal distance. (T. Carter.)

The two condenser lenses, plano-convex, are mounted each on a separate board. A circle is turned out with a rabbet in each board, in which the condenser seats itself, and is secured therein by three buttons. The rear condenser board A is $6\frac{3}{4}$ in. square. The front board B is of the same width, but $8\frac{1}{2}$ in. long. To the rear one a strip is screwed across the top edge, and the front one is hinged to this strip. At their bases, coming between them, two small abutting strips are secured. The thickness of the strips is such that the boards, when brought together with the strips in contact, are strictly parallel, and the lenses are held apart from each other.

The frame or base of the lantern is a three-sided square, a little over $6\frac{3}{4}$ in. across, and 13 in. long in internal

measurement. It is closed at the front and open at the back of the lantern. It is $2\frac{1}{2}$ in. deep, $7\frac{1}{2}$ in. from its front; the back condenser board is hinged to a strip that runs across the top of the frame, and is screwed firmly thereto, flush with its upper surface. A long brass hook *f* and staple are provided for holding the condensers in place when vertical. The boards are held together, when desired, by another shorter hook *c* with staple. The condensers are then in place for horizontal projection. To arrange them for vertical projection, the small hook *c* is unfastened, the front condenser *B* is pushed up until the two are at an angle of 90° , and a plane mirror is inserted, resting against the two bottom strips. The mirror should be mounted on a thin board or on a brass plate, so as to provide strength and protect its back.

A mortice is cut in the front condenser $6\frac{3}{4}$ in. from its top, $\frac{5}{8}$ in. wide and $3\frac{1}{2}$ in. long. A piece of board *a* is cut to slide smoothly back and forward through this mortice. For retaining the strip in any desired place, a hand screw *e* is placed on the side of the condenser board, which is notched at both its lower corners. A strip of brass is attached to the side of this strip for the screw to press against.

The strip carries the slide carrier *b* and lens *C*. The lens is attached to a board about 4 in. wide and $5\frac{1}{2}$ in. high, with a tenon projecting from its base. A mortice is cut near the end of the sliding strip to receive this tenon.

A second mortice or slot, $4\frac{1}{8}$ in. long and 2 in. wide, is made in the strip *a*. The slide carrier *b* is a board $6\frac{1}{2}$ in. high by $4\frac{1}{2}$ in. wide. To its base is attached a piece of wood 3 in. square. This is $\frac{1}{2}$ in. thick, and below it is a second piece of the same length, but just 2 in. wide. The second piece

enters the slot in the sliding strip *a*, and the slide carrier rests upon the shoulders formed by the upper block. A hand screw *d* is arranged to hold the slide carrier in place where desired. A smaller movable mirror *D* is supplied, to be supported above the objective when the lantern is to be used for vertical projection.

A piece of sheet iron is fastened across the bottom of the main frame, on which the lantern *E* rests. In the front of the same frame a notch is cut in which the piece *a* rests. To make its position in the front condenser board more secure, a second strip may be attached just below the mortice and to the back of the board. For lantern, any good form of screened lamp may be used. If necessary, a sheet-iron box may be arranged to enclose the source of light;

55.

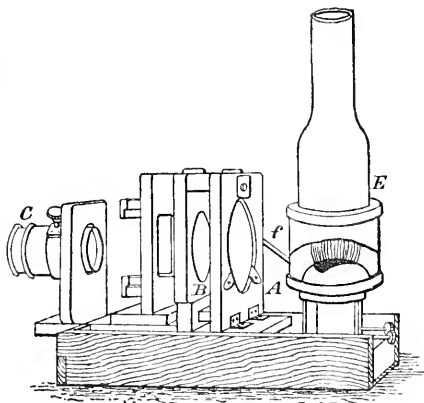

Portable lantern.

but with such a lantern as is here shown it is quite unnecessary.

Fig. 54 shows the whole ready for mounting, the lamp being lighted and ready for work. The lamp should always be lighted before beginning, as it may take 5 min. for it to attain its full power. Fig. 55 shows the whole put

together and arranged for exhibiting views. By removing the slide-carrier, the entire space between condenser and objective is free for the introduction of apparatus or performance of experiments. A soap bubble can be blown and projected in this space. A glass of water can be very prettily shown, and the lantern will be found admirably adapted for the experimenter's use. Fig. 56 shows the lantern arranged for

The slide carrier can also be moved backwards and forwards. By these two adjustments, the slide carrier can be brought to any point desired in the cone of rays converging from the condensers. By moving the lantern backward and forward, any modification in the direction of the light rays emerging from the condenser can be given. A lime light can be used instead of an oil lamp; but as the object was to show a portable lantern, the former has been shown in the cuts. (T. O'Connor Sloane.)

56.

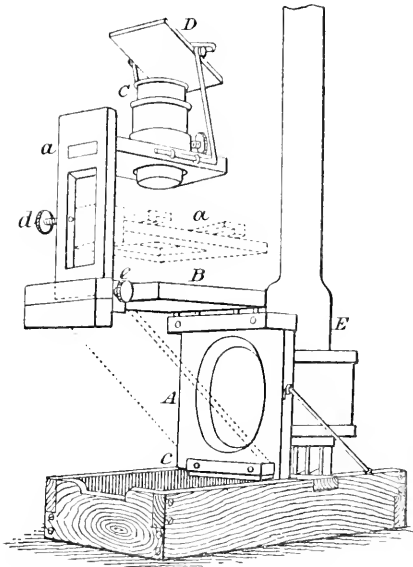

Portable lantern.

vertical projection, the outline of the mirror being given in dotted lines. As the slide-carrier is not always used for work in this position, it, too, is shown in dotted lines.

If all is properly constructed, the apparatus will be susceptible of all kinds of adjustments. The sliding board *a* can be moved back and forth in the mortice in the front condenser board.

(*e*) *Pentaphane Lamp.*— This lamp has no fewer than 5 wicks, hence the name "Pentaphane," or 5-fold light. Besides the improvement in the lamp, there are some others not before met with in the ordinary lantern. The shape is somewhat different—the square front carrying the objective being an arrangement for exhibiting opaque objects, which has hitherto been accomplished by a separate piece of apparatus, the aphengoscope, the use of which necessitated altering the position of the lantern, whereas in this case it is effected almost momentarily. For exhibiting transparencies, the objective is screwed into the bottom flange, with a cap screwed in to exclude the light when not in use. The light from the lamp passes through the condenser in the ordinary way to the objective. When required for opaque objects, such as a C.D.V., medal,

works of a watch, &c., &c., all that is required to be done is simply to screw the objective into the top flange. The flat mirror at the bottom is then brought into use, and fixed at a proper angle to throw the light from the condenser back on to the object by a piece of metal drilled with a number of holes, and a pin fixed beneath. The object is then reflected

through the objective on to the screen. This arrangement will be found very serviceable for introducing many interesting objects in the course of an exhibition, which otherwise could not be done without first having them

moderate-sized lecture rooms. The difficulty of the accurate adjustment of the wicks, so as to avoid smoke, &c., from so many burners, is obviated by a very simple but, at the same time, very effective arrangement of a fan or

57.

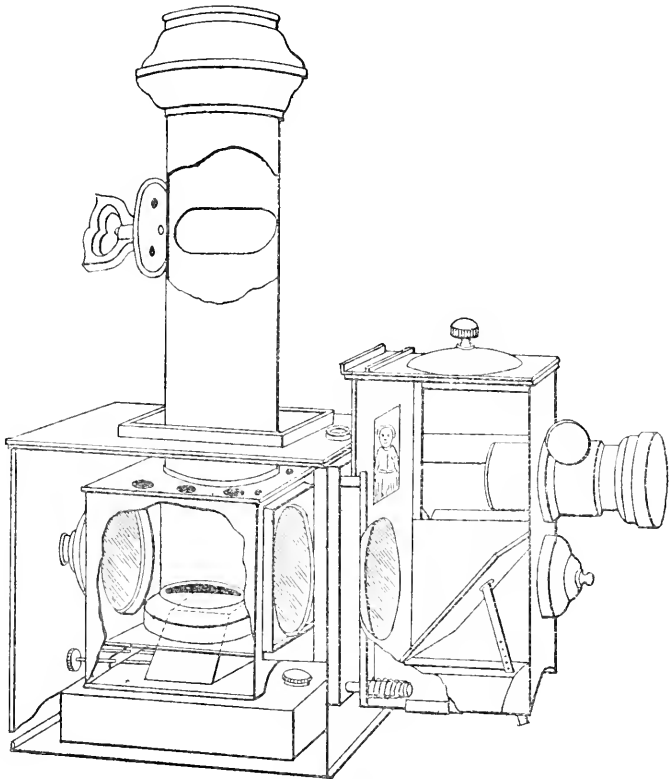

Pentaplane lamp.

photographed and made into slides in the ordinary way. The 5 wicks of the lamp are arranged parallel, and the light given is, certainly, one of most intense brilliancy and, for transparencies, all that can be desired for schools or

shutter placed in the iron chimney of the lamp, which regulates the current of air so that, when the flames are left at a moderate height all level, by turning the fan the current of air is increased, and the combined flames

drawn upwards and towards the centre, where the greatest amount of illumination is, of course, required. The lantern appears to be well made in all its parts; is fitted with 4 in. condensers and portrait combination objective; and is made exceedingly portable, packing

are used, but for the mere purpose of exhibiting a series of photographic views there is no need of two lanterns, unless it be for the purpose of *effect*, and that is no small matter in a lantern entertainment. To see a picture come on the screen in its proper place and

58.

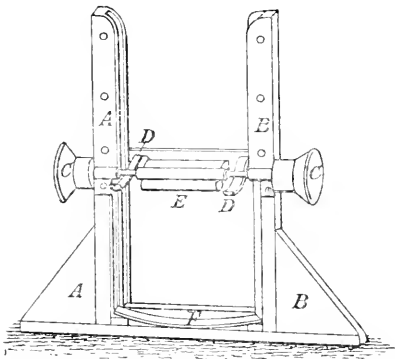

59.

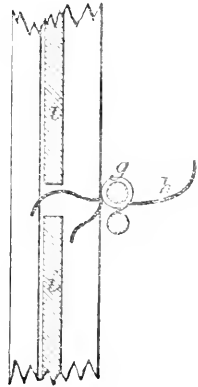

Carrier for slides.

into a light iron case only 15 in. by 7½ in. by 13 in., and leaves nothing to be desired by those who wish for a compact and complete instrument ready at a moment's notice.

Carrier for Slides.—The lantern slide carrier may sound to some a very unimportant part of the lantern outfit, yet it is the very back-bone of a successful entertainment. Chadwick, who has done much to simplify lantern manipulations, has overcome, to a certain extent, the difficulty of exhibiting slides of various sizes. A universal size of slide would do much to advance the interests of photography and remove a load of anxiety from the mind of the lantern conductor. We would then be in a better position to exchange slides with other nations, and be sure of exhibiting them without any special arrangement in the form of our carriers.

Chadwick's improved carrier is simple and effective enough when two lanterns

remain there quietly till the lecturer has passed his remarks upon it, and to pass as quietly away, is a pleasure we seldom enjoy under present circumstances. When a single lantern is used we are accustomed to see the pictures pass along the screen in regular, and sometimes irregular, succession with an ugly streak of black between each, caused by the binding of the two glasses and the round or cushion-shaped mask between them. Why this has been so long the form of mounting slides is difficult to understand: it is much better to leave out the mask, and with the picture close up to the edge, bind only the top and bottom of the slide; and if the push-along process of exhibiting be adopted, we have something more approaching a panoramic effect, and the eye will not be so painfully impressed with what in reality appears more prominent than the picture itself, namely, its mask and binding. This,

with the single lantern, will be found a practical way of getting over the difficulty when slides of various sizes are to be exhibited; indeed there need be no limit to the length of the landscape slide, though for portraits the mask is indispensable. A universal size of slide, after all, would be the most acceptable.

I shall now describe my carrier and the mode of using it. The only difficulty in the way of its being immediately adopted is that a special arrangement is necessary to be made with that part of the lantern which bears the lens. The improved Sciopticon requires no alteration except in the hood which shades the light between the condenser and the objective. The carrier requires no great amount of mechanical skill to effect the desired alteration. Figs. 58, 59 give some idea of the shape and mechanical arrangements of the carrier in its improved form:—

A B Fig. 58 is the frame, which may be made of either wood or metal. C is a spindle which passes from side to side of the frame, terminating at each end with a suitable thumbscrew, by which it is turned in the act of changing the slide. D, two metal plates passed through the above spindle, which act as levers in pushing away the slide. E may be called a self-acting balance lever, the form and action of which will be better seen in Fig. 59. F is a spring to counteract the force of the falling slide, upon which the successful working of the carrier much depends, in adjusting which be careful to give it a slight turn inwards, so that the slide on falling may not be forced outwards. Fig. 59 is a full size section of the principal part of the carrier as seen from the side: *g* is the spindle; *h* the self-acting balance lever, which is simply a plate of metal bent round the spindle in the form represented, the round black part of which is filled with lead, thus causing the lever to press against the slide *i*, and hold it in position till forced away by the spindle levers in the act of changing the slide.

In using the carrier, drop a slide in at the top of the frame at A B, Fig. 58,

till it rests on the spring F. That being exhibited on the screen, drop another slide in at the top as before, while the spindle levers are lying in a horizontal position, thus preventing the top slide from coming in contact with the bottom one. The lecturer having finished his description of the view on the screen, gives the signal, while you give the thumb-screw C a slight turn, and, in a flash, the scene is changed. The slide, on being expelled from the carrier, falls forward upon a cushion or pad, from which it is removed during the description of the succeeding slide, and so on till the close of the lecture. (J. McKean.)

(*f*) *Bimetal Lantern*.—A difficulty with many has been that they cannot obtain coal gas; and they find the oxy-calcium process with spirits of wine not easy to manage. The symmetrical condenser is now much in use. A hint for steadying the jet and lime holder is by filing away the supporting rod on the side opposite to the screw. This simple plan is so effectual for the object designed that it ought to be generally known and adopted.

Sources of light are the first point for consideration. The forms are as follows: The lowest form of lime-light is the oxy-calcium or spirit-lamp jet. In this form a jet of oxygen gas is thrown on to a spirit-lamp flame, and, striking on a cylinder of lime, produces the lowest form of lime-light. This light, under usual conditions, is equal to 150 candles.

The next is the safety oxy-hydrogen jet. Here we use a jet of gas from the nearest gas fitting, and through this the oxygen jet is thrown, as described, on to the lime. This form is perfectly safe, and gives a light equal to 190–200 candles.

The most powerful of all is the true oxy-hydrogen jet. Here we have both gases (the oxygen and hydrogen) under a much higher pressure. The jet is so constructed that the two gases mix in the chamber of a jet, and pass through the jet into the lime cylinder. This jet is equal to 400–425 candles. The light is most intense, and with it views 35 ft. diam. may be shown. Its great draw-

back is that it is only safe in the hands of an experienced operator. It is a form requiring careful manipulation in every respect, but if certain conditions are complied with, it can be used without danger.

Highley describes an oxy-spirit lamp which seems perfect in all its arrangements. Pumphrey's vaporiser, when you cannot get coal gas, is an inexpensive apparatus, and can be used with any lantern, the spirit being volatilised, and burned without a wick at the mouth of an ordinary safety jet. There are, however, two or three points to be observed in order to ensure success. Much depends upon the construction of the burner. If you use an oxygen nozzle with a very small bore, and force the gas through it by strong pressure—say 56 lb. or more on the bag—there will be a dark nucleus in the centre of the incandescent lime spot, supposing the cylinder of lime to be somewhat near to the orifice of the jet. And not only so, but on looking into the anterior glass of the lens from the front, you will see the same dark centre, with a ring of light surrounding it, something like an annular eclipse of the sun. The explanation is that the two gases are travelling at so different a rate at the time of their emergence from the jet, that they do not mix properly, and hence there is an excess of oxygen in the middle of the flame, producing a cooling effect.

Some say that the greater the pressure on the gas bag in the oxy-calcium process, the better the light; but in my own practice I find quite the reverse, and have obtained the best results by using a low pressure not exceeding 28 lb. The oxygen then travels slowly, and mixes more thoroughly with the spirit vapour before the flame touches the lime. *Quantity* of oxygen, however, is important, and hence I enlarge the bore to $\frac{1}{32}$ in. to compensate for the diminished pressure. A single trial will show the advantage of this enlargement of the bore, the light being better and more steady, whilst the lime requires to be turned seldom, or not at all.

Look at the matter from a common-sense point of view. In this oxy-calcium process you have spirit of benzoline vapour escaping slowly through a large orifice of $\frac{1}{4}$ in. diameter, and you send a small and rapid stream of oxygen into the centre of it. Unless, therefore, the lime cylinder be at some distance, the two gases cannot mix. When, however, you use a larger stream, and one whose rate of travelling corresponds more nearly with that of the spirit, the admixture is perfect, and complete combustion is the result. At all events, whatever the theory may be, there is no doubt that in practice the latter method gives the best result.

The $\frac{1}{32}$ in. oxygen orifice may be measured by an amateur sufficiently nearly by stamping it on a sheet of paper, and making five impressions, side by side, which ought then to measure $\frac{1}{4}$ in.; or by picking out a stocking needle which exactly fits into the bore, and pricking a few holes on paper close together.

A beginner will, perhaps, find a difficulty in centring the jet in the lantern when it is heated by the small lamps employed with Pumphrey's vaporiser. To avoid this, cut a circle of paper the size of the condenser, with a small hole in the middle, and stick it on the back glass with a wafer. You will then see exactly the height at which the jet should be fixed to bring the lime spot on a line with the optical axis, and it will remain only to cut a half cork, or a piece of soft wood, and tie it, underneath, on to the supporting pillar, so that for the future the jet may be dropped on to it, and screwed up securely. I work the oxy-calcium process with the lime cylinder rather near to the jet, although not quite so near as in the oxy-hydrogen process. In all comparative experiments, the distance from the jet should be noted, as it has an influence upon the result. The *soft* limes are preferable to the hard, when low pressure is to be employed. As to construction see Figs. 60-70. If we suppose, side by side, two mahogany body lanterns, and if we place one of them on

the top of the other, making the necessary arrangements as to carrying the trays, etc., we have the first principles of the bi-unial lantern. In doing this we find an obstacle arises, the disc of the upper lantern does not coincide or register with that from the lower one. Hence we are compelled to either tilt the upper lantern downwards, or in some way to obviate this. If we, therefore, allow the stage carrying the condenser, slide holder, telescope front, and focus lens of the lower lantern to remain as it is, but fit the upper stage to the mahogany body with a hinge, and arrange for its adjustment, which can be done by having a spring to press it outwards and two milled-head screws to draw it back, we then are able to cause both discs to coincide on the screen. This plan was the one adopted by Highley. Other makers adopt a preferable arrangement, and make both stages movable. Assuming that, instead of two lanterns, one on the other, we make a body specially adapted, dimensions as follows would be suitable:—

Fig. 60 shows the wood body; height 18 in., inside measurement 7 in. by 9 in., bottom projecting $3\frac{1}{2}$ in. The bottom, Fig. 61, $13\frac{1}{2}$ in. by $9\frac{1}{2}$ in. It is easy to make a lantern, which, for appearance, looks compact and portable; but nothing smaller than the sizes named will give an instrument that will work well with good ventilation. It is a somewhat costly matter if, in reducing space, we find some evening that the woodwork of the lantern is on fire, and that one or both condensers are damaged. Inside the body should be a lining of either sheet iron or tin plate. Figs. 62 to 65 show various views of this. It should be kept off the mahogany, so that an air space of $\frac{1}{2}$ – $\frac{5}{8}$ in. is left all round. This, when the lantern is in use, allows a current of air to pass up, and so prevents undue heating of the wood. Fig. 62 shows the side measuring $18\frac{3}{8}$ in. by 9 in., with holes 6 in. square. Fig. 63 is the back, 6 in. wide. A good way of holding up the lining is to screw it to wood blocks (the thickness of the air space), which, if placed in the angles,

will not interfere with the air currents. At the bottom of the lantern, and secured to the feet, is a tray-holder of sheet-iron; in this slides the bottom tray, measuring $3\frac{1}{2}$ in. by $8\frac{1}{2}$ in., and shown at Fig. 66. Half way up is another tray to work with the second or upper system of lenses, and this is carried by another holder, which should be riveted, *not soldered*, to the metal lining. In work, the lower jet would so heat the bottom of the upper holder, and, in consequence, the tray, that damage would result. To obviate this use a flame guard or deflector. This is a piece of sheet iron, shown at Fig. 65, also riveted to the lining and tin below the bottom of the tray holder, the air space between being found to sufficiently protect the upper jet and tray from damage. Farther up the lining is turned over on a wire, so as to terminate about 1 in. below the mahogany work. By this means the hot air passing up the air space escapes into the upper chamber of the lantern, and so out by the hood. On the right hand side of the lantern should be the doors; they are 6 in. square, with a hole $1\frac{1}{4}$ in. diameter through the centre (see Fig. 67). The doors, as well as the body itself, should have a tin or sheet-iron lining, kept off $\frac{1}{2}$ in., as described. In the centre of the doors should be a circular hole $1\frac{1}{4}$ in. diameter. The use of this is to be filled with a piece of dark blue glass (the tin lining being cut away to match) through which the operator can examine his limelight jet, without being exposed to its dazzling brilliancy or having to open the door.

Next comes the back (see Fig. 63); here we must cut away the wood and lining, so as to obtain an aperture through which the tray and limelight jet pass. At the front, Fig. 64, two circular holes must be cut where the condensers pass through, and should be $\frac{1}{2}$ – $\frac{3}{4}$ in. larger than their diameter.

As to the arrangement of front, Stewart, Middleton, and many other well-known makers fit the entire lens system to a brass plate or stage, Fig. 68, which is hinged to the lantern body,

and adjusted, as described; the condenser being carried by a short tube projecting into the lantern, whilst the power or focus lens is carried, as usual,

across the centre of the lantern front, and carrying the condenser on the inner side, and the brass front and focus lens as before described. In this form, Fig. 69,

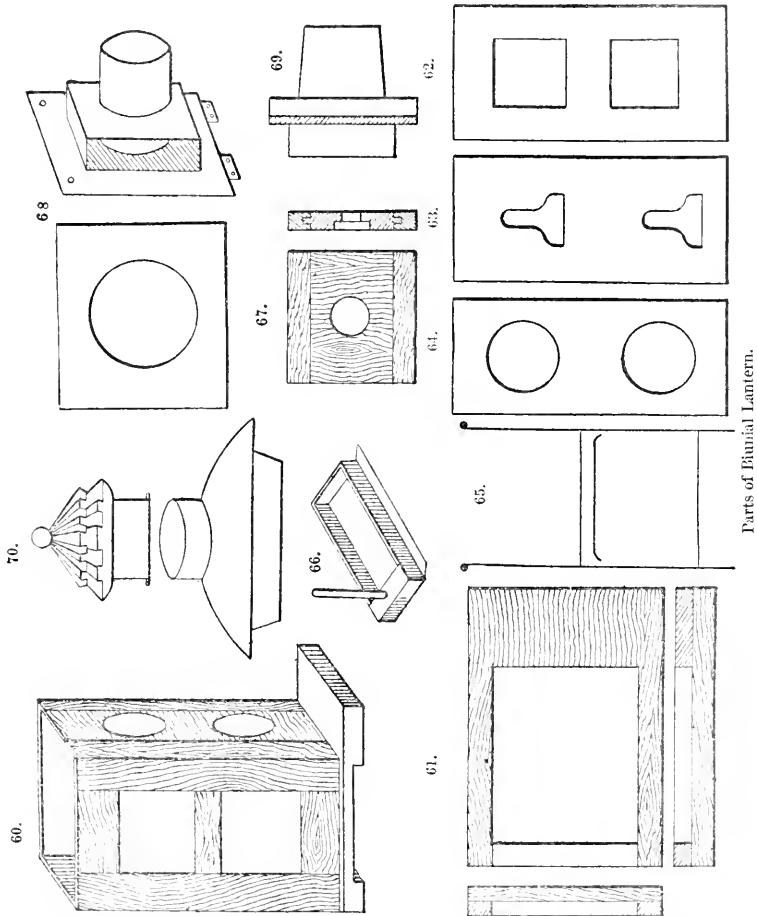

Parts of Bimial Lantern.

at the end of the brass part. Wood, and several other manufacturers, on the other hand, fit, as it were, a mahogany door hinged to a cross bar running

the slide-holder and stage are of mahogany, and on this plan (which is superior in many points) all our highest class bi- and tri-unial lanterns are constructed.

This plan, though more costly, has advantages in appearance and facility of adjustment—the coincidence of the discs being secured with milled-head screws passing through the ends of a brass strap running across the doors. This has one great advantage: it dispenses with springs of any kind. The wood and cap for the top of the lantern are shown at Fig. 70. The condensers should be either $3\frac{1}{2}$ in. or 4 in. diameter. The focus lenses, which should be of the double achromatic form, with rack and pinion, are now made to give long and short focus.

The utility of this is in working with a screen of given size, say, for instance, 10 ft., 12 ft. 15 ft. or 20 ft. Assuming we have an achromatic power of which the short focus is $4\frac{1}{2}$ in., and the long 9 in., we can utilise the concave of the back combination, as also the crossed bi-convex lens, to either further prolong or shorten the focus. Taking the example of a screen 20 ft., and supposing we have to work in a room 25 ft. long, our double combination just covers it nicely. But, supposing the room was 50 ft. long, we should be just in the middle of the audience. We will use the long focus lens, and, placing ourselves at the further end of the room, we still throw the 20 ft. disc. By the same mode, if we have a room larger still, by using the concave back we can still further lengthen the focus. By this means an expert operator can place himself at any convenient distance, and still maintain his given diameter of view on the screen. The front or tubes of this form of lantern are so constructed as to slide one within the other, and by this means we are able to lengthen our tubular front when using long-focus lenses. (*Amateur Work.*)

Slides.—*Printing frame.*—To print transparencies for the lantern by contact, when the negative is of a larger size than the picture required, necessitates some special kind of printing frame, if the negative is to be kept free from scratches. The following may be simply made, and will be found a great convenience where a number of pictures are

required alike:—Take an ordinary printing frame, say a 12 by 10, of the kind made to use without a plate-glass in front, and in the rebate where the negative is usually placed fasten, with strips of paper all round the edges, a piece of very flat glass; turn the frame over, and on the other side of the glass fasten a mask of paper or cardboard having an opening $3\frac{1}{4}$ in. by $3\frac{1}{4}$ in. exactly in the centre. Now, in place of the ordinary hinged back, make a frame of the same size and thickness, with an opening in the centre about 6 by 4 in., and cover all over one side, with the exception of the opening, with a piece of velvet. This frame, when placed in position, will be held by the springs that originally held the hinge back. To complete the arrangement, cut out a piece of dry mahogany 1 in. thick, and exactly 6 by 4 in. to accurately fit the opening in velvet-covered board, and on this block draw a square $3\frac{1}{4}$ in. by $3\frac{1}{4}$ in. exactly central. At one end of this square glue down a very thin slip of hard wood—that is, rather thinner than the glass plates to be used—and at the other end cut a mortice $3\frac{1}{4}$ in. long, and about 1 in. wide, right through the block, beginning just within the $3\frac{1}{4}$ in. line, say $\frac{1}{16}$ in. less. Into this mortice fit a piece of wood $3\frac{1}{4}$ in. by 1 in. by $\frac{1}{2}$ in. On to one side of this piece glue a similar strip of hard wood to that placed on the end of the block only, projecting $\frac{1}{4}$ in. each end, and on the other side screw a similar piece so that it can be removed. Place the piece in the mortice and screw on the back slip of wood; there will then be left a space of $\frac{1}{2}$ in. at the end, just room to put a piece of bent steel clock spring sufficiently strong to clip the $3\frac{1}{4}$ in. plate in position. The sides of the block may be rebated down $\frac{1}{2}$ in. at the $3\frac{1}{4}$ in. line to allow the thumb and finger to adjust the plate in exact position. To complete the frame, place the block in the opening of velvet board, and arrange an ordinary brass pressure frame spring to keep it in position. For use, take the frame, remove the board, and adjust the part of negative required over the $3\frac{1}{4}$ in.

opening, then place over the velvet-covered board, and fasten down the springs. The $3\frac{1}{4}$ in. plate is now clipped in the block, and dropped carefully into the opening over the negative, and after exposure is lifted out in the same way, so that any number of exposures may be made exactly registered in the same position, without the chances of injury to the negative which often occurs unless some such arrangement is adopted. (A. Cowan.)

Size, Shape, and Mounting.—The size generally adopted for a lantern slide is $3\frac{1}{4}$ in. square, with $\frac{1}{4}$ in. margin, which gives the sight of the picture $2\frac{3}{4}$ in. square. By "square" I mean the so-called cushion shape—that is, square, with the four corners rounded. All lanterns of any pretensions are fitted with condensers of 4 in. diameter, and this will take nicely the shape above-named without any falling off at the corners, the diagonal of the opening of the masks for the purpose being $3\frac{3}{4}$ in. If the lantern is fitted with condensers of $3\frac{1}{2}$ in. diameter only, masks with round openings can only be used for all pictures, unless one is satisfied with only small-sized pictures. As regards condensers, many of the modern lanterns are fitted with condensers made with two plano-convex lenses, mounted with their convex sides to each other, and the two plano surfaces outwards. For limelight, a condenser of this kind is the *worst* form, as it is almost impossible, when centering the light (especially when the mixed jet is used, where the light emanates from a very small spot only), to get a perfectly flat field, or "depth of focus"; and the adjustment of the light requires to be very accurate or the disc is not perfectly white. Not so if the other form of compound condenser be used, made up of a bi-convex lens, and the other lens of a meniscus form; and when mounted, the side which is concave being towards the light, and the convex side towards the screen. A condenser of this kind always gives the best results with the mixed jet. The defect in the first-named

condenser is not so great if the safety or blow-through jet is used, as the spot of light on the lime is much larger; and the defect is still less in the oil lantern, as the size of the flame is still larger. The plano-condensers are used as being much cheaper.

To avoid mistakes, the masks for lantern slides are best made of what is known in the paper trade as surface paper—that is, paper black one side and white on the other, the black side being placed towards the film, and the white side towards the cap glass, and on this white side of the paper the name of the subject can be written with pen and ink. The white side is also very convenient, as it can be easily seen in a very dull light by the operator. In making slides for amateurs, I generally mount them in this way; but I think a more elegant way is to use masks black on both sides, and write the title in white with a pen. To do this, get a bottle of Chinese or permanent white, empty the contents into a much larger bottle, and thin down with water, stirring well with a piece of stick kept for that purpose, to a consistency that will flow in an ordinary fine-pointed pen. Or, if the title is long, it is best to use a steel pen called crow-quill size, or a lithographic pen; the writing is then quite as easily done as with an ordinary pen and ink. The white must be occasionally stirred or shaken up, as the pigment being heavy soon settles.

Whichever system of mounting is used, the white side, or where the title is written, this side always goes to the light, unless the pictures are to be seen by the audience on the other side of the sheet, then matters are reversed, and the white or written side of the slide must go towards the sheet.

The shape of opening of the mask is a matter of taste and judgment according to the subject; for ordinary landscape or interiors, the cushion shape will generally be found the best, except in some instances where there is something objectionable in the

corners, then a circular opening may be an improvement. Or take the subject of a distant landscape with too much of a grassy field in the foreground, the circular shape decidedly will be a very great improvement; in few instances an oval will be a greater improvement still. For portraits, the oval form is far superior to any other.

In many instances, the square or cushion shape is not suitable to the subject, especially where slides have to be made from negatives not taken for that purpose. The $7\frac{1}{2}$ in. by 5 in. and the $7\frac{1}{4}$ in. by $4\frac{1}{2}$ in. size negatives, are mostly very unsuitable to contract into a square shape, unless the sides contain unimportant matter and can be cut off; if the whole of the subject has to be included, it is better to make a mask of the same proportions. In some instances, the sky can be made higher; if the subject be a flat country scene, then the sky being made higher will give a better representation of the flat or marshy country; but if the subject be mountain scenery, making the sky higher would have the effect of dwarfing the mountains, which would not be truthful; just the same as in mounting an ordinary portrait, the higher the subject is mounted the taller he or she looks, and the lower the shorter, and it is just the same with the landscape subjects before alluded to. Many pictures are entirely spoiled by injudicious mounting, whereas, with a little care and taste, their value would be greatly enhanced. The masks I use I generally purchase by the gross, of the standard sizes, taking care that they are accurately cut and not out of the centre; and for odd sizes I have a lot of shapes made of hard sheet brass, $3\frac{1}{4}$ in. square outside, with the various sized openings, using the Woodbury cutter, which is very easy, cutting on a piece of plate-glass.

As to the binding of slides, nothing is better than *thin* black paper—not the ordinary so-called needle-paper that is generally used. The thicker the paper the more easily it is pushed

off. Many use gum to stick it on with. Paste with the thin paper sticks far better than gum. The heat of the lantern makes the gummed paper tumble off the glass, whereas it has no effect if paste is used. To make the binding more durable, if a little trouble is not an object, and the thin paper is used, just pass a camel-hair brush, charged with ordinary negative varnish, over the paper, which makes it very hard, and stand a lot of rubbing without getting damaged. (W. Brooks.)

Making.—The requisites of a good lantern picture are:—(a) Artistic composition, the arranging of the subject in such a manner that as the eye wanders over it its beauties continue to grow, and the imagination receives an unalloyed feast of satisfaction and pleasure. To some extent it is possible to teach the art of composition—at all events, so far that its simplest canons may escape violation—but the capacity of rendering true art is a gift of nature. (b) The technical excellence of the picture, its mechanical production.

The wet process yields the best results in many cases. It is at times somewhat troublesome; still, with care and observation, its difficulties can be overcome. Collodion—that is, pyroxyline dissolved in ether and alcohol—forms the vehicle to receive the sensitive salts, and a collodion that has been iodised some time is necessary, otherwise the high lights of the picture will suffer. Thin glass cut to the standard size is taken, and after standing some time in sulphuric acid and water, it is carefully dried with a cloth free from soap or other grease. One side of the glass is then coated with the following solution, which must first be filtered through filter paper:

White of egg, well beaten.	
Ammonia liquor 0·880	.. 1 oz.
Water, according to quantity	
of albumen	15–20 oz.

The coating is performed by pouring a small pool in the centre of the plate, then gently inclining it so that it runs

to each corner; the excess may be thrown away. So soon as the plates are dry, they are ready for use. With a soft brush carefully dust the prepared surface, flooding it with collodion in a similar manner, but returning the excess to the stock bottle. This is to avoid dust, a serious enemy. During the draining the corner should be kept in contact with the bottle, and the plate gently rocked to avoid a streakiness or uneven setting of the collodion. Directly it is sufficiently set—the best test of which is trying the upper corner with the finger—it is steadily and evenly lowered into the sensitising bath by means of a dipper.

A good bath for lantern slides is made as follows:—

Pure nitrate of silver
recrystallised .. 40 gr.
Distilled water .. 1 oz.

rendered slightly acid with C.P. nitric acid, one or two drops of which will be sufficient for 12 oz. solution.

When the bath is mixed, for each 12 oz. add $\frac{1}{2}$ oz. of the iodised collodion, and shake very thoroughly; let stand 2 hours, then filter. The bath should now be quite clear and in good working order, but may occasionally be placed in the sun for a few hours, and afterwards filtered, when it will work cleanly until the silver is exhausted. When the plate has been in solution about 2 minutes, it should be slightly moved to help the escape of the solvents, and in about 4 minutes may be examined by yellow light. If the surface is free from greasy lines, it is ready for exposure in the camera.

A good negative is necessary for a successful slide. It should be "plucky," so as to admit of a fair exposure.

A good developer is made as follows:—

Protosulphate iron .. $\frac{1}{2}$ oz.
Acetic acid 2 "
Honey 1 "
Alcohol $\frac{1}{4}$ "
Water 8 "

Use plenty of developer, and cover the plate in one even wave; never mind

spilling a little, though practice will enable you to avoid this. As soon as all detail is well up, thoroughly wash and intensify with—

Pyrogallie acid .. 24 gr.
Citric acid 24 "
Acetic acid $\frac{1}{4}$ oz.
Water 24 "

Enough to cover the plate is taken, to which, immediately before use, a few drops of the silver bath are added.

Do not over-intensify, as the picture does not lose much in fixing, for which operation hyposulphite of soda may be used on the ground of safety, but cyanide of potassium acts more quickly and perhaps more cleanly. Slides by this process are a good color, and do not need toning. A coat of clear varnish improves the transparency of the shadows.

Whether printing in contact or by means of the camera, I strongly recommend a full exposure. Gelatine plates are sure to show fog if forced, and however slight that may be, it should ensure their immediate rejection. Indeed, it is well to select a really good slide as a standard both as to density, tone, and clearness in the high lights, and those that do not come up to it should not be kept. For dry plates I prefer a soft negative full of detail. If the skies are not sufficiently opaque, they must be stopped out.

The solutions required are 10 per cent. ones of the following: Pyrogallol, bromide of potassium, ammonia, carbonate of ammonia, and carbonate of potash. The pyro is mixed as follows: 4 oz. sulphite of soda are dissolved in boiling water and rendered acid with citric acid. The pyro is then added, and the whole made up to 10 oz. with water. The other chemicals are simply mixed with water, and all will keep well. A developer giving a beautiful purple tone with Mawson's and Thomas' plates is—

Pyro solution .. 30 minims.
Bromide 30 "
Ammonia 30 "
Carbonate ammonia 30 "
Water to make up to 1 oz.

The same colour can be obtained with Fry's plates by slightly increasing the exposure and bromide, while a fine engraving black is got by shortening the exposure, increasing the ammonia, and leaving out the carbonate of ammonia. Sepia is obtained by full exposure and using carbonate of potash or soda in place of ammonia; but some makes of plate will not yield the sepia tone.

While the plates are developing, keep them in motion; it adds to their vigour, and avoids flatness, and prevents deposit settling upon them. After fixing and moderately washing, they may be cleared in—

Alum	2	oz.
Citric acid	$\frac{1}{2}$	„
Water	10	„

The addition of 2 oz. protosulphate of iron and $\frac{1}{4}$ oz. more of citric acid will considerably moderate the tone, and by slightly reducing the slide increases the clearness of the high lights. If any deposit appears upon the surface, rub gently with the finger or a tuft of cotton wool. The slide is now well washed, allowed to dry slowly away from dust, and then varnished. (E. H. Jaques.)

(b) After your negatives are dry, the next step is to make a lantern transparency from them. The method is very simple. A $3\frac{1}{4}$ by $3\frac{1}{4}$ gelatino-bromide plate is exposed behind the negative to the light of a good gas-lamp for 3–30 seconds, as the density of the negative may require (6 seconds is the rule for a good negative). Develop with ferrous oxalate, to which a little chloride of ammonium may be added (3 drops of 10 per cent. solution to 1 oz. of developer): fix, wash well, immerse in alum solution made slightly acid with hydrochloric acid, wash dry, and mount behind a piece of good clean glass. (H. P. H.)

(c) On dry plates.—All the manipulations can be carried on in the evening, with much greater rapidity, as well as economy, than any other method of producing pictures. A perfect lantern slide must possess two qualifications, viz., absolutely clear glass in the high lights, and, when held up to the window with a

ground glass or other suitable background, full and distinct details in the shadows. For contact printing (which is the method largely practised), the following should be provided:—One glass pan (4 by 5) for developing; two glass pans (5 by 7); as these will hold two plates each at a time, they will often be found useful when fixing and clearing. It frequently happens that the first plate is not entirely fixed by the time the second is ready to be placed in the hypo.; hence a large tray is quite essential. One deep printing frame. A student or other kerosene lamp, with a porcelain shade, is the best for making the exposure, and a developing lantern yielding plenty of diffused orange-coloured light is essential for the dark room. In the dark room the negative is now placed in the printing frame, and the box of sensitive plates is opened; one is then laid upon the face of the selected portion of the negative most suitable for a slide. Next hold the frame up in front of the orange-coloured lantern, to obtain the correct adjustment of the slide with reference to the picture, and carefully keep the plate in position while laying the frame down to put in the pressure board. It is now ready for exposure, which should be made with the frame fixed at a distance of about 12 in. from the lamp. Considerable latitude is allowable in the duration of the exposure, provided the developer is made to correspond to it. A long exposure, 15–40 seconds (according to the density of the negative), with a dilute developer is the most suitable, yielding warm brownish tones with fine detail in the shadows.

After the exposure is made, the plate is developed in the dark room, with the following solutions, prepared after Carbutt's formula:

No. 1.—IRON.

Water	4	oz.
Sulphate of iron	480	gr.

Dissolve, filter and add

Sulphuric acid .. 5 drops or minims

No. 2.—OXALATE.

Water	8 oz.
Sulphite of soda (crystals)	120 gr.
Citric acid	15 gr.

Dissolve and add

Neutral oxalate of potash .. 2 oz.

Now test with blue litmus paper; if it remains blue, add a few drops at a time of a strong solution of citric acid until the paper turns faintly red, then add

Citric acid	50 gr.
Bromide of potassium	10 „

And filter.

No. 3.—FIXING BATH.

Hyposulphite of soda	1 oz.
Water	5 oz.

The developer should be mixed as follows:—

No. 2 (Oxalate potash solution)	4 oz.
--	-------

To which add

No. 1 (Iron solution) ..	1 oz.
--------------------------	-------

And then dilute with

Water	1 to 3 oz.
---------------	------------

The development will be slow, and should be continued until the details are fully out, and the image distinctly seen on the back of the plate. After development, the plate is well washed in running water; and placed in the fixing bath; another thorough washing is necessary, then it is immersed for 30 seconds in the following:—

CLEARING SOLUTION.

Alum	160 gr.
Water .. .	5 oz.
Sulphuric acid	2 dr.

Again wash the plate thoroughly, and finish by holding it under the tap, while passing over the face of it a broad camel-hair brush, which will remove any adhering particles of sediment. The plate is then placed on a negative rack, and should be thoroughly dry before being mounted.

Abandoned negatives, with the film cleared off by boiling in water, can be utilised for the protecting glasses by being cut up to the proper size. Care

should be taken to use glass free from spots or bubbles. (J. E. Brush.)

(d) The advantages of the carbon process are twofold:—(1) Absolute control over the tone of the transparency; (2) purity of the high lights. To ensure this latter, however, one precaution is necessary, namely, that the room where the tissue is dried must not be warmed by gas or lamps, unless means are provided for carrying off the products of combustion. If they are present in the air, an insoluble skin is formed on the tissue, and the high lights are consequently degraded. An actinometer is necessary as a guide to exposure, and in most carbon printing works one is usually employed by the printers, but not always.

Woodburytype is especially suitable for lantern slides. The relief is simply a carbon print; but the tissue, instead of being highly charged with colour, is only lightly tinted, the object being to obtain as great a thickness as possible in the shadows, so as to facilitate the printing operations afterwards. Skill is here required—not only in the preparation of the tissue, but in drying the developed relief. The advantages of this process are that, once a satisfactory relief is obtained, any number of printing moulds can be secured from it by pressure in the hydraulic press, from each of which numbers of prints can be obtained of the exact tone and depth desired. It has the further advantage of allowing of a considerable amount of retouching. For instance: if the negative be full of pinholes, these produce little raised points on the relief, which can be cut down. On the other hand, if there be any black spots on the negative, these form raised ones on the leaden mould, which can also be cut down. These advantages are shared by stannotype. All spots are touched out fully on the negative, and from this a positive is made, in which they show as white spots. From this positive a “relief” is produced, in which these white spots will be raised ones, and can, therefore, be cut down before the tin-foil is applied. This process has the

further advantage that the positive can be either direct (of the same size as the original negative) or copied in the camera of any size; but it also shares with the Woodbury process the drawback of only being economical when considerable numbers are required.

Perfect lantern slides are realised from gelatine plates, either by direct contact printing or in the camera, combining not only perfect transparency, but every gradation of tone from the warmest chocolate to the coldest black.

The days of collodion for outdoor work are nearly gone, and for lantern slides they are certainly numbered. Their cold tone might be passed over, or, perhaps, improved; but their fatal defect is the difficulty in obtaining due transparency in the shadows. Gelatine plates for the amateur seem to present the greatest number of advantages of any process, and there is no reason why—for amateur work at any rate—a larger camera than $3\frac{1}{4}$ in. square should be needed. Either from the negative an enlarged print direct may be made, or from the positive (or lantern slide) an enlarged negative might be produced of sufficient sharpness for all practical purposes. With the ordinary lantern, the condensers, being 4 in. in diameter, are large enough to cover the effective part of the $3\frac{1}{4}$ in. square picture, while, with a very little modification, enlarged negatives quite equal to full-sized direct negatives might be produced.

It is often complained of enlargements that they lack crispness, and undoubtedly this is frequently the fact. But is it due to inherent defects in the process or defective manipulation? To commence: how many negatives are themselves sufficiently crisp to bear examination with the ordinary focussing eyepiece. If they will not bear this amount of amplification it is, of course, impossible to produce sharp enlargements from them. On the other hand, sharp photographs have been produced of minute objects, such as diatoms, in which the amplification has

been carried to thousands of diameters. A magnification of upwards of 100 diameters, with a degree of sharpness still requiring the aid of a magnifier to distinguish details, is within the range of the common microscope objective; and, having repeated the experiment with different objectives and the same success, I have no hesitation in saying that there is no reason why negatives should not be satisfactorily enlarged to any extent. (G. Smith.)

(e) Albumen process.—It may be interesting to many to know the old system of working, so that they can realise the difficulties attendant upon it, which gave rise to so much prejudice against the albumen process, particularly amongst amateurs. Accordingly, before commencing the details of the modern method, we shall digress for a moment to give a brief outline of the old process, so that the more recent improvements may the better be understood, and therefore appreciated. In the earliest methods the plate was coated with plain un-iodised albumen, and then dried. The iodising of the film was afterwards effected by exposing it to the vapour of iodine, in the same manner as in the daguerreotype process, until it became decidedly of a yellow tint. It was then sensitised by immersion for a short time in a solution of nitrate of silver strongly acidified with acetic acid, similar to that employed in the calotype process. An improvement on this plan was effected by adding an iodide to the albumen itself, which simplified matters considerably, as it did away with at least one troublesome and disagreeable operation. The method of working was this:—A certain quantity of albumen was taken, and to it was added the proper proportion of iodide of potassium. The addition of bromide was also made by some workers. The whole was then whisked into a stiff froth. The directions usually given for this part of the operations were that the albumen should be whisked until the vessel containing it could be inverted without the contents running

out. After standing some hours for the albumen to subside it was ready for use.

The plates were coated in the following manner:—They were first affixed to a plate-holder, which consisted of a piece of guttapercha fastened on the end of a stick, as pneumatic plate-holders had not been invented at that period. The guttapercha was made sticky by melting it in the flame of a spirit lamp, and the plate attached. The albumen was now poured on and distributed, and afterwards equalised by centrifugal force, by giving the plates a rapid rotary motion by spinning the stick between the fingers. The plate was then detached, and put into the drying-box. This consisted of a box containing a number of grooves into which shelves of porous wood fitted horizontally, the box being mounted on levelling screws. Previously to using the box the shelves were removed, and placed, together with the box, either in the sun or in front of a fire to thoroughly desiccate them, so that the wood should be rendered as absorbent as possible. The shelves were now replaced in the grooves, and the box carefully levelled. It was then ready for the reception of the plates, which, it will be seen, were dried entirely by the moisture from them being absorbed by the wood of the shelves and box.

Now it is clear that if the box were not accurately levelled, or if the shelves had become warped, the films would be of unequal thickness, and the plates, consequently, useless. Up to this point dust was the greatest enemy, for the smallest particle settling on the film was almost certain to cause a spot, and it will be noticed that up to this time the plates were always in a position to favour floating particles coming into contact with them. The sensitising was effected in a bath of aceto-nitrate of silver in much the same manner as at present. But the development was materially different from that now practised, inasmuch as the picture was brought out with a saturated solution of gallic acid, with a few drops of aceto-

nitrate of silver added, instead of, as now, with pyro-gallic acid. The time occupied in the development of a picture by gallic acid was rarely much less than $\frac{1}{2}$ hour, and it frequently took as much as 2 hours if it were at all under-exposed. But, by the method about to be described, it does not take much longer to develop and fix an albumen than it does a gelatine plate.

Having thus given a short outline of the old-fashioned albumen process, we shall proceed with the details of the present system of working. In the first place, we commence with the preparation of the albumen itself—say 10 oz. This will require 12–15 eggs, according to their size. These, if available, should by preference be “new laid,” though good French eggs will answer nearly, if not quite, as well. The eggs must be broken, and the whites carefully poured away from the yolks, keeping the latter in the shells. The germs should then be separated. To 10 oz. of the albumen, $\frac{1}{2}$ dr. glacial acetic acid in $\frac{1}{2}$ oz. water is added, and the whole intimately mixed by stirring with a glass rod. No attempt should be made to cause it to froth, which if done would give rise to trouble; $\frac{1}{2}$ minute's stirring is all that is necessary. The acid will produce a precipitate, and render the albumen exceedingly limp. After standing a few hours, it is passed first through a piece of muslin to remove the coagulum, and afterwards filtered through a piece of sponge plugged in the neck of a funnel. After filtration, 40 minims of ammonia, .880, is added, which causes the albumen to regain much of the viscosity the acid had destroyed. Albumen thus prepared will keep quite good for many months, if preserved in well-corked bottles.

For use, the albumen is iodised by adding 1 dr. iodide of ammonia dissolved in $\frac{1}{2}$ oz. water; sometimes 10–12 gr. bromide are also added. The albumen being ready, we proceed to coat the plates. For this purpose some old iodised collodion is required. Any commercial sample that has been iodised for a length of time will answer,

provided it yield an even and structureless film. If it be very old, it will possibly give a thin and tender film, in which case a little fresh pyroxyline must be added to give it body.

The glass plates being thoroughly cleaned and ready to hand, one is taken and coated with the collodion. After this has been allowed to set, the plate is immersed in a dish of common water, where it is allowed to remain, with occasional agitation, until all greasiness has disappeared. It is then rinsed under the tap and placed standing on a pad of blotting-paper to drain, while another plate is being collodionised. Now take the drained plate and pour over it, beginning at one end, a little of the iodised albumen. Flow it over in a wave, so as to carry the superfluous water before it, which, with the albumen, should be allowed to run off into the sink. Drain the plate somewhat closely, and apply a second lot of albumen, avoiding air-bubbles, and keep it in motion on the plate for $\frac{1}{2}$ a minute or so in order that the albumen may penetrate into the collodion film. Then pour off into a measure, and stand the plates in a rack to drain. The second lot of albumen from one plate will do for the first application to the next, and so on. By this means the albumen will be economised.

After a dozen plates have been coated, take the first one and hold it in front of a clear fire until it is dry, and so, in turn, with the remainder. When the plates are dry, it is a good plan to make them as hot as the hand can bear, for this treatment will prevent the films from blistering in the after operations, which otherwise they may have a tendency to do with some samples of collodion. Instead of drying the plates by the fire, some prefer to allow them to dry spontaneously; but, in this case, it will be found a good plan to make them thoroughly hot, for the reason just mentioned. Plates thus prepared will keep for years if preserved in a dry place. It need scarcely be mentioned that all these operations may be performed in open daylight.

The formula for the sensitising bath stands thus:—

Nitrate of silver ..	2 oz.
Distilled water ...	1 pt.
Iodide of potassium ..	5 gr.
Glacial acetic acid	
(52°)	2½ oz.

The method of mixing is as follows:—First, the iodide is dissolved in the water, then the nitrate of silver is added, and the whole is well stirred with a glass rod until the silver is dissolved. The solution is then filtered, and, finally, the acetic acid is added, when the bath is ready for use. The object of adding the iodide is to saturate the bath with iodide of silver, in order to prevent any of that salt being dissolved out of the film after it is once formed, which otherwise might happen. Sufficient of the solution to cover the plate to be sensitised is poured into an ordinary dipping bath. The plates are then immersed (with the precautions usual in the wet-collodion process) for a period of $\frac{1}{2}$ –1 minute only. In summer, when the solution is warm, 30 seconds will be ample, and in winter the longer time may be allowed; but it should never be exceeded, as the sensitising takes place very rapidly, and a longer time than is necessary is liable to affect the plate injuriously.

By continual use, the bath will become discoloured, as does that employed for sensitising albumenised paper. It may, however, be decolourised by simply shaking it up with a little kaolin. If the bath be much used—or if it be allowed to stand in an open vessel when out of use—the addition of a small quantity of acetic acid from time to time will be necessary. Some operators prefer to employ a new solution for each batch of plates. In this case, the plates are usually sensitised in a flat dish, when, of course, a much smaller quantity of solution will suffice. When the plates are taken from the bath, they are placed in a dish of distilled water to remove the major portion of the free

nitrate, after which they are thoroughly washed under the tap to eliminate the remainder. They are then reared up on a pad of blotting paper to drain, and are afterwards dried.

The drying may be accomplished in any of the boxes used for gelatine plates, and, as the film is very thin, it does not retain much moisture; therefore the plates dry very much quicker than do gelatine. As many who do not possess properly-constructed drying boxes, or cupboards, may like to try the albumen process, it may be mentioned that one, suitable for the purpose, may be extemporised by taking an ordinary box, or packing case, and placing it in front of the fire for an hour or so to thoroughly desiccate the wood. In this case the plates are placed on some dry blotting-paper, and in a few hours the plates will be perfectly dry, the moisture from them having been absorbed by the desiccated wood. We have ere now used a common hatbox when anything more suitable was not at hand. It may be as well to mention here, for the information of those who have never prepared albumen plates, that it must not be expected that the films will be dense and creamy like those of gelatine, or even of wet collodion, as they are always very thin and transparent.

Printing the transparencies may be effected either in the camera or by superposition, the latter being the method usually followed; but if the negatives be a different size to that of the required slide, the camera must be used, and with it a lens capable of giving good definition with a large aperture. For, compared with wet collodion, the albumen process is slow, and in comparison with gelatine very slow indeed, although it is not so slow as the gelatine chloride process. With the camera the exposure will necessarily be somewhat long, and, as a rule, when prolonged exposures have to be given, the colour of the image is rarely very satisfactory.

In printing by superposition, either diffused daylight or artificial light—

such as a gas flame or a paraffin lamp—may be employed. With regard to the time of exposure little can be said, as all will be dependent upon the source of light employed, the distance the plate is placed from it, as well as upon the density of the negative itself. Therefore, the experimentalist must determine this matter for himself. This he can easily do by exposing a plate or two under a negative of average intensity, giving different times for different portions of it, and then developing. One or two plates exposed in this way will enable a very correct judgment to be formed as to the exposure required in future for every class of negative. When once this is arrived at it remains constant, because, unlike the gelatine, each batch of albumen plates prepared may be relied upon as being of equal sensibility.

We now come to the development of the image. This at one period was treated, and preserved, as a great secret. The developing solution, after all, is very similar to that used in the wet-collodion process before the iron developer was introduced, except that it contains a little citric acid, and that it is employed warm. A good developer is as follows:—

Pyrogallic acid	..	25	gr.
Glacial acetic acid	..	$\frac{1}{2}$	oz.
Citric acid	10	gr.
Water	10	oz.

This solution had better be made and kept in a Florence flask, so that it can be heated and kept warm over a spirit lamp when required for use.

The exposed plate is first placed in a dish of distilled water, heated to about 150° F. until it has acquired that temperature. It is then removed, slightly drained, and flooded with the developing solution, which has previously been heated to about 130—140° F. Immediately before the solution is applied, it must have about 4 drops per oz. of a 5 gr. solution of nitrate of silver added. If properly exposed, the image will quickly appear, and by the way it comes out it may be judged if the

exposure has been rightly timed or not, similarly as in the development of plates by any other process. As the films are so very thin and transparent, the density of the image can easily be judged of by transmitted light. It is always best to err on the side of under than over-density, because, in the latter case, the slides will always appear dense and heavy on the screen; whereas if they be slightly thin it may, to some extent, be remedied in the toning. As a guide in the development, it may be borne in mind that the more fully the plates are exposed and the more rapidly they are developed, as also the less silver employed in the developer, the warmer will be the colour of the image; while the slower the development, either from the solution being cold or the plate under-exposed, or if too much silver be used, the more the picture will approach an olive-brown tone.

As the development proceeds the plate must be carefully watched for stains or fog. If any appear, the plate must at once be washed under the tap, and the surface rubbed with a pledget of cotton wool, which will remove them. The development can then be recommenced with a fresh batch of solution and silver, repeating the treatment with the cotton wool if found necessary. When the development is complete, the plate must be thoroughly washed under the tap to remove all traces of the pyrogallic acid, which, if allowed to remain, would tend to injure the toning bath.

The plate is now ready for fixing and toning. This is usually done in one bath, which is made as follows:— $\frac{1}{2}$ lb. hyposulphite of soda is dissolved in $\frac{1}{2}$ pint water; then 3 gr. of chloride of gold, dissolved in 2 oz. water, is added very gradually, and with vigorous stirring. After standing 12 hours and being filtered it is ready for use. It is then placed in a flat dish and the plate is immersed. The iodide is quickly dissolved out, but the toning proceeds slowly— $\frac{1}{4}$ — $\frac{1}{2}$ hour or more being frequently required to obtain deep, rich

tones. But much depends upon the colour and density of the image at starting. When the desired tone is obtained, the plate is well washed under the tap, and afterwards soaked in plenty of water, and again rinsed to ensure the entire removal of all traces of the hypo. Indeed, as much care should be bestowed on this part of the operation as in the case of gelatine negatives, in order to ensure permanency.

Alkaline gold toning (after fixing in plain hyposulphite and thoroughly washing) may be employed instead of the double fixing and toning bath: but the colour obtained has not been so satisfactory as by the method just described, which is that used by Ferrier and Soulier. (*Brit. Jl. Photog.*)

(f). By contact printing. This is capable of producing slides equal in quality to any other mode of preparation that an amateur, or one who does not make a specialty of such work, can produce, and is at the same time so simple that any ordinary amateur can obtain satisfactory results.

In the first place, no dark room is required, as the emulsion can be prepared by gaslight, and no more care is required than in the preparation and printing of albumenised paper. No washing of the emulsion is necessary; indeed, as far as the brilliancy of the slide is concerned, it is a disadvantage. One can see how the printing of the slide is going on as well as if it were an ordinary albumenised paper print; and the latter is the greatest gain of all, because we do away with the uncertainties of the blind processes, i.e., any process in which light forms an invisible image requiring development.

To A. L. Henderson is due the credit of proposing the addition of $\frac{1}{3}$ acetate to $\frac{1}{3}$ each of the citrate and chloride salts. From some experiments he exhibited, I at once thought he had found a process suitable for the production of lantern slides. After a few experiments, I decided to do away with the citrate because of the cold tones it gave, and because I could not obtain the same brilliancy and range of tones as when

I used acetate and chloride of silver only.

So far, I have obtained the most satisfactory results by producing a fine sepia tone with the following formula. There is hardly anything, perhaps, in which the taste of different persons varies so much as in the tone of a lantern slide. For myself, I much prefer a warm sepia tone to the cold black or purple tones. But almost any color can be got from red through the brown shades to purple. The sodium chloride converts about $11\frac{1}{2}$ of the 28 gr. of silver nitrate into silver chloride. By using a larger proportion of chloride there is far less brilliancy, and I did not want to use a larger amount of acetate than possible on account of it being a more unstable salt, and a large proportion might affect the keeping qualities.

I have not yet experimented in the direction of having an excess of silver nitrate in the film. It is quite possible that we might increase the speed of printing by so doing, and by adding a little citric acid make the plates keep well, the same as with albumenised paper. But we must remember that we have a quantity of nitrate of soda in the films, which probably acts the same as the free silver, because it was formerly used with silver nitrate to sensitise albumenised paper.

To prepare the emulsion, put in a small jam pot :

Gelatine	40 gr.
Acetate of soda .. .	8 "
Water	2 oz.

The gelatine is allowed to swell, and is then dissolved by standing the jam-pot in hot water.

In a test-tube or small bottle is dissolved :

Silver nitrate .. .	28 gr.
Distilled water .. .	1 oz.

This is stood in the same hot water, so as to be about the same temperature.

When the gelatine is *thoroughly* dissolved, the nitrate of silver solution is poured into the jam-pot in a gentle

stream, quickly stirring with a glass rod all the time.

Into another test tube put :

Chloride of sodium ...	4 gr.
Acetate of sodium .. .	6 "
Water	1 oz.

When dissolved, this is added to the above, the stirring being continued.

Meanwhile 2-3 oz. water is poured on to 160 gr. gelatine. In about $\frac{1}{4}$ hour the surplus water is poured off, and the gelatine is added to the emulsion; the contents of the jam-pot are to be kept at about 100° F. until the whole of the gelatine is dissolved. It is then put aside in the dark for 24 hours to set.

The details of filtering, coating the plates, printing, and toning, I will go into soon, and will now only refer to one or two points about the preparation of the emulsion. I generally use a Swiss gelatine, but Henrick's or any good gelatine will do as well; indeed, this process does capitally for using up samples of gelatine which are not quite up to the mark for dry-plate work. As to the light, I prepare the emulsion and coat the plates by the light of a small paraffin lamp in perfect safety.

I will now describe the mode of preparing the plates, printing, &c. The jam-pot containing the emulsion is stood in hot water until the latter has thoroughly dissolved; $\frac{1}{2}$ oz. alcohol and sufficient water is added to make the quantity up to 6 oz.

It is then filtered. For filtering, use a small paraffin lamp glass with the bottom edge turned up (they can be bought at an oil shop for about 2*l.* each). A piece of washleather or 4 or 5 thicknesses of fine muslin is tied on the bottom of the lamp glass. The dissolved emulsion is poured in, and by blowing in at the top of the glass the emulsion runs rapidly through, and is then ready for coating the plates.

To clean the plates, scrub them with a nail-brush and water in which a little washing soda has been dissolved; they are then well rinsed in cold water, and stood up to dry in the racks. After they are dry, they are just dusted with

a piece of clean washleather and stacked in a heap.

For coating such small plates, the best way is with a small silver teaspoon. A spoonful of the emulsion is poured on the centre of the plate, and can be guided to the edges with the spoon if necessary.

For amateurs or those not accustomed to plate coating, this is an important point, besides a measured quantity being put on each plate. When the emulsion is poured from a small teapot or similar article, it has to be put down and a glass rod taken up. While looking after these things the emulsion is meanwhile cooling, and perhaps running off the edges of the plate, but with the spoon the eyes need not be taken from the pool of emulsion on the plate.

For levelling the plates after coating do not use a large glass or slate slab, but have some strips of plate glass about 2 ft. long and $2\frac{1}{2}$ in. wide; these are stood in rows on a level table or board. Suitable strips of glass can be got very cheap at a glass-cutter's, because any odd sizes from his scrap heap will do. When a large flat slab is used, if any emulsion gets on the back of the plates, they stick to the slab, and in the dull light of the dark room, when coating rapid bromide plates, this sticking is a great nuisance. With the strips of glass, the plates can be laid down on them without the emulsion running off the plates, and can be easily detached from them even if stuck with some emulsion on the backs.

The plates are put away to dry in the usual way. I never find it necessary to use heat when drying plates on a small scale. My drying-box is in a room at the top of the house, the fireplace of which is closed up. The outlet of the drying-box goes into the chimney, and gets a capital draught, keeping the window in the room closed when drying plates.

For these plates any one can easily make a temporary drying-box by standing the racks on a shelf in the fire-grate, and covering a thick cloth over the front of the fireplace in the same

way as a sweep does when sweeping a chimney. Then place 2 or 3 little pieces of wood on the floor to form little inlets between them for the air to pass between the floor and the cloth; a piece of fine muslin thrown over the racks would keep any dust, &c., from the plates.

To print, the plates are put in a printing-frame against the negative, the same as a piece of albumenised paper. One can judge how deep to print by opening one-half of the printing frame back, and by looking down on the back of the transparency; when the whole of the high lights of the picture are just tinted, it will be printed deep enough.

Fuming the plates with ammonia is a great improvement in every way. Do this by standing a few of the plates against the sides of a small box. Then pour a few drops of ammonia on a piece of blotting paper, put it in the bottom of the box, which is closed for a short time, and the plates are then ready for printing.

The great difficulty with these plates, until recently, has been with the toning. The action was not only slow, but I could not get the warm brown or sepia tones I was trying for. I tried a number of different toning formulas, but all had the same action, though some bleached more than others. At last it struck me that I had a slight excess of acetate of soda in the film, so I tried the gold alone, and then got the tones I wanted, and far more quickly. The formula was:—

Chloride of gold	..	15 gr.
Water (distilled)	..	15 dr.

as the stock solution.

In a clean developing dish I took of the

Chloride of gold		
solution	8 minims.
Water	1 oz.
Common whiting		2—3 gr.

The plate was put into this toning-bath, without washing, until the image had quite lost its red colour, and was

then well washed and put into a bath of

Hyposulphate of soda	1 oz.
Water	5 oz.

for about 15 minutes, and again well washed.

Lately I found I could tone the plates in about $\frac{1}{2}$ the time taken by the above bath, by adding acids to the gold before neutralising with the whiting. The bath was made as follows:

Gold solution	8 minims.
Hydrochloric acid	2 "
Nitric acid	1 "
Water	1 oz.
Whiting	2—3 gr.

This bath toned the plate very rapidly and equally, but requires the plate to be rather more deeply printed than when the acids are not used. I have not had time to try any comparative test with prints from the same negative, as to which bath gives the best tones and results, and can only speak now as to the rapidity. It is better not to print in direct sunlight if the sun is at all warm, as the warmth sometimes causes the films to stick slightly.

There are two uses for these plates, besides lantern slides and transparencies. By printing less deeply and backing with tinted or drawing paper (film to the paper), they do capitally for producing photo-crayons. But for professional photographers, their great use will be in the reproduction of negatives, as one can not only see how deep to print with both the transparency and the second negative, but parts can be shaded during printing to get details in other parts which may be too dense in the original negative.

It will be also seen, however, that any amount of "dodging" can be done. The transparency can be retouched as required, any shadows which print too heavy can be reduced in the same way as too dense negatives are locally reduced. Then we can do any amount of double printing, printing in clouds, etc., on the transparency. The name of the view can be painted on it without

having to reverse the letters. We can vignette or mask when printing from either the original negative or the transparency. In fact, we can build up, so to speak, the picture on the transparency as we require it, because we can see what we are doing. And when it is perfect, we have only to print by contact a second or any number of negatives from it, which negatives can be printed from on to paper without any trouble of vignetting, etc., for each separate print. And to my mind, Henderson's discovery of the use of acetate of silver with the chloride in the gelatine film for contact printing will lead to very important results, in the aid it will be, practically, to photographers in their every-day work. (H. S. Starnes.)

Colouring. — (a) Use transparent colours, namely, Prussian blue, gamboge, carmine, verdigris, madder brown, indigo, crimson lake, and ivory black, with the semi-transparent colours, raw and burnt sienna, and vandyke and cappel brown, thinning oil colours with ordinary megilp to a degree just sufficient for proper working, and using for a medium for laying on the first coat of water colours gelatine thoroughly dissolved and hot. When perfectly dry this coat can be shaded and finished with water colours mixed in the ordinary way with cold water; but the manipulation of the added colours must be gentle, so as not to disturb the layer first put on the glass. A thin coat of the best mastic varnish heightens the effect of shades painted in water colours, but oil colours require no varnish.

(b) Having failed in getting results to please myself by dabbing, stroking, and many other dodges, I have now succeeded in getting perfect gradation of tone by pouring on a filtered solution of colour, previously ground up with "medium," in an agate mortar. Pour it on very dark at the top of the picture and flow it down to the horizon, then back again slowly, and allow it to drain off at the edge; when the proper depth is attained, blot off the drainings from the edge; when dry, the outline of the

horizon is easily obtained sharp by rubbing off the paint which has run over the border with a fine paper stump. Should any dust settle in spite of all precaution, make your clouds at the faulty part, thus getting rid of specks. (G. Smith.)

My troubles began in slide painting in making a sufficiently fine outline; and this is how I overcame this difficulty, and hit upon a plan at once as good, if not better, than that given by Dallinger of drawing on ground glass with a pencil:—I first hunted up an old round table; this I painted a dead black colour, smoothing it off with sandpaper and filling up all cracks; then another coat of black, with plenty of turps in and a few pinches of vermilion to take off any tendency to blue in the paint. When thoroughly hardened, you have a circular black-board, upon which you may sketch your intended outline. With a white chalk crayon, work as many fine outlines as you think proper. I then from this took a negative with an instantograph, using the $3\frac{1}{4}$ in. by $3\frac{1}{4}$ in. prepared "lantern dry plates" of Lancaster, giving about 5 seconds in dull weather, and developed until the black table began to show the merest trace of darkening; then I worked off and fixed and dried. I then had a most beautiful outline of the subject I wished, and done in $\frac{1}{4}$ the time it would have taken me to draw on the glass direct, and far better, and shows beautifully on the screen. Any amount of detail can be quickly done on the round black board, with the positive assurance that it will show well when magnified. (H. Green.)

Having prepared two pieces of wood—one of them having a long, tapering point, that of the other being more obtuse and of dimensions suitable for being easily held by the fingers—wrap tightly round them a small piece of thin washleather. They will then present an appearance suggestive of crayon stumps. I would recommend the beginner in this art to procure a number of good engravings of landscape scenery

having a nearly uniform sky with a few light clouds; because, if he study these, he cannot fail to acquire a good idea as to the forms of and effects produced by such clouds. It will be well for him to practise with a pencil and a sheet of paper those forms best adapted for the special picture on which he is engaged. Having thus previously determined upon the nature of the clouds—confining himself at first to those white, fleecy ones which are so frequently seen floating across a clear blue summer sky—let him apply the larger of the stumps, and, with a motion conforming to the curling outlines of the cloud, remove the sky-paint. There is room here for great artistic display; indeed, it is nearly the only stage in the whole course of painting a photographic transparency in which artistic taste can be shown. I have seen a transparency-artist point a common match with a penknife, wrap round it a bit of thin washleather, and in less than a minute pick out clouds in a picture which no amount of protracted labour could have improved upon. I called it "genius": he said there was no genius in it, other than that which was the result of study and practice. In many cases the mere suggestion of a cloud proves effective. Let the upper edge be clean and sharply cut, and avoid the bad taste of bringing the cloud up near to the projecting tree or spire and then breaking it off suddenly. Carry it boldly across the projection, which quite ignore. The advantage of doing so will be found when at an after-stage the colour is removed from the spire, by which the sky is thrown back, the other being brought near. It is so easy to clean off the sky with the stump that the tyro is often tempted to overdo his clouds; hence he must be cautioned against this. I have spoken of pure white fleecy clouds; at a more advanced stage he must try to back up the silver edges of his clouds with a more materialistic colour. For this purpose a little Payne's grey, warmed with rose madder very sparingly applied, will produce a good effect. It is not easy to

impart a knowledge of cloud-making altogether by precept, so I would recommend the pupil to purchase a few well-painted slides, and observe the special means employed to obtain such effects as are produced. The sky being completed, remove by means of the fine stump all paint from the distant hills, trees, spire, and indeed from every portion of the picture except the sky. If there are distant mountains, colour them with crimson and raw sienna, or crimson and blue, according to their nature, keeping carefully to their outlines. Observe that no dabbing need be had recourse to when painting the rest of the picture, unless it be a subject in which there is a smooth, unbroken portion, such as a lake or the sea. As this is supposed to give a reflection of the sky, it must be painted in a similar manner. Observe, also, that every portion of the picture must be painted stronger and in brighter colours than would be the case were it a small picture which was to remain and be viewed as such, because by magnifying a 3 in. picture up to 12 ft. the colours become attenuated by the act of enlargement; therefore, the colours may be strongly applied, in the certainty of their being toned down when projected on the screen. To return to the mountains; while the distance is warm and of a ruddy purple, keep the shadows cold, especially in the nearer ones. When painting the mountains avoid using the brush in such a way as to cause a ridge of paint to form an outline, but as far as possible work the brush from the margin inwards. By doing so the sky is left undisturbed. This also applies to trees. For these a green is employed composed of gamboge and Prussian blue. This will answer for the greater number of subjects in which there is foliage; but the addition of crimson lake will be necessary to obtain such warmth as that associated with autumnal tints. There are some specimens of foliage which may be fittingly coloured by lake and gamboge alone; but a judicious mixture of the colours mentioned will serve every

purpose. It is not as if the painting were being made on clean or transparent glass. Here the foliage is composed of shades more or less dark, and, what is of importance also, of a tone that may range anywhere between a warm ruddy brown and a cold black, according to the method adopted by the photographer in toning. And this renders it impossible to say definitely what pigments ought to be employed in painting them. If the foliage be sombre and heavy, the gamboge should then predominate. This applies also to a grass lawn or meadow. All that will be required for the trunk of a tree will be to warm it up with burnt sienna, well thinned. (J. J. Houston.)

(d) When preparing photographic transparencies for colouring, do not treat them in precisely the same way as if intended to be used without colour. If you examine a fine slide, by any well-known maker, embracing rural scenery with much foliage, it will be found that whereas in nature the foliage was green, of a more or less bright hue, in the photograph it is many shades darker than it should be, owing to the number and density of the atoms of the silver composing the foliage, this being the case to such an extent as to prevent the green pigment from showing at all.

This is quite a different matter from painting a photograph on paper or porcelain, for, in these the blackest shadows or heaviest foliage can be lighted up at pleasure by the use of opaque or body colours, or by mixing a little flake white with the transparent pigments which alone are applicable to transparency painting. But it, in a transparency, recourse were had to this procedure, it would make things worse than before, for the luminous equivalent of flake white when applied to paper is, in a transparency, the thinning of the deposited silver so as to allow more light to be transmitted, the touch of pure white light given to form the highest light in the one finding in the other its equivalent in the complete removal of the image by the needle

point or penknife, so as to leave nothing but bare glass.

To one who has had some experience both in making and colouring transparencies, it is not difficult to obtain the best class of photograph for receiving colours with effect, although it may prove difficult to describe the characteristic features of such photographs. Perhaps the best idea will be conveyed by saying that it ought to be "outlines," and even its outlines should not be too dense. A very brief exposure and rather long development afford the keynote to the nature of the manipulations requisite to secure the best effect.

Plates prepared by the old-fashioned tannin process, and developed by acid pyro and silver, give an effect peculiarly well adapted for receiving colour in the highest style of the art; but the exposure must be short and the development forced. When the picture is laid face down on a sheet of white paper, the appearance presented should be that of a properly printed proof upon paper, while the intensity, when raised up and looked through, must show a sufficiency of vigour.

Having obtained a suitable transparency, it must next be varnished. Some years ago I adopted the use of a varnish composed of sandarac dissolved in methylated spirit. It gave a clear, bright film, and both oil and water colours took to it nicely; but I sometimes had occasion—as every painter of lantern slides will have to do more or less frequently—to pick out bits, and put in, or rather take out, touches of high light by means of the needle-point. I found, however, to my extreme dissatisfaction, that the collodion film would chip and break off round the spot upon which I operated, and that if I drew fine lines by my scratch-point they became jagged and broken. Being recommended to try white hard spirit varnish diluted with alcohol, I did so with a result even worse than before. Having read of the virtues of castor oil when added to a plain sandarac varnish, I tried it with excellent effect.

I have also employed, with the greatest degree of success, a solution of albumen composed of the white of an egg beaten up with twice its volume of water together with 10 drops of ammonia. After the frothy mass has settled, the clear liquid is poured off. To use it the transparency is flooded with the liquid, which is then drained off at one corner and the picture immediately immersed in a tray of hot water, the temperature of which is but little under the boiling point. This coagulates the albumen, leaving it not only of a glassy degree of brightness, but modified in such a manner as to render it unaffected by either water or oil paints, while it is susceptible of the most delicate touches of another class of pigment, which I shall describe before concluding.

The question now arises: What class of colour is best for transparency printing—oil, water, or varnish? This cannot easily be answered; each has its own advocates. They are all good in their way, and there are some transparency artists who employ them all even in one picture. As oil pigments appear to enjoy the greatest amount of popularity, I will speak of them first. Although nearly every dealer in lantern appliances keeps boxes of colours for sale, it will be advantageous, especially for the beginner, to purchase from artists' colourmen, under their definite names, the various colours required. They are conveniently put up in tubes and are sold at a very low price—4*l.* and upward. It must also be noted that only very few pigments can be employed, owing to the paucity of such as are quite transparent; hence the expenditure for an outfit is very small.

For blue, *Prussian blue* forms the most useful among all the blue pigments, and one can get along very well indeed without any other, although there are some subjects in which *Payne's grey* comes in handy. There are other transparent blues, such as *Chinese blue* and *cyanine blue*; but the Prussian is susceptible of such easy modification by the admixture of others

that no other is really required. The best yellows are *gamboje*, *Italian pink*, and *yellow lake*. There is but little difference between the two last, although the former of them is probably the more advantageous. The *gamboje* is useful for foliage, and with a small proportion of Prussian blue forms a good green. Both *raw* and *burnt sienna* must be procured. The former is useful in the representation of light, dry, sandy earth, dry roads, and light-coloured houses; the latter is a very transparent brown of an orange tint. Both *Vandyke brown* and *burnt umber* are useful, but much less so in a photographic transparency than in other classes of work, because any subjects which were of these tones in nature will be represented so very darkly in the photograph as to require scarcely any colouring at all. *Crimson lake* and *pink madder* complete the list. The latter by itself dries very slowly, but by the admixture of megilp or mastic varnish its drying is quickened. This applies also to the Italian pink. A tube of *lampblack*, by which to render any portion more or less opaque; a tube of megilp, for use as a vehicle; and a bottle of mastic varnish and pale drying-oil, together with a few sable brushes, a palette, palette-knife, and large camel-hair brush complete the outfit.

The most important piece of work in the painting of a lantern landscape being the sky, I close this article by describing how it is done, premising that I do all my painting upon a retouching desk, which I find to answer this purpose rather better than the easels specially prepared for transparency painting. Let us imagine that the subject is a landscape, having about $\frac{2}{3}$ sky, into which a tree, and a spire project upward. Mix on this palette a little burnt sienna and pink madder, and having charged a brush with this, draw it in streaks across the sky a little above the horizon, and then laying down the brush dab it all over with the point of the first or second finger until it presents a uniform

appearance. Never mind the fact that the paint has been carried over the tree and the spire; it must be removed from them by a pointed piece of soft wood as the last operation of all. Next apply to the upper portion of the sky some Prussian blue, and in so doing remember that there is no use whatever in hoping or attempting to make it quite uniform by means of the brush alone. The finger is the all-potent instrument by which uniformity is secured, and "dabbing" with it must be had recourse to. Bear in mind that the sky is of a deeper hue at the zenith than near the horizon; therefore let the dabbing be performed in such a manner as to retain more of the paint at the top, than lower down, the quantity being so attenuated by the time it descends to the warm layer already applied as to merge into it quite imperceptibly. The laying on of a uniform coat seems very easy to the onlooker; but it is only by dint of several trials carefully made that success is attained. As the beginner will probably spoil several skies before he succeeds to his own satisfaction, a soft piece of calico dipped in spirit of turpentine will be a useful aid to him during his novitiate.

To complete the blending of the colours, and to obliterate the slight textural markings arising from the roughness of the finger tip, is the function of the large camel-hair brush already mentioned. It must be whisked very lightly over the surface; and, if cleverly done, all surface asperities will disappear, and the colouring look as if the glass were stained. Until the sky presents such an appearance the formation of clouds must not be thought of.

(c) The glass for the slides must be very carefully selected; it should be plate glass cut to the size of the object glass in the magic lantern in which it is used. It must be entirely free from air bubbles, and streaks of any sort; even the best plate glass has a rough and a smooth side, which can be found out by passing the hand over its surface, and

so detecting any unevenness. As any irregularities will interfere with the smoothness of the colour to be laid on, the smooth side of the glass must be carefully marked and used in all the plates.

A flat palette is a necessity for oil colours; but for water colours, a palette with a rim to keep in the tints is the best. A palette knife is required for mixing together oils, colours, or varnishes, but is not wanted for water colour slides, except to take out larger lights. A maul stick, to keep the hand from touching the wet painting, can be made by covering one end of a light but firm cane with wool, so as to form a round knob, and tightly binding the wool over with wash leather, notching a groove in the cane to render the binding string quite secure.

For brushes, red sable are best, being stronger in their hair than black sable or camel-hair, and they have a firmer and finer point than either of the others; the brushes should be enclosed in flat tin, one of every (6) size.

Dabbers are made by the amateur from round camel-hair brushes; one

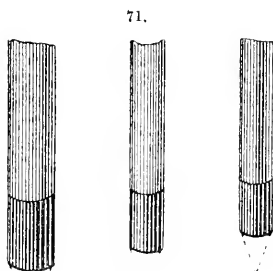

Dabbers.

of each of the 6 sizes are used. The points of the round brushes must be cut off as shown in Fig. 71, the dark lines show the part of the brush to be retained, the white space within the spots the portion to be cut away. In order

that the ends cut should be rounded, they must be burnt to shape, after cutting, by being held in the flame of a candle. They must be twisted and turned round and round, so as to shape them to the proper form. When this is attained, clean off the traces of burning from them by rubbing them well with the finest sand paper.

When the slide is painted, it requires to be mounted in a frame. These frames are made of wood; mahogany is generally selected, but deal will answer all the purpose. The three shapes for these frames are square, oblong, and round. The wood should be about $\frac{1}{2}$ in. thick, and where the glass is to be inserted, the edge should be bevelled or have a rabbet on one side, the glass should be slipped in on this side, and a tiny steel or brass rim laid over it to keep it in its place. In choosing the wood for these frames, select only that which is perfect in grain and has no knots.

Paint slides by lamp or candle-light, as, being intended for exhibiting by artificial light, it will be seen at the time of painting whether the right effect has been produced.

Commence operations by drawing a perfect outline of the picture on a piece of paper, which is laid under the glass as a guide. When a much larger picture than the size of the slide is to be copied, as long as the prominent features of the picture are seized upon, the effect is attained, and one or two accessories will look better than a quantity crowded into a small space.

Should any inaccuracies be found when the outlining is finished, the colour can be removed by the knife. When all the corrections are made, and the outlining is judged complete, it must be fixed to the glass by washing all over its surface a varnish made of Canada balsam, diluted freely with turpentine. Having completed the outline, fixed it with varnish and rubbed up the glass well, proceed to the second painting.

Moonlight subjects can be rendered pleasing if the appearance is given of the clouds moving, or rather sailing past

the moon. This is managed by having two pieces of glass where the sky is painted. The wooden frame will have to be double on one side, to contain the fixed piece of glass, and the other to form a groove for the movable piece to rest on. Upon the fixed glass the moon is painted and a light sky without clouds. The movable piece of glass is only a narrow strip, just sufficient to hold the clouds. Fleecy and dark clouds should be painted upon it in such a manner as sometimes to allow the moon to be feebly visible, at others partly or completely obscured. Make these clouds as unlike each other as the narrow strip they are on will allow. Do not leave large spaces in between, and let the strip they are painted on be of a good length, so as to give greater variety. Have a thin piece of wood fixed to the end of the strip, to serve as a handle, and when the slide is being exhibited insert the strip of glass, and push it slowly along.

not revolving, and is particularly useful for comic slides. Thus a dog killing a rat is depicted in the act by using the lever slide. Paint the dog with the exception of his head and neck, and all the requisite surroundings, upon the fixed glass, and upon the movable one his head and neck with the rat in his jaws. When fixing the slide in the lantern be careful that the neck on one glass is quite joined to the shoulders on the other, and that the colouring of the animal is exactly similar on both glasses. By working the lever up and down, as shown by the dotted lines in the figure, the head and neck of the dog will be in motion, and the rat will look as if it were being well shaken. (*Artistic Amusements.*)

ELECTRICS. (iii. 68-201.)

Batteries.—Amidst the enormous advances made in the practical applications of electricity during the last 10-

72.

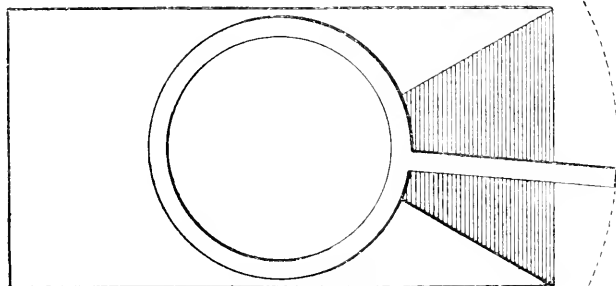

Lever Slide.

This is only an amateur contrivance, but will answer several purposes, especially whenever some small objects are required to move straight along and disappear, while the larger part of the picture remains stationary. A ship as in full sail can be drawn across a sea-piece by this contrivance.

Fig. 72, known as the lever slide, is used when the motion of the movable piece of glass is to be up and down, and

12 years, the galvanic battery occupies almost exactly the same position as a generator of electricity that it did at the beginning of that period. This state of things is certainly not due to a lack of interest or want of investigation, for although the professional inventor and most of those who look to electricity for their livelihood have turned their attention to fields offering more immediate returns for their labours, there are

probably very few amateur electricians who have not at one time or another dabbled in the subject in the hopes of making some discovery which would bring both fame and fortune.

On the other hand, it cannot be said that the subject is not a promising one, for the broad idea of the direct conversion of chemical into electrical energy covers many possibilities, as does the kindred one of the conversion of heat into electrical energy through the medium of electrical energy, and any real advance in either of these directions must be of the most widespread importance.

The great fault is rather a misdirection than a lack of energy, which often seems to be due to an entire ignorance of, or failure to grasp, fundamental principles, and consequently both time and money, that might have produced some good results if expended in the right direction, are wasted in attempting to accomplish the impossible; and, although he naturally fails in the endeavour, the inventor often manages to persuade both himself and other people that he has actually achieved success; in fact, those who are suffering from what has been aptly termed the "primary-battery disease," can only be classed with such paradoxists as the flat-earth theorists, the substantial philosophers, and the perpetual motionists.

To make any substantial progress one must give up ringing the changes on sulphuric versus hydrochloric acid, bichromate of potash versus chromic acid, nitrate of soda versus nitric acid, and go and strike out on more original lines, but always remembering that all battery phenomena take place in strict accordance with the laws of chemical combination and the conservation of energy. Some of these may briefly be put as follows:—1. Whenever two or more substances combine chemically, they liberate a certain amount of energy, which is called the energy of chemical combination. 2. The amount of energy liberated depends on the chemical affinity between them. If

they have a strong tendency to combine, it will be large; but if they only unite with difficulty, and under the most favourable circumstances, it will be small. 3. To break up a chemical compound into its constituent substances or "elements," will require the expenditure of exactly as much energy as was liberated by those elements when combining, so that if a substance leaves a compound of which it forms part in order to combine with some other substance for which it has a greater affinity, the resultant amount of energy set free will be the difference between these two actions. 4. The greater portion of the energy freed by chemical combination usually takes the form of heat, and raises the temperature of the bodies concerned to a greater or less degree.

The familiar phenomena of "burning" or "combustion" offer us the most important example of the above laws that can be selected; for, besides being the method universally employed for obtaining both heat and light, it is at present almost the only known means of producing mechanical energy artificially and on a large scale. Here such substances as wood and coal, which are compounds consisting principally of hydrogen and carbon ("hydrocarbons"), combine with the oxygen of the air to form carbon dioxide (CO_2) and water (H_2O). The chemical affinity of carbon and hydrogen for each other is small, while both have a strong affinity for oxygen; consequently but little energy is absorbed in breaking up the original compound, and there is a tremendous generation of heat which maintains the burning substances at a temperature sufficient for the emission of both radiant heat and light in large quantities, although the main portion of the energy passes off in the hot gases. "Rusting" or "oxidation" is another well-known example of the same nature, but metals take the place of the hydrogen and carbon, and the action is ordinarily so extremely slow that the heat generated in the process is dissipated into the air and neighbouring bodies long before it

can produce any perceptible rise of temperature, and there is nothing therefore to suggest "combustion" in the ordinary sense of the word.

As already implied, a galvanic or voltaic cell (also termed "battery," although, strictly speaking, this word should only be used in reference to a number of individual cells) is essentially an apparatus for the direct conversion of the energy of chemical combination into electrical energy instead of into heat. In almost all batteries at present of any practical value, the electrical energy is obtained by the combination of zinc with sulphuric acid to form sulphate of zinc, or, as it may be termed, the "combustion" of zinc in sulphuric acid.

Every grain of zinc converted into zinc sulphate in this way sets free a fixed and definite amount of energy, a part of which is absorbed in other chemical changes taking place at the same time, while under ordinary circumstances the remainder appears as heat, and indicates its presence by raising the temperature of the liquid. If, however, a piece of copper is placed in the acid with the zinc, and the two are connected by a wire outside the liquid, the latter portion of the energy shows itself as a current of electricity passing through the acid from the zinc to the copper, and back again by the connecting-wire; but the point which we wish to emphasise is that, no matter in what form the energy may be present, whether it remains as chemical energy, whether it is directly converted into heat in the liquid, whether it appears as electricity (being afterwards reduced to heat partly in the cell, and partly in the outside wire), or whether, as is most usual, it is divided in a varying proportion between all the three, the total amount available is in each case precisely the same, and it follows, therefore, that the quantity of electricity to be obtained by the consumption of a given weight of zinc is strictly limited, the maximum output being reached when the whole of the energy takes this form. As a matter of fact, no cell absolutely realises

this condition, although certain forms (not of much practical use) do so theoretically; but in the greater number the energy utilised electrically does not, and cannot, exceed 40 to 90 per cent. of the total amount; and it is important to remember that the electromotive force of a cell, when freshly set up, affords a direct indication of the utmost percentage that could be so utilised, provided there were no losses due to "local action" and "polarisation."

It has been determined from theoretical considerations that the electromotive force of zinc combining with SO_4 to form ZnSO_4 is 2.36 volts, and the nearer the E.M.F. of any given cell to this value the greater is its possible efficiency—in other words, the maximum energy that can be utilised electrically: the total energy liberated by the zinc: : the E.M.F. of the cell: 2.36. For a Daniell cell this ratio will be $\frac{1.08}{2.36}$, or 45 per cent.; for a Bunsen

cell $\frac{1.8}{2.36}$, for 75 per cent.; for a bi-chromate cell $\frac{2}{2.36}$, or 85 per cent., and

so on. To account for the remainder of the energy we must look a little closer into the chemical changes taking place in the cell.

Zinc can only combine with sulphuric acid by liberating an equivalent amount (chemically speaking) of hydrogen—thus $\text{Zn} + \text{H}_2\text{SO}_4 = \text{ZnSO}_4 + \text{H}_2$, and just as zinc gives up energy and generates an electromotive force, so hydrogen absorbs energy, but in lesser amount, when set free from the combination, generating at the same time a "back" or negative electromotive force of about 1.46 volt; consequently the resultant E.M.F. of the cell is only the difference of these two actions, or about .9 volt ($2.31 - 1.46$), and the rest of the energy passes away in the escaping gas. If, however, some material is provided for which the hydrogen has a strong affinity, and with which it can re-combine, once more yielding up the whole or a portion of its potential energy

the E.M.F. of the cell will be increased in proportion, and this is one of the chief objects accomplished by the depolarising fluid. In the Daniell cell, with a solution of copper sulphate for the "depolariser," the hydrogen displaced by the zinc in its turn displaces the copper—thus, $\text{CuSO}_4 + \text{H}_2 = \text{H}_2\text{SO}_4 + \text{Cu}$, the metal being deposited on the negative pole; but the actual gain of E.M.F. is not very large, because the greater portion of the energy released by the hydrogen is absorbed by the liberated copper, which has nearly as strong an affinity for SO_4 as the hydrogen itself, and exerts a back E.M.F. of 1.25 volt. The resultant E.M.F. of the cells is now made up as follows:— $2.36 - 1.46 + 1.46 - 1.25$, the two middle figures representing the liberation and recombination of the hydrogen to form sulphuric acid, of course, neutralise each other and cancel out, leaving $2.36 - 1.25 = 1.1$ volt approximately, which means that more than half of the energy of the dissolved zinc has merely been transferred to the deposited copper.

The action of the depolariser in the Grove, Bunsen, and bichromate cells, including their various modifications, is, from our present point of view, very much more effective; but as the chemical changes are more complicated, and their exact nature uncertain, they cannot be followed with the same precision as those in a Daniell cell. In every case, however, the liberated hydrogen abstracts oxygen from the depolariser to form water, nitric acid being broken up into oxide of nitrogen, and chromic acid being reduced in the same way to oxide of chromium, which combine with the sulphuric acid present to form sulphate of chromium; but very little energy is absorbed in effecting these decompositions, and most of the energy of the hydrogen is returned to the circuit, which accounts for the high E.M.F. of the cells.

If a zinc plate is placed in dilute sulphuric acid with the positive plate of an ordinary lead accumulator—that is, a lead plate covered with lead peroxide

(PbO_2)—we have a combination which gives an E.M.F. of 2.36 volts, showing that it is possible for this cell to utilise the whole of the energy electrically. As with the other depolarisers, hydrogen abstracts oxygen from the peroxide, reducing it to PbO , which combines with the sulphuric acid to form lead sulphate— $\text{PbO}_2 + \text{H}_2 = \text{PbO} + \text{H}_2\text{O}$ and $\text{PbO} + \text{H}_2\text{SO}_4 = \text{PbSO}_4 + \text{H}_2\text{O}$.

Many kinds of zinc-consuming batteries have long been used for working electric telegraphs, bells, telephones, and other similar apparatus; but none of them has ever been successfully applied to the production of electricity commercially and on a large scale for the purposes of electric-lighting, motor-driving, &c. The great difficulty in the way is that of cost. As long as small currents only are required, the expense of the material consumed in generating them is a relatively small one, and does not need much consideration, especially when, as is often the case, there are no other means of accomplishing the object in view; but as a method of producing electrical energy in quantity, batteries have to compete with other and cheaper ways of gaining the same end. For instance, zinc is a far more expensive fuel than coal, although the potential energy of the latter has first to be converted into mechanical energy in a steam-engine, and then into electricity by a dynamo, while the former effects the conversion at one step.

The amount of zinc consumed in producing an electrical horse-power (746 watts) for one hour = $\frac{2}{E}$ lb. (E repre-

sents the working E.M.F. of one cell) supposing there were no loss by local action. If the battery were generating the full E.M.F. that is theoretically possible, namely, 2.36 volts per cell,

this would give $\frac{2}{2.36} = .85$ lb., and,

although it is improbable that the terminal E.M.F. of any battery would, when at work, much exceed 2 volts per cell, as some loss due to the internal resistance must take place, we will

assume that this minimum figure can be attained; then, zinc costing 3*d.* per lb., an electrical horse-power hour would cost 2½*d.* for zinc alone.

Now, the combustion of 1lb. of coal generates at least five times as much energy as 1lb. of zinc. On the other hand, a steam-engine will only convert 10 per cent., or about one-tenth of this into mechanical work, consequently, the energy to be obtained from 1lb. of coal

burned in a steam-engine is $\frac{5}{10} = \cdot 5$, or

one-half of that to be obtained from 1lb. of zinc consumed in a battery. In other words, 2lb. of coal will be required to produce one horse-power hour, which agrees with the results actually obtained from good engines working under favourable conditions.

Reckoning coal at 16*s.* per ton, 2lb. costs ⅓*d.*, which will be the cost of the material used to obtain one mechanical horse-power hour in this way, and if this is transformed into electricity by means of a dynamo, the cost of an electrical horse-power hour may be put at a ¼*d.*, which will allow ample margin to cover the losses of this second conversion.

The relative cost, therefore, of energy produced from zinc and from coal is as 2½*d.* to ¼*d.*, or as 10 to 1, and this without making any allowance for the expense of the exciting fluid and the depolariser, which would cost at least as much again as the zinc itself. (E. J. Wade.)

The statements which have been recently made in the daily papers as to the effects produced by the use of primary batteries in lighting railway carriages have brought many queries, not a few from persons who appear to imagine that the cost of lighting by that means is measured by the first cost of the battery and the lamps. Most schoolboys have nowadays learned the simple lesson that out of nothing, nothing comes; but judging by some of the paragraphs in daily papers, it is perhaps excusable that not a few of our querists should imagine that something remarkably cheap has been discovered, and that they can have the electric

light at a merely nominal cost. We have recently pointed out, not once merely, but several times, that an electric light obtained from any known battery is really expensive as compared with the same amount of illumination obtained from gas or other cheap source of light, and that there is no hope of reducing the expense until someone discovers a battery the decomposition of the elements of which will produce a substance or substances which shall be worth at least as much as the raw materials themselves. We have, from time to time, described cells or battery arrangements, patented and otherwise, the inventors of which thought they had made one step towards the desired goal; but at present, notwithstanding all the puffing, we are unacquainted with any battery which, all things considered, is cheaper than the well-known combination of zinc and carbon excited by dilute sulphuric acid and bichromate of potash or nitric acid. For bells, telephones, and telegraphs, electro-metallurgy and medical purposes, other arrangements are more suitable; but in the case of electric lighting and electro-motors, a constant and ample supply of energy to the full capacity of the battery is required, and at present we have not found a cheaper metal to oxidise or consume than zinc. This is an old tale. It must be quite 40 years since Staitte took out a patent in which the commercial value of the residual products was mentioned, and latterly we have had several inventors taking up the old idea, without, however, demonstrating by actual receipts that they obtained any return worth mentioning for the zinc and sulphuric acid expended. Probably if primary batteries came to be used on a very large scale indeed, a sufficient quantity of residual products might be obtained to find a ready sale; but it is extremely doubtful whether more than a fraction of the prime cost would be recouped, unless the battery can be induced to manufacture some unknown and really valuable substance whilst giving out current. In one of the new

batteries, which is, we believe, working very well on several railways, lighting carriages with lamps of 5 to 10 candle-power, zinc and carbon form the two elements, and the battery is excited by a composition named "oxidone," the exact nature of which is kept secret until the patents are completed. The working cost of this battery is stated to be as low as $\frac{1}{8}d.$ per hour for each 5-candle lamp, and a battery of 16 cells will supply 18 lamps and can be charged for 40 hours—that is, the battery can be used for 10 hours on each of 4 days without needing to be recharged. Taking batteries as we know them in practice, such a result as that must be regarded as very good indeed; but if the cost has been arrived at by allowing for the sale of the residual products, it will at once be seen that the battery is not so cheap as a good steam-engine and dynamo, for when current is obtained by the oxidation of zinc the cost is about 9 times greater than when a machine is used, and the source of the energy is coal at about 20s. a ton. Sprague worked out this little sum for the benefit of all whom it concerns some years ago, and he found that taking the expense of the battery as only 4d. per lb. of zinc, the cost of a horse-power for 24 hours was 25s., whereas the same amount of energy could be obtained from a common steam-engine and coal at 20s. for 10·29d. Even if we suppose the residual products of any battery in which zinc is employed return 2d. for every lb. consumed—and no one has supposed that possible amongst the most sanguine inventors—it will be seen that the common steam-engine has still the advantage as a motive power. Electrical machines have been considerably improved since Joule calculated that 75 lb. of zinc would be necessary for one to maintain 1 h.p. for 24 hours; but so have steam-engines, and, therefore, we are brought back to the simple datum that the oxidation of zinc can produce so much and no more energy, and that unless some one can be found to pay a high price for sulphate of zinc

there is no chance of any of the well-known cells in which it is consumed becoming a cheap source of electric light. It seems abundantly clear, from a number of experiments, that the most that can be expected from the best steam-engines and dynamos is 200 candles of incandescent lighting per h.p.; and as it is also tolerably apparent that 2 lb. of zinc are necessary to obtain the same quantity of energy, we have 6d. as compared with $\frac{1}{4}d.$ as the relative cost of the two sources of energy for electric lighting. It is not impossible that these figures are too favourable to the battery, for Sprague says that the cost of an equivalent of energy by a common steam-engine, is only '00112d., while by a Daniell's battery it is '0541d. There is this to be said, however, that even if the cost of working a 20-candle lamp is as much as $\frac{1}{2}d.$ per hour, there are many persons who would prefer it to gas or any other illuminant; and if the new batteries can be made to produce a really useful substance as a residual, the trouble and attention they may entail will not stand in the way of their adoption. So far as we know, a 20-candle light cannot be maintained at a cost of $\frac{1}{2}d.$ per hour, even when the zinc and the acid can be purchased in quantities at the lowest price; but if a battery is in existence which will yield such results, it is a pity those who own it do not make it known, for it is certain they would have a very wide sale, provided they could guarantee its performance. At the price named it would be too costly for lighting on the large scale; but there are very many persons who would go to the expense of fitting up the battery and the lamp if they could have a light of 20 candles at a cost of $\frac{1}{2}d.$ an hour. Possibly before long some one may invent an iron or a lead battery, and then those who are so anxious to have the electric light will probably have an opportunity of gratifying their desires; as, indeed, they may now, if only they are prepared to pay for them. But so long as zinc is used there is small

chance of primary batteries supplanting dynamos and steam-engines. (*Eng. Mech.*)

Axo.—The Axo battery, constructed by the Leclanché Battery Co., of America, is an "improved" form of Leclanché, intended to overcome some of the defects of batteries of the porous cup class. The porous cup has a flange which rests on the rim of the jar and forms of itself a cover for the cell. The zinc passes through an independent aperture of its own in the shoulder of the jar. The carbon conductor has inclined sides, increasing in size from the top to the bottom. By gravitation, therefore, the particles of the surrounding mixture are always in perfect and continuous electrical contact with its surface. The carbon itself is provided with ventilating grooves extending along its sides, by which it is much more readily relieved of the bubbles of gas which form on its surface and retard the electric action, than by the holes usually run through the seal and into the mixture. The well-known lead cap of the carbon is dispensed with, and in its place is used a thimble with thumbscrew, which can be slipped off and replaced in a moment. The battery wire passes through a small hole in the top of the thimble, and into a recess in the carbon, against which it is clamped by the thumbscrew.

Bichromate piles, especially those single liquid ones that are applied to domestic lighting, all present the grave defect of consuming almost as much zinc in open as in closed circuit, and of becoming rapidly exhausted if care be not taken to remove the zinc from the liquid when the battery is not in use. This operation, which is a purely mechanical one, has hitherto required the pile to be located near the place where it was to be used, or to have at one's disposal a system of mechanical transmission that was complicated and not very ornamental. In order to do away with this inconvenience, which is inherent to all bi-

chromate piles, Mareschal has invented and had constructed an ingenious system that consists in suspending the frame that carries all the battery zincs from the extremity of a horizontal beam, and balancing them by means of weights at the other extremity. The system, being balanced, the lifting or immersion of the zincs then only requires a slight mechanical power, such as may be obtained from an ordinary kitchen jack, through a combination that will be readily understood upon reference to Fig. 72A. The axis M of the jack, on revolving, carries along a crank M D, to which is fixed a connecting-rod A, whose other extremity is attached to the horizontal beam that supports the zincs and counterpoises. If the axle M be given a continuous revolution, it will communicate to the rod A an upward and downward motion that will be transmitted to the beam and produce an alternate immersion and emersion of the zincs.

Upon stopping the jack at certain properly selected positions of the rod MD, the zincs may, at will, be kept immersed in the liquids, or *vice versa*. This is brought about in the following way: The jack carries along in its motion a horizontal fly-wheel V, against whose rim there bears an iron shoe F, placed opposite an electro-magnet E. In the ordinary position, this shoe, which is fixed to a spring, bears against the felly of the wheel and stops the jack through friction. When a current is sent into the electro-magnet E, the brake shoe F is attracted, leaves the fly-wheel, and sets free the jack, which continues to revolve until the current ceases to pass into the electro.

The problem, then, is reduced to sending a current into the electro and in shutting it off at the proper moment. This result is obtained very simply by means of an auxiliary Leclanché pile (the piles got up for house bells will answer). The current from this pile is cut off from the electro F by means of a button B when it is

desired to light or extinguish the lamps. In a position of rest, for example, the crank M D is vertical, as shown in the diagram to the right in Fig 72A. The circuit is open between M and N through the effect of the small rod

and one for manœuvring the apparatus through a closing of the contact B. With Mareschal's system, bichromate piles may be utilised in a large number of cases where a light of but short duration is required until the battery is exhausted, without the tedious manœuvring of a winch and without inconvenience. The jack permits of a large number of lightings and extinctions being effected before it becomes necessary to wind up its clockwork movement. This operation, however, is very simple, and may be performed every time the battery is visited in order to see what state it is in. Mareschal's apparatus is an indispensable addition to every case of domestic electric lighting in which bichromate piles are used, and, in general, to all cases

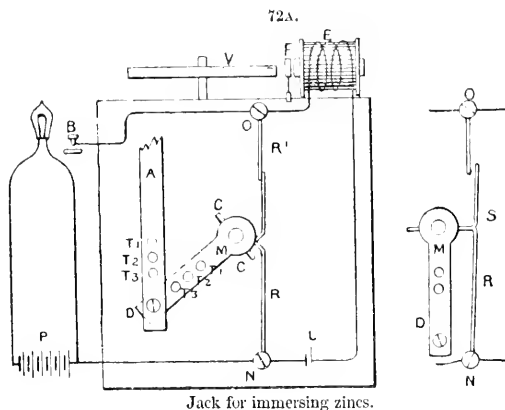

Jack for immersing zincs.

C, which separates the spring R from the spring R'. As soon as the circuit has been closed, be it only for an instant, the crank leaves its vertical position, the rod C quits the bend S, and the spring R, by virtue of its elasticity, touches the spring R', and continues its contact until the crank M D having made a half revolution, the rod C repulses the spring R, and breaks the circuit anew. The brake then acts, and the crank stops after making a revolution of 180° and immersing the zincs to a maximum depth. In order to extinguish the lamp, it is only necessary to press the button B again. The axle M will then make another half revolution, and, when it stops, the zincs will be entirely out of the liquid. The depth of immersion is regulated by fixing the crank-pin D in the apertures T₁ or T₂ of the connecting-rod. This permits the travel, and consequently the degree of immersion, to be varied. The device requires three wires, two for connecting the lamp with the battery,

uselessly exhausted in open circuit. It will likewise find an application in laboratories, where the bichromate pile is in much demand because of its powerful qualities, and where it is often necessary to control it from quite a distant point. (*La Nature*.)

Caution, for.—The battery consists of a series of carbon and zinc plates, presenting a very large surface, which is exposed to the action of a solution of bichromate of potash with sulphuric acid. Each plate is rectangular in shape, as in Fig. 73, but each has one of its top corners cut away. The zincs, as in Fig. 73, are deficient at the upper right-hand corner, and the carbons, as in Fig. 74, are cut away, corresponding to the left upper corner. In this way space is left to join each series of plates by a strong brass rod provided with washers, by which their distance apart is regulated. The rods are joined to a common handle above by metal pieces, care being, of course, taken to secure the insulation of one series from the other.

Fig. 73 represents the battery arranged in its most compact and portable form, the reservoir being an oak box lined with sheet lead. The zinc and carbon elements are lifted in and out of it by means of the wooden handle A, by which they are all supported, and which rests by its ends in grooves cut at each end of the box. When required for use, the bichromate solution previously prepared is poured in from a bottle. After use, the plates are raised out of the solution by means of the handle, washed by dipping into a large vessel of water, and replaced in the box, the contents of which have been previously emptied away.

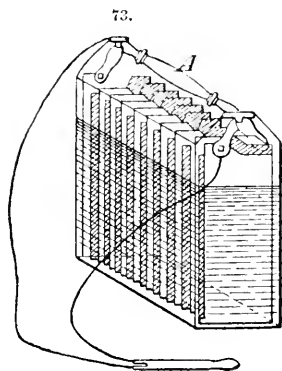

Battery for cautery.

Fig. 74 represents the battery as arranged for ordinary use. The reservoir contains a large quantity of solution in which the carbon plates are immersed to $\frac{1}{2}$ of their height. The zinc plates are lifted entirely out of the solution by the action of the iron weight B, which more than counterbalances them. The drawing represents them in process of being lifted out. It fails to show that the connection of this bar with the zinc series is made by arms of metal outside the box. When required for use, the bar weight B is lifted by hand, the zinc plates dip into

the solution, and ultimately pass into the narrow spaces which are interposed between each pair of the fixed carbons. If the battery be required to act for any length of time, the solution is effectually agitated and polarisation prevented by an occasional elevation and depression of the weight.

The internal resistance of this battery is very small; its power of overcoming resistance in the external circuit is proportionately little, and accordingly only 30 silk-covered ropes of copper wire are necessary in connecting it with the platinum to be heated. (C. Coppinger.)

Chromic acid.—(a) Prescott describes

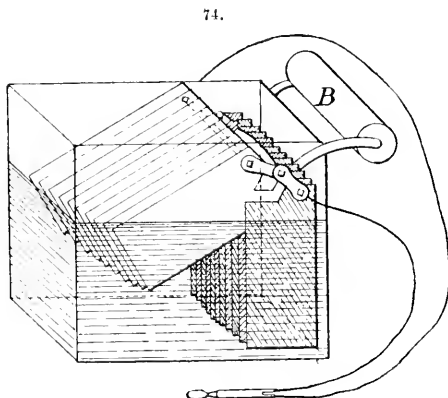

Battery for cautery.

a chromic acid battery where bichromate of potash and sulphuric acid take the place of nitric acid in the Bunsen battery. The solution is made by dissolving $\frac{1}{2}$ lb. bichromate of potash in 5 lb. hot water, and when cold, adding strong sulphuric acid. The zinc is placed in the outer jar containing a saturated solution of common salt, which is made by adding salt until the water can dissolve no more. Five of these cells give a fair current to a small lamp, but the porous pots are soon ruined—sometimes the bottom coming completely off.

But to make a cheap battery of this

description for bells, the elements must be reversed. In the outer jar should be a large surface of carbon in bichromate solution (adding a few drops of sulphuric acid), the lumps of graphite packed closely round the porous pot. Inside the porous pot a strip of zinc is placed in a solution of salt. Two of these cells coupled for intensity will be sufficient to ring any ordinary bell. If you do not wish to spoil the porous pots, place just enough salt to acidulate the water—say $\frac{1}{2}$ teaspoonful to each. The bichromate will last a long while; but the saline solution in the porous pot should be changed once in 6-8 weeks. To keep a couple of porous pots in clean water in reserve would be as well, as all the impurities would soak out in the mean time. A couple of these cells can easily be made up by experimental electricians for next to nothing in cost, as many have most of the materials required at hand.

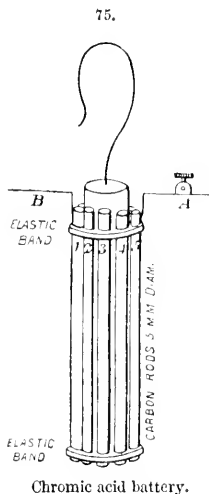

(b) Fig. 75 is better than the ordinary form, being much more convenient and compact, and giving a greater current. This battery is very constant, and will light a lamp for many hours. The

cell may be used with the usual chromic-acid solution. E.M.F. 2.03 volts. Internal resistance for 4 sq. in. zinc surface = $\frac{2}{3}$ ohm; copper-wire to be attached to the binding-screw A of next cell. This wire may also be used to suspend the elements. To keep the carbon rods at a suitable small distance from the zinc rod and from each other, small pieces of rubber tubing are slipped on each rod at the two ends, and are seen in the sketch partly covered by the elastic bands, above which the carbons are coated with copper by electrolysis, and have soldered to them a flexible ligament of fine copper wire, and other wires (A and B) for supports to suspend the elements in the neck of a bottle. The ligament is cut through between the rods marked 2 and 3, so that when the two elastic bands have been removed the carbons may be detached from the zinc. The above is the arrangement of carbon and zinc elements for one cell, the carbon being in the form of rods.

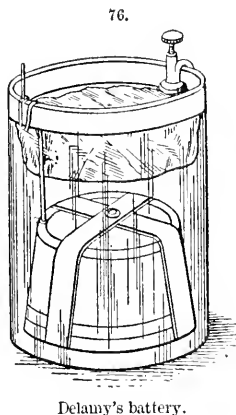

Delamy's.—Fig. 76 is a modification of the standard gravity battery. The sulphate of copper is enclosed in the straw-board box, the zinc in a paper envelope, and the rim of the jar has attached to it on the inside by a sticky substance a

band of rubber cloth. The advantages claimed for the cell are as follows:—When the battery is first set up, the dust of sulphate of copper is not instantly dissolved and diffused throughout the liquid, coating the zinc with copper, as is the case with the ordinary cell. Several minutes elapse before discolouration of the fluid begins, and then only at the bottom of the cell, from whence it rises very gradually, never reaching the zinc. If the box be filled, the charge of copper is always uniform. Deposited or spongy metallic copper cannot fall upon the crystals from the zinc, and caking or massing in the bottom of the jar is thus prevented. The copper electrode is held firmly in position, always the same distance from the zinc. In a battery of any considerable number of ordinary cells it would be difficult to find two alike in this respect. There are little or no stalactitic formations from the zinc, and consequently no local action, rendering the battery very useful for open-circuit work. When water is poured in to make up for evaporation, the equilibrium of the fluids is not disturbed. The deposit on the zinc thus protected is easily removable, requiring no hacking or scraping. One zinc will endure two charges of sulphate of copper. The band around the rim is one of the most important features of the cell, as it prevents zinc sulphate from creeping over. It offers simply a mechanical obstruction. It works perfectly in practice. Of course, these strips or bands may be applied to any battery requiring them. They serve equally well for Leclanché battery; and, to attach them to cells of any kind already up, it is only necessary to see that the

rims of the jars are clean and dry. The sticky side of the strip should be heated slightly and pressed on firmly all round.

Friedlander's.—Fig. 77 shows this portable battery with incandescent lamp attached for ordinary use, but various modifications of a more or less ornamental character are manufactured. Fig. 78 illustrates the manner in which the electrodes are arranged. They consist of carbon blocks and zinc rods attached to an axis which can be turned from the outside by means of a knob, so that when the light is not required the electrodes are turned into a horizontal position clear of the liquid. By lowering them more or less, the intensity of the

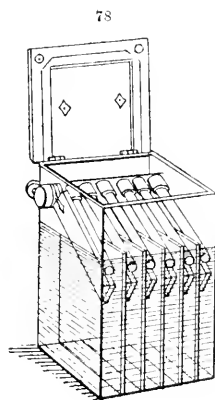
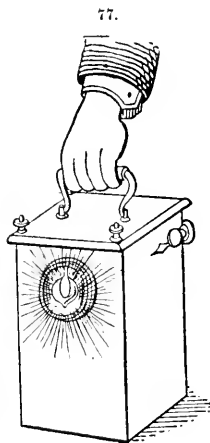

Friedlander's battery.

light can be regulated. The exciting fluid is a solution of chloride of zinc and bichromate of potassium, and has no fume or smell. With a 3 c.p. lamp, one charge of the electrolyte will last for about $3\frac{1}{2}$ lamp hours. The exhausted liquid must then be poured away and fresh solution filled in, an operation requiring no more skill than the filling of an ordinary oil lamp. The carbon electrodes, which are specially prepared,

do not need renewal, but the zinc rods must of course from time to time be replaced. This portable battery and lamp is intended for use in warehouses and other places where ordinary lamps are inadmissible on account of fire risk, and also for use in bedrooms and other places where light is only required for a short time.

Gas.—Following are details concerning an 18-cell battery of Treeby's design, using material which can be easily obtained, and which requires no special construction, though it would be better if the glass cells were less deep, as it would reduce the height of the battery more than 1ft. The cells are placed in a framework made of vulcanised fibre, as it is strong and easy to work.

For the construction of the frame are required 4 pieces of fibre $50\frac{1}{2}$ in. by 2in. by 1in., and these will make the uprights; 4 pieces $15\frac{1}{8}$ in. by 2in. by 1in., for cross bars; 2 pieces $13\frac{7}{8}$ in. by 13in. by $\frac{1}{2}$ in., for the top and bottom of frame; 2 pieces 46in. by $9\frac{1}{2}$ in. by $\frac{3}{8}$ in., for the sides; and a piece of $\frac{1}{4}$ in. plate-glass, $45\frac{1}{2}$ in. by $13\frac{5}{8}$ in. for the back, together with 19 pieces of $\frac{1}{8}$ in. patent plate-glass, $13\frac{1}{2}$ in. by 10in. To construct the framework, first take one of the uprights, and having mitred one end across the thickness, take a saw, cut immediately below the mitre, $\frac{3}{8}$ in. deep, and another $\frac{1}{2}$ in. below that, and plough out the groove with a plough plane (Fig. 79, top end); then $3\frac{1}{2}$ in. and 4in. respectively from bottom of upright take 2 saw-cuts $\frac{3}{8}$ in. deep, and plough out between them, making $\frac{1}{4}$ in. below lower groove a mortise hole $\frac{1}{2}$ in. by $\frac{3}{4}$ in. This do to all the 4 uprights, afterwards cutting a $\frac{3}{8}$ in. rabbet on either side between the upper and lower grooves in the case of two, the other two being rabbeted on one side only as shown by dotted line, Fig. 79. When this is done, take the two last uprights and cut 17 grooves $2\frac{1}{2}$ in. apart, $\frac{3}{16}$ in. deep, by $\frac{3}{8}$ in. broad; these will then have the appearance of Fig. 79. Now take the two side-pieces, 46in. by $9\frac{1}{2}$ in. by $\frac{3}{8}$ in., and plane a mortise cut $\frac{1}{2}$ in. deep along the top

and bottom of each, and after laying one of the grooved uprights upon them, mark off and cut 17 grooves corresponding to the ones made in uprights. These must exactly meet when fixed in their places. Again, take one of the sides, and, marking off 1in. from the top, bore exactly in centre of side a $\frac{1}{4}$ in. hole and 17 other ones $2\frac{1}{2}$ in. from each other; these holes are for the rubber tubing which conveys the gas to the cells, and which are connected to the gas-taps M, Fig. 81. On the other side mark off in the same way, boring two $\frac{1}{8}$ in. holes 3 in. from either side. These are for the connecting wires from cells (Fig. 80), Y being binding screws, the small dots above being the holes. This having been done, take the two top and bottom pieces $13\frac{7}{8}$ in. by 13in. by $\frac{1}{2}$ in. and cut two rabbets $\frac{3}{8}$ in. deep on the bottom side of the top piece and the top side of the bottom respectively at the back—these rabbets being for the glass back to fit into—afterwards fitting them both to the sides by cutting their corresponding mitres on right and left. Now when two of the cross-bars have been mitred at their ends and the other two have had their ends shaped to tenons so as to fit into the mortise-hole at bottom of uprights, the framework ought to be completed and merely require fixing, which had better be done with bichromated isinglass glue, being careful to rough the parts to be glued with sand-paper or a coarse file, using small brass screws $\frac{7}{8}$ in. long for fixing the sides and cross-bars, and red lead putty for fixing the glass back.

When thoroughly secure, varnish with a stilish solution of shellac in spirit, to which has been added, whilst warm, 10 per cent. of solution of rubber in chloroform and 2 per cent. of copaiba oil. When the varnish is dry, slide the glass plates into their grooves. Fig. 84 will perhaps give a general idea of the battery when fitted with cells, G being zinc wings sloped forward in order to concentrate the draught, and on which are hung two leaden tubes E, with branches terminating in little cups to catch drips from battery cells, the above

being so pivoted that they can swing round when the cells require to be taken | ought to be about 28ft. high, and which terminates with a large ventilating cowl

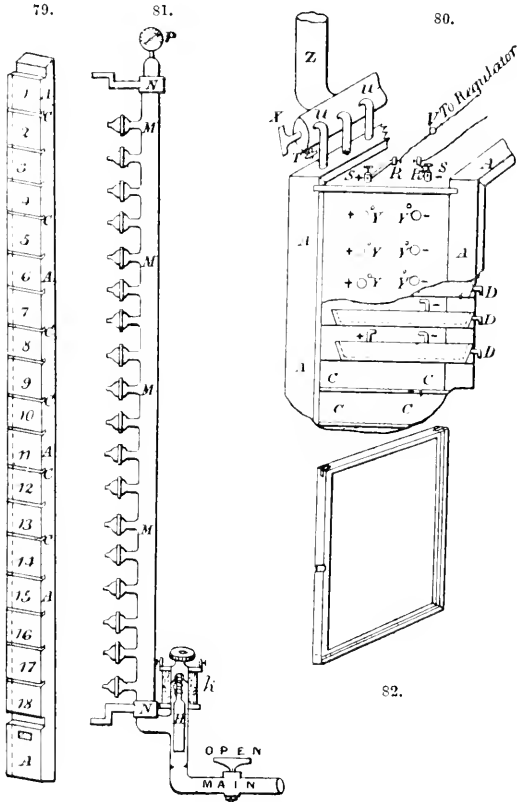

Trechby's battery.

A, vulcanised frame; C, grooves for sliding glass partitions; D, overflow drip tubes; K, gas regulator; L, screw cap; H, core float; M, gas-cocks leading into cells; N, brackets for fixing gaspipe; P, pressure indicator; R' R, shunt binding-screws; S, main binding-screws; T, tap for condensed water; W, condenser; V, lamp; X, damper for draught; Y, binding-screws from cells.

out of their compartments. In Fig. 81 | to ensure always a thorough draught
 will be seen 3 of the 6 pipes leading | through battery box, and of the other
 from battery box into chimney Z, which | parts shown in Fig. 80. W is a recep-

tacle for any water condensed in chimney, X being a damper contained in it, T being a small tap or outlet for condensed water. It will also be seen from Fig. 80 the position of cells allows of a clear $2\frac{5}{8}$ in. space behind for draught. In Fig. 81 M is a brass tube fitted with 18 nozzles and taps, by which to conduct hydrogen gas to cells, these being connected by means of short lengths of $\frac{1}{4}$ in. rubber tubing. The brass tube terminates at the top with a pressure-gauge P, and has at its bottom end a regulator K, which regulates both the pressure and quantity of gas, for it will be seen that when the gas is turned on, the float H, which is made of thin iron, rises until a series of small perforations, halfway along its length, come opposite the opening of pipe leading gas to cells; then on any lamp being turned on in the main S, a shunt current R passes through regulator and controls the gas according to the resistances of the lamps in parallel; the regulator can also easily be adjusted by turning screw-cap L.

It may seem unnecessary to have both a pressure gauge and taps to all the nozzles; but, apart from the convenience of shutting off some cells, in case of a leakage of hydrogen gas, which has no smell, it can at once be determined and the cell cut off. It will also be perceived that the bobbin of regulator is a shunt on the main leading wires, V being a lamp inserted in shunt; but this is quite optional, as by reversing the regulator and readjusting screw-cap, it can be used direct on the main leads.

Now to come to one of the most important parts of the battery—viz., the wire mesh frames to fit into glass cell. For these are required 36 pieces of vulcanite, $12\frac{1}{2}$ in. by $\frac{3}{8}$ in. by $\frac{3}{8}$ in., 36 pieces $9\frac{1}{2}$ in. by $\frac{3}{8}$ in. by $\frac{3}{8}$ in., and these will make the 18 top or positive frames, and for the bottom frames will be required the same number of pieces, $12\frac{1}{2}$ in. by $\frac{3}{8}$ in. by $\frac{3}{8}$ in. and $9\frac{1}{2}$ in. by $\frac{3}{8}$ in. by $\frac{3}{8}$ in. respectively. All these can be nicely cut out of two half-sheets of vulcanite $\frac{3}{8}$ in. thick. In addition to the

above will be required 18 pieces, $12\frac{1}{2}$ in. by $9\frac{1}{4}$ in., of silver wire gauze, 120 mesh, and 18 pieces, 12 in. by 9 in., together with several lengths of copper or silver wire, No. 18 gauge, and a good many gutta-percha whip-lashes for sealing in with, and 36 strong elastic bands $\frac{1}{2}$ in. wide.

The first thing to do is to mitre, mortise, and tenon all the vulcanite strips, and to take a saw-cut $\frac{1}{8}$ in. deep down the inside $\frac{2}{10}$ in. from the edge, boring a hole on one side, 4 in. from top side, for the connecting wire to pass through (Figs. 82 and 83). On the other side in the centre on outside of frame file a small groove about $\frac{1}{4}$ in. wide across it; this is for the rubber tubing.

83.

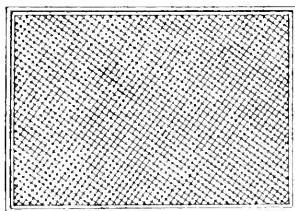

Wire mesh.

The next thing, after fitting all the frames, is to fix the silver-wire mesh inside them, and to do this first take the gauze and turn it up $\frac{1}{8}$ in. all round, running a silver or copper wire, No. 18 B.W.G. under the lap, twisting the two ends together where they meet (Fig. 83); then taking the shorter piece of vulcanite with the hole in it, pass the twisted wires through and press the wire edging into saw-cut by means of a blunt screw-driver. This also do on the opposite side with the other piece, soldering the wires to the mesh with metallic putty, and sealing over the saw-cut with a piece of gutta-percha whip-lash; then take the two longer pieces, and having placed the other side of the wire mesh into their respective saw-cuts, fix the ends of the pieces in their place,

with a solution of gutta, passing a rubber band all round the frame. Now press the wire edging home on either side to bottom of saw-cuts, soldering as before, and sealing with gutta-percha. This will strain the wire mesh, and make it quite tight—an absolute necessity for the proper working of the cell. The wire mesh-plate is now nearly completed, but will have to be placed in a silver bath until the wires of gauze are cemented together, when it will have to be transferred to a platinum bath. All the other frames must be treated in the same way. When the smaller frames have been sealed in the bottom of their respective glass cells, place the larger ones over them, on the upper side of which has previously been placed about 1½ lb. granulated platinised carbon, about the size of 4 or 5 shot. The cells are now practically finished, except for the addition of a dilute acid, and can be placed in their different compartments.

No doubt the above is capable of many improvements, such as the corrugation of the plates, closing up the face of battery and using forced draught; but the wire gauze plates will only be beaten by thin porous metal ones made of some less costly metal. The difficulty of the cell is that it must be kept absolutely level, so that the positive or upper plate is never out of capillary attraction with the dilute acid in the cell, and yet it must be never underneath the surface. To remedy this I tried floating the positive plate; but this so diminished the available surface that I prefer the level kept constant by overflow tubes, such as D, the evaporation being also kept constant by turning damper X. This latter will be fairly rapid, as the air not only passes over, but permeates through the layer of carbon in cell.

It is as well to mention that before turning gas on to battery, if all the cells are connected in parallel and coupled to eight ½-gal. Bunsens grouped in series of two for about 10–20 minutes, discharging once or twice, but being very careful not to attack silver mesh, the inter-

molecular porosity of the plate will be much increased. The last charging had better remain in the plates until the gas is turned on to battery, as owing to what I call a molecular suction the freshly-liberated hydrogen from gas apparatus seems to take the place of the hydrogen disengaged in cell more readily when circuit is closed afterwards.

Now as to cost and efficiency. The cost is easily calculated, and would be between 50*l.* and 60*l.*; the absolute efficiency is difficult to calculate, but as the current density in discharge has varied from .1 to nearly .3 per sq. in. in the several kinds of plates experimented with, I think I should be justified in stating that a 25-cell battery constructed on the above lines, exposing 140sq. in., or 1sq. ft. of negative area, would give about 1 electrical H.P.—a poor result from such a mighty edifice of cells—and would cost from 80*l.* to 90*l.*, or not more than a first-class gas engine of the same power. Of course, future improvements would greatly increase the output of the above, and might possibly reach 2 H.P. or 1500 watts.

With regard to the working of gas batteries, there is a critical point at which the greatest effect takes place: this is that point at which the combining elements occupy the least possible space without giving or losing heat to the surrounding solution. Thus, in an oxy-hydrogen cell with perfect plates the critical point is 4° C., but the intermolecular porosity increases with the temperature, and the temperature increases the pressure of gas at a constant volume, therefore the temperature must vary as the thermo-molecular porosity of the material, of which the plates are composed, and the pressure must vary as the temperature, to obtain a constant volume, and since it will be seen that the limit of temperature must lie between 4° C. and 100° C., in all probability unless the atmospheric pressure on positive plate is increased, the greatest effect would take place when the negative plate is heated to 100° C., using a pressure of gas at 5·21b.

81.

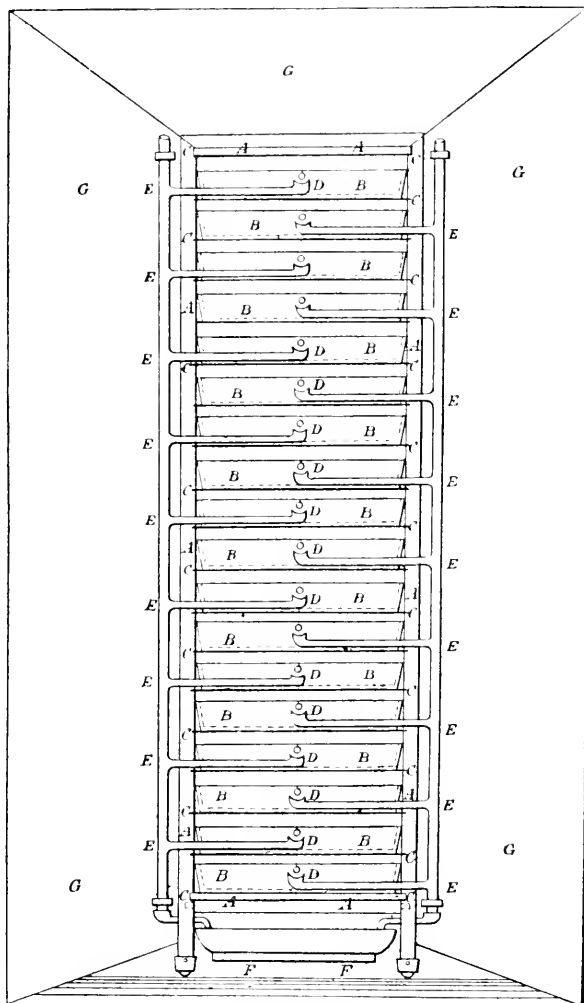

Treeby's battery.

A, vulcanised fibre frame; B, glass cells; C, plate glass supports dividing cell compartments; D, overflow drip tubes from cell; E, catch cups and tubes to lead away overflow drip; F, basin to hold surplus water; G, zinc wings to concentrate draught.

per sq. in., the solution remaining a 4° C.; but, of course, in actual practice, a compromise must be made, so as to give the best results. Therefore, I suggest that the negative plate be made very thin, which also increases its molecular porosity, so that the energy of the current may generate the heat required, and that the positive plate be kept cool by the evaporation which takes place,

when the metal will be pierced with tiny holes, according to the coarseness of the mesh used. (A. Treeby.)

Holtzer.—The desire to obtain an open-circuit battery of large generating power, and one which should quickly recuperate, led to the construction of the Holtzer cylinder battery of the Leclanché type, shown in Fig. 85. As will be seen, the battery consists practi-

85.

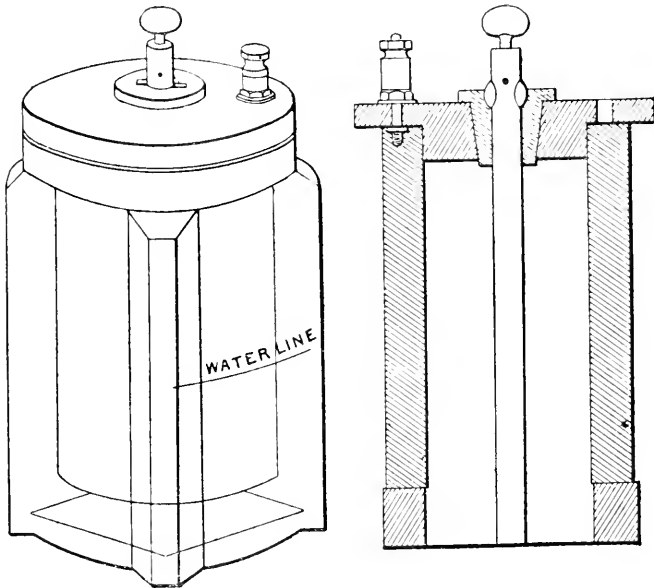

Holtzer battery.

so that the solution in the immediate vicinity of the plate where the combination takes place should be as nearly as possible 4° C.; also a low temperature is more conducive to the formation of ozone in the carbon above positive plate. It may be worth mentioning that a very thin plate can be made by taking very thin metal foil and burnishing over a piece of iron wire gauze,

usually of two parts only, as the cylinder, zinc, and connector form the first part, they being collectively united and forming one piece alone; the second part being the glass jar. The cylinder, resting on the top of the jar, forms by its weight a well-sealed joint, thus preventing evaporation. There are no fragile parts to be easily broken, but one strong heavy carbon of cylindrical

form, having a binding post well secured to it and thoroughly protected from salts. The zinc is separated from the cylinder by a porcelain piece of wedge shape to secure a close fit. Thus is presented one of the simplest and most practical forms of Leclanché battery obtainable.

Imchnetzki.—This battery has a considerable E.M.F. and very great constancy. The exterior containing cell is of tinned iron, with a base of cast iron; the interior cell, open at the base, is of paraffined cardboard, and contains 8 porous diaphragms. Melted paraffin wax is poured at the bottom of the first cell, and when this is cold the second is introduced. There are thus 9 compartments perfectly insulated, of which 4 contain sulphate of soda with plates of zinc, and the other 5 are filled with chromic acid with electrodes of specially prepared graphite. The interior cell being a little lower than the exterior, two flattened funnels can be placed in the spaces by which the two solutions are poured in. The liquid arrives at the same level in all the compartments. At a certain height openings are made by which the excess liquid can flow through. An outlet is made at the bottom of the first cell by which the whole of the compartments can be emptied by the simple turning of a tap. The positive electrode is in compressed graphite, with a metallic gauze, to which the terminals are soldered and covered with paraffin wax. The graphite is light and very compact, so that the liquid in which it is immersed does not rise by capillary attraction and does not oxidise the terminals, which usually happens with other batteries. In certain types the negative pole is also made of graphite. The E.M.F. of this battery is about 2.12 volts if both electrodes are of graphite; the internal resistance is 0.08 ohms.

Iron.—A novel and simple form of electric battery has recently been invented in Italy. It consists of conical vessels of cast iron and porous earthenware, with nitric and sulphuric acid. An iron cone is placed point downwards

in a stand, and is partly filled with strong nitric acid. In this there is placed a cone of porous earthenware containing dilute sulphuric acid. Then follows an iron cone surmounted by an earthenware one, and so on in a series, each vessel containing its respective acid. It follows that the inner surface of each iron vessel is bathed in nitric acid, and becomes passive, acting the part of the platinum or carbon in an ordinary cell. The outer surface is attacked by the dilute sulphuric acid, and takes the place of the zinc. There are no connections to make, the simple building of the pile putting all the parts into union. The earthenware cones are 8 in. diameter and 4 in. high, and contain 550 c.c. of 10 per cent. sulphuric acid solution. The iron vessel contains 110 c.c. of nitric and sulphuric acids, the latter being 3 times the volume of the former; 60 elements, arranged in two piles, have a resistance of $10\frac{1}{2}$ ohms, an electro-motive force on open circuit of 81 volts, and on closed circuit of 45 volts, with a current of $4\frac{1}{10}$ ampères. After 5 hours the difference of potential falls to 28 volts, and the current to $2\frac{7}{10}$ ampères.

Kousmine.—By making use of the phenomenon of diffusion, Kousmine has succeeded in overcoming the increase in internal resistance of the bichromate of potash battery due to the formation of crystals on the positive electrode. The positive carbon electrode consists of 4 strips attached to the lid of the battery. The negative zinc electrode consists of a circular grating, resting on the bottom of the battery. By means of a funnel a 15° B. solution of sulphuric acid is introduced, until it just reaches the lower end of the carbon strips. A 6 to 7 per cent. solution of bichromate of potash is next introduced. The two liquids do not mix, on account of the great difference in their densities. When the battery is short-circuited, it is easy to see that chemical action only takes place close to the lower end of the carbon strips, which are gradually surrounded by a violet ring 2-3 mm. deep. Above this region the bichro-

mate solution retains its original colour. The bichromate solution being very weak, the chromic crystals dissolve as soon as they are formed, and the positive electrode is not covered by a deposit as in other batteries. The solution of these crystals, having a greater density than the surrounding liquid, falls to the bottom. The sulphate of zinc also falls to the bottom of the cell, causing more sulphuric acid to rise. A cell tested by a committee of experts showed:—Height 20cm., diameter, 15cm., surface of zinc 176sq. cm., bichromate solution 6 per cent., sulphuric acid 15° B. After having been circuited for 8½ hours on an external resistance of .32 ohm, and then left on open circuit for 10½ hours, the cell continued to work for 4½ hours, when the circuit was again closed, and it gave during 13 hours 36 ampère-hours for an expenditure of 48grm. of zinc.

Lalande-Chaperon.—The inventors hoped from experiments they made that by combining zinc and an alkaline solution with an efficient depolarising solid, they could fulfil the necessary conditions for a cell which should remain mounted for a long period, like the Leclanché, whilst furnishing a constant and large current, several ampères for instance, though but of small dimensions. Following out this train of thought, the trial of metallic oxides as depolarising material, a large number of which are insoluble in alkalies, was naturally indicated. Among all those examined none seemed to supply electrodes of such capacity as oxide of copper. Peroxide of manganese gives a high E.M.F. with an open circuit, but in alkali elements, as also in sal-ammoniac elements, polarisation ensues very quickly for a duty of some importance. They did not think it worth while to follow up the examination of this combination subsequently extolled by Leuchs. The various oxides of iron, natural or artificial, turned out badly, and were not reduced in any appreciable manner in the battery. However, the small layer of oxide formed by oxidation through heat on plates of

iron placed at the positive pole was reduced rapidly enough, and made good contact with depolarisers, even solids. This quality of making with the positive electrode sufficiently good contact to allow the battery to work well, to make good contact, is very variable, not only with the nature of the oxides, but also with their physical state. Thus oxide of copper formed by roasting copper in the air is generally found to be in good condition for use; whilst chemically precipitated oxide makes far inferior contact with the electrode. The binoxide of mercury, which it would appear should show properties very much resembling those of oxide of copper, depolarises slowly and badly, whether it is used with a support of copper, iron, carbon, or even mercury. Oxides of the precious metals (silver, platinum, gold) give high electromotive forces, and depolarise regularly. Oxide of silver has given, in D'Arsonval's hands, an E.M.F. of more than 1½ volt. Unhappily, the price and the high molecular weight of silver render its use very limited. The battery thus formed is not completely reversible; the silver reduced to oxide in the working of the battery only absorbs electrolytic oxygen in an incomplete manner, whilst with copper the absorption is complete up to perfect oxidation. The same electromotive forces are obtained, in fact, by the use of the oxide or chloride; the latter, having a heat of formation far higher than that of the oxide, evidently will not give the same E.M.F. unless it undergoes a preliminary transformation. High electromotive forces might be hoped for with the higher oxides of nickel and cobalt obtained by an electrical recharging of elements working as secondary batteries; but these products make bad contact with the supports. Oxide of bismuth, on the contrary, which is formed by using the lower nitrate, might answer readily; but it is very inferior to oxide of copper. Bin oxide of lead cannot be used.

Having ascertained in a general manner that the combination of the

properties of oxide of copper and those of alkaline solutions enabled them to construct a cell which would last and give a high duty, it remained to design simple forms for different uses. The use of agglomerate depolarising solids has been much upheld. Products having energetic depolarising properties, and offering great resistance to the dissolving action of caustic alkalis, are prepared by mixing a small quantity of oxychloride of magnesium with oxide of copper, and moulding the material on a metal support to ensure contact. This method of using the oxide readily permits of the formation of elements of small volume and large surface. It is necessary to remark, however, that under ordinary conditions, when the battery must not be recharged after running down, these agglomerate plates become, as in the Leclanché cell, a useless residue, and the work expended in their manufacture is entirely thrown away. On the other hand, the pure metallic copper obtained by the reduction of the unmixed oxide is far from being valueless. Accordingly, it seems more practical to apply the oxide to the conducting support, which in this case should be horizontal, by its own weight alone. Constructed under these conditions, in which the depolarising material rests on a plate, or, better still, at the bottom of a metal jar, is the most handy form for numerous purposes. The use of agglomerate plates should be reserved for special cases.

In these cells the zinc is placed in the upper part, and when in work the very dense solution of zincate of potash which is formed falls to the bottom of the jar, where it lies in a syrupy layer, so that to the very end the zinc is in contact with the dilute alkaline liquid which should attack it. This it does under these conditions with perfect regularity, whilst plates of zinc immersed as far as the bottom of batteries of the same kind are eaten away with increasing rapidity from bottom to top. A plate of zinc 3 mm. thick, placed horizontally, can be eaten away so regularly as to

have at last a uniform thickness of only $\cdot 2$ - $\cdot 3$ mm. In batteries at rest the separation of the solution of potash and the saturated solution of zincate which falls to the bottom may be clear enough to permit of renewing the exciting liquid by syphoning off the saturated parts to replace them. Soda gives apparently the same results as potash, both as regards E.M.F. and internal resistance. Potash avoids the formation of creeping salts. This inconvenience can, however, be avoided in large cells by simply covering the surface with a liquid not attackable by soda. It is useful to employ sufficiently concentrated solutions, up to 30-40 per cent., for instance. A solution containing 5-6 per cent. of potash dissolves but very little oxide of zinc; and a solution of alkaline zincate precipitates oxide of zinc when diluted with water. There is, therefore, a far greater relative proportion of unused alkali the more dilute the solution is. When the alkaline solution in the battery is saturated, though the circuit be closed, the zinc continues nevertheless to be attacked; but then oxide of zinc is deposited as much at the bottom of the jar as on the zinc, which it covers with a hard crust. The appearance of these deposits indicates the exhaustion of the battery. The carbonic acid of the air is absorbed by the potash of the batteries, especially if the surface is not protected by a cover or layer of liquid. This absorption, which otherwise is very slow, is only inconvenient so far as it renders useless the quantity of potash converted into the carbonate state. When the alkaline solution is saturated with oxide of zinc and remains exposed long enough to the action of the air, it causes insoluble crystals to be deposited in water (which appear to be oxide or hydrate of zinc). One serious inconvenience is found in nearly all batteries intended to remain untouched for a long period; that is that the zinc, even with an open circuit, is rapidly attacked at the level of the liquid and to a small distance below the surface. It may in this way be com-

pletely cut in two, even if it be a thick plate, and the working of the cell be stopped. The use of insulating varnish or protecting bands of rubber gets over this difficulty. If the zinc be suspended by a wire or rod of any other soluble metal, a local couple is formed which rapidly destroys the electrode at the point of attachment. A rod or plate of brass or of amalgamated copper may be used as a support for the zinc. Amalgamated zinc will not form a couple with amalgamated brass, even after a long period of immersion. This method is adopted for all batteries required for any length of time. The zinc is always completely immersed and suspended by a conductor of amalgamated brass connected with a terminal.

The oxide of copper battery can be made in many different forms, according to the service it is intended for. Models with an external iron jar offer the advantage of being hermetically closed, readily portable, and of great solidity—very important qualities for cells enclosing a caustic liquid. In one of these forms (Fig. 86) the outer jar, of .09m. diameter, looks like a shell. It constitutes the positive pole: a terminal A projects as shown. The outside of the jar is paraffined when cold, so as to prevent rust and short circuiting. The zinc D is formed of a cylinder .02m. diameter, soldered to a rod of amalgamated brass K, fitted in a rubber tube G, and carries the terminal F. The tube is also traversed by a metal tube terminated by a plug H, formed of split rubber tubing. These cells are usually delivered filled with the potash solution, so that to mount them it is only necessary to throw in the proper quantity of oxide of copper, which spreads over the bottom at B, and to close the cell by means of the rubber stopper carrying the zinc. This arrangement is particularly handy for use in rooms for telephones or electric bells. This type will give a duty amounting to nearly 2 ampères. A smaller type of .05m. diameter is fully capable of several years' electric bell work.

Fig. 87 shows another type of her-

metically-closed cell which has more recently been brought into use. It has a large surface, .22m. diameter, and gives a duty of 8 to 10 ampères, which allows of its being used for the same

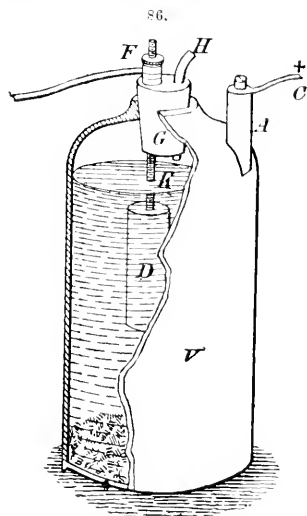

Latande-Chaperon battery.

purposes as the Bunsen and bichromate batteries, viz.:—Charging accumulators, lighting houses, electro-plating, induction coils, &c. The arrangement of this cell is very similar to that of the foregoing. The oxide of copper B is similarly spread over the bottom of the jar; the zinc D, consisting of a long plate rolled in spiral form to offer a large surface, is suspended from an ebonite cover G, fitted on to the mouth of the jar by means of screws, as shown, and having a rubber washer to secure the joint. These large elements have the same charge as large trough cells, viz., 2 kilo. potash and .9 kilo. oxide of copper, and can be used instead of them for all purposes. They are capable of a considerable amount of work. For instance, a trough battery has kept an Edison 5-candle lamp alight

for more than 200 hours. By using 6 elements one can carry on nickel-plating work during nearly 2 months at the rate of 7 hours per day, which requires 3 Bunsen elements. The latter require to be remounted every 2 days, | the support of the depolarising material is of copper, a small quantity of the latter is dissolved, giving a blue colour to the liquid. The copper obtained by the reduction of the oxide, however, is not dissolved. By employing iron or

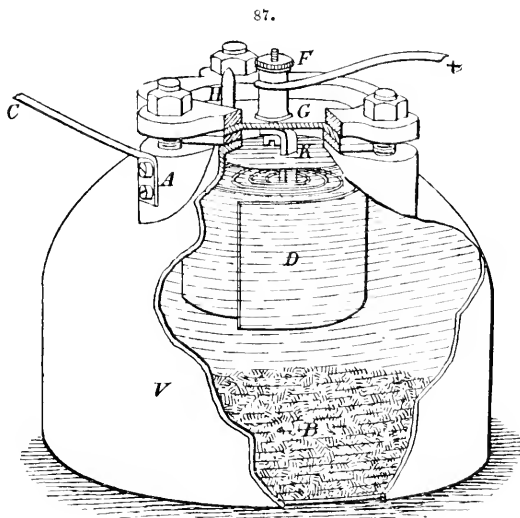

Lalande-Chaperon battery.

and do not give nearly such a constant current, thus causing numerous troubles. These iron batteries have the remarkable property of being able to give without polarisation a duty of far higher force than corresponding non-metallic combinations; it seems that the surface of the iron must be charged with occluded hydrogen, which is carried gradually as far as the oxide of copper, and thus assists the depolarising action in a continuous manner.

It remains to design some practical reversible batteries, having a large and small duty. When an oxide of copper battery is exhausted, and a suitable current is made to traverse it, the oxygen at the positive pole is wholly absorbed by the reduced copper; but if

cast-iron as a support this attacking and dissolution of the copper is avoided, provided that the oxide used has been free at the outset from metallic copper. The great difficulty lies in the deposition of zinc. This metal is precipitated in a form which is not sufficiently coherent, particularly when it is required to have moderate thicknesses. This difficulty may be avoided either by precipitating the zinc on a very large surface of brass or amalgamated copper (on a mass of copper shavings for instance), or by precipitating it on a horizontal surface of amalgamated brass, covered with an excess of mercury and furnished with depressions for this metal to lodge in. The under part of this support is further covered with an

insulator. The zinc can then only arrange itself on the surface, and as it immediately amalgamates, the deposit becomes coherent, and can, without loss, furnish a fresh amount of current by its dissolution.

Moist.—Imprimis, it should always be borne in mind that the circulation of the liquid is of fundamental importance in electro-chemical generators, so that all so-called "dry" (really *moist*) batteries necessarily fail in a most essential particular, and are even conceptually faulty: it is, therefore, clearly out of the question that a "dry" battery of a certain composition should ever be as efficient as a "wet" battery of the same composition, and the employment of a "dry" battery can only be excused on the plea of convenience in handling—a plea that avails but in a few instances. Even if the operations of gilding and plating could at all be conducted satisfactorily by the employment of "dry" cells, there would be no reason whatever for preferring them to ordinary cells; as a matter of fact, however, a "dry" cell is comparatively useless for such a purpose. It will undoubtedly ring a bell, and if large enough and moist enough it may do so for a long time; it will also plate, but no one, except perhaps the "dry battery" manufacturer, has found an advantage in having plating cells dry. The current of a dry cell is, moreover, very inconstant, and the internal resistance is high. (H. G. L.) Being simple and convenient, they naturally recommend themselves to the inexperienced amateur who will not think for himself. Such batteries only act as long as their packing is moist and chemical action possible. That action does not last long, because the new product which results from the oxidation of the zinc being practically a solid, cannot fall to the bottom by its higher specific gravity, as it does in the liquid cell; it remains where it is formed, and shields the zinc against the further action of the packing. Inventors pretend that the waste products are absorbed and

new moisture regenerated. That is impossible in a dry cell. The zinc cylinders of these cells offering a large surface, the chemical action must go on for some short time before all the moisture is neutralised; so long a current will flow. Still, the non-removal of the waste product must speedily prove fatal to every dry cell.

Regeneration can be effected in different ways: by passing a current through them and making them a sort of accumulator, or by diluting a solution. But who will undertake that trouble, when the ordinary Leclanché, which costs not half as much, does all the work for more than a year without any regeneration? True it is, that competition has brought the price of the latter cells so low that it scarcely pays to make them well, and that they often fail on that account. Respectable houses will always sell a proper article, because they know how to, and it costs no more to make. There are occasions when dry cells are very suitable. When you go out testing or bell-hanging, it is more convenient to carry a small dry cell than a liquid one, and even so with the medical electrician. In such cases lasting time is not of much importance.

(A. C.)

I made up a dry battery which was in use 6 months for bell ringing; and although of small size and very simple, it is equal to two Leclanché cells. I cast a slab of plaster of Paris with a little oxide of zinc with it, mixing it with water as thin as I could for it to set well, and when thoroughly set I dried it in an oven; when dry I soaked it in a strong solution of chloride of zinc; and mixing a spoonful more of plaster with the same solution, I spread it over one side of the slab, and pressed a zinc plate on it before it was set. Then I did the same on the other side, and put on a plate of lithanode, of course leaving one end of each projecting for binding screws. Afterwards I rolled paraffined paper round the whole, and tied it up tight with string. Its simplicity, cheapness, and portability leave nothing to be desired as far as bell work

goes, and I think it would be useful for continuous-current work. (A. L.)

Radiguet's.—Batteries with two liquids, that is to say, with bichromate and carbon, with acidulated water in the external vessel and zinc in the

appreciable wear taking place in open circuit. Consequently, the battery is constantly ready to furnish light through the simple closing of a commutator. But, it is necessary to assure as complete amalgamation of the zincs as possible in order to prevent wear in open circuit.

In order to fulfil this condition, Radiguet in the first place devised the arrangement shown in Fig. 88. The lower part of the zinc dips into a cup containing mercury, which gradually rises on the surface of the zinc and prevents local action. Owing to this simple precaution, the zincs are capable of remaining permanently in the acidulated water, thus permitting practically of having light at any moment whatever. The keeping of this system in order is therefore reduced to the renewal of the acidulated water every week or fortnight, according to the service required of the battery, and to the renewal of the depolariser every 4 or 5 weeks.

In order to render this system still more convenient and practical, Radiguet has devised some new apparatus, which do away with the replacing of the zinc electrodes and the dismounting

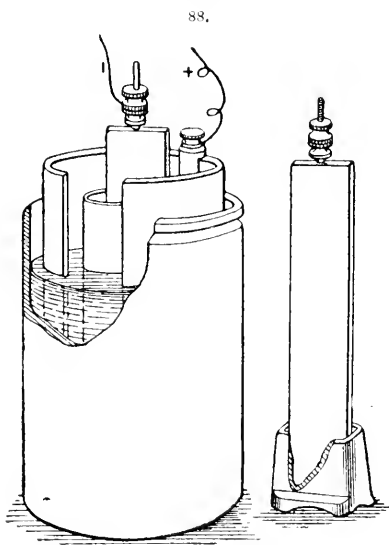

Radiguet's 2-liquid battery.

porous one, have the great advantage of much diminishing local action, and consequently the wear of the zinc. The internal resistance of the pile is increased by reason of the presence of the porous vessel, and so this kind of battery permits of lighting but one lamp at once per battery.

One of the best known models is the 8 element battery of Radiguet (Fig. 88). In this battery it is necessary to change the acidulated water of the porous vessel several times before the bichromate solution is exhausted: but if particular precaution be taken in amalgamation of the zinc, it will be possible to leave the latter continually immersed in the acidulated water without any

of the batteries, by adapting a special negative electrode and using a siphon, which is primed and unprimed by blowing, for the changing of the liquids. The ordinary siphons are primed by suction. This method, which is dangerous in the handling of acid liquids, has prevented its application to the manœuvring of batteries of large discharge. The Radiguet siphon (Figs. 89, 90), permits of blowing with the mouth (without any fear of the liquids rising to the lips), or of employing blowing apparatus, such as rubber bulbs, &c., which, never being in contact with the corrosive liquids, last indefinitely. Fig. 89 represents a section of this siphon dipping into a vessel from which it is desired to re-

move the liquid. It consists essentially of two concentric tubes. One branch of the siphon is enclosed in a tube B of larger diameter, having at its lower part an orifice, smaller than the section of the tube A. At its upper part, it is provided with an ajutage D, connected with the bulb F, through a flexible tube E. When B is immersed in any liquid,

It is easy to see that the apparatus may serve for the complete or partial emptying of a vessel of any depth by causing the length of the tube and branch A to vary. If, when the siphon is in operation, it is desired to stop it, it suffices to blow in a volume of air greater than the capacity of the large tube B. This air, forced through the tube A,

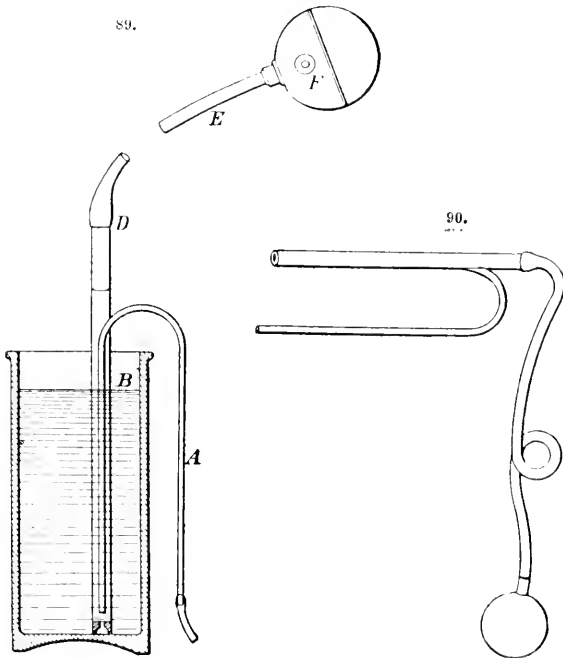

Radiguet's siphon.

the level in the tubes B and A is the same as in the vessel. Things being in this state, if the tube B be blown into, the pressure abruptly increases, and the liquid tends to escape through two apertures—the lower orifice of B and the branch A of the siphon, into which it is forced until the flow through A (that is, the priming) takes place.

drives out the liquid and unprimes the siphon. It will be seen, then, that through the same manœuvre it is possible at any moment to effect a flow or stoppage of a liquid, as conveniently as by the use of a cock, without having to touch the liquid, and whatever be the form and location of the vessel containing it. By means of this apparatus,

it is possible, without disturbing a battery of piles or accumulators, to empty any element and wash it as carefully as may be desired.

But the most original part of this new style of bichromate battery is undoubtedly the amalgamating support, for, as its name indicates, it permits not only of keeping up the amalgamation of the zincs, but also of using (instead of plates and cylinders of zinc of determinate size) shavings, scrap of all shapes, or spheres prepared especially for this purpose.

This electrode is formed as follows (Fig. 91). Into a cup of porcelain, or of

contains apertures that permit of the free circulation of the liquid. Its diameter is greater than that of the cup, so that the sulphate of zinc may not fall upon the surface of the mercury and finally put an end to the amalgamation.

In Fig. 92 the mercury cup is connected with the central rod through two strips of copper containing apertures into which passes a pin that likewise traverses the porcelain cup. In this way, all the parts of the electrodes are mechanically connected with each other and electrically with the mercury.

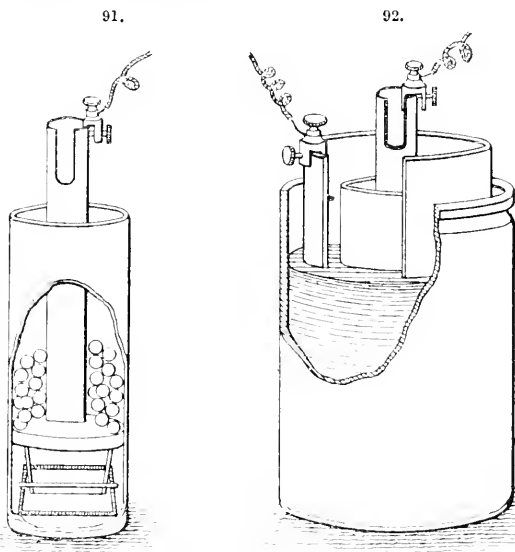

Radiguet's amalgamating supports.

any other substance not attacked by acid, there is put some mercury containing traces of zinc. Above this cup is placed a copper receptacle fixed to a hollow rod of the same metal. This is designed to receive fragments of zinc of variable form and size. The central rod constitutes the negative electrode, and

If acidulated water be introduced into a porous vessel containing an electrode of this kind, the following phenomenon will occur: The mercury will rise upon the copper and zinc, and rapidly cover them with a layer of mercury, which will soon protect them from the action of the acidulated water. If the circuit

of the battery be closed, and it be made to discharge a current of normal intensity, the amalgamation will proceed during the operation. If the battery be made to discharge a very intense current, the mercury will soon disappear from the surface of the zinc; when the battery ceases to discharge, the mercury will ascend the surface of the electrode again and protect it against the action of the acid.

From the following experiment, due to Prof. Daniel, it is possible to give an explanation of these phenomena, which have hitherto been attributed to capillary phenomena not well understood.

If, in a tube containing acidulated water, we place a drop of mercury, and through the tube pass a current of a certain intensity, the mercury will move along the tube in the direction of the current. There is a carriage of the mercury under the mechanical action produced by the current, and the velocity of the mercury's motion is so much the greater in proportion as the current is intenser.

Analogous phenomena must take place in Radignet's battery. In consequence of the attack on the zinc, and of the currents produced within the battery, a transfer of the mercury takes place. But, as the pellicle of mercury that has formed protects from chemical action the metal upon which it has deposited, the reactions can continue to occur only in the parts not yet amalgamated; consequently, the mechanical effects of the internal currents of the battery cause the mercury to rise progressively to the surface of the liquid, that is to say, until the negative electrode is completely protected by the mercury from the attack of the acidulated water.

Upon the whole, in this element, the internal currents, when any are produced, are utilised in the amalgamation of the zincs attacked, and that, too, the more quickly in proportion as the reaction is more energetic. Despite those important improvements, direct lighting by batteries with two liquids is not yet perfect. As it is possible to supply but

one incandescent lamp per battery, the applications are necessarily limited to small spaces. Nevertheless, the improvements pointed out are interesting, for it is not very probable that, in the future, mechanical energy will be capable of being utilised for the lighting of a single lamp, and this application, modest as it is, justifies the use of direct lighting by batteries. Moreover, the combined use of the amalgamating support and of the siphon primer by blowing allows of the batteries being left mounted for a relatively long time, without appreciable wear in open circuit. The maintenance is very easy, since it suffices to throw zinc scrap into the vessel from time to time, in measure as it is consumed, just as we throw coal into a stove, care only being taken to stir the upper fragments and to brush them, now and then, with a hair pencil (like the pencils used by artists) in order to clean the surfaces of contact. (*Sci. Am. Sup.*)

Renard.—Renard batteries belong to the chromic depolarising class, in which free chromic acid and hydrochloric acid, more or less diluted or mixed with sulphuric acid, are used. Each element consists of a cylindrical ebonite tube, a platinised silver electrode 1mm. thick, rolled into the form of a tube, and a non-amalgamated zinc cylinder of a diameter about $\frac{1}{3}$ that of the vessel. The complete substitution of hydrochloric for sulphuric acid has permitted of quintupling the specific power of the element. On making but a partial substitution of hydrochloric for sulphuric acid, we obtain attenuated liquids that give the same quantity of total electric energy, but with a specific discharge so much the smaller in proportion as the attenuation is higher.

The liquid may be prepared with pure or crystallised or with commercial chromic acid. As the non-attenuated liquid is unstable and disengages chlorine, even at the ordinary temperature, it is prudent not to make the mixture until two days before it is to be used. Mixtures attenuated to 80 per cent. are more stable, and can be prepared 2-3

months previous to use. All the liquids are prepared by mixing three elementary liquids in variable proportions. Liquid A is a solution of chromic acid containing, per litre, 530 c.c. chromic acid and 770 c.c. soft water. Liquid BCl is a solution of commercial hydrochloric acid made to indicate 18° B. Liquid BS is an aqueous solution of commercial sulphuric acid marking 29° B (density 1.2515). It is obtained by mixing 450 grm. of sulphuric acid of 66° B. with 800 c.c. water. The mixture of the two latter liquors forms an intermediate liquid called sulpho-hydrochloric, which is so much the richer in BCl liquid in proportion as one desires to obtain a greater specific power. The letter B, followed by an index, designates a mixture of the two last liquids containing 1 per cent. in volume of sulphuric solution shown by the index. Thus, for example the liquid B 80 contains 80 volumes of liquid BS and 20 of liquid BCl. The figure 80 bears the name of degree of attenuation. The liquid used in the battery consists of equal volumes of the liquid A and a mixture of the two others.

Whatever be the degree of attenuation, the electric energy obtained per litre of liquid is sensibly the same. It varies between 50 and 60 watts-hour per litre. The duration of the discharge is more or less prolonged, according to the degree of attenuation. This attenuation may be obtained with other products, sulphate of soda, for example; but the specific energy is thus reduced. On arresting the discharge at the moment in which the intensity of the current falls to one-half of the maximum is obtained from 180,000 to 196,000 joules per litre of liquid, and 144,000 to 158,000 joules per kilo. On endeavouring to increase the total electric energy, Renard has devised a liquid that gives as many as 253,000 joules per litre, which would reduce the necessary volume of liquid to 14.5 litres per kilowatt-hour. But as this liquid contains 100 grm. CrO_3 and 200 c.c. per litre, it has the drawback of being very dear and slightly viscid, and

of making the zincs sticky. Practically, the best liquid is that which contains 200 c.c. HCl and 60 c.c. CrO_3 .

The battery generally has the form of a cylinder of a length 10 times its diameter. This form has the advantage of facilitating the cooling of the liquid, of diminishing the internal resistance, and of rendering the upsetting of the liquid more difficult. In the light batteries the reservoirs are of ebonite; in the stationary ones they are of glass or porcelain.

In the pneumatic battery, designed for lighting (Fig. 93), the elementary vessels A are sealed to the cover of a large, tight vessel H, and the lower part contains an orifice O of small diameter. Upon forcing air into the large vessel or collector by means of a rubber bulb *d*, or of a pump, the liquid is made to rise in all the elements at once. A cock permits of regulating the immersion of the elements, and consequently, the internal resistance of the current. This arrangement is adapted to attenuated liquids only; with the normal liquid, the cooling would not proceed quickly enough. The vessel L and the bulb *d* serve to fill and empty the battery. The positive electrode of the light batteries (Fig. 94) is formed of a tube of platinised silver 1mm. thick. The weight of the platinum on the two surfaces is about $\frac{1}{10}$ that of the silver, and its thickness is about $\frac{1}{1000}$ mm. The use of platinised silver greatly reduces the weight, the volume, and the internal resistance of the elements. On account of the high price of these electrodes, carbon is substituted for them in the batteries in which attenuated liquids are employed and in which lightness does not play an essential rôle. In order to facilitate the free circulation of the liquid, and to exhaust all the supply contained in the cylindrical vessel, the tube is split throughout its entire length to a width of a few mm.

The negative electrode consists of a cylinder of zinc or non-amalgamated zinc wire, whose diameter is about $\frac{3}{1000}$ that of the vessel, and is calculated to serve but once. This is guided

and held in the centre of the platinised silver tube by several discs of ebonite. Experience has demonstrated that in chlorochromic liquids, ordinary zinc is not so readily attacked as amalgamated zinc, as soon as the proportion of

battery by no means presents the characters of a perfect one. The variations in the temperature of the liquid, its alteration, and the diminution in diameter of the zinc during the discharge act so as to modify the constants of the

93.

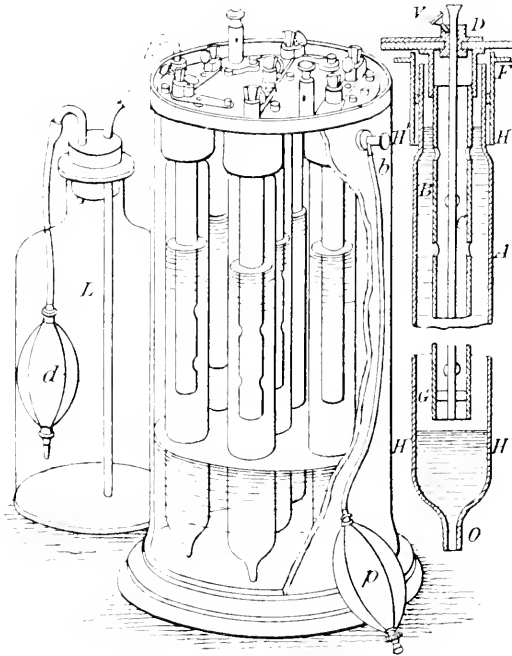

Pneumatic battery for electric lighting.

A, elementary vessel; B, carbon; C, zinc; D, fastening of the zinc; V, binding screw; *b*, cock; H, level of the liquid in the large vessel; H' level of the liquid in the elements.

chromic acid exceeds 180 grm. per c.c. of solution A. The amalgamation is costly, and renders the zinc brittle, and its suppression permits of the use of lead in the pneumatic batteries. This could not be done with amalgamated zinc, for the drops of mercury, flowing accidentally over the lead, would soon perforate the envelope.

The discharge of a chlorochromic

elements at every instant. On another hand, the liquid of the battery exerts an important local chemical action entirely independent of the electric action, and in such proportions that it is necessary to always remove the zincs from the liquid when the battery is not in service.

If it is desired to exhaust the battery in a very short time, the local action,

which is proportional to the time, will have a very slight influence, but the electrical rendering will be feeble, as the difference of potential at the terminals is low when the battery is giving a large discharge upon a circuit with

potential is 1.20 to 1.25 volt per element, whatever be the temperature and the degree of attenuation of the liquids. This normal potential corresponds to a normal current which characterises the element. This normal current is itself

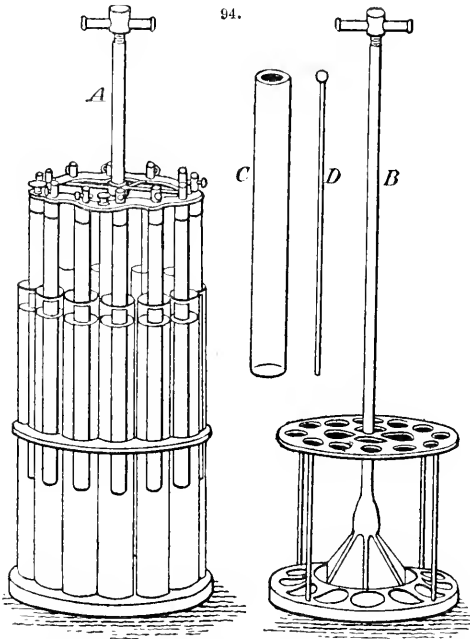

Light chlorochromic battery.

A, collection of 12 elements, weighing 10 kilogrammes and having a power of 220 watts;
B, mounting of the battery; C, platinised plate of silver rolled into a tube; D, zinc.

hardly any resistance. If, on the contrary, the discharge is small, the electric rendering will be excellent, but the local action will then become preponderant, and will diminish the total rendering. It will be understood that between these two extremes there is a certain discharge which corresponds to the maximum rendering. Experience has demonstrated that such rendering is maximum when the difference of

a function of the temperature. Thus, for a variation of 20° C., the intensity passes from 1 to 1.6 for the non-attenuated liquid, and from 1 to 1.4 for the liquid attenuated to 80 per cent. So it is expedient to modify the degree of attenuation of a liquid with the temperature of the season. A liquid attenuated to 80 per cent., which is excellent during the summer, should be replaced by a 50 per cent. liquid for

winter, when the battery is to be used for electric lighting.

In the discharge of a battery of 24 elements in tension, containing in all 6.3 litres of liquid attenuated to 80 per cent. and discharged upon three Swan lamps of 27 volts, and of 1.25 to 1.30 ampère, mounted in derivation, the power, after a very marked syncope, at first increases regularly for an hour and a half, and afterwards slowly decreases. At the end of $2\frac{1}{2}$ hours the electric power disposable is insufficient to supply the three lamps. It afterwards falls very rapidly.

Taking, for a basis, the duration of $2\frac{1}{2}$ hours, the total electric energy produced represents 547 watts-hour—say, 35 watts-hour per litre. We can depend in practice upon 50 watts-hours per litre—say, 20 litres per kilowatt-hour. Upon constructing the different parts of the battery with care, it is possible to produce apparatus that weigh but 86 lb. per electric horse hour—say 88 lb. per kilowatt-hour, zincs included. By forcing the proportion of chromic acid, it has even been possible to obtain one horse hour for 55 lb.—say one kilowatt-hour for 70 lb. With this rich liquid, a group of 12 elements, mounted by twos in tension and by sixes in derivation, weighed 22 lb. along with the frame. Each of these groups was capable of discharging 22 kilogrammètres (220 watts) per second at the end of 30 minutes' operation—say 22 watts per kilogrammetre. Taking into account the performance of the motor, it requires four such groups, weighing 88 lb. altogether, to produce an effective power of one horse (736 watts) disposable upon the shaft. By reducing the dimensions of the elements, Renard has succeeded in constructing a battery of 36 elements, 20 mm. diameter, weighing 11 lb., and yielding as much as 1.5 horse for 20–25 minutes, say 22 lb. per electric horse, and 55–66 lb. per horse hour.

These figures establish the fact that chromochloric batteries are the highest generators of electric energy now known. Despite the high price of the

products used in them, they are capable of finding an application in all cases where lightness constitutes the main desideratum.

Selby's.—In seeking for a form of cell by which the expense and internal resistance of porous pots could be avoided, I arrived at a stoneware jar containing the usual bichromate solution plus sulphuric acid, a piece of thin platinum wire clothed with pure black rubber, and a $\frac{1}{8}$ -in. tube cemented to the wire at 1 in. from the bottom. The square inch of wire was then made into a flat spiral capable of picking up a small quantity of mercury (Fig. 95), the rubber tube being simply for insulation, so that the platinum should not affect the result. On plunging this into the jar of solution, a good current was produced for a short time; when withdrawn for examination, it was found that *part* of the mercury still adhered to the platinum wire, although action had ceased; a fresh dip of mercury restored the effect. On investigation I found that the mercury had been used with zinc, and was in fact an *amalgam*. The absence of zinc meant absence of effect. On this result a simple and effective cell was formed (Fig. 96). A small jar (2 oz. Liebig's extract of meat jar) was divided off by a *glass partition* cemented in with bicycle tire cement (more expensive than Chatterton's, but much stronger for grooveless partitions, jointing parchment paper cells for Leclanchés, rubber, gutta-percha, shellac, and bitumen) reaching *nearly* to the bottom of jar; mercury is then poured in (dotted in Fig. 96) to form a "sealed joint" to separate the fluids; carbon on the one side of the partition (but *suspended* so as not to touch the surface of the mercury) in bichromate potash sulphuric acid solution, and on the other side zinc standing in the mercury in *plain water* to assist in counterbalancing the bichromate fluid on the other side, so as to require less mercury to make a safe joint. Of course the jar is represented wider than is really the case, so as to prevent confusion in the sketch. I was led

to this form by many circumstances, among others by the peculiar way in which a zinc in bichromate battery

battery jar. Mercury is then poured in to form a "water joint," a paraffin lamp chimney with a "crinkled" top

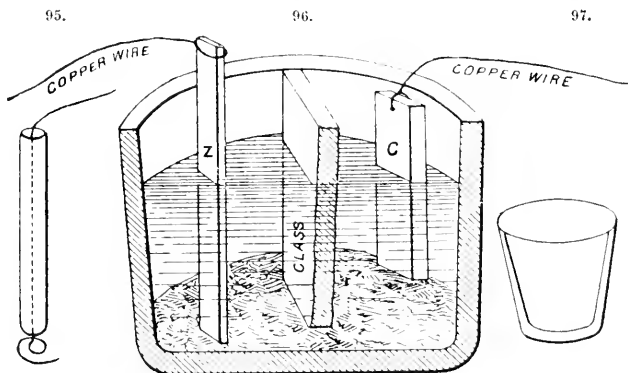

Selby's battery.

was "undermined" where it was outwardly protected by a cement which resisted the action of the dilute acid solution in the porous pot.

For cheapness and handiness, glass tumblers or drinking glasses with what are known as *well bottoms* (Fig. 97) would make up very handy cells for experimental purposes.

Further experiments led to a "thistle tube" of glass arrangement, the tube (Fig. 98) being bent in a gas flame as shown, mercury placed therein, and copper wire being passed down the stem into the mercury. This is simply placed in a jar of solution containing the carbon, but the mercury must receive occasional replenishments of small pieces of sheet zinc, which readily dissolve in it. The thistle tube is convenient for lifting in and out, and it can be lashed to a spring clothes peg clipped on the top of the jar.

But for permanent use a small shallow pot of earthenware (such as Needham's metal polish is sold in—Fig. 99) has a round zinc rod cemented in firmly, so as to form a means of lifting in a complete state out of the outer

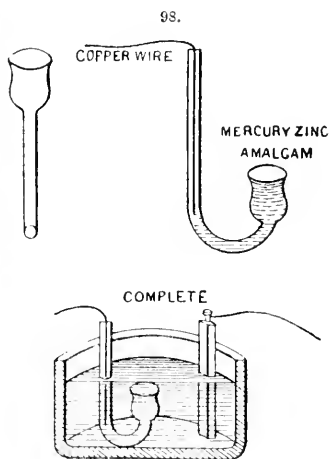

Selby's battery.

(Fig. 99) is then inverted and passed down the zinc rod into the mercury, and filled with *pure water* to counterbalance the pressure of the surrounding

fluid (bichr. potass + ac. sulph., usual solution), in which stands the carbon.

This water remains purely free from any acidity for months, and by careful tests I find that the addition of sulphuric acid simply weakens the battery

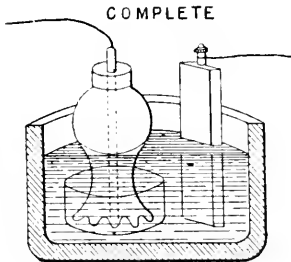
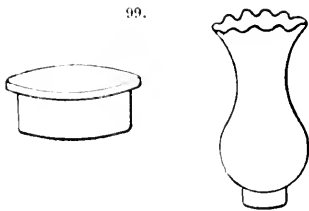

Selby's battery.

by setting up a "counter" current. In the "porous pot form" the acid seems quite necessary to lower the resistance of the fluid, but here it is different. Of course a preferable form to avoid risk of cement giving way would be to make the glass and the dish in one (in glass), with piercings to ensure the continuity of the body of mercury in contact with the zinc and the bichrom. ac. fluid.

The thistle tube arrangement I do not like, owing to having to supply the zinc, and the surface of mercury is too small, but the other arrangements I have tested for six months successfully. (*Elec. Review*).

Selenium.—Fritts and Hopkinson have devised a new process for manu-

facturing very sensitive selenium elements in which the entire mass is influenced by light. This result is obtained by a preparation of the selenium itself, and the construction of elements whose sides are made of a material that conducts both electricity and light well. Several thin sheets of reheated selenium are enclosed between these sides, and it results therefrom that the current traverses the selenium in the direction of the light that strikes it; and it appears that, owing to this arrangement, the changes in resistance caused by the light (or, in other words, the property that selenium possesses of regulating light) become much developed.

The selenium is selected in as pure a state as possible, and is formed into sheets that are placed between blocks of a material to which it does not adhere. The selenium is softened by heat, so as to render it as thin as is judged necessary, and the sheets are afterward cooled under pressure. Two thin sheets of mica are introduced between the selenium and the blocks, so as to facilitate the separation of the sheets of selenium and the blocks forming the mould. When it is desired to have sheets very sensitive to the light, it is necessary to make them so thin that they appear, before reheating, of a blood-red colour when they are looked at against the light.

Fig. 100 shows the press employed for softening the selenium plates by this process. It consists of a heating box *a*, with a door *a'*, and a strong shelf *b*, provided with a groove in which slides the piece *b'*. A screw *c* serves to exert pressure, and *c'* represents a support which passes along the sides of the box and over the shelf *b*. A gas flame *d* furnishes the heat, and a thermometer *d'* shows the temperature. The apparatus is completed by a certain quantity of scrap iron, which equalises the temperature under the pressure plates *b²*, *b³*. These latter are placed upon a movable piece *b'*, and their position is so regulated as to make their centres coincide with the axis of the screw *c*,

which then exerts an equal pressure. By this process the selenium is softened and converted into sheets of the desired thickness. In order to make elements of these sheets, one of them is fixed (Fig. 101) in the centre of a rubber

wires are stretched between the metallic supports $f f'$. Moreover, movable shutters are sometimes placed upon the glass sides of the element, so that the light that strikes them may be regulated.

100.

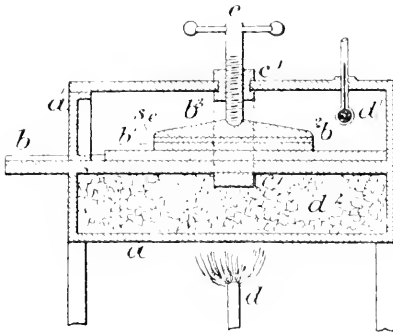

Selenium element.

101.

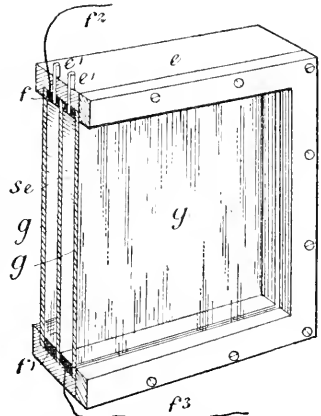

Selenium element.

frame c , provided on each side with metallic supports $f f'$, and the sheet is insulated from the latter by bands of a proper material. On each side is a glass cover $g g'$, fixed to the rubber frame e by cement. The supports f are connected with the wires $f_2 f_3$ and communicate thereby with the pile or the circuit of the electric current. The two sides of the sheet of selenium dip into a transparent conducting liquid, which is poured into the elements by means of tubes $e e'$, that likewise serve for the exit of the gases formed through the electrolysis of the liquid. The light traverses the liquid and falls upon the selenium plate of the element, and the current reaches the plate by the same route. Sometimes wires placed at equal distances are made to pass through the liquid, in order to secure an equal distribution of the current in the liquid electrode. These

Instead of a liquid conductor, sheet platinum, gold, or silver is sometimes used as the electrode of the selenium, but this must be thin enough to allow the light to pass through it. Goldleaf answers very well, and, when used, is first wetted with alcohol, and the selenium is then placed over it, and afterward reversed so that the gold shall be on top. The goldleaf is then spread smoothly by blowing over its surface. After the gold has been connected with the circuit, it is covered with glass or a transparent varnish, in order to fix it in place and protect it against accident.

Fig. 102 represents a dry element of this kind that has given very good results. sc represents the selenium between a metallic plate h and a piece of goldleaf i , to which a wire j of the circuit is attached. The current in this case passes from the entire surface of the goldleaf to the lower plate, and

traverses all parts of the sheet of selenium. This latter is entirely exposed to the action of the light that

102.



Selenium element.

traverses the goldleaf. (*La Lumière Electrique*.)

Skriwanof.—This is simply a chloride of silver cell, with caustic potash instead of chloride of zinc. Two of the cells, contained in ebonite cases buckled to the belt of the performer, keep a star light going, and the light is readily controlled by the wearer. Each cell consists of a zinc plate bent into the form of a U, and holding in its inside a plate of silver coated with chloride of silver. The zinc plate forms one pole of the cell and the silver the other. A solution of caustic potash—75 parts potash to 100 water—is poured in, and as a porous diaphragm, the chloride of silver is covered with parchment paper. The vessel is of ebonite, with closed mouth, which, however, is opened when fresh liquid has to be put into the cell. This is necessary after every hour's run, and the chloride of silver has to be replaced after 3–4 hours' use. The cell is thus expensive; but this is of minor importance in theatrical work as compared with its small size and weight— $3\frac{1}{2}$ oz.

Sloane's.—This battery, Fig. 103, is a very efficient and simple form for open or closed circuit work. It represents a favourite and recent type for such cells, and can be put together with the minimum number of tools and appliances. The cover is made of wood. If a circular vessel is used, the cover should be cut in a circle equal in diameter to the outside of the jar, and a

shoulder should be formed to hold it in place and prevent lateral motion. Any number of holes, according to the size, are bored through it, one set for the reception of the carbons and the others for the zincs. Care should be taken to bore these holes truly vertical to the plane of the cover, and the bit used should make a hole of exactly the right size to fit the carbon and zinc respectively. The fit must be a very tight one, so that the rods have to be driven into their places with a mallet or hammer.

For the positive elements, zinc rods, such as sold for the Leclanché battery, are used. Such rods can be bought 6–8 ft. long and of uniform diameter. Pieces are cut off of the proper length, a cold chisel, hack saw, or file being used. A very easy way of dividing the rod is with mercury. A fine groove is filed around it. A globule of mercury is placed in a saucer with a little dilute sulphuric acid. A thin slip of zinc, or a strip of galvanised iron, is dipped in the mercury. Some adheres to it. This is then drawn around the cut, so as to fill it with mercury and amalgam. Then the rod is broken off, either in the hand or in a vice. It becomes almost as brittle as a pipe stem. This process is hardly to be recommended for the upper ends of the zincs. These have to be soldered, and the mercury interferes with the operation to some extent.

For negative elements, electric light carbons are used. The copper is dissolved off by nitric acid, they are washed, dried, cut to the proper length by a saw or cold chisel, and their upper ends are soaked in hot paraffin.

Both elements are now driven into their respective places. With each carbon a slip of copper $\frac{1}{4}$ in. wide is also introduced, and lies alongside, pressed hard against it and projecting about as much below the cover. As shown, a wire is carried around the outer circle of the carbons, and is soldered to the copper strips. If a central carbon has been used, a special connection is soldered to it and to the main wire.

The end of the wire is carried up through a hole in the cover. A second wire is soldered to the zincs, this piece lying on the upper surface of the cover. Concentrated hydrochloric acid is the best flux for the zincs. If desired, the

sulphuric acid. After a few minutes' immersion, the zinc will be ready to amalgamate, and the rods will shine like silver after a few minutes' rubbing with the galvanised iron and mercury. The soldering may of course be dis-

103.

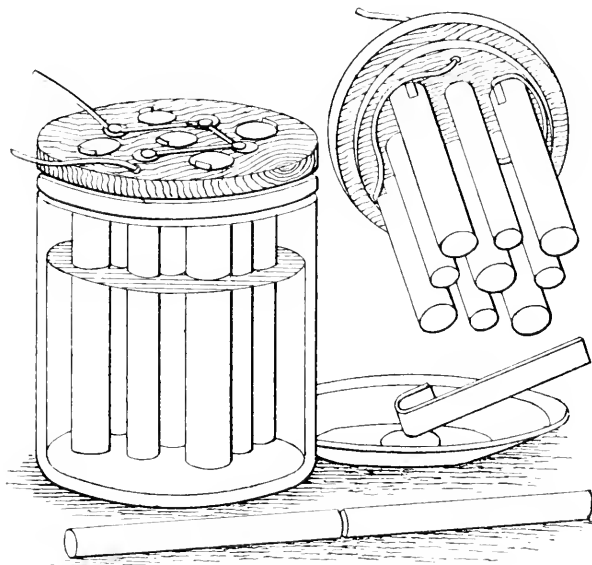

Single fluid battery.

projecting end of the zinc connection may be secured to the wood by a staple. This is not necessary if the soldering is solid.

To amalgamate the zincs, a strip of galvanised iron is far the best instrument. The end of such a piece, which may be 2 in. by $\frac{1}{2}$ in., is bent into a hook, so as to fit the zinc rods. This is dipped into the globule of mercury as it lies under a little dilute acid, and is rubbed up and down the rods. If the mercury does not take hold at once, the zincs and carbons may be dipped nearly to the level of the cover in dilute

pensed with. Instead of strips of copper, the ends of some pieces of wire may be flattened and driven into the holes along with the carbons and zincs. By twisting together the ends of these, zinc connections and copper connections separately, the battery will work perfectly if care is taken to avoid short-circuiting. When it is made in a hurry, for temporary use only, the paraffining of the carbons may be dispensed with, and the copper may be left upon their upper ends. The wires may be soldered directly to this, although such connection is rather weak,

For bichromate solution, $2\frac{1}{2}$ oz. bichromate of potash in fine powder are shaken up in 10 fl. oz. water. To this $2\frac{1}{4}$ fl. oz. sulphuric acid are added slowly with constant stirring. Great care should be taken in pulverising the bichromate of potash, as it causes ulcers if inhaled. For open circuit work, a solution of sal ammoniac may be used. The ends of burned-out carbons, such as are thrown away by the lamp attendants, answer perfectly for the smaller sizes of this battery.

Water.—Strips of zinc and copper, each 2 in. wide, are soldered together along their edges so as to make a combined strip of a little less than 4 in. wide, allowing for the overlapping. It is then cut by shears into pieces about $\frac{1}{4}$ in. wide, each composed of half zinc and half copper. A plate of glass, very thick and 1 ft. or less square, is heated and coated with shellac about $\frac{1}{8}$ in. thick. The strips of copper and zinc are bent into the shape of the letter U, with the branches about $\frac{1}{4}$ in. apart, and are heated and stuck to the shellac in rows, the soldered portion being fixed in the shellac, and the two branches standing up in the air, so that the zinc of one piece comes within $\frac{1}{16}$ in. of the copper of the next one. A row of 10 in. long will thus contain about 30 elements. The rows can be about $\frac{1}{5}$ in. apart, and therefore in a space 10 in. square nearly 800 elements can be placed. The plate is then warmed carefully so as not to crack, and a mixture of beeswax and rosin, which melts more easily than shellac, is then poured on the plate to a depth of $\frac{1}{2}$ in., to hold the elements in place. A frame of wood is made around the back of the plate with a ring screwed to the centre, so that the whole can be hung up with the zinc and copper elements below. When required for use, lower so as to dip the tips of the elements into a pan of water, and hang up again. The space between the elements being $\frac{1}{16}$ in. will hold a drop of water which will not evaporate for possibly an hour. Thus the battery is in operation in a minute, and is perfectly insulated by the glass and

cement. This is the form I have used; but the strips might better be soldered face to face along one edge, cut up, and then opened. (Prof. Rowland.)

Weymersch.—The standard size consists of a rectangular trough of ebonite or wood, $9\frac{1}{2}$ in. by 11 in. by $13\frac{3}{4}$ in., divided into 6 cells by means of ebonite partitions. In each cell is firmly fixed a porous pot having a capacity of about 1 qt., and fitted with a short ebonite pipe; all these pipes are secured to an ebonite pipe running the full length of the battery, and fitted with an ebonite tap and a gauge-glass or level. It will be seen that by this means all the porous pots are connected together, and can be quickly and easily emptied, when the solution is exhausted, by merely opening the tap. In a like manner all the outside cells are connected together and fitted with a tap. The general arrangement has been made with a view to reducing the time required for charging or emptying to a minimum, and permits of the battery being charged or emptied in a few minutes without the usual disagreeable labour attending these operations.

Two stoneware barrels, each having a capacity of 6 gal., are placed on a shelf above the battery level and fitted with stoneware taps, to which are attached lengths of rubber tubing. One of the barrels is filled with the exciting liquid, 1 of sulphuric acid to 18 of water, the other with the new depolariser. When it is required to charge the battery, the tubes are fixed on to the ebonite battery taps, and the solutions allowed to flow until they rise to the marked point on the levels; the battery is then ready for immediate work. When the solutions are spent, the battery taps are opened and the solutions allowed to flow away.

The elements are zinc and carbon; each cell contains two sheets of zinc placed in the outside cell, one on each side of the porous pot. The carbon plate is placed inside the porous pot with the depolariser. The carbon heads are well coppered and securely fixed in tinned brass clamps, into which solder

is run, thereby making a perfect and lasting contact, and doing away with the constant trouble usually given by carbon contacts. The zincs are specially amalgamated, and if the current is not allowed to exceed the maximum for which the battery is designed, they do not require reamalgamating.

The charge of depolarising liquid for the 6-cell battery of the dimensions given is 11 pints; the voltage in open circuit 13 volts, and the working current for the best results 15 ampères; this current is maintained for 7 hours per charge. During this time the current is very nearly constant, rising for the first 2-3 hours, then remaining constant for about 3 hours, and finally dropping slowly to the starting-point; these variations are very small. The total energy given out per charge is about 1300 watt hours, of which 750-

Two of the above batteries will run ten 8 c.p. incandescent lamps, or sixteen 5 c.p. lamps for 7 hours, and if, as indicated above, the number of lamps is reduced, a further run of 3-4 hours can be obtained. It is specially suited for small installations, motive power for boats, lathes, dental machinery, &c.

Bells. *To ring while door is being opened.*—(a) Fig. 104. A is a spring of hard brass about $\frac{1}{16}$ in. thick and 1 in. wide, fixed on to architrave moulding of door frame; B is a similar spring fixed on to door; the connections are shown, C being short helix where the door hinges, to prevent the wire breaking; D, bell; E, battery; F, switch to cut off when not wanted.

(b) Fig. 105. A is a piece of wood or metal screwed on to door. D is made of wooden bar let into the door frame at top right-hand corner, supports a

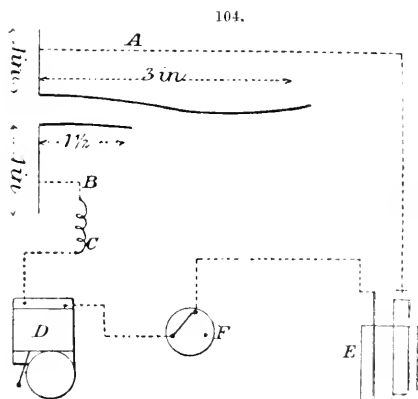

Bell to ring by opening door.

800 watt hours are expended in the external circuit, or say, 230 watt hours per quart of solution. If, after the 7 hours' work, the current is reduced, by reducing the number of lamps in circuit to about 10 ampères, a further run of 3-4 hours can be obtained, giving a total energy per quart of depolariser of 300 watt hours.

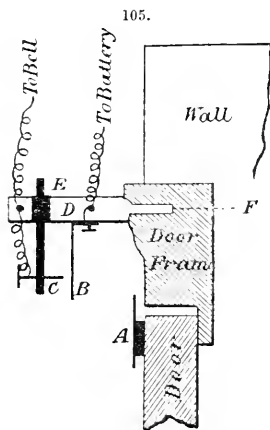

wooden rod E which carries the brass screw C. B is a piece of watch or small clock spring bent, and then hardened at a right angle; a hole is drilled (or punched) while soft, and the spring, well brightened, is screwed on to the block as shown. When the door is opened, A presses the spring B against the screw C, and when returning to its

place A presses B away from C. Thus the bell will only ring when door is being opened. The block may be 6 in. long, and A may be made of steel spring, which gives longer contact.

Carbons.—Max Nitsche-Niesky recommends the following: Good coke is ground and mixed with coal-tar to a stiff dough, and pressed into moulds made of iron and brass. After drying for a few days in a closed place, it is heated in a furnace where it is protected from the direct flames, and burned, feebly at first, then strongly, the fire being gradually raised to white heat which is maintained for 6–8 hours. The fire is then permitted to slowly go down; when perfectly cold, the carbon is taken out of the furnace. (*Neu. Erfind.*)

The best way is to buy them ready cut from retort scurf; but the following may be useful:—The size of the carbon is the first thing to determine. First satisfy yourself as to the size you wish to make it, and when made let it remain so. Take, for instance, a carbon for use in an ordinary 5 by 7 Fuller or Bunsen battery. Make it, say, 2 by $8\frac{1}{2}$ in. Procure two pieces of sheet iron or brass, preferably brass, but the former will answer, 3 by 10 in., not less than $\frac{1}{4}$ in. thick and perfectly flat. Then make, or have made, from a rod of metal $\frac{1}{2}$ in. square and about 22 in. long, a rectangular frame of three sides, whose internal dimensions will be 2 by 10 by $\frac{1}{2}$ in. or thereabouts. These three pieces constitute the mould, and in order to complete it, it only remains to place the U-shaped frame between the two plates, fastening the whole firmly together by means of screw clamps, and you will have an oblong box, open at one end. See that the parts fit as closely as possible. Next pulverise in an iron mortar a quantity of gas-retort carbon or common coke, taking care to have a little more than is sufficient to fill the mould. The finer the coke powder the better. Place it in a glass or earthenware dish, and pour upon it a small quantity of syrup or dissolved sugar. Mix and knead the mass tho-

roughly with the fingers, adding by degrees a little of the syrup until it becomes sufficiently moist to bind well when pressed together. Set the mould on end, drop in enough of the mixture to fill it about $\frac{1}{3}$, and stamp it down lightly with a $\frac{1}{4}$ in. rod. Continue the operation until the mould is full, then get a piece of wood or metal nearly large enough to fit the mould for use as a rammer. Place one end in the opening, and strike it smartly with a mallet. The mass will be driven down about 2 in. and tightly compressed. With a little water mix up some plaster of paris to the consistency of dough, and press it into the opening, having previously removed the rammer. Force it down, and continue adding the plaster till the end is thoroughly closed. The contents of the mould are now ready for the "carbonising" process. Make a good coal fire, place the mould upon it and expose to a red heat for an hour or more. Allow it to remain until the fire has gone out. When cold enough to admit of being handled by the fingers, remove it, and if the experiment has been properly conducted, you will find the carbon complete. It is true that a carbon made in this way is not so dense as the commercial article; but for ordinary battery purposes it will be found equal to any, and all that can possibly be desired. (*Eng. Mech.*)

Jacquelin describes three methods of purifying carbon. 1. Treatment with dry chlorine at a high temperature. In this way silica, alumina, magnesia, alkalies, and metallic oxides are removed as volatile chlorides, and the combined hydrogen forms hydrochloric acid. The carbon should be cut into sticks before submitting to this process. The vacuities left in the carbon after treatment with chlorine may be filled up, and the mass made compact, by heating in a closed vessel with some hydrocarbon such as heavy coal oil. In the course of a few hours a sufficient deposit of carbon will have taken place. 2. The carbon may be treated in an iron vessel with fused caustic soda. In this way aluminates and silicates are

formed, and may be removed by washing. Dilute hydrochloric acid is next applied to dissolve oxide of iron and earthy bases, and the carbon is finally washed with distilled water. 3. By immersion for 24 hours in hydrofluoric acid diluted with twice its weight of water, carbon may be efficiently purified. The danger accompanying the use of hydrofluoric acid is an objection to this method. These three processes are applicable to gas-retort carbon or to Russian graphite. The author has also prepared pure graphitoid carbon from heavy hydrocarbons. It is of excellent quality, but he is unable to state its relative cost. He notes that natural graphite from Siberia gives twice as bright a light when purified as when used in its natural state.

Commutators.—(a) Fig. 106 represents a small, practical apparatus by

ordinary electric bell. The mechanism comprises an 8-toothed ratchet wheel carrying 4 pins. The button itself carries a pin that extends to the teeth of the ratchet wheel. Every time the button is pressed, the ratchet wheel advances one tooth, from left to right, and makes $\frac{1}{8}$ revolution. Under the button is a spiral spring that has the effect of pushing it out as soon as the pressure is removed—the ratchet wheel keeping the position that it has obtained. The 4 pins, through the revolution of the ratchet wheel, press in succession against a horizontal strip of brass, forming a spring that alternately opens and closes the circuit, according as one of the pins is or is not opposite the slightly curved part of the strip. Fig. 106 represents the button in the open circuit position. To prevent the ratchet wheel from moving backward, a second flat

106.

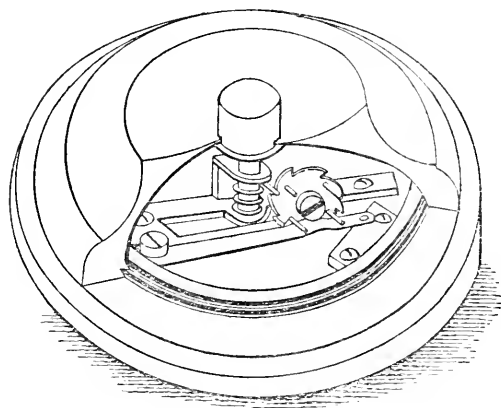

Salomon's commutator.

Salomon. It is designed to open and close a circuit successively by one and the same manœuvre, and is particularly applicable to the lighting and extinguishing of lamps or to continuous electric bells. It has the appearance and dimensions of the button of an

spring engages with each tooth and holds it in place.

(b) An elegant device has been got up by Grangier, of Dinard, for the purpose of lighting or extinguishing a lamp at a distance, from any number of points, by the sole aid of a button and two

wires. The principle of it is very simple. It consists in actuating the electro-magnet of a relay commutator by pressing upon one of these buttons. The motion of the armature revolves a ratchet wheel $\frac{1}{2}$ revolution at each manœuvre. This revolution is utilised for effecting contacts through the aid of two springs that press against friction rollers provided with parts that are successively insulating and conducting, thus effecting an opening and closing of the circuit connected with the two springs.

Automatic.—(c) The object of this apparatus, Fig. 107, also by Salomon. is to permit of effecting, in a certain

before it has to be wound up again, but it is unnecessary to say that such a limit is not absolute, and that it depends solely upon the proportions of the apparatus and the weight of its spring. The apparatus consists of a clock-work movement, which, every 30 seconds, every minute, or more, according as need be, is thrown into gear and causes the revolution of an axle $\frac{1}{4}$, $\frac{1}{6}$, or $\frac{1}{8}$ turn, according as 4, 6, or 8 series are used. This rotary motion changes the communications of the external circuit, puts a new series in circuit, and removes that which has just operated. This result is very easily obtained by means of metallic fingers fixed spirally

107.

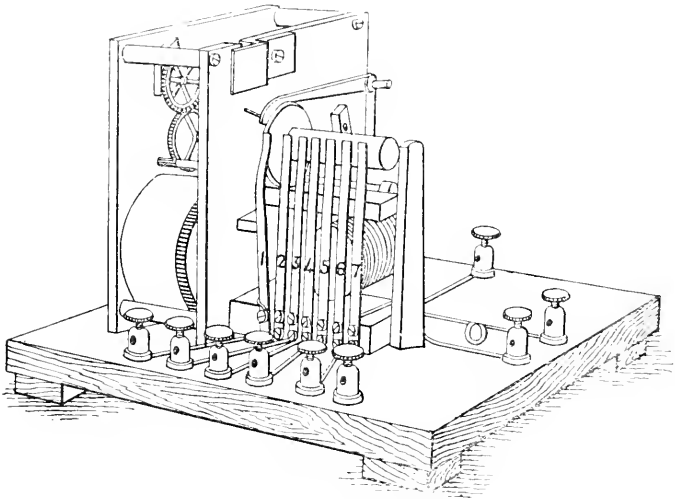

Automatic commutator.

measure, a nearly constant lighting by Leclanché piles, through a method of automatic substitution of several series operating one after the other, and depolarising themselves during the period of rest. The apparatus, when once wound up, gives 2700 commutations

upon the revolving cylinder, and which come successively into contact with springs, 2, 3, 4, 5, 6, 7, that communicate with the positive poles of the different batteries, the negative poles being connected with a common return circuit.

In order that the commutator may not work while the piles are not operating, an electro-magnet is placed beneath the revolving cylinder. As long as the lamps are out, the clock-work movement is locked; but as soon as the lamps are lighted, the electro-magnet attracts its armature, which throws the clock-work movement into gear, and the purely mechanical function of the commutator can then be produced. According to Salomon, it would require 6 batteries of a special model to secure a continuous lighting of indefinite duration, at the rate of 1 ampère, 1.5 volt per element, in making commutations every 30 seconds, thus leaving 150 seconds of rest between two successive periods of work.

Salomon's commutator, by means of slight modifications, may be utilised with advantage for an analogous service—that of the charging of a series of accumulators through a small number of elements (bichromate or sulphate of copper). The commutator should, say every $\frac{1}{4}$ hour, make the charging pile pass automatically from one series to the other, and thus perform, systematically and methodically, a manoeuvre hitherto effected by hand, but quite irregularly.

In his last arrangements of the chlorine pile, Upward uses an apparatus whose function is exactly the same as that of the one just described, but its high price leads us to believe that the Salomon arrangement, slightly modified, would solve the problem in a simpler and more economical manner.

Galvanometer.—To every worker in physics or electricity a good and reliable galvanometer is a prime necessity; but the prices asked for such by instrument makers often constrain one to get along with some rude and imperfect makeshift. But as a merely trifling expense, an instrument may be made which shall be equal in performance to any that can be bought, and which requires but little mechanical skill on the part of the maker.

Procure 1 ft. of 3 in. brass tubing, 5 in. of $2\frac{1}{2}$ in. tubing, 6 discs of brass

plate 3 in. diameter, and a piece of hardwood plank, or, better, vulcanite, the latter to serve as a base to the finished instrument. From the 3 in. tube saw a piece $2\frac{1}{4}$ in. long and nicely square its ends. This is for the body or barrel of the galvanometer. Crosswise of this, and midway from either end, a slit 2 in. long and $\frac{1}{8}$ in. wide is next to be made.

Now take the $2\frac{1}{2}$ in. tube, and with a broad half-round file fit one end of it to the side of the barrel—a rather difficult feat for a novice. When fitted it is to be soldered in place, immediately over the slit in the barrel. In this and

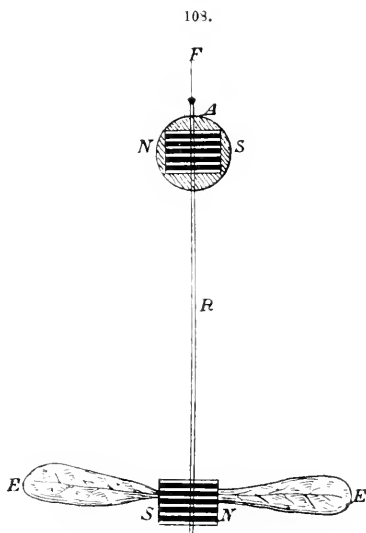

Galvanometer needle.

R, aluminium wire; A, mirror; N S, magnetic system; F, silk fibre; E E, dragon fly wings.

subsequent operations of soldering the joints are to be "sweat" together, that is, the pieces are bound in place with wire, plumbers' acid and solder put around the joint, and the whole heated in a lamp until the solder flows into

the joint, when it may be "wiped" with a piece of cloth. Thus is formed the standard of the instrument, which serves to support it upon its base. To this end a plug of wood may be driven firmly into the open end of the standard, and a large screw passed up through the base into it, thus binding the two together. The base may be turned or finished in any form to suit the taste of the maker, and it should be provided with 3 levelling screws threaded through the base itself or through projecting arms of brass.

At the central point of the top of the barrel drill a small hole, and over the hole solder a brass ferrule for holding a glass tube, which last is to carry the suspension arrangement. Now take your piece of 3 in. tubing again and saw from it two rings, each $\frac{3}{4}$ in. wide. After smoothing the ends of these, slit them open and take out a small portion, so that they may just be sprung into the barrel. While in this position, with a little projecting, one of the discs is to be laid upon either ring and secured by soldering. Thus are formed two shallow cups for containing the coils. Through the centre of one of these cups make a hole $\frac{3}{4}$ in. diameter, and also in each cup two fine holes, one near the circumference, the other near the centre, for passing out the terminals of the coils. In the cup having the large central hole, the small hole is to be made close by the edge of the large one.

The coils themselves may next be wound. Make a spool of wood, 1 in. between the heads, and having its core $\frac{3}{8}$ in. diameter at one end, $\frac{5}{8}$ in. at the other. The spool head on the smaller end of the core is made removable, so that the coil when finished may be drawn from the spool. Pin the spool to any convenient support with a large screw, and insert a peg near the margin of the free head, to serve as a handle for turning the spool in winding the coil. The wire to be used will depend upon the purpose for which the instrument is to be employed. No. 24 to 28 wire is good for general purposes; but the general worker will find it advan-

tageous to have three sets of coils of No. 16, 28, and 36 wire respectively, and it was that other cups and coils might be made at leisure that the extra tubing and discs were provided.

109.

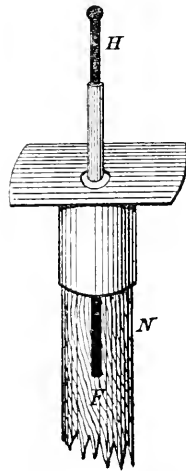

Suspension.

H, sliding wire for adjusting needle; F, silk fibre; N, glass tube.

Before winding, the wire is to be cooked in hot paraffin until all air is driven off. Make a small hole through the spool head close to the larger end of the core, pass one end of the wire through this hole, and then, guiding the wire with one hand and turning the spool with the other, fill up the spool, making the winding as snug and perfect as possible. To permit of adjustment, the outer diameter of the coil should be a trifle less than the diameter of the cup that is to contain it. Carefully take away the removable spool head, and without disturbing the coil give it a thin covering of *solid* shellac upon its exposed face and edge. The shellac is melted and neatly smoothed upon the coil with a hot iron. The coil may now

be most carefully removed from the spool, and its other face, as well as the portion within the conical hole, coated with shellac as above. The second and subsequent coils are made in the same manner. The coils are fixed in the cups by pouring melted rosin about them, first taking care to pass the terminals through the holes provided for them.

The needle or magnetic system next demands attention, and it will test the skill of the beginner. A piece of No. 16 aluminium wire, 3 in. long, is flattened at either end for $\frac{1}{2}$ in. of its length, and through one end a minute hole is pierced. A staff for carrying the magnets and mirror is so formed. For the magnets procure a rather wide watch spring, anneal it well, and file or grind a portion of it until it is made as thin as newspaper, about .07 mm. Cut from this 12 pieces, each $\frac{3}{8}$ in. long, and roll them about a steel wire into little hollow cylinders $\frac{1}{16}$ in. diameter. (Some manufacturers use short flat pieces of narrow watch spring for this purpose).

The 12 cylinders are then to be dipped in a strong solution of potassium ferrocyanide, heated to bright redness, and suddenly plunged into cold mercury. By these means they are made extremely hard, and will retain a very strong magnetic charge. To magnetise, string them on a wire, and put in a solenoid through which the strongest available current, preferably that from a dynamo, is made to pass.

On little square scales of mica arrange the magnets in two sets of 6 each, taking care that in each set the poles of the individual magnets shall lie in the same direction. Secure them upon the mica scales with a very little shellac varnish, and in the same way the mica scales upon the staff, one at either end, being very careful that the combined poles point in opposite directions in the two sets of magnets. In front of the magnets near the upper end of the staff (the end having the minute hole) is placed a mirror, and fixed with shellac. These mirrors may be bought for a small sum of the dealers, or easily made

by grinding very thin a piece of plate glass and silvering its unground side. The ordinary microscopic cover glasses are rarely perfect enough to be used as mirrors. Our needle now needs only the addition of a pair of dragon-fly wings, in the position indicated in Fig. 108, to make it complete. These wings bring the needle quickly to rest after a displacement.

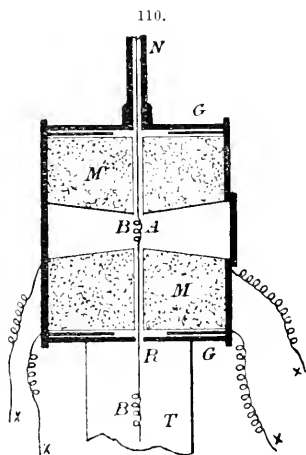

Section of Galvanometer.

G, G, galvanometer barrel; M M, coils; A, mirror; B B, magnetic system; C, lens; T, tube for standard; N, glass tube; R, aluminium wire; X X, terminals of coils.

A glass tube 10 in. long is now to be fixed upright in the ferrule on the top of the barrel. A little sulphur melted upon the heated end of the tube accomplishes this. The top of the tube must be provided with an arrangement for suspending the needle. Fig. 109 shows how this is made. Another ferrule fits the glass tube. On it rests a small plate of sheet brass, which is perforated, and through the latter a split tube passes, grasping a wire, and moves in the tube with gentle friction. The ferrule, the plate, and the split tube are united with solder. To suspend the

needle, remove the sliding wire and to its extremity attach with varnish one end of a long fibre of silk, such as may be drawn from white embroidery silk or a white silk ribbon (unspun silk fibre is preferable for this purpose, but the twisted fibre may be straightened by steaming). Press a little ball of wax upon the free end of the fibre, and drop the ball down through the split tube into the galvanometer barrel, and push

111.



The Telescope.

T, paper tube; P, draw tube; L, lens; W, wire.

the wire in place. The end of the fibre in the barrel can now be caught and threaded through the hole in the needle staff, secured, and the wings put through the slit at the bottom of the barrel, where they should swing freely in the tube below. The coils can now be pushed into place, the coil having the large hole being the front one. In this hole a spectacle lens of 4 ft. focus, ground to a fit, is to be cemented. The suspension wire is moved up or down until the mirror is seen to occupy the centre of the coil. Two of the coil terminals are to be joined so that the current may circulate in the same direction in each coil, and the other two are connected to screw posts upon the base of the instrument.

A small bar *controlling magnet* is provided, either upon a separate stand, or it may be attached to the glass tube with the aid of a split cork. The instrument itself is now complete, except some means for reading its indications. The following simple device accomplishes that purpose better than the most elaborate and costly telescope and scale. Procure one of those lenses sold as reading glasses. It should be about 3 in. diameter and 6 in. focus. Make a stiff tube of paper 2 ft. long, 3 in.

internal diameter. The tube should be furnished with a telescopic slide at one end, and in the slide a peep hole. The lens is to be fixed in the tube at its own focal distance from the peephole, and opposite the peephole, also in focus of the lens, a fine wire or spider line is stretched. Fig. 110 shows the device in section and will make the details clear.

A scale of equal parts printed or marked upon paper and attached to a strip of board is the only remaining detail. The telescopic device is secured so as to point directly at the galvanometer mirror, about 6 ft. distant, and a few trials will enable one to place the scale so that a distinct view of the divisions may be had upon looking through the telescope. Remember that the scale is seen reflected in the swinging mirror, and there will be but little difficulty in securing the correct adjustments.

An instrument made by the writer in the foregoing manner, though it has a resistance of only 50 ohms, gives a detection of 20 divisions of its scale through a resistance of 250,000 ohms, the current being furnished by a single Daniell's cell. It can be made without a lathe. There is but a single screw about it, and the whole cost of construction need not be more than 10-12s.

Lamps.—(a) A very good form of lamp can be made of a 3 neck globe, to be procured at the chemical apparatus shops, in the shape of Fig. 112: *a* is the globe and *b* two of the necks, which should be fitted with corks, drilled to receive pieces of No. 1 brass wire, and then cemented in. Fig. 113 shows one of the brass wires drilled about $\frac{1}{4}$ in. down to receive a length of carbon, and a hole at the other end to fasten the connecting wires to. A piece of very fine carbon is inserted between the wires (about 1 in. long by $\frac{1}{16}$ in.) leaving $\frac{1}{2}$ in. exposed. The globe is filled with nitrogen by burning out the oxygen in the following manner:—A stopcock is cemented into the third neck and then screwed into a capped gas jar, which is placed in a pneumatic trough with a

Lighting.—The following tables are very useful:—

TABLE I.—COST OF LAYING 100 YD. OF DOUBLE CONDUCTOR UNDERNEATH THE FOOTWAY OF A LONDON STREET.

	Single No. 16.	7 16	12 12	19 16	37 16	2 Sets. 37 16	4 Sets. 37 16	6 Sets. 37 16
Area, sq. in.	0032	0225	0773	1613	0.5	1.0	2.0	3.0
Area, sq. mm.	2.08	14.6	50	104	322	645	1290	1935
Weight per 100 yd. run, lb.	7½	53½	183¼	392	1153	2306	4612	6918
£ s. d.	0 4 10	1 14 6	5 18 0	12 13 0	£ 37 5 0	74 10 0	149 0 0	224 0 0
Cost of copper at 7¼d. ..	1 3 2	4 8 6	11 2 0	24 17 0	70 15 0	141 10 0	283 0 0	424 0 0
Cost of insulation								
Total cost of cables ..	1 8 0	6 3 0	17 0 0	37 10 0	108 0 0	216 0 0	432 0 0	648 0 0
Casing, bitumen, & cement	5 3 0	5 5 0	8 0 0	12 10 0	16 0 0	22 0 0	40 0 0	55 0 0
Labour, laying	3 0 0	4 0 0	5 0 0	5 0 0	6 0 0	10 0 0	18 0 0	35 0 0
Trenching and repairing ..	25 0 0	25 0 0	25 0 0	25 0 0	25 0 0	25 0 0	30 0 0	35 0 0
Surface boxes & connection	5 0 0	7 0 0	10 0 0	10 0 0	10 0 0	10 0 0	10 0 0	10 0 0
Engineer & superintendent	3 0 0	4 0 0	5 0 0	5 0 0	6 0 0	10 0 0	20 0 0	25 0 0
Total	42 11 0	51 8 0	70 0 0	95 0 0	114 2 0	179 0 0	301 0 0	567 0 0
Add extra, if copper at 9¼d.	0 1 1	0 8 0	1 7 0	2 17 0	3 5 0	8 10 0	17 0 0	34 0 0
Cost of copper per lb. laid } complete	42 12 151 16	0 71 7	0 97 17	0 117 7	0 187 10	0 318 0	0 601 0	0 874 0
Current in amperes	5 13 6	0 19 4	0 7 9	0 5 0	0 4 1	0 3 3½	0 2 8½	0 2 7½
Cost per ampere	1.2	8.1	28	58	90	360	720	1080
	35 10	0 6 8	0 2 10	6 1 13	9 1 6	0 1 0	0 17 6	0 16 8

TABLE II.—COST OF LAYING 100 YD. OF DOUBLE CONDUCTOR OF BARE COPPER CARRIED ON INSULATORS IN A CULVERT.

Area in sq. in.	0.25	0.5	1.0	2.0	2.55	3.00
Area in sq. mm.	161.25	322.5	645	1290	1645	1935
Weight of copper in lb. per 100 yd.	576	1153	2306	4612	6125	6918
	£ s. d.	£ s. d.	£ s. d.	£ s. d.	£ s. d.	£ s. d.
Cost of copper at 7 $\frac{3}{4}$ d. per lb.	18 15 0	37 5 0	74 10 0	149 0 0	190 0 0	224 0 0
Laying	9 0 0	9 12 0	9 12 0	9 15 0	9 15 0	10 0 0
Insulators	0 4 6	0 4 6	0 4 6	0 4 6	0 4 6	0 4 6
6 surface boxes and connections	10 0 0	10 0 0	10 0 0	10 0 0	10 0 0	10 0 0
Culvert, 18 in. \times 12 in., for two lines conductor, in brickwork and cement, replacing pavement	53 8 0	53 8 0	53 8 0	53 8 0	53 8 0	53 8 0
Engineers and superintendence	6 0 0	10 0 0	10 0 0	10 0 0	10 0 0	15 0 0
Total	97 7 6	120 9 6	157 14 0	232 7 6	263 7 6	312 12 6
Extra for copper at 9 $\frac{1}{2}$ d. per lb.	3 5 0	8 10 0	17 0 0	34 0 0	43 10 0	51 0 0
Total	100 12 6	128 19 6	174 14 6	266 7 6	306 7 6	363 12 6
Cost of copper per lb. laid complete	42d.	27d.	18.2d.	13.8d.	12d.	12.5d.
Current in amperes	90	180	360	720	910	1080
Cost per ampere	1 2 3	0 14 5	0 9 8	0 7 5	0 6 9	0 6 8 $\frac{1}{2}$

TABLE III.—COST OF 10,000-LIGHT OR 600-KILOWATT PLANT.

A.T.—ALTERNATING TRANSFORMER DISTRIBUTION.		B.T.—ACCUMULATOR TRANSFORMER DISTRIBUTION.	
Generating station, buildings, chimney shaft, water tanks, and general fittings	£ 11,950	Generating station, buildings, chimney stack, water tanks, and general fittings	£ 8,000
Dynamos and exciters—865 kilowatts, including spare sets, divided as convenient..	5,540	Dynamos—600 kilowatts, in 6 sets of 100 kilowatts each ..	4,800
Motive power, i.e. engines, boilers, steam and feed connections, belts, &c., at 8 <i>l.</i> 12 <i>s.</i> per I.H.P.	12,470	Motive power, i.e. engines, boilers, steam and feed connections, &c., at 8 <i>l.</i> 12 <i>s.</i> per I.H.P.	8,600
500 transformers, i.e. one to every pair of houses, at 15 <i>l.</i> each	7,500	4 groups of accumulators, in all 240 cells, in series, at 40 <i>l.</i> per cell, including stands ..	9,600
2000 yd. primary or charging main, exterior to area of supply, at 308 <i>l.</i> per 100 yd.	6,160	2000 yd. charging main, at 306 <i>l.</i> 17 <i>s.</i> 6 <i>d.</i> per 100 yd. (see Table II.)	6,137
20,000 yd. distributing main, 50 mm. sectional area, at 91 <i>l.</i> 7 <i>s.</i> (see Table I.)	14,270	20,000 yd. distributing main, 161·25 mm. sectional area, at 100 <i>l.</i> 12 <i>s.</i> 6 <i>d.</i> (see Table II.)	20,125
Regulating gear	500	Regulating gear	2,500
	<u>£57,440</u>		<u>£59,762</u>

TABLE IV.—WORKING EXPENSES AND MAINTENANCE OF 10,000-LIGHT, OR 600-KILOWATT PLANT.

	A.T.		B.T.	
	£	s. d.	£	s. d.
<i>Materials—</i>				
Coal: 4380 tons at 17 <i>s.</i>	3,723	0 9
„ 2550 „ 17 <i>s.</i>	2,167	0 0
Oil, water, and petty stores: 1500 hours at 7 <i>s.</i> 6 <i>d.</i> + 7520 hours at 1 <i>s.</i>	925	0 0
Oil, water, and petty stores: 1400 hours at 5 <i>s.</i>	350	0 0
Total cost of material ..			<u>4,645</u>	<u>0 0</u>
<i>Labour—</i>				
2 foremen drivers at 45 <i>s.</i> , 6 drivers at 30 <i>s.</i> , 9 firemen at 24 <i>s.</i> ; sundry labour	1,388	8 0
1 foreman driver at 45 <i>s.</i> , 2 drivers at 30 <i>s.</i> , 3 firemen at 24 <i>s.</i> ; sundry labour	975	0 0

	A.T.			B.T.								
	£	s.	d.	£	s.	d.	£	s.	d.			
Brought forward	1,388	8	0	4,648	0	0	975	0	0	2,517	0	0
<i>Salarics—</i>												
1 chief at 500 <i>l.</i> , 2 assist- ants at 200 <i>l.</i> each, 4 clerks at 80 <i>l.</i> each ..	1,220	0	0
1 chief at 500 <i>l.</i> , 1 assist- ant at 200 <i>l.</i> , 4 clerks at 80 <i>l.</i> each	1,020	0	0
				2,608	8	0				1,995	0	0
<i>Maintenance of Plant—</i>												
Motive power and dyna- mos: 10 per cent. on 18,010 <i>l.</i>	1,801	0	0
Motive power and dyna- mos: 10 per cent. on 13,400 <i>l.</i>	1,340	0	0
Buildings and fittings: 5 per cent. on 11,000 <i>l.</i> ..	550	0	0
Buildings and fittings: 5 per cent. on 8000 <i>l.</i>	400	0	0
Transformers: 10 per cent. on 7500 <i>l.</i>	750	0	0
Accumulators: 15 per cent. on 9600 <i>l.</i>	1,440	0	0
Mains: 7½ per cent. on 20,430 <i>l.</i>	1,532	5	0
Mains: 2½ per cent. on 26,262 <i>l.</i>	656	10	0
Regulating gear: 10 per cent. on 500 <i>l.</i>	50	0	0
Regulating gear: 10 per cent. on 2500 <i>l.</i>	250	0	0
				4,583	5	0				4,086	10	0
				2,939	13	0	8,598	10	0
2100 units × 365 days = 766,500 units. Cost per unit	3.75 <i>d.</i>	2.7 <i>d.</i>

(R. E. B. Crompton.)

piece of phosphorus on a little stand (Fig. 114). When all is ready, the P is lighted by a hot wire, the jar placed over it, and the stopcock opened. Phosphoric acid is formed, which eventually dissolves in the water. When the globe

is quite clear again, shut the stopcock, and unscrew the globe from the jar. It can then be screwed to any of the gas brackets, and insulated wires running inside or outside the gaspipe from a battery of at least 6 large Bunsens. A

very fair light is the result, increased of course by the number of cells employed (Fig. 115). The globe can be bought at Jackson's, 65, Barbican, for about 1s.

negative, which takes 4 in. These slide in tubes, A being the heavier; F C E is a lever with its fulcrum at C, the end E being half as long as F. The

E end is connected by an ivory or bone connecting-rod to B, as shown, and the end of F by similar means to F from E. On the negative carbon-holder hangs an iron cylindrical weight, which slides easily in the coil G. When no current is passing, the carbons touch; but when the current is switched on, the iron weight is drawn down the coil, and the electric arc is formed. On the current becoming weaker, the positive carbon falls, forcing up the negative half the distance by means of the lever F C E. This restores the arc, and the carbons are locked by the coil. Any other arrangement may be employed to lock the carbon, the chief point claimed for this lamp being its simplicity. (C. Crawford Cory.)

Microphone. — Fig. 117 is a microphone which any person who has the materials at hand can easily construct for himself. The vibrating plate A consists simply of a visiting-card of medium thickness cut square. Such a shape is much better than round, as the latter, although more elegant in appearance, does not give so good results. To this card are affixed by means of sealing-wax 3 thin and light discs of carbon BBB of the kind used for the

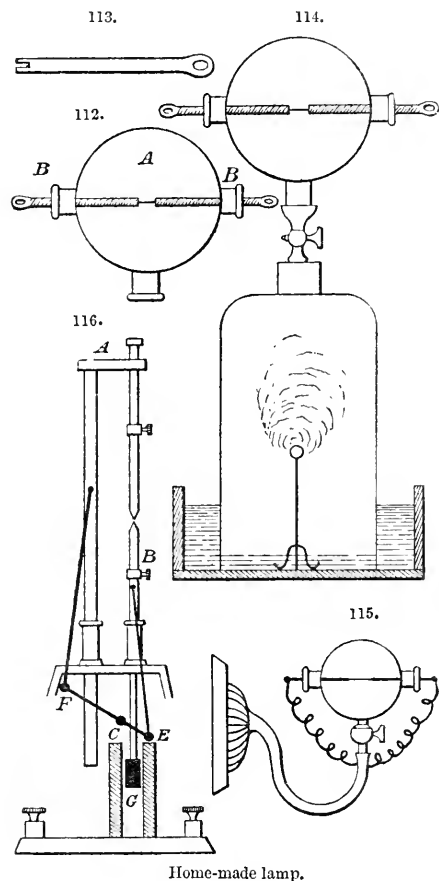

Home-made lamp.

(b) Fig. 116 is a regulator lamp of my own design, and which works very well indeed (the box is removed for clearness); A is the positive carbon-holder, which takes 8 in. of carbon, and B, the

electric light. These 3 discs occupy symmetrically the 3 apices of an equilateral triangle, and are put into communication by means of copper wires *b*. With this object in view, a small aperture is

formed in each disc, and into this is fixed the extremity of a copper wire either by cement or friction. The copper may be advantageously replaced by platinum. Finally, the 3 wires are united.

the latter it passes through the wire *b*, into the disc BB, to return to the terminal D, in traversing the two rods CC.

This little instrument will prove very sensitive to the voice and all noises,

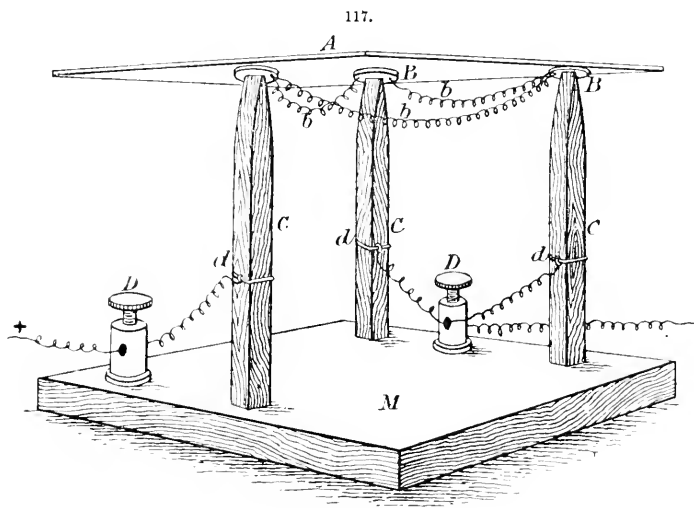

Easily constructed microphone.

The rest of the apparatus consists of a square wooden base *M*, which supports 3 prismatic carbon rods *CC*, that exactly correspond to the 3 discs *BB*. The two rods *CC* communicate by copper or platinum wires *dl* with the same terminal *D*. The third rod *C* communicates alone with a second terminal *D*. The upper extremity of these carbon rods must be chisel-shaped, such a form having been found to give the best results, inasmuch as the contacts become fewer in this case. The rods are fixed to the wooden base by means of sealing-wax.

The theory of this microphone is very simple. The current enters, for example, through the terminal *D*, follows the rod *C* and then the disc *B*. From

provided that the plate *A* be given a proper weight, one that is neither too heavy nor too light. If this be done, the voice of a person speaking in an ordinary tone may be distinctly heard at the end of the room that contains the microphone. The sounds of a piano are particularly well rendered by it. The apparatus must be placed upon a table at a distance of 2–3 yd. in order to protect it from the jarring of the earth.

As for the pile necessary for saturating the instrument, one small Bunsen or two or three Leclanché elements may be used. Apropos of the Leclanché pile, a modification of it formed of a zinc and a carbon plate, both of them dipping into a saturated solution of bichromate

of potash and hydrochlorate or sulphate of ammonia, is very simple, and avoids the costly mechanism designed to remove the zinc from the action of the acid when the pile is at rest. This element does not wear away when the current is interrupted, as in the Leclanché pile. One obstacle at first rendered the use of this pile very difficult, and that was the fact that the ammoniacal salts rose along the carbons and attacked the communicating wires so that these broke and thus interrupted the electric current. But it is only necessary to dip the carbons into a bath of boiling paraffin, then allow the whole to cool, and afterward to scrape the carbon with a knife so as to free its surface of the paraffin. This latter material penetrates the pores of the carbon without notably changing its electric conductivity. The liquids are thus no longer able to rise through capillary attraction. Leclanché got around the difficulty by leaden armatures, but the means described above are simpler. The electromotive force of this new element appears to be greater than that of a Leclanché of the same dimensions. (*La Nature*).

Motors.—It is generally understood that an efficient electric motor cannot be made without the use of machinery and fine tools. It is also believed that the expense of patterns, castings, and materials of various kinds required in the construction of a good electric motor is considerable. The little motor shown in Fig. was devised and constructed with a view to assisting amateurs and beginners in electricity to make a motor which might be driven to advantage by a current derived from a battery, and which would have sufficient power to operate an ordinary foot lathe or any light machinery requiring not over 1 man power.

The only machine work required in its construction is the turning of the wooden supports for the armature ring. The materials cost less than 8s., and the labour is not great, although some of the operations, such as winding the

armature and field magnet, require some time and considerable patience. On the whole, however, it is a very easy machine to make, and if carefully constructed will certainly give satisfaction. Only such materials as may be procured anywhere are required. No patterns or castings are needed.

Beginning with the armature, a wooden spool A (Fig. 118) should be made of sufficient size to receive the soft iron wire of which the core of the armature is formed. The wire, before winding, should be varnished with shellac and allowed to dry, and the surface of the spool on which the wire is wound should be covered with paper to prevent the sticking of the varnish when the wire is heated, as will presently be described. The size of the iron wire is No. 18 American wire gauge. The spool is $2\frac{3}{16}$ in. diameter in the smaller part and 2 in. long between the flanges. It is divided at the centre and fastened together by screws. Each part is tapered slightly to facilitate its removal from the wire ring. The wire is wound on the spool to a depth of $\frac{3}{8}$ in. It should be wound in even layers; and when the winding is complete, the spool and its contents should be placed in a hot oven, and allowed to remain until the shellac melts and the convolutions of wire are cemented together. After cooling, the iron wire ring B is withdrawn from the spool, and covered with a single thickness of adhesive tape, to ensure insulation.

The ring is now spaced off into 12 equal divisions, and lines are drawn around the ring transversely, dividing it into 12 equal segments, as shown in Fig. 120. Two wedge-shaped pieces C of hard wood are notched and fitted to the ring so as to enclose a space in which to wind the coil. This coil consists of No. 16 cotton-covered copper magnet wire, 4 layers deep, each layer having 8 convolutions. The end *a* and the beginning *b* of the winding terminate on the same side of the coil. The last layer of wire should be wound over 2 or 3 strands of shoe thread, which should be tied after the coil is complete, thus binding the

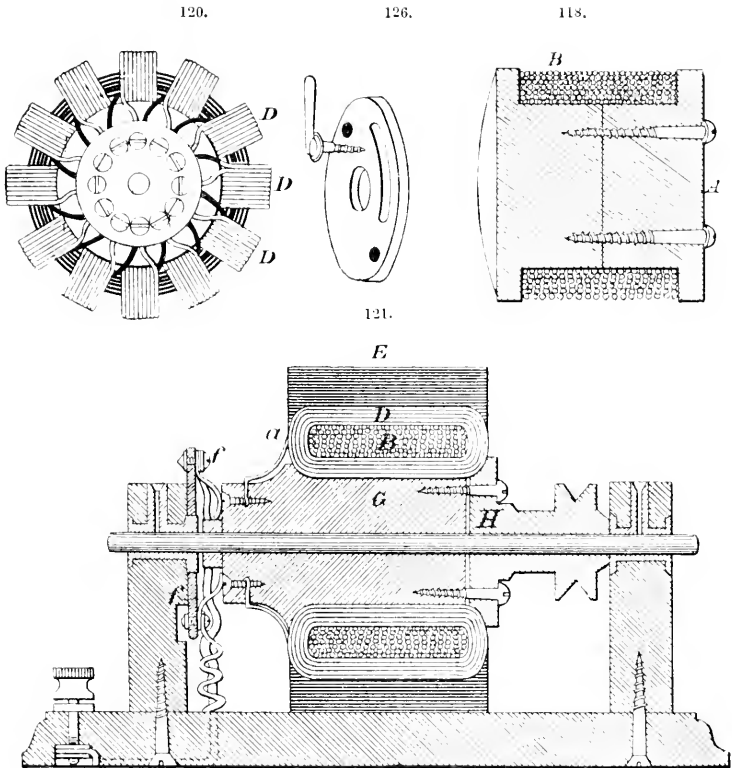

Fig. 118, armature core; fig. 121, transverse section; fig. 120, end view of armature showing commutator; fig. 126, brush-holding disc.

wires together. When the first section of the winding is finished, the wire is cut off and the ends (about 2 in. long) are twisted together to cause the coil to retain its shape. After the completion of the first section, one of the pieces C is moved to a new position, and the second section is proceeded with, and so on until the 12 sections are wound. The coils of the ring are then varnished with thin shellac varnish, the varnish being allowed to soak into the interior of the coils. Finally the ring is allowed to remain in

a warm place until the varnish is thoroughly dry and hard.

Care should be taken to wind all the coils in the same direction, and to have the same number of convolutions in each coil. A convenient way of carrying the wire through and around the ring is to wind upon a small ordinary spool enough wire for a single section, using the spool as a shuttle.

The ring is mounted upon a wood support or hub G, and is held in place by the wooden collar H, both hub and collar being provided with a con-

119.

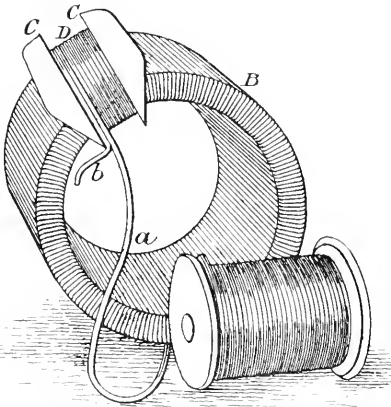

Winding the armature.

case flange for receiving the inner edges of the ring. The collar H is fastened to the end of the hub G by ordinary brass wood screws. Both hub and collar are mounted on a $\frac{9}{32}$ in. steel shaft formed of Stubs' wire, which needs no turning. A pulley is formed integrally with the collar H. The end of the hub G, which is provided with a flange, is prolonged to form the commutator, and the terminals *a b* of the ring coils are arranged along the surface of the hub and inserted in radial holes drilled in the hub in pairs. The wires are arranged so that one hole of each pair receives the outer end of one coil, and the other hole receives the inner end of the next coil, the extremities of the wire

123.

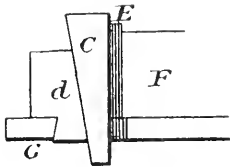

122.

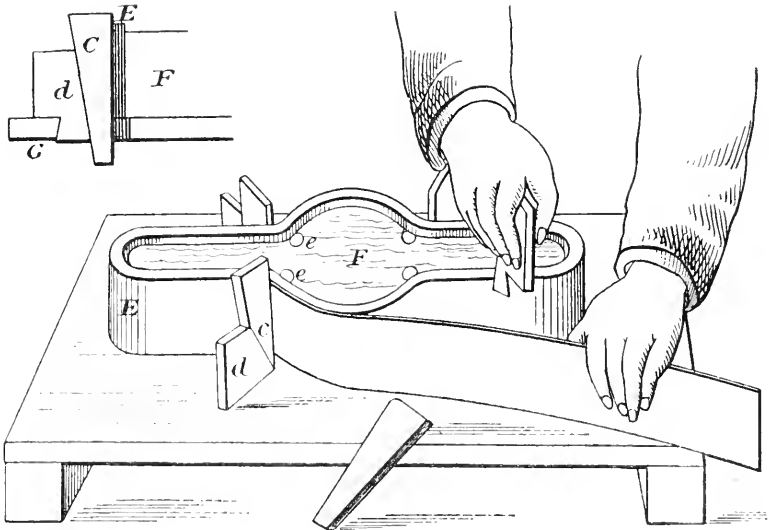

Forming the field magnet.

being scraped before insertion in the holes. The distance between the holes of each pair is sufficient to allow a brass wood screw to enter the end of

12 pairs of terminals, there will of course be required a corresponding number of brass screws. These screws are inserted in the end of the hub G, so

125.

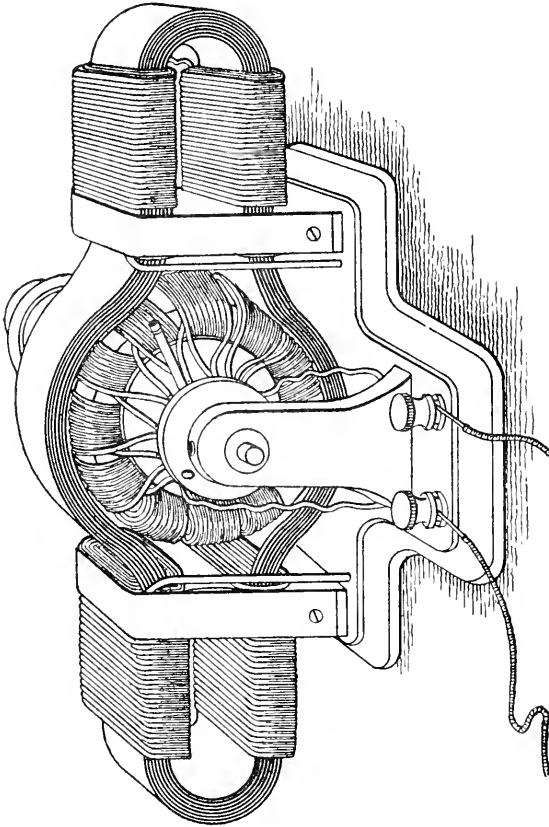

Simple electric motor.

the hub G, and form an electrical contact with both wires of the pair, as shown in Fig. 121.

There being 12 armature sections and

as to come exactly even with the end of the hub. This completes the armature and the commutator.

Before proceeding to mount the arma-

ture shaft in the journal boxes, it will be necessary to construct the field magnet, as the machine must, to some extent at least, be made by "rule of thumb."

The body E of the field magnet consists of strips of Russia iron, such as is used in the manufacture of stoves and stove pipe. The strips are $2\frac{1}{2}$ in. wide, their combined length being sufficient to build up a magnet core $\frac{7}{16}$ in. thick, of the form shown. The motor illustrated has 15 layers of iron in the magnet, each requiring about 26 in. of iron, approximately 33 ft. altogether.

The wooden block F, on which the magnet is formed, is secured to a base board G, as shown in Fig. 122, and grooves are made in the edges of the block, and corresponding holes are formed in the base to receive wires for temporarily binding the iron strips together. Opposite each angle of the block F, mortises are made in the base board G, to receive the keys *d* and wedges *c*. Each key *d* is retained in

has reached the required thickness, the wedges *c* are forced down so as to hold the iron firmly, then the layers of iron are closely bound together by iron binding wire wound around the magnet through the grooves *e* and holes in the base board G.

The next step in the construction of the machine is the winding of the field magnet. To ensure the insulation of the magnet wire from the iron core of the magnet, the latter is covered upon the parts to be wound by adhesive tape or by cotton cloth attached by means of shellac varnish.

The direction of winding is clearly shown in Fig. 124. 5 layers of No. 16 magnet wire are wound upon each section of the magnet, the winding of sections 1 and 2 being oppositely arranged with respect to each other. In like manner, the winding of sections 3 and 4 is oppositely arranged. The winding of section 1 is also opposite to that of 3, and that of 2 is opposite to that of 4. The winding begins at the outer end of

124.

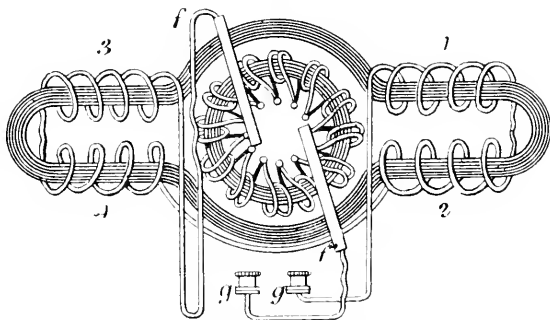

Circuit of simple electric motor.

the mortises by a dovetail, as shown in Fig. 123. By this arrangement, each layer of the strip of iron may be held in position, as the formation of the magnet proceeds, the several keys *d* and wedges *c* being removed and replaced in succession as the iron strip is carried around the block F. When the magnet

the magnet, and ends at the inner end of the section. When the winding is completed, the temporary binding is removed. The outer ends of 1 and 2 are connected together, and the outer ends of 3 and 4 are connected. The inner end of 2 and 4 are connected. The inner end of 3 is to be connected with the com-

mutator brush *f*. The inner end of 1 is to be connected with the binding post *g*, and the binding post *g* is to be connected with the commutator brush *f*.

The field magnet is now placed upon a base having blocks of suitable height to support it in a horizontal position. A block is placed between the coils to prevent the top of the magnet from drawing down upon the armature, and the magnet is secured in place by brass straps, as shown in Fig. 125.

The armature is wrapped with 3 or 4 thicknesses of heavy paper, and inserted in the wider part of the field magnet, the paper serving to centre the armature in the magnet. The armature shaft is levelled, and arranged at right angles with the field magnet. The posts in which the armature shaft is journalled are bored transversely larger than the shaft, and a hole is bored from the top downward, so as to communicate with the transverse hole. To prevent the binding of the journal boxes, the exposed ends of the armature shaft are covered with a thin wash of pure clay and allowed to dry. The posts are secured to the base, with the ends of the armature shaft received in the transverse holes. Washers of pasteboard are placed upon the shaft on the opposite sides of the posts, to confine the melted metal, which is to form the journal boxes. Babbit metal, or, in its absence, type metal, is melted and poured into the space around the shaft through the vertical hole in the post. The journal boxes thus formed are each provided with an oil hole, extending from the top of the post downward. If, after cleaning and oiling the boxes, the shaft does not turn freely, the boxes should be reamed or scraped until the desired freedom is secured.

All that is now required to complete the motor is the commutator brushes *f f*. They each consist of 3 or 4 strips of thin hard rolled copper, curved as shown in Fig. 124, to cause them to bear upon the screws in the end of the hub *G*. The brushes are secured by small bolts to a disc of vulcanised fibre, or vulcanite, at diametrically opposite points, as

shown in dotted lines in Fig. 126, and the brushes are arranged in the direction of the rotation of the armature. In the brush-carrying disc is formed a curved slot for receiving a screw, shown in Fig. 126, which passes through the slot into the post and serves to bind the disc in any position. The disc is mounted on a boss projecting from the inner side of the post concentric with the armature shaft. The brushes are connected up by means of flexible cord as shown in Fig. 125. The most favourable position for the brushes may soon be found after applying the current to the motor. The ends of both brushes will lie approximately in the same horizontal plane. When the motor is in operation, the direction of the current in the conductor of the field magnet is such as to produce consequent poles above and below the armature.

Eight cells of plunging bichromate battery, each having one zinc plate 5×7 in. and 2 carbon plates of the same size, will develop sufficient power in the motor to run an ordinary foot lathe or 2 or 3 sewing machines.

The dimensions of the parts of the motor are tabulated below:

Length of field magnet (inside)	10½ in.
Internal diameter of polar section of magnet	3½ "
Width of magnet core	2½ "
No. of layers of wire to each coil of magnet	5
No. of convolutions in each layer	34
Length of wire in each coil (approximate)	95 ft.
Size of wire, Am. W. G.	No. 16.
Outside diameter of armature	3½ in.
Inside diameter of armature core	2½ "
Thickness " " " "	2 "
Width " " " " wound	2½ "
No. of coils on armature	12 "
No. of layers in each coil	4
No. of convolutions in each layer	8
Length of wire in each armature (approximate)	30 ft.
Size of wire on armature, Am. W. G.	No. 16.
Length of armature shaft	7½ in.
Diameter of armature shaft	¾ "
" " wooden hub	1½ "
Distance between standards	5½ "
Total weight of wire in armature and field magnet	6 lb.

(G. M. Hopkins.)

Phonogram and Graphophone.—From the researches of a number of experimenters with the phonograph, it appears that:

(1) The embossing point should be abandoned for a process of engraving—that is to say, instead of pressing the registering surface with a style, as in the original phonograph, an outline should be produced parallel to the surface of inscription.

(2) The best substance answering all the requirements of the question raised by engraving by means of the style, is beeswax hardened by paraffin or some other similar substance.

127.

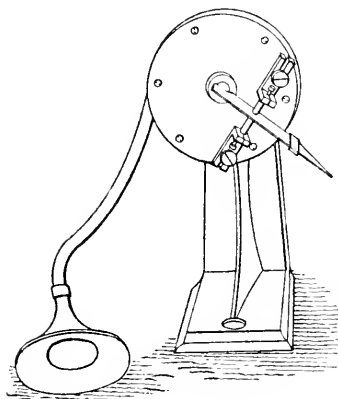

Phonogram and graphophone.

(3) To speak in a high tone is unnecessary, the ordinary tone giving the best results, although the intensity of the sound produced does not excel that of the telephone.

In 1886, Dr. Chichester, Dr. Bell, and C. S. Tainter took out a patent for engraving the phonogram and for the use of wax, and, as a result of their labours, produced, in the spring of 1887, the graphophone, the first really practical apparatus of the phonographic type, which was exhibited at Washington. This instrument reproduced the

voice with the intensity of a good telephone; but the deformations due to the engraving were great enough to render the voice unrecognisable, unless the fancy was exercised, and one had a previous acquaintance with the speaker. The impression was obtained upon a cardboard cylinder covered with wax. As soon as the graphophone became known in America, Edison, encouraged by the results obtained with this instrument, recommenced his experiments with the phonograph, and after having tried the embossing point anew abandoned it for the engraving, thus confirming the accuracy of the conclusion of Bell and Tainter. The graphophone and the new phonograph of Edison seemed then to be practically the same instrument, only differing in form and the nature of the motor used.

The difficulties which the embossing point presented would disappear, as Prof. Thomson observed, if a surface could be found whose resistance to the embossing point was exactly proportionate to the depth of this embossing. Every trial confirmed these conclusions, for the more one attempts to speak loud the more indistinct becomes the articulation. It is necessary, then, to trace the vibrations as in the old phonograph of Scott, parallel, and not perpendicular to the sheet, and to reduce to a minimum the resistance offered by the substance engraved. Berliner observed that lampblack was impracticable and insufficient; but he saw that the greyish deposit of lampblack, produced by a kerosine flame, gave a finer line than the thick dark deposit produced at the top of the same flame, and this observation led him to previously grease the registering surface by applying a layer of printing ink or oil paint by the aid of a roller or a brush. The smoke then gives a deposit of a fatty appearance, and of such a consistence that if it is touched with a style a free line is produced without any blister, even when examined with a microscope. The phonautogram obtained is then engraved mechanically, chemically, or

photo-chemically. After numerous attempts, Berliner has arrived at a process by which a reproduction can be obtained in less than an hour (even in 15-20 minutes if necessary), and which can afterwards be multiplied indefinitely by the electrotyping pro-

and divided in front. E is a piece of rubber tube fitted into the division in B, and supporting the end of the style C, which is formed of a thin sheet of metal vibrating on two steel pivots F. D is a piece of writing-paper strengthened by a spring plate, the end of which constitutes the tracing point. There is a piece of rubber tube placed round the style to control its vibrations. H is a disc of felt placed between the case of the diaphragm and the diaphragm itself, to control the superfluous vibrations and prevent resonance. The whole is placed upon a light support (Fig. 127).

128.

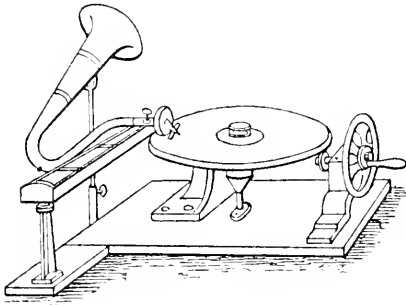

Phonogram and graphophone.

129.

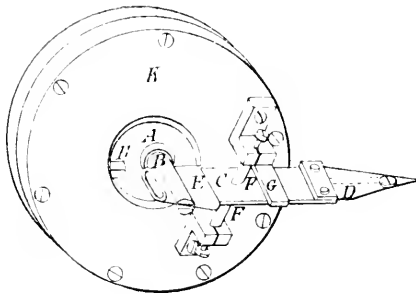

Registering apparatus.

cess, which Berliner calls the art of engraving the human voice with aquafortis, and which we call more simply phonogravure. The registering apparatus (Fig. 129) consists of a case K, which serves to support the whole. The centre of the diaphragm A carries a small brass cylinder B riveted to it,

The apparatus reproducing the words of the speaker (Fig. 128) is constructed on the same plan, but is of smaller dimensions and more rigid in the vibrating parts. The end of the style consists of an iridium point, to avoid the wear caused by continual rubbing with the metal.

Harder metals give a more intense sound than substances less resisting or elastic, as rubber or plaster of Paris. The hard metals, such as copper, nickel, or brass, speak louder than zinc; but there is a grinding, unless the writing surface is very smooth, and polished with the greatest care. This grinding is scarcely perceptible on polished glass, and Berliner hopes, by moulding the registers, to obtain an outline in relief which shall give intense sounds with a minimum of unnecessary noises.—(*La Nature*).

Regulators.—An ingenious electric regulator, which is so simple that any amateur can construct it, and that, too, at little expense, has been devised by C. Pollak. A few small pieces of wood, some brass, and 4 wires, are

all that is necessary for the construction of a regulator which will operate in a very satisfactory manner. In addition to its great simplicity, this lamp has the advantage of being based upon an entirely new principle—that of the expansion of the wires that lead the current to the carbons under the in-

corresponding wire. At the other extremity they are prolonged by a straight portion d , and a spiral forming a carbon holder.

In order that the carbons may be always kept opposite each other, the displacement of the holders is guided by a bent wire $c\ c'$ affixed to the board. The length of the lever arm d is about 4 in., while the distance from the point of attachment of the wires a to the centre of the spring is $\frac{8}{10}$ in., so that the motions are amplified at the ratios of 1 to 5.

In a normal state, the distance of the carbon holders is about $1\frac{1}{4}$ in. When the carbons are put in, each is made to project $1\frac{3}{4}$ in., so that the holders have to be spaced $2\frac{1}{2}$ in. apart, corresponding to an elongation of about $\frac{1}{4}$ in. of the wires $a\ a'$. If, at this moment, the lamp be interposed in an electric circuit, the current will pass into these wires and heat them, and the springs being thereby bent back the carbons will tend to separate, and an arc will form. The length of the latter will be determined

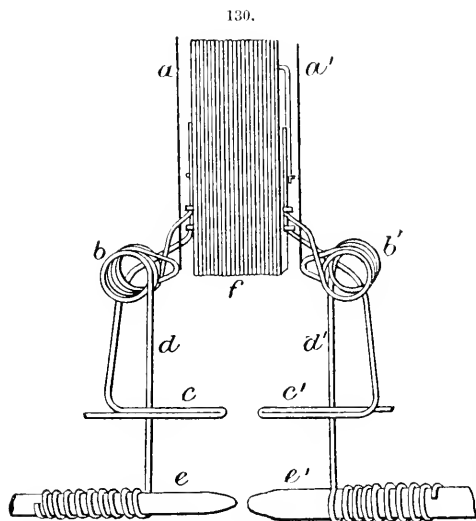

Regulator.

fluence of the said current and its variations, the same part serving at the same time for the lighting or formation of the arc, and for regulation in measure as the carbons wear away.

Fig. 130 shows the first of these apparatus that was constructed, and will easily allow the operation to be understood. Along a board f , about 6 ft. long, are stretched 2 brass wires $a\ a'$, $\frac{7}{10}$ in. diameter. These are fixed at the upper part to the 2 terminals of the lamp, and kept taut below by the action of double spiral springs $b\ b'$. These latter are formed of simple brass wire, and are fixed at the side of the board, and form in the centre a lateral appendage, to which is soldered the

by the condition that the tensions of the springs and wires balance each other for the corresponding strength of the current; for, as the regulation is made in series, and bears on the current, we ought naturally to group these lamps in derivation.

In measure as the carbons wear away, the resistance of the arc increases, the current diminishes, and the wires contract, allowing the springs to carry back the carbons. It is easy to see, and experiment shows it, that the current tends to diminish slowly in measure as the lamp burns. Such gradual diminution in luminous intensity offers scarcely any inconvenience in a lamp of this kind. With the divisions indicated

the lamp will operate for about 3 hours.

The diameter of $\frac{1}{50}$ in. for the regulating wires is determined by the value of the current adopted, 5 ampères; and the condition that the temperature of the wire be relatively high, about 120° C. If the temperature is too low, the regulation will be effected too slowly; and if it is too high, the elasticity of the wire will be destroyed, and the latter will elongate permanently under the action of its spring.

The temperature of 120° C. has been calculated by means of the well-known formula—

$$d = \sqrt[3]{\frac{4 R i^2}{\pi^2 t h J}}$$

where t is the elevation of temperature, R the specific resistance, i the current, h the coefficient of regulation (0.0002), d the diameter of the wire, and J the mechanical equivalent of heat.

The length does not here figure explicitly, but it in fact determines the current. In order to keep the latter constant by diminishing the length, it is necessary to increase by so much the proportion of amplification of the levers, and this has been done in a later model of smaller dimensions. If, with the same temperature, we desire to modify this current, it will suffice to shunt the regulating wires by properly calculated auxiliary resistances.

The ambient temperature plays an important role, since it modifies the initial tension of the wires. To get free from this influence, which in certain cases would necessitate a different regulation for each temperature, it suffices to replace the wool by a frame of the same metal as the wires a . Pollak has likewise adapted his system to lamps regulatable in derivation, with vertical carbons, by making the regulating wire act upon a ring brake that allows the upper carbon to slide.—(*La Lumière Electrique*).

Storage.—Get 2 half-round porous cups and a round glass jar large enough for the 2 porous cups to stand in upright. Get 2 plates of sheet lead $\frac{1}{16}$ in.

thick, wide enough to fit the half-round side of the porous cups and deep enough to come an inch or so above the top edge of the cups and jar. Solder a stout copper wire or a screw post to each lead plate at the top. Place the lead plates in the cups, and fill the cups nearly full with a paste made of red lead mixed with a solution of sulphate of soda thin enough to run like a cement. The glass jar containing the cups should be filled to within $\frac{1}{2}$ in. of top of cups with sulphuric acid and water, about 1 part acid and 8 of water. One plate should be marked X, so that, in charging, the currents will be correctly connected. This may be charged by attaching to a series of 12 sulphate of copper cells for 24 hours, or from a dynamo. It should always be charged in same direction, and it will improve by repeated chargings. A wooden cover may be fitted to the glass jar, and evaporation of the fluid should be replenished by adding water. Two or more cells of this battery will work small motors, lamps, and induction coils, and if thoroughly charged will retain a large volume of electricity for considerable time. After once being well charged, 4-6 cells of sulphate of copper battery will recharge it.—(*Jl. of the Telegraph*.)

Referring to the main objection in storage batteries—that storage involves a loss of some 50 per cent.—Prof. Lodge says there are many cases where the convenience of storage outweighs the evil of waste altogether, as, e. g. (1) where the power of the source would be otherwise so completely wasted that every fraction of it stored is clear gain—terrestrial water-power for instance; (2) where regularity and continuity of supply are needed, while the source of power is irregular and fitful—wind and wave power; (3) where the available source is weak but continuous, while the supply is needed only for a short time at intervals—small water-power for instance, or a small steam-engine which can be used during the daytime to store up a supply of current for light at night. The following remarks on what may be

termed the practical history of storage batteries will be useful to many, but there are not a few electricians who will ask whether, after all, Planté's old form of secondary battery is not quite as useful as any of the newer and patented forms.

The first form of manufacture consisted in rolling up sheets of lead and composition with trousering to keep them separate. The difficulties found were that the coatings would not adhere, but became detached in large flakes; that the trousering got corroded through and permitted short circuiting; and that, free circulation of fluid being impossible, the acid became exhausted in some places and concentrated at others, and thus every sort of irregularity began. Now regularity or uniformity is of the most vital and fundamental importance in any form of battery. If any part of a plate is inactive, that part is better away; if any plate in a cell is inactive, it is better away; and if any cells of a battery are inactive, they are infinitely better away. The rolling or coiling up of the sheets being found awkward in practice, and liable to detach the coatings, flat plates came to be used, then perforated plates, and then cast grids; these last having such large hole space that they held enough composition, and held it securely enough, to enable the trousering or intermediate porous material to be dispensed with. This was an evident step in advance; free circulation of the liquid became possible, and could be assisted by stirring; there was nothing to corrode except the plates themselves, and the composition, being in the cells or holes of the grid, might be reasonably expected to adhere. So far, expectation was not altogether belied. The adhesion was not perfect, it was true, and pieces of composition sometimes fell out of the holes, especially if too powerful currents were passed through the cell, but still it was much better than it had been; and if the plates were filled, properly formed, and fairly treated, the composition adhered extremely well and securely. The cir-

ulation of the liquid was not automatically perfect either, but mechanical agitation could be readily applied; without it the acid near the bottom of the cells tended to become more concentrated than that near the top, not by reason of gravitation undoing diffusion, which is impossible, but because during each charging fresh acid is formed, and in great part falls to the bottom in visible streams. Another great advantage was that some amount of inspection of the plates became possible, and experience as to the actual behaviour and appearance of the plates began to be accumulated.

The main difficulty now experienced was how to keep the plates from touching. They might be put in wooden frames, or elastic bands might be stretched round each of them, and if they would only keep flat it was impossible they should touch unless the composition should drop out of the holes. Sometimes the composition did drop out of a hole, and bridge across the interval between two plates, but the more common and more fatal experience was that the plates would not keep straight. In a few months the positives were found to swell, and as they swelled to buckle—to buckle and twist into every variety of form, so that elastic bands, wooden frames, and every other contrivance failed altogether to prevent short-circuiting. The cause of the buckling is of course irregular and one-sided swelling, and the cause of swelling is apparently the gradual peroxidation and sulphating of the material of the bars of the lead grid, which occupy less room as metallic lead than as oxide. As the bars swell they press on the inclosed composition, occasionally driving it out, but more frequently, and with properly made and treated plates universally, distending themselves and stretching the whole medial portion of the plate. The edge or frame of the grid is stronger than the middle bars, and is not so easily stretched; in a good and uniformly worked plate it does stretch, and an old positive plate is some $\frac{1}{4}$ in. bigger every way than a new

one, but if one face of the plate is a trifle more active than the other, it is very plain that the most active side will tend to become convex; and buckling once begun very easily goes on. To cure it two opposite plans have been tried: one is to leave the plates as free and unconstrained as possible, hanging free it may be from two points, thin, and with crinkled or crimped margins to allow for expansion; the other is to make them thick and strong, with plentiful ribs for stiffness, and besides to clamp them up to one another as tightly as may be, and thus in mechanical ways to resist buckling and distortion. I do not know that anyone could say for certain beforehand which of these two plans would be likely to answer best, but practice is beginning to reply in favour of the latter, and well-braced plates of fair thickness show no unmanageable tendency to buckle. It must be remembered that no material can buckle with a force greater than that necessary to restore it to flatness, and this force in the case of lead is very moderate. Hence it may be fairly hoped to overcome and restrain all exuberances by suitable clamps and guides arranged so as to permit flat and even growth, but to check all lateral warpings and excrescences.

Uniformity of action is still essential, especially if all the plates in a cell are clamped together. Plates mechanically treated alike ought to be electrically so treated also, and it is impossible to keep a set of plates working satisfactorily together unless the contact of each is thoroughly and equally good, so that each may receive its fair share of current. Defects of contact have been a fruitful source of breakdown and irregularity. Clamps and screws of every variety have been tried, but the insidious corroding action of nascent oxygen exerted through the film of acid which by spray and creeping forms and concentrates on the lugs—this corroding action crawls between the clamped surfaces, gradually destroys all perfect contact, and sometimes produces almost complete insulation. Contacts

on the negative plates give but little trouble; contacts on the positives have taxed a great amount of patience. Lead contacts "burned," i. e. melted, not soldered on, are evidently less liable to corrosion than brass or copper fittings, or than any form of clamp, but they are apt to be somewhat clumsy if of sufficient conductivity, and moreover they are awkward to undo again, and somewhat troublesome to do. However they have proved themselves so decidedly the best that now no other contacts will be used, and their reintroduction has been followed by a marked improvement in the behaviour of the cells. So long as contact with one plate was better than with another, a thing quite possible to happen without any difference being perceptible to the eye, so long was it possible for one or two plates to remain almost wholly inactive while another one or two received far more than their share of current, and became distended, warped, overcharged, and ultimately crumbled away. If one or two plates in a cell are black, and giving off torrents of gas, while the rest are brown and idle-looking, it is pretty fair evidence of irregular and insufficient contact, or else of some great discrepancy in the age or make of the plates. This point also is one that was not attended to in the early stages of manufacture; plates were made for stock, and cells were made up with plates of all ages selected at random from the store. Directly uniformity is perceived to be essential, this is recognised as obviously bad. Plates intended to work together should be of the same age and make; and, inasmuch as keeping does not improve them, the best plan is not to make for stock, but to keep material ready, and then quickly make up as wanted. Plates in work deteriorate slowly, but they are wearing out in the fulfilment of their proper function; plates in idleness deteriorate as quickly, and they are rusting out in fulfilment of no function at all. Worn-out plates, however, are by no means valueless. Lead material has a well-recognised price, and if attention

were given to the subject, it is probable that decrepit and useless plates might be made to yield a very large percentage, if not the whole, of their original lead. For it must be remembered that plates deteriorate not by waste but by accretion: an old plate contains as much lead as a new one, but it contains it with the addition of oxygen and sulphur; no longer a tenacious coherent frame, but a crumbling mass of incoherent powder.

The age of plates is a point of vital interest, though but little is known as to the possibilities in this direction at present. A year may be regarded as a fair average age at the present time; but this is a low rather than a high estimate. Thick plates are found to last far longer than thin, which is only natural when it is remembered that the wearing out is due to corrosion, that corrosion proceeds mainly from the surface inwards, and that the internal portions of a thick plate are to a great extent protected by the mass of superincumbent material. If it can be shown, as we understand it can (1), that the cost of materials is far more than the cost of manufacture; (2) that the worn-out material has a market value not incomparably less than the original; and (3) that the frequency with which plates have to be renewed is not such as to cause much inconvenience; then we hold that the first stage of the durability difficulty has been overcome. Much more may be hoped for in this direction as experience increases, and it is not extravagant to hope that a well-ribbed, properly-clamped, and fairly-treated thick plate may last as long as 5 years before it becomes disintegrated.

It is evident, however, that in a region where pure experiment is pre-eminent, and where the units of time are months and years, instead of hours and days, the accumulation of experience is a slow and tedious process. It is no use making statements involving periods of 5 years when no one has had the present improved form in use for so much as 6 months. Nevertheless it is possible to see that the present cells

are better than their predecessors; and as their predecessors have lasted in good condition for a year and more, it is not presumptuous to indulge in well-founded hopes. Many of the difficulties connected with the early forms of battery were aggravated by Utopian notions concerning internal resistance and compactness. The internal resistance of a cell was so beautifully small, that the manufacturers were tempted to diminish it still further by putting the plates far too close together. $\frac{1}{8}$ or $\frac{1}{10}$ in. interval is well enough if the plates had been hard rigid slabs of perfect flatness; but it was madness to pack flexible lead plates full of composition certain to swell and liable to drop out so near together as this. Security and dependableness were sacrificed to a natural desire for sudden and Utopian perfection. We may hope that these lessons have been profited by, and that the manufacturers perceive that confidence and security are the first conditions of success, and that minutiae as to the number of naughts before the significant figures in the specification of resistance begin, though those also are of importance in their turn, are yet of quite secondary consideration. Moreover, this packing of the plates so closely did not really do much to secure the result desired; the greater part of the resistance of half run-down cells is not in the liquid between the plates, but in the surface or scum separating each plate, and especially each negative plate, from the liquid, and hence putting the plates a safe distance, say $\frac{1}{4}$ or $\frac{1}{2}$ in. apart, exerts an effect on the total resistance which is certainly far more than compensated by the ready opportunity thus afforded for access by both sight and touch. The old opaque boxes, choke full of plates, with slight rubber bands between them, were started and left to Providence. No one could see what went on, nor could one readily get at anything to rectify what was wrong. In the present glass boxes properly arranged on accessible shelves, with only plugs or studs between the plates, clear vision

through the cell in any direction is easy, and accidental obstruction not only very seldom occurs but if it does it can without difficulty be seen and removed. But it must be granted that these boxes are less compact than their predecessors, and for some purposes, such as locomotion, compactness is of the first importance.

We have spoken mainly of difficulties connected with the positive plates, and have said nothing concerning the negatives. It is not that these are not susceptible of improvement, but their faults have been of a less imperious and obtrusive nature. They are not perfect, but they do fairly well, and there has been little need to worry much about them until the extraordinary behaviour of positives had been taken in hand and checked. The time is coming to attend to these also. They fail not from exuberance, but from inertness. As they grow old they do not swell, and warp, and burst, and crumble, like the positives, but they grow quietly hoary, and serenely decay. The composition in a worn-out negative consists of white sulphate through and through, but the frame remains intact, and it consequently never falls to pieces, nor does it swell. Impurities in the acid used tell upon a negative plate—nitric acid is fatal. Acid much too weak or very much too strong is also deleterious, and idleness is bad. The difficulties connected with negatives mostly depend on their aggravating property of always requiring a quite opposite treatment to positives. The less a positive is formed and overcharged the better. A negative delights in complete formation and frequent overcharge. In recognition of this it is now customary to form them separately and to give the negative a thorough dose of hydrogen without commencing the corrosion of the positive by an overdose of oxygen. When the discharge from a cell begins to flag, it is the resisting scum of sulphate that has formed over the negative plate which is responsible for the flagging. The true E.M.F. of a cell is wonderfully constant throughout the whole dis-

charge; but the internal resistance is all the time increasing, at first very slowly, ultimately, towards the end, with a rush. One such run-down cell in the midst of a lot of others therefore obstructs the current terribly. If only a series of cells could, with certainty, be made to work together uniformly, if a series of cells could behave as well as some of the cells in it, no one would have cause to complain.—(*Nature.*)

Repeated experiments have shown that the capacity of a secondary battery cell varies with the rate at which it is charged and discharged. For instance, a cell, such as used on street cars, gave a useful capacity of 137·3 ampère hours when discharged at the average rate of 45·76 ampères, and this same cell yielded 156·38 ampère hours when worked at the rate of 22·34 ampères. At the commencement of the discharge the electro-motive force of the battery was 2·1 volts, and this was allowed to drop to 1·87 volts when the experiment was concluded. The entire active material contained in the plates of one cell weighed 11·5 lb., therefore, the energy given off per lb. of active substance at the above high rate of discharge was 62·225 ft.-lb., and when discharging at the lower rate of 22·34 ampères, the available useful energy was 72·313 ft.-lb., or nearly 2·2 electrical H.P. per lb. of active matter. But this active substance has to be supported, and the strength or weight of the support has to be made sufficiently great to give the plate a definite strength and durability. The support of the plates, inclusive of the terminals above referred to, weighs more than the active material, which consists of peroxide of lead and spongy lead, so that the plates of one cell weigh actually 26·5 lb.; add to this the receptacle and acid, and you get a total of about 41 lb. per cell when in working order. 70 of these cells will propel an ordinary street car for $4\frac{1}{2}$ hours, whilst consuming the stored energy at the rate of 30 ampères, or over 5·6 electrical H.P. The whole set of 70 cells weighs 2,870 lb., which is barely $\frac{1}{3}$ of the entire weight of the car

when it carries 40 adult passengers; therefore, the energy wasted in propelling the accumulator along with a car does not amount to more than 20 per cent. of the total power, and this can be afforded so long as animal power is the only competitor. From numerous and exhaustive tests with accumulator cars in this country and abroad, I have come to the conclusion that the motive power for hauling a full-sized street car for 15 hours a day does not exceed 7s., and this includes fuel, water, oil, attendance, and repairs to engine, boiler, and dynamo. We have thus an immense margin left between the cost of electric traction and horse traction; and the last objection, that relating to the depreciation of the battery plates can be most liberally met, and yet leave ample profits over the old method of propulsion by means of animals. (Reckenzaun.)

Telephones.—(a) A good working telephone may be made as follows:—Make 2 tin drums 6 in. diameter and 4 in. deep. They should have a heavy wire formed in same as $\frac{1}{2}$ gal. cup. The wire should not be less than No. 9. Take raw hide that has been divested of hair, stretch it over the drum while wet, and bind it on with a small wire; let it remain till perfectly dry. A very thin hide, such as squirrel, cat, coon, is the best. Thick hide will not work well. Now to erect your drum, wire, &c.; having set your posts and put up your insulators, which may be made of wire and suspended from arms which have been nailed to the posts, bore a hole in the wall where the drum is to be placed, run the wire through your drum and through the raw hide in the centre, having a button ready. Pass the wire through the eye of the button and back through the drum and twist tightly, letting the button go, resting it on the hide. Put up the wire at the different insulators (string loop suspenders) till it reaches the other end of the line; then proceed to do as at first. If the wire has been properly stretched, and all the work has been done as it should have been

done, you will have a good and cheap telephone. No. 18 copper wire for main line should be used. (*American Artisan.*)

(b) I have been for some time engaged in endeavouring to arrange a telephone switch-board and telephone transmitter, which should be simple, easy of construction, effective in operation, and not an infringement of any patent. I believe that I have fully succeeded in all these objects; a patent for the arrangement could only be valid as for a particular combination of parts, and as the combination of parts is susceptible of so many variations a patent would be practically useless. The following description will enable any amateur to make them:—

Switch-Board.—Take a piece of mahogany 8 in. by 4 in. by 1 in., plane it up and varnish it. On the top, at a distance of $\frac{3}{4}$ in. from the top, fix 7 terminals, $\frac{1}{2}$ in. apart. These are numbered in Fig. 131, 1, 2, 3, 4, 5, 6, 7, and are for the following connections: 1 2 3 are connected together by the brass plate as shown; 1 is connected to the return line or earth wire; 2 to the zinc pole of the battery; 3 and 4 to the bell wires; 5 to the carbon pole of the first cell; 6 to the carbon pole of the last cell; and 7 to the line wire. P is a strip of brass with the knob K at the lower end; it is secured by 2 screws at the upper end, and is then bent upwards so as to press against the bridge B, which is a strip of brass secured by the screws at each end, each of which screws passes through a piece of brass tube which keeps the plate B about $\frac{1}{4}$ in. from the board. The piece P is connected by a wire underneath the board (all the connections are made underneath), with the terminal screw 7. Under the knob K is a screw with a flattened head, which is connected with terminal screw 6; this constitutes the ringing key. H is a piece of $\frac{1}{4}$ -in. brass rod with the hook at the bottom, and the round brass disc D about $\frac{7}{8}$ in. diameter, soldered about $\frac{1}{2}$ in. from the upper end; this rod works freely up and down through the two pieces of angle brass A. S is a spiral

spring of brass wire which, when the telephone is taken off the hook, causes this rod to rise, and the disc D then presses the thin pieces of hammer-hardened brass C against the upper

disc D and the other against the upper angle brass A. When the telephone is on the hook, the disc D rests on the piece of brass R, which acts as a contact and as a stop. The total play allowed to D is about $\frac{3}{16}$ in.; the lower angle brass A is connected with the bridge B; the piece of brass R is connected with the terminal 4; and the thin piece of brass C with the upper hinge. T and T' are brass screws to which the flexible wires of the telephone receiver are attached; T is connected with terminal 5, and T' with the lower hinge. M is merely a piece of mahogany to which the pieces C and R are attached.

We now require a square frame of $\frac{1}{4}$ in. mahogany, 4 in. square in outside measurement, and $1\frac{3}{8}$ in. deep; apertures are cut in the bottom side of this to allow the rod H and the ringing key P to move freely. This case is attached to the hinges marked, and with a face piece of pine about $\frac{1}{2}$ in. thick, boxes up the whole of the apparatus, leaving only 2 in. of the board at the top, and the same at the bottom uncovered; a small plate of brass is screwed to this box opposite to the hinges, and one screw into the switch-board prevents the box from being opened.

To the centre of this piece of pine the microphone transmitter shown in Fig. 132 is attached.

This microphone is thus constructed:—Take a piece of pine about $\frac{3}{16}$ in. thick, $\frac{7}{8}$ in. wide, and $1\frac{3}{4}$ in. long; remove part of one edge so as to leave

a projection as shown, and about $\frac{1}{16}$ in. deep and $\frac{3}{16}$ in. square, by which it is attached to the centre of the pine face of the box; put a sawcut down through it

131.

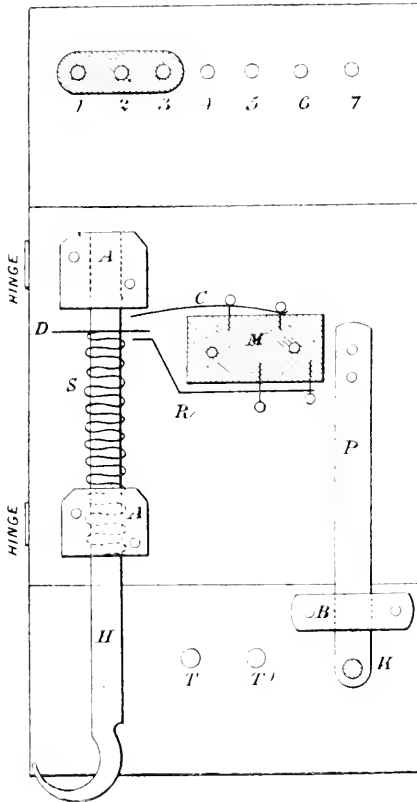

Switch-board.

angle brass A. In order to ensure a good contact, this strip of brass C is slightly canted at the end so as to give two rubbing contacts, one against the

to within about $\frac{1}{4}$ in. from the bottom. Take two pieces of $\frac{1}{4}$ in. carbon rod, E, $1\frac{1}{2}$ in. long, and cut a recess in the middle of each half-way through, and a little more

brass, and then secure the carbons by screws to the piece of pine as shown in E. These pieces of carbon should be parallel, level, and a little less than $\frac{1}{8}$

in. apart; the wire from one carbon is taken to the top hinge, and from the other to the bottom hinge. Some of the carbon rods now sold have a coating of glaze, which is almost a non-conductor. Always remove this with emery-paper. This piece of pine with the carbons attached is now screwed to the centre of the pine cover of the box, and care must be taken that it does not touch anywhere else, and is not touched by anything. The microphone is completed by making two small conical pieces of carbon N, as shown, with a small hole in the centre of each; a lucifer match or other small piece of light wood is then filed or sand-papered down until it is as small as a knitting-needle, and will just go into the holes in the carbon cones. In one carbon cone, put a piece of this wood about $\frac{1}{2}$ in. long, and in the other carbon cone a piece about $\frac{3}{4}$ in. long, and round the bottom of each of these pieces of wood put a small ring of lead wire; they are then put in position on the carbon rods, and appear as shown in Fig. 132, end view, where E is one of the horizontal pieces of carbon rod, and N the carbon cones; they should oscillate freely. Cut these carbon cones from $\frac{3}{16}$ in. rod.

I have long been of opinion that the hard carbon microphone works by make-and-break as completely as the Morse tapping key, and that the suggestions as to minute arcs, &c., were unwarranted by facts. I have also satisfied myself that the Bell telephone or my clear-speaking telephone, and certainly the latter, will reproduce human speech when actuated by an intermittent current, or current of sudden impulses, and that the idea that

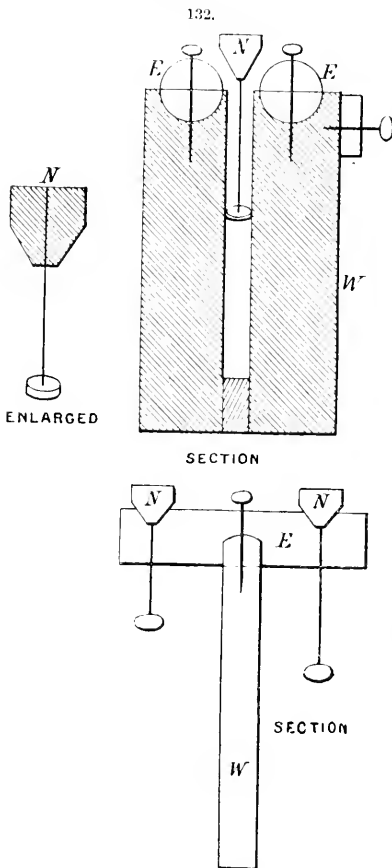

Microphone transmitter.

than $\frac{3}{16}$ in. wide; drill a small hole in the middle of each recess; bend a narrow piece of very thin sheet brass over the top of each arm or leg of the piece of pine; solder a wire to each piece of

phone or my clear-speaking telephone, and certainly the latter, will reproduce human speech when actuated by an intermittent current, or current of sudden impulses, and that the idea that

what Bell describes as an undulatory current is essential to the reproduction of human speech, is altogether untenable. I wanted to get rid of the spark so often seen in a microphone when a strong battery is used, and which has been the subject of so much learned writing. I believed that this spark was merely due to the well-known "extra current," and I determined to try the plan that has for very many years been in use for getting rid of the spark at the contacts of electric clocks and other apparatus. I therefore made a resistance coil of 54-55 ft. of No. 36 B.W.G. German-silver silk-covered wire, which gives a resistance of little more than 100 ohms. I connected the ends of this resistance coil to the two hinges; no spark is perceptible, and the articulation with my clear-speaking telephone as a receiver, is as nearly perfect as anything I have met with in the telephone line. This coil is fastened inside the case above the hinges by a small screw.

I do not advise the use of induction coils with transmitters, and the above-described switch-board must be altered and made more complicated if they are used; but the arrangement is suited for any good receiver. In connecting up two stations, it will, of course, be remembered that the battery connections at one station must be reversed; that is, the carbon wire attached where I have directed the zinc wire to be attached, and the zinc wire attached where I have directed the carbon.

For battery power, I find that the battery required to ring a fairly good ordinary bell works this arrangement well; thus, if two Leclanché cells ring the ordinary bell nicely, then put one Leclanché cell at each end of the line in circuit with the telephone; if three Leclanché cells are required to ring the bell, then put two cells at one end of the line, and one cell at the other end in circuit with the telephone.

I have omitted to mention that outside the pine cover to which the microphone transmitter is fixed, I screw by

its 4 corners a piece of cork $3\frac{1}{2}$ in. square and about $\frac{1}{4}$ in. thick, with a $\frac{5}{8}$ in. hole punched out of the centre. This damps all the sound vibrations, except where they are alone required, that is, in the centre where the microphone is attached, and is a great improvement.

Simplicity and efficiency I have alone had in view, and I believe that anyone, amateur or professional, who may try this arrangement will say that I have fully succeeded; whilst as to cost, this switch-board and transmitter can be made and sold with a fair trade profit for about 15s. (H. B. T. Strangways).

Welding.—(a) The history of electric welding extends over a much longer period of time than is generally supposed. Some years ago, Prof. Elihu Thomson, among experiments by which he intended to prove the substantially identical nature of electrical energy under any and all circumstances, reversed an ordinary Ruhmkorf induction coil, showing thereby the difference of potential between the current in the primary and that in the secondary of the coil. In performing this experiment he brought the terminals of the coarse secondary winding of the coil into contact, and was surprised to notice that a high degree of temperature was reached instantaneously at the point of contact—in fact, such a high degree of heat that the ends were stuck quite firmly together, the copper wire being actually melted, so that it required considerable force to separate them. Later, in the course of manufacturing electric-lighting apparatus, it became an imperative necessity to discover some means of having more perfect joints in copper wire than could then be obtained. Then his mind reverted to the old experiment, and electric welding became an assured art. This discovery was made several years prior to the building of a welding machine. Subsequently Prof. Thomson designed and built a small machine with which to weld fine wires. The experiments with this apparatus were so successful that the inventor decided to build larger

and better apparatus, and experiment further with a view to welding, if possible, much larger pieces of metal. These experiments were also successful, and the invention has been much further developed in the past year or two.

The principle involved in the Thomson process of electric welding is very simple, as indeed is most of the apparatus also. The Thomson process of electric welding consists simply in forcing through the pieces of metal to be welded currents of such large volume that these pieces can carry them without heating. Now, when the pieces are placed in abutment, the point of greatest resistance is where they contact with each other, and it is of course at this point that the heat is first generated. The instant heat is generated at the point of contact, the resistance at that place enormously increases, and a consequent more rapid development of heat is the immediate result. The metals are consequently raised to a high welding temperature in a very remarkably short space of time, and upon a slight pressure being applied to force the pieces together, a perfect welding is effected.

The field that is open for the process of electric welding is surprisingly vast. One of the most important reasons why electric welding is making way so rapidly is that the heat generated by the current is the only pure heat known. The blacksmith, when welding with either a gas furnace or a coal fire, is constantly running the risk not only of burning his metal, but of introducing into it foreign matter in the form of gases which are very deleterious to the substances of either iron or steel, which are the principal metals worked by blacksmiths. The heat generated by the electric current is absolutely free from all foreign and harmful substances. Again, the heat effected by the current is under perfect control, and can be made entirely automatic. The heat can be begun, and a stop put on the apparatus which will control the heat perfectly.

Then, welding by the Thomson process is a much neater and quicker operation; also, no skilled labour is necessary to operate an electric welding apparatus. A young man not knowing anything of the conditions under which different metals should be welded, in a very short time became so expert in handling these machines that he can now, on the first trial, make perfect welds in any of the ordinary metals and in almost all varieties of steel, including even Mushet and manganese steels.

There are hundreds of applications of the process. As an example of small work, the welding of gold rings is an assured success, making a better joint than is now made, doing away entirely with soldering, and in its place making a continuous gold ring; the work is accomplished in about $\frac{1}{3}$ of the time; and soldering material is saved, an enormous wasting of heat is done away with, and the dangers of burning gas are entirely obviated.

As an example of somewhat larger work, there is the welding of axes. The axe is made of a body of ordinary wrought iron, to which is welded an edge or face of fine tool steel, tempered and toughened. The pieces of metal, before welding, have to be prepared somewhat in this manner. That is, a groove is cut in the body of the axe while a taper is cut on the face or blade, the latter being set into the former and the pieces welded in this position. Now, in electric welding this preparation is done away with.

As an example of much larger work, take the welding of pedestals and locomotive frames. This is an entirely different class of work. The pieces have to be carefully prepared, a raised portion being left on the base or edge of the frame, and a taper groove being cut in the pedestal, so that it may fit down over the raised portion referred to. In the first place, on locomotives are 5 or 6 copper rings, the wire composing which is of small diameter. The joints in these rings are at present made with a blowpipe flame, and it

takes an expert some 4 or 5 minutes to make a single one. Electricity can make them in as many seconds. There are also on each one of these locomotives at least 150 joints in iron, from $\frac{1}{2}$ in. area of section to several in. area. Now, it takes 4-15 minutes to make these joints by the ordinary process; electricity can do the work in at least $\frac{1}{5}$ of the time. There are on each locomotive 4 frames, each frame having on it at least 2—sometimes 3, 4, and 5 pedestals. Suppose that the average is 3 pedestals per frame. That makes 12 pedestals to the locomotive. To prepare the ends of the pedestals and the taper on the base of the frame takes some 40 minutes. They have to be heated and hammered into shape while hot. After they are prepared in this manner they have to be reheated to a welding temperature, placed under a steam hammer and welded, this last operation requiring 30-40 minutes. (O. K. Stewart.)

(b) Although large structures of wrought iron and of mild steel commonly have their parts united by bolting or by riveting, and although much ingenuity has been expended in so arranging and proportioning riveted joints as to obtain, in the joints, the greatest percentage of the strength of the material, nevertheless, cases occur in all structures where the union of these metals by welding becomes almost a necessity, or if not a necessity, a matter of convenience and economy. Wrought iron, in addition to its many other merits, has the merit of being, *par excellence*, the weldable metal; mild steel also possesses this merit, but nevertheless there is always a feeling of doubt about a weld, although welds are of necessity largely trusted. No better illustration of this can be given than that of a common chain, each one of its manifold links having a separate weld. In the early days of making suspension bridges, the links, unless the wasteful process of cutting away a large portion of the bar was resorted to, were made by forming the eyes separate from the bar, and by welding them on. To

obviate these difficulties, as long ago as 1845, Howard devised a plan which, while avoiding the necessity of welding on the eyes, avoided also the waste of material before alluded to. Within the last few years a plan of "upsetting" the ends of the bars by mechanical means, so as to obtain the requisite material for the formation of the eye, has been introduced in the United States. Although imperfection in a weld may arise from insufficient heat, or indeed from an excess of heat, or from the application of inadequate power to bring the heated surfaces together, probably by far the greater proportion of defective welds arises from the presence of some foreign body between the surfaces to be welded, or, as it is expressively called, "dirt" of some kind or another. Attempts have been made to obviate these difficulties by employing gaseous or liquid fuels, and, in rare cases, by the removal of the oxide of the metal from the surfaces, by turning or planing. The welds that were successively employed for the welding of railway tires in the days prior to the present system of making these tires by continuous rolling, and in the hoop form, comprised an ordinary scarf weld, bird-mouth welds in both directions, single-wedge welds, and double-wedge welds. In all these cases hammering was employed; but for carriage tires, at all events, the butt-weld was used. In the early days of wrought-iron ordnance, where it was desirable to have in one piece a wrought-iron tube, so long in relation to its diameter that it would have been difficult to have welded it up as a single coil, it was made by welding two coils together, each of about half the length of the desired tube. It need hardly be said that every one of the modes of heating employed involved that the heat should proceed from the outside inwards. There were also the chances of inadequate heat; of an excess of heat; and, as has already been stated, of the presence of "dirt" in the weld. Moreover, there was the difficulty of ascertaining to what state

he heat had attained; commonly in small welds the pieces were withdrawn from the fire, with the consequent risk of picking up "dirt" during re-introduction. Among the desiderata for heating for welding purposes, the mode adopted should admit of uniform heating throughout the sectional area to be welded; it should admit of absolute regulation of the heat; it should be free from the possibility of introducing either particles of fuel or gases between the welding surfaces, and it should admit also of complete inspection during the time the heating is going on. All these desiderata are afforded by electrical heating. As regards the power of an electric current in passing through substances to develop heat, the most familiar instance is probably that of the carbon filament of an incandescent lamp, now so largely used in theatres, in clubs, and in private houses. It is common knowledge that electrical energy is compounded of electro-motive force or potential, or preferentially "pressure," multiplied into the amount of the current, or the pressure multiplied into the quantity. Whenever this electrical energy has to pass through a conductor, the resistance of that conductor to its passage destroys a certain portion of the electrical energy, which energy so destroyed reappears in the form of heat, and must appear in the very conductor which has been the cause of the destruction of the electrical energy. Therefore the amount of heat produced must be that which was the thermal equivalent of the electrical energy destroyed. What the temperature would be, and in most cases it was the temperature reached by the conductor, as the result of the passage of a given quantity of current, which is of importance, depends not only upon the heat-units produced, but upon other considerations. Although electric energy is represented by the multiplication of the pressure into the current, it will be found that the heating effect of any given current is independent of the pressure, and that the heat produced is in proportion to the current

employed. As regards the heating effect of any given current upon different materials, if there were an absolutely perfect conductor, which offered no resistance to the passage of an electric current, no amount of electrical energy could heat it, because no extent of conductor could destroy any part of that electrical energy. On the other hand, in the case of a material absolutely impermeable to an electrical current, it need hardly be said that no heating could result, as no current could pass. Fortunately, the materials commonly welded, iron and steel, hold a very happy position as conductors in the scale of metals for the purpose of being electrically heated. The electrical resistance of metals increases, however, with an increase in their temperature. This question of the increase of resistance due to increase of temperature has been investigated by Dr. Hopkinson, and the results obtained have been published in the *Philosophical Transactions* for the year 1889. This increase of resistance to the passage of the current, as the temperature increases, is of great utility in electrical welding. Consider the two ends of bars to be welded; mere ordinary rough surfaces; the first contact is made upon numerous points, through these the current passes, and they become rapidly heated, and offer more and more resistance. As endway pressure is applied, the surfaces in contact become of larger and larger area, until all are heated up uniformly. The greater current seeks those parts which, although in contact, are at a lower temperature, and this goes on until contact and uniform temperature are obtained. Having regard to the fact that the particular form of electrical energy needed for imparting heat is that of large current and low pressure, it will be seen that there is very great difficulty, amounting almost to a commercial impossibility, of transmitting electrical energy in such a form over any but very short distances, for, unless the conductors were of enormous size, they themselves would be

injuriously heated by the passage of the current; and, moreover, the pressure required to drive these large currents through any considerable length of conductor would be so large a percentage of the working pressure as to add very greatly to the power required. For these reasons it is desirable that the electrical energy should only take the form of large current and low pressure in the very neighbourhood of the welding-machine itself. In all probability the great use of electric welding-machines would be for uniting pieces of special and difficult form, and for dealing with refractory metals—refractory

which have been broken, and to weld best steel for tools on to commoner materials. It is obvious that a machine that gives the power of heating any material with an absolutely controllable heat, and that enables that heat to be inspected and to be communicated without the advent of impurities, must have many uses in the arts, in preparing pieces for brazing, for stamping, and in a variety of other ways; in fact, there can be no doubt that the existence of such a machine will itself give rise to a large number of new uses. (Sir F. Bramwell.)

(c) The reason for which machines

133.

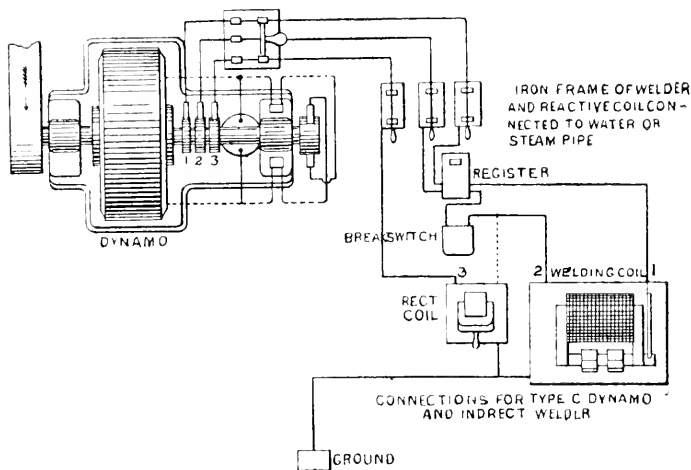

Electric welding apparatus.

in the sense that they do not lend themselves to successful welding by any of the ordinary processes.

At the Crewe works one of these welding machines is in use, shutting on eyes to screwed rods of some $\frac{1}{8}$ in. diameter; the weld is made close up to the screw, which is in no way injured in the process. It has also been employed to weld ends to tubes, to weld together the parts of twist drills

have been invented, has been for the purpose of reproducing faithfully and constantly a set of conditions necessary to obtain a certain result. When the conditions in any case are few, and the product simple, generally one design of machine will be sufficient. With an increased number of conditions, however, the complexity of the apparatus increases rapidly, and demands, in many cases, subdivision into different

processes to be executed by separate machinery. What constitutes skill in a working man, for instance, is the ability co-ordinately to reproduce a number of operations or movements; to be, in other words, a perfect machine, or to produce the same result, even if other conditions than those previously contemplated should arise.

points and low conductivity for heat, easily fusible metals, and especially good conductors, baffle all attempts as long as an exterior heating source is employed.

The electric welding process has not only made it possible that operators not particularly skilled in the art of blacksmithing can produce good sub-

134.

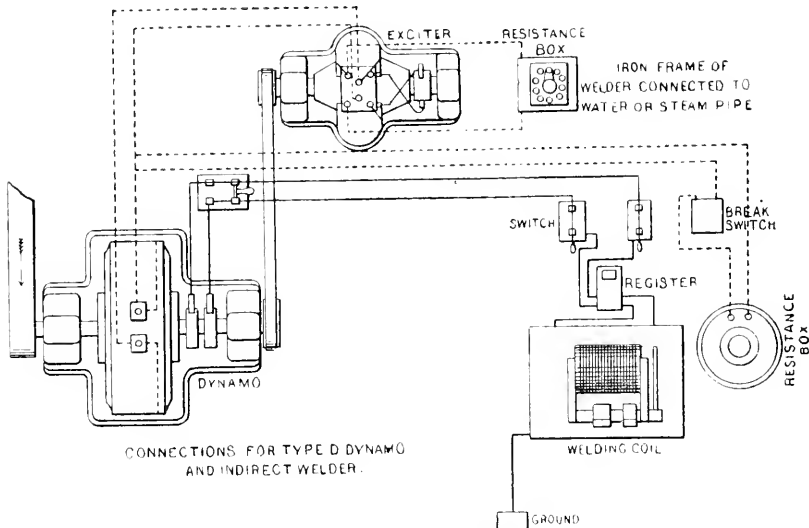

Electric welding apparatus.

To secure uniform results in the practice of a difficult operation, there are two ways possible.

1. To employ skilled help for the complex portion of the work alone.

2. To substitute for the more complex portion of the operation, one more readily controlled.

The ordinary welding process requires the greatest skill at the hands of the blacksmith for heating the metals to the proper temperature and at the right spot, while preventing the accumulation of cinder or scale. While skill may be successful with metals of high melting

stantial welds, but has created an art equally adaptable to all metals and combinations of metals.

The following are all the metals, alloys, and combinations so far actually welded with success by the Thomson process:—

METALS.

Wrought iron.	Tin.
Cast iron.	Zinc.
Malleable iron.	Antimony.
Wrought copper.	Cobalt.
Cast copper.	Nickel.
Lead.	Bismuth.

Aluminium.	Gold (pure).
Silver.	Manganese.
Platinum.	Magnesium.

ALLOYS.

Various grades of tool steel.	Fuse metal.
Various grades of mild steel.	Type metal.
Steel castings.	Solder metal.
Chrome steel.	German silver.
Mushet steel.	Aluminium alloyed with iron.
Stubs steel.	Aluminium brass.
Crescent steel.	Aluminium bronze.
Bessemer steel.	Phosphor bronze.
Cast brass.	Silicon bronze.
Gun-metal.	Coin silver.
Brass composition.	Various grades of gold.

COMBINATIONS.

Copper to brass.	Wrought iron to tool steel.
Copper to wrought iron.	Gold to German silver.
Copper to German silver.	Gold to silver.
Copper to gold.	Gold to platinum.
Copper to silver.	Silver to platinum.
Brass to wrought iron.	Wrought iron to Mushet steel.
Brass to cast iron.	Wrought iron to Stubs steel.
Tin to zinc.	Wrought iron to crescent steel.
Tin to brass.	Wrought iron to cast brass.
Brass to German silver.	Wrought iron to German silver.
Brass to tin.	Wrought iron to nickel.
Brass to mild steel.	Tin to lead.
Wrought iron to cast iron.	
Wrought iron to cast steel.	
Wrought iron to mild steel.	

But Prof. Thomson was not satisfied with his progress made above ordinary welding; he early recognised the importance of a machine in which all conditions for successful operations are mechanically controlled to produce uniform results, work rapidly, and require little or no attendance.

Such machines, now known as automatic welding machines, have proved to

be of special importance in connection with easily fusible metals, enabling the successful welding of aluminium, silicon, and aluminium-bronze, which require, even with the electric process, considerable skill.

Before entering into a detailed description of the automatic welder, a few general data on welding will be in order.

The Thomson process of electric welding can be and has been worked by means of continuous or alternating currents; secondary batteries or unipolar machines may be and have been used. There are such conditions as transportability, absence of motive power, situation in continuous distribution district, &c., which may make it advisable to use the continuous current. The alternating currents, however, have so far been found the best adapted to be economically produced of large volume at low E.M.F. They are easily and economically controlled, and allow of being distributed at high pressure with small conductors, and of being reduced to working pressure wherever needed. They have, however, another beneficial effect, which is of importance in all welds of large sections.

It is a well-known fact among manufacturers of incandescent lamp filaments of large section that the inner portion in a filament is apt to be overheated. In treating filaments as used in the commercial series lamp, in hydro-carbon atmosphere, the writer once thought of producing a specially good quality of carbon by starting with an extremely thin base .004 in. thick, and obtaining a filament 90-95 per cent. of which consisted of hard, grey, lustrous carbon. His idea was also to extend this process to the manufacture of arc light carbons, and even produce pencils of about $\frac{1}{4}$ in. diameter. What was his surprise, however, to find that although the lustrous surface presented at all times a dense grey structure, the core lost this character after a certain thickness of carbon had been deposited. In fact, a number of concentric layers would be discovered, from the inmost graphite to

the dense grey, semi-crystalline at the outside.

This action can in my mind only be attributed to the over-heating of the carbon particles in the inside. A similar action takes place in a bar of iron if heated by an electric current. The surface exposed to radiation will be at a lower temperature than the core. It is true that the heating of the metal will increase its resistance and thus tend to equalise the temperature, but not enough in all cases. By the use of alternating currents we gain, however, an assistance in the self-induction. The effect of the latter is especially marked, and has a tendency to concentrate the heat on the surface.

If there is any place that receives more current than another, the effect of the self-induction is emphasised by the fact that the surrounding part is cool, and its permeability is greater than the part traversed by the surplus of current. With very large and especially wide metal pieces the unevenness of distribution may be remedied by approaching iron masses to create at a given spot a greater self-induction or counter E.M.F., thus diverging the current from that section. Prof. Thomson has early recognised the importance of, and has patented, a device to prevent the heating of the metal at a given spot by creating locally increased self-induction or magnetic effects.

In view of this, it is interesting to note the paper controversy between parties disputing the priority of a device that is to produce exactly the opposite result, with, however, the same means and conditions.

Two methods of distribution are in use: the direct and the indirect. In the former an alternating current dynamo is used, having two windings on the armature, one of which furnishes currents rendered continuous by a commutator to excite the field magnets, and is controlled by switch and rheostat; the other consisting of a single turn of heavy copper cable furnishes the welding current, which is led through collector and brushes to movable copper

clamps suitable to receive and guide the welding specimens during the operation.

In some other forms the field-magnet is the movable part, in which case no

135.

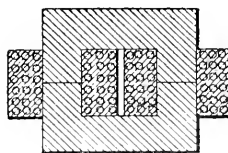

Transformer.

heavy currents have to be carried through collector and brushes. No direct welders are built at present for currents larger than 4000 ampères.

The indirect method of distribution is almost exclusively used to-day. It consists in its simplest form of one alternating current dynamo, self or separately excited, and one welder that is a transformer, with the necessary clamping and operating appliances. The self-exciting dynamos used are 1000-20,000 watts output, and may be regulated by means of a reactive coil to give a varying E.M.F. never to exceed 300 volts.

They are substantially built to withstand sudden strains, and have self-oiling bearings; brushes are never to be moved and perfectly sparkless, requiring no other attendance but cleanliness.

The winding on the transformer being one for all set, variation in the E.M.F. has to be obtained either by varying by hand the initial E.M.F. of dynamo, or to excite a dynamo to the lowest potential required, it being so compounded as to give with the maximum work the increased E.M.F., or finally to maintain a constant E.M.F. at dynamo under all loads, and vary the E.M.F. at the transformer by interposing a variable resistance, or, preferably, self-induction. The transformer itself may be built so as to give a different ratio of conversion, either by moving the primary and secondary relatively to each other, or

by shunting lines of force by means of an iron bridge between primary and secondary, or by altering the number of turns in primary and secondary by a switch.

When a single plant is used—viz. one dynamo and one welder, it is the dynamo generally which, if separately excited, is regulated by means of a rheostat in the exciter circuit or by a reactive coil in series with exciting coil on armature if self-excited. Fig. 133 shows the connections used with a separately excited machine. The only thing different from similar installations is the break-switch, which is operated by a foot treadle, and automatically opens the circuit when foot pressure is re-

136.

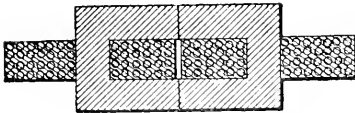

Transformer.

moved. This prevents any mishaps when operated by uninitiated persons, as all action ceases when one leaves the apparatus. The primary voltage never exceeds 300 volts, with 100 alternations or 50 complete cycles per second. Nothing but the very best insulation is used in the primary wiring. It is deemed necessary to protect customers, not only against any shocks, but even against the scare of one, and we recommend to permanently ground the secondary, which in welding apparatus is virtually the table and pressure devices.

Fig. 134 shows the connections used for a self-excited composite dynamo, which has two windings on armature, a longer main and shorter exciting coil. Both are wound in the same direction, and currents generated therein pass in multiple commuted through the shunted field-magnet; after this through line No. 2, controlled by a break switch and split, one returning through reactive coil and line 3, the other through welder

and line 1 to their respective windings. The exciting effects of each circuit add themselves. Reactive coil is conveniently placed near the welder. Dynamo is regulated from minimum to 300 volts, and excited for each weld anew.

For some work which requires to be done at great speed, the second method is resorted to; that is, to keep the field constantly excited by fixing a variable reactive coil in a given position just enough to produce about 150 volts, the lowest E.M.F. required. The proportion of the field-magnets, the E.M.F. of exciting coil, and the resistance of a shunt to field, are such as to produce an over-compounding of 100 per cent. in this case with largest current in primary.

This method of regulation is very nice, as it is absolutely automatic, responds quickly, the field of the dynamo not requiring to "build" every time from residual magnetism alone. We sometimes call it "cubic compounding," as it produces a constant heating effect for variable cross sections and variable lengths as well. With this modification the wiring is slightly altered, the break-switch breaking only the main circuit, leaving the exciting circuit permanently closed.

The methods so far described are only used when a single welding machine is to be operated. It was early recognised that if the process is at all to be used on a commercial basis, that at least the generating of the necessary currents should be limited to as few machines as possible. It required, in other words, a dynamo, giving a nearly constant E.M.F. of sufficient capacity to feed a number of welders while maintaining for each absolute independence.

Since all welding for a long while to come will probably be operated in isolated plants, the dynamo is to be placed in the hands of an engineer generally, not an expert in electrical matters, and has, therefore, to be easily attended and free from all the little faults and kinks which are at present the sole consolation of the dynamo tender. One of its prime requirements are close automatic regulation under all loads.

Constant potential, self-regulating dynamos are manufactured in various sizes, and are self-exciting up to 30,000 watts output. Dynamos with larger

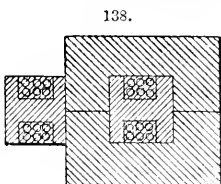
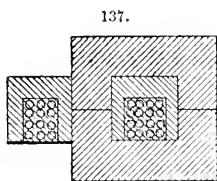

Transformers.

output are separately excited; but also self-regulating. Either constant potential or a percental increase with load can be obtained, and the regulation responds even if the load consists of self-inductive translating devices.

I lay some stress on the regulation of the dynamo for the reason that the generators are not to be placed in the hands of special attendants, as in case of a central station, but have to deliver their currents under constant pressure whatever may be the conditions of work they are subjected to; even an automatic regulator would hardly be able to follow the rapid variation of load.

The following conditions influence the perfection of the work, and are variable with different materials and sizes:—

1. Projection of the abutted pieces in the path of the current.
2. E.M.F. of welding current as controlling the strength of current flowing.
3. End pressure applied to force the abutting ends into each other at welding heat.
5. Interruption of current at proper time.

1. The projection of the abutted pieces varies with the diameter. It has been found that for copper, a projection of twice the diameter for each clamp gives the most economical results. With steel and iron, the most economical projection equals the diameter, and is for brass $1\frac{1}{2}$ times the latter.

The projections sensibly affect the energy required, and the most economical one depends upon the heat-conducting properties and specific resistance of the specimens. Accordingly high conducting bodies require longer projections, highly resistant ones short projections. Conductors of larger and smaller diameters may be welded by giving to each its respective projection. In the same manner may wires of different material be joined to each other.

It is easily understood that since unequal projections on different sized

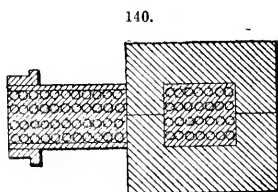
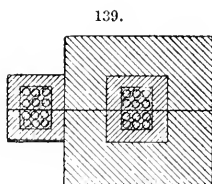

Transformers.

conductors produce the proper heating of both at their junction, equal projection of equal sized conductors will be required. All other conditions neglected, it is important to keep the projection for a given size and material constant.

2. The E.M.F. required depends upon the projection and the resistance of the material to be welded. For larger

cross section, the specific self-induction plays an important rôle, and indirectly the shape of the specimen.

Another factor affecting the E.M.F. is the resistance between clamps and material and the resistance of copper conductors. The E.M.F. required for iron and steel is nearly double that for copper, and would be 4 times if equal projection were used for both.

A certain drop of E.M.F. will be found from the clamps to the specimens. This drop is rather low on material having naturally bright surfaces, as, for instance, copper, brass, German silver, tin, or even cold-rolled iron and steel. For a large class of work, however, especially in carriage hardware, the surfaces to be used for contacts have a light scale left after passing through the rolls, which has either to be removed by grinding or filing, or to be overcome by the E.M.F. of the current. In a good many cases, the introduction of a special process of cleaning is deemed to be more expensive than to use a little extra power to work through the scales.

3. For uniformity of result the end pressure required to press the abutting specimens into each other at welding

141.

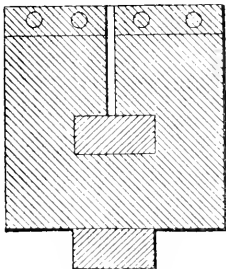

Transformer.

heat is of more importance than any of the former agencies: this is, in fact, the one which controls and rectifies any inaccuracies in the former conditions. If the pressure necessary for a given size and material is used, the weld cannot

be performed until the metal has acquired the necessary plasticity to yield to the pressure. If, for one reason or another, the E.M.F. and, consequently, the current should have been too strong, the time necessary for welding alone is affected, and in this case shortened. The bars will, however, be united at the same temperature and with the same force, whatever the time may have been used to bring about the plasticity necessary. The pressure will in some respects influence the heat by forcing the metals into each other at either higher or lower temperature, and by so doing cause the action to be interrupted at an earlier or later period, as may be required.

The pressure required varies with the material, and is approximately 1800 lb. per sq. in. for steel, 1200 per sq. in. of iron, 600 lb. per sq. in. of copper. It varies also with the area of cross section, as indicated by its being expressed a function with the surface as one of the factors.

4. The interruption of the current as soon as the weld is completed is important for all easily fusible metals. When two copper wires are welded together, the welded portion being increased in cross section owing to the end pressure, if the current is not interrupted a large portion of the conductor on either side of the weld, including the latter, becomes heated, and will melt and be torn asunder before any pressure device could follow and over-bridge the gap.

The current should, therefore, be interrupted as soon as the weld is completed. It is also sometimes required that the parts to be welded should be of a certain predetermined length, in which case the interruption of the current as soon as the allowable distance has been reached is essential.

All these conditions are maintained constant in the automatic welder before us, which is the first commercial type of its kind. This welder is not entirely automatic in the strict sense of the word. The degree of automatic action has to be considered for each individual

object separately. This machine contains, however, the leading features as covered by Prof. Thomson's patent, with a few improvements in mechanical construction. The capacity of the machine is nominally copper wire No. 6 to No. 17 A.G. It will, however, weld larger and smaller sizes. It weighs 130lb. complete; the secondary is one solid copper casting of a cross section resembling a hollow square box with one of the sides removed.

This casting is firmly screwed to an iron table. A saw-cut at right angles to the plane of loop creates the two poles, one insulated from the table, and the other constituting a V-shaped bearing suitable to receive a sliding clamping device.

The hollow part of the secondary is to receive the primary coil which is

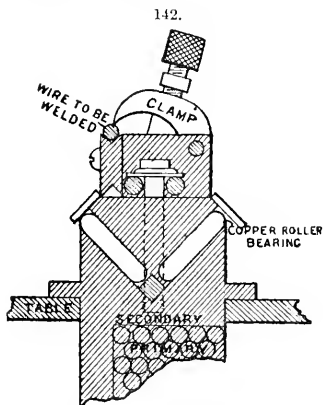

Arrangement of Clamps.

separately wound in a form and insulated with special care. Two U-shaped laminated iron cores embrace primary and secondary.

It has been found that the best form of transformer is the one in which the primary and secondary coils are coaxially placed on an iron core, so as to oblige all lines of force generated by the former to cut through the latter. If the two windings are placed side by side on an iron core or on opposite legs,

as shown in Fig. 135, there is a tendency to form consequent poles at the point where the two windings meet, due to the leakage of lines of force. The leakage will depend upon the distance between the two legs and upon the length of magnetic circuit. It has been purposely increased and turned to advantage by Prof. Thomson, for obtaining constant current in the secondary while the primary is supplied with constant E.M.F., Fig. 136. When, however, constant E.M.F. in secondary is required, it is important that this leakage should be decreased to a minimum.

Various forms of secondary may be employed to work consistent with the above principle. A few of these are shown in Figs. 137, 138, 139, and 140, in which cases the secondary is preferably a solid copper casting. Forms shown in Figs. 140 and 141, however, permit hard rolled copper plates to be used.

For mechanical reasons and convenience, forms Nos. 137 and 138 are mostly used, and actual experience shows practically no leakage. This construction permits of removing the primary without disturbing the secondary in the least. It also gives the least possible self-induction for a given cross section.

It is often found stated that when large quantities of alternating currents have to be conveyed through copper conductors, it is important to have the same laminated or subdivided in smaller conductors to reduce self-induction. This may be true to a certain extent. The shape of cross section is, however, far more important than the lamination.

An experimental compound conductor, consisting of a number of flat copper ribbons in parallel, showed a self-induction of *three* when the ribbons were closely packed, of *two* when separated into two parts, and *one* when spread open like a fan.

The explanation for this was given by Prof. Thomson, when he showed self-induction to depend mostly upon the length of the lines of force surrounding a conductor when traversed

by intermittent or alternating currents.

The pole which is insulated from the table constitutes the stationary clamp. The uninsulated pole, which is considerably larger, has on its upper side a long V-shaped groove parallel with the axis of the secondary, Fig. 142. A movable copper block, also V-shaped, fits in the bearing, and can be slid in the same forward and backward.

This movable block carries the second clamp. The current necessary for welding has to pass through this sliding contact. The welding of small copper wire, or any other easily fusible metal, is a very difficult thing, if special apparatus is not used. The current required is very large, several hundred amperes for wire not larger than No. 17 A.G.

The metal when it reaches welding heat readily melts away, and has to be followed by the movable clamp, so as to prevent the breaking of the circuit. This latter action, when it occurs, is so violent that a special device is necessary to prevent injury to the coil in case of such a rupture. The movable clamp, in order to follow the softening of the metal, has, therefore, to have as little friction as possible, and yet has to make a good contact to carry the heavy currents. The clamp is furthermore required to move in true guides so as to abut the small conductors with their axes in line. The heating necessarily brought about when rapid and continuous welding is done must not interfere with the bearing, and cause the carriage to stick through expansion.

All these conditions have been complied with in using the V-bearings, the carriage being held down in contact by means of a heavy spring, and number of copper rollers being interposed between the carriage and the bearing, Fig. 142. The copper rollers are simply short pieces of $\frac{1}{4}$ in. hard-rolled copper wire rounded at the ends. There are 16 altogether, 8 towards the front and 8 towards the back of carriage, equally distributed on both sides of the bearing.

A stationary rod at apex of bearing prevents the interference of the two

rows of rollers. Between the two sets of rollers in front and in back a bolt passes applying the spring pressure, forcing the carriage into contact with the bearing. A pressure of 40lb. may be employed, and yet the carriage will move freely. These 16 rollers have to transmit a current of approximately 3000 amperes. They absorb about 20 per cent. of the total energy, which loss is, however, fully balanced by the reliability and simplicity of the device. This loss is, moreover, only on the maximum sizes, and becomes insignificant on small work.

An adjustable coiled spring pulls the sliding clamp toward the stationary one. In front and pivoted on a lever is the distance gauge, which may be inserted between the two clamps. This gauge carries on a central disc a number of steel pins of varying lengths, but equal projection on either side of disc. These projections, if inserted between the two clamps, give the necessary distance required for a given size wire, the disc against which the wires are abutted ensuring equal projection of both ends to be joined. On the back of the apparatus a switch is located in the primary circuit, which is normally held open by a spring. By moving the handle to the right the primary will be closed, and the switch locked by a little catch underneath the table. A pin fastened to movable clamp will lift the catch and release the switch, thus opening the circuit.

An intermediate lever between catch and pin operated by a sliding rule, which serves also as an index, permits of varying the point of cut-off, which has to be in a certain relation to the distance between clamps. The position of cut-off, tension of spring, distance between clamps corresponding to each other, are marked with the same figure, which is also inscribed on a wire gauge fastened to the welder. By inserting a wire into the gauge the number read will give the necessary adjustments at once.

If, by imprudence, the switch should

be moved to the right while no stock is inserted and the clamps in contact with each other, the switch cannot be locked, and the fuse in primary will be blown, without, however, causing any damage.

The insertion of the distance gauge between clamps locks the switch, so that primary can only be closed after withdrawing the gauge.

The operation is as follows:—

1. The wires to be welded are gauged.

2. The distance gauge and cut-off are set to correspond with number on gauge.

3. The movable clamp is moved to the right and gauge inserted.

4. Both wires are securely clamped, care being taken to abut the ends squarely against the disc.

5. The gauge is withdrawn.

6. The switch is moved to the right.

7. The reactive coil moved toward a position of minimum reaction, and restored to maximum after weld has been completed.

8. The clamps are opened and the weld removed, after which the operation can be repeated.

If a good many welds of the same size material are to be made, the reactive coil may once for all be set in a given position, and the switch alone be operated.

Welds made with the automatic machine have attained a uniformity not obtainable with very skilled operators working without it. In fact, small, easily-fusible wires can scarcely be welded with certainty with ordinary apparatus. For aluminium especially the automatic apparatus is needed.

The reactive device used in connection with welders is the type recently described by Prof. Thomson, in which a cast is made to more or less cover the primary, the self-induction of which is to be altered. To obtain still a larger range, the windings of primary can be coupled in series, or multiple series, or multiple, by a switch in base of coil.

As mentioned before, the welding of easily fusible metals may sometimes cause a rupture of the secondary cir-

cuits, which, owing to its violence and volume of energy, may cause a burn-out of the primary if not guarded against. This danger is not very great in the automatic machine, since the end pressure does not depend upon the attentions of the operator. A special device is, however, used as an extra precaution against all emergencies.

Breaking a high-tension circuit rapidly is not easily done. An arc generally follows the break, and this lengthens the time of the rupture. If the voltage of the circuit to be broken is so low that over the slightest distance an arc cannot follow, the break will be instantaneous. This is the case with the secondary circuit of welding transformer. The voltage, being ordinarily only one volt, would, even if increased tenfold, not be able to maintain an arc. However, multiplied in the primary it will cause E.M.F. sufficient to pierce through the insulation as ordinarily used. This action is similar to a Rhumkorff coil, in which the interrupter is caused to break under oil or water. The discharge is taken care of by a special apparatus.

While the machine before us is only one type embodying the principal features contained in all, others have been manufactured, or are in process of construction, in which the automatic character has been carried out even further, as in the welding of rings and chains. The present model in its first form is able to produce 250 ft. of chain in a day without any attendance to speak of, the plain wire being fed into the machine at one end and the complete chain coming out of the other.

The automatic principle is, however, not confined to small conductors. We have welders with 40,000 watts output, capable of welding 1 in. copper or 2 in. iron, constructed and working daily on that plan. The projections are determined by adjustable stops; the pressure, the most important of all, is hydraulic, and regulated by an automatic reducing valve, the exhaust being used for cooling clamps at the same time. The primary is controlled by adjustable

reactive coils from a constant potential circuit, and is interrupted at the proper time by the clamps. While not all machines to-day are operated on this plan, I am convinced that the evolution of the welding process tends in that direction, and that the welding in future will be, in the full sense of the word, a purely mechanical operation. (H. Lemp.)

A method of welding by electricity, devised by Nicolas Von Benardos, of St. Petersburg, has recently attracted considerable attention on the Continent, and possesses several features which render it quite distinct from the various processes of fusing and reducing by means of the electric current or the electric arc, proposed from time to time by Siemens, Clowes, Thomson, Wallner, and others. It seems, moreover, to be thoroughly practical. An account of the process, together with a description of the advantages which are claimed as resulting from it, has been given by Prof. Ruhlmann, of Chemnitz, after a careful study of the Benardos process at St. Petersburg; and the following account follows closely his able and interesting articles published recently.

Benardos works directly with the electric arc produced between a carbon pencil as one terminal and the metal to be treated as the other terminal. This has been suggested and tried before. But the carbon was made the negative pole, as it was feared that otherwise the consumption would be embarrassingly rapid. Hence the metal became the positive pole, that is to say, it became exposed to energetic oxidation; and a great deal of the trouble experienced by other experimenters arose from this circumstance. In the Benardos process the carbon forms the positive terminal; it is, of course, quickly consumed, but can easily be replaced; on the other hand, there is a favourable reducing action going on in the fused metal. The great importance of this modification can easily be tested by changing the poles, when the work soon becomes enveloped in a dense cloud of oxidised products. The intense heat of the arc melts even the most

refractory metals almost instantaneously; but the action is purely local, like that of the blowpipe, and only those parts upon which the arc plays directly are attacked, the adjoining portions undergoing little change; and the fused mass solidifies and cools very quickly. In the Benardos process the material requires little or no preparation. Even a pretty thick layer of oxide will be reduced and drop off, while smaller quantities of oxide unite to form a slag with the sandy clay frequently added as a flux. This slag prevents the oxidation of the metals while cooling. No other fluxes are required. The operations can also be carried on under water, although the gases and steam generated cause trouble. Nevertheless, an apparatus has been constructed to facilitate such work by forcing the water away from the parts to be treated by means of compressed air. One of the chief advantages claimed for the new system appears to be that the arc is brought to the work, and not the work taken to the arc, which would mean transformers, crucibles, or other apparatus. Size is hence a question of secondary importance, and unwieldy pieces may be dealt with, although for soldering work of the ordinary kind a special operating table is employed as more convenient. An accident at Struve's emery works, St. Petersburg, directed general attention to this process. The works have a vertical boiler with heaters, some of which had become leaky, and the works were practically at a standstill. The consulting engineer declared that the repairs would be rather expensive, and might occupy 3 weeks' time. Benardos inspected the boiler, and offered to repair the heaters that very day. The boiler was put on a truck, taken to his works, treated electrically on the truck, and wheeled back, all in 3 hours. Prof. Ruhlman saw the boiler in full action the next working day. Fig. 148 is reproduced from a photograph taken during these repairs, and illustrates the simplicity of the process. We may mention another case reported by Prof.

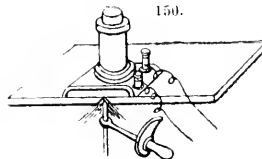
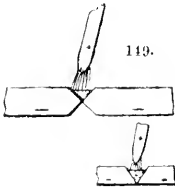
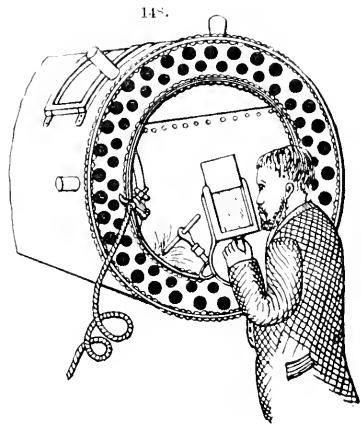
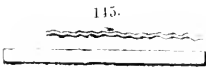
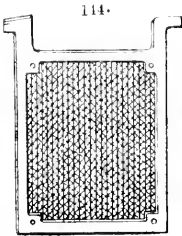
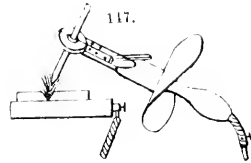
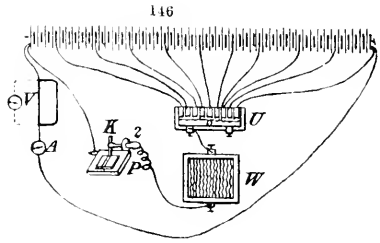
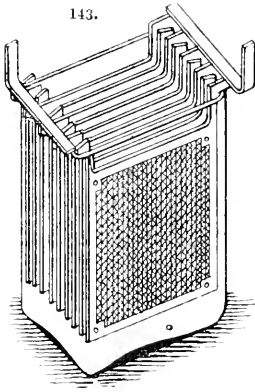

Ruhlmann. A cast-iron flywheel of more than 5 tons weight had been broken into several pieces while being taken down from the truck. The pieces were fused together within a few hours, and the following day the flywheel was in place and at work.

A glance at Figs. 143-50 will give an idea of the great variety of circumstances under which this process is applicable. It is clear that flywheels cannot be treated in the same way as telegraph wires; and that a soldering and welding plant, to be really useful in the workshop or foundry, should be able to deal with delicate articles of a few lb. or oz. in weight equally well as with heavy pieces. Economy will in general be in favour of one source of power for the various operations; but then the operator must have thorough command over the volts and ampères of his currents if the arc is to have the proper volume and temperature. The length of the arc may, within small limits, be adjusted at will; the currents themselves may be modified with the help of resistance coils. But this is not sufficient. Supposing that the workman has to do a little tin soldering, and to weld two large thick boiler plates a few minutes later, he must be in a position to vary both tension and quantity of the currents within very wide limits. A dynamo alone would not do, there must be accumulators also, and these of a special kind capable of being charged with strong currents and discharged either at a few ampères or at several hundred times that amount. Faure accumulators are not adapted for such work, nor are those of the Plante type, as they cannot store up sufficient quantities of electricity, although they bear strong charging and discharging currents. Benardos has constructed accumulators for the work which are not strikingly novel, but seem well fitted for their special purpose. Prof. Ruhlmann saw at St. Petersburg some cells in very fair condition which had been in use for more than $1\frac{1}{2}$ year. It is further noteworthy that at the Creil works, where the Benardos processes

have been under trial for some time, serious difficulties had to be encountered until the accumulators already there were exchanged for the Benardos battery. The complete cell (Fig. 143) weighs 35 lb. and contains 9 lead plates (Fig. 144), all of the same kind, 4 positive and 5 negative, with $1\frac{1}{2}$ sq. yd. total surface. Each plate consists of a frame cast of pure lead, 6 in. by $7\frac{3}{4}$ in. surface, and $\frac{1}{2}$ in. thick. The interior of the frame is filled with strips of thin lead, alternately straight and corrugated (Fig. 145), soldered into their places; the latter strips are bent in such a manner as to facilitate upward currents in the liquid. Such currents arise during charging, owing to the development of gas, which, if kept within proper limits, is thought advantageous to these cells; the upward currents equalise the difference in density; the curvature of the bent strips favours the liberation of the small gas bubbles, and checks the formation of larger bubbles, which would cause buckling. Caoutchouc prisms separate the positive and negative plates, the poles of which are simply soldered to stronger lead strips running along either side of the cell. Diluted sulphuric acid of 1.25 sp. gr. circulates freely between the plates. The total weight of the complete cell (35 lb.) is made up of 24 lb. for the 9 plates, 8 lb. for the acid, and 3 lb. for the glass jars. The cells have an interior resistance of 0.002 ohm and give 2.5 volts, when continually charged while at work; 50 to 70 of these cells are joined in a battery; several batteries, 3 for instance, are grouped in parallel, and are continually charged by a shunt dynamo. Fig. 146 explains the ordinary connections. The shunt dynamo charges the 50 accumulator cells in series; a voltmeter and an amperometer are inserted at V and A. From the positive terminal of every fifth cell a wire leads to a plug switchboard U; from U the current passes through a variable resistance W, and from thence through a flexible cable to the carbon holder Z and the carbon pencil K. The operator manipulates his holder Z, the metal to

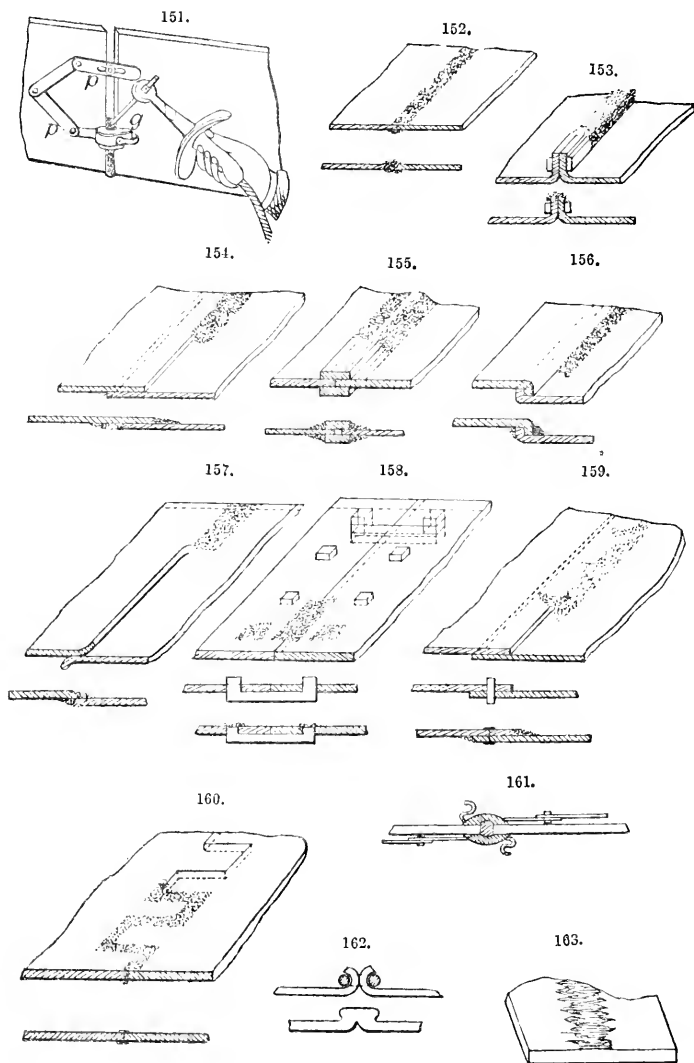

Electric Welding.

be fused, placed upon the table P, being joined directly to the negative terminal of the battery. By inserting the plug in the switchboard U, the operator may obtain currents from 5 cells, twice 5, and so on to 10 times 5 cells. If considerable masses of metal are to be dealt with, currents of considerable strength are needed. These are obtained by grouping the batteries or certain sets of cells in parallel. Supposing the dynamo gives currents of 175 volts and 120 ampères, that there is a battery of 70 cells coupled in series, and that it is desired to solder two boiler plates $\frac{2}{8}$ in. thick. The carbon holder is connected with the positive terminals of the fortieth cells of 3 groups. The carbon pencil is allowed to touch for a fraction of a second, and is taken off again immediately, so that between the plates and the carbon pencil an arc of a few millimetres length is formed. The iron melts like wax; but the action seems too powerful, the molten metal hissing and evaporating distinctly. In such a case one of the 3 parallel groups is cut out. Should the action then be too sluggish, one or more parallel groups is added. Sometimes the arc proves too small or extinguishes frequently; in such cases the number of cells in each group has to be increased.

The carbon holder (Fig. 147) resembles a pair of scissors, and consists of two copper bars having a round hole near the end, in which the pencil is held firmly, either by the friction of the parts or by means of a little wedge as shown in the figure. The flexible cable passes through the wooden handle. During working, the holder becomes hot, and may have to be cooled by plunging it into cold water. The operator wears strong leather gloves, and his hand is further protected by a metal screen fixed on the holder. He looks at his work through a dark glass as in Fig. 148, which protects both his eyes and face from the radiated light and heat better than ordinary dark spectacles would do. The lungs also may need protection from the vapours of copper, lead, and other metals or

alloys. When possible, means should be provided to carry off such vapours with a blast of air. The construction of the holder permits of a quick replacement of the carbon pencil. The diameters of these carbons vary greatly. For more delicate work, where a few cells would suffice, fine pencils of only $\frac{1}{16}$ in. are required; while boiler plates, such as mentioned above, are welded together by means of thick carbon rods of up to $2\frac{1}{2}$ in. diameter. The carbon is pointed before using it. Ordinary light-carbons do not answer well, as they are generally too soft; the inventor prefers Carré carbons.

One of the most important applications of the new process is for welding plates of all thicknesses. For the very finest sheets of 1 mm. and less, the Electro-Hephaest Company prefer a modification of the Elihu Thomson process, although their own process is sometimes equally good (compare Figs. 168-170). But all stronger plates up to several centimetres thickness are subjected to the arc.

To effect this with ordinary plates, the edges are feathered as in Fig. 149, and pressed together. The furrows are filled with little pieces of the same material, and the arc is then applied while fresh pieces are added until the furrow is completely filled with the molten mass. The plates are immediately afterward finished under the hammer. In making iron welds, the small pieces for filling are always of wrought iron. With iron, a flux of clay sand is recommended; with copper, borax, or sal-ammoniac. When the plates are joined on their lower surface, Benardos suggests a powerful electromagnet, placed as indicated in Fig. 150, to prevent the liquid metal (provided the material be para-magnetic) from flowing off; whether this suggestion will prove practical is doubtful. The apparatus shown in Fig. 151 looks more practical; it is intended to be employed when making vertical seams. The pincers *p* carry two pieces of graphite or coke *g* forming a sort of chamber at the spot where the fusion is to be

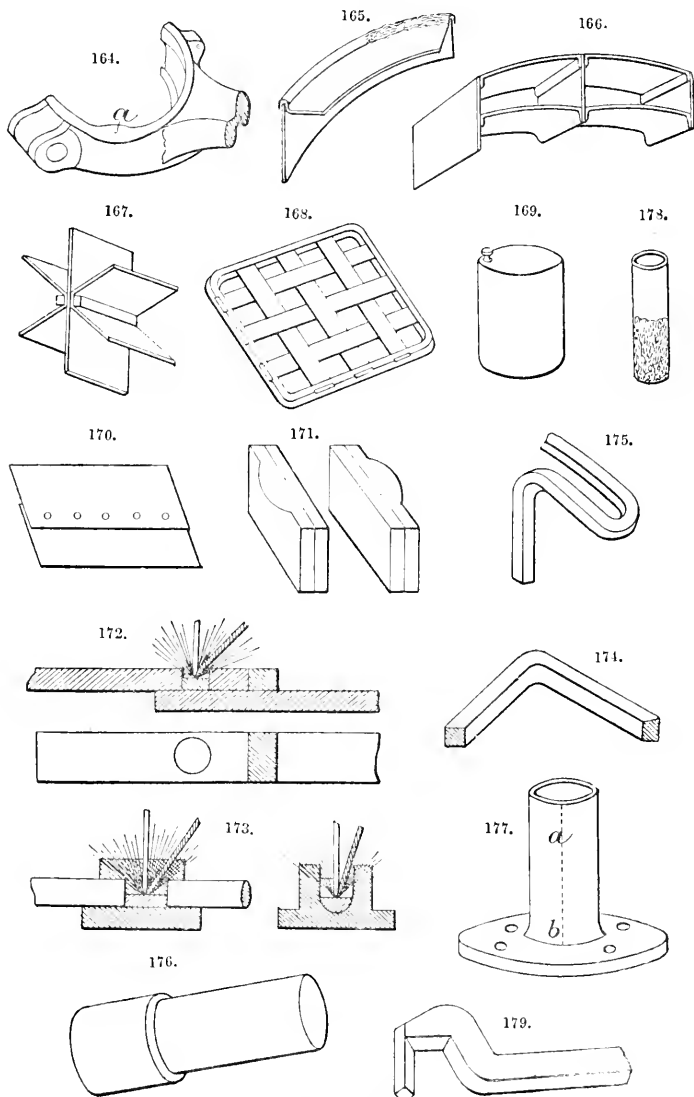

Electric welding.

carried on. As soon as the mass has hardened sufficiently, the carbon pieces are pushed farther up. Carbon pieces are frequently employed to prevent the flowing off of the fused material. Figs. 152-161 exemplify other ways of joining plates in cases where a perfectly straight surface is not insisted upon. For thinner plates, the method Fig. 161 seems to offer particular advantages; for two $\frac{1}{8}$ in. plates a seam 1 yd. long can be made in 7 minutes. When plates are to be joined at an angle, the process is of course exceedingly simple.

If two iron bars are to be joined end to end, the one bar is roughly centered in a lathe, and the other pressed against it; the body of the lathe is connected with the negative pole. A few momentary touches with the carbon will make the two bars stick together sufficiently so that they move as one piece with the lathe. While the lathe is turned slowly, the welding is effected by the addition of material in small quantities at a time. To join two telegraph wires, the ends are bent (Fig. 162), a little iron ring is pushed over the hooks, and the whole is fused into a sort of button; the resulting joint leaves nothing to be desired as to conductivity and breaking strength, and the whole operation can be accomplished with a few cells, and in 2 minutes for 4 mm. wires.

So far we have only spoken of joining materials of the same kind. But the intense heat of the arc supplies alloys which are hardly known under other circumstances, so that iron and copper, tin, zinc, lead, steel, cast iron and steel, wrought iron and steel, aluminium and platinum, etc., can be united. This promises important progress in the working of metals. Prof. Ruhlmann has exhibited specimens of iron plate welded to red copper, iron plated with tin, and iron plated with lead. In such cases there is probably at the junction of two metals a layer of alloy. Chemical manufacturers would be thankful for cheap copper retorts coated inside with platinum, or iron vessels coated with lead. Prof. Ruhlmann saw at St. Petersburg a number of copper tubes

soldered into a cast-iron plate, and this iron plate coated with copper several mm. thick.

If the metals can be joined by the electric arc, they can also be separated by the same means. For instance, holes can be made if the metal is permitted to flow off. To pierce a hole 1 in. diameter through two plates $\frac{1}{2}$ in. thick takes about 4 minutes. The next step is to rivet the plates in this way; this is shown in Fig. 159, where they are $\frac{1}{2}$ in. plates, the rivet $\frac{3}{8}$ in. thick, and the operation took 8 minutes. It seems, however, more advisable to punch or drill the holes.

It has been said, above, that the materials undergo little chemical change under this treatment. The question seems very important for iron, whose behaviour is so remarkably influenced by slight variations in the composition. To test this question, wrought iron droppings from the welding process were fused again by means of the arc to a bar of about 15 mm. thickness, and this bar turned down to 10 mm. The breaking weight of this bar was 23.8 tons per sq. in. with an elongation of 17.5 per cent. The fracture was fibrous, like that of soft steel. This electrically fused iron (Fig. 175) resembles soft steel in other respects, notwithstanding its origin; it is malleable, can be welded, can be bent both hot and cold, and is scarcely harder than soft steel. The following table gives analyses made by Vieuville. The columns B refer to the original metal before electrical treatment; the A columns show the composition of the metal after the treatment. The changes are slight, and appear rather favourable.

The tensile strength tests of electrically made joints yielded most satisfactory results. Two pieces of rolled charcoal iron, joined as in Fig. 152, showed a breaking strength of 18 tons per sq. in., the iron itself giving 21 tons; the elongation was 9 per cent. In another instance, 93 per cent. of the initial tensile strength was observed. A plate riveted electrically rent finally outside the riveting line. The electri-

	B.	A	B.	A.
<i>Steel.</i>				
Carbon.. ..	0·44	0·22	0 52	0·29
Silicon.. ..	0·03	trace	0·05	trace
Manganese	0·57	0·14	0·42	0·36
Sulphur	0·041	0·036	0·039	0·035
Phosphorus	0·102	0·100	0·07	0·050
<i>Iron.</i>				
Carbon.. ..	0·38	0·15	0·30	0·13
Silicon	0·03	0	trace	0
Manganese	0·53	0·16	0·36	3·30
Sulphur	0·160	0·120	0·110	0·070
Phosphorus	0·137	0·124	0·105	0·087

cal riveting or the joining of plates without rivets, particularly as in Fig. 152, seems to offer material advantages for some purposes.

The remaining figures illustrate specimens exhibited by Prof. Ruhlmann before the Electrotechnical Society. Fig. 163 is a cast iron plate, Fig. 164 a cast iron eccentric broken in pieces and joined again at *a*; the junction is said to be quite homogeneous, and neither harder nor more brittle than the solid metal. This suggests the finishing of cast iron pieces by means of the electric arc. Fig. 165 represents a piece of a cask, Fig. 166 part of an iron boat. That even finer plates may be subjected to this process is demonstrated by Figs. 167 and 168; but as already remarked, for very fine plates and wires the Elihu Thomson process appears preferable. Fig. 169 is a specimen of neat workmanship, a little steam boiler, formed out of three pieces, shell, top, and bottom. A section through an electric rivet is illustrated in Fig. 171; Fig. 172 shows how the so-called half rivet is made, and Fig. 173 how stronger bars are joined. In Fig. 174 a bar welded in this manner has been bent cold under the hammer at right angles at the line of junction. The specimen Fig. 175 consists entirely of electrically fused iron which has already been described; it has been bent cold without showing any fissures or irregularities. The shaft Fig. 176 was formed by fusing

together three pieces. The iron tube Fig. 177 was welded at *a*, and provided with a flange at *b*, by the same process; the copper tube Fig. 178 is also a specimen of electric welding. Fig. 179 is a turning tool of ordinary iron with a steel bit welded to it.

These instances do not cover the whole field where electric welding and soldering might advantageously be applied. Chains may be produced with welded links, tools provided with steel points and edges, cables joined, pans made without rivets and plated, and many kinds of repairs, especially in cast iron, become possible. The process will probably be studied with particular interest by the shipbuilder. The cost of such a welding plant would not be heavy. The dynamo and accumulators could weld and repair during the day and provide light in the evening. This would be one more reason for introducing electrical power into the workshop. (*Engineering.*)

Several patents have recently been granted to Elihu Thomson for improvements in welding apparatus, one of which is illustrated in Fig. 180. It comprises two rotary electrodes *RR'*, one of which is suitably insulated from the supporting base, to which electrodes a current of large heating volume is led by means of the brushes *CC'*. Suitable means, as the screw *S*, indicated, are provided for throwing the rollers into closer, or more remote adjustment. The

two pieces of metal which are to be welded in a continuous line, are introduced between the electrodes and fed gradually forward, the weld being produced by the heat developed in the strips as they move between the rolls. These strips are indicated in the engraving. By making the rolls of

developed is in proportion to the resistance, danger of burning is incurred. In order to avoid this the pieces to be welded when placed in the clamps and pressed into good contact, have the current admitted suddenly in a large amount, causing a rapid accumulation of heat at the joint, and when the welding temperature is nearly reached, the current is diminished by means of a core suddenly thrust into a cell in the primary circuit, thus choking off part of the primary current and reducing the strength of current in the welding circuit.

Another invention of Prof. Thomson's consists in maintaining at the holding clamps, or at the point where the current enters the work, an alternating current of fairly uniform potential, so as to produce a gradual heating of the work automatically through a gradual increase of resistance due to rise of temperature. The primary circuit is supplied with an alternating current of uniform character as to potential, so that as the resistance at the joint varies by reason of the increasing heat, the strength of

current will be lowered and danger of overheating be obviated.

Wire Insulating (c).—A new method of insulating electric wires has recently been adopted in Germany. Paper is first of all prepared by soaking in an ammoniacal solution of copper, a process which confers upon the paper durability and makes it impervious to water. The pasty mass so prepared is now applied to the wires to be insulated, by means of a special machine, after which treatment the coated wires are dried, and finally passed through a bath of boiling linseed oil.

(b) Having had occasion for a year to apply for the decoration of articles of jewellery, the procedures pointed out by Nobili and Becquerel for obtaining coloration by means of baths of alkaline plumbates and ferrates, I

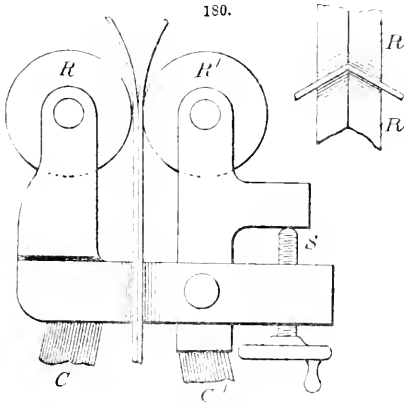

Electric welding.

suitable section, various conformations may be given to the product of the welding operation, one design of the invention being to produce tubes or pipes having a continuously welded seam. In the detached view is shown a number of rollers R R' , for producing a weld between two pieces of metal, resulting in a trough having a ∇ -shape in cross-section.

Prof. Thomson has also patented a method of welding involving the idea of gradually or suddenly throwing on a current capable (if continued) of heating the pieces to be welded beyond the necessary temperature, and then, before such temperature is reached, diminishing the current, with the effect of preventing overheating or too rapid heating. In some cases the resistance during the welding operation rapidly rises, and as the amount of heat

observed that the articles thus coloured became absolutely proof against all galvanic action; that is, their surfaces, when once coated with peroxide of lead or of iron, were insulated, and no longer conducted the electric current. A wire of copper, brass, or even iron, may thus be coated with an insulating layer like a stratum of resin or gutta-percha. This principle, I believe, admits of easy utilisation in preparing wires and cables for use in telephony and telegraphy. The method of obtaining this insulating stratum is, from an industrial point of view, very practicable, and the cost trifling. The hardness of this coating, which resists all atmospheric action, is a guarantee of its durability. The insulation is absolute. The method of preparation is very simple. A bath of plumbate of potash is prepared by dissolving 10 parts litharge in 1000 of water, to which have been added 200 of caustic potash, and boiled for about

ducing any action upon the objects to be coated. Such a wire, if placed in a circuit, and brought in contact with another wire in connection with a galvanometer, leaves the latter entirely unaffected. (Wiedemann.)

(c) Fig. 181 shows a simple insulating cleat made of "celluvert" or "kartavert," largely used in America for telegraph, telephone, electric light, and electric bell (inside) wiring, and meets its intended purpose admirably, as it is at once strong, light, and cheap. Unlike other cleats or staples, it cannot readily be shattered by an ill-directed blow from a workman's hammer while being fastened down with nails or tacks. These cleats are made for single or double wires, but it will be seen that by cutting a double cleat across the centre it will answer for a single wire.

Joining.—The following directions for making joints in conductors for the arc and electric lights are reproduced from

181.

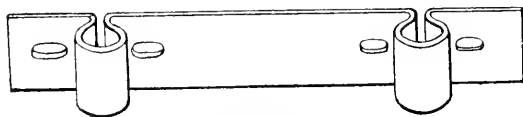

Insulating cleat.

$\frac{1}{2}$ hour. It is allowed to settle, decanted, and is then ready for use. The wire to be coated with peroxide of lead is attached to the positive pole, and a small platinum anode to the negative. Finely-divided metallic lead is precipitated upon the negative pole, and the wire is coated with peroxide of lead, which passes successively through all the colours of the spectrum. The insulation is complete when it takes a brownish-black colour. The wire thus covered is quite insensible to electric action. Articles perfectly cleaned may be attached to it, and connected with the negative pole of a gilding, silvering, or nickeling bath without the current, however powerful, pro-

Munro and Jamieson's 'Electrician's Pocket-book.'

In preparing the ends of the principal conductors, remove the two external tapes for a length of about 5 in. from each end to be joined. Remove the rubber and the internal layer of tape for about $1\frac{1}{2}$ in., and lay the wire bare with emery-paper (Fig. 182). Solder together the wires that compose the cable for a length of about 1 in., and bevel off the two extremities with a fine file. Bring the two bevelled ends together, and solder them in such a way as to obtain a conductor of uniform thickness. Wind a fine copper wire spirally around the joint, and solder the whole together as shown

in Fig. 183, and always use rosin instead of acid as a flux.

Afterward, to apply the insulating material, take a very sharp knife and work the rubber to a point for a length of $\frac{1}{2}$ in. from the conductor, and cover the metallic joint with a layer of prepared cotton tape $\frac{5}{8}$ in. wide (Fig. 184).

These instructions apply to the principal conductors. In branch lines for incandescent lighting, the extremities are prepared by removing the braid, tape, and rubber for a length of about $\frac{1}{4}$ in. at each end, and unwinding the cotton covering of the conductor for about $1\frac{1}{2}$ in. The extremities of the

182.



183.



184.



185.



186.



Joining wires.

Over the tape wind spirally a band of pure rubber $\frac{3}{4}$ in. wide (stretching it well in doing so), and cover the joint with a series of wrappings running alternately to the right and left, until it gets to be as thick as the rubber covering of the wire, or a little thicker. This stage is shown in Fig. 185. After this, it is necessary to apply a small quantity of a solution of rubber to each layer, and allow the alcohol sufficient time to evaporate before putting on another layer.

This effects a union of the different layers of rubber. The external covering of the conductor is composed of two layers of prepared tape, $\frac{5}{8}$ in. wide, applied in opposite directions, with a strong gum lac varnish between them, and above these, again, a layer of impermeable tape, with a coat of varnish over all (Fig. 186). Care must be taken to keep the hands, tools, and materials clean and dry.

wire are then cleaned with emery paper and beveled off with a fine file, as shown in Fig. 187. The two beveled edges are then brought together and soldered, while a thin copper wire is wound around as before (Fig. 188). The metallic joint is then covered with the thin layer of cotton that has previously been unwound from the extremities (Fig. 189).

Over this cotton covering there is wound spirally, and in a contrary direction, a ribbon of pure rubber, $\frac{5}{8}$ in. wide (care being taken to stretch it as before), until an insulation of the desired thickness is obtained (Fig. 190). In this case also a solution of rubber is applied to each layer in order to make the whole solid.

Finally, two layers of felt tape, 5 in. wide, are applied in an opposite direction, with an intermediate layer of strong gum lac, and, over all, a coat of varnish (Fig. 191).

In T-shaped joints of branch wires for incandescent lighting the ends are prepared by removing from the principal conductor 5 in. of the two external layers of rubber and the cotton are afterwards drawn back

187.

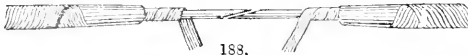

188.

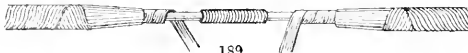

189.



190.



191.



Joining wires.

192.



193.



194.



195.

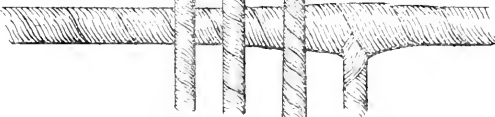

Joining wires.

nal layers of tape. After this the rubber covering and internal tape are removed from the wire for a length of $1\frac{1}{2}$ in.; 6 in. of the external covering and tape are removed from the end of the wire that is to be joined to the principal conductor. The two layers of rubber and the cotton are afterwards drawn back

for 3 in. and the rubber is removed—the cotton being left for covering the metallic joint. The wires that compose the conductor should be soldered

together, and the solid wire wound 2 or 3 times around the principal conductor and afterward 3 or 4 times upon itself.

Then the whole is soldered together (Fig. 192). Each end of the principal conductor must be worked to a point with a very sharp knife for $1\frac{1}{2}$ in., and the solid wire be covered with cotton up to its junction with the principal conductor and all around. The metallic joint must be covered with a wrapping of cotton tape covered with rubber (Fig. 193).

A well-stretched band of pure rubber, $\frac{5}{8}$ in. wide, is applied spirally, the winding being begun at the rubber covering of the solid wire, running to and around the joint, and as far as the rubber covering at each end of the principal conductor—thus forming a series of layers in opposite directions, until the desired thickness is reached (Fig. 194).

As in the preceding cases, it is also necessary here to apply the solution of rubber between the layers. Externally, the wire is protected by two layers of prepared tape ($\frac{5}{8}$ in. wide), wound around in an opposite direction with an intermediate coating of a concentrated varnish of gum lac, then above this an envelope of impermeable tape, and finally a coat of varnish (Fig. 195). All these operations must be performed with the greatest neatness and with dry hands.

METAL WORK.

Bronzes. (a)—Before a work of art can be cast in bronze, it must be in existence in some other material, and it may not be altogether superfluous to describe briefly the various stages an article must pass before it can be introduced to the world as a bronze. The sculptor usually embodies his first idea in a sketch, not, however, in most cases on paper, but in wax or clay. A sculptor's sketch is simply a statuette, very roughly modelled, and usually not more than 5 or 6 in. high. Works of this size do not require any internal

framing for their support, and therefore lend themselves readily to any changes of design, even of the most radical description.

The attitude of the figure, the principle, masses of the drapery, and, in short, the general arrangement of the composition having been decided on, the next step is the construction of a full-sized framing of iron, without which the statue in plastic clay or wax could not stand, but would yield to its own weight, and sink a shapeless lump to the floor. With the assistance of the iron framing, or skeleton, running through every part, it can be preserved for a sufficient time—often for several years—to permit the artist to bring it to that perfection of which he is capable. But even then it is not to be regarded as a complete work; for the plastic material, whatever it may be, is certain to be destroyed by its very plasticity. Therefore, that it may be preserved, it must undergo a transformation which will render it hard and durable. If the statue has been modelled in a certain manner, and with specially prepared clay, the action of fire will produce this result, and then we call it terra-cotta. The only other method of preserving the model is to cast it. By this means, although the plastic model is destroyed, a *facsimile* is produced in another and more durable material.

Casting involves 5 processes:—

1. The construction of the hollow mould.
2. The preparation of the fluid material.
3. The casting or pouring into the mould.
4. The solidification in the mould.
5. The liberation of the cast from the mould.

A mould is made over a piece of sculpture by the application of some soft material which has the property of rapidly becoming hard. By this means a concave impression is obtained, from which again, by a similar process, a convex *facsimile* of the original model may be produced. There are many

kinds of moulds used by artists. The sculptor roughly divides all moulds into simple and piece moulds. A simple mould is made all in one, without any loose parts, like a seal, or a pastrycook's jelly mould. A piece mould, on the contrary, is made of two or more parts, according to the requirements of the work. Moulds are also called "open" or "closed." An open mould is one of which one side only

Moulds are made of very various materials, according to the objects for which they are constructed. Plaster is the most common, but wax and gelatine are also much used by artists. For bronze founding, the foregoing materials are unavailable. The sculptor who would cast in bronze must use a material that will resist the intense heat of the liquid metal. Moulds for metal casting are made of sand and

196.

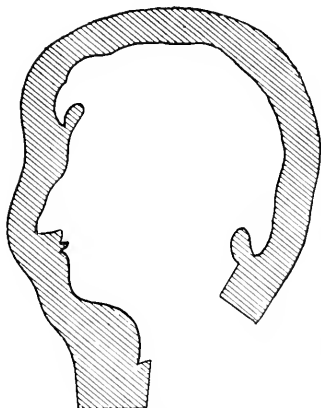

Simple close waste mould.

receives an impression. Simple moulds are, for instance, usually open moulds, so also are piece moulds of bas-reliefs or other flat objects. A close mould is almost always a piece mould, it may or may not be a safe mould. A safe mould is made up of many separate parts, so constructed as to be easily withdrawn from each other. These moulds can be used many times over without injury either to themselves or to the cast—hence their name "safe." A waste mould is made of one or of many pieces, but it can be used only once; it is destroyed or wasted in the process of casting. Some open moulds are shown in Fig. 197: A, the cast; B, the cope or case of mould; C, the loose pieces of mould.

197.

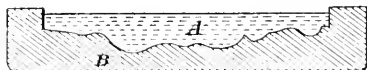
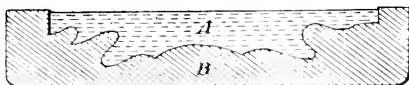
*Simple Safe Mould**Simple Waste Mould**Safe Piece Mould*

loam, of *luto* or *potéc*, or, for small works, of *compo*.

Supposing an artist has completed a statue, and, having already cast it in plaster, wishes to reproduce it in bronze. If this work is of large dimensions, it is very unlikely that he will have suitable premises for the purpose, for although small works can be cast almost anywhere, no casting on a large scale can be reasonably undertaken unless a suitable foundry is available. Such a foundry should consist of a large and lofty room about 40 ft. long by 24 ft. wide, the larger indeed the better. A row of small furnaces should be built along the wall at one end, and at the other end should be situated the recuperatory furnace for large work, whilst

a very large portion of the floor should be occupied by the "pit." The small furnaces before mentioned are draft furnaces of the ordinary type, and are made to take crucibles up to about 60 lb. capacity. By pouring the contents of several crucibles together, castings of considerable size can be made, even with these small furnaces. Larger quantities than can be conveniently melted in the small furnaces must be treated in the reverberator, which is occasionally made of very great capacity.

The "pit" is used to bury the moulds previously to casting. This is with a twofold object; partly that the pressure of the earth outside the mould may enable it to resist the pressure of the metal from within; and also in order that the openings through which the metal is poured may be placed at a convenient level, which would not be the case if large moulds rested on the floor of the foundry.

Besides the large and small furnaces and the pit, the artist would also require at least one blacksmith's forge and a powerful crane, not to mention drying stoves and pugging mills, and store-rooms for various purposes. It is extremely unlikely that the artist will be in possession of such premises and plant. It follows then that he must, as a rule, consign his larger works to one of the commercial foundries for execution. Nor is there any very great hardship in this. It is in such cases only requisite that the great lines and masses should be faithfully reproduced. Any delicacy of touch that might be put into such a work would be useless, because it could not be seen, and, therefore, would not be missed in the casting. It occasionally does happen, however, that such premises are at the artist's disposal, and in this case, the best work is certainly expected of him.

There are two principles whereby artistic bronzes may be produced. The one is that known as "piece moulding," and is identically the same as that employed in making castings for machinery, &c. Continental artists and founders call it *moulage*

à la Française, it having been brought to great perfection in France, where, indeed, it is supposed to have had its origin. The other process is that known as "Cera Perduta," or waste wax process. It is the more ancient of the two, and has been practised from time immemorial by the artists and artizans of Italy. Both methods have been, and are, successfully employed for the production of works of the greatest size.

There are reasons why an artist should sometimes prefer one method and sometimes another. When a piece of sculpture is to be produced on a very large scale, it is usual for the artist to make not only a careful sketch, but also a model, usually about life size; and on this model he will bestow all his skill and art; taking into account the distance at which the colossal work will have to be viewed, its height above the level of the spectator, the effect of the atmosphere in diminishing its apparent bulk, and in distorting its lines, the influence of any surrounding objects, and more especially the varying effects of light and shade. When this model has been carefully completed, the work is then reproduced in all its details on the large scale. One pair of hands will not suffice for the production of so large a work, and several assistants are usually employed, under the supervision and control of the master, who, working with them, is thus able to produce what is practically an exact enlargement of his smaller model.

Works on a colossal scale cannot be produced by the eye alone, but must be the result of scientific procedure. The forms are so large that the workman cannot see the effect of what he is doing. If he has to descend from a scaffold 10-12 ft. high, and go perhaps 50-60 ft. off, before he can get a comprehensive view, it is not likely that he will be able to correct any error which his eye may have discovered, because by the time he has again ascended the scaffold he can no longer recognise the exact spot that required alteration.

In these large works, anything like individuality of touch is at a discount, surface modelling is practically useless, and artistic effect is alone realised by the rhythm of line, the harmony of proportion, by the skilful arrangement of masses of shadow, and by the true relation of each plane to the rest of the work. If this is achieved, the result will be an artistic success, not to be enhanced by any amount of delicate manipulation, which would be entirely lost at the distance required for a comprehensive view of the work. It is, therefore, wise in the artist to select that method of casting which, while it faithfully reproduces these essential qualities, affords the least chance of mishap, and the greater facility for retrieving disaster.

The artist who enters on the production of a very colossal work is in the position of a general opening a campaign. He forms his plan and lays down broadly the lines on which he intends to proceed: but he cannot foresee all the chances of war, nor the varying incidents which may oblige him to modify his plans if he would attain the reward of his labours.

Thus it is clear that for such works there is no system of founding so good as that which gives most scope to the founder, even if it were at the sacrifice of a very small degree of sharpness in the castings.

With regard to small works, however, the case is very different, and exactly in proportion as these are small does the importance of delicate touch and surface modelling increase; not that the other qualities are diminished in value, for they are just as important as ever; but merely from the fact that the eye of the spectator is able to take in on the small scale that which it was unable to appreciate on the large. Many persons who are unaccustomed to look at sculpture intelligently, and who think that art means pictures alone, would be surprised to learn that there was any difference between the touch of one sculptor and the handling of another. For such persons a work is finished in

proportion as its surface presents a polished uniformity. This idea is fostered by the miserable cabinet bronzes which are turned out wholesale by certain manufacturers, and are termed "art bronzes." These are often copies of fine originals, but most of their value is lost from the fact that they are cast in many pieces, which are then joined together, filed, and chased up in a happy-go-lucky commercial style by a not over skilful artisan. Thus every trace of the original hand is obliterated, all that remains is the design, and even with that liberties are often taken. The turn of a head, the movement of an arm, are often varied according to the convenience or ignorance of the fitter.

The object of casting statues in bronze by piece moulding is to diminish the risk by facilitating the process. It is obviously easier to cast a part than the whole of a statue. This is the principle which underlies commercial castings. As an example take a figure representing Divine Wisdom, standing on a tortoise surrounded by waves, and supported by a branch of coral. The first operation of the founder is to cut off the head and arms of the plaster model, and the coral branch at its side. These are carefully replaced, being fitted with what are known as Roman or box joints, which, if properly made, ensure in the most effectual manner that the various parts shall not be misplaced.

The plaster model thus becomes a compound of five separate parts, fitted accurately one to the other. This makes the work of the founder much more easy and rapid. To mould and cast the head, the arms, and coral branch, each by itself, is so simple an operation that almost any lad in the foundry could be entrusted with it; but to cast the statue all in one piece would entail some rather complicated piece moulding. When denuded of its head, arms, and coral branch, the trunk is also a comparatively simple object to mould, though there is in the folds of the drapery a great deal of piece moulding which requires care and skill. The process briefly is as follows:—The trunk

of the figure is laid in an iron box or flask of suitable size, and loosely packed in with the loam used by bronze founders. The figure being only about half imbedded in this loam, the surface of which is carefully pressed and smoothed all around the model, the latter presents somewhat the appearance of a *bas-relief*. The loam back-ground is then lightly and evenly powdered over with parting-dust, lycopodium being much used for this purpose on the Continent. The object of this is to prevent one portion of the mould from adhering to another.

The moulder then proceeds to work on the projecting portions of the model, making separate pieces so that they can be withdrawn and replaced at will. When he has made as many pieces as his judgment tells him are requisite, he places another iron box or flask upon the first, and having applied the parting dust to the work, he makes of the same loam the cope or case which is to retain all the pieces of the mould in position, and which is itself held together by the flask, which is merely an open iron frame. The two flasks are then turned over, and the first flask, with its loosely packed loam having been removed, the freshly exposed side is moulded in the same manner as the former, and the cope or case is formed as before. The two flasks can now be separated, and the pieces of the mould removed one by one from the figure, and accurately replaced in the mould. This gives a correct imprint of the plaster model. If the metal were cast into this it would be quite solid, therefore it must be cored. The core is made by filling the cavity of the mould with the same loam, so that the figure is again reproduced. As, however, this loam figure occupied the entire cavity of the mould, it must be pared down, so that an empty space may remain between its surface and the interior of the mould. This space is that which will be occupied by the metal.

Of course such a core has to be supported by an internal iron framework, the ends of which, projecting through

the openings of the neck, the arms, and at the base, serve to keep it in position; without this it would of course fall to one or other side, and thus prevent the flow of the metal.

Openings must be provided in the mould for the admission of the metal, and for the escape of the air; but the vents for the air need not be so carefully arranged in casting on this system as in casting by waste wax, because the loam is very porous, and the joints in the mould facilitate the escape of the gases. By this process the risk in casting a statue is reduced to a minimum; no small advantage where colossal work is concerned. Nevertheless, when the bronze is cleaned from the loam, it will be found to be covered with lines from the joints of the mould; it is also not unlikely to be covered with a sort of hard skin, composed of particles of sand which have been vitrified by the intense heat. This skin and these lines have to be removed, and the various parts of the figures must be joined together. It is very frequently found necessary to go over the entire figure with the file and chasing tool, to bring the work to one tone, and in that case it is not possible for the statue to retain any claim to be considered an autograph work. There can remain on it no touch of the original artist, and the fact of his signing it, and even numbering and dating it, will not save it from being merely a more or less excellent copy, and not an original.

Of course, if a sculptor chose to do the chasing and fitting himself he could do so, but think of the waste of time, not to mention the fact that even then the work would probably lose something of its original freshness and spirit.

This system of piece moulding for bronze is admirable for commercial purposes, and for colossal work it is all that can be desired, but otherwise its value is small, and a statue executed by this method cannot be esteemed by anyone who understands sculpture at more than a fraction of the price of the same statue if cast by the waste-wax process.

This waste-wax process, so unimportant commercially, is all-important artistically. It is by this method alone that a sculptor can produce original bronzes in his own studio, without the drawbacks incidental to the former process of piece moulding.

Roughly speaking, this process is as follows:—The sculptor makes, of plastic wax, an exact model of the work which he desires to cast in bronze. This model must be hollow, the thickness of the wax being exactly that intended for the bronze. This wax model is moulded, both inside and outside. The mould must be all in one piece, and without seams. The wax, therefore, cannot be withdrawn without destruction either to itself or to the mould. But as the mould must be preserved till after the bronze is cast, the wax is withdrawn by melting it out. The bronze is then poured into the cavity.

Of course, this is not so simple as it sounds, and yet there is nothing in it that may not be successfully carried out by an artist in his own studio with small works, that is to say, under life-size.

The first thing that claims attention is the wax. This must be made harder for summer weather, and softer for winter use, unless, indeed, the artist is careful to keep his studio always at one temperature. This seems a small matter, but, nevertheless, it is of great importance, and much of one's comfort in working depends on it.

There are many different wax compositions, almost every founder having his favourite mixture. The chief ingredients, however, are beeswax and Venice turpentine. Some artists make use of no other ingredients and use no colouring matter. Most men, however, use in addition to the above, rosin, lard, tallow, and pitch in varying quantities. Excellent wax can be made either with or without these latter. Yellow wax is not easy to model in; it is therefore the general practice to stain it, in order to get rid of some of its transparency. In Italy, it is almost always coloured a brilliant red, with sulphide of mercury, which is

entirely evaporated when the wax is melted out, and leaves no residue in the moulds. Almost any pure vegetable colour will do, or, indeed, any colour that will burn without leaving a residue; this is easily tested by placing a lump of the wax in a small white clay crucible, closing the top with a cover, to prevent any dirt getting in, and then burning away the wax. When the wax appears to have been consumed, gradually raise the temperature to a cherry-red heat, and then let it cool down. If, when the crucible is quite cool, you find it also quite clean, without any residue, you may be sure that your wax is good, and that the pigment used is perfectly safe.

Having prepared the wax, and satisfied himself that it is of the right quality, the artist proceeds to construct his model. He could make this at once in wax, and then cast it, but in event of a failure his work would be lost. As this is undesirable, he usually proceeds exactly as if the work were to be sent to a foundry, and having prepared his plaster model, he cuts it in pieces and moulds it in plaster, making safe moulds of each part. From these moulds the hollow wax models are produced. Of course, it is far better for the artist himself to re-touch these than that they should be so treated by any other person.

There are various ways of producing these wax models. Some artists cast them by pouring the melted wax into the mould, in which a core has been previously placed; others line out the mould by squeezing into it sheets of wax that have been prepared so that they easily take the required impress. Others, again, brush the liquid wax into the various parts of the mould, and having thus satisfied themselves that the surface is everywhere covered with a thin layer, they put the mould together, and fill it with melted wax, which, after a few seconds, is emptied out, leaving, however, an equal layer adhering to the former coat. This operation may be repeated as often as desirable; each time increases the thickness of the wax,

and consequently of the bronze. Making the wax casts sounds a simple matter, and yet it is almost the most difficult thing connected with the waste wax process.

In Italy, where this system is much practised, nearly every *formatore* can get out good casts, but here it is different, and the sculptor will probably have to train his moulder. It is merely knack and practice, and any intelligent moulder will soon get into the way of it.

Extreme sharpness of impression is not so very important, though that of course counts for something; but it is generally preferable to work the waxes entirely over, and instead of merely re-touching, to finish the work in the wax. It is the inside of the wax cast that is very important, because it should have a proper thickness of wax in every part, no more and no less. It is safe, however, to have rather too heavy than too light a cast, as there is no vitreous skin formed by a thick casting, as is usually the case when the piece mould system is employed.

The various parts which compose the figure having been prepared in wax, it is the part of the artist to join them together, and finish the work in wax exactly as he wishes that it should appear in bronze. The wax, being hollow, must be moulded or cored on the inside.

If the work is a very small one, say 18 in. high, you may finish the wax first, and then put a few wires through it at various points, which serve to keep the core in place; you can then pour the liquid core into the wax model, which will be strong enough to resist the pressure during the few moments required for the material to solidify.

If, however, the work is much larger, the wax will not have strength to support its own weight, much less the internal pressure of the core. In such a case, it is requisite that the core be cast before removing the wax model from its mould. The plaster safe mould must in this case be so constructed that it can receive and hold in place the irons which support the core and retain it in position. For this purpose, holes must

be made through the walls of the safe mould to permit the irons to project. They must afterwards be held by the walls of the waste mould in which the bronze is to be cast.

The safe mould then, being lined to a proper thickness with wax, and having the core irons in position, is filled up with the liquid composition used for coring. The usual mixture is plaster and brickdust; some use other ingredients,—indeed over 2 dozen have all been used for this purpose. The proportions are very various, some recommending $\frac{1}{3}$ brickdust and $\frac{2}{3}$ plaster—and others $\frac{2}{3}$ brickdust to $\frac{1}{3}$ plaster. The truth is that these materials vary so much in their character that those proportions which are quite satisfactory in one locality are worthless in another. It is best to use as little plaster as will suffice to bind the materials together.

The core, being surrounded by liquid bronze, is under conditions exactly opposite to those of the mould which contains the metal. The action of the metal is exerted to compress the core and to burst the mould. Moreover, its greatest bursting power is exerted whilst it is in a state of perfect fluidity; on setting, it contracts, relieving the pressure on the mould, and powerfully compressing the core. If the core is too hard and unyielding, it is certain to crack the bronze. It should be what is technically called “puffy,” that is to say, somewhat easily compressible; on the other hand, unless it has some ventilation to the outer air, it should not be too porous, or it will generate gas too rapidly by contact with the hot metal. In cores of considerable size it is always safest—indeed, necessary—to provide some means of escape for these gases by venting the core.

When such a vent or “lantern” is used, the core can be made more spongy, and consequently more readily yielding to the compression of the cooling metal. It is, however, a fact that, while modern practice amply justifies the use of a core-vent or lantern, the largest works cast by this method of which we have any historical record were all success-

fully cast without any such precaution, nor is there any mention of such a practice before the latter half of the present century.

The wax model with the core inside can be kept for an indefinite time, and thus the artist has ample opportunity to work on the wax, and bring it to as high a degree of perfection as his talents will permit. When, however, he desires to cast it, his first care must be the arrangement of the jets and vents. The jets are tubes destined to distribute the metal throughout the cavity of the mould, and the vents are other tubes which afford an exit to the air violently expanded and displaced by the molten bronze. The jets are comparatively unimportant, for the bronze, following the laws of fluids, will certainly fill every part of the mould, provided the air offers no obstacle to its progress.

It is, therefore, usual to have more vents than jets, and they should be so placed that wherever there is a bell or pocket formed by the configuration of the mould in which the air might be imprisoned, there must also be a vent provided for its escape. It may seem strange, but greater attention is needed in this respect in small than in larger works, because in a large work the metal does not set so rapidly, and thus gives time for the air to escape into the pores of the mould, whilst the pressure to do so is much greater. In any case the labour of placing these jets and vents is but small, and as their importance is paramount, the best advice always will be "When in doubt put a vent—put a dozen rather than run even a small risk."

Piece-moulding in loam does not require the same attention in this particular, as the joints in the mould act as a complete network of vents. This seems a very great advantage over the wax process, and so it would be were it not that the method of placing these jets and vents is so easy and simple that it involves but little skill, and is easily done by an assistant. The artist need not lose his time over it, beyond defining their positions and relative sizes.

The jets and vents, being merely a system of tubes leading from the outside of the mould to its inner cavity, become of course filled with metal, which remains as solid rods attached at one end, while the other end is free in the air. All that is therefore needed is to make rods of wax of the required size, and attaching them by one end in their proper position on the surface of the work, bend them into the required curves. As, however, it would be inconvenient to pour through more than one jet, it is usual to join them together in groups, and to bring these again together to one main jet, which leads directly from the basin, or "sow," into which the bronze is poured. By this means, the bronze flows from the main jet through all the subsidiary ones to the different parts of the mould.

The vents are treated in exactly the same manner, except that they do not usually end in one main duct but in several, as may be most convenient, nor do they rise to the basin, but come to the open air at the top of the mould, outside of the space occupied by the pouring basin.

Besides the jets and vents there are other rods of wax which are called drains or spouts; these are placed on the lowest portion of the work, and lead through the thickness of the mould, but slanting a little downwards to the open air. Their object is to drain away the wax where it is melted out, after which they have to be securely stoppered up. In very small works drains are entirely omitted, and the mould is merely turned upside down to allow the wax to run out.

There are two principles of pouring bronze, each of which has its advocates. The one is the descending and the other the ascending principle. In the former the bronze is cast directly into the cavity from above, as shown on Fig. 198, which is not designed to represent any particular work, but merely to illustrate a principle. By this method, the bronze enters through all the various jets, and gradually fills the mould until it reaches the top. In the second or ascend-

ing principle, as shown on Fig. 199, the jets are taken right down to the bottom of the mould before they are allowed to enter its cavity. The metal of course rises to its own level, thus filling the mould from the bottom.

the molten metal, causing the latter to boil and work, and thereby endangering the delicate and frail inner surface of the mould. Moreover, the streams of metal, having united at the bottom, must rise and pass again over the surface of the

198.

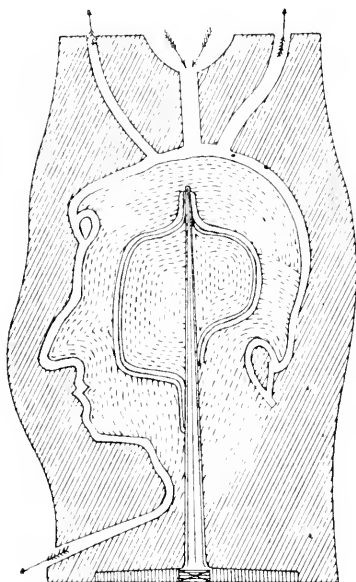

Descending process.

199.

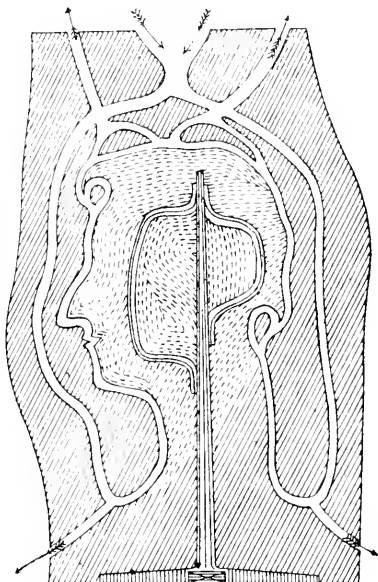

Ascending process.

The disadvantages of the descending or direct method are these. When the bronze is cast, it flows directly into the mould in numerous streams, which trickle over the core and over the surface of the mould, making a great amount of atmospheric disturbance in the cavity. These streams unite at the bottom, and then the mould begins to fill after the air contained in it has been heated and expanded to the utmost; nay, it is more than probable that portions of air caught between two metal streams may be dragged along and forced to escape by bubbling upwards through

mould before it can be completely filled. In the ascending principle, the streams of metal pass harmlessly to their lowest level before entering the cavity of the mould, thus its surface cannot be injured by the downward rush, and the air is not brought in contact with the metal until it begins to rise in the mould. No particle of air can become entrapped, for it is all above the surface of the rising bronze, with a free exit through all the vents above, through which it is forced by the pressure of the rising bronze, and by its own enormous expansion, which, however, cannot be so great or so sudden

as when the metal enters from above. Therefore, always cast on the ascending principle.

The jets and vents having been arranged with due consideration, it becomes necessary to think of the mould, and to consider the qualities to be sought for in a mould for bronze casting. In the first place, the material used must be one that is easy of application, and of a nature to resist the intense heat to which it must of necessity be subjected. It must also not be antagonistic to the metal, which would otherwise be spurted violently from the jets and vents, besides which it would certainly yield a blunt and bad impression. There are many recipes for such moulds extant; almost everyone who practises this art has his favourite mixture, concerning which much secrecy is observed. There is, however, no great secret about this matter. Many of these moulds, especially those of large size, which, of course, have to endure the most heat, are made of *luto*, or *potée*, as it is indifferently called. This is nothing more than a mixture of which the basis is fine loam. The loam may be natural or artificial; the whole secret consists in purifying it sufficiently, and in grinding it very fine before use. The materials mixed with it are fire-clay (burnt and ground to an impalpable powder), emery, rotten-stone, hammerscale, &c., &c., the only object being to obtain a very fine and fire-resisting powder. Old crucibles powdered up are highly recommended by no less an authority than Cellini. Some material has also to be used that will bind this powder together. The celebrated founder, Jean Balthazar Keller, used white of egg and horse-dung. Cellini preferred rotten rags and cow-dung. The result sought for and attained in either case was the same. The body of the mould was composed of a very fine fire-resisting powder, held together by some other less refractory body, the result of which was that the mould, when tolerably dry, was firm and solid enough, but when exposed to a great heat it became very friable and porous. These moulds took a long

time to make, but the operation was not one that required great skill on the part of the workmen employed.

This is the method of construction:— A sufficient quantity of the material having been prepared of the requisite degree of purity and firmness, a small quantity of it is placed in a mortar, and ground up until it becomes of the smoothness and consistency of oil paint. Armed with a soft bristle brush, and with a pot of this paint, the assistant proceeds to give the work one complete coat—an even, thin coat, just as if he wished to colour it. This is allowed time to dry, when, if it has been laid on thinly and evenly, it will be found to have dried without a crack. A second coat is now laid on in the same way, and with the same care, as thinly as possible. This is again allowed to dry, and so on for about 30 coats. After the first 5 or 6 coats, however, a portion of cow-hair may be worked into the paint, and it may be spread a little thicker. After about 30 coats have been given, there will be a thickness of about $\frac{3}{4}$ in., and the mould may now be completed by building up in thicker layers until a sufficient strength is obtained. The mould must be hooped about in all directions with iron bands to strengthen it. After this, it being apparently pretty dry, a temporary kiln is built round it, and a gentle fire is kept up until the wax flows out through the drains before mentioned. A considerable quantity of wax will be lost, but some of it may be saved by placing tubes at the drains to lead it outside the kiln. This operation is usually, but not invariably, conducted in the pit beneath where the metal is to be melted.

When the wax has ceased to run, the fire must be let out, and the kiln taken down, in order that the drains may be stopped. These must be plugged with great care with the same material used for the mould; the kiln is then built up again, and the firing is carried on as before, until the wax has been completely dissipated. When there seems to be no trace of wax left, the fire must be still kept up, and indeed urged on,

until the mould and core are both of a fine cherry-red, after which the fire may be let out, and the whole allowed to cool slowly down. If the mould is at the right heat, it can be seen on looking down the openings of the vents and jets, or on putting a piece of tarred rope down, when it will take fire if the heat is right.

The kiln being cool enough, it must be pulled down, and the pit must be filled up with fine dry earth, pressed firmly and evenly all round the mould, so that the top alone, showing the openings of the jets and vents, is visible above the ground. Be the work small or large, this process of firing is exactly the same, only that a mould for a very small figure can be fired in about 8 hours, and a statue may take 5 weeks.

For small works it is not advisable to use a *luto* mould. Compo is quite good enough, any mixture of which plaster and brickdust are the chief components. Many founders use for the moulds exactly the same composition that they use for the core, and it saves trouble to do so. It is better practice, however, to use a somewhat stronger compo for the mould. Some make an inner skin to their moulds, of a closer and harder composition than they use for the backing up, and this is in accordance with theory and good practice. But unless the heat is carefully regulated, these layers sometimes separate in the firing. We will suppose, however, that the work has been successfully fired, and is in the pit earthed up and ready to cast.

The next consideration is the furnace. This may be made in many different forms.

First in power and capacity is the reverberatory furnace, with its saucer-shaped hearth, and its flat-domed roof. It may be made of every varying size, but it is inconvenient when made for small charges. These furnaces are a very ancient invention, but until the end of last century they were made without any chimney, the draught being supplied through two or three long trenches,

with the aid of wind-sails. Modern practice has dispensed with these last, and added a tall chimney, besides flattening the dome of the roof very considerably.

The furnace most suited for small works in the artists' studio is, however, the common air-furnace for crucibles. This furnace is cheap and easy to build, and takes up but little room. It is usual to build a row of them in the form of a low wall along one end of the workshop. The usual size takes a crucible with a charge of about 40-60 lb. of metal; this is easily lifted out by one man. If more metal is required, several crucibles are poured at once. These furnaces are, however, sometimes made of much greater size, and crucibles are used which will take 1000 lb. of metal; but these, of course, are not likely to be used by artists very frequently. Very convenient is a portable furnace, exactly suited for artists' occasional use; it will take a charge of 32 lb., quite enough for a small bust, or a sketch, or statuette. Fig. 200 shows an ideal foundry in section: A, pit; B, entrance to pit; C, shed or store over stairway; D, crucible furnace; E, ashpit with gratings; F, firebox of reverberator; G, hearth of reverberator; H, chimneys; I, flues; K, wall of foundry; L, cross-beam; M, foundry crane.

The metal most suitable for artistic work is an alloy of copper and tin, either with or without the addition of zinc, lead, or both. The mixture used by the Kellers was, copper 91·4; zinc 5·53; tin 1·7; lead 1·37. Copper 87·8; zinc 6·52; tin 5·1; lead 0·58; gives also a very good metal. Copper 93, tin 7, gives an excellent bronze. An equal quantity of yellow brass mixed with this gives an excellent and easy-flowing metal. Bronze is usually considered to be improved in colour by using zinc, and lead is supposed to aid it greatly in flowing. Tin gives great hardness, and when the amount of tin used is over 20 per cent. the metal becomes useless for artistic purposes. A bronze composed of copper and 3-4 per cent. of

tin gives an excellent and beautifully red metal. This alloy, however, when used in small quantities, is apt to prove

than those alloys which contain a considerable amount of zinc or lead.

The operation of firing is very simple.

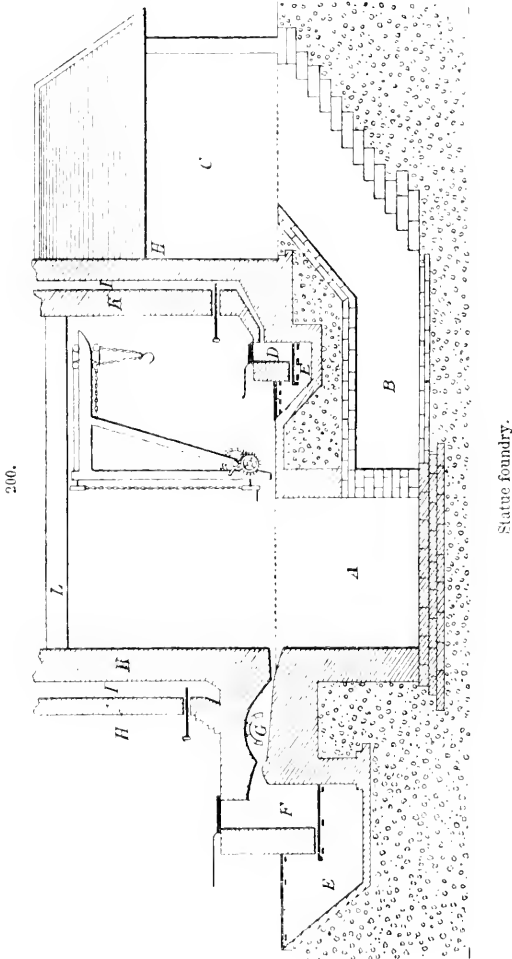

rather sluggish, and requires more nice management as to the degree of heat

If the crucibles used are those known as the Salamander brand, there are no

precautions to be observed. The crucible stand is placed on the bars at the bottom of the empty furnace. The height of this stand should be such as to bring the top of the crucible 2 in. below the throat of the furnace. The stand should have a thin layer of ashes on it, to prevent the crucible sticking to it. Then put in as much metal as the crucible will contain, and cover it over with a proper cover: throw 2 or 3 shovelfulls of live coke into the furnace, and fill up all round your crucible with good clear broken coke up to the level of the crucible top. Place some large pieces of coke on top, taking care that they do not get in the throat of the furnace, and so choke the draught. Put on the cover of your furnace and draw out the damper, and fire as hard as you can until you find that the metal has run; then add more and more by degrees until you have a full charge. Some keep a thick layer of charcoal dust on top of the metal, others do not take any precaution to prevent the formation of dross. Most persons, however, add a little borax, which powerfully cleanses the metal. It must be well skimmed off before pouring.

When the metal is ready to be withdrawn from the furnace, the coke must be cleared away from the pot, so as to make room for the crucible tongs. These are placed over the pot, and kept closed by a ring. The pot is then lifted vertically by one or by two men, and if it is a small one it is poured at once out of the tongs, but if it is a large one it is placed in a receptacle called a cradle, which is carried by two or more men. Sometimes it is poured into a hand ladle, or shank, and thence into the mould. This is not, however, usually done unless the contents of several crucibles is required, and then it is better to form a large basin, or core, at the top of the mould, the openings of the jets being closed with plugs. All the crucibles should be poured into this basin before drawing the plug; this ensures a clean casting, as all impurities float on the surface, and are not carried into the mould. When this basin is not

used, it is of the utmost importance that the bronze should be thoroughly skimmed. If the metal runs down quietly, and rises up in the vents till it reaches the surface, it is a sure sign that the mould has filled properly. If, on the other hand, it makes much noise, and, worst of all, if it spurts and splutters in going down, and does not rise up again in the vents, it is certain that the casting is a failure.

The moulds for small—indeed for all—work should be broken down as soon as practicable after the metal has set, but great care must be used not to expose the surface of the casting too soon, for while it is red hot bronze is extremely fragile and liable to injury. The statue, on being freed from its mould, will be found with its system of jets and vents perfect as they were made in wax. These are then cut off with a saw as near as convenient to the surface of the statue. The figure is then well brushed with wire brushes, to remove all the particles of the mould; it is then placed in a bath of very dilute acid to pickle, as it is called. This cleans the surface of the metal very completely, and the artist can then repair any little defect that remains, as, for instance, the places where the jets have been and the like, after which it is usual to give the work its patina or colour, which is produced by the action of various salts and acids on the surface of the bronze. A great variety of tints are obtainable, and in the selection of these every artist will, of course, exercise his own taste and judgment.

Although there are, both in England and abroad, excellent statue founders, whose work leaves nothing to be desired as far as the ordinary run of bronze work is concerned, and who are even able to go considerably beyond the average requirements of commercial sculpture, yet it is a matter of deep regret that autograph work in bronze is almost non-existent in England at the present time. Sculptors used, even in this country, to be their own bronze founders, and that at no very distant date.

If artists could be persuaded to become once more their own founders, as far, at least, as small works are concerned, I do not think that it would be a matter for regret even to the manufacturers of cabinet bronzes. These would still command a large sale, as the autograph works produced by artists would of necessity be higher in price and few in number. It may be objected that bronze casting is not an artistic but a mechanical employment. Against this view of the case I must earnestly protest, as my own experience is that bronze casting requires quite as much artistic skill as marble carving, and that neither the one nor the other should be in other hands than the artist's own. (G. Simonds.)

It is necessary, in the wax process, that the mould shall be hot, but it is not made hot on purpose; the bronze is poured in as soon as the mould is cool enough. In small castings, the hotter it is the better, so that it is not red-hot; in large castings it should be pretty cool, because the body of metal being so large, it heats the mould so much, that if it were too hot at first, it would produce sandburn on the surface. The joining of the pieces is done by the box-joints already described; a small rim of metal is left standing at the edge of each joint, and when the two are fitted together, these little rims are screwed or riveted together, and then the metal is worked down with punches. Sometimes they are burned together. In order that the colour may be uniform, it is necessary, that, when casting a subject in many parts, the whole of the metal should be mixed at once, whether it be cast all at once or not, so that there may be no mistake about getting the same alloy each time.

The green *patina* on statues is usually given by some acid or salt, sal ammoniac being generally used. The surface is scratchbrushed and cleaned off as perfectly as possible, to get off every particle of grease, and then a strong or weak solution, according to the colour desired, is stippled on with brushes; if the statue be warm, so much the better,

as it makes the evaporation quicker. Some *patinas* are produced by heat. It is a very complicated subject, and one on which very little is known, and consequently the results are various. There seems no scientific accuracy about it. The Chinese and Japanese probably know more about it than we do.

In some cases, a small piece is cut out of the wax model for the introduction of the core, and is afterwards fitted on again. In larger works, openings must be left to get the core out, as it is not desirable to leave it in. That is one reason why large statues should not be cast in one piece. A colossal figure cast in wax in one piece at Pappi's in Florence, the height being 12 ft. 4 in., was a very large and difficult work to cast in one piece. In order to get the core irons out without injury, little boxes had to be made here and there, with lids, and these lids, instead of being put back into their places and closed up, were attached by little jets and vents of their own to the casting; then the core irons were got through the openings, and each little lid was afterwards fitted into its place, and all those joints had to be closed up. It seems just as well to have the statue in several pieces fitted with a good box-joint.

In a large statue the cores add very much to the weight; besides which the core might absorb moisture and freeze, and cause cracks in the statue. This has occurred in some bronzes at Venice where the core had been left in. In small articles there is no objection to leaving the core in, except the additional weight, which would not be great.

As to the proper thickness for the metal, in large work the thinner the better, in small work it would be difficult to cast if they were made too thin. What is very thin for a large work would be very thick for a small one; and small works are generally much thicker in proportion than large ones. It is very difficult to get a uniform thickness throughout if the wax is very thin. A casting no thicker than a penny would be very thin. The thickness is governed by the surface over

which the metal has to run. It would not do to be too thin, or the metal would chill before the whole surface was covered. In the Wellington monument, the metal is about $\frac{3}{8}$ in.; in the Sphinxes $\frac{1}{2}$ in., because there is a greater surface for the metal to run over. In the Beaconsfield statue it is about $\frac{3}{8}$ in.; but in some portions $\frac{5}{8}$ in. Some portions of a statue may be almost solid, where there are folds in the drapery not large enough to get a core in properly; but it does not do to cast too many parts thick, or in cooling they will draw away from the thinner parts and break.

(b) The method of making moulds for the *Cera perclata* process appears to me to be antiquated and by no means simple, or likely to give certain results. The material used for the cores, *i.e.*, plaster of Paris and brickdust or loam, although firm when set, becomes friable and weak after firing, causing great liability to waste and risk of sandy dirty castings. A certain amount of plaster is necessary for constructive purposes, but some binding material, such as soda or other flux, should be mixed with the core to bind it together, when burnt; the venting of the cores may be greatly assisted by adding sawdust to the mixture, which burns out, leaving the core porous, and assisting its strength by the fusible salts contained in the wood.

For the outer mould a first layer of very fine loam, ground in petroleum oil, should be applied with a brush, and over this a few coats of mixture of fine sawdust and loam, to which has been added a proportion of short fibrous asbestos, the outer casing being made of the same mixture but coarser. Each coating must be put on in such a manner by the point of the brush as to leave a rough surface, which readily binds and adheres to the next coating, and it will, of course, be understood that the asbestos fibre must be mixed by hand; if ground in a mill the fibre is destroyed, and the asbestos becomes useless. A mould made in this manner can be done rapidly, dries in a short

time, and will never crack; in fact, it is strong enough to stand the pressure of the fused metal in small work without binding or any external assistance, and there is no risk in handling the moulds without any special care. I have lifted a block of this material 30 to 40 lb. weight when half dried, by one corner, and dropped it a distance of 3 ft. without a crack appearing. The system of pouring the metal from underneath is not so important with these moulds; they are as firm as an ordinary Bath-brick. At the same time it is always advisable for artistic work where fine surfaces are necessary. The air outlets may be formed by thin sticks of wax, as they can be numerous and very small; but the "gate" or inlet for the metal is usually much better for large surface work if made wide than very narrow, and if of this shape it can usually be placed where it can be cut off, and no finishing is necessary.

There is one method of pouring which is only practised for some special purposes, but which would give perfect results in figure casting, as the metal flows calmly in without any rush or disturbance. In this method the gate or inlet is at one side near the bottom, the basin or "sow" is immediately below it, and the basin and mould are fastened together and mounted on a swivel. As soon as the melted metal is placed in the basin, the whole is gradually tilted over, the metal flowing quietly from the basin into the mould, the vents and riser being of course on the same side as the gate or inlet, so that when the mould is turned completely over all the openings are on the upper side.

Many castings are liable to be spoiled through deficiency of metal; this can always be obviated by taking a known bulk or weight of modelling wax for the work, and weighing the remainder after the work is done. A little simple calculation will enable the correct quantity of metal to be ascertained, and an allowance of about 25 per cent. additional will cover all necessary for gate, riser, and vents. (Thos. Fletcher.)

(c) The Japanese are the real authorities to whom we must turn for guidance in the use and treatment of alloys, both in texture and colour. First, as regards texture, they seem to delight in copying in metal-work the most delicate texture; even the bloom on the surface of fruit is not beyond their admirable skill. In tracing the nature of their methods, it is necessary to repeat what has often been said respecting the alloys they employ in order to produce their wonderful results. There is a wide range of such alloys, but the principal of them are but few. There is an alloy of silver and copper, sometimes with equal proportions of precious and base metal, and there are endless varieties of copper of different degrees of purity. There are several kinds of brass. They have also a remarkable series of alloys, in which the precious metal replaces the tin and zinc of ordinary bronze; but really their main alloys, with the exception of bronze, are comprised in the following examples.

The first is called *shuku-do*; it contains:—

(c) Copper	94.50
Silver	1.55
Gold	3.73
Lead11
Iron and Arsensic . .	traces
(Gowland.)	99.89

(b) Copper	95.77
Silver	0.08
Gold	4.16
(Kalischer.)	100.01

or in addition to about 95 per cent. of copper, as much as 4 per cent. of gold. It has been used for very large works. Colossal statues are made of it, one cast

at Nara in the 7th century being specially remarkable. The quantity of gold is, however, very variable, and certain specimens contain only 1.5 per cent. of the precious metal. The next important alloy used by the Japanese is called *shibu-ichi*:—

(c) Copper	67.31
Silver	32.07
Gold	traces
Iron52

(Gowland.) 99.90

(d) Copper	51.10
Silver	48.93
Gold12

(Kalischer.) 100.15

There are many varieties of it, but in both these alloys, *shuku-do* and *shibu-ichi*, the point of interest is that the precious metals are, as it were, sacrificed in order to produce definite results, gold and silver, when used pure, being employed very sparingly to heighten the general effect. In the case of *shuku-do*, the gold appears to enable the metal to receive a beautiful rich purple coat or patina when treated with certain pickling solutions, while *shibu-ichi* possesses a peculiar silver-grey tint of its own, which, under ordinary atmospheric influences, becomes very beautiful, and to which the Japanese artists are very partial. These are the principal alloys, but there are several varieties of them, as well as combinations of *shuku-do* and *shibu-ichi* in various proportions, as, for instance, in the case of *kin-shibu-ichi*, the composition of which would correspond to one part of *shuku-do* rich in gold, and two parts of *shibu-ichi* rich in silver.

Pickling solutions are made up respectively in the following proportions, and are used boiling:—

	(e)	(f)	(g)
Verdigris	438 gr.	87 gr.	220 gr.
Sulphate of copper	292 gr.	437 gr.	540 gr.
Nitre	—	87 gr.	—
Common salt	—	146 gr.	—
Sulphur	—	233 gr.	—
Water	1 gal.	—	1 gal.
Vinegar	—	1 gal.	5 fl. dr.

That most widely employed is (c). When boiled in (g) solution, pure copper will turn a brownish red, and *shaku-do*, which contains a little gold, becomes purple. Very small quantities of metallic impurity affect the colour resulting from the action of the pickle. Copper containing a small quantity of antimony gives a shade very different from that resulting from the pickling of pure copper. But the copper produced in Japan is often the result of smelting complex ores, and the methods of purification are not so perfectly understood as in the West. The result is that the so-called "antimony" of the Japanese art metal-workers, which is present in the variety of copper called *kuromi*, is really a complex mixture containing tin, cobalt, and many other metals, so that a metal-worker has an infinite series of materials at command with which to secure any particular shade; and these are used with much judgment, although the scientific reasons for the adoption of any particular sample may be hidden from him. It is strictly accurate to say that each particular shade of colour is the result of minute quantities of metallic impurity.

The action of these solutions is remarkable. You have copper to which a small amount of silver and a small amount of gold are added. The amount of gold may be variable, and artificers often take credit for putting in much more than analysis proves to be present; but a small amount of gold, it may be only 1 per cent., is sufficient to entirely change the character of the copper, and when you come to treat it by pickling solutions, you get a totally different result from what you would if copper alone were employed. The Japanese also take copper and dilute it, sometimes half copper and half silver, sometimes only about one-third silver and all the rest copper, and that gives the lovely series of grey alloys which, either by exposure to atmospheric influences, by handling, or by treatment of suitable pickles, gives the beautiful series of light and dark greys of which

the Japanese are so particularly fond, and to which the name of *shibu-ichi* is given. Then, again, they have copper in which small amounts of impurities may be present, and the nature of such impurity and its amount, which seldom exceeds $\frac{2}{10}$ th per cent., is quite sufficient to change the character of the copper. The Japanese, working in no small measure by rule of thumb, find that certain varieties of copper are best suited for definite processes, and they store them up and use them in a definite way.

In all these cases the precious metals are deliberately sacrificed with a view to produce a definite result. Why cannot we use the alloys (of which we have the analyses) in order to produce results in these lovely grey tints? The finest piece of *shaku-do* that I know, with its blue bloom, is a beautifully-carved sword hilt from the collection of Mr. Edward Dillon; and *shaku-do* forms the basis of many specimens of Japanese art. In a little medicine case, the base is *shaku-do*, nearly of the composition given in Analysis No 1. The enrichments are the grey *shibu-ichi*, a *kuromi* fish, with 24 tiny dots of gold in the space of about one-eighth of an inch. Then there is a *shibu-ichi* shell, with a gold shell placed beside it, and a *kuromi* carrot, on which a grey *shibu-ichi* mouse, with *shaku-do* spots let into him, is feeding. All this lavish adornment is most perfectly done. The actual method of manipulation I will now describe.

In the plate of light brown bronze (Fig. 201), which presents the simplest possible case, there is no attempt at a raised surface; the artist has simply taken a plate of bronze, $8\frac{1}{2}$ in. diameter, he has cut a design in it, and inlaid that design with *shaku-do*. Wherever he has scooped out the drawing of the beautifully graceful bird, he has inlaid *shaku-do*; and he has taken a darker variety of *shaku-do*—that is to say, one which contains a little more gold which, when treated with a suitable pickling solution, will come out a little darker—and has in that way produced exactly

the effect of an Indian-ink painting, in a dark and comparatively light shade, effect by a raised surface, but the design is completed by an inlay of dark *shaku-do* on lighter *shaku-do* on a bronze basis.

201.



Japanese plate.

202.

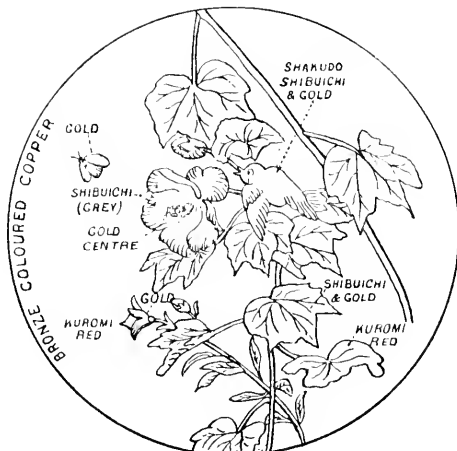

Japanese plate.

In Fig. 202, a larger plate, 18½ in. diameter, is, on the whole, a fair example of the treatment of the complex series of alloys. They first of all take a plain surface of copper. In this case there is a raised ornament, instead of a perfectly flat one. They scoop out the outline of a leaf, undercut it to a certain extent, make the leaf that they wish to insert of a particular alloy—it may be *shaku-do* tipped with gold, the surface being roughened and the gold hammered on just as a dentist would—then the whole design is fitted in like a puzzle, and the result is they build up a picture gradually, using coloured alloys, or alloys which may be coloured by the action of a pickle. The basis is a plate of copper. In one place is a leaf which is not really raised, but a little sunk below the surface of the original plate. The only relief it possesses is obtained by hammering a light variety of gold over it. Then comes a red bud of *kurumi*, set with its golden points. Then a *shibu-ichi* leaf, half of which is of red *kurumi*, and the bird, of *shaku-do*, with all its feathers carefully drawn, and the lustrous effect of the plumage produced with really consummate skill by the use of fine lines. Then comes a

on a piece of glazed brown paper. There is no attempt at producing an

shibu-ichi flower with a golden centre. This is typical of the work they do;

however large or small it may be they simply inlay these coloured alloys, using generally a sombre base.

they employ a darker alloy for producing the effect of painting on metal, so to speak, in a very remarkable way.

203.



Japanese knife handle.

204.

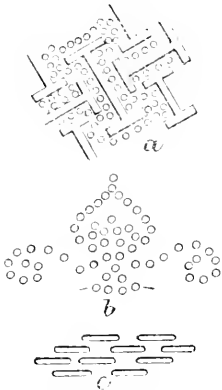

Japanese ornament.

There is one example in Huish's collection, a knife handle, which presents the effect of a duck's back and wings in comparatively high relief with his neck under water (Fig. 203). He is a *shoku-do* purple duck, plunging through silvery-grey water, but his body is in high relief, his neck is of a different *nuance*, of tinted *shoku-do* to the rest of his body, and it is so beautifully let in that it is visible only in certain lights, but it produces exactly the effect of the duck's neck being below the surface of the water. No European artificer could obtain such a result; it shows the most beautiful effects, not merely of texture but brilliancy and transparency. The colour effect is produced by the use of the pickles—the composition has been already given; but many of the extremely valuable old Chinese bronzes have acquired their tint simply by

205.

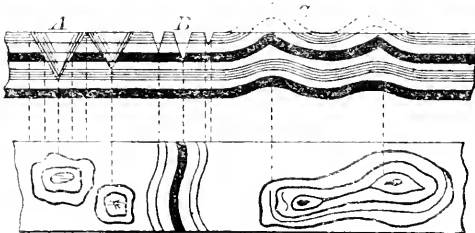

Japanese alloys.

The Japanese do not merely trust to obtaining effects by high relief, as is the case with this plate; very often

long exposure to atmospheric influences.

At *a* (Fig. 204) is a portion of an ordi-

ary Chinese bronze kettle, in which the ornament has been obtained by little punctures from behind, which reflect the light. When first looked at, you would think there were two metals, a copper kettle inlaid with silver; but it is nothing but the effect of the polished surface of brownish copper, with raised prominences from behind to reflect the light and produce the effect of another metal; *c*, Fig. 204, is another example of

which the Japanese employ are taken in thin sheets and soldered together—*kurumi*, *shibu-ichi*, and *shaku-do*—in alternate layers, as shown in Fig. 205; they drill conical holes *A B* in them to a greater or less depth, or roll them out, and then beat them up from behind, and then file off the prominences *C*, and then beat the sheets until the holes are obliterated, and thus get these different strata, and produce the beautifully

206.

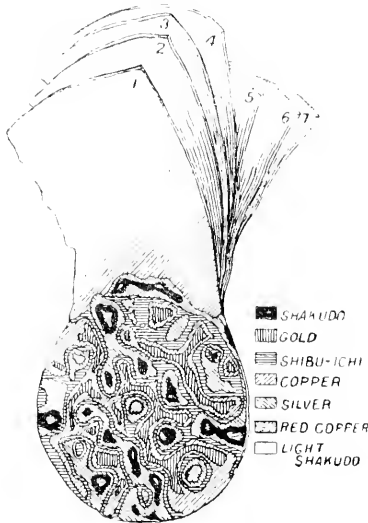

Japanese alloys.

207.



Japanese bead.

similar ornament. Often the surface is very beautifully worked, and the effect is produced entirely without any variation of colour, for the tint is uniform throughout, of a characteristic brass. The surface is produced by simply striking it all over with a blunted tool, which gives the particular lines *c* (Fig. 204).

The particular Japanese alloys are those to which the names of *moku-mo* (wood grain) and *miyu-nagashi* (marbled) are given. The characteristic alloys

banded effects. Fig. 206 shows more accurately the method of actual work, the pattern being produced by beating up a seven-layered plate from behind, and filing the surface flat.

Fig. 207 is a cylindrical bead about $\frac{1}{2}$ -in. high; half the cylinder is of the marbled alloy (produced as shown in Fig. 206), and the rest of the cylinder is made up of bands of red-copper *shaku-do* and silver, beautifully soldered. Fig. 208, a wonderful piece of manipulation, is a bead $\frac{3}{4}$ -in. diameter; half the sphere

is of grey *shibu-ichi*, and the rest is composed of very fine soldered plates, showing how perfectly the complex alloy

shuku-do, the effect of wood-grain (*moku-me*) being exactly imitated.

The lobster red of the Japanese is, I believe, not a product of pickling at all, but is cuprous oxide, formed by heating copper in air (it may be in air and steam, as is the case with their well-known and brilliant coloured commercial samples of metal), and then burnishing it, but I am not certain about it.

The Americans have produced some very beautiful alloys which show a rich purple tint. They are apparently of silver, and running over the object, usually small, is a damask pattern in a darker shade of the same purple line. This beautiful damask-like ornament is produced apparently by inlay, yet it is not possible to see that there is any inlay. I believe the patina in this particular case is in some way produced by the action of light.

Many of these alloys may be blended by casting; you may have an alloy with a solidifying point a little lower than the rest, and pour the two alloys in succession, and the one which sets first may be covered by the other one. Take for example a bronze god clothed in brass, with brass anklets and bracelets. That is done by pouring brass round a copper casting of suitable form. Endless modifications may be produced in this way by pouring alloys one over the other. (Prof. Roberts-Austen.)

Colouring Metal Wares.—

Small metallic articles, buttons, clasps, buckles, and others, have different coloured films produced on them by various methods. Some of these are known as oxidised silver. Rainbow colours are produced on brass buttons by stringing them on a copper wire and dipping them in a bath of plumbate of soda freshly prepared by boiling litharge in caustic soda, and pouring it into a

porcelain dish. A linen bag of finely pulverised litharge or hydrated oxide of lead is suspended in the solution, so as to keep up the original strength of the solution. While the buttons are in the solution, they are touched one after

298.

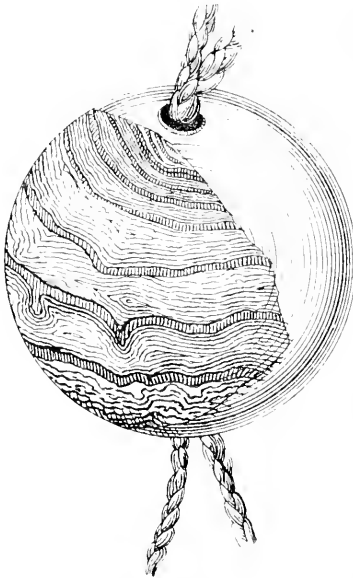

Japanese bead.

299.

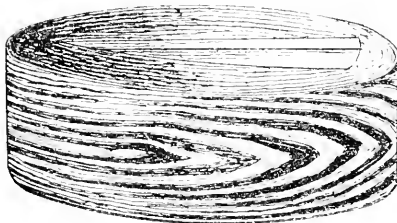

Japanese knife socket.

may be worked, even into a rounded surface. Fig. 209 represents a knife socket of alternate layers of copper and

the other with a platinum wire connected with the positive pole of a battery, until the desired colour appears. The galvanic current employed must not be too strong. The colours are more brilliant if they are heated after they have been rinsed and dried. Coloured films are more conveniently produced upon bright brass by different chemicals, by painting with them, or by immersion. For example: Golden yellow.—By dipping in a perfectly neutral solution of acetate of copper. Dull grayish green.—Repeatedly painting with very dilute solution of chloride of copper. Purple.—Heating them, and rubbing over with a tuft of cotton saturated with chloride of antimony. Golden red.—A paste of four parts of prepared chalk and mosaic gold.

In covering an article with any coloured bronze in powder, it is first rubbed with a very little linseed oil, and the bronze is dusted evenly over it from a dust bag. It is afterwards heated in an iron pan to about 480° F. In recent times small articles are also roughened by dipping in strong nitric acid, and, after washing and drying, they are coated with a rapidly drying alcohol varnish that has been coloured yellow with picric acid, red with fuchsin, purple with methyl violet, or dark blue with an aniline blue. This gives the desired colour with a beautiful metallic lustre. These colours are not very durable and are for inferior goods.

Copper Welding.—The art of welding copper was well known to the ancients; but the secret by which two pieces of copper can be joined so as to present as perfect a union as that made in welding iron was by some accident lost, and many millions have since been spent in resuscitating it from oblivion. The lost art is stated to have been at last rediscovered by James Burns, of Pittsburg. The economic value of the process lies in the fact that, even by the best methods now known to metallurgists, copper scrap cannot be economically utilised because of the difficulty in welding a mass of pieces into one body. Burns recently demonstrated

before a critical audience that his process is not a mere sham. After flattening a rod of copper $\frac{3}{4}$ in. diameter, he formed a disconnected ring. The usual "scarfing" process—forming a union by means of an oblique joint—followed; and then the operator, after sprinkling a certain powder over the piece, proceeded to make a weld which, when cooled, showed a perfect union. He next took the ring, which measured 2 in. diameter, and submitted it to a strain until its longest width had been extended $\frac{3}{4}$ in., its shorter width being narrowed to a corresponding degree, a circle being thus changed into an ellipsis. This was a more severe test than iron is expected to stand, and demonstrated conclusively that the union of the two ends of the rod was not the mere "brazing" of the copper-smith.

Burns's discovery opens up a new field in working copper, and will in all probability cause great changes in some lines of manufacture. At present, to make a copper ring for fitting over a joint, or making a gasket or joint, it had to be cut round out of a solid plate, causing great waste. To repair broken or defective pipes, brass had to be used; and should an intense heat strike the brazed part afterwards, the brass would melt and ruin the piece. But by the Burns process the economic use of copper is assured, and copper scrap, now worth but one-third its weight of new copper, would be as high in value as ingot copper. It is said that the ingredients which form the powder used by Burns in welding are very cheap.—(*Chambers's Journal*.)

Enamels for Iron and other Metals.

When the enamel becomes separated from the metal, or when the iron bends away from the enamelled side, *i.e.*, when the contraction of the enamel on cooling, is less than that of the iron, one of the following alterations must be made in the composition of the enamel:—

(a) Increase the amount of silica.

(b) Replace part of the boric acid by silica.

(c) If lead is present, replace part of the lead oxide by alkalis or alkaline earths.

(d) Replace part of the alkaline earths by alkalis.

(e) Increase the alkalis and diminish the boric acid.

(f) Instead of tin oxide, use bone ash.

If the enamel breaks, and the iron bends towards the enamelled side, and the contraction of the enamel is therefore greater than that of the iron, the constituents must be altered in the opposite sense. The following relations by weight give, according to Petrik, good and reliable enamels:—

	Pb O.	Na ₂ O.	Si O ₂ .	B ₂ O ₃ .	Sn O ₂ .	Ca O.
I.	30·8	18·5	47·1	3·6	—	—
II.	15·4	18·5	47·1	3·6	15·4	—
III.	32·4	6·0	58·1	3·4	—	—
IV.	—	18·5	63·3	7·8	—	10·4
V.	—	18·5	36·7	14·0	30·8	—
	Na ₂ O.	Si O ₂ .	B ₂ O ₃ .	Sn O ₂ .	Bone Ash.	
VI.	18·5	52·1	14·0	15·4	—	
VII.	18·5	36·7	14·0	—	30·8	
VIII.	18·5	36·7	14·0	15·4	15·4	
IX.	18·5	52·5	14·0	7·7	7·7	

The relation between tin oxide and bone ash is of great importance.— (*Monit. de la Ceramique et de la Verrerie.*)

Gold Beating.—The rough gold is put into a stone crucible, melted, and poured into a mould which gives it the right width for rolling. About 5 oz. of gold is generally moulded at a time. It is then run through rollers, the pressure of which is so great that the little bar of gold that is 1 in. wide and about 3 in. long, after being run through several times, becomes a strip about 14 yds. long and about the thickness of a hair. The strip is then cut into 1 in. squares. These squares are put into what is called a "cutch." This cutch is composed of 180 skins $3\frac{1}{2}$ in. square. The material that these skins are made of is an invention of French origin, and is kept secret. Formerly vellum was used. A gold square is placed between each skin, one directly over the other, until the cutch is filled. Two parchment bands are put over them in opposite directions to keep them from shifting. The cutch is then beaten for 15-20 minutes with a 16 lb. hammer. The gold is then taken out of the skins, quartered by a skewer, and put into what is called the "shoder." The number of skins in a shoder is 680.

These skins come from what is called the "bung gut" of an ox, one animal furnishing but two skins. The shoder skins are 4 in. square. They are put between the skins in the same manner as in the cutch. They are then beaten for $1\frac{1}{2}$ hours with a 10 lb. hammer, taken out, and again quartered with a piece of reed. They are then put into the mould one over the other, as before, until the 900 skins which the mould contains are filled. This is beaten with a hammer weighing 7 lb. for 3-4 hours. The leaf is then ready to be trimmed and booked. Before the beating process, the skins are heated and primed to prevent the leaf from sticking. Heated presses are used to take the moisture from the skins. Each skin is rubbed with a hare's foot with plaster of Paris on both sides before beating. Each one of the first squares of gold beaten out makes 25 leaves, or one book. The trimming of the leaves before they are put into books is done by a sled-shaped machine called a wagon. The trimming and booking is done mostly by girls. The trimmings that are left from the leaves are scraped together and melted over. A little salt added makes it thoroughly clean. The granite block that the beating is done on is

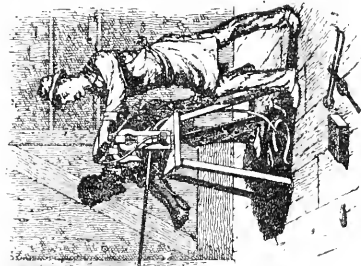

WINDING GOLD "MILL" IN THE ROLLS

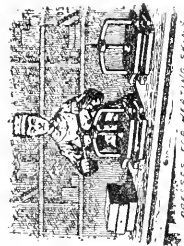
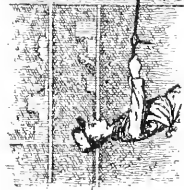

PRESSES FOR PRESSING SKINS

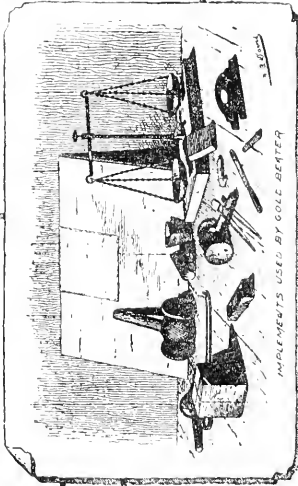

INSTRUMENTS USED BY GOLD BEATER

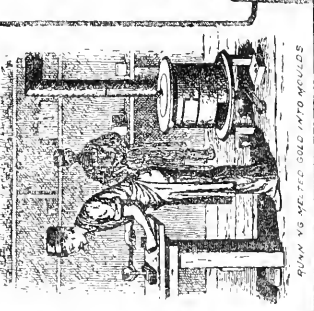

SMALL GOLD MELTED INTO PARTICLES

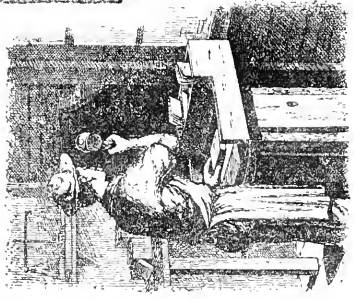

A BEATER AT WORK ON A MOUND.

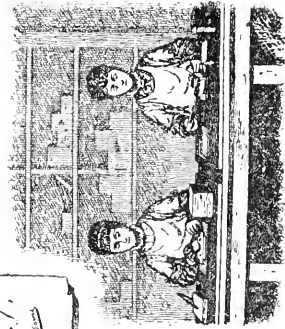

TRIMMING AND BLOCKING GOLD LEAF

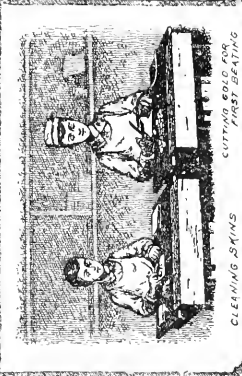

CLEANING SKINS CUTTING GOLD FOR PRESS BEATING

about 3 ft. high, the top surface being ground down perfectly smooth, so as to prevent the blows of the hammer from cutting the under side of the mould. The operations are well shown in the illustration on p. 242. (*Scient. Amer.*)

Moulding and Casting.—*Moulders' Tools.*—These comprise the rammer, vent wire, trowel, various cleaners, bead and flange, and similar tools used for sleeking, and finally the workmen's hands. Simple though these may appear, their proper employment involves a knowledge of the first principles of the art of moulding. The workmen's hands are purposely included, because in the making of a mould very much often depends on the way in which the hands are used. Tools will often damage a mould, the hands seldom do; the sense of touch is more reliable than the pressure of a tool, and for this reason a good moulder seldom uses the latter when his hands can be of service. Thus, in making an uneven bed for the bedding down of a pattern, the whole surface will be gone over in detail with the hands, in order to judge of its equal consistence, or otherwise; soft places are rendered firm by pressure and the addition of more sand, and the surface is roughened by rubbing the palms of the hands to and fro over it.

Sand is tucked under flanges and ribs and into angles by the hand; pouring basins, too, are rounded up with the palms of the hands and fingers, as well as runner and riser heads. Broken parts are mended better and safer with the finger than with the trowel, loam is daubed on by hand, small patterns are lifted out by the fingers better than with spikes; in fact, the hands of a moulder are of exceptional use to him.

There are two types of rammers employed, the "pegging" and the "flat rammer," and each is used in different sizes. *a* (Fig. 211) shows a pegging rammer, and the size of the flat end piece by which the sand is punched may vary from 1 in. by $\frac{3}{4}$ in. to 3 in. by 1 in.; *b* represents a modified form, *a* being capable of going into narrower spaces than *b*. For ramming between very

narrow spaces, such as the teeth of small gear wheels, and for small cores, a simple round rod of iron is often used. The bulk of the work is done with these pegging rammers, *c* being reserved for finishing off the sand to an approximately level face with the face of the flask or pattern, as the case may be, and for levelling beds.

The flat rammer *d* represents the largest size used, ranging from 5 in. to 6 in. diameter; and is fitted with a wooden handle, the others having iron handles. It is used for going over the largest surfaces and for filling in the sand around boxes placed in foundry pits. The handle is self-wedging, as shown at *e*; the hole being tapered, the head of the wedge touching on the bottom of the hole drives the cleft handle outward, filling up the enlarged tapered space. On the proper use of the rammer depends in a large measure the successful issue of the work in hand. Ramming must be done wisely, with due regard to the character of the mould and the position of the section which is being rammed.

Molten metal always has a tendency to fly off from a hard surface, because the gas generated from the moisture present cannot get away readily, but forms a cushion between the metal and the mould. In a hard rammed open sand mould which is not vented, the gases will be seen bubbling up through the iron, giving rise to little jets or fountains of metal. In a closed mould, the bubbling of the metal against a hard surface from which the air cannot escape with sufficient rapidity will break away the sand in patches, causing scabbing. In chilled moulds, not properly dried and warmed, the metal will blow out. For this reason, a green sand mould should always be rammed only as hard as is necessary to sustain the pressure of metal. The pressure of metal is always greatest on the bottom, and when the depth becomes very great, dry sand moulds are preferable for this reason. But with green sand moulds of moderate depth a hard bed is necessary to withstand the pressure of metal, and

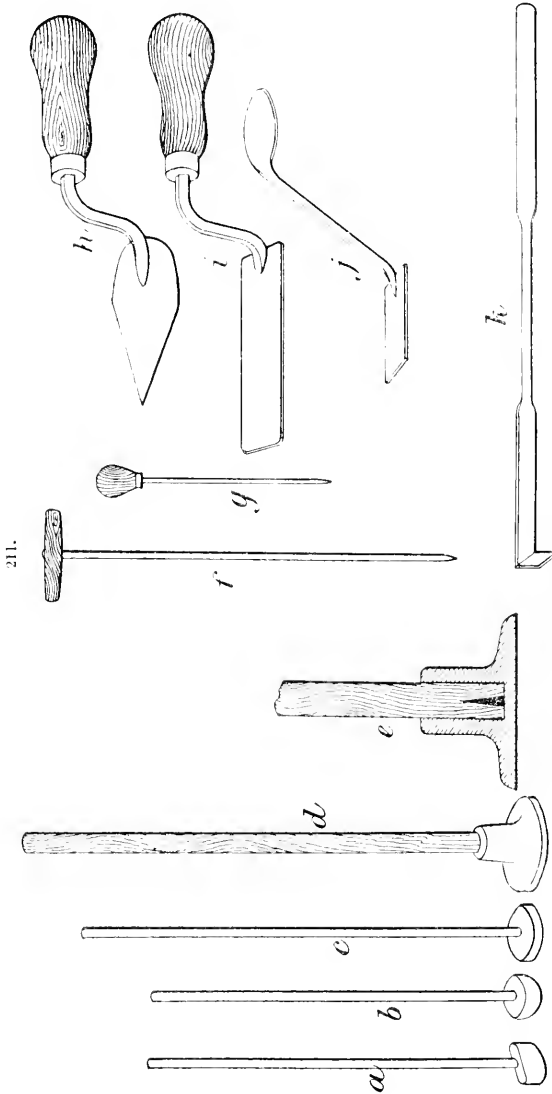

Molders' tools.

then the practice is to ram a hard bottom stratum, and over this a thin stratum of softer and more open sand. Bubbling at the surface is thus prevented, as the gas gets through the more open sand into the denser body or backing below, which is well vented, the venting being proportional to the hardness of the bed. In the case of a thin shallow casting, soft ramming at the surface is of more importance than in a deeper one, because in the former case there is little counter pressure exerted by the metal tending to drive the gas downward. Harder ramming may be done in the top of a mould than in the bottom, because any pressure exerted there is relieved at once by the risers, while that in the bottom is constant.

At the sides of a mould, again, the ramming may be harder than at the top or bottom, because the gas can escape readily. In any case, the harder the ramming, the more complete should be the venting, and care should be taken when ramming to punch the sand, not the bars or lifters or rods. This would disturb and crack the sand, and possibly cause it to fall out of the mould. Neither should the pattern be struck by the rammer, since that means undue compression of the stratum of sand in the immediate proximity, with a resulting scab at that place.

The vent wire is another moulder's tool of the first importance. Small vent wires of $\frac{1}{8}$ – $\frac{3}{16}$ in. in diameter are represented at *g* (Fig. 211); large ones of $\frac{1}{4}$ – $\frac{3}{8}$ in. being shown at *f*. Since the latter are long and large, they require the use of both hands to drive them through the sand, and hence they are provided with a cross handle. Only in the case of some special work can venting be dispensed with, the exceptions being, for the most part, loam and open sand moulds; but all green and dry sand moulds are vented. The necessity for venting lies in the presence of air in the mould and of gas generated by the decomposition of moisture in the sand. The amount of gas thus produced would astonish any but a moulder or a chemist. So soon as a mould is poured, from every

vent in the top, bottom, and box joints issues the hydrogen, which, when fired, burns in long lambent tongues of blue flame, and continues to burn for half an hour or an hour, according to the size of the mould. There is enough gas thus carried off quietly and safely to blow up the mould a great many times, if that were desirable.

The presence of a few blow holes in castings will often cause them to be condemned, yet these are due to the confinement or entanglement of some extremely small portion of gas, some few ten-thousandths perhaps of that which has escaped through the vents. Hence the necessity for allowing full provision for the rapid and complete exit of the gases generated within the mould. Of course the vent wire is not the only means of venting employed. When large masses of sand, both green and dry, have to be vented, it is usual to ram up a central portion of ashes as a reservoir for the air, which rushes off in large volumes. These ashes must not be too close to the faces of the mould, especially where there is much liquid pressure, since the sand would be apt to yield there, and produce lumpy castings.

In the case of many dry sand cores, ashes not only afford a good vent, but allow the core to yield to the shrinkage of metal. As to the manner of using the vent wire, there is no need that it should touch the pattern. The practice of moulders differs in this respect; some cover the pattern with pricker holes, while others, who are more careful, scarcely leave a mark thereon. Of course, when the wire touches the pattern the vent has gone far enough; but a careful moulder, when the nature of the work admits of it—that is, when the distance from the face of the sand lying outside to the face of the embedded pattern is pretty regular, as in work having tolerably flat outlines—will gauge the distance by first touching the pattern with the wire, measuring the length, and then pushing the wire in to a distance $\frac{1}{4}$ – $\frac{1}{2}$ in. less, as required. The reason why this space can be left

is that the porous nature of the sand allows the gas to strike through the thickness intervening between the termination of the vent and the face of the mould.

For this reason, also, sand of a close texture and rammed hard requires more and closer venting than a free and open sand. When, as in bedded-in moulds, the vents are driven from the bottom face downward, the surface is always rubbed over with sand to close the openings of the vents. If this is not done, the metal gets into the vents and chokes them up, producing a scabbed, if not actually a waster casting. The distance between the termination of the vents and the face of the mould will depend altogether upon the nature of the work.

The heavier the work, the greater the thickness of intervening sand, because the pressure tending to force the air through is greater; but in very thin, light work, it is necessary to bring the vents close to the surface. Sand which is overdamped will require more venting than drier sand, because obviously there is more gas generated. For close and hard rammed sand, abundant venting supplies in an artificial manner that freedom of exit for the gas which the sand itself, through its density, fails to provide.

The connecting together of the vents in a mould is done in several ways. There is the vent pipe, which connects the vents going down to the coke bed with the outside of the mould. There are the vents from the bottom of the drag in turned-over moulds, which connect the vertical vents from the lower mould face with the outside of the flask. There are the vents from the upper mould face coming directly through the cope; and lastly, the vents coming out at the joints of the flasks, and bringing off the air from the mould sides. In cases of the latter kind, though the vents or "gutters" may be put in at random, there is, presuming no closing up of their openings takes place, a certainty that the air will strike through, because the mass of sand has already been honey-combed with the smaller vent wires.

The trowel (*h i j*) is a tool which is constantly in use, doing duty for a variety of purposes, and being carried, like the carpenter's rule, in the trousers' pocket, ready for immediate service. In company with the moulder's hands, it shares the shaping, mending, and finishing of moulds, and is just as serviceable as its namesake used by the mason and bricklayer. It is employed for cutting, digging up, and loosening the sand in small masses; for patching on portions which have become broken down; for smoothing and sleeking over the flat surfaces of moulds, and for smoothing down the blacking and plumbago (graphite) whether used wet or dry; while the butt end of the handle is improvised for thrusting in nails used when mending up. The trowel even becomes a sort of rough gauge, for the moulder usually tests the closeness of the joint of a pattern, or flask, or core, by attempting to thrust in the blade of his trowel. If the blade passes in, the joint is open; if not, there is not much the matter. Again, he marks the outsides of flasks with the trowel, chalking the sides of the flasks and drawing 2 or 3 lines from one across to the other, and when the flasks are finally closed for casting, the coincidence of the lines indicates coincidence of the mould joint within. Again, for pressing down or "pinning" the joint edges of moulds, and so preventing crushing, the trowel is always used, as it is for scraping out core prints when too small for their cores, and for cutting vent channels or gutters, making good the joints of cores and drawbacks, and for a multitude of kindred uses. *i* (Fig. 211) shows the common form of trowel, averaging about 5 in. long. This is called the "square" trowel, to distinguish it from the "heart" trowel *h*. *j* illustrates a combination trowel called the "heart" and "square," which is used only as a touching-up and finishing tool, being made in smaller sizes than the other.

The remaining figures represent tools which are all used for cleaning, mending, sleeking, and finishing moulds. They are called by different names, though

212.

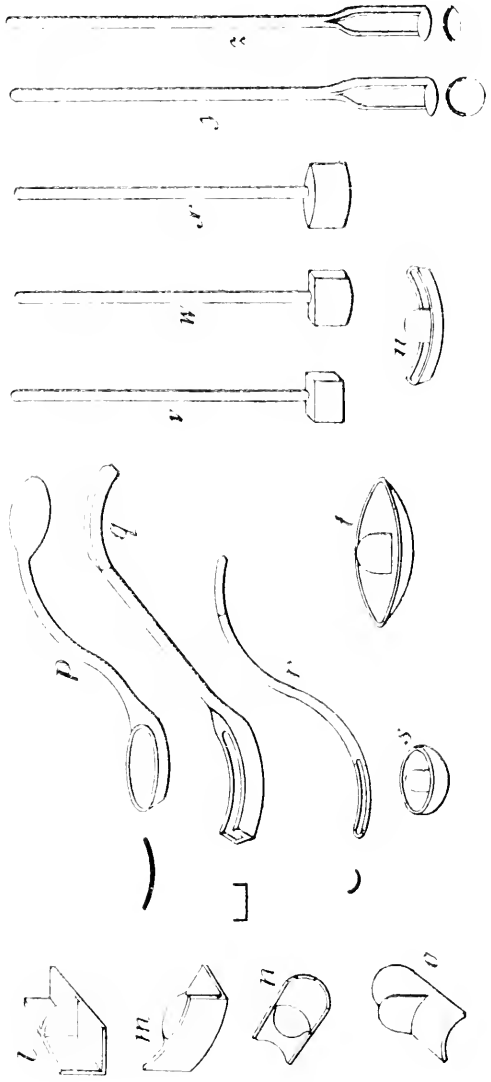

Molders' tools.

their functions are essentially similar, the names being derived from the more especial uses to which they are applied, or to their fancied resemblance to common articles. *k* is the "cleaner," a tool which ranks next after the trowel in point of general utility. Its long thin blade is used for cleaning and smoothing the vertical faces of the deep and narrow portions of moulds into which the trowel would not reach, for mending up similar sections where the fingers cannot enter, for boring holes in moulds for chaplet stalks, and for core vents; while the turned-out foot, standing at right angles with the end opposite, is used for lifting out sand which has fallen into the bottom of deep narrow moulds, for mending up and making good damaged parts similarly situated, for pressing sand around cores after they have been placed in their prints, and for many similar purposes besides. These cleaners are made in widths of blade ranging from $\frac{1}{4}$ in. to about $1\frac{1}{2}$ in.

All the remaining tools (Fig. 212) are finishing tools. Taking them in order, *l* is a square corner "sleeker," or "slicker," or "slaker," or "smoother," and is used for sleeking the internal faces of moulds which stand at right angles with each other. *m* is a tool of the same character, but having one face curved for sweeps. *n* is a head tool, used for sleeking the hollow impressions left by heads. *o* is a hollow head, by which the rounding edges of moulds are finished, or those edges which become the "hollows" of the casting. All these are made in several sizes, large and small, as convenient. *p* is a spoon tool, the shapes of the bowls resembling those of spoons. They are handy for finishing hollow work. The head tool *r* differs from the spoon tools in being narrow, parallel, and quicker in curve. It is used for cleaning and finishing heads in circular and hollow work. *q* is a tool differing from the last in having square edges, which sufficiently indicate its use. *v v x* are flange tools, being used for smoothing the bottom edges and sides of flanges and flange-like moulds. *y z* are boss tools, *s* is a button sleeker,

t is a pipe sleeker, and *u* a modification of the latter. All the tools in this group are made in different sizes, and some in modified forms, and all alike, either in iron or in brass. They require to be kept clean, and free from rust and dirt. For special work other tools besides these are made. The most convenient box in which to keep these small tools is a plain open one with a bridge of iron screwed across the top, by which to carry it from one part of the shop to another, as required.—(*Industries.*)

Smiths' Work.—Though none but a professional smith could hope to undertake elaborate works in wrought iron and steel, yet many simple jobs can be done with a very moderate amount of practice, such as the bending, drawing down, upsetting, shaping, and welding of the plainer kinds of work.

In a small shop, an ordinary forge would be rather cumbersome. Hence one of the small portable forges would be preferable to a mass of brickwork and iron, if it were not for the difficulty of carrying off the smoke. If the forge is to be in a closed building, there must be a hood and chimney. If, on the other hand, it could be placed without the building, protected by a lean-to roof, a portable rivet or similar forge would be lighter and less expensive. The circular bellows in Fig. 213 are either of the single or the double blast type, the latter giving a continuous current of air, but being also the more expensive of the two. Forges with 16 in. bellows are the smallest made, and either these or 18 in. would be the handiest for a small shop. A light framework of bar iron supports the circular hearth. The circular bellows are carried beneath, and are worked by the handle, levers, and rocking shaft, the blast being conveyed through the bend pipe into the back of the hearth.

The ordinary fixed forge is built of brick or stone. The hearth bricks simply enclose a hollow space which is filled with cinders, and upon which the fire is laid. The hearth back is of brick or stone, faced at its lower portion with a plate of iron, through which the tuyere

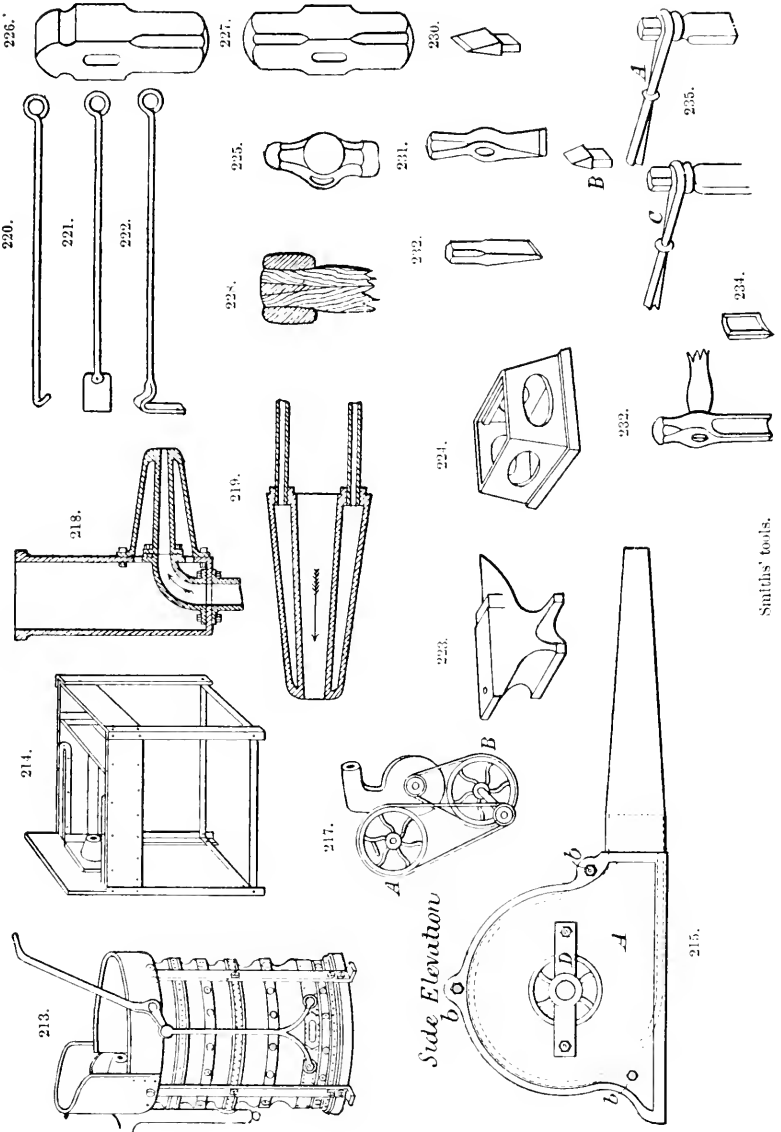

Smiths' tools.

passes, and pierced at its upper portion with a square hole leading into the chimney. The chimney need not be long, its function not being the production of blast, but only of a sufficiency of draught to lead away the smoke. The face of the hearth for a few inches inward from the edges is usually covered with a sheet of cast or wrought iron, for the sake of protection to the bricks. Two troughs occupy the front of the forge—a coal bunk, and a slake or water trough, the two often being made in one casting.

About the cheapest forge which can be made is that shown in Fig. 214, and one which any amateur could construct at a low cost, and with very little trouble. It can be employed out of doors, or placed indoors under a hood and against a wall leading into a chimney. Angle irons for the supports, flat bar iron for the horizontal stretchers, and sheets for the hearth and coal bunk are all that are required. The bearing surface of the angle iron will keep the structure from rocking; but if there is any tendency to unsteadiness when working the bellows, a diagonal brace on each framing will prevent it. The blast may be taken from long bellows placed underneath, and worked by means of a lever handle, set conveniently behind the hearth back, but keyed to a rocking shaft which moves in bearings bolted to the under side of the hearth plate. The rocking shaft passing thus underneath to the front of the forge actuates a lever and connecting rod, completing the connection with the bottom board of the bellows. Or the blast can be taken from a blower at the back, either with single or multiplying gear. A small forge of this type may measure out and out 26 in. long, 22 in. wide, and 30 in. high. The angles may measure $1\frac{1}{2}$ in. \times $1\frac{1}{2}$ in. \times $\frac{1}{4}$ in., the bar stretchers $1\frac{1}{4}$ in. \times $\frac{1}{4}$ in., and the sheets about $\frac{1}{8}$ in. thick.

The supplying of the blast is effected either by means of bellows of circular or long pear-shaped form or by fans or by blowers, and in these matters the purse and the convenience of the user

would be consulted. Bellows are worked by a handle and rocking staff, and attached to the forge, or distinct therefrom, according to convenience. A fan is preferable to bellows, and is worked by hand or foot, or power, but should be driven with multiplying gear to get up the speed. In factories a single fan worked by a belt from the engine supplies blast to a range of forges; a throttle valve under the control of the smith regulating the passage of the blast to each forge. Numbers of small forges are now sold very cheaply fitted with fans, or with Root's blowers, so that the old fashioned leather bellows seem to be doomed to ultimate extinction. A small fan is shown in Fig. 215. The cheeks A are of cast iron grooved to a bare $\frac{1}{8}$ in. deep *a*, to take the strip of sheet iron or brass B, which is cemented in with white lead and clamped together with bolts *b* passing between the sides. The fan spindle *c* is carried in bridge-like bearings D, bolted to the sides of the cheeks, and the fan itself is composed of dished sides of sheet iron or tin E, between which the vanes *d* are soldered. The dished sides are soldered to brass rings *e*, which run against the inner faces of the cheeks. The vanes or blades are also soldered to the curved ribs *f*, on the central boss, made of gun metal. The actual fan requires to be nicely balanced, owing to the high speed at which it rotates. The fan sides are each furnished with a central hole to admit the air. Instead of flat cheeks, two castings can be made with curved outlines, and bolted together with a central outside flange, in the manner so familiarly known in foundry and other fans; but this means the making of two rather troublesome half patterns. The form of blade used in the common old fashioned fan is shown in Fig. 216, but it is noisy. It is easy to make, the blades revolving within the outer casing, and as close to the sides without actually touching them as possible.

By multiplying gear, we mean some arrangement by which the proper speed of a fan can be imparted without excessive labour at the hand wheel. A

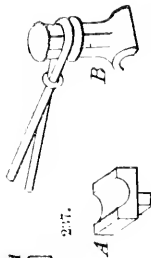
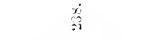
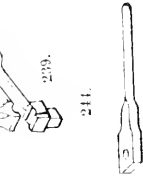
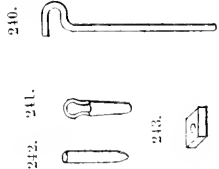
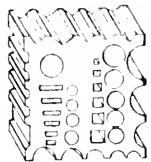
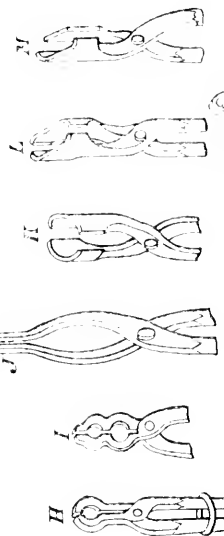
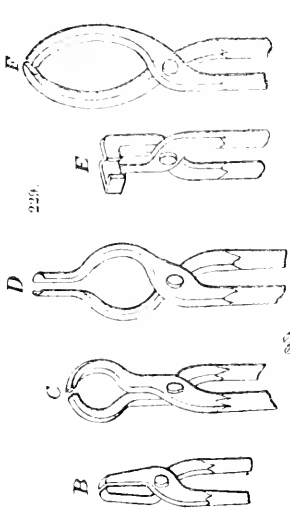
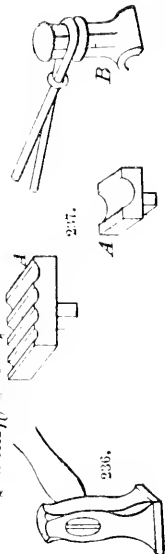
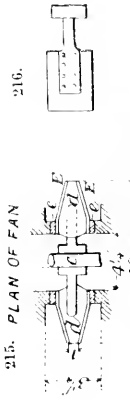
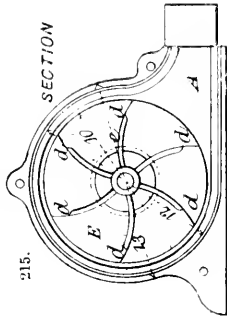
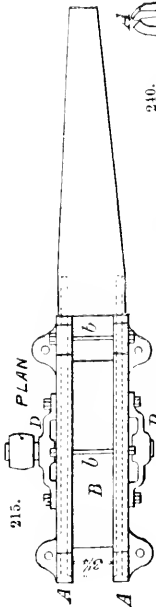

Smiths' tools.

hand wheel driving direct to the fan pulley will do, but with multiplying gear smaller wheels and less work will effect the same results. The perspective view (Fig. 217) illustrates this gear, the relative positions of the wheels varying as best adapted to the forge itself, and, of course, a treadle can be substituted for the handle. As drawn, the wheel A would be to one side of the forge clear of the hearth, its bearing being bolted to the hearth back, the bearings of the other wheels being bolted to the stretchers underneath the hearth. 10 in. would be a good size for the wheels A and B. Bands are preferable to ropes running round grooved pulleys, since the latter properly require tightening gear for alterations in length due to temperature.

There is also the tuyere or tue iron to be considered, its function being the conveying of the blast to the fire. The nose of a tuyere would rapidly burn away, and does inevitably burn in time; but its destruction is retarded by the formation of a water chamber behind and around it, a current of cold water being made to circulate by convection within a conical cylinder through which the blast pipe passes, the whole being attached to a cistern or "water bosh." Fig. 218 shows this, the more modern type, in section, and Fig. 219 a section of the older tue iron, made either in cast or in wrought iron. These are illustrative, however, of the tuyeres used for large forges; but the small forges here figured are not provided with a water tuyere, because they are not subject to so fierce a heat as those of larger dimensions, and they are used intermittently. The nozzle which receives the blast pipe is, therefore, simply thickened up in these cases, and the boss piece is cast in one with a back plate, and thus bolted to the hearth back, so as to be readily renewable, as in Figs. 213, 214.

The firing tools are the poker (Fig. 220), the slice (Fig. 221), and the rake (Fig. 222). A ladle is also used for lifting water from the slake trough for the damping down of the fire.

The anvil (Fig. 223), of wrought iron, steel faced, is often supported at its proper height—about 2 ft.—on a block of wood, having spikes driven in at the corners to keep the anvil in place. A much neater and better way is to have a hollow standard of cast iron (Fig. 224) furnished with ledges for the anvil, and with holes at the sides for clearing out the scale and dust. Such a casting is easily made from a pattern by coring out, gives less recoil than wood, and looks neat. Anvils weigh from a few lb. to 4-5 cwt., one of 2 cwt. being of suitable size for light work. The conical end is called the "beak," or "bick," the steel top the "face," the body the "core." There is a square hole, or sometimes two square holes, in the face to receive the anvil cutter and the various bottom tools.

Of the large number of tools of different shapes employed by smiths, those which are in most constant request are the hammers and tongs. After these come the different sets, swages, fullers, and flatters. A smith who works alone is vastly more limited in the number of tools which he can employ than one who has a striker to assist him. When a man is holding his work with the one hand and the hammer with the other, he cannot be holding top swages and flatters and sets as well. But when a two-handed job is required, help can usually be obtained.

Of hammers there are two principal types, each varying in weight and shape, the hand hammer (Fig. 225) and the sledge (Figs. 226, 227). The former weighs 1-4 lb., the latter about 4-14 lb. A hand hammer of 2-3 lb. weight is useful for general work, the lightest hammer, about 1½ lb., being chiefly used by the smith to indicate to his striker at which points to direct his blows, the heavier hammers for drawing down and forging light works. The lighter sledges are used "up-handed," that is, for lifting and striking in a circular arc simply, over the work. The heavier sledges are swung in a complete circle, or "about sledge." The handles of each of these hammers are made of ash, well

spoke-shaved, and smoothed with glass paper, and are wedged with a single wood wedge, as shown in Fig. 228, wedges of wood being less likely to work loose than those of iron.

Taking the various tongs in order (Fig. 229), we have A and B the flat bit tongs, having flat parallel jaws, the width of opening of the jaws being greater in the "open mouth" A than in the "close mouth" B—the former being used for thick, the latter for thin work, but each being similarly used for the purpose of grasping flat iron bars and sheets. The pincer tongs C are made in two forms, the first being simply concave in the jaws, the second veed as shown, the function of each being the grasping of round, square, or hexagonal bars. The hollow space behind the jaws allows of collars and similar expansions on forged work being enclosed thereby. D are tongs of similar type, but more widely useful, because longer and more enlarged behind the jaws. The "crook bit tongs" E are very common, and are made in various sizes, their peculiar shape permitting of a bar of iron passing down by the handles, while the lip on one jaw serves to retain the bar in place. The "hammer tongs" F grasp punched work, entering into the punched holes. The "hoop tongs" G are for holding rings of thin metal. H are "bolt tongs" for grasping bolts or rings of round bar iron. I, J are two forms of "pliers," the latter being in constant use for general light work, picking up light rods, punches, drifts, hardening and tempering tools, etc. K are "hollow bit tongs," made in many sizes for holding rods of circular or other sections. While L and M are "flat tongs," two of the commoner modifications of the last type, and also made in several sizes for grasping flat bars of different widths and thicknesses. These embrace the principal types of tongs, but like many other tools, they rapidly increase in number, and a single forge will have 20-50 pairs of different sizes and in various modifications.

All tongs are made to grasp their

work by means of a "coupler" embracing the handles or reins (Fig. 229 H), and just tapped over with a hammer until they tighten themselves, so that the smith has only to turn the tongs and work about, the coupler maintaining a firm hold of the jaws on the work.

For cutting off bars, rounding edges, and rough dressing of forgings to shape, the chisels, or "sets," and the gouges are employed. First there is the anvil cutter (Fig. 230), whose shank drops into the square hole in the anvil, before mentioned. The chisel edge being therefore uppermost, when a bar of cold iron is placed across it and struck with the hammer, the bar being rotated the while, the latter is nicked circularly, and may then be easily broken across the edge of the anvil, the fracture appearing of a crystalline character. The "hot" and "cold" sets (Figs. 231, 232) are also chisel-like tools, the difference in these consisting in the angle at which they are ground, the "hot set" being ground thin, the "cold set" relatively thick, and used, as their names imply, for cutting bars hot or cold. These are handled in a similar fashion to hammers, or on withy rods or rods of iron, the sketches indicating both forms, and the modes of handling applying indifferently to either. Tools like Figs. 233, 234, differ only in respect to their width and radii, their edges being curved to various sweeps for cutting corresponding outlines on red hot iron. These "gouges" or "hollow sets" are struck by the sledge, the smith holding the tool by the withy handles, while the striker directs his blows on the head. The bevel is either inside or outside; and when cutting through a thick mass of iron, it is necessary to withdraw them occasionally, and dip them momentarily in water to prevent softening and loss of temper.

Besides these there are a large number of non-cutting tools of different forms. Chief among these is the "fuller," used, as its name implies, for "fullering" or drawing down iron in a series of grooves, for welding, or for obtaining a flat surface, or for produc-

ing a starting point from which to bend a bar. A "top fuller" is shown in Fig. 235, A, a "bottom fuller" or "anvil fuller" at B, the latter resting by its shank over the anvil hole, the former being handled hammerlike, or by withes. The top fuller may be used while the bar rests upon the anvil face, or the bar may rest upon the bottom fuller and be struck by the hammer above, or the bar may be drawn down between the top and bottom fullers, the upper one being struck by the sledge while the bar is moved into successive positions until the iron is thinned or tapered by a series of grooves. The "nicking fullers" (Fig. 235) are made in various sweeps, and they fulfil the same purpose for circular shafts and rods that the others do for flat bars.

To finish plane surfaces, the "flatter" (Fig. 236) is employed. This is also struck by the sledge, and finishes or flattens the surface, removing the uneven ridges and indentations left by the hammers and fullering tools.

The "swages" form also a very large family in themselves. They are so termed because by their agency work is "swaged" or drawn down and made to assume definite outline corresponding with the shapes of the swages. These are, therefore, dies in principle, because the work can only assume the shapes given to the swages. Being also used in pairs, one top, one bottom, they are commonly called "top and bottom tools." Some shapes are given in Fig. 237. A are bottom swages, that is, they fit by their square shanks into the hole in the anvil face. The shape of the corresponding top swages is seen at B. The ordinary shapes are the half-round, the veed, and the hexagonal, each being required in different sizes. Fig. 238 represents a swage block for a heavier class of work, the various sectional forms around its edges answering the purpose of bottom swages. It is conveniently laid upon a cast iron stand, similarly to the anvil, on which stand it can also be laid flat in order that the central holes

shall fulfil the functions of "heading tools," that is, of the type of Fig. 244, for finishing the square shoulders of bolt heads and similar flat expansions. The top and bottom swages are frequently united in one with a bent rod of iron, which serves to keep them in line, and becomes a convenient handle. They are then turned "spring swages," or "spring tools" (Fig. 239).

There are three modes of handling tools employed by smiths. The first, just now referred to, of wedging the hammer head fast in the shaft. The second, that made use of with some of the sets, gonges, fullers, and flatters, in which the handle is simply thrust through an eye in the tool without any attempt at wedging, the reason being that their constant and almost close contact with red-hot iron would cause wedges to work slack almost directly. Hence the smith, previous to using either of these tools, usually strikes the butt end of the shaft on the anvil to tighten the head. Lastly there is the method of fixing by hazel rods. These are straight hazel sticks about $\frac{1}{2}$ - $\frac{3}{4}$ in. in diameter, twisted round the necks of the tools (Figs. 235, 237), the elastic wood preventing painful jarring and blistering of the hand of the smith. Before being bent, they are soaked in water and steamed over the fire, the operation being alternately repeated until they are sufficiently pliable to bear bending and twisting, but not taking more than a minute or two. The parallel rods are united permanently by a coupler, and are never taken off the tools except when they need renewal. Very often it is the practice to substitute iron rods for those of wood, as being more durable, the rods being bent in the same manner.

A hook wrench (Fig. 240) is used for giving a slight amount of torsion to flat bars while red hot, which have become twisted or winding in the process of forging. Fig. 241 may be taken as a type of the punches which are employed for piercing holes through red-hot iron, and Fig. 242 of the drifts for enlarging and making them parallel,

the work being laid upon a bolster (Fig. 243) the while. Fig. 244 is a heading tool, of which there are several sizes used for shouldering the heads of

As a simple example of the practice of forging, take the connecting rod (Fig. 245), one with a forked end being purposely chosen as being more

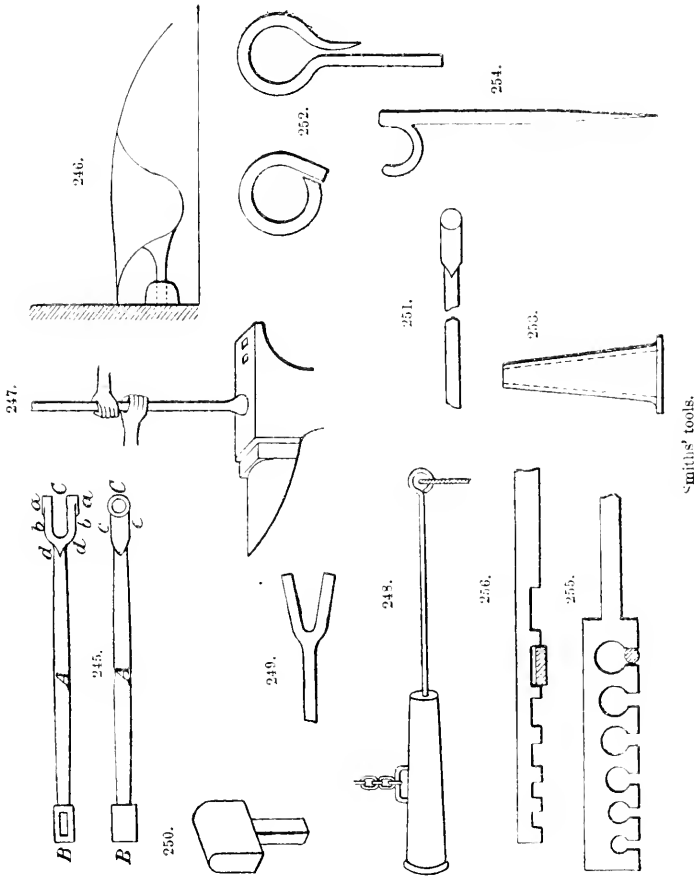

Smiths' tools.

bolts and rivets, or any work provided with collars, though where a collar is welded, or otherwise formed on the centre of a bar, collar swages are often used in preference.

complete for purposes of illustration. This could obviously be made by building up—that is, the enlargements at the ends could be welded on a bar of the diameter A; or by swaging down,

in which the diameter A would be hammered down from a bar of the sizes B or C of the larger ends; or by jumping up, where the ends would be beaten up or "upset" on a bar of diameter A. Or it can be made by a combination of these processes if a bar of medium dimensions only is available.

Say we have a piece of bar of the dimensions A; we can get on very well with that. We build a fire in such a way as to obtain "a solid core of heat"—that is, we have a certain portion in front of, but away at a distance of a few inches from the tuyere, intensely hot, and for the time being open above, but flanked at back and front with two masses of wetted hard-caked small green coal or "slack," which partially confine the heat (Fig. 246), and form a reserve supply for the incandescent mass; and the larger the forging the larger the reserve of "stock." Putting that portion of the bar which requires to be heated—in this case the end—into the centre of the fire, cover it over with a mixture of stock and new coal, so as to enclose it completely, localising the heat where required by keeping wet coal over the portion which is not to be heated. Then the blast is put on, and the heat is enclosed and intensified around the bar. The bar, especially if large, is to be turned partly round in the fire now and again to equalise the heat, the blast meanwhile hollowing the fire in the immediate vicinity of the bar; now and then, also, it will be partly withdrawn in order to be sure that it does not get burned. The heat at which it should get taken from the fire varies with circumstances, a full, red heat being suitable for ordinary forging; while for jumping up, and welding, the iron should be white hot, and just beginning to throw off vivid sparks. Beyond this temperature it becomes burned and spoiled. When the bar is at the white heat, it is removed from the fire by means of hollow bit tongs and transferred to the anvil, whence we will follow the process through, remembering that in smiths' work the whole manipulation must be

foreseen from the beginning, and the tools all be at hand, so that there shall be no hesitation and loss of time and heat. We will first suppose that the hollow of the forked end is to be slotted out of the solid, and then, for further illustration, we will assume that the hollowing out is to be done at the anvil.

While at a white heat we shall "upset" the iron in order to obtain sufficient breadth for the forked end, and to do this a short heat only will have to be taken on the end of the bar. Thus if the length of the forked portion C were 3 in., the end of the bar would be heated only to a length of 7-8 in. If more length is required, two successive heats should be taken. That portion of the bar, then, which lies beyond the part which has to be upset will not become bent or otherwise distorted during the upsetting process, but remain rigid. The upsetting is performed either by jumping the bar heavily end on to the anvil, the hot portion, of course, being downward (Fig. 247), hence also called jumping up, or it is hammered with the sledge, swung in a nearly horizontal arc, the smith holding the bar horizontally on the anvil with the tongs, or a heavy cast-iron monkey (Fig. 248), suspended by a chain, is swung heavily against the end of the bar.

When the amount of jumping up which is required is slight, the first method suffices; for heavy work the latter plans are adopted. Upsetting reduces the length and increases the breadth and thickness, and the enlargement, being very irregular in outline, must needs be made considerably larger than is actually required. At the same time, since the jumped mass will be of a rudely circular shape, being simply an expansion of the shape of the bar, a rough outline of the shape finally required must be imparted to the end by hammering, the hammering and upsetting alternating, so that the iron, still retaining its heat, is hammered approximately level and square on four sides, forming a rectangular block or

lump at the end of the round bar, its extreme dimensions being slightly larger than the out and out dimensions of the bosses *a*. By this time it will probably have lost most of its heat, and will go back to the fire to be made nearly as hot as in the first place. By means of the fuller first and the flatter afterward, the hollows around the bosses and the flats *b* will be set down, and similarly the flats *c*. The outside rounding of the bosses will be imparted by cutting off a portion of the corners with a hot set, then hammering with an ordinary hammer, and smoothing off with a top swage struck by a sledge. The whole of the black dimensions will remain when finished a trifle over the bright finished sizes, to give sufficient allowance for machining. The rounding off at *d* is first rudely cut with the hot set, or with a gouge tool, the heads of those tools being struck with the sledge. The angularities will be beaten down rapidly with the hammer, and a top and a nicking swage of suitable curves will be used to impart a finished outline.

The bar will now go into the fire again, and the heat will be taken over it extending from the fork to about the centre. A nicking fuller may be used to shoulder down the square bar to a circular section just where it departs from the forked end, or if the bar is small it may be simply hammered at the angles with a hand hammer or sledge. When the diameter is roughly reduced down to the required size next the fork, the original size remaining at the centre, it will be readily finished by swaging, the proper allowance being left for turning. This need not occupy more than one heat. The other half of the rod can be swaged down in another heat. Then there remains the stub end B which has to take the strap, and this will be jumped up in a short heat similarly to the forked end, finished with the flatter, and neatly fullered down around the neck.

In this illustration we have supposed the space between the fork ends to be slotted or drilled out of the solid.

But if the forked ends were so wide apart that the slotting or drilling out of the interspace would be considered a heavy task, or if the end were that of a rough lever or pump rod which would not pay for machining, the forks would be forged as follows: If the width of the bar were less than twice the thickness of each fork, it would first require to be jumped up until its width were somewhat more than twice the thickness—that is to say, if the forks were $\frac{3}{4}$ in. thick, the width of the bar should be rather more than $1\frac{1}{2}$ in., say $1\frac{3}{4}$ in. or 2 in. As before, a short heat is then taken, extending no farther than just beyond the shoulder. The flat portion is laid on the anvil, and divided through the centre with a hot set, cutting first from one side, then from the other, and meeting in the centre.

Sometimes a hole is first punched at the bottom of the hollow. Once divided, it is readily opened out first to the V-shape (Fig. 249), then the hollow is formed by jumping and hammering over a bottom fuller of considerable breadth and depth (Fig. 250), sometimes termed a dresser, or joint dresser, until a rough outline of the bifurcation is obtained. Then the more exact outlines and thicknesses are given in a second heat by judicious hammering, and finishing, partly over the dresser, partly on the flat overhang of the anvil, if the space between the forks is sufficient to permit of this. Finally, when the shaping is done, the forks must be tried for parallelism with the axis of the bar, and if out of truth, they will be set over with the hammer.

It is easy to see how a difference in relative proportions would modify the method of making which ought to be adopted, and since our connecting rod is selected, not as of any particular size, but illustrative only of different methods of forging, we will now make it the medium of sundry remarks in reference to the practice of welding.

Upsetting is hard work when the quantity of metal to be upset is large, and particularly so when done without the aid of a monkey, or in the absence

of a massive plate which is frequently sunk in the floor for the same purpose. Welding is, therefore, much easier in certain instances. But the stub end B (Fig. 245) is not so much larger than the original size of the bar in the centre; therefore we may upset that very well. Also, when the sum of the widths of the two forks is little more than that of the original bar, and the forks are forged as in the last example, we may accept the jumping up method as being practicable. Moreover, in the first instance described, we upset the bar on the supposition that, though the end was solid, it was not of great width, and this would also be applicable to the ends of many light levers. But assuming the end were both solid and wide, measuring, say, over the bosses 3 or 4 times the diameter of the bar in the centre, welding then would be preferable because involving less labour.

When making a weld, there are three points to be borne in mind: to have a joint of sufficient area, and in suitable direction for hammering up; to have the necessary temperature; and to be sure of perfectly clean surfaces. For the first condition, a scarf joint, that is, one running diagonally with the common axis of the pieces to be shut (Fig. 251), is to be preferred, and is, therefore, commonly employed when practicable. When a scarf joint cannot be used, a veed or cleft joint is suitable. When that cannot be employed, a spreading joint, made by fullering down a portion of the bar, is resorted to. A plain butt joint, except when the abutting surfaces are of large area, is seldom used; but flat *surface* shuts are common. The temperature for welding iron is that just now referred to, when the iron begins to sparkle, and to drop off in globules. For steel, the temperature is lower, barely approaching to a white heat. Different qualities of iron and steel require different degrees of heat, and the temperature in each case become a matter of experience. When the ends to be welded are taken from the fire, any scale adherent to the sur-

face must be detached by striking the bar smartly on the anvil, joint face downward, or by sweeping away the scale with a muck brush. If any persistently adhering scale remains on the faces, the shut should not be made.

Fractures occur sometimes from this reason, the weld being perfect near the edges, but faulty in the centre. The joint surfaces are usually dusted with sand, but this is not so essential as it is sometimes stated to be, provided the scale is removed in the manner stated, for numbers of ordinary iron shuts are made without it. The weld is made immediately that the faces are brought into contact, by rapid hammering, every second at the welding heat being of vital importance. When closed together with the hammer, the joint of a good weld should not be visible, the presence of a black line indicating that the shut is imperfect. If during hammering the bar becomes reduced or drawn down below its proper size, diameter, width, or thickness, as the case may be, it must be slightly jumped up to thicken it sufficiently, and then swaged circular, or smoothed with the flatter. Iron and iron are easily welded, so are the milder varieties of steel; but some hard and brittle steels require tact and practice to weld properly, and some, if heated over a certain temperature, crumble under the hammer.

In a connecting rod, the cotter way in the stub end is usually drilled and filed out, but in many instances cotter ways and holes of other shapes are punched and drifted, either to save the labour of drilling previous to filing through, or as being suitable enough for the purpose which they have to fulfil. Before punching, the iron is brought to a welding heat, or nearly so, laid upon the anvil, and the punch, struck with the hammer, is made to pass half way through from one face. It is then knocked back, the iron turned over and punched from the opposite face, the holes meeting, therefore, in the middle or thereabout. Then a drift is inserted in the hole, and either

driven half way in from each side, or right through, according to circumstances. While the drift is still in place, opportunity is taken of giving a rough kind of finish to the exterior outline. Punches and drifts become red hot, and soften and bend if they remain more than a few minutes in contact with the iron, so that it is necessary to remove them once or twice from a deep hole and quench them in water. Punches and drifts are usually picked up with the pliers, though the former are sometimes finished with withy handles. They are circular, oval, or rectangular in section, the difference being that while a punch is tapered, a drift is parallel for a considerable portion of its length, and tapers only toward the end.

When bending work, various devices are resorted to. A turn-down edge at right angles would be bent over the edge of the anvil, the flat of the bar lying horizontally across the anvil, the smith grasping the tongs, and steadying them against his leg to resist the force of the endlong blows. The bar is frequently nicked across slightly with a fuller previous to bending, and the fuller, having a circular section, does not divide the fibre as a set would do. Eyes or rings are bent around the beak of the anvil, whose tapered outline permits eyes, rings, loops, and curves of many different diameters being bent. Fig. 252 shows the method of welding a ring and an eye. Rings of large diameter are finished on the conical mandrel (Fig. 253). Small rings are finished on a parallel bar or mandrel of suitable diameter, the bar remaining in place while the outside is finished with flatters or swages. When eyes are being bent, or other work being performed on bars of considerable length, the trouble of supporting the opposite end is saved by driving a rest (Fig. 254) into the ground, and placing the bar in the hollow.

When doing forging, it is necessary to take measurements rapidly—not an easy task with hot iron. Hence, gauges notched to different sizes are made of

sheet iron, say $\frac{1}{8}$ in. thick, the size of each notch being stamped above it, Fig. 255 being a gauge for round, Fig. 256 one for flat bars.—(*English Mechanic.*)

Tools, keeping in condition.

—The following hints may be found useful, especially in amateurs' shops where tools are not always in use:—

Wooden parts.—The wooden parts of tools, such as the stocks of planes and handles of chisels, are often made to have a nice appearance by French polishing; but this adds nothing to their durability. A much better plan is to let them soak in linseed oil for a week, and rub them with a cloth for a few minutes every day for a week or two. This produces a beautiful surface, and at the same time exerts a solidifying and preserving action on the wood.

Iron parts.—Rust preventives.—The following recipes are recommended for preventing rust on iron and steel surfaces:—

1. Caoutchouc oil is said to have proved efficient in preventing rust, and to have been adopted by the German army. It only requires to be spread with a piece of flannel in a very thin layer over the metallic surface and allowed to dry up. Such a coating will afford security against all atmospheric influences, and will not show any cracks under the microscope after a year's standing. To remove it the article has simply to be treated with caoutchouc oil again, and washed again after 12–24 hours.

2. A solution of indiarubber in benzine has been used for years as a coating for steel, iron, and lead, and has been found a simple means of keeping them from oxidising: It can be easily applied with a brush, and is easily rubbed off. It should be made about the consistency of cream.

3. All steel articles can be perfectly preserved from rust by putting a lump of freshly-burnt lime in the drawer or case in which they are kept. If the things are to be moved, as a gun in its case, for instance, put the lime in a muslin bag. This is especially valuable for specimens of iron when frac-

tured, for in a moderately dry place the lime will not want renewing for many years, as it is capable of absorbing a large amount of moisture. Articles in use should be placed in a box nearly filled with thoroughly-slaked lime. Before using them rub well with a woollen cloth.

4. The following mixture forms an excellent brown coating for preventing iron and steel from rust: Dissolve 2 parts crystallised iron chloride, 2 antimony chloride, and 1 tannin in 4 of water, and apply with sponge or rag, and let dry. Then another coat of paint is applied, and again another if necessary, until the colour becomes as dark as desired. When dry it is washed with water, allowed to dry again, and the surface polished with boiled linseed oil. The antimony chloride must be as nearly neutral as possible.

5. To keep tools from rusting, take $\frac{1}{2}$ oz. camphor, dissolve in 1 lb. melted lard; take off the scum and mix in as much fine black-lead (graphite) as will give it an iron colour. Clean the tools and smear with this mixture. After 24 hours rub clean with a soft linen cloth. The tools will keep clean for months under ordinary circumstances.

6. Put 1 qt. freshly-slaked lime, $\frac{1}{2}$ lb. washing soda, $\frac{1}{2}$ lb. soft soap in a bucket and sufficient water to cover the articles; put in the tools as soon as possible after use and wipe them up next morning or let them remain until wanted.

7. Soft soap with half its weight in pearlash, 1 oz. of mixture in about 1 gal. boiling water, is in everyday use in most engineers' shops in the drip-cans used for turning long articles both in wrought iron and steel. The work, though constantly moist, does not rust, and bright nuts are immersed in it for days till wanted, and retain their polish.

8. Melt slowly together 6-8 oz. lard to 1 oz. rosin, stirring till cool; when it is semi-fluid it is ready for use. If too thick, it may be let down by coal-oil or benzine. Rubbed on bright surfaces ever so thinly it preserves the

polish effectually, and may be readily rubbed off.

9. To protect metals from oxidation, polished iron or steel for instance, the requisite is to exclude air and moisture from the actual metallic surface; therefore, polished tools are usually kept in wrappings of oil-cloth and brown paper, and, thus protected, they will preserve a spotless face for an unlimited time. When these metals come to be of necessity exposed in being converted to use, it is necessary to protect them by means of some permanent dressing, and boiled linseed oil, which proves a lasting covering as it dries on, is one of the best preservatives, if not the best. But, in order to give it body, it should be thickened by the addition of some pigment, and the very best, because the most congenial of pigments is the ground oxide of the same metal, or in plain words, rusted iron reduced to an impalpable powder, for the dressing of iron and steel, which thus forms the pigment or oxide paint.

10. Slake a piece of quicklime with just water enough to cause it to crumble in a covered pot, and while hot add tallow to it and work into a paste, and use this to cover over bright work; it can be easily wiped off.

11. Olmstead's varnish is made by melting 2 oz. rosin in 1 lb. fresh sweet lard, melting the rosin first, and then adding the lard and mixing thoroughly. This is applied to the metal, which should be warm, if possible, and perfectly cleaned; it is afterwards rubbed off. This has been well proved and tested for many years, and is especially well suited for planished and Russian iron surfaces which a slight rust is apt to injure very seriously.

Rust Removers.—(1) Cover the metal with sweet oil, well rubbed in, and allow to stand for 48 hours; smear with oil applied freely with a feather or piece of cotton wool after rubbing the steel. Then rub with unslaked lime reduced to as fine a powder as possible. (2) Immerse the article to be cleaned for a few minutes, until all the dirt and rust is taken off, in a

257.

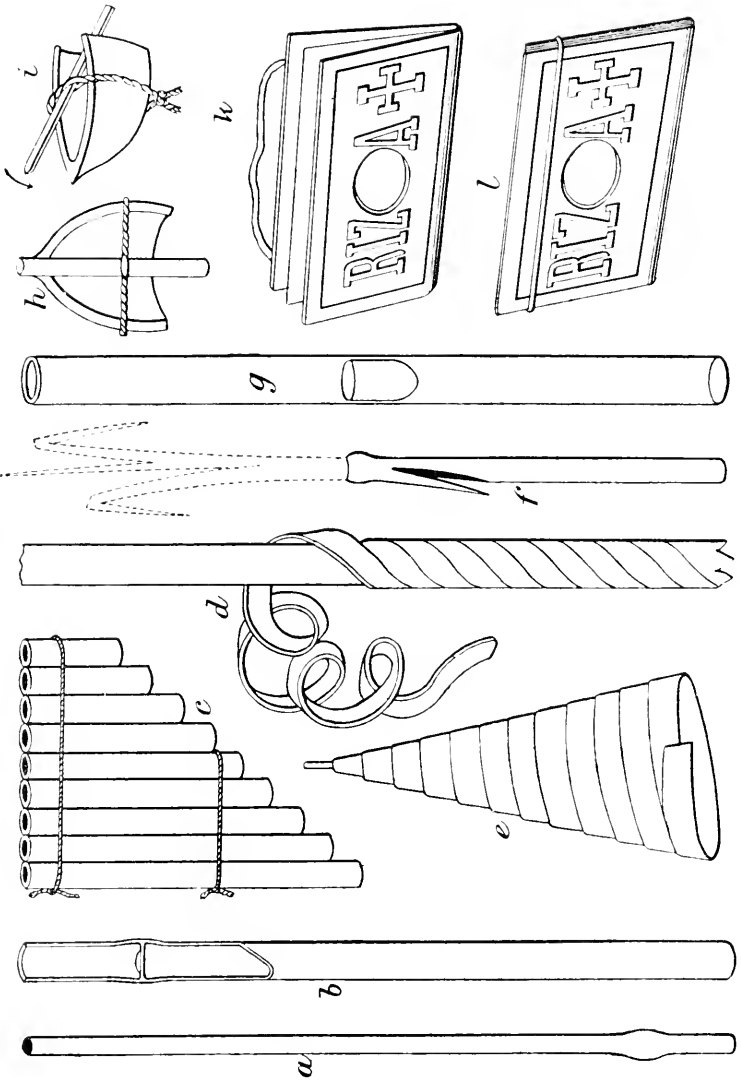

Some home-made musical instruments.

strong solution of potassium cyanide, say, about $\frac{1}{2}$ oz. in a wineglassful of water; take it out and clean it with a tooth-brush with some paste composed of potassium cyanide, castile soap, whiting and water mixed into a paste of about a consistency of thick cream.

MUSICAL INSTRUMENTS.

(iv. 279-300.)

Take an oat culm or the culm of any other cereal still green, having a knot at one end, and the other end free, and make a simple longitudinal incision in it (a Fig. 257). On blowing in the free end, there will be obtained a sharp, strident sound, somewhat recalling the noise made by large grasshoppers, if care be taken to produce the sounds at close enough intervals.

If a piece of reed be so cut as not to damage the membrane that lines the interior *b*, and one sings in one of the ends of the instrument, the exact sounds of the reed pipe will be obtained. There is no need of cutting both sides of the reed. One will suffice. On putting the reed crosswise in the mouth, in such a way that the membrane comes between the lips, and on singing through the nose, the effect will remain the same.

The union of several reeds or other tubes, one alongside of the other, the lower end closed and the upper open, will give a mouth organ *c*, upon which little airs may be played if the tubes are attuned according to the gamut.

To make a flageolet, select a smooth willow branch of the desired length, and, after bevelling off one end, remove the bark. Then put the bevelled piece back in place after properly cutting it so as to allow of the passage of air. Next, with the remaining cylinder of wood, a piston is made and inserted in the tube. It is clear that the deeper the piston is inserted, the sharper the sound will become. With a little skill and patience, it will become easy to play various airs with this instrument.

The manufacture of the hautboy is based upon the same principle of decor-

ating wood which is in sap, but it differs in construction. Here it is necessary to take a branch of willow or other tree, about $1\frac{1}{4}$ in. diameter and 3 ft. long, and cut a spiral in it *d*. After the bark has been peeled, the spirals are wound around each other in such a way as to overlap them slightly. In this way there will be obtained a long cornet, the back spiral of which is fixed by a thorn *e*. Next, a small branch, $\frac{1}{4}$ in. diameter, is peeled, one of the sides on the two opposite faces is thinned, the thin edges thus obtained are slightly juxtaposed, and the uncut end is introduced into the hautboy. When this instrument is blown, a very loud sound is obtained, recalling that of the hautboy or bassoon.

A cheap pitch pipe *g* may be made as follows: Take a small glass or metal tube about $\frac{1}{4}$ in. diameter, or even a piece of reed or a cardboard tube, and introduce it into a small cork to a depth of $1\frac{3}{4}$ in. by means of a small rod of measured length. This makes an excellent pitch pipe, which, according to use, gives the medium *la*₃ note of the female voice, of the centre of the piano, and nearly the second string of a well tuned violin. If *ut*₄ be preferred, make the tube about $1\frac{1}{2}$ in. deep.

h i represent the cricket known to schoolboys. It is made with a nutshell and a stick held by a twisted cord.

Following is a method of making a very simple reed pipe: Take the cardboard cover of a package of cigarette paper and make two apertures in it, facing each other and $\frac{1}{2}$ in. diameter. Leave one-half of the paper within *k*, close the covers *l*, and play as with an ordinary instrument of the kind.—(*La Nature*.)

PACKING AND STORING.

(iv. 23-40.)

Acids.—(*a*) The use of liquid carbonic acid contained in steel bottles, introduces a certain element of danger, to minimise which Fleischer has devised a safety crate for such bottles, as illustrated in Fig. 258. Carbonic acid is

258.

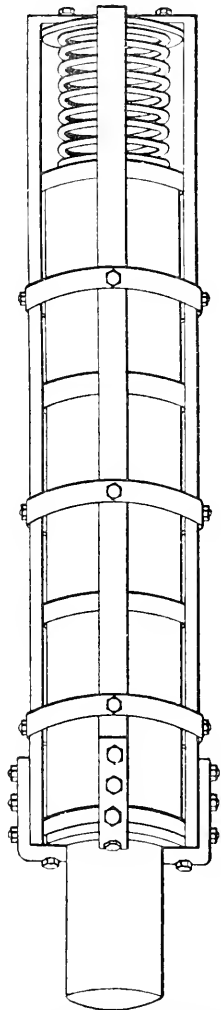

Safety crate for carbonic acid bottles.

generally compressed in steel bottles to a pressure of about 100 atmospheres;

but the pressure depends so largely upon the method of filling and upon the temperature, that it cannot be very strictly defined. It is therefore necessary to have a large margin of safety, and before putting a bottle into use it is generally tested to 250 atmospheres. In spite of this precaution, explosions do occasionally occur, and this has created a certain feeling of uneasiness in Germany, where the carbonic acid industry has of late years developed to a very large extent. The use of steel bottles for the transport of liquid carbonic acid was introduced in Germany about four years ago, and now there are over 100,000 bottles in daily use. When the bottles are sent by railway or cart, they are generally only placed in wooden boxes, which is certainly an inadequate protection against rough handling and shocks in transport. That an explosion of such a bottle may have serious consequences, is shown by a note which has been read by Guntermann before the German Society of Engineers, describing an explosion of a carbonic acid bottle on board a Rhine steamer. Fortunately the explosion occurred on a Sunday, when nobody was on board; but the amount of damage done to the frame work and deck of the vessel was very considerable, whilst even on shore the concussion was sufficiently strong to break several windows.

The immediate cause of an explosion may be either concussion or exposure to high temperature, and the Fleischer safety crate is designed to avoid the former cause, and to lessen the destructive result if the explosion should be occasioned by the latter cause. The crate consists of a stout iron framework formed by rings and longitudinal bars, which surround the bottle on all sides. A spiral spring is inserted between the bottom of the crate and the bottle, so that if the bottle is carelessly put down during transport, the spring gives and the shock is softened. If, notwithstanding the application of the crate, a bottle should burst, the crate prevents the pieces being thrown about; but there is little probability of the bottle

flying to pieces at all, for if the fracture occurs in the side wall, it cannot easily extend over a distance greater than that of two consecutive rings of the crate; and if the bottle is blown out the spiral spring will give, and allow the carbonic acid to escape gradually. The crate has the further advantage that it does not interfere with the filling of the bottle, and is therefore also a protection during the process of filling; while for transport, the wooden packing cases hitherto customary may be omitted.—(*Industries.*)

(b) A very simple but ingenious contrivance—it is so simple that the wonder is the idea has never occurred to anyone before—for protecting the upper portion of carboys when packed in hampers, is called the “Marple Carboy Protector.” The main object of this appliance is the protection from breakage of carboys when shipped abroad. It is well known

balancing rope. Some years ago we saw a patent package consisting of a stumpy kind of barrel in which the bottle was permanently fixed, embedded in a kind of cement up to the neck, with a lid and handles. This was very good in its way, but it will be easily understood that expense alone prevented its general adoption.

The “Protector,” as will be seen from Figs. 259, 260, 261, is simply a loose lid made to fit the hampers, and consists of two metal rings, the smaller and inner one intended to fit round the neck of the bottle, after being well packed with straw or hay on the top, whilst the larger or outer ring fits just inside the top hoop of the hamper, to which it will be lashed with twine or wire. The two rings are braced together with extra-strong narrow hoop-iron, and the whole is then varnished like the “Marple” hampers.

259.

260.

261.

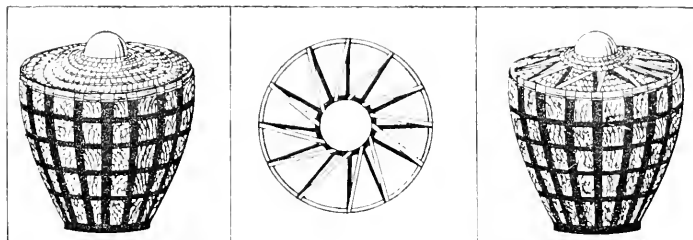

Bottle packed for protector.

Protector.

Bottle packed with protector.

in the chemical trade that all sorts of devices are made use of to prevent breakage of bottles containing acids and expensive solutions when consigned on long voyages. Some manufacturers even go to the trouble and expense of placing the full carboy (hamper and all), in small empty casks, packing them well with straw, making up the lid, but leaving handle holes at the sides of the cask. Others cover the top of the hamper with a circular piece of timber with a hole in the centre to fit round the neck of the bottle, and then fasten it down to the hamper with

This appliance ensures almost absolute immunity from breakage, and its cost is trifling as compared with other contrivances hitherto in vogue. The only part of the bottle that is exposed is the corked portion of the neck, and as the “Marple” hampers are shaped so as to stow easily in tiers, the slight projection of the cork above the level of the “Protector” is of no material consequence. We may add that as evidencing the practical value of the “Protector,” we saw a cargo of vitriol in bottles being stowed in a narrow canal boat—perhaps the most awkward

kind of "vessel" to stow carboys in—and with the "Protector" affixed, the carboys were being stowed away in tiers four or five deep like so many drums, and the workmen were standing and walking about on the tops of the bottles as though they were on terra firma.

The only drawback we can see to the general use of the "Protector" is that when affixed it is not easy to see when the bottle is getting full. This will militate against its use, say for the muriatic acid trade, where the bottles are usually filled by hose quickly, but where bottles are filled by funnel, and a recognised rule adhered to of filling every bottle with a given weight, and no more, of any particular chemical, there is no reason why the "Protector" should not prove as great a boon for the home trade as it undoubtedly will for the foreign trade as regards chemicals consigned in carboys.—(*Chem. Trades Jour.*)

(c) It has been shown that concentrated sulphuric acid of 66° B. brought into contact with straw, wood, and other organic stuffs at ordinary temperature, can develop volatile organic acids and sulphurous acid in considerable quantity. This sufficiently explains the destruction of iron parts of vessels, etc., not in actual contact with escaping acid, and indicates that sleeping in enclosed spaces in which concentrated sulphuric acid is being conveyed can only be warranted where ventilation is very good.

Eggs.—(1) Buy boxes from the grocer at 1s. a dozen and pack in meadow hay. Procure a suitable size box, fill with hay, press down tightly, then makes holes with two fingers and thumb of the right hand, and place the eggs in position with the left hand. Dozens can be packed in this way in a very short time. Divisional boxes, paper wrapping, cork, bran, sawdust, all fade away as soon as this simple, expenseless, handy, and expeditious plan is adopted. Never buy boxes from the manufacturer of boxes for sittings; they are too careful of the wood and quality. (J. Francis-Brown.)

(2) The box may be a plain, nicely-finished one, 14 $\frac{3}{4}$ in. by 5 $\frac{1}{4}$ in. by 3 $\frac{1}{4}$ in., with the top, bottom, and sides rabbeted, so that each part receives support for its entire length, making the box, as a whole, very strong and rigid. This is a capital form of box, and it is only to be regretted that such a one is not in the market at a reasonable price for general use.

(3) I send thousands of eggs to London with a strip of corrugated paper about 2 in. wide wrapped round each egg (corrugations inwards, of course), and a layer of hay top and bottom and between each layer of eggs, in wicker baskets (circular by preference). There is scarcely ever a single egg broken, and it is the simplest, safest, and most rapid packing of the many modes I have tried and seen. The wrappers are retained in place simply by juxtaposition; eggs large ends downwards. The paper is that commonly used for wrapping medicine bottles for post. (Francis Bacon.)

(4) The eggs may be packed in a rectangular hamper, 15 in. by 7 in. by 5 in., each egg wrapped first in fine shavings and then in a piece of coarse paper wrapping, which is folded on the breadth, and not the lengthways, of the eggs. The bottom and sides of the hamper are lined with fine wood-shavings, and the eggs placed end to end in a double row on the packing, with another layer of the shavings on the top of all. The eggs cannot come to any harm; but the cost of the hamper plus the cost of the postage puts this form of package out of the question for moderately cheap eggs sent by post. The postage alone would be 7 $\frac{1}{2}$ d., and this with 6d. for the hamper is a large slice out of 3s. 6d. or 5s.

(5) My new-laid eggs sent to London are packed in clean, soft straw in boxes 9 in. deep, four layers to the box; the boxes contain 300, 400, and 500 each (120 to the 100); as much straw should be placed on the top of the box as will make the lid quite tight when tied down; this prevents the contents from moving in transit. The breakage in

this way does not exceed 1 per cent. New-laid eggs sent to the south coast towns are packed in Tully's patent boxes, cardboard divisions, thick felt between. I never have a complaint of breakage in these boxes. Pheasants', turkeys', goose, and fancy fowls' eggs, are always packed in baskets, each egg wrapped in soft hay separately. These are sent to nearly all parts of the United Kingdom, France, Italy, and Belgium, and I never hear of an egg being broken. Sawdust, bran, &c., are very unsafe packing, as the contents move about, besides excluding all air, which, when packed in boxes, is very injurious to eggs intended for incubation. I always send eggs for hatching by rail, as if there is any breakage possible, the Parcel Post will do it. (G. Russell.)

(6) The box may be of the ordinary 12-division type, but a layer of corrugated paper is placed top and bottom, and a small roll of the same material in each division to hold and protect the eggs. The principle appears to be right and very simple.

(7) My experience is that those eggs travel best that are first wrapped in paper, then packed tightly in sawdust, in divided wooden boxes.

Oat-chaff and bran I dislike; hay is good, but I think quite unnecessary. In large towns all these have to be purchased, whereas sawdust, as a rule, costs nothing, and is, in my opinion, better than anything else into the bargain. I generally place a few half-sheets of newspaper on the top of the sawdust to prevent any working out during the journey. The lids of the boxes should of course never be nailed down; they should be either screwed or tied securely with strong string.

There is generally a slight difficulty in unpacking the eggs, as the sawdust, when fine and well pressed, sets firmly round each egg. This is overcome by putting a thick layer of sawdust on a table, then turning the box upside down, sliding the lid off, and drawing out the divisions, and with them the eggs *en masse*.

Suggested precautions:—

(a) Always rest eggs 24 hours after a journey.

(b) Always print or write legibly "Eggs for Sitting" on each box.

(c) Always make a string or wire handle to each box.

(d) Never nail an egg-box. (R. de Courey Peele.)

(8) At all times I have used (in preference to hay or any other packing material) flax dust, which is more elastic than anything else I can obtain, at the same time being wonderfully light-weighting. This dust may be bought in quantity where the flax (Dew Ripe) is grown; but I believe it is chiefly confined to the south-west counties of England.

(9) The box is a light wooden one, divided into 12 compartments for eggs. The partitions come full out to the sides of the box, giving great strength. The eggs are very tightly packed in hay in each division, with a layer of hay top and bottom, and on the top of that a layer of chaff. So protected with an elastic cushion like hay, it must be exceedingly rare for an egg to be broken.

(10) I invariably use soft bands of hay, and pack in ordinary wood boxes—which I can procure at grocers' or "sweet" shops for 1s. a dozen—of as little weight as possible. I add a thin pad of hay at top and bottom.

(11) If people would pack their eggs as pheasant dealers do, there would be no talk of broken eggs or bad hatching by shaking. I send away a good many fancy ducks' eggs—eggs that are as fragile as thrushes'—yet I never hear of any being broken. Use light baskets, not boxes; roll each egg in a hay-band, first wrapping it in plenty of paper; pack the eggs small end down, pressing them close together; line the basket with hay, also place hay at the bottom; press hay well in between eggs, a 2 in. layer of it on top of them, then next lot of eggs—if necessary—and so on to the top; place several folds of paper between the hay and lid, taking care if the lid is arched to fill the arch with

hay; label the basket "Eggs for Sitting," and send by rail. My baskets are always returned by parcel post, at a cost of 3d. (A. Bayldon.)

(12) A very good type of box for sending eggs by post or rail is made of stout brown cardboard, strengthened with linen at the corners and at the joining of the top and bottom with the sides, and the inside is fitted with tubular receptacles or pockets for the eggs, made of thinner cardboard. The box is light, and yet strong, the arrangement of the pockets or divisions giving additional resisting power to pressure. The pockets or divisions come right up to the top, thus giving perfect support to the bottom and lid, whilst their tubular form gives considerable lateral strength. The only objection to these neat and handy boxes is their price—6s. per doz., which is too much for boxes used for cheap sittings.

(13) My best results invariably have been from eggs packed in 12-division boxes; and I find hay better than either bran or cork, and the firmer packed the better. Both bran and cork are liable to pack tighter with the journey, leaving the eggs loose and shaky; or if there are any crevices, part escapes, which makes it worse. I fear eggs are sometimes sent out stale, and the germ weak in other cases, but am convinced that if well and, above all things, firmly packed, from vigorous parents, and untampered with, a journey of a few hundred miles, and even tossing on the sea, will affect them but little. (A. Allison.)

(14) The true secret of safety lies more in the packer than in the mode of packing or transmission. Packing is an art in itself, and does not necessarily accompany successful poultry-breeding. If anyone notices the apparently hasty and careless way in which a professional hand works, and tests the result against the ordinary amateur's, whose parcel arrives with its contents smashed to atoms, though enrolled like a mummy with layer after layer, it will be apparent that packing, like many other

things, is a knack which comes more easily to some than others. A light, but firm touch, which seems to be rough, but in reality is merely the application of pressure in the right place, is chiefly what is wanted, and is better than all the patent boxes in the world. One more trivial detail is important: A piece of strong string, to serve as a handle, often saves the box from being dropped or banged down. For large quantities, such as 42 doz., doubtless patent boxes are invaluable. (T. J.)

(15) I have tried all plans—packing in bran, in sawdust, in oat-chaff, in moss, and many other things; but for the last 16 years I have discarded every plan as being unsafe except the one I now describe. Each egg is carefully wrapped in newspaper, and then in soft hay, such as old hay-bands or hay too soft for horses. They are then packed in the basket described below, and each egg is again packed well in with hay, the basket previously being lined at the bottom with the same material. After all the eggs are securely packed, the basket is filled with hay, and the cover wired or tied down.

The baskets I use are such as have been employed for conveying fruit to market, and I purchase them at about 4s. per dozen, including lids. These baskets vary in size from one capable of holding one sitting of eggs to one fully able to contain four sittings, and I procure them in great quantities at a time, about 400 or so. The railway carriage is of course an extra item in cost of baskets, but this does not exceed in a quantity more than about a farthing per basket.

The reason I prefer baskets to boxes is because, owing to the elasticity of the former, if thrown down there is no violent concussion, as would occur if the latter were used, and they do not split if subjected to undue violence. I have sent eggs all over the continent of Europe, to Italy, Russia, Spain, &c., where the chance of a box arriving safely would be very small indeed, and I venture to say that I do not hear of

twenty broken or twenty cracked eggs in a whole season; and I may state that in many seasons I send out over 400 baskets of eggs thus packed, sometimes with one sitting only, sometimes with mixed sittings of many varieties. I have frequently sent large numbers of eggs to the United States of America, even to San Francisco, and they have all arrived safely, and this I venture to say could not possibly have happened if any other plan at present known of packing eggs had been adopted.

I always send eggs by rail where practicable, for this reason only—that size of package in journey by rail is not of such importance as size of package if sent by Parcel Post: consequently, by rail more packing can be used than if sent by Parcel Post.

I usually prefer fastening the lids down with copper wire in lieu of string, as giving greater security, and being less liable to be tampered with by dishonest people.

As a last remark, I think it would not here be out of place to mention that whenever a sitting of eggs is procured, no matter from whom, and no matter how packed, or how short the journey, has been, the eggs should be unpacked carefully and laid on bran or some soft substance, on their sides, for at least 24 hours before being put under a hen or into an incubator. This is necessary to enable the contents of the egg to perfectly recover after the amount of oscillation they have experienced from their journey. Where this plan is not adopted, I venture to say it has a great deal to do with the non-success of the hatching process. (E. Snell.)

(16) I use partitioned boxes, made to hold 1 doz. and 2 doz., and larger for ducks' eggs than for fowls' eggs. They are strong, light, and inexpensive, with "Eggs" printed in large letters on the cover, costing about $1\frac{1}{2}$ l. each (by the gross) for the 1 doz. size. For packing I use either wheat-chaff from the threshing-machine, oat-straw cut into short chaff, or cork-dust that the foreign grapes are packed in, which I get by asking for of my grocer. I take two or

three handfuls of either, and throw in the bottom of the box, each compartment being about one-third full, then put in the eggs large end down, throw some more chaff over the eggs, and press tight down in the corners of each compartment with the points of the fingers, then fill the box a little above the level with chaff, so that the cover will press tight on the chaff and keep the eggs from shifting or shaking. Fasten on the cover with two flat, broad-headed tacks $\frac{3}{4}$ in. long, one at each end, make a hole with a small brad-awl, and press in the tack (do not use a hammer), then tie the box round with a strong piece of string, to which the label is attached.

(17) I use a hamper of conical shape, such as is used in the trade for packing butter, 11 in. deep, and 12 in. diameter at the top. At the bottom of the basket is nearly 3 in. of hay, and on this is placed the first layer of 11 eggs, each wrapped in soft hay; on the top of these is another good layer of hay, and then on the top of this 16 eggs; then another layer of 16 eggs, and then more hay to fill up to the lid. There is, of course, a protecting lining of hay to the sides of the basket. The eggs are all very tightly and very neatly packed.

(18) Tully's box is very strongly made with $\frac{3}{4}$ in. wood, iron hinges, handle, and clasp for padlock (often a very desirable precaution); the bottom has a felt lining, on which stand the divisions, made of stout millboard, and on the top of these is another piece of felt to protect the eggs from the lid. The arrangement of the divisions is good. It will be best understood by Fig. 262, the thick outer lines of which represent the sides of the box, and the thin ones the millboard. It will be seen that none of the sides of the compartments is formed of the sides of the box, and that the eggs are therefore not only protected from concussion, but from being crushed by any "give" in the sides, which latter, however, would not occur in a so stoutly-made box. The principle is a good one, and might

be adopted with advantage in boxes of a slighter make.

262.

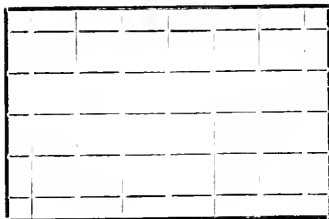

Egg box.

(19) Each egg is first wrapped in a piece of vegetable parchment (same as used by grocers for butter), and then some soft meadow-hay is put round, making it about the size of an orange. They are then placed in a box (made to the size required—from 1 dozen to 6 dozen) side by side, with soft hay at the bottom, and then a thin layer at the top. This plan is by far the best.

The box is then tied as an ordinary parcel with two strings across the ends, and then the string is brought over the top of the box and twisted round and round until a handle is formed for the porters to carry them with; this prevents their being thrown about, and is an excellent idea. I always send by rail, and not by Parcel Post. Last year I sent away over 6000 eggs, and gave perfect satisfaction, or I should have had to replace them. Some went to Italy, Scotland, Ireland, and other places.

The vegetable parchment can be obtained for about 2*d.* per lb., suitable for this purpose. (H. Warren.)

(20) Freeth and Pocock's boxes are simple, and the eggs are as safe from injury inside as it is possible for them to be. Not even the roughness and carelessness in handling of the Parcel Post people could succeed in breaking an egg in one of these boxes—and that is saying just as much as it is possible to say.

For sending either very valuable eggs, or eggs a very long distance,

nothing could well be better than these boxes, but their high price (1*s.* 4*d.* each) puts them out of the question for general use for such eggs as are sold at 3–5*s.* a sitting.

The boxes are strongly and neatly made of wood, with wire-hinged lid; the inside is lined with felt made into pockets, into which the eggs are put; and there is a false cover lined with felt, which is placed on the top, and then when the lid is shut down all is secure.

(21) Edey's boxes are very similar to other 12-compartment boxes, except that they are intended to be used in conjunction with corrugated paper, a piece of which is placed top and bottom, between the partitions and the bottom and top, and small slips rolled cylindrically and placed in the compartments to hold the eggs. The packing is simplicity itself, and ought to afford ample protection to the eggs. The price of the boxes, properly fitted, is 4*s.* per doz., or 40*s.* per gross. In future the boxes should be made rather larger, as at present the compartments, when fitted with the corrugated paper, will not fairly take large-sized eggs.

(22) Brown's baskets for the transmission of eggs for incubation are circular in shape, with an inside diameter of 12 in. at the top and 8½ in. at the bottom, and are similar to those ordinarily used for packing small fruit for the market. They are strong, elastic, and serviceable, but more adapted for eggs sent by rail than by Parcel Post. The price is 4*s.* per dozen.

PERCOLATION. (iv. 198–209.)

Fig. 263 shows an arrangement suggested by Ungerer for the process of repercolation. A number of percolators *a b* are placed on a suitable stand, one above the other, so that the tube of one percolator passes through a cork fitted into the mouth of the one below: 6 to 12 of these vessels may be used one above the other. The stand consists of a board with pairs of projecting pegs placed at such distances that there is

room for the cylinders between them. Boards having a horseshoe-shaped piece cut out on one side are placed on these pegs, and serve to support the cylinders in their places. The menstruum is

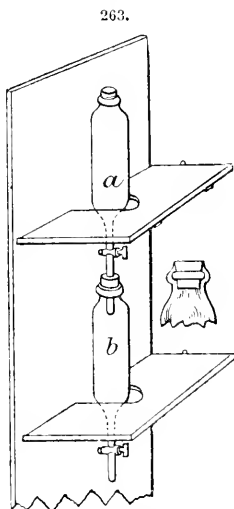

Repercolator.

allowed to run into the top cylinder, either freely or (in order to increase the pressure) through a long tube attached to the top. The liquid permeates the substance in the cylinder and runs through into the cylinder below, and so on to the bottom, where it is drawn off as the strongest possible tincture. By adjusting the lowest stop-cock the speed of flow can be properly regulated. The number of vessels and the speed of percolating should be so regulated that the tincture begins to flow from the lowest cylinder just when the contents of the top one have been thoroughly exhausted. As soon as the top cylinder is exhausted it is removed, the whole column of vessels is raised up a stage, and a newly-filled vessel is added at the bottom. In this way the process becomes continuous, and a con-

centrated extract can be made, except, of course, towards the end of the operation.

PRESERVING. (ii. 443-468.)

Books.—In certain parts of China, the British Consul at Swatow observes, books are extremely liable to be attacked by insects. They first destroy the glue used in the backs of books, and gradually perforate the whole volume. Cockroaches, too, entirely disfigure the covers by eating away patches of the glazing.

The remedy for both these nuisances is easy. The late Dr. Hance, who had a large library, used the following recipe:—

Corrosive sublimate ..	5 dr.
Creosote	60 drops.
Rectified spirit	2 lb.

This mixture, a violent poison, he applied with a brush in the joint of the book at every 6 or 7 pages, and, as a preventive of the ravages of cockroaches, he varnished the cover of the book with a thin clear spirit-varnish. In binding books, it would be only necessary to add a small quantity of the above mixture to the glue used, and to give a coating of spirit-varnish to the cover, to secure complete protection from the attacks of insects of all kinds.

Distilled Water.—In the first place, contrary to the general opinion, condensed steam does not always furnish pure distilled water. The drip from the cylinders of steam engines is never fit for use, not being half so good as ordinary rainwater. In preparing distilled water, the directions generally given to reject the portion that first comes over should never be omitted.

The best water from which to prepare the distilled article is, in my opinion, good clear well water. Rainwater is generally well loaded with organic matter, and holds generous quantities of ammonia in solution. Ammonia, of course, distils over, and this impurity the Pharmacopœia does not permit. Prof. Lloyd once said that

in order to prepare an acceptable article of distilled water from the city at Cincinnati, it was necessary to distil 3 to 4 times from an ordinary apparatus; but that now, by carrying a standpipe to the third storey of his factory, the product obtained was good.

The following procedure in distilling and storing will never fail to give satisfaction. Say the still is of 5 gal. capacity, not more than 4 should ever be distilled therein: take then $4\frac{1}{4}$ gal. of good clear well water; boil violently in a bright tin vessel for 10 minutes—this drives off almost the last trace of ammonia; then introduce into the perfectly clean still; start the process; reject the first $\frac{1}{2}$ gal., and save the succeeding $2\frac{1}{2}$ gal.

This is to be stored as follows: Prepare an empty carboy by boring with a rat-tail file a hole in the solder: through this hole introduce a glass siphon, made air-tight at the point of contact with the carboy by slipping over the siphon tube a piece of rubber tubing, and on the longer arm of the siphon place another piece of rubber tubing about 4 in. long, provided with a pinchcock. Into the mouth of the carboy fit a perforated cork, holding a glass tube filled with cotton; this is to be inserted as a stopper, the tube filled with cotton acting as a vent. All the air entering the carboy will be drawn through the cotton, thus being filtered perfectly free from motes. It is these motes, or dust particles, among which the seeds of the confervæ exist that cause the ropiness which is to be avoided.

The distilled water in dropping from the mouth of the condenser into the receiver, as a rule, becomes contaminated with air motes, and unless these be removed before the water is finally deposited in the carboy, confervoid growths will appear.

To accomplish this, the distilled water must be brought to a boil in a bright tin vessel, the warm carboy thoroughly rinsed with it, and when, at last, the container is full, insert the perforated stopper carrying the tube

filled with cotton; start the siphon, and now, if the stopper is not removed, the entire contents may be used, as required, and not a single fleck will form therein. (J. N. Hurty.)

Food—Boracic Acid as a Preservative.
—Boracic acid only acts when present in large quantity. It prevents the growth and multiplication of germs, but does not kill them even in a 1 per cent. solution. Experiments with milk gave very unsatisfactory results, as an addition of 4 per cent. boracic acid only preserved the milk for 4 days. Horseflesh may be preserved for 6 weeks by the use of 3 per cent. of the acid. Boracic acid is supposed to be harmless, but recent investigators prove it to be dangerous, as it strongly acts upon the mucous membrane of the large intestine. A dose of 4 grm. killed a large rabbit; 2 grm. made a dog very sick. The acid is much used in Sweden for preserving fish and milk, but cases of poisoning have already occurred in that country. Long continued use of the acid is not favourable to good health, and at all events its addition to milk should be prohibited. (Emmerich.)

"Adulteration" with Boracic Acid.—The increasing use of boracic acid, as well as of other so-called antiseptic agents for the preservation of articles of food, is a matter which demands immediate and most serious attention. Boracic acid is generally added to milk and cream in the form of certain proprietary articles, which are sold to the trade under different fancy names. Some of the more commonly used preparations, which consist of a mixture of boric acid (partly anhydrous and partly hydrated) with borate of soda, are added (in solution) in the proportion of at least 7 gr. of the solid substance to 1 pint of milk. In cream, it is generally added in at least double this quantity per pint. Inasmuch as both the farmer in the country and the dairyman in the town are likely to use these preparations, these amounts may be largely increased. The amounts mentioned are also very likely to be exceeded through the carelessness or

ignorance of those making use of such substances for preserving purposes.

But scanty information is to be obtained as to the action of boracic acid and borates on the human subject. These substances do not appear to have been much used as internal remedies, and, accordingly, but little information as to their action is to be found in the text-books. One authority states that borax acts as a mild alkali on the alimentary canal; tending to render the fluids alkaline, and to cause diuresis; that it checks fermentation due to organisms, and is used as a diuretic and antacid. Another eminent authority who was consulted in connection with the report previously alluded to refers to the tendency of these substances to set up diarrhœa, a disease very prevalent in hot weather, when the preservatives are most used to prevent the change which milk and cream are apt to undergo rapidly at a high atmospheric temperature. The medicinal dose of the acid as laid down in the British Pharmacopœia for an adult ranges from 5 to 30 gr., and, on the authority of Dr. Dudfield, and of others, it may be computed that $\frac{1}{12}$ of the quantity, say a maximum of $2\frac{1}{2}$ gr. would be a suitable dose for a child under one year. It is quite possible that a strong, healthy infant, taking 1 qt. of milk daily might absorb as much as 20-25 gr. in that time, having regard to the likelihood of the minimum amounts mentioned being exceeded.

The experiments of Dr. J. Förster go to show that the addition of boracic acid to articles of food in far smaller proportions than is customary is injurious to health. This author considers that "even small doses of it are injurious to the digestive organs." The injurious action, he says, depends on the circumstance that the drug acts so as to materially increase the proportion of solid matters and nitrogen in the fœces separated. Its action on the intestinal discharge is well marked, even by the exhibition of as little as 4 gr. per diem, and is stated to be in direct relation to the quantity taken,

and to be maintained for some time after the doses of the drug have ceased. The action described is perceptible, not only with vegetable or animal foods, which contain a large proportion of indigestible ingredients, but also when highly-digestible foods, such as milk and eggs, are taken. Food to which the acid has been added tends to cause an increase in the secretion of gall during assimilation. One of its most important actions, however, according to this author, is the increase which it causes in the discharge of albuminous substances from the intestinal canal.

E. Hötter has recently published a series of experiments on the action of boron compounds on plants. The absorption of such compounds was found by him to destroy the chlorophyll, and hence to arrest the processes of assimilation. The roots are affected, and soon die. Free boric acid was found to be more prejudicial than the alkali salts.

Apart from the experiments referred to, it is sufficiently plain that an "antiseptic" substance of any kind, if introduced into food must, by its very nature, be injurious to the health of the consumer. It is evident that the introduction of antiseptics of any kind into the alimentary canal must upset the conditions necessary to health. The danger is the greater because it is insidious, and because the effects produced are not violent or sudden, but such as will create disturbances and ultimately serious injury, which are likely to be ascribed to anything but the real cause. The question of quantity does not bear upon the matter in any way. It has, or should have, no bearing legally. Any quantity that is sufficient to produce the "antiseptic" effect in the food itself, must be regarded as injurious, even if the undoubtedly harmful action of continued small doses of a "preservative" substance be left out of consideration. It must be remembered that boracic acid preservatives are very extensively used. In butter, milk, cream, fish, meat, and in preserved foods and proprietary preparations of various kinds, boracic acid is to be

constantly found. I have recently found it to be present in large amounts in meat "extracts" and "fluids" intended especially for the use of invalids and children, and which, I regret to say, are belauded in inflated language by members of the medical profession, who, had they known of the presence of boracic acid, would surely have condemned them. The unavowed presence of boracic acid in such preparations, or in the milk and cream so largely used by invalids and children, might, and, in most cases, probably would, seriously disturb a physician's course of treatment.

Attempts have been made to confine the issue by asserting that it is as permissible to add boracic acid to a food as it is to add salt in certain instances (as in the case of salt meat). This contention is at once disposed of by pointing out the physiological fact that salt is a food, and that boracic acid is not. Again, boracic acid and compounds of it are not natural constituents of milk or of any food. They are not themselves "foods," but "drugs."

Proceedings could be taken against the vendors of milk containing boracic acid compounds under the 3rd Section of the Sale of Food and Drugs Act, which prohibits, with certain unfortunate reservations, the "mixing, colouring, staining, or powdering" of any article of food with any ingredient or material *so as to render* the article injurious to health. It is a matter of great difficulty, however, to prove "injury to health" to the satisfaction of an ordinary court. It is almost necessary in all such cases to be able to produce some poor creature who has been almost "done to death" by that which is complained of. Under this section also it is practically a necessity to state the percentage of the injurious substance, to afford, of course, a useful bone of contention for members of the legal profession, and not to obstruct in any way the wide loop-hole for the escape of offenders, duly left by the legislature, in this section. I contend that it is unnecessary to state percentage

in a matter of this kind. The 6th Section of the Act makes it an offence to sell to the prejudice of the purchaser any article of food which is not of the "nature, substance and quality" of the article demanded by the purchaser, and provides that no offence is committed under this section if "any matter or ingredient not injurious to health has been added, because such addition is required for the reduction or preparation of the food as "an article of commerce," or "in a state fit for carriage or consumption," and "not to conceal the inferior quality thereof." The 2nd Section of the Amendment Act of 1879 provides that it is no defence to prove that the "article of food in question, though defective in 'nature,' or in 'substance,' or in 'quality,' was not defective 'in all three respects.'" That is, proceedings would be justified by a defect in any one respect.

There appears, however, to be an impression abroad that there is no offence under the 6th section unless the adulterant forms a "substantial portion"—that is, presumably, more than a fractional part of the article as sold to the purchaser. Taking the case of milk, it ought hardly to be necessary to point out: (1) That milk containing boracic acid compounds is not of the nature, substance and quality of *milk*; (2) That even if defect in *nature* and *substance* is only constituted by the presence of an adulterant in what is popularly called "a substantial amount" (that is, forming a large integral portion of the article), defect in *quality* is at once established by the presence of boracic acid in milk, and that such defect is independent of the question of quantity; further, (3) the admixture of boracic acid compounds with milk is not *required* for preserving it in course of transit from producer to consumer. Refrigeration, which adds nothing to the milk, is the recognised and legitimate method, if such preservation for transit be deemed necessary; and (4) the addition of the preservatives does serve the purpose of concealing the *inferior quality* of the milk, as it

allows stale milk to be supplied as fresh, and as it is far more easy and less expensive than the better method of refrigeration.

I therefore hold that vendors of foods containing boracic acid compounds commit offences under the 3rd and the 6th Sections of the Act of 1875, and the 2nd Section of the Amended Act of 1879. Whether offences under the Act, however, are committed or not, I do not see how it is possible to arrive at any other conclusion but that the use of these preservatives is a serious form of adulteration. In my view, the absolute prohibition of their use is the only safe and proper course to take; although if it be desired to throw a sop to that large class of persons who are always morbidly anxious to follow middle courses, it may be admitted that the compulsory labelling of such "preserved" articles with the name of the substance or substances used, would be productive of great and immediate benefit. It is remarkable that those who defend the use of "preservatives," and assert them all to be "harmless," in any amount, should take such pains to conceal the fact that they have been used. In regard to several proprietary articles I have examined; I have had before me, apparently, the full details of the manufacture, given with the most child-like candour; everything, *except* the admixture of boracic acid, which was found in them all. In the case of certain "preserved" creams, it is asserted on the labels that "the cream being separated as soon as it is drawn from the cow, it will keep sweet longer." Comment upon this is needless.

Abroad, the use of "preservatives" is almost universally prohibited. If the legislature and if local authorities were in earnest about the suppression of adulteration, their use would be prohibited here. (E. E. Cassal, in *Analyst*.)

Use of Preservatives.—It is well known that in summer many milk dealers add some preparation of boric acid in order to retard coagulation of

milk. Such preparations are, and have been, openly advertised in numerous forms, and have been recommended by scientific men. Less well known is the fact that boric acid and its soda salt is most frequently to be met with in butter, especially Normandy and Belgian butters. Norwegian and other foreign fish is cured with salt and boric acid; meat is preserved with it, and it is even found in preparations intended for invalids, such as in so-called sterilised peptonates.

In beer, especially foreign imported beer, in wines, preserved fruit, and, perhaps, in milk, salicylic acid or salicylate has been used for preservation, whilst sulphurous acid or bisulphite of lime is of common use by the brewer, the manufacturer of lime juice, and the butcher. And, lastly, it appears that benzoic acid or benzoates are gradually taking the place of salicylic acid. Other antiseptics have been from time to time proposed and used, such as fluosilicates, nitrates, &c.

In reference to the quantity of boric acid which is necessary to produce any appreciable effect upon milk, I am not aware of any analytical results obtained by the analysis of actual trade samples. Mattern finds that 1 grm. boric acid per litre retards the coagulation of milk at 15° C. for 24—36 hours; .5 grm. only 21 hours, whilst at 35° C. .5 grm. is without effect, and 1 grm. retards the coagulation for 10 hours. In summer, therefore, when the addition of boric acid is practised, not much less than 1 grm. per litre of milk would probably be employed.

Of borated butters I have made numerous analyses, and give some of my results in percentages:—

Boric acid	.09	.11	.09	.14	.26	.41
Borax	.19	.16	.15	.23	.33	.55

Both boric acid and borax being calculated as crystallised. The preparation always employed in the case of butter, as far as my experience goes, consists of a mixture of boric acid or borax, in widely varying proportions, freed from a part of the water of crystallisation by

heating. As typical the following analysis may find a place:—

Water	36.8
Borax (anhydrous) ...	24.0
Boric acid (anhydrous)	39.2

To preserve fresh fish about 2 grm. of boric acid are used to each kilo of fish.

Salicylic acid has not, I believe, ever been largely used in this country as a food preserver. It answers but very badly in the case of milk and butter, and its use is now chiefly confined to foreign fermented beverages. As to the quantity, 1 grm. per litre was frequently used when salicylic acid had reached its height of popularity. When in course of time the objections against its use were not only heard, but resulted in prohibitive legislation in many countries, 5 grm. were declared to be sufficient by its advocates to keep 100 litres of Bavarian beer for home consumption, and 20 grm. for export.

If we now enter into the question as to the physiological effect of the preservatives mentioned, we at once meet with the most diametrically expressed opinions. Whilst inventors introduce every antiseptic as absolutely harmless, and quote experiments by which it is shown that large and continued doses of antiseptic were administered without evil effects, other enquirers come to absolutely different conclusions. Literature teems with arguments in favour of and against some of these substances, and it must be conceded that direct and palpably injurious effects on healthy individuals have not been traced to any of the antiseptics herein considered. But when so much is conceded, a wide field for discussion yet remains.

On the one hand it must be recognised that to prevent waste of good human food by avoiding or retarding its decomposition is a meritorious achievement, and one upon which the thought of the scientific man cannot be too much concentrated. Yet it must be allowed that the indiscriminate addition of chemical substances which exert a poisonous action on bacterial and other

organisms cannot be safely left in the hands of more or less ignorant vendors of articles of food, even if no directly poisonous or injurious action can be traced upon a healthy adult by their use. It is evident that substances which interfere with the growth of fungoid organisms like bacteria or yeast cells, must have some action upon the complicated human animal; and even if exuberant health and abundant gastric secretions may be capable many times to overwhelm the effect of the antiseptic, the effect itself must remain and detract from the efficiency of the human organism. It is inconceivable that the protoplasm of a bacteria be vitally affected by a substance which at the same time be utterly inert upon human protoplasm. The effect is evidently a question of quantity. The absolute quantity may not be sufficient to show itself palpably upon a body weighing, say, 1½ cwt., but it must be there all the same.

The Comité Consultatif d'Hygiène Publique of France reports in reference to the use of benzoic acid in articles of food that all antiseptics are injurious to natural digestion, because the addition of antiseptics of any kind is irrational as far as assimilation is concerned, and may be injurious to the normal action of the organs of digestion.

In times gone by, when the causes of the decomposition of food were not understood, the discovery of a preservative was doubtless an achievement; but now, when we not only know these causes, but can prevent decomposition indefinitely by exclusion of germs, or by cold, without the addition of any kind of foreign material, we surely should make an attempt to discriminate between processes of preservation. If preservation could not be effected without the addition of some foreign material, the benefit to mankind of preventing good food substance from decomposition would doubtless be greater than the slight physiological evil effect of the antiseptic itself. But as preservation of any article of food is possible without addition of chemicals, it seems to me that the time has come to protest against

the present practice of allowing the addition of any antiseptic which the dealer in food may choose to make.

France was the first to raise objections against the use of preservatives. Most of the beer consumed in France used to be imported from Germany. When it was discovered that such beer almost invariably contained salicylic acid, a vigorous agitation, in the interest of French home brewers, commenced. Finally, the Paris Court of Appeal decided that the addition of salicylic acid was to be considered an adulteration, and to the prejudice of the purchaser. The addition was declared to be not harmless, it having been shown that salicylated ales were a source of danger to the community, that salicylic acid was a drug, the use of which had to be ordered by a medical man, and could not be left with the trader. This judgment was based upon a Report of the Commission of the Academie de Medicine of Paris on the action of Salicylic Acid on Food. The Commission reported on numerous cases in which the preservation of articles of food by salicylic acid has produced serious results, and is of opinion that it is proved that small but continued doses of salicylic acid or salicylates, may produce serious gastric disturbances, especially with old persons and such who suffer from affections of the liver or organs of digestion. For these reasons the addition of salicylic acid, or salts, should not be allowed to articles of food.

What was originally probably a trade protectionist movement soon became a general opinion. The indiscriminate use of antiseptics should not be allowed, and one State after another passed laws forbidding the addition of preservatives to food, in some cases antiseptics generally, in others specified substances only.

Thus, by order of the Municipal Council of Buenos Ayres, the sale of beer containing salicylic acid was prohibited after March 31st, 1888. Other South American States followed. The town of Milan passed a similar law, referring to the prohibition of salicylic acid in beer, wine, and other articles of

food; whilst the police of Berlin prohibited the addition of any kind of preservative whatever to milk.

In 1888 the Dutch Government caused an inquiry to be made into the use of salicylic acid in beer, and, as a result, all addition of salicylic acid to food was prohibited. The Italian Ministry in 1887 declared the addition of all substances to wine, which were not naturally contained in wine, to be an adulteration; in 1888 the Spanish Government followed with an absolute prohibition of antiseptics in wine, and the Austrian with that of salicylic acid.

In Germany a distinction is made between salicylic acid added during mashing, to check the growth of the acid-producing organisms, such an addition at that stage of brewing being allowed, not any of the acid, or only traces of it, being said to remain in the beer, and between the subsequent addition of salicylic acid to fully fermented beer, which is prohibited.

When salicylic acid had thus been virtually suppressed, other antiseptics came into vogue. Thus, in France, the use of benzoates became frequent, partly on account of the greater power of these compounds, partly because they are more difficult to trace and detect than salicylic acid. In Germany, sulphites and borates were more largely employed, and numerous preparations containing these as active ingredients were thrown upon the public. Thus, according to Polenske, the following articles have been advertised in Germany:—

Sozolith: containing 39.7 per cent sulphurous acid, as sodium salt.

Australian Meat Preservative: consisting of sulphites.

Berlinite: borax, with a little boric acid and nitrate of potash.

Chinese Preservative powder: boric acid, with sodium chloride and sulphate.

Brockmann's Salt: borax, boric acid, sodium chloride, and potassium nitrate.

Australian Salt: borax.

Barmenite: boric acid and salt.

Magdeburg Preservative Salt: borax, boric acid, and salt.

Heydrich's Salt: sodium chloride, potassium nitrate, and boric acid.

Again, as in the case of salicylic acid in previous years, long discussions arose as to the physiological activity of these substances. Liebreich contended that boric acid was perfectly harmless, but others have been able to trace distinct physiological effects to its administration; whilst, in 1889, the Society of Bavarian Analytical Chemists discussed the use of boric acid as an antiseptic, and came to the conclusion that it was objectionable from a sanitary point of view.

In England we have done absolutely nothing. On the contrary, the use of antiseptics has been virtually sanctioned in brewing. The law 48 and 49 Vict., Cap. 51, declares that a brewer of beer shall not add any matter or thing thereto *except* finings, or other matter or thing sanctioned by the Commissioners of Inland Revenue. The use of antiseptics, notably bi-sulphite of lime, which is here chiefly used in beer, is therefore distinctly conditional upon the sanction of the Inland Revenue Commissioners; and the same would be the case in other articles of food, since the chemists of the Inland Revenue Commissioners are referees for cases under the Food and Drugs Act. The Sale of Food and Drugs Act, par 6, allows to be added to food any matter or ingredient not injurious to health, if the same is required for the production or preparation thereof as an article of commerce in a state fit for carriage or consumption. No one, surely, can contend that preservatives are necessary for the production or preparation of milk, butter, beer, wine, etc., in a state fit for carriage or consumption, for the great majority of the samples analysed are free from antiseptics. Good milk, fresh butter, sound beer, can be made and sold without antiseptics. As a matter of fact, they have been so sold for centuries, until sham science came in and taught the dirty and the careless producer how to evade the natural punishment of dirt and mismanagement. Antiseptics are convenient to such pro-

ducers, but they are not *required*. Hence we have no option but to consider them as adulterations. The practice is utterly unjustifiable, except from the point of view of a dealer, who wants to make an extra profit, who wants to palm off a stale or ill-prepared article upon the public. (O. Hehner, in *Analyst*.)

Fruit Candying.—Leghorn occupies the first place in Italy, and perhaps throughout the Mediterranean, for the preparation of candied citron and orange peel. Citron is brought for this purpose from Corsica, from Sicily, from Calabria, and other southern provinces of Italy, from Tunis and Tripoli, and even from Morocco; while the oranges imported into Leghorn, whether for consumption or for candying, are nearly all brought from the islands of Sicily, Sardinia, and Corsica. In all the countries contributing the raw fruit for this industry, it is treated in the same manner for the over sea passage. The fruit is simply halved and placed in hogsheads or large casks, filled with a fairly strong solution of brine, the fruit being halved merely to ensure thorough preservation of the rind by an equal saturation of the interior as well as the exterior surface. In these casks it arrives at the doors of the manufactory. The first process to which it is then subjected is the separation of the fruit from the rind. This is done by women, who, seated round a large vessel, take out the fruit, skilfully gouge out the inside with a few rapid motions of the forefinger and thumb, and, throwing this aside, place the rind unbroken in a vessel alongside them. The rind is next carried to large casks filled with fresh cold water, in which it is immersed for two or three days, to rid it of the salt it has absorbed. When taken out of these casks, the rinds are boiled, with the double object of making them tender and of completely driving out any trace of salt that may still be left in them. For this purpose they are boiled in a large copper cauldron, for one to two hours, according to the quality of the fruit and the number of days it has been immersed in brine. When removed

from this cauldron, the peel should be quite free from any flavour of salt, and at the same time be sufficiently soft to absorb the sugar readily from the syrup in which it is now ready to be immersed. The next process to which the rind is subjected is that of a slow absorption of sugar, and this occupies no less than eight days. The absorption of sugar by fresh fruit in order to be thorough must be slow, and not only slow but also gradual; that is to say, the fruit should be at first treated with a weak solution of sugar, which may then be gradually strengthened, for the power of absorption is one that grows by feeding. The fruit has now passed into the saturating room, where on every side are long rows of immense earthenware vessels, about 4 ft. high and 2 ft. in extreme diameter, in outline roughly resembling the famed Etruscan jar, but with a girth altogether out of proportion to their height, and with very short necks, and large open mouths. All the vessels are filled to the brim with citron and orange peel, in every stage of absorption—that is to say, steeped in sugar syrup of about eight different degrees of strength. This process almost always occupies eight days, the syrup in each jar being changed every day, and with vessels of such great size and weight, holding at least $\frac{1}{2}$ ton of fruit and syrup, it is clearly easier to deal with the syrup than with the fruit. To take the fruit out of one solution and to place it into the next stronger, and so on throughout the series, would be a very tedious process, and one, moreover, injurious to the fruit. In each of these jars, therefore, there is fixed a wooden well, into which a simple hand suction pump being introduced, the syrup is pumped from each jar daily into the adjoining one. A slight fermentation next takes place in most of the jars, but this, so far from being harmful, is regarded as necessary, but is not allowed to go too far. There is yet another stage, and that, perhaps, is the most important, through which the peel has to pass before it can be pronounced sufficiently saturated with sugar. It is now boiled in a still

stronger syrup, of a density of 40° by the testing tube, and this is done in large copper vessels over a slow coke fire, care being taken to prevent the peel adhering to the side of the vessel, by gently stirring with a long paddle-ladle. This second boiling occupies about one hour. Taken off the fire, the vessels are carried to a large wooden trough, over which is a coarse open wire netting. The contents are poured over this, and the peel is distributed over the surface of the netting, so that the syrup—now thickened to the consistency of treacle—may drain off the surface of the peel into the trough below. The peel has now taken up as much sugar as is necessary. Next comes the final process, the true candying, or covering the surface of the peel with the layer of sugar crystals, which is seen on all candied fruits. To effect this a quantity of crystallised sugar—at Leghorn the same quality of sugar is used as is employed in the preparation of the syrup—is dissolved in a little water, and in this the now dried peel, taken off the wire netting, is immersed. The same copper vessels are used, and the mixture is again boiled over a slow fire. A short boiling will suffice for this last process, for the little water will quickly be driven off, and the sugar upon cooling will form its natural crystals over the surface of the fruit. Poured off from these vessels, it is again dried upon the surface of the wire netting, as before described. The candying is now complete, and the candied peel is ready for the packing-room, to which it is carried in shallow baskets. In the packing-room may be seen hundreds of boxes, of oval shape and of different sizes, for each country prefers its boxes to be of a particular weight.

Plants. — *Dried Plants.* — Dried plants are apt to be destroyed by insects, and large collections would soon become the prey of the larvæ of *Anobiun*, *Ptinus*, &c., were not the precaution taken to protect them against the attacks of these pests.

Certain persons are content to keep their plants in tightly closed cases in

which they place phenic acid, camphor, or oil of thyme. Others, once or twice a year, place their packages of plants in a box especially constructed for the purpose, and therein impregnate them with the vapor of sulphide of carbon. How dangerous it is to handle this substance is well known, and it should be used with great caution. The sulphide box should be lined with zinc, and should be closed hermetically by a well-adjusted cover, whose prominent flange enters a gutter, which may be filled with water, and which is affixed to the upper part of the box. After placing a vessel containing a certain quantity of sulphide of carbon at the bottom of the box, the packages are put in place, each being partially opened, so that the vapour disengaged may penetrate everywhere. After the box is closed, it should remain so for several days, after which the cover is removed, and the packages are exposed to the air until the odour of the sulphide has entirely disappeared. There is a process of preservation which is more generally employed, and which consists in immersing the specimens in the following solution:—

75 per cent. alcohol	...	1 qt.
Bichloride of mercury	...	$1\frac{1}{2}$ oz.

This liquid is a very violent poison, so the use of it requires great precaution. The following formula is sometimes preferred, because the sublimate preserves its properties more intact:—

90 per cent. alcohol	...	1 qt.
Water	...	$2\frac{1}{2}$ oz.
Bichloride of mercury	...	$1\frac{1}{2}$ oz.
Muriate of ammonia	..	$\frac{3}{4}$ oz.

The bichloride is dissolved in the alcohol, the muriate in the water, and the two solutions are mixed.

The plants are immersed in the liquid as follows: A deep porcelain plate of rectangular form, and a little larger and wider than the herbarium paper, is filled with the solution and placed upon a table between a package of plants to be poisoned and a package of driers. Then the tickets are detached from the first specimen, so that they may not be

ruined by a stay in the alcohol, and, as a greater precaution, in order to prevent any soiling contact, they are fixed with pins so that they project externally upon a wrapper. A good supply of wrappers should be within reach. This wrapper thus prepared is placed upon a drier, and then, with wooden or whalebone nippers, *a* Fig. 264, the specimens are seized and immersed in the liquid. Nippers made of metal should never be used for this purpose. The form figured is the one adopted at the Museum of Natural History, and can be easily made by any one for himself.

After the specimens have remained in the liquid for a short time, they are taken out with the nippers and allowed to drain; then they are placed in the cover, which is closed and covered with a drier. The same operation is performed on the rest of the specimens. As soon as a large enough package has been formed it is put in a well-aired place, so as to permit of the evaporation of the alcohol. At the end of 24 hours it is necessary to replace the damp driers by dry ones. A longer stay in them would blacken the specimens.

It must not be thought that the specimens thus prepared are for ever proof against the attack of insects. The herbarium should be often inspected, and a few drops of preservative liquid be thrown upon such specimens as are beginning to be attacked. This operation may be very easily performed with the bottle represented in *b*. This is closed with a rubber stopper, through which pass two glass tubes, one for the passage of the liquid and the other for the entrance of air.

Certain families of plants are much more sought after than others by insects. As a general thing, fleshy plants and those that contain starch are the first ones eaten; the grasses, ferns, and mosses, on the contrary, are very rarely attacked. After the plants have been poisoned, it only remains to arrange them in the herbarium. To this effect, they are fixed upon simple sheets of strong, sized paper, in such a way that they will hold well. Thus prepared

they are put in wrappers. The mean dimensions of the mounting paper are 12×18 in. | amined when necessary. Several species should never be fixed upon the same sheet.

264.

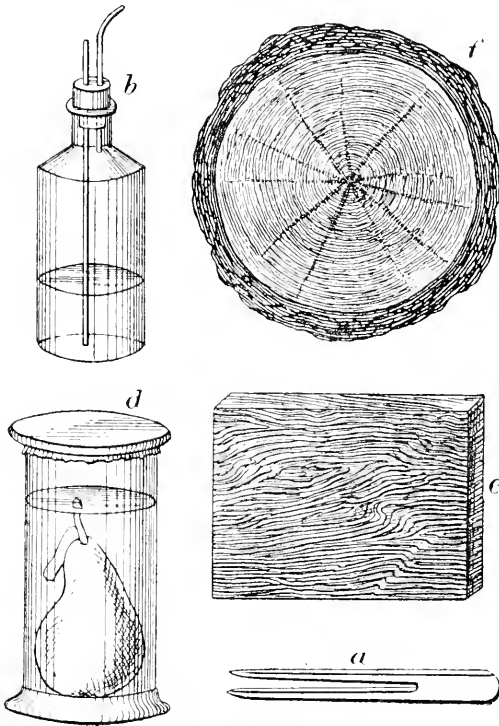

Preserving botanical specimens.

For fixing the specimens, use small straps of gummed paper arranged here and there in such a way (c, Fig. 265) as to hold all the parts, without, however, concealing them. Instead of straps some persons use pins, but the use of these is more difficult, and they have the drawback of breaking the delicate parts of plants by their contact. The specimens must not be glued to the paper, but should be detachable at will, so that they can be thoroughly ex-

Large specimens, the lichens, with their support, and certain fungi can be fixed only upon very strong paper or even upon cardboard, and it is sometimes indispensable to sew them on with cord. In order to prevent them from injuring the neighbouring plants in the package, good cushions of soft paper should be interposed. In all cases sufficient space should be reserved at the bottom of the sheet for the reception of the labels. To the left is placed that of

the collector or of the person from whom the specimen was received. This label should always be carefully preserved, for it is the one that must give authority in the case of doubt. It should bear the number and the notes taken in the

lopes, and whenever it is desired to make an analysis, it is better to use them than to injure one's collection. The sheets filled with specimens are placed in wrappers, and it only remains to classify them by families and put

265.

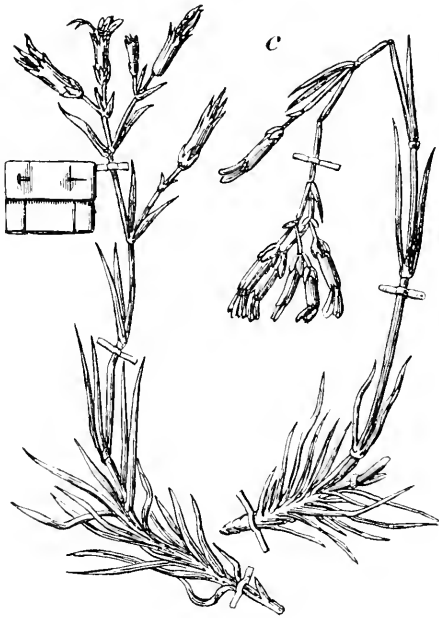

Preserving botanical specimens.

memorandum book. When it is a question of *exsiccati*, that is to say, of collections of which several examples exist, the numbers permit of easily finding the names of the plants when the latter are described and published. To the right is placed a label by itself sufficiently large to allow bibliographic data and observations to be added to the name. The flowers and fragments that become detached during the preparation of the specimens must not be registered, but should be preserved in small enve-

loped packages, which should be arranged in tight cases in a dry place, and where the temperature is as equable as possible. Care should be taken to allow nothing to enter the room devoted to the collection that could attract insects, and never to allow plants to enter it that have not first been poisoned. Several sheets on which are mounted species belonging to the same genus may be enclosed in the same wrapper. To the upper right hand corner of the wrapper should be glued a small,

conspicuous ticket bearing the name of the species. This renders researches much easier.

Conspicuous tickets are also used for the genera, but these are fixed upon simple sheets, so that they can be easily shifted. They must be very distinct from the preceding. They may, for example, be made longer, and of a different colour. They are usually affixed to the middle of the sheet. The family ticket should be larger still, and also of another colour. It is fixed to the left of a simple sheet.

The herbarium packages should not be too bulky. They are kept between cardboards, fastened together with straps.

An excellent measure taken at the herbarium of the Paris Museum consists in placing the species, according to their country, in wrappers bearing labels of various colours, corresponding to the 5 parts of the world. White indicates European species, yellow represents those of Asiatic origin, blue is for Africa, green for America, and red for Oceania. This arrangement permits of easily finding the species in which one is interested when he is making researches upon the flora of a region. Besides, it shows at a glance the geographical distribution of each species, genus, and family.

Fruits.—A collection of fruits is the indispensable complement of the herbarium. To render work easier it is as well to place it as near the latter as possible.

After well washing the freshly-gathered fruits in order to free them from foreign matter (care being taken during the operation not to rub them in such a way as to deprive them of certain important characters, such as colour, villosity, etc.), they are put into jars containing alcohol and water. These fruits should carry a securely fastened parchment label, on which is written the number of the memorandum book. The lead pencil has the advantage over ink that the writing does not become effaced in alcohol; yet for greater safety, it is preferable to form the numbers with a punch. A series of figures does

not cost very dear, by reason of the security offered by the tickets that it permits of making.

If a person is travelling, and wishes to ship the fruits, he will merely have to close the jars tightly with good corks, covered with a thick layer of bottle wax. Sealing wax dissolves in alcohol, and it is therefore very important to have corks that adjust themselves perfectly to the vessel if one wishes the corking not to be defective. The jars should be carefully packed to prevent breakage. They should be accompanied with a catalogue bearing notes from the memorandum book opposite the numbers.

When it is desired to arrange the fruits, it is often necessary to change the alcohol, which, in certain cases, rapidly darkens. The liquid should be changed several times, until it remains of sufficient limpidity.

A large number of systems have been devised for closing the jars. A cork stopper, when of good quality, has the advantage of being easy to insert and extract, and that is to be taken into consideration if it is necessary to examine the specimens often. At the museum are used jars with a lip, which are covered with glass discs, held by glaziers' putty. After the latter is dry, a piece of bladder is glued to the disc, and its edges are tied around the neck with a string. Finally, the whole is covered with thin tin foil. There is nothing further to do but to put a label on the jar bearing the name of the fruit, its origin, and the name of the collector. As the same number is carried by the specimen in the herbarium and the jar containing the fruit, it permits of easily bringing together these parts when it is desired to study them.

Dry fruits are simply put into glazed boxes or into bags or jars.

The classification of the collection of fruits should be done in the same order as that of the herbarium.

Wood.—Specimens of woods should be kept in a separate room from that of the herbarium. They usually contain numerous insects' eggs, and, from time

to time, they should be put into the sulphide of carbon box. They should, as far as possible, be of uniform dimensions, and, in order that the structure of the wood may be well seen, the same species should be represented by longitudinal and transverse sections, *e, f*. Specimens of wood should be labelled and classified with the same care and in the same order as the other collections.

Classification of Collections.—It is indispensable to classify collections and to catalogue them, so that the objects that they contain may be easily found, and one may know what he owns. The catalogue should be numbered, and the numbers placed upon the tickets of the genera and species to which they correspond. This considerably facilitates researches. In order to avoid beginning a new numbering every time that additions are made, it is necessary to take works for one's guide that, as far as possible, contain the total number of genera or species of the region that one has taken as a limit. (*La Nature.*)

Wood.—An interesting account of a new process for preserving wood was lately given in a paper read before the Western Society of Engineers, Chicago. The method referred to is known as the zinc-creosote process, dead oil and chloride of zinc being the active agents employed. It is specially suitable for railway sleepers, bridge timbers, and for situations where wood is exposed to any great degree of moisture. The timber is first of all steamed in a vacuum; the oil is then injected into the cylinder in which the wood is placed; after which the chloride of zinc is applied by pressure. It is said that the oil penetrates the pores of the wood to a certain extent, and the chloride of zinc goes to those portions unreachd by the oil. According to the writer of the paper, J. P. Card, the method will give the best results of any process for the money spent.

CORROSION AND PROTECTION OF METAL SURFACES.

Some substances are applicable to the preservation of most metallic surfaces, and may therefore be mentioned before dealing with those which can be applied only with discrimination. Such may be said to consist chiefly of solid hydrocarbons in combination with liquid hydrocarbons, etheric or fatty oils. Amongst the solid hydrocarbons, preferably india-rubber, paraffin, and ozokerit are used; whilst among the liquid hydrocarbons and oils, rectified petroleum, ligroine, and turpentine-oil are preferably applied for the manufacture of the above composition. A valuable combination is produced by melting 1 part of paraffin under moderate heat (about 150° F.) in a closed vessel, and by then adding and mixing 2-4 parts of rectified petroleum, ligroine, or turpentine-oil, with the melted paraffin. According to the greater or lesser quantity of liquid which is added, the consistency of the composition varies. It can be applied to the surface of the metals by means of a stiff brush.

Copper.—The corrosion of copper by oxidation on exposure to the air takes place very slowly, the metal becoming soon coated with a skin of carbonate commonly called "verdigris," though that name is correctly applied to a basic acetate of copper. This familiar film on the surface of exposed copper constitutes a protection against further oxidation. The action of salt water on copper which is also accessible to the air is rapid, but may be in some degree modified by alloying a small proportion of phosphorus with the metal. Dr. Percy has made the remark that for more than a century European metallurgists have been familiar with small thin bars of cast copper, of Japanese manufacture, which present a beautiful rose-coloured tint, due to an extremely thin and pertinaciously adherent film of red oxide of copper, or cuprous oxide. This tint is not in the least degree affected by free exposure of the bars to

the atmosphere. He has had such bars in his possession for more than 30 years, and although they have been freely exposed to the atmosphere during the whole of that period, yet they have not undergone the least change in appearance. Every one knows that when a piece of ordinary copper is exposed to the atmosphere, it speedily acquires a dark-coloured tarnish. Hence the conclusion that there is some peculiarity on the surface of the Japanese copper, which protects the underlying metal from atmospheric action, and that peculiarity, it may be demonstrated, is the presence of a film of cuprous oxide, in a particular physical state, which acts like varnish. The bars of Japanese copper are actually cast under water, the metal and the water, previously heated to a certain degree, being poured at a high temperature. When copper is so cast, under suitable conditions of temperature, it acquires a coating of cuprous oxide, which acts in the manner described. The temperature is such that the so-called spheroidal action of water comes into play, and the metal flows tranquilly under the water. The superficial oxidation is probably due to the action of a film of steam, which there is reason to believe surrounds the copper under these conditions; and when copper is heated to a high temperature in steam, the latter, as shown by Regnault's experiments, is decomposed, with the evolution of hydrogen, and the formation of cuprous oxide.

Iron and Steel.—The different varieties of iron and steel will not oxidise (rust) in dry air, or when wholly immersed in fresh water free from air, but they all do so when exposed to the action of water or moisture and air alternately. Very thin iron oxidises more rapidly than thick iron, owing to the scales of rust on the former being thrown off as soon as formed in consequence of the expansion and contraction from alternations of temperature. Iron plates are more durable when united in masses than when isolated. The oxidation of iron is to a great extent arrested by vibration.

The comparative liability to oxidation of iron and steel in moist air, according to Mallet, is—

Cast iron	100
Wrought iron	129
Steel	133

Cast iron does not rust rapidly in air. When immersed in salt water, however, it is gradually softened, made porous, and converted into a sort of graphite. Mallet found that the rate of corrosion decreased with the thickness of the casting, being during a century $\frac{1}{10}$ - $\frac{1}{30}$ in. in depth for castings 1 in. thick. Stevenson found the decay to be more rapid than this.

Wrought iron oxidises in moist air more rapidly than cast iron. The evidence as to its rate of corrosion in salt water is rather contradictory. Rennie found that it corroded less quickly than cast iron, but Mallet's experiments showed that it corroded more quickly.

Steel rusts very rapidly in moist air, more quickly but more uniformly than wrought iron, and far more quickly than cast iron. Low shear steel corrodes more quickly than hard cast steel. Recent experiments show that steel immersed in salt water is at first corroded more quickly than wrought iron, but that its subsequent corrosion is slower, and the total corrosion after a long period of immersion is less than that of wrought iron.

In the course of a paper read by McElroy before the Western Society of Engineers, on the causes of corrosion in cast-iron pipes, the author observed that a prominent cause of corrosion is the class of materials used, and also the method of the manufacture of pipes in ordinary foundries. In the first place, a cheap and easily melted pig is selected—specifications and the inspection of quality and mixture not being strict—and the castings (for convenience of handling) are generally made in green-sand moulds laid at a slope of about 10° from the horizontal. Impure metal is therefore run in a way that aggravates its defects. The core bars are coated with straw ropes, which may be more

or less soft and loose, coated with loam more or less soft and wet, and sprinkled with sand.

If not very carefully wedged, these bars will rise; and they are seldom stiff enough to resist the upward pressure of the molten metal. The usual spring at the centre for the core of an 8-in. pipe is $\frac{1}{16}$ – $\frac{1}{8}$ in.; or as much as $\frac{3}{16}$ in. with a 6-in. pipe. The metal, poured in from the upper end, first fills the lower section of the mould; and as it rises round the core to fill the upper section, its weight springs the bar upward to the extent indicated, making the casting thicker at the lower, and thinner at the upper side. The denser, hotter, and purer metal fills the lower portion; the impurities naturally floating upward to settle in the thinner metal as it cools. Here gather portions of the sand coating of the mould; while the bubbles of the metal, caused by the development of gas from the vegetable matter of the loam, and from its dampness, tend to perpetuate themselves in blisters and air cells.

The usual defects in these cheap castings are, therefore, inequality in thickness, air cells and blisters, sand holes, cold chutes from chilled metal, and mixtures of sand and iron. Such pipes are also frequently out of line, from the effect of unequal contraction. Pipes of this description are peculiarly liable to corrosion; containing as they do mixtures of metal of different densities, together with much graphite. The duration of such pipes in the ground is largely affected by the amount of disturbance they receive. If well laid at a good depth, and thoroughly backed, they may continue serviceable for many years; but their defects are likely to become suddenly prominent upon comparatively slight external interference. In favourable circumstances they may last more than thirty years; but the majority, if tested after less use, will show flaws that would have ensured their rejection if detected when new.

Gruner has lately published the results of a year's researches into the comparative oxidisability of cast iron, steel, and soft iron, under the influences

of moist air, sea water, and acidulated water. Having done justice to the earlier labours of Mallet, Phillips and Parker, he explains the arrangements made to secure a perfectly fair trial. The following results were obtained. The experiments with moist air are still proceeding; but so far, it was found that in 20 days the steel plates lost 3–4 grm. for every 2 sq. decimeters of surface. Chrome steel, rusted more, and tungstated steel less, than the ordinary carburetted steel. Cast iron lost only about half as much as the steel, and spiegeleisen less than grey iron. Sea water dissolves iron rapidly, and acts upon it more powerfully than on steel, most powerfully of all upon spiegeleisen. In 9 days, the steel plates with 2 sq. decimeters of surface lost 1–2 grm., while Bessemer metal lost 3·5 grm., phosphorised iron 5 grm., and spiegeleisen 7 grm. Tempered steel was less affected than the same steel twice annealed, soft steel less than chrome steel, and tungstated steel less than the ordinary steel with the same proportion of carbon. It is evident from these experiments that manganese sheets ought not to be used on the hull of a vessel. Acidulated water dissolves cast iron much more rapidly than steel, but not spiegeleisen. (*La Metallurgie.*)

In the rusting of iron there is formed, together with an evolution of hydrogen, which combines with nitrogen, forming a small quantity of ammonia, ferrous carbonate. This changes very quickly into ferric hydrate, mixed with ferrous oxide, and enclosing some unaltered ferrous carbonate. The presence in rust of ferrous oxide, carbonic acid, and ammonia, is thus explicable. Rust formed under water is, in consequence of the smaller amount of acid present, usually richer in protoxide of iron, and therefore a little magnetic, and of a deeper tint than that formed in air. It is accordingly assumed that the carbonic acid present in the atmosphere and in water acts, in the production of rust, similarly to those acids in which iron dissolves, the only difference being that, in the rusting of iron, the ferrous

salt first formed changes, before it is dissolved, into basic ferric salt or ferric hydrate, which change is a natural result of the solution of iron in an insufficient quantity of the acid or water present, or both. The denser the iron, the smoother and more even its surface, the less is the contact between it and the attacking substances, and, under otherwise similar conditions, so much the better, of course, will it withstand rusting. If the latter has begun, it promotes its own further formation, as rust, like other porous bodies, absorbs gases and therefore takes up moisture and acids from the air. Besides, where rusting has already begun, the change from the first-formed ferrous compound to ferric hydrate is attended by a setting free of the active acid, which is then in a condition to act powerfully in the formation of fresh rust. Rust already formed must therefore be quickly removed, in order that a new layer shall not be produced. Rusting, being promoted by acids existing in the air, is also accelerated by those present in water, and for this reason iron is destroyed more quickly in marshes and bogs than in lakes or considerable currents of water, which are generally comparatively free from acids. The tendency of iron to rust is also increased by some salts dissolved in water. Thus it is explained why pieces of cast iron can, by long immersion in sea water, be changed to loose masses, retaining the same outward form, but consisting essentially of carbon. Iron which has been metamorphosed in this manner contains more carbon in proportion to the completeness with which the iron itself has been dissolved. The mass, when taken out of the water, possesses a low specific gravity, and such great porosity that a condensation of air, and simultaneous rise of temperature take place, sometimes sufficient to cause the spontaneous ignition of the whole. If a substance negative to iron, such as scale, tin, &c., partially covers its surface, the portions coated are of course protected, but the uncovered portions are only so much the more liable to

rust: therefore, before coating pieces of iron with oil-paint one should free them from all scale by the action of dilute acid. If, as appears to be the case, contact with impurities renders iron positively electrical, their existence in its interior must also promote rusting. Thus, forged iron appears to rust first along the bands of impurity occurring in it. A partial coating of a metal positive to iron, such as zinc, not only protects the covered portions of the iron, but also hinders the rusting of the unprotected parts, the more completely, indeed, the smaller they are. A coating of fat also protects iron, for some time; but when the fat, by absorption of oxygen from the air, has become rancid and in part changed into fatty acids, the tendency of the iron to rust is increased. From the part which galvanic influences take in the rusting of iron, it follows that those substances positive to iron, which, when in mere contact with it, prevent it from rusting, *promote* the same if they are alloyed with the iron, because such alloys are in general more positive than iron itself. Thus, manganese alloyed with iron promotes the tendency of the latter to rust. So long, however, as the quantity of manganese is uniform and not too large, its effect in this direction is inconsiderable. If, on the other hand, the quantity is uniformly distributed, the rusting of the portions of iron richer in manganese, and therefore more positively electrical, must be greatly promoted by contact with those parts poorer in manganese; hence the presence of unequally distributed quantities of manganese appears to largely augment the tendency of iron to rust. Association with electro-negative substances, such as carbon and phosphorus, diminishes the tendency of iron to rust, if the quantities of the electro-negative substances be evenly distributed through its whole mass. But iron poorer in metalloids in contact with iron richer in these bodies, becomes more positively electrical, and thus the rusting of the poorer portions proceeds more rapidly. Sulphur is an exception among the metalloids, inasmuch as it promotes

rusting. Forged iron rusts more easily. With an increase in the amounts of carbon, silicon, and phosphorus present in iron, the tendency to rust diminishes, so that cast iron is the more capable of resistance to rusting, accordingly as it contains more combined carbon, silicon and phosphorus, and becomes denser. Grey cast iron is, as is well known, poorer in combined carbon and less dense than white. Both characters induce a greater tendency to rust. Perhaps the mechanically-contained graphite also contributes to this, as galvanic action may arise from its contact with the iron. In spite of its lower density, and the contained graphite, grey cast iron withstands rusting better than steel, although the amount of combined carbon in the latter is probably at least as large as in the former. This is probably accounted for by the greater freedom of steel from silicon and phosphorus. The circumstance that grey iron smelted with coke is less soluble than that obtained from charcoal may be similarly explained, viz., by its greater proportion of silicon, and probably also, phosphorus. Spiegeleisen withstands rusting better than granular white cast iron, by reason of its greater density and larger amount of carbon. Elaborate experiments in connection with this subject were made by Parker, whose results are for the most part in accordance with the foregoing statements. (Akerman.)

Protection.—(1) Galvanising consists in covering the iron with a thin coating of zinc. The iron is cleaned by being steeped for some 8 hours in water containing about 1 per cent. of sulphuric acid, then scoured with sand, washed, and placed in clean water. After this the iron is heated, immersed in chloride of zinc to act as a flux, and then plunged into molten zinc, the surface of which is protected by a layer of sal ammoniac. The process differs slightly according to the size and shape of the article. It is a simple one, and may be applied to small articles in any workshop. Kirkaldy found that galvanising does not injure iron in any way. The zinc protects the iron from oxidation so

long as the coating is entire; but if the sheet iron be bad, or cracked, or if the zinc coating be so damaged that the iron is exposed, a certain action is set up in moist air which ends in the destruction of the sheet.

The sheets are generally galvanised before they are corrugated; but as in process of corrugation the sheets, especially the thicker ones, sometimes crack slightly on the surface (unless the iron is of the very highest quality), it is an advantage, with all sheets thicker than 20 gauge, to galvanise after corrugation, so as to fill up with zinc any cracks that may have occurred. As, however, a larger quantity of zinc adheres to the corrugated than to the flat sheets, they have, when so coated, a distinctly higher value. (Matheson.)

(2) Painting is an effectual method of preserving iron from oxidation, if the paint is good and properly applied, and the iron in a proper condition to receive it. In order that the protection by painting may continue, the surface should be carefully examined from time to time, so that all rust may be removed. The paint may be renewed directly it is necessary.

Cast iron should be painted soon after it leaves the mould, before it has time to rust. The object of this is to preserve intact the hard skin which is formed upon the surface of the metal by the fusing of the sand in which it is cast. After this a second coat should be applied, and this should be renewed from time to time as required. In any case, all rust upon the surface of castings should be carefully removed before the paint is applied. Small castings are often japanned. Before painting wrought iron care must be taken to remove the hard skin of oxide formed upon the surface of the iron during the process of rolling, and which, by the formation of an almost imperceptible rust, becomes partly loose and detached from the iron itself. An attempt to prevent this rusting is sometimes made by dipping the iron, while still hot, in oil. This plan, however, is expensive, and not very successful. The scale is

sometimes got rid of by "pickling," the iron being first dipped in dilute acid to remove the scale, and then washed in pure water. If the trouble and expense were not a bar to its general adoption, this is the proper process for preparing wrought iron for paint, and it is exacted occasionally in very strict specifications. But somewhat the same result may be obtained by allowing the iron work to rust, and then scraping off the scale preparatory to painting. If some rust remains upon the iron, the paint should not be applied lightly to it, but by means of a hard brush should be mixed with the rust. Ordinary lead paints, especially red lead, are often used for protecting iron work, but they are often objected to on the ground that galvanic action is set up between the lead and the iron. Matheson recommends oxide of iron paints for iron work generally, and bituminous paints for the inside of pipes or for ironwork fixed under water. The ironwork for roofs, bridges, and similar structures, generally receives one coat of paint before it leaves the shops, and two or three more after it is fixed.

(3) Dr. Angus Smith's process is an admirable means for preventing corrosion in cast-iron pipes. The pipes having been thoroughly cleaned from mould, sand, and rust, are heated to about 700° F. They are then dipped vertically into a mixture consisting of coal-tar, pitch, about 5-6 per cent. of linseed oil, and sometimes a little resin, heated to about 300° F. After remaining in the mixture several minutes, long enough to acquire the temperature of 300° F., the pipes are gradually withdrawn and allowed to cool in a vertical position. Perfect cohesion should take place between the coating and the pipe, and the former should be free from blisters of any kind. In practice, the heating of the pipes before immersion is found to be very expensive, and is frequently omitted. However, many engineers consider it essential for really good work.

(4) All turned, fitted, and tooled surfaces should have a coating of tallow

mixed with white-lead to deter its melting and running off. Dr. Percy recommends rosin melted with a little Gallipoli oil and spirit of turpentine, of such proportions as will make it adhere firmly without chipping off, yet admit of being easily detached by gentle scraping.

(5) Ventura Serra, after many years of experiment and observation, having noticed that knives used in cutting plants belonging to the family of Euphorbiaceæ did not rust, is led to recommend for this purpose an alcoholic solution of gum (resin of) euphorbium. This when applied to steel, iron, or copper, forms a thin, uniform, and very adherent layer, which effectually protects the metal. Experiments with copper immersed in sea-water—a ship's sheathing—were followed by gratifying results.

(6) According to the 'Engineer,' J. Machabee has some little time since invented a composition to preserve iron from rust, applicable also to other materials, such as stone or wood, used in conjunction with metal. The following is the composition:—Virgin wax, 100 parts; Gallipoli, 125; Norwegian pitch, 200; grease, 100; bitumen of Judea, 100; gutta-percha, 235; red-lead, 120; white-lead, 200. These ingredients are mixed together in a boiler in the order above, the gutta-percha being cut up in small pieces, or rasped. The mixture is stirred at each addition, and poured into moulds. For iron, it is melted and laid on with a brush.

(7) Girders, angle-irons, and similar large masses of iron, are often placed in exposed situations, where damp air, steam, and acid vapours have access. If the iron be put up in the rough, it very speedily rusts, and under favouring conditions the corrosion soon reaches a dangerous point. Contractors generally agree to supply such irons painted in three coats of minium, which, if honestly done, to a certain extent protects the metal; but a novel mode of treating girders is to heat them until, if touched with oil or fat, they cause it to fizzle, and then plunge them into a

vat of mixed oil and grease. This mode of treating cast iron is said to be superior to any "painting," as the oleaginous matter actually penetrates the pores, and prevents oxidation for a very long time, while it does not prevent painting, if desirable, afterwards.

(8) The results of some experiments on the preservation of sheet-iron used in railroad bridges have been published by the directory of the Government railroads of the Netherlands. From 32 sheets half was cleaned by immersion for 24 hours in diluted hydrochloric acid; they were then neutralised with milk of lime, washed with hot water, and while warm, dried and washed with oil. The other half was only cleaned mechanically by scratching and brushing. 4 of each kind were then equally painted with red-lead, with 2 kinds of a red paint of oxide of iron, and with coal-tar. The plates were then exposed to the weather, and examined after 3 years. The result was—(a) That the red-lead had kept perfectly on both kinds of plates, so that it was impossible to say if the chemical cleaning was of any use. (b) That one kind of iron oxide red paint had better results on the chemically-treated plate than on the other—in fact, a result equal to that of the plate painted with red-lead; while the other kind of iron oxide red gave not very good results on the plates when only scratched and brushed. (c) That the coal-tar was considerably worse than the paint and had even entirely disappeared from those iron sheets which had not been treated chemically, but only cleaned by brushing. (*Eng. Mech.*)

(9) Cast-iron Pipes.—The water from mines frequently contains enough acid to attack cast-iron pipes, destroying them in a short time. Oil colours and varnishes offer but a limited resistance, and the process of enamelling employed in Oberschlesia, says Engelhardt of Ibbenburen, although permanent and effective, is expensive. Cement is cheaper, and is unacted upon by these waters, and the only question to be settled was whether it would adhere to

the smooth iron with sufficient firmness. Two similar pieces of rolled iron were taken, and one of them painted over 5 times with a very thin cement, so that the coating was $\frac{1}{5}$ in. thick. Both pieces were suspended near together in that part of the shaft where the water had attacked the signal cable most violently, and were left there 4 months. On taking them out, the unprotected iron was found to be reduced to $\frac{1}{4}$ its original thickness; the other, in which a hole had been bored to suspend it, had suffered the same corrosion at the exposed portion; the cement covering was dark brown, but perfectly hard and unattacked by the acid. The cement was broken off, and the surface of the iron exhibited the dark-blue colour and lustre that it had on leaving the rolls. As this coating adhered so well to the smooth rolled iron, to which it cannot cling so tightly as to the rougher surface of cast iron, the experiment was continued on a larger scale. A 26-in. discharge pipe in the Oeyhausen shaft was protected on the inside with cement. The coating remained unchanged for 2 years, while the pump was in constant operation. At the beginning of last winter, the pump was stopped, and the pipe being no longer under water, the cement was so much injured by the frost that it scaled off. Several other experiments were made with similar results. The pipes should be new, or, if old, well cleaned from rust before applying the cement, which is mixed as thin as is possible without injury to its tenacity. The pipe is moistened before the cement is applied, a thin coating of cement is put on and allowed to dry; when hard, it is moistened, and a second coating is applied; and so on 4 or 5 times. The operation cannot be conducted so well in very hot weather, as the cement dries too quickly; nor must the pipes be exposed to frost during the operation or afterward. This unfortunate sensitiveness to cold may perhaps yet be overcome by interposing some semi-elastic material between the iron and cement. (*Iron.*)

(10) Dr. W. H. Sterling's process

consists in the impregnation and saturation of the structure of the metal with a non-oxidising or non-oxidisable substance, by forcing it into the intercellular spaces of the metal by pressure while the iron is in an expanded condition, induced by heating. He gives one method by which his invention may be applied, and which he recommends as being eminently practical and useful. A vessel of any suitable material, of sufficient strength, is made in the form and size best adapted to those of the iron article to be treated, with the lid so constructed that the vessel may be closed hermetically; at the bottom, pipes are arranged for conveying steam and water alternately, for the purpose of heating and cooling the interior. Connected with this vessel is a force-pump, for producing the necessary pressure, and appliances for obtaining a vacuum. The iron to be treated is heated to the desired temperature, placed in the above vessel, the top is closed hermetically, and dry or superheated steam is turned into the pipes at the bottom, to keep the metal at the required temperature; also, at the same time, an atmospheric vacuum is produced by an ordinary air-pump connected with the chamber; the proper quantity, sufficient to fill the vessel, of pure paraffin or paraffin in solution with one of the pure mineral oils, having been also previously heated to the required temperature, is now let into this chamber and forced under pressure into the intercellular spaces of the iron, those having so enlarged by the expansion of the metal from the heat and removal of the atmospheric pressure as to readily admit the hydrocarbon preservative. When the iron has remained under this liquid pressure a sufficient time, it is gradually cooled by turning cold water instead of steam into the pipes, the pressure being kept up, however, until the iron is cool. Certain qualities of iron may be treated without the atmospheric vacuum, but as the iron expands very much more, while greater pressure is obtainable by its employment, and the additional cost is not to be considered he recommends

its use as desirable. (*Van Nostrand's Magazine*.)

(11) To preserve iron from oxidation when exposed to the air, Reigelmann takes the ordinary paints made up of boiled linseed-oil and the oxides of the heavy metals, and incorporates therewith in the cold about 10 per cent. of calcined magnesia, baryta, or strontia, which has been previously steeped in an equal weight of light mineral oil. To preserve iron from rusting in the earth, as, for instance, gas or water pipes, water tanks, the sides of iron ships, &c., he melts 100 parts rosin and 25 of gutta-percha in 50 of paraffin; this resinous compound is then stirred into mineral oil, so as to have the consistence of paint, with which are then incorporated in the cold 20 parts calcined magnesia. In place of magnesia, equal weights of caustic baryta may be added, according to circumstances. After the addition of the magnesia, the mixture is anew diluted with mineral oil until it can be applied with a brush. To preserve pieces of polished machinery or other article of iron or steel, and to be able to guarantee them against rust during carriage, the coating is composed of vaseline, or of heavy mineral oils, with the addition of 20 to 30 per cent. of calcined magnesia. If the coating is to serve only for a short time, instead of calcined magnesia, the same quantities of burnt lime, marble, or dolomite may be used. For packing and covering iron articles, such as wire, chains, files, &c., cloth or paper may be used, one side of which is coated with the last-mentioned mixture, whilst the opposite side is rendered impermeable by the application of a layer of chromated glue. (*Chem. Rev.*)

(12) In mixing paints for iron surfaces it is of the first importance that the best materials only should be used. Linseed-oil is the best medium, when free from admixture with turpentine. A volatile oil like turpentine cannot be used with advantage on a non-absorbent surface like that of iron, for the reason that it leaves the paint a dry scale on the outside, which, having no cohesion

can be readily crumbled or washed away. Linseed-oil, on the other hand, is peculiarly well adapted for this purpose. It does not evaporate in any perceptible degree, but the large percentage of linolein which it contains combines with the oxygen in the air and forms a solid translucent substance, of resinous appearance, which possesses much toughness and elasticity, and will not crack or blister by reason of the expansion or contraction of the iron with variations of temperature. It is, however, remarkably adhesive, impervious to water, and is very difficult of solution in essential oils, spirits, or naphtha, and even in bisulphide of carbon. Another important advantage of linolein is that it expands in drying, which peculiarity adapts it to iron surfaces; since cracks, however minute, resulting from shrinkages, expose enough of the metal to afford a chance of corrosion, which will spread in all directions, undermining the paint and causing it to scale off, besides discolouring it. With all its advantages, however, the best linseed-oil paint is but poorly adapted to long service as a protection to iron surfaces exposed to extreme variations of temperature and to all kinds of weather. Even the continuous film of linolein, notwithstanding its compactness and the additional substance afforded by the body of the paint, gradually loses its toughness, curls up, and peels off. If chipped by accident before it has lost its hold on the iron, we find, if we carefully examine the exposed spot, that a thin film of oxide has formed under it. This fact accounts for its diminished adhesion. Iron, in uniting with oxygen to form a rust, increases its bulk in proportion to the amount of oxygen it has taken up, and necessarily occupies greater space. In a word, it swells, and in so doing pushes off from it the paint film, which sooner or later drops away from it. This undermining action of rust is the chief difficulty to be contended with in effectually preserving iron surfaces by means of paints or varnishes. It is not improbable that the linolein, itself an

oxide, may impart oxygen to the iron, and thus promote rusting. This idea has been suggested by Prof. Williams in a recent treatise on the subject; and, whilst purely speculative, it may account for the oxidation of iron surfaces when to all appearance effectually protected by a coat of paint thick enough and continuous enough to exclude both air and damp. In selecting a paint for iron, mechanical adhesion is a consideration of the first importance. In this respect paints differ widely; but it must be remembered that in painting or varnishing a metallic surface, mechanical adhesion is all we have to depend upon. With absorbent surfaces it is different. Prof. Williams gives it as his opinion, based on observation and experiment, that pitchy or bituminous films are especially effective as regards their adhesion to iron: for example, solutions of asphalt, or pitch, or petroleum, or turpentine. These are also very effective as regards continuity, owing to the fact that in drying they form plastic films, which yield with the contraction and expansion of the iron, and show no tendency to crack. If the surface is rusty, they penetrate the oxide scale and envelope the particles very effectually, making them a portion of the paint. The solubility of such a film may be counteracted by mixing it with linseed-oil. The experiment may easily be tried by mixing about 2 parts Brunswick black with 1 of red- or white-lead or litharge. Red-lead is the best for many reasons, if finely-ground and thoroughly mixed with linseed-oil. Any one of the several kinds of bitumen may be used; either natural mineral asphalt, pine pitch, or artificial asphalt, such as gas-tar or the residuum of petroleum distillation in cases where the crude oil has been distilled before being treated with acid. This gives a very hard bright pitch, which is soluble in "once run" paraffin spirit, and makes the base of an excellent cheap durable paint for ironwork in exposed positions. During the past few years have appeared many accounts of the preservative influence of paraffin when applied to iron

surfaces, and recommending it in all classes of ironwork which can be treated hot. The most effective mode of applying it is to heat the iron *in vacuo*, in order to expand it and open its pores, when paraffin raised to the proper temperature is poured into it. By this means the iron is penetrated to a sufficient depth to afford a very effectual protection against oxidation, especially when a suitable paint is subsequently applied. Any non-oxidisable substance would probably answer, but paraffin is as cheap as any, and quite as good, if not better; the exception as to quality being made in favour of some vitreous enamel, which, while costing more, would certainly be more permanent in its results. Brushed upon the outside merely, it is doubtful whether paraffin would have much effect upon the iron, while it certainly would tend to lessen, if not destroy, the mechanical adhesion of a surface paint. There is no reason, however, why bridge-work, iron fronts, &c., should not be treated with paraffin before they leave the shops where they were made, which would greatly simplify the problem of their easy and economical preservation from oxidation. In the absence of such treatment, a careful coating with the paint above described will probably prove the most effectual means of protecting iron surfaces. (*Amer. Painters' Mag.*)

(13) The iron is subjected to the action of dilute hydrochloric acid, which dissolves the iron, and leaves on the surface a pellicle of homogeneous graphite, which adheres well to the surface of the iron. The piece to be preserved is next treated, in a hydraulically closed receiver, by hot or cold water, or, better, by steam, in such a manner as to completely dissolve and remove the chloride of iron formed. Finally, the piece of iron is left to dry in the receiver, from which all liquid has been removed. A solution of india-rubber, gutta-percha, or gum-resin in essence of petroleum, is then injected. On the essence being evaporated, there remains a solid enamel-like coat on the surface of the iron. Instead of previously

eliminating the iron salt, it may be utilised in forming a kind of vitreous enamel. For this purpose, the iron is immersed, after treatment with the acid, in a bath of silicate and borate of soda. A very pure and brilliant silico-borate of iron is formed, which closes up the pores of the metal. As to the disengaged chlorine, it combines with the free soda, forming chloride of sodium, which remains dissolved in the liquid. (*Scient. Amer.*)

(14) Bower-Barff process.—Briefly, this process, as now worked, is as follows:—The iron goods, whether rusty or not, are, without preliminary treatment of any kind, placed in a suitable chamber sufficiently capacious to hold about one ton weight of contents, and this chamber is heated by the combustion therein of carbonic oxide gas, produced near at hand by several gas furnaces, an excess of air over that requisite for combustion being admitted also into the chamber, after having been heated in its passage through coils of pipes placed immediately underneath the operating chamber. A film of magnetic oxide forms upon the immediate surface of the iron articles, and this appears to be surmounted with one of ferric oxide (Fe_2O_3) and it is by the subsequent reduction of this substance by means of carbonic oxide that the coating of magnetic oxide is increased to the requisite extent. In brief, the excess of air present in one stage of the process seems to form ferric oxide, and when the proportion of air present is reduced (as it may be at will) so that carbonic oxide is present, then the ferric oxide becomes reduced to the lower state of oxidation, its oxygen contributing to the production of carbonic anhydride. The time required varies from 3 to 12 hours, and the magnetic oxide as thus formed exhibits a very pleasing French-grey or leaden tint. Should the colour, however, be unsuitable to the intended use of the iron articles, the more costly metals may be deposited upon them. (Kingzett.)

Prof. Barff has at various times published further details of the results of

the process. As to the action on the strength of the iron, bars treated have been tested for breaking and tensile strain, and the result is that the strength of the iron is not affected. The coating gives great hardness to the surface of iron, when the coating is sufficiently thick (even less than $\frac{1}{16}$ in.). An ordinary flat rasp will not remove it without great labour, and it resists emery powder, will for a long time resist a rasp, and remove pieces of steel from it. Substances which adhere to iron, zinc, and enamel will not adhere to it. Saucepans in which sticky substances are cooked can be cleaned with the greatest ease, after they have been oxidised, a simple wipe removing all dirt. A urinal in constant use for months had no deposits on it. Water was evaporated in an oxidised pan for 6 weeks—common tap water; the water never boiled, but was slowly evaporated; the deposit found was removed with a duster: it did not stick to the iron. This is a matter of great importance to boilers, and for pipes through which water is to be conveyed. Articles coated can be submitted to a high temperature, even a red heat, without the coating being injured or disturbed. At present iron wire cannot be treated successfully—the wire can be treated and will not rust, but it cannot be bent to a sharp curve without the coating coming off. Riveted iron plates can be most successfully treated; the process tightens the rivets and assists the caulking. Weights were treated for the Government, and submitted to tests, and the process is now recommended by the department for the standard weights throughout the country. Prof. Barff has not yet met with any sample of cast iron which could not be properly treated. Wrought iron requires a somewhat different treatment; a lower temperature, about 900° F. (493° C.) suits it best, and steel also. It is not well to expose articles very different in bulk at the same time; all that are put into the muffle should be pretty nearly equal in bulk. For instance, very heavy articles, such as a 56-lb. weight, should not be

treated with gutter spouts. Cast and wrought iron should not be treated together. For the chamber at present in use, 2 ft. \times 2 ft. 6 in., and 1 ft. 6 in. high, the outlay on fuel for subjecting the articles within the chamber to superheated steam for 10 hours is 5s. In a manufactory this cost would be greatly reduced. A West Bromwich firm, working the patent under a royalty, inform him that the cost will not approach that of galvanising iron, and he supposes it will little exceed that of the periodical three-coat paintings. The increase caused by oxidation can be estimated, and to fit nut and screw for each other, allowance must be made for this in casting. As to the treatment of riveted articles, and the danger that the coating film would be removed, there is some difficulty in this; he supposes boilers will be treated in large chambers when made up. When the rivets were hammered or pressed into the plates, the coating is removed, and of course these spots would be attacked by rust. The remainder of the plates might be protected from abrasion; the practical difficulty is to re-oxidise the rivets *in situ*. To accomplish this he proposes to cover the band of rivets with a porous cap of silicate cotton, and to subsequently re-oxidise that portion. But even if this were not successful, the rusting of the rivets would be of little practical injury, as it would take so many years to rust through a rivet, and the corrosion could not spread laterally, on account of the repellent character of the black oxide. As to the pressure of steam in the boiler, 40 lb. is the extreme; but they are obliged to use considerable force to effect the double object of keeping out atmospheric air and to efficiently oxidise the surfaces treated. The oxidation only proceeds till the pores of the iron are all filled up with black oxide; but with very thin objects, great caution has to be taken, lest they should be oxidised through.

(15) The method of preserving iron by forming an inoxidisable film or coat upon the surface has been tried in

France, the process adopted being modifications of those patented by Barif and Bower. According to Kraft, Bourdon encloses the articles to be preserved in a cylinder closed at both ends by riveted plates, into one of which the steam supply pipe enters, while the other is supplied with 3 openings. Into one of these a thermometer is fitted; the second is supplied with a stopcock through which to allow the water condensed to run off. This must be done frequently, as the steam must be as dry as possible. To the third is fitted an escape-valve for the steam. The most favourable conditions for success are the following:—The pressure must amount to 2 or $2\frac{1}{2}$ atmospheres, the temperature must be from 626° to 644° F. (330° to 340° C.), and 5 hours must be allowed for the completion of the operation. A covering of a greenish-black colour is obtained, which adheres firmly and is perfectly stable. The cylinder is placed in a sort of oven, maintaining its shell at about 930° F. (500° C.). The thermometer, plunged in the steam of the interior with its registered part protruding so as to allow observations, showed, however, only 644° F. (340° C.). If the current of steam is stopped, the thermometer will almost instantly rise to 930° F. (500° C.). The coating is a perfect success; care must, however, be taken that no parts of the articles are soldered together by tin solder, as the latter melts at 442° F. (228° C.). Even if the connection remains intact, there will always be a few minute globules of solder detached and stains caused. Copper must be used instead. In further following up his experiments, Bourdon conceived the idea of replacing the steam by hot air. He proceeded as follows:—A coil of pipe communicating at one end with the open air ascends gradually through a reservoir heated to 248° F. (120° C.), whence it enters the cylinder in which the articles to be operated upon are enclosed. This cylinder is identical with that used for steam. The escape-valve leads into a tank containing water, permitting a better regulation of the air current. This must

pass very slowly. The interior pressure is but a little above one atmosphere, as the apparatus communicates with the open air. The temperature of the air in the cylinder is 536° F. (280° C.); the time consumed, 5 hours. A layer $\frac{1}{2}$ -in. in thickness is obtained, capable of resisting the action of emery-paper, and unaffected by dilute sulphuric acid. The layer possesses a fine greenish-black colour. To ensure perfect success, the articles must be suspended completely free. After removing them from the apparatus, they are rubbed with a greasy cloth; stains, if any, are removed with emery-paper or iron-dust. It has been found that with an elevation of temperature under pressure of one atmosphere a very thick layer is obtained, which, however, scales off easily. The adherence is, therefore, a question of temperature and not of pressure, as was formerly supposed. Those pieces coated by hot air were for one month exposed to the weather without being attacked in the least. On removal of the exterior black rind, a grey layer is discovered below the same, which to some extent becomes rusty on exposure. The rust, however, does not adhere as on metallic iron, but is easily removed by scraping with a piece of wood. This fact also applies to articles coated by steam. Last June, Bourdon tried the process on 400 rifle barrels at once. Similar trials have since been made, showing the practicability of using it on a large scale. The principal point is to obtain a current of air sufficiently abundant to secure a proper thickness of the layer, but of a circulation slow enough to allow the air to act on the iron. The French Government has already adopted the process at some of its arsenal manufactories.

(16) A process of painting, as a substitute for galvanising, has been invented by Neujean and Delaite, of Liege. It is specially intended for objects of large dimensions, which cannot easily be moved, and therefore cannot well be dipped into a bath of melted zinc. The zinc, when finely pounded, is simply mixed with oil and siccativ. In this

way a varnish is obtained, which is applied with a brush in the usual manner. A single layer is sufficient, but two are preferable. The coated objects can be left as they are, or bronzed and painted as required.

(17) An anti-corrosion paint for iron. If 10 per cent. of burnt magnesia, or even baryta or strontia, is mixed cold with ordinary linseed oil paint, and then enough mineral oil to envelope the alkaline earth, the free acid of the paint will be neutralised, while the iron will be protected by the permanent alkaline action of the paint. Iron to be buried in damp earth may be painted with a mixture of 100 parts of rosin (colophony), 25 of gutta-percha, and 50 of paraffin, to which 20 of magnesia and some mineral oil have been added. (*Neueste Erfind.*)

(18) A simple and economical way of tarring sheet iron pipes to keep them from rusting is the following:—The sections as made should be coated with coal tar and then filled with light wood shavings, and the latter set on fire. The effect of this treatment will be to render the iron practically proof against rust for an indefinite period, rendering future painting unnecessary. In proof of this assertion, the writer cites the example of a chimney of sheet iron erected in 1866, and which, through being treated as he describes, is as bright and sound to-day as when erected, though it has never had a brushful of paint applied to it since. It is suggested that by strongly heating the iron after the tar is laid on the outside, the latter is literally burnt into the metal, closing the pores and rendering it rust proof in a far more complete manner than if the tar itself was first made hot and applied to cold iron, according to the usual practice. It is important, of course, that the iron should not be made too hot, or kept hot for too long a time, lest the tar should be burnt off. Hence the direction for the use of light shavings instead of any other means of heating. (*Gas Light Journal.*)

(19) Grace Calvert some years ago drew attention to the fact that steel

after immersion in caustic soda or caustic potash is preserved from liability to rust. This apparently valuable information does not seem to have been acted upon by chronometer makers and others, to whom any method of securing immunity from rust would be of considerable service. Balance springs for chronometers have been occasionally coated with collodion, but the thickness and rapid decay of this film interferes with the timekeeping of the chronometer, and is therefore objectionable. On inquiring of one chronometer maker, we were told that he had treated some springs with caustic soda at the time Calvert published his work, and that these springs were still free from rust; but as they had not been exposed to damp with other springs not so treated, he was unable to deduce any opinion as to the advantage of the process. So it is generally. Practical men are continuously occupied with their work, and have unfortunately no time for experiments, though they suffer day after day from an evil the removal of which is probably within their grasp. (*Mechanical World.*)

(20) To preserve iron from rust in Ceylon it requires to be first well scraped and cleaned; and if for outside work, such as bridges, roofs, girders, &c., it should be well coated with tar paint. The following receipt will be found to answer well, viz. coal-tar 9 gal., slaked lime 13 lb., turpentine or naphtha 2–3 qt. The use of the lime is for neutralising the free acid in the tar. This paint is very fluid, and well adapted for roofing, galvanised or black corrugated iron, &c.

(21) At Port Chester, Pa., pipes have been treated by a new process, which is said to have advantages over the Bower-Barff process. Haupt describes the plan as follows: After the pipes have been lowered into the retorts by means of a traveller, the retorts are closed for about 15 minutes until the contents are heated to the proper temperature. Steam from the boiler at 60 lb. pressure is then introduced into the superheater, which it traverses, and

from which it escapes at the temperature of the iron, upon which it acts for about one hour. A measured quantity of some hydrocarbon is then admitted with a jet of steam, followed again by a fixing bath of superheated steam, which completes the process. The absence of pressure and of explosive gases is a proof that all the operations have been nicely regulated, and that a perfect absorption and union of the carbon, oxygen, and hydrogen with the iron has been effected. The protection is said to be a real conversion of the metal to a certain depth into a new material. There is no coating that cracks or can be destroyed by bending, hammering, rolling, or heating.

(22) Too much stress cannot be laid upon the condition of the surface of the iron at the time of coating; and it is perfectly essential either to have a dry surface or else a composition which is not affected by water. Prof. Lewes remarks that when an old iron structure is broken up, on the backs of the plates may often be seen the numbers painted on them in white lead and linseed oil when the work was put together, and under the paint the iron is in a perfect state of preservation, the secret being that the paint was put on while the plates were hot and dry.

Compounds prepared with boiled linseed oil are open to objection, on account of the presence of lead. The drying of boiled linseed oil is due to the fact of its containing a certain quantity of an organic compound of lead; and the drying property is, moreover, imparted by boiling it with litharge (oxide of lead), so that lead compounds are present even when the oil is not mixed with red or white lead pigment. When boiled oil dries, it does so by absorbing oxygen from the air, and becomes converted into a kind of resin, the acid properties of which also have a bad effect upon iron. Protectives of the class of tar and its derivatives, such as pitch and black varnish, and also asphalt and mineral waxes, are regarded by Prof. Lewes as among the best. Certain precautions, however, must be taken in

the case of tar and tar products, both of which are liable to contain small quantities of acid and ammonia salts. If care is taken to eliminate these, and if it could be contrived to always apply this class of protectives hot to warm iron, the question of protection would be practically solved; bituminous and asphaltic substances forming an enamel on the surface of iron which is free from the objections to be raised against all other protectives—that is, of being microscopically porous and therefore pervious to water. Spirit or naphtha varnishes are condemned by Prof. Lewes as open to several objections. Varnishes to which a body has been given by some pigment, generally a metallic oxide, are preferable to the last class, if the solvent used is not too rapid in its evaporation, and if care has been taken to select substances which do not themselves act injuriously upon iron, or upon the gums or resins which are to bind them together, and are also free from any impurities which could do it.

At the present time, as the author truly remarks, the favourite substance for this purpose is the red oxide of iron; but care should be taken to exclude from it free sulphuric acid and soluble sulphates, which are common impurities and extremely injurious. The finest coloured oxides are, as a rule, the worst offenders in this respect, as they are made by heating green vitriol (sulphate of iron), and in most cases the whole of the sulphuric acid is not driven off; the heat required being injurious to the colour. The acid is often neutralised by washing the oxide with dilute soda solution; but very little trouble, as a rule, is taken to wash it free from the resulting sulphate of soda, which is left in the oxide. The best form of oxide of iron to use for paint making is obtained by calcining a good specimen of hematite iron ore at a high temperature. When prepared in this way, it contains no sulphates, but a proportion of clay which is harmless if it does not exceed 12–18 per cent. Paint makers can easily test their red oxide for soluble sulphates by warming a little of it with

pure water, filtering, and adding to the clear solution a few drops of pure hydrochloric acid and a little chloride of barium solution. If a white sediment forms in the solution, the sample should be at once rejected.

In the application of a preservative coating to iron, Prof. Lewes directs, first, thorough scraping and scrubbing from all non-adherent old paint and rust. New iron should be pickled with dilute acid to get rid of every trace of mill scale; the acid to be neutralised afterward by a slightly alkaline wash, and this again to be washed off by clean water. Under these conditions, and

(23) For several years, G. W. Gesner, of New York, has been experimenting with a process for giving articles of iron and steel a rust-proof coating. Plant has been established at South Brooklyn, which has been in operation for some time past. The accompanying illustrations, Figs. 266, 267, and 268, show its construction. It consists substantially of a bench of two ordinary gas retorts placed side by side in a furnace heated by a grate. Each retort is heated to a temperature of 1000-1200° F., as may be determined by the character of the articles to be treated. The latter are introduced by means of a crane and

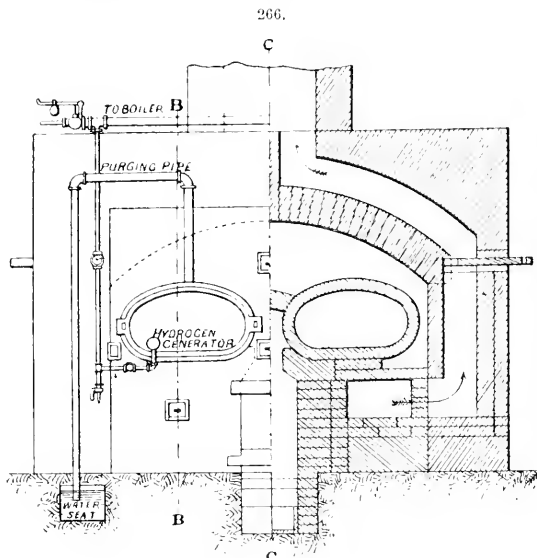

Gesner's rust-proofing furnace.

given a composition of good adhering properties, but little apprehension need be felt with regard to the ravages of corrosion, the chief remaining risks being from abrasion or other mechanical injury to the composition, coupled with improper constituents in itself. (*Scient. Amer.*)

pulley, care being taken that they do not touch one another. After closing and testing the retort, the heating continues for about 20 minutes. Then steam is introduced into what Gesner calls a "hydrogen generator," shown in Figs. 267 and 268. It is a simple pipe, open at the rear end. Gesner claims that

in the passage of the steam through this $\left| \frac{1}{2} \right.$ pint of naphtha is permitted to flow
 generator hydrogen is generated, which $\left| \right.$ into the retort for 10 minutes. The

267.

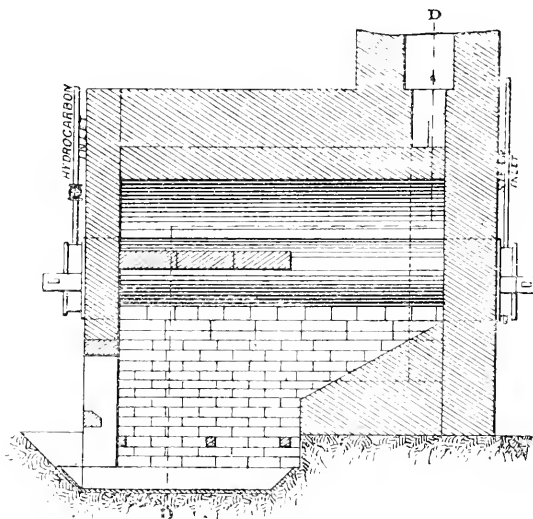

Gesner's rust-proofing furnace.

268.

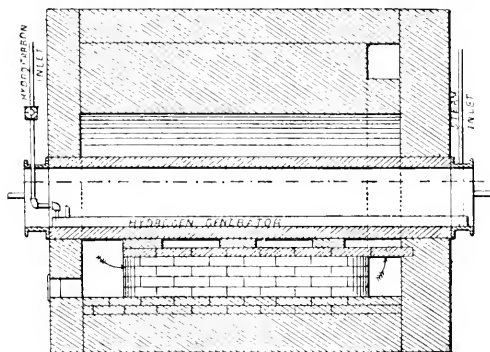

Gesner's rust-proofing furnace.

fills the retort. This operation goes on $\left| \right.$ flow of hydrocarbon is then stopped, and
 for 35 minutes, at the end of which time $\left| \right.$ the steam which has been allowed to

enter the generator during the whole operation is continued for 15 minutes longer. The whole time employed in the operation is therefore 1 hour and 20 minutes. The "purging-pipe," which dips into an open vessel of water, as shown in Fig. 266, to the depth of $1\frac{1}{2}$ in., carries off any excess of gases produced in the operation. In cases where articles treated are ornamental, such as art hardware, they are given a bath of cold whale oil or paraffin oil to render them more even in tone. In other articles no oil is used. The plant now established at South Brooklyn is rated at a capacity of 6 tons per day of boiler tubes $7\frac{1}{2}$ ft. long, or 2 tons of ornamental hardware, the rate of production of treated goods depending upon the time required for handling them. The average cost in America of fuel per day is reported by Gesner to be 7s., including coal for the boiler.

To substantiate his claim that hydrogen has a function in the creation of a rust-proof coating, Gesner quotes the following analysis, made by Stillman & Gladding, of New York, of a sample of the surface of cast iron prepared by the process: Carbon, 1.01 per cent.; hydrogen, 0.22 per cent.; sand, 6.70 per cent.; and iron, 66.10 per cent. The chemists add that the iron is present as metallic iron and as oxides of various constitution.

In order to determine whether the treatment had any adverse effect upon the strength and resistance of wrought iron and steel suitable for boiler, ship, and bridge purposes, a series of tests were made by B. H. Coffin, in charge of the testing department of Henry Warden, Germantown Junction, Philadelphia, Pa. We quote as follows from this report:—

"5 steel pieces of iron were cut from a single plate $\frac{1}{2}$ in. thick, and 5 more similarly from a $\frac{3}{8}$ in. steel plate. These were machined to suitable sizes for the standard 8 in. test piece, giving a section of about 9.71 sq. in. for the iron and 0.51 sq. in. for the steel. Three of each of these sets were forwarded to Gesner for treatment, who retained one

and returned the remainder. The tests were made with a 200,000 lb. Olsen machine, and the measurements with Brown & Sharp's micrometer gauges, and are believed to be accurate.

The pieces were gauged both before and after treatment, and showed no change. The tests show practically no effect whatever upon the iron, with the exception of a slight decrease in the elongation. As the reduction of area is not fully ascertained, it is impossible, without further evidence, to say whether or no the ductility is affected. At any rate the ductility being so low, this small reduction, if proved to exist, would be of comparative unimportance in affecting the value of the metal. The steel is benefited. The annealing undergone during the treatment has softened it to some extent; it has lost about 5 per cent. in strength but gained 5 per cent. in elongation. This metal originally would not have come up to specifications, being insufficient in stretch. The treatment has not reduced the tensile strength below the assigned limit; at the same time it has brought the elongation up to requirements. Pieces of both iron and steel were bent cold to an angle of 45° without showing any fracture or scaling of the treated surface.

The following are the results of the tests:—

	Elongation Per cent.	Reduction of Area.	Elastic Limit.	Ultimate Stress.
IRON—				
Untreated	10.5	12.9	32,350	45,040
	10.1	11.6	33,750	44,880
Treated ..	8.4	13.4	33,740	42,620
	6.6	11.6	33,640	45,770
STEEL—				
Untreated	21.6	43.3	41,960	58,250
	19.1	42.8	43,050	59,120
Treated ..	24.1	40.9	39,050	55,880
	26.0	44.9	37,390	55,220

A large variety of iron and steel goods have been already treated in quantities by the South Brooklyn Rust Proof Iron and Steel Works, among them being builders' and art hardware, roofing shingles, stove fittings, pipe and pipe fittings, parts of water meters, steam radiators, pistols, and other

articles. The colour produced is a dark blue. (*Iron Age*.)

(24) Some machinery makers use a kind of thin black japan for preserving the brightness of polished parts. Some months ago the writer was in several works of Lancashire toolmakers, and noticed this black material in use. It is easily laid on with a brush in the same way as paint, and is very readily removed at any time with a rag soaked in turpentine. It does not attack the metal, as the acid from fats is so liable to do, and has the great advantage of being much more cleanly both in use and appearance, being perfectly hard and dry, and thus allowing the machinery to be handled, which, in packing for railway transit or shipment, is very important. In many cases a great deal of the ordinary white-lead and tallow is rubbed off in the packing operations, and the object sought by its application is thus defeated. A good substitute for such mixture is very desirable, and the subject is worth the attention of engineers and machine makers. (T. T.)

Lead.—Soft water, especially when full of air, or when containing organic matter, acts upon lead in such a way that some of it is taken up in solution, and the water is poisoned. Vitiating or impure air acts upon lead in a somewhat similar manner. Pure water, not containing air, does not act upon pure lead. When the water contains much oxygen, the lead is oxidised; and oxide of lead, a highly poisonous substance, is to some extent soluble in water. If there is much carbonic acid present it converts some of the oxide into carbonate of lead, which is almost insoluble and therefore comparatively harmless. The waters which act most upon lead are the purest and most highly oxygenated, also those containing organic matter—nitrites, nitrates, and chlorides. The waters which act least upon lead are those containing carbonate of lime and phosphate of lime, in a less degree sulphate of lime. Some of these form a coating on the inside of the pipe which protects it from further action. Some vegetable

substances contained in water, peaty matter for example, also protect the pipe, by forming an internal coating upon it. It appears therefore that hard waters, containing (as they generally do) carbonate of lime, do not readily affect lead. Soft waters, such as rain water, and water obtained by distillation—water polluted with sewage—water in tanks having a muddy deposit—may all become poisoned when in contact with lead. The mud of several rivers, even the Thames, will corrode lead, probably from the organic matter it contains, but it does not necessarily follow that any lead has been dissolved in the water. Bits of mortar will also corrode lead. Vegetables and fatty acids arising from fruit and vegetables, cider, sour milk, &c., also act upon lead.

(1) Prof. Emerson Reynolds has described a process for the protection of lead against corrosion, which is done by coating it with a film of sulphide of lead. He recommends the following method:—Take 4 dr. solid caustic soda, dissolve it in $3\frac{1}{2}$ pints water, and add to the liquid $4\frac{1}{2}$ dr. nitrate of lead, or an equivalent of other lead salt, with 62 fl. dr. water; raise the temperature of the mixture to 194° F. (90° C.). If sufficient lead salt has been added, the liquid will remain somewhat turbid after heating, and must then be rapidly strained or filtered through asbestos, glass-wool, or other suitable material, into a convenient vessel. The filtered liquid is then well mixed with 25 fl. dr. hot water, containing in solution 1 dr. sulpho-urea or thio-carbamide. If the temperature of the mixture be maintained at about 158° F. (70° C.), deposition of sulphide of lead or galena, in the form of a fine adherent film or layer, quickly takes place on any object immersed in or covered with the liquid, provided the object be in a perfectly clean condition and suitable for the purpose. When the operation is properly conducted, a layer of galena is obtained, which is so strongly adherent that it can be easily polished by means of the usual leather polisher. It is not neces-

sary to deposit the galena from hot liquids, but the deposition is more rapid than from cold solutions.

(2) Dr. Percy observes that in the collection of the Museum of Practical Geology, in London, is a number of very thin sheets of lead, coated with bands of varied and extremely bright colours. Although the atmosphere has had free access to these sheets for about 30 years, the colours are as bright as they were at first. The sheets were prepared at Beaumont's smelting works, by dexterously skimming in the process of desilverizing lead by Pattinson's process. The colours are certainly caused by excessively thin films of oxide of lead of various thickness.

(3) Applying an internal bituminous coating is said to be successful.

(4) Boiling for 15 minutes in a solution of sulphide of soda, by which the surface becomes coated with a film of sulphide of lead, insoluble in water.

Silver.—(1) To prevent silverware from tarnishing, it is only necessary to brush it over with alcohol in which a little collodion has been dissolved. It dries immediately, leaving a thin transparent invisible covering on the silver, which can be removed at any time by dipping the article in hot water.

(2) Silver paper. This is not the thin ephemeral-looking paper which the French are fond of calling *pelure d'oignon*, but a product discovered by a German pharmacist, and used, we are told, in some of the large towns for preserving silver from tarnish of all kinds. 6 parts ordinary caustic soda are dissolved in sufficient water, and the solution is diluted to 20° B. To this solution 4 parts oxide of zinc are added, and the liquor is boiled until this oxide is dissolved. Sufficient water is now added to bring the solution down to 10° B. Thin paper or calico soaked in this solution and dried will effectually preserve the most highly polished silver from the tarnishing action of sulphuretted hydrogen, which is contained in appreciable quantities in the air of all densely-inhabited localities. Several journals have mentioned this prepara-

tion, but the exact manner of carrying it out is that given above from the German periodical in which it appeared. It is evident that not only silver objects may be preserved by this device for a considerable time, but scientific instruments made in other metals might be protected also during a long journey by sea or land from the oxidising influence of the damp air. All that is necessary is to wrap up the articles completely in the paper, so that no external air can come in contact with them. (Burgoyne.)

Zinc.—Damp air soon attacks zinc surfaces, but forms a film of oxide which arrests further corrosive action. Should the air, however, contain acid vapours, as it does in towns and near the sea, it is rapidly destructive. Soot is very injurious, forming a galvanic couple with the zinc, excited by the acid and watery vapour of the air. In contact with copper, iron, and lead, especially in the presence of moisture, voltaic action is also set up, and soon destroys the zinc. This metal is also much affected by lime, even in the form of chalky water; and by all acids, organic not excepted, hence it should not be joined to oak nor placed where urine may reach it.

PUMPS AND SIPHONS

(iv. 87-108).

Pumps. *Acid.*—Although this device, in slightly different forms, has been in use for some time, yet the convenience of the modification shown in Fig. 269 may render it worthy of description. A B C are 3 glass tubes passing through the rubber stopper D, A and B ending just below the stopper, and C reaching to the bottom of the bottle. To B is attached a double-valve rubber bulb. A is so bent that while the bulb is clasped in the hand, the thumb can easily be held over the open end of A at H. Acid can then be forced out through C, and the flow may be checked instantly by removing the thumb from H. The left hand is thus left free to hold under C the vessel into

which the acid is to flow. A glazed earthenware dish is placed upon the table under C to catch the drippings. For the use of large classes of beginners in general chemistry this apparatus is well adapted, since accidents resulting from careless handling are rendered almost impossible, and both acid and

stoneware, plunger and valves also being of this material. The valves and seatings are easily accessible by removing the valve-box covers, and the lift of the valves is adjustable. In case of injury to any portion of the pump, it can be replaced at a small cost. The pumps are made in sizes to lift 240-

269.

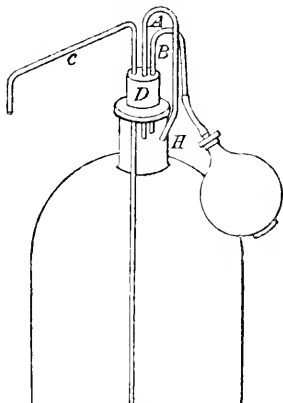

Acid pump.

270.

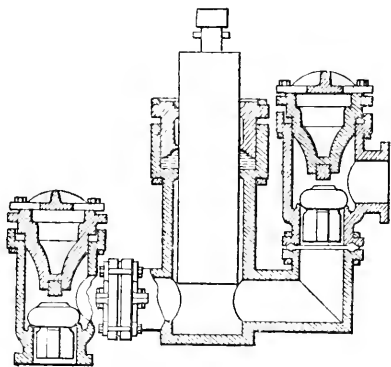

Stoneware acid pump.

time are economised. The same device may be used for carbonyls, the tube C being extended upward, so that an acid bottle may stand on the box beneath it, and H being kept closed by a piece of rubber tubing and a pinch cock. (L. M. Dennis in *Amer. Chem. Jour.*)

Doulton and Co., of Lambeth, have for some years past devoted special attention to the subject of stoneware pumps for acids, and have spared no effort to produce a thoroughly efficient and reliable apparatus. The original design has been greatly modified, and the present pattern shown in Fig. 270 embodies all the improvements suggested by many years' practical experience. Each pump, before being supplied, is put into actual work with a 30-ft. head of water and tested as to efficiency, and so to ensure satisfactory working. They are strongly constructed of acid-proof

2000 gal. per hour. They appear to be giving great satisfaction.

Water.—This article will treat of the combined application of two natural forces to the elevation of water. These forces are: first, the heat of the atmosphere; and second, the comparatively low temperature of the water to be raised. Fig. 271 shows the general arrangement of an apparatus worked on this principle. This apparatus has been built at Auteuil, where it operates very well, although the French climate is not favourable to the operation of such a device.

F is a small building covered by a roof E, which is exposed to the south, and this roof is formed of 10 metallic plates, which are numbered 1, 2, 3, 4, 5, 6, 7, 8, 9, 10. Each of these plates consists of 2 sheets of iron riveted together on all their edges, and separated

271.

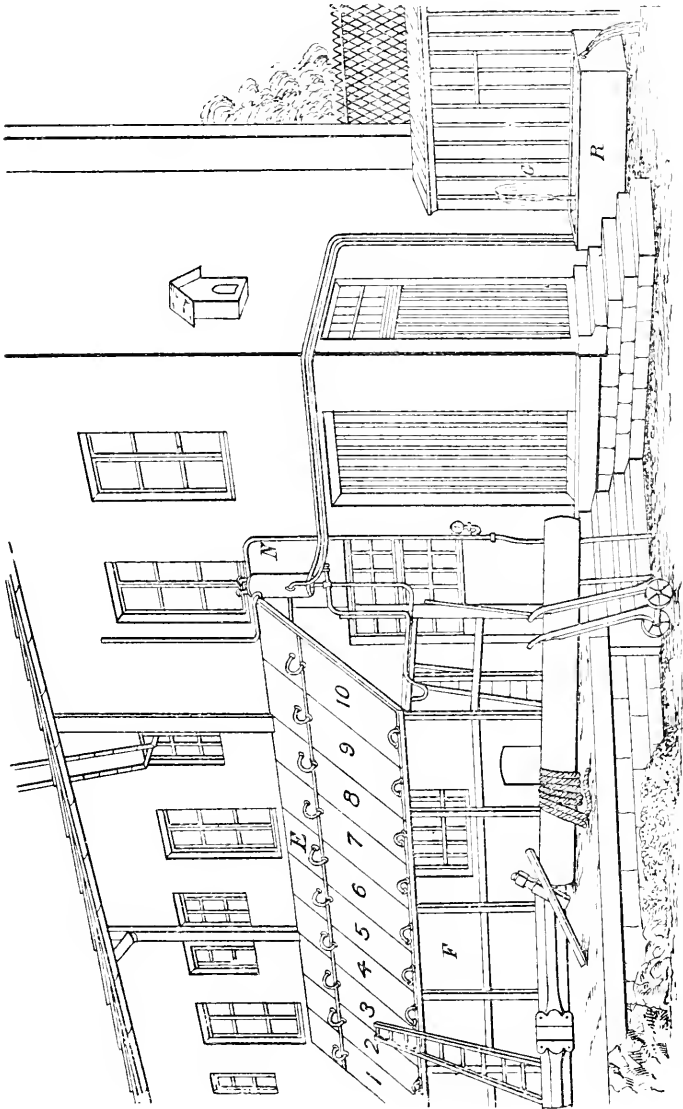

Raising water by the heat of the sun.

slightly by filling pieces. Each plate thus constitutes a water-tight receptacle, in which a volatile liquid can be held. Various liquids can be used, but preference is given to a solution of ammonia. Under the influence of atmospheric heat, the solution emits vapours, and these vapours or gases escape through tubes, one of which is provided for each plate, and are conducted to the receptacle N. Any liquid which may have been carried along by the gas is taken back to the plates by a tube. By another tube the gas escapes from the vessel N. This gas has a pressure of 1, 2, or 3 atmospheres, according to the work which is to be done. It is conducted through a tube to a hollow sphere, which is placed in the well or tank from which the water is to be elevated. This sphere contains a rubber diaphragm, which can attach itself to either half of the sphere.

Let us suppose, for instance, that the sphere is full of water; the rubber diaphragm, consequently, will rest against the upper half or hemisphere. If, now, the pressure of the ammonia gas is brought to bear on the diaphragm, it will be forced to rest on the lower hemisphere; but in order to do this, the diaphragm must eject the water which fills the sphere. This causes the formation of a jet of water, as shown above the tank R near the letter G. But the gas must be driven from the sphere after it has been emptied of water, so that the operation may be renewed. This is accomplished in the following manner: In the centre of the diaphragm a float is inserted, which carries a rod by which a slide is actuated. One of the apertures in this slide coincides with the gas inlet, and the other with the outlet. When the diaphragm rests on the upper hemisphere the inlet is opened, and the water escapes; when it moves toward the lower hemisphere the inlet is closed, the outlet is opened, the sphere is filled with water again, and so on.

This would complete the operation if the ammonia gas did not cost anything; but as it is expensive, it must be used over and over indefinitely. Here we are

aided by the low temperature of the water, which is made to pass through a serpentine pipe contained in a water-tight vessel containing part of the ammonia solution used. The solution is cooled by the water in the pipe, and is ready to absorb ammonia. Then, as soon as the outlet is opened, the ammonia gas conducted into it is absorbed, the pressure which was exerted in the sphere is removed, and water can again enter the sphere. A final precaution is taken, which is to attach a little pump to the float, by means of which the ammonia solution can be pumped back into the roof E.

The apparatus at Auteuil raises over 300 gal. of water per hour. In warm countries, the same apparatus would raise 792 gal. a distance of 65 ft. The calculation of the results to be obtained by this apparatus is based on the following considerations:

A sheet of metal 1 yd. square absorbs 11 calories for a difference of 1° C. Each plate which has a surface of $\frac{1}{4}$ sq. yd. absorbs 44 calories per hour. If there is a difference of 6° , 264 calories will be taken from the atmosphere every hour; and by combining this quantity of heat with the cooling action of the water, it is easy, by the difference of tension produced, to obtain an inexpensive force for raising water.

This apparatus differs from the numerous devices by which attempts have been made to utilise solar heat by means of the Archimedean mirror, by which only secondary heat is obtained. It is not necessary to concentrate the heat by metallic or other mirrors; the atmospheric heat is the basis of the operation, and all roofs exposed to the sun can be used for this purpose. In this manner a valuable motive power can be obtained in warm countries without loss of room. Generating plates, such as described, can be applied to any roof, and if we consider, that with only 10 such plates 792 gal. can be raised 65 ft. per hour, we can easily understand that a great elevating power can be obtained by increasing the number of plates. (*La Nature*.)

Siphons.—(a) The following arrangement of siphon is little known, though used at various times, and for various purposes, the last 20 years. It simply consists in having the ends of an equal legged siphon bent up as in Fig. 272. When the above is once charged, and the openings kept level, it will draw the liquid from a vessel, stopping, of course, when the level of the liquid reaches that of the openings, but will start into action again if the level of liquid rises. Chemical readers will find a glass tube, bent

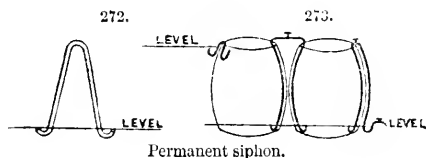

as above, very handy in the laboratory for decanting, as, when not in use, it can be hung ready charged on a nail against the wall. The principle may be applied to a couple of rain water-butts, with the object of not cutting the casks in any way below the water-line, obviating oozing and dropping—the common complaint about the connection of water-butts. It answers very well. Fig. 273 is the arrangement. Put a long turn-up on the overflow siphon—about 9 in.—so that evaporation can take place to some extent without interfering with the stability of the water in the pipe. For charging the two long siphons, have a small gas tap soldered on the top of each, through which to suck out the air, after which screw up the little nut or plug of taps very tight, so that they cannot be opened by meddling fingers. The overflow may be charged in a tub of water, and afterwards adjusted on edge of cask, so as to keep the level about 1 in. from top when raining heaviest. The siphon for laboratory use above mentioned could be improved by making one of the legs straight, and fixing it to a piece of rubber tube with a pinch tap. Arranged thus it could be carried about without fear of up-

setting the balance of the water in the two legs.

(b) The numerous experiments in disinfecting with sulphurous anhydride have shown that the chief difficulty in the way of various applications of it reside in the imperfection of the apparatus designed for holding and distributing this liquefied gas under strong pressure. As this agent is called upon to render great services in a host of cases in which the sulphurous acid produced by the direct combustion of sulphur, and without pressure, cannot be used, it is of importance to prevent to as great a degree as possible any leakage, and to be able under all circumstances to easily bottle, carry, handle, and apply this powerful disinfectant. After many experiments, Dr. Victor Fatio, of Geneva, has succeeded in

constructing for this purpose an apparatus that permits of quickly and safely charging siphons from the fountains in which the anhydrous sulphurous acid is delivered to consumers.

Fig. 274 shows one of the siphon apparatus being charged with sulphurous acid from one of Pictet's metallic fountains. The specially arranged siphon is provided at the upper part with a tube, by means of which it is put in communication with the fountain through a bent tube. To the siphon there is adapted a key which permits of opening and closing it before and after the introduction of the liquefied gas. Another key is fitted to the fountain. At the upper part of the device, which rises when the siphon is full, there is a handle for tightening it up. For disinfecting a room by means of a siphon of sulphurous acid, it suffices to empty some of the liquid into a basin and allow it to evaporate. By means of a rubber tube running through a hole in the door or wall, a room may be disinfected from a siphon placed outside. (*La Nature.*)

(c) Bode and Wimpf have designed a new kind of siphon, which is of great use for siphoning off acid, caustic or poisonous liquids. Its special feature

is due to the fact that it is not set by suction, but by blowing, so that the liquid to be siphoned off can never get into the mouth. Fig. 275 represents the construction. The tube D is surrounded by a wider one C, closed at the top, and provided with a ball valve B at the end E. On putting the apparatus into a

and no liquor being able to enter the siphon, it empties itself. The siphon need never be removed from the liquid, either at the start or at the end. C. Gerhard, of Bonn, and the Möncheberg Pottery, are prepared to supply the siphon to the trade. It can be made of glass, earthenware, ebonite, rubber, and

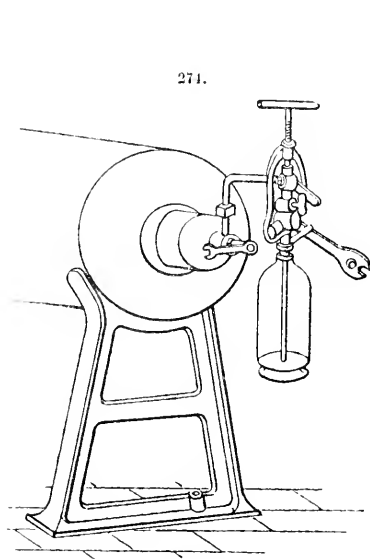

Acid siphon.

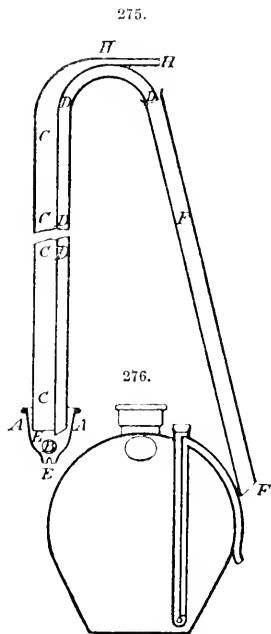

Siphon primed by blowing.

liquid, the ball valve is raised, and the tubes C and D are filled to the height of the surrounding liquor. If now air be blown into the tube H, the valve is closed, and the liquid being driven from C into D and F sets the siphon to work. The blowing is then discontinued and H is closed. If it be desired to interrupt the flow, it is only necessary to blow again a little stronger through H. The valve B is now pressed into its seat,

metal. It is also intended to fit Woulff's bottles with this siphoning arrangement, as shown in Fig. 276, for drawing off acids in the course of the manufacture. (*Chem. Zeit.*)

(d) When, at an elevated point in a meadow, there exists a spring or vein of water that cannot be utilised at a distance, either because the supply is not sufficient, or because of the permeability of the soil, it becomes very advantage-

ons to accumulate the water in a reservoir, which may be emptied from time to time through an aperture large enough to allow the water to flow in abundance over all parts of the field. The storing up of the water permits of irrigating a much greater area of land, and has the advantage of allowing the watering to be effected intermittently, this being better than if it were done continuously. But this mode of irrigating requires assiduous attention. It is necessary, in fact, when the reservoir is full, to go and raise the plug, wait till the water has flowed out, and then put in the plug again as accurately as possible—a thing that it is not always easy to do. The work is a continuous piece

the outlet R, where it is fixed by means of a piece of rubber of peculiar form that allows the other extremity B D E to revolve around the axis K, while at the same time keeping the outlet pipe hermetically closed. This rubber, whose lower extremity is bent back like the bell of a trumpet, forms a washer against which is applied a galvanised iron ring that is fixed to the mouth of the outlet pipe by means of 6 small screws. This ring is provided with 2 studs, which engage with 2 flexible thimbles K L, affixed to the siphon by 4 rivets. These studs and thimbles, as well as the screws, are likewise galvanised. Between the branches A B D E of the pipe is soldered a sheet

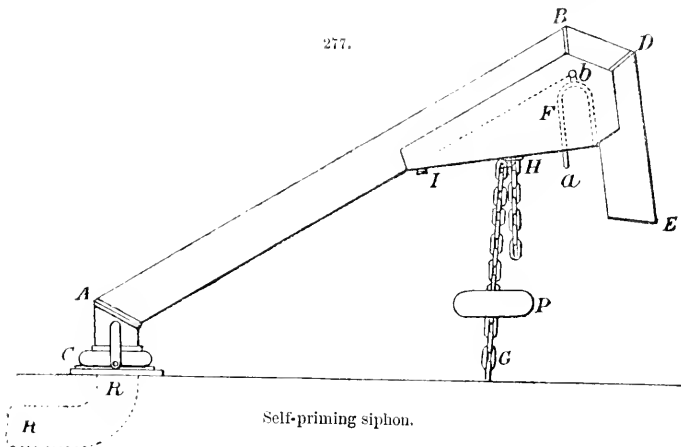

of drudgery, and takes just as much the longer to do in proportion as the reservoir is more distant from one's dwelling. In order to do away with this inconvenience, Giral, of Langogne (Lozère), has invented a sort of movable siphon that primes itself automatically, however small be the spring that feeds the reservoir in which it is placed. The apparatus (Fig. 277) consists of an elbowed pipe C A B D E of galvanised iron, whose extremity C communicates with

of galvanised iron, which forms isolatedly a receptacle or air-chamber F, that contains at its upper part a small aperture *b*, that remains always open, and, at its lower part, a copper screw-plug *d* and a galvanised hook H. In the interior of this chamber is arranged a small leaden siphon *a b c* whose longer leg *a* passes through the bottom, where it is soldered, and whose shorter one *c* ends in close proximity to the bottom. Finally, a galvanised iron chain G H, fixed at G to

the bottom of the reservoir, and provided with a weight P of galvanised iron, is hooked at H to the siphon and allows it to rise more or less, according as it is given a greater or less length. From what precedes, it will be seen that the outlet is entirely closed, so that, in order that the water may escape, it must pass into the pipe in the direction E D B A C. This granted, let us see how the apparatus works: In measure as the water rises in the reservoir, the siphon gradually loses weight, and its extremity B D H is finally lifted by the thrust, so that the entire affair revolves upon the studs K, until the chain becomes taut. The apparatus then ceases to rise; but the water, ever continuing to rise, finally reaches the apex *b* of the smaller siphon, and through it enters the air-chamber and fills it. The equilibrium being thus broken, the siphon descends to the bottom, becomes primed, and empties the reservoir. When the level of the water in descending is at the height of the small siphon *abc*, this latter, which is also primed, empties the chamber F in turn, so that, at the moment the large siphon loses its priming, the entire apparatus is in the same state that it was at first. In short, when the water enters the reservoir, the siphon, movable upon its base, rises to the height at which it is desired that the flow shall take place. Being arrested at this point by the chain, it becomes primed and sinks, and the water escapes. When the water is exhausted, the siphon rises anew in order to again sink; and this goes on as long as the period of irrigation lasts. This apparatus, which is simple in its operation, and not very costly, is being employed with success for irrigating several meadows in the upper basin of the Allier. (*Le Génie Civil.*)

(c) As well known, the general solution of the problem of storing water, a vital question for agriculture, is the following: To unite all the sources that are not utilisable, on account of their too feeble discharge, in a reservoir of appropriate dimensions which is emptied one or more times in

24 hours through a sluice of dimensions such that the water collected can be entirely distributed over the surface to be irrigated, in a relatively short time. Experience, in fact, has proved that if water is profitable distributed to profusion, it is but slightly so when it flows in a thin stream in a trench of which it wets only the banks.

Instead of having a sluice to be opened at definite intervals, it long ago occurred to some persons to make use of the ordinary siphon. It suffices, in fact, that the latter shall prime itself automatically in order to have a rapid and intermittent emptying of the reservoir. But the conditions necessary for such automatic priming are sometimes difficult to carry out. The source, in fact, must be very regular, and have a pretty large discharge, larger than that of the siphon during the short space of time in which the latter, operating at first as a waste pipe, is upon the point of priming itself. If this critical point is passed, the priming is effected and the reservoir is emptied by reason of the greater velocity that the head of water gives the liquid in the siphon.

But if the source is intermittent, irregular, or diminishes, it may happen that the siphon will no longer perform the functions of anything but a waste pipe. Priming will no longer be able to be effected, and the abrupt emptying of the reservoir will no longer take place.

In certain special cases, this state of things can be remedied by establishing a well of water for the reception of the long branch of the siphon. The overflow is thus reduced and the priming can take place.

This, in reality, is merely a palliative of a result that is so uncertain in all cases that it is usually preferred to empty the reservoir by opening a sluice at stated intervals. Hence an annoying restraint, and a very poor utilisation of the water at one's disposal.

In fact, the user generally opens the sluice in the morning and evening. Between these two intervals and at night, if the reservoir is full, the water

flows out slowly, and irrigates but a small surface.

Different means have been proposed for obtaining an automatic discharge, and especially for preventing the ever possible neglect to manœuvre the sluice. At the last agricultural exhibition at Tulle was shown a recently devised and very simple system, the great advantage of which is the entire absence of any mechanism whatever subject to get out of order. It is a siphon, but it has been so arranged by Delavallade that the problem is entirely solved despite all the difficulties enumerated. Fig. 278

278.

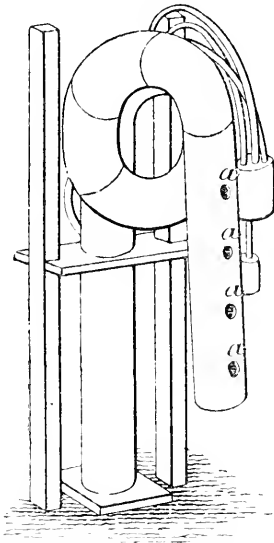

Siphon for intermittent discharge.

gives a general view of the apparatus and the manner in which it is arranged in the sluice hole of a reservoir. Thus placed, and supported by 2 wooden posts, one has no longer to pay any attention to it. Whatever be the irregularities in the discharge of the source, the siphon will never act as a waste pipe, and will prime itself as soon as the

desired level of water is reached in the reservoir.

The latter once empty, the siphon will be unprimed, and will reprime itself a few hours later. The instant of unpriming, and consequently the level of the water remaining in the pond, is fully under the control of the farmer. It suffices, in fact, to form a series of apertures *a* in the short branch of the siphon, and close them with wooden plugs that are removed according as it is desired that the water shall descend to such or such a level in the reservoir.

As shown in the sections in Figs. 279, 280, the apparatus is constructed in two different forms, but the principle of both is absolutely the same.

The bell siphon (Fig 279) consists of a tube, which is inserted in the sluice hole and is provided at its upper part with a circular water reservoir A. A movable bell, provided with an internal circular diaphragm B, covers the whole and rests upon the tube. It is provided with two small external reservoirs R R' connected by a tube *t*. The lower reservoir R' communicates with the interior of the bell, through small apertures.

Two bent tubes T T' put the reservoir R in communication with the two chambers *aβ* formed in the bell by the diaphragm B. A third tube S below the two others starts from the reservoir R, traverses the bell, and hangs vertically in the interior of the central tube fixed in the sluice.

Fig. 280 represents the second form of the apparatus. It is an ordinary doubly revolving siphon. The general arrangements are the same as those just described. It is to be remarked that the part A of the bent siphon will always remain full of water, like the reservoir A in the bell siphon.

Let us suppose that the pond has just been emptied; the unprimed siphon will be entirely empty, except in the parts A. The water gradually rises in the reservoir, and consequently in the short branch of the siphon, in the reservoir R, through the intermedium of the reservoir R', and in the 3 tubes

T T' S. In measure as the water rises, the air is driven forward until the moment that the siphon is about to operate as a waste pipe. It thus takes a certain pressure in the chamber α (tube T), on account of the presence of

cumstances with the external level of the liquid. It results from this, that whatever be the discharge of the source, the tube S, placed beneath T and T' will be very quickly immersed.

In reality, this tube is merely an

279.

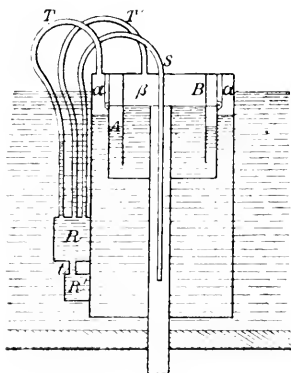

280.

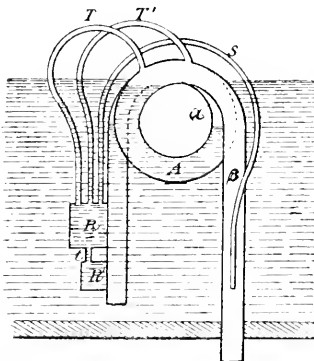

Siphon for intermittent discharge.

water in the internal reservoir A. In the chamber β , on the contrary, it remains at the pressure of the atmosphere, since the long branch of the siphon opens in the free air. It is starting from this moment that the automatic priming of an ordinary siphon may take place, if the requisite conditions of discharge be present, the air confined in the upper parts being carried along by the first jet of the liquid. If such conditions are not fulfilled, there always remains in the upper part of the siphon or of the bell some air that must be got rid of, or the pressure of which it will suffice to diminish sufficiently to produce an abrupt ascending motion of the internal liquid column, and consequently a priming.

Such is the principle to be applied, and the way it is done is as follows: In consequence of the presence of a certain volume of compressed air in the internal chamber α , the velocity of the siphon's flow as a waste pipe is infinitely small, and increases proportionally much more slowly than under ordinary cir-

auxiliary siphon whose diameter is small enough to allow its priming to be always certain. It will therefore empty the reservoir R almost instantaneously. As, on another hand, the latter can fill itself but slowly, on account of the small diameter of the tube t , there will occur, in order to fill the vacuum formed, an abrupt draught and a putting in equilibrium (through the tubes T T') of the air occupying the internal chambers $\alpha \beta$. At this very moment, the jet of water issuing from the auxiliary siphon in the central tube, or the long branch of the siphon, causes a suction in the chamber β , and establishes in the whole ($\alpha \beta$) a pressure sensibly less than that of the atmosphere. From this complete rupture of equilibrium between the internal liquid and gaseous strata of the siphon results a sort of ram stroke that effects an automatic priming. From the very beginning, the remaining air is carried along by the liquid, with a considerable velocity, dependent upon the height of the water

in the pond, which latter rapidly empties until the apparatus is unprimed.

The system, with a few slight modifications of detail, is applicable as follows: 1, to the flushing chambers in the sewers of large cities; 2, to the submersion of meadows, and in general to all the problems of irrigation; 3, to the automatic emptying and renewing of the water in garden fountains and in ponds especially set apart for pisciculture; 4, and, finally, to the draining of quarries, mine holes, etc., without machines, provided there be a low point for the flow. (*La Nature.*)

WATERPROOFING (iv. 1-23).

Boots.—(10) 1 part ozokerit in 2 parts castor oil, and 1 part lamp-black added, makes an excellent application, as the boots will take a thin polish after. (11) Salad oil 1 pint, mutton suet 4 oz., white wax and spermaceti of each 1 oz., melted together, and applied to the boots warmed before the fire. (12) Much used by fishermen: Melt 3 oz. spermaceti in a ladle, and add $\frac{3}{4}$ oz. rubber, cut into thin shavings. When dissolved, add $\frac{1}{2}$ lb. tallow, 2 oz. pure lard, and 4 oz. amber varnish. Mix well, and while still warm apply with a brush, giving two or three coats. It leaves a good polish, and is preservative as well as being waterproof.

Rubber Goods.—Under ordinary conditions rubber for vulcanising is usually mixed with sulphur and heated to a high temperature, when chemical combination takes place between the sulphur and the rubber, producing a much more valuable compound for ordinary purposes than unvulcanised rubber; the former remaining soft at very low temperatures and firm at high temperatures, whilst the latter becomes hard and quite plastic respectively at those temperatures.

In making cloth for waterproof garments another method is employed for vulcanising the rubber, viz., by wetting its surface with a mixture of somewhere about 5-10 parts chloride of sulphur

dissolved in 100 parts bisulphide of carbon, and then heating the fabric gently to evaporate away the excess of these substances; the rubber-covered cloth cannot be heated to a high temperature like the rubber alone, because the heat would be liable to injure the cotton, silk, or wool of the fabric, or destroy or injure the colours.

The bisulphide of carbon softens and penetrates the fine layer of rubber, carrying with it the chloride of sulphur dissolved in it, and it is generally supposed that the chloride of sulphur breaks up, the sulphur combining with the rubber producing vulcanisation, and the chlorine combining with the hydrogen producing hydrochloric acid which is liberated. This reaction is clearly not the correct one, and it is probable that the reverse is more in accordance with the facts, viz., that the chlorine of the sulphur chloride combines with the rubber producing vulcanisation, leaving the sulphur in the free state, or only partially in combination with the rubber, because in rubber vulcanised by the cold process I have found free sulphur to be present.

From a piece of rubber-covered cloth I separated the rubber, and submitted it to analysis, by mixing it thoroughly in small pieces with pure sodium carbonate and igniting, then dissolving the whole in water and adding to it peroxide of hydrogen previously treated with excess barium chloride (to separate sulphuric acid or sulphates). The peroxide ensures the conversion of the lower oxides of sulphur into sulphuric acid, whilst the excess of barium chlorides precipitates the sulphuric acid in the solution, which is then weighed as barium sulphate.

Another portion of the made-up solution was neutralised, and the chlorine present titrated. The rubber previous to ignition, as above described, had been well boiled in water and dried to separate any hydrochloric acid which might be present, but only a faint trace of chlorine compound could be thus separated from the rubber.

The total sulphur present in the

rubber amounted to 2.60, and the total chlorine to 6.31 per cent.

The yellow-coloured sulphur protochloride is best adapted for vulcanising, because it does not act too strongly upon the rubber, whilst the dark coloured chloride of sulphur, containing as it does a large quantity of the higher chlorides of sulphur, is liable to render the rubber quite hard by vulcanising it too much. The theory generally adopted to explain this is, that these higher chlorides break up easily, liberating their sulphur which thus combines in greater quantity with the rubber; but my experiments and analyses prove that it is chiefly the chlorine and not the sulphur of the chloride of sulphur which produces the vulcanisation.

A rubber substitute, much used at present, is produced by acting on vegetable oils, such as rape, linseed, etc., with a mixture of chloride of sulphur and bisulphide of carbon; the oil becomes converted into a solid substance resembling rubber to some extent, but being much more brittle. This body is now used in large quantity for mixing with rubber for the purpose of cheapening its production. On analysis of some samples of this material I have invariably found that it contained a much greater proportion of chlorine than of sulphur, and this process therefore is a vulcanisation by chlorine rather than by sulphur.

Recently I analysed three samples of rubber substitute, the one termed "special" another "spongy" rubber substitute, the third being similar to the first in appearance. The first contained sulphur 3.4 and of chlorine 7.6 per cent.; the second contained of sulphur 4.56 and of chlorine 8.22, and the third 2.67 of sulphur and 7.90 of chlorine per cent.

These rubber substitutes contain considerable quantities of oily matters soluble in ether, which I have also found to be chlorine and sulphur compounds of the oils. The first yielded 20.0 per cent., the second 14.3, and the third 11.5 per cent. of these thick

oily matters soluble in ether. This oily substance from the first sample contained 2.6 per cent. of sulphur and 6.1 per cent. of chlorine, whilst that from the second contained 2.97 and 6.87 per cent. of sulphur and chlorine respectively.

Some rubber manufacturers regard this oily matter as injurious to the rubber, and reject any substitute which contains any considerable proportion of it. I have found, however, by experiment that this oily compound instead of acting injuriously on rubber, actually acts as a preservative of it; some rubber threads were smeared with this oily extract, some with ordinary (unvulcanised) rape oil, and some left untreated; these were put into an incubator at 150° F. for a few days when it was found that the oil-treated rubber was quite soft and rotten, whilst the other two had remained sound; after a few days more, the original rubber threads had become quite rotten, whilst the threads smeared with the oily part of the vulcanised oil remained quite sound.

The first and second samples of rubber substitute were examined for soluble chlorides or hydrochloric acid, by boiling in water: the first gave 0.18 per cent. of chlorine soluble in water, and the second 0.05 per cent.

It has been known for some time that copper salts exert a most injurious influence on rubber. Copper salts are sometimes used in dyeing cloth, which are afterwards employed for waterproofing with rubber, and it seems quite astonishing what a small quantity of copper is required to harden and destroy the rubber, and the destructive effect of copper is further enhanced if the cloth contains oily matter in which the copper has dissolved.

As an example, a piece of cloth, alleged to have damaged the thin coating of rubber on it, was found to contain copper, and with a view of demonstrating this point, I took one piece in its original condition. To the end of this I pasted a similar piece of cloth from which the oily and greasy matters

had been removed by ether, and to the end of this again, I pasted another piece of the same cloth, from which I had removed both oily and greasy matters and copper; these three pieces joined end to end into one, were then coated in the usual way with rubber, and then hung in an incubator at 150° F. In the course of a few days, the rubber on the original cloth had become soft, and it then hardened and became rotten and useless; the second piece, from which the greasy matters had been removed, then became quite hard and rotten, whilst the part from which both greasy matters and copper had been removed has remained in a perfectly elastic and good condition.

Prof. Dewar observed accidentally, that metallic copper when heated to the temperature of boiling water in contact with the rubber exerted a destructive effect upon it. With a view of finding whether this was due to the copper *per se*, or to its power of conducting heat more rapidly to the rubber, I laid a sheet of rubber on a plate of glass, and on it placed four clean discs, one of copper, one of platinum, one of zinc, and one of silver. After a few days in an incubator at 150° F. the rubber under the copper had become quite hard, that under the platinum had become slightly affected and hardened at different parts, whilst the rubber under the silver and under the zinc remained quite sound and elastic. This would infer that the pure metallic copper had exerted a great oxidising effect on the rubber, the platinum had exerted a slight effect, whilst the zinc and silver, respectively, had had no injurious influence on it. A still more curious result was this, that the rubber thus hardened by the copper contained no appreciable trace of copper, the copper, therefore, presumably sets up the oxidising action in the rubber without its permeating it. (W. Thomson.)

Woollen Goods.—What is asserted to be an effective process for waterproofing woollen goods has come into use among German manufacturers, the cloth in

this case gaining considerably in weight, and, though perfectly waterproof, impedes neither air nor perspiration. A solution is made of 100 parts alum, 100 of glue, 5 of tannin, and 2 of soluble glass, by dissolving alum in a moderate quantity of boiling water. The glue is steeped in cold water until it has absorbed twice its weight of water, and is then dissolved by heat; the tannin and soluble glass are well stirred into the solution of glue, to which the alum solution is then added, and the whole stirred and allowed to cool. 2 lb. of the gelatinous mass is boiled for 3 hours in 3 gal. water, fresh water being constantly added to allow for evaporation. The bath is now permitted to cool to 80° C. and in this the material to be rendered waterproof is kept for $\frac{1}{2}$ hour, then withdrawn, and the moisture allowed to drip from it for several hours. Finally the cloth is stretched on a frame, and dried at a temperature of 50° C., then calendered.

GLASS MANIPULATING.

(iii. 226-240).

Breaking.—(b) In breaking a glass tube, e.g., a combustion-tube, a small scratch is made with a file at the required place. At each side of this scratch, and about 1-2 mm. away from it, a small roll of wet blotting-paper is laid round the tube. The free space between is then heated all round over a Bunsen burner, or better still, over a small blowpipe-flame. A clean and even fracture is thus obtained, exactly between the two rolls, without dropping water on the hot glass. The rolls are made by cutting two strips of filter-paper, sufficiently large to form rolls 1-2 mm. high, and 2-4 cm. wide. The strips are folded once, lengthways, laid on the table, moistened, flattened out, and then wrapped on to the tube, so that the fold lies nearest the file-scratch, and fold lies accurately upon fold in the successive layers. The thickness of the rolls, and their distance apart, has, of course, to be varied, according to the diameter of the tubes.

Equally good results are obtained with the thinnest test-tubes, the thickest combustion-tubes, beakers, flasks, and glass bell-jars. In those cases, where the sides are slanting, as, for instance, with funnels, an obvious alteration in the construction of the paper rolls need only be carried out. (*Analyst.*)

Cutting.—(3) To cut glass jars, fill the jar with lard-oil to where you want to cut the jar; then heat an iron rod or bar to red heat, immerse it in the oil; the unequal expansion will crack the jar all round at the surface of the oil, and you can lift off the top part.

(4) The following is said to be an easy way of cutting glass bottles, carboys, &c., into hand-lights. Pass 5 or 6 strands of coarse packing twine round the bottle on each side of where you want it divided, so as to form a groove about $\frac{1}{8}$ -in. wide; in this groove pass one turn of a piece of hard-laid white line, and extend the two ends, and make them fast to some support; then have a tub of cold water close to you, and, grasping the bottle by the neck with one hand, and the bottom with another, saw the bottle quickly backwards and forwards for a short time; you will soon notice a burning smell caused by the friction of the hard cord. After about one minute's friction, by a side motion of the bottle, throw it out of the line into the water, and then tap against the side of the tub, when the bottom will drop off. Carboys can be cut as easily, but being larger, they require two persons to see-saw them backwards and forwards. The line of twine to form the groove must be put on quite tight, and then wetted to tighten more, so as not to shift; but let the groove and stout cord be dry. The cutting cord should not be less than $\frac{1}{8}$ -in. thick; the edge of the glass after cutting, should be rubbed on a grindstone, as it is very sharp.

(5) If a bottle is to be cut into two pieces, a notch is filed in its side. Then, by applying a hot iron or glass rod, first on one side then on the other of the notch, a smooth crack $\frac{1}{2}$ -in. long will sometimes form. But as this does

not always take place, and, as in cutting glass only one of the pieces is wanted, a crack may be started well away from the desired place. Assuming such a crack to be formed, it may be led in any direction by slowly moving in advance of it, and in contact with the glass, the end of a pipestem, of an iron or a glass rod, heated to a full red heat. The speed with which the rod is to be moved depends on the crack. It should be kept about $\frac{1}{4}$ in. in advance thereof, and should be moved continually away from the end, as the crack extends itself. In this way a flask can be cut into a spiral, or heavy plate glass divided with fair accuracy.

The great point is to have the line of the cut well marked. If a bottle is to be cut off, to make a battery jar for instance, a string tied or a rubber band sprung around it about $\frac{1}{4}$ in. from the place of division forms a convenient guide. The cut may be carried around parallel with the string or band. Then a half-hour's grinding on a horizontal pane of glass, with sand, camphor, and turpentine, will finish the edge perfectly. In marking the place for cutting, a pointed piece of soap may be used, as a string can only be employed on cylindrical objects. This method of working is attended with one inconvenience. Unless a rod of large size is used, continual reheating is necessary. A glass rod as thick as a penholder will carry a cut about 2 in. at a heat. A pipestem or tennenny nail will do the same. To obviate waiting, several rods may be used, some heating while one is in use.

A fine gas jet, burning from a fine glass jet at the end of a rubber tube, has also been suggested, but is inconvenient. Little carbon pencils, that burn with flameless incandescence, may be used instead of a heated rod. These, however, are troublesome to make.

The use of what is sold by the fireworks dealers under the name of punk was suggested by a consideration of the points given above. This substance

burns slowly, without flame, and maintains a strong incandescence until quite consumed. The incandescent part takes the shape of a cone, like a sharpened pencil. As long as the piece lasts, its burning end maintains this form. By blowing upon it the heat can be materially increased. On trial, it was found to cut glass perfectly. The only objection to it is that if rubbed against the glass the ash soils its surface, so that the progress of the crack cannot be conveniently watched. But in practice it is not necessary to hold it in contact with the glass, as it radiates heat enough to lead the crack, if held very close and not in absolute contact therewith.

By using punk the trouble of shifting from rod to rod and the necessity of a source of high heat, a Bunsen burner generally, is obviated. The punk can be lighted with a candle, or even with a match, and is ready for use immediately. A long stick will last for $\frac{1}{2}$ hour, enough to do a great deal of work. The only difficulty is in starting the crack. It may be done by heating the glass, and touching it with a drop of water. This generally starts several, and the one pointing in the most convenient direction may be chosen, and carried where desired. The method first spoken of as applicable to bottles, that of filing a notch and heating the glass first on one side and then on the other, cannot be depended on. (S. T.)

Drilling.—(5) Glass may be readily drilled by using a steel drill hardened, but not drawn at all, wet with spirits of turpentine. Run the drill fast and feed light. Grind the drill with a long point and plenty of clearance, and no difficulty will be experienced. The operation will be more speedy if the turpentine be saturated with camphor. With a hard tool thus lubricated glass can be drilled with small holes, say up to $\frac{3}{16}$ in., about as rapidly as cast steel. A breast or row drill may be used, care being taken to hold the stock steady, so as not to break the drill.

(6) To file glass, take a 12 in. mill file, single cut, and wet it with the

above solution—turpentine saturated with camphor—and the work can be shaped as easily and almost as fast as if the material were brass.

(7) To turn in a lathe, put a file in the tool stock and wet with turpentine and camphor as before. To square up glass tubes, put them on a hard wood mandrel, made by driving iron rod with centres through a block of cherry, chestnut, or soft maple, and use the flat of a single cut file in the tool post, wet as before. Run slow. Large holes may be rapidly cut by a tube-shaped steel tool cut like a file on the angular surface, or with fine teeth, after the manner of a rose bit; great care being necessary, of course, to back up the glass fairly with lead plates or otherwise to prevent breakage from unequal pressure. This tool does not require an extremely fast motion. Lubricated as before, neat jobs of boring and fitting glass may be made by these simple means. The whole secret is in good high steel, worked low, tempered high, and wet with turpentine standing on camphor.

(8) The method usually recommended for boring a hole of considerable size in glass is by means of a copper tube fed with emery and turpentine. This may answer better in a vertical drilling machine than in the lathe, but amateurs who are not ordinarily happy enough to possess the former appliance, will usually employ the lathe, wherein it does not prove a very satisfactory process, being difficult to manage, horribly dirty, and exceedingly slow. The pressure necessary also causes a piece to be punched out with chipping of the edges of the hole at the back before the drill-tube goes clean through.

It is, of course, quite easy to drill small holes in glass by means of a properly hardened spear-pointed steel drill running at 100–200 revolutions per minute, and having to bore some 1 in. holes in discs of plate-glass 3 in. diameter, I thought it worth while to try what could be done with a steel tool. After several trials this finally assumed the form of a square-ended bar

ground flat on one end, so as to have 4 working edges, and as a graver tool on the other, for clearing out the circumference of the hole as it progresses, and made very hard by getting, as the smiths say, "all the water."

A couple of the discs were fixed together with turners' cement, and fixed centrally on a wooden face-plate by the same means. When cold, the square-nosed tool, held at an angle of 45° to the horizontal, point downwards over the T-rest, had one of its edges pressed firmly against the revolving glass. The lathe was driven at about 60 per minute, and the work lubricated by just dipping the tool occasionally in turpentine. Too much turpentine flowing over the work does not answer. The action is not exactly a cutting one, but seems rather a kind of local breaking up of the glass immediately under the edge of the tool, which goes on evenly after the finest edge of the tool is lost, and is apparently the same as that which occurs in using the small drills for glass.

The hole, however, went merrily and cleanly through the outside plate without any considerable chipping at either surface. The graver point was used when necessary to keep the sides of the hole parallel. When, however, the outer plate was wedged off by the insertion of a knife blade, and the second proceeded with, some chipping occurred at the inside surface, since the wood backing did not give a sufficiently solid support. For this the remedy is easy and obvious. (J. Brown.)

(9) To make a small hole in a plate of glass is a comparatively simple matter. All that is required to do it is a very hard, sharp drill, some means for turning it, and a lubricant, such as turpentine, for causing the drill to cut rapidly. A drill made in the usual form from steel wire and hardened by heating it until it is dark red and then plunging it in mercury, will be very hard, but not tough. Before the drill is heated it should be driven into a block of lead, so that its point will just be enclosed by the lead, and after the drill has been hardened in the mercury its point

should be inserted in the indentation in the lead, and the temper of the shank of the drill should be drawn over a lamp or gas flame to a blue. The lead prevents the drill point from becoming heated sufficiently to draw the temper, by conducting the heat away as fast as it arrives at the point. When the shank of the drill becomes blue to within a short distance of the lead, the drill, together with the lead, should be plunged into cool water.

The drill prepared in this way should be wet with turpentine while in use, to cause it to "take hold." It is advisable to drill from opposite sides of the glass whenever this is possible. The hole may be enlarged by means of a sharp round file wet with turpentine. When larger holes are required, these can not conveniently be made with a drill. A copper or brass tube charged with emery and water or emery and turpentine, and rotated in contact with the glass, will soon cut a hole a little larger than the tube.

Simple ways of guiding and revolving the tube are shown in Fig. 281. The glass to be drilled, which may be the plate of an electrical machine for example, is placed upon a table with a few thicknesses of paper underneath its centre. Two blocks are placed on the table at diametrically opposite edges of the disc and a thick bar of wood, which is bored at the centre to receive the copper or brass tube, is placed upon the blocks and clamped firmly to the table. The glass plate is arranged so that its axis coincides with that of the hole in the bar. The plate is then clamped in place by gently inserting two wooden wedges between the wooden bar and the glass.

The tube by which the cutting is done is stopped by a wooden plug at the middle of its length, and in the upper part is inserted a soft rubber stopper which rests upon the wooden plug, also a piece of heavy rubber tubing which rests upon the stopper. In the rubber tube is inserted one end of a close-fitting metal shank, the other end of which is fitted to an ordinary

drill stock. This arrangement provides for a certain amount of flexibility in the connection between the tube and the drill stock. The tube is revolved by the gearing of the drill stock while it is supplied with a mixture of No. 4 emery and water or emery and turpentine. The pressure on the drill stock should be light, and the tube must be lifted frequently to allow a fresh

ways, and may eventually come to replace, at least in part, engraving by means of a revolving wheel, or even the well-known hydrofluoric acid method.

The apparatus used is very simple, and is shown in Fig. 282. Well-dried sand, contained in the cylindrical vessel *a*, is allowed to flow in a continuous manner through the tube *c*, whose length and inclination can be

281.

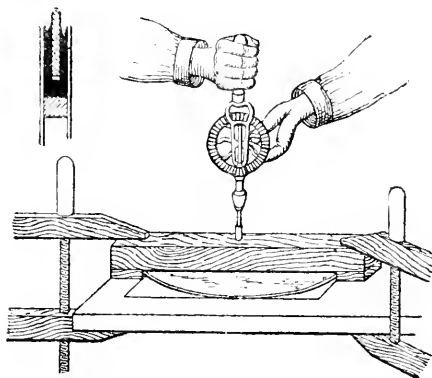

Drilling glass.

282.

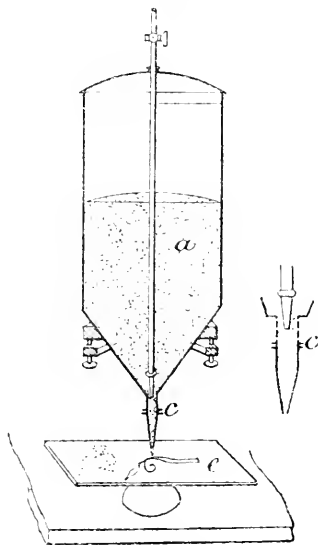

Etching glass.

supply of emery to reach the surface being cut. This device makes a hole in the glass in a short time.

If a larger aperture is desired, the glass is first drilled in the manner described, and enlarged by careful cutting with a diamond. (*Scient. Amer.*)

Etching.—(3) The process here described consists in corroding glass by violently projecting sand upon its surface by means of a current of air or steam. It is very probable that it will be found of service in a great variety of

altered at will, so as to regulate the fall of the sand. The tube conveying the current of air or steam terminates just above this spout, in a nozzle containing a series of fine holes. The sand, urged on by the jet, is thrown violently against the glass plate *c*, or other body placed within its range, and thus exerts a corroding action. By varying the quantity of the sand, the volume and velocity of the current, as well as the diameter of the jet, more or less rapid effects are produced.

Bodies much harder than glass have been submitted to the action of sand thus thrown forcibly against their surface, and have been as rapidly worn away. In a series of experiments recently conducted in New York, a hole 3 cm. diameter was drilled through a block of corundum in 25 minutes, a pressure of 300 lb. being used. With a pressure of 100 lb., a hole 3 cm. diameter and 8 mm. depth was formed in a steel file in 3 minutes. The weight of a diamond was sensibly diminished in a minute, and a topaz utterly destroyed.

In engraving on glass very little pressure is needed, the current from the bellows of an enameller's lamp being quite sufficient. In this way the divisions on graduated tubes, the labels on bottles, &c., can easily be engraved in laboratories with but little trouble.

The portions of the glass which are to remain clear are covered with paper, or with an elastic varnish, these substances being sufficiently exempt from the corroding action of the sand.

(4) A. Müller Jacobs has lately described a photomechanical process for etching on glass which possesses several novel features. The inventor has previously shown that certain resinate colours are sensitive to light, and, after exposure to light, the dye stuff becomes soluble in alcohol or other solvent. The sensitive resinate is made as follows:—

Colophony	100	gram.
Caustic soda	10	„
Crystals sodium carbonate	33	„
Water	1000	c.c.

The mixture is boiled for 2 hours with 1000 c.c. water, and is then mixed with 500 c.c. of a hot solution of 7.5 gm. methyl violet 3 B (methyl green, chysoldine, magenta, &c.); 60 gm. magnesium sulphate are now gradually stirred into the solution, and the precipitated colour is washed and dried at 60°C. The sensitive film is prepared from these resinate colours by dissolving a mixture of 20 gm. resinate violet, 8 gm. resinate green, 8 gm. of

the chysoldine, and 4 gm. of the magenta in 130 c.c. pure benzene and 70 c.c. chloroform. This solution is then mixed with 120 c.c. of a caoutchouc solution (50 gm. caoutchouc, digested with 4000 gm. carbon bisulphide, heated on a water bath until half the bisulphide has distilled off, then benzene added to make the total weight 3333 gm.) After standing for a few days the solution is filtered through cotton wool, and kept in the dark for use. The plates can be either of metal or glass, and are coated with this mixture, dried, and exposed to light under the negative which is to be reproduced. The time of exposure varies from $\frac{1}{4}$ to 3 hours, depending on the intensity of light and the relative amounts of green and red dyestuffs in the resinate colour used. The exposed plate is kept in a cool, dark place until ready for developing. This process consists in immersing the plate in a solution of 1 part benzene and 3 parts turpentine. After the solution of the soluble colours, the plate is washed in petroleum spirit and made ready for the etching process. For matt etching on glass the author recommends fuming hydrofluoric acid containing 10 per cent. of water. (*Industries.*)

(5) Comparatively cheap etching solutions can be prepared, which are equal in effect to the expensive fluorine salts.

I. Two solutions are first prepared, (a) consisting of 10 gm. soda in 20 gm. warm water, (b) consisting of 10 gm. potassium carbonate in 20 gm. warm water. Solutions (a) and (b) are now mixed, and to the mixture is added 20 gm. concentrated hydrofluoric acid, and afterwards a solution (c) consisting of 10 gm. potassium sulphate in 10 gm. water is added.

II. Mix 4 c.c. water, $1\frac{1}{3}$ gm. potassium carbonate, 0.5 c.c. dilute hydrofluoric acid, 0.5 c.c. hydrochloric acid, and 0.5 c.c. potassium sulphate. This mixture is treated with hydrofluoric acid and carbonate of potassium until it produces the required degree of opacity on being tried upon a piece of glass.

The addition of a small quantity of hydrofluoric acid to solution I. brings about a fine granulated appearance on the surface. (*Lainer.*)

(6) A still simpler process than either of these has been invented by Kampmann. In preparing an opaque etching fluid Kampmann uses a wooden vessel, the iron fittings of which are protected from the corrosive action of the acid fumes by a layer of asphaltous material. This vessel is filled to about $\frac{1}{2}$ its contents with strong hydrofluoric acid, which is then partially neutralised by cautiously and gradually adding some crystals of soda: more soda is added, and the mixture is stirred with a small wooden rod. The point at which the neutralisation of the acid should cease is indicated by the mixture frothing and becoming sufficiently viscid to adhere to the stirring rod. It is, perhaps, scarcely necessary to say that the acid fumes are highly injurious, and that this process should be carried on in the open air, in order to allow the vapour to pass rapidly away. The most hygienic and satisfactory process of all would be to carry on the operation in a "draught cupboard."

The contents of this wooden vessel now consist of sodium fluoride and the unneutralised hydrofluoric acid. This mixture is transferred to a wooden tub and diluted with 5-10 times its volume of water, according to the degree of dilution desired. It is objectionable to use the mixture in a too highly concentrated condition, for then the etched surface of the glass is irregular, coarse-grained, and apparently strewn with tiny crystals; if, on the other hand, the dilution is too extreme, the etched surfaces will be transparent instead of opaque. Either of these two conditions of the etching fluid can easily be remedied, for if it be too strong water must be added, and if too weak, a small quantity of hydrofluoric acid partially neutralised with soda. A good recipe for preparing a small quantity of this etching fluid is the following: 240 c.c. commercial hydrofluoric acid, 600 grm.

powdered crystallised soda, 100 c.c. water.

These etching fluids are best used by taking the following precautions. The glass is first thoroughly cleansed from all impurities, and is then provided with a rim of wax composed of the following ingredient:—Beeswax, tallow, colophony, and powdered asphalt, kneaded together. The rim prevents the acid from spreading over those parts of the surface which it is not desired to etch. The glass is then etched for a few minutes with an ordinary etching solution (H.F.—1:10) which is then poured off, the surface being afterwards washed with water and wiped as dry as possible with a piece of sponge. The surface is then ready for the opaque etching fluid, which is poured on till it forms a thick layer. The operation is allowed to progress for one hour, when the liquid is poured away and the surface washed with water. Water is further allowed to stand on the glass until a thin film of silicate is observed to form; the film is then brushed off, the surface is finally cleansed with water, and the wax is removed.

By varying the action of this opaque etching fluid or paste, various degrees of opacity may be produced, and if the opacity be greater than that which is desired, the surface can be cleared to any extent by using the etching solution of hydrofluoric acid.

Frosting.—(b) *Verre Givre*, or hoar-frost glass, an article now made in Paris, is so called from the pattern upon it, which resembles the feathery forms traced by frost on the inside of the windows in cold weather. The process of making the glass is as follows:—The surface is first ground either by the sand blast or the ordinary method, and is then covered with soft varnish. On being dried, either in the sun or by artificial heat, the varnish contracts strongly, taking with it the particles of glass to which it adheres; and as the contraction takes place along definite lines, the pattern produced by the removal of the particles of glass resembles very closely the branching

crystals of frostwork. A single coat gives a small, delicate effect, while a thick film, formed by putting on two, three, or more coats, contracts so strongly as to produce a large, bold design. By using coloured glass, a pattern in half-tint may be made on the coloured ground, and after decorating white glass the back may be silvered or gilded.

Powdering.—Powdered glass is frequently used instead of paper, cloth, cotton or sand for filtering varnishes, acids, &c. It is not soluble or corrodible. Sand, if purely silicious, would be better, but such sand is difficult to get; it too often contains matters which are easily corroded or dissolved. Powdered glass when glued to paper is also used for polishing wood and other materials. It cuts rapidly and cleanly, and is better than sand for most purposes. Glass is easily pulverised after being heated red hot and plunged into cold water. It cracks in every direction, becomes hard and brittle, and breaks with keenly cutting edges. After being pounded in a mortar it may be divided into powders of different degrees of fineness by being sifted through lawn sieves.

Stoppers, fitting.—Very few stoppers properly fit the bottles for which they are intended. The stoppers and bottles are ground with copper cones, fed with sand and made to revolve rapidly in a lathe, and the common stock are not specially fitted. To fit a stopper to a bottle that has not been ground, use emery or coarse sand kept constantly wet with water, and replaced with fresh as fast as it is reduced to powder. When all the surface has become equally rough, it is considered a sign that the glass has been ground to the proper shape, as until that time the projecting parts only show traces of erosion. This is the longest and hardest part of the work, as after that the glass simply needs finishing and polishing. For that purpose emery only can be used, owing to the fact that the material can be obtained of any degree of fineness, in

this respect differing from sand. Otherwise the operation is the same as before, the emery being always kept moistened, and replaced when worn out. The grinding is continued until both the neck of the bottle and the stopper acquire a uniform finish, of a moderate degree of smoothness, and until the stopper fits so accurately that no shake can be felt in it, even though it be not twisted in tightly.

Tubes, sealing.—To seal tubes hermetically after gases have been admitted under pressure, the following arrangement was employed with complete success:—The experimental tube A is joined to a T-piece B, the lateral limb of which is constructed, as shown in Fig. 283; a glass plug D is ground

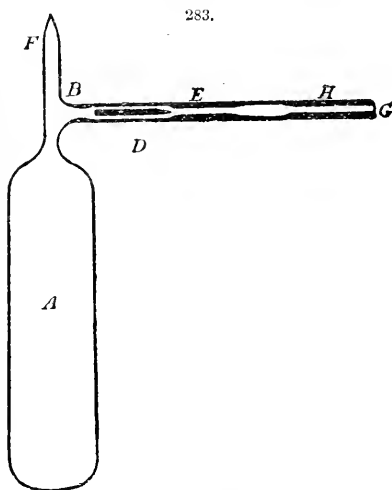

Sealing glass tubes.

into the tube at E, and serves the purpose of a valve opening inward. When gas under pressure is allowed to enter the tube at G, the valve opens, but on removing the pressure from without it at once closes; the escape of gas from A is thus prevented, and the tube may be sealed before the blowpipe at H.

When the tube contains a liquid, the plug should be moistened with it; this will prevent the escape of gas while the tube is being sealed, even though the plug does not fit very accurately. In the absence of any liquid, greater care in grinding the plug is required. The tube F serves for the admission of liquid into the experimental tube in the first instance; it is then closed, and at the end of the experiment it is opened and the contents of the tube are removed. The rest of the apparatus is thus kept intact, and may be used repeatedly, especially if the tube at H is fairly long. (A. Richardson, in *Chem. News*.)

couple of coats of paint or varnish being applied all over as a preservative. The working face *a* will be much improved by laying a piece of school slate over it. The dimensions of *a* must in some measure depend on the work in

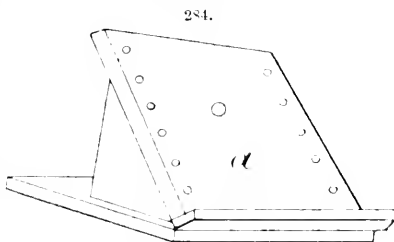

MODELLING AND PLASTER CASTING.

Modelling in some plastic material is the first step in learning to execute work in more solid materials, such as wood and stone. With a plastic substance, such as clay, it is possible to correct errors and introduce improvements while the design is in course of development, and various ideas can be worked out easily and rapidly in a preliminary manner which will indicate very faithfully what the effect would be in wood or marble, papier maché or leather. Moreover, when proper clay is used, the model itself may be baked and rendered permanent.

The Workshop.—The room or workshop where modelling is to be carried on should be reserved for that purpose, or a portion of a room may be so used. The floor should either be bare boards or covered with oilcloth. Under a window should stand a firm table, with the light falling on it either in front or on the left side. This table will be surmounted by a slate or stone slab, or by a wooden stand on which the clay is manipulated. A slab is preferable to wood, as being unaffected by the moisture exuding from the clay. When a wooden stand is used, it may take the form shown in Fig. 284. This is made of ordinary deal, the sides being well clamped to ensure rigidity, and a

hand, but about 2 ft. from side to side, and 1½ ft. from top to bottom edge are average figures. The height above the floor should be such that the work to be modelled comes level with the workman's face, standing. A handy accessory to the modelling stand is a miniature turn-table carrying the slate; a piece of board with a pin attached to the back, fitting into the hole in *a* will answer the purpose, and greatly facilitates getting at all sides of the object under treatment; but it has this disadvantage, that a certain degree of instability is introduced; slate on the modelling stand may be replaced by covering the latter with sheet lead or zinc, anything in fact which will not absorb moisture.

The Material.—(a) Pottery Clay.—Many workmen employ ordinary blue clay such as is used for making earthenware, and commonly known as kaolin. This may be purchased at the places where it is dug, in Dorset, Devon, Cornwall, &c., or from potters in any part of the kingdom. In large quantities it costs about 3*l.* a ton; in lesser parcels about 4–5*s.* a cwt., and in still smaller about 1*d.* a lb. But not less than ¼ cwt. is of any service, as its weight is disproportionately greater than its bulk. In quality it should be as pure as possible, not gritty, and

capable of being freely worked. Colour is no guide, being due to the presence or absence of a small proportion of iron, and varying accordingly from a reddish-brown to a pale-grey tint. When purchased from dealers at about 10s. a cwt. it should be in a fit state for use; but when bought at the pit or from the potter it will be in the rough state, and must undergo a refining process before application.

This refining process consists in very carefully cutting the mass up by means of wires fitted in handles, which will reveal the presence of any coarse or gritty particles. Or it may be subjected to a thorough beating with an iron bar, all foreign matters being picked out as discovered. This must be followed by a kneading process, whereby its consistency is rendered suitable and homogeneous. Suitability in this case means somewhat softer than putty, so that it can be freely and readily worked and formed by the fingers. If it becomes too soft, this can be remedied by leaving it open to the air for awhile, when it soon loses part of its moisture; if too dry, it must be broken up in water and re-kneaded, unless adding a little water and folding a wet cloth round it will suffice, as it sometimes does. The addition of a little fine sand well incorporated with the mass facilitates the working, especially in large objects.

Having worked the clay into good condition, the next thing is to keep it so, which simply means preventing it from drying. Nothing answers the purpose better than a glazed earthenware pan of a capacity of 6-7 gal., which can be furnished with a wooden cover, and at the bottom of which a little water is put. Here the clay will remain soft for many weeks. Even when not in use, clay should never be allowed to get quite dry, but always put in the pan with water and worked up. The more it is used the better it becomes, getting seasoned as it were. As soon as a model is done with it should be broken down into walnut-sized pieces, very carefully examined

for possible impurities, and put to soak at once. The same rules as to moisture hold good in the unfinished or finished model as in the original clay. Without application of moisture the clay will quickly dry, the sequel to which is shrinkage and cracks. The remedy is to occasionally sprinkle the model with water from a brush or spray-bottle while at work on it, and to always keep it surrounded by a moist envelope when not at work on it. This envelope usually takes the form of calico next the model, and coarser more absorbent cloths outside; and when it is desirable not to allow contact between the envelope and the model, the latter is protected by a slight wooden framework, or by inserting little sticks into the model where they can do no harm, and holding the cloths off by their projecting ends. As an extra precaution, a waterproof material may form an outside covering as it will more effectually prevent evaporation. Changes of temperature should be guarded against, and especially extremes whether of heat or cold.

(b) Pipeclay.—Much the same conditions apply to pipeclay as to china clay. It may be obtained of plasterers and pipemakers, the latter being less likely to contain fragments of plaster of Paris, for which it must be carefully examined.

The Tools.—The tools required are of the simplest description and may all be made at home, or purchased from edge-tool dealers. Those made from any hard close-grained wood such as pear, are just as good as more expensive articles in bone or ivory. Fig. 285 is a chisel-shaped tool with a bent point; Fig. 286, a flat blade with one edge smooth and the other serrated; Fig. 287, a double spoon-shaped or bent spatula; Fig. 288, a combined sword-blade and pointed spoon; Fig. 289, an oblique chisel edge and sharply curved spoon bowl; Figs. 290, 291, flat bowls for roughing out; Fig. 292, a combined bent point and toothed blade; Fig. 293, a wire tool; Fig. 294, a toothed rake of brass wire, which may

285.



286.



287.

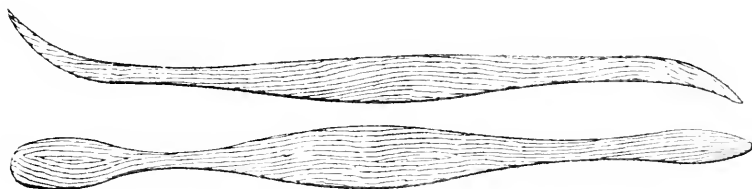

288.



289.



Clay modelling tools.

290.

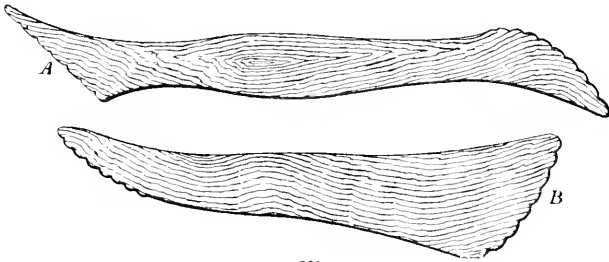

291.

292.



293.



294.

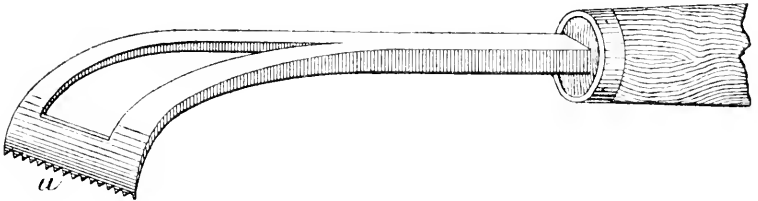

295.

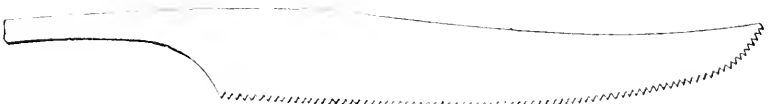

Clay modelling tools.

be in several sizes, from $\frac{1}{2}$ in. to 3 in. across the edge *a*. Fig. 295 a handled blade of flattened brass wire. All the wooden tools can be easily cut out of pearwood with a pocket knife, and finished with a rasp and fine sand paper. They are mainly destined to replace the modeller's thumb where that cannot be used, and the chief thing to guard against is the occurrence of points or sharp edges. A few odd pieces of pearwood at hand will always enable the modeller to cut a new tool for any particular piece of work in hand. The simplest is the best. Other necessities will be a serrated straight-edge about 18 in. long for smoothing backgrounds, a fine sponge, a plummet, a pair of callipers which will embrace the shoulders, and a pair of compasses.

The Operation.—Select a very simple image on which to try your prentice hand. Place it at a convenient height level with the modelling table. Prepare a foundation of the necessary thickness, taking great care to work it into a uniform and coherent mass. Level it true with the straight-edge, and place temporary strips of wood at the sides, as a guide. From the mass carve away very gradually, by a scraping motion, from the necessary parts so as to create a broad general resemblance to the selected object, always avoiding taking away too much, and frequently checking dimensions by the compasses and callipers. It will only be after some practice that the eye will be able to grasp the essential features, and detailed work should not be attempted till success attends the efforts made in bolder subjects. The most important point is to so work that the whole operation shall consist in cutting away, and avoid having to build up. Added portions will rarely have exactly the same consistency as the body, and unless very carefully attached will be insecure. Solid objects, such as animal images, busts, &c., will be the easiest to commence on. Foliage and articles of fine texture are much more difficult to imitate.

The first step in laying the foundation is to accurately sketch the outline of

the proposed object on the modelling board, by means of pencil or crayon. Commence with clay that is fully soft, and always avoid retaining it too long in the hand, as it thereby soon dries and loses its cohesion. Work the clay into little rolls and lay it on by holding the roll in one hand and pressing the clay into place with the other. The chisel-shaped tool is employed to keep the clay correctly to the pattern, and the greatest care must be exercised to press it perfectly down and prevent any air bubbles or other impediments to absolute adhesion between clay and board. The foundation must be finished all over before any building up is attempted. This refers, of course, to flat work, such as panels, which are afterwards to be copied in wood. When making additions, it is very essential that both surfaces to be joined should be somewhat softer than the bulk.

Modelling in Wax is better adapted for small objects. The material consists of wax slightly coloured by the addition of a pigment and somewhat softened by a solvent. A good recipe is said to be: 200 parts clear wax, 26 Venice turpentine, 13 lard, and 145 precipitated bole, mixed and well kneaded in water. But many prefer to purchase prepared wax from an artists' colourman. The tools used are the same as for clay, but smaller, blunter, and generally of bone. The operation consists in building up rather than cutting down; and the chief precaution is to keep the tool moistened with water to prevent adhesion. Considerable practice with clay is a good preliminary to trying wax.

Plaster Casting.—(1) The model (of clay or otherwise) is first covered with a layer of good plaster of Paris mixed, or "gauged," as plasterers call it, to the consistency of batter, and coloured with a little red or yellow ochre. This layer should average about $\frac{1}{4}$ in. thick. It is best applied with the pewter or metal spoon used to mix the plaster with. The plaster is mixed in a basin half full of water, into which it is sprinkled by the hand, as oatmeal is sprinkled in making stirabout; when the plaster

reaches the surface of the water, it is about sufficient, but experience soon teaches the right proportion. The mixed plaster can be jerked by a dexterous twist of the spoon into the deep undercut places, and care must be taken not to inclose bubbles of air. A practical moulder would place the clay slab in a vertical position, as he would see the process of his work better. A large model would require several mixings of plaster, as when the plaster begins to set or harden, it is useless for moulding. When the first coloured coat of plaster is hardened, a wash of clay-water should be applied nearly all over it, and the second coating, which may be of coarser stuff, put on to the thickness of about 1 in. If the mould is very large, some strips of iron nail rod, $\frac{1}{2}$ in. square, may be imbedded in the back of the mould to prevent warping. When the mould is set hard, it must be turned over, and the clay picked out. If the work has been modelled on a board or slate, or best of all, on a plaster slab, it may be necessary to pass a wire between the clay and the board to separate them. When the mould has been well cleaned and washed with a soft brush, it should be soaked in a tub of water until quite saturated through and through, drained, but not wiped, and a sufficient quantity of superfine plaster, carefully mixed, poured into it, and, by moving the mould about, carefully distributed all over. This may be backed with coarser plaster, and strengthened with iron rods, which in this case should be painted or coated with a varnish of rosin and tallow. When the cast is set hard, the most difficult part, called "knocking out," begins. A light mallet and a carpenter's firmer chisel, by a few dexterous strokes applied upon the edge, will separate the coarse outer backing of the mould, prevented from the wash of clay water from adhering to the first coloured layer. The cast should then be placed upon a soft elastic bed—an empty sack folded is as good as any—and by gentle taps, holding the chisel perpendicularly or nearly so, to the face of the work, the coloured plaster may

be snapped off, sometimes in large, sometimes in minute pieces, the colour preventing the operator chipping away the best part of his work, which may happen when mould and cast are of one colour. A chisel 1 in. or more broad may be used for the first rough work; smaller will be required for delicate parts.

A figure in the round may be moulded by the same process, but the mould must be in two parts. A strip of clay 1 in. or so wide must be fixed all round the clay figure, to be removed when the first half of the mould is done. The edge of the first half must have sunk holes, made by any convenient steel modelling tool, to ensure the fitting of the two halves of the mould. Projecting limbs must be cut off with a fine wire, and cast separately. If an iron support enters the back of the model, a little clay must be put round it, close to the model, to enable the iron to be drawn through the mould, and the hole in the mould stopped up with plaster. The two parts, carefully saturated and bound together, may be about half-filled with well-mixed superfine plaster, as thick as cream, which, by carefully turning and inclining the mould, can be made to cover the whole of the mould, leaving a large hollow to be filled with a coarser plaster, in which a painted iron rod may be inserted. Good plaster smells sweet, sets in 10-20 minutes as hard and as crisp as loaf sugar. Bad plaster smells of sulphur, and never sets hard. Beginners must make sure of their materials, and even then should try their hands on unimportant work.

Small reliefs may be moulded in wax. A border of clay or strips of wood a little higher than the highest part of the model must be fixed all round, and melted beeswax with a little rosin and tallow added, poured over the clay. When the wax is cold, and the clay well washed out, superfine plaster can be poured in as into a plaster mould. The wax is afterwards melted off or softened before a fire and peeled off, to serve again as often as you please. Hands and arms, and legs and feet, can be easily moulded in plaster, care being taken to

grease or oil the skin well. The outside of the moulds may be deeply scored before the plaster sets, so as to break off in convenient pieces for putting together again.

In taking the cast of the face of a living subject (or victim), he or she should be placed sitting in a chair as if about to be shaved; the skin carefully greased, the hair and eyebrows smoothed down with clay or soft soap and superfine plaster, slightly coloured with ochre, mixed in warm water, dexterously splashed over the face with a silver spoon, care being taken to leave the nostrils free. The mould should not be quite $\frac{1}{4}$ in. thick, and may be broken off in two or three pieces, which can be afterwards joined.

(2) To prepare Plaster of Paris.—Immerse the unburnt gypsum for 15 minutes in water containing 8–10 per cent. of sulphuric acid, and then calcine it. Prepared in this way it sets slowly, but makes excellent casts, which are perfectly white instead of the usual greyish tint.

(3) Transparent Casts.—Beautiful semi-transparent casts of fancy articles may be taken in a compound of 2 parts unbaked gypsum, 1 of bleached beeswax, and 1 of paraffin. This becomes plastic at 120° F., and is quite tough.

(4) To toughen Casts.—Immerse in a hot solution of glue long enough for the mass to be well saturated. They will bear a nail driven in without cracking.

(5) Mending Models.—Sandarac varnish is the best material. Saturate the broken surfaces thoroughly, press them well together, and allow them to dry.

(6) Plaster Moulds.—Glycerine is said to be a good coating for the interior, but practical plaster moulders still use, as of old, a mixture of lard and oil.

(7) With small Models.—For making small models in plaster, gelatine is generally used. Good glue, mixed with treacle or glycerine answers every purpose. The composition that the "chromograph" is made of will answer very well. The model is immersed in it, and, when cool, a cut is made with a sharp

knife, and the elastic nature of the composition allows the model to be taken out. The mould should be greased before the plaster is poured in; when set, it is extracted in the same manner as the original model. Large figures are poured in plaster moulds; these are made in pieces, which are fitted together with wooden pegs. The peg is inserted in one piece before the plaster sets. This piece is trimmed off, in order to prevent the wet plaster adhering to the next piece; the latter should be greased with lard; the whole of the mould is thus built up of pieces. In pouring the model, pieces of wood or wire should be placed in the legs or arms to strengthen them. To cast brass in plaster, the mould should be previously made hot, which might be fatal to the stability of the plaster.

(8) To make casts or moulds of plaster of Paris from metal types, without air-bubbles or "picks," use the finest and purest plaster of Paris obtainable. When filling a mould, learn to beat up the requisite quantity of cream quickly, and with care to avoid making it too thick. In pouring this in, use a good camels' hair brush to displace air-bubbles; a mere surface cover of this thin cream is all that is requisite. While doing this, have ready the thicker plaster, of the consistence of light syrup, and fill up the mould at once. In about 20 minutes you can open the mould, if your plaster is pure and has been properly mixed. If you do not put too much oil on the type, and have used your brush properly, you will find clear, sharp moulds.

(9) Metal may be cast in moulds made of plaster of Paris and talc mixed; or of pounded pumice and plaster of Paris in equal quantities, mixed with washed clay in the same proportion. The mould must be heated very hot when used, if the cast is to be made of copper or brass, but a less degree of heat will serve for lead and tin. You may safely use plaster for zinc castings, taking the precaution of thoroughly drying the parts of the mould, e.g. in the kitchen-range oven; care, however,

must be taken not to use too much heat, or the plaster will be burned—just as much as is unpleasantly hot to the hand. The zinc should not be hotter than will give it sufficient fluidity for pouring. In this way 4 or 5 good castings may be taken, after which the mould gets cracked and scales on the surface; this spoils it for fine work, but is of little consequence for battery zines.

(10) In many cases it is advisable to preserve copies of small carved objects for future use, and this is easily done by taking a plaster cast of the work. To take an impression of the object of which a cast is desired, a substance known as squeeze-wax is used, and this is made of the following ingredients, viz.: 2 lb. flour, $\frac{1}{2}$ lb. best beeswax, $\frac{1}{2}$ lb. linseed oil, and a small quantity of rouge; these should be thoroughly mixed together, and then exposed to the air. Should the squeeze-wax become hard at any time, it may easily be softened by slightly warming and well kneading. In taking a cast, the wax should be well pressed into every portion of the work, and then gently withdrawn, the mould thus formed being filled with plaster of Paris, the plaster having been mixed with water until it is of the consistence of cream. After standing for a few hours the squeeze-wax can be taken off, leaving a copy of the carving in plaster. Care should be taken to obtain the plaster fresh, as after being exposed to the air it loses some of its properties, and does not harden well. These remarks on taking plaster-casts apply only to small objects that are not deeply undercut; larger casts, and casts of subjects carved on more than one side, are taken in sections.

(11) Anatomical Specimens.—Prepare the specimen by making it as clean as possible; place on oiled paper, in a position that will show it to advantage. Soft projections may be held in position with threads suspended from a frame or from a heavy cord stretched across the room. Paraffin melted on a water bath is painted over the prepara-

tion with a soft brush, the first layer being put on with single and quick strokes, that the rapid cooling of the paraffin may not cause the brush to adhere to the preparation, thus drawing the soft tissues out of place, until the mould is formed about $\frac{1}{8}$ in. thick; all undercuts must be well filled. When the mould is hard it can be readily separated from the preparation; it is then well washed with cold water. Stir fine dental plaster into cold water to consistency of cream, pour into the mould and out again several times, so that there will be no air bubbles on the surface, then fill the mould and let it stand until hard. Place the whole in a vessel containing boiling water until the paraffin is all melted; wash with clean boiling water. When the cast is thoroughly dry, it may be painted with oil colours by coating it first with shellac varnish. Casts of any part of the body may be made from a living subject, if the parts are not too sensitive to bear the heat of the paraffin, which varies from 104° to 140° F.

(12) Natural Objects.—Taking plaster casts of natural objects is thus explained by Prof. Boyd Dawkins:—The material of the mould is artists' modelling wax, which is a composition akin to that used by dentists; and as it becomes soft and plastic by the application of heat, though in a cold state it is perfectly rigid, it may be applied to the most delicate object without injury. As it takes the most minute markings and striations of the original to which it is applied, the microscopic structure of the surface of the original is faithfully reproduced in the cast. The method is briefly this:—Cover the object to be cast with a thin powder of steatite or French chalk, which prevents the adhesion of the wax. After the wax has become soft, either from immersion in warm water or from exposure to the direct heat of the fire, apply it to the original, being careful to press it into the little cavities. Then carefully cut off the edges of the wax all round, if the undercutting of the object necessitates the mould being in 2 or more pieces, and let the wax cool with

the object in it, until it is sufficiently hard to bear repetition of the operation on the uncovered portion of the object. The steatite prevents the one piece of the mould sticking to the other. The original ought to be taken out of the mould before the latter becomes perfectly cold and rigid, or it will be very difficult to extract. Next pour in plaster of Paris, after having wetted the mould to prevent bubbles of air lurking in the small interstices; and if the mould be in 2 pieces, it is generally convenient to fill them with plaster separately before putting them together. Dry the plaster casts either wholly or partially. Paint the casts in water-colours, which must be fainter than the hues of the original, because the next process adds to their intensity. The delicate shades of colour in the original will be marked in the cast by the different quantity of the same colour which is taken up by the different textures of the cast. After drying the cast, steep it in hard paraffin: ordinary paraffin candles will serve the purpose. Cool, and hand-polish the cast with steatite.

(13) Photographic Plaster Casts.—The following method of taking plaster casts by means of photography originated with Fink.

An ordinary piece of patent plate-glass, which should measure 2 or 3 in. each way bigger than the original, is coated in the dark-room with a mixture made up of the following solution:—In 15 oz. water is dissolved 1 oz. potash bichromate, the former being warmed gently, and then gradually 2 oz. gelatine are added. As soon as the latter has dissolved, and the solution has about reached the simmering point, it should be filtered through fine linen into a glass beaker, and then poured upon the glass plate above referred to. The gelatine solution is poured upon the centre of the plate, and then drawn towards the margins by means of a fine brush. It is applied again and again until the thickness amounts to about $1\frac{1}{2}$ line. As plates prepared in this way require 2 to 3 days to dry, it is well to prepare a good many at one time, and to place

them when dry in a box well screened from the light. The sensitiveness of the plates has not been found to suffer, even after preservation for a period of 6 weeks.

When a suitable negative has been obtained of the object, and, furthermore, a diapositive from the negative, the prepared plate is placed, face downwards, against the collodion side of the cliché in the printing-frame, and printed in diffused daylight for a period varying from 10 to 40 minutes. The plate is then taken out of the printing-frame (in the dark room), put into a dish, and poured over with lukewarm water until the relief is fully developed. The plate is then dried by means of filter-paper, and coated with glycerine (any superfluity of this substance being also removed with filter-paper), a fine and large badger brush being employed for the purpose.

The plate, which has hitherto been manipulated in the dark, may, after the development of the relief, be further manipulated in daylight, and the plaster cast proceeded with in an ordinary workroom. The manner of making the cast is as follows:—In a couple of evaporating dishes, some alabaster gypsum is put, and two mixtures are made with ordinary spring water, one having the consistence of oil, and the other that of thick cream. The gelatine mould is taken in one hand and a little of the thinner plaster liquid is poured upon it, the mould being at the same time tapped with the open hand from the bottom, in order that no air-bubbles be formed. After this the plate is placed horizontally upon a table, and the thicker paste is poured on, making a film $\frac{3}{8}$ to $\frac{1}{2}$ in. high. This latter, after it has stood for 15–18 hours, is carefully separated at the edge with a knife, and by employing a little force the cast is removed from the mould. This plaster cast may be employed for many purposes, and will serve for taking a casting from, with a metal fusible at a low temperature. With amateurs and photographers, such a proceeding is, however, difficult, and if a metallic cast is required it is best to

send the plaster one to a type-foundry or similar establishment. Retouching may be done if necessary with a needle upon the plaster cast. There is not so much difficulty in taking metallic casts from the plaster moulds. It is only necessary to thoroughly bake the casts, and while still warm brush over with a little wax. (*Eng. Mech.*)

(14) *Cast* that can be Washed.—The prize offered by the Prussian Minister of Commerce and Industry for a method of preparing plaster casts that permit of being washed was conferred upon Dr. W. Reissig, of Darmstadt. From Dr. Reissig's essay on the subject the following points are abstracted:—

In preparing these casts it is not only desirable to obtain a surface which should not wash away, but also to include a simple process for preventing dust entering the pores, and render them more easily cleansed. Laborious experiments showed that the only practical method of accomplishing this and retaining the sharpness of outline was to convert the lime sulphate into (1) baryta sulphate and caustic or carbonate of lime, or (2) into lime silicate by means of potash silicate. Objects treated in this way are not affected by hot water or hot soap solutions, but from the method of preparation, they remain porous, catch dust, &c., and when first put into water eagerly absorb all the impurities. To avoid this evil, subsequently coat the articles, now rendered waterproof, with an alcoholic soap solution, which penetrates more easily, deeper, and more freely into the pores than an aqueous solution. After the alcohol evaporates, a layer of soap remains, which fills the pores, and when washed it is converted into a sud which removes the dust without allowing it to penetrate.

(a) *Process with Baryta Water.*—This is the simplest, easiest, and cheapest method. It depends upon the fact that gypsum, or lime sulphate, is converted by baryta water into baryta sulphate (which is totally insoluble), and caustic lime, which latter is converted by contact with the air into lime carbonate.

The practical method of carrying this out is as follows:—A large zinc vessel is required with a tight-fitting cover. In each vessel is a grating made of strips of zinc, resting on feet $1\frac{1}{4}$ in. high. This vessel is $\frac{3}{4}$ filled with soft water at 54° to 77° F. (12° to 25° C.), and to every 25 gal. of water is added 8 lb. fused or $1\frac{1}{4}$ lb. crystallised pure hydrated barium oxide, also 0.6 lb. lime previously slaked in water. The solution stands about 4° Beck (1.0241 sp. gr.). As soon as the baryta water gets clear, it is ready to receive the casts. They are wrapped in suitable places with cords, and after removing the scum from the baryta bath, are dipped in as rapidly as possible, face first, and then allowed to rest upon the grating.

Hollow casts are first saturated by rapid motions, then filled with the solution and suspended in the bath with the open part upwards. After the cords are all secured above the surface of the liquid, the zinc vessel is covered. The casts are left in it for 1 to 10 or more days, according to the thickness of the waterproof strata required. After taking off the cover and removing the scum, the plaster casts are drawn up by the strings, rinsed off with lime-water, allowed to drain, carefully wiped with white cotton or linen rags, and left to dry, without being touched by the hands, in a warm place free from dust. The same solution which has been used once can be employed again by adding a little more baryta and lime.

Of course this process can only be applied to casts free from dust, smoke, dirt, coloured particles of water, rosin, varnish, soap, animal glue from the moulds, or sweat from the hands. To prevent the casts getting dust upon them, they should be wrapped in paper when taken from the mould, and dried by artificial heat below 212° F. (100° C.). If, in spite of every precaution, the casts when finished show single yellow spots, the latter can be removed in this manner:—The perfectly dry, barytated casts, saturated with carbonic acid, are painted over with water and oil of turpentine,

then put in a glass case and exposed to the direct rays of the sun.

(b) Process with Silicate of Potash Solution.—This depends upon the conversion of the lime sulphate into lime silicate, an extremely hard, durable, insoluble compound, and is accomplished by the use of a dilute solution of potash silicate containing free potash. To prepare this solution, first make a 10 per cent. solution of caustic potash in water, heat to boiling in a suitable vessel, and then add pure silicic acid (free from iron) as long as it continues to dissolve. On standing, the cold solution usually throws down some highly-silicated potash and alumina. It is left in well-stoppered glass vessels to settle. Just before using, it is well to throw in a few bits of pure potash, or to add 1 or 2 per cent. of the potash solution. If the plaster articles are very bulky, this solution can be diluted to $\frac{1}{2}$ with pure water.

The casts are silicated by dipping them (cold) for a few minutes into the solution, or applying the solution by means of a well-cleaned sponge, or throwing it upon them as a fine spray. When the chemical reaction, which takes place almost instantly, is finished, the excess of the solution is best removed with some warm soap-water or a warm solution of stearine soap, and this finally removed with still warmer pure water.

The casts, which can be immersed or easily moved around, may be treated as above when warm; a very short time is required, but some experience is necessary. In every case it is easy to tell when the change is effected, from the smooth dense appearance, and by their feeling when scratched with the finger-nail. It is not advisable to leave them too long in the potash solution, as it may injure them. A little practice renders it easy to hit the right point. The fresher and purer the gypsum and the more porous the cast, the more necessary it is to work fast. Castings made with old and poor plaster of Paris are useless for silicating. These silicated casts are treated with soap as above.

In washing plaster casts prepared by either method, use a clean soft sponge, carefully freed from all adherent sand and limestone, wet with lukewarm water, and well soaped. They are afterwards washed with clean water. They cannot, of course, be washed until thoroughly dry and saturated with carbonic acid. The addition of some oil of turpentine to the soap is useful, as it bleaches the casts on standing. The use of hot soapsuds must be avoided.

(15) Hardening.—Following is a new process of hardening plaster so as to adapt it to the construction of flooring in place of wood, and to other purposes for which it cannot be used in its ordinary state on account of its want of hardness and resistance to crushing. Julte recommends the intimate mixture of 6 parts plaster of good quality with 1 part finely sifted, recently slaked white lime. This mixture is employed like ordinary plaster. After it has become thoroughly dry, the object manufactured from it is saturated with a solution of any sulphate whose base is precipitated in an insoluble form by lime. The sulphates best adapted for the purpose, from every point of view, are those of iron and zinc.

With zinc sulphate, the object remains white, as might be supposed. With iron sulphate, the object, at first greenish, finally assumes, through desiccation, the characteristic tint of iron sesquioxide. The hardest surfaces are obtained with iron, and the resistance to breakage is 20 times greater than that of ordinary plaster. In order to obtain a maximum of hardness and tenacity, it is necessary to temper the limed plaster well in as brief a space of time as possible, and with no more water than is strictly necessary. The object to be hardened should be very dry, so that the solution employed may penetrate it easily. The solution should be near the point of saturation, and the first immersion should not exceed 2 hours. If immersed too long, the plaster would become friable.

The proportions of lime and plaster may be varied according to the results

to be obtained; nevertheless, the proportions of 1 to 6 have given the best results.

As it is important that the plaster should not be spread over the surface by passing and re-passing the trowel for too long a time, the fastest workman will always be the best one to employ. When sulphate of iron is used, the slabs are of the colour of iron rust; but if linseed oil boiled with litharge be passed over the surface, they assume a beautiful mahogany colour, and offer a certain superficial elasticity to the tread. If a coat of hard copal varnish be added, the colour becomes very beautiful.

On spreading a 2 or 3-in. layer of limed plaster in a room, and treating it in the way above described, is produced a floor which is smooth, and which, in most cases, fulfils the office of an oak floor, but which has the advantage over the latter of costing one fourth.—(*Scient. Amer.*)

(16) Reducing and Enlarging Plaster Casts.—Ordinary casts taken in plaster vary somewhat, owing to the shrinkage of the plaster; but it has hitherto not been possible to regulate this so as to produce any desired change, and yet preserve the proportions. Höger has, however, recently devised an ingenious method for making copies in any material, either reduced or enlarged, without distortion.

The original is first surrounded with a case or frame of sheet metal or other suitable material, and a negative cast is taken with some elastic material, if there are undercuts; the inventor uses agar-agar. The usual negative or mould having been obtained as usual, he prepares a gelatine mass, resembling the hektograph mass, by soaking the gelatine first, then melting it and adding enough of any inorganic powdered substance to give it some stability. This is poured into the mould, which is previously moistened with glycerine to prevent adhesion. When cold, the gelatine cast is taken from the mould and is, of course, the same size as the original. If the copy is to be reduced, this gelatine cast is put in strong alco-

hol and left entirely covered with it. It then begins to shrink and contract with the greatest uniformity. When the desired reduction has taken place the cast is removed from its bath. From this reduced copy a cast is taken as usual. As there is a limit to the shrinkage of the gelatine cast, when a considerable reduction is desired, the operation is repeated by making a plaster mould from the reduced copy, and from this a second gelatine cast is taken and likewise immersed in alcohol and shrunk. It is claimed that even when repeated there is no sacrifice of the sharpness of the original.

When the copy is to be enlarged instead of reduced, the gelatine cast is put in a cold water bath, instead of alcohol. After it has swollen as much as it will, the plaster mould is made as before. For enlarging, the mould could also be made of some slightly soluble mass, and then by filling it with water the cavity would grow larger, but it would not give so sharp a copy.

STEREOTYPING (iv. 217-28).

While the previous article on this subject conveyed an account of the processes of stereotyping as generally carried on, so much original research and applied science is contained in Prof. Bolas's series of Cantor Lectures on the subject, at the Society of Arts in 1890, as to warrant a supplementary notice embodying his remarks.

An early method, which is worth reproduction on account of its simplicity, was known as "polytype." According to this, the page type, or the original to be copied, is slightly oiled, and fixed face downwards on a block of wood, supported, at some little distance, over a paper or cardboard tray, into which melted type-metal has been poured. Just as the type-metal begins to show distinct signs of solidification, the block carrying the page of type is allowed to fall on the soft metal; and on separating the two, a reverse or mould is obtained. This reverse or mould, being now fixed upon the lower face of the

drop-block, is allowed in its turn to fall on the surface of type-metal contained in a paper tray, this metal being at the point of solidification as before. The paper tray is of course crushed in each case, and to regulate the thickness of the "strike," metal gauges are fixed alongside the paper tray, and in such position that the frame or chase containing the original, when down, shall rest upon them.

It is easy to copy this method by the aid of an ordinary stamping press provided with a quick screw. Fig. 296 conveys a good idea of a simple form of

tion than that of striking the matrix into semi-fluid type-metal.

At another period Firmin Didot adopted the plan of forcing the forme of type by dead pressure against a sheet of soft lead, and the matrix or reverse thus obtained served for obtaining printing plates by the method of striking into semi-fluid type-metal just described. It is easy to obtain a reverse in soft sheet-lead by dead pressure; and if the lead matrix is placed in the ordinary stereotype casting-box, casts may be obtained from it in ordinary type or stereotype metal, these alloys melting at a lower

temperature than the lead. In a similar way a lead matrix may be made by driving an ordinary type punch - ways into a piece of lead, and the lead matrix being adjusted to an ordinary hand-mould of the right body size, it is easy to cast a number of types in it, which are about as good as the original; this being often a very convenient process to follow when a few extra types are wanted in a hurry.

In the usual casting operations it is generally necessary that the mould in which the casting is made should be of less fusibility than the material cast, although there are rare cases in which this does not hold good; but in the case of the striking method just described, we have a method by which an impression may be obtained in a much more refractory material than the original matrix. For example, an impression in sealing wax taken from type may be quickly driven down on the surface of type-metal just on the point of commencing to solidify, and will yield a perfect cast in the alloy, e.g., by means of the quick screw-press before used. Similarly, a die in high steel may be made from a silver or copper coin, if the steel is heated to bright whiteness, and the coin, attached to a drop-hammer, is allowed to fall upon it. The main points to ensure success appear to

296.

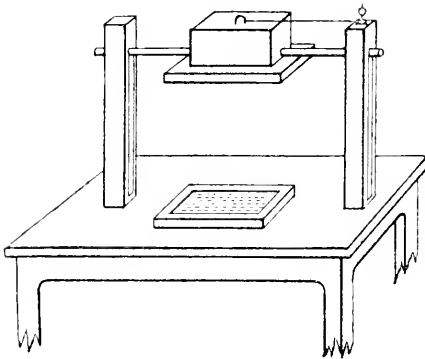

Early polytype apparatus.

apparatus originally used, and which was constructed of hard wood. The arrangement of parts is sufficiently obvious without further explanation, excepting that it may be mentioned that the rod carrying the catch which releases the block should stretch from one standard to the other, the catch being taken out of the staple in the drop-block by putting the wire in torsion. This process is still in occasional use for the rapid reproduction of small typographic ornaments or blocks, but in such cases the matrix is generally a thick electrotype cast made from the original block. For initial letters or ornaments about $\frac{1}{2}$ in. square, there is probably no quicker or better method of reproduc-

be forming of the steel block as a blunt cone, so that the middle shall first come in contact with the original, and the protection of the hot steel from the action of the air till the last instant. Dies made by this process are sometimes so perfect as to recall the smoothness and perfection of an electrotype; and it is no uncommon thing for mints to send coins in order to obtain fresh dies for the replacing of injured ones. The method of moulding by striking into soft metal is of great value, and those interested in methods of typographic reproduction should bear in mind the possibilities of this method. If, for example, numerous small stereotypes in hardened steel were required, they could readily be obtained by the "striking" method, a steel die (itself, let us suppose, "struck" from an electrotype) being used.

Very much of interest and importance arose out of experiments carried on in the office of Firmin Didot, in Paris, about the end of the last century and the beginning of this. In the first place, the introduction of a hard type-metal containing copper, this being due to Herhan, at the time a workman in the employment of Didot, and the hard metal was introduced to enable the type to stand the strain of moulding by dead pressure against lead plates. One of Herhan's alloys contained:—Lead, 25 parts; antimony, 15; copper, 6.

Another notable outcome of the work in Didot's office was the production of a matrix by punching the letters into it successively, a device of Guillot, another workman in the service of Didot. Guillot called his process "graphitype," and he drove the steel type-punches successively into a copper plate, this plate being then used as a matrix for casting a stereotype. Guillot's method may be regarded not only as the parent of the various "type-writer" methods of making matrix sheets or strips, but also of Herhan's next introduction—the use of matrix types.

It is easy enough to illustrate the principle of Guillot's "graphitype" by driving punches into the face of a

copper plate, using a guide rule to keep the line, and then casting from the plate in the usual casting-box. In this form, however, it is hardly a practicable method, but its modern developments, in which a kind of type-writer is used to make a matrix out of wood (the end of the grain) or soft paper, may perhaps come into general use.

Herhan, whose hard metal has just been referred to, developed the idea of his fellow workman, and made it more practicable by setting up the page with matrix types instead of driving the punches into a plate of copper, this arrangement allowing corrections to be made, and also ensuring that the whole of the printing surface shall be in one plane. Herhan's types were of brass or copper, and generally similar to the ordinary types, but in place of the projecting or male letter of our ordinary type, was a female or matrix letter, just the reverse of the face of the usual type. Such letters are set just as ordinary types, excepting that they are arranged in the stick and chase non-reversed, and a proof can be taken on the press; preferably, however, on thin paper, such as is used for copying letters, as the impression must be read through the paper if it is to be read non-reversed. Another way of taking a proof is to lay a sheet of plain paper on the "forme," and over this a sheet of black manifold paper, the coating of which sets off on the plain paper when the pressure is applied. The "forme" being locked up, and any large whites overlaid with special quadrats (or high quadrats may be used in the first instance), it is shut up in a casting-box, and the stereotype is made directly from it. Didot issued several books printed from stereotypes made by this method.

The "linotype" system of Mergenthaler, in which a very cleverly designed machine brings a number of matrices into a row, so that a line is cast, may be regarded as in some sense a development of the idea of Herhan.

Considering that, in the case of newspaper work, printing is always

done from stereotypes, it seems to me that it would be a more reasonable and direct proceeding to set the matrices, and cast the required plate directly into the matrix forme, rather than to delay matters by the intermediate process of moulding. Although Herhan devised excellent methods of striking his matrix type quickly, and in true register, from the original-punches, an engineer of the present day could do better: he could design a machine which would turn out brass or copper matrix types about as quickly as wire nails are cut off and headed, and the cost per lb. of the matrix type possibly might not exceed that of ordinary types. Again, it is quite easy to make the matrix types radial, so that they can be "made up" in curved boxes, and plates for rotary machines cast as soon as the last lines are set or the final corrections made. I cannot help thinking that the time is not far distant when Herhan's matrix types will largely replace those used now, and it need scarcely be said that the ordinary typesetting and distributing machines would be as available with these as with the sort of type now in use. It certainly seems absurd to set a "forme," and mould a matrix from it when it is just as easy to set up the matrix, and to cast directly into it.

The plaster process of stereotyping was now established, and soon came into very general use for certain classes of work, and the next great step was the paper process, in which softened paper is forced down upon the original type "forme," and in the mould thus obtained one cast or more can be made. This has become essentially the stereotyping method, and has ousted all other processes, except for special work. Among other things, it has rendered possible the modern newspaper; and the facility which it affords for rapidly producing any required number of curved plates, suited for rotary machines, has revolutionised printing as far as rapid production is concerned. Moreover, the process is so simple and so easy that any person may, for a cost

of a few shillings, produce small stereotype plates equal in sharpness and general excellence with those made in the most perfectly fitted establishment.

The essential principles of the paper-mould method are as follows:—On a pad of soft paper, built up of about 20 thicknesses of soft blotting-paper, stapled together at the edges, a hard impression from a page of type is taken. It is now placed between two slabs of dry wood, which slabs are separated to a distance of something under $\frac{1}{4}$ in. by strips of the same material, and melted type-metal is poured in at the top. On separating the slabs of wood you have a fairly good cast of the original type, and the whole process of producing it has taken less than a minute. In practice, however, dry paper is not used for making the mould, but a number of sheets are pasted together, and this combination is used damp.

The soft pasteboard ready made is known to the workman as "flong," a corruption of *flan*, a thin farinaceous cake sold in Paris. This is laid on a warm and slightly oiled page of type, and the back is beaten with a stiff brush until the soft pasteboard has taken a perfect impression of the face of the type. On the back now lay a piece of blanket, pinch the whole in a screw press, the press having been previously warmed. The drying of the mould may, under such circumstances, take from a few minutes to $\frac{1}{2}$ an hour, according to the temperature and the frequency with which the blanket and other packing is changed. Being clamped between slabs of warm iron, metal is poured in, and a cast is obtained, little if at all inferior to the original type in sharpness. Here you have the essential features of the paper-mould process, the most important of all stereotyping processes.

Working Details of the Paper-Mould Process.—This method well merits close study, especially as at present workmen often so far follow the traditions of their craft as to lose sight of such points of special advantage as might easily be grasped if tradition were allowed to

give way more freely to thought and experiment.

The page of type, or "forme," which is to be moulded, instead of being locked up in the chase surrounded with the ordinary wooden furniture, has a type-high border about $\frac{3}{8}$ in. wide around it; but the face of this type-high border does not come quite close up to the type, there being a space of $\frac{1}{8}$ in. between them. This type-high border is ordinarily obtained by surrounding the forme with strips of type-metal called "clumps," or "stereo-clumps," these clumps being type high, and about $\frac{1}{2}$ in. wide; but a bevel on the edge placed next to the type reduces the face-width to about $\frac{3}{8}$ in., and gives the clear space of about $\frac{1}{8}$ in. or so between the face of the clump and the type. The object of the clumps is to form a level bed for the strips of metal—commonly called "gauges"—which determine the thickness of the plate. The space between the type and the face of the clump leaves room for the saw-cut if the plate is to be trimmed close, or for the bevel if the plate is to be trimmed for mounting with catches on a metal block.

Now the forme should be planed level, not too tightly locked up, and its face must be slightly but completely oiled, this being done by rubbing it with a flat brush, not too heavily charged with oil, the brush being about as stiff as an ordinary hat brush. The traditions of the trade ordain that the oil should be the finest olive oil; but as a matter of fact, neither olive oil nor cotton-seed oil, which is now commonly sold as olive oil, is the most suitable, as these oils—and more especially the latter—are saponified very readily by any trace of alkali which may remain on the forme. A much more suitable oil is the very thin mineral lubricating oil which is sold retail at 1s. 6d. a gal. Here is a case in which an article sold at the lowest price is the best, and in connection with stereotyping—as indeed with most industries—there are many such cases; so much so that one must look with suspicion on the common but vague

instruction to "use only the very best materials." The practical interpretation of this is to use just those samples for which the shopkeeper chooses to charge the highest prices; and when such an instruction is given as generally applying to all materials used in a craft, one may, perhaps, reasonably suppose that it is given because the instructor's knowledge of the materials is too uncertain for him to specify what qualities are desirable. Generally speaking, the forme is slightly warm when oiled; if it is cold and damp the oiling is almost certain to be unsatisfactory, and the mould may adhere to the type.

We now come to a very important matter: the flong and the materials used in its preparation. First, let us take the paste used to cement the various layers of paper together, and as to this matter one finds in the usual instructions merely a confusing crowd of recipes without the smallest indication as to choice between them, and some of these recipes order the use of materials the special service of which it is very difficult to conjecture.

As an adhesive, ordinary gum (arabic or acacia gum) is undesirable; it penetrates the substance of the paper, tends to make it unmanageably hard and brittle when dry, and, weight for weight, it gives less adhesion between sheet and sheet than is the case with starch or flour paste. Gum is specially bad in relation to the fine tissue which forms the face of the flong, as in penetrating this it not only tends to adhesion with the type, but where the gum has penetrated the face of the cast obtained will have a rougher texture than elsewhere. In addition, gum is expensive, and, what is perhaps worse, very variable in quality.

Starch paste is a very good adhesive, as its water principally penetrates the sheets, leaving the starch where most wanted, and that sponginess, which is a characteristic of good and useful flong, is retained.

Good as simple starch paste is, a paste made from a moderately glutinous flour, such as wheat flour, is better, as the gluten gives the starch greater

consistency and adhesiveness without other disadvantages. Moreover, wheat flour paste is easier to prepare and to manipulate than starch paste, and, if measured by adhesive power, is very much cheaper. Besides, it penetrates the paper even less than starch paste. Altogether the advantage rests with wheat flour paste as the main adhesive.

Glue (the term includes gelatines and sizes) by itself is not a very suitable or desirable adhesive to use, as it is subject to the same disadvantage as gum arabic as regards penetration of the paper, yet in a lesser degree; but when used in conjunction with sufficient flour paste, the penetrating quality is eliminated, and owing to the setting of the glue the flog acquires increased sponginess, and also the valuable quality of being more rapidly compressed by the face of the type when the metal is warm, as the glue melts and consolidates the compressed parts. In addition, by the use of glue along with flour paste, the flog becomes capable of holding rather more water without becoming flabby, and where the flog is not compressed, it dries more spongy than would otherwise be the case. There is advantage in using glue with the paste, whether the type is to be moulded cold or warm, but very especial advantage in the latter case. The sort of glue most suitable is the soft and degenerate glue sold retail in the oilshops at 4*d.* per lb., high-priced hard glues and fine gelatines being very much less suitable. Instead of using glue, it saves time to purchase size, but care should be taken to use the low-priced size sold as common size (14 lb. for 1*s.* in London oilshops), and not the harder and finer size known as "patent size."

We may then dismiss all adhesives but flour paste, and glue; the former can be used by itself, but glue by itself is not very satisfactory. Together they give the best result, for reasons already stated.

It is desirable to mix some mineral matter with the paste, and for this use we find, among other additions, the

following recommended:—Whiting litharge, white lead, kaolin, other clays, Paris white, zinc white, barytes white.

The use of the mineral matter is twofold. It makes the compressed parts of the mould more hard and stony than they would otherwise be, and less subject to blister or scale during drying or casting, and it makes the uncompressed parts of the flog more spongy and uniform in texture. At the same time it makes the whole mould more resistant to heat.

Of the above, the only very definitely objectionable substances are litharge and white lead, as, owing to the moisture and heat the lead poison is specially liable to be absorbed into the system of the workmen; and of the rest, whiting seems the best, its softness of texture, fineness, and the ease with which it is compressed, enabling it well to fulfil the double function as stated above. At any rate, not one of the above is superior to whiting; whiting, moreover, is cheap, and easy to get.

We now come to the preparation of the paste. Into an iron pan put 6 lb. whiting and 20 lb. (2 gal.) water. If the whiting is allowed to remain in the water for 1–2 hours it will be found that the lumps have completely broken down, and the mixing will be easy. If, on the other hand, you try to mix whiting which has only just been put in the water, it works into clots and becomes unmanageable. The hands form the most convenient tools for mixing the whiting and water, as also for working in the next addition, 4½ lb. wheat flour.

This being thoroughly incorporated, the pan is set for the mixture to boil, it being constantly stirred with a wooden stirrer, having a T-shaped head which can be kept in motion close to the bottom of the pan, and so eliminate all chance of burning. As soon as the mixture boils add 14 lb. soft size, or 3½ lb. common glue, 10½ lb. (1 gal. and nearly ½ pint) water. The glue to be soaked in the water till quite soft.

In order to give the paste such qualities as shall ensure the mass keeping

good for years, 4 oz. crystallised phenol (carbolic acid) are now stirred in, and all that remains to be done is to work the mixture through a sieve having about 20 meshes to the linear inch, or it may be strained through a piece of net.

Three sorts of paper are used in making the flong. First, a fine hard tissue paper for the face; secondly, blotting paper to form the porous body; thirdly, stout and tough brown paper for the back, to give strength and to support the blows of the beating brush. It is of very great importance that the tissue paper which forms the face of the flong should be strong and fine in fibre, uniform in texture, and free from holes, all qualities which add to the expense of a paper, and any expenditure which secures the above is well bestowed, economy on this score being bad policy. A tissue which becomes pappy and soft when in contact with the paste, or which allows its exudation through holes, may cause adhesion between the forme and the mould, with the attendant delays and disadvantages. The tissue papers sold for pottery transfers are generally very suitable for stereotyping, and some makers supply a special kind. The sort sold at Lloyd's paper office in Crown-court, at 11*l.* per lb. is made to a special size, 24 by 56 in., so as to be suitable for newspaper work.

As regards the blotting paper, the cheaper sorts answer as well as the more expensive, and I do not think the lowest priced papers contain irregularities or lumps so pronounced as to be disadvantageous. Suitable demy paper, weighing 23 lb. to the ream, costs 10*s.* 6*d.* per ream.

The brown paper for the back of the flong should be made of tough, strong fibre, free from knots and lumps; moreover it should be soft, and not heavily rolled. Such a paper is expensive, costing about 4*l.* per lb.; but, as in the case of tissue, it is poor economy to use a backing paper of unsuitable character.

To prepare some flong, the materials will be:—

	Approximate weight, gr.
Brown paper (1 sq. ft.) ..	200
Blotting paper, 3 thicknesses (3 sq. ft.)	355
Tissue paper (1 sq. ft.) ..	25
	580

The brown paper is laid flat and pasted uniformly by means of a rather soft, flat brush, the paste being, by preference, slightly warm, on account of the glue it contains, although, with the above-mentioned proportions it is possible (though undesirable) to work it cold. A sheet of blotting is now laid on, and the pasting is repeated over each layer of paper, but in the case of the last pasting, which holds down the tissue paper, only a small quantity should be applied, and that as uniformly as practicable. A convenient way of laying down the tissue paper is to roll it on a wooden cylinder, and then to roll it off this on to the pasted surface; and all through the operation great care should be taken that no paste comes in contact with the outside face of the tissue; generally speaking, the wooden roller requires wiping after each use. Close contact of the several constituent sheets of the flong is best ensured by laying a clean paper over it after each addition, and rubbing it down with the hand, or with a cloth folded so as to form a pad. Hard rolling should be avoided, as it tends to lessen that sponginess which is so desirable a quality. If the paste has been applied in about the right quantity, the sq. ft. of flong, the paper of which weighed about 580 gr., will, when wet and fresh, weigh about 1400 gr., about 820 gr. of this being paste; in this state it is too wet and too soft for convenient use, but if exposed to the air until something like 300 gr. of water have evaporated—that is to say, until the sq. ft. weighs about 1100 gr.—its consistency will be right for working. These weights are given principally in order that persons working from directions may be able to prepare a sample which shall have a convenient consistency, after which the remembrance

of this sample should be a sufficient guide.

It is desirable to prepare the flog in the first instance with excess of moisture, and to allow this to evaporate spontaneously, as during this process of evaporation the paper swells and takes a plasticity and sponginess which is difficult to obtain in any other way. Moreover, the manipulation of making the flog is easier and more satisfactory when a soft paste, containing a full proportion of water, is used. If, however, one has occasion to prepare a piece of flog for immediate use, the best way is to employ as little paste as practicable. Quite apart from the question of the amount of moisture present, it is undesirable to make use of freshly-prepared flog, as it is never so homogeneous as that which has been kept for some days. It may be stored in a varnished tin tray of the right size, a stout plate of zinc being laid on the top. Generally speaking, it is best to lay the sheets of flog face to face, as the backs are likely to have been soiled with paste, and paste should be kept from the face. Flog prepared with the above-mentioned paste will keep any length of time without decomposition or mildewing, but it may become partially or completely dry. This may be remedied by one or more dippings in water, with a full allowance of time for its absorption. When flog has completely dried, it is rather a trouble to get it once more into good working condition, the best way being to dip it in cold water, pile it in the storing tray, and keep this latter in a warm place, repeating the operations, if necessary. Dry flog is an article of commerce, but it is more trouble to get it into good working condition than it is to start with the plain sheets of paper. It is often recommended to use two thicknesses of tissue paper on the face of the flog, and to interpose tissue between the several sheets of blotting paper, but these courses are open to objection, and, as far as my experiments go, have no balancing advantage. Two thicknesses of tissue on the face, with paste between,

offer no greater security against paste reaching the type than does one thickness of tissue, and, moreover, for ease and rapidity of application, it is desirable to make the paste as fluid as practicable, and also to so work as not to involve the extra care and labour consumed in applying very thin layers of paste, and it is obvious that the larger the proportion of thin paper entering into the composition of the flog, so much thinner must be the layers of paste in order to obtain flog containing the same proportions of paste and paper. It takes much longer to spread a very thin layer than a moderately thick layer of paste.

Ease and quickness in working are generally on the side of moulding small forms rather than large, so that, when work is sent in assemblages of many pages, it is often desirable to re-impose, so as to bring down the dimensions to demy folio, or thereabout; but when large pages of close matter, such as newspaper pages, are concerned, the stereotyper has no option but to mould the formes as received. When several pages are imposed together for moulding, it is sufficient to allow a pica ($\frac{1}{8}$ in.) between them, unless the edges are to be bevelled, in which case quite twice as much space will be required to allow for the saw cut and two bevels. The type-high clumps, as before stated, surround the whole.

Sometimes the stereotyper will have to clean the forme himself, from the carelessness of the printer who sends it to him, and in this case it should be scrubbed over with a solution of the cheapest quality of caustic soda in water (1 part soda to about 8 water), well rinsed and dried.

The forme, clean, dry, oiled and warm, is laid on a planed slab of iron, or "beating surface," heated from underneath, the heating being by gas or steam. The beating surface may be, and often is, an extension of the bed of the drying press (Fig. 297). The hand is now lightly passed over the face to detect any letter which may stand high, and the "planer" is brought into use if necessary. All is

now ready for the moulding. Take a piece of the flong, dust its surface over with powdered French chalk, taking care to wipe off all excess, then lay it face downwards on the forme, and now comes the operation of beating.

297.

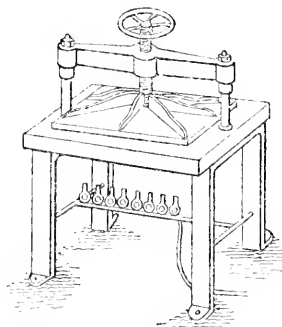

Drying press.

The brush used for beating may vary in shape or weight, according to the habit of the workman, but the bristles must be good and closely packed, and the operation of beating is so similar to that of driving in a nail, that any person who is able to strike his nail every time in such a way that it shall be sent forwards and without any tendency sideways, will probably make a satisfactory mould the first time; while one in whose hand the hammer sways round uncertainly and uncontrolledly, hitting the nail at all sorts of angles, and perhaps even bending it, will not be very successful in making a paper mould from the type. In such a case it is perhaps better to educate the mind to the conditions necessary for successful hammering, by watchfully and painstakingly learning to drive drapers' pins up to the head in deal, than to waste flong and spoil type.

The face of the brush must fall flat on the back of the flong, very little side-driving being sufficient to shift the flong, and spoil the sharpness of the

mould; and a good plan is to first beat a line right across the page, and then to extend this first towards one end of the page and then towards the other. A damp cloth is sometimes laid over the flong in beating, but if the brown paper is tough and nery the cloth is not needed, and much time is saved by not using it—far more than is equivalent to the difference in price between good and bad paper. Moreover, when the cloth is used, it becomes difficult to give such local treatment as is necessary on parts where words or rules stand almost by themselves, or where there may be a mass of small type closely set, to say nothing of the special treatment required where engravings are included in the forme. As a rough guide to the extent to which the beating is to be continued, it may be stated that with flong of the right degree of softness, the divisions between the words set in long primer or brevier should show distinctly on the back of the flong. If the flong is very soft, the beating must not be continued until these divisions are so distinct as with normal flong, and if the flong is very hard one will only obtain sufficient relief by making the divisions show very clearly.

The progress of the beating may always be seen by steadying the mould with one hand and turning back one corner, and the flong should always be so soft that this can be done without straining or stretching the part turned over. Where there are extensive whites in the forme, the mould will be arched downwards, and some support is needed in such places, or the arched parts would crush down by the weight of metal in the casting-box, and much metal would have to be cut away from the plate. The usual way is to paste the back of the flong, and to lay in the deep parts a few pieces of paste-board or of old mould, after which a second sheet of brown paper is pasted and laid over all. A very gentle beating is now given to the mould, care being taken not to beat this last paper down into the hollows, as the main use of this sheet is to string or tie the domes and

hollows formed in the main part of the flong.

Another way — more employed in newspaper offices — is to fill in the hollows with whiting, or dry plaster of Paris; the pasted sheet of brown paper being laid over as before.

The impression is now sharpened up by planing. The printer's planer — which is a slab of hard wood — is placed on the mould and struck several times with a mallet. This should be repeated several times, moving the planer between-times, and care must be taken not to shift or strain the mould sideways. Two or three thicknesses of blanket, or still better, enough blotting paper to make up about $\frac{1}{2}$ in. thick, being placed over the mould, the forme and mould are pinched up in the drying press (Fig. 297).

A few words more about the beating brush. If the face is not level, or should become unlevel by use, it may be burned flat by contact with a plate of iron heated to a dull redness, and by the same means the edge and corners farthest from the handle may be very slightly sloped off, thus making it more easy to give local treatment to any special part of the mould. Workmen who have skill and confidence in the use of the brush may strike tolerably hard, and they often find it a convenience to load the brush by fastening a plate of lead to the back. Some of the Continental workmen, instead of using a brush, prefer to use a wooden blank provided with a handle and covered with several thicknesses of cloth or "moleskin." Then, again, a rolling machine, or a vertical press, is occasionally used in making the mould, but the press and rolling machine are of little use except in the case of tolerably solid and uniform formes, such as the pages of a newspaper. The rolling machine formouling consists merely of a moving bed with an adjustable cylinder over it, bed and cylinder being geared together. The machine, however, is seldom used without the brush being used as an adjunct. Sometimes the press or machine is used to set the flong firmly in position

on the type, the brush being used for finishing; and sometimes the brush is used first, and the machine is employed to sharpen up the impression, to do what the planer does in the process of making a mould by hand.

A sufficient drying of the mould may be effected in as short a time as 3-4 minutes, in which case the heat is urged almost to the softening point of the type, or the heat may be more moderate, so that the drying takes as much as $\frac{1}{2}$ hour. It may, however, be taken that in the case of ordinary commercial stereotyping some water is invariably left in the mould; many hours baking at a temperature of 200° C. being necessary for the removal of the last traces of moisture. So that, when the best possible results are required, it is desirable to considerably extend the time allowed for drying.

In ordinary cases — the work not being subject to the extreme need of haste which exists in the case of newspaper stereotyping — the forme will remain in the drying press for 10-15 minutes, during which time the blanket (or covering of blotting paper, as the case may be) may have been changed 2 or 3 times; or if this is not done, the press should be undone, and the covering turned over to allow the more ready escape of moisture. All this time the bed of the press may be conveniently heated to a temperature of 100°-130° C. the former being about the degree of heat obtained if the bed forms the top of a steam-chest fed with waste or "exhaust" steam; but if "live" steam of about 30 lb. pressure is used, the temperature will be something like 130° C.

To return to the forme and mould. The mould leaves the forme at once. When any adhesion occurs, something is wrong with the work, *e.g.*, tissue paper not impervious; excess of paste under tissue paper, thus breaking up tissue; tissue broken in beating, from too hard blows or extreme softness of flong; mould too deep, so as to fit over the shanks of the types, or even penetrating between them; paste on face of the flong, from careless making or piling;

imperfect oiling of forme, or unsuitable oil; alkali or other foreign matter on type.

But a slight tendency to adhere can generally be combated by repeatedly lifting the edges of the mould, as far as is possible without bending or straining the mould; and then letting it spring back; at the same time slightly loosening the quoins and beating the back of the mould with the brush. (Fig. 298).

298.



Beating brush.

In the case of persistent sticking, the only alternative is to heat the forme once more and repeatedly moisten the back of the mould with water. In this case the mould will be spoiled.

The mould, as it comes off the forme, is dry to the touch, but ordinarily not dry enough to give a good cast, and before drying it further it is convenient to trim the edges to the outsides of the gutters left by the clumps; and to paste on to one end a flap of brown paper long enough to project 2 in. or so out of the casting-box, and, at the same time, to allow a head of metal of not less than 6 in. For this purpose, a more adhesive paste is required than that used for making the flog. Stiff rye flour paste is best.

The mould may now be laid on a hot surface to further dry, or, better still, it may be baked in a steam or gas-oven, heated to about the same temperature as the moulding press; but in any case it should be kept flat by placing over it a piece of heavy but small-meshed wire net, and if necessary a weight is put upon this. A suitable wire net is made with iron wire of No. 16 I.W.G. (.064 in. diameter), and 6 meshes to the linear inch, and can be had from firms that furnish millers' plant. The ordinary wire gauze or net sold at the hardware shops, having 6 meshes to the inch, is

made of much thinner wire, and is not much used for the present purpose, as it has not sufficient rigidity to keep its shape as a slab or plate. The wire net should be in contact with the tissue paper side or face of the mould, as slight indentation on this side will do no harm, whereas any indentation on the back of the mould will show on the face of the cast; and when several moulds are piled in the oven for baking, they should be laid back to back and face to face, with a piece of sheet metal (say stout tinplate) between the backs, and one of the wire-net sheets between the faces.

The baking, or second drying, being at an end, we come to the casting, and before this is done it is a very common practice to brush some finely powdered French chalk into the mould, and then to dust out the excess by turning the mould face downwards, and gently beating the back with a flat slice of cane. This is quite unnecessary if the mould is very dry; but by the use of French chalk the effect of any trace of moisture remaining in the mould is minimised, and, moreover, the cast separates from the mould more easily—a matter of some importance when it is wished to make several casts in the same mould.

All is now ready for laying the mould in the casting-box, the casting-box having been warmed by a gas jet underneath, or by casting a few blanks in it. The mould is laid face upwards on the horizontal slab of the casting-box (Fig. 299), the brown paper flap hanging a little over the lip of the box. The picahigh gauges are laid along the gutters formed by the clumps, the top leaf of the box is closed down and clamped by the screw, and the casting-box is swung on its axis, so as to bring the lips to the top.

When stock sizes have to be stereotyped, it is convenient to use set gauges, like Figs. 300 or 301, but in other cases it is usual to employ adjustable gauges, such as Fig. 302.

When the mould is charged with type-metal, it is necessary, in order to

obtain a good cast, that the whole of the metal inside should remain fluid until the mould is completely filled with metal, as if any part solidifies before the mould is full, the cast is sure to show curved streaks where the cast has

299.

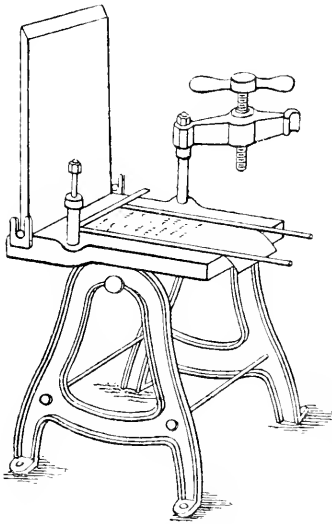

Casting box.

solidified, and the fresh metal has not run up so closely as to make a sound cast. This is most noticeable at the back of the cast, where the casting-box

302.

300.

301.

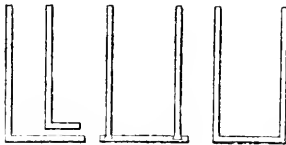

Stereotype gauges.

exercises the most sudden cooling action on the metal, and the object of heating the casting-box is to diminish the tendency to this sort of thing. Heating the

casting-box is generally insufficient in itself, when the cast is large, unless the heat is raised to nearly the melting point of the metal—an obviously inconvenient course. It is very much more convenient and satisfactory to warm the box only slightly (say to about 100° C.), and to cover the face with a non-conducting coating, which may be extremely thin; in fact it is sufficient to sponge the iron plate over with a very thin wash of jewellers' rouge (finely divided ferric oxide, or practically, much the same thing as finely divided iron rust) and water, a film of the oxide so thin as to be scarcely noticeable serving to retard the solidification of the metal during the short time required to fill the mould. Although a thin wash of jewellers' rouge is the best coating material to employ when very delicate castings of type metal are to be made in metal moulds (as, for example, in casting the thinnest "leads"), a thicker and coarser mixture, made by stirring $\frac{1}{4}$ lb. red ochre into $\frac{1}{2}$ pint water, is often used, this being applied with a brush. London stereotypers, however, more usually lay a sheet of thin card-board over the back plate, or a sheet of thin paper will be quite as effectual in preventing the chilling of the metal; but stereotypers generally prefer the card, as lasting longer and being easier to handle. The card, however, is liable to blister, and so cause inequalities in the thickness of the plates. In the absence of a metal casting-box, excellent work may be done by using two slabs of dry wood, held together by screw clamps.

All is now ready for the casting of the stereotype. To ascertain whether the temperature of the metal is about right, a strip of card or of old mould is immersed in it for a few seconds. If the card becomes of a medium brown, the heat is right (about 320° - 330° C.), if it chars and blackens, the temperature is too high; should it merely become yellowish or light brown, more heat must be applied. When the metal is too hot, it can be rapidly brought down by stirring in some cold metal. It is

important that, when poured, the surface of the metal should be clean and free from scum or oxide, as this might lodge in the cavities of the mould and render the cast unsound; and the most convenient way of cleaning the surface is to throw into the pot some powdered rosin, which melts and so far agglomerates the oxide that it can readily be removed by skimming with a perforated iron spoon. Sufficient metal is now taken out of the pot by an iron ladle—one with a flat pouring-side (Fig. 303)

303.



Ladle.

is often used—and the metal is poured steadily, but not so quickly as to cause splashing, into the mould. Under ordinary circumstances, it makes but little difference whether the stream is poured against the back plate of the casting-box or against the face of the mould, although the former is the most usual course, and some persons make a point of drawing the ladle along the lips of the mould during the operation of casting.

The metal used for stereotyping is much the same as ordinary type metal, only, as a rule, the stereotyper is content with an alloy tending too much towards softness, while of late years type founders have been moving in the direction of harder and harder metal. An alloy well suited for ordinary work contains 20 per cent. of antimony, the remainder being lead; or lead 4 parts, antimony 1 part. For preparing this alloy, a very safe lead to use is the soft lead which has formed the linings of tea-chests, or if commercial pig lead is used, a soft sample should be selected, and this may be sufficiently judged of by scratching the surface with the finger nail. Hard pigs often contain traces of zinc; this metal, which is especially bad in stereotyping alloys, being used in some of the desilverising

processes, and the last traces are not always removed. When, however, the hardness of the pig lead is known to be due to antimony, copper, or tin, it may be used quite safely; in fact, hard lead then becomes more desirable than soft lead. The lead and antimony being put together into the iron melting pot, sufficient heat is applied to melt the former, when the antimony gradually dissolves in the melted lead, forming an alloy which fuses at about 300° C. Lead melts at something like 330° C., while antimony fuses at 450° C., or a low red heat; the stereotype metal following the general rule that alloys melt at considerably lower temperatures than the mean melting points of their constituents. Sometimes stereotypers reduce the proportion of antimony so that the alloy only contains 10 per cent. of the metal, but in this case the alloy is noticeably soft, and wears badly in printing. A very superior stereotype metal, which is not only harder but more fusible than the above-mentioned, can be made by melting together 3 parts lead, 1 of antimony, and 1 of tin. Old mixed type generally makes an excellent stereotype metal, and will often bear the addition of nearly half its weight of lead. Type metals, like so many alloys, are harder when the cooling has been very rapid than when it has been comparatively slow, and casts obtained, in a given alloy, by the paper process, are consequently softer than those by the striking process of Carez and Didot.

The most positively objectionable impurity likely to find its way into the stereotyping metal is zinc, this metal making the alloy flow badly, and the face of the cast rough and patchy, doubtless by its tendency to separate from the other metals. It is, therefore, important to keep watch against its introduction into the stereotype foundry, and in melting up old type or scraps, any portions which remain unmelted, and float on the surface after the bulk is fused, should be skimmed off, as these are likely to contain the lighter and less fusible zinc. The larger the proportion of lead in the stereotype

metal, so much greater is the evil effect of the zinc. Zinc in lead or in type metal may be removed by calcining at a low red heat, the zinc oxidising with the first portions of the lead; but the same treatment also removes the antimony, or at any rate a considerable proportion of it. The tendency of antimony to oxidise is so much greater than that of the lead, that stereotype metal used many times becomes softer from the loss of antimony. A little arsenic—say 1-2 per cent.—increases the fluidity and hardness of a stereotyping metal.

Now take the cast out of the box, and the usual thing is to trim it, or cut it up into pages with a circular saw, and as the cuttings are carried round by the saw, and thrown upwards and forwards by the ascending side, it is usual to fix a screen (as shown in Fig. 304), to pre-

304.

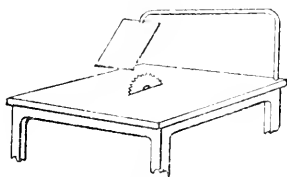

Circular saw.

vent them going into the eyes of the operator. The screen is ordinarily made of sheet metal, but sometimes a neatly fitted and curved glass plate is used. Generally speaking, however, I have preferred to use a leaf of the transparent flexible celluloid, which can now be readily obtained as thin as a card, and as transparent as glass.

Instead of a circular saw, the tool known as a zinc hook (Fig. 305) may be used for dividing the plate. A metal straight-edge is used as a guide, and the cutting edge of the zinc hook is drawn along it a sufficient number of times to plough a groove half through the plate, when it becomes easy to break it.

For trimming the edges, a hand plane

is ordinarily used in conjunction with a shooting board, the ordinary wooden shooting board and jack-plane of the joiner answering the purpose very well. Fig. 306 represents an iron shooting

305.



Zinc hook.

306.

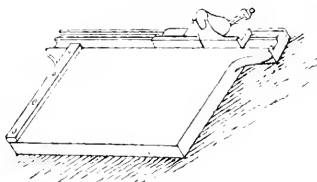

Shooting board.

board and iron plane specially made for stereotypers' use, a second plane being provided for bevelling. When the trimming planes are driven by power, the arrangement is generally substantially similar, the plane moving to and fro on a guide, while the plate to be trimmed is fed up against it, although sometimes a revolving cutting is used instead of a plane.

Thin stereotypes, cast pica-high for mounting on blocks, ought not to require planing at the back, provided that reasonable attention is devoted to matters which influence their thickness and truth, such as the flatness of the slabs of the casting-box, the accuracy and right placing of the gauges, the keeping of the mould flat while drying, and the proper condition of the cardboard covering the back slab of the casting-box. It is easy to cast plates so true as to require no planing, indeed so true that the arrangement ordinarily used for planing or rather scraping, the backs of thin stereotypes, would make them worse, not better. The arrangement is a kind of drawbench in

which the plate is slowly forced under a stout knife placed almost vertically, and one form of it is represented by Fig. 307.

The travelling part is one with the two racks, while the double gearing and the arrangement for reversing by shifting

an angle of 60° on the approaching side, and 15° is a good angle for cutting edge, leaving an angle of relief of 15° . When a cutting tool rapidly removes small shavings of stereotype metal—as in the case of a circular saw or rotary cutter—there is a tendency for the clean

307.

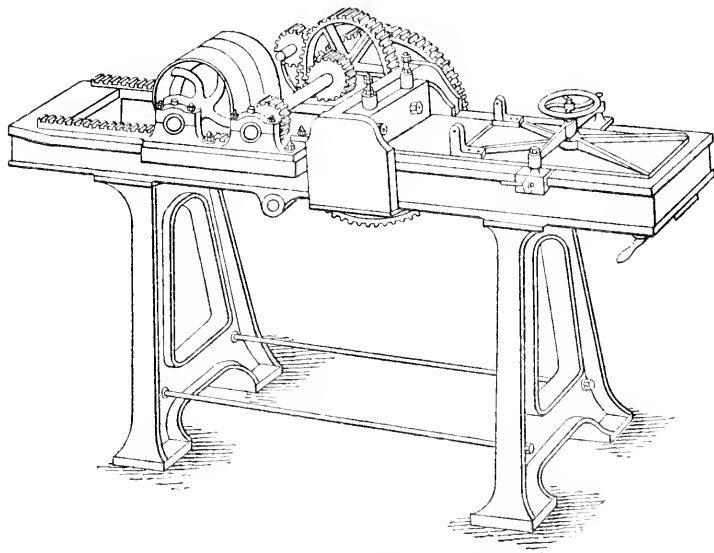

Draw bench for scraping back of plates.

the strap from the middle pulley—which is idle—to the right or left, according as one wants backward or forward motion, will be obvious to anyone who has given attention to machinery. The slow heavy cut, with a cutter at right angles to the plate, is essentially wrong, and tends to drag the plate out of shape, and, unless care is taken will sometimes lift it from the bed of the machine. A machine tool for cutting stereotype metal will not work efficiently at a much less speed than 12 ft. per second between it and the metal. In ordinary cases, the cut is clean and easy with such a speed, and

particles of metal to weld together, and also for some of them to weld upon the clean surface of the work, thus making it rough, but a minute film of thin mineral lubricating oil prevents the tendency to welding, and it is generally sufficient to allow a brush charged with the oil to very lightly play against the cutter or the work, according to circumstances. The free use of oil on stereotypes is objectionable for obvious reasons. For heavy work, water containing a little soap is more efficient, but it must be used freely. The above remarks as to the relation of stereotype metal to cutting tools apply more

especially to the ordinary and rather soft alloys. It is a matter of surprise to me that a planing machine with a revolving cutter like that used for thickening floor boards is not always used for the backs of stereotypes when planing is required.

In most cases—at any rate for jobbing work—the stereotype plates are brought up to type height by being nailed or screwed down on mahogany boards, these being, roughly speaking, $\frac{3}{4}$ in. high; and, from the printer's point of view, it is very desirable that the thickness of the whole should exactly equal the height of the type, a matter which may very well be gauged by a sort of bridge (Fig. 308), under

308.

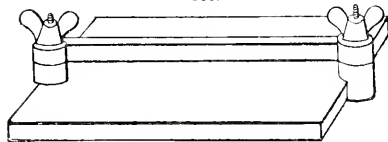

Gauge for height.

which the mounted stereotype can be just passed if it is the right height. Wood blocks expand when exposed to damp, and contract when they dry, and consequently they vary from time to time; so printers, when using wood-mounted stereotypes, would save time by passing them one at a time, and face downwards, under such a bridge set to type height. The low places can then be readily brought up with paper patches in far less time than when made up in the chase. As a matter of fact, stereotypers very seldom send out the blocks too high, as the printer finds it much easier to pack up than to plane off.

Printing from stereotypes becomes much more easy and certain if, instead of being mounted upon material which, like wood, varies in thickness with difference in the degree of dryness, the stereotypes are either cast type-high in the first instance, or are mounted upon

some firm foundation not subject to considerable variations of thickness.

Casting the plates type-high is a common practice for ephemeral work, as in that case the plates can be melted as soon as done with; but it is the usual practice not to cast the plate quite solid, a number of hollow spaces at the bottom, generally arched or domed, serving to lighten the plate. Any person with elementary notions of handicraft can devise for himself ready means of making cores for placing in the casting-box so as to produce the required cavities, and several ingenious forms of adjustable core are now made, among which may be specially mentioned that in which a set of core-bars of graduated sizes enables one to readily cast type-high blocks to any required width. For very small blocks, it is more convenient to cast solid, and if reasonable care is taken, the blocks may be cast so accurately to type-height, that planing at the back becomes quite unnecessary, and the sides may readily be squared up with the hand plane (Fig. 306), or sometimes it is more convenient to cast small metal mounting-blocks, and to solder the thin stereotypes upon these.

Metal mounting-blocks, upon which bevel-edged stereotype plates are held by catches placed round the edges, are on the market in various forms, much cleverness being sometimes noticeable in the devices for enabling the printer to build up any required size of mounting-block out of stock sizes. In the case of an ingenious device by Harvey Dalziel, the loose clips are avoided, and by dividing the mounting-block diagonally, variations in size are very readily provided for by the insertion of suitable distance pieces. Fig. 309 illustrates the arrangement. The small diagram at the west side is a sectional view showing the clips, which are one with the blocks, and it also shows the coring of the blocks, while the diagram under it shows a pair of twin blocks in plan. Next we have the same adapted for a larger plate by the insertion of one of the various distance pieces, a series of

which is shown on the outer side of the group. Fine adjustments can be made by inserting an ordinary lead, and it is obvious that these adjustments can be made to take effect either across or along the page, or may be apportioned between the two.

shooting board (Fig. 306) being convenient for this purpose. For working in narrow places, and close up to the type face, a "firmer" chisel of suitable width may be used, or a scraper shaped like Fig. 310, and one angle of the scraper may advantageously be ground

309.

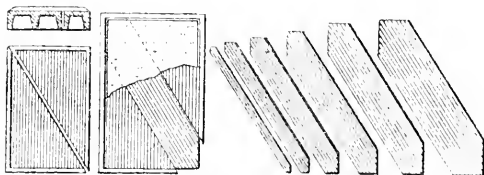

Dalziel's stereo blocks.

A very firm and satisfactory blocking up of the stereo plate is a method due to Brightley. A few short pieces of wire are soldered to the back of the plate, and it is laid on its face and surrounded with a type-high border. A mixture of calcareous cement and water is filled in level with the top of the border, and a flat plate, slightly oiled, is laid over and weighted. Brightley used Roman cement, but in the present day Portland cement is more convenient. This method is unsuitable when the plates are wanted for immediate use, as in ordinary cases the mould should not be removed for about 12 hours, and 2 days should elapse before the mounted stereotypes are used for printing.

It very often happens that the stereotype requires some work done upon its face, such as cutting away the parts corresponding to large white surfaces, raising low parts, or "sinks," or soldering in letters or electrotypes. For chipping away extended whites, a very convenient tool is the carpenters' gouge, driven by a rather light mallet, an assortment of 4 or 5 gouges, the narrowest about $\frac{3}{16}$ -in. across, being ample. When chipping away the metal with gouge and mallet, it is desirable to place the stereotype on a planed iron surface, provided with a transverse bar against which it can rest, the iron

on the edge of the grindstone, so as to shape it into a chisel-like tongue about $\frac{1}{16}$ -in. wide, or a special tool, like Fig. 311 may be used for scraping between the lines. Sometimes a routing-out machine is used, in which a conical dome-shaped revolving cutter,

310.



Triangular scraper.

311.

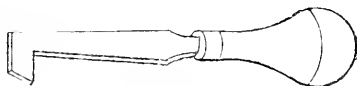

Parallel ended scraper.

provided with universal movements, is brought down on the plate; but, in ordinary cases, there is little or no saving of time by the use of such a machine. When there is a "sink" on the face of the stereotype—this being generally the result of an arching of the mould*—it may be brought up by

* May arise from a scrap of metal or other foreign body under the flong, penetration of liquid metal through a hole in the flong, or the joint of the paper flap, from distortions of the mould during drying, or by careless clamping up in the casting-box.

laying the plate face down on a planed iron surface (a sheet of paper being interposed if this is thought necessary), and hammering on the back with a broad and round-faced hammer, such as that used by shoemakers for beating out leather; a little paper packing being then pasted on the back to support the hollow. In beating down the "sink," care must be taken to strike in the middle of the place rather than at the edges, and to strike the fewest blows

in a type requires some care and watchfulness, but it is very easily done. The stereotype is clamped face upwards on the punching-out slab (Fig. 312), and with the line containing the false letter immediately in front of the bridge. The adjustable part of the bed, shown at the left of the diagram, being now set so as to leave a gap exactly under the line, the chisel (Fig. 313) is used to make an indentation round the letter, at any rate on those sides where access

312.

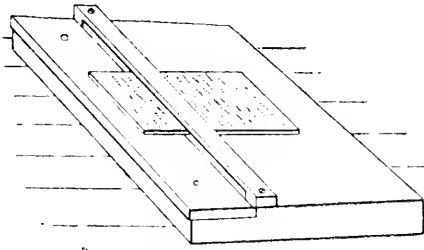

Punching-out slab.

that will do the work, otherwise the plate may be distorted so much as to render it useless. In the case of the thick curved stereotypes used for newspaper work on rotary machines, the

can be had, the chisel being placed with the unbevelled side next the letter to be removed, and being held vertically. A punch like one of those shown in Fig. 313, and of the right size for the letter to be removed, is now held firmly atop of the letter, and is driven through the plate by a hammer. Any metal driven beyond the plane of the back may now be cut off with a sharp chisel; and if any indentation of the face round about the hole is visible, it can be dealt with as re-

commended in the case of a "sink." The hole is now trimmed, by means of a rectangular file†, to the bare size of the type to be inserted, and the type, after having been scraped clean on

313.

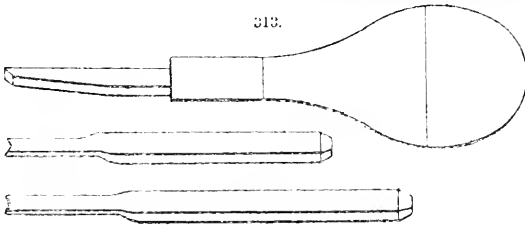

Tools for removing false letters.

machine minder will often bring up a low line* by driving a chisel obliquely into the metal above it and below it.

Cutting out a false letter and solder-

* The standing lines in newspapers and periodicals are often low to paper.

the sides, is inserted from the back. The face of the letter having been

† Files of rectangular section down to a square file about $\frac{3}{16}$ in. across can be obtained at watchmakers' material shops of Clerkenwell or Soho.

adjusted to its exact position and level, the stereotype is laid face downwards on the punching-out slab, no paper being interposed between them. A little powdered rosin is dusted on, and with a rather fine pointed soldering bit a trace of solder is applied at two opposite points of the join. The shank of the type is then nipped or broken off, and the place is filed or scraped level. Sometimes a skilled workman will put a patch of solder over a false letter, and out of this engrave the required character, but such a method of working is more usually adopted when a dot or the tail of a letter is broken off and must be replaced.

The soldering is very easy if a few points are attended to. The copper bit being heated to a heat a little under redness, is rapidly cleaned about the point with a file, and quickly dipped into an acid solution of chloride of zinc,* and then rubbed on a stick of soft solder which itself has been moistened with the same solution; it thus becomes well amalgamated with the solder, or is "tinned," to use the expression of the workshop. To keep the soldering bit in a good condition, its tip may be rapidly dipped in the acid chloride of zinc solution after each heating, and being then charged with solder it is ready for use on the stereotype plate, and if the part to be soldered is sprinkled over with powdered rosin, this will be sufficient protection, and the small drop of solder carried up on the tip of the bit will unite and flow readily. The acid chloride of zinc solution should not be applied to the type metal, as it rather corrodes it than protects it.

When much soldering has to be done, as for example, if electrotypes of woodcuts are to be soldered into stereotype plates, a soldering bit, heated by a small gas blowpipe, is a great convenience and saving of time, and the device represented in Fig. 314 is a specially

* Commercial hydrochloric acid saturated with zinc, and when poured off from the excess of metal, is mixed with $\frac{1}{4}$ its bulk of hydrochloric acid.

convenient one for the stereotyper, and the instrument itself can easily be constructed by any all-round mechanic. The tubes leading gas and air respectively (the air being conveniently supplied by a foot bellows) are shown first

314.

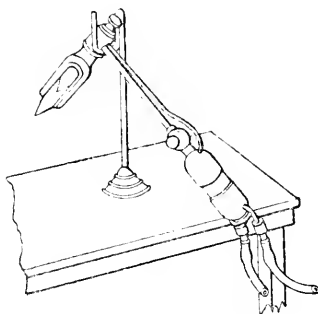

Soldering bit.

passing through a wooden handle and thence into the cylindrical head of the apparatus, where is fitted a small Herapath's blowpipe, the flame of which plays upon the small copper bit held, as shown, by two lugs extending from the cylindrical head. A cock is placed on the gas-pipe just over the handle, and where it can be operated by the thumb of the right-hand, while the crutch shown on the figure forms a convenient support for the blowpipe when not in use.

Although very little care and attention on the part of the workman will enable him to use ordinary soft solder of the tinman without fear of melting the adjacent parts of the plate, there are cases where it may be desirable to use a more fusible solder, in which case Wood's cadmium solder may be employed. It melts at a temperature considerably under that of ordinary solder, works nearly as easily, and is quite as strong. It is prepared by melting together cadmium 2 parts, tin 4 parts, and lead 2 parts.

An alloy of bismuth 2 parts, tin 1 part, and lead 1 part, forms a solder

easy to use, moderately strong, and melting below the boiling point of water. When figures have to be altered several times, this solder is convenient to use, as those first soldered in can be readily removed by immersing the plate in boiling water or heating it till, when touched with a wet finger, one can just feel steam formed, then giving the figure a slight tap to drive it out.

In stereotyping for newspaper work, everything is carefully studied to attain speed, especially in the case of the evening papers, and it becomes possible to mould a page and cast a plate in about 10 minutes. In such cases, the plates are cast curved, so as to fit the cylinder of the machine used.

Two workmen beat the flong to make the mould; a rolling press being often used to finish the moulding. There is generally very little packing of the whites to be done, so it suffices to sprinkle a little whiting upon the back of the mould, and scrape it into the hollows with a straight-edge, after which the final thickness of brown paper is pasted on, and the forme is run under a hot press to dry, the heat being as great as can be ventured upon without damage to the type. In 2-3 minutes the mould is removed, finally dried on a hot surface for another similar period, is dusted with French chalk, and is then placed in a curved casting-box (Fig. 315), the metal being poured in at the side of the page, while in the older pattern of curved casting-box it was poured in at the top. The metal is poured from a large three-handled ladle like that used in iron foundries. The trimming of the cast is generally done while it is warm, and by slow-moving tools, as chips rapidly removed from the hot metal are more likely to weld on the freshly-cut surface than is the case with cold metal. Therefore, the ordinary machine for boring the inside of the cast, and in which a single knife is made to revolve slowly and take one heavy cut (Fig. 316), is less unsuitable than might at first sight be supposed. But in this case, if a revolving cutter were used, and were

fed with slightly soapy water by a series of conduits in the cutter-bar, it is quite likely some economy of time would be effected. Soap, like oil, soils the surface of the type metal sufficiently to prevent welding.

315.

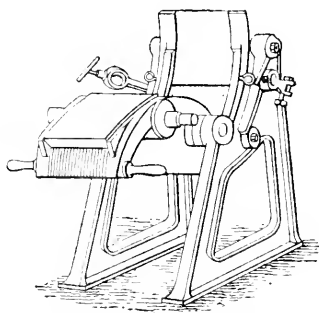

Casting-box for curved plates.

316.

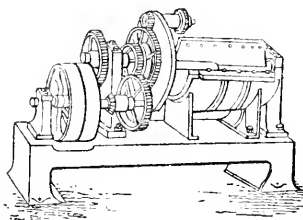

Machine for boring inside of curved plates.

A common form of apparatus for trimming and bevelling the edges of the curved stereotypes is that shown in Fig. 317, the plate being clamped down on a suitable saddle, and trimmed by adjustable knives, the holders of which are moved backwards and forwards by hand. Another trimming machine is represented by Fig. 318. In this case we have a revolving cutter and the plate is fixed upon a saddle which traverses and rotates by hand gearing.

Occasionally plates intended for printing on rotary machines are cast flat

and afterwards bent to the required curve, and there are two methods of doing this. In one case the plate, previously warmed, is forced down into a

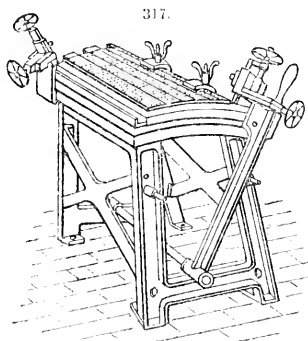

Trimming curved plates.

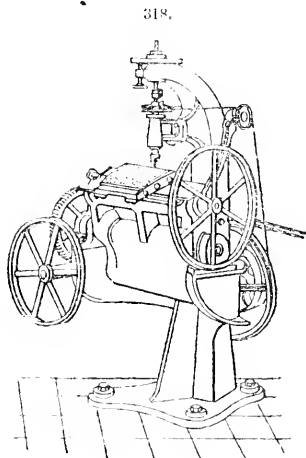

Revolving cutter.

curved die by a sort of platten formed of stiff leaves of spring steel, but when the same machine is intended to bend to any curve, a bed piece, similarly formed of plates of spring steel, must be

laid over the die. In the other case the stereotype is laid between steel plates thin enough to spring, and is rolled several times through a set of 3 rollers, one of which is adjustable so as to give the required set.

In either case, it is necessary to place paper or a blanket between the face of the stereotype and the steel plate, and the results of the bending are seldom quite satisfactory, unless the plate to be bent is fairly solid, as in the case of an ordinary newspaper page, any extended whites interfering with the regularity of the bending. In the case of electrotypes, which are ordinarily backed up with a softer metal, the bending is easier, and electrotypes are often bent that they may be soldered into curved plates for illustrated newspaper work.

The work of the newspaper stereotyper is very seriously interfered with if any wood-mounted blocks are inserted in the forme he has to mould, the heat passing so much more slowly through wood than through metal as to make it almost a matter of certainty that the mould will be less dry when over such blocks; this being not only calculated to give a rough face to the lines, but also to lead to a distortion of the face of the mould in the second drying. This evil is especially apparent in the case of the zinc process blocks, which are made very thin, and are consequently mounted on an extra thick block of wood. The separate moulding of the blocks and casting type high, or the mounting of them upon solid metal bases, is so easy that there is scarcely an excuse for being so unfair to the workman as to send pages containing wood-mounted blocks when a stereotype is required in a minimum of time.

Probably the interfering influence of the wood mount is largely responsible for the tradition that the paper process is unsuited for the reproduction of the finest engraved work, but personally I am quite convinced that if all or most reasonable precautions* are taken to

* Such as clean and evenly but slightly oiled original; well united, thoroughly seasoned

ensure the very best results, stereotypes can be made by the paper process, which are equal in fineness of surface and definition to the best electrotypes, and are superior in durability to many of the very thin shells of copper on a base of very soft metal, which pass now-a-days. The paper process is, however, very ill adapted for moulding direct from wood cuts, owing to the action of the heat and moisture on the wood; and it is seldom employed for this purpose unless in the case of very small blocks, or when time necessitates it. The stereotype by the paper process is, when at its best, smooth, brilliant, and lustrous on the face, where the metal takes the impress of the compressed and hardened matrix; while the low parts, which are cast in contact with the spongy part of the mould, are always rough and often unsound in the sense of being permeated by holes and faults. The depths are nicely rounded and the square shoulders of the type-shanks show not at all, or only faintly.

In all ordinary stereotyping work, some moisture remains in the mould. It is possible to make a fairly sharp cast in a mould which is quite wet. By using Wood's fusible metal,* which melts considerably under the boiling point of water—say between 60° and 70° C.—a very fairly good cast is obtained, the heat not being sufficient to convert the water into steam. This experiment is interesting, not only as showing a possible means of making a stereotype in a shorter period than the usual time—although the high price of bismuth tends to put it outside practical work—but also as illustrating a point of some

importance, that, in the case of a mould not very thoroughly dried, the best result is obtained with the metal at as low a temperature as practicable, whereas in the case of a mould baked for a long time, the hotter the metal is, the better the result, provided it just stops short of burning the paper; so it is possible to have failures either from the metal being too hot or too cold. The use of French chalk on the face of the mould tends to minimise the mischief resulting from traces of moisture in the mould, but as it invariably makes the face of the cast a little rough, it should only be used when needed. Another use of French chalk is when numerous casts are required from the same mould, as it tends to prevent adhesion between the cast and the mould. When a large number of casts are required from one mould, other precautions to be observed are to use a well-cemented and ripened flong which is not too soft, to avoid making the mould too deep, and to beat with numerous gentle blows, rather than with a smaller number of heavy blows, as this tends to give a mould in which the depths are nicely rounded off, and do not follow the nearly vertical sides of the type face. Again, patches of old mould, or pieces of thin sheet metal, may be laid in the more considerable depths of the forme, so as to support the flong where subject to the greatest strain. Some stereotypers do this in the case of most ordinary work; while those who have a difficulty in beating the flong without shifting it, do the same in the case of all very open formes.

The question of damage to type during the process of stereotyping is one of some importance, and it mainly steps in when a high temperature is employed for drying. If the forme is very tightly locked up in the chase it may, in expanding and softening under the heat, become elongated, while, on the other hand, it may become shortened by the pressure of the drying-press. These two circumstances tend to make a newspaper fount become of unequal

and rather dry flong; drying thoroughly in the press with occasional tightening up; long baking of the mould; non-use of French chalk; a suitable hard metal—say the tin alloy mentioned—and this at as high a temperature as the mould will bear; and a considerable "head" and margin of metal in casting, the margin being of the full thickness of the gauges.

* 1 part cadmium, 2 tin, 4 lead, and 7 bismuth.

height, and the fount is rendered useless.

Let the formes be locked with only a moderate force, sufficient to secure safe lifting. With the enormous power at the operator's command, only a slight turn of the wrench produces enough pressure on the type to secure this end—which may be verified by experiment—and then loosen the formes as soon as they are placed on the hot stereotyping bed, so as to allow for expansion. When possible, lifting the formes at all should be dispensed with: they should be imposed and then slid along on a continuous bed or imposing surface right on to the moulding bed, so as to avoid all possibility of accident. With such convenience at command, there would be no necessity at all for excessively powerful locking apparatus, and the ordinary wooden quoin and side-stick would be found sufficient. We strongly advocate the insertion of wood furniture—say about two-line pica reglet—between the long side-stick and the type; for, in case of undue expansion of the type in the process of moulding for stereotyping, the wood would give way before the metal type, and the latter would therefore be preserved.

It is sometimes desirable to mould work, in case of a future demand; but this is not done so often as it might, because the printer does not care to take the trouble of sending the formes to the stereotyper. Now it is a very easy and inexpensive thing for any printer to mould his formes immediately they come from the machine, and to keep the moulds in case of future need. Take the formes of a 16-page publication; a set of light metal frames fit in the gutters so as to bring these up to the level of the face of the type. The pieces of flong—each corresponding to a page, with the necessary margin—may be rather over-dry than moist; with them you can mould a page at a time, and not many seconds are required for moulding each page, while as each mould is made it is lifted off and set aside. The formes need not even be washed, as the remaining ink does no

harm in this case; and the moulds being removed at once, there would be but little risk of adhesion, even if there were not a trace of ink on the type. The damp moulds are now laid between quires of rough paper, this being sufficient to keep them flat during the time of drying, which may be several days. When dry, they are stored away in bundles. In casting from one of these moulds a few pieces of old mould are pasted into the hollows at the back, and the brown paper flap is pasted as usual on that edge which is to be the top, but the extra thickness of brown paper at the back is dispensed with. In some newspaper offices, it is the practice to take the moulds off some of the earlier pages while wet, and dry them separately. When the mould is removed wet, there is a contraction of about $\frac{1}{130}$ linear.

More or less successful attempts have been made in the direction of moulding the type in a dry and spongy millboard, and casting at once—these methods being called instantaneous stereotyping processes; but nothing of this sort has come into general use. The pressure required for a newspaper page would be enormous, and the results hitherto have not been quite satisfactory.

The paper process of stereotyping lends itself very well to the production of plates for printing in several colours, whether for typographic or block work. A series of plates cast in immediate succession, in the same well-dried mould, corresponding very exactly; and it is better to cut away from each plate those parts not wanted, than to attempt to block them out in the mould, as this latter course may easily lead to distortion. In cutting away the waste metal from the plates, care must be taken not to strain or distort them, and for such a purpose the routing-out tool alluded to is very useful.

The mention of cutting away plates for printing in several colours recalls a use made of stereotypes early in this century by Charles Babbage. He would obtain a number of casts of a block showing a complex machine, and by

cutting them away he would produce a separate block showing each important organ of the machine, and these would be printed alongside the complete sketch.

TOBACCO PIPES.

Among the branches of industry which have been a consequence of the introduction of tobacco, the manufacture of pipes has become of considerable importance. Immense quantities of wool, meerschaum, china clay, and pipe clay are annually converted into pipes, principally in England, France, Germany, and Austria; a smaller quantity being produced in Holland and Turkey. Wooden, china, and meerschaum pipes are made mostly in Germany and Austria, and among clay pipe producers England takes the first rank. Although the value of clay pipes is comparatively small, the enormous quantity in which they are made makes them an important product of industry to England.

Clay.—The principal pipe factories are located in Dorsetshire and Devonshire, where a pure variety of potters' clay is found in great abundance. It resembles kaolin in its character, although it contains a little less silica, and remains quite porous after baking. The clay is first freed of all impurities by levigation, and then undergoes repeatedly a process of kneading and curing in open tanks, exposed to the air, in much the same way as clay for other purposes is treated. After it has acquired the desired plasticity, it is divided into masses of about 50 lb. each, which are then given to the formers.

The first step in making a pipe is the formation of the stem in a metal mould. A small lump of clay is left attached to the rod, of which the cup is afterward formed. The rod is then pierced through its length with an oiled brass rod. Holding the pipe by the free end of the stem, the operator now imparts to the cup its external form by means of a copper mould, in which, if

ornamental pipes are to be made, are engraved the designs. It is provided with a spring to open it automatically. The pipe then passes to a third operator, who forms the inside of the cup with his fingers, and establishes communication between the cup and the stem by piercing the separating wall with the brass rod. The pipe is now put aside to dry in the sun, after which it is ready for the oven. Three men finish 600–700 pipes a day.

Fig. 319 represents an oven used by English pipemakers. The fire *A* is located centrally in the oven. The heated gases circulate through the space *B*, formed by the walls of the oven and by the muffle *C*, which receives the pipes. The latter are introduced through the door *E*, and arranged in the position indicated, on shelves made of biscuit. An oven of this kind usually contains 2000 pipes. The pipes are generally baked for 8–9 hours.

Ordinary pipes receive no glazing of any kind, while some of the better class are painted and glazed. They are very porous, hence their tendency to adhere to the lips. To overcome this, the mouth ends are dipped in water containing a little pipe clay in suspension, and polished. By this means the pores of the clay are stopped. Pipes of better quality are covered with a mixture of soap, wax, and gum, and then polished.

Difficulty is occasionally experienced in holding the pipes in proper position in the oven. Some manufacturers fill the oven with fine sand after the pipes are in position. The sand fills all interstices and supports the pipes.

The clay pipe, like the needle, has to undergo a large number of operations before reaching the state in which we find it in commerce. The manufacture of it requires much manipulation, and, despite the progress of mechanics, the machine has not been introduced.

For the manufacture of pipes, all clays are not equally suitable. Use is made of plastic and usually white clay, and sometimes of clay coloured by metallic oxides. Such clays are not met with in France in a sufficient state

of purity, but are procured from the Belgian Arlennes.

tion. The first operation that the material undergoes is consequently a cleaning, which is done partly by hand by children, and is finished by a washing of the clay and allowing it to deposit in basins of large dimensions.

The second operation is the mixing of the earths in definite proportions. As each clay has a different property, the mixing of several kinds is necessary in order to obtain products that vary as to colour, hardness, &c.

This mixing is one of the principal secrets of the manufacturer, and an operation that requires no end of study as may be required by commerce. It is performed in pug mills actuated mechanically, and identical with those used in ceramics. The clay comes from the mill perfectly homogeneous and in a state of medium plasticity. It is then carried by an elevator to the rooms of the rollers in the upper part of the building. It is distributed in blocks over wooden tables, around which are seated 12-15-year-old children, who are called "rollers," and who take a block of proper size in each hand and form it into a ball by rolling it on the table in different directions. Then, exerting a pressure with the hand upon a part of the ball, and giving it a backward and forward motion, they very quickly give it the form of a pipe whose bowl and stem are in the same axis. They have produced a "roll." The roll made, they bend up the head of it slightly and place it alongside of them upon a board. These boards, containing a definite number of rolls, are carried to the moulders.

319.

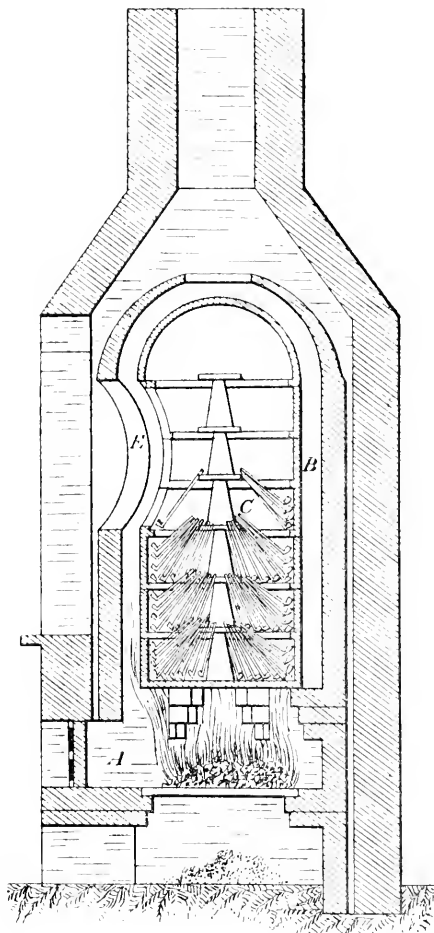

Pipe-makers' oven.

These clays always contain impurities, consisting of oxides, sand, fragments of rocks, &c., in variable propor-

of them upon a board. These boards, containing a definite number of rolls, are carried to the moulders.

320.

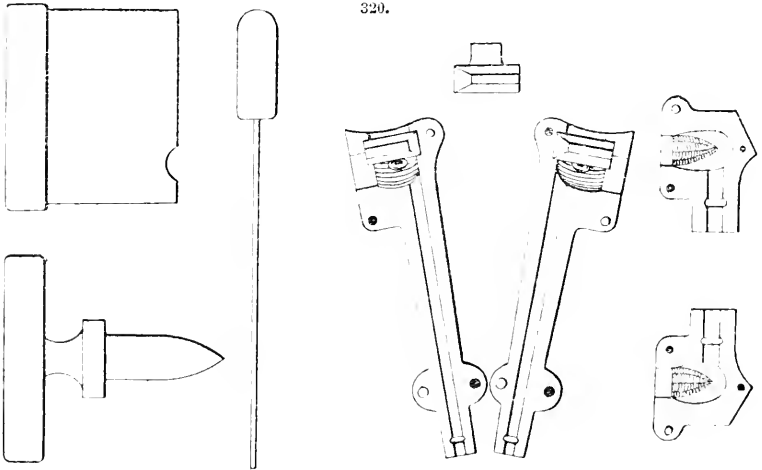

Pipe-moulders' tools.

321.

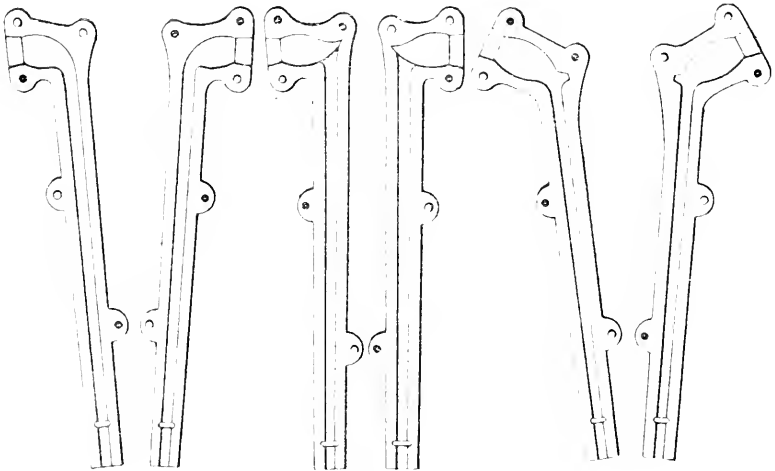

Pipe-moulders' tools.

The moulders' tools are shown in Figs. 320, 321; they include a mould of one or more pieces, a compressor, a long needle, a steel knife, and a press.

The mould for simple pipes consists of two pieces of hollow steel, fitting together very accurately. For ornamental pipes it is of several pieces of chiselled bronze, held together in a steel case. The compressor is of steel, and is mounted upon a handle, and has the internal form of the bowl. The press is an ordinary vice fixed to the edge of the table (Fig. 322).

tion in a few instants on pipes 15 in. long and 0.15 in. diameter in the thickest part.

This operation is performed in the same way upon pipes of all sizes.

The roll, thus pierced, and still containing the needle, is placed in the mould, and the latter is closed and put in the press. Then the workman takes his compressor and pushes it into the open part of the mould until he meets with the extremity of the needle that enters the bowl. The clay is thus compressed and the excess is removed by means of

322.

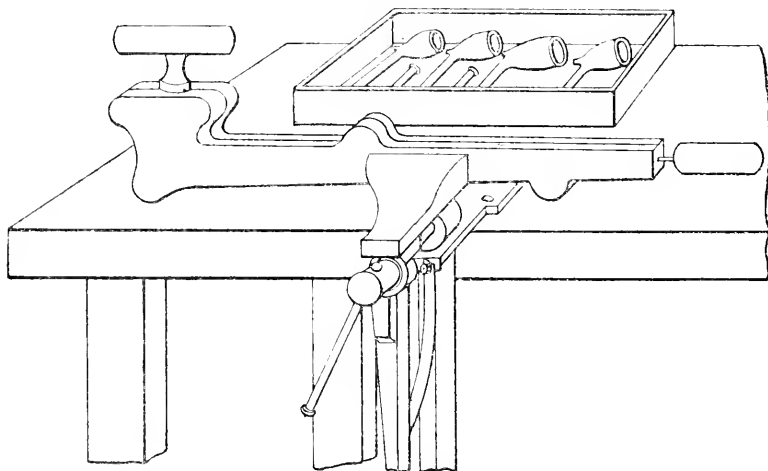

Pipe-moulders' table.

When the roll reaches him, the moulder places his open mould before him, and then taking a roll, the head of which he places upon a special support, he thrusts his needle into the centre of the tail of the roll, and pushes it up to the head, guiding it with two fingers of the left hand, so as to keep it exactly in the centre. An inexperienced person who should try to shove the needle into the roll could not advance more than $\frac{1}{2}$ in. without pushing it through the side, while the workman performs the opera-

the knife. The moulder then removes his tool, opens his press, and then his mould, takes out the pipe and passes his knife over it, so as to remove the traces of the junction of the two parts of the mould, takes out the needle, and places his pipe upon a board alongside of him.

The pipes are arranged with care upon these boards, with their stems resting here and there upon small sticks or else upon very fine sand.

When these boards are full they are delivered to the finisher, who allows the

pipes to harden a little before finishing them. The finisher begins by passing another needle into the stem, then scrapes off the seams, and removes the lines or scars formed on the stem by the various parts of the mould, and, with a copper tool, indents the figures that are to appear upon the pipe. He then arranges the pipes upon other boards, and leaves the needle in them so as to prevent a curvature of the stem during drying. The boards, holding a gross of pipes, are taken to the driers, whose temperature is very high.

When the pipes are sufficiently dry, workmen polish them with tools analogous to those used by burnishers, and which are manœuvred in the same way.

The pipes are then carried to other workmen, who verify them, reject the defective ones, and proceed to put the perfect ones in the saggars. These latter are terra cotta boxes, in which the pipes are arranged in circular beds, the bowls placed downward, and the stems united above by a defective stem in order to prevent them from getting out of place during carriage. When the saggars are full they are carried to special furnaces, and are superposed as in pottery furnaces.

In large manufactories, the operation of baking is the same as in potteries. The furnaces are in batteries of three; while one of them is being fired another is in process of cooling, and the third is being charged.

Each furnace bakes about 600 gross of pipes per day. The duration of the baking varies according to the clay, but it is at least 5 hours, and sometimes reaches 8-9.

After the baking, the furnace is allowed to cool for about 24 hours, then the saggars are taken out and the pipes are removed. The latter are then examined, and those that are well baked are polished anew.

Although the pipe is finished, it has yet to undergo another operation before it can be used, and that is dipping. The object of this is to remove the porosity of the clay, which without this would stick to the lips. For this operation the

pipes are taken and dipped, one by one, in a hot bath of soap water and wax, and then drained and dried.

The manufacture of the common pipe is at length finished; but, before being delivered to the trade, certain other operations are necessary: it must be labelled, and certain styles be wrapped up, and all must be packed.

The packing is done in wooden boxes filled with straw. The pipes are arranged alongside of each other in the boxes, and the intervals between them are filled with fine straw. The workmen must have some experience, for, if the packing is too tight the jolting that the box receives will be transmitted to the interior and break the pipes; and, if it is too loose, the pipes will strike against each other and pieces will be chipped off.

This operation must be carefully performed, as some boxes go to America, others to Australia, South Africa, and even to Northern Siberia.

All the operations above described are applied to the wholly white pipe. If the pipe is coloured, it necessitates several new operations. After the pipes have been baked, they are carried to the glazing room. The operators in this latter are usually women, each of whom has in front of her a series of cups containing liquid glazes of various colours, and each cup provided with a small stick. Each pipe is taken up by the operator, who, with the stick, puts a glaze upon it either in the form of dots or bands. It is in this way, dot by dot, that the pipes that are styled glazed are finished. These pipes are remarkable for the finish that they exhibit.

The pipes thus ornamented are arranged upon plates and put in furnaces raised to a high temperature, where they undergo a new baking that vitrifies the glazing. Then, after being labelled and wrapped up, they are packed.

So much for the manufacture of pipes properly so called. With such manufacture is incorporated an accessory one—that of moulds. The moulds are of steel and of bronze. Moulds for plain pipes are of steel, and those for

ornamental pipes are usually of bronze, chilled internally. If the pipe represents a head or a complicated subject, this part of the mould is made in several pieces, in order to allow of the removal of the object. In this case the mould is always complicated, and is made with difficulty, for all the parts of it have to fit accurately and without leaving any seams on the figure.

The workmen who make these moulds must know how to sculpture very well, and must also possess some skill in the reproduction of complicated subjects, and know how to divide and arrange their moulds. These moulds are very costly. Some of them, which furnish true works of art, have cost as much as 120*l*.

We said in the beginning that mechanics could not be applied to this industry, and the reader has now seen that the only operation that could be performed mechanically is that of moulding.

The clay pipe industry is remarkable from more than one point of view. Aside from the difficulties of manufacturing, we find the division of labour pushed to its extremest limit, and this permits of a cheap production and of low selling prices after passing through three hands—those of the producer, the wholesaler, and the retailer.

It is remarkable, in that it gives employment to an entire family, and that, too, without occasioning a fatigue disproportionate to age or sex. This manufacture is essentially French, and its importance is daily increasing, despite the formidable competition of wooden pipes and of cigarettes, French products being much superior to those of other countries.

A pipe manufactory occupies an area of about 100,000 sq. ft., and gives employment to 500–600 persons, exclusive of children less than 12 years of age. The annual product is 120,000 gross. The number of styles is infinite, and is daily increasing, as the dealer is continually asking for new models. (*Les Inventions Nouvelles*.)

The clay of which these are made

is obtained in Devonshire, in large lumps, which are purified by dissolving in water in large pits, where the solution is well stirred up, by which the stones and coarse matter are deposited; the clayey solution is then poured off into another, where it subsides and deposits the clay. The water, when clear, is drawn off, and the clay at the bottom is left sufficiently dry for use. Thus prepared, the clay is spread on a board, and beaten with an iron bar to temper and mix it; then it is divided into pieces of the proper size to form a tobacco pipe; each of these pieces is rolled under the hand into a long roll, with a bulb at one end to form the bowl; and in this state they are laid up in parcels for a day or two, until they become sufficiently dry for pressing, which is the next process, and is conducted in the following manner:—The roll of clay is put between two iron moulds, each of which is impressed with the figure of one-half of the pipe; before these are brought together a piece of wire of the size of the bore is inserted midway between them; they are then forced together in a press by means of a screw upon a bench. A lever is next depressed, by which a tool enters the bulb at the end, and compresses it into the form of a bowl; and the wire in the pipe is afterward thrust backwards and forwards to carry the tube perfectly through into the bowl. The press is now opened by turning back the screw, and the mould is taken out. A knife is next thrust into a cleft of the mould left for the purpose, to cut the end of the bowl smooth and flat; the wire is carefully withdrawn, and the pipe is taken out of the mould. The pipes when so far completed, are laid by 2 or 3 days, properly arranged, to let the air have access to all their parts, till they become stiff, when they are dressed with scrapers to take off the impressions of the joints of the moulds; they are afterwards smoothed and polished with a piece of hard wood.

The next process is that of baking or burning; and this is performed in a furnace of peculiar construction. It is

built within a cylinder of brickwork, having a dome at top, and a chimney rising from it to a considerable height, to promote the draught. Within this is a lining of fire-brick, having a fire-place at the bottom of it. The pot which contains the pipes is formed of broken pieces of pipes cemented together by fresh clay, and hardened by burning; it has a number of vertical flues surrounding it, conducting the flame from the fire-grate into the dome, and through a hole in the dome up to the chimney. Within the pot several projecting rings are made; and upon these the bowls of the pipes are supported, the ends resting upon circular pieces of pottery, which stand on small loose pillars rising up in the centre. By this arrangement a small pot or crucible can be made to contain 50 gross of pipes without the risk of damaging any of them. The pipes are put into the pot at one side, when the crucible is open; but when filled, this orifice is made up with broken pipes and fresh clay. At first the fire is but gentle, but it is increased by degrees to the proper temperature, and so continued for 7-8 hours, when it is damped, and suffered to cool gradually; and when cold, the pipes are taken out ready for sale.

Briar-root.—(1) The following note on the so-called briar-root pipes is from a report on the trade and commerce of Leghorn:—An interesting industry has been started here lately by a Frenchman from Carcassonne, for the export of material for the manufacture of wooden pipes. Similar works are also to be found at Sienna and Grosseto. Selected roots of the heath (*Erica arborea*)—preference being given to the male variety—are collected on the hills of the Maremma, where the plant grows luxuriantly and attains a great size. When brought to the factory, the roots are cleared of earth, and any decayed parts are cut away. They are then shaped into blocks of various dimensions with a circular saw set in motion by a small steam-engine. Great dexterity is necessary at this stage in cutting the

wood to the best advantage, and it is only after a long apprenticeship that a workman is thoroughly efficient. The blocks are then placed in a vat, and subjected to a gentle simmering for a space of 12 hours. During this process they acquire the rich yellowish-brown hue for which the best pipes are noted, and are then in a condition to receive the final turning and boring, but this is not done here. The rough blocks are packed in sacks containing 40 to 100 dozen each, and sent abroad, principally to France (St. Cloud), where they are finished into the famous G. B. D., or “Pipes de Bruyère,” known to smokers in England under the name of “Briar-root pipes.” The production of this article is considerable, 4 hands turning out about 60 sacks per month. Consignments are also made to England and Germany. (*Gard. Chron.*)

(2) The root of the “Briar Ivy” is the substance most generally used in America for pipe making, it being selected for the purpose on account of durability, hardness, and the bright polish which it is capable of taking. It is found throughout the Southern States generally—the best qualities growing in Virginia—and is sent to the market in large pieces which vary in size from that of a man’s fist to the dimensions of a good sized keg. It costs the manufacturer 6-8¢ per ton, the price depending upon the quality of the wood.

The above information was imparted to us by one of the manufacturers of pipes in this city, while wending our way from his office to the cellar underneath the factory, where the rough briar-root was stored. As we entered the last mentioned apartment, we noticed, heaped against the walls, the odd shaped pieces of the wood. Some had just been received, for a workman was busily engaged in throwing them into an oven which, heated by steam pipes, served to dry out all sap and moisture the wood might contain. In the middle of the cellar a circular saw was in motion, cutting the dry pieces into slices about 2 in. thick, which as soon as finished were received by boys

and piled in regular heaps. From this underground apartment, the slabs are sent to a drying room on one of the upper floors, where they are kept heated at a moderate temperature for 6 months, during which time the wood becomes thoroughly seasoned.

Following our guide, we next entered the workshop. Here the clatter of innumerable wheels and the buzzing of saws and lathes rendered speech out of the question. Picking our way over heaps of wood and edging between countless belts, we were at length arrested before a workman who, sitting on a bench in which revolved a circular saw, had at his side a pile of the slabs which we had already seen cut, down in the cellar. Taking one piece at a time, he pressed it against the blade, and in a few seconds it was divided into several smaller blocks of the shape of Fig. 323.

323.

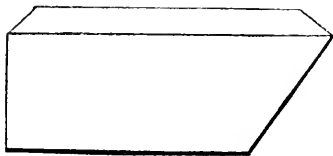

324.

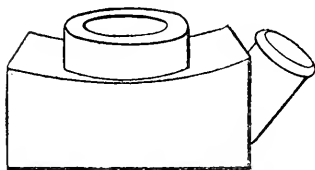

Briar pipe making.

The blocks vary in dimensions according to the size of pipe to be made. Very little of the wood is wasted, the odd pieces being all worked up into stems or small pipes.

The blocks as soon as cut are passed over to the turners. Standing beside one of the workmen, we watched him as

he placed the piece in the lathe chuck. A pressure of the boring tool, and the interior of the bowl of the pipe was excavated, then a part of the exterior was turned; and finally the block was reversed, and, in a few revolutions, the end for the stem completed. The entire operation did not occupy more than 10 seconds, the pipe, when thrown to one side, appearing as in Fig. 324. Still it was far from finished. It had to be carved into shape, and, to witness the process, we were conducted to another part of the room where the filers were at work. Each operative had before him a revolving disc, one side and the edges of which were cut coarse or fine, like files. This instrument removes the wood in either large or small quantities as may be desired. If the pipe is to be ornamented, the finer files are used to cut away minute portions. The workmen are all well skilled, and reproduce apparently intricate designs with wonderful accuracy. The most delicate work, such as faces, flowers, &c., are cut by hand.

After the carving is completed and a hole is drilled for the stem, the pipe is thoroughly sandpapered by holding it against a revolving wheel covered with that material. This done, it is passed to the burnisher, where a brilliant polish is given to the wood by allowing it to rest against a rotary disc made of layers of chamois leather.

We next passed to the finishing room, where, seated at long tables, we found a number of workmen engaged in fastening to the pipes the pewter tops and covers, together with the small bits of chain and bands which hold the stems and mouthpieces in place. The latter are manufactured from the tips of horns which are bought from the comb makers for the purpose. These tips are turned to the shape desired, holes are drilled through their length, and then they are bent into shape by the action of heat, and finally coloured black by a peculiar kind of dye. When completed, they are carried to the finishing room and there attached to the pipes. Nothing further remains to be done but to pack the

finished pipes in boxes, label and mark them, and they are ready for the market.

The factory which we have described manufactures over 150 gross of pipes weekly. Other woods besides briar root are used, none, however, equalling it in durability and beauty. Among these are apple, cherry, mahogany and poplar, which are made into the cheaper pipes, which cost 36-48s. per gross. The most expensive articles are made from the briar root and carved by hand, costing some 48s. per dozen. (*Scient. Amer.*)

Charcoal.—The use of charcoal in the preparation of pipe heads, a long time practised, has lately experienced many improvements, so that now pipes are produced remarkable for a deep black, lustrous appearance, and of very great durability. The material consists of a mixture of 2 parts best charcoal black and 1 part best black peaty earth, ground so finely that, when rubbed between the fingers no trace of granules is perceptible. Two parts of this mixture are then united with one part of an equally well pulverised residuum of distilled cannel coal, containing still a portion of its bitumen, and the whole rubbed together thoroughly till all the three ingredients are uniformly combined. The mixture is then placed in iron boxes, in which are sunken moulds corresponding to the pipe heads, and while the boxes are then heated to the boiling point of water, stamps with rough surfaces are forced under hydraulic pressure into the openings of the heads, so that this process, united with the increased temperature, not only combines the carbonaceous mass into compact pipe heads, but also produces a smooth exterior, and at the same time a rough inner surface.

Meerschäum.—The following is a new process for preparing artificial meerschäum. Precipitates are prepared by means of a solution of soluble glass: (a) of silicate of magnesia, by precipitating it through a solution of sulphate of magnesia; (b) of silicate of alumina, by precipitating through a solution of alum; (c) of silicate of lime, by precipitating through a solution of chloride

of calcium. All these solutions are diluted, 1 part salt being used for 10 parts water. In order to precipitate the solutions, the operation is performed at 20° C., except in the case of the silicate of alumina, for which the solutions have a temperature of about 50° C. (d) A solution of fused chloride of calcium (1 part to 15 of water) is precipitated at 15°-20° C. by a solution of sulphate of soda (1 to 15). The precipitate of sulphate of lime is first dried, and then freed of the larger part of the water that it may contain, by compressing it, and exposing it upon hurdles in a stove. Finally, it is totally dehydrated by heating it in a very clean iron kettle. The sulphate of lime thus prepared is in the form of a very fine and very white powder. It is carefully preserved in boxes that are kept in a perfectly dry place.

Into 33 lb. of water at 40° C. are put 19 lb. of precipitate *d* in 20 successive and nearly equal portions. The mixing should be done with much care and with rapid stirring. There are afterwards added to the mixture the following substances, weighed in advance: 7 $\frac{3}{4}$ lb. of precipitate *a*; 3 $\frac{3}{10}$ lb. of precipitate *b*; 5 $\frac{1}{2}$ lb. of precipitate *c*. All these precipitates should be mixed with water, and then the mass, which is in the form of a thin *bouilli*, is immediately introduced into a vessel through a No. 20 brass sieve, and thence into wooden boxes that rest upon large slabs of plaster covered with canvas, and about 4 in. thick. In about 15-25 minutes the mass may be detached from the sides of the frame by means of a blunt blade of brass, and the frame may be removed. The mass is left upon the slabs of plaster until it is sufficiently dry to be sawed into small blocks of various dimensions, according to requirements. These blocks are more thoroughly dried upon hurdles in a stove. Then they are worked with a knife or in a lathe, and are waxed and polished as in the case of objects made of genuine meerschäum. It should be remarked that, on introducing the hot mixture into the frame, care should be taken not to

introduce air bubbles at the same time. Varying proportions of precipitates *a*, *b*, *c*, may be used. The larger the proportion, the harder and heavier will be the final mass.

Therapeutic.—This improved form of smoking pipe is introduced to notice, primarily to provide a means of combating the smoker's habit, and to do away with the injurious element in it to which its baneful effects are due, by abstracting the noxious constituents of tobacco smoke, whilst leaving the aromatic principles unaffected, thereby making it available for daily use by delicate or invalid smokers, to whom total prohibition would often be little short of a punishment. The so-called "smoker's heart and concomitant cardiac troubles," "smoker's amaurosis," "smoker's sore-throat," and other laryngeal, pharyngeal, and nasal diseases exemplify this, and such cases may be permitted the use of their tobacco from this pipe at a time when possibly it could not be allowed from any of the ordinary

nicotina or nicotine, which is a colourless oil at ordinary temperature, but volatilises at 480° F.; (*b*) a volatile oil nicotianin or tobacco camphor; (*c*) volatile aromatic principles; (*d*) watery vapour. The action of smoking as a nervous stimulant is probably not due to the nicotine itself, but to the stimulus of the smoke on the sensory nerves of the mouth and nares, which reflexly stimulates the vaso-motor centre, and so dilates the vessels of the brain. Hence the desirability of getting rid of the nicotine. In the "therapeutic" pipe principles for removing the nicotine are carried into practical effect. A reference to Fig. 325 will show that the pipe by a modification in the boring is divided into the three chambers E, C, and that occupied by the fitting B, E being the bowl for tobacco, C a chamber below E, and occupied by the "radiator" A, which is simply a box with a perforated top and bottom, and fits tightly on the bush on the under surface of the bowl by means of a projecting rim. If this

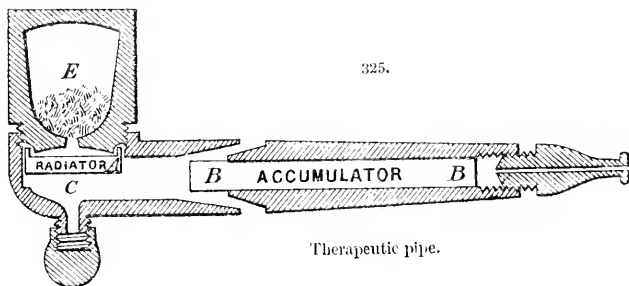

Therapeutic pipe.

kinds. Secondly the pipe may be made useful as a means of turning to practical account, and utilising the habit of smoking as an adjunct to treatment by inhalation of volatile medicaments, so that the vapour of the remedy employed may be directed to the affected surfaces. Tobacco smoke is a mixture of several volatile ingredients, the chief of these being (*a*) the volatile liquid alkaloid

box be filled with any fine powder, all the smoke passing through the interstices will come in contact with the particles of powder and be robbed of its heat, which is carried away by radiation through the pipe head. If the powder be a volatile one, this fact is available for therapeutic purposes. The smoke next enters the "smoke chamber" C, where it is further cooled. Thereafter

it passes along the tube-like chamber contained in the stem, and occupied by the "accumulator" B, B, which consists of a bundle of prepared fibres about 3 in. long, and by the contiguity of the fibres to each other this bundle forms a series of capillary tubes. I have obtained smoke absolutely free from acidity. D is a cup for drainage. Both the fittings A and B are readily replaced by new ones when exhausted, so that a pipe which is always clean is not the least of the considerations to be borne in mind. To make it effective as a therapeutic agent, the patient should be instructed to exhale the medicated smoke through the nose, by which act it is carried into the pharynx. Chloride of ammonium,

out using tobacco, perform the act of smoking, the current set up will carry the powder well back into the fauces, the suction greatly facilitating this. (C. W. Jones.)

Hookah.—Fig. 326 shows hookah complete. A, a special meerschaum bowl; D, a turned piece of wood to fit bowl, and left long enough to go into cork; C, a good, sound, tight-fitting cork; T, a glass tube about $\frac{1}{4}$ -in. diameter, fitted into bottom of D, and of such a length as to be about $1\frac{1}{2}$ in. above bottom of water-bottle, vase, &c., G; G, a small piece of tube (glass) $\frac{1}{4}$ -in. diameter, put through cork, and projecting about $\frac{1}{2}$ in. under cork; S, the "snake" or tube (rubber $\frac{1}{16}$ - $\frac{1}{2}$ in. dia-

326.

328.

327.

329.

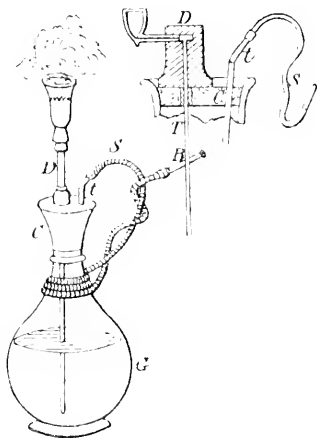

Hookah.

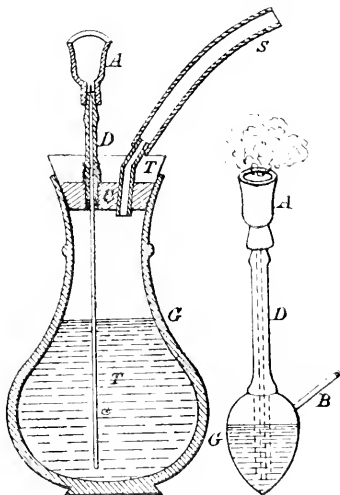

Hookah.

tannic acid, salicylic acid, benzoic acid, and sulphur, have all yielded satisfactory results, especially the first two. Another possible use of the pipe is that of an insufflator, for by taking out the accumulator B, and charging either the radiator A, or the empty stem with the powder to be insufflated, and then with-

meter) attached to T; B, the mouthpiece. Water in bottle should always be about 3 in. below end of tube T; and should be renewed frequently as it soon gets discoloured. Fig. 327 is a section of Fig. 326. Fig. 328 shows pillar D adapted to an ordinary pipe, the mouthpiece being unscrewed, the bowl may be

screwed on to face of pillar, instead of inserting whole stem of pipe, as sketched. Fig. 329 shows the hookah, as commonly used in India. A, burnt clay bowl; D, turned wooden pillar; C, coco-nut shell; B, bamboo mouthpiece. Water, of course, below entrance to mouthpiece. The letters refer to same parts in all the sketches. If the cork can be got sound, and of sufficient length, keep it

come through tube in sufficient quantity, the top of the cork must be varnished, or have a coat of rubber varnish.

TAPS.

(1) A tap simple of construction, and costing next to nothing, consists of a cork, having a straight, clean-

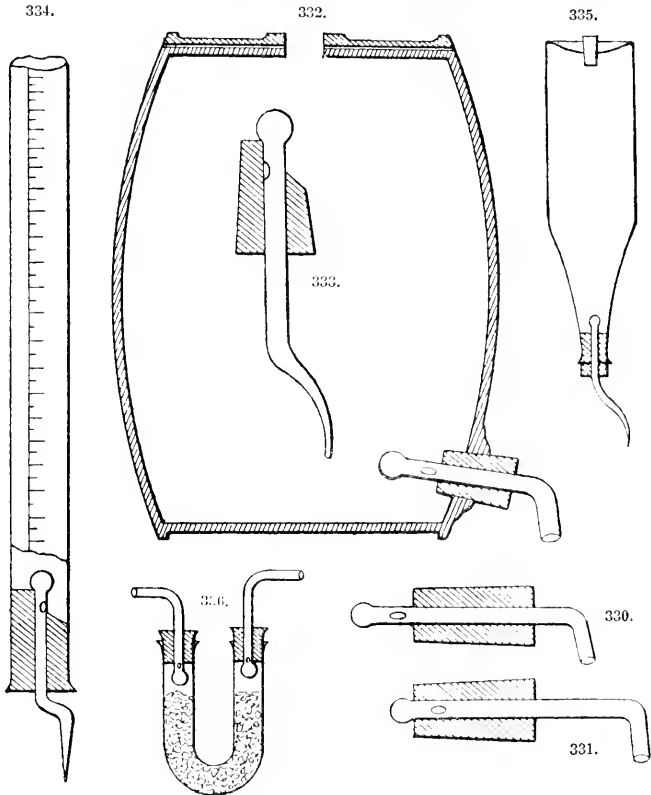

Simple forms of taps.

projecting above neck of bottle, as shown by dotted line in Fig. 327. If air gets into vessel, and smoke does not cut hole, through which is inserted a piece of glass tubing sealed at one end, and having a small hole cut on one

side. The position of said hole is determined by the length of cork used. Figs. 330 and 331 show this clearly, where the first shows the tap open; the second shut. The manipulation is done by pressing the tube in and out. Fig. 332 is a jar suitable for photographic or electric cell stock solutions.

(2) A different form of tap is shown in Fig. 333. To open and shut the latter form, it is only necessary to turn the tube on its axis, there being a slice cut diagonally off one side of the cork. This form is specially valuable where it is important that the volume of liquid in the containing vessel should remain constant—e. g., burettes (Fig. 334).

cut with small, round file, kept wet. The corks may be of cork or rubber, as found most suitable. (R. McLaren).

(3) An indestructible water-tap, invented by Sir William Thomson (Fig. 337), is entirely of metal, no other material being used in its construction. The perishable rubber, fibre, or leather washer-valve employed in ordinary screw-down cocks is entirely dispensed with. The perishable packing or washer generally used around the spindle is also dispensed with. Perfect watertightness is, nevertheless, obtained. The metal valve on reaching the seat, also of metal, is not suddenly arrested and compelled to seat itself hap-

337.

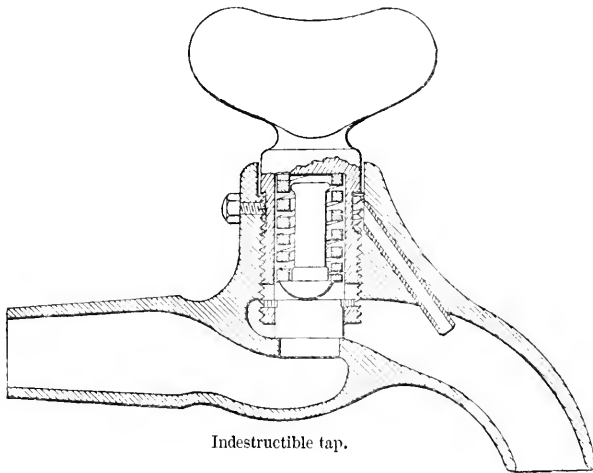

Fig. 335 is a handy separator (for working with oils, &c.), made from an old olive-oil bottle, a hole being made in the bottom for an inlet.

In calcium chloride U-tubes that require to be weighed accurately before and after experiments, the taps will be found very useful (see Fig. 336).

It will be observed that the sealed ends of the tubes are slightly inflated; this prevents them being accidentally pulled right out. The hole is easily

hazard, but continues to turn upon its seat as the handle is turned, receiving meanwhile a gradually increasing pressure from a spring, centrally applied through the medium of the rounded head of a stop. The valve is thus rubbed upon its seat at every opening and closing, and both valve and seat thereby acquire and maintain a perfect fit and burnish. No material wear is shown after the tap has been opened and closed hundreds of thousands of times, and experiments

show that even if the seat of the valve be purposely damaged it automatically rights itself. No packing is used to prevent upward leakage. All water which passes the screw when the tap is open enters an annular space, and is drawn off into the bib through the eduction tube, in which a current is induced by the velocity of the water flowing through the bib. This device is thoroughly effective. The washers used in ordinary cocks are a source of constant trouble and expense. Numerous materials have been tried; but long experience has shown that they differ only in degrees of badness. By Sir William Thomson's invention they are entirely abandoned, and metal to metal is for the first time rendered perfectly water-tight.

Practical men will appreciate the importance of these improvements, whether for cold or hot water. For the first time a screw-down tap has been produced with no perishable parts, and so constructed that the wearing parts—that is to say the valve and its seat—tend rather to improve than deteriorate by use. These taps have now been under test and in use all over the country for more than a year with perfect success, and users may therefore feel assured that in adopting them they are not running any risk or experimenting with an untried invention.

TYING AND SPLICING.

Usually the size of rope is denoted by its circumference in inches. The hemp fibre from which ropes are made is first spun into yarn or threads, the longest fibre producing the best rope; several yarns spun together form strands, 3 strands form a hawser laid rope; 3 hawsers or 9 strands form a cable-laid rope, when twisted together. Shroud-laid rope has a central core surrounded by 4 strands. The hawser-laid rope is the one most generally used. The question of the strength of ropes, and their safe working load, under varying circumstances, is of great importance. A series of experiments were carried out in 1873 at the Royal

Arsenal, Woolwich, by the Inspector of Machinery, the result of which showed that Italian hemp ropes are stronger than Russian in the proportion of 100 to 79 max. or 93·4 min. Russian hemp ropes are the least rigid in the proportion of Italian 100 to Russian from 80·4 to 96·5, and also that the deterioration of hempen ropes, after a few months wear, although still apparently good, was very marked. With the best rope after 6 months' use, the loss of strength was 25-50 per cent. Thus showing the necessity of allowing a large margin of strength for safety. Ropes stowed away in damp places, or put away wet, rapidly deteriorate, so that care should be taken to see that the ropes are thoroughly dry before being stored, and that the store-room also is free from damp. If stored away wet, sometimes the rope is worm-eaten in the centre, owing to the development of a species of fungus, probably from the paste used.

The thumb knot *a* and figure of 8 *b* (Fig. 338) are used to prevent ropes passing through blocks or slipping. To make the figure of 8 knot, pass the end of the rope under, round, and over the standing part, then up through the bight or loop. The reef knot *c* is useful for joining together two ropes of equal size. With dry rope, it is equal in strength to the other part. If wet, the knot will generally slip before the rope breaks.

The standing and running parts of each rope must pass through the loop in the same direction, i.e. from above downwards, or *vice versa*. If they pass in the opposite direction the knot is termed a granny, and cannot be undone when tightened up with the same ease that a reef knot can. A draw reef knot *d* is made in the same manner, except that a bight is drawn through instead of the rope end; it is useful to cast off when in an inaccessible position. Single sheet bend *e* is used for joining the ends of a rope, or hanging to a bight. Take a bight or double at one end, holding it in the left hand, and pass the end of the other rope held in

338.

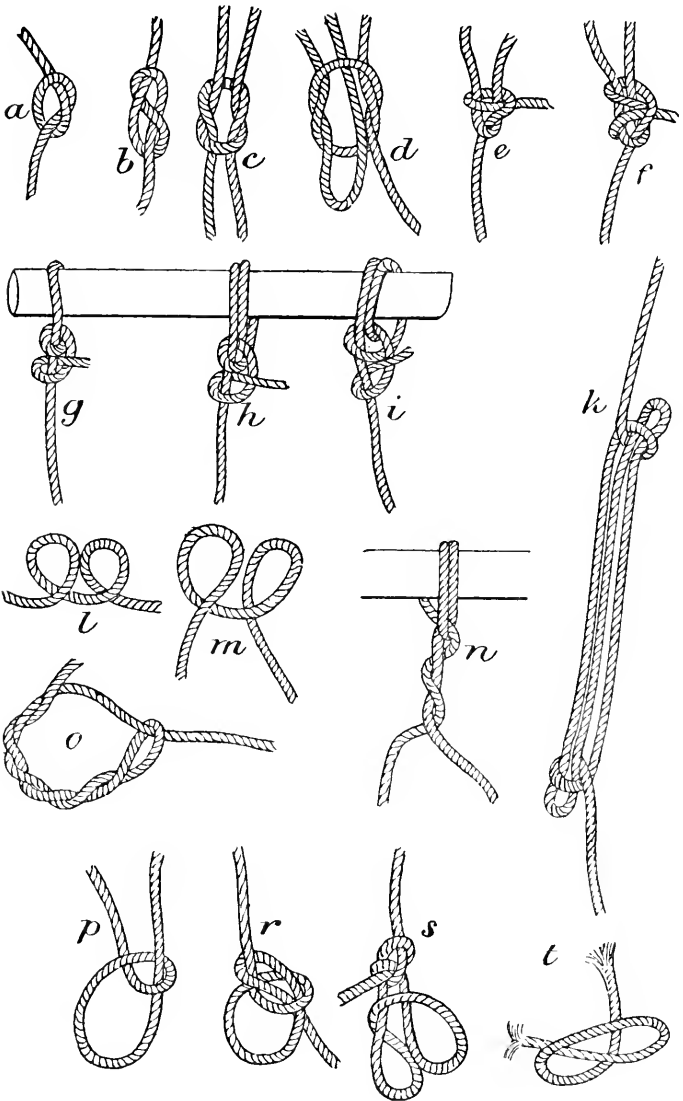

Knots.

the right hand up through this bight, down on one side under and up over the bight, and under its own standing end. The **double sheet bend** *f*, in which the running end is passed twice round the bight and under its own standing end each time, is used where greater security is required; *g* shows two half-hitches; *h*, round turn and two half-hitches; and *i* the fishermen's bend. In the latter, two turns are taken round the spar, or other object, and the end is passed over the standing part, and through the turns next to the spar, over its own part then forming one half-hitch, the second half-hitch being taken round the standing part alone. It is very useful for attaching ropes to rings or staples. Sometimes it is necessary to shorten a length of rope quickly. This can be done as shown by sheepshank *k*; lay the rope up in 3 parts, and a hitch taken over each bight, with the standing and running parts respectively of the rope, and drawn tight. To secure a rope to the end of a beam or spar, a clove hitch *l m n* is used, made as follows:—Grasp the rope with the left hand, back down, and right hand back up. Reverse each hand so as to form two loops *l*, lay them together as at *m*, and slip the two loops so formed over the end of beam or spar. In case the loops cannot be slipped on to the end, pass the end over and round the spar, and bring it up to the left of the standing part, and again round the spar, in the same direction, to the right of the first turn, and bring the end up, between the spar, the last turn, and the standing part *n*. This is one of the most useful knots for making fast to an object; it is very simple, and so effective that generally the rope breaks before slipping.

Timber hitch *o* is useful for lifting timber or dragging spars. When properly made, it will not slip; it is easily undone when the strain is taken off. Pass the end round the spar, and round its standing part, close to the spar. Then twist it two or three times back round itself, and draw tight. A half-hitch taken with the standing part adds to its security.

Bowline knot is shown in *p r s*. Holding the standing part in the left hand, form a loop in the rope running end uppermost, loop towards the body; pass the running end up through the loop, as shown at *p*, down under the standing part from right to left, back over the standing part, and through the original loop; then draw taut the end and double of the loop together *r*. A running bowline *s* can be formed round a spar, and tightened at any point. To make it, take the coil of the rope in the left hand, pass the running end round the spar from left to right, and draw it back with the right hand as far as required; still holding the end in the right hand; take the standing part in the same hand; pass the left hand under the standing part, and with the finger and thumb seize the running part of the rope close to the spar; draw it underneath the standing part from right to left and up, and at that point make a bowline knot on it with the running end. The knot is then run through the loop. Its use is to form a loop at the end of a rope that will not slip, or tighten up.

Catspaw *t*: 2 loops made on a rope in order to hang a tackle on. To make it form two equal bights or loops *t*. Grasp a loop in each hand, and roll them on the standing part 3 or 4 complete turns; then hook into both loops *A*, Fig. 339. This is an exceedingly handy method of attaching a rope to the block hook, owing to its simplicity, and the ready manner in which it can be eased off.

Whipping BCD. To whip a rope, is to tie a piece of small twine round the end, to prevent the strands from untwining and forming loose ends. Ropes intended for tackles particularly should be whipped before the blocks are threaded. When treated in this manner ropes will easily pass through the block sheaves, thus preventing much annoyance and waste of rope, it being quite a common occurrence with some workmen to cut a yard off the rope end because it is frayed. Take a piece of fine twine, 2-3 ft. long in proportion to

339.

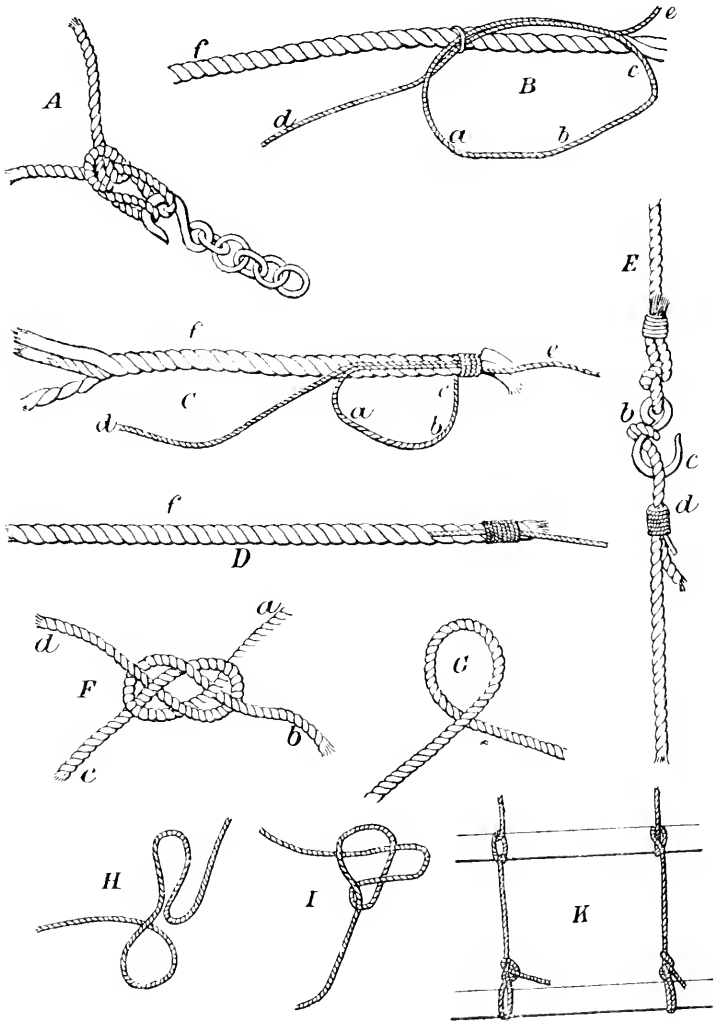

Knots.

the size of the rope, and place it as shown in B, one end to the right, the other to the left, quite close to the rope. Wind the loop *abc* tightly round the end of the rope *f*, and the two ends *d e* of the whipping twine, a sufficient number of times to secure the ends C; then by drawing the two ends *d e* tight, the whipping is tightened up D.

E represents a double Blackwall hitch. It is used for securing a tackle to a rope. To make it, place the rope near its end, against the hook of the block at *a*, cross the rope at *b*, and again inside the hook at *c*. If seized with a few turns of twine at *d* it will be more secure. This method of attachment will in a great measure prevent the rope from cutting itself on the hook.

Carrick bend F. Lay the end of a rope or chain under its own standing part, as shown at G, then with another rope or chain *c d*, lay its end under both parts of the eye formed by *a b*, and parallel to that part which is uppermost; then bring it alternately over and under the parts of *a b* and itself. This knot is used for fastening the 4 guys to a derrick. But its principal use is for bending a large rope to a small one.

Drag rope knot H I K. This is a useful knot for attaching hand spikes to drag by. It may also be used as a ladder by securing it firmly at each end.

The sheet-bend or weavers' knot A, Fig. 340. This knot is usually employed by netters, and is called by sailors "the sheet bend." It is readily made by bending one of the pieces of cord into a loop *a b*, which is to be held between the finger and thumb of the left hand; the other cord *c* is passed through the loop from the farther side, then round behind the two legs of the loop, and lastly under itself, the loose end coming out at *d*. In the smallness of its size, and the firmness with which the various parts grip together, this knot surpasses every other; it can, moreover, be tied readily when one of the pieces *a b* is exceedingly short; in

common stout twine, less than 1 in. is sufficient to form the loop. The above method of forming it is the simplest to describe, although not the most rapid in practice; as it may be made in much less time by crossing the two ends of cord *a b* in B on the tip of the forefinger of the left hand, and holding them firmly by the left thumb, which covers the crossing; then the part *c* is to be wound round the thumb in a loop, as shown in the figure, and passed between the two ends, behind *a* and before *b*; the knot is completed by turning the end *b* downwards in front of *d*, passing it through the loop *c*, and tightening the whole by pulling *d*. As formed in this mode, it is more rapidly made than almost any other knot; and, as before stated, it excels all in security and compactness; so firmly do the various turns grip each other that, after having been tightly pulled, it is very difficult to untie; this is the only drawback to its usefulness, and in this respect it is inferior to the reef-knot, which is made in precisely the same manner that a shoe-string is tied, only pulling out the ends instead of leaving them as bows.

Binding knot C D. This knot is exceedingly useful in connecting broken sticks, rods, &c., but some difficulty is often experienced in fastening it at the finish; if, however, the string is placed over the part to be united, as shown in D, and the long end *b* is used to bind around the rod, and finally passed through the loop *a*, as shown in C, it is readily secured by pulling *d*, when the loop is drawn in, and fastens the end of the cord.

Clove hitch E F. For fastening a cord to any cylindrical object, one of the most useful knots is the clove hitch, which, although exceedingly simple and most easily made, is one of the most puzzling knots to the uninitiated. There are several modes of forming it, the most simple being perhaps as follows:—Make two loops, precisely similar in every respect, as *a* and *b* in E, then bring *b* in front of *a*, so as to make both loops correspond, and pass

340.

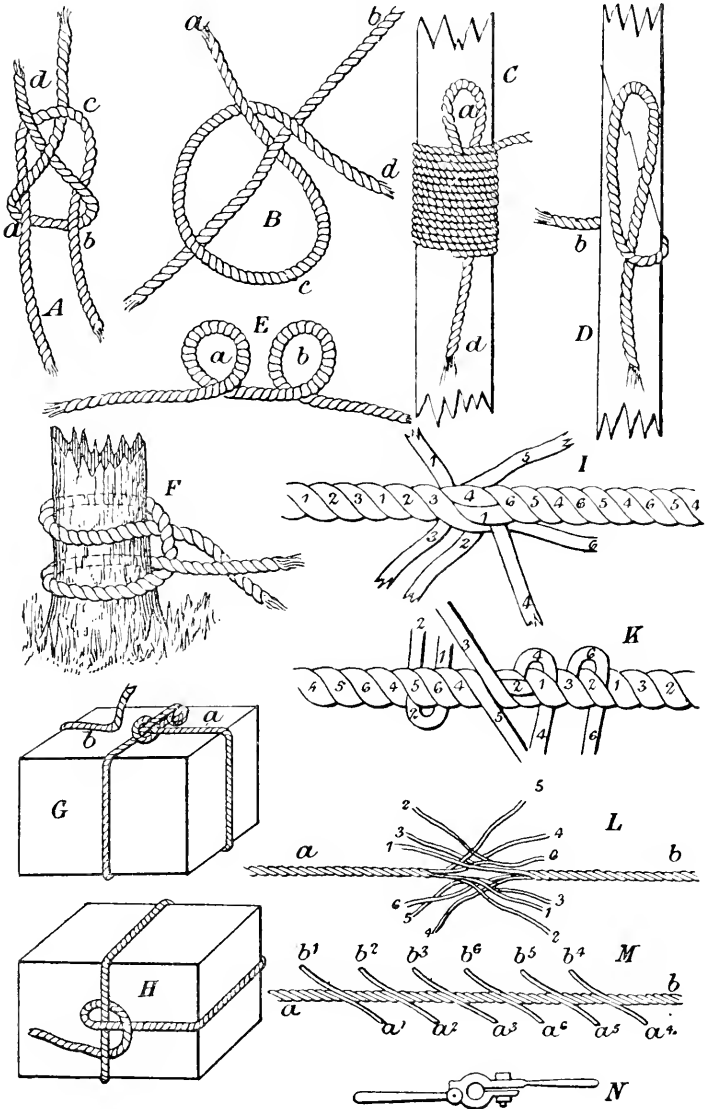

Knots and splices.

them over the object to be tied, tightening the ends; if this is properly done, the knot will not slip although surrounding a tolerably smooth cylindrical object, as a pillar, pole, &c. This knot is employed by surgeons in reducing dislocations of the last joint of the thumb, and by sailors in great part of the standing rigging. The loop which is formed when a cable is passed around a post or tree to secure a vessel near shore, is fastened by what sailors term two half-hitches, which is simply a clove hitch made by the end of the rope which is passed around the post or tree, and then made to describe the clove hitch around that part of itself which is tightly strained, as in F.

Tying a parcel G H. The tying up of parcels in paper is an operation which is seldom neatly performed by persons whose occupations have not given them great facilities for constant practice. Let a single knot be made in the end of the cord, which is then passed around the box or parcel. This knotted end is now tied by a single hitch around the middle of the cord G, and the whole is pulled tight. The cord itself is then carried at right angles round the end of the parcel, and where it crosses the transverse cord on the bottom of the box H it should, if the parcel is heavy and requires to be firmly secured, be passed over the cross cord, then back underneath it, and pulled tightly, then over itself; lastly, under the cross cord, and on around the other end of the box. When it reaches the top, it must be secured by passing it under that part of the cord which runs lengthways in a G, pulling it very tight, and fastening it by two half-hitches round itself. The great cause of parcels becoming loose is the fact of the cord being often fastened to one of the transverse parts as *b* in G, instead of the piece running lengthways, and in this case it invariably becomes loose. The description may perhaps be rendered clearer by the aid of the figures, which exhibit the top and bottom of a box corded as described. The cords, however, are shown in a loose state, to

allow their arrangement to be perceived more easily.

Short splicing I K. There are two ways of making a short splice—one by passing the strands left-handed, the other by passing them right-handed. But the former method is the more generally adopted, because of its neat appearance. Unlay the strands of each rope about 1 ft. or more, then crutch them together—that is, lay them so that each strand lies in a groove of the rope. Afterwards pass a strand of one rope over a strand of the other, as shown in I, front view, where No. 4 is passed over No 1, so as to form a common knot. In a like manner pass No. 5 over No. 3, and No. 6 over No. 2. Draw these strands tight, and proceed as follows:—Take strand No. 6, K, back view, and after reducing the yarns by cutting a few out of the inside, pass it over No. 2; continue doing so until it is worked out. It will be seen, by reference to K, that No. 6 is passed three times over No. 2, but the third time it is merely pushed through and not drawn tight. Strands Nos. 4 and 2 are in a similar position. All the corresponding Nos. represent the same strand, so No. 4 will pass over the same strand (No. 1) till worked out; No. 1 over No. 4, and No. 2 over No. 6. No. 5, which is shown loose, passes over No. 3. In passing the strands be careful to reduce the yarns each time after the first, and spread them out so that they will lie flat, and also see that all the yarns lie parallel.

Splicing wire rope, L M N.—The increasing use of endless wire rope for underground haulage, elevated wire ropeways, and for hoisting, gives importance to methods of splicing.

About 84 ft. of rope is required to put in a good smooth long splice. The wire ropes employed in ropeways are made of 6 strands of 7 wires each, and a core or heart; as there are two rope ends to splice together, there will consequently be 12 strands to be tucked in. Operators usually tie the stops that mark the length of rope, about where the centre of the splice will be. In

this case the usual way is to unlay each rope up to that point, and place the strands of rope *a* between the strands of rope *b*, the cores or hearts of the ropes *a* and *b* being cut off so that the cores of the ropes abut against each other. There will be then 42 ft. of strands each side of the stop, as is shown in L.

It is important that each strand should be in its proper place, so that none of them crosses other strands, or that two strands be not where one strand should be (by placing your fingers between each other in natural position this will be understood). Then strand No. 1 of rope *a* is unlayed, and strand No. 1 of rope *b* fellows close, and is laid snugly and tightly without kink or bend in its place, until within 7 ft. of the end; a temporary seizing is then put on, securing ropes and strands at this point. Strand No. 1 of rope *a* is then cut off, leaving it 7 ft. long. Then strand No. 2 of rope *a* is unlayed, and strand 2 of rope *b* is laid in its place to within 21 ft. of its end. Strand No. 3 of rope *a* is unlayed, and strand No. 3 of rope *b* is laid in its place to within 35 ft. of end. By this time you have reached within 7 ft. of the centre, and, reversing the operation, unlay strand No. 4 of rope *b*, and lay in its place strand No. 4 of rope *a*, to within 7 ft. of its end; unlay No. 5 of rope *b*, and lay in No. 5 of rope *a*, to within 21 ft. of its end; finally, unlay No. 6 of rope *b*, and lay in its place No. 6 of rope *a*, to within 35 ft. of its end. The strands are now all laid in their places and seized down for the time being, the ends are cut off, as with the first strand, to 7 ft. long, and present the appearance as in M.

The next operation is to tuck in the ends, and we will proceed to tuck in *b* 1. It will be remembered that the ropes are made of 6 strands, laid around a core or heart, usually of hemp, of the same size. Two clamps N made for this purpose are fastened on the rope so as to enable the operator to untwist the rope sufficiently to open the strands and permit the core to be taken out, which is cut away, leaving a space in the centre of the rope; the strand *b* 1 is

placed across *a* 1, and put in the centre of the rope in place of the extracted core, forming, in fact, a new core. A flat-nosed T-shaped needle used in splicing, the point of which is about $\frac{1}{2}$ in. wide by $\frac{3}{16}$ in. thick, rounded off to an edge, is well adapted to this purpose. The strand *b* 1 is laid in its entire length, the core being cut off exactly at the extremity of strand *b* 1, so that when the rope is enclosed around the inserted strand, the ends of the strand and core should abut. If there is much space left in the centre of the rope without a core, the rope is liable to lose its proper form, and some of the strands fall in, exposing the projecting strands to undue wear. The same operation is performed with *a* 1, running the other way of the rope, and so on, until all the strands are tucked in, which, if properly done, will leave the rope as true and round and as strong as any other part.

Some operators prefer to start from the end of one rope and consequent end of splice. The operation is about the same, but more care has to be used in bringing all the strands to an even tension in the parts spliced.

The diamond hitch, Fig. 341. This is largely used for tying goods to be carried on animals' backs. The pack saddles *c* may be of the simplest description, resembling small, light sawbucks, with side boards fastened under the crossed pieces, to come upon the animal's back. In saddling, a piece of blanket is first put on, then the saddle is girthed, or, "cinched," on very tightly.

The operation of packing involves the use of the peculiar knot, very famous in its way, termed the "diamond hitch." By its agency the packs are fastened rigidly in position on the back and sides of the animal carrying them. After the animal has been saddled, the packs, divided into two even portions, are slung up, half on each side, by two packers. To the parts of the saddle corresponding to pommel and cantle, short lines are fastened. The packers hold the packs up against each side of the pack animal, and passing the ropes around the articles

from underneath, and up, over, and across the back, tie the ends together so as to hold all in position. Any small articles are piled on top, and all is ready for the diamond hitch.

To make this, a piece of 2 or 3 in. rope is used, about 30 ft. long. One end is fastened to a short girth or cinch *d*. To the other end of the cinch is secured

B passes over the second and under the first lead of the rope lying across the packs, and as near the centre as may be. The state of things at this point is shown in *a*, Fig. 341.

The left-hand part of the half-hitch is passed under the cross rope by A, while the free end of the rope is passed as described by B. *b* shows this phase

341.

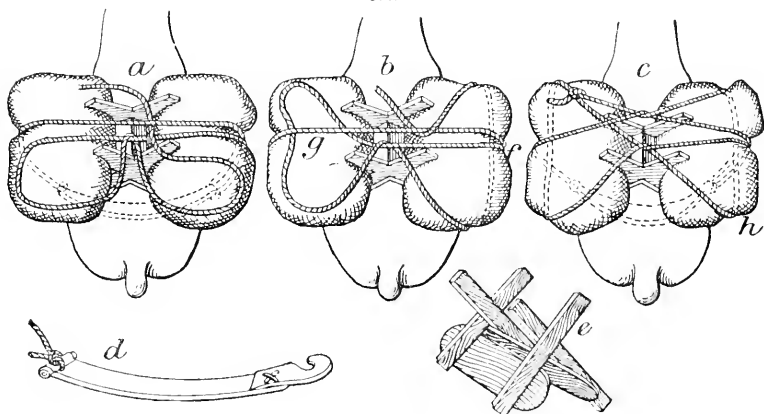

Diamond hitch.

a large flat hook, generally made of wood. In the army a long leather strap, about 1 in. wide, is used instead of the rope. Throughout the whole operation the packers work in pairs. One stands on the near or left side of the animal, whom we shall designate as A: the other stands on the off or right side, and will be called B. The packing rope and cinch are taken by A on the near side. He swings the hook end of the cinch across under the animal's belly to B, who catches it. Then A makes a bight in the part of the rope near the cinch, and throws it over across the top of the pack to B, who inserts it in the hook. Thus two leads of the rope run over the top of the pack transversely. A then turns a half-hitch with a large loop in the next succeeding part of the rope, and passes the free end to B. This end

of the operation. In this way two loops are formed, one for each side. A's loop lies under the cross line, while B's loop comes outside of everything. All these operations are executed in a few seconds, no exact order being followed. The tightening process comes next. B begins to pull the rope backward and upward, grasping it at *f*, putting his knee, or even foot, against the hook for a purchase, while A takes in the slack as fast as given him from B's successive pulls, grasping and pulling the rope at *g*. When no more can be gained, and the poor brute is compressed as much as possible, A passes the loop on his side tightly around and partly underneath his half of the pack. Then B, grasping the rope at *h*, pulls diagonally backward and outward. This begins to "spread the diamond." He next puts his loop

in position, when A, taking hold of the free end of the rope, pulls it diagonally forward and outward, over the withers of the horse. This completes the spreading of the diamond, and it will be at once seen that this separation of the two leads of the rope tightens it with enormous power. After A has

trying to relieve himself by motion. To untie the hitch, the end of the line is untied and cast loose, and withdrawn from under the cross lead of the rope. Then the whole being slackened, the bight is withdrawn from the hook, and the rope comes off without a knot. If a knot is formed, it is a sign that a

342.

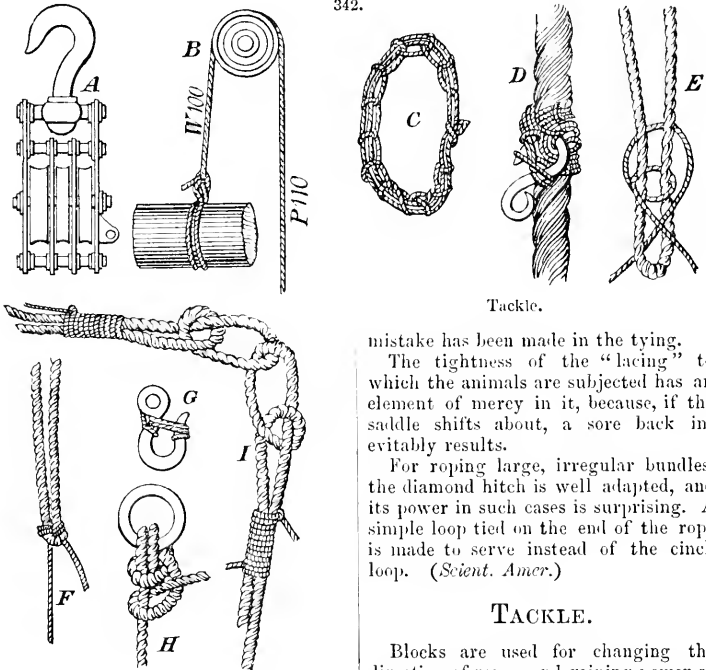

Tackle.

mistake has been made in the tying.

The tightness of the "lacing" to which the animals are subjected has an element of mercy in it, because, if the saddle shifts about, a sore back inevitably results.

For roping large, irregular bundles, the diamond hitch is well adapted, and its power in such cases is surprising. A simple loop tied on the end of the rope is made to serve instead of the cinch loop. (*Scient. Amer.*)

TACKLE.

given the final pull, he ties the free end of the rope wherever convenient, thus completing all. The final result is shown in c. The last two pulls consolidating the pack nearly double up the poor animal. The cinch, often cruelly narrow, is drawn up into his belly until the profile forms a double curve, his body being violently squeezed upward. After packing, the poor beast will sometimes go off, as it were, on tiptoes,

Blocks are used for changing the direction of ropes, and gaining power at the expense of time. They are made sometimes of wood frames, with a rope "strop" and thimble eye. The sheaves are usually brass, running on a wrought-iron centre pin, which passes through the frame and sheaves. Fig. 342 A shows a treble block. Generally blocks are made with light steel or sheet-iron plates for the sides, strengthened by wrought-iron links, where the strain is most direct. The suspending hooks are

connected by a strong cross bar to the side links, and are capable of being easily moved, either round their own axis, or through an angle of 90° on each side. Blocks are called single, double, or treble, according to the number of sheaves which revolve on the centre pin. Snatch, or leading blocks, are single, with an opening on one side to admit a rope without passing its end through.

A simple "tackle" consists of one or more blocks rove with a single rope or "fall." When a tackle is in use, one end of the fall is made fast, and the other is hauled upon. The fixed end is called the "standing" end, the other the "running end." Each part of the rope contained between the blocks, or between either extremity and a block, is called a return of the fall. To overhaul a tackle is to separate the blocks. This should always be done from the standing, and not from the movable block: to round in is to bring the blocks closer together by hauling on the fall. When a rope is passed through the sheaves of a block, it is bent to a curve suiting the radius of each sheave passed over. The sheaves should be exactly the same diameter in each pair of blocks working together. Owing to the stiffness of the rope, and friction of sheaves on the pin, the theoretical power is considerably reduced. The weight any system of blocks will lift is found by multiplying the power by the number of ropes attached to the movable block, including the standing end if fixed to it. For example, suppose we have 3 sheaves in use in each block, then the additional power acquired would be (theoretically) 6. The average additional power required for each sheave to compensate for friction is found to be about roughly 10 per cent. With 3 sheaves in use this would be 10×3 , or 30 per cent. Therefore, to raise a weight of one ton, a power of $\frac{2240}{3} + 1.3 \text{ lb.} = 970 \text{ lb.}$ would be required. In hauling on a fall, men exert a pull of about 80 lb., or half their weight under favourable

circumstances. In this case the least number of men required would be—

$$\frac{970}{80} = 12 \frac{1}{10}, \text{ or say } 13 \text{ men.}$$

Therefore, in calculating the advantage gained by using blocks, $\frac{1}{10}$ of the weight to be lifted must be added for every sheave in use, as shown in B. Suppose it is required to lift a weight of 12 tons with a pair of treble-sheaved blocks threaded with a 5-in. rope, the theoretical gain of power is 6 to 1, and the power required will be $\frac{1}{6}$ of R the total resistance to be overcome, which is compounded of W the weight to be raised, plus the resistance arising from stiffness of rope, and friction. Therefore we have $W + \frac{1}{10} W$ for each sheave in use. Now 6 sheaves are in use, therefore, $R = W + \frac{6}{10} W$.

$$P \text{ the power} = \frac{R}{6} = \frac{W + \frac{6}{10} W}{6}.$$

If 12 tons have to be lifted we have—

$$P = \frac{12 + \frac{6}{10} \text{ of } 12}{6} = 3 \frac{1}{5}.$$

A good rule for calculating the "safe working" strength of a new rope, of white hemp, is to square the circumference in inches, and divide by 8. For instance, the safe working strength of a 5-in. rope would be $\frac{(5)^2}{8} = 3 \frac{1}{8}$ tons. As another example we will calculate what weight can be raised by a "tackle" consisting of 2 treble blocks, rove with a fall of 6-in. rope, without exceeding the working strength of the rope. Here we have by formula

$$(1) \frac{(6)^2}{8} = 4 \frac{1}{2} \text{ tons}$$

as the maximum strain on the running end of the "fall." Then $P = 4 \frac{1}{2}$ tons, and $6 P = R = 27$ tons, as the theoretical weight. For each sheave in use we must deduct $\frac{1}{10}$ of 27, or $2 \frac{7}{10}$ for friction. Then as we have 6 sheaves in use, $6 \times 2 \frac{7}{10} = 16 \frac{2}{10}$, as the total amount to be deducted from the theo-

retical gain, leaving as the actual power $27 - 16 \frac{2}{10}$ or $10 \frac{8}{10}$ tons.

The following table gives the observed ratio of useful to theoretical work done in different tackles with white rope fall, viz.:—

Theoretical power of tackle.	Percentage of useful work.	Value of P.
Single	90 per cent.	1·1w
2 : 1	81·0 "	0·62w
3 : 1	75·0 "	0·45w
4 : 1	68·0 "	0·37w
5 : 1	61·5 "	0·32w
6 : 1	59·0 "	0·28w

If anything, the table gives a higher efficiency than would be obtained in ordinary use. It is highly necessary to keep blocks in good order, to see that all the parts are sound, that the sheaves are quite free on the pin and properly lubricated. Time spent in attending to these important details is well spent, as the friction on badly lubricated sheaves reduces their efficiency very much. Sometimes in using blocks it is found that they twist, and cause the rope to ride against itself; new rope especially. To prevent this twisting, a bar is sometimes placed through a part of the blocks, or at right angles to the "returns" close to the block. One of the best plans is to lash a handspike across the block; a light line may be lashed to each end and act as guys. This twisting of the tackles during use is a constant source of annoyance and waste of power often at a time when the power is wanted.

It has been found by experiment that if the blocks are allowed to twist one complete turn, the power required to overcome friction will be increased 40 per cent.

New ropes are bad to deal with at first, owing to their tendency to twist, or, perhaps we should say, untwist, or unlay. It is difficult to uncoil a coil of rope without getting it full of "kinks." When practicable, the coil of rope

should be placed on a roller, and the end walked away with. Ropes intended for reeving "tackles" should be well stretched first. In order to do this, lay the rope out to its full length; connect one end to the barrel of a winch, and the other end to a holdfast, with a swivel-eye to admit of the rope unlaying itself. As the winch is worked and the rope made taut, it will begin to unlay; continue the strain up to the "working strength" of the rope, according to the following table of "working strengths," when it may be left taut for an hour, and then reeved.

TABLE OF HAWSER LAID CORDAGE.

Circumference. in.	Safe working load in tons.	
	New.	Woru.
4½	2½	2½
4	2½	2
3½	1½	1½
3	1½	1½
2½	1½	1½
2	1½	1½
1½	1½	1½
1	1	1

Ropes used with a thimble eye are safer than when ropes are slung over hooks, or fastened by knots. The hook of a block will soon destroy a rope under great pressure. It is true economy to use eyes where possible and convenient. In addition to the "knots" given under "Tying and Splicing," p. 368, the following will be found useful in connection with blocks. C shows a "selvage" formed of returns of spun yarn in a circle bound together. They are used principally for attaching the hook of a tackle, the "selvage" being passed round the object and hooked into the tackle. To make a "selvage," place two pins at a distance from each other, equal to the intended length of the "selvage;" wind returns of spun yarn round the pickets until the "selvage" is thick enough; then bind them

together by half-hitches, with the running end at a distance of $1\frac{1}{2}$ in. apart.

D shows the application to a rope. Lay the middle part of the "selvagee" over the rope, then bring both bights under and around the rope in opposite directions, until the bights are close, then place the hook in both bights.

E shows a double bend, useful for bending a small rope on to a larger one; it will be noticed that the smaller rope is passed twice round the larger one. In F the bend is drawn taut.

G shows a block hook, with a few turns of spun yarn taken round in order to prevent its clearing itself when hooked to anything, and is termed "mousing" a hook.

It is a fishermen's bend. Two complete turns are taken round the ring, or other object, through the two turns next to the ring, over its own standing part, thus forming one half-hitch; the second half-hitch is taken round the standing part alone.

I is a rolling bend. To make it, take a half-hitch with the running end round the standing part, lash them together just beyond the hitch, and size the end to the standing part; each part is exactly alike. It is sometimes called a "hawser bend."

VELOCIPEDES.

Repairs.—Bent Handle Bar.—This is one of the most common accidents which happens to a bicyclist, and is also one of the most easily remedied. If the handle bar is badly bent, turn the machine upside down, so that it rests on the saddle and centre-pin head, get something to fasten the straight end of the handle bar firmly to the floor, then take hold of the pedal, and standing with one foot on the bent end, press it gradually down until it is straight.

Bent Crank.—Another of the many troubles of a touring cyclist, who if he is in a lonely part of the country and has a spill, finds on picking his machine up that the crank has bent sufficiently to stop the front wheel from going round. The best way to remedy this is

to lean the machine against a wall or post with the bent crank inside, i. e. between the wall and the wheel; then turn the wheel until the crank is at the highest point, and, standing on the pedal, push it slowly down so that you do not bend the pedal pin instead of the crank.

Buckled Wheel.—(a) This is what is known amongst mechanics as a burst wheel. Most bicycle wheels will, if properly managed, spring back when pulled; this, however, is beyond the power of one alone, and is most easily accomplished by about four sitting on the ground with the wheel laid flat between them, and, taking hold round the rim, pulling steadily until the wheel springs, when in most cases it may be ridden many miles without any further bother.

(b) In most cases, if a buckled wheel is taken by two persons and twisted back, it will jump into its former position, and is often little the worse; if, however, it wobbles badly when being turned, it may be put right by slackening all the spokes, straightening the bent ones; then, casting the eye along one side of the wheel rim, the bends will be easily seen. These may be pressed straight over a block of wood on the floor or bench. When the rim is thus made straight, tighten up the spokes and true the wheel by measuring from hub to rim with a lath of wood, placing it close alongside of each spoke. All this may be done by an amateur without removing the tyre, and need cost him nothing.

Bent Backbone.—Although cyclists sometimes have the misfortune to come a cropper, which is so violent as to bend the backbone until it overlaps the front wheel, yet it is by no means so common an occurrence as the accidents before mentioned; however, it is as well to know what to do in the worst cases as in the more trivial ones. Sometimes a backbone is so far bent as to make it practically impossible for anyone but a skilled workman to bend it back to its proper shape; but there are many instances when, with a little perseverance

and a good deal of physical strength, one may so straighten it that it can be ridden without fear of further mischief. To straighten one then, take the backbone out of the head and put it (the head) under a heavy weight, or if you have a companion get him to stand on it, then put a stone or a block of wood under the place where it is bent and press down slowly, because if you jerk it you will most likely snap the backbone, which would leave you in a worse plight than before.

Electric Light for.—I have fitted to my 52 in. "Express" an adaptation of Glascorp's light—the motor being an ordinary magneto-electric machine, worked by the hind wheel, and aided by a small pocket battery. The only drawback I find is that when the machine is at rest the light is extinguished. This is, however, obviated in a measure by the use of the pocket battery. The carbons are fed by a train of wheels actuated by the front wheel, the consumption being about 1 in. per hour. The apparatus altogether does not take up more room than an ordinary valise, and the light, to say the least, is very steady, giving about 120 candles, as shown by a photometer. The magneto-electric machine is of the ordinary type, having a rotatory magnet, and was purchased for the purpose for 17s. 6d. (second-hand). Altogether the apparatus cost about 5l., and gives me every possible satisfaction, as with its assistance I can see clearly 200 yd. ahead on a dark night. (J. T.)

REPAIRING BOOKS.

Bookbinding has been already described in vol. iv. pp. 228–267.

Cloth-bound books, that is, books which have been sent out by the publisher in cloth cases, by reason of the demand for cheap books, are, at the best, but very imperfectly bound; and, as a consequence, after the first reading they require to be repaired—in many cases, if the book is worth it, re-bound. This is not the fault of the publisher's binder; he must do them cheaply

because the public demand a cheap book.

These books, during the process of binding, pass through from 10 to 20 different operations, and the price which the binder gets for his complete work would hardly cover the cost of sewing in other circumstances; and yet every dodge is tried to make them as strong as possible, and to wear well in the hands of the public.

Whenever they begin to show signs of getting loose, or if a leaf or a section comes away, the best plan is to take them to pieces and re-sew them and put them into the case. We call this "re-casing," and if done properly the book will last very much longer than it would have done in the original binding. To do this successfully, proceed in the following manner:—Open both boards back until they touch each other, allowing the book to stand upon one end, as shown at Fig. 343; insert a sharp knife at the back between the case and the book, and cut carefully down one side through the lining (and tapes or cords, if any), then down the other side; this will separate the book from the case. The case may now be laid aside, and the book taken to pieces. Begin by laying the book upon the bench with the front up. The back will thus be at the left-hand. Lift the half of the endpaper which still adheres to the book, and gently but firmly remove it, laying it over to the left-hand, with the face down. Do not throw it away; in the meantime it will keep the title-page clean. Now turn over leaf by leaf until you come to a signature: this is a letter or a number at the bottom right-hand page of every section. The first which you will come to is likely to be B or 2, and this is likely on page 17. When you have found this, give it a gentle pull, first from the head, then from the tail; this will expose the thread with which the book has been sewn; cut this thread all the way down with a knife, and so separate the sheet from the rest of the book. Now open this sheet at the centre, and remove the threads which will be found; then scrape off

the glue from the back of the sheet, and lay it down upon the end-paper *face down* at the left-hand. Go through the book in the same way, looking always for the signatures, which will follow in alphabetical or numerical order. If divided at any other place the sheet will be torn, which should be carefully

Dog-ears can be taken out of the leaves of a book by damping them slightly with the tongue, as the most ready means, and pinching them across the corner with the finger and thumb.

When the book has been all taken down, the joint is hammered out of it —i.e. you will find some of the sections

343.

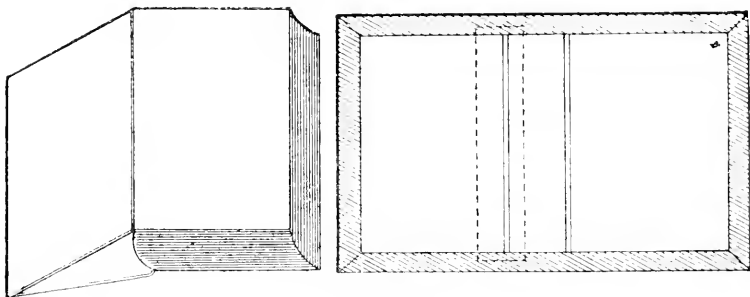

Re-casing a book.

avoided. It may, however, happen that a sheet has been torn even before the "taking-down" was commenced; in that case, "tip" the leaf or leaves with paste, and lay it carefully along the back of the other part of the section. Leaves thus pasted do not open up to the back like the other leaves of the book, and this may be an objection to some people. A narrow strip of tissue-paper will join two leaves together nicely; they can then be placed in the book, and will open up as well as any other leaf. If a leaf is torn across the page, take a little paste upon the finger and paste the edges of the torn part; place a strip of tissue along the tear, both sides, and leave it to dry. It can then be torn away, and in doing so the tissue will skin or split, and leave sufficient sticking along where it was pasted to thoroughly mend the tear. Music is mended in this way, but it will be best to paste the tissue all over, and leave it upon the leaf; the heavy printing of the music shows through well enough to be read, and the mend is hardly seen at all.

bent at the back, hammer these flat. When this is done, it is knocked up straight and sawn in for three bands, and sewn as already directed. The case should now be cleaned inside, all the old lining should be stripped off, the back strengthened by putting a strip of strong brown paper upon it. The book is end-papered, lined, and put into the case; the directions for which have already been given.

If a cloth case is torn at the joint, do not attempt to mend it by *sewing it*, or even gluing a piece of cloth on the outside of the cover. Take it off the book, and insert a flat knife along the broken part to raise the cloth from the board; cut a strip of binders' cloth as near the colour of the case as possible. Glue it, and slip it in below the part you have raised, glued side to the board, of course; allow it to be broad enough to come into the back about half-way, rub it down well. Now glue the part which was raised off the cover with the finger, and lay it down neatly upon the new piece. The dotted lines in Fig. 343 will show the position of the patch, which *must*

be between the board and the cover. A corner may be patched in the same way by lifting the cover and slipping the patch under. If patches of cloth are put on the top of the cover, they will peel off in no time, and will require continual sticking down.

Cloth cases which have become faded or spotted by rain or otherwise, may be freshened up by washing with diluted glair, about half and half glair and water. A large sponge should be used, and the gilded parts avoided as well as possible. The glair dims the gold. After the book has become thoroughly dry, it should be rubbed lightly all over with a piece of pure rubber (not the vulcanised stuff that is used for cleaning paper); this will take away remaining dirt, and brighten up the gold a little.

Leather-bound books are treated much the same. It will, however, seldom be necessary to re-sew these, because they will have been sewn much stronger than cloth books. If the board is torn away at the joint, treat it exactly as directed for the cloth book: Take away the case and patch it with a piece of leather same colour as the original cover, putting it between the cover and the board; if both boards are torn, remove them and the old back as carefully as possible; raise up the leather along the back of the old boards, put on a new piece (bringing it over on both sides), turn it in, and lay down the old cover upon the top, pasting it well, and, when thoroughly dry, paste on the old back upon the new one. The book will also require new end papers. These can be put in from the directions already given. Instead of washing leather covers with glair, use paste-water. When dry, a coat of thin shellac varnish will improve the appearance.

It is, unfortunately, impossible to regild them unless they are taken to the original binder, who alone has the necessary tools. New lettering-pieces, however, may be made at any binder's, the cost of which would only be a few pence, and put on over the old one, or the old one may be removed entirely and the new one put in its place.

Photographic albums are a source of much trouble. The cheaper sorts are after a few weeks' usage very much dilapidated, and although we may feel proud of our collection of photographs, yet we feel ashamed of our album, and fail to bring it out when our friends call upon us, and thus deprive them of a pleasure and ourselves of a means of entertaining them.

Albums may, however, be patched and mended to look as good as new, and may even be made stronger than they were at first. The point of weakness in albums is the joints. Each leaf has, or should have, a joint. In the better kinds these joints are made of cloth or leather. You will observe that these joints are placed underneath the paper forming the leaves. When patching a leaf, remove the paper carefully, or rather raise it from the joint, take out the old one and put in the new one, whether it is leather or cloth, and paste the paper down again. Go over every leaf carefully, and put in new joints where required. Take the album out of the case. This is easily done, as the end paper is thick, and only sticking to the board at the edges.

If there has been a lining on the back, take it off, and straighten every leaf. You will find them shift about in all ways if moved by the fingers. Glue the back well with good strong glue, not too thick, and cut a piece of strong linen the length of the back and about 2 in. broader; glue this and put it on the back, allowing 1 in. to come on each side. Take care to make this stick well to the back by rubbing it closely with a folder or the handle of a tooth-brush. Strengthen the back of the case by gluing a strip of brown paper inside. Place the album in the case again, glue the end-papers, and put it in the press. Leave the back open, for if glued to the album it will not open freely, and the leaves will stand up instead of lying flat.

The leaves are often slit where the cards are put in. These can be mended as the leaves of a book are mended; description already given. (*Eng. Mech.*

NETTING.

(1) The tools employed in netting are exceedingly simple, and can, in case of necessity, be made by any person with the aid of an ordinary pocket-knife and some pieces of hard wood. The most important are the needles on which the string to be employed is wound, and the mesh pegs or spools on which the netting is worked.

Needles are of two kinds; those made alike at both ends, with converging prongs, between which the twine is passed (*a* Fig. 344), and those made with an eye and tongue at one end and an open fork at the other (*b c d*). On these the twine is wound by fastening it to the tongue, then carrying it down one side to the prongs of the fork and bringing up the other; then hitching it over the tongue and carrying it down to the fork again, on the same side as that it was brought up, and so repeating the operation until the needle has sufficient twine wound upon it. The needles made with eyes will be found superior to those alike at both ends, as they are not liable to be caught in the net whilst working. They are made of various sizes, according to the stoutness of the cord they have to carry, and are modified, so as to fit them for various uses. Sometimes the eye and tongue are made very long, as in *b*, which is a reduced representation of a needle used by the Hull netters, its advantage being that it carries a large amount of twine, the hitches of which pass round the sides of the long tongue without making a sudden swelling, which is very inconvenient to the netter, as it prevents the needle being passed rapidly through the meshes.

In case needles of the ordinary kind cannot be readily obtained, substitutes may be extemporised out of two pieces of wire bent as in *c*, the wires being soldered, or, in case of necessity, even tied tightly together.

Short needles, about 4 in. long, are required in mending nets. That represented in *d* is an exceedingly convenient form; being thinner at the point, and

carrying the string sunk in the broad grooves on the sides, it passes through the meshes with great facility, a point of much importance in mending damaged nets. Netting needles can be purchased of any required size at most cordage warehouses, and they are readily made from thin pieces of hard wood, such as box, oak, ash, &c., by the aid of a common fret saw and a half-round file.

Mesh pegs or spools, on which the netting is worked, are best made of very hard wood, such as box for the smaller, and oak or beech, &c., for those of larger size. A considerable number are required if various nets are being made, as the size of the openings in, or meshes of, the net depends entirely on the size of the mesh peg employed. Cylindrical or round mesh pegs, which are sometimes used, are much less convenient than such as are flat. The edges of flat spools should be quite straight; otherwise the meshes of the net will be of unequal size; and they should be very smooth, so that the loops will slip off rapidly when desired.

Mesh pegs of the form shown in *e* are used by the Grimsby netters for the sea fisheries. They are all 4 in. long, and usually made in sets of 5, the number being shown by the shallow holes at one end of each peg. No. 1 is $2\frac{1}{2}$ in. wide by 1 in. thick; No. 2, $1\frac{3}{4}$ in. by $\frac{3}{4}$ in.; No. 3, $1\frac{1}{2}$ in. by $\frac{3}{4}$ in.; No. 4 (shown in the figure), $1\frac{3}{8}$ in. by $\frac{3}{4}$ in.; No. 5, $1\frac{1}{4}$ in. by $\frac{5}{8}$ in. They have each a hole bored through the short diameter for the purpose of stringing them together.

When large meshes are required, as in walling for trammels, the mesh peg would be too broad to be held by the thumb and forefinger, in which case it should be made as in *f*, the hollow part passing between the thumb and bottom joint of the forefinger of the left hand. These mesh pegs can be made of any desired width; but when very wide they should be made very short, never exceeding a few in. long.

It is a very common error to call mesh pegs or spools by the name of meshes, and a great amount of confusion results from using one word to signify two

things. By the Yarmouth netters a mesh peg is sometimes termed a "shale," and by some writers it is spoken of as a mesh pin, or mesh stick.

diamond or square shaped; each mesh, except those at the sides of the net, has four sides and four knots, one at each corner. The meshes are formed by net-

344.

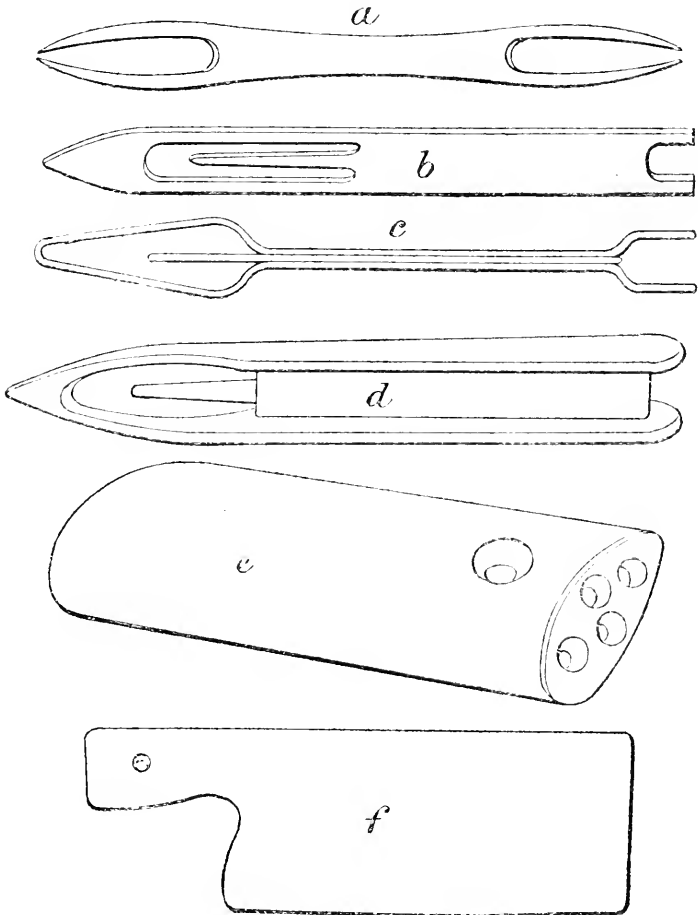

Netting needles.

Meshes are the openings between the cords of the net. They are either ting a succession of loops. The last row netted consists of loops, each of which,

with the halves of two loops in the previous row, constitutes a complete mesh. Thus in A Fig. 345, $a b c$ are the last loops formed, d is one being made (the needle and mesh peg are not shown for the sake of clearness), e is a loop in the row previously made, which would form part of the next mesh to be made if the netting were continued.

The string or cord on which the netting is commenced is usually termed the foundation. It is shown in f .

The knot employed in making nets is that which is known as the "weavers' knot" or the "bend knot"; it is used not only to join together the ends of the cords of which nets are made, but is the means by which the loops forming the meshes are fastened together, every knot in a net being a weavers' or bend knot. As the mode of making this knot with rapidity is not very generally understood, and as the knowledge of its arrangement is of essential importance to the netter, it is necessary to explain its formation at some length. The simplest mode of making a bend knot is as follows: Bend a piece of twine into a loop $c d$ Fig. 345 B; pass the second piece of cord through the loop from the farther side; then carry it round behind the two cords of the loop, bring it forward and pass the end under itself, bringing it out at a ; pull the end b tight, and the bend knot is completed. When one of the ends of twine is very short (as is usually the case in net mending) it can be made into a loop, $c d$, and another piece of twine can be securely tied to it, even if the loop is only 1 in. long. On looking at the knot, it will be seen that it can be securely tightened by pulling the end b , which bites the end a securely; whereas if a is pulled it slips under b without biting.

The above explanation shows the formation of the knot as it is used when stout cords or ropes are united by its means; but when it is employed to join threads or string, as in weaving or netting, a much more expeditious mode of making the knot is employed. The ends of the two cords to be united are crossed on the end of the forefinger of

the left hand, the cord $a b$ Fig. 345 C, being first placed on the finger, and the other cord $c d$ put across it. The left thumb, the position of which is shown by the dotted line, is then placed over the crossed cords. The cord b is then to be wound round (over the thumb) in a circle and passed between the two ends, behind a and before c , as shown in Fig. 345 D. The knot is completed by turning the end c downwards, passing it through the loop at e , securing it under the left thumb and pulling b , when the knot is formed as shown in Fig. 345 E. It is also represented in Fig. 345 B, but turned over to show the other side, the letters of reference being the same in both figures. Facility in making this knot *must* be acquired, as its use is indispensable to the netter.

A knot which will be found of great use in shortening or lengthening the cords employed in stretching out the different parts of a net whilst it is being mended is shown in Fig. 345 F. A loop of cord a is formed into an eye; through this the two ends of the same, or of a second, cord are passed and twisted, as shown at b ; this secures the ends, and prevents them slipping back through the eye. The great advantage of this knot is that, when it is wished to shorten the cord, the eye is pushed farther back, and the twist or half-bend pulled tight down to it. On the other hand, when it is requisite to lengthen the cord, the reverse proceeding is had recourse to.

It is not generally known that there are two perfectly distinct modes of netting; one of these, which is adapted for making small meshes, is the only one usually recognised; the other is employed for strong work and coarse meshes. The former is called the under edge, or little finger knot, or, in general parlance, simply "netting."

To commence a cord, tie together the two ends of the cord forming the foundation (f Fig. 346 G), and secure it firmly in any convenient manner, as by passing it under the foot, letting the part to which the netting is to be attached reach 3-4 in. above the knee when the netter is seated. In making

345.

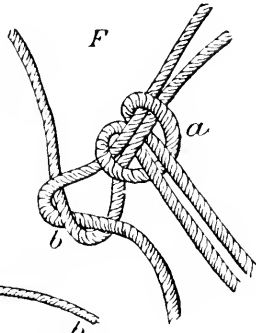
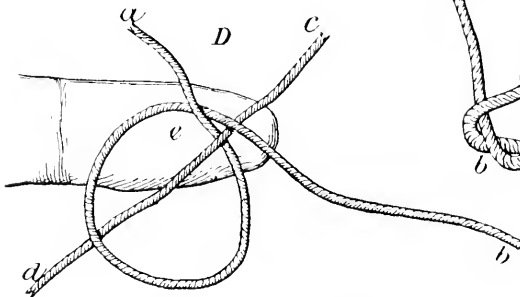
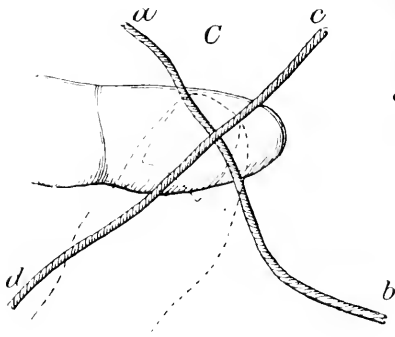
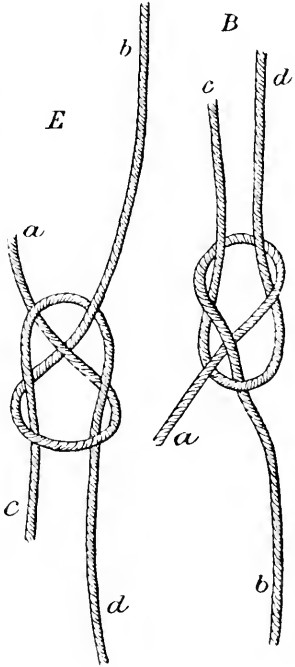
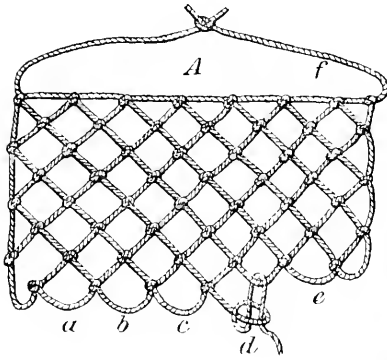

Netting.

large nets, which are most rapidly executed if the netter works standing, the foundation should be fastened to a hook, or rod in a wall, placed as high as the face of the netter; it then not only bears the weight of the net, but also supports the left hand, which holds the mesh peg. Tie the loose end of the string with which the net is to be made, which has been previously wound on the needle, to the foundation, as shown at *d*. The mesh peg *s* is held between the thumb and forefinger of the left hand, and the knot *d* is pulled up close to its edge. The needle carrying the string is brought back over the mesh peg, then forwards underneath it, the string being caught by the third finger *r*, which should be kept well away from the mesh peg as shown in the figure; it is then carried forwards under the mesh peg and then to the left, being caught by the thumb as shown at *t*. The loose string is then thrown forward on the foundation, and the needle, having been brought backwards, is again passed forwards through the loop of cord that is hitched on the third finger, then under the mesh peg, and lastly through the foundation; this is the position represented in Fig. 346 G. The right hand is now shifted from the back part of the needle to the front end, and it is pulled forwards from under the mesh peg and through the foundation. By this action the loose cord is drawn tight round the little finger, and the knot is completed, but requires tightening. This is done by first loosening the cord under the thumb, then allowing it to slip off the third finger; all the slack cord is then pulled up by the right hand, and when the knot which is thus formed is pulled close to the mesh peg (against which it is held by the forefinger), the loop is allowed to slip off the little finger at *l*, and the string is pulled tight, thus completing the knot and netting a single loop on to the foundation. In describing these movements it is necessary to mention them as if they were perfectly distinct from one another, but in the actual practice of an expert netter there is no pause between them, and they

follow each other so rapidly as to seem one continued movement.

In Fig. 346 G, the thumb and forefinger are shown away from the knot in order that it may be seen, but quick workers hold the end of the thumb and tip of the forefinger together, and the second finger holds the knot as it is tightened.

The loop first netted is allowed to remain on the mesh peg, and a second, which is a repetition of the first, is then made, and as many more as may be required to complete the first row. When these loops are too numerous to be conveniently held, they are pushed off the left end of the mesh peg. The loops in the first row netted do not form complete meshes, but when the mesh peg is withdrawn appear as in Fig. 346 H, which shows a foundation with three loops netted on it and a fourth not tightened up. If the foundation is pulled out before a second row of loops is netted, the knots become loose, and the string lengthens into a straight cord.

When the required number of loops has been made, the mesh peg is pulled out and the foundation and the row of loops are turned over, so as to bring the under side on top and the right hand end to the left. The netting is then recommenced in the same manner, with this difference, that, instead of passing the needle through the foundation, it is passed through the loops of the row first made; these being taken up in succession one after another. The mode in which a loop is taken up is shown in Fig. 346 J, where two loops of a row are shown on the mesh peg and a third in the process of formation (to avoid confusion, the other parts of the net are not shown).

Netting on to a row of loops is done with much greater facility than netting on a foundation cord, and should be practised by the learner in the first instance, if he can obtain a teacher to net a few rows for him to begin upon; the first loop on a foundation is more troublesome than those following, as the foundation cord is not kept close up to the mesh peg.

346.

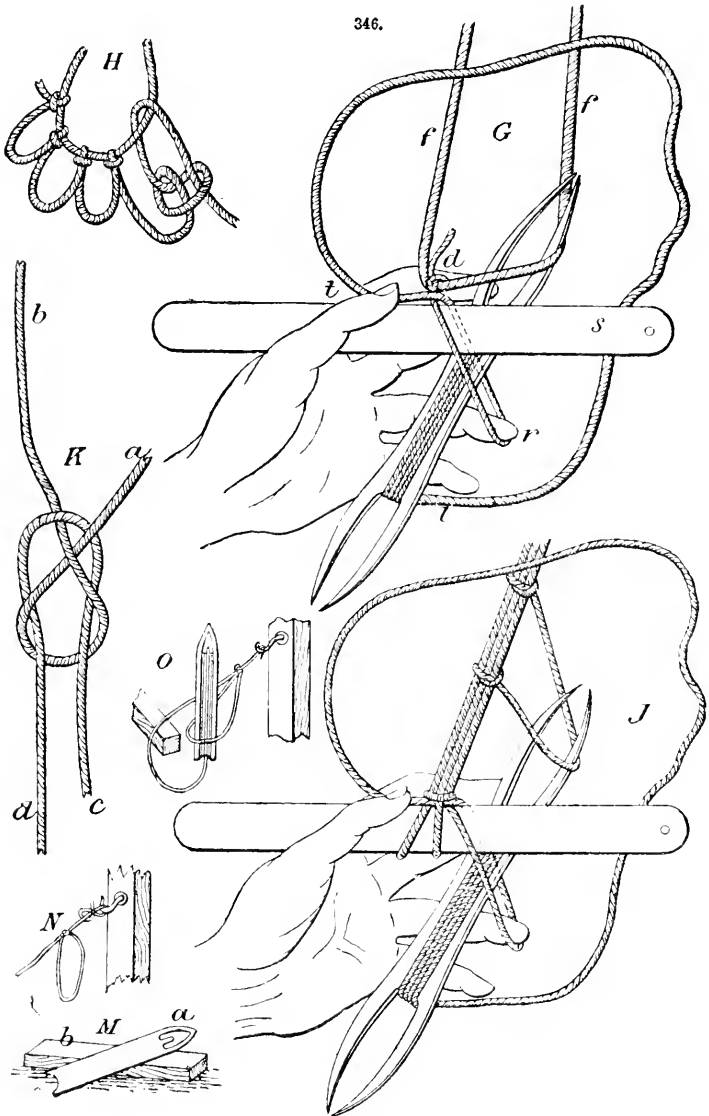

Netting.

In looking at the loops made in netting, it will be found that they are united by weavers' or bend knots, as shown in Fig. 346 K, the bend being formed by the loop that is taken up, and the cord *b* being that attached to the needle. It follows that if *b* is pulled tight, it bites securely upon *a*, and renders the knot firm and difficult to unpick.

In 1845 Every described a different method of holding the mesh peg, which he terms the spool, by which he claimed to gain a considerable increase in speed. He says there is nothing which tends so much to swiftness in netting as a proper and loose or easy way of holding the mesh peg; this will be best understood by an examination of Fig. 347 L, which gives the true position of the fingers at the commencement of the stitch: it is a method not generally known, but by far the best, giving such perfect freedom to the hand, and so open a space for the needle to pass through.

It is convenient to hold the mesh peg at an angle of forty-five degrees; indeed, that is the natural position when the fingers are properly placed. It will be evident, upon an inspection of the figure, that the thumb and first finger hold the mesh peg, leaving the three remaining fingers perfectly at liberty to stretch out and hold up the next mesh or loop to be taken, besides drawing back to free themselves from the string, at the proper moment during the operation of forming the knot.

Speed has been increased 300-400 knots per hour by adopting this method of holding the mesh peg. In netting with fine string upon a peg about 1 in. wide, which is the most favourable size for speed, one can average about 1300 knots per hour: the greatest number that can be effected in the above time being 1750, all circumstances of course favourable.

In the common method of holding the mesh peg, it is inconvenient to pass the needle between the mesh peg and forefinger, where there cannot be any open space to admit of the needle being thrown through, as it should be; in addition to this, there is another disadvantage,

namely, the cramped state of the other fingers, which cannot free themselves properly from the string at the time when it is being drawn up for the knot.

As to the method of making the knot: The mesh peg being in its place, with the forefinger turned behind it, under the netting, and the needle in the right hand, with the string stretched out, the first part of the operation is to pass the needle round the end of the mesh peg to the right, laying the string over the second and third fingers, then taking it forward and catching it under the end of the thumb, where it is held whilst the needle passes back again, throwing the string forward on the net already made, at which instant the left hand should be turned with the knuckles downwards, and the two fingers having string upon them should be stretched forward under the mesh about to be taken; in this position there is an open passage for the needle, which has passed round, and is thrown through, being caught on the other side; as it passes through, the string gets on the little finger, and the other two may be withdrawn at once; therefore, on the needle being snatched back, one pull ties the knot, without any sawing or trouble, which always occurs to some extent in the common method. The movement here described cannot be properly effected unless the netting is laid over a table, or something by which it is held up on a level with the hand, a position much more favourable for speed than when the net hangs down.

Reid says that Every's method is a well-known mode of holding the peg, and one which comes quite naturally to learners, but in the first lessons to his workers it is especially avoided, as it is considered the very worst form of holding the mesh peg. The importance of this to a worker is very great, as, should the habit be contracted, the value of the work would be diminished 50 per cent., both in speed and quality of work, and any worker would be discharged if found using her tools in this manner.

In a correspondence which took place in *The Field* some years since, F. Allies

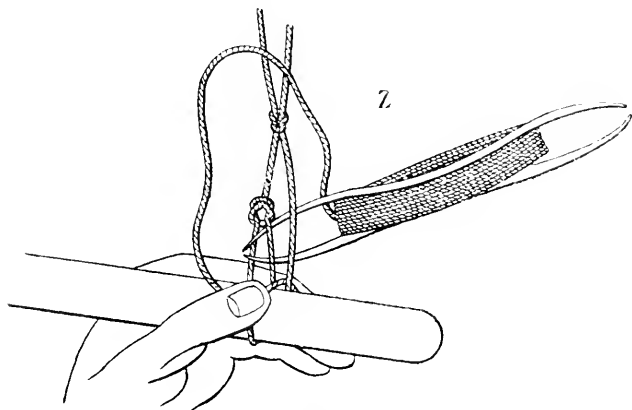
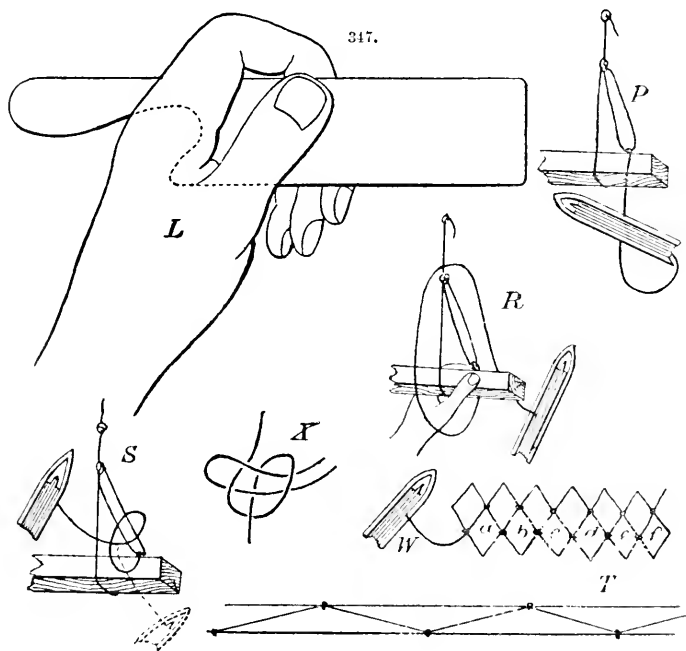

Netting.

stated that, with an inch spool and patent thread, a quick netter ought to more than double the rate of speed claimed by Every, and net at the rate of 3600 loops per hour. (T.)

(2) The instruments for netting consist of a needle *a*, and a mesh *b* (Fig. 346 M). From 8 in. to 10 in. is a good length for the needle, while the mesh stick must vary according to size of net. A mesh stick will make a mesh twice its own size. Thus, a stick $\frac{1}{2}$ in. square will make a 1 in. mesh. To fill the needle, pass the string around the tine, or inside point, round the heel of the needle, then up round the tine again, until the needle is full. Fasten the end of the string to a hook and tie a loop in it N. Lay the mesh stick underneath the string, and pass the needle up through the loop O (346). Pull it tight, so that the end of the loop rests against the mesh stick P (347). Now comes the important part—the formation of the knot. Hold the mesh stick in your left hand with the thumb on the string, and with the needle in the right hand; now with a quick jerk throw the bight or loop of the string over the stick and left wrist, as shown in R. Push the point of the needle up between the first loop made and the string to the left of it, pull the needle through, and bring the knot into shape S, then tighten by pulling the needle in the direction of the dotted lines, and the knot is tied. This simple knot is the foundation of all net-making, and once succeed in that and you will very soon be able to manufacture almost anything. Slip out the mesh stick and take the same stick through the loop you have just made, and so continue on, passing the needle every time through the last loop made, until you have made enough. By the time you have made as many as you think requisite, your work ought to look something like T. Unfasten the end from the nail and untie the first loop made. Pass a piece of cord through the upper row of meshes, tie the ends of the cord together, and hang it over the hook. Go on with the work as before, only do not slip the loop off the stick as at first. Knot

through *f* Fig. W, then through *c*, *d*, *c*, and so on, until you have travelled along the whole width. Then turn the work over and travel back again in the same manner. Presuming the string breaks, or you wish to join another ball, the way to do it is with a "becket-hitch," commonly called a "weaver's knot." Form a bight, pass one part up through it, then over, under and back through its own loop, as in X.

(3) Lawn Tennis Nets.—There are many persons who are thoroughly familiar with the ordinary method of netting—that is to say, as far as making the loops and meshes is concerned—who do not know the construction of square-meshed nets, such as are required for lawn tennis and other similar games. The following instructions will enable anyone capable of making the ordinary diamond-shaped netting to construct also square-meshed nets for tennis or other purposes.

In making nets in which the meshes are of large size, the spools or mesh pegs are usually flat. When very large they become awkward to hold, in which case it will be found much more convenient to have them cut the shape shown in Fig. 344 *f* than to allow them to remain of equal size from end to end. In using these spools, the base of the thumb goes into the deep notch shown at the left extremity of figure.

By the term loop, we mean the loop formed around the spool, as each knot is made in succession, the last row netted always consisting of a series of loops, each of which, with the two loops of the preceding row into which it is knotted, constituting a complete mesh.

In making square-meshed netting it is necessary to be able to make the knots in a different manner from that usually adopted, to net in fact with the fishermen's knot. This is done as follows: Let the spool and netting be held in the usual manner. Then, to make a new loop, bring the needle backward over the spool; then carry it forward under the spool, *but without catching the string on any finger*. Pass the needle upwards through the loop that is to be taken up, and pull it close up to the spool, seizing

the twine passing through the loop with the forefinger and thumb of the left hand. The loose twine should be allowed to fall over to the left, and down in front over the netting; and the needle should then be passed upward between the loop that is being taken up and the last one secured. On tightening the loose twine, the knot is completed.

This mode of netting is shown in Fig. 347 Z, where the twine may be traced from the last-formed knot round the spool, through the loop, then to the left, where it is secured by the thumb; the loose twine is shown lying over the netting, and the point of the needle is just inserted behind the loop that is being taken up. To finish the knot, the needle must be pulled through, and the string drawn tight.

A very slight examination will show that the knot made by this method is the same as that resulting from the common mode of proceeding.

In reality the stitch is much more simple than the one ordinarily used, and can be made with very much greater rapidity. It necessarily follows that anyone used to the old mode will find this new plan awkward at first, and will fail to net as neatly as before; but the strangeness is soon overcome, and great rapidity attained. With stout cord the advantage is very great; there is no sawing of the twine required to tighten the knot, consequently no fraying either of the twine or the fingers.

Another immense advantage possessed by this knot is that it can be made, using one, two, or three fingers instead of the spool, and with a short end of the string without a needle, so that in mending nets it is really invaluable.

Two points, however, we have omitted to mention: the method is not adapted to very small netting, and it is always necessary that the spool should be larger than the needle, otherwise the latter sticks in passing between the loops. Again, there are certain stitches that cannot be made in this manner, such as the first row or foundation of a diamond-meshed net.

Diamond-meshed nets are commenced,

as is well known, by netting a number of loops into a foundation, and when as many as are required are made, netting a second row into the first.

Square-meshed nets, as shown at Fig. 348 A, are made by commencing at one angle or corner, and netting diagonally across the square to the opposite corner. In beginning a square-meshed net, one loop *a* Fig. 348 B, is first netted on to the cord which is used as a foundation; this loop may be of larger size, as it is only temporary, being removed when the net is completed. The spool is then withdrawn, and two loops are netted into the one first made; the last of these two should always be made with what is known as the fishermen's knot, as, if made in the ordinary manner, a lopsided knot is the result. The spool is again withdrawn from these two, and a new row is commenced; this will consist of three loops, two being formed by taking up the last loop of the previous row twice. The netting is to be continued in the same manner, the last loop of every row being taken up twice. By this means a half-square of netting will be formed, of which the last row is the diagonal, and the two sides *a c* and *a b*, Fig. 348 A, form the selvages on each side of the half-square. When the sides of the square are of the required length, a single row should be netted without the extra loop at the end; and then, to form the remaining half of the square, the rows should be continued, but with this difference, that, instead of netting two loops into one, as before, *the last two loops in every row should be taken up with the needle together*: thus the width of the netting will be gradually diminished to one mesh, and when the net is stretched out it will be found a complete square formed of square meshes, as shown at Fig. 348 A.

In order to make the angle neater, the spool should be withdrawn before the last knot is tightened, so that the last loop is made to come into the angle; and the first knot should be untied, and the large front loop *a* Fig. 348 B also drawn up tight, so as to render the net correct in shape.

348.

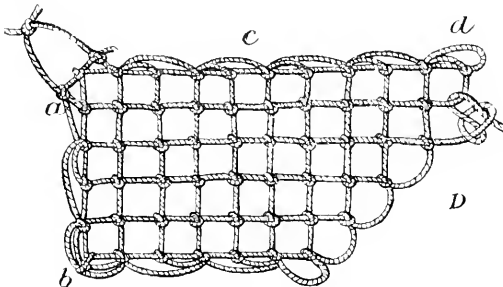
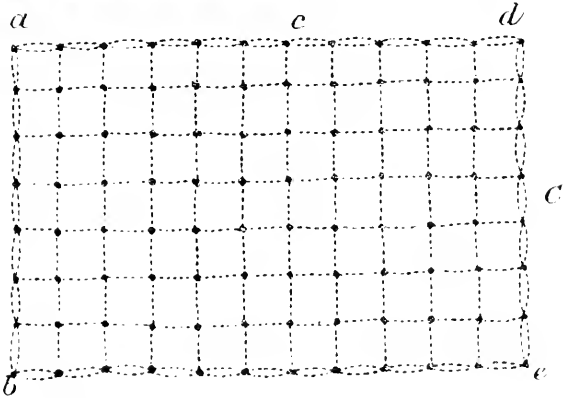
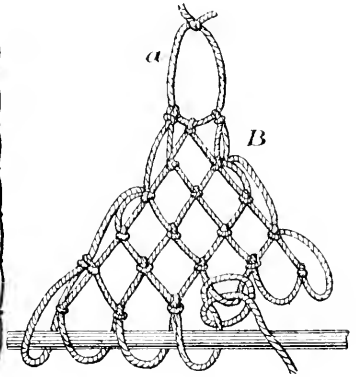
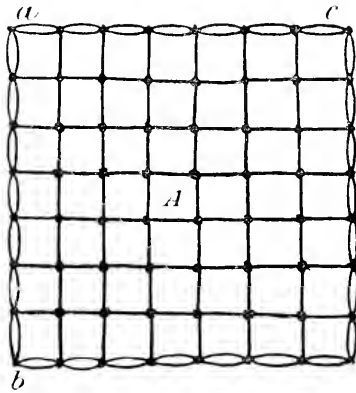

Making square-meshed nets.

The netting of an oblong net, such as shown in Fig. 348 C, is a rather more complicated matter. This is commenced with a half-square as before, the length of the sides determining the width of the net. This done, at the end of the next row the last two loops are to be taken up at once; but on returning to the end of the succeeding row, two loops are to be netted into one as before, and this alternation is to be continued. At the end of *one row two loops are to be taken up at once*, and at the end of the *next row two loops are to be netted into one*. The side at which the latter is done—*a c d*—will be the long side of the oblong, and when this is of the required length, two loops are taken up at *each end of each row*; and the net diminished to the point *e*.

In making an oblong great care must be taken always to diminish or increase at the proper sides of the net, otherwise a confused mass of useless netting will be the result. This error is easily avoided if a few threads of coloured string or a riband is tied at the angle *b*, to show which side should be diminished by taking up two loops in one.

This proceeding may perhaps be rendered clearer by a consideration of Fig. 348 D, in which *a* is the first loop. Five rows are then netted, each being increased by netting two loops into the last of each row, making the half-square *a b* and *c*. Then on returning to *b*, two loops are taken up together, and at the side *a c d* two loops are netted into one, and when the required length *a* to *d* is reached, two loops are taken up together at the end of every row and the net diminishes to a point completing the oblong.

A lawn tennis net of the M.C.C. regulation size is 5 ft. high by 8 yd. long, and the mesh is $1\frac{1}{2}$ in. square. The strongest and most durable cord to employ is that called mattress twine, the usual price being about 6*d.* a ball; 10 balls are generally required for an ordinary-sized net.

To make a net of this size a half-square of 40 rows would have to be made before one side should be diminished

by taking up two loops in one, and then the long side *a c d* should be continued for 192 rows before diminishing to the corner *e* Fig. 348 C by taking up two in one at both ends of every row.

It is hardly necessary to add that a net of 10 or 12 yd. length for double games can be made by simply continuing the side *a c d* until the required length is obtained.

(4) Mending Nets.—The ability to mend nets is an art of rather rare occurrence; except amongst fishermen and their wives, there are perhaps 100 persons who can make nets for every one who can repair them when damaged. The first step towards acquiring this power consists in learning to make a bend knot. This has been already described (p. 386) and illustrated (Fig. 345). A knot, which will be found of the greatest use, not only in fastening the cord to which the foundation of a net is attached, but also in stretching out the different parts of a net whilst it is being mended, has been described on p. 386, Fig. 345 F.

It is impossible to mend nets by using the ordinary netting stitch which is employed by most persons. What is termed the fishermen's mode of making the knot is absolutely necessary. This was described fully on p. 392. In mending a torn or damaged net, the first operation is to spread the net out as flatly as possible, *with the loops in the same position with regard to the mender as they were to the netter when the net was made*. In the case of a lawn-tennis net the corner or angle at which the net was commenced must be farthest from the operator. The damaged or torn part must then be cut away in regular rows, as shown in Fig. 349 E, where the whole of that part represented by dotted lines is supposed to have been removed. The short ends of string that are knotted into the loops 2, 3, 4, 5, and 6 must be unpicked, when those loops will remain uninjured; and the knots at 14, 15, 16, 17, and 18 must also be unpicked, so as to liberate the loose ends of those loops that have been cut away; but

the knots at the sides of the part removed, viz., at 1, 13, 7, and 19, must be left, otherwise those loops would be opened, which is not requisite.

The mender should then take a short needle (one of those alike at both ends is most convenient for mending); fill

to form the new loop being ascertained by measuring from 1 to *a*.

When there are a large number of meshes to be filled in, a spool may be used, but when there are only a few it is neither necessary nor desirable to employ one.

349.

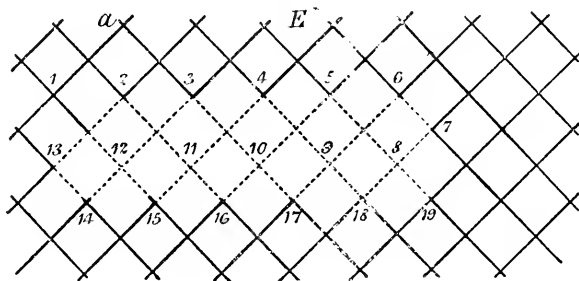

Mending net.

it, but not over-full, with twine of the same size as that used for the original netting; or twine slightly finer may be employed, as, being new, it will be stronger than the old. The end of the twine should then be fastened by a bend knot to the loop 1, the needle passed upwards through loop 2, then the twine should be taken between the thumb and fore finger of the right hand, and a length measured equal to the distance from the knot at 1 to just beyond the knot at *a*, this gives the exact length of twine required to form the new loop from 1 to 2; this new loop is caught on the little finger of the left hand, and pulled back; the point of the old loop 2 and the cord passing through it are held by the thumb and fore finger of the left hand, the loose twine is thrown over to the left, the needle is brought to the right, and the knot is completed by passing the needle under the loop 2 from right to left. In short, the loop 2 is taken up by the fishermen's knot, only made on the little finger, instead of on a spool, the length of the twine required

The new loops from 2 to 3, 3 to 4, 4 to 5, and 5 to 6 are made in the same way, and then the side 6 to 7 must be made by netting into 7 as into a loop. This completes the first row of new loops.

The second row has now to be netted into the first. If performed as recommended, without a spool, it may be worked backwards from right to left with great facility; or the netting may be turned over on to the other side, when the second row can be completed in the usual direction, from left to right.

In this manner the space cut away must be filled up, until the last row is reached; this requires different treatment. In Fig. 349, 3 rows of loops only are shown as having been removed. When the second has been entirely replaced, the twine will be attached to the knot at 13; to complete the repair pass the needle through the loop 14, and secure it by a bend knot, 14 being the loop of the bend knot, and taking care that the side 13 to 14 is of the proper length; then knit into loop 12

from 14, return to 15, and so on, connecting the whole in the following order—11 to 16, 10 to 17, 9 to 18, and lastly 8 to 19, which completes the repair. Of course the reparation of larger rents and more extensive damages is only an extension of the same proceeding as is here described with reference to three rows of loops. The description of this process doubtless appears tedious, but the performance is, with a little practice, sufficiently easy. (T.)

WALKING STICKS.

(1) At the present time there is, comparatively speaking, no limit to the material that can be turned to account for the purpose of walking and umbrella stick making; indeed there is always a keen look out being kept up for new sources of material, and a constant introduction of novelties, both in the sticks themselves and in the adaptation of them to meet the demand of fashion. So great, varied, and numerous are these demands, that of late years, especially in Continental countries, many persons have taken up with the cultivation of sticks of certain kinds, exclusively to supply the walking-stick market. In this country, land is generally of too high a value for it to be placed under such a system of culture, though quite recently large quantities of ash saplings, in which the roots have all been directed in one way to form what is known as cross-heads, have been grown in the county of Surrey.

Some 20 years ago the first collection ever got together illustrating the materials used for walking sticks was presented to the museum of the Royal Gardens, Kew; and quite recently this collection has been entirely revised and augmented by the same firm which originally presented it, namely, Henry Howell & Co., of Old Street, St. Luke's.

Forest produce from all parts of the world is here deposited. From the East and West Indies, Singapore, Java, China, and other eastern countries, are derived a great variety of sticks, principally, however, belonging to the bamboo and

palm tribes. The sticks, as required for the workshops, are drafted from the stores. Some are so crooked that they require a great deal of straightening before anything else is done with them, and this straightening process is one of the most interesting and remarkable. On the top of a very hot stove is a heap of sand, in which the sticks are plunged, and kept there till they have become quite pliable. The workman then takes the crooked stick while it is still hot and inserts it into a notch cut in a stout board, placed at an angle inclined from him, and bends and strains it, occasionally casting his eye along it to see that it is straight, and when perfectly so it is thrown down to cool, and when cold it is quite rigid, without the slightest fear of it ever going back to its natural crookedness. In this way some of the most irregular and apparently worthless sticks are made to assume an appearance almost impossible, when we consider that the workman has nothing but practice and a well trained eye to guide him. Heat is a very important element in the manipulations of a stick-maker, and produces very different effects on the several kinds of woods, the degree of heat necessary to straighten one kind of stick being often sufficient to completely spoil another kind. The same power which makes a crooked stick straight is applied to make a straight one crooked, and so we find that the rigid stems of bamboos, partridge canes, and all the various kinds of English sticks which are required to be curled or twisted, are by the application of heat made to assume almost any shape or form. Thus, ladies' sunshade handles at the present time, especially those of bamboo or partridge cane, are twisted and even tied into double knots.

By far the largest number of sticks used are those known as natural sticks, that is, saplings of trees or climbing plants, where the roots have sufficient character to form handles or knots. These are always more in demand, whether for walking, umbrella, or sunshade sticks, than those that are cut from the solid, like letter-wood, ebony,

boxwood, beef-wood, partridge-wood, &c. Messrs. Howell, with the view of bringing to light undeveloped resources, have had some notes drawn up and circulated amongst their correspondents, on the points to be observed in collecting raw sticks, canes, &c., for walking sticks, umbrella handles, &c. The total length should not be less than 42 in., end to end, and if possible they should be 48 in. The best sizes are of the diameter of $\frac{1}{2}$ -1 in., measured about midway; they should not be larger than $1\frac{1}{4}$ in. It is indispensable that the diameter should gradually diminish from the root, or handle, to the point, so that the stick is not "top-heavy." It is always better, when possible, to send sticks with some kind of handle; if the plant be pulled up, the root should be left quite rough and untrimmed; if a branch be cut off, a part of the parent branch should be left on to form a knob or crutch handle. Sticks without handles can be used, especially if they are nicely grown and have any peculiarity of structure or colour; but if there is any handle, however small, it should not be cut off. Young saplings of the different kinds of palms, bamboos, &c., should always have the root left on. Occasionally the form of the root or handle part is attractive, while the stick itself is weak and defective; in such cases the handles only should be sent, and they should measure 15-18 in. long. In sending specimens of new sticks, it is better to send only small quantities, say one or two dozen, at most, of each kind, then if approved, further quantities can be asked for. Specimens of anything remarkable for form or colour, whether in the roots or stems of woody, herbaceous, or reedy structures, should be sent, as sometimes the most unlikely things are found to possess value for use either as umbrella handles or walking sticks.

It will be seen from these notes that, as before stated, the chief demand is for natural sticks, many of which lend themselves readily to the varied designs so necessary for ladies' sunshades. Not many years since the whole of the machinery in use was worked by hand,

but in consequence of it being necessary to turn out very large orders with great rapidity, steam power was introduced, which sets in motion band and circular saws, planes, and rasps, with the result that a stick of the toughest description can be converted into a marketable article in a very short time. So dexterous do the workmen become in the use of these tools that they seldom make even the slightest error in their work, and the rapidity with which the workers in gold and silver mounting perform their delicate manipulations is remarkable. Besides the precious metals, a great variety of valuable stone mounting is effected in this department, amongst the stones used being Mexican onyx, agate, jasper, various marbles, and occasionally even the more precious stones, including diamonds. Ivory, horns of all kinds, rhinoceros, buffalo, stag, sea-horse, walrus tusks, &c., are also largely used.

In enumerating the materials used in the manufacture of walking sticks it has been thought best to classify them in alphabetical order according to their commercial names. Though the following is a fairly complete list, and represents most of those exhibited in the Kew Museum, it is by no means an exhaustive list, additions being frequently made.

Acacia.—The name of this stick designates its peculiar colouring rather than its botanical origin, and any stick that is sufficiently strong, and lends itself readily to artificial colouring, is used, such as crab, dogwood, &c.; the specimens at Kew are the produce of a hardwooded shrub or small tree, found in the forests of Mid and Southern Europe, probably belonging to the dogwood order. The sticks, in their prepared form, have found much favour for ladies' umbrella and sunshade handles. They are made in various shapes, but the colour is generally bluish or greyish, with a metallic lustre, and occasional dark streaks.

Apse or Asp.—This is the wood of the aspen (*Populus tremula*); it is very light both in colour and weight, and has little else, perhaps, to recommend it for

walking sticks. The supply is obtained from our own country.

Ash (*Fraxinus excelsior*).—This tree furnishes a variety of sticks, known in trade under different names, as, for instance, the root ash, which consists of the saplings with the roots attached, which form the handle; then there is the cross-head, in which the roots, instead of forming a somewhat globular knob, take a twist at right angles from the stem. These, as has been before stated, have been grown, and so directed during their growth, on a large scale in Surrey during the last two or three years. The figured ash is another form, in which the bark has been scarified into various designs during growth, and on healing has left a permanent marking. These latter are, perhaps, more curious than beautiful, but still they have their admirers. The ash can be treated in various ways with the bark either left on or removed. Some of those with the bark remaining, when properly cleaned, dressed, and polished, make very pretty sticks, and are not unlike those of the orange.

Bamboo.—The bamboos furnish a great variety, and a very large bulk of the material used by the walking-stick maker. They come, of course, chiefly from the East, but their botanical sources are difficult to determine. Amongst those which may be called true bamboos, namely, those furnished by the genus *Bambusa*, may be mentioned the Whampoa bamboo, probably the produce of *Bambusa metake*. They are noted for their irregular jointing; they are of a clean, lemon-yellow colour, and not long since were much used for sunshade handles. They are imported from China. The yellow bamboo and the black bamboo are also well known, their colours being indicated by their commercial names. These canes are imported from Japan and China, and are no doubt the produce of species of *Bambusa*, as is also probably the beetle-cane, so named from its intensely black colour and its scaly appearance near the root, which, however, makes it very pretty. This is also the product of a

Chinese species. The dog-head bamboo is not a true bamboo, but is furnished by a species of *Arundinaria*, a closely-allied genus. The name dog-head has been given to this stick from the natural growth of the rhizome roughly representing the head of a dog, so that it is easily carved and converted into good representations of dogs' heads. These sticks are imported from China.

Bakow.—This is apparently the produce of a palm, but at present its origin remains unknown. The sticks are imported from Singapore.

Bay Tree or Laurier Thyn.—These sticks are apparently the produce of a species of *Eugenia*, though nothing definite is known about them. The wood is very hard and close-grained, almost white in colour, but with a cinnamon brown bark covering the irregular root, which makes good handles for umbrellas. They are imported from Algeria.

Beef-Wood.—This wood is of a dull reddish colour, close and even grained. It is apparently cut from the trunk of a large tree, perhaps that of *Ardisia coriacea*. It is imported from Cuba.

Beetle Cane.—See Bamboo.

Birch.—The saplings of *Betula alba*. The roots make good handles, and the supply is obtained from our own country.

Blackthorn.—This well-known hedge plant, known also as the sloe (*Prunus spinosa*), makes excellent walking sticks. There is always a demand for them, for when properly dressed and polished there is no other stick that has so dark a coloured bark. Latterly there has been a large sale for a special kind of blackthorn brought from Ireland, and known as Irish blackthorns. They are distinct from the ordinary blackthorn in being flattened instead of cylindrical.

Black Tork.—The botanical origin of this stick has not been determined. It has a dark-coloured bark, and the root forms an irregular knotted handle. The wood, which is hard and close-grained, forms a very rigid stick, revealing, when the bark is taken off, a dark brown wood with occasional light patches. It is imported from the West Indies.

Boxwood, Persian.—This is the true box (*Buxus sempervirens*), the wood of which is so well known as to need no description. The irregularity of the branches recommends it, when peeled of its bark, for walking sticks, and the sticks cut out of the solid trunk make good umbrella sticks, besides which it is often carved into various devices for ladies' sunshades. Another kind of wood, very similar in appearance to true box, but known as West Indian boxwood, is used to some extent for the same purposes. The West Indian boxwood of botanists is *Vitex umbrosa*, but this wood does not agree with that, and at present cannot be satisfactorily identified.

Briar.—This is also the produce of a West Indian tree (*Zanthoxylum Clavatum*), the bark of which is tuberculated, or warted, for which reason it is valued for walking sticks. They are imported from the West Indies.

Cabbage, Jersey. — A well-known variety of the common garden cabbage (*Brassica oleracea*), the stems of which grow in the Channel Islands to a height of 10 or 12 ft.

Carob or Caroubier (*Ceratonia Siliqua*).—A branching tree about 30 ft. high, native of the Mediterranean coast. The knotted and irregular branches, when straightened, make excellent walking sticks. They are imported from Algeria.

Carolina Reeds.—These are slender, bamboo-like canes, the produce, apparently, of a species of *Arundinaria*. They are imported from China.

Cedar-Wood.—This is the wood of the common pencil cedar (*Juniperus virginiana*). It is only occasionally used, and is too well known to need description. It is imported from North America.

Cherry (*Prunus cerasus*).—Of late years this has become a very important stick, both for walking sticks and sunshade handles. Two distinct forms of the cherry are known in the stick trade, namely the scented and the tiger cherry. The former has a dark brown bark, which has a peculiarly sweet scent, and in consequence, is seldom or never

polished, the effect of which would, of course, be to kill the perfume. The tiger cherry has a bark with patches of a beautiful golden lustre, which is heightened by the addition of polish. These sticks are imported in large quantities from Austria and Hungary, where the growth for pipes and walking sticks constitutes a staple industry.

Chestnut.—These are branches or saplings of the Spanish chestnut (*Castanea sativa*). When peeled the wood is of a very light colour, but is hard and durable. The sticks are obtained principally from France.

Coffee.—These sticks are the produce of the ordinary or Arabian coffee-tree (*Coffea arabica*), and are brought here from the West Indies. They are very hard and heavy, with a light-coloured bark, and have but little to recommend them.

Cork.—The produce of the cork oak (*Quercus Suber*). Though these sticks are somewhat clumsy in appearance, owing to the thick and rugged deposit of bark or cork, they are light in weight from the same reason. They are imported from Spain and Algeria.

Crab.—Two kinds of stick are furnished by this plant—the wild form of the cultivated apple (*Pyrus malus*), the plainer sticks being known as crab, and the knotted or irregular sticks as warted crab. They are the produce of our own country, though some are imported from the Continent.

Date Palm.—These are the midribs of the leaves of this well-known palm (*Phoenix dactylifera*) with the leaflets cut off, rounded and smoothed, and then polished. They are imported from Algeria.

Dogwood (*Cornus sanguinea*).—This is a well-known shrub of our own hedges, the wood of which is hard and not liable to splinter; hence it was at one time much used for butchers' skewers. These properties, together with those of rigidity and lightness, have caused the sticks to become very much in favour with walking-stick makers. On this account they are much used for the "pillars" or sticks of

umbrellas and sunshades, often having other handles or knobs fixed to them. They are imported in large quantities from France, Germany, and other parts of the Continent.

Ebony.—Several kinds of ebony are known in the trade as Ceylon, Macassar, and flowered ebony. The two former are the produce of *Diospyros ebenum*, and the latter of a totally different plant, namely, *Brya ebenus*. The first is a native of Ceylon and India, and furnishes the best true ebony, while the second is a small tree, native of the West Indies, and is sometimes known as green ebony and cocus-wood, so much used for making flutes. The ebonyes furnish very choice sticks, which are cut from the solid wood.

Eucalyptus.—This, as its name implies, is the produce of *Eucalyptus Globulus*, better known, perhaps, as the blue gum. It is a native of Australia, but has been introduced into many other parts of the world. The supply for the stick trade comes from Algeria.

Fullers' Teazle (*Dipsacus Fullonum*).—This plant is probably only a cultivated variety of the common teazle found wild in our copses and hedges (*Dipsacus sylvestris*). The plant is cultivated in some parts of this country, as well as in France and Germany, for the sake of the hooked bracts of the flower-heads, which are used for teasing or carding cloth. The adaptation of the stems for sunshade handles is very singular, for most of those used for the purpose are fasciated or abnormally twisted in the process of growth, so that they become double or treble their normal size. This fasciation was at one time considered to be unusual in the teazle, and their appearance a few years since in thousands as sunshade handles came as a surprise to the botanist. It exemplified, however, what has been before said, how apparently useless products can be made subservient to the demands of commerce. Teazle stems are imported from France.

Furze, sometimes also known as Whin or Gorse (*Ulex europæus*).—The stems of this common British plant are, as is well

known, very irregular in their growth. When they are straightened and properly dressed, however, they make extremely pretty walking and umbrella sticks, and are in great demand.

Gru-Gru.—These are the saplings of a palm, the botanical origin of which cannot be accurately determined, inasmuch as the name gru-gru is equally applied to *Astrocaryum vulgare* and *Acrocomia sclerocarpa*, both South American species. The sticks are very beautiful, being of a rich dark brown with fine white longitudinal lines near the joints. The rootheads also are very handsome. The sticks are imported from the West Indies.

Guelder Rose (*Viburnum Opulus*).—The sticks from this well-known shrub are very attractive when dressed and polished. The bark which covers them is of a rich brown, thickly marked with white lines. They are of a comparatively recent introduction, and are very much in demand. They are sometimes known under the name of Balkan rose, being imported from the neighbourhood of the Balkans.

Hazel.—This well-known stick is the produce of *Corylus Avellana*, and has quite recently increased very much in favour both for walking and umbrella sticks. A variety known as silver bark hazel is the most beautiful. The sticks are imported from various places on the continent of Europe.

Holly (*Ilex aquifolium*).—The sticks of this favourite shrub are so much used for walking sticks, whip-handles, and similar uses that they need only to be enumerated. They are chiefly the produce of our own country.

Hornbeam (*Carpinus Betulus*).—A well-known hard-wooded tree; the wood is of a very light colour, but makes durable sticks. The market is supplied by English growth.

Jambee, or Jambeze.—This is apparently the produce of the palm, which has yet to be determined.

Lancewood.—This wood, supposed to be the produce of *Duguetia quitarensis*, a tree of South America, is much used for shafts of carriages, whip-handles,

and the top joints of fishing-rods, in consequence of its elasticity and strength. For the same reason it is used for walking and umbrella-sticks.

Loya Canes.—The stems of an Australian palm (*Calamus australis*). They have somewhat the appearance of a rattan, to which they are a close botanical ally.

Malacca (*Calamus scipionum*).—Like the last, these are the stems of a climbing palm, imported, not from Malacca, but from Siak, on the opposite coast of Sumatra. They are a very choice stick, and fetch perhaps the highest price of any stick in the market.

Maple (*Acer campestre*).—The branches of this well-known British tree are sometimes used for walking sticks, as well as the wood of its American ally, the bird's eye maple (*Acer saccharinum*).

Medlar (*Pyrus germanica*).—Sticks of this plant are imported from France. They are sometimes covered with numerous transverse gashes, which is done in the stem during growth for the purpose of ornamentation.

Midgen.—This is the stem of an Australian palm (*Kentia monostachya*). It makes a very pretty stick, from the markings or scars of the fallen leaves being very close together.

Mountain Ash.—A well-known ornamental tree of our shrubberies (*Pyrus Aucuparia*). The sticks are slender but strong.

Mountain Bay.—A slender palm, the source of which is unknown.

Myall Wood (*Acacia homalophylla*).—A leguminous tree of Australia, the violet-scented wood of which is well known and has been much used of late in the manufacture of pipes. The sticks are not polished, so as to preserve the scent.

Myrtle.—Whether this is the produce of the *Myrtus communis* is somewhat doubtful. It makes excellent walking and umbrella sticks, which are imported from Algeria.

Nana Canes.—This name has been given to the hollow reed-like stems of *Arundo donax*, the rhizomes of which

form excellent handles for umbrellas and sunshades. They are imported from Algeria.

Oak (*Quercus Robur*).—The saplings and branches of this well-known British tree are much used for walking sticks, and are always in favour. Under the name of Brazilian oak, a stick that has met with a very large demand has been known in the market for some few years. It is corrugated longitudinally, and knotted throughout, the knots being especially thick near the knob. Though this stick is a great favourite, its botanical origin at present is obscure. It is imported from Bahia, and is sometimes known as the Ceylon vine.

Olive (*Olea europæa*).—This is another favourite stick for which there is always a large demand; the dark green bark has a character of its own, and the brown markings of the wood, when stripped of its bark, has much to recommend it. Olive sticks are imported chiefly from Algeria.

Orange.—The orange sticks, which are imported chiefly from Algeria, are probably the produce of other allied species besides that of the common orange (*Citrus aurantium*). The bark of the orange, when dressed and polished, has a bright, greenish colour, with white streaks, and makes extremely pretty sticks, for which there is a constant demand.

Orange, Black.—This is a distinct product from the foregoing, and is not furnished by any species of *Citrus*, but by the common broom (*Cytisus scoparius*). The bark has somewhat of the orange marking, but its colour is nearly black, as its trade name indicates. It is imported from Algeria.

Palmyra.—These sticks are cut from the solid wood of the palmyra palm of India (*Borassus flabelliformis*). Two varieties are known, black and red, the one with intense black lines, the other with red. The wood is imported from India.

Partridge Canes.—Under this name an immense quantity of canes, with and without the bark, are annually imported from China. Though they are a

specially favourite stick for walking, umbrellas, and sunshades, the botanical source still remains unknown. They are largely used for the twisted and curled handles now so much in vogue.

Partridge Wood (*Andira inermis*).—This is a large tree of the West Indies. The wood is close-grained and hard, and takes a good polish; it is used chiefly for umbrella handles.

Penang Lawyer (*Licuala acutifida*).—This is a palm, the saplings of which, with the roots attached, are imported in considerable quantities from Penang.

Pimento (*Pimenta officinalis*).—A tree common in Jamaica, where it is largely cultivated for the sake of its fruits, which are the allspice of commerce. For the stick and umbrella trade large quantities of the young saplings are imported from the West Indies. The sticks are valued specially for umbrella handles, in consequence of their rigidity and non-liability to warp.

Pomegranate (*Punica Granatum*).—These sticks come mostly from Algeria, where they are specially cultivated.

Rajah Cane.—This favourite stick has been known in commerce for some 20 years or more. It is imported from Borneo, and for a long time after its introduction its botanical origin remained a mystery. It has, however, since been referred to the genus of palms *Eugeissonia*, and probably to the species *minor*. The commercial name rajah is said to be derived from the fact of the duties paid for its export being claimed by the Rajah of Borneo.

Rattan.—Under this name a variety of sticks, apparently the produce of different species of *Calamus*, are known. Thus we have root rattans, white hard-barked rattans, monster rattans, miniature rattans, and so on. They are all of a similar character, with the scars of the fallen leaves strongly marked in transverse rings. They are the produce of Eastern countries.

Snakewood (*Brosimum Aubletii*).—This is also known under the name of letter-wood and leopard-wood. It is the produce of a large tree, native of Guiana, Northern Peru, Brazil, and

Trinidad. The wood is extremely hard, of a reddish-brown colour, marked with dark transverse blotches. It makes one of the handsomest sticks known, and when mounted with gold has a very rich appearance.

Thistle.—Under this name the stems of the mullein (*Verbascum Thapsus*) are known in commerce. They are slender and very light, both in colour and weight; they are, however, very prettily marked, and make good handles for umbrellas.

Tonquin Canes.—These are slender-jointed sticks of the character of bamboos, and are the produce of an unknown species of *Arundinaria*. They make light and strong sunshade handles, and are very much used for that purpose. They are imported from China.

Whangee.—This is a well-known cane imported from Japan, and is formed of the rhizome or underground stem of a kind of bamboo (*Phyllostachys nigra*). The cane is very pliable, and is very distinctly marked by the transverse scars of the young shoots, where they have died out, and where the rootlets have fallen off. The canes are mostly of a pale yellow colour, but there is a variety with black scars known as the black whangee.

Whitethorn.—This is another name for hawthorn (*Crataegus Oxycantha*). The wood is very hard and close-grained, and makes very strong sticks.

Zirracote.—A close-grained, nearly black wood; used mostly as a cabinet wood. It takes a good polish, and has a very handsome appearance. (J. R. Jackson).

(2) Walking sticks should not be cut or pulled later in the spring than February, nor earlier in autumn than October, the best time being from early December to mid-February. They should not be stripped of bark nor worked till half dry, and meantime should be stored in a cool and moderately dry place. It is best to leave all roots and spurs on the stick about 1 in. long when laying aside to dry. When half dry their suppleness is at its greatest, and working is facilitated.

Holly sticks must be only rough trimmed when put away to season. Ash sticks must also be rough trimmed and well seasoned before they are barked and polished. The wood and curiously-formed root-knobs of ground ash admit of excellent grotesque carving.

Of all home-grown sticks oak is the most reliable, and stout oaken cudgels are esteemed by most persons as some of the best props to failing legs, as well as the best weapons for self-defence against quarrelsome dogs and rowdy ruffians. Straight sticks of sapling oak are not always easily obtained, but copse-wood sticks pulled from the stumps of trees form excellent substitutes. These should be selected for walking-sticks which taper gradually from $\frac{3}{4}$ in. just below the knob or crutch, down to $\frac{1}{2}$ in. at the opposite end. Gnarled and crooked oak sticks are sometimes fancied, and heavy cudgels are sometimes selected for defensive purposes. Oak sticks split in drying when the bark has been stripped off, or the knots cut too close, or the sticks put away to dry in a very warm dry place; they are then rendered useless for walking-sticks and cudgels. The wood and also the form of the knobs or roots will admit of much taste being displayed in carving.

From the roots of elm trees, saplings with a coating of rough bark will shoot up straight to a height of 10-12 ft. These will furnish good walking-sticks of the fancy type, the rough bark serving the purpose of ornamentation when the sticks are dried, stained, varnished, and polished. The wood is also durable, but not very supple when dried, and sticks of it are not suitable to hard usage. The usual precautions must be taken in drying them.

Light sticks of hazel may be cut or pulled from almost every hedgerow and in any wood. Saplings are not unfrequently found of most symmetrical proportions, tapering from 1 in. down to $\frac{1}{2}$ in. through a length of 10-12 ft., these are used by country swains as goads for the oxen, and form very tough sticks. The wood is very light,

but it has the disadvantage of bending and remaining crooked when leaned upon heavily. It is also soft, and may be easily carved. Occasionally, hazel sticks may be found grotesquely entwined with honeysuckle, and the stem so deeply furrowed with the supple vine as to enclose the convolutions of the climber. Sticks of this kind are valued as fancy sticks, and look well when properly prepared, varnished and polished.

In exposed positions the blackthorn is only a dwarf shrub, but in sheltered hedgerows and woodlands it attains a height of 20 ft., and its saplings run up to a length of 6-8 ft. straight and taper, but covered with stout spines and small twigs. These saplings make excellent walking-sticks, both when they can be dug or pulled up, and also when they have to be cut off. The spines and twigs must not be cut off close until the stick is half dried, and then cut with a sharp knife; in fact, the knots from the spines and twigs when left as slight round excrescences enhance the beauty of the finished stick. Blackthorn is more famous for its hardness, strength, stability, and durability, than for lightness, elasticity, and suppleness. A cudgel made of blackthorn will deal heavy blows, but when matched against one of oak would splinter at the knots, the oak being the tougher stick. The wood is hard and not easily carved, but the root knobs will admit of a very fine and smooth polish, most grateful to the palm of the hand of the tired pedestrian. Its congener, the whitethorn, or hawthorn, is not so suitable for walking-sticks, being more brittle and less durable.

Among fruit trees, the cherry will furnish some very nice fancy sticks, supple, and of tolerable strength; and apple wood, when well and carefully dried, will yield some good sticks. Grape-vine and briar sticks cannot be relied upon for stability when leaned upon.

When sticks are half-dried, that is, when the bark is shrunken, has lost its

sappy greenness, and refuses to peel freely, they may be trimmed, straightened, or bent as required. To bend or to straighten them, they may be held over steam until rendered supple, or buried in hot wet sand until this end has been attained; they must then be given the form they are intended to assume (whilst still hot), and kept in

suggestive in themselves. One or two things should, however, receive consideration in designing a knob, and the first should be the ultimate use of the stick. If the stick is to be a fancy one, to be carried and swung in the hand, more for appearance than for use, then any amount of skill in carvings may be expended on the knob;

350.

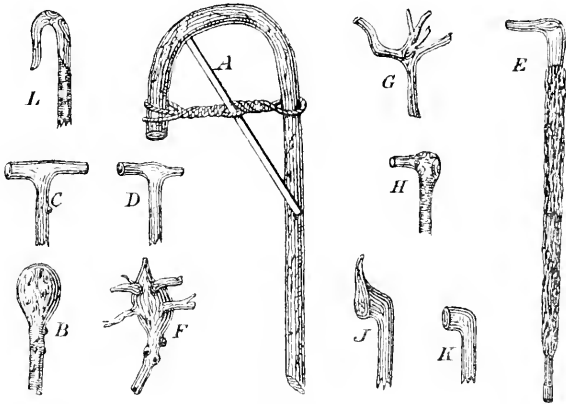

Walking sticks.

this form until they are cold, straight sticks being tied firmly in small bundles, and wound with a coil of rope from end to end, or suspended from a beam by the knob end, whilst a heavy weight is hung from the small end. Crooks may be turned by immersing the end in boiling water for 5-10 minutes, then bending it to the desired form, and securing it in this position with a tourniquet (Fig. 350 A) until the stick is cold. The bark may next be taken off with a sharp knife, if so required, and care must be taken not to splinter or chip the wood of the stick. Knots may be trimmed at the same time, and the knob trimmed up to shape. Hard and fast rules cannot be given for the formation of knobs, since their form must be regulated by the natural knobs, and these are often very

but if the stick is for use, we should first consider its use. Round smooth-headed knobs (Fig. 350 B) carved and polished to fit comfortably into the palm of the hand, will meet with most acceptance from those who use a stick as a support. But knobs thus formed, and shorn of a projecting crook or hook, often slip from beneath the arm or out of the hand when its owner wishes to use both hands for some purpose. The head of a dog with a long muzzle, the head of a swan or a goose, forms an appropriate design for such a stick. The crutch (Fig. 350 C) or half-crutch form (Fig. 350 D) is also a comfortable one, but the ordinary crook (Fig. 350 A), although useful for many other purposes, does not fit comfortably in the hand, it is too much of a hand-ful, and the central support usually

finds its bearing under the forefinger instead of the palm of the hand. Sharp carving on the knob should always be discouraged, for it only hurts the hand, but the neck of the knob may receive the carver's attention.

Elm sticks with the rough bark left on (Fig. 350 E) must be neatly trimmed, naked around the neck of the knob, and at the bottom of the stick just above the ferrule, loose bark should also be neatly trimmed with a sharp knife, and the whole lightly gone over with medium glass-paper. The stick should then receive a dressing of boiled linseed oil, and be left to dry. When dry, it will be well to go over the smooth parts with a little polish, and finally give one or two coats of hard spirit or copal varnish. Holly, ash, hazel, cherry, apple, birch, etc., should have part of their bark only taken off with a sharp knife, leaving all knots smoothly trimmed, rounded, and clean. The sticks should be then lightly glass-papered, and, when smooth, dressed with boiled linseed oil, dried, polished, and varnished. Oak sticks look best when carefully barked in hot water, cleared of the loose bark by rubbing with canvas, dried, dressed with boiled linseed oil, again dried, then polished and varnished with oak varnish. Blackthorn sticks should be only partly barked, the knots smoothly trimmed, then glass-papered quite smooth, dressed and varnished as directed for other sticks. Sticks may be stained black after they have been glass-papered, and before they are dressed with oil, by first brushing them over with a hot and strong decoction of logwood and nut-galls, and when this has well dried, brushing over them some vinegar or acetic acid in which a quantity of proto-sulphate of iron, some iron rust, or some old rusty nails has been steeped some 2-3 days previously. A brown or mahogany tint may be given by adding some dragons' blood to the polish, and a yellow tint may be obtained by adding yellow ochre. Some persons use ink for a black stain, and others put drop black in the varnish,

but the black stain above mentioned is preferable to all others. The sticks are to be polished and varnished after the stain is dry. The bottom ends of walking-sticks should be guarded from excessive wear by a neat brass ferrule, but these are more cheaply bought than made. They should be secured to the stick by two small screws, one on each side of the stick, to prevent them from coming off when they get loose in dry weather.

The remaining diagrams in Fig. 350 indicate as follows:—F, blackthorn knob in the rough; G, ash root as dug up; H, ash root trimmed; J, ash or oak knob as pulled from pollard or stump; K, the same trimmed; L, stick bent and trimmed to form a crook. (G. Edwinton).

(3) Use Judson's simple dyes; they are so clean, and moreover so economical in their application that they take the leading part in all work of fancy or intricate workmanship. Put the stains on with a camel-hair brush, diluted with water. For dark stains use copal varnish, or purchase some from a coach painter. For light woods use the light crystallised varnish, such as is used for the tops of washstands, &c. Old damaged sticks that are varnished should have the varnish eaten off with liquor ammoniac, then rinsed, scoured, stained, and varnished again.

(4) Make a solution of 3 parts glue in 100 of warm water; to this add 1 part whiting, 2 parts orange chrome. Mix well. Apply hot with a soft brush to your sticks. When thoroughly dry, rub down with a piece of dry flannel. Apply a second coat of colour if deeper tints be required, or use burnt umber and brown ochre for oak tints. When dry, apply the following varnish:—Coarsely-powdered copal and glass, each 4 oz.; alcohol, 64 O.P., 1 pint; camphor, $\frac{1}{2}$ oz. To be heated over a water bath, with constant stirring, until the copal is dissolved. When cold, decant the clear portion. Be careful that the alcohol does not inflame.

BOAT BUILDING.

(a) The first thing to be done is to design the boat intended to be built, and

which moulds similar to that shown by B are now made. The construction of these moulds does not require any particular care except that they must be

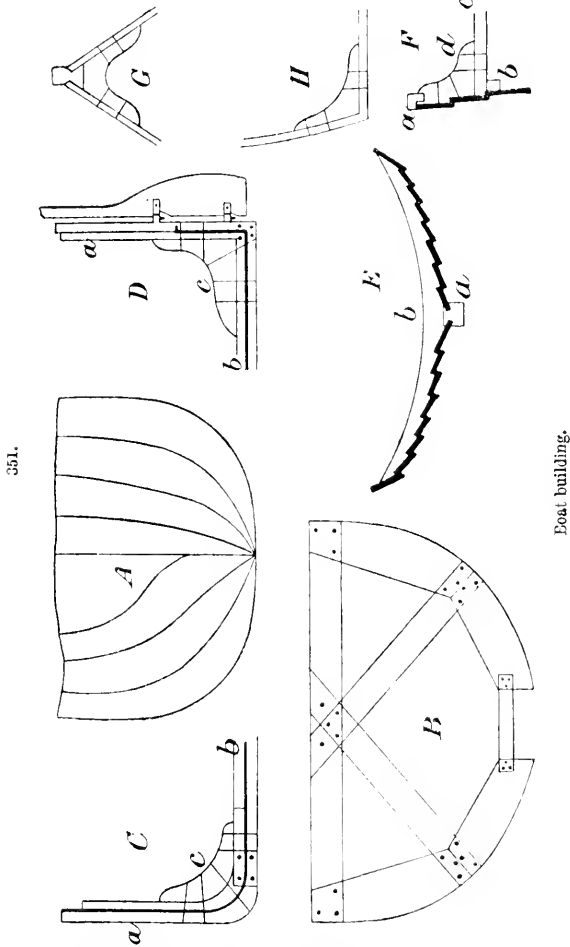

draw a plan similar to that represented by Fig. 351 A. The designs must now be drawn upon a floor full size, from

made sufficiently strong to resist pressure during building, and must be extremely accurate along the outside.

This done, the building of the boat may now be commenced—if possible under a rainproof shed—by laying the keel and tenoning to it the stem *a* on Fig. C, and sternpost *a* on Fig. D. Should the keel not be thick enough for tenoning, it may be box-scarfed, by cutting away half of each. After this the keel must be fixed in the stocks, the stem and sternpost plumbed to see if they are true, and thereafter stayed by pieces of wood from the floor of the workshop. The keel should be cut, technically speaking, rabbeted, as shown in *a*, Fig. E, so as to allow the garboard strake to fit in the stem, and sternpost should also be cut in a similar manner where shown by the lines *b* in Figs. C D. A stout piece of wood is now nailed from the top of the stem to the sternpost, in order to keep them better together, and afford additional support to the moulds when inserted. The knee *c* in Fig. D, apron *c* in Fig. C, and transom *b* in Fig. D, are now inserted; the holes being bored with a fine auger, the nails being driven in from the inside, and securely clinched from the outside, as shown by Figs. C D. Oak, ash, or elm is generally used for the foregoing, and all bent timber must be grown. The moulds can now be placed in their position and firmly secured. Thereafter, measure the half girth of the midship mould, and divide it into an equal number of sections, after allowing about $\frac{3}{4}$ in. for the landings at each plank or strake. Having determined upon the number of strakes, mark off an equal number on the stem, rabbet line, sternpost, and transom—it will be seen that the strakes taper considerably fore and aft—and begin planking. To do this, a novice may require an apparatus for steaming the planks, that they may bend more easily. This, although it must be steamtight, need not be an elaborate affair. A wooden box of the desired length, and about 8 in. square inside measurement, with a door at either end, will suffice. If the builder cannot secure steam from a boiler, he will require to place this box upon legs sufficiently high safely to

allow a fire and pot underneath, from which he can make a wooden steam pipe to the box above. The garboard strake—the plank nearest the keel—is fitted on first, and so on upwards. Some of the strakes will be found to be curved or “sneyed” in a curious manner; but the correct curve of the strake to be fitted on can generally be got by clamping it to the preceding strake, and marking the curve with a pencil. The strakes are nailed together in the following manner:—The strake to be fitted on is secured in its proper place by clamps or wooden screws, a hole is bored through both planks at the landings, a roving nail is then driven in from the outside through a roove in the inside, which is held in its place by a rooving iron—a kind of pincers which allows the nail to pass through. The end of the nail is then cut off all but a very small portion; a holder-on is then put to the back of the nail from the outside, and the inside portion of the nail still remaining is hammered back upon the roove, thus, in a manner, forming a rivet. At the stem, sternpost, and transom, of course, the nails are simply driven in. It may be necessary to bevel the edges of the bilge strake with a plane, in order to keep the correct curve. The planking almost invariably is of yellow pine, and some boat-builders recommend painting the landings with red lead, when the strakes are put together, alleging that it keeps them from rotting the better. After the planking is finished, the moulds are taken out of the interior, and the timbers are inserted, being clinched in a similar manner as the strakes. They are generally of elm, or other hard wood, and will require about 4 hours’ steaming. The floors *b* in Fig. 352 E are next inserted, but are not as yet clinched, as, after being steamed and nailed in their position for a day or so, they are removed to be joggled—cut to fit the planks—as shown in the diagram. If grown timber can be had, the floors can be joggled and put in at once. The floors extend from bilge, and are of hard wood. The gunwale is now fitted

on. This can be done in several ways: by cutting down the timber heads a sufficient depth to allow the gunwale to rest on them and lie flush with the top strake by cutting away $\frac{1}{2}$ in. or so off the top of the timber heads, and joggling the gunwale to admit of their insertion; or as is shown by *a*, Fig. F, by rabbeting

on both sides, as shown by Fig. H. A stringer *b*, in Fig. F, is now put on each side, running from bow to stern, and clinched through the timbers on which the seats in *c* Fig. F rest. The seats are also clinched to the knees *d* in Fig. F. These knees are also clinched to the top strake. The bow and stern

352.

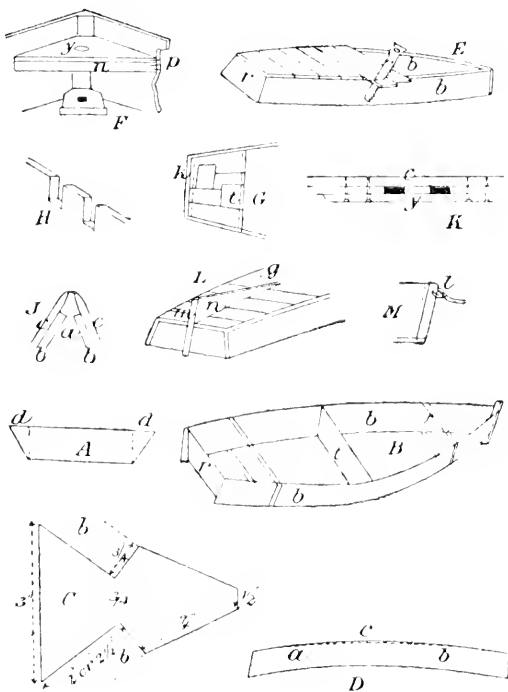

Boat building.

the gunwale and fitting it on over the top strake, to which it is either clinched or nailed. If either of the two former plans were adopted, the top strake should be of elm. The gunwale is of boxwood. A stout knee is inserted and secured at the base, as shown by Fig. G. A knee is also inserted at the transom

bolts, bow and stern gratings, and bottom boards are now made and put in. The bottom boards are nailed together before being put in, and then secured by a clasp, that they may be easily removed for cleaning the bottom of the boat. The rudder now alone remains to be made, and is hung on pintles, as

shown in Fig. D. For the equipment of such a boat as this, the builder may calculate that oars will cost 6d. per lineal ft. The anchor should weigh 110. per ft. of boat in length, but if a sailing boat with ballast, $1\frac{1}{2}$ lb. per ft. In that case, a step will be required to be made for the mast, which should be nailed to the keel. All the nails used in the construction of the boat must be of copper. Also an iron clasp to each. The mast must be fitted to the seat, the seat being cut to receive half of the girth of the mast. For the mast a good Norwegian pine—home-grown timber is useless—about 20 ft. can be got for about 6s. in its rough condition, and is dressed by an adze before being planed. Longitudinal cracks are of no consequence in a spar; but the slightest saw transversely denotes that it is sprung—so useless. This never occurs but in masts which have been used, when care also must be taken that there are no signs of rotteness anywhere, especially at the joints. A sail—presumably a lugsail—of best duck will cost about 1s. 4d. per sq. yd.; but if the builder desires to make it himself—a difficult and delicate task—good duck can be purchased for 8d. per yd. Duck is most suitable for all descriptions of small boats. In any case avoid cotton, as it does not hold the wind, is very frail, liable to rot, and soon turns an unchangeable dirty colour, disheartening alike to sail and spectator. Boats similar to that given here are very commonly built “*à l’alle-bouée*”; that is, the bow and stern are shaped alike, the lines at the stern being a little fuller. Opinions differ as to their respective appearances; but if it is the builder’s desire to have a boat that shall “laugh at all disaster, and with wave and whirlwind wrestle,” he could not do better than build it in this manner, as besides possessing many minor advantages, a boat so shaped will run before the wind in a gale that her “square-sterned” consort could not be kept ahead 5 minutes in. (J. McCash).

(c.) Take 10 or 11 cedar boards $\frac{1}{2}$ in. thick, and not less than 7 in. wide;

also, 2 cedar boards 1 in. thick, 14 in. wide, and 13 ft. long, free from knots. The latter will be called the sideboards. They should both be of same quality, so that one will bend as easily as the other. Cedar is used throughout, except where the name of the wood is given.

A piece is cut, shaped like Fig. 352 A, with the entire length 4 ft., the width 12 in., and the distance *d* from the end to the dotted line $\frac{1}{4}$ in. We will name this the cross-board. A piece of oak is cut of similar shape, but making the entire length 20 in., width 13 in., and distance *d* 6 in. This is the stern-piece.

Both ends of each side-board are sawed off level, like the ends of the cross-board, and with same slant at both ends. The level at one end of the side-board should be the reverse of that at the other, making one edge 12 ft. 8 in. long, and the other 12 ft. The side-board has the appearance of Fig. A elongated. The tapering of the side-boards at the ends, necessary in the construction of a scow, is not required here. The necessary upward curve of the bottom is obtained by the bending of the side-boards, as described hereafter.

Set the side-boards *l*, Fig. B, on edge parallel with the longer edges uppermost, and at about the middle place the cross-board *f* between, also with its longer edge uppermost. Nail the side-boards *l* lightly to the cross-board *f*. With the aid of ropes, draw two ends of the side-boards together; the other ends draw against the stern-piece *n*. In a piece of oak, about 18 in. long, cut grooves throughout its length, and make its cross section like Fig. C. This “stem-piece,” as it is called, is placed between the ends of the side-boards that were drawn together. After altering the shape of the stem-piece, if necessary, so that the ends of the side-boards shall fit closely into the grooves, the side-boards are securely nailed to both stem-piece and stern-piece. The projecting upper end of the stem-piece is sawed off, and the boat is inverted carefully.

The convex edges of the side-boards are planed down 1 in. or more at the

middle *c* Fig. D, so that the bottom (the boat is now bottom up) may be flat from *a* to *b*, making easy curves at *a* and *b*. This flattening of the bottom is not useless, the draft being thereby diminished, and the speed probably increased.

Bottom boards $\frac{3}{4}$ in. thick are nailed on crosswise (Fig. E), and the projecting ends are sawed off. A long bottom board is put in, and the cross-board, which was only temporary, is knocked out.

Fig. F represents the seat at the bow. The cross-piece *n* is secured by nails driven through the side-boards into its ends, as at *p*. In Fig. G, which represents the seat at the stern, the cross-piece *l* is fastened in the same manner. There is a cleat at *k*. The seats in both bow and stern are about 3 in. below the edges of the side-boards, and the seat-boards are lengthwise.

We are now ready for the "upper streaks," as they are called. Two strips are cut 12 ft. 5 in. long, 2 in. wide, and 1 in. thick: two notches, each $1\frac{1}{2}$ in. long, and nearly 2 in. deep, are cut in the upper edge of each side-board, Fig. H. They are 3 in. apart, and the point midway between them is 5 ft. 1 in. from the stern, measuring on a straight line in the middle of the boat. All the longitudinal measurements hereafter given are upon this line.

The upper streaks are now nailed on the outside of the side-boards even with the upper edges of the latter. The joint made by the upper streaks at the bow is shown by Fig. J, in which *a* is the stem-piece, *d* the side-boards, and *c* are the upper streaks. The rowlocks are now completed by a short strip *g*, Fig. K, strongly screwed on the inside, over the notches. Make tholepins, and fit them into these mortises. It is often convenient to have another pair of rowlocks about 2 ft. nearer the bow, that when a person sits in the stern, the rower may shift forward to better distribute the weight, for a boat rows hard when the stern is weighted down.

Make two cleats for the rower's seat, with their aft ends 6 ft. from the stern, and their upper edges $7\frac{1}{2}$ in. below the

edges of the side-boards. Saw off a seat-board 3 ft. 10 in. long.

Invert the boat and fit a piece of 1 in. board, *n*, Fig. L, upon its edge, at the stern, upon and perpendicular to the bottom. It is fastened at *g* by a screw, between *g* and *m* by nails driven into it through the bottom from the inside of the boat, and by the strip *m* of the same thickness, nailed on the end of *n*, and crossing the stern-piece vertically, to which it is screwed.

A $\frac{3}{4}$ -in. hole is bored through the stern-piece at *l*, Fig. M, through which the painter, 10 ft. long, is tied. An iron strap, shaped like the double line in the same figure, is screwed to the cutwater.

The proper length for oars is about 7 ft.

The boat is now caulked, unless already rendered water-tight by an equivalent method. Nail-heads are covered with putty, two coats of paint are applied, and the skiff is completed.

ANEMOMETERS.

(a) Fig. 353 is a simple anemometer that anyone can make: *a* is the pressure-plate, exactly 6 in. square, made of galvanised iron and fastened to the pillar of a 10 lb. spring balance *b*; the cylinder of the balance being fixed to the vertical tube *c*, which carries the vane, &c., to the end of the iron rod, in balance, is attached a wire which passes over a wheel inside *c*, shown in drawing, but, of course, in the tube, and so that the copper wire can go down centre of *c* to the weight of *d*, which must have a slit in one side to run over a wire soldered inside *c*: this keeps lower wire straight and prevents torsion. The wire is joined up in two at the bottom of *d*, and the two wires should be continued down to the bottom. The vane is of the usual form, but should form a balance for the other side, and must be weighted to form the balance necessary. The wire is continued down into the room in which dial is fixed. Here make a dial 12 in. diameter and divide it into 36 divisions, each division being a full

inch from the next: these divisions will indicate pounds, and if you divide the spaces between each into 5 you will have everything you require. The

(b) A multiplying anemometer, applicable to the measurement of the velocity of air-currents, to meteorological observations, and to the determination of waterflow, consists of a tube formed of two truncated conical tubes, the smaller ends of which are of the same area (Venturi's tubes). In this tube a much smaller one of similar construction is placed, as shown in Fig. 354. If greater delicacy be required, a third may be added, the whole system being eccentric. (Fig. 355). The constricted part of the outer compound tube is surrounded by a hollow jacket, and connected with it by the small interval which separates the two truncated cones. This jacket is in connection with a water-thermometer, which indicates the velocity of the current to be measured. This arrangement for a single compound tube is shown in Fig. 356. The utility of the instrument depends upon the fact that in such a case, as

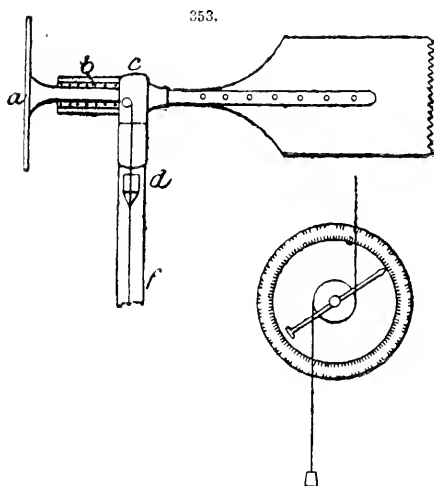

Simple anemometer.

centre wheel has a groove, and its circumference should be exactly the length of the rod in balance, or rather the length from 1 to 9 lb., every pound giving 4 lb. on dial. Now fix at the end a thin wire or watch-chain, the latter would be better, the old chains used in our grandfathers' verge watches — this, by the bye, must be connected to upper as well as lower wires; to the bottom one then hang a weight just sufficient to keep finger in place. Having all done, get another similar balance and fix it up against dial-plate, letting it mark 1 lb.; this will be 4 lb. on dial down below; mark this on the dial; then let upper balance be pushed on to 2 lb., mark 8 below, and so on till the whole dial is marked, then divide and mark pounds. You may go over this again and again until you have carefully marked the dial, and your anemometer will be finished. (W. J. L.)

shown in Fig. 356, the reading of the manometer attached to the jacket is

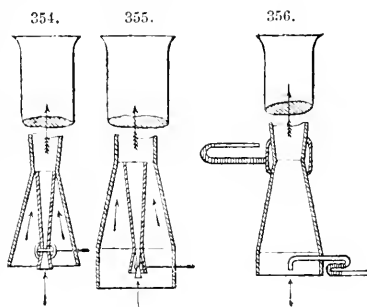

Multiplying anemometer.

several times that indicated by a manometer at the orifice of the tube. The former is of course negative, whilst

the latter is positive. The relation between the two may be, for example, 6:1. In an instrument consisting of two compound tubes, and in one of three tubes, the readings were related to those at the orifice in the proportions 20:1 and 80:1 respectively. The instrument is simple, rigid, portable, and inexpensive; it affords a check on the ventilating apparatus of mines, and by a simple clockwork arrangement could be made to indicate defective ventilation; lastly, its multiplied reading conduces to great accuracy.

ANGLES, MEASURING.

A simple means of measuring angles is shown in Fig. 357. The board *a* usually of deal, which should be about 15 in.

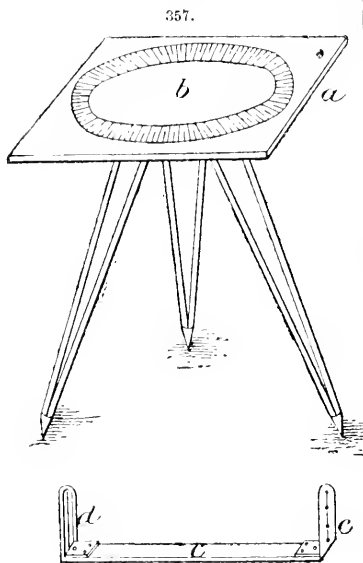

Measuring angles.

square, underneath it has screwed on to it in the centre a brass boss, which fits into a similarly shaped recess in the

wooden head of a folding tripod stand. A brass clamping screw passes from below through a hole in the centre of the tripod head, and screws into the brass boss on the board. By this means the board, or plane table as it is here termed, can be smoothly turned round horizontally into any position and securely clamped there.

On the top of the board is pasted or glued a cardboard protractor *b*. These protractors are about 12 in. diameter, and are graduated to $\frac{1}{2}$ degrees, and can be bought for a small sum. Care should be taken to attach this flatly to the board.

The next essential is a sight-rule *c*. This consists of a flat piece of some hard wood about 15 in. long by $2\frac{1}{4}$ in. wide, and $\frac{3}{8}$ - $\frac{1}{2}$ in. thick, having one edge bevelled. On each end is fitted centrally a brass sight-vane—one *d* having a wide slot through its upstanding part, down the centre of which is fitted a fine wire or hair; the other *e* has a fine slit down its centre.

To measure an angle between two objects, the plane table is set up as level as possible by eye, the sight rule is placed across the centre of the protractor, and pointed in the direction of the left-hand object, the eye being applied to the slit in *e*, and the wire in *d* being brought into coincidence with the object. Care must be taken that the bevelled edge of the rule lies nearly over the centre of the protractor. This is easily ensured by placing the finger or the uncut end of a pencil touching the centre point, and using this as a pivot round which to turn the rule. The graduations of the protractor cut by the bevelled edge of the rule are then read at each end, and their mean is taken as the true direction of the object. A similar observation is then taken to the right-hand object, care being always taken to use the mean of the readings at each end of the rule. The difference between the readings to the two objects give the angle required.

A most surprising degree of accuracy can be obtained by the use of this

simple instrument by repeating the observations on a different part of the graduation. It is, in fact, a very fair theodolite without the telescope.

If a magnetic compass is used in conjunction with the plane table, and by its means the table and protractor be turned round and set magnetic north and south, accurate magnetic bearings of objects can be obtained with equal facility. (G.)

BAROMETERS.

(1) To make a cheap. Obtain a straight fine glass tube, about 33 in. long, and with a clean interior, sealed at one end, and having an even uniform bore of about $2\frac{1}{2}$ lines diameter. The mercury to be used should be perfectly pure, and free from all air and moisture. This latter requisite may be assured by heating the mercury in a porcelain dish to nearly the boiling-point, previous to using it. The tube is then held securely, with the open end uppermost, and carefully filled with the liquid metal. The open end of the tube is then securely covered with the finger, the tube is inverted, and the end is covered by the finger plunged below the surface of a little mercury placed in a small vessel to receive it. The finger is then removed, when the mercury in the tube will immediately fall to a level of about 30 in. above the surface of that in the small reservoir below. In order to attach the scale correctly, it will be necessary to compare the indications with those of some good instrument.

(2) Exhaustion of tubes without application of heat. The defects inherent to the methods at present employed for exhausting barometer tubes induced Klobukow to study the various methods, especially that of Bogen, adopted in meteorological observatories. By a modification of the latter he succeeds in producing a complete vacuum by means of a mercury column without application of heat—Bogen's method. A well-dried barometer tube is charged with pure mercury, the imprisoned air

is removed by shaking, and the orifice is closed with the finger; it then is inverted over a mercury trough, partly immersed in the metal, placed in a vertical position, and the surplus of mercury allowed to escape. The tube is again closed by pressing the fingers on to the open end, brought in a horizontal position, and gently shaken for a short time. After a portion of the air embedded in mercury has entered the vacuum, the tube is transferred to the trough, manipulated as before, and the operation is repeated twice or three times till the mercury is freed from the adhering air. When the section of the tubing is reduced to that of a capillary tube, the filling with mercury by this method is impracticable; this difficulty is overcome by the following modification.

The barometer tube *b* being filled with mercury in the usual way, is connected by a rubber tubing of 2-3 in. long to a glass tube, open at both ends, of the same diameter and length as *b*; the tubes are placed in the position as shown in Fig. 358, and *a* is filled with mercury. Care being taken that no air remains confined in the bend *c*, a few taps should be given to the rubber tubing by the hand, or pressed by the finger with sufficient force to cause the emission of a few drops of mercury. By introduction of an air bubble into the tube *a*, and partial closing of the orifice with the finger, all air confined in the rubber bend is expelled by compression of the rubber. The compression being maintained for a few seconds till a small portion of the mercury has been forced out and the tube hermetically closed, when the closed end is immersed in mercury, and the finger withdrawn from the orifice, Fig. 359.

The following operation consists in the formation of a vacuum:—By raising the barometer tube *b*, Fig. 360, it then is lowered while *a* is moved in a nearly vertical position, Fig. 361, which causes a migration of the previously produced vacuum *fg* to the opposite portion *hi* of the tube. The exhaustion of the tube is repeated twice or three times,

during which the tube is gently moved until the characteristic sound of the metal, on lowering and raising of the tube, becomes audible. After complete exhaustion, the tubes are disconnected, *b* is closed and immersed in mercury.

of the fine tube being open, the expanded air gets out through this end. Next, before the air has had time to cool, plunge the open end of the tube below the surface of a vessel containing mercury. As this air cools it shrinks

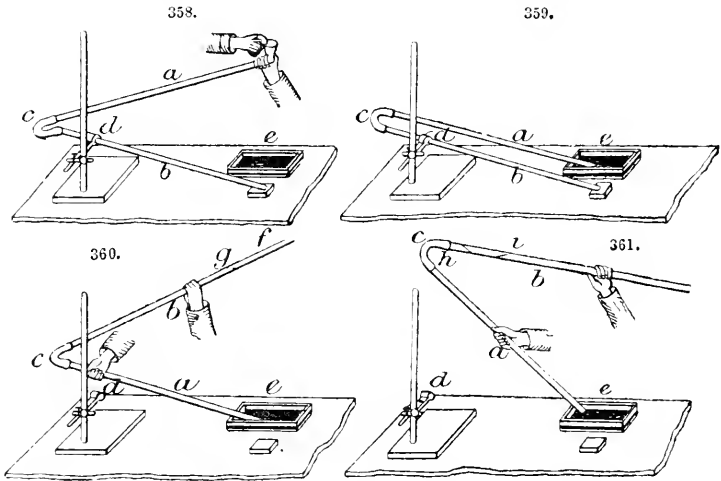

Exhausting barometer tubes.

The charging of *a* with mercury is effected by means of a small funnel, Fig. 358, and a complete exhaustion of the tubing is attained within 20–30 minutes.

The method is applicable to siphon and cistern barometer, and can also be used for the exhaustion of capillary tubing; the employment of an air pump and application of heat in exhausting the latter will greatly accelerate the operation. The manipulations which the method requires are simple; they can be performed with good results by persons unaccustomed to experimental work, always giving an excellent vacuum.

(3) How to fill a tube with quicksilver. Having got the tube which is open at one end (narrow end), heat the bulb in a flame; in doing this the air in the bulb expands; but the other end

into less bulk, and the pressure of the air from without drives the mercury to occupy the vacant space. Part of this mercury will therefore be driven into the bulb. We next take the bulb with the mercury in it, and heat it well above the flame of a lamp, bulb, tube, and all. The mercury will soon begin to boil, and its vapour will be driven out, and the air before it, until bulb and tube will both be filled with vapour of mercury. When this is done, we plunge the open end of the tube once more into a vessel of mercury. As there is only vapour of mercury in the tube, when this cools it will condense, and the mercury in which the instrument is plunged will go into the bulb and tube, and it will be filled. Be very careful not to inhale the mercury fumes. (R. W.)

(4) Application of Wright's appa-

ratus for distilling, to the filling of barometer tubes. In Fig. 362, *a* is a vessel full of impure mercury; *b* a tube about 30 in. long; *c* an enlargement of *b*; *d* and *e* tubes inclined in opposite directions; *f* an arm for connecting with a Sprengel pump; *g* a tube a little over 30 in. long; *h* a reservoir with an outlet to the air; *h* is filled with pure mercury.

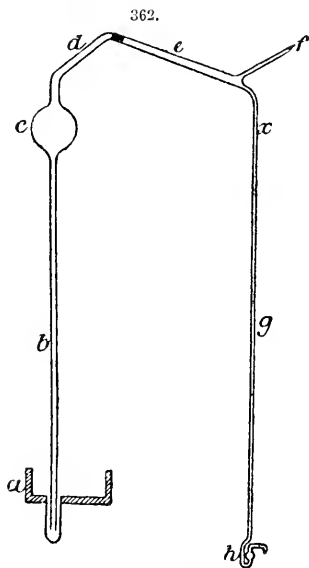

Filling barometer tubes.

The air is now exhausted through *f*; the mercury rises in *b* and *g* until *c* is partially filled; a Bunsen burner is placed under *c* and the mercury distils over into *g* and flows out through *h*.

If now *g* is cut off at *x* a few inches below the junction of *c* with the arm *f* (the part *h* being no longer used), and a glass cock be inserted at *x*, then by means of a short rubber tube this cock can be connected with the open end of the barometer tube to be filled, which latter will take the general position of the whole tube *g*.

The rubber tube must be covered with melted sealing wax. The impure mercury in *a* should first be washed in acids and dried before introduction. At the beginning of operations, *a* is full of impure mercury, but the rest of the apparatus contains only air. The Sprengel pump is set in motion and gradually exhausts the air from *b*, *c*, *d*, *e* and the barometer tube, until no air bubbles can be seen in the running mercury of the Sprengel pump, and until the sharp click is heard when the drops of mercury fall. The tube *f* is then sealed or a stop cock in it is turned, cutting off the Sprengel pump; the Bunsen burner under *c* is lighted, and the mercury will distil over into the barometer tube, which will thus be filled without allowing the mercury to come into direct contact with the air.

The barometer tube should be constantly watched in order to detect any air bubbles that may be carried over; when seen they must be cooked out by heating the tube slightly by means of a Bunsen burner. When the barometer tube has become filled with the mercury, the cock at *x* can be closed, the sealing wax is broken, and the tube is replaced by another. (F. Waldo).

(5) Cleaning barometer tubes. To clean the tube of a film, &c., get a piece of iron wire and fix on the end of it a piece of wash-leather. It must be very fine wash-leather, cut into narrow strips; wrap the iron wire from end to end, leaving a thicker piece at the end to tightly fit the tube.

Clean with warm water, soda, and soap-powder, afterwards with cold water, using the covered wire all the time, of course replacing the wet with dry leather to finish. If the wire is not covered, the tube will most assuredly break, if not at the time, certainly within 48 hours after using the wire. Clean the mercury with nitric acid and water, say, for 4-5 lb. of mercury, 4 teaspoonfuls of acid, and 20 teaspoonfuls of water; put the whole into a soup-plate, and put it in the oven or before the fire, and heat up to about 140°-150° F., stirring it at intervals until the acid

forms a sort of a powder or refuse on the top of the mercury. When cold, run the mercury through a fine paper cone a few times, and then it is fit for use.

(6) Use double cotton-covered copper wire, such as is used for electrical purposes. With such, I have never broken a tube. The idea that suggested such to me was a most ingenious form of diamond for cutting gauge-tubes. It was a short metal rod covered with cotton with the diamond arranged at one end. An adjustable stop at the end next the hand gave the length required. By inserting it in the tube and gently turning it with the diamond part against the inside of the tube, the inner skin was cut through and the tube easily parted. It was found in practice an advantage to subsequently anneal the cut end. This gave me the idea of using a metal rod with safety to clean a tube with; and, as already stated, I have never had a smash. But I need hardly say I never attempted to force in too tight a wad of washleather. On the contrary, it fitted very loosely.

(7) Siphon barometer. A few words must first be said regarding the selection of the glass tube, as on its fitness for the purpose the instrument's future excellence will very much depend. Ordinary white, easily fusible glass tube should not be used, as the mercury is apt to attract its oxide of lead, and not only become impure, but by adhesion to the inside of the bore hinder the free oscillation of the barometric column. The proper kind of tubing is that which shows a greenish tinge in the glass when looked at endways. For either of the instruments shown in Figs. 363 or 364, it should not be less than $\frac{3}{8}$ in. outside diameter and $\frac{1}{4}$ -in. bore; and if slightly larger may still be used with advantage.

For the siphon barometer, Fig. 363, a piece of tube about 38 in. long is required. This is to be well cleaned by running through it plenty of warm soft water, while at the same time a little swab made from a piece of soft, fine linen, tied in the middle of a cord, is

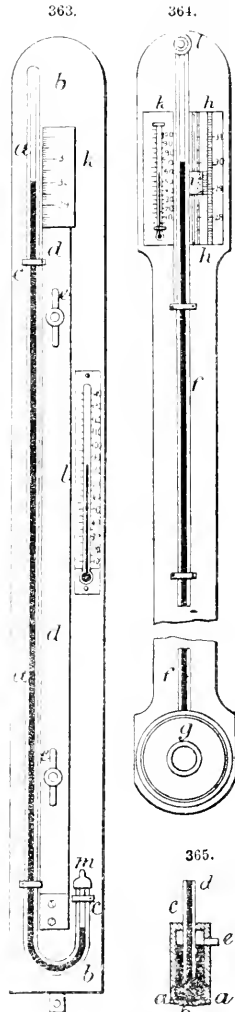

Siphon and cistern barometers.

pulled through the bore from end to end. After the water has drained out, alcohol, in which precipitated chalk is

suspended, should be applied to the inside by means of the swab. A clean swab, moistened with alcohol, will remove the particles of chalk, when, the cord being withdrawn, distilled water is to be poured through, after which the tube must stand in an upright position till it has drained perfectly dry, a little cap of paper, meantime, being placed on its upper end to exclude dust. The inner surface of the tube must finally be polished with a small piece of soft washleather fixed on the end of a clean, smooth brass wire.

The tube thus cleaned and dried is now to be closed at one end by drawing it apart in a gas flame about 2 in. from the extremity. The narrow pointed end, which forms when the tube is drawn asunder, should be pressed and rotated in the flame till a substantial and well-rounded closing has been obtained. About 32 in. from the sealed extremity a U-shaped bend is to be made. Care must be taken to make the curve a gradual one, as failure in this respect would not only mar the appearance of the instrument, but might also tend to narrow the bore and make the bend a weak point. The arc of the curve is to be $1\frac{1}{4}$ in. The longer limb of the siphon is thus 32 in. long, and the shorter one about 3 in. The short limb is not to be bent down quite parallel with the longer one, but should make a slight angle with it, to render the subsequent introduction of the mercury more easy. The tube *a* is to have adapted to it a supporting stand *b*, which may be a piece of dressed walnut, 34 in. long, $3\frac{1}{2}$ in. wide, and about $\frac{3}{8}$ in. thick, rounded off at the top, and furnished with a brass screw and ring for hanging up. A shallow groove, curved to correspond with the bent tube, is made on the wood. The 3 small brass clasps *c*, provided for attaching the tube to its support, may be readily cut from sheet-brass, polished, bent to shape, and drilled with a hole in each end to receive the appropriate small brass screws. The sliding-scale support *d* is a slip of cherry or mahogany, 1 in. wide, $\frac{3}{16}$ in. thick, and 28 in. long,

having two longitudinal cuts *l* made therein, through which pass the screws *f*, which fasten it to the walnut scale and allow of its motion upward and downward. These screws may be of brass with milled heads, or a cheap and excellent substitute may be found in 2 brass buttons with screw-stems sold for fastening carriage aprons. These are to have their stems passed through the longitudinal cuts *c*, and screwed into appropriate holes in the walnut support till their projecting shoulders bind on the scale support and prevent it from moving, except when required. The bottom *k* of the sliding scale support is a piece of sheet-brass cut to shape and attached by two small rivets or screws. Its angle or corner *i* is used as an index, as will afterward be explained. A scale *k* made of a piece of ivory veneer, 4 in. long and about $1\frac{1}{2}$ in. wide, is required for the upper end of the sliding support. This must be carefully and accurately divided into inches and tenths, the lowest inch mark being numbered "29," the next "30," and the upper one "31." It will be well to have the figures and lines done by an engraver; but, if economy be a consideration, the markings can be very well ruled with a fine pen, and after the ink has dried a coat of thin dammar varnish will protect the lines from injury by moisture. The ivory scale is now to be fixed to the sliding support, with the upper end of which its top exactly corresponds. If the measures have been correctly made, its 30-inch mark will now be situated exact 30 in. from the bottom of the brass index. An excellent cement for attaching the ivory to the wood is made of a little isinglass dissolved by heat in equal parts of alcohol and water. The walnut support *b* should receive two or three coats of copal varnish. The cherry wood slide *d* may either be finished with boiled linseed oil or varnish, according to taste.

All parts of the instrument being thus fitted, it only remains to introduce the mercury. For this purpose the tube *a* being detached from the

support, is placed upon a level table and sustained by small pieces of wire, so that the short limb is uppermost, the long limb lying flat upon the table. The mercury used should be as pure as possible: though if freshly-distilled mercury cannot be had that of commerce may be used, provided it has not become contaminated by lead or kindred metals. A fair test of the goodness of mercury is made by dropping a little into a clean white plate and causing it to run about. If bright round globules are formed, which readily coalesce and leave no trails of discolouration on the china, the metal is sufficiently pure. If, however, the drops become pear-shaped and soil the plate with dull, metallic splotches, the metal must be rejected. Before being used for filling, the mercury should in any case be forced through small pinholes in a piece of thin chamois skin to remove mechanical impurities. The tube being filled, is next raised gently into a vertical position, with its closed end uppermost. The mercury will descend a few inches, showing the Torricellian vacuum in the upper part of the longer limb, while at the same time it rises and overflows from the open orifice of the short limb. From the latter, enough of it should be displaced, by inserting a small round piece of wood into the bore, to leave a couple of inches empty. After this it only remains to finish the instrument by attaching the tube *a* to its support with the brass clasps *c* and screws. A narrow strip of green surface paper, 4-5 in. long, slipped behind the upper part of the tube where the vacuum appears, is an improvement to the look of the instrument and an assistance when taking the readings. It will now be evident at a glance that by bringing the corner *i* of the brass index *h* level with the surface of the mercury in the short limb, as often as an observation is to be made, the height of the mercurial column in inches and decimals will at once be shown on the ivory scale.

A small thermometer *l* fixed beside the sliding scale is at once a useful and

ornamental addition to the barometer. A small cap *m* of metal or wood must be loosely fitted over the open end to exclude dust. (A. F. Miller).

(8) Cistern barometer. The tube must be cleaned as already described, and closed at one end; but instead of being bent it is left straight, and cut off at a length of 32 in. Fig. 365 shows a section of the cistern, which is simply a small wooden cup turned neatly out of hard wood; its outside dimensions being $1\frac{1}{2}$ in. diameter and $2\frac{1}{4}$ in. high, and the inside cavity being $1\frac{1}{8}$ in. diameter and 2 in. deep. A cut made with a fine saw along the line *a* separates the underneath part of the cistern as a small wooden ring, to the bottom of which must be glued a piece of stout wash-leather *b*, made loosely convex so as to bulge readily inward and outward, forming the cistern-bottom and supplying a movable surface on which the atmospheric pressure is to act. A hole *c* in the closed top admits the pipe *d*, which passes down into the cistern till its end is level with the line of division *a*, and is secured in place by being cemented where it goes through the wood of the top. A small hole *e* for adjusting the height of the mercury is made $\frac{1}{2}$ in. below the closed top of the cistern, and stopped for the time with a little wooden plug.

The filling with pure mercury is to be done as already described in the case of the siphon, except that the tube may now be placed in a nearly vertical position with its closed end downward; a small straight funnel is to be used for pouring through. The cistern, which, owing to the position of the tube, is also to receive as much mercury as will fill it to the edge *a*, after which the ring-shaped piece, bearing the wash-leather bottom *b* is coated with glue on its sawn surface and pressed on in place, so closing the cistern. As soon as the glued joint is firm, the tube may be turned up into proper position by placing the finger on the washleather bottom, and pressing it inward till the orifice of the tube is felt, when the whole is quickly inverted. Thus no air

enters the tube during the moment of turning over; and as an instant later its opening is covered by the mercury of the cistern, the vacuum is now secured. Care should be taken, however, never again to turn the cistern bottom upward. The tube being now in a vertical position, the level of the mercury is adjusted by removing the plug from the hole *e* when the superfluous metal escapes and the column in the tube descends, leaving the vacuum above. The plug is then to be reinserted and glued in place.

The stand (which it is well to make and fit to the tube before the latter is filled) is shown in Fig. 364. It may be of walnut, mahogany, or cherry, and its general style and finish must depend on the taste of the maker. A shallow groove down its centre receives the tube *f*, and an oblong cavity at the bottom admits the back of the cistern, while its front may be covered with a hollow ornamental turning *g* as represented. The scale *h*, which in this case should be 5 in. long, may be ruled on ivory as already suggested, though an instrument of this description is really deserving of a well-made engraved scale, with a vernier giving readings to the hundredth part of an inch. Such a vernier *i* is a narrow piece of ivory $1\frac{1}{8}$ in. long, provided with a groove to receive the inner edge of the ivory scale along which it slides next to the tube, a hollow being cut in the wood of the stand behind the scale to admit of its motion. It is divided into 11 equal parts by 10 horizontal lines numbered downward from 1 to 10, each of the divisions measuring therefore $\frac{1}{10} - \frac{1}{100}$ in. The 30-in. line of scale is to be placed exactly 30 in. above the centre of the hole *e*, which marks the level of the mercury in the cistern. It is best to affix the scale to the stand by little brass screws. A small thermometer *k*, opposite the barometer scale, adds to the elegance and efficiency of the instrument. A slip of green surface paper should be pasted in the groove behind the tube before the latter is fixed in place. The top of the tube *f* should be

covered by a small turned button *l* of bone or wood. (A. F. Miller.)

(9) There is no occasion to wash out barometer tubes at all if new, and old should on no account be used; the only cleaning required, and all damp inside the tube must be avoided most carefully, as it is almost impossible to dry it afterwards, is a clean bunch of cotton on end of a string passed through the tube once or twice, or swab of linen. On no account pass *wire* of any kind through glass tubes, as if you do the tube will infallibly break in a short time. The longer limb of the siphon need only be 32 in., as the range of barometer never exceeds 31 in. The extra length represents a terribly extra weight of mercury, and as that metal is very dear, a good many pence are saved. The mercury, if bought from a respectable firm, is quite pure enough without being distilled, but on *no account must damp* be allowed to get to it before being placed in the tube. The best way of filtering the mercury is to take a piece of writing paper and well dry it before a fire, then twist it into a cone with a very fine hole at the bottom exactly like the grocers do up sugar in; a little knack is required for this, but will soon be acquired. Now comes the worst job of all, the filling. The usual method is to shake it in, but it is a most difficult thing to describe. The proper way is to introduce an inch or two of mercury, very gradually warm the tube, and boil the mercury; allow it to cool, and add another inch or two; warm, boil, and allow to cool; and so repeat till full.

But I have never seen a *siphon* tube boiled; the air is thoroughly shaken out, until, when the tube is slightly inclined, the metal strikes the top of the tube with that peculiar click which shows all air is expelled.

If amateurs take my advice, and do not boil, they will save themselves a good deal of trouble and loss, as very likely 3 or 4 tubes will fly during the boiling. Thus there is loss of tube, and, what is more expensive, mercury; and I will promise that if the air is well shaken out, the tube will read within

$\frac{9}{100} - \frac{3}{100}$ of a standard barometer. Of course these remarks do not apply to pediment or standard instruments.

The wooden cisterns are screwed, and the leather is laid on the bottom, being cut to fit inside the flange. Now fasten the tube in the top, the end of the tube being level with the bottom of cup-like depression in upper part of cistern. When fastened, fill the cistern with mercury up to level with top of cup, part screw on bottom with the leather previously fitted, and you will find it securely held between the two surfaces of the wood. Glue a slip of paper round outside of joint, and it is finished. There need not be any hole inside if done this way, and therefore no glue used that is at all likely to touch the mercury, as if once damp gets in the instrument is ruined.

(10) The vernier should be $1\frac{1}{10}$ in. long, and this should be divided into 10 equal parts, each part would then be equal to $\frac{1}{10}$ in. by $\frac{1}{10}$ of $\frac{1}{10}$ in., that is to say to $\frac{1}{100}$ in. by $\frac{1}{100}$ in. or $\frac{1}{100}$ in.

(11) Camphor Barometer, or "Storm glass." It was discovered by our ancestors that the height of the undissolved camphor in a camphor bottle was different in different states of the weather, and it became quite customary to keep a camphor bottle in sight, in order to anticipate the change in the weather, it being thought that an increase in the height of the camphor indicated approaching rain or wind. The inventive genius of our age could not long allow the instrument to remain in this crude form. The camphor* and alcohol were put into long glass tubes hermetically sealed at the top, and adjusted in a frame with a thermometer attached. The side of the frame next the tube was divided into three divisions. On the bottom one was marked the word "Fair," on the middle one "Change," and on the top one "Storm." A note accompanying the instrument

stated that the weather was indicated by the word in the division with which the top of the chemical substance corresponded. It also stated that the direction of the wind was shown by the substance being a little higher on the opposite side from which the wind came. These were manufactured and sold all over our country under the name of "Storm Glasses," or "Chemical Barometers." One firm, adopted the name of "Signal Service Barometer," and a number of people in possession of these instruments really think they have one of the genuine barometers which the Signal Service use in its predictions.

The fact that the manufacturers have hermetically sealed the top of the tubes fortunately assists in an investigation of the cause of the instrument's action, for it is evident at once that the contents of an impermeable, air-tight vessel of glass can neither be affected by variations in the atmospheric pressure nor moisture. That light is not the cause of its action can be easily shown, for the chemical substance varies in height in the dark just as it does in the light. Neither can its changes be due to the action of the electricity of the air, for the changes of the tube take place the same in a protected shelter as they do in the open air, and the electric potential inside of a shelter is always zero. We turn to changes of temperature for the cause of its variations, and find a most satisfactory explanation of its action. If it is winter, one can easily convince himself of this by taking the instrument into a warm room. If now the instrument be hung out of doors, the precipitate will in a little while increase greatly in quantity, and if the difference of temperature is considerable, the alcohol in the tube will be filled from top to bottom. I have a tube on which I have divided the length from the top of the alcohol down to the bottom into ten parts, and these again into ten parts, so that I can read the height of the precipitate at any time in hundredths of the greatest height to which it is possible for it to extend. March 24, I found the instrument hanging in my

* Other ingredients besides the camphor are now included. I find it stated that two parts camphor, one part nitrate of potash, and one part sal ammoniac are put into the alcohol, and a little water added.

room read 21 on the scale, temperature inside of room 73° , outside 27° . I placed the instrument outside, and in two minutes little stars began to form at the side and to move down toward the bottom and up to the top again in the centre of the tube. These continued to increase in size, and in 5 minutes the alcohol was about $\frac{1}{4}$ full of them. As these increased and the circulation of the liquid became slower, they began to accumulate at the bottom and somewhat at the top, until in 20 minutes the alcohol was full from top to bottom. I brought it inside the house, and in a few minutes the precipitate began to take on a more attenuated appearance and to slowly decrease in height. In 20 minutes it read 21 again. Readings of the height of the precipitate taken every 10 minutes were as follows: 4:55 P. M., 100; 5:05 P. M., 93; 5:15 P. M., 80; 5:25 P. M., 50; 5:35 P. M., 21. Another instrument with a scale arranged in exactly the same manner had been hanging outside for a month or two, and read 50 during the whole experiment. The instrument in my room was next put into warm water, and I found that at a temperature of about 100° ever particle of the precipitate would disappear.

If allowed to remain in the water while it cooled, little stars or flakes would begin to appear in the alcohol, and when it had fallen to a temperature of 70° or 75° , the alcohol would be entirely filled with the precipitate. If, then, the indications of the instrument are to be relied on, it is easy to get up a storm on short notice.

Suppose, when an instrument has been carried out of a warm room and the precipitate fills the alcohol from top to bottom, that it is left outside, as was done on the first of January, with the instrument hanging outside referred to above. In such a case, after the instrument has been out some time, the column of precipitate will begin to shorten, even though the temperature remains the same; and it will be noticed that the bottom presents a more compact appearance. After about a

week or 10 days, the precipitate will have entirely lost its feathery appearance, except, perhaps, a little at the top, and will present a compact granulated mass filling about half the tube, if it is winter, and about one-quarter, if it is summer. If while the column of precipitate was shortening there was any considerable change in temperature, there might be some minor oscillations in the length of the column, but the whole tendency would be downward. When this state is attained, the precipitate dissolves very slowly in the alcohol, and the instrument is capable of going through considerable changes in temperature without much change in the height of the precipitate. Thus, suppose in the morning the temperature was 40° , and by noon had risen 50° , the height of the column may show no perceptible decrease, because the dense crystals dissolve slowly, and the alcohol lacks considerable of containing as much as it could dissolve at the latter temperature; but when toward night the temperature again falls to about 40° , the liquid is nearly saturated; and, if by the next morning the temperature has fallen to say 32° , the liquid will be filled to a considerable height with light, feathery crystals which readily dissolve on a rise of temperature, or if the temperature remains stationary, settle to the bottom changed into the more compact granular crystals. To illustrate from observation—on January 13, the temperature in the room for about a week had been ranging from about 60° to 70° , and the height of the precipitate in the instrument had been almost steady at 23 on the scale, when the temperature in the room on the evening of the 13th fell to 52° , and light flakes of precipitate began to form. I knew the liquid was now supersaturated, and any further decrease in temperature would cause a decided precipitation. On the morning of the 14th, the temperature had fallen to 43° , and the height of the column of precipitate was 32 on the scale. I observed the instrument inside the house and the one outside, three times a day during

January and February, and it was always found that the height of the two columns varied in opposite directions whenever the temperature changes inside and outside were in opposite directions.

I observed the instrument three times a day during the whole summer and autumn of 1881, and there was never an increase in the height of the precipitate without a corresponding fall of temperature, or a decrease without a corresponding rise of temperature. It will thus be seen that the instrument is not a "storm glass" or a "chemical barometer," but a chemical thermometer, and a very poor thermometer at that.

Do its indications bear any relation to weather changes? Yes; because temperature changes are closely related to other weather changes. In the summer under an extended but moderately high pressure area, or anti-cyclone, there usually exists beautiful, fair, warm, settled weather, and the top of the precipitate will be even with the division marked "Fair." When showers come on, the air turns cool, and the precipitate rises to the division marked "Change." Whenever an area of decided low pressure passes over the country, the air is warm in front of it; and as the centre passes over, there is usually a sudden fall of temperature. This causes the precipitate to rise up to the division marked "Storm," and the wind in such cyclonic systems is always high, especially in their rear. In the winter the top of the precipitate is nearly always up in the division marked "Change," and as the weather is eternally changing, I suppose it may be considered about right. On the contrary, a decided anti-cyclone may in summer bring cool weather; and the precipitate will rise up into the division marked "Storm," accompanied by the clearest skies and delightful breezes. It is also common for rains to pass over without any material changes in temperature. In such cases the height of the precipitate will remain unchanged. The indications of the instrument are then

sometimes right, sometimes wrong, like the negro's dumb watch, which was always right twice a day, but, as it gave no indications of the time when it was right, it was not worth much as a practical instrument. (H. Helm Clayton.)

(12) Glycerine Barometer. — The marked influences of the variations in the pressure of the atmosphere upon the disengagement of carbureted gases in coal mines has led engineers to devise a new barometer that will not only indicate the most minute variation of atmospheric pressure, but will indicate it so plainly that miners and others not experienced in making barometric observations can readily detect the variations.

Among the instruments of this class one of the most interesting is the large water barometer constructed for the Royal Society by Prof. Daniell, in 1830, which, however, was not a success, as the effects of the pressure were annulled by the effect of the temperature upon the vapour found in the Torricellian vacuum.

B. Jordan, a member of the office of the English mining archives, has spent several years in studying the different liquids that might possibly be applicable in constructing an accurate and highly sensitive barometer, and finally found that glycerine produced the best results. A glycerine barometer constructed by Jordan, 1870, is still in use. The glycerine is very pure, and has a specific gravity of 1.26, and on account of its high point of ebullition the vapours have no perceptible tension at the ordinary temperature, and it will only congeal at a very low temperature. The height of a column of glycerine is 26 ft. 9 in., and a variation of $\frac{1}{15}$ in. of mercury corresponds to a variation of about 1 in. in the column of glycerine. As glycerine is very apt to absorb the moisture of the air, it is covered with a thin layer of prepared thickened petroleum in the cistern of the barometer. Jordan has constructed barometers for the South Kensington and Jermyn Street Museums; both have given perfect satisfaction, and to show the

scientific value of the instrument the Royal Society has built one at the Kew Observatory.

366.

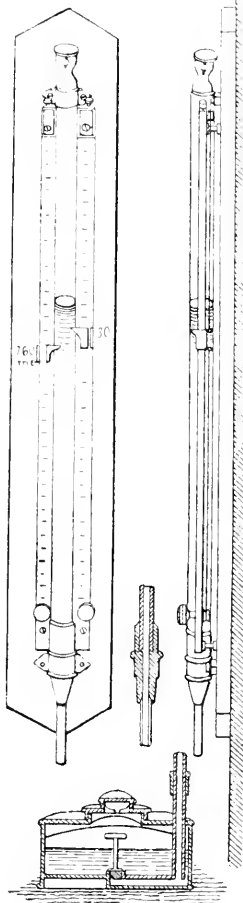

Glycerine barometer.

This instrument is shown in Fig. 366, and consists of a cylindrical cistern of

tinned copper, about 6 in. high and 10 in. diameter, provided with a screw cover or cap, having a small opening leading into a recess containing cotton to act as filter and keep out the dust. The large barometric tube is made of ordinary gas pipe, about $\frac{3}{4}$ in. diameter, and is rigidly attached to the cylindrical cistern or cup. The upper end of this tube fits into a piece of bronze, into which a glass tube, $\frac{3}{4}$ in. diameter and about 4 ft. high is securely cemented. This tube terminates in a cup inclosing a rubber packing. Graduated scales provided with indicators are placed at each side of the glass tube, the one on the left side indicating the inches and tenths of inches, and the right-hand scale shows the equivalent measure of a corresponding column of mercury. The scales are attached to an oaken plank, which is fastened to the wall of one of the upper storeys of the observatory, and the large tube passes down to a room situated 26 ft. 9 in. lower. The glycerine in the barometer is coloured with aniline red. Before putting the glycerine in the tube, it is boiled at a temperature of about 180° to expel the air and to make it purer. The air is exhausted from the barometer tube by means of an air pump. Regular observations are made with the instrument at the Kew Observatory, where it is considered to be a scientific instrument of the greatest precision.

(13) How to make a Glycerine Barometer.—A bottle about a quarter filled with glycerine, coloured red with magenta or crimson aniline, has a glass tube of about the diameter of a pencil passing airtight through the cork, which is inserted airtight into the bottle. The lower end of the tube dips beneath the surface of the glycerine. The bottle is made to contain compressed air by blowing into the upper end of the tube. On removing the mouth, part of the glycerine will rise in the tube until the weight of the liquid column in the tube and the atmosphere balance the internal air pressure on the surface of the glycerine. The column in the tube will tend to rise when the pressure of the atmos-

phere diminishes, or the temperature of the compressed air rises, and to fall when the atmospheric pressure increases or the temperature of the compressed air diminishes. So far as the variation in the height of the column is due to changes in atmospheric pressure, the column moves in the opposite direction from that in a mercurial barometer.

It will now be seen that it is desirable to eliminate from the reading of the barometer scale the effect due to a change in temperature. Simultaneously observe the reading of the barometer and a thermometer at hand. Next find the difference between the readings, calling that of the thermometer the minuend. The difference is regarded as the relative pressure of the atmosphere at the time of observation. The divisions on the instrument are $\frac{1}{4}$ in. apart, and the length of the tube above the bottle is 25 in. It seems better to have 100 divisions than any other number. These divisions bear no relation to those on mercurial and aneroid barometers. Each instrument is intended to be compared with itself to indicate a relative pressure of the atmosphere. In the instrument the degrees are marked and numbered with a pen on a strip of paper obtained from a ribbon roll; this is pasted upon a neat wooden case behind the tube. The case has a recess into which the bottle is set. A neat piece of wood, of the proper shape, secures the bottle, while leaving it almost entirely in view. Two small wire staples secure the tube to the scale. If desirable, a paper scale may be pasted upon the tube, thus dispensing with a case.

Of course, it is liable to be broken when thus constructed. The use of a thermometer is scarcely necessary if the barometer is kept in a cellar or any place where the temperature is nearly uniform.

With a tube 3-4 ft. long, the bottle may be buried in a large box of dry sawdust, or any other poor conductor of heat, in a finely divided state. The instrument will then give fair results without using either a thermometer or a cellar.

The advantage of using glycerine, instead of water, is that glycerine scarcely evaporates; besides, it will not freeze except at a very low temperature, and if a minute quantity of water be present, it never becomes solid.

A thin glass tube, 4 ft. long, can be bought for 5*d.* at the drug stores in cities. The glycerine and magenta will cost less than 2*d.* By making an ornamental case one may, with a little ingenuity, produce a beautiful instrument. It will foretell fair, changeable, and stormy weather as well as a mercurial barometer costing thirty times as much.

The upper end of the tube should be loosely filled with cotton to keep out the dust. After having forced air into the instrument, it should not be allowed to approach a horizontal position, for the compressed air may blow the column out of the tube; if this does not happen, a large air bubble may separate the column, and render the instrument useless. No particular dimensions are requisite for either the bottle or the tube. The magenta is used merely to render the column more readily visible. Other colours may be used, but this is the most beautiful. (J. Asher.)

(14) Portable mercurial barometer. The chief faults in the ordinary barometer are imperfect vacuum and a degree of capillarity in the mercury which makes it difficult to read the true level. With portable barometers it is rare to get accurate results. Kralvitch overcomes the obstacles by the instrument shown in Fig. 367. The two chambers *ab* as well as the tubes joining them, are filled with pure dry mercury. The chamber *a* communicates with the chamber *d* by a capillary tube. On tipping the barometer, the mercury in *b* flows into *a*, displacing the air, which escapes by the tube *c* into chamber *d*, and cannot return to the barometric chamber *a*. The reservoir *h* assists in filling the tube, which is done cold. On reversing the tube, the air collects and escapes at the hole *o*. At *m* is a rubber tube uniting the two portions of the instrument and capable of

being closed by a pinch cock. By repeatedly reversing the tube, all air is at last forced out of the barometric chamber *a*. The instrument is rendered portable by reversing it, and putting the pinch-cock on the rubber tube.

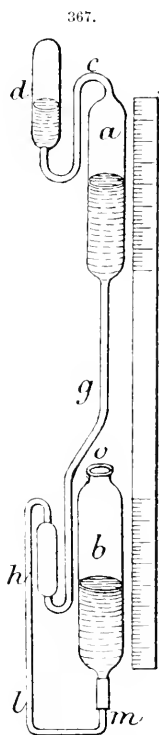

Portable barometer.

(15) How to read the barometer. The barometer is only an extremely sensitive balance, or a manometer showing the variations of atmospheric pressure. The early makers of one form of the instrument had the unfortunate idea of marking certain points on the dial with the words "fair," "rain," "storm," &c.; their example has been followed blindly, and hence

the bad reputation of the barometer. The passage of dry winds over our heads naturally causes the barometer to rise, while damp winds have the reverse effect; but it must not be forgotten that rainy winds in Europe come from the south-west, and are ascendant in latitude—they raise the air, and in the same degree lighten the barometer; on the contrary, dry winds come from the north and east, are void, and descendant in latitude—they drive the air towards the surface of the earth, and cause the barometer to fall. The barometer shows very well the great atmospheric perturbations—the only condition being that we should learn how to use it. The diurnal course of the sun above the horizon exercises its influence on the barometer, it heats the atmosphere, causing ascending currents of air, which create a fall in the level of the mercury in the afternoon, and a return towards the former level in the evening. It is evident that the barometer may vary from three distinct causes; by change of altitude, under the influence of dry and moist winds, and under the action of the solar rays dependent on the hour of the day. These premises being stated, it is not astonishing that two excellent instruments, one placed, for instance, on the lower, and the other on the upper part of a house, should never agree. Proprietors of certain instruments declare that theirs are the only barometers to be trusted; old friends will dispute about them. With the present mode of graduation, it is rare to find two barometers in the same house marking even the same division of the dial; the instrument which marks "variable" on the ground-floor will incline to "rain" on the fifth storey, for in a house 60 ft. high the difference in the height of the column of air is about 2 mm. Take a small aneroid wheel barometer in your hand, and walk up or down a street with a sharp ascent, and you will find the needle deflect towards "fine" as you descend, and fall as you rise, every 30 ft. representing about 1 mm. in the barometric variation.

French barometers are generally graduated for Paris, and cannot possibly be correct in places of different altitudes. The position of the index is altered. The barometer is affected much by latitude, and a little by longitude; the oscillation is altered, and no change in the index will correct the error.

Suppress the deceptive indications on the dial, and the barometer may be consulted anywhere with profit. When the mercury is rising or falling, the indication of the same foretells faithfully the probable weather to be expected. The only exception occurs when two opposing currents are struggling against each other; in such a case the barometer will be scarcely affected, yet the rain may fall suddenly.

Generally, rapid variations of the instrument indicate change; when the fall is rapid, rain may be expected; when very rapid, storms. The importance of the atmospheric perturbation is in proportion to the rapidity of the fall of the mercury, but the duration of bad weather is in general long in proportion as the fall has been gradual and continuous. If the mercury mount very rapidly, the weather is not completely changed; it mounts more rapidly than it falls, but still there are differences to be observed. In testing the condition of the mercury by tapping gently with the finger, it is not safe to accept the rising of the index as a sign of fine weather; it must be remembered that the barometer, unless acted upon by a tolerably energetic current, has a marked tendency to rise between 5 o'clock in the afternoon and midnight, to fall between midnight and 5 o'clock in the morning, and to rise again between 5 a.m. and mid-day.

CAMERA LUCIDA.

(1) The camera lucida is an apparatus which renders great services to landscape painters by permitting them to see upon their canvass or drawing-paper the landscape that they wish to reproduce, and to sketch its outlines with an accuracy and rapidity that cannot be

attained by means of the unaided eyesight. For reducing or enlarging drawings, maps, plans, &c., the camera lucida also gives excellent results. In short, this instrument forms part of the professional tools of the majority of artists, designers, engravers, &c.

The camerae lucidae invented by Wollaston have since been more or less improved upon, but all are based upon the same principle. They consist of a right-angled triangular prism, one of whose faces is covered with a small mirror. The rays, proceeding from the object whose image it is desired to see, first meet the prism, where they are refracted at their entrance and exit and then strike the mirror, and from this are reflected so that the draughtsman receives them in the direction of the sheet upon which he wishes to draw, and is thus enabled to trace their contours with a pencil. But a Wollaston camera lucida costs 1-5*l*. Now it is possible to obtain the same effects as are given by this apparatus, by using a simple mirror, or any bit of silvered glass, this fact being due to a physiological peculiarity of our vision.

When we look at an object, each of our eyes perceives its image, but the two images are superposed, and we thus have a perception of but a single object. If, by a slight pressure upon one of our eyes, we move the globe of the latter, while looking at the same object, the two images will be perceived separately, or, in other words, we shall see double.

It is probable that animals whose eyes have different directions, those for example that have eyes at the side, like many herbivora (hares, gazelles, &c.), or that carry them upon peduncles (like crustaceans), do not perceive superposed images as we do.

It is due to such superposition of images that when we station ourselves before a sheet of white paper affixed to a wall, and turn so as to face it, it is possible, by looking with one eye into a small mirror, to see upon the paper, by means of the other eye, a reflection of the object situated behind us, and to thus easily follow or trace its outlines.

It is a very simple matter to get up a camera lucida upon this principle.

As for the arrangement of the apparatus, we may affix a small mirror with wire to the cover of an open sketch-book, and so place ourselves that we may, with the left eye regarding the mirror, see with the right a reflection of the object that we desire to draw. This image will be seen upon the vertical part of the drawing-paper in front of us, and we may then follow it in all its outlines and details, as we would do with an ordinary camera lucida. (*La Nature*).

(2) In all forms of camera lucida are more or less defects, such as limitation of field, distortion, indistinctness of image or of drawing-point, awkwardness of position, &c. Being engaged in endeavouring to simplify and perfect the construction and adjustment of Wenham's high-power binocular prism, it occurred to me that his arrangement of prisms might be modified, so as to be available as a camera lucida in which the defects of the forms hitherto made would be considerably reduced if not entirely eliminated.

Assuming a 45° inclination of the microscope to be the position most generally convenient for drawing, I drew on a large scale the system of prisms which appeared to be suitable for a camera lucida. Messrs. Ross undertook to construct the prisms to my drawings, and the apparatus was found upon trial to answer my expectations fully. I am induced to describe it because it has also met with much approbation from microscopists, who were previously disinclined to believe in the possibility of any new device at the present day, which should be substantially better than the numerous older forms which apparently exhausted the subject.

It is well known that all forms of reflecting prisms acting by means of *one* reflection are extremely sensitive in regard to the position of the mirror in relation to the microscope, as also in a less degree in relation to the eye; the slightest deviation from the normal position in many cases entirely destroy-

ing the effectiveness of the apparatus. For this reason camerae lucidæ acting by *one* reflection have not found favour, though their apparent simplicity has induced the construction of many such forms.

In order to obviate the difficulties incident to the use of *one* reflection; many devices have been made acting by *two* reflections, and where these have been so contrived as to act like parallel mirrors, the reflected image has possessed the advantage peculiar to this principle, of being practically insensitive to slight differences of position relative to the microscope or to the eye, remaining in fact stationary within a considerable range of adjustment, as in Wollaston's camera lucida.

My device (Fig. 368) consists of a combination of a right-angled prism (Fig. 369), ABC, and a rhomboidal prism DEFG, so arranged that when adjusted very nearly in contact (i.e. separated by only a thin stratum of air) the faces BC and DE are parallel, and consequently between DE and BE they act together as a thick parallel plate of glass through which the drawing-paper is viewed. The rhomboidal prism is so constructed that when the face GF is applied at right angles to the optic axis of the microscope, the axial ray II passes without refraction to I on the internal face EF, whence it is *totally* reflected to J in the face DG. At J a part of the ray is reflected to the eye by *ordinary* reflection in the direction JK, and a part transmitted to J' on the face AC of the right-angled prism. Of the latter a portion is also reflected to K by *ordinary* reflection at J'. The hypotenuse face AC is cut at such an angle that the reflection from J' coincides with that from J at the eye-point K, thus utilising the secondary reflection to strengthen the luminosity of the image. The angle at G is arranged so that the extreme marginal ray H' from the field of the B eyepiece strikes upon DG at a point just beyond the angle of total reflection, the diffraction-bands at the limiting angle being faintly discernible at this edge of the field. This

angle gives the greatest amount of light by *ordinary* reflection short of *total* reflection.

By this arrangement the Ramsden circle over the eyepiece comes just above the camera lucida, and the field of view

object is in a luminous field the light on the object (especially with lamplight) may be advantageously subdued by ground glass or similar means. The eye may be removed as often as required from the camera, and the work recom-

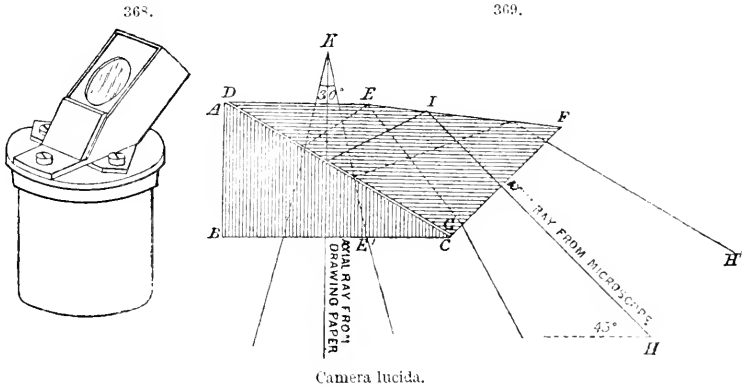

Camera lucida.

is not in any way reduced; all that can be seen directly through the B eyepiece (say 30° of field) is perfectly depicted in the camera lucida, whilst the drawing being viewed direct is of course not cut down in field.

In practice the microscope should be inclined about 45°, and the image accurately focused through the eyepiece as usual. The camera is then slid on the eyepiece and pushed down more or less until the microscopical image is seen distinctly and the illumination of the field is equal throughout. The drawing-paper is placed on the table immediately under the camera. The observer will then see the microscopical image projected on the paper, at the same time viewing the pencil-point directly. The *whole* pupil of the eye is available for both images, the diaphragm on the apparatus being considerably larger than the pupil. It may be necessary to balance the illumination either by subduing the light in the microscope or by increasing it on the drawing-paper. It will generally be found that when the

menced without the slightest shifting of the image; and with properly balanced illumination, fully shaded drawings can be made with very little practice. The drawing-paper should in every case be placed at the distance of distinct vision, either using spectacles or not. If the vertical position of the microscope be preferred, the drawing-paper may be inclined 45°, either in front or at the side of the instrument. For very accurate drawings in all azimuths, the drawing-paper should of course wholly coincide with the plane of the optical image, as with every other form of camera lucida. A spring clip is provided in which a screen of black paper may be put to shade the eye not in use.

This form of camera lucida can be modified so as to project the image at any desired angle. It can be used with the dissecting microscope or hand-magnifier, also on a stand for architectural or mechanical drawings. (H. Schröder.)

DENDROMETER.

There are various methods of ascertaining the heights of trees, all more or less satisfactory; but the simplest and most efficient contrivance that has

parallel lines are drawn at right angles to the edges. The square is attached by means of a pivot and clamp screw to a stout iron-shod pole about $4\frac{1}{2}$ ft. long—a convenient height for taking tree measurements.

This instrument is constructed on the

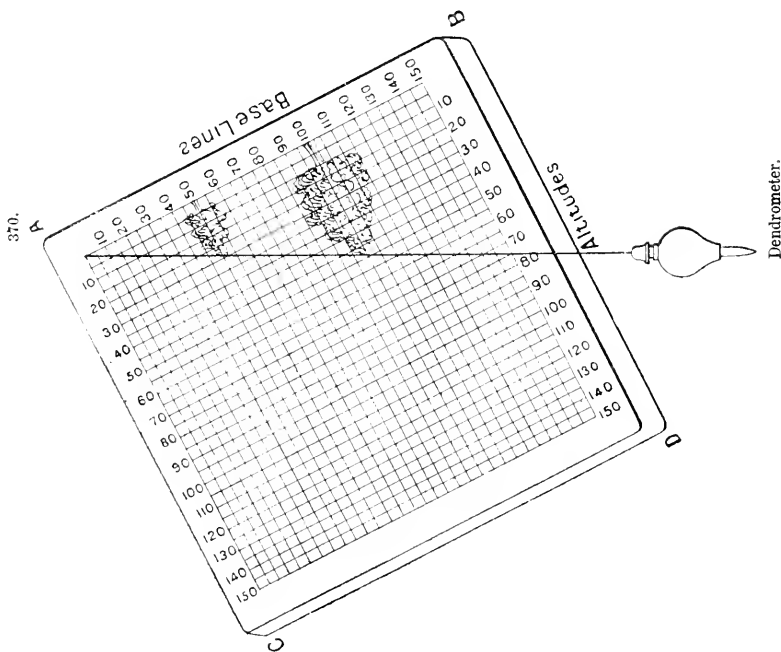
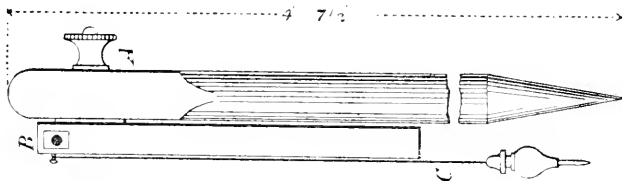

come under our notice is a little instrument invented by Kay. It consists of a square board (Fig. 370), having its sides $9\frac{1}{2}$ in. long. On the sides of this square,

principle which applies to all right-angled triangles. The side *AB* (Fig. 370) is termed the base-line, and corresponds with the horizontal line from the tree

or other object intended to be measured, to the foot of the observer. The lines running perpendicular to the base line represent the altitude or height of the object either in feet, links, or yards, according to the scale by which the base line is measured. The height of any given tree is indicated on the face of the dendrometer at the point where the plumb line (suspended from the point A) intersects the perpendicular line corresponding with the distance on the base line from the centre of the trunk of the tree to the observer. The figures along the top and bottom of the instrument show the number of divisions corresponding to the lines of altitude intersected by the plumb line.

Each line of altitude represented on the instrument corresponds with a unit of the scale employed, whether this scale be in feet, links, or yards. The base line is marked only at every fifth unit, thus, 5, 10, 15, 20, and so on. Whatever standard of measurement is fixed upon, whether it be in feet, links, or yards, for the base line, it is of course understood that the lines of altitude must be fixed to the same scale. The divisions on the face of the instrument are 150, but if at any time it be desired to ascertain the height of an object above 150 ft., the divisions of the instruments must be termed yards, when, of course, a height of 450 ft. can be measured.

The mode of using the dendrometer is as follows:—Suppose the object to be measured be a tree. The operator must first place himself at a sufficient distance from the tree so that the extreme top of it can be distinctly seen. Note must then be made of the distance from

the centre of the bole of the tree to the staff of the dendrometer. At this point (where the operator stands) the staff of the dendrometer is to be fixed in the

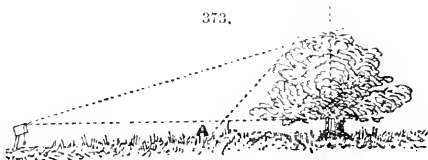
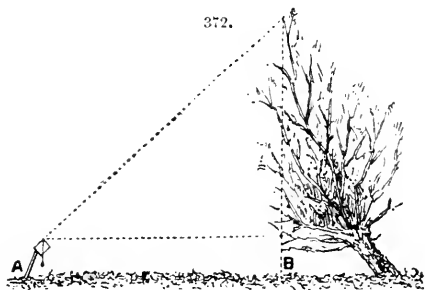
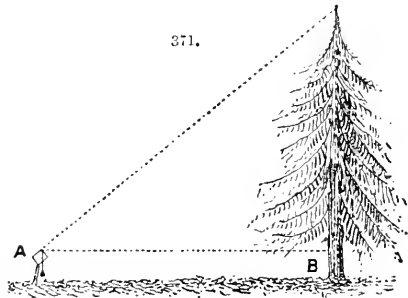

Dendrometer.

ground. Then setting the instrument in the direction of the tree turn the square face of the instrument (which works on a pivot fixed at the upper angle) until the plumb line falls direct upon the line A B (Fig. 370). Fix the square in this position by the clamp

screw, and then look through the "sight" (the perforation running through the square from C to A, Fig. 370), and mark the place on the tree where the line of sight cuts the tree, as at B in Fig. 371. This point (B) will give the level corresponding to the height of the observer. Next loosen the clamp screw and turn the square until the line of sight cuts the extreme top of the tree, then tighten the clamp screw again. The plumb line will then be seen to make a triangle with the base and altitude lines, as shown in Fig. 370. The height of the tree will be indicated by the number of the line of altitude, which is intersected by the plumb line, on the base line corresponding with the measured distance from the tree.

The diagram (Fig. 370) shows clearly what takes place during an observation. Suppose the base line from the centre of the tree trunk to the observer measures 50 ft., and after "sighting" the top of the tree the plumb line falls over the square in the manner indicated in the diagram (the upper figure), the height of the tree measured would then be 25 ft. Again, if the base line measured 100 ft., and after "sighting" the topmost point of a tree, the plumb line fell across the square, as in the lower figure in the diagram, the tree would be 50 ft. in height. Of course, in every case the height from the ground to the observer's eye must be *added* to the height read on the instrument.

In measuring reclining trees or other objects, care must be taken not to measure the base line from the centre of the tree trunk, but from the point on the ground perpendicular to the highest part of the tree. This point may be ascertained by holding a plumb-line between the eye and the tree, and marking on the ground the place thus indicated, as at B, Fig. 372. On finding this point perpendicular to the highest part of the tree, the observer may proceed as in the preceding instructions.

It will thus be seen that in measuring objects not exactly perpendicular, some care is necessary in the operation, or the measurements will be inaccurate. In the case of ascertaining the height of an object, as for instance that represented in Fig. 372, if the base line were measured from the centre of the bole, instead of from the point B, the observed height would be too great. In short, if the base line were measured from the centre of the bole on the side to which the tree is leaning, it would give too great a height, and on the other hand, if the base line were measured on the side the tree is leaning from, the height so ascertained would be less than the true height of the tree.

In measuring the height of round or flat-topped trees, the observer must choose a station sufficiently distant, so as to fully see the highest part. If viewed too near, as at A in Fig. 373, it is impossible for one to see the highest part of the tree, and the result is that the height is greatly increased. Therefore, in order to avoid such errors, the object should be viewed as far back as possible, so as to obtain a view of the highest point right over the true perpendicular, or, in the event of this not being possible, the perpendicular and height of some definite point may be ascertained as in Fig. 372.

The height of any part of a tree or other object may be ascertained by subtracting the result of one observation from that of another.

This instrument possesses many advantages. It is simple, no calculation being required; the height of any tree or other object can be ascertained at any convenient distance, and by it the height of any portion of a tree, such as the height of the trunk, can be ascertained from one station. It is, moreover, light and portable, not its least recommendation for an instrument of this kind.

PATENTS, DESIGNS, AND TRADE-MARKS.

The following information on the above subjects has been supplied to us by Mr. W. P. Thompson, F.C.S., M.I.M.E., British and International Patent Agent of Liverpool, Manchester, Nottingham, and London.

The table on next page gives the principal countries and colonies where patents can be obtained, and designs and trade-marks registered.

EXPLANATION OF TABLE.

1. The first column gives the names of the countries; "T" after many of these signifies that besides the first cost a periodic tax (usually an annual one) is levied on the patent on pain of forfeiture of the patent rights.

2. The column headed "Protection" signifies the number of months during which the invention is protected (by the International Convention or otherwise) by the filing of a provisional application in Great Britain.

3. The column headed "Working" states the length of time in years after the date of the patent within which working within the realm must be commenced, on pain of forfeiture of the patent rights.

4. The next column, headed "Duration," gives the maximum number of years for which patents are usually granted. In some cases, as in England and Denmark, this can be extended in the case of very meritorious inventions which have not sufficiently paid their inventors.

5. The next column gives the average initial cost of patents, including patent agent's fees. In complicated cases the

cost is greater; in very simple cases it is less.

6. The next column gives the average cost of registering a design, usually for a period of about five years.

7. And the next that of registering an ordinary trade-mark in one class of goods, usually for about fourteen years, with power to renew.

FURTHER PARTICULARS.

Patents for inventions are granted in all civilised countries and colonies except the Dutch dominions, Servia, Roumania, Egypt, Cyprus, Persia, and China, but only the more important ones are set down in the table. In nearly all countries they are granted only to the original inventor or his assignees, and only then if he applies for the patent before the invention has become publicly known or worked in the realm.

Designs are protected incomparatively few countries, unless they come under the head of inventions, when they can be covered by patents. In some countries, as set forth in the table, they can be protected for a few years by registration.

Trade-marks are protected from infringement in all civilised countries by common law or special registration, but where registrations are granted they are not protected till the registrations are effected.

Copyright in books can be obtained in nearly all countries by authors resident in the country, and by authors resident in other countries with which such countries have copyright treaties. International copyright law is, however, still in embryo and very defective.

PATENTS, DESIGNS, AND TRADE-MARKS.

	Protec- tion.	Work- ing.	Dura- tion.	Patents.	Designs.	Trade- Marks.
				£ s. d.	£ s. d.	£ s. d.
Great Britain and Ireland						
Provisional, 9 months . . .	9	..	$\frac{3}{4}$	4 4 0	..	1 0 0
Completing (T)	11 11 0	..	3 0 0
Total	none	14	15 15 0	15s. to 3l. 3s.	4 0 0
United States	7	none	17	20 0 0	5l. to 13l.	4l. or 10l.
Canada (T)	12	2	15	18 0 0	5 0 0	10 0 0
India (T)	12	none	14	23 0 0	10 0 0	8 0 0
Victoria (T)	12	none	14	16 0 0	5 0 0	9 0 0
New South Wales	none	none	14	18 0 0	5 0 0	8 0 0
Queensland (T)	none	none	14	19 0 0	5 0 0	8 0 0
South Australia (T)	none	none	14	14 0 0	5 0 0	10 10 0
New Zealand (or T)	12	none	14	18 0 0	4 10 0	7 0 0
France and Colonies (T)	6	2	15	14 0 0	4 0 0	6 0 0
Belgium (T)	6	1	20	8 10 0	4 0 0	6 0 0
Holland	none	none	none	11 0 0
Germany (T)	none	3	15	15 0 0	5 0 0	8 0 0
Austria and Hungary (T)	none	1	15	13 0 0	5 0 0	6 0 0
Italy (T)	6	1 to 2	15	14 0 0	6 0 0	7 0 0
Switzerland (T)	7	3	15	12 0 0	6 0 0	10 0 0
Spain and Colonies (T)	6	2	20	22 0 0	11 0 0	7 0 0
Portugal (T)	6	2	15	19 0 0	none	5 10 0
Denmark and Iceland	none	1	5	13 0 0	none	12 0 0
Sweden (T)	7	3	15	15 0 0	none	10 0 0
Norway (T)	7	3	15	13 0 0	none	8 0 0
Russia	none	$\frac{3}{4}$	3	25 0 0	6 0 0	7 0 0
"	none	$2\frac{1}{2}$	10	75 0 0		
Turkey (T)	none	2	15	29 0 0	none	12 0 0
Brazil (T)	7	3	15	36 0 0	none	13 0 0
Argentine Republic	none	2	5	38 0 0	none	20 0 0
Chili (T)	none	none	15	62 0 0	none	

For further information on this subject the reader is referred to the useful manuals "Facts for Inventors" and "All about Trade-marks," supplied post free by Messrs. W. P. Thompson and Co., of 6, Lord Street, Liverpool; 6, Bank Street, Manchester; Angel Row, Nottingham; and 323, High Holborn, London, W.C.

INDEX.



- ABEL POWDER, composition, 66.
Acacia walking sticks, 398.
Acid pumps, 301.
— siphon, 305.
Acidproof cement, 13.
— lute, 13.
Acids, evaporating, 45.
— packing, 262.
Adams's air bath, 34.
Aerifilter, 55.
Air baths, 32.
— exhausting, 414.
— ovens, 32.
Albumen prints, 112.
Albums, repairing, 383.
Alloys capable of electric welding, 198.
— eutectic, 76.
— fusible, 76.
Amide powder, strength, 67.
Armonia as a fire extinguisher, 80.
— dynamite, strength, 67.
Anatomical specimens, casts of, 328.
Anemometers, 411.
Angles, measuring, 413.
Aps^c walking sticks, 398.
Ash walking sticks, 399.
Asp walking sticks, 398.
Atlas powder, composition, 66.
— firing points, 65.
— strength, 67.
Automatic rapid filter, 58.
— sprinklers, 73.
Axo battery, 131.
- BAKOW WALKING STICKS, 399.
Bamboo walking sticks, 399.
Barometers, 414.
— camphor, 421.
— cheap, 414.
— cistern, 419.
— cleaning tubes, 416.
— exhausting tubes, 414,
— filling with mercury, 415.
— glycerine, 423.
— portable, 425.
— reading, 426.
— siphon, 417.
— storm glass, 421.
— vernier, 421.
Batteries, electric, 125.
— for electric welding, 209.
— storage, 185.
Bay-tree walking sticks, 399.
Beating gold, 241.
Beefwood walking sticks, 399.
Beetle canes, 399.
Bellite, strength, 67.
Bells, electric, 162.
Belting, cement for, 13.
Bend knot, 372 386.
- Benefcke's cement, 13.
Bennett powder, composition, 66.
Benzene, extinguishing, 80.
Benzoic acid in food, 274.
Bernardos electric welding, 209.
Bichromate batteries, 131.
Binding knot, 372.
Birch walking sticks, 399.
Bird's upward filter, 64.
Bishop's sprinkler, 76.
Bunial lantern, 102.
Black orange walking sticks, 402.
— tork walking sticks, 399.
— writing ink, 82.
Blacksmithing, 248.
Blackthorn walking sticks, 399.
Blackwall hitch, 372.
Block hook, 3-0.
Blocks, rope, 377.
Blue-black writing ink, 82.
— marking ink, 85.
Boat building, 407.
Books, cloth bound, 381.
— discoloured cases, 383.
— dog-ears, 382.
— leather bound, 383.
— preserving, 270.
— recasing, 381.
— repairing, 381.
— — albums, 383.
— torn cases, 382.
Boots, waterproofing, 311.
Boric acid for keeping food, 271.
Bottle cement, 13.
— labels, 4.
— lacquer, 89.
Bower-Barff iron, 292.
Bowline knot, 370.
Boxwood walking stick, 400.
Brass lacquer, 89.
Briar root pipes, 361.
— walking sticks, 400.
Bright's fire alarm, 79.
Bronzes, 219.
— casting, 219, 225.
— — works, 220.
— compositions, 229.
— furnace, 229.
— Japanese, 234.
— models, 219.
— moulds, 220, 233.
— patina, 232.
— pickling solutions, 234.
— piece moulding, 221.
— pouring, 226.
— shakudo, 234.
— shibu-ichi, 234.
— waste wax process, 221.
— wax models, 224.
Brown's sprinkler, 76.

- Brugères powder, composition, 66.
 Budenberg powder, composition, 66.
 Buildings, fireproofing, 67.
 — River Plate fireproof, 70.
 — timber firing without flame, 67.
 Bunsen burner, wire, 11.
 Burritt sprinkler, 76.
CABBAGE WALKING STICKS, 400.
 Calcium chloride drying process, 38.
 Camera lucida, 427.
 Camphor barometer, 421.
 Candying fruit, 277.
 Cap cement, 13.
 Carbodynamite, composition, 66.
 Carbon prints, 111.
 Carbonic acid crate, 263.
 — — — for cooling, 19.
 Carbons, electric, 163.
 Carboy protector, 264.
 Carey's sprinkler, 73.
 Carob walking sticks, 400.
 Carolina reeds, 400.
 Carrick bend, 372.
 Casein cement, 13.
 Casting, 243.
 — bronzes, 225.
 Catspaw knot, 370.
 Caution battery, 132.
 Cedar wood walking sticks, 400.
Cements, 13.
 — acid proof, 13.
 — belting, 18.
 — Benicke's, 13.
 — bottle, 13.
 — cap, 13.
 — casein, 13.
 — China, 18.
 — cutlers', 13.
 — Davy's, 18.
 — glass, 13.
 — — to metal, 13.
 — glue, 14.
 — gutta-percha, 17.
 — hot-water pipes, 14.
 — labels, 15.
 — metallic, for stone, 18.
 — microscopical, 15.
 — rubber, 17.
 — — to metal, 17.
 — stone, 18.
 — Soulan's, 13.
Centrifugal driers, 41.
 — filtering, 63.
Cera perduta bronzes, 221.
 Charcoal tobacco pipes, 363.
 Cherry walking sticks, 400.
 Chestnut walking sticks, 400.
 China cement, 18.
 Chloride of calcium drying process, 38.
 Chlorochromic battery, 153.
 Chromic acid battery, 133.
 Cistern barometer, 419.
 Clamps, wire, 9.
 Clay modelling, 321.
 — tobacco pipes, 355.
 Cleaning barometer tubes, 416.
 Clove hitch, 370, 372.
 Coffee walking sticks, 400.
 Cold drying, 42.
 Colouring magic lantern prints, 119.
 Colouring metal wares, 239.
 Commutators, electric, 164.
 Concentrating by cold, 42.
 — — — heat, 32, 45.
 Concrete floors, 70.
 Condenser, Liebig, 6.
 Congreve's sprinkler, 74.
 Constant water bath, 40.
 Contact printing, 116.
 Cooling, 19.
 — by evaporation, 19.
 — water, 19.
 Copper, corrosion, 283.
 — oxide battery, 143.
 — plates, welding, 211.
 — protection, 283.
 — welding, 240.
Copying, 22.
 — black process, 23.
 — blue process, 22.
 — chemical methods, 22.
 — copper plates, 27.
 — dynamo-electric machines, 27.
 — galvano-caustics, 27.
 — ink, 83.
 — magneto-electric machines, 27.
 — mechanical methods, 24.
 — mounting drawings, 28.
 — nature printing, 27.
 — paper, permanently moist, 24.
 — photo-chemigraphy, 27.
 — printing frame, 22.
 — type printing, 27.
 — typographic blocks, 28.
 — zincotypes, 25.
Cordite, composition, 66.
 Cork puller, wire, 11.
 — walking sticks, 400.
Corrosion, copper, 283.
 — iron, 284.
 — lead, 300.
 — metal surfaces, 283.
 — silver, 301.
 — steel, 284.
 — zinc, 301.
 Cotton waste, printing ink from, 86.
 Crab walking sticks, 400.
 Cutlers' cement, 13.
 Cutting diamonds, 1.
DATE PALM WALKING STICKS, 400.
 Davey powder, composition, 66.
 Davy's cement, 18.
 Dawbny's floors, 70.
 Delamy's battery, 134.
 Dendrometers, 430.
 Dennett's floors, 70.
 Desiccating, 32.
 Designolles powder, composition, 66.
 Diamond hitch, 375.
 Diamonds, cutting, 1.
 — polishing, 1.
 Dish covers, japanning, 95.
 Distilled water, preserving, 270.
 Distilling, 42.
 — mercury, 42.
 — water, 44.
 Dogwood walking sticks, 400.
 Dole powder, composition, 66.
 Dop, 2.
 Double Blackwall hitch, 372.

- Double sheet bend, 370.
 Doulton-Peto floors, 70.
 Drag rope knot, 372.
 Drawings, duplicating, 22.
 — mounting, 27.
 Draw reef knot, 368.
 Dried plants, keeping, 278.
 Dry batteries, 147.
 — plates for magic lanterns, 110.
 Drying, 32.
 — agricultural produce, 38.
 — air baths, 32.
 — calcium chloride, 38.
 — cold, 42.
 — cold-air machine, 39.
 — fruit, 38.
 — grain, 38.
 — hydro extractors, 41.
 — mechanically, 41.
 — presses, 42.
 — tea, 38.
 — water ovens, 40.
 Dualine composition, 66.
 Duplicating writings, 22.
 Dynamite, composition, 66.
 — firing points, 65.
 — strength, 67.
 Dynamo-electric machines, 27.

EBONY WALKING STICKS, 401.
 Eggs, packing, 265.
 Electric batteries, 125.
 — axo, 131.
 — bichromate, 131.
 — chlorochromic, 153.
 — chromic acid, 133.
 — copper oxide, 143.
 — Delamy's, 134.
 — dry, 147.
 — for cautery, 132.
 — Friedlander's, 135.
 — gas, 136.
 — Holtzer, 141.
 — Imchenetzki, 142.
 — iron, 142.
 — Konsmine, 142.
 — Lalande-Chaperon, 143.
 — moist, 147.
 — pneumatic, 152.
 — priming siphon, 148.
 — Radiguet's, 148.
 — Renard's, 151.
 — Selby's, 155.
 — selenium, 157.
 — single fluid, 159.
 — Skrivanof, 159.
 — Sloane's, 159.
 — storage, 185.
 — suspending frames, 131.
 — Treeby's, 136.
 — water, 161.
 — Weymersch, 161.
 — wire mesh frames, 138.
 — bells, 162.
 — carbons, 163.
 — commutators, 164.
 — connector, wire, 11.
 — energy, 125.
 — fire alarms, 79.
 — galvanometers, 166.
 — graphophone, 182.
 — Electric holing, 213.
 — joints, stability, 213.
 — lamps, 169.
 — light for velocipede, 381.
 — lighting, 52, 170.
 — — co-t, 170.
 — microphones, 174.
 — — transmitter, 192.
 — motors, making, 176.
 — phonogram, 182.
 — powder, composition, 66.
 — regulators, 183.
 — riveting, 213.
 — soldering, 213.
 — storage, 185.
 — telephones, 190.
 — transformers, 200.
 — welding, 193.
 — — battery, 209.
 — wires, insulating, 215.
 — — joining, 216.
 Emmensite, firing points, 65.
 — strength, 67.
 Enamels for metals, 240.
 Encaustic letters, 5.
 Endorsing ink, 87.
 Erhardt powder, composition, 66.
 Etching glass, 317.
 — liquid, 5.
 Eucalyptus walking sticks, 401.
 Eutectic alloy, 76.
 Evans and Swain's solid wooden floors, 70.
 Evaporating, 45.
 — acids, 45.
 — cooling by, 19.
 — multiple, 45.
 Exhausting air from tubes, 414.
 Explosives, 65.
 — composition, 66.
 — firing points, 65.
 — strengths, 65, 67.
 Extinguishing apparatus, 73.
 — benzene, 80.
 — compounds, 73.
 — petroleum, 80.
 Extraction apparatus, 7.

FASTENING LABELS ON METAL, 5.
 Figure of eight knot, 368.
 Filter, automatic rapid, 53.
 — germicide, 53.
 — Johnson's 54.
 — Mallié, 55.
 — papers, folding, 59.
 — Paulson's, 53.
 — porcelain, 55.
 — presses, 42.
 — pumps, 58.
 — support, 57.
 Filtering, 53.
 — assisting, 63.
 — centrifugal, 63.
 — fine precipitates, 62.
 — funnels, 62.
 — in vacuo, 56, 63.
 — laboratory methods, 56.
 — media, selecting, 62.
 — oxidisable precipitates, 57.
 — paper and linen, 62.
 — rapid, 58, 59.
 — secrets of, 62.

- Filtering under pressure, 63.
 — upwards, 63.
 — vacuum pump for, 56, 59, 63.
 — viscid liquors, 56, 63.
 — water, 53.
 Fire alarms, 79.
 Firedoors in theatres, 78.
 Fireproofing, 67.
 — buildings, 67.
 — causes of fires, 68.
 — extinguishing compounds and apparatus, 73.
 — floors, 69.
 — sprinklers, 73.
 — textiles, 80.
 — theatres, 71.
 — timber, 80.
 — — firing without flame, 67.
 — whitewash, 69.
 Fires, causes, 67.
 — from flues, 68.
 — — oxidised iron, 69.
 — — pipes, 68.
 Fishermen's bend, 370, 380.
 Fishing nets, making, 384.
 Flong, 335, 336.
 Floors, concrete, 70.
 — cost, 71.
 — fireproof, 69.
 — loads, 71.
 — solid wooden, 70.
 — weight, 71.
 Folding filter papers, 59.
 Food, preserving, 271.
 Forcite, composition, 66.
 — firing points, 65.
 Forge, 248.
 Forgeries, detecting, 87.
 Fortis powder, composition, 66.
 Foundry, statue, 229.
 Freezing mixtures, 19.
 — out water, 42.
 Friedlander's battery, 135.
 Fruit candying, 277.
 — drier, 38.
 Fullers' teazle walking sticks, 401.
 Fulminate, mercury, firing points, 65.
 Fulminates, strength, 67.
 Funnels, filtering, 62.
 Furnace, bronzes, 229.
 Furze walking sticks, 401.
 Fusible alloys, 76.

GALVANISING IRON, 237.
 Galvano-caustics, 27.
 Galvanometers, 166.
 Garden labels, 5.
 Gardner's floors, 70.
 Gas battery, 136.
 — lighting, 49.
 — liquor as a fire extinguisher, 80.
 Gelatine, camphorated, firing points, 65.
 — explosive, composition, 66.
 — — firing points, 65.
 — — strength, 67.
 Gellignite, composition, 66.
 Gems, cutting, 1.
 — polishing, 1.
 Germicide filter, 53.
 Gesner's rust-proofing process, 237.
 Giant powder, composition, 66.

 Glass, breaking, 313.
 — cements, 13.
 — cutting, 314.
 — drilling, 315.
 — etching, 317.
 — — liquid, 5.
 — fastening labels to, 6.
 — frosting, 319.
 — labels, 5.
 — lacquer, black, 89.
 — powdering, 320.
 — stoppers, fitting, 320.
 — to metals, cementing, 13.
 — tubes, sealing, 320.
 — writing on, 5.
 Glue, dry, 14.
 Glycerine barometer, 423.
 — explosive, strength, 67.
 Gold beating, 241.
 — lacquer, 90.
 Goniometers, 413.
 Gorse walking sticks, 401.
 Grain drier, 38.
 Grangier's commutator, 161.
 Graphophone, 182.
 Graphs, 22.
 Green powder, composition, 66.
 Grinnell's sprinkler, 75.
 Grove battery, liquor for freezing, 19.
 Gru-gru walking-sticks, 401.
 Guelder rose walking sticks, 401.
 Guncotton, firing points, 65.
 — strength, 67.
 Gunpowder, firing points, 65.
 Guthrie's eutectic alloy, 76.
 Gutta-percha cements, 17.

HAHN POWDER, COMPOSITION, 66.
 Harris sprinkler, 76.
 Harrison's sprinkler, 74.
 Hawser bend, 380.
 Hazel walking sticks, 401.
 Heliography, 23.
 Heliogravure, 25.
 Hellhoffite, strength, 67.
 Herbarium specimens, keeping, 278.
 Hercules powder, composition, 66.
 Holders, wire, 9.
 Holly walking sticks, 401.
 Holtzer battery, 141.
 Homan and Roger's floors, 70.
 Hookab, 365.
 Hornbeam walking sticks, 401.
 Horsley powder, composition, 66.
 Hot-water pipes, cement, 14.
 Hydro-extractors, 41.
 — nitro-cellulose, firing points, 65.

ILLUMINATING AGENTS, 48.
 Imchenetzki battery, 142.
 Indelible ink, 84.
 — stamping ink, 86.
 Indian ink writing on glass, 5.
 Ink, 82.
 — action of bleaching agents on, 87.
 — black writing, 82.
 — copying, 83.
 — — without press, 83.
 — endorsing, 87.
 — eraser, 87.
 — indelible, 84.

- Ink, invisible, 84.**
 — marking, 85.
 — pad, 87.
 — polygraphic, 86.
 — powder, 87.
 — printing, 86.
 — restoring faded, 87.
 — stamping, 86.
 — stencil, 85.
 — waterproof, 87.
- Insulating cleat, 216.**
 — wires, 215.
- Invisible ink, 84.**
- Iron battery, 142.**
 — coating, 288.
 — corrosion, 284.
 — galvanising, 287.
 — lacquer, 91.
 — lute, 14.
 — painting, 287.
 — plates, welding, 211.
 — protection, 287.
- JAMBEE WALKING STICKS, 401.**
- Japanese bronzes, 234.**
 — lacquer, 91.
- Japanning dish covers, 95.**
 — metal, 92.
 — Tonbridge ware, 94.
 — trays, 95.
 — wood, 94.
- Johnson's filter, 54.**
- Joining electric wires, 216.**
- Jolin's sprinkler, 77.**
- Judson powder, composition, 66.**
- KEEPING BOOKS, 270.**
 — distilled water, 270.
 — dried plants, 278.
 — food, 271.
 — tools, 259.
 — wood, 283.
- Kellow and Short powder, composition, 66.**
- Kieselguhr dynamite, firing points, 65.**
- Kl-rushi, 91.**
- Knots, 368.**
- Kousmine battery, 142.**
- Kup powder, composition, 66.**
- LABELS, 4.**
 — bottle, 4.
 — cements, 15.
 — encaustic, 5.
 — fastening on metal, 5.
 — garden, 5.
 — glass, 5.
 — plant, 5.
 — varnish, 5.
- Laboratory apparatus, 6.**
 — wire, 7.
 — filters, 56.
- Lacquers, 89.**
 — black for glass, 89.
 — bottle, 89.
 — brass, 89.
 — gold, 90.
 — iron, 91.
 — Japanese, 91.
 — steel, 91.
 — urushi, 91.
- Lalande-Chaperon battery, 143.**
- Lamps, electric, 169.**
- Lancewood walking sticks, 401.**
- Lanney powder, composition, 66.**
- Lantern pictures, making, 108.**
- Lanterns, magic, 95.**
- Lapidaries' work, 1.**
- Laudy's copying process, 23.**
- Laurier thyn walking sticks, 399.**
- Lawn tennis nets, making, 392.**
 — mending, 395.
- Lead, corrosion, 300.**
 — protection, 300.
- Leonard sprinkler, 78.**
- Letters, encaustic, 5.**
- Library insects, 270.**
- Liebig condenser, 6.**
- Lighting agents, 48.**
 — burners, 50.
 — cost, 48.
 — economics, 52.
 — electric, 52, 170.
 — gas, 49.
 — magnesium, 51.
 — petroleum, 48.
 — theatres, 72.
 — water gas, 51.
- Lime bisulphite in food, 274.**
 — light, 102.
- Lindsay's floors, 70.**
- Lorrain's fire alarm, 79.**
- Loya canes, 402.**
- Lutes, 13.**
 — acid proof, 13.
 — cap, 13.
 — iron, 14.
- MACCABY'S SPRINKLER, 74.**
- Magic lanterns, 95.**
 — albumen prints, 112.
 — biennial, 102.
 — carbon prints, 111.
 — carrier for slides, 101.
 — cheap, 95.
 — colouring prints, 119.
 — contact printing, 116.
 — gelatine plate, 95.
 — lever slide, 119.
 — lights, 102.
 — pentaphane, 99.
 — portable, 97.
 — printing frame, 106.
 — Pumphrey's vaporiser, 103.
 — reflecting, 95.
 — slides, 106.
 — shape, 107.
 — size, 107.
 — making, 108.
 — mounting, 107.
 — wonder camera, 96.
 — Woodburytypes, 111.
- Magnesium lamps, 51.**
- Magneto-electric machines, 27.**
- Malacca canes, 402.**
- Mallie filter, 55.**
- Maple walking sticks, 402.**
- Marking ink, 85.**
- Measuring angles, 413.**
 — height of trees, 430.
- Medlar walking sticks, 402.**
- Meerscham pipes, 363.**
- Meganite, composition, 66.**

- Melinite, strength, 67.
 Mercury fulminate, firing points, 65.
 — strength, 67.
 — purifying, 42.
 — stills, 42.
 Mesh pegs, netting, 384.
 Metal surfaces, corrosion and protection, 283.
 — wares, colouring, 239.
 — work, 219.
 Metals capable of electric welding, 198.
 — enamels, 240.
 — fastening labels to, 5, 6.
 — japanning, 92.
 — writing on, 6.
 Meteor, 4.
 Mica powder, composition, 66.
 Microphones, 174.
 — transmitter, 192.
 Microscope cement, 15.
 — stand, wire, 11.
 Midden walking sticks, 402.
 Modelling, 321.
 — clay, 321.
 — stand, 321.
 — tools, 322.
 — wax, 325.
 Moist batteries, 147.
 Mokuyiki, 91.
 Motors, electric, 176.
 Moulders' tools, 243.
 Moulding, 243.
 — sand, 243.
 Moulds, bronze, 220, 233.
 Mountain ash walking sticks, 402.
 — bay walking sticks, 402.
 Mounting drawings, 28.
 — magic-lantern slides, 107.
 Mousing a hook, 380.
 Multiple evaporation, 45.
 Musical instruments, home-made, 262.
 Myall wood walking sticks, 402.
 Myrtle walking sticks, 402.
- NANA CANES, 402.
 Natural objects, casts of, 328.
 Nature printing, 27.
 Netting, 384.
 — Every's system, 390.
 — mending, 395.
 — needles, 384.
 — pegs, 384.
 — shales, 385.
 — spools, 384.
 — square meshed, 392.
 Neumeyer powder, composition, 65.
 Nitro-glycerine, firing points, 65.
 — strength, 67.
 Nobel's powder, strength, 67.
- OAK WALKING STICKS, 402.
 Oil lighting, 48.
 Olive walking sticks, 402.
 Orange walking sticks, 402.
 Ovens, air, 32.
 Oxland powder, composition, 66.
 Oxonite, strength, 67.
 Oxy-calcium lamp, 102.
 Oxy-hydrogen lamp, 102
 — light, 73.
- PACKING, 262.
 — acids, 262.
 Packing eggs, 265.
 Pack-saddle knot, 375.
 Pad ink, 87.
 Painting iron, 287.
 — lantern slides, 119.
 Palmyra walking sticks, 402.
 Paraffin lighting, 48.
 Parcels, tying, 374.
 Parnelle's sprinkler, 74.
 Partridge canes, 402.
 — wood walking sticks, 403.
 Paste, 337.
 Patina on bronze, 232.
 Paulson's filter, 53.
 Penang lawyer canes, 403.
 Pentaphane lamp, 99.
 Percolation, 269.
 Percolator, water bath, and still, 12.
 Perkins's cooling apparatus, 20.
 Petroleum, extinguishing, 80.
 — lighting, 48.
 Phonogram, 182.
 Photochemigraphy, 27.
 Photograph album, repairing, 383.
 Photographic plaster casts, 329.
 Photographs, magic lantern, 108.
 Pickling bronzes, 234.
 Picric powder, firing points, 65.
 Pictet's freezing liquor, 19.
 Pimento walking sticks, 403.
 Pinchcock, wire, 9.
 Pipe-makers' oven, 356.
 — moulders' table, 358.
 — tools, 357.
 Pipes, coating, 288.
 — hot-water, cement, 14.
 Plant labels, 5.
 Plants, preserving, 278.
 Plaster casting, 325.
 — casts, enlarging, 332.
 — hardening, 331.
 — reducing, 332.
 — that will wash, 330.
 Plates, welding, 211.
 Pneumatic battery, 152.
 Poitevin's copying process, 23.
 Polishing diamonds, 1.
 Polygraphic ink, 86.
 Pomegranate walking sticks, 403.
 Porcelain filter, 55.
 Pouring bronze, 226.
 Precipitate filter, 57, 62.
 Preserving books, 270.
 — food, 271.
 — plants, 278.
 — wood, 283.
 Presses, drying, 42.
 Printing ink, 86.
 Prints, copying, 22.
 Protection, copper, 283.
 — iron, 287.
 — lead, 300.
 — metal surfaces, 283.
 — silver, 301.
 — steel, 287.
 — zinc, 301.
 Pumphrey's vaporiser, 103.
 Pumps, acid, 301.
 — filter, 58.
 — substitutes, 302.
 — water, 302.

- Pyrolite, composition, 66.
 Pyronome, composition, 66.
- QUADRUPLE EVAPORATION, 45.**
- RACKAROCK, COMPOSITION, 66.**
 — strength, 67.
 Radiguet's battery, 148.
 Rajah canes, 403.
 Rattan canes, 403.
 Reef-knot, 368.
 Renard's battery, 151.
 Rendrock, composition, 66.
 Retort stand, wire, 9.
 River Plate houses, 70.
 Roburite, composition, 66.
 Roche's copying process, 22.
 Rolling bend, 380.
 Ropes, hawser laid, 379.
 — mousing a hook, 380.
 — sizes, 368.
 — storing, 368.
 — strength, 368, 378.
 — tackle, 377.
 — tying and splicing, 368.
 — whipping, 370.
 Roughton's sprinkler, 74.
 Rubber cements, 17.
 — to metal, cementing, 17.
 — waterproofs, 311.
 Running bowline, 370.
 Rusting iron, 284.
 Rust preventives, 259.
 — removers, 260.
 Ruthenburg sprinkler, 76.
- SACCHARINE SOLUTIONS, COLD CONCENTRATION, 42.**
- Safety valve for extraction apparatus, 7.
 Salicylic acid in food, 274.
 Saline solutions, cold concentration, 42.
 Salomon's commutator, 164.
 Saxifragine, composition, 66.
 Schwartz powder, composition, 66.
 Selby's battery, 155.
 Selenium battery, 157.
 Selvagee, 379.
 Sensitising paper, 23.
 — solutions, 23.
 Seshime-urushi, 91.
 Shakudo, 234.
 Shales, netting, 385.
 Sheepshank, 370.
 Sheet bend, 368, 372.
 Shi'u-ichi, 234.
 Short splicing, 374.
 Silver, corrosion, 301.
 — fulminate, strength, 67.
 — protection, 301.
 Single fluid battery, 159.
 — sheet bend, 368.
 Siphon barometer, 417.
 Siphons, 305.
 — acid, 305.
 — for batteries, 148.
 — intermittent, 308.
 — permanent, 305.
 — primed by blowing, 306.
 — self priming, 307.
 Skrivanof battery, 159.
 Skyf, 4.
- Sloane's air bath, 32.
 — battery, 159.
 Smirke's sprinkler, 77.
 Smith's coating for iron pipes, 288.
 Smith's tools, 248.
 — work, 248.
 Snakewood walking sticks, 403.
 Snyder's stock, 2.
 Solder, Grinnell's, 76.
 Soldering, electric, 213.
 — stereotypes, 350.
 Soulan's cement, 13.
 Spence powder, composition, 66.
 Splicing, 374.
 Spools, netting, 384.
 Sprinklers, automatic, 73.
 Stamping ink, 86.
 Stands, wire, 9.
 Statue foundry, 229.
 Steel, corrosion, 284.
 — lacquer, 91.
 — protection, 287.
 Stencil ink, 85.
 Stereotyping, 332.
 — heating brush, 341.
 — surface, 339.
 — casting box, 342.
 — curved plates, 351.
 — drying press, 340.
 — early method, 332.
 — flog, 335, 336.
 — gauges, 343.
 — metal, 344.
 — paste, 337.
 — principles, 335.
 — soldering, 350.
 — trimming plates, 345.
 Still, water bath, and percolator, 12.
 Stone cement, 18.
 Stoppers, fitting, 320.
 Storage batteries, 185.
 Storing acids, 262.
 — eggs, 265.
 Storm glass, 421.
 Sulphurous acid in food, 274.
 Switchboard, 190.
- TACKLE, 377.**
 Taps, 366.
 Tarring iron, 295.
 Tea drier, 38.
 Teazle walking sticks, 401.
 Telephones, 190.
 — switchboard, 190.
 Tennis nets, making, 392.
 — mending, 395.
 Test-tube holder, wire, 9.
 — stand, wire, 11.
 Textiles, fireproofing, 80.
 Theatres, firedoors, 78.
 — fireproofing, 71.
 — lighting, 72.
 — oxy-hydrogen light, 73.
 — pyrotechnics in, 72.
 — scenery, 72.
 — Shaw's curtain, 71.
 — structural precautions, 71.
 — wash for woodwork, 72.
 Thistle walking sticks, 403.
 Thomson's tap, 367.
 — welding apparatus 21

- Thumb-knot, 368.
 Timber, fireproofing, 80.
 — firing without flame, 67.
 — hitch, 370.
 — incombustible, 81.
 — preserving, 283.
 Tin, fastening labels to, 6.
 Tobacco pipes, 355.
 Tonbridge ware, japanning, 94.
 Tongs, wire, 9.
 Tonite, composition, 66.
 — strength, 67.
 Tonquin canes, 403.
 Tools, keeping, 259.
 Tracings, mounting, 27.
 Transformers, electric, 200.
 Transparencies, printing, 106.
 Trays, japanning, 95.
 Treby's gas battery, 136.
 Trees, measuring height, 430.
 Tripod stand, wire, 9.
 Tubes, sealing, 320.
 Tweezers, wire, 9.
 Type printing, 27.
 Tying, 368.
 — bundles, 375.
 — parcels, 374.
 Typographic blocks, 28.
 UPSETTING IRON, 256.
 Upward filtration, 63.
 Urushi, 91.
 VACUUM FILTER, 56, 63.
 — pump for filtering, 56, 59, 63.
 Varnish, label, 5.
 Velocipede, bent backbone, 380.
 — — crank, 380.
 — — handle-bar, 380.
 — buckled wheel, 380.
 — electric light for, 381.
 Victor sprinkler, 77, 78.
 Viscid liquors, filtering, 56, 63.
 Volney's powder, strength, 67.
 Vouge's gelatine, explosive strength, 67.
 Vulcan powder, composition, 66.
 Vynaud powder, composition, 66.
 WALKING STICKS, 397.
 — — materials, 397.
 — — preparing, 403.
 — — staining, 406.
 — — varnishing, 406.
 Walworth's sprinkler, 76.
 Wash-bottle, 12.
 Waste-wax bronze casting, 221.
 Water bath, constant, 40.
 — — percolator, and still, 12.
 — battery, 161.
 — cooling, 19.
 — distilling, 44.
 — filtering, 53.
 — gas, 51.
 — ovens, 40.
 — pumps, 302.
 — raising, 302.
 — Water removing by calcium chloride, 33.
 — — by centrifugal machines, 41.
 — — by cold, 42.
 — — by heat, 32, 45.
 — — by presses, 42.
 Waterproof ink, 87.
 Waterproofing boots, 311.
 — rubber, 311.
 Wax compositions for models, 224.
 — modelling, 325.
 Weavers' knot, 372, 386.
 Weights, wire, 11.
 Welding bars, 213.
 — copper, 240.
 — — plates, 211.
 — electric, 193.
 — iron plates, 211.
 — metals to each other, 213.
 Weymersch battery, 161.
 Whangee canes, 403.
 Whin walking sticks, 401.
 Whipping a rope, 370.
 White powder, composition, 66.
 Whitethorn walking sticks, 403.
 Whitewash, fireproof, 69.
 Whiting's sprinkler, 74.
 Whittaker's copying apparatus, 22.
 Wilkinson's floors, 70.
 Wire apparatus for laboratory, 7.
 — Bunsen burner, 11.
 — clamps, 9.
 — cork puller, 11.
 — electrical connector, 11.
 — microscope stand, 11.
 — pincock, 9.
 — retort stand, 9.
 — rope, splicing, 374.
 — test-tube holder, 9.
 — — stand, 11.
 — tongs, 9.
 — tripod stand, 9.
 — tweezers, 9.
 — weights, 11.
 Wires, insulating, 215.
 — joining, 216.
 Wonder camera, 96.
 Wood, fireproofing, 80.
 — firing without flame, 67.
 — incombustible, 81.
 — japanning, 94.
 — preserving, 283.
 Woodburytypes, 111.
 Wooden, solid, floors, 70.
 Writting, detecting forged, 87.
 — ink, black, 82.
 — — blue-black, 82.
 — on glass, 5.
 — on metals, 6.
 Writings, duplicating, 22.
 ZINC, CORROSION, 301.
 — fastening labels to, 6.
 — protection, 301.
 Zincotypes, 25.
 Zitracote walking sticks, 403.

RD. MELHUIH & SONS,

Nos. 84, 85, 87, FETTER LANE, LONDON.



CARVING TOOLS, J. S. Addis's Celebrated Manufacture
IMPORTERS OF MACHINES FOR FRET SAWYERS.

Also Hand Frames, Saws, Designs, Fancy Woods, and every requisite for this beautiful art.

TOOL
CABINET
&
WORK-BENCH

OUR
FAMOUS TOOLS
PRIZE MEDAL
TECHNICAL
SCHOOLS
1884

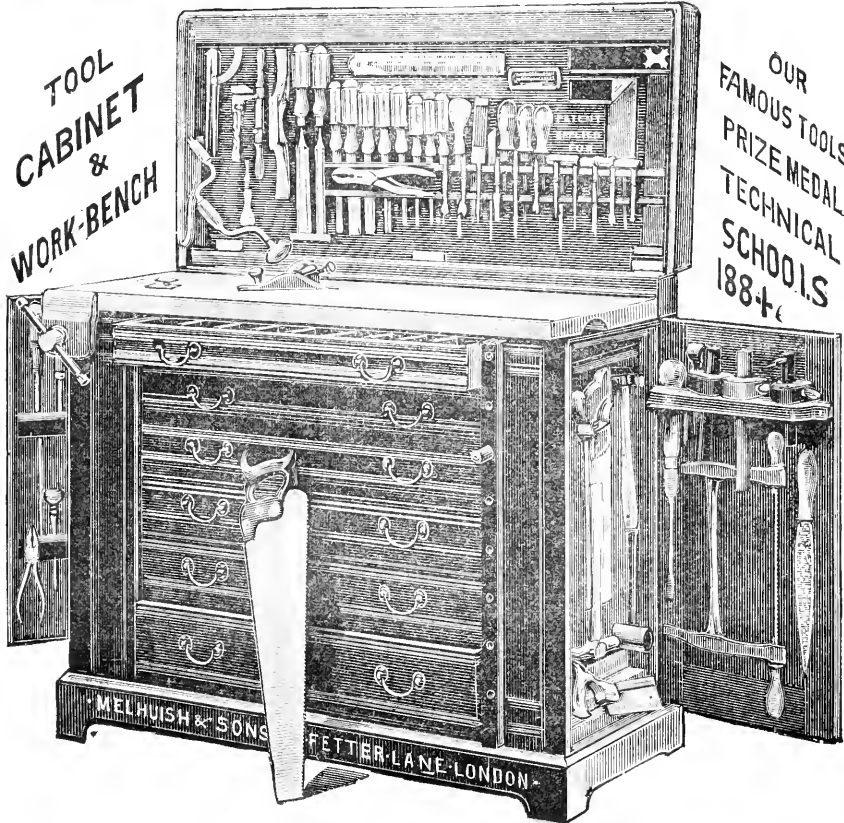

CHARLES NURSE & CO.,
 182, WALWORTH ROAD, LONDON, S.E.,
 PLANE MAKERS & TOOL MERCHANTS.

(ESTABLISHED 1841.)

Honourable mention for excellence of workmanship, 1862 Exhibition.

NURSE'S PATENT (No. 5139) REGULATOR for easily adjusting the irons of all English Pattern Bench Planes, and which can be easily applied to any maker's planes, 2s. each.

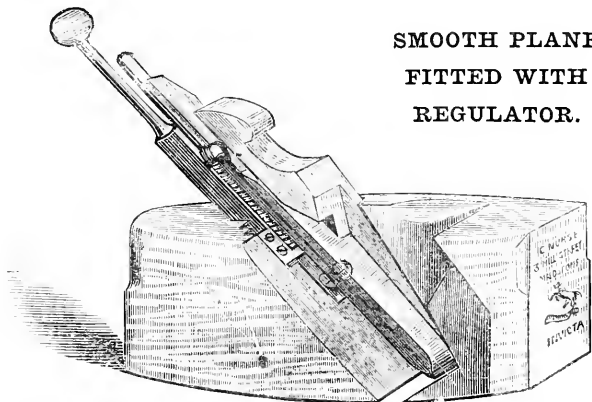

**SMOOTH PLANE
 FITTED WITH
 REGULATOR.**

Best Quality Smooths, 2 $\frac{1}{4}$ in., fitted with Regulator, 6/6 each.	
” ” Jacks, 17 in. \times 2 $\frac{1}{4}$ ” ” 7/6 ”	
” ” Trys, 22 in. \times 2 $\frac{1}{2}$ ” ” 9/- ”	

Illustrated Price Lists free to all parts of the world.

Cheapest House for **BEST LONDON SAWS & STANLEY CO.'S
 AMERICAN IRON PLANES.**

CHARLES NURSE & CO.,
 182, WALWORTH ROAD, LONDON, S.E.

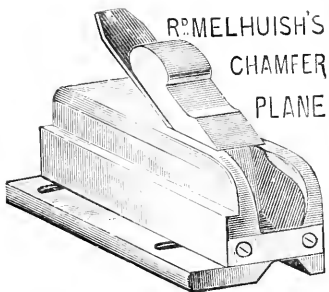

R. MELHUIH'S
CHAMFER
PLANE

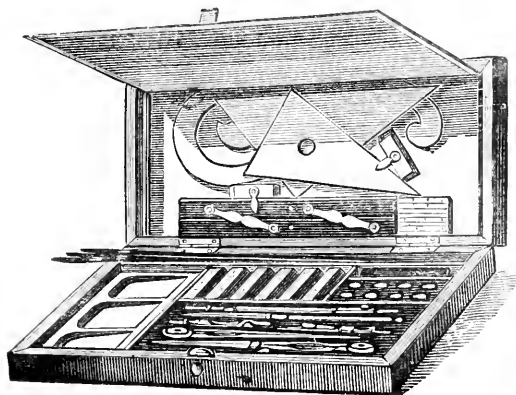
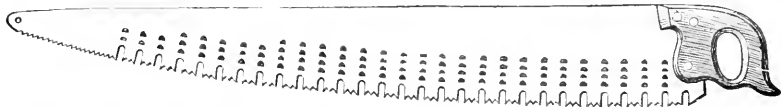
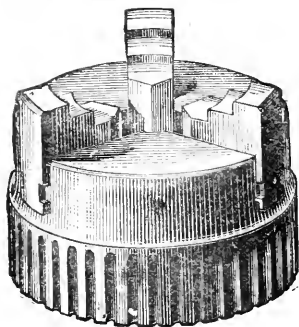
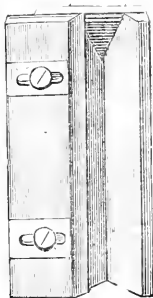

PRIZE MEDAL
FOR EXCELLENCE OF
**MACHINES
AND TOOLS,**
CITY GUILDS' TECHNICAL
INSTITUTE,
Health Exhibition, 1884.

GOLD MEDAL
Awarded 1890.

RD. MELHUIH & SONS,

FETTER LANE,
Holborn Circus,
LONDON.

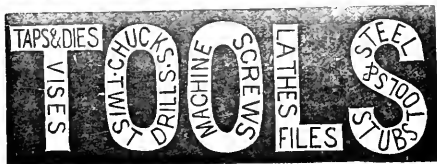

THE "STOTT" GOVERNOR.

WHAT IS IT?

THE "STOTT" GOVERNOR IS A SELF-ACTING GAS TAP fixed to the meter or service pipe. It closes with every INCREASE, and opens with every DECREASE of pressure from the street mains.

If you shut off a part of your jets, the "STOTT" shuts off so much of the gas at the meter, and thus prevents it being wasted at the remaining burners.

If you turn on more lights, the "STOTT" turns on more gas at the meter, and always gives a good light without FLARING or HISSING at the burners.

The "STOTT"
Governor SAVES
from 10 to
40 per cent.

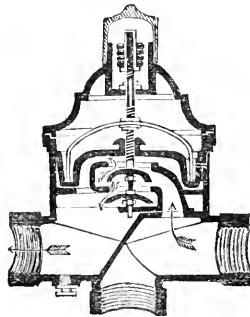

OVER
50 MEDALS
have been
Awarded the
"Stott" Governor
since 1879.

THE "STOTT" GOVERNOR has been adopted by the British and Foreign Governments, and by the principal Railway Companies in the world.

If you wish to know the cause of heavy gas bills, and how to avoid them, apply to

- J. STOTT & Co., Vernon Works, Oldham, and**
- Do. 22, Market Street, Manchester.
 - Do. 174, Fleet Street, London.
 - Do. 34, Queen Victoria Street, London.
 - Do. 36, Boar Lane, Leeds.
 - Do. 83, Dale Street, Liverpool.
 - Do. 127, New Street, Birmingham.
 - Do. 48, Lower Sackville Street, Dublin.
 - Do. North Pier, Blackpool, &c.

THE
“STOTT-THORP”
PATENT
REFLEX LIGHT,

FOR USE IN
SHOPS, SCHOOLS, CHURCHES, THEATRES, WORKS,
AND WAREHOUSES.

CHEAP

SIMPLE

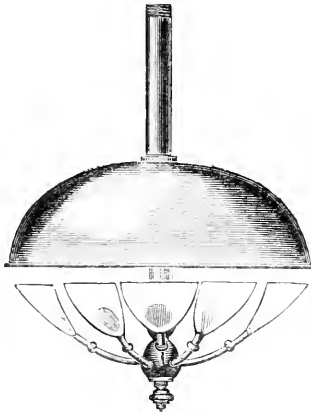

BRILLIANT

EFFECTIVE

NO SHADOW! NO TROUBLE!

In fact there is no drawback whatever with this system.

THE “STOTT-THORP”
GIVES BETTER RESULTS THAN ORDINARY STARLIGHTS,
With One-half the consumption of Gas.

DOLLOND

HEAD OFFICE—
1, LUDGATE HILL,
BRANCH—
62, OLD BROAD STREET,
LONDON.

OPTICIAN

TO THE ADMIRALTY, THE TRINITY HOUSE, THE CROWN
AGENTS FOR THE COLONIES, &c.

ESTABLISHED 1750.

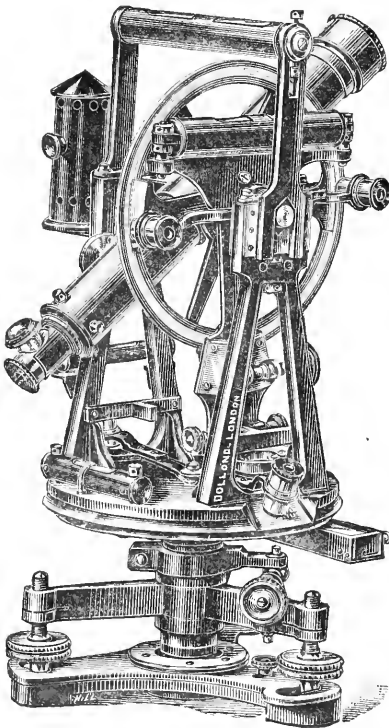

MAKER OF THE
**IMPROVED
Y-LEVEL.**

Acknowledged to be the most
perfect Level for work requiring
great accuracy.

THEODOLITES
AND
TRANSIT INSTRUMENTS
OF HIGHEST QUALITY.

Mathematical
Instruments,
Binocular Field Glasses.

SHIPPERS SUPPLIED ON
SPECIAL TERMS.

SEND FOR CATALOGUES.

THE "SHAW"

PATENT SELF-ACTING GAS GOVERNOR FOR CONSUMERS.

HAS NO EQUAL
FOR SIMPLICITY,
EFFICIENCY,
and DURABILITY.

GOLD MEDAL, SALTAIRE,
1887.

GOLD MEDAL, COLOGNE,
1889.

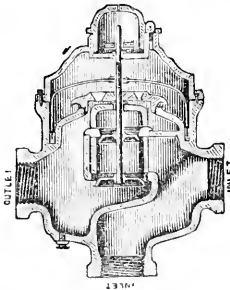

As supplied
to Her Majesty's
Government.

GOLD MEDAL, YORK,
1889.

THE "JAMES WATT"
SILVER MEDAL, 1889.

THE ONLY "JAMES WATT"
SILVER MEDAL EVER AWARDED TO A GAS GOVERNOR.

The "Shaw" Reduces Gas Bills from 10 to 40%,
with a better light.

THOMAS NEWBIGGING, Esq., M. Inst. C.E., says, "The 'Shaw' performs the functions of a Governor with certainty and constancy. I pronounce it to be a satisfactory and trustworthy instrument in every respect."

For full particulars apply

JOSEPH SHAW,

ALBERT WORKS, HUDDERSFIELD.

LONDON: 115 & 117, CANNON STREET.

MANCHESTER: 5, EXCHANGE ARCADE.

Depôts: Liverpool, Birmingham, Glasgow, Dublin, &c.

'Practical Hints on Gas Consumption,' a 72-page Pamphlet, showing how to consume Gas to obtain the best results, post-free, Twopence.

ELECTRICAL SUPPLIES
 FOR
 ENGINEERS AND CONTRACTORS.
APPLETON, BURBEY,
 AND

ELECTRIC LIGHTING.

CATALOGUE FREE.

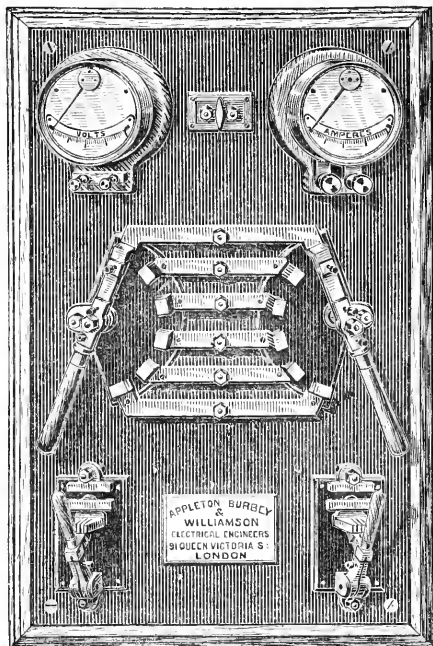

CATALOGUE FREE.

ELECTRIC BELLS.

WILLIAMSON,
 ELECTRICAL ENGINEERS AND MANUFACTURERS,
 91, **QUEEN VICTORIA STREET, E.C.**

WORKS:—HATTON GARDEN, E.C.

Lewis's Mechanical and Electrical Engineering Works,

37, NEW OXFORD ST., LONDON, W.C.

(OPPOSITE MUDIE'S LIBRARY).



ALL KINDS OF SPECIALITIES MADE FOR
CIVIL ENGINEERS, BUILDERS, ARCHITECTS,
PATENTEES, INVENTORS, & AMATEURS.

ESTABLISHED 1846.

All kinds of Machinery for Trade made and improved for
producing the various Articles of Trade.

Plain and Ornamental Lathes Fitted with Hardened Steel Collars and
Mandrills, Slide Rests, Chucks, Tools, &c., &c.

GENERAL REPAIRS DONE FOR THE TRADE.

A very superior Testing Pump kept in stock, will test over
500 lb. per square inch, very compact, all within
7 inches square, from £3 15s.

37, NEW OXFORD STREET, LONDON, W.C.

Electric Bells from 2s. 6d. each, upwards.

Invalid's Bell, set complete, from 12s. 6d.

Bell sets, complete from 8s. 6d. ; wire, 25 yds., 1s. ; 50 yds., 1s. 9d. ; 100 yds., 3s.

Pushes, from 6d. each ; Burglar Alarms, from 1s. each.

No. 2, Leclanché Cells, 2s. each, complete.

Zincs, Porous Cells, &c.

Shoiking Coils, complete, from 3s. 6d.

Small Motors, complete, from 4s. 6d.

Dynamo, from 16s., upwards.

Medical Coils, from 15s.

37, NEW OXFORD STREET, LONDON, W.C.

PICTURE FRAME MAKING.

INSTRUCTION BOOK.

4TH EDITION.

Illustrated with 150 Diagrams, Designs, Patterns, &c. Containing instructions in Cutting, Mitreing, Joining, Fitting, Mount Cutting, and every particular connected with Frame Making and Fitting.

INCLUDING PATTERN BOOK OF MOULDINGS OF ALL KINDS, WITH PRICES.

Also Prices of Ornamental Corners.

Best Gold Corners, Mounting Boards, Cut Mounts, Oval Frames, Oak Oxford Frames,

And everything connected with Picture Framing.

Sent Post-free, 6½d. in Stamps.

Plane.
Saw.
Vice.
2 Blocks.
24-in. Rule.
Hammer.
Pincers.
Chisel.
Oilstone.
Gluepot.
3 Bradawls.

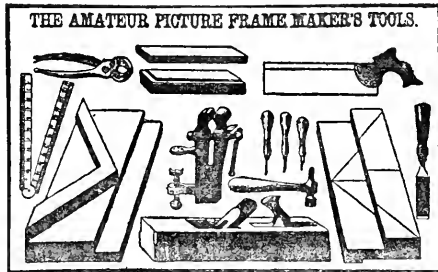

3 lbs.
assorted
Brads.
Instruction
Book.
The Set
Packed in
Strong Box.
Sent on
receipt of
2ls.

GEO. REES' MOULDINGS.

MOULDINGS FOR PICTURE FRAMES.

MOULDINGS FOR DECORATION.

MOULDINGS FOR PANELLING.

MOULDINGS FOR CABINETS.

MOULDINGS FOR ALL PURPOSES.'

ENGRAVINGS.

ETCHINGS.

SPORTS.

G. REES,

115, STRAND.

(CORNER OF SAVOY STREET)
CHEAPEST HOUSE IN LONDON.

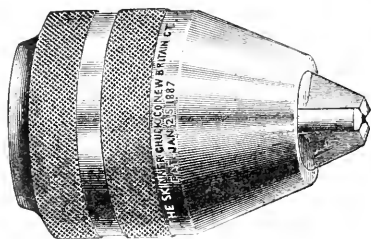

THE SKINNER DRILL CHUCK.

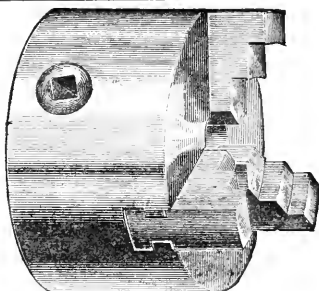

AMATEUR'S GEARED SCROLL CHUCK.

LEE'S ILLUSTRATED CATALOGUE OF SELECTED AMERICAN TOOLS & MACHINERY.

Lathes, Chucks, Slide-rests, Lathe Dogs, Polishing Lathes, Drilling Machines, Drills, Parallel and Instantaneous Grip Vices, Screw Stocks, Taps and Dies, Saws, Wrenches, &c., &c., specially selected from the best American Manufacturers, therefore of the very highest quality, and at low prices.

Send for Illustrated Catalogue, 150 Illustrations, price 6d., post-free.

R. A. LEE,

76, 77, 78a, HIGH HOLBORN, LONDON, W.C.

Please state whether American Tool, or Model Steam Engine Catalogue is required, when ordering.

ENGINE CASTINGS. — LEE'S WORLD-FAMED BRASS CASTINGS, with his improved "Tenon," or Chuck Pieces, on all parts requiring to be turned, are supplying a want long felt; being easily turned even by the most unskilled amateur.

TO AMATEURS.—R. A. LEE is now supplying all his best sets of HORIZONTAL ENGINE CASTINGS from 1-in. bore, with the Steam and Exhaust Ports accurately cast in the Cylinders, free of charge, thus saving an immense amount of work in fitting up and insuring accuracy in one of the most important parts of the Engine.

Thousands of Sets of these Castings have been made into working Engines by amateur mechanics.

GREAT REDUCTION in the Price of CASTINGS.—Complete Sets for Horizontal Slide-valve Engine, $\frac{1}{2}$ -in. bore, 1-in. stroke, 1s. 6d., post-free, 1s. 9d.; $\frac{3}{4}$ -in. bore, 1 $\frac{1}{2}$ -in. stroke, 2s. 3d., post-free, 2s. 9d.; 1-in. bore, 2-in. stroke, 4s., post-free, 4s. 6d.; 1 $\frac{1}{2}$ -in. bore, 2 $\frac{1}{2}$ -in. stroke, 8s. 9d., post-free, 9s. 9d., by Parcels Post. All sizes up to 6-in. stroke at equally low prices. Each Casting has Lee's improved "Tenon," without which model castings are practically useless.

MODEL STEAM ENGINES of every description, from the smallest to powerful Engines.

LEE'S ILLUSTRATED CATALOGUE,

New and Revised, Prices greatly Reduced.

To Amateurs the most useful book extant, and largest and best Catalogue in the Trade, 64 pages, 110 Illustrations, price 6d. post-free.

Please mention this Book when writing.

ONLY ADDRESS,

76, 77, & 78a, HIGH HOLBORN, LONDON, W.C.

Gateway entrance directly opposite the Inns of Court Hotel.

AWARDED PRIZE MEDAL, INTERNATIONAL INVENTIONS EXHIBITION, 1885.

TO INVENTORS.

PRIVATE WORKSHOP,

WITH ENGINE, DYNAMOS, LATHES, AND EVERY
REQUISITE FOR WORKING OUT ELECTRICAL
OR MECHANICAL INVENTIONS.

Use of the above can be had on very moderate terms
per day or longer period.

ELECTRICAL GOODS OF EVERY DESCRIPTION
BOUGHT FOR CASH.

A LARGE SELECTION ALWAYS IN STOCK
AT VERY LOW PRICES.

J. W. KING,

13, St. John's Square, Clerkenwell,

LONDON, E.C.

USEFUL BOOKS.

BOAT BUILDING FOR AMATEURS, PRACTICAL. Containing Full Instructions for Designing and Building Punts, Skiffs, Canoes, Sailing Boats, &c. Fully Illustrated with Working Diagrams. By ADRIAN NEISON, C.E. Second Edition, Revised and Enlarged by DIXON KEMP, Author of 'Yacht Designing,' 'A Manual of Yacht and Boat Sailing,' &c. In cloth gilt, price 2s. 6d.

BOOKBINDING FOR AMATEURS: Being Descriptions of the various Tools and Appliances required, and Minute Instructions for their Effective Use. By W. J. E. CRANE. Illustrated with 156 Engravings. In cloth gilt, price 2s. 6d.

FIREWORK-MAKING FOR AMATEURS. A complete, accurate, and easily-understood work on Making Simple and High-class Fireworks. By Dr. W. H. BROWNE, M.A. Price 2s. 6d.

MODEL YACHTS AND BOATS: Their Designing, Making, and Sailing. Illustrated with 118 Designs and Working Diagrams. By J. DU V. GROSVENOR. In leatherette, price 5s.

PIANOFORTES, TUNING AND REPAIRING. The Amateur's Guide to the Practical Management of a Piano without the intervention of a Professional. By CHARLES BABBINGTON. In paper, price 6d.

PAINTING, DECORATIVE. A Practical Handbook on Painting and Etching upon Textiles, Pottery, Porcelain, Paper, Vellum, Leather, Glass, Wood, Stone, Metals, and Plaster, for the Decoration of our Homes. By B. C. SAWARD. Price 5s.

PICTURE-FRAME MAKING FOR AMATEURS. Being Practical Instructions in the Making of various kinds of Frames for Paintings, Drawings, Photographs, and Engravings. Illustrated. By the Rev. J. LUKIN. Price 1s.

REPOUSSE' WORK FOR AMATEURS: Being the Art of Ornamenting Thin Metal with Raised Figures. By L. L. HASLOPE. Illustrated. In cloth gilt, price 2s. 6d.

SHEET METAL, WORKING IN: Being Practical Instructions for Making and Mending Small Articles in Tin, Copper, Iron, Zinc, and Brass. Illustrated. Third Edition. By the Rev. J. LUKIN, B.A. Price 6d.

TAXIDERMY, PRACTICAL. A Manual of Instruction to the Amateur in Collecting, Preserving, and Setting-up Natural History Specimens of all kinds. Fully illustrated with Examples and Working Diagrams. By MONTAGU BROWNE, F.Z.S. In cloth gilt, price 7s. 6d.

TURNING FOR AMATEURS: Being Descriptions of the Lathe and its Attachments and Tools, with Minute Instructions for their Effective Use on Wood, Metal, Ivory, and other materials. By JAMES LUKIN, B.A. Illustrated with 144 Engravings. In cloth gilt, price 2s. 6d.

WOOD CARVING FOR AMATEURS. Containing Descriptions of all the requisite Tools, and Full Instructions for their Use in producing different varieties of Carvings. Illustrated. Price 1s.

All books sent carriage free.

L. UPCOTT GILL, 170, Strand, London, W.C.

Dogs
 Ferrets
 Guns
 Birds
 Curios
 Furniture
 Provisions
 Tricycles
 Dress
 Cameras
 Cattle
 Pictures
 Plants
 Jewellery
 Plate
 Books
 Tools
 Poultry
 Pets
 Bicycles

&c., &c.

EASILY
BOUGHT, SOLD,
 or EXCHANGED
 THROUGH
The Bazaar,
Exchange and Mart.

Articles on Carpentry, Turning, Gilding, Designing, Dog Management, Sport, or other subjects of interest to gentlemen, are given in every issue.

"That excellent but seductive journal."—
Saturday Review.

PRICE 2d., OF ALL NEWSAGENTS.

Office: 170, STRAND, LONDON.

Estab. 1852. **PERKEN, SON & RAYMENT** Catalogue Free.

MANUFACTURE CAMERAS, LENSES, &c.

'OPTIMUS'

Trade **Photographic Apparatus of every description.** Mark.

"OPTIMUS" PHOTOGRAPHIC SETS,
With tripod and every necessary complete.

"OPTIMUS" MAGAZINE CAMERA.

Pictures $4\frac{1}{2}$ by $3\frac{1}{2}$ inches.

Rack
adjusting
Camera,
for Plates,
 $4\frac{1}{2}$ by $3\frac{1}{2}$,
£3 8s.



For Plates,
 $6\frac{1}{2}$ by $4\frac{1}{2}$,
£5 15s.
Plates,
 $8\frac{1}{2}$ by $6\frac{1}{2}$,
£9 10s.

Carries Twelve
Dry Plates,
—
No
Dark Slides.
Plates changed
by turning
a Button.

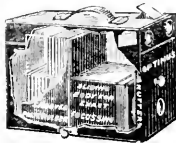

The most
convenient
yet invented,
—
Price, with
Rectilinear
Lens and
Shutter,
£6 6s.

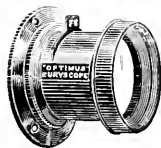

"OPTIMUS" EURYSCOPE.

"Working as it does with such a large aperture ($1/5$ approx.), it serves as a portrait and group lens, as well as a landscape and copying objective. There is no doubt of its proving a most useful lens."—J. TRAILL TAYLOR, *Brit. Journal of Photography*.

"We are pleased to find upon trial that the lens ('Optimus' Rapid Rectilinear) sent for review is really an EXCELLENT INSTRUMENT."—*Photographic News*.

"Optimus" Rapid Euryscope.
 5×4 63s. 7×5 94s. 6d. 8×5 110s. 9×7 129s. 10×8 220s.

"Optimus" Wide Angle Euryscope.
 5×4 63s. 7×5 94s. 6d. 9×7 129s. 10×8 220s.

"Optimus" Rapid Rectilinear.

5×4 33s. $6 \times 4\frac{1}{2}$ 45s. 7×5 49s. 6d. $8 \times 5\frac{1}{2}$ 64s. $9 \times 6\frac{1}{2}$ 82s. 6d. $10 \times 7\frac{1}{2}$ 127s. 6d. $11 \times 8\frac{1}{2}$ 142s. 6d. $12 \times 9\frac{1}{2}$ 180s. $13 \times 10\frac{1}{2}$ 220s.

"Optimus" Wide Angle Symmetrical.

5×4 32s. $6 \times 4\frac{1}{2}$ 52s. 6d. $8 \times 5\frac{1}{2}$ 82s. 6d. $10 \times 7\frac{1}{2}$ 127s. 6d. $12 \times 9\frac{1}{2}$ 142s. 6d. $13 \times 10\frac{1}{2}$ 180s. $14 \times 11\frac{1}{2}$ 220s.

"Optimus" Quick-Acting Portrait.

Diam. 2 inches. $2\frac{1}{2}$ inches. $3\frac{1}{2}$ inches. 3 inches.
Price 90s. 120s. 180s. 16s.
1 B 2 B 3 B

Rayment's Patent Camera (Long Focus).

Price includes 3 Double Dark Slides.

$4\frac{1}{2} \times 3\frac{1}{2}$ 120s. 5×4 120s. $6\frac{1}{2} \times 4\frac{1}{2}$ 145s. $8\frac{1}{2} \times 6\frac{1}{2}$ 168s. 10×8 212s. 12×10 258s. 15×12 314s.

"Optimus" Camera (Long Focus).

Price includes 3 Double Dark Slides.

$4\frac{1}{2} \times 3\frac{1}{2}$ 130s. 5×4 153s. $6\frac{1}{2} \times 4\frac{1}{2}$ 137s. $8\frac{1}{2} \times 6\frac{1}{2}$ 175s. 10×8 227s. 12×10 275s. 15×12 333s.

Portable (A.R.) Camera.

Compact, Rigid, and of Excellent Finish.

$4\frac{1}{2} \times 3\frac{1}{2}$ 102s. 5×4 104s. 9d. $6\frac{1}{2} \times 4\frac{1}{2}$ 118s. $8\frac{1}{2} \times 6\frac{1}{2}$ 146s. 3d. 10×8 174s. 6d. 12×10 216s. 15×12 274s. 6d.

"OPTIMUS" Wide Angle CAMERA (Long Focus).

Price includes 3 Dark Slides.

5×4 140s. $6\frac{1}{2} \times 4\frac{1}{2}$ 165s. $8\frac{1}{2} \times 6\frac{1}{2}$ 188s. 10×8 230s. 12×10 288s. 15×12 350s.

Price List, Post-free.

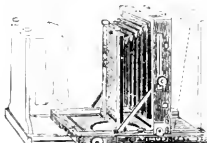

"I should strongly recommend Rayment's Camera. It is LIGHT, COMPACT, very RIGID, and extends to about double the usual focus."—*Amateur Photo.*

99, HATTON GARDEN, LONDON, E.C.

A. W. REID & CO.,

Sanitary Engineers,

Makers of Lavatories, Urinals, Baths, Plumbers' Brasswork, Sanitary Earthenware, Fireclay Sinks, Folding Lavatories for Steamships, &c.,

69, ST. MARY AXE, LONDON, E.C.

SOLE MANUFACTURERS OF

PEARSON'S PATENT TWIN-BASIN WATER CLOSET.

FOR
SIMPLICITY,
FOR
CLEANLINESS,



FOR
SECURITY
AGAINST
SEWER-GAS.

These Closets have been thoroughly tested by many years' use in Hospitals, Schools, Railway Stations, Hotels, Factories, Warehouses, Mansions, and Cottages, with the very best results. They have been tried and approved by the highest Sanitary Authorities, by Architects, and by the Medical Profession.

Below is an extract from one of the numerous Testimonials received:—

SURVEYOR'S OFFICE, GUY'S HOSPITAL, LONDON, 10th February, 1877.

"Taken altogether, I have seen nothing to equal the Pearson's Closet, or I should not have introduced them for use in the Hospital."

(Signed) ARTHUR BILLING,
Surveyor to the Hospital.

**PATENT FOLDING LAVATORIES,
HIGHLY RECOMMENDED WHERE SPACE IS OF IMPORTANCE,**

For
Consulting Rooms
and
Libraries.

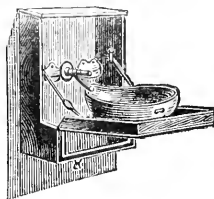

For
Smoking
and
Billiard Rooms.

SPONS' ENCYCLOPÆDIA

OF THE

INDUSTRIAL ARTS, MANUFACTURES, & COMMERCIAL PRODUCTS.

EDITED BY C. G. WARNFORD LOCK, F.L.S., &c., &c.

In Super-royal 8vo, containing 2100 pp., and Illustrated by nearly 1500 Engravings.

Can be had in the following bindings :— £ s. d.

In 2 vols., cloth 3 10 0

In 5 divisions, cloth 3 11 6

In 2 vols., half-morocco, top edge gilt, bound in a superior manner 4 10 0

In 33 monthly parts, at 2s. each.

Any Part can be had separate, price 2s., postage 2d.

COMPLETE LIST OF ALL THE SUBJECTS.

	Part		Part		Part
Acids	1, 2, 3	Dyestuffs	14	Narcotics	21, 22
Alcohol	3, 4	Electro-Metallurgy	14	Oils & Fatty Substances	22, 23, 24
Alkalies	4, 5	Explosives	14, 15	Paper	24
Alloys	5, 6	Feathers	15	Paraffin	24
Arsenic	6	Fibrous Substances	15, 16	Pearl and Coral	24
Asphalte	6	Floor-cloth	16	Perfumes	24
Aerated Waters	6	Food Preservation	16	Photography	24, 25
Beer and Wine	6, 7	Fruit	16, 17	Pigments and Paint	25
Beverages	7, 8	Fur	17	Pottery	25, 26
Bleaching Powder	8	Gas, Coal	17	Printing and Engraving	26
Bleaching	8, 9	Gems	17	Resinous and Gummy Substances	26, 27
Borax	9	Glass	17	Rope	27
Brushes	9	Graphite	18	Sadt	27, 28
Buttons	9	Hair Manufactures	18	Silk	28
Camphor	9, 10	Hats	18	Skins	28
Candles	10	Ice, Artificial	18	Soap, Railway Grease, and Glycerine	28, 29
Carbon	10	Indiarubber Manufactures	18, 19	Spices	29
Celluloid	10	Ink	19	Starch	29
Clays	10	Jute Manufactures	19	Sugar	29, 30, 31
Carbolic Acid	11	Knitted Fabrics (Hosiery)	19	Tannin	31, 32
Coal-tar Products	11	Lace	19	Tea	32
Cocoa	11	Leather	19, 20	Timber	32
Coffee	11, 12	Linen Manufactures	20	Varnish	32
Cork	12	Manures	20	Wooland Woollen Manufactures	32, 33
Cotton Manufactures	12, 13	Matches	20, 21		
Drugs	13	Mordants	21		
Dyeing and Calico Printing	13, 14				

E. & F. N. SPON, 125, Strand, London.
New York: 12, Cortlandt Street.

In 18 Parts, price 2s. each.

Bound in cloth, 3 Divisions, 13s. 6d. each.

Or, in One Vol., cloth, £2; half-morocco, £2 8s.

A SUPPLEMENT

TO

SPONS' DICTIONARY OF ENGINEERING, CIVIL, MECHANICAL, MILITARY, AND NAVAL.

EDITED BY ERNEST SPON, ASSOC. MEM. INST. C.E., MEM. SOC.
ENGINEERS, OF THE FRANKLIN INSTITUTE, AND OF
THE GEOLOGISTS' ASSOCIATION.

Any Part can be had separate, price 2s., postage 2d.

COMPLETE LIST OF ALL THE SUBJECTS.

	No.		No.		No.
Abacus	1	Coal Mining ..	6, 7	Lights, Buoys, and	
Agricultural Imple-		Coke Ovens ..	7	Beacons ..	13, 14
ments	1	Copper	7	Machine Tools ..	14
Air Compressors	1, 2	Docks	7, 8	Materials of Construc-	
Animal Charcoal Ma-		Drainage	8	tion, Strength of	14, 15
chinery	2	Dredging	8	Mercury	15
Antimony	2	Dynamo-Electric and		Meters	15
Axles and Axle-boxes	2	Magneto - Electric		Ores	15
Barn Machinery ..	2	Machines	8	Piers	15
Belts and Belting ..	2	Dynamometer ..	8, 9	Pile Driving	15
Blasting	3	Electrical Engineer-		Pneumatic Transmis-	
Boilers	3	ing	9, 10	sion	15
Brake	3	Engines, Varieties of	10	Pump	15
Brick-making Ma-		Explosives	10	Pyrometer	15
chines	3, 4	Fans	10	Road Locomotive	15, 16
Bridge	4, 5	Founding	10, 11	Rock Drill	16
Cages	5	Gas, Manufacture of	11	Rolling Stock	16, 17
Calculus	5	Hammers	11	Sanitary Engineering	
Canals	5	Heat	12		17, 18
Carpentry	5	Horse Power	12	Shafts and Shaft Fit-	
Cast Iron	5, 6	Hydraulics	12	tings	18
Cement, Concrete,		Hydro-geology ..	12	Steel	18
Limes, and Mortar	6	Indicator	12, 13	Stone-working Ma-	
Chimney Shafts ..	6	Iron	13	chinery	18
Coal Cleansing and		Lifts, Hoists, and		Tramways	18
Washing	6	Elevators	13	Well Sinking and	
				Boring	18

CENTRAL

**Patent & Trade-Mark Offices,
97, NEWGATE ST., LONDON.**

PROVISIONAL PROTECTION FROM £2 2s.

INVENTORS' OWN PROVISIONAL APPLICATIONS COMPLETED
FOR £6, INCLUDING DUTY AND DRAWINGS.

FOREIGN PATENTS ON EQUALLY MODERATE TERMS.

CIRCULAR, WITH PARTICULARS, FREE ON APPLICATION.

S. S. BROMHEAD,
CONSULTING ENGINEER, Mem. Society of Arts,
97, Newgate St., London.

20 YEARS' EXPERIENCE.

INVENTORS ASSISTED IN THE DISPOSAL
OF PATENTS.

J. BAKER & SONS,

58, CITY ROAD, LONDON, E.C.

Highest Awards ever given for Bread Machinery, Biscuit Machinery,
Chocolate and Confectionery Machinery, and Ovens.

15 GOLD MEDALS.

Highest Award, London, 1884;
Highest Award, Amsterdam, 1886;
Highest Award, Edinburgh, 1886;
Highest Award, Saltaire, 1887;
Highest Award, Adelaide, 1887;
Highest Award, Barcelona, 1888;
Highest Award, Melbourne, 1888-9;
Highest Award, Paris, 1889.

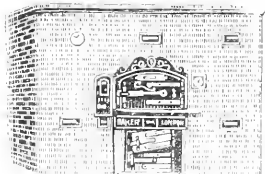

The Bailey Baker Ovens.
The Best Ovens in existence, clean,
smokeless, and economical; over,
1500 in use.



Melting Jam Pans.

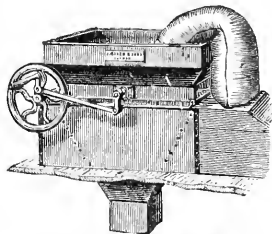

Patent Flour Sifting and Mixing
Machine.

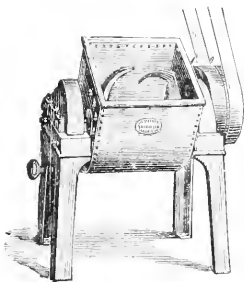

Hodgkinson Dough
Kneader.

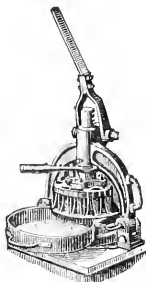

Patent Table
Dough Divider.

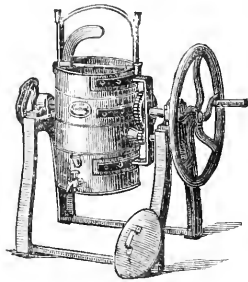

Arm Beater Cake Making
Machines.

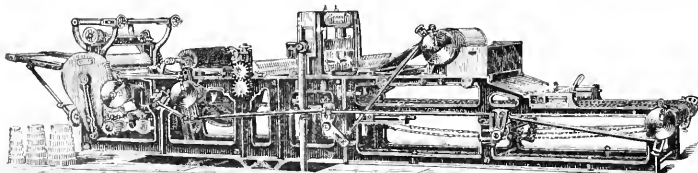

Latest Improved Patent Biscuit Cutting Machines.

[Copyright Illustrations.]

*Crown 8vo, cloth, with numerous illustrations, Price 5s. each ;
by post, 5s. 4d.*

WORKSHOP RECEIPTS,

FOR THE USE OF
MANUFACTURERS, MECHANICS, AND SCIENTIFIC AMATEURS.

FIRST SERIES.

CONTENTS: Bookbinding—Bronzes—Candles—Cement—Cleaning—Concretes—Dyeing—Electro-Metallurgy—Enamels—Engraving—Etching—Firework Making—Freezing—Fulminates—Furniture Creams, Oils, Polishes, Lacquers, and Pastes—Gilding—Glass Cutting—Glass Making—Graining—Gums—Horn Working—India-rubber—Ink—Japans—Lacquers—Marble Working—Matches—Mortars—Paper Hanging—Painting in Oils—Photography—Polishes—Pottery—Silvering—Soap—Solders—Taxidermy—Treating Horn, Mother-o'-Pearl, and like substances—Varnishes—Veneering—Whitewashing, &c., &c.

SECOND SERIES.

CONTENTS: Acidimetry and Alkalimetry—Albumen—Alcohol—Alkaloids—Baking-powders—Bitters—Bleaching—Boiler Incrustations—Cements and Lutes—Cleansing—Confectionery—Copying—Disinfectants—Dyeing—Staining and Colouring—Essences—Extracts—Fireproofing—Gelatine, Glue, and Size—Glycerine—Gut—Hydrogen Peroxide—Ink—Iodine—Iodoform—Isinglass—Ivory Substitutes—Leather—Luminous Bodies—Magnesia—Matches—Paper—Parchment—Perchloric Acid—Pigments—Paint and Painting—Potassium Oxalate—Preserving.

THIRD SERIES.

CONTENTS: Alloys—Aluminium—Antimony—Barium—Beryllium—Bismuth—Cadmium—Cæsium—Calcium—Cerium—Chromium—Cobalt—Copper—Didymium—Electrics (including alarms, batteries, bells, carbons, coils [induction, intensity, and resistance], dynamo-electric machines, fire risks, measuring, microphones, motors, phonographs, photophones, storing, telephones)—Enamels and Glazes—Erbium—Gallium—Glass—Gold—Indium—Iridium—Iron—Lacquers—Lanthanum—Lead—Lithium—Lubricants—Magnesium—Manganese—Mercury—Mica—Molybdenum—Nickel—Nisbium—Osmium—Palladium—Platinum—Potassium—Rhodium—Rubidium—Ruthenium—Selenium—Silver—Slag—Sodium—Strontium—Tantalum—Terbium—Thallium—Thorium—Tin—Titanium—Tungsten—Uranium—Vanadium—Yttrium—Zinc—Zirconium.

FOURTH SERIES.

Waterproofing: rubber goods, cuprammonium processes, miscellaneous preparations—**Packing and Storing** articles of delicate odour or colour, of a deliquescent character, liable to ignition, apt to suffer from insects or damp, or easily broken—**Embalming and Preserving** anatomical specimens—**Leather Polishes—Cooling Air and Water**, producing low temperatures, making ice, cooling syrups and solutions, and separating salts from liquors by refrigeration—**Pumps and Siphons**, embracing every useful contrivance for raising and supplying water on a moderate scale, and moving corrosive, tenacious, and other liquids—**Desiccating:** air- and water-ovens, and other appliances for drying natural and artificial products—**Distilling:** water, tinctures, extracts, pharmaceutical preparations, essences, perfumes, and alcoholic liquids—**Emulsifying** as required by pharmacists and photographers—**Evaporating:** saline and other solutions, and liquids demanding special precautions—**Filtering:** water, and solutions of various kinds—**Percolating and Macerating—Electrotyping—Stereotyping** by both plaster and paper processes—**Bookbinding** in all its details—**Straw Plaiting** and the fabrication of baskets, matting, &c.—**Musical Instruments:** the preservation, tuning, and repair of pianos, harmoniums, musical boxes, &c.—**Clock and Watch Mending:** adapted for intelligent amateurs—**Photography:** recent development in rapid processes, handy apparatus, numerous recipes for sensitizing and developing solutions, and applications to modern illustrative purposes.

E. & F. N. SPON, 125, Strand, London.

New York: 12, Cortlandt Street.

BULL'S METAL.

This Alloy is a malleable Brass possessing very valuable characteristics. It can be easily rolled, forged or otherwise wrought at a red heat, when it acquires an elastic limit and tensile strength higher than those of Boiler Plate Steel. It has also within a considerable range the advantage of perfect elasticity similar to good steel, a quality almost unique in Copper Alloys.

The chief applications of Bull's Metal forgings are—Stern Shafts, Pump Rods, Rams, Bolts and Nuts, Valves and Valve Spindles.

Its uniformity combined with the leading characteristics referred to, render the Alloy suitable for most purposes in which great strength and resistance to strain and corrosion are desiderata.

SUPPLIED BY

THE PHOSPHOR BRONZE CO.,

LIMITED,

**87, SUMNER STREET, SOUTHWARK,
LONDON, S.E.**

Under arrangement with the Sole Licensees for the
United Kingdom, and the Inventor.

Culinary Flavouring Essences and Fruit Syrups.

PUREST! CHEAPEST!! BEST!!!

FOR ICES, CONFECTIONERY, MINERAL WATER TRADES, &c.

E. F. LANGDALE,

Essence, Essential Oil, & Perfume Distiller,

LANGDALE, Holborn Hill, 1775.



The Burning of Langdale's Distillery on Holborn Hill; by the Lord Gordon Rioters in 1780, of which an interesting account will be found in Charles Dickens' "Barnaby Rudge."—Chaps. 62 & 63.

"PRIZE MEDAL" ESSENCES

DISTILLED FROM

HERBS, FRUITS, & SPICES,

GATHERED IN THEIR BLOOM
AND FRESHNESS.

For Flavouring Spirits, Custards, Wines,

Jellies, Ices, and for all Culinary

Purposes.

Distillery, 72 & 73, HATTON GARDEN, LONDON, E.C.

PRIZE MEDAL Essence of Vanilla,
Lemon, Orange, Pine-Apple, Raspberry,
Celery, Cloves, &c.

PRIZE MEDAL Essence of Bitter
Almonds, Ratafia, Noyau, Peach Kernels,
&c., purified free from Prussic Acid by
Langdale's process.

Every description of Essence, Essential Oils,

Vanillas, always in stock.

TRADE MARK.

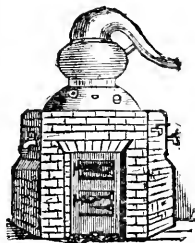

LANGDALE, 1775.

JUST PUBLISHED.

In demy 8vo, cloth, 600 pages, and 1420 Illustrations, 6s.

SPONS'
MECHANICS' OWN BOOK;
A MANUAL FOR HANDICRAFTSMEN AND AMATEURS.

CONTENTS.

Mechanical Drawing—Casting and Founding in Iron, Brass, Bronze, and other Alloys—Forging and Finishing Iron—Sheetmetal Working—Soldering, Brazing, and Burning—Carpentry and Joinery, embracing descriptions of some 400 Woods, over 200 Illustrations of Tools and their uses, Explanations (with Diagrams) of 116 joints and hinges, and Details of Construction of Workshop appliances, rough furniture, Garden and Yard Erections, and House Building—Cabinet Making and Veneering—Carving and Precutting—Upholstery—Painting, Graining, and Marbling—Staining Furniture, Woods, Floors, and Fittings—Gilding, dead and bright, on various grounds—Polishing Marble, Metals, and Wood—Varnishing—Mechanical Movements, illustrating contrivances for transmitting motion—Turning in Wood and Metals—Masonry, embracing Stonework, Brickwork, Terracotta, and Concrete—Roofing with Thatch, Tiles, Slates, Felt, Zinc, &c—Glazing with and without putty, and lead glazing—Plastering and Whitewashing—Paper-hanging—Gas-fitting—Bell-hanging, ordinary and electric Systems—Lighting—Warming—Ventilating—Roads, Pavements, and Bridges—Hedges, Ditches, and Drains—Water Supply and Sanitation—Hints on House Construction suited to new countries.

E. & F. N. SPON, 125, Strand, London.

New York: 12, Cortlandt Street.

BOOKS RELATING

TO

APPLIED SCIENCE

PUBLISHED BY

E. & F. N. SPON,

LONDON: 125, STRAND.

NEW YORK: 12, CORTLANDT STREET.

The Engineers' Sketch-Book of Mechanical Movements, Devices, Appliances, Contrivances, Details employed in the Design and Construction of Machinery for every purpose. Collected from numerous Sources and from Actual Work. Classified and Arranged for Reference. *Nearly 2000 Illustrations.* By T. B. BARBER, Engineer. Second Edition, 8vo, cloth, 7s. 6d.

A Pocket-Book for Chemists, Chemical Manufacturers, Metallurgists, Dyers, Distillers, Brewers, Sugar Refiners, Photographers, Students, etc., etc. By THOMAS BAYLEY, Assoc. R.C. Sc. Ireland, Analytical and Consulting Chemist and Assayer. Fifth edition, 481 pp., royal 32mo, roan, gilt edges, 5s.

SYNOPSIS OF CONTENTS:

Atomic Weights and Factors—Useful Data—Chemical Calculations—Rules for Indirect Analysis—Weights and Measures—Thermometers and Barometers—Chemical Physics—Boiling Points, etc.—Solubility of Substances—Methods of Obtaining Specific Gravity—Conversion of Hydrometers—Strength of Solutions by Specific Gravity—Analysis—Gas Analysis—Water Analysis—Qualitative Analysis and Reactions—Volumetric Analysis—Manipulation—Mineralogy—Assaying—Alcohol—Beer—Sugar—Miscellaneous Technological matter relating to Potash, Soda, Sulphuric Acid, Chlorine, Tar Products, Petroleum, Milk, Tallow, Photography, Prices, Wages, Appendix, etc., etc.

The Mechanician: A Treatise on the Construction and Manipulation of Tools, for the use and instruction of Young Engineers and Scientific Amateurs, comprising the Arts of Blacksmithing and Forging; the Construction and Manufacture of Hand Tools, and the various Methods of Using and Grinding them; description of Hand and Machine Processes; Turning and Screw Cutting. By CAMERON KNIGHT, Engineer. *Containing 1147 illustrations, and 397 pages of letter-press.* Fourth edition, 4to, cloth, 18s.

Just Published, in Demy 8vo, cloth, containing 975 pages and 250 Illustrations, price 7s. 6d.

SPONS' HOUSEHOLD MANUAL:

A Treasury of Domestic Receipts and Guide for Home Management.

PRINCIPAL CONTENTS.

Hints for selecting a good House, pointing out the essential requirements for a good house as to the Site, Soil, Trees, Aspect, Construction, and General Arrangement; with instructions for Reducing Echoes, Waterproofing Damp Walls, Curing Damp Cellars.

Sanitation.—What should constitute a good Sanitary Arrangement; Examples (with Illustrations) of Well- and Ill-drained Houses; How to Test Drains; Ventilating Pipes, etc.

Water Supply.—Care of Cisterns; Sources of Supply; Pipes; Pumps; Purification and Filtration of Water.

Ventilation and Warming.—Methods of Ventilating without causing cold draughts, by various means; Principles of Warming; Health Questions; Combustion; Open Grates; Open Stoves; Fuel Economisers; Varieties of Grates; Close-Fire Stoves; Hot-air Furnaces; Gas Heating; Oil Stoves; Steam Heating; Chemical Heaters; Management of Flues; and Cure of Smoky Chimneys.

Lighting.—The best methods of Lighting; Candles, Oil Lamps, Gas, Incandescent Gas, Electric Light; How to test Gas Pipes; Management of Gas.

Furniture and Decoration.—Hints on the Selection of Furniture; on the most approved methods of Modern Decoration; on the best methods of arranging Bells and Calls; How to Construct an Electric Bell.

Thieves and Fire.—Precautions against Thieves and Fire; Methods of Detection; Domestic Fire Escapes; Fireproofing Clothes, etc.

The Larder.—Keeping Food fresh for a limited time; Storing Food without change, such as Fruits, Vegetables, Eggs, Honey, etc.

Curing Foods for lengthened Preservation, as Smoking, Salting, Canning, Potting, Pickling, Bottling Fruits, etc.; Jams, Jellies, Marmalade, etc.

The Dairy.—The Building and Fitting of Dairies in the most approved modern style; Butter-making; Cheesemaking and Curing.

The Cellar.—Building and Fitting; Cleaning Casks and Bottles; Corks and Corking; Aërated Drinks; Syrups for Drinks; Beers; Bitters; Cordials and Liqueurs; Wines; Miscellaneous Drinks.

The Pantry.—Bread-making; Ovens and Pyrometers; Yeast; German Yeast; Biscuits; Cakes; Fancy Breads; Buns.

The Kitchen.—On Fitting Kitchens; a description of the best Cooking Ranges, close and open; the Management and Care of Hot Plates, Baking Ovens, Dampers, Flues, and Chimneys; Cooking by Gas; Cooking by Oil; the Arts of Roasting, Grilling, Boiling, Stewing, Braising, Frying.

Receipts for Dishes—Soups, Fish, Meat, Game, Poultry, Vegetables, Salads, Puddings, Pastry, Confectionery, Ices, etc., etc.; Foreign Dishes.

The Housewife's Room.—Testing Air, Water, and Foods; Cleaning and Renovating; Destroying Vermin.

Housekeeping, Marketing.

The Dining-Room.—Dietetics; Laying and Waiting at Table; Carving; Dinners, Breakfasts, Luncheons, Teas, Suppers, etc.

The Drawing-Room.—Etiquette; Dancing; Amateur Theatricals; Tricks and Illusions; Games (indoor).

The Bedroom and Dressing-Room; Sleep; the Toilet; Dress; Buying Clothes; Outfits; Fancy Dress.

The Nursery.—The Room; Clothing; Washing; Exercise; Sleep; Feeding; Teething; Illness; Home Training.

The Sick-Room.—The Room; the Nurse; the Bed; Sick Room Accessories; Feeding Patients; Invalid Dishes and Drinks; Administering Physic; Domestic Remedies; Accidents and Emergencies; Bandaging; Burns; Carrying Injured Persons; Wounds; Drowning; Fits; Frost-bites; Poisons and Antidotes; Sunstroke; Common Complaints; Disinfection, etc.

The Bath-Room.—Bathing in General; Management of Hot-Water System.

The Laundry.—Small Domestic Washing Machines, and methods of getting up linen fitting up and Working a Steam Laundry.

The School-Room.—The Room and its Fittings; Teaching, etc.

The Playground.—Air and Exercise; Training; Outdoor Games and Sports.

The Workroom.—Darning, Patching, and Mending Garments.

The Library.—Care of Books.

The Garden.—Calendar of Operations for Lawn, Flower Garden, and Kitchen Garden.

The Farmyard.—Management of the Horse, Cow, Pig, Poultry, Bees, etc., etc.

Small Motors.—A description of the various small Engines useful for domestic purposes, from 1 man to 1 horse power, worked by various methods, such as Electric Engines, Gas Engines, Petroleum Engines, Steam Engines, Condensing Engines, Water Power, Wind Power, and the various methods of working and managing them.

Household Law.—The Law relating to Landlords and Tenants, Lodgers, Servants, Parochial Authorities, Juries, Insurance, Nuisance, etc.

On Designing Belt Gearing. By E. J. COWLING WELCH, Mem. Inst. Mech. Engineers, Author of 'Designing Valve Gearing.' Fcap. 8vo, sewed, 6d.

A Handbook of Formulae, Tables, and Memoranda, for Architectural Surveyors and others engaged in Building. By J. T. HURST, C.E. Fourteenth edition, royal 32mo, roan, 5s.

"It is no disparagement to the many excellent publications we refer to, to say that in our opinion this little pocket-book of Hurst's is the very best of them all, without any exception. It would be useless to attempt a recapitulation of the contents, for it appears to contain almost everything that anyone connected with building could require, and, best of all, made up in a compact form for carrying in the pocket, measuring only 5 in. by 3 in., and about $\frac{3}{4}$ in. thick, in a limp cover. We congratulate the author on the success of his laborious and practically compiled little book, which has received unqualified and deserved praise from every professional person to whom we have shown it."—*The Dublin Builder*.

Tabulated Weights of Angle, Tee, Bulb, Round, Square, and Flat Iron and Steel, and other information for the use of Naval Architects and Shipbuilders. By C. H. JORDAN, M.I.N.A. Fourth edition, 32mo, cloth, 2s. 6d.

A Complete Set of Contract Documents for a Country Lodge, comprising Drawings, Specifications, Dimensions (for quantities), Abstracts, Bill of Quantities, Form of Tender and Contract, with Notes by J. LEANING, printed in facsimile of the original documents, on single sheets fcap., in paper case, 10s.

A Practical Treatise on Heat, as applied to the Useful Arts; for the Use of Engineers, Architects, &c. By THOMAS BOX. With 14 plates. Sixth edition, crown 8vo, cloth, 12s. 6d.

A Descriptive Treatise on Mathematical Drawing Instruments: their construction, uses, qualities, selection, preservation, and suggestions for improvements, with hints upon Drawing and Colouring. By W. F. STANLEY, M.R.I. Sixth edition, with numerous illustrations, crown 8vo, cloth, 5s.

Quantity Surveying. By J. LEANING. With 42 illustrations. Second edition, revised, crown 8vo, cloth, 9s.

CONTENTS :

<p>A complete Explanation of the London Practice. General Instructions. Order of Taking Off. Modes of Measurement of the various Trades. Use and Waste. Ventilation and Warming. Credits, with various Examples of Treatment. Abbreviations. Squaring the Dimensions. Abstracting, with Examples in illustration of each Trade. Billing. Examples of Preambles to each Trade. Form for a Bill of Quantities. Do. Bill of Credits. Do. Bill for Alternative Estimate. Restorations and Repairs, and Form of Bill. Variations before Acceptance of Tender. Errors in a Builder's Estimate.</p>	<p>Schedule of Prices. Form of Schedule of Prices. Analysis of Schedule of Prices. Adjustment of Accounts. Form of a Bill of Variations. Remarks on Specifications. Prices and Valuation of Work, with Examples and Remarks upon each Trade. The Law as it affects Quantity Surveyors, with Law Reports. Taking Off after the Old Method, Northern Practice. The General Statement of the Methods recommended by the Manchester Society of Architects for taking Quantities. Examples of Collections. Examples of "Taking Off" in each Trade. Remarks on the Past and Present Methods of Estimating.</p>
---	--

Spons' Architects' and Builders' Price Book, with useful Memoranda. Edited by W. YOUNG, Architect. Crown 8vo, cloth, red edges, 3s. 6d. Published annually. Nineteenth edition. Now ready.

Long-Span Railway Bridges, comprising Investigations of the Comparative Theoretical and Practical Advantages of the various adopted or proposed Type Systems of Construction, with numerous Formulæ and Tables giving the weight of Iron or Steel required in Bridges from 300 feet to the limiting Spans; to which are added similar Investigations and Tables relating to Short-span Railway Bridges. Second and revised edition. By B. BAKER, Assoc. Inst. C.E. Plates, crown 8vo, cloth, 5s.

Elementary Theory and Calculation of Iron Bridges and Roofs. By AUGUST RITTER, Ph.D., Professor at the Polytechnic School at Aix-la-Chapelle. Translated from the third German edition, by H. R. SANKEY, Capt. R.E. With 500 illustrations, 8vo, cloth, 15s.

The Elementary Principles of Carpentry. By THOMAS TREGOLD. Revised from the original edition, and partly re-written, by JOHN THOMAS HURST. Contained in 517 pages of letter-press, and illustrated with 48 plates and 150 wood engravings. Sixth edition, reprinted from the third, crown 8vo, cloth, 12s. 6d.

Section I. On the Equality and Distribution of Forces—Section II. Resistance of Timber—Section III. Construction of Floors—Section IV. Construction of Roofs—Section V. Construction of Domes and Cupolas—Section VI. Construction of Partitions—Section VII. Scaffolds, Staging, and Gantries—Section VIII. Construction of Centres for Bridges—Section IX. Coffier-dams, Shoring, and Strutting—Section X. Wooden Bridges and Viaducts—Section XI. Joints, Straps, and other Fastenings—Section XII. Timber.

The Builder's Clerk: a Guide to the Management of a Builder's Business. By THOMAS BALES. Fcap. 8vo, cloth, 1s. 6d.

Practical Gold-Mining: a Comprehensive Treatise on the Origin and Occurrence of Gold-bearing Gravels, Rocks and Ores, and the methods by which the Gold is extracted. By C. G. WARNFORD LOCK, co-Author of 'Gold: its Occurrence and Extraction.' *With 8 plates and 275 engravings in the text, royal 8vo, cloth, 2l. 2s.*

Hot Water Supply: A Practical Treatise upon the Fitting of Circulating Apparatus in connection with Kitchen Range and other Boilers, to supply Hot Water for Domestic and General Purposes. With a Chapter upon Estimating. *Fully illustrated, crown 8vo, cloth, 3s.*

Hot Water Apparatus: An Elementary Guide for the Fitting and Fixing of Boilers and Apparatus for the Circulation of Hot Water for Heating and for Domestic Supply, and containing a Chapter upon Boilers and Fittings for Steam Cooking. *32 illustrations, fcap. 8vo, cloth, 1s. 6d.*

The Use and Misuse, and the Proper and Improper Fixing of a Cooking Range. *Illustrated, fcap. 8vo, sewed, 6d.*

Iron Roofs: Examples of Design, Description. Illustrated with 64 Working Drawings of Executed Roofs. By ARTHUR T. WALMISLEY, Assoc. Mem. Inst. C.E. Second edition, revised, imp. 4to, half-morocco, 3l. 3s.

A History of Electric Telegraphy, to the Year 1837. Chiefly compiled from Original Sources, and hitherto Unpublished Documents, by J. J. FAHIE, Mem. Soc. of Tel. Engineers, and of the International Society of Electricians, Paris. *Crown 8vo, cloth, 9s.*

Spons' Information for Colonial Engineers. Edited by J. T. HURST. *Demy 8vo, sewed.*

No. 1, Ceylon. By ABRAHAM DEANE, C.E. *2s. 6d.*

CONTENTS:

Introductory Remarks—Natural Productions—Architecture and Engineering—Topography, Trade, and Natural History—Principal Stations—Weights and Measures, etc., etc.

No. 2. Southern Africa, including the Cape Colony, Natal, and the Dutch Republics. By HENRY HALL, F.R.G.S., F.R.C.I. With Map. *3s. 6d.*

CONTENTS:

General Description of South Africa—Physical Geography with reference to Engineering Operations—Notes on Labour and Material in Cape Colony—Geological Notes on Rock Formation in South Africa—Engineering Instruments for Use in South Africa—Principal Public Works in Cape Colony: Railways, Mountain Roads and Passes, Harbour Works, Bridges, Gas Works, Irrigation and Water Supply, Lighthouses, Drainage and Sanitary Engineering, Public Buildings, Mines—Table of Woods in South Africa—Animals used for Draught Purposes—Statistical Notes—Table of Distances—Rates of Carriage, etc.

No. 3. India. By F. C. DANVERS, Assoc. Inst. C.E. With Map. *4s. 6d.*

CONTENTS:

Physical Geography of India—Building Materials—Roads—Railways—Bridges—Irrigation—River Works—Harbours—Lighthouse Buildings—Native Labour—The Principal Trees of India—Money—Weights and Measures—Glossary of Indian Terms, etc.

Our Factories, Workshops, and Warehouses: their Sanitary and Fire-Resisting Arrangements. By B. H. THWAITE, Assoc. Mem. Inst. C.E. *With 183 wood engravings*, crown 8vo, cloth, 9s.

A Practical Treatise on Coal Mining. By GEORGE G. ANDRÉ, F.G.S., Assoc. Inst. C.E., Member of the Society of Engineers. *With 82 lithographic plates.* 2 vols., royal 4to, cloth, 3l. 12s.

A Practical Treatise on Casting and Founding, including descriptions of the modern machinery employed in the art. By N. E. SPRETSON, Engineer. Fifth edition, with 82 plates drawn to scale, 412 pp., demy 8vo, cloth, 18s.

A Handbook of Electrical Testing. By H. R. KEMPE, M.S.T.E. Fourth edition, revised and enlarged, crown 8vo, cloth, 16s.

The Clerk of Works: a Vade-Mecum for all engaged in the Superintendence of Building Operations. By G. G. HOSKINS, F.R.I.B.A. Third edition, fcap. 8vo, cloth, 1s. 6d.

American Foundry Practice: Treating of Loam, Dry Sand, and Green Sand Moulding, and containing a Practical Treatise upon the Management of Cupolas, and the Melting of Iron. By T. D. WEST, Practical Iron Moulder and Foundry Foreman. Second edition, *with numerous illustrations*, crown 8vo, cloth, 10s. 6d.

The Maintenance of Macadamised Roads. By T. CODRINGTON, M.I.C.E., F.G.S., General Superintendent of County Roads for South Wales. Second edition, 8vo, cloth, 7s. 6d.

Hydraulic Steam and Hand Power Lifting and Pressing Machinery. By FREDERICK COLYER, M. Inst. C.E., M. Inst. M.E. *With 73 plates*, 8vo, cloth, 18s.

Pumps and Pumping Machinery. By F. COLYER, M.I.C.E., M.I.M.E. *With 23 folding plates*, 8vo, cloth, 12s. 6d.

Pumps and Pumping Machinery. By F. COLYER. Second Part. *With 11 large plates*, 8vo, cloth, 12s. 6d.

A Treatise on the Origin, Progress, Prevention, and Cure of Dry Rot in Timber; with Remarks on the Means of Preserving Wood from Destruction by Sea-Worms, Beetles, Ants, etc. By THOMAS ALLEN BRITTON, late Surveyor to the Metropolitan Board of Works, etc., etc. *With 10 plates*, crown 8vo, cloth, 7s. 6d.

The Artillery of the Future and the New Powders. By J. A. LONGRIDGE, Mem. Inst. C.E. 8vo, cloth, 5s.

Gas Works: their Arrangement, Construction, Plant, and Machinery. By F. COLYER, M. Inst. C.E. *With 31 folding plates,* 8vo, cloth, 12s. 6d.

The Municipal and Sanitary Engineer's Handbook.

By H. PERCY BOULNOIS, Mem. Inst. C.E., Borough Engineer, Portsmouth. *With numerous illustrations.* Second edition, demy 8vo, cloth, 15s.

CONTENTS:

The Appointment and Duties of the Town Surveyor—Traffic—Macadamised Roadways—Steam Rolling—Road Metal and Breaking—Pitched Pavements—Asphalte—Wood Pavements—Footpaths—Kerbs and Gutters—Street Naming and Numbering—Street Lighting—Sewerage—Ventilation of Sewers—Disposal of Sewage—House Drainage—Disinfection—Gas and Water Companies, etc., Breaking up Streets—Improvement of Private Streets—Borrowing Powers—Artizans' and Labourers' Dwellings—Public Conveniences—Scavenging, including Street Cleansing—Watering and the Removing of Snow—Planting Street Trees—Deposit of Plans—Dangerous Buildings—Hoardings—Obstructions—Improving Street Lines—Cellar Openings—Public Pleasure Grounds—Cemeteries—Mortuaries—Cattle and Ordinary Markets—Public Slaughter-houses, etc.—Giving numerous Forms of Notices, Specifications, and General Information upon these and other subjects of great importance to Municipal Engineers and others engaged in Sanitary Work.

Metrical Tables. By Sir G. L. MOLESWORTH, M.I.C.E. 32mo, cloth, 1s. 6d.

CONTENTS.

General—Linear Measures—Square Measures—Cubic Measures—Measures of Capacity—Weights—Combinations—Thermometers.

Elements of Construction for Electro-Magnets. By Count TH. DU MONCEL, Mem. de l'Institut de France. Translated from the French by C. J. WHARTON. Crown 8vo, cloth, 4s. 6d.

A Treatise on the Use of Belting for the Transmission of Power. By J. H. COOPER. Second edition, *illustrated,* 8vo, cloth, 15s.

A Pocket-Book of Useful Formulæ and Memoranda for Civil and Mechanical Engineers. By Sir GUILFORD L. MOLESWORTH. Mem. Inst. C.E. *With numerous illustrations,* 744 pp. Twenty-second edition, 32mo, roan, 6s.

SYNOPSIS OF CONTENTS:

Surveying, Levelling, etc.—Strength and Weight of Materials—Earthwork, Brickwork, Masonry, Arches, etc.—Struts, Columns, Beams, and Trusses—Flooring, Roofing, and Roof Trusses—Girders, Bridges, etc.—Railways and Roads—Hydraulic Formulæ—Canals, Sewers, Waterworks, Docks—Irrigation and Breakwaters—Gas, Ventilation, and Warming—Heat, Light, Colour, and Sound—Gravity: Centres, Forces, and Powers—Millwork, Teeth of Wheels, Shafting, etc.—Workshop Recipes—Sundry Machinery—Animal Power—Steam and the Steam Engine—Water-power, Water-wheels, Turbines, etc.—Wind and Windmills—Steam Navigation, Ship Building, Tonnage, etc.—Gunnery, Projectiles, etc.—Weights, Measures, and Money—Trigonometry, Conic Sections, and Curves—Telegraphy—Mensuration—Tables of Areas and Circumference, and Arcs of Circles—Logarithms, Square and Cube Roots, Powers—Reciprocals, etc.—Useful Numbers—Differential and Integral Calculus—Algebraic Signs—Telegraphic Construction and Formulæ.

Hints on Architectural Draughtsmanship. By G. W. TUXFORD HALLATT. Fcap. 8vo, cloth, 1s. 6d.

Spons' Tables and Memoranda for Engineers; selected and arranged by J. T. HURST, C.E., Author of 'Architectural Surveyors' Handbook,' 'Hurst's Tredgold's Carpentry,' etc. Eleventh edition, 64mo, roan, gilt edges, 1s. ; or in cloth case, 1s. 6d.

This work is printed in a pearl type, and is so small, measuring only 2½ in. by 1½ in. by ½ in. thick, that it may be easily carried in the waistcoat pocket.

"It is certainly an extremely rare thing for a reviewer to be called upon to notice a volume measuring but 2½ in. by 1½ in., yet these dimensions faithfully represent the size of the handy little book before us. The volume—which contains 118 printed pages, besides a few blank pages for memoranda—is, in fact, a true pocket-book, adapted for being carried in the waistcoat pocket, and containing a far greater amount and variety of information than most people would imagine could be compressed into so small a space. . . . The little volume has been compiled with considerable care and judgment, and we can cordially recommend it to our readers as a useful little pocket companion."—*Engineering.*

A Practical Treatise on Natural and Artificial Concrete, its Varieties and Constructive Adaptations. By HENRY REID, Author of the 'Science and Art of the Manufacture of Portland Cement.' New Edition, with 59 woodcuts and 5 plates, 8vo, cloth, 15s.

Notes on Concrete and Works in Concrete; especially written to assist those engaged upon Public Works. By JOHN NEWMAN, Assoc. Mem. Inst. C.E., crown 8vo, cloth, 4s. 6d.

Electricity as a Motive Power. By Count TH. DU MONCEL, Membre de l'Institut de France, and FRANK GERALDY, Ingénieur des Ponts et Chaussées. Translated and Edited, with Additions, by C. J. WHARTON, Assoc. Soc. Tel. Eng. and Elec. With 113 engravings and diagrams, crown 8vo, cloth, 7s. 6d.

Treatise on Valve-Gears, with special consideration of the Link-Motions of Locomotive Engines. By Dr. GUSTAV ZEUNER, Professor of Applied Mechanics at the Confederated Polytechnikum of Zurich. Translated from the Fourth German Edition, by Professor J. F. KLEIN, Lehigh University, Bethlehem, Pa. Illustrated, 8vo, cloth, 12s. 6d.

The French-Polisher's Manual. By a French-Polisher; containing Timber Staining, Washing, Matching, Improving, Painting, Imitations, Directions for Staining, Sizing, Embodying, Smoothing, Spirit Varnishing, French-Polishing, Directions for Re-polishing. Third edition, royal 32mo, sewed, 6d.

Hops, their Cultivation, Commerce, and Uses in various Countries. By P. L. SIMMONDS. Crown 8vo, cloth, 4s. 6d.

The Principles of Graphic Statics. By GEORGE SYDENHAM CLARKE, Major Royal Engineers. With 112 illustrations. Second edition, 4to, cloth, 12s. 6d.

Dynamo Tenders' Hand-Book. By F. B. BADT, late 1st Lieut. Royal Prussian Artillery. *With 70 illustrations.* Third edition, 18mo, cloth, 4s. 6d.

Practical Geometry, Perspective, and Engineering Drawing; a Course of Descriptive Geometry adapted to the Requirements of the Engineering Draughtsman, including the determination of cast shadows and Isometric Projection, each chapter being followed by numerous examples; to which are added rules for Shading, Shade-lining, etc., together with practical instructions as to the Lining, Colouring, Printing, and general treatment of Engineering Drawings, with a chapter on drawing Instruments. By GEORGE S. CLARKE, Capt. R.E. Second edition, *with 21 plates.* 2 vols., cloth, 10s. 6d.

The Elements of Graphic Statics. By Professor KARL VON OTT, translated from the German by G. S. CLARKE, Capt. R.E., Instructor in Mechanical Drawing, Royal Indian Engineering College. *With 93 illustrations,* crown 8vo, cloth, 5s.

A Practical Treatise on the Manufacture and Distribution of Coal Gas. By WILLIAM RICHARDS. Demy 4to, with *numerous wood engravings and 29 plates,* cloth, 28s.

SYNOPSIS OF CONTENTS :

Introduction—History of Gas Lighting—Chemistry of Gas Manufacture, by Lewis Thompson, Esq., M.R.C.S.—Coal, with Analyses, by J. Paterson, Lewis Thompson, and G. R. Hislop, Esqrs.—Retorts, Iron and Clay—Retort Setting—Hydraulic Main—Condensers—Exhausters—Washers and Scrubbers—Purifiers—Purification—History of Gas Holder—Tanks, Brick and Stone, Composite, Concrete, Cast-iron, Compound Annular Wrought-iron—Specifications—Gas Holders—Station Meter—Governor—Distribution—Mains—Gas Mathematics, or Formulae for the Distribution of Gas, by Lewis Thompson, Esq.—Services—Consumers' Meters—Regulators—Burners—Fittings—Photometer—Carburization of Gas—Air Gas and Water Gas—Composition of Coal Gas, by Lewis Thompson, Esq.—Analyses of Gas—Influence of Atmospheric Pressure and Temperature on Gas—Residual Products—Appendix—Description of Retort Settings, Buildings, etc., etc.

The New Formula for Mean Velocity of Discharge of Rivers and Canals. By W. R. KUTTER. Translated from articles in the 'Cultur-Ingénieur,' by LOWIS D'A. JACKSON, Assoc. Inst. C.E. 8vo, cloth, 12s. 6d.

The Practical Millwright and Engineer's Ready Reckoner; or Tables for finding the diameter and power of cog-wheels, diameter, weight, and power of shafts, diameter and strength of bolts, etc. By THOMAS DIXON. Fourth edition, 12mo, cloth, 3s.

Tin: Describing the Chief Methods of Mining, Dressing and Smelting it abroad; with Notes upon Arsenic, Bismuth and Wolfram. By ARTHUR G. CHARLETON, Mem. American Inst. of Mining Engineers. *With plates,* 8vo, cloth, 12s. 6d.

Perspective, Explained and Illustrated. By G. S. CLARKE, Capt. R.E. *With illustrations*, 8vo, cloth, 3s. 6d.

Practical Hydraulics; a Series of Rules and Tables for the use of Engineers, etc., etc. By THOMAS BOX. Ninth edition, *numerous plates*, post 8vo, cloth, 5s.

The Essential Elements of Practical Mechanics; based on the Principle of Work, designed for Engineering Students. By OLIVER BYRNE, formerly Professor of Mathematics, College for Civil Engineers. Third edition, *with 148 wood engravings*, post 8vo, cloth, 7s. 6d.

CONTENTS :

Chap. 1. How Work is Measured by a Unit, both with and without reference to a Unit of Time—Chap. 2. The Work of Living Agents, the Influence of Friction, and introduces one of the most beautiful Laws of Motion—Chap. 3. The principles expounded in the first and second chapters are applied to the Motion of Bodies—Chap. 4. The Transmission of Work by simple Machines—Chap. 5. Useful Propositions and Rules.

Breweries and Maltings: their Arrangement, Construction, Machinery, and Plant. By G. SCAMELL, F.R.I.B.A. Second edition, revised, enlarged, and partly rewritten. By F. COLYER, M.I.C.E., M.I.M.E. *With 20 plates*, 8vo, cloth, 12s. 6d.

A Practical Treatise on the Construction of Horizontal and Vertical Waterwheels, specially designed for the use of operative mechanics. By WILLIAM CULLEN, Millwright and Engineer. *With 11 plates*. Second edition, revised and enlarged, small 4to, cloth, 12s. 6d.

A Practical Treatise on Mill-gearing, Wheels, Shafts, Riggers, etc.; for the use of Engineers. By THOMAS BOX. Third edition, *with 11 plates*. Crown 8vo, cloth, 7s. 6d.

Mining Machinery: a Descriptive Treatise on the Machinery, Tools, and other Appliances used in Mining. By G. G. ANDRÉ, F.G.S., Assoc. Inst. C.E., Mem. of the Society of Engineers. Royal 4to, uniform with the Author's Treatise on Coal Mining, containing 182 *plates*, accurately drawn to scale, with descriptive text, in 2 vols., cloth, 3l. 12s.

CONTENTS :

Machinery for Prospecting, Excavating, Hauling, and Hoisting—Ventilation—Pumping—Treatment of Mineral Products, including Gold and Silver, Copper, Tin, and Lead, Iron, Coal, Sulphur, China Clay, Brick Earth, etc.

Tables for Setting out Curves for Railways, Canals, Roads, etc., varying from a radius of five chains to three miles. By A. KENNEDY and R. W. HACKWOOD. *Illustrated* 32mo, cloth, 2s. 6d.

Practical Electrical Notes and Definitions for the use of Engineering Students and Practical Men. By W. PERREN MAYCOCK, Assoc. M. Inst. E.E., Instructor in Electrical Engineering at the Pitlake Institute, Croydon, together with the Rules and Regulations to be observed in Electrical Installation Work. Second edition. Royal 32mo, roan, gilt edges, 4s. 6d., or cloth, red edges, 3s.

The Draughtsman's Handbook of Plan and Map Drawing; including instructions for the preparation of Engineering, Architectural, and Mechanical Drawings. *With numerous illustrations in the text, and 33 plates (15 printed in colours).* By G. G. ANDRÉ, F.G.S., Assoc. Inst. C.E. 4to, cloth, 9s.

CONTENTS:

The Drawing Office and its Furnishings—Geometrical Problems—Lines, Dots, and their Combinations—Colours, Shading, Lettering, Bordering, and North Points—Scales—Plotting—Civil Engineers' and Surveyors' Plans—Map Drawing—Mechanical and Architectural Drawing—Copying and Reducing Trigonometrical Formulæ, etc., etc.

The Boiler-maker's and Iron Ship-builder's Companion, comprising a series of original and carefully calculated tables, of the utmost utility to persons interested in the iron trades. By JAMES FODEN, author of 'Mechanical Tables,' etc. Second edition revised, *with illustrations*, crown 8vo, cloth, 5s.

Rock Blasting: a Practical Treatise on the means employed in Blasting Rocks for Industrial Purposes. By G. G. ANDRÉ, F.G.S., Assoc. Inst. C.E. *With 56 illustrations and 12 plates*, 8vo, cloth, 10s. 6d.

Experimental Science: Elementary, Practical, and Experimental Physics. By GEO. M. HOPKINS. *Illustrated by 672 engravings.* In one large vol., 8vo, cloth, 15s.

A Treatise on Ropemaking as practised in public and private Rope-yards, with a Description of the Manufacture, Rules, Tables of Weights, etc., adapted to the Trade, Shipping, Mining, Railways, Builders, etc. By R. CHAPMAN, formerly foreman to Messrs. Huddart and Co., Limehouse, and late Master Ropemaker to H.M. Dockyard, Deptford. Second edition, 12mo, cloth, 3s.

Laxton's Builders' and Contractors' Tables; for the use of Engineers, Architects, Surveyors, Builders, Land Agents, and others. Bricklayer, containing 22 tables, with nearly 30,000 calculations. 4to, cloth, 5s.

Laxton's Builders' and Contractors' Tables. Excavator, Earth, Land, Water, and Gas, containing 53 tables, with nearly 24,000 calculations. 4to, cloth, 5s.

Egyptian Irrigation. By W. WILLCOCKS, M.I.C.E., Indian Public Works Department, Inspector of Irrigation, Egypt. With Introduction by Lieut.-Col. J. C. ROSS, R.E., Inspector-General of Irrigation. *With numerous lithographs and wood engravings*, royal 8vo, cloth, 1*l.* 16*s.*

Screw Cutting Tables for Engineers and Machinists, giving the values of the different trains of Wheels required to produce Screws of any pitch, calculated by Lord Lindsay, M.P., F.R.S., F.R.A.S., etc. Cloth, oblong, 2*s.*

Screw Cutting Tables, for the use of Mechanical Engineers, showing the proper arrangement of Wheels for cutting the Threads of Screws of any required pitch, with a Table for making the Universal Gas-pipe Threads and Taps. By W. A. MARTIN, Engineer. Second edition, oblong, cloth, 1*s.*, or sewed, 6*d.*

A Treatise on a Practical Method of Designing Slide-Valve Gears by Simple Geometrical Construction, based upon the principles enunciated in Euclid's Elements, and comprising the various forms of Plain Slide-Valve and Expansion Gearing; together with Stephenson's, Gooch's, and Allan's Link-Motions, as applied either to reversing or to variable expansion combinations. By EDWARD J. COWLING WELCH, Memb. Inst. Mechanical Engineers. Crown 8vo, cloth, 6*s.*

Cleaning and Scouring: a Manual for Dyers, Laundresses, and for Domestic Use. By S. CHRISTOPHER. 18mo, sewed, 6*d.*

A Glossary of Terms used in Coal Mining. By WILLIAM STUKELEY GRESLEY, Assoc. Mem. Inst. C.E., F.G.S., Member of the North of England Institute of Mining Engineers. *Illustrated with numerous woodcuts and diagrams*, crown 8vo, cloth, 5*s.*

A Pocket-Book for Boiler Makers and Steam Users, comprising a variety of useful information for Employer and Workman, Government Inspectors, Board of Trade Surveyors, Engineers in charge of Works and Slips, Foremen of Manufactories, and the general Steam-using Public. By MAURICE JOHN SEXTON. Second edition, royal 32mo, roan, gilt edges, 5*s.*

Electrolysis: a Practical Treatise on Nickeling, Coppering, Gilding, Silvering, the Refining of Metals, and the treatment of Ores by means of Electricity. By HIPOLYTE FONTAINE, translated from the French by J. A. BERLY, C.E., Assoc. S.T.E. *With engravings.* 8vo, cloth, 9*s.*

Barlow's Tables of Squares, Cubes, Square Roots, Cube Roots, Reciprocals of all Integer Numbers up to 10,000. Post 8vo, cloth, 6s.

A Practical Treatise on the Steam Engine, containing Plans and Arrangements of Details for Fixed Steam Engines, with Essays on the Principles involved in Design and Construction. By ARTHUR RIGG, Engineer, Member of the Society of Engineers and of the Royal Institution of Great Britain. Demy 4to, *copiously illustrated with woodcuts and 96 plates*, in one Volume, half-bound morocco, 2l. 2s.; or cheaper edition, cloth, 25s.

This work is not, in any sense, an elementary treatise, or history of the steam engine, but is intended to describe examples of Fixed Steam Engines without entering into the wide domain of locomotive or marine practice. To this end illustrations will be given of the most recent arrangements of Horizontal, Vertical, Beam, Pumping, Winding, Portable, Semi-portable, Corliss, Allen, Compound, and other similar Engines, by the most eminent Firms in Great Britain and America. The laws relating to the action and precautions to be observed in the construction of the various details, such as Cylinders, Pistons, Piston-rods, Connecting-rods, Cross-heads, Motion-blocks, Eccentrics, Simple, Expansion, Balanced, and Equilibrium Slide-valves, and Valve-gearing will be minutely dealt with. In this connection will be found articles upon the Velocity of Reciprocating Parts and the Mode of Applying the Indicator, Heat and Expansion of Steam Governors, and the like. It is the writer's desire to draw illustrations from every possible source, and give only those rules that present practice deems correct.

A Practical Treatise on the Science of Land and Engineering Surveying, Levelling, Estimating Quantities, &c., with a general description of the several Instruments required for Surveying, Levelling, Plotting, &c. By H. S. MERRETT. Fourth edition, revised by G. W. USILL, Assoc. Mem. Inst. C.E. 41 *plates, with illustrations and tables*, royal 8vo, cloth, 12s. 6d.

PRINCIPAL CONTENTS :

Part 1. Introduction and the Principles of Geometry. Part 2. Land Surveying; comprising General Observations—The Chain—Offsets. Surveying by the Chain only—Surveying Hilly Ground—To Survey an Estate or Parish by the Chain only—Surveying with the Theodolite—Mining and Town Surveying—Railroad Surveying—Mapping—Division and Laying out of Land—Observations on Enclosures—Plane Trigonometry. Part 3. Levelling—Simple and Compound Levelling—The Level Book—Parliamentary Plan and Section—Levelling with a Theodolite—Gradients—Wooden Curves—To Lay out a Railway Curve—Setting out Widths. Part 4. Calculating Quantities generally for Estimates—Cuttings and Embankments—Tunnels—Brickwork—Ironwork—Timber Measuring. Part 5. Description and Use of Instruments in Surveying and Plotting—The Improved Dumpy Level—Troughton's Level—The Prismatic Compass—Proportional Compass—Box Sextant—Vernier—Pantagraph—Merrett's Improved Quadrant—Improved Computation Scale—The Diagonal Scale—Straight Edge and Sector. Part 6. Logarithms of Numbers—Logarithmic Sines and Co-Sines, Tangents and Co-Tangents—Natural Sines and Co-Sines—Tables for Earthwork, for Setting out Curves, and for various Calculations, &c., &c., &c.

Mechanical Graphics. A Second Course of Mechanical Drawing. With Preface by Prof. PERRY, B.Sc., F.R.S. Arranged for use in Technical and Science and Art Institutes, Schools and Colleges, by GEORGE HALLIDAY, Whitworth Scholar. 8vo, cloth, 6s.

The Assayer's Manual: an Abridged Treatise on the Docimastic Examination of Ores and Furnace and other Artificial Products. By BRUNO KERL. Translated by W. T. BRANNT. *With 65 illustrations*, 8vo, cloth, 12s. 6d.

Dynamo-Electric Machinery: a Text-Book for Students of Electro-Technology. By SILVANUS P. THOMPSON, B.A., D.Sc., M.S.T.E. [*New edition in the press.*]

The Practice of Hand Turning in Wood, Ivory, Shell, etc., with Instructions for Turning such Work in Metal as may be required in the Practice of Turning in Wood, Ivory, etc.; also an Appendix on Ornamental Turning. (A book for beginners.) By FRANCIS CAMPIN. Third edition, *with wood engravings*, crown 8vo, cloth, 6s.

CONTENTS :

On Lathes—Turning Tools—Turning Wood—Drilling—Screw Cutting—Miscellaneous Apparatus and Processes—Turning Particular Forms—Staining—Polishing—Spinning Metals—Materials—Ornamental Turning, etc.

Treatise on Watchwork, Past and Present. By the Rev. H. L. NELTHROPP, M.A., F.S.A. *With 32 illustrations*, crown 8vo, cloth, 6s. 6d.

CONTENTS :

Definitions of Words and Terms used in Watchwork—Tools—Time—Historical Summary—On Calculations of the Numbers for Wheels and Pinions; their Proportional Sizes, Trains, etc.—Of Dial Wheels, or Motion Work—Length of Time of Going without Winding up—The Verge—The Horizontal—The Duplex—The Lever—The Chronometer—Repeating Watches—Keyless Watches—The Pendulum, or Spiral Spring—Compensation—Jewelling of Pivot Holes—Clerkenwell—Fallacies of the Trade—Incapacity of Workmen—How to Choose and Use a Watch, etc.

Algebra Self-Taught. By W. P. HIGGS, M.A., D.Sc., LL.D., Assoc. Inst. C.E., Author of 'A Handbook of the Differential Calculus,' etc. Second edition, crown 8vo, cloth, 2s. 6d.

CONTENTS :

Symbols and the Signs of Operation—The Equation and the Unknown Quantity—Positive and Negative Quantities—Multiplication—Involution—Exponents—Negative Exponents—Roots, and the Use of Exponents as Logarithms—Logarithms—Tables of Logarithms and Proportionate Parts—Transformation of System of Logarithms—Common Uses of Common Logarithms—Compound Multiplication and the Binomial Theorem—Division, Fractions, and Ratio—Continued Proportion—The Series and the Summation of the Series—Limit of Series—Square and Cube Roots—Equations—List of Formulæ, etc.

Spons' Dictionary of Engineering, Civil, Mechanical, Military, and Naval; with technical terms in French, German, Italian, and Spanish, 3100 pp., and *nearly 8000 engravings*, in super-royal 8vo, in 8 divisions, 5l. 8s. Complete in 3 vols., cloth, 5l. 5s. Bound in a superior manner, half-morocco, top edge gilt, 3 vols., 6l. 12s.

Notes in Mechanical Engineering. Compiled principally for the use of the Students attending the Classes on this subject at the City of London College. By HENRY ADAMS, Mem. Inst. M.E., Mem. Inst. C.E., Mem. Soc. of Engineers. Crown 8vo, cloth, 2s. 6d.

Canoe and Boat Building: a complete Manual for Amateurs, containing plain and comprehensive directions for the construction of Canoes, Rowing and Sailing Boats, and Hunting Craft. By W. P. STEPHENS. *With numerous illustrations and 24 plates of Working Drawings.* Crown 8vo, cloth, 9s.

Proceedings of the National Conference of Electricians, Philadelphia, October 8th to 13th, 1884. 18mo, cloth, 3s.

Dynamo - Electricity, its Generation, Application, Transmission, Storage, and Measurement. By G. B. PRESCOTT. *With 545 illustrations.* 8vo, cloth, 1l. 1s.

Domestic Electricity for Amateurs. Translated from the French of E. HOSPITALIER, Editor of "L'Electricien," by C. J. WHARTON, Assoc. Soc. Tel. Eng. *Numerous illustrations.* Demy 8vo, cloth, 6s.

CONTENTS:

1. Production of the Electric Current—2. Electric Bells—3. Automatic Alarms—4. Domestic Telephones—5. Electric Clocks—6. Electric Lighters—7. Domestic Electric Lighting—8. Domestic Application of the Electric Light—9. Electric Motors—10. Electrical Locomotion—11. Electrotyping, Plating, and Gilding—12. Electric Recreations—13. Various applications—Workshop of the Electrician.

Wrinkles in Electric Lighting. By VINCENT STEPHEN. *With illustrations.* 18mo, cloth, 2s. 6d.

CONTENTS:

1. The Electric Current and its production by Chemical means—2. Production of Electric Currents by Mechanical means—3. Dynamo-Electric Machines—4. Electric Lamps—5. Lead—6. Ship Lighting.

Foundations and Foundation Walls for all classes of Buildings, Pile Driving, Building Stones and Bricks, Pier and Wall construction, Mortars, Limes, Cements, Concretes, Stuccos, &c. *64 illustrations.* By G. T. POWELL and F. BAUMAN. 8vo, cloth, 10s. 6d.

Manual for Gas Engineering Students. By D. LEE. 18mo, cloth, 1s.

Telephones, their Construction and Management.
By F. C. ALLSOP. Crown 8vo, cloth, 5s.

Hydraulic Machinery, Past and Present. A Lecture delivered to the London and Suburban Railway Officials' Association. By H. ADAMS, Mem. Inst. C.E. *Folding plate.* 8vo, sewed, 1s.

Twenty Years with the Indicator. By THOMAS PRAY, Jun., C.E., M.E., Member of the American Society of Civil Engineers. 2 vols., royal 8vo, cloth, 12s. 6d.

Annual Statistical Report of the Secretary to the Members of the Iron and Steel Association on the Home and Foreign Iron and Steel Industries in 1889. Issued June 1890. 8vo, sewed, 5s.

Bad Drains, and How to Test them; with Notes on the Ventilation of Sewers, Drains, and Sanitary Fittings, and the Origin and Transmission of Zymotic Disease. By R. HARRIS REEVES. Crown 8vo, cloth, 3s. 6d.

Well Sinking. The modern practice of Sinking and Boring Wells, with geological considerations and examples of Wells. By ERNEST SPON, Assoc. Mem. Inst. C.E., Mem. Soc. Eng., and of the Franklin Inst., etc. Second edition, revised and enlarged. Crown 8vo, cloth, 10s. 6d.

The Voltaic Accumulator: an Elementary Treatise. By ÉMILE REYNIER. Translated by J. A. BERLY, Assoc. Inst. E.E. With 62 illustrations, 8vo, cloth, 9s.

Ten Years' Experience in Works of Intermittent Downward Filtration. By J. BAILEY DENTON, Mem. Inst. C.E. Second edition, with additions. Royal 8vo, cloth, 5s.

Land Surveying on the Meridian and Perpendicular System. By WILLIAM PENMAN, C.E. 8vo, cloth, 8s. 6d.

The Electromagnet and Electromagnetic Mechanism. By SILVANUS P. THOMPSON, D.Sc., F.R.S. 8vo, cloth, 15s.

Incandescent Wiring Hand-Book. By F. B. BADT, late 1st Lieut. Royal Prussian Artillery. *With 41 illustrations and 5 tables.* 18mo, cloth, 4s. 6d.

A Pocket-book for Pharmacists, Medical Practitioners, Students, etc., etc. (British, Colonial, and American). By THOMAS BAYLEY, Assoc. R. Coll. of Science, Consulting Chemist, Analyst, and Assayer, Author of a 'Pocket-book for Chemists,' 'The Assay and Analysis of Iron and Steel, Iron Ores, and Fuel,' etc., etc. Royal 32mo, boards, gilt edges, 6s.

The Fireman's Guide; a Handbook on the Care of Boilers. By TEKNOLOG, föreningen T. I. Stockholm. Translated from the third edition, and revised by KARL P. DAHLSTROM, M.E. Second edition. Fcap. 8vo, cloth, 2s.

A Treatise on Modern Steam Engines and Boilers, including Land Locomotive, and Marine Engines and Boilers, for the use of Students. By FREDERICK COLYER, M. Inst. C.E., Mem. Inst. M.E. *With 36 plates.* 4to, cloth, 12s. 6d.

CONTENTS:

1. Introduction—2. Original Engines—3. Boilers—4. High-Pressure Beam Engines—5. Cornish Beam Engines—6. Horizontal Engines—7. Oscillating Engines—8. Vertical High-Pressure Engines—9. Special Engines—10. Portable Engines—11. Locomotive Engines—12. Marine Engines.

Steam Engine Management; a Treatise on the Working and Management of Steam Boilers. By F. COLYER, M. Inst. C.E., Mem. Inst. M.E. New edition. 18mo, cloth, 3s. 6d.

A Text-Book of Tanning, embracing the Preparation of all kinds of Leather. By HARRY R. PROCTOR, F.C.S., of Low Lights Tanneries. *With illustrations.* Crown 8vo, cloth, 10s. 6d.

Aid Book to Engineering Enterprise. By EWING MATHESON, M. Inst. C.E. The Inception of Public Works, Parliamentary Procedure for Railways, Concessions for Foreign Works, and means of Providing Money, the Points which determine Success or Failure, Contract and Purchase, Commerce in Coal, Iron, and Steel, &c. Second edition, revised and enlarged, 8vo, cloth, 21s.

Pumps, Historically, Theoretically, and Practically Considered. By P. R. BJÖRLING. *With 156 illustrations.* Crown 8vo, cloth, 7s. 6d.

The Marine Transport of Petroleum. A Book for the use of Shipowners, Shipbuilders, Underwriters, Merchants, Captains and Officers of Petroleum-carrying Vessels. By G. H. LITTLE, Editor of the 'Liverpool Journal of Commerce.' Crown 8vo, cloth, 10s. 6d.

Liquid Fuel for Mechanical and Industrial Purposes. Compiled by E. A. BRAYLEY HODGETTS. *With wood engravings.* 8vo, cloth, 7s. 6d.

Tropical Agriculture: A Treatise on the Culture, Preparation, Commerce and Consumption of the principal Products of the Vegetable Kingdom. By P. L. SIMMONDS, F.L.S., F.R.C.I. New edition, revised and enlarged, 8vo, cloth, 21s.

Health and Comfort in House Building; or, Ventilation with Warm Air by Self-acting Suction Power. With Review of the Mode of Calculating the Draught in Hot-air Flues, and with some Actual Experiments by J. DRYSDALE, M.D., and J. W. HAYWARD, M.D. *With plates and woodcuts.* Third edition, with some New Sections, and the whole carefully Revised, 8vo, cloth, 7s. 6d.

Losses in Gold Amalgamation. With Notes on the Concentration of Gold and Silver Ores. *With six plates.* By W. MCDERMOTT and P. W. DUFFIELD. 8vo, cloth, 5s.

A Guide for the Electric Testing of Telegraph Cables. By Col. V. HOSKIER, Royal Danish Engineers. Third edition, crown 8vo, cloth, 4s. 6d.

The Hydraulic Gold Miners' Manual. By T. S. G. KIRKPATRICK, M.A. Oxon. *With 6 plates.* Crown 8vo, cloth, 6s.

"We venture to think that this work will become a text-book on the important subject of which it treats. Until comparatively recently hydraulic mines were neglected. This was scarcely to be surprised at, seeing that their working in California was brought to an abrupt termination by the action of the farmers on the *débris* question, whilst their working in other parts of the world had not been attended with the anticipated success."—*The Mining World and Engineering Record.*

The Arithmetic of Electricity. By T. O'CONOR SLOANE. Crown 8vo, cloth, 4s. 6d.

The Turkish Bath: Its Design and Construction for Public and Commercial Purposes. By R. O. ALLSOP, Architect. *With plans and sections.* 8vo, cloth, 6s.

Earthwork Slips and Subsidences upon Public Works: Their Causes, Prevention and Reparation. Especially written to assist those engaged in the Construction or Maintenance of Railways, Docks, Canals, Waterworks, River Banks, Reclamation Embankments, Drainage Works, &c., &c. By JOHN NEWMAN, Assoc. Mem. Inst. C.E., Author of 'Notes on Concrete,' &c. Crown 8vo, cloth, 7s. 6d.

Gas and Petroleum Engines: A Practical Treatise on the Internal Combustion Engine. By WM. ROBINSON, M.E., Senior Demonstrator and Lecturer on Applied Mechanics, Physics, &c., City and Guilds of London College, Finsbury, Assoc. Mem. Inst. C.E., &c. *Numerous illustrations.* 8vo, cloth, 14s.

Waterways and Water Transport in Different Countries. With a description of the Panama, Suez, Manchester, Nicaraguan, and other Canals. By J. STEPHEN JEANS, Author of 'England's Supremacy,' 'Railway Problems,' &c. *Numerous illustrations.* 8vo, cloth, 14s.

A Treatise on the Richards Steam-Engine Indicator and the Development and Application of Force in the Steam-Engine. By CHARLES T. PORTER. Fourth Edition, revised and enlarged, 8vo, cloth, 9s.

CONTENTS.

The Nature and Use of the Indicator:	Of the Loss attending the Employment of
The several lines on the Diagram.	Slow-piston Speed, and the Extent to
Examination of Diagram No. 1.	which this is Shown by the Indicator.
Of Truth in the Diagram.	Of other Applications of the Indicator.
Description of the Richards Indicator.	Of the use of the Tables of the Properties of
Practical Directions for Applying and Taking	Steam in Calculating the Duty of Boilers.
Care of the Indicator.	Introductory.
Introductory Remarks.	Of the Pressure on the Crank when the Con-
Units.	necting-rod is conceived to be of Infinite
Expansion.	Length.
Directions for ascertaining from the Diagram	The Modification of the Acceleration and
the Power exerted by the Engine.	Retardation that is occasioned by the
To Measure from the Diagram the Quantity	Angular Vibration of the Connecting-rod.
of Steam Consumed.	Method of representing the actual pressure
To Measure from the Diagram the Quantity	on the crank at every point of its revolu-
of Heat Expended.	tion.
Of the Real Diagram, and how to Construct it.	The Rotative Effect of the Pressure exerted
Of the Conversion of Heat into Work in the	on the Crank.
Steam-engine.	The Transmitting Parts of an Engine, con-
Observations on the several Lines of the	sidered as an Equaliser of Motion.
Diagram.	A Ride on a Buffer-beam (Appendix).

In demy 4to, handsomely bound in cloth, *illustrated with 220 full page plates*,
Price 15s.

ARCHITECTURAL EXAMPLES IN BRICK, STONE, WOOD, AND IRON.

A COMPLETE WORK ON THE DETAILS AND ARRANGEMENT
OF BUILDING CONSTRUCTION AND DESIGN.

By WILLIAM FULLERTON, ARCHITECT.

Containing 220 Plates, with numerous Drawings selected from the Architecture
of Former and Present Times.

*The Details and Designs are Drawn to Scale, $\frac{1}{8}$ " , $\frac{1}{4}$ " , $\frac{1}{2}$ " , and Full size
being chiefly used.*

The Plates are arranged in Two Parts. The First Part contains Details of Work in the four principal Building materials, the following being a few of the subjects in this Part:—Various forms of Doors and Windows, Wood and Iron Roofs, Half Timber Work, Porches, Towers, Spires, Belfries, Flying Buttresses, Groining, Carving, Church Fittings, Constructive and Ornamental Iron Work, Classic and Gothic Molds and Ornament, Foliation Natural and Conventional, Stained Glass, Coloured Decoration, a Section to Scale of the Great Pyramid, Grecian and Roman Work, Continental and English Gothic, Pile Foundations, Chimney Shafts according to the regulations of the London County Council, Board Schools. The Second Part consists of Drawings of Plans and Elevations of Buildings, arranged under the following heads:—Workmen's Cottages and Dwellings, Cottage Residences and Dwelling Houses, Shops, Factories, Warehouses, Schools, Churches and Chapels, Public Buildings, Hotels and Taverns, and Buildings of a general character.

All the Plates are accompanied with particulars of the Work, with Explanatory Notes and Dimensions of the various parts.

Architectural Examples—Town Hall—

211

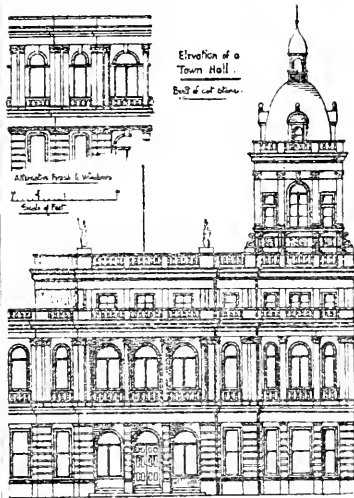

Architectural Examples—Brickwork &c

4

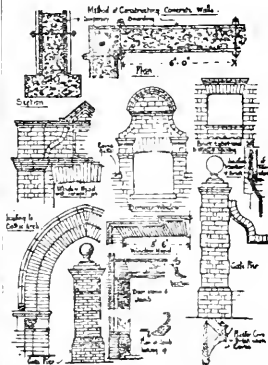

Architectural Examples—

21.

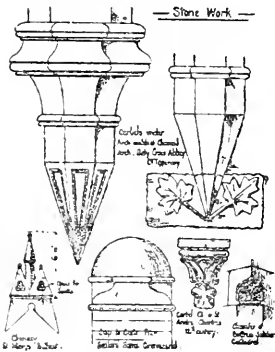

Architectural Examples—Windows

72

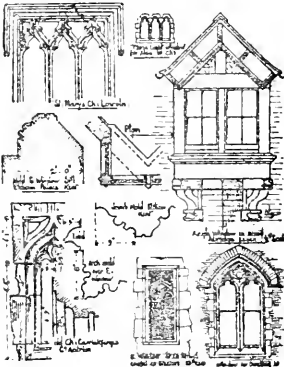

Crown 8vo, cloth, with illustrations, 5s.

WORKSHOP RECEIPTS, FIRST SERIES.

BY ERNEST SPON.

SYNOPSIS OF CONTENTS.

Bookbinding.	Freezing.	Paper.
Bronzes and Bronzing.	Fulminates.	Paper Hanging.
Candles.	Furniture Creams, Oils,	Painting in Oils, in Water
Cement.	Polishes, Lacquers,	Colours, as well as
Cleaning.	and Pastes.	Fresco, House, Trans-
Colourwashing.	Gilding.	parency, Sign, and
Concretes.	Glass Cutting, Cleaning,	Carriage Painting.
Dipping Acids.	Frosting, Drilling,	Photography.
Drawing Office Details.	Darkening, Bending,	Plastering.
Drying Oils.	Staining, and Paint-	Polishes.
Dynamite.	ing.	Pottery—(Clays, Bodies,
Electro - Metallurgy —	Glass Making.	Glazes, Colours, Oils,
(Cleaning, Dipping,	Glues.	Stains, Fluxes, Ena-
Scratch-brushing, Bat-	Gold.	mels, and Lustres).
teries, Baths, and	Graining.	Scouring.
Deposits of every	Gums.	Silvering.
description).	Gun Cotton.	Soap.
Enamels.	Gunpowder.	Solders.
Engraving on Wood,	Horn Working.	Tanning.
Copper, Gold, Silver,	Indiarubber.	Taxidermy.
Steel, and Stone.	Japans, Japanning, and	Tempering Metals.
Etching and Aqua Tint.	kindred processes.	Treating Horn, Mother-
Firework Making —	Lacquers.	o'-Pearl, and like sub-
(Rockets, Stars, Rains,	Lathing.	stances.
Gerbes, Jets, Tour-	Lubricants.	Varnishes, Manufacture
billons, Candles, Fires,	Marble Working.	and Use of.
Lances, Lights, Wheels,	Matches.	Veneering.
Fire-balloons, and	Mortars.	Washing.
minor Fireworks).	Nitro-Glycerine.	Waterproofing.
Fluxes.	Oils.	Welding.
Foundry Mixtures.		

Besides Receipts relating to the lesser Technological matters and processes, such as the manufacture and use of Stencil Plates, Blacking, Crayons, Paste, Putty, Wax, Size, Alloys, Catgut, Tunbridge Ware, Picture Frame and Architectural Mouldings, Compos, Cameos, and others too numerous to mention.

Crown 8vo, cloth, 485 pages, with illustrations, 5s.

WORKSHOP RECEIPTS, SECOND SERIES.

BY ROBERT HALDANE.

SYNOPSIS OF CONTENTS.

Acidimetry and Alkali- metry.	Disinfectants.	Iodoform.
Albumen.	Dyeing, Staining, and Colouring.	Isinglass.
Alcohol.	Essences.	Ivory substitutes.
Alkaloids.	Extracts.	Leather.
Baking-powders.	Fireproofing.	Luminous bodies.
Bitters.	Gelatine, Gluc, and Size.	Magnesia.
Bleaching.	Glycerine.	Matches.
Boiler Incrustations.	Gut.	Paper.
Cements and Lutes.	Hydrogen peroxide.	Parchment.
Cleansing.	Ink.	Perchloric acid.
Confectionery.	Iodine.	Potassium oxalate.
Copying.		Preserving.

Pigments, Paint, and Painting: embracing the preparation of *Pigments*, including alumina lakes, blacks (animal, bone, Frankfort, ivory, lamp, sight, soot), blues (antimony, Antwerp, cobalt, cæruleum, Egyptian, manganate, Paris, Péligot, Prussian, smalt, ultramarine), browns (bistre, hinau, sepia, sienna, umber, Vandyke), greens (baryta, Brighton, Brunswick, chrome, cobalt, Douglas, emerald, manganese, mitis, mountain, Prussian, sap, Scheele's, Schweinfurth, titanium, verdigris, zinc), reds (Brazilwood lake, carminated lake, carmine, Cassius purple, cobalt pink, cochineal lake, colcothar, Indian red, madder lake, red chalk, red lead, vermilion), whites (alum, baryta, Chinese, lead sulphate, white lead—by American, Dutch, French, German, Kremnitz, and Pattinson processes, precautions in making, and composition of commercial samples—whiting, Wilkinson's white, zinc white), yellows (chrome, gamboge, Naples, orpiment, realgar, yellow lakes); *Paints* (vehicles, testing oils, driers, grinding, storing, applying, priming, drying, filling, coats, brushes, surface, water-colours, removing smell, discoloration; miscellaneous paints—cement paint for carton-pierre, copper paint, gold paint, iron paint, lime paints, silicated paints, steatite paint, transparent paints, tungsten paints, window paint, zinc paints); *Painting* (general instructions, proportions of ingredients, measuring paint work; carriage painting—priming paint, best putty, finishing colour, cause of cracking, mixing the paints, oils, driers, and colours, varnishing, importance of washing vehicles, re-varnishing, how to dry paint; woodwork painting).

Crown 8vo, cloth, 480 pages, with 183 illustrations, 5s.

WORKSHOP RECEIPTS, THIRD SERIES.

By C. G. WARNFORD LOCK.

Uniform with the First and Second Series.

SYNOPSIS OF CONTENTS.

Alloys.	Indium.	Rubidium.
Aluminium.	Iridium.	Ruthenium.
Antimony.	Iron and Steel.	Selenium.
Barium.	Lacquers and Lacquering.	Silver.
Beryllium.	Lanthanum.	Slag.
Bismuth.	Lead.	Sodium.
Cadmium.	Lithium.	Strontium.
Cæsium.	Lubricants.	Tantalum.
Calcium.	Magnesium.	Terbium.
Cerium.	Manganese.	Thallium.
Chromium.	Mercury.	Thorium.
Cobalt.	Mica.	Tin.
Copper.	Molybdenum.	Titanium.
Didymium.	Nickel.	Tungsten.
Electrics.	Niobium.	Uranium.
Enamels and Glazes.	Osmium.	Vanadium.
Erbium.	Palladium.	Yttrium.
Gallium.	Platinum.	Zinc.
Glass.	Potassium.	Zirconium.
Gold.	Rhodium.	

WORKSHOP RECEIPTS,

FOURTH SERIES,

DEVOTED MAINLY TO HANDICRAFTS & MECHANICAL SUBJECTS.

BY C. G. WARNFORD LOCK.

250 Illustrations, with Complete Index, and a General Index to the
Four Series, 5s.

Waterproofing—rubber goods, cuprammonium processes, miscellaneous preparations.

Packing and Storing articles of delicate odour or colour, of a deliquescent character, liable to ignition, apt to suffer from insects or damp, or easily broken.

Embalming and Preserving anatomical specimens.

Leather Polishes.

Cooling Air and Water, producing low temperatures, making ice, cooling syrups and solutions, and separating salts from liquors by refrigeration.

Pumps and Siphons, embracing every useful contrivance for raising and supplying water on a moderate scale, and moving corrosive, tenacious, and other liquids.

Desiccating—air- and water-ovens, and other appliances for drying natural and artificial products.

Distilling—water, tinctures, extracts, pharmaceutical preparations, essences, perfumes, and alcoholic liquids.

Emulsifying as required by pharmacists and photographers.

Evaporating—saline and other solutions, and liquids demanding special precautions.

Filtering—water, and solutions of various kinds.

Percolating and Macerating.

Electrotyping.

Stereotyping by both plaster and paper processes.

Bookbinding in all its details.

Straw Plaiting and the fabrication of baskets, matting, etc.

Musical Instruments—the preservation, tuning, and repair of pianos, harmoniums, musical boxes, etc.

Clock and Watch Mending—adapted for intelligent amateurs.

Photography—recent development in rapid processes, handy apparatus, numerous recipes for sensitizing and developing solutions, and applications to modern illustrative purposes.

NOW COMPLETE.

With nearly 1500 illustrations, in super-royal 8vo, in 5 Divisions, cloth. Divisions 1 to 4, 13s. 6d. each; Division 5, 17s. 6d.; or 2 vols., cloth, £3 10s.

SPONS' ENCYCLOPÆDIA

OF THE

INDUSTRIAL ARTS, MANUFACTURES, AND COMMERCIAL PRODUCTS.

EDITED BY C. G. WARNFORD LOCK, F.L.S.

Among the more important of the subjects treated of, are the following:—

- | | | |
|--|---|--|
| Acids, 207 pp. 220 figs. | Fur, 5 pp. | Photography, 13 pp. 20 figs. |
| Alcohol, 23 pp. 16 figs. | Gas, Coal, 8 pp. | Pigments, 9 pp. 6 figs. |
| Alcoholic Liquors, 13 pp. | Gems. | Pottery, 46 pp. 57 figs. |
| Alkalies, 89 pp. 78 figs. | Glass, 45 pp. 77 figs. | Printing and Engraving, 20 pp. 8 figs. |
| Alloys. Alum. | Graphite, 7 pp. | Rags. |
| Asphalt. Assaying. | Hair, 7 pp. | Resinous and Gummy Substances, 75 pp. 16 figs. |
| Beverages, 89 pp. 29 figs. | Hair Manufactures. | Rope, 16 pp. 17 figs. |
| Blacks. | Hats, 26 pp. 26 figs. | Salt, 31 pp. 23 figs. |
| Bleaching Powder, 15 pp. | Honey. Hops. | Silk, 8 pp. |
| Bleaching, 51 pp. 48 figs. | Horn. | Silk Manufactures, 9 pp. 11 figs. |
| Candles, 18 pp. 9 figs. | Ice, 10 pp. 14 figs. | Skins, 5 pp. |
| Carbon Bisulphide. | Indiarubber Manufactures, 23 pp. 17 figs. | Small Wares, 4 pp. |
| Celluloid, 9 pp. | Ink, 17 pp. | Soap and Glycerine, 39 pp. 45 figs. |
| Cements. Clay. | Ivory. | Spices, 16 pp. |
| Coal-tar Products, 44 pp. 14 figs. | Jute Manufactures, 11 pp., 11 figs. | Sponge, 5 pp. |
| Cocoa, 8 pp. | Knitted Fabrics — | Starch, 9 pp. 10 figs. |
| Coffee, 32 pp. 13 figs. | Hosiery, 15 pp. 13 figs. | Sugar, 155 pp. 134 figs. |
| Cork, 8 pp. 17 figs. | Lace, 13 pp. 9 figs. | Sulphur. |
| Cotton Manufactures, 62 pp. 57 figs. | Leather, 28 pp. 31 figs. | Tannin, 18 pp. |
| Drugs, 38 pp. | Linen Manufactures, 16 pp. 6 figs. | Tea, 12 pp. |
| Dyeing and Calico Printing, 28 pp. 9 figs. | Manures, 21 pp. 30 figs. | Timber, 13 pp. |
| Dyestuffs, 16 pp. | Matches, 17 pp. 38 figs. | Varnish, 15 pp. |
| Electro-Metallurgy, 13 pp. | Mordants, 13 pp. | Vinegar, 5 pp. |
| Explosives, 22 pp. 33 figs. | Narcotics, 47 pp. | Wax, 5 pp. |
| Feathers. | Nuts, 10 pp. | Wool, 2 pp. |
| Fibrous Substances, 92 pp. 79 figs. | Oils and Fatty Substances, 125 pp. | Woollen Manufactures, 58 pp. 39 figs. |
| Floor-cloth, 16 pp. 21 figs. | Paint. | |
| Food Preservation, 8 pp. | Paper, 26 pp. 23 figs. | |
| Fruit, 8 pp. | Paraffin, 8 pp. 6 figs. | |
| | Pearl and Coral, 8 pp. | |
| | Perfumes, 10 pp. | |

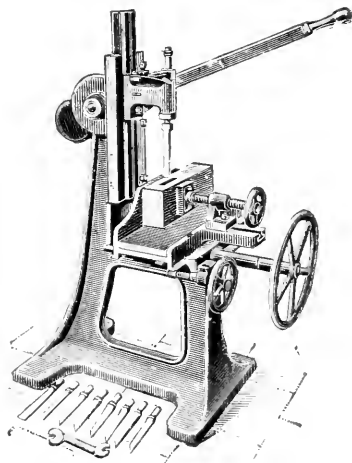
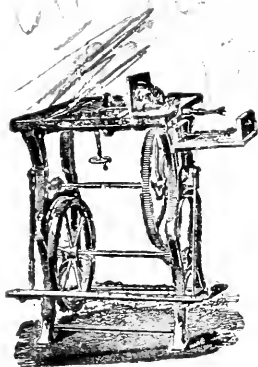

NOTICE.

BRITANNIA CO.

ARE

BONA-FIDE MAKERS

OF

300 VARIETIES OF MACHINE TOOLS.

 Makers to the British Government.

SPECIAL TOOLS DESIGNED OR MADE TO DRAWING.

*Catalogues 6d., list of second-hand which
have been taken in exchange, 2d.*

**Gas and Steam Engines. Boilers. Shops and
Factories fitted up complete.**

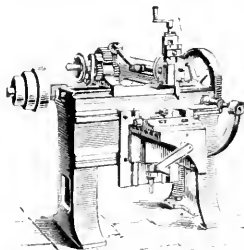
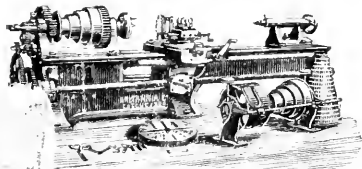

Show Rooms: 100, HOUNDSDITCH, LONDON.

All Letters to BRITANNIA WORKS, COLCHESTER.

GETTY CENTER LIBRARY



3 3125 00114 1858

