

METALLURGY

A CONDENSED TREATISE

FOR THE USE OF

College Students and Any Desiring a
General Knowledge of the
Subject

BY

HENRY WYSOR, B.S.

PROFESSOR OF METALLURGY IN LAFAYETTE COLLEGE

SECOND EDITION

EASTON, PA.:
THE CHEMICAL PUBLISHING CO.
1914

LONDON, ENGLAND:
WILLIAMS & NORGATE
14 HENRIETTA STREET, COVENT GARDEN, W. C.

W. H. HART

T. N. P.

8 MAR 8

1914

COPYRIGHT, 1914, BY EDWARD HART.

W

W

W. H. HART
ANNOUNCED

PREFACE

The aim and ideal in this book, as stated in the preface to the first edition, is to set forth the history, practice and philosophy of metallurgy in a brief, clear manner. The primary object was to supplement a course of lectures given to engineering students, but further thought and consultation with other teachers convinced me that there was need for an elementary treatise on metallurgy in many American colleges.

Every teacher knows that his most ardent and painstaking efforts will be futile if he fails to enlist the student's interest. A book may be far from profound and rudimentary to a fault, but nevertheless, successful if it presents fundamental subjects in a style that arouses interest and, therefore, commands attention. Aside from the prerequisites of accuracy and clearness class room books should be readable and well balanced. In elementary courses the text should be used from cover to cover, and the expediency of omitting certain chapters or articles should not be felt from either the academic or the technical point of view. The beginner needs perspective rather than detail, breadth rather than depth, and when given a view of the subject as a whole and shown something of its meaning his mind will submit more willingly, if not zealously, to abstraction and detail. No criticism is made of compendiums or of texts in which subjects are dealt with exhaustively. These have their indispensable places in special courses and as works of reference.

The criticisms of the first edition of this book have been carefully weighed. While adhering to the original ideal, the effort has been made to improve the text in every way possible, and to make it more useful. A number of chapters have been rewritten, many new illustrations have been added, and the book as a whole is somewhat enlarged.

I take pleasure in acknowledging my indebtedness to all who

have co-operated with me, or from whom I have, consciously or unconsciously, derived assistance. I have endeavored to justify, in a larger measure, the favorable opinions and confidence awarded the first edition of this work.

EASTON, PA.,

January, 1914.

H. W.

CONTENTS

CHAPTER I

	PAGE
INTRODUCTION	I
PHYSICAL PROPERTIES OF METALS.....	I-12
Testing Metals	8-12

CHAPTER II

REFRACTORIES AND FLUXES.....	13-23
Acid Materials	14
Basic Materials	16
Neutral Materials	17
Fluxes and Slags	18
Testing Refractories	20

CHAPTER III

COMBUSTION AND THERMAL MEASUREMENTS.....	24-42
Combustion	24
Calorimetry	25
Pyrometry	29

CHAPTER IV

THE NATURAL FUELS	43-48
Wood	43
Peat	43
Lignite	44
Coal	45
Natural Gas	48

CHAPTER V

THE PREPARED FUELS	49-66
Charcoal	49
Coke	51
Producer Gas	59
Water Gas	65
Typical Analyses of Fuels.....	66

✓ CHAPTER VI

ORE DRESSING	67-88
Ores	67
Weathering	69

	PAGE
Hand Picking	69
Breaking	69
Pulverizing	73
Sizing and Classifying	76
Washing	79
Flotation	83
Magnetic Separation	84
Electrostatic Separation	85
Pneumatic Concentration	86
Calcining and Roasting	86
Agglomerating	86
 CHAPTER VII 	
FURNACES AND ACCESSORY APPARATUS.....	89-99
Kilns, Blast Furnaces and Forges.....	90
Reverberatory Furnaces	91
Muffle, Crucible, Retort and Vacuum Furnaces.....	92
Electric Furnaces	92
Regenerative Firing	93
Blast Apparatus	93
Blowing Engines	93
Fans	96
Rotary Piston Blowers	96
Centrifugal Blowers	97
 CHAPTER VIII 	
IRON—ORES AND PROPERTIES	100-113
History	100
Ores	101
Properties	104
Effect of Other Elements.....	105
Chemical Properties	112
 CHAPTER IX 	
IRON SMELTING—CHEMISTRY OF THE BLAST FURNACE PROCESS.....	114-122
The Blast Furnace	114
Chemical Changes	116
Blast Furnace Slag	120
Wall Accretions	121
Blast Furnace Gas	122
Flue Dust	122
 CHAPTER X 	
IRON SMELTING—THE BLAST FURNACE PLANT AND PROCESS.....	123-149
Description of the Plant.....	123

CONTENTS

vii

	PAGE
Blowing in	134
Burdening the Furnace	135
Fuels and Fluxes	137
Management of the Blast.....	139
Casting	145
Disposal of the Slag and Dust.....	147
Thermal calculations	148

CHAPTER XI

CAST IRON	150-162
Properties and Uses	150
Iron Founding	152
Malleable Castings	160
Testing Cast Iron	160

CHAPTER XII

WROUGHT IRON	163-172
History	163
Properties	165
Puddling	166

CHAPTER XIII

STEEL—THE CEMENTATION AND CRUCIBLE PROCESSES.....	173-178
Definition	173
The Cementation Process	173
The Crucible Process	176

CHAPTER XIV

STEEL—THE BESSEMER PROCESS	179-186
Acid Bessemer Process	179
Basic Bessemer Process	185

CHAPTER XV

STEEL—THE OPEN HEARTH PROCESS.....	187-200
Acid Open Hearth Process.....	187
Basic Open Hearth Process.....	193
Chemistry of the Open Hearth Process.....	195
The Talbot Process	199
The Bertrand-Thiel Process	200
The Monell Process	200
The Duplex Process	200

	PAGE
CHAPTER XVI	
STEEL—ELECTRIC PROCESSES	201-205
Electric Furnaces	201
Electric Refining	203
Relative Merits of Different Processes.....	204
CHAPTER XVII	
FURTHER TREATMENT OF IRON AND STEEL.....	206-224
Casting Ingots	206
Stripping Ingots	209
Forging	211
Annealing and Tempering	220
Testing Steel	222
CHAPTER XVIII	
COPPER—ORES, PROPERTIES, ETC.	225-236
History	225
Ores	225
Properties	226
Dressing Ores	229
CHAPTER XIX	
COPPER SMELTING	237-259
Reverberatory Smelting	237
Blast Furnace Smelting	242
Converter Processes	250
Chemistry of Copper Smelting.....	255
Hydro-metallurgy of Copper	257
CHAPTER XX	
COPPER REFINING	260-267
The Furnace Process	260
The Electrolytic Process	262
CHAPTER XXI	
LEAD—ORES, PROPERTIES, ETC.	268-272
History	268
Ores	268
Properties	268
Dressing Ores	270
CHAPTER XXII	
LEAD SMELTING	273-284
Reverberatory Smelting	273
Hearth Smelting	275

	PAGE
Blast Furnace Smelting	276
Chemistry of Lead Smelting.....	280
Products of the Lead Blast Furnace.....	281
CHAPTER XXIII	
LEAD REFINING.....	285-292
Softening	285
Desilverizing	286
Electrolytic Refining	291
CHAPTER XXIV	
ZINC	293-301
History	293
Ores	293
Properties	294
Dressing Ores	295
Smelting	296
Refining	301
CHAPTER XXV	
TIN AND MERCURY	302-307
Tin Ores and Properties.....	302
Tin Smelting and Refining.....	303
Mercury Ores and Properties.....	304
Mercury Smelting	305
CHAPTER XXVI	
SILVER	308-321
History of Gold and Silver.....	308
Ores	308
Properties	309
Smelting	310
Amalgamating	310
Leaching	319
Refining	321
CHAPTER XXVII	
GOLD	322-341
Ores	322
Properties	322
Washing	323
Smelting	324
Amalgamating	324

	PAGE
Leaching	329
Refining and Parting	339
CHAPTER XXVIII	
NICKEL, ALUMINUM, MANGANESE AND THE RARER METALS.....	342-352
Nickel	342
Aluminum	345
Manganese	348
Chromium	349
Tungsten	350
Molybdenum	350
Vanadium	350
Bismuth	351
Platinum	352
CHAPTER XXIX	
ALLOYS	353-373
History	353
Properties	353
Constitution	355
Temperature Curves	358
Chemical and Microscopical Examination.....	361
Manufacture	362
Tables of Composition	365
Welding	368
Plating	369

ILLUSTRATIONS

FIGURE		PAGE
1	Tensile Test Specimens	8
2	Testing Machine	9
3	Scleroscope	11
4	Seeger Cones	22
5	Parr Calorimeter	26
6	Electric Resistance Pyrometer	31
7	Thermo-electric Pyrometer	32
8	Bristol Pyrometer	33
9	Optical Pyrometer	36
10	Bristol Recording Pyrometer	39
11-12	Leeds & Northrup Recording Pyrometer.....	40, 42
13	Charcoal Mound	50
14-15	Beehive Coke Ovens	52, 53
16	By-product Coke Ovens	55
17	Temperature Chart of Coke Oven.....	58
18	Siemens Gas Producer	60
19	Morgan Gas Producer	61
20	Blake Crusher	70
21	Gyratory Crusher	72
22	Stamp Battery	73
23	Stamp Mortar	74
24	Chilian Mill	75
25	Huntington Mill	77
26	Jig	80
27	Wilfley Table	81
28	Isbell Vanner	82
29	Principle of Wetherill Separator.....	85
30	Lime Kiln	90
31	Blowing Engine	94
32	Fan Blower	96
33	Rotary Piston Blower	97
34	Centrifugal Blower	98
35	Turbo Blower	99
36	Iron Blast Furnace	115
37	Plan of Iron Smelting Plant.....	124
38	Blast Furnace Bosh	125
39	Gayley Bosh Plate	126
40	Tuyere and Cooler	127

FIGURE		PAGE
41	Bethlehem Iron Furnace and Hoist.....	129
42	Dust Catcher	130
43	Cowper Hot Blast Stove.....	132
44	McClure Hot Blast Stove.....	133
45-46-47	Hot Blast Temperature Records.....	140
48	Gayley Dry Blast Chamber.....	143
49	Iron Runner and Dam.....	146
50	Pig Casting Bed	146
51	Whiting Cupola	154
52	Wheel Casting	157
53	Roll Casting	159
54	Effect of Chill	159
55	Catalan Forge	163
56	American Bloomary	164
57	Muffles for Experimental Puddling.....	166
58	Puddling Furnace	169
59	Bloom Squeezer	171
60	Cementation Furnace	174
61	Bessemer Converter	181
62	Device for Rotating Converter.....	182
63-64	Open Hearth Furnace	188, 189
65	Diagram of Open Hearth Heat.....	197
66	Campbell Furnace	199
67	Electric Furnace Types	202
68	Steel Pouring Ladle	206
69	Diagram of Split Ingot.....	208
70	Ingots, Bogie and Molds.....	209
71	Blooming Mill	212
72	Wobbler and Coupling Box.....	213
73	Universal Mill	214
74	Three-High Mill Rolls	215
75	Steam Hammer	217
76	Hand Reverberatory Roaster	232
77	McDougal Roaster	234
78-79	Reverberatory Matte Smelter	238, 239
80-81	Copper Blast Furnace, Round Type.....	244, 245
82	Copper Blast Furnace, Rectangular Type.....	246
83	Copper Converter	253
84	Principle of Electrolysis	263
85-86	Arrangement of Electrodes	265
87	Lead Reverberatory Smelter	273
88-89	Lead Blast Furnace	276, 278
90-91	Parkes Desilverizing Plant	288

ILLUSTRATIONS

xiii

FIGURE		PAGE
92	Cupellation Furnace	290
93	Zinc Distillation Furnace	299
94	Spirek Mercury Furnace	306
95	Amalgamation Pan	315
96-97	Gold Dredge	326, 327
98	Cyanide Flow Sheet	332
99	Zinc Precipitation Boxes	336
100	Aluminum Reduction Furnace	348
101-102	Temperature Curves	359
103	Freezing Point Curve	360
104	Tinning Pot	370

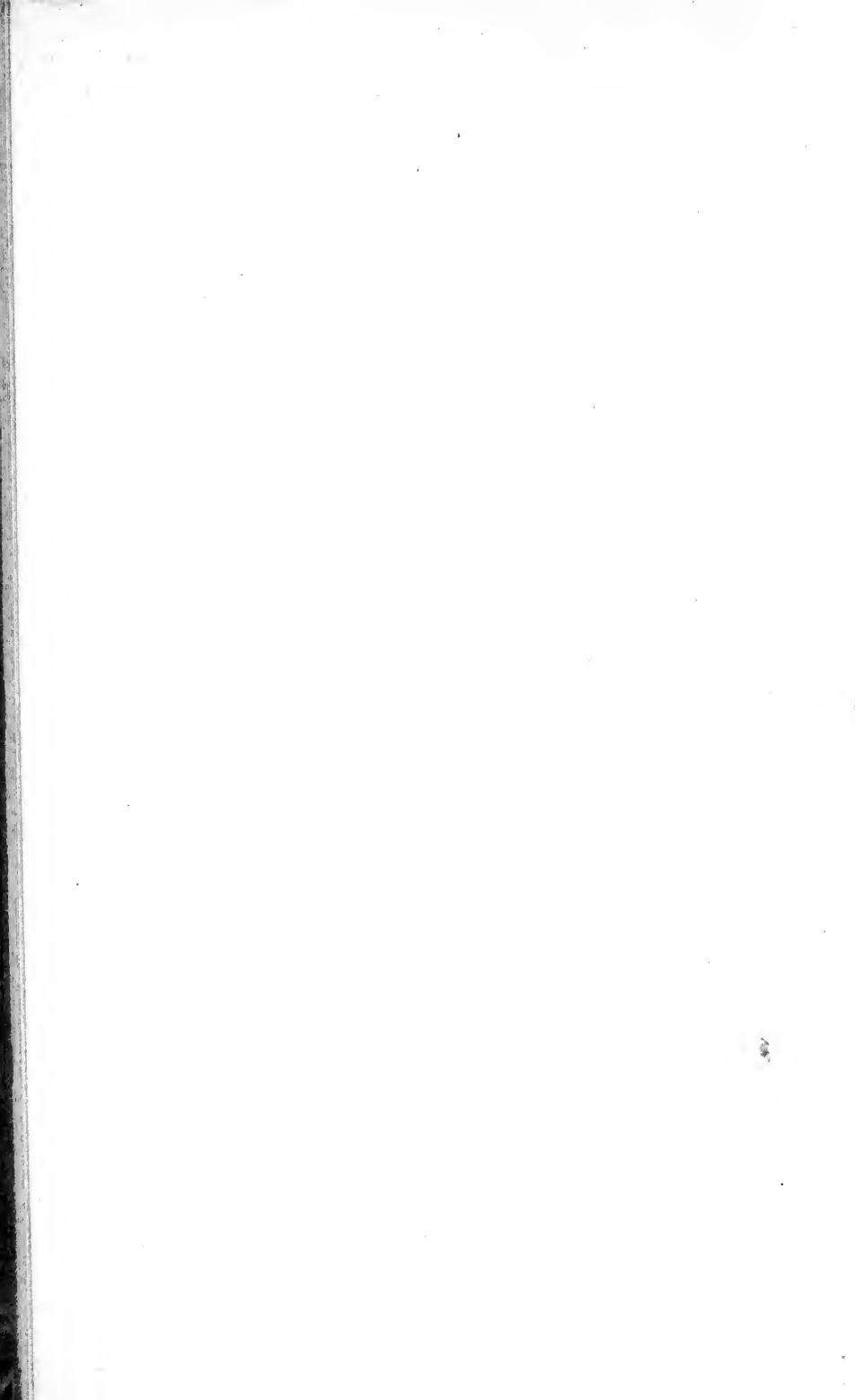

CHAPTER I

INTRODUCTION

The science of Metallurgy treats of the properties of the metals and of the processes by which they are prepared from their ores. The science further includes a study of the ores, fuels and all the materials used in metallurgical industries, together with the structures and machinery employed.

Metallurgical processes are essentially chemical. The metals generally occur in such stable combinations as to require reacting substances and often the powerful agency of heat to bring about their separation and purification. As viewed in this light, metallurgy might be classed as a branch of industrial chemistry. The industry has, however, grown to such enormous proportions, and is so closely linked with other branches of engineering, as to warrant its being studied as a separate branch.

An understanding of the physical and chemical properties of the metals, fuels and refractory materials is essential to the metallurgist, and he must also familiarize himself with machinery, which has come to play so important a part in modern practice. With these facts in view, the principles upon which metallurgical operations in general are conducted are laid down in the opening chapters of this treatise, and a special study is made of the fuels and refractory earths, the construction of furnaces and combustion. It is the aim throughout this book to show the application of scientific principles in winning the useful metals, and while much of the matter is necessarily descriptive, it is to the end stated that the student's attention is especially called.

THE PHYSICAL PROPERTIES OF THE METALS.

The value of metals depends almost entirely upon their physical properties. Their great strength and rigidity, together with their pleasing appearance, have commended them for economic and ornamental uses from the earliest times. To the manufacturers of to-day, who supply the markets with the useful metals,

a knowledge of these properties, and of the ways in which they may be developed and improved, is indispensable. Some of these are well known as characteristics of all the common metals, while others are observed only when the metal is subjected to peculiar conditions. The subject is taken up here in a general way, and the properties are carefully defined without reference to any specific metal. As the individual metals are studied, reference will be made to their characteristics and acquired properties.

Fracture.—The fracture, or appearance of the freshly broken surface of a metal, is to some extent an index to its other properties. Each metal has its characteristic fracture, and the same metal under varying conditions of purity and mechanical treatment presents fractures differing accordingly. In some instances the quality of a metal may be inferred, and an approximate estimate made of the amount of impurities it contains, by simply examining its fracture.

When metals cool from a state of fusion, like most other solidifying substances, they tend to form crystals. But the conditions attending the cooling of metals do not, as a rule, permit of any high degree of crystallization. As seen by the naked eye, the structure appears granular in most instances, but upon polishing and carefully etching a surface, the crystalline structure may be seen with the aid of a microscope. The structure of metals, as shown by their fracture, is affected by any impurities present, by heat treatment and by such mechanical treatment as hammering or rolling.

Tenacity.—By tenacity is meant the property of resisting a tensile or stretching force. The extent to which a metal will resist being pulled apart is termed its tensile strength. The tenacity of metals varies with the composition, temperature and treatment, and is improved in most metals by the addition of certain other elements in the proper proportions. It is of greatest importance in metal that is used for structural purposes. It is one of the few properties which can be determined quantitatively, and for which an absolute mathematical expression can be obtained.

Elasticity.—Any substance which is capable of returning to its original form and size after being distorted is said to be elastic. A substance that is perfectly elastic will retain this property after being distorted an infinite number of times. Liquids and gases are perfectly elastic, but solids are not. It is a well known fact that metal springs, after long usage become “set,” their original shape being permanently altered. Glass is shown to be elastic by bending a straight rod, which will remain straight afterward. If, however, the rod is supported at the ends in a horizontal position, with a weight attached at the middle, and allowed to remain for a few weeks, it will be permanently bent.

When the elasticity of a metal has been destroyed to such an extent that it shows little or no tendency to return to its original form it is said to be *plastic*. Some metals, such as lead and gold, are naturally plastic. These are less of the nature of true solids.

The extent to which a metal can be stretched or compressed without rupture is termed its *elastic limit*. This value may be measured and expressed numerically as the units of force necessary to rupture a bar, the area of whose cross-section is given. If the composition of the bar is homogeneous, and it is of uniform thickness between the points at which the force is applied, equal additions of force will produce equal elongations or depressions, until the elastic limit is reached.

The spring balance serves to illustrate the above statement. The pointer, moving over a scale or dial, is attached to, or operated by the loose end of a spring. The other end of the spring being fastened, it is compressed or stretched when weights are placed on the pan. The pointer is seen to move equal distances for equal additional weights.

From what has been said it is clear that the amount of force required to produce any elongation, within the elastic limit, can be estimated, provided it is known how much is required to produce a given elongation. If the elasticity remained perfect, the force necessary to double the length of a bar is termed its *modulus of elasticity*. Suppose, for example, that a bar of steel

is stretched from eight inches to 8.03 inches by a force of 126,000 pounds. The modulus of elasticity would be—

$$0.03 : 8 :: 126,000 : x, \text{ or } 33,600,000 \text{ pounds.}$$

This value is, of course, purely theoretical, as no metal has so high a limit of elasticity.

Toughness and Brittleness.—The resistance which a metal offers to being pulled apart after its elastic limit has been reached is due to toughness. The tough metals are scarcely elastic—if either one of these properties is developed in a metal, it is usually done at the expense of the other. As a rule, metals are toughest when in the pure state.

The brittle metals are those which, relatively speaking, are neither malleable nor ductile. Such metals are usually hard, but can be easily broken, and in some cases powdered under a hammer. Brittleness is opposed to toughness, and is rarely desired in any metal. It is influenced chiefly by foreign elements, but it frequently develops where strains are applied in different directions, or in metal that is subjected to violent shocks. Changes in temperature have a marked effect upon the brittleness of metals. The best way to remove brittleness is by annealing.

Malleability and Flow.—Metals which can be permanently extended by pressure without fracture are termed malleable. Degree of malleability is shown by the thinness of the sheet into which the metal can be hammered. As a rule, this property is most perfect in a metal when it is pure, and it generally increases with temperature to a certain limit. In this connection the relation of temperature to physical properties in metals is most remarkable. While malleability is generally increased with each increment of temperature, the brittle or granular state is developed in most metals before the fusion point is reached. Cohesiveness is so far diminished in some metals that they will crumble to powder under a blow. The term flow relates to the molecular movements of metals in the solid state. With the exception of mercury, none of the metals flow in the usual sense of the term, but all of them become mobile under sufficient

pressure, *i. e.*, they flow as viscid liquids do. If hardness or elasticity is developed in a metal, its malleability is diminished. It is chiefly upon this property that the processes of rolling and hammering depend.

Forging.—This term relates to all operations in which the shape of metals is altered by pressure. These include rolling, hammering and pressing. When the metal is shaped between dies the operation is known as die or drop forging, depending upon the manner in which the force is applied. The more malleable metals will flow into the smallest interstices of the dies and yield perfect impressions. Such metals and alloys are used in coin striking. The property of flow may be taxed still further by causing a metal under great pressure to flow from an aperture. Lead pipe is made by pressing a solid block of lead which has been cast into a stout cylinder. The opening through which the lead flows has the outside diameter of the pipe, and in this opening a mandrel is centered, corresponding to the inside diameter.

Ductility.—The ductile metals are those which are capable of being drawn into wire. The property of ductility depends mostly upon tenacity, malleability and toughness. It will be seen by referring to the table (p. 8) that the malleable metals are the most ductile. Most metals show great changes in their ductility with changes in temperature. The property is improved by annealing.

Wire Drawing.—Wire is made by drawing a bar of metal, somewhat larger in diameter than the resulting wire, through funnel-shaped holes in dies of hard steel. A number of dies may be employed, depending upon the size to which the wire must be reduced. The end of the bar is first sharpened until it will pass through the openings, and is gripped by the forceps of the machine. The pressure that is brought to bear by the funnel-shaped holes is about the same in effect as that of rolling, while the stretching force compels extension in the one direction. The tenacity of the finished wire is tried, since it sustains the entire drawing force.

Pipe drawing and spinning are operations in which both

malleability and ductility are essential, and serve to illustrate the different ways in which the principles may be applied.

Fusibility and Volatility.—All the metals are fusible and all are volatile. Some are infusible, and but few are volatile at ordinary furnace temperatures. The metals of commerce may have much lowered melting points, due to impurities. In all processes for extracting metals by smelting, advantage is taken of their fusibility. It is of importance to know the melting points of metals, and as well their behavior in the liquid state, in connection with the foundry industries.

Diffusion and Liquation.—Most metals have the property of forming homogeneous mixtures with other metals. This is known as the alloying property or the property of diffusion, and the mixtures are called *alloys*. Some metals alloy in all proportions, while with others it is very difficult to bring about any union at all. It has been found possible to develop properties in alloys to a degree which has never been attained with any single metal. As might be supposed, some of the properties of alloys are intermediate between those of the constituent metals, but this is not true of all.

It is generally understood that metals diffuse only when one or both are in the liquid state, but it is possible with moderate pressure to make plastic metals diffuse slightly, and under enormous pressure the more brittle metals may unite. This obviously makes use of the flowing property. Some metals, having practically no alloying affinity will, upon cooling from a fused mixture, separate more or less completely into layers according to their specific gravities. This is called liquation, and is the opposite of diffusion. The solubilities of the different components for each other vary with the temperature, and therefore alloys change in composition while cooling in almost all instances. This subject is further discussed in Chapter XXIX.

Welding.—This is the property of uniting without fusion. The requirements for welding are that the pieces to be united shall be in a plastic condition, fairly pure, and the faces to come in contact clean. Enough pressure must be applied to bring the

molecules into intimate contact. A hard metal may be welded by heating it until it becomes plastic. If a coating of oxide forms, it must be removed. As a rule, the pieces to be welded must be of the same kind of metal. Exceptions are found with iron and platinum, lead and tin and some others.

Occlusion.—By this term is meant the absorption and retention of gas. The property varies greatly with the metals, and the same metal absorbs different quantities of the different gases. As a rule, gases are dissolved most freely when the metal is pure and in the molten state. On cooling most of the gas is discharged, often producing the effect of boiling, while some is retained as accumulated bubbles (“blow-holes”) under the hardening surface, or held by the metal in “solid solution.” The physical properties in general are known to be affected in metals by occlusion.

Conductivity.—The metals are the best conductors of heat and electricity. The extended use of the electric current has led to the improvement of the conductivity of the metals used in the transfer of power. The property is much altered by the presence of impurities, only a trace in some instances affecting it. Conductivity varies inversely with the temperature of the metal.

Magnetism.—The magnetic property of iron has long been known and studied. It has been discovered in some other metals and alloys, but it is much weaker in these and is not of practical value. It is affected by impurities and temperature.

Density.—One of the distinguishing features of metallic substances is their superior density, or specific gravity. While it is true that metals, taken as a class, are heavier than other substances, there are exceptions, and there is no relationship between the density and the other properties of metals. This property is made use of in practically all processes of metal extraction.

The following groups show the orders of tenacity, malleability, and ductility:

TENACITY.		
1 Steel	4 Copper	7 Zinc
2 Nickel	5 Aluminum	8 Tin
3 Iron	6 Gold	9 Lead

MALLEABILITY.

1 Gold	5 Tin	8 Zinc
2 Silver	6 Platinum	9 Iron
3 Copper	7 Lead	10 Nickel
4 Aluminum		

DUCTILITY.

1 Gold	5 Iron	8 Zinc
2 Silver	6 Nickel	9 Tin
3 Platinum	7 Copper	10 Lead
4 Aluminum		

TESTING METALS

Most of the metal that comes on the market is bought under certain specifications relative to its physical properties. These properties are largely interpreted from chemical analysis, but in many instances mechanical testing is required. By this means the effort is made to subject a piece of the metal, representing the whole, to strains similar to those encountered in actual service, the force applied being measured, and its effect upon the test-piece noted.

Tensile Testing.—This is performed by subjecting a bar to a direct pull in a machine which measures the force exerted. The specimen is actually pulled asunder if the ultimate strength is to

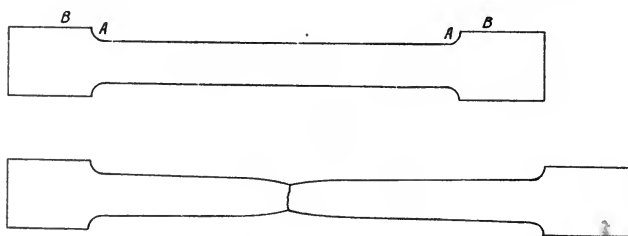

Fig. 1.—Test Pieces.

be determined. Fig. 1 represents a tensile specimen before and after it is broken. The size and shape of these bars is not fixed, but is varied to meet different requirements. The bar is turned on a lathe to a uniform diameter, which is accurately measured with a micrometer. Punch marks are made at the points AA,

which are usually from two to eight inches apart. The bar is grasped by the machine at the points B B. After the bar has been broken, measurements are again taken of the length and the diameter at the point of fracture, to ascertain the elongation and contraction.

The construction of a testing machine is shown in Fig. 2. The

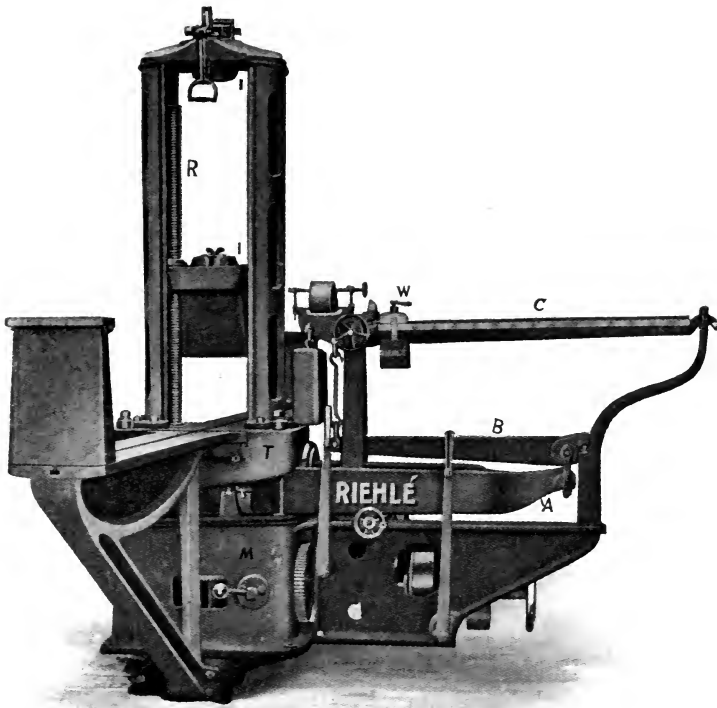

Fig. 2.—Riehle, Standard Testing Machine.

base of the machine consists of a substantial, cast iron box, M, enclosing the driving mechanism. The power is transmitted by gearing to the two large screws, one of which is visible, R. By turning these screws the pulling head is moved. The top and pulling heads, I I, are fitted with threaded sockets or special holders

for the specimens. The top head is supported on two cast iron columns which are bolted to the weighing table, T. The table rests upon the two main levers of the weighing mechanism. One of the levers is enclosed within the other, A, and each lever branches into a Y to give a broad support for the table. The friction at the points of support is minimized throughout the weighing apparatus by the use of steel knife edges resting on steel plates. The intermediate lever, B, and its connection with the main lever and the beam, C, are clearly shown in the cut. With this system of levers the strain exerted upon the specimen may be counterbalanced by moving the weight, W, along the beam. The stress is measured in pounds or kilograms which are marked on the beam.

Transverse tests may be made by aid of the V-shaped tools, one of which is shown attached to the under side of the pulling head and the other two set up on the weighing table. The tools upon the table are set at equal distances from the middle, and the specimen is supported on these in the horizontal position. The pulling head is lowered upon the specimen until it is sufficiently bent or broken.

Crushing tests are made by placing the specimen between two dies, one of which rests upon the center of the table and the other is attached to the pulling head.

Elastic Limit.—This value is usually found in connection with the tensile test. If the stretching force is applied at a constant rate and a counterbalance on the beam is maintained a sudden weakening of the specimen will cause it to stretch more with a unit increase of load. In other words the unit deformation takes place with a smaller increment of load when the specimen has weakened. This is called "permanent set," and is indicated by a rather sudden drop of the beam. In commercial testing this "drop of the beam" is interpreted as elastic limit. The reading on the beam does not represent the true elastic limit on account of some inaccuracies in the test, but it may be very near the true value. As determined in commercial testing the modulus of elasticity means the ratio of unit stress to unit deformation. This

is found by measuring the deformations corresponding to each unit of stress applied. A graphic representation is obtained by plotting the load units as ordinates and the corresponding deformations as abscissa, and connecting the points thus found by a curve. The abnormal stretching of the bar when permanent set takes place is indicated by a rather sudden change in the direction of the curve.

Hardness Tests.—Since hardness is an indeterminate property, different definitions are obtained by the different methods employed for testing the property.

The Sclerometer (Greek *sclero*, hardness), which was intro-

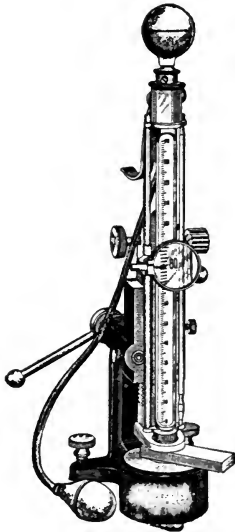

Fig. 3.—Shore Scleroscope.

duced by Thomas Turner, measures hardness in terms of resistance to a cutting tool. A standard diamond point is weighted until it will produce a standard scratch upon the smooth surface of the test specimen. The weight required then becomes the measure for hardness.

The Brinell Test consists in depressing a hardened steel ball into the surface of the specimen and measuring the diameter of

the depression made. The so-called "hardness number" is found by dividing the maximum pressure exerted by the calculated spherical area of the segment.

The Scleroscope has lately come into prominence as an instrument for testing hardness. It was invented in 1906 by A. F. Shore. Fig. 3 shows the instrument with a small specimen in position for the test, which consists in dropping a miniature tup hammer upon the specimen and noting the height of the rebound. In order to offset the effect of surface elasticity the hammer is armed with a diamond having a rounded striking face, and will make a depression in the hardest metals. The hammer is enclosed in a glass tube which is graduated to show the height of rebound. It is lifted to the dropping position by suction, and supported in such a way as to allow easy disengagement. The mechanism for creating the suction and releasing the hammer is actuated by means of the rubber bulb connected as shown. The scleroscope scale is divided into 140 equal degrees, giving range for all of the metals. The scale is based upon the average hardness of tool steel, which is taken as 100.

CHAPTER II

REFRACTORIES AND FLUXES

The refractory materials comprise all substances, natural or artificial, that are practically infusible. These are indispensable to the metallurgical industries. The parts of furnaces and retaining vessels that are subjected to high temperatures are constructed of such materials as will withstand heat and chemical attack to the highest possible degree under the conditions imposed. Specifically, some of the more important requirements of a refractory material are as follows: (1) It must not fuse or soften. (2) It must not crumble or crack. (3) There must be minimum contraction or expansion. (4) The heat conductivity and gas permeability must be low. (5) It must resist to a considerable degree, mechanical abrasion and chemical attack by substances brought in contact with it. It is, of course, impossible to obtain or prepare a substance that will answer to all the above requirements under the varying conditions of practice. The needs of each case must be understood, and from the materials available the one best suited may be selected.

The refractory properties of any material are dependent upon its chemical composition and its consistency, *i. e.*, the size of the grains composing it and the density in general. A brick will crack if it has a high coefficient of expansion and is unevenly heated, and it will crumble if the internal strains are sufficient to force apart the constituent grains.

Classification.—There are a number of substances which withstand the action of heat alone to a high degree, but react chemically if certain other substances come in contact with them. It is necessary, therefore, in lining a furnace for any specific operation to select that material which is least affected by the slags or mixtures peculiar to that operation. The refractories are classified, according to their chemical properties, as *acid*, *basic* and *neutral* materials. It is a well known fact that acids and bases neutralize each other mutually with the formation of new compounds. An acid lining would be corroded and melted out if

the mixtures of the furnace were basic in character, and vice versa. The neutral refractories have practically no reaction with either acid or basic substances.

ACID MATERIALS

Silica.—This is, strictly speaking, the only acid refractory substance used. The others owe their acid character to the presence of silica. It occurs nearly pure as quartz and in combination with metallic oxides. The fusion point of silica is very high, though it is easily melted in the electric arc furnace. It expands slightly when heated, but is otherwise practically unaltered at ordinary furnace temperatures. Heated in contact with basic metallic oxides, it forms silicates, many of which are readily fused. Silica, as a refractory material, is used chiefly in the form of loose sand, cut stone and brick.

Cut Stone is prepared from natural quartzite rocks such as the granites, gneisses and sandstones. A superior, silicious rock, known as ganister, has found extensive use in this country and in Europe. The best quality of ganister that has been found in this country is at Mt. Union, Pa., and in Wisconsin.

Silica Brick are prepared from selected quartzite rock with a small admixture of clay or lime. The function of these added substances is to effect a bond, which they do by forming silicates upon the surfaces of the quartz grains at the high temperature of the brick kiln. Whatever compound is formed fuses and becomes saturated with silica, which is present in overwhelming excess, and cements the grains together. Brick in which the bond used is alumina are known in this country as quartzite, and those in which the bond is lime as ganister brick.

In the manufacture of quartzite brick the sandstone and clay rock are crushed together and intimately mixed. After adding water the mixture is further worked and compressed, and then molded into bricks. The pressure exerted brings the silica grains into close contact, which insures their actual union when the silicate of aluminum fuses about them. The molding is generally done by hand. The hard-pressed, machine-made bricks are

stronger, but less refractory. After molding the bricks are stacked in the drying room. This is provided with a metal floor, and is heated from below by steam or hot air. The waste heat from the kilns may be utilized for this purpose. The bricks are next stacked in the kilns and burned for a period of from seven to ten days at a high temperature. The round style, down-draft kiln is most commonly used. Some of these kilns have a capacity of 100,000 brick. The temperature is determined by means of Seger cones. It may exceed $1,600^{\circ}$ C. The temperature should be higher than that to which the brick will be exposed in service.

Ganister brick are compounded from the ground mass of stone or a mixture of raw stone and grog (old brick) and freshly-burned, pure lime. The latter is added in the form of milk of lime.

Clay.—This term is applied to the most abundant and widely used class of refractory materials. Clay is formed by the natural decomposition of rocks of the feldspar group. Clay deposits are either residual or sedimentary. Residual deposits occupy the same space and position as the rocks from which they were derived, and sedimentary or bed clays are those which have been transported, chiefly by water, and deposited. By the sorting action of water both the physical and chemical composition of clay may be greatly altered, the size, shape and specific gravity of the particles determining their order of deposition. In composition clays vary from pure kaolin, which is hydrated aluminum silicate, to variant mixtures of this mineral with undecomposed feldspar, free silica as sand grains and gravel, iron combined as oxide, silicate or sulphide, the alkaline earths, oxide of titanium, the alkalis and organic matter. The subjoined table gives the composition of some important metallurgical clays. The wide use of clay is largely due to its becoming plastic and cohesive when wet. For this reason bricks and crucibles may be manufactured from it without the use of a binding material. When ignited sufficiently to drive off the combined water, clay loses its plasticity, but if pressed before ignition it cements itself into a hard mass. Clay shrinks during ignition on account of the

loss of water. This combined water can not be restored after ignition. For this reason burnt and raw clay are often mixed by manufacturers to lessen shrinkage. Clay is the furnace builder's mortar. In building substantial furnace walls the bricks are set in fire-clay, and sometimes it is plastered over the walls to form a seamless lining.

The most refractory clays are those containing an excess of alumina. The impurities (basic oxides), though they might be highly refractory when isolated, have a softening effect on the clay on account of their chemical action. Alumina, being a weak base, does not form an easily fusible compound with silica, but with another base, such as lime, an easily fusible, compound silicate may be formed. Sulphide of iron is sometimes met with in clay, existing as small grains or crystals. This is highly objectionable, since on being heated strongly the sulphide is converted into ferrous oxide, which in turn combines with silica. The ferrous silicate formed is then fused out, leaving a cavity. The amount of ferric oxide that is allowable in a good fire-clay is a disputed point. As much as two per cent. is not unusual and does not seem to be detrimental. The lime, magnesia and alkalis together should not amount to more than two per cent.

TYPICAL FIRE-CLAYS.

Silica	75.00	61.50	50.35
Alumina.....	17.10	26.15	33.65
Ferric oxide	1.05	0.35	0.75
Ferrous oxide.....	0.15	0.40	—
Lime	0.50	0.15	—
Magnesia.....	0.10	0.05	—
Potash	0.30	—	0.50
Soda	0.15	0.05	0.10
Titanic acid.....	0.05	1.40	0.80
Water	6.50	10.00	13.75

BASIC MATERIALS

Magnesia.—The mineral magnesite, or carbonate of magnesia, is frequently met with, associated with serpentine and other silicious rocks. Large known deposits are rare, though some

important recent discoveries have been made. The main source of magnesite in this country is California, where some of great purity is found. More is imported from Greece and Styria.

When magnesite is ignited at high temperature it gives off carbon dioxide, and the residue is magnesium oxide or magnesia. This substance is highly refractory, and it is the most satisfactory material known for some purposes. It is crushed and used on the hearths of basic furnaces or manufactured into bricks for constructing the walls. Magnesia has no binding property of its own, but strong bricks are made by mixing with it a small quantity of silicious material and compressing. The price of magnesia precludes its more general adoption.

Lime is made from calcite or limestone, just as magnesia is prepared from magnesite. It is even more infusible than magnesia, but its use as a refractory is hardly important enough to mention. Its strong affinity for water causes it to attract moisture from the atmosphere, and as a result it crumbles. If, however, lime be mixed with sufficient magnesia, a very satisfactory material is obtained. Fortunately, there is a natural mixture of this kind, known as dolomite.

Dolomite.—Like magnesite and limestone, dolomite requires to be strongly ignited before use. On account of its abundance, dolomite is the most important of the basic lining materials.

Bauxite.—This is the sesquioxide of aluminum with varying amounts of the corresponding oxide of iron. The chief sources in the United States are Georgia, Alabama and Arkansas. Bauxite is highly refractory when free from silica, and it is but feebly basic. It has proved itself an excellent lining material, and its more general adoption is expected if it becomes more abundant.

NEUTRAL MATERIALS

Graphite.—This substance, otherwise known as plumbago or black lead, is an allotropic form of carbon. It is mined chiefly in Ceylon, Siberia and Austria. The only mines in this country of any importance are in New York. The origin of graphite is

not known, though it is supposed to be vegetable. It occurs with both calcareous and silicious rocks in veins or lumps, or in the form of scales disseminated through the rock. Graphite has not been fused in the isolated form, and oxidation occurs but slowly at furnace temperatures. In the electric arc it burns freely, but does not fuse. Graphite would have a very wide application as a refractory material if it were not for its high cost. Its principal uses are in the manufacture of crucibles and bricks for special purposes, and in foundries. It is used alone or mixed with clay.

Chromite.—The use of chrome ore, or chrome-iron ore, has been restricted to a few operations on account of its scarcity. It has been found most satisfactory under the severe test of high temperature and in contact with both acid and basic materials. Chrome ore is manufactured into brick, lime being used as a binding material.

THE FLUXES

In the extraction of metals from their ores, and in their subsequent purification, the refuse matter of the ore (the gangue) and the accumulated impurities have to be dealt with. These substances are often of a refractory nature, and remaining unfused, would retard the process and prevent complete separation of the metal. Advantage is here taken of the behavior of acid and basic substances toward each other. Some substance of the opposite chemical character to the gangue is added, and combination ensues with the formation of an easily fusible compound. The substance added is called a *flux* and the resulting compound is *slag*. Any operation in which the metal is extracted in the state of fusion is termed *smelting*. The word *cinder* is used interchangeably with the word *slag*, but it has a wider meaning. Cinder, as used in this text, means refuse matter that is not fused.

Like the refractories, the fluxes are divided into the three classes—acid, basic and neutral. Slags may be made either acid or basic by adding to them an excess of the proper flux. They may be made more fusible, without altering their acid or basic

properties, by adding a neutral substance having a low melting point. The common fluxes are: *Acid*, silica; *Basic*, lime, magnesia, ferrous oxide, manganous oxide and alumina, which is feebly basic; *Neutral*, fluorspar.

Slags.—The main function of slags is to separate gangue stuff or impurities from metals, and to protect them from the injurious action of gases or other substances while they are heated to high temperatures. Being poor conductors, they conserve heat by retarding radiation from the body of metal they cover. To the smelter a knowledge of the properties of slags is of greatest importance, especially as regards their chemical behavior and fusibility. Their formation temperature and fluidity are also of importance. The temperature at which substances will combine to form a slag may differ considerably from that at which the slag will melt. The formation temperature is generally lower, but the slag reactions generate heat, and as a result the temperature may rise above the melting point of the slag. It is to be observed that fusibility and fluidity are not parallel properties with slags. Some slags of low melting points remain viscid through a considerable range of temperature, while others requiring a high temperature for fusion become quite liquid with a few additional degrees of heat.

Constitution of Slags.—A slag may consist of a single compound, but most frequently two or more silicates are present, and in these other substances are dissolved or suspended. While in the fused state the slag is of uniform composition if the temperature remains constant, but upon cooling some constituents may pass out of solution or segregate. By segregation is meant the concentration of constituents in certain portions of a solidifying mass on account of the failure of the solvent to hold them. The highest degree of concentration must take place in that portion which solidifies last, since solvent power diminishes with temperature. This phenomenon is otherwise known as selective freezing. Analogies are found in the freezing of water containing dissolved salts. It is here observed that the first crystals of ice formed are relatively free from salts, and as freezing pro-

gresses the solution becomes more concentrated in dissolved matter. If substances in solution do not separate by crystallization during the process of freezing the result is a *solid solution*. Slags of this kind are observed to be vitreous glasses, and those containing matter that is not dissolved are stony in appearance. Generally speaking, metallurgical slags are silicates in which an excess of either silica or bases may be dissolved, or if the saturation limit be passed, precipitated. While it is generally true that the oxides of the metals are bases, it should be understood that some behave as acids in the presence of strong bases. This is notably the case with alumina.

In making slag calculations the silicates are classified according to the ratio of oxygen in the base to oxygen in the acid. The following table gives the names and ratios for the different silicates of monoxide and sesquioxide bases. The metal of the base is represented by the letter M:

Monoxide base	Sesquioxide base	Ratio	Name
$4\text{MO} \cdot \text{SiO}_2$	$4\text{M}_2\text{O}_3 \cdot 3\text{SiO}_2$	2 : 1	Subsilicate
$2\text{MO} \cdot \text{SiO}_2$	$2\text{M}_2\text{O}_3 \cdot 3\text{SiO}_2$	1 : 1	Monosilicate
$4\text{MO} \cdot 3\text{SiO}_2$	$4\text{M}_2\text{O}_3 \cdot 9\text{SiO}_2$	2 : 3	Sesquisilicate
$\text{MO} \cdot \text{SiO}_2$	$\text{M}_2\text{O}_3 \cdot 3\text{SiO}_2$	1 : 2	Bisilicate
$2\text{MO} \cdot 3\text{SiO}_2$	$2\text{M}_2\text{O}_3 \cdot 9\text{SiO}_2$	1 : 3	Trisilicate

TESTING REFRACTORIES

The specific properties of raw materials or manufactured articles like brick are best studied by aid of a direct test. Means have been devised for testing refractories to determine the extent to which they will answer to the requirements as laid down on page 13, and their fitness for certain applications. Results so obtained are not, however, to be taken as conclusive in every instance, since the conditions of the test are not often identical with the conditions of practice. For example, the temperature employed may be just as high or higher than that in practice, and practically the same substances may be brought in contact with the material tested, but the combined and variable effect of different factors obtaining in practice, can not be reproduced on the small scale of a laboratory test. A more practical, though more

expensive, test is made by the experimental use of the material on the industrial scale.

The Melting Points of most refractories are above the range of ordinary furnace temperatures, but many of them soften or actually fuse at the high temperatures occasionally employed. In view of this and of the relation of melting points to the formation of slags, determinations of the direct effect of heat upon refractories and fluxes is of interest and importance. The results tabulated below were obtained by C. W. Kanolt in the laboratory of the Bureau of Standards. The specimens were from one to two cm. in diameter, and were heated in an Arsem, graphite, vacuum furnace using electric resistance. The temperatures were determined by means of a Morse optical pyrometer.

Material	Melting point, C.
Fire-clay brick	1649
Bauxite brick	1565-1785
Silica brick	1700-1750
Chromite brick	2050
Magnesia brick	2165
Kaolin	1735-1740
Bauxite clay	1795
Bauxite	1820
Alumina	2010
Chromite	2180
Silicon carbide	above 2700

A practical test of the refractoriness of clays may be made by the use of "Seger cones."¹ Each sample to be examined is finely ground, and after thorough mixing, is moistened with water and kneaded into a stiff dough. From each sample are molded small, triangular pyramids. After carefully drying the pyramids are heated in a muffle furnace, and the effect is noted by their behavior. As shown in Fig. 4 the pyramid containing a clay that is infusible at the temperature employed retains its form and the edges remain sharp, while the less refractory ones show a tendency to curl. Some may actually fuse to a globule. The tem-

¹ For a fuller discussion of this subject see "The Collected Writings of Herman A. Seger," 1, p. 224.

perature of the muffle is determined by means of a pyrometer. Pyramids made of tested clay of known fusion temperature may be used for this purpose. The temperature, as determined by the standard pyramid, is indicated at the moment the head is bent down until it reaches the level of the base.

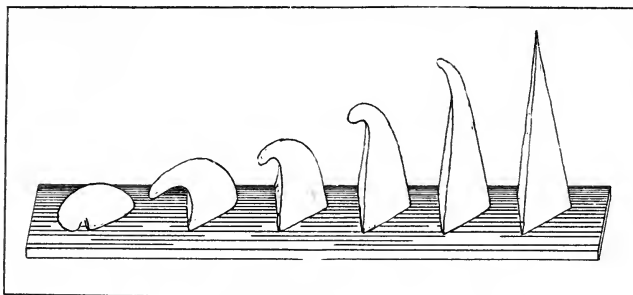

Fig. 4.

The Expansion or Contraction of refractories under the influence of heat is an important consideration in furnace building. As has been pointed out silica expands slightly and clay shrinks when heated. Graphite remains practically constant. The various mixtures of different substances afford all possible variations within the extreme limits in the change of volume of refractory products. Aside from the composition, the pressure that is exerted upon them and the temperature at which they are burned affect the expansion or shrinkage of brick. Tests may be made in a practical way by heating brick in a furnace with pyrometer attachment, the expansion or shrinkage being measured by aid of a pivoted beam one end of which is supported by the brick. The other end of the beam may be extended to magnify its upward or downward movement, the readings being obtained by means of a pointer on the beam and a scale placed behind it.

The Heat Conductivity of refractories is a determining factor in the efficiency of many furnace operations. It depends largely upon the temperature at which the material is burned, increasing

with the burning temperature, and it rises rapidly with the present temperature of the material. The following table was prepared by A. L. Queneau from M. S. Wologdine's figures.¹

Conductivity Material (Brick)		
	Gram calorie seconds per sq. cm. per cm. per 1° C. difference	Relative conductivity
Graphite	0.025	100.0
Carborundum	0.0231	92.4
Magnesia	0.0071	28.4
Chromite	0.0057	22.8
Fire-clay	0.0042	16.7
Building	0.0035	14.0
Bauxite	0.0033	13.2
Terra cotta	0.0022	9.3
Silica	0.0020	7.8

¹ Elec. & Met. Ind., VII, 383.

CHAPTER III

COMBUSTION AND THERMAL MEASUREMENTS

The term combustion, as used in this text, means the rapid combination of any substance with oxygen. When the reaction of oxygen upon a substance produces visible effect, that substance may be said to be in a state of combustion. Combustion will not take place with most substances until they are heated to a temperature exceeding 400° C. The ignition or kindling temperature of a substance varies with its physical and chemical conditions such as state of subdivision and purity. Any substance employed for producing heat by virtue of its combustion is a *fuel*. The heat of combustion is, therefore, due to the union of the elements composing fuels with the element oxygen. If a fuel yields a combustible gas when heated to the kindling temperature a flame is produced. Flame, therefore, attends the burning of gas, oil, soft coal and wood, while charcoal, coke and anthracite, if entirely free from volatile combustibles, burn without flame in a ready supply of oxygen. Glowing particles or vapors give color and luminosity to flame. Luminosity is generally due to particles of carbon. If combustion is not complete a luminous flame will deposit carbon in the form of soot. Hydrocarbon gases are dissociated in the process of combustion with the liberation of carbon, though the appearance of incandescent carbon in the flame is prevented if a combining excess of oxygen is diffused with the gas before ignition.

The offices of fuels are twofold. In addition to their being the usual means of obtaining high temperatures, they often play the important part of decomposing the ores by chemical action with them, and liberating the metals. In this capacity they are termed *reducing agents*. The term reduction generally means taking oxygen from a compound, or the opposite of oxidation. The heat derived from the combustion of fuel is not necessarily confined to the reactions with atmospheric oxygen, but it may be due in part to that oxidation which is coincident with the reduction of metallic oxides, thus :

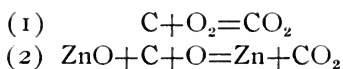

In reaction (1) the oxygen is taken entirely from the air, while in reaction (2) half of the oxygen is taken from the oxide of zinc. The heat of oxidation is the same in both cases, but in (2) heat is absorbed by the reduction of zinc oxide. A reaction in which heat is evolved is called *exothermic*, and one in which heat is absorbed is called *endothermic*. It may be said, in general, that oxidation is exothermic and reduction is endothermic. The amount of heat derived from the burning of fuel depends upon the energy with which the fuel combines with oxygen, and the temperature produced depends upon the energy, rate of combustion and the nature of the products of combustion.

CALORIMETRY

The heating value of a fuel is expressed by the number of unit weights of water that one unit weight of the fuel will raise through one degree of temperature by its combustion. The unit of weight chosen is the kilogram, and the amount of heat necessary to increase the temperature of one kilogram by one degree, Centigrade, is called one heat unit or one *calorie*. To be exact, the water must be at 4° C.

Other units are employed to express heat values. The small calorie is the amount of heat required to raise one gram of water 1 degree C. The British thermal unit (B. t. u.) is the amount of heat required to raise one pound of water 1 degree at 39° F. One B. t. u. is equal to 0.251996 calorie.

The heating power of fuels is determined experimentally by burning a weighed sample under a weighed amount of water in such a manner that the heat evolved is absorbed by the water, and the rise in temperature is indicated by means of a delicate thermometer. An apparatus designed for such a determination is called a calorimeter.

The Parr Calorimeter is shown in sectional elevation in Fig. 5. The principal parts are the cartridge, D, in which the fuel is burned; the copper vessel, A, holding two liters of water for

absorbing the heat; the insulating vessel, B, and the delicate thermometer for indicating the rise in temperature of the water.

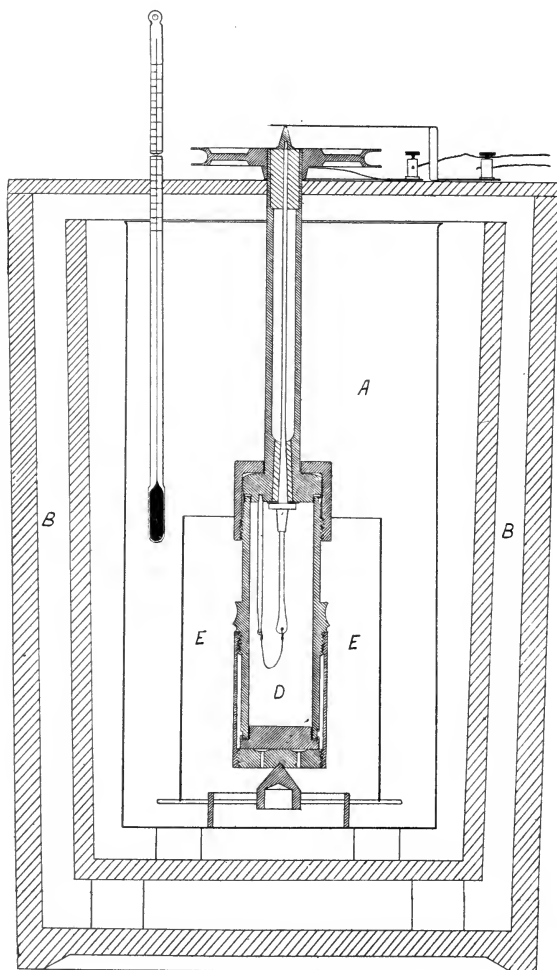

Fig. 5.—Parr Calorimeter.

The short cylinder, E, surrounding the cartridge, is open at both ends, and has a centrally attached pivot for supporting the cartridge and giving it a bearing for rotation. The cartridge is re-

volved during a determination by means of a small motor. Turbine wings are attached to the cartridge for stirring the water and maintaining uniformity of temperature. The cartridge, in detail, consists of a stout metal cylinder, which is closed at the bottom by a disc and at the top by the base of the hollow spindle carrying the rotating pulley. The discs are secured by caps, which screw on the cylinder, the joints being made tight by rubber or lead gaskets. Sodium peroxide and other oxidizing agents are used to supply the oxygen. The mixed charge of fuel and reagent is ignited by means of a loop of fine iron wire through which a current is conducted of sufficient strength to burn the wire. A rod, passing through and insulated from the spindle, and the spindle itself, serve as conductors for the current.

Bomb Calorimeters.—The principles upon which calorimeters of this type are constructed are similar to those of the apparatus just described, but the fuel is burned in compressed oxygen. The combustion takes place in a strong steel vessel known as the bomb. The inner walls of the bomb are lined with enamel or a refractory metal. It is made in two parts which are closed by a threaded and carefully machined joint. A needle valve is used for introducing the oxygen from a pressure tank. The portion of fuel to be burned is held in a small platinum or nickel pan supported on wires, which also serve to conduct the current for ignition. Instruments of the bomb class represent the highest degree of perfection that has been attained in calorimeter construction.

Calorific Power by Calculation.—Knowing the calorific powers of the several elements constituting a fuel, its heating value may be calculated from the results of a chemical analysis. For example: A fuel contains 80 per cent. carbon, 15 per cent. hydrogen, and 5 per cent. sulphur. Referring to the table (p. 28) for the elements—

$0.80 (8080) + 0.15 (34,500) + 0.05 (2,220) = 11,750$ calories.

If the fuel contains oxygen already combined with hydrogen, it is obvious that so much hydrogen is not available as a com-

bustible ingredient, and should be deducted from the total hydrogen in calculating the calorific power. Since oxygen combines with one-eighth of its own weight of hydrogen, the calorific

power of hydrogen becomes $\left(H - \frac{O}{8}\right) 34,500$.

Calorific Intensity.—By calorific intensity is meant the temperature to which the products of combustion will be raised when a fuel is burned under given conditions. The highest temperature is attained when a fuel is burned in a ready but not excessive supply of pure oxygen. The calorific intensity is found by dividing the calorific power by the weight of the products of combustion, multiplied respectively by their specific heats, thus:

$$C. I. = \frac{C. P.}{W_1S_1 + W_2S_2 + W_3S_3, \text{ etc.}}$$

The weights of the several products are represented by W_1 W_2 W_3 , etc., and the specific heats by S_1 S_2 S_3 , etc. Engineers use a similar expression to denote the *evaporative power* of fuels. Numerically expressed, the evaporative power is the weight of water, at 100° C., that a unit weight of a fuel will convert into steam. It is found by dividing the calorific power by 537, the latent heat of steam.

CALORIFIC EFFECT OF SOME OXIDATION REACTIONS.¹

Element	Product	Calories
Hydrogen	H ₂ O	34,500
Carbon	CO ₂	8,080
Silicon	SiO ₂	7,720
Phosphorus	P ₂ O ₅	5,966
Sulphur	SO ₂	2,220
Iron	Fe ₃ O ₄	1,585
Zinc	ZnO	1,321
Copper	Cu ₂ O	321
Lead	PbO	239
Mercury	HgO	110
Nitrogen	NO	-1,541

¹ Substantially the values given by Thomsen.

PYROMETRY

Laboratory experiments may be valuable so far as they go, but the actual efficiency of fuels can not be determined in this way. No more should be expected from such determinations than the relative heating values. The most practical results are gained by putting the fuels into actual use for a reasonable length of time, and measuring their efficiencies by the work done or by whatever means are at hand. In the attainment of high temperatures, which is necessary in many metallurgical processes, the temperatures are indicated by means of pyrometers (high temperature thermometers). These instruments are especially useful when it is desirable to know the range of temperature over a considerable length of time, as they are now designed to record temperatures automatically. Such records may be used to denote efficiency or regularity of heating, as the case requires.

Thermometer and Pyrometer Scales.—It should be noted that temperature measurements are not absolute, because absolute zero in temperature is not known. All measurements are, therefore, relative only. The Centigrade or Celcius scale, which is universally employed in scientific work, places the melting point of pure water ice at zero and the vapor of boiling water, under 760 millimeters pressure, at 100 degrees. The thermometer scale is calibrated by placing the bulb of the instrument in direct contact with water under these two conditions, and having found these two points, the intermediate unit degrees will correspond to the 100 intermediate and equal divisions of the scale, provided that the bore of the thermometer tube is of uniform caliber. Likewise the scale may be extended upward, each division marking an equal expansion of the liquid which, within the limitations of the materials used, will correspond to equal increments of temperature. The calibration of all pyrometers is based, directly or indirectly, upon the standard gas thermometer, since the law governing the increase of pressure of a gas at constant volume admits of the greatest accuracy of application through the widest range of temperatures. With the perfecting of the means of applying the different principles for determining high tempera-

tures the calibration of pyrometers is made more accurate, approaching the ideal, which is the continuation of the thermometer scale.

The first practical pyrometer appears to have been devised by Wedgwood, who realized the need of determining and controlling the temperature of his pottery kilns. The indicator which he used depended upon the contraction of clay at high temperatures. A number of pyrometers have since been invented, making use of different principles. Brief descriptions of some of the more important ones are here given.

Metal Expansion Pyrometer.—Instruments of this class are designed to measure the expansion of a single metal or of two metals acting differentially when heated. They are limited to low temperatures.

Specific Heat Pyrometer.—Heat is transferred from the furnace to be tested to a definite weight of water by a metal of known specific heat. The temperature to which the water is raised, which is a function of the temperature of the furnace, is determined by means of a thermometer.

The Siemens Water Pyrometer is of this class. It is suitable for approximate measurements only and its upper limit is about 950° C.

Heat Conduction Pyrometer.—A current of water of known temperature flows at constant rate through a tube placed in the furnace. The increase in temperature is proportional to the temperature of the furnace.

Gas Pyrometers.—With this class of apparatus the expansive force of heated air or other gas is made use of. The gas is confined in a vessel of porcelain or metal, which is placed in the atmosphere to be tested. The vessel has a tubular extension, which extends outside of the furnace and communicates with a delicate pressure gauge.

Electric Resistance Pyrometer.—The principle of this instrument was put forward by Werner Siemens. It was further developed by William Siemens, who introduced platinum wires

instead of base metal for the resistance, and was finally perfected through the efforts of H. L. Callendar and others. The apparatus consists essentially of a battery, a galvanometer, a Wheatstone bridge for measuring resistance and a platinum resistance wire for insertion into the furnace.

The principle of the resistance pyrometer is shown in Fig. 6, in which B represents the battery, P the platinum resistance wire, known also as the bulb, and G the galvanometer. The battery current is divided at a, encountering the two equal resistances,

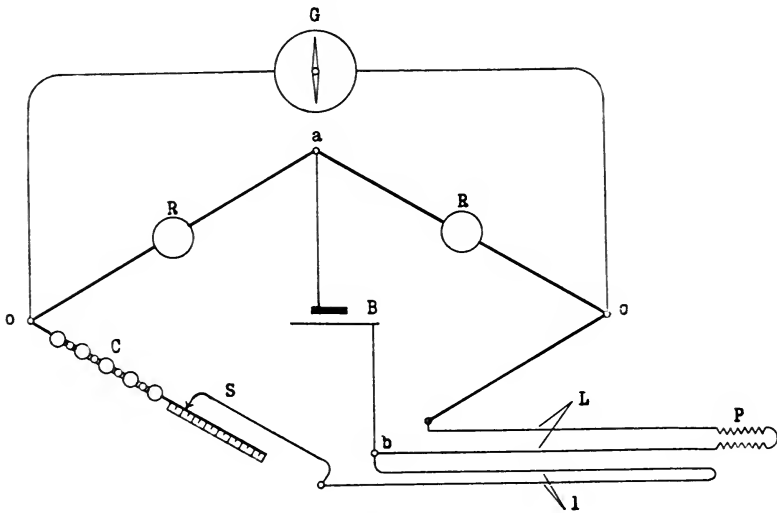

Fig. 6.

RR, which constitute two arms of the bridge. In the other two arms of the bridge are interposed the platinum wire, the coils, C, and the slide, S, the combined resistance of which is equal to that of RR. Under these conditions the potential at the points, oo, will be zero, and there is no deflection of the galvanometer needle. Differences in the potential are brought about only by changes in the temperature of the bulb, since practical means are employed to maintain constant temperature for all the other resistances. The loop wire, l, is inserted to compensate for the variable resistance of the lead wires, L, being composed of the same metal

and subjected to the same temperature conditions as the lead wires. In order that there may be no thermo-electric effect at the juncture with the bulb, the lead wires are made of platinum. The circuit is reunited at b, from which point it is returned to the battery over a single wire.

In using the pyrometer the bulb is placed in the temperature to be determined, and its increased resistance is compensated by inserting plugs to cut out coils, C, the fine adjustment being made by means of the slide. The exact balance is indicated by the return to zero of the deflected, galvanometer needle. The resistance of the separate coils and of the slide wire being known, the increased resistance of the bulb is thus measured. This may be interpreted and the instrument calibrated in terms of temperature by comparison with a standard.

Thermo-Electric Pyrometer.—When two different kinds of metal are in contact their electric equilibrium is disturbed by

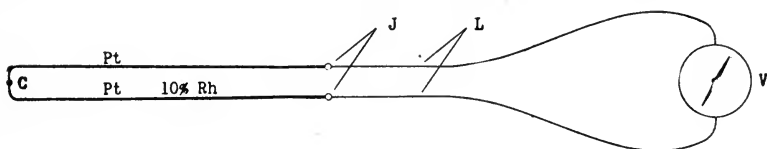

Fig. 7.

changes in temperature. If, therefore, the metals are connected at separate points, unequal temperature at these points will cause an electric current to flow around the circuit, and the intensity of the current will be proportional, within certain limits, to the difference in temperature. In order to apply this principle in pyrometry it is obviously necessary to use refractory metals. For measuring temperatures not exceeding 600° C. and where great accuracy is not essential iron, copper, nickel and other base metals are used, and in accurate higher temperature work the platinum metals are used. The perfection of the thermo-electric pyrometer is due chiefly to Le Chatelier, who introduced the platinum-rhodium couple. The principle of the thermo-electric pyrometer is shown in Fig. 7. The thermo-couple, commonly called the "fire end," is composed of a platinum wire and a wire of plati-

num alloyed with 10 per cent. of rhodium. The couple wires are fused together at C, and are connected with a millivoltmeter, V, by the conductors, L. If the temperature of the rest of the apparatus is kept constant the electromotive force measured by the millivoltmeter will be a function of the temperature at C, and the instrument may be calibrated to read degrees of heat when the couple is placed in known temperatures. These temperatures are obtained by the use of substances of known melting points.

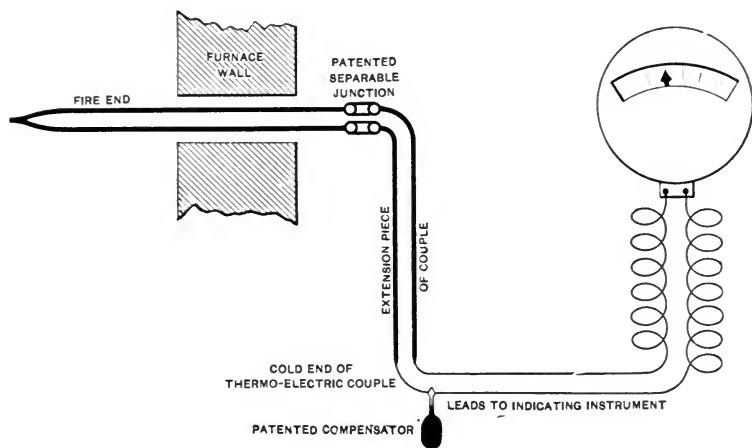

Fig. 8.—Principle of Bristol Pyrometer.

The junction, J, of the couple and conductors is conveniently kept at constant temperature by immersing it in melting ice. Theoretically the whole apparatus outside of the furnace should be kept at constant temperature, since an electromotive force is established at any junction of different kinds of metal.

Fig. 8 shows the principle of the Bristol thermo-electric pyrometer as designed for commercial use.

A compensator is used to offset the effect of variations in temperature outside the furnace, on the "cold end" of the couple. The compensator consists of a glass bulb, having a narrow neck, containing mercury. A platinum resistance wire passes through the walls of the neck and dips downward into the mercury. Changes in temperature cause a rise and fall of the mercury in

the neck of the bulb, as in the capillary tube of a thermometer. This regulates the resistance by short-circuiting more or less of the wire loop.

Radiation Pyrometer.—The radiant energy emitted by heated bodies is proportional to their temperature provided they do not transmit or reflect energy. Those bodies which absorb all radiant energy thrown upon them are called "black bodies." Ordinarily the interior of furnaces or substances treated therein fulfill the ideal black body conditions sufficiently to permit of measuring their temperatures by measuring a definite portion of their radiant energy or emissivity. Charles Fery, of Paris, invented a pyrometer based upon this principle and the Stefan-Boltzman Law, which holds that the radiation from a black body is proportional to the fourth power of its absolute temperature.

The Fery pyrometer consists essentially of a telescope tube containing a concave mirror, a delicate thermo-couple and, separately, of a millivoltmeter. When the telescope tube is pointed toward a heated surface the mirror receives and reflects a portion of the radiant heat, which is focused upon the thermo-couple and measured by the millivoltmeter. In calibrating the apparatus comparison is made with the standard gas pyrometer, and readings above this range are calculated upon the basis of the above law of radiation.

Optical Pyrometers.—These are otherwise known as radiation pyrometers. The principles of radiation are discussed above. In the methods here considered, the measurements are determined by the intensity of the light emanating from heated bodies.

One of the simplest methods in optical pyrometry is that employed by Holborn and Kurlbaum in Germany and by Morse in this country. A telescope is used in which an incandescent lamp is interposed between the eye and the heated surface under observation. The current is supplied from a battery, and is controlled by means of a rheostat and measured by an ammeter. While the observer sights the heated surface through the telescope he adjusts the current until the lamp filament disappears by reason of its being heated to the same temperature as the

object forming the background. Under proper conditions the amount of current required is an expression for the temperature, and the apparatus may be calibrated by comparison with a standard pyrometer. Temperatures ranging from 600° C., the lower limit in optical pyrometry, to $1,100^{\circ}$ may be determined with the above instruments with practical accuracy.

Le Chatelier was the first to perfect an optical pyrometer and put it into convenient form, which he did in 1892.¹ The Le Chatelier apparatus is a modified photometer in which the light from the heated surface under observation and that from a standard gasoline lamp are focused before the eye in separate fields, side by side, for the purpose of comparison. Readings are obtained from a scale attached to an adjustable diaphragm, by means of which the light from the source under observation is diminished until the two fields are the same in intensity. Absorption glasses are employed when very high temperatures are to be determined. Since the eye is more sensitive to red light the entire observation area is seen through a red glass.

The Wanner Pyrometer, which was brought out in 1901, was the first of the spectrophotometer type. The standard light used with this apparatus is a lamp burning amyl acetate. For convenience in use an incandescent lamp is used, though it is necessary to standardize this with the amyl acetate lamp and to carefully regulate the current to keep the brightness of the electric lamp constant. Fig. 9 shows the essential parts of an optical pyrometer of the Wanner type as arranged for standardization. The dotted lines indicate the paths of the light rays from the amyl acetate lamp, L, and the incandescent lamp, N. The light from N is reflected by the right angle prism, P, and passes into the pyrometer tube through the slit T_2 , while the light from L comes straight through the slit T_1 . The rays from the two sources are first rendered parallel by the lens, O_1 , and then changed to a continuous spectrum by the prism, P_2 . The Rochon prism, P_3 , next separates the rays into polarized planes at right angles.

¹ J. de Phys., (3) 1, p. 185.

By means of the lens, O_2 , and the bi-prism, P_4 , only two red

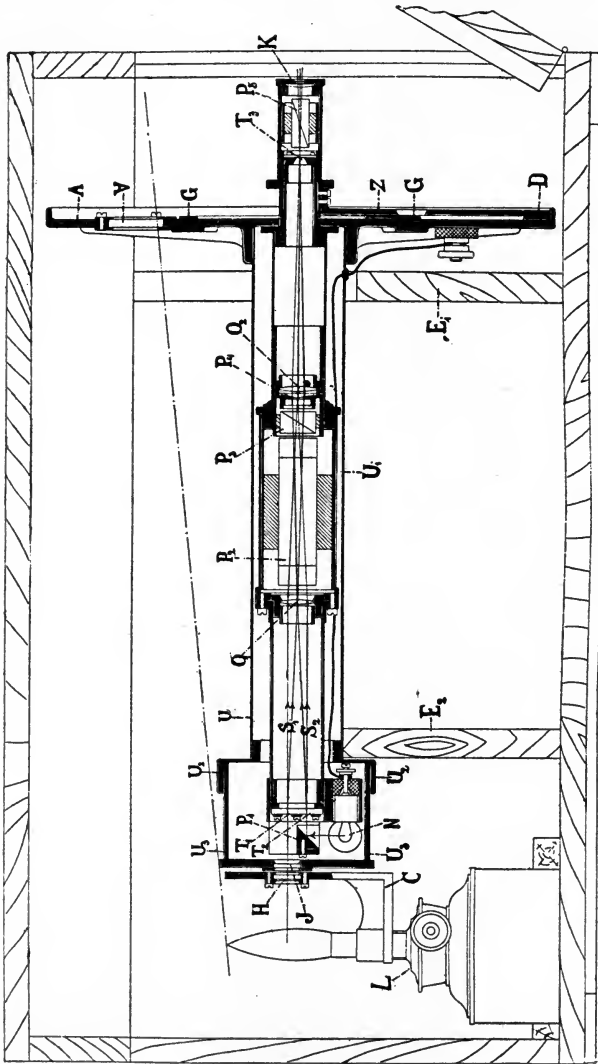

Fig. 9.—Section through Optical Pyrometer. (Courtesy of Scientific Materials Co.)

bands of light are brought into the slit, T_3 . These represent the portions of light admitted from the two sources polarized in

planes at right angles and appearing as contiguous, red fields, P_5 is a Nicol prism known as the analyzer. This may be revolved concentrically with the axis of pyrometer tube, and the angle of rotation is measured upon a scale by a finger attached to the revolving member. If the analyzer is at an angle of 45° with the plain of polarization of the light from the two sources and the light from them is equal, the observer, looking through K, sees a single red disc of light. If the light from one source is more intense half of the field will be brighter, but equal brightness is established by turning the analyzer. In standardizing the pointer is set at the angle which corresponds to the temperature of the amyl acetate flame, and the current is adjusted by aid of a rheostat until the intensity of the incandescent lamp corresponds with that of the standard. The apparatus is now ready for use, the light from the source under observation being substituted for that of the amyl acetate lamp and the electric light becoming the standard for comparison. The scale may be extended by comparison with standard pyrometers or it may be calibrated upward indefinitely in accordance with Wien's law.¹

The direct, temperature-reading scale is due to G. A. Shook,² who has also designed scales for the above pyrometer to read temperatures of substances which do not fulfill black body conditions. A separate scale must be calibrated for each substance in accordance with its emissive power.

Melting Point Pyrometry.—Having once determined, by the most accurate means available, the melting points of pure salts, metals or other substances of definite composition, these substances may be used as a means of determining temperatures or of calibrating pyrometers. One of the most common applications of this method is the use of clay pyramids, already described (p. 21).

Having made these from a clay of definite composition and tested them in a known temperature, that temperature will be

¹ Wied. Ann., 58, p. 662; 1896. This subject has also been investigated by Planck, Paschen and Wanner whose papers were published in Ann. d. Phys. (1899-1900) and elsewhere.

² Met. & Chem. Eng., XL, p. 532.

indicated by the softening of other pyramids made from the same clay.

Pyrometer Records.—The usefulness of pyrometers has been greatly enhanced by the introduction of automatic recorders. Any pyrometer which indicates temperatures continuously and without adjustment by an attendant may control a mechanism which plots the temperature record autographically or photographically. Autographic records are plotted on paper charts which are ruled to represent units of time and temperature, and photographic records are made upon sensitized plates or films which are acted upon by a beam of light reflected from a mirror on the moving system of the galvanometer or other instrument. The photographic method is capable of great precision, but it is generally unsuitable for practical work, owing to the inconvenience of having to develop the record before it can be seen. In general, the direction of the curve representing time is obtained by aid of a clock movement or a constant speed motor.

Recorders are chiefly used in connection with thermo-electric and resistance pyrometers, and are known, according to their manner of working, as deflection and balance instruments. The essential difference is that deflection instruments make the record by direct contact of the galvanometer needle with the chart, unless the apparatus is photographic, and balance instruments employ a separate mechanism which produces the record, and at the same time, restores an electrical balance to the galvanometer.

The Bristol recorder, shown in Fig 10, is of the deflection type, and is specially designed for use with base metal couples, which give a comparatively high electromotive force. The recorder consists of a galvanometer and a clock movement for driving the chart upon which the temperature is registered. The galvanometer needle is extended into a slender arm, which is bent at right angle near the end and pointed. The chart revolves behind the pointer, and is accurately ruled to indicate the position of the pointer in terms of temperature degrees. The chart has a sensitized, smoked surface which takes an imprint from the pointer by momentary contact with it at frequent intervals. The

contact is made by vibrating the chart, which is done by a mechanism under control of the clock movement. A practically continuous record is thus obtained.

The Bristol recorder is also designed to give a record in ink. The galvanometer arm carries a capillary gold tube, one end of which is brought into contact with the chart and the other end

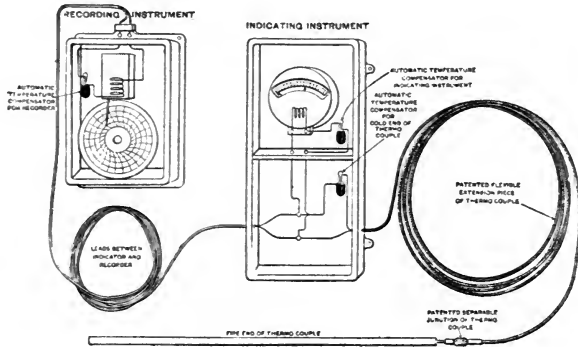

Fig. 10.—Bristol Recorder.

is simultaneously touched by an inking pad. A fine ink dot is thus printed every 10 seconds. Except for the moment the recorder arm is thus engaged it is free to take up any position.

The Leeds and Northrup apparatus is a representative of the balance type of recorders. Its mechanism will be understood from the following description and by reference to the drawing, Fig. 11, and subjoined legend. The moving galvanometer coil, O, carries a square rod pointer, shown in cross-section directly below the letter. Aside from the galvanometer, the entire mechanism is actuated by the shaft, N, which is driven by a constant speed motor. The shaft carries the cams, C', C'', C''' and C''', by which motion is communicated to the different members. The cam C''', lifts the rocker arm, H, and the face, I, lifts the pointer of the galvanometer against the arm of one of the right angle levers, L and L', if the pointer is deflected, or if not deflected the pointer is lifted through the narrow gap between the levers, and no motion is communicated to either. Being pivoted at the points, r and r', the levers will obviously be rotated by the

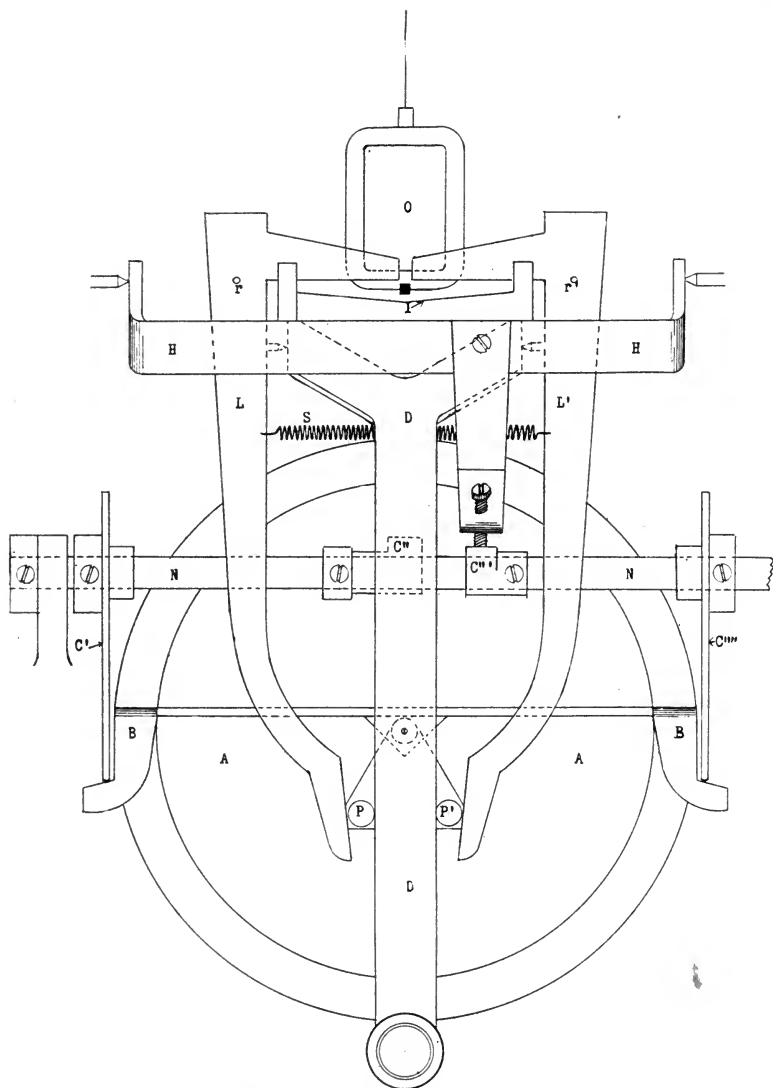

Fig. 11.—Mechanism of Leeds and Northrup Recorder.

A—Clutch disk; B—Clutch arm; C'—Cam; C''—Cam; C'''—Cam; C''''—Cam; D—Clutch lever; H—Rocker arm; I—Rocker face; L—Right angle lever; L'—Right angle lever; N—Cam shaft; O—Galvanometer coil; P—Clutch arm post; P'—Clutch arm post; r—Lever pivot; r'—Lever pivot; S—Lever spring.

interposition of the pointer through an arc proportional to the arc through which the pointer is deflected. The levers are held by the coil spring, S, so that the lower ends press against the posts, P and P', which are a part of the clutch arm, B. The clutch arm is pivoted on the suspended lever, D, concentrically with the disc, A, against which it is pressed by a spring to form a clutch. At the same time the cam, C''', effects the rotation of the arm it is pushed away from the disc by the cam, C'', but the clutch is restored as soon as the above described motions are completed. The arm is brought back to its horizontal position by the cam, C', if it was rotated clockwise, or by C''', if it was rotated counterclockwise, and the disc, being now in engagement with the arm, revolves with it. As may now be seen, a deflection of the galvanometer will cause a proportional movement of one of the right angle levers; this motion is communicated to the clutch arm, and this, being subsequently restored to the horizontal position while engaged with the disc, revolves the disc, clockwise or the reverse, through an arc proportional to the needle deflection. A wheel carrying a slide resistance is mounted on the same shaft that carries the disc, and by means of this the resistance in the electric system is balanced, and the galvanometer needle returns to zero. This shaft also carries a cord wheel for placing the pen-carriage in position on the chart relative to the galvanometer deflection. The sensitiveness of the galvanometer is unaffected, since no part of it except the pointer is at any time engaged with the recorder mechanism, and the pointer is free, except at brief intervals, to take any position within its arc of rotation.

This recorder may be used with either a resistance or a thermoelectric pyrometer. The Wheatstone method of balancing resistances is used with the former, and with the latter the potentiometer method is used. This consists in balancing the voltage of the thermo-couple against a variable known electromotive force.

Fig. 12 is a photographic view of a Leeds and Northrup recorder which is designed to print a number of temperature

records on the same chart. A print wheel is substituted for the pen, and the different temperatures are represented by figures which are printed in the proper positions on the chart. The

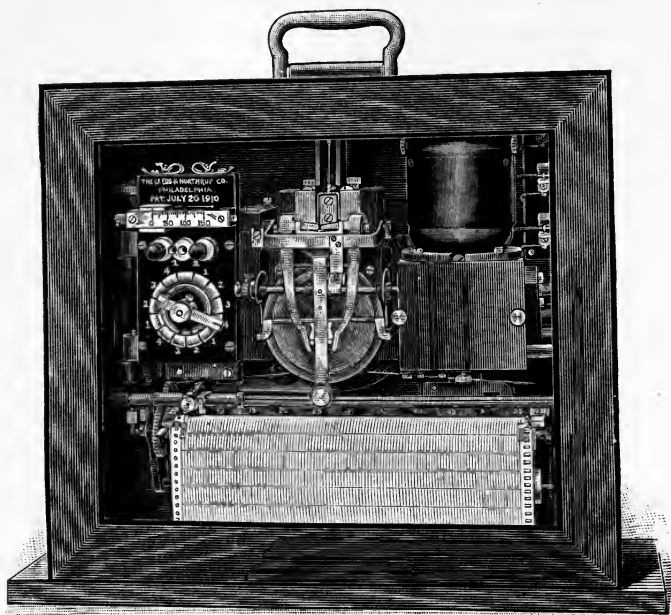

Fig. 12.—Pyrometer Recorder. (The Leeds and Northrup Co.)

galvanometer is successively connected with the different pyrometer bulbs by a switch which is manipulated automatically. The records are, therefore, intermittent, the time of intermission increasing with the number of records carried.

CHAPTER IV

FUELS

The three physical conditions of matter are represented in the fuels. Practically all the fuels used in metallurgical operations consist of some kind of coal, or a product of coal. Not infrequently constituents of an ore that is being smelted or of a metal that is being refined play the role of a fuel, in some instances furnishing all the necessary heat.

There are several points favoring the use of fluid and gaseous fuels. On account of the ease with which they can be handled and their freedom from foreign matter, gases can be burnt with greatest economy, technically speaking, and a high temperature is reached in a minimum time; the heat can be directed to the locality desired and the temperature easily controlled; the contents of the furnace is not contaminated with foreign matter, and there is no ash to be disposed of. In consequence of these facts greater uniformity of working is possible. There are, however, some important operations requiring fuel in the solid form, and the relative abundance and low cost of solid fuels maintains for them first place.

The industrial fuels embrace quite a variety of substances. Some of these are used in their natural state and some are artificially prepared. In the classification of fuels the first division is, therefore, suggested. Representative analyses of the fuels are given on p. 66.

THE NATURAL FUELS

Wood.—Air dried wood consists mainly of cellulose ($C_6H_{10}O_5$) and a variable amount of uncombined water. Its usage as a fuel continues in localities where forests abound and coal is dear. The heating power of wood is low, as would be inferred from its composition. Being the material from which charcoal is prepared, wood is still of some importance to metallurgical industries.

Peat.—This material, though of but slight use in metallurgy, is interesting from a scientific standpoint in its relation to the

other fossil fuels. Peat is formed by the decomposition of vegetable matter without free access of air. In the composition of plant tissues carbon is the nucleus or central element with which the other elements, chiefly oxygen and hydrogen, are combined. These elements are attached to the carbon by feeble chemical bonds—a characteristic of carbon compounds—and in the decomposition of plant matter under peculiar conditions the carbon is gradually isolated, though a part may pass off in combination with hydrogen as marsh gas (CH_4), and a part in combination with oxygen as carbonic acid gas (CO_2). The localities in which peat forms are swampy, the necessary conditions being plant growth to furnish the carbonaceous material; sufficient warmth to promote decomposition, and the presence of water, which covers the deposit and prevents complete decomposition. When conditions have been favorable this process has gone on year after year, each crop being deposited on the remains of the one preceding, until a peat bed of considerable depth has been formed. The gases mentioned above are easily detected in peaty marshes. Large deposits of peat occur in Ireland, and in less quantity it has been found in the northeastern part of the United States.

It is readily seen from its composition that peat is a poor fuel. It is extremely variable in composition, the carbon varying from 50 to 60 per cent. in dried samples. The ash may be as low as 1 or as high as 33 per cent., due to the admixture of earthy matter. The best peat is found at the bottom of the bed, where decomposition has proceeded furthest. In the surface portion the plant roots and stems can be seen. Peat is too bulky to be transported profitably. Its value is greatly increased by drying and pressing. It is manufactured for domestic use into briquets.

Lignite.—This material belongs to a more recent geological period than the true coals. In composition it may be considered as intermediate between peat and coal. The principal deposits of lignite in the United States are west of the Mississippi River.

The lignites are characterized by their brownish streak and

luster and frequently by their woody (ligneous) structure, showing perfectly the grain of the wood from which they are formed. Whole trunks of trees are sometimes found imbedded in lignite deposits. Lignites are often spoken of as the "brown coals." They are quite variable in composition, and are comparatively poor fuels, though they may be profitably used for making gas.

Coal.—Modern metallurgy is dependent for its fuel almost entirely upon coal, or varieties of fuel derived from coal. No substance has been mined so extensively as coal, and no other substance is the source of so many and varied manufactured products. There is still much that is not understood about the formation of coal, but there is no doubt that it is of vegetable origin, representing the oldest of such formations. All woody or fibrous structure has disappeared in the true coals, and in some varieties the carbon has been almost completely isolated. Quite a good deal may be learned about the composition and properties of a coal by a simple examination. This is conducted as follows:

A certain weight of the coal to be examined is put into a weighed crucible. After covering the crucible to prevent the escape of solid particles, it is heated gradually to bright redness, and that temperature is maintained for a few minutes, after which the crucible and its contents are cooled and again weighed. The volatile matter, or loss in weight, consists partly of water, but chiefly of hydrocarbon gases resulting from the decomposition of the coal. These with some hydrogen and possibly sulphur constitute the "volatile combustible matter" of coals. The residue in the crucible consists mainly of carbon and the non-combustible part of the coal, or the ash. If the volatile matter is very high, the residue will have fused or cemented together into a cake of some firmness. If the coal softens and swells a good deal, the cake is left light and friable—characteristic of coals high in volatile combustible matter. If on the other hand, there is but slight softening and less volatile matter, the cake is harder and firmer and more difficult to burn. Such a residue is termed a true coke. The experiment may be further continued by re-

moving the crucible lid, and heating externally until the carbon of the residue is entirely consumed. The residue now remaining is the ash, which is determined directly by weighing. The difference between the sum of the weights of volatile matter and ash, and the weight of the coal is called "fixed carbon," a term which is practically though not absolutely correct. If the volatile matter is very low the residue in the covered crucible will appear the same after as before ignition.

The Coals Classified.—The fundamental properties of a coal may be learned from the above experiment, and also its fitness as a fuel for certain operations. For industrial purposes, coals are classified according to their behavior during combustion. Some burn with and some without flame, the former usually showing a tendency to fuse or soften when heated. In general, those coals yielding volatile combustible matter, and consequently burning with a flame are called *bituminous*, and those yielding but little volatile matter and burning with practically no flame are called *anthracite*.

Bituminous.—The coals of this class vary much in composition and general properties. They are intermediate between the lignites and the anthracites, and may be said to represent every stage of transition between these widely differing classes. There is, however, no sharp line of difference between lignite and true coal, or between bituminous coal and anthracite. The bituminous coals are characterized by their black or brownish color, dull luster, cubical or conchoidal fracture and the ease with which they burn. They are, by far, the most abundant, and are very widely distributed. With further reference to their manner of burning, the bituminous coals are divided into the following general classes:

Class 1. Cannel Coals.—This class differs from the others in several particulars. The cannel coals burn with greatest ease, and many varieties can be kindled with a match, but they do not soften when heated. They are dense in structure, black with a dull luster, and do not soil the hands. Cannel coal is readily distilled, and yields a rich illuminating gas, the residue contain-

ing but little combustible matter. The percentage of ash in cannel coal is generally high, rendering it unfit for direct firing.

Class 2. Long-Flame, Caking Coals.—This class comprises what are generally known as the soft coals. These coals resemble the cannels in burning with a long, smoky flame, but unlike the cannels, they soften and swell when heated, and if finely divided, run together forming a pasty or tarry mass. The volatile matter distils off from this, leaving a light, porous cake. If the cake is dense and hard it indicates that a large amount of mineral matter (ash) is present. On account of this fusing property special methods of firing are employed, where clinkers are objectionable or the draft would be shut off. The long flame coals are much used for heating boilers, for certain types of furnaces and for making gas.

Class 3. Short-Flame, Coking Coals.—This is now the most important class of coals on account of the variety of industries it affects. It embraces all varieties of coal which can be used for making metallurgical coke. The typical coals of this class burn with a short flame, yield less gas than the other bituminous coals, and they soften and swell but little when burning. When burned under proper conditions they cement together, forming a dense, hard coke of high calorific power. The best varieties yield about 80 per cent. of coke. These coals are largely used for raising steam, but their chief use is in coke making. They will be further studied under this subject. There are a number of varieties intermediate between the coking coals and anthracite.

Anthracite.—The anthracites represent the oldest of all the coal formations. They are found in many parts of the world, but in comparatively small quantities. The largest known deposits are those of Eastern-central Pennsylvania. The characteristic properties of true anthracite are superior hardness to all other coals, submetallic luster and density of structure. It rings when struck and soils the hands but little. When burnt in a plentiful supply of air, anthracite gives little or no flame, being practically free from volatile gases. It shows no tendency to soften in the fire, and is difficult to kindle. Anthracite is not much used in metal-

lurgy except as a reducing agent where coke would not answer. It is the favorite domestic coal, and is used quite extensively for heating boilers, especially locomotive boilers.

Natural Gas.—The chief component of this remarkable fuel is marsh gas, the same substance that is formed by the decomposition of vegetable matter in peat formations, and is always found in soft coal and oil measures. The presence of natural gas, which is always associated with petroleum, is due partly to the retaining properties of the rock in which it occurs. It is found in porous limestone and sandstone, usually under great pressure. The only large deposits of natural gas known are in the United States. It was discovered at a few points more than a hundred years ago, the first recorded use of it being at Fredonia, N. Y. (1821), where it was used for lighting purposes. Gas was discovered in Western Pennsylvania by oil prospectors, and this led to the opening of the immense reservoirs in Ohio, Indiana and West Virginia. Gas has been found in all of the Ohio Valley states, Kansas and Oklahoma in large quantities. Nearly all of the middle states from New York to Texas produce some gas. The most important recent discoveries have been made in California. It was the common belief for a while that the gas deposits were inexhaustible, and large quantities of this valuable material were wasted, there being no immediate use for it. Up to the year 1895 more gas is said to have been wasted than was actually used. The idea of piping it to the distant cities and manufactories had not occurred to the oil seekers. Wells were drilled into the gas-bearing rock, and after allowing all the gas in that vicinity to escape, the wells were sunk deeper for the oil. When it was found that the supply of this ready made fuel was becoming exhausted, steps were taken to utilize it, and the price began to advance. Gas is led through pipes to centers of large consumption often at great distances. It is impossible to tell how long natural gas will last, even if the rate of consumption were known, but it will probably not be used many more years in the metallurgical industries.

CHAPTER V

THE PREPARED FUELS

The artificial or prepared fuels, as described in this text, are those which have been chemically altered from their natural state. They are prepared almost exclusively from coal and wood, and, practically speaking, are either solids or gases.

The principles made use of in the manufacture of fuels are destructive distillation and partial combustion of the natural material. Processes involving destructive distillation are common in chemical industries. By the term is meant the heating of any compound without access of air, until it is decomposed, and the volatile constituents are driven off. In the destructive distillation of fuel materials, the products are compound gases, tarry matter, water holding various substances in solution, and a residue of carbon with varying amounts of impurities. The residue is usually the product aimed at, while the others (the by-products) may be utilized, though they are often allowed to waste.

Charcoal.—When wood is distilled the hydrogen and oxygen pass off mainly as water. A small portion of the carbon also passes off in combination with these elements, while the greater part remains behind in a practically pure form, as charcoal. The preparation of charcoal was engaged in by the ancients, and is still an important industry, though the use of this fuel in metallurgy has been almost abandoned. There are, however, even in civilized countries, districts that are heavily wooded and without coal, in which large amounts of charcoal are made and used. The composition and quality of charcoal depends upon the kind of wood from which it is made and the manner in which it is prepared. Mature woods of slow growth are the best, and the charring should be done slowly and until the *fixed* carbon begins to burn. From this it is seen that the best charcoal is not made by purely distillation processes. Good charcoal retains the structure of the wood showing the pores and rings of annual

growth. It should be firm, and should burn without flame in a plentiful supply of air. Charcoal has a remarkably absorbent power, taking up many times its own volume of a gas, or a quantity of water. For this reason its usefulness as a fuel is greatly impaired by exposure to the weather.

Charcoal is a by-product in the manufacture of acetic acid and methyl alcohol. This is of an inferior grade, as the wood is distilled from retorts that are heated externally, and to which no air is admitted. The result of this is that no combustion takes place, and the residue is not completely charred. The charring is most complete when the volatile combustible matter is burned in contact with the wood, no external heat being used. In localities where large quantities of charcoal are used, it is made in heaps covered with turf, or in ovens, constructed so that the

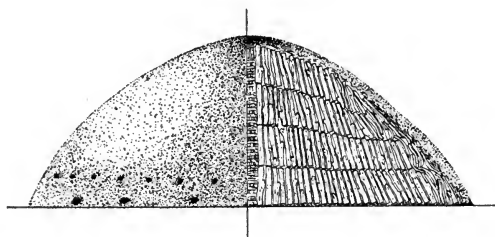

Fig. 13.

proper amount of air can be admitted. The wood for charcoal burning should be felled in winter, while it contains the least sap, and allowed to season until late in the following summer. If kept longer the wood might become too dry, and loss would occur in burning. The bark is sometimes stripped off, as it contains phosphorus, and makes inferior charcoal.

Fig. 13 shows the arrangement of a charcoal heap or mound. One half of the drawing is a section through the interior, showing the arrangement of the wood. The heap is built upon a circular foundation of earth, which is trenched around for drainage. The diameter of the heap at the base is about 40 feet, and it contains four courses of wood cut in 4 foot lengths and set on

end. The wood is set around a central, triangular flue, the small and crooked pieces being placed on the exterior. The finished heap is covered with leaves, and upon these a seven inch layer of earth is thrown. The top of the flue is left open for firing the heap, and openings are made at intervals around the base to admit air.

The heap is kindled by dropping fire brands down the central flue and filling it with dry wood. The opening at the top is then closed, and the fire is left to smolder. At the end of two weeks the charring is well under way. The process is now hastened by opening a row of small holes around the mound at a distance of 2 to 3 feet from the ground line. The wood in the upper and central portion of the heap is the first to be converted into charcoal, and the charring proceeds downward and outward. The collier packs the earth down upon the heap, and carefully avoids any access of air in the upper part. As the fire approaches the circle of small flues the smoke issuing therefrom becomes blue and hot, all water vapor having disappeared. The flues are closed and another lot is made further down. When the fire reaches the second line of flues the process is completed. The time required is 18 to 21 days. A heap of the above dimensions should yield upwards of 2,000 bushels of charcoal.

Coke.—Coke was first manufactured and used by Dud Dudley, an English iron master, in the early part of the 17th century.¹ The peculiar condition of affairs in England at that time did not permit Dudley to reap the fruits of his invention, and his enterprise had to be abandoned. It was almost a hundred years before coke making was resumed. Its superiority over coal as a blast-furnace fuel once fully appreciated, coke was soon made on the large scale. The original process consisted in smoldering a heap of coal under a cover of earth or cinders, the product being irregular in quality and the yield low. Coke was first manufactured in the interest of the iron industry, which industry has continued to be its chief consumer.

¹ A reprint of Dudley's interesting paper "Metallum Martis" appeared in *Jour. Iron and Steel Inst.*, 1872, 2, 215.

The present processes of coke manufacture employ three distinct methods for disposing of the volatile combustible products, or as they are known, the by-products. Hence there are three distinct types of oven. In the ovens of the first type the by-products are consumed for the most part in the oven, and in contact with the solid matter, the combustion being finished at the mouth of the oven. A small amount of air is necessarily admitted into the oven to accomplish this result. The ovens of the second class do not admit air, but the by-products are distilled off and burned underneath or at the sides of the oven, furnishing the necessary amount of heat to carry on the distillation. The third

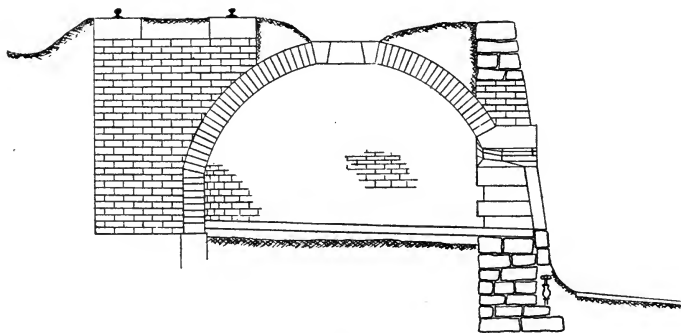

Fig. 14.

class of ovens makes use of the initial heat of the by-products for the distillation, but recovers the larger part of them for other purposes.

1. *The Beehive Oven.*—The form of this oven suggests the name. The section of a beehive oven is shown in Fig. 14. It is a hemispherical enclosure, lined with fire-brick, the outer walls being built of rough stone or other cheap material. The circular opening at the top is for introducing the charge, and is the flue from which the products of combustion and distillation escape. The opening at the side and base is for withdrawing the coke. Fig. 15 shows the general arrangement of the ovens. These are called “bank” ovens. They are also built in double rows, and are then known as “block” ovens. The bank ovens are

cheaper to construct, but the block ovens can be operated more economically. A railway traverses the system, and over this the larry with coal for the ovens is driven. The larry is generally operated by electricity. The space in front of the ovens is the coke yard, and below this is a standard gage track for the coke cars. The ovens are built as near the coal mines as practicable, so as to save transportation costs.

Coke burning in beehive ovens is a simple operation and requires no skilled labor. The crushed coal, or slack is charged and kindled, enough heat remaining after each charge is withdrawn to kindle the next. The door at the side is closed with

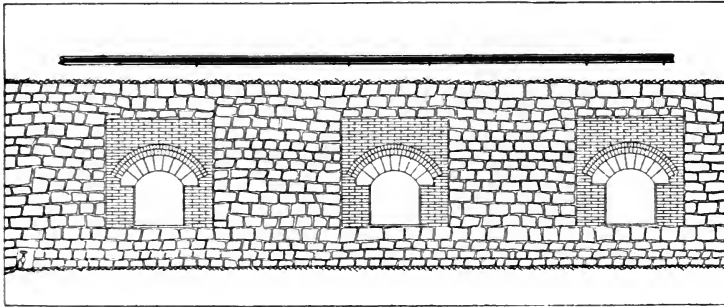

Fig. 15.

the exception of a small opening to admit the necessary amount of air. The temperature rises slowly, and after a few hours a flame appears at the mouth of the oven. Heat is reflected upon the mass from the dome-shaped lining, and it becomes glowing hot after most of the volatile matter has been driven off. Combustion may be said to begin at the top and proceed downwards. In an oven taking a charge of 5 tons of coal, the time required for driving off the volatile matter is about 48 hours. The coke may be taken at this stage, but it is usually allowed to remain in the oven for 60 hours from the time of charging. During the last 12 hours the side door is closed completely, while the coke remains at a bright red heat. Water is now introduced into the oven at the top, by means of a hose, until the coke is cool enough

to handle. The coke is raked out through the side-door by laborers. Mechanical drawers have been installed at some of the large plants.

2. *Ovens Excluding Air and Burning the By-Products.*—While the beehive oven is cheapest to build and to operate, there is a tremendous waste of heat sustained, and by the admission of air into the oven some of the coke itself is burned. These losses have been greatly lessened by excluding the air from the coking chamber, making the process entirely one of distillation. The necessary heat is generated by burning the products of distillation underneath and at the sides of the chamber. The Copée oven may be taken as a representative of this class. It differs entirely from the beehive oven, the interior being rectangular and measuring 30 feet in length, $1\frac{1}{2}$ feet in width and 4 feet in height. The roof is arched, and through this three openings with hoppers are provided for introducing the charges. A number of these ovens are built in series with the longer axes parallel. About 30 vertical flues are built in each wall common to two ovens. These open into the ovens and into horizontal flues situated under the ovens and running their entire length. Small ports open into the flues from the top to admit air.

An oven being hot from previous running, receives a charge of fine coal, and the ends of the chamber are closed with iron doors. The distillation begins at once, and the gases pass into the vertical flues where they are mixed with air and ignited. From these they are conducted into the horizontal flues where the combustion is completed. The heat generated by the burning of these gases is transmitted to the coking chamber. The ovens are worked in pairs, the one being charged when the distillation in the other is half done. The supply of gas is kept up in this way.

3. *Ovens Excluding Air and Recovering the By-Products.*—It was seen from the description of the Copée oven that the by-products are not made use of except in connection with the coking process. The heat needed for distilling a coking coal is far less than that produced by burning the volatile products. In

recognition of this fact the by-product oven has been designed to reserve a part of the volatile matter, to be used for other purposes. This is accomplished by utilizing the initial heat of the gases as they come from the oven, and burning as much as is necessary to keep up the temperature of distillation. Of the by-product ovens now in use, the Otto-Hoffman is the most prominent. This oven has itself undergone changes in the details of its construction, some important improvements having been introduced. It is of German origin, being the improved form of one designed by C. Otto, of Germany.

Fig. 16 represents a type of Otto-Hoffman oven. The section to the left of the line AB is through an oven chamber, and the section to the right is through the wall between two ovens.

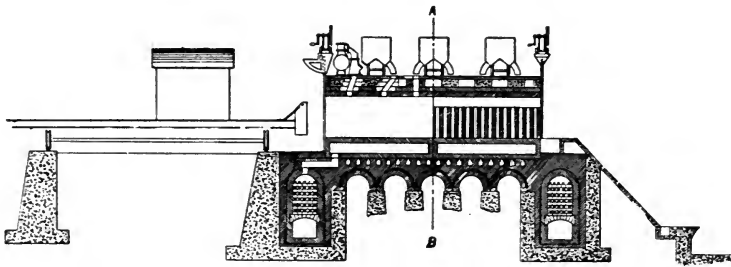

Fig. 16.

The ovens are supported on arches of masonry, and the superstructure is reinforced with beams and tie-rods. Three larries traverse the system on top to supply coal to the ovens. The openings for introducing the coal are shown in the section to the left of the line AB. The opening to the extreme left serves for the passage of gas from the oven, from which it is conducted into the main, shown in cross-section. The coke is pushed out of the ovens by means of a ram, which is shown at the left. This machine traverses the entire system of ovens at right angles to their axes. It carries a long beam or plunger with a head corresponding in shape to the cross-section of an oven, and an engine for driving the beam to and fro. With this device an oven is

quickly emptied of its charge, and the coke is quenched entirely outside.

In heating these ovens, the regenerative principle is employed. The arched chambers, shown in cross-section at the right and left of the foundation, are filled with checker-work of fire-brick. This admits of the free passage of gases through the chambers, and exposes a very large surface for the heating or cooling of the brick work as the case may be. The waste products of combustion are led through one of these regenerators until the brick work is heated to their own temperature. The air for the combustion is heated by passing it through the opposite regenerator, which has already been heated. By means of reversing valves, the hot gases and the air are alternated in their courses so that one of the regenerators is being heated while the other is heating the air. With this saving of waste heat, the amount of gas needed for heating the ovens is much lessened. The combustion takes place in a chamber beneath the division walls, the gas being admitted alternately from burners at the ends of the ovens, and air from the regenerators. The products of combustion are directed upward through the vertical flues in one half of the partition wall, then through the horizontal flue above the oven and downward through the vertical flues in the other half of the partition wall. The heat passes through the thin walls of fire-brick and distills the coal. After surrounding the ovens the products of combustion are led through the regenerators, and finally into the main flue communicating with the stack.

The gas from the coking chambers is cooled to recover tar, and then passed through scrubbers which recover ammonia. The purified gas is suitable for illuminating purposes.

Important improvements are being introduced every year, bringing about greater economy in operation or higher yield, and in some instances a better quality of product. Some of the most notable improvements have been in the introduction of coke quenching machines.

Coke Quenching Machines.—These machines are designed to quench a charge of coke without exposing it to the air and with-

out breaking the mass to pieces as it is drawn from the oven. The quenching machine is essentially a closed iron car of sufficient capacity to hold the entire charge from an oven, and provided with the necessary apparatus for spraying the coke and discharging it when it is quenched. The water is delivered to the coke through nozzles inside the car. The coke is pushed into the car by means of a ram, and is quenched by the water and steam, the conditions being somewhat the same as in the beehive oven, in which the coke is quenched by running in the water from the top. The coke is discharged mechanically into freight cars, thus doing away entirely with manual labor.

Desulphurization of Coke.—All grades of coke contain some sulphur, a very objectionable ingredient in any fuel to be used for smelting iron. The sulphur exists in the coal principally as pyrite (FeS_2), and is largely, though not completely, evolved in the process of coking. Various attempts have been made to remove this remaining sulphur from coke, but no process has proved satisfactory for general use. One, however, that is worthy of notice consists in passing steam through a heated mass of coke to decompose sulphides and convert the sulphur into a volatile form, thus:

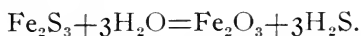

The difficulties here met with are due to the fact that carbon decomposes water at high temperature, entailing a loss of coke and disintegration of the lumps, and to the failure of the steam to permeate the coke mass thoroughly.

Practical Considerations.—The preparation of coal for the oven has an important bearing on the quality of the coke. After crushing the impurities are removed from the coal as far as possible. These consist principally of shaley and earthy matter, which would increase the amount of ash from coke, and of iron pyrites, which accounts for most of the objectionable element, sulphur. The impurities are removed from coal chiefly by washing processes. The coking power of coal is roughly determined by heating it with varying proportions of sand. The coking power is expressed by the number of grams of sand per gram of

coal that can be treated with a coherent coke as the result. It is shown, then, that the quality of coke depends largely upon the quality of coal from which it is manufactured. If the coal is too hard, it will not soften in the oven sufficiently to produce a coherent coke. If, on the other hand, the coal is too soft, the coke will be light, friable and of low heating value. Coke may be prepared from the harder coals by first mixing them, after crushing, with soft coal or any material yielding much tar, and pressing. A process is now in use for making firmer and more compact coke from the softer coals, which consists in ramming or packing the coal as it is charged into the oven. Aside from the improvement in the quality of the coke a larger yield is gained by charging compressed coal, and the amount of coke breeze produced is lessened.

C. G. Atwater, in his paper on "Development of the Modern

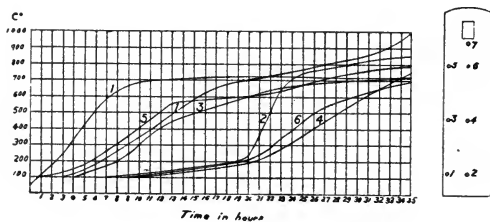

Fig. 17.

By-Product Coke Oven."¹ gives some interesting data on the progress of coking in the Otto-Hoffman oven. The diagram (Fig. 17), taken from his paper, shows the progressive temperatures in different parts of the oven. The drawing at the right represents the door of the oven, and the small circles the points at which the holes were bored for taking the temperatures. The numbers correspond with the numbers of the lines in the diagram. This experiment shows that the distillation begins in that portion of the charge lying next to the oven walls, and proceeds toward the center of the mass. The gases passing from the interior, on coming in contact with the hotter coke, deposit carbon, thus in

¹ Trans. Amer. Inst. Min. Eng., 33, 760.

a measure accounting for the increase in yield over the beehive oven.

The economical operation of by-product ovens is largely offset by their high initial cost. As coke producers for blast furnaces, they have been made to compete with the beehive ovens in this country. It is the common belief that by-product coke is inferior to that produced in beehive ovens for blast furnace work, but this is not necessarily so. The production of by-product coke, both for domestic and industrial uses, is yearly increasing. The statistics below have their significance.

The following figures show the rapid increase in the proportion of by-product coke since 1893, the year in which the first was produced in the United States. The figures represent percentages of the total amounts of coke made each year in both kinds of oven.

1893	1901	1907	1908	1909	1910	1911	1912
0.01	5.41	13.75	16.14	15.91	17.12	22.07	25.27

Producer Gas.—No fixed composition can be assigned to a gas of this name, though the analysis given at the end of the chapter is typical. It consists essentially of carbon monoxide mixed with a large amount of nitrogen. For this reason its calorific power is low. It is almost odorless when pure and is poisonous. It is generally enriched with water gas and hydrocarbons.

Almost any kind of solid fuel may be used in the preparation of producer gas, on the principle that carbon, in a limited supply of oxygen, burns to carbon monoxide. This is probably most accurately expressed as follows:

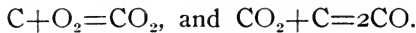

The necessary condition for the above reactions is that there be sufficient heat for the dissociation of carbon dioxide in the presence of an excess of carbon. The blue flame often seen playing over a grate of coals is due to carbon monoxide, which results from clogging of the draft. The gas producer, omitting details of construction, is nothing more than a deep bed of coals to which the supply of air for combustion is regulated.

The original producer, as designed by Siemens, is represented in Fig. 18. The coal is fed in at the hopper, H, the space over the grate bars, B, being kept about two-thirds full. The gas in passing up from the fuel bed enters the flue, F, through which it is conducted into the gas main, GM. The openings, OO, are for introducing bars to stir the fire and break up the clinkers. Water is kept in the ash pit under the grate. The vapor from this en-

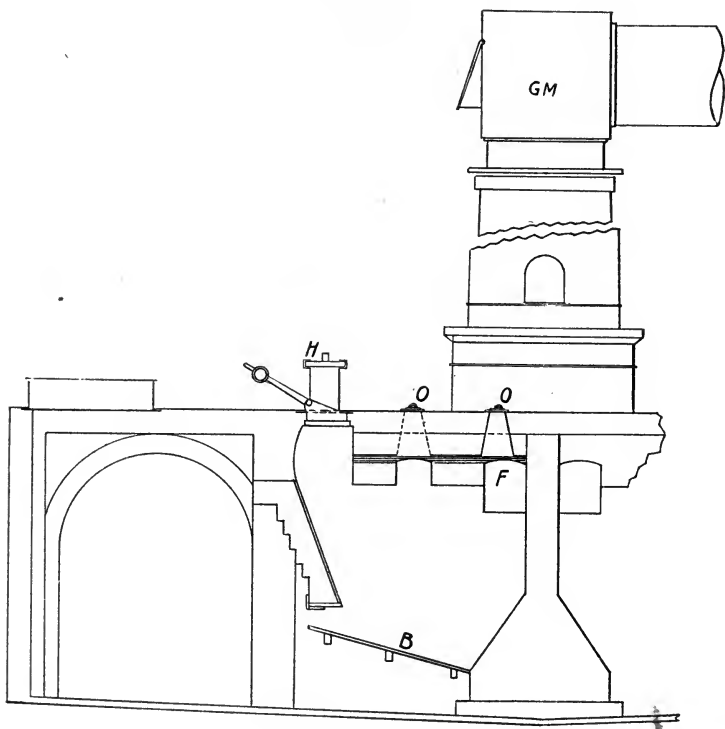

Fig. 18.

ters the fire bed, where it is decomposed. The presence of steam in the producer prevents, to a large extent, the formation of clinkers. Steam also enriches the gas, as will be shown later.

Fig. 19 represents the Morgan producer, with automatic charging apparatus. The producer is constructed of fire-brick encased

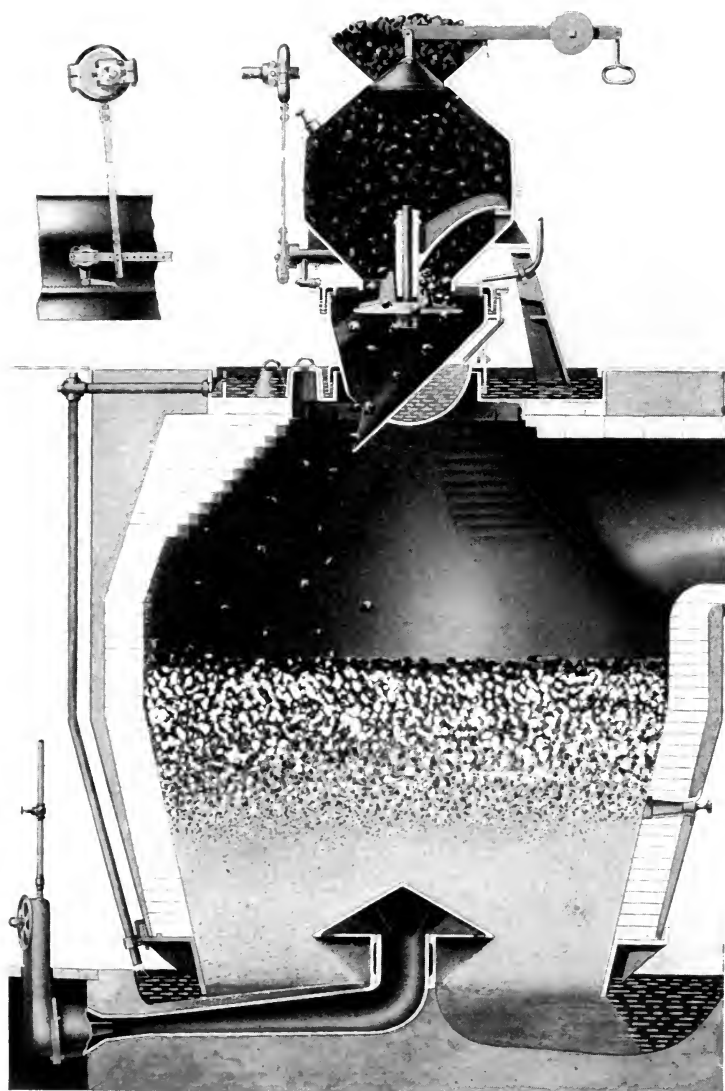

Fig. 19.—Morgan Continuous Gas Producer. (Morgan Construction Co.)

in iron plates. It is cylindrical in shape and contracted toward the bottom. No grate is used, but the ashes are received in a pan of water, which serves to cool them and to seal the bottom of the producer from the air. Air is supplied to the producer through a central pipe terminating near the bottom. The pipe is provided with a cap for distributing the blast. Steam is supplied with the blast, the supply being regulated by means of a valve. The automatic feeding device is a special feature of this producer. The coal is fed in continuously from the hopper, and a slowly rotating, inclined spout distributes it evenly over the surface of the fuel bed. The spout and top of the producer are water-cooled.

The water-sealed type of producer is now in most common use. The Taylor producer is an important exception. This is provided with a revolving bottom, and the fuel is supported on a deep bed of ashes. In connection with some gas producer plants, accessory apparatus is employed for the recovery of tar.

The manufacture of producer gas is now associated with many important industries. The advantages gained in the use of gas as fuel have been fully demonstrated, and it has been left to modern invention to prepare it economically and in large quantities. The producer is advantageous as a means of converting a poor fuel into gas. Inferior coal, lignite, peat and wood may be thus transformed into an excellent fuel for industrial purposes.

Before leaving this important subject it will be well to note the efficiency which might be expected of a good gas producer. How much heating value, theoretical and actual, is lost in the conversion of solid fuel into gas? The calorific power of carbon is the total heat generated when it is burned to carbon dioxide, or 8,080 calories. The amount of heat generated when it is burned to carbon monoxide is 2,416 calories, (inside the producer), leaving 5,664 calories to be evolved in the combustion of carbon monoxide, (outside the producer).

If all the heat generated in the producer could be transferred to the combustion chamber of the furnace, the efficiency of the

conversion would obviously be 100 per cent. Losses occur from radiation and leakage through the walls of the producer and the gas conduit, from the heat rendered latent in the formation and expansion of gases and from other sources unaccounted for. A large amount of the heat of combustion in the producer ($C+O=CO$) may be saved mechanically by using insulating material to retard radiation, or by heating the air supplied to the producer with the outgoing gases. It may be economized chemically by introducing steam into the producer, which absorbs heat by its reaction with carbon—

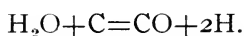

The decomposition of steam is attended by an absorption of 29,100 units of heat, while but 2,416 units are evolved in the formation of carbon monoxide. It is seen that while more heat is absorbed than is evolved in the above reaction, the producer gas is enriched with carbon monoxide and hydrogen, and a quantity of heat equal to that absorbed is regained in the combustion of the hydrogen.¹ This does not take into account the heat required for generating the steam, which is done outside the producer. The greatest economy is gained when just enough steam is used to utilize the excessive heat in the producer. The amount of steam should be regulated according to the character of the fuel used and other conditions in the producer, and it is best determined by actual experiment. The example below shows the loss of calorific power, under given conditions, when a solid fuel is converted into gas.

The materials contributing to the production of the gas are—

	Per cent.
Carbon (free)	30.78
Carbon (combined)	20.15
Hydrogen	6.72
Oxygen	30.56
Water (steam)	11.79

Supposing that these substances are converted into methane, carbon monoxide and hydrogen gases, and the gases cooled, what is the loss in calorific power?

¹ Hydrogen burnt to steam evolves 29,100 heat units. If the steam is liquefied, 34,500 heat units are evolved.

(1) The methane is the sum of the combined carbon and the hydrogen, or 26.87 per cent., by weight, of the combustible gases.

(2) The hydrogen is deduced from the percentage of water in the mixture—

$$\text{H}_2\text{O} : \text{H}_2 :: 11.79 : X, \text{ or } 18 : 2 :: 11.79 : X = 1.31 \text{ per cent.}$$

(3) The carbon monoxide is derived from the free carbon—
 $\text{C} : \text{CO} :: 30.78 : X, \text{ or } 12 : 28 :: 30.78 : X = 71.82 \text{ per cent.}$

The combustible elements in the fuel are carbon and hydrogen, and their ratios are—

$$\text{C} = \frac{20.15 + 30.78}{6.72 + 20.15 + 30.78} = 88.34 \text{ per cent.}$$

$$\text{H} = \frac{6.72}{6.72 + 20.15 + 30.78} = 11.66 \text{ per cent.}$$

The heating power of the fuel before the conversion is—

$$0.8834 (8,080) + 0.1166 (34,500) = 11,161 \text{ calories.}$$

The heating power of the gas is—

$$0.2687 (13,250) + 0.0131 (34,500) + 0.7182 (5,664) = 8,080 \text{ calories.}$$

The loss of heating power is, therefore, $11,161 - 8,080 = 3,081$ calories, or the efficiency of the conversion is 72 per cent.

With the precautions to prevent loss of sensible heat in the gases and careful operation of the producer, the efficiency may be as high as 90 per cent., or even higher. In practice, with the best modern producers, the efficiency is commonly placed at 88 per cent. The following example is taken from actual practice in which the Morgan producer was used.

The analyses and calorific powers of the coal and the gas are as follows:

COAL (CALCULATION FOR ONE POUND).		
Ingredient	Percentage	Calorific power in British thermal units
Carbon.....	50.87	$0.5087 \times 14,500 = 7,376$
Hydrocarbons.....	37.32	$0.3732 \times 20,000^1 = 7,464$
		14,840

¹ This value is estimated, exact information not being at hand for its determination.

GAS (CALCULATION FOR 1 CU. FT.).

Ingredient	Volume	Calorific power in British thermal units
Carbon monoxide	0.245	78.37
Hydrogen.....	0.178	57.66
Methane	0.036	36.19
Other hydrocarbons	0.032	50.93
		<u>223.15</u>

1 lb. of coal yields 55 lbs. of gas, which when cold has a calorific power of—

$$55 \times 223 = 12,265 \text{ B. t. u.}$$

The efficiency is, therefore—

$$100 (12,265 \div 14,840) = 89 + \text{ per cent.}$$

Water Gas.—Many attempts have been made to prepare hydrogen on the large scale from water. It has been shown that more energy is expended in the decomposition of water than is developed in the combustion of hydrogen. Practically pure hydrogen may be prepared by the electrolysis of water and by the reducing action of some metals at red heat. Since carbonic oxide is itself a gas, pure hydrogen does not result from the decomposition of water by carbon, but the result is a mixture of the two gases—

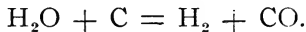

The mixture contains theoretically equal volumes of hydrogen and carbon monoxide, and is known as water gas. The commercial product is somewhat variable in composition, and contains other gases as impurities.

Water gas is manufactured in a producer of similar construction to the ordinary gas producer. Under regular working conditions the producer carries a deep bed of burning coke. Air is blown through the fuel bed from the bottom until it is heated to incandescence. The resulting gas, which is of poor quality, is carried off through a flue at the top of the producer. The blast is now shut off for a few minutes while steam is introduced

above the fuel bed and drawn downward through the incandescent mass. The water gas resulting from its decomposition is taken out through the same openings by which the air blast is introduced, the openings into the air and gas pipes being controlled by means of valves.

Water gas is not suitable for domestic uses, being highly poisonous and practically odorless. It burns with a pale-blue flame, and its calorific power is very high. It has been employed to some extent for heating high temperature furnaces.

TYPICAL ANALYSIS OF FUELS

SOLIDS

	Carbon	Hydrogen	Oxygen	Volatile combustible matter (Nitrogen 2)	Fixed carbon	Ash
Wood	50	6	42
Peat	59	6	34
Cannel coal	46.0	34.5	19.5
Caking coal	34.0	60.5	4.5
Coking coal	25.0	68.0	7.0
Anthracite	2.0	91.0	7.0
Charcoal	3	2	93.0	2.0
Coke (48 hours)	0.88	89.10	10.02
Coke (72 hours)	0.82	88.62	10.56

GASES.

	Methane	Other hydro- carbons	Hydrogen	Carbon Monoxide	Carbon Dioxide	Nitrogen	Oxygen	Water
Natural..	93.5	0.5	1.0	0.5	0.25	4.0	0.25	..
Coal.....	42.0	3.5	45.0	6.0	0.5	1.0	1.0	1
Water...	2.0	..	45.0	45.0	4.5	1.5	1.0	1
Producer	2.5	0.5	1.2	27.0	2.0	56.0

CHAPTER VI

ORE DRESSING

The extraction of a metal and its preparation for the market involves a number of processes. The details of a process depend upon the physical and chemical properties of both the ore and the metal. There are usually four distinct operations, or classes of operations, from the first treatment of the ore to the last work on the finished metal.

ORES

Any natural substance containing metal in sufficient quantity to justify its extraction is an ore. The amount of metal which any mineral must contain to be an ore depends upon the price of the metal and the cost of preparing it. For example, iron ores to be profitably worked, must yield nearly half of their weight in metal, while gold ores may be treated with profit if they contain but a fraction of an ounce of gold to the ton.

Composition.—The metals usually occur in combination with non-metallic elements, though some occur uncombined, or native. The ores are usually associated with some non-metallic material such as earthy matter or rock. This is known as vein-stuff, or gangue. The summary here given represents practically all the common ores, showing the elements with which the several metals are combined. The groups are given in the order of their importance.

Oxides Iron, manganese, chromium, tin, aluminum, copper.
Sulphides ... Copper, lead, zinc, silver, mercury, iron.
Carbonates .. Lead, zinc, iron, copper.
Native Copper, silver, gold, platinum, mercury.
Silicates Zinc, nickel.
Arsenides ... Nickel, cobalt.
Chlorides ... Silver, lead.

Deposition.—The various formations or deposits of ores belong to different geological ages. It is not definitely known how any of them were formed, or what changes they have undergone from their original state. There is much conclusive evidence as

to both physical and chemical changes affecting ores, gained from a study of the earth's crust, and from the changes that are now in progress. The position, for example, of some ore deposits has been altered by upheavals or sinking of the strata, due to earthquakes and other disturbances, while immense quantities of ore are shown to have been transferred from place to place by the action of water. The deposits of ores naturally fall into three classes:—

Beds, or deposits which conform to the direction of the rock strata. If the rocks lie in horizontal plains, the ore beds will be flat; or if the rock strata be tilted, the ore will fill the space between. Many deposits of this class have been formed by the action of water, as, for example, those in the valleys of streams, known as alluvial deposits.

Veins or Lodes.—A great many ores are found in what appear to be fissures or cracks in the earth's crust. They do not conform to the stratification of the rocks, but cut through the rock-mass at an angle. Such deposits are known as veins. They may vary in thickness and in the direction of their extent. The continuity is often broken off suddenly, due to faulting in the earth's crust.

Pocket ores are those which are found in small patches or cavities. They are often met with in the vicinity of veins. Pocket ores are often of excellent quality, but so scattered as to be unprofitable for mining.

Properties.—The physical condition of ores often has more bearing on the methods by which they are treated than their chemical composition has. The methods of mining and dressing are determined almost entirely by their physical properties, most of these methods being purely mechanical. The chief characteristics and properties to be considered are specific gravity, crystallization and attraction for water, which are essential to washing processes; resistance to crushing and grinding forces; magnetic and electric properties, including the behavior of certain minerals toward electro-magnets and static electricity; solubility, the all-essential property in leaching pro-

cesses, and action toward heat, including decrepitation, fusibility, volatility, chemical decomposition and, incidentally, such changes as may affect or develop any of the properties above enumerated.

ORE DRESSING

A great deal may be gained by dressing ores. In the first place, the ore may be greatly concentrated, reducing the cost of transportation, lessening the amount of fuel needed for smelting and increasing the output; secondly, it may be possible to remove or greatly diminish the quantity of those ingredients of the ore which would contaminate the metal; lastly, the ore is delivered to the smelter in more convenient shape and of more uniform composition. Under such conditions the process of smelting may be conducted with greater regularity and efficiency than would otherwise be possible.

Of the processes used in dressing ores the more common are weathering, hand-picking, breaking, pulverizing, sizing, washing, magnetic separating, calcining, roasting and agglomerating.

Weathering.—Some ores are much improved after long exposure to the weather. During the freezes of winter the lumps are split up, ore cleaving and falling away from the rocks with which it is associated. Impurities may be rendered soluble by the action of the atmosphere and leached out by the rains, or the metallic portion itself may be recovered directly in this way. Weathering processes are necessarily slow, often requiring years, and yet they offer the only feasible means of treating some ores.

Hand Picking.—This method of concentration depends entirely upon the intelligence of laborers to select the ore from the worthless material in which it is imbedded. Some very undesirable impurities may be seen and rejected in this way. Hand picking is not employed except with ores of a high market value or in countries where labor is cheap.

Breaking.—Ores occurring in masses of rock must be reduced to small lumps, so that in subsequent treatment they will be exposed more fully to the action of heat or chemical agencies. There are two types of rock and ore breakers in general use,

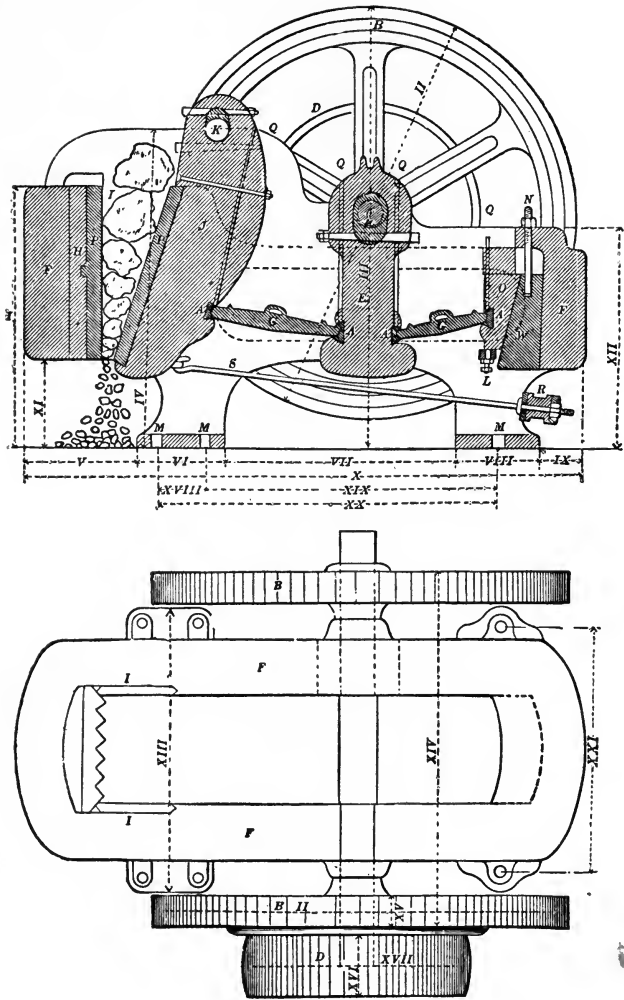

Fig. 20.—Blake Crusher. (Allis-Chalmers Manufacturing Co.)

AA, still bearings for toggle plates; B, flywheel; D, driving pulley; E, Pitman;
 G, toggle plates; H, fixed jaw; I, checks; J, movable or swing jaw;
 K, bar;
 L, set screws for toggle block; N, wedge adjusting stud; O, toggle block;
 PP, jaw plates; R, rubber spring; S, rod; W, wedge block.

viz., jaw crushers, of which the Blake machine is a well known representative, and gyratory crushers, of which the Gates machine is a good example.

The mechanism of the Blake machine is well illustrated in Fig. 20. The ore is crushed between two jaws, one of which is stationary. The swinging jaw is driven by a powerful toggle movement communicated from the revolving shaft. The shaft carries two heavy fly-wheels and the driving pulley. The crushing jaws are faced with hard steel plates. The machine is adjustable for crushing to different sizes, the jaws being brought closer together by raising the wedge block, W, by means of the stud, N, and by the use of longer toggle plates.

A vertical section of the gyratory crusher is shown in Fig. 21. In this machine the ore is crushed by the action of a gyrating spindle within a circular shell of steel. The outer shell of the machine is made in two sections bolted together, the lower section being supported on the base plate and the upper section carrying the hopper for receiving the ore and the "spider" which furnishes the upper bearing for the spindle. The lower part of the spindle has a journal bearing in the eccentric hub of a bevel gear, the gear having a bearing concentric with its own rotation in the base plate. The gear meshes with a bevel pinion which, with the driving pulley, is carried on a horizontal shaft. To the head of the spindle is keyed a bushing by which the spindle is supported and adjusted at different heights. In the hub of the spider is secured a bushing to carry the weight of the spindle, and also to furnish the upper bearing. The spider bushing has a spherical top, and the spindle bushing has a socket-shaped flange which rests upon this. The cylindrical bearing is tapered slightly to permit of the gyratory motion of the spindle. The crushing head of the spindle has the shape of a truncated cone, and the shell around it resembles an inverted truncated cone. A circular, V-shaped space is, therefore, left between the crushing surfaces. The crushing surfaces are of chilled iron or hardened steel. The shell is lined with steel die plates which are renewable.

When the machine is run empty the spindle is free to rotate with the gear, but when a lump of stone is introduced it can not rotate, but retains the gyratory motion. The crushing head is brought successively near the opposite surface in the direction of the gyration, and as one side of the head approaches the shell

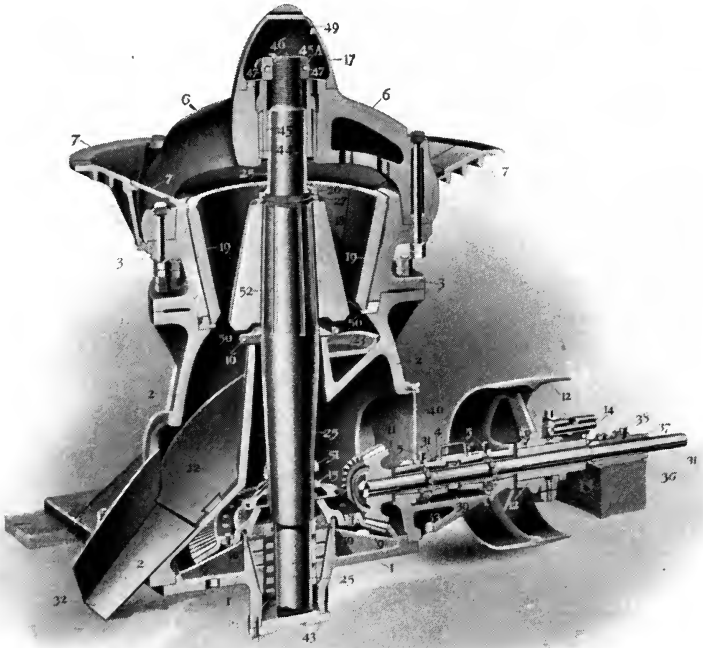

Fig. 21.—Gyratory Crusher. (Allis-Chalmers Manufacturing Co.)

the opposite side recedes from it. As the pieces are reduced in size they settle by gravity until they fall between the bottom edges of the crushing surfaces. The material is carried out by a chute which passes through the side of the lower section of the shell.

It may be seen from the illustration that by raising the spindle

the ore will be crushed to smaller size. The spindle is raised for this purpose, and as the wear increases the size of the opening between the crushing surfaces.

Pulverizing.—Many ores must be reduced to powder before

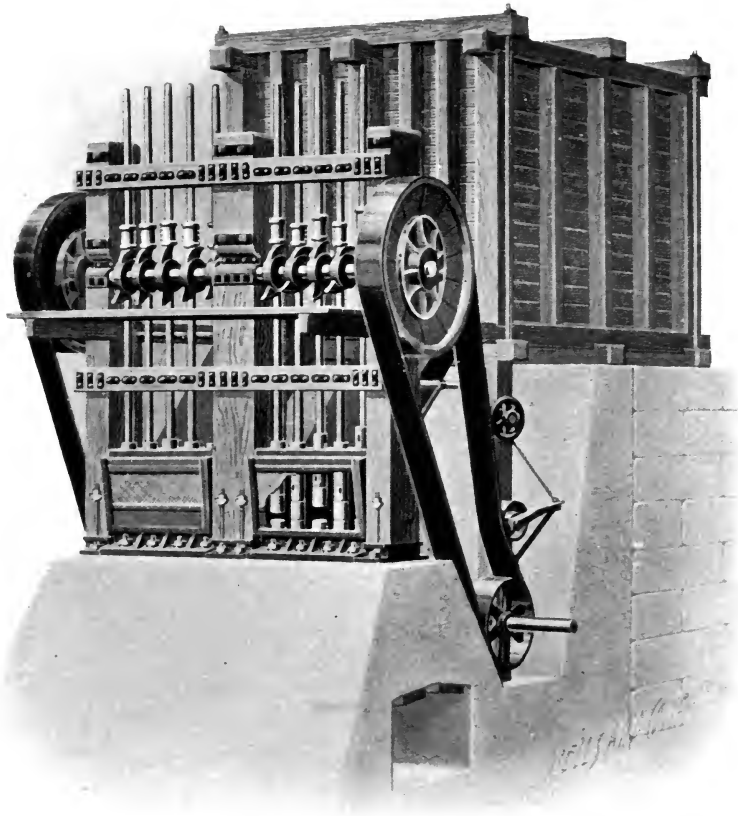

Fig. 22.—Stamp Battery. (Allis-Chalmers Manufacturing Co.)

the metal or metallic portion, which exists in such minute particles, can be disentangled. This is done by stamping or grinding after the preliminary breaking. Of the variety of mills in use for pulverizing ores the stamp mill is the most adaptable.

The general arrangement of a gravity stamp mill is shown in Fig. 22. The stamps are arranged in groups of five, and are lifted in a certain order by cams set at different angles on the driving shaft. The stamps drop by gravity upon dies placed in the

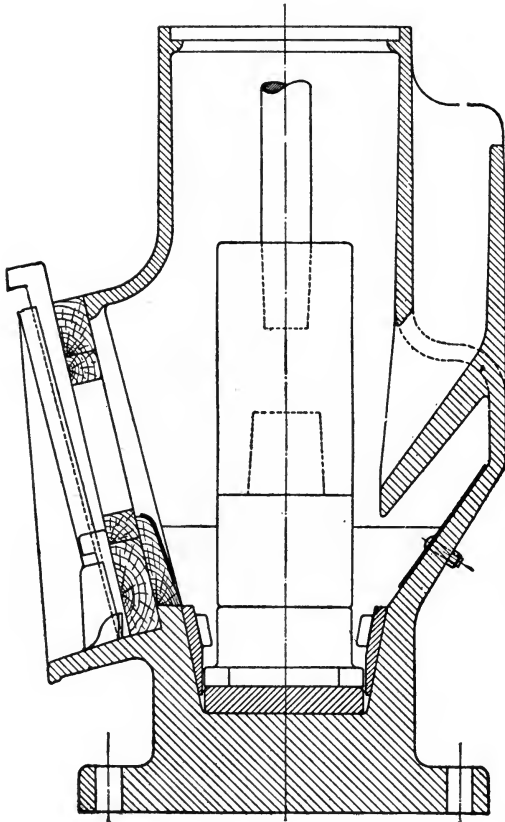

Fig. 23.

mortar. The heads of the stamps are armed with hard steel shoes, and the dies are of the same material. The mortars are cast iron. The ore is fed into the mortars from a hopper behind the battery, and as it is pulverized under the stamps it is distributed by them and thrown against the screens which are set

in front. The ore that is sufficiently pulverized passes through the screens and is taken away for further treatment.

The stamping process is made more rapid by the use of water in the mortars. The water may be added intermittently or continuously. If a large quantity of water is not objectionable with the pulp, a continuous stream is allowed to run into the mor-

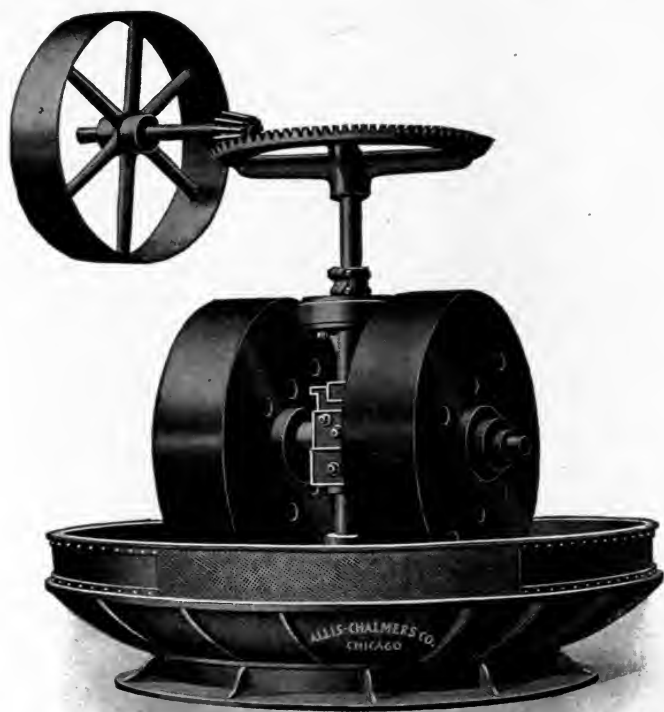

Fig. 24.—Chilian Mill.

ters. This in passing out through the screens carries away the fine ore, and the mortars are kept cleaner than they are when the ore is crushed dry.

Fig. 23 shows the section of a mortar with the screen in position. The opening at the back is for the intake of ore. The

mortar is lined with steel, and amalgamated copper plates are bolted in the front and back when gold ores are treated. Where large crushing capacity is desired, double discharge mortars are used. These are designed for wet crushing and are equipped with screens both in front and behind.

The Chilian Mill.—This mill consists of a circular iron pan upon which two or three heavy rollers revolve (Fig. 24). The rollers turn upon a horizontal axle, which is driven by a vertical shaft. The tires of the rollers are of hard steel, as is also the plate upon which they travel. Being placed near the center of the pan, the rollers are twisted at the same time they are revolved upon the track, with the result that the ore is ground rapidly and very fine. The ore is fed upon the pan by an automatic device, and it is thrown constantly in the path of the rollers by scrapers which are carried on the revolving shaft. The discharge screen is placed at the side, the ore being thrown against it by the action of the rollers.

The Huntington Mill.—This mill also grinds with rollers, but unlike the Chilian mill, there is no twisting of the rollers upon the surface of the ring-die. The rollers, of which there are four, are suspended from a plate which revolves with a vertical shaft passing through the center of the machine. The shaft is geared to a horizontal pulley shaft. The rollers are free to revolve on their own spindles, and when the mill is in operation they swing by centrifugal force against the side of the pan enclosing them. The ring-die upon which they revolve is of hardened steel. One inch of space is allowed between the rollers and the bottom of the pan. The discharge screens are placed above the rollers, over the openings shown in the cut (Fig. 25).

The Huntington mill is designed for wet grinding, and is particularly adaptable to the grinding and amalgamating of soft gold ores. The mercury is held in the bottom of the pan, where it is not disturbed by the movement of the rollers.

Sizing and Classifying.—These operations have for their object the sorting of crushed or finely divided ore preparatory to concentrating. Sizing relates to methods of sorting or grading

according to the sizes of the particles, and is usually done with screens. Classifying relates to operations in which the particles are separated according to their rate of settling in water.

Screens are of many forms and the methods of using them differ widely. Some are adapted to wet methods, but dry screening is much more common. The coarsest ones, such as are used for sizing coal and other lump material, commonly consist of parallel bars determinately spaced, and held in position by means

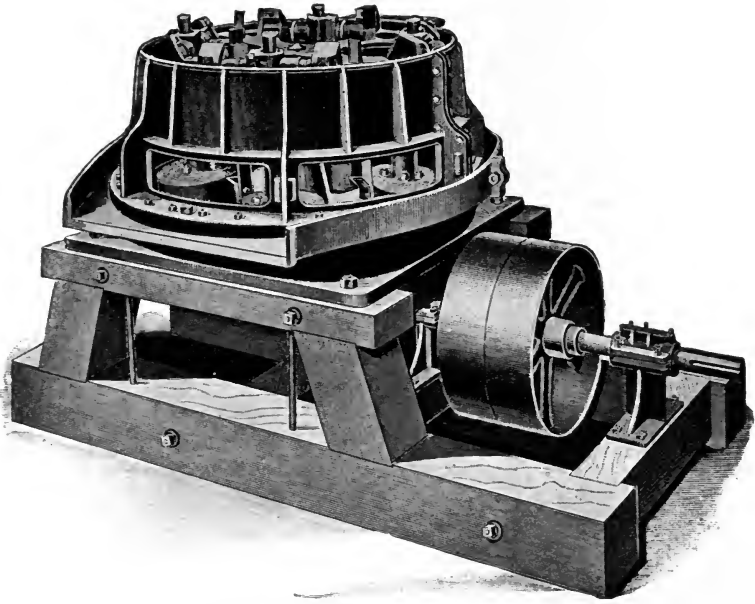

Fig. 25.—Huntington Mill. (McAllister-Chalmers Manufacturing Co.)

of bolts. Such a device is called a grizzly or bar screen. Grizzlies are usually placed at an incline, and when the ore is thrown upon them the small pieces fall through, and the larger ones slide down upon a coarser grizzly or into a stock receiver. For finer sizing, screens are made of perforated metal or wire cloth, and in use are generally given motion of some kind. Riddles are screens with plain, flat surfaces, and have a reciprocating

or gyrating motion with or without pulsation. Trommels are revolving screens usually made in the form of a cylinder, though sometimes of a prism. They are given an axial incline sufficient to advance the coarse particles, while the fines are quickly separated as the ore is tumbled about. Trommels are often made in two or more sections with screens of increasing coarseness in the forward direction, thus accomplishing the separation of a greater number of sizes. Belt screens are used to some extent in wet sizing. The screen is in the form of an endless belt, which revolves about two rollers so that the spans sag slightly from horizontal planes. The ore is spread on in a thin layer, and the under sizes fall into a hopper or chute placed between the rollers, while the oversizes are discharged as they pass over the forward roller. The belt has no secondary motion and the ore is not tumbled about as it is on other screens, but separation is assisted by spraying with water.

Classifiers are designed to separate mineral grains of different specific gravities by taking advantage of the difference in the time required for them to settle in water. Examples of the sorting action of running and still water on a grand scale are afforded by the natural deposits in the beds of rivers and seas. Many of the most valuable mineral deposits owe their origin to processes of this kind. The function of a classifier is to separate the different kinds of pulp grains so that they may be concentrated separately by appropriate means. When material to be concentrated is all of one class or nearly so the work is made lighter and more efficient. If there is considerable difference between the specific gravity of the pulp grains they may be separated by subjecting them to the action of a rising current of water under sufficient pressure to lift all but the heaviest grains. The light grains will be carried upward and floated away by the current, and the heavy ones will settle down through the current.

Since classifiers using clear, hydraulic water continue to dilute the pulp, there must be some means of dewatering this and of allowing the slimes or lighter values to settle. This is accomplished by means of classifiers having compartments through

which the slime flows at a slow rate, or the settling may be done in still water. When the suspended matter has settled the water flows to waste.

Washing.—Under this head may be included all methods of concentration in which water in motion is used. The classifying methods, above described, would also be included where actual concentration is accomplished. Washing machines are of many types and varieties, and the best kind to use depends principally upon the specific gravity and size of the lumps or grains of the ore. Space permits of but brief descriptions of some leading types of washing machines.

Log Washer.—This in its simplest form consists of an inclined cylindrical trough, down which water flows and inside of which there is a revolving shaft armed with stout helical blades. The ore is put in at the lower end of the trough, and is acted upon by the log blades after the manner of a screw conveyer, but the lumps are tumbled and broken more by the blades than they would be if the helix were continuous. The current of water against which the ore is forced washes down the earthy matter. Log washers are suitable for washing lump ores only.

Jigs represent an old type of washer which has been modified to many forms, and is still in common use. Jigs are suitable for washing ore when it is in the form of small lumps or coarse sand. Fig. 26 gives the vertical section through two compartments of a jig. The jig consists essentially of a sieve or a set of sieves upon which the ore is held, while water is forced upward through the ore by means of a piston, or the sieve itself is moved in the water. Jigs with stationary sieves are the more common. As shown in the illustration, the sieves are placed over the water compartments, to which hydraulic water is supplied through pipes at AA. The downward movement of the piston forces the water in both compartments upward through the sieves, upon which the ore is placed. The water overflows at the top, carrying with it the light, earthy matter and leaving the larger and heavier particles of ore upon the sieves. Some jigs are built with a number of compartments, the ore being discharged from one

sieve to the next, which is placed on a lower level. Jigs are commonly built of wood, the parts which are subjected to greatest wear being of iron.

The concentration of ore that is in a very finely divided state, with a minimum waste of values, affords difficult and varied problems, for the solution of which many processes have been developed. In dealing with the undersizes of classified pulp, the coarser grains constitute what are known as sands and the finer ones slimes. The separation of mineral grains, as in pre-

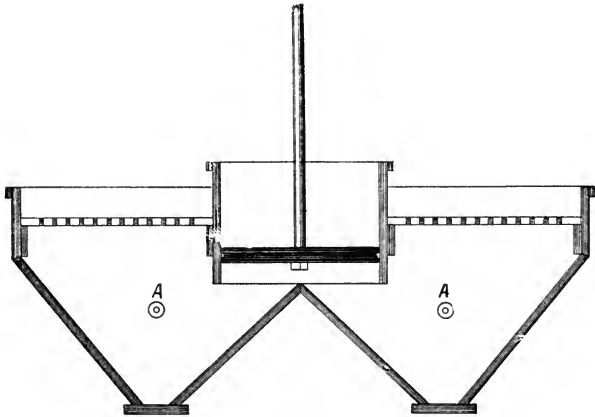

Fig. 26.

viously discussed processes, is based principally upon their specific gravity, size and form. Concentration is effected by allowing the pulp to flow with a sheet of water over a slightly inclined surface, which may be stationary or mechanically shaken, and smooth or provided with riffles. Riffles are channels or pockets, formed by attaching blocks or parallel strips. The direction of the riffles is crosswise with the flow of pulp. They serve to detain the heavier particles or concentrate, while the lighter particles or tailings are carried over with the current.

Buddles and Sluices are representatives of stationary washers for slimes. The buddle has a smooth surface over which the pulp flows, and upon which the grains collect, broadly speaking, in zones according to their rate of settling. Sluices have special

application in the treatment of gold ores, and are described on p. 325.

Shaking Tables are in very general use, fulfilling perhaps more than any other class of machine, the conditions for concentrating fine sands. The Wilfley table may be taken as the representative of this type of concentrator. The Wilfley Concentrator is shown pictorially in Fig. 27. The table otherwise known as the deck, is a trapezium, approaching a rectangle in form. It is

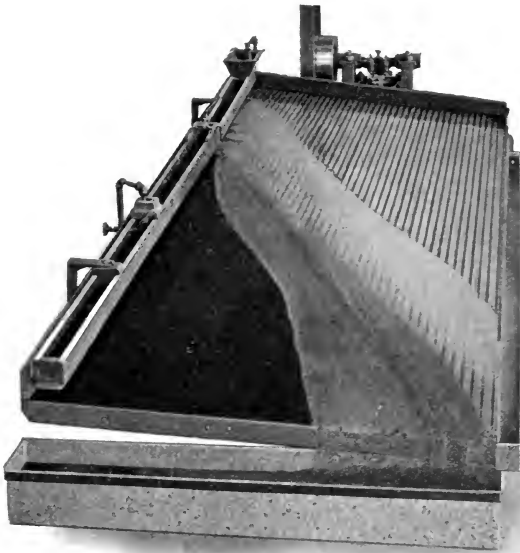

Fig. 27.—Wilfley Concentrating Table. (The Mine and Smelter Supply Co.)

covered with linoleum, and about two-thirds of the surface is riffled with strips of wood, tacked on, and terminating in a diagonal line across the deck. The deck has a transverse inclination and a longitudinal, reciprocating motion, which is accelerated in the forward direction and correspondingly diminished in speed with the return stroke. The pulp and water are supplied from feed boxes carried on the upper side of the table, the ore box having the length of the shortest riffle cleat, and the water box extending along the clear space. By gravity the sheet of

pulp flows sidewise across the table, the heavier particles being caught by the riffles. The head motion throws the pulp forward, stratifying the particles, which are further sorted by the clear water at the ends of the riffles. The heaviest particles or rich concentrates are discharged from the end and farthest up the incline of the table, the other grades down toward the lower corner, while the light tailings pass over the riffles and are discharged at the lower side.

The Vanner.—This machine is used for concentrating fine sands and slimes. The features common to different vanners

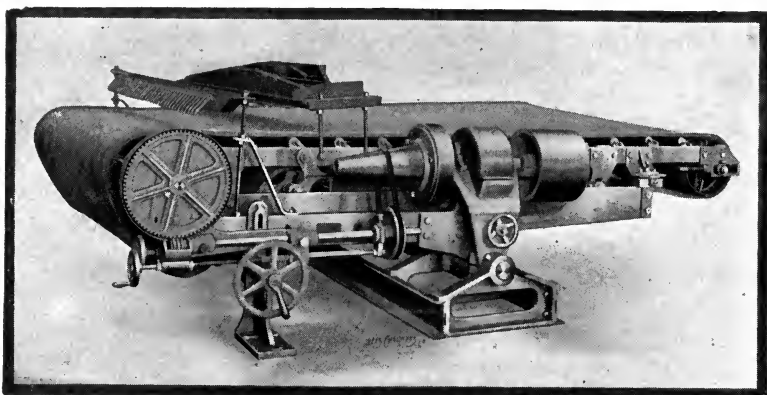

Fig. 28.—Isbell Vanner. (Allis-Chalmers Manufacturing Co.)

are the broad belt with flanged edges, the shaking table carrying the rollers upon which the belt is revolved and the ore and water distributors. The upper span of the belt, which forms the concentrating table, is supported between the end rollers by a number of small rollers having their bearings in the shaking table. An adjustment is provided by which the machine may be tipped, so that when in operation the belt forms a moving, inclined plane with the direction of the motion up hill. In addition to this the frame carrying the belt and ore distributor is shaken gently by lateral jerks.

Fig. 28 represents an improved vanner, designed by J. F. Isbell. The machine is attached to a heavy, transverse shaft and sup-

ported upon a strong foundation of steel channels. This shaft is, therefore, the axis upon which the machine is revolved or tilted, which is done by means of a cast iron stand placed at the head and provided with a cam, hand-wheel and locking device. The stand serves also to hold the vanner steady when it has been tilted to give the proper inclination to the table. The driving shaft with its main pulley, fly-wheel and cone pulley and the worm gear driving mechanism are clearly shown in the cut. The driving shaft also carries an eccentric for actuating the side shake motion of the table. It is rigidly supported from the main shaft. The worm gear for driving the vanner belt is connected with the head roller by a spiral steel spring. This gives flexibility, which is necessary since the roller is shifted in the side shake motion, while the driving mechanism remains stationary. The vanner belt may be revolved at different speeds by shifting the flanged pulley of the driving gear to different diameters of the cone pulley on the main driving shaft. The side shake motion is given to the shaking table together with the vanner belt and ore spreader which it supports, but the water box is attached to the rigid side arms and remains stationary when the machine is in operation. The shaking frame, which is made of steel, is bolted to the ends of heavy leaf springs set on edge and attached midway to the transverse shaft. The springs maintain a horizontal motion of the table from the eccentric drive which is highly desirable in the delicate operation of vanning.

Flotation.—This process is based upon the fact that substances heavier than water may be floated by reason of surface tension if they do not attract water, *i. e.*, water does not wet their surfaces. The sulphides as a rule may be separated from other minerals by flotation. In carrying out the process the dry, finely divided ore is distributed in a thin, even layer over running water. The minerals which do not attract water are carried forward, and the others are deposited. Modifications of the flotation process comprehend the treatment of ores with acids, and the use of different floating mediums such as salt and soap solutions and oils. When acids are used carbonate minerals

are buoyed by the bubbles of carbon dioxide gas that are generated and adhere to their surfaces. A preliminary roasting will qualify some ores for treatment by a flotation process.

Magnetic Separation.—This was suggested by Abraham, of Sheffield in 1882.¹ It is applicable to any ore containing a magnetic ingredient, whether that ingredient is to be saved or rejected. Minerals that are attracted are called paramagnetic, and those that are repelled are called diamagnetic. Earlier methods of separation were adaptable only to strongly magnetic materials, and were practically limited to the separation of magnetite from other minerals.

With machines now made, using powerful electro-magnets, a number of weakly magnetic minerals, which were formerly supposed not to be susceptible to magnetic forces at all, may be separated. Their variation in magnetic properties makes it possible to further separate and concentrate paramagnetic minerals. Some minerals are rendered magnetic by heat, and for this reason ores are often roasted before they are put through the separator. Pyrite is not affected by the strongest magnets, but it loses sulphur at a low furnace temperature and becomes strongly magnetic. The requirements for all ores is that they be in a finely divided state and usually dry, though some machines are designed for wet separation.

The Wetherill separator is designed for concentrating weakly magnetic minerals. This machine operates upon the principle shown in Fig. 29. The ore is distributed over the conveyor belt, B, by means of the feed roller under the hopper. The conveyor belt passes between two horse-shoe electro-magnets, which are supported in the position shown. The poles of the upper magnet are wedge-shaped, while those of the lower magnet are flattened. The paramagnetic minerals are more strongly attracted by the upper, wedge-shaped poles than by the lower ones, so that the tendency of the magnetic particles is to cling to the upper poles as they are brought into the magnetic field. The magnetic particles jump upward, but they do not come in actual contact with

¹ Dingler's Poly. Journal, 288, pp. 203-209.

the poles, since the thin cross-belts, B^1 , pass closely under the upper poles. The ore adheres to these until it is carried by them out of the magnetic field. The non-magnetic particles of ore fall from the conveyor belt as it passes over the forward pulley.

Electrostatic Processes.—These differ from magnetic processes, being based on the principle that bodies equally charged with static electricity repel. This recalls the familiar experiment in physics, in which the pith ball is repelled when touched by the wax stick having a static charge.

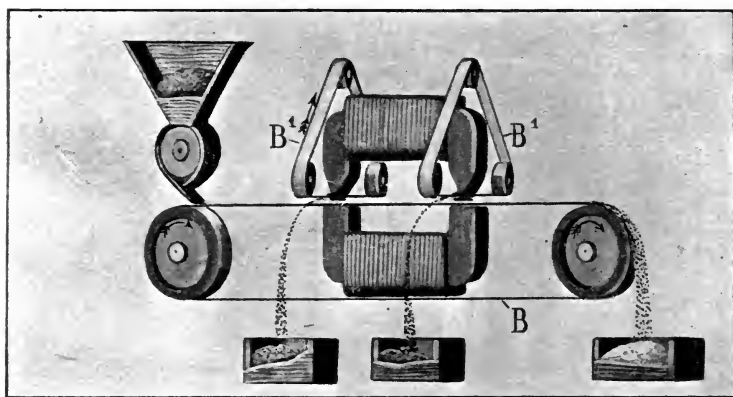

Fig. 29.—Principle of Wetherill Type "E" Magnetic Separator.

The application of this principle in ore concentration depends upon the fact that there is great variation in the electric conductivity of minerals. Taken as a class, the sulphides are comparatively good conductors. Zinc sulphide is an exceptionally poor conductor among the sulphides, and this is fortunate in view of the fact that blende and galena are so commonly associated and their separation has offered such difficulty. An electrostatic separator contains a horizontal, revolving cylinder, which is grounded to form an electrode. Another electrode is placed opposite, and is connected with a high tension current. The ore is fed onto the roller, and as it is brought into the field between the electrodes the good conducting minerals become charged immediately

and are thrown from the roller. The poor conductors drop in a vertical tangent or are carried further around.

Pneumatic Concentration.—Air may be used as a current or blast for separating minerals varying in specific gravity, the action being somewhat analogous to that of water in jigs and classifiers, or separation may be effected in still air by projecting the fine particles through it. Air concentrators are especially useful where a great deal of dust has to be dealt with.

Calcining and Roasting.—These two terms are used somewhat interchangeably among metallurgists. A distinction, however, should be made. To calcine a substance is to drive off volatile matter by heating. It differs from distillation, since the volatile matter is not recovered. To roast a substance is to heat it while adding something to react chemically with it.

Examples of calcining are afforded by the heating of oxidized ores to drive off the water, and in the "burning" of limestone, dolomite, etc., to expel carbon dioxide. The process is generally conducted in kilns (p. 90).

Ores are commonly roasted to convert sulphides into sulphates and oxides—*oxidizing roasting*, or into chlorides—*chloridizing roasting*. In the first instance the air plays the important part in the elimination of sulphur, while in the latter chlorine must be supplied.

Agglomerating.—This comprehends all processes by which finely divided materials are converted into lumps. The exploitation of low grade ores, requiring concentration as fines, and the increased output of smeltery dust have resulted in the annual production of enormous quantities of pulverulent material. How to handle this material is often a serious problem, especially if it is to be treated by a blast furnace process. It is of great advantage, and to a large extent, necessary for ore that is charged into blast furnaces to be in lump form. Agglomerating comprises briquetting, nodulizing, sintering and other processes having a similar aim.

Briquetting is perhaps the oldest of the processes for lumping ores. It consists in pressing the material into molds of the size

desired. Coal tar or other binding agents are often used, and the lumps are sometimes heated superficially to make them harder and stronger.

Nodulizing is a process of heating the ore in a slightly inclined, cylindrical furnace. The furnace revolves, and the temperature is raised until some ingredient, added if necessary, fuses. The result is that the loose particles of ore are cemented together and form ball-like masses of different sizes.

Sintering is accomplished by heating the mass of ore to incipient fusion or until some constituent fuses, acting as a binder for the more refractory particles. Sintering is frequently conducted in connection with a roasting operation. When sulphides are sintered the necessary heat is generated by the rapid combustion of the sulphur. A blast of air is commonly employed, hence the generic term "blast-roasting." The air passes through a layer of the ore, which is supported on a perforated hearth. In some processes the blast is conducted upward and in others downward through the ore. The Huntington-Heberlein process (p. 272) is representative of up-draft and the Dwight-Lloyd of down-draft processes. On account of its wide adaptability, the latter process is described here. The ore to be sintered must be in a finely divided state, and it may be moistened to render it coherent. It is spread in an even layer upon a grate, where it is kindled by a hot flame, as from an oil or gas jet, and then brought over a suction box, which draws air down through the layer of ore, effecting a speedy sintering of the mass. Oxidized ores are mixed with crushed coal or other suitable fuel to create the necessary heat. Two distinct types of machines are employed in the Dwight-Lloyd system. These are known as the drum type and the straight line or conveyor type.

In the drum type machine the grate forms the periphery of a large drum, which is slowly revolved on friction rollers. The ore is fed on the rising side of the drum, and the sintered material is scraped off on the opposite side. Air is drawn through the ore by means of a suction box, which makes close contact with the underside of the grate.

The straight line sintering machine has a level grate made up of a number of rectangular sections called pallets. These are provided with rollers on which they travel about an endless track, conveyor fashion, being driven by means of sprocket wheels. Underneath the upper span of the track is the suction box. The rim of this is planed as are also the sides and bottoms of the pallets. This prevents air from entering except through the layer of ore and the openings in the grate, since the pallets are driven from behind and slide over the rim of the box, the wheels hanging idle during this part of the transit. The ore is spread on from a hopper, and kindled as it begins to pass over the suction box. The pallets pass around semicircular guides and from thence on return tracks to the sprocket wheels. By these they are lifted and pushed forward to receive a fresh charge of ore. In passing around the semicircular guides the surface formed by the pallets is broken and the pallets are inverted. This serves to break and dislodge the sinter. It has generally been found advantageous to employ a few less pallets than are required to make a solid train. The break in the train will, of course, occur at the discharge guides, and each pallet will drop down and strike its predecessor, thus effecting a dislodgment of adhering matter.

CHAPTER VII

FURNACES AND ACCESSORY APPARATUS

Most of the improvements which have marked the development of modern practice in metallurgy have been mechanical. Furnaces have been altered in form and increased in capacity, and machinery has been introduced and improved to meet the increasing demands for larger yields of metal. Metallurgical processes are primarily chemical, the first problems which they present involving principles in chemistry. Application is made of these principles in the intelligent selection of materials for constructing furnaces, in the use of fuel, and in the isolation of metals from their compounds. Improvements in metallurgical processes, as above indicated, have been largely the work of engineers.

For that all important part of the furnace, the lining, a material of reasonable cost is selected that will best stand the conditions inside the furnace. As a means of preserving the linings of furnaces water cooling is often resorted to, especially if the lining is exposed to the scarifying action of molten materials. One method of cooling is to introduce hollow blocks of metal into the furnace wall, maintaining a circulation of cold water through the blocks. Another method is to line the wall on the outside with a water jacket, *i. e.*, a shell of metal through which water is circulated. In some instances the refractory lining is dispensed with altogether and the water jacket substituted.

On account of the high cost of most refractory materials the outer walls and foundations of furnaces are commonly built of brick, concrete or stone. In most furnaces the masonry is reinforced with iron. One method of supporting the brick work is to construct a frame of iron or steel beams and tie-rods. The beams are set vertically or horizontally against opposite walls and secured with the tie-rods. Metal bands may be used for supporting round structures. It is often necessary to provide a means of tightening and loosening the framework on account of the contraction and expansion of the walls. Furnace walls are most

completely reinforced by encasing them in iron plates riveted together to form a shell. Cast iron or structural columns are often used in the foundation work to carry the superstructure of a furnace instead of the more cumbersome masonry.

The principal types of furnaces are classified and defined here with the object of simplifying their descriptions later. Furnaces may be divided into four general classes, many variations being found in each class.

1. Furnaces in which the Fuel and the Substances are Treated in Contact.—Under this class belong kilns, blast furnaces and forges or shallow hearths.

Kilns.—This type of furnace is employed exclusively for calcining and roasting. One of the simplest forms of kiln is that

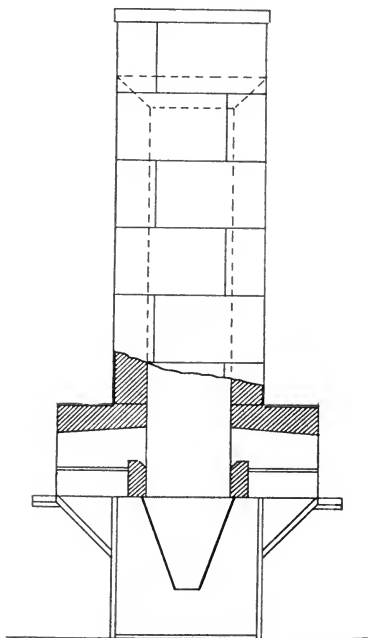

Fig. 30.

used for calcining limestone. Fig. 30 represents a lime kiln, which is cylindrical in form, $6\frac{1}{2}$ feet inside diameter and 30 feet

high. It is thickly lined with fire-brick, and is encased in a boiler plate shell. The stone is put in at the top, and is calcined by the flame from the grates shown at the sides, and the lime is received in the hopper at the bottom.

Rotary kilns are used for calcining finely divided material. The most important of this type is the cement kiln, which is cylindrical in form and revolves at a slight incline from the horizontal position. It is fired with coal dust, which is blown in at the lower end with a jet of air. Roasters of this type are described on pp. 233, 234.

Blast Furnaces.—By these are meant the tall structures, or those whose height is greater than their diameter using a blast of air. Among these may be included the furnaces now generally used for smelting iron, copper, and lead; cupolas for remelting metals, and converters for refining. Descriptions and illustrations of blast furnaces will be found on pp. 114, 243, 246 and 276.

Forges.—At one time this term was used to denote the peculiar form of hearth used in iron smelting. It has a more general meaning now, though it usually refers to the smith's forge, or any kind of wind furnace for reheating metal, without fusion, and in contact with fuel.

2. Furnaces in which the Substance Treated is in Contact with the Flame and Products of Combustion, but not in Contact with Solid Fuel.—Under this class belong the many types of reverberatory furnaces. Reverberatories are the most common of all furnaces, serving a great variety of purposes. The distinctive features in their construction are the separate hearth or fireplace in which the fuel is burnt, or an arrangement for gas; the low-arched or dome-shaped roof which reflects heat on to the hearth, and the stack for maintaining the draft. Reverberatory furnaces are usually fired with soft coal or gas. A typical form is illustrated on p. 169.

Mechanical Reverberatories have been introduced and in many processes they have been generally adopted. Among these are mentioned roasting furnaces with automatic stirrers (p. 233), and

the rocking and tilting furnaces used in steel manufacture (p. 199).

3. Furnaces in which the Substance Treated is not in Contact with either the Fuel or the Products of Combustion.—Furnaces of this class bear no relation to each other, except in that all are designed to shield the ore or metal from the action of fuel or gases while heat is being applied. The furnaces so constructed are fitted with muffles, crucibles or retorts, as the case may require.

Muffle Furnaces are principally used for roasting ores which require a strongly oxidizing atmosphere, or in general, when the temperature and atmosphere about the substance are to be carefully controlled.

Crucible Furnaces are used in refining, alloying and remelting operations in general, in which small amounts of metals are treated. The crucibles are heated by means of a flame and hot gases, or by direct contact with glowing coals. A closely fitting lid protects the contents of the crucible entirely from the fuel and gases. A description of the manufacture of crucibles and of a crucible furnace is given under the subject of Crucible Steel.

Retort Furnaces are employed for the distillation of volatile metals from their ores or from alloys. They are used in the smelting of zinc and mercury, and in some refining processes where these metals are to be separated from others. The by-product coke ovens afford other examples of retort furnaces.

Vacuum Furnaces.—When it is desirable to heat a substance without contact with any gas a vacuum furnace is used. It is generally heated electrically, and the air is withdrawn by means of high efficiency pumps. In vacuum furnaces metals may be melted or annealed, and their real properties may be more accurately determined, since the properties are not masked by the presence of occluded or combining gases. Its high cost would, of course, preclude vacuum refining on the large scale.

Electric Furnaces.—In 1849 Despritz made use of the heat of an electric arc, a battery being used for generating the current

(Moissan). Electric heating, like most other applications of electric energy, could not gain much headway until after the invention of the dynamo. Siemens, Moissan and Huntington were pioneers in the construction of electric furnaces. Modern furnaces, designed for large operations, have been built by a number of inventors, whose names the different furnaces bear. The principles of different types of electric furnaces are shown in Fig. 67 on p. 202.

Regenerative Firing.—The heat regenerator was introduced in 1817 by Robert Stirling. The regenerative system as now used, is due chiefly to William and Frederick Siemens. The regenerator is a storage chamber for surplus heat; an apparatus for retaining a portion of the waste heat, and returning it to the furnace from which it was taken. The products of combustion, and in some cases, the combustible gases themselves, which can not be utilized in the furnace, are led into the regenerator where a large part of their sensible heat or the heat of their combustion is absorbed. A part of this heat is returned to the furnace by passing the air or gas supplied to the furnace through the regenerator.

BLAST APPARATUS

The development of methods and apparatus for supplying air under pressure to furnaces marks an interesting chapter in the history of metallurgy. The ancient furnaces were blown by means of bellows, a method still used in a small way. An ingenious device known as the *tromp*, described on p. 163, was used during the early days of iron manufacture in Europe. Bellows blowers were built in larger sizes with the development of water and finally of steam power, but with the advent of the steam engine the bellows were soon replaced by piston blowers. Rotary blowers represent the latest developments in blast apparatus. They are based on different principles, vary greatly in design and have the widest range of adaptability. Representatives of the principal types of apparatus are described below.

Blowing Engines.—These are reciprocating piston blowers, which are usually connected directly with steam engines. They

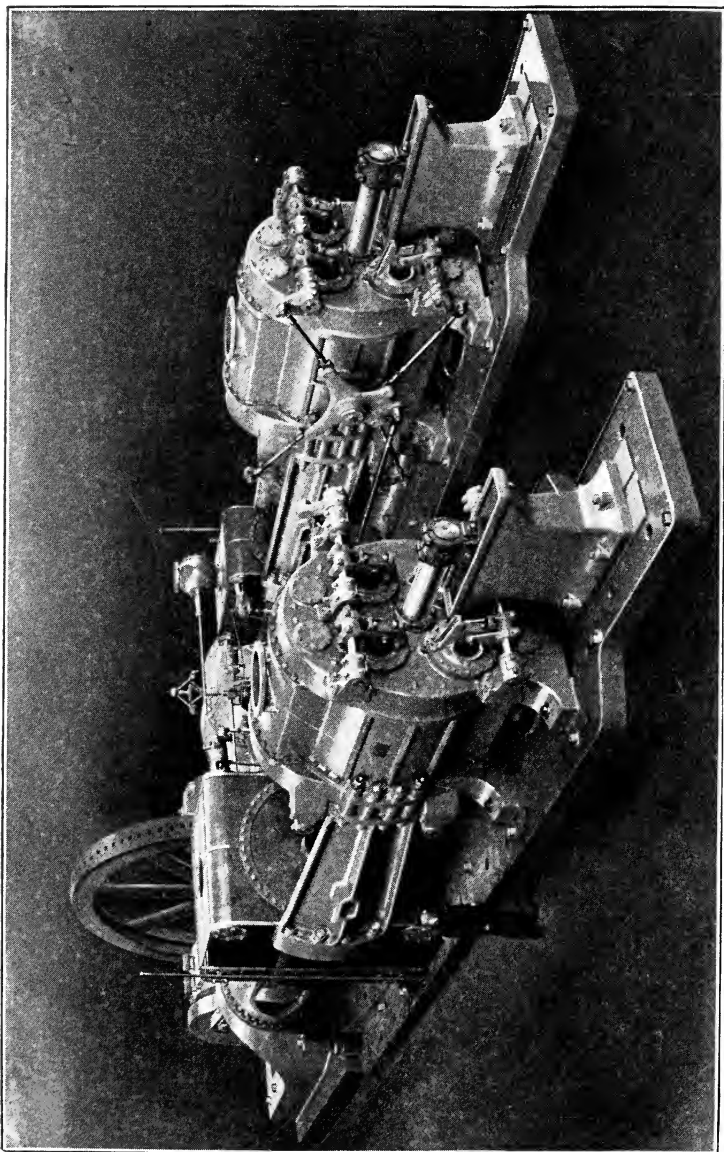

Fig. 31.— Cross-Compound Blowing Engine. (Allis-Chalmers Manufacturing Co.)

are designed to deliver upwards of 30,000 pounds of air under pressures not exceeding 30 pounds per square inch. Those which deliver air under higher pressure are known as compressors.

The large engine shown in Fig. 31 is designed for blowing iron blast furnaces, converters, etc. It is of the cross-compound type, and has a capacity of 30,000 cubic feet of air per minute under a pressure of 30 pounds per square inch. The steam and air cylinders are placed tandem, the piston heads being carried on a continuous rod. The rods are extended through the ends of the cylinders and supported on slides, thus preventing uneven wear on the piston heads and cylinders. The large fly-wheel gives steadiness of motion to the engine. The air cylinders are shown in the foreground. Air passages are provided in the cylinder castings, leading from the middles to the heads. The air is admitted and discharged under control of mechanically operated valves on the heads of the cylinders. The outside mechanism of the air valve gear is shown on the cylinder to the right in the illustration. The valves are operated in time with the piston by means of a wrist plate, which has a bearing on the side of the cylinder. The wrist plate is given a slight, rotary motion alternately in opposite directions by an eccentric attached to the main shaft of the engine. The motion is communicated to the valves by crank shafts to which the arms of the wrist plates are attached. The crank shafts are shown on the ends of the cylinders. The discharge valves are closed by plungers at the moment the piston, in approaching them, reaches the end of its stroke. The plungers recede after seating the valves, leaving them to be opened automatically by the pressure of the air in the cylinder. The intake valves are operated entirely by the mechanism, their opening and closing being timed with the stroke of the piston. With each stroke of the piston the cylinder is filled with air from one end and emptied from the other end.

The vertical type of blowing engine is also in general use. It has the advantage over the horizontal engine in taking up less floor space. On the other hand, the horizontal engine is more stable and more easily accessible.

Gas Engines are to a considerable extent replacing steam engines for blowing purposes. This is most notable in iron smelting, the waste gas from iron furnaces being admirably suited for running gas engines.

Fans.—The fan is a simple device for creating a blast under slight pressure, usually not exceeding 10 ounces per square inch. As shown in Fig. 32, the apparatus consists of a set of blades which revolve in a casing. The air enters about the axis of the impeller and is driven against the walls of the casing and outward through the tangential opening at a pressure corresponding to the centrifugal force created by the impeller. Fans are capable of delivering large volumes of air, and cost little to install

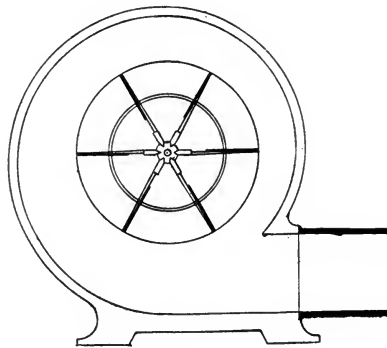

Fig. 32.

and maintain, but they are wasteful of power, and are restricted to low pressure work.

Rotary Piston Blowers.—These are also known as positive pressure blowers, since they are designed to displace definite volumes of air against variable pressures. The construction is shown in Fig. 33, which is a sectional elevation of a blower. Two impellers revolve in opposite directions within a cylindrical case. The impellers are two-lobed and so carefully shaped as to maintain the slightest possible clearance between each other; also there is a minimum clearance between the lobes and the walls of the case.

Looking at the drawing, it may be seen that if the left-hand impeller is revolved clockwise and the other one in the opposite direction, each impeller in making one revolution, will carry two pockets of air through in the direction indicated by the arrows. The air is caught in the space formed between the lobes of the impeller and the case. Blowers of this type are built to deliver

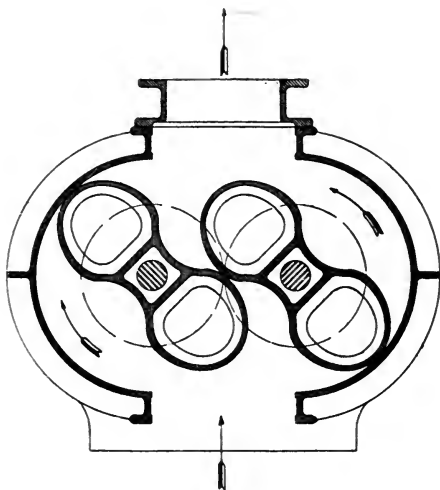

Fig. 33.—Section through Connersville Positive Blower.

large quantities of air, and are in very general use for pressures not exceeding 10 pounds per square inch.

Centrifugal Blowers.—These machines represent the latest development in blast apparatus. They are designed to deliver large volumes of air at any pressure up to and sometimes exceeding 30 pounds. The sectional drawing, Fig. 34, represents a centrifugal blower, consisting of an impeller surrounded by a set of stationary vanes and enclosed in a circular case. The impeller blades are curved and radial at the circumference. The stationary vanes are so placed as to conduct the currents of air from the impeller blades longitudinally into the outer space enclosed by the case. The air enters at the inner diameter of the impeller and is discharged through a pipe connected with the

top of the case. The action of the vanes makes the chief difference between the operation of this machine and a fan. In the latter most of the centrifugal velocity of the air is wasted in eddy currents, and the energy is largely transformed into heat. Aside from its high efficiency the centrifugal blower is a machine of great adaptability. It requires less space than any other blower doing the same amount of work, and the rapidity with

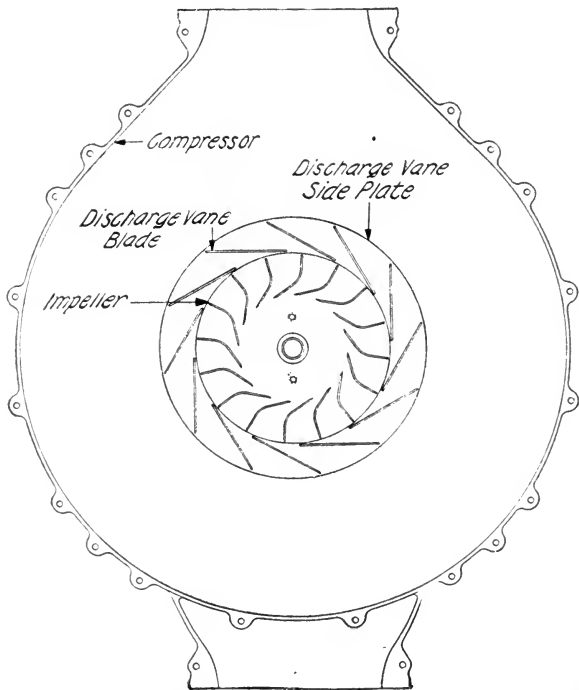

Fig. 34.—Centrifugal Blower. (General Electric Co.)

which it can be driven makes possible its direct connection with a turbine or an electric motor.

Fig. 35 represents a centrifugal blower driven by a steam turbine. Such a set is commonly called a turbo-blower.

Multi-stage compressors are used for high pressure work.

In these the air is compressed successively by two or more impellers, which are carried on the same shaft and enclosed in a

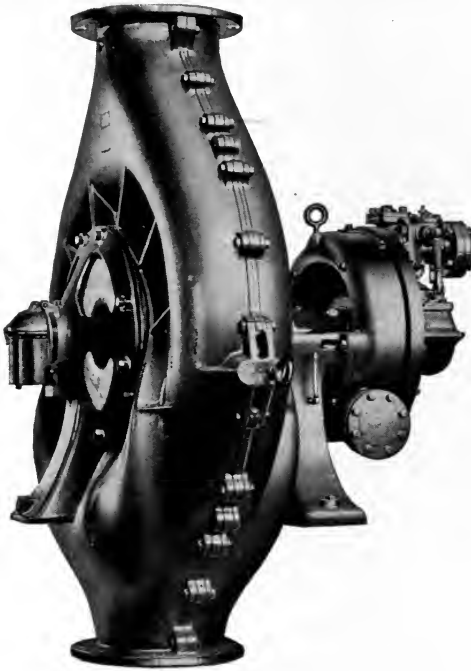

Fig. 35.—Turbo-Blower. (General Electric Co.)

common casing. The impellers are separated by diaphragm walls, and through these and the casing proper passages are provided for leading the air from one impeller to the next.

CHAPTER VIII

IRON—ORES AND PROPERTIES

History.—No metal has played so important a part in history and civilization as iron. The knowledge of its properties, and consequently the intelligent use of it, has marked the rise of nations, and the material power of nations to-day is represented by the amount of iron they use. As to its origin, very little can be said that is authoritative, nothing being known of the time or the place in which it first appeared in the arts. There is sufficient evidence that some of its most useful properties have been recognized and utilized for thousands of years. There are a number of scriptural passages in which iron is mentioned, and one in the Book of Daniel compares it with other substances (Dan. II, 40). Archaeological research has furnished many specimens of ornaments, tools and weapons, and it is quite likely that the proportion of iron implements was greater than the findings show, owing to the fact that iron is more rapidly destroyed by natural chemical attack than the other metals with which the ancients were acquainted. The earliest reference to iron in Assyria is about 1400, B. C. This probably antedates its use in Egypt, and it appears that Assyria furnished iron to Egypt for a long period of time. Strong evidence points to the Celtic tribes of Central Europe as the first iron workers of that continent and as the introducers of iron into Greece, Italy and Britain. Iron implements were common in Greece in the time of Homer, whose writings frequently allude to iron, but it appears to have been unknown prior to that time, for the Acropolis remains of Mycenae yield no iron. It is possible that India or some other eastern country with unwritten history produced iron before it was known in Europe. The manufacture of iron by barbaric people in Africa and Asia is still carried on as it has been for untold generations, and with some the art of hardening it with carbon has long been practiced. In upper Italy iron was known about 1000, B. C. The most famous mines were at Noreia in Noricum, and the superior quality of Noric iron is

frequently referred to by Pliny and the Augustine writers. With their rise in power the Romans became the leading consumers of iron, and the art of smelting and working it was developed and spread largely through Roman invasion under Julius Caesar. The iron industry grew with the nations of Europe, England, Germany and France taking the lead, and the English brought it to America. The first iron plant in America was erected on the James River, in Virginia, in 1619.

ORES

Iron occurs as oxides, carbonates, sulphides, and native. Native iron is found in meteorites, and as such is only of scientific interest. The oxides are by far the most important ores of iron.

Oxides.—All the common ores of iron are included in this group, as are also the richest ores. Oxide of iron is an ingredient of almost every soil, and as an ore it is often found in a high degree of purity. Some ores are more highly oxidized than others, those containing the least amount of oxygen being magnetic. The former are represented by the general formula Fe_2O_3 , and are known as hematite, while the latter are represented by the formula Fe_3O_4 and are known as magnetite.

Hematite.—This is the common ore of iron, composing almost entirely the great deposits of Lake Superior and the greater part of those of the Appalachian region and the West. It occurs in amorphous and granular masses and in earthy form, and is deposited in beds, veins, and pockets. Hematite is usually without water of combination (anhydrous), though some varieties are hydrated. The anhydrous ores yield a red powder, and the powder of hydrated ores is brown or yellow. Among the anhydrous ores are:

1. *Specular ore*, occurring in crystals of metallic luster and often iridescent. It is an important Lake ore, and very pure.
2. *Micaceous ore*, so called from its resemblance to mica, is often found in glistening scales of great beauty. This is also a very pure ore, and is found principally in the Lake region.
3. *Kidney ore* occurs in small quantities, though often in the

neighborhood of large veins. It is found in radiating masses, made up with small, reniform or kidney-shaped surfaces, suggesting the name. It is frequently met with in the Eastern states.

4. *Red Fossil ore* is characterized by its being unctuous to the touch and, in general, by its red color. It occurs both earthy and massive. Besides its importance as a Lake ore, red fossil ore occurs in large quantities in the East and South, being the chief ore in Alabama.

Of the hydrated oxides or brown hematites two varieties may be noted:

1. *Limonite*, otherwise known as *Ochre* and *Bog Ore*, occurs in large quantities in the Eastern states and the Mississippi Valley. It is an easy ore to smelt, the gangue often containing both silicious and calcareous substances, making it self-fluxing.

2. *Goethite* is an unimportant ore, distinguished from limonite only in its containing less water of combination.

Magnetite.—It is seen from the formula (Fe_3O_4) that this ore may carry as much as 72 per cent. of iron. When in their purest form the magnetites are the most valuable ores that are smelted. In addition to their magnetic property, these ores are distinguished by their dark color, submetallic luster and weight. They are hard, massive and refractory. In this country the chief deposits of magnetite are in New York and New Jersey, though it is not infrequently found with hematite in the Mississippi Valley and elsewhere. It is also an important foreign ore. The famous deposits of Sweden, probably the richest in the world, consist mostly of magnetite.

Carbonates.—These comprise a much poorer class of ores than the oxides. The highest content of iron possible, according to the formula, FeCO_3 , is a little more than 48 per cent. The chief carbonate ore is

Siderite or spathic iron, which is grayish-white to reddish-brown in color, yields a light colored powder, and is easily decomposed by heat into the magnetic oxide and carbon dioxide. An argillaceous variety of this ore occurs, usually in the vicinity of coal deposits, and is known as *clay iron stone*. Carbonate

ores are not uncommon in the East, especially in Pennsylvania. They have for a long time been mined in Great Britain, though they are now becoming exhausted. Though poor in iron, rarely exceeding 40 per cent., these ores have been prized for their freedom from phosphorus, a very objectionable impurity in iron.

Sulphides.—Attention is called to the sulphides as interesting, though not important sources of iron. The principal compounds of this class are Pyrite (FeS_2) and Pyrrhotite (Fe_7S_8). Pyritic ores are the chief raw material from which sulphuric acid is manufactured. The sulphur is so completely removed in by-product roasters that the residues are suitable for iron smelting.

Some Impurities in Iron Ores.—Iron ore gangue is generally acid in character, the bases alumina, lime, magnesia, etc., being insufficient to neutralize the silica. Sulphur and phosphorus are deleterious elements often encountered, and in rare cases arsenic is present. Manganese is contained in almost all iron ores, its presence being rather desirable. Titanium, chromium and zinc are not uncommon impurities. In some instances these metals have so far replaced the iron as to justify a special name for the ore. The mineral *ilmenite*, for example, contains a mixture of ferric and ferrous oxides with the dioxide of titanium. The best known American deposits of high titanic iron are in New York. *Chromite*, the sesquioxide of chromium mixed with ferrous and ferric oxides, is another well known and very valuable compound ore. Chrome-iron ore occurs at various points in the United States in small quantities, but this country's supply is drawn chiefly from abroad. A more remarkable mixed ore occurs in New Jersey, known as *Franklinite*. It contains three metals, iron, manganese and zinc in workable quantities.

Dressing Iron Ores.—The larger part of the iron ore in the United States requires no preliminary treatment, though most ores could be improved for blast furnace smelting by some concentrating or agglomerating process. Such processes have come more into use with the increase in the production of low grade and fine ores. Carbonate and hydrated ores may be profitably

calcined; those containing sulphur roasted; those containing much gangue washed or concentrated with magnetic machines, and the fine ores may be agglomerated by one of the sintering or briquetting methods.

The Oliver Iron Mining Company operates a large washing plant embodying some novel features in iron ore dressing. The ore is sluiced down over a grizzly where any large lumps of rock are separated. The smaller sizes pass into trommels, and the larger sizes pass onto a picking belt, and after hand picking are dumped into the shipping bin. The oversize ore from the trommels is carried to the shipping bin, and the undersize ore is treated in log washers. From these the coarser ore goes to the shipping bins and the fines to smaller turbo log washers. The fines from the turbo washers are concentrated by means of Overstrom tables.¹

PROPERTIES

Pure Iron.—Iron is grayish white in color and highly lustrous. The specific gravity is 7.8 and the fusion point is about 1,530° C. It is remarkably tough, malleable and ductile, and its tensile strength is about 40,000 pounds per square inch. Iron possesses the property of magnetism to a higher degree than any other metal. Iron welds readily, can be welded to a few other metals, and will form alloys with almost all metals. While in the molten state iron occludes oxygen, nitrogen and other gases which may be in contact with it.

Pure iron is a very uncommon article of commerce, though there are some grades which contain so little foreign matter as to possess properties approximately the same as those above noted. Since the properties of a metal are governed by its composition and by heat and mechanical treatment, the possibility of developing or improving these properties is readily seen. In no metal has this been realized to so great an extent as in iron. Within certain limits, by alloying or combining other elements with iron in varying proportions, a metal of any desired property may be produced. Hence has arisen the great variety of com-

¹ Min. & Eng. World, XXXV, 949.

mercial irons, each designed for specific purposes. A knowledge of the effect of impurities is indispensable to iron manufacturers.

Effects of Other Elements on the Properties of Iron.—It is impossible to state accurately and completely the effect of the various elements found in iron—a full and systematic research has never been made. The only way to gain full information on this subject would be to add the elements to iron separately and in varying proportions, and then to test each product. This would be an exceedingly laborious task, which the end would not justify. Since the effect of any ingredient is influenced more or less by the presence of others, and since commercial iron usually contains a number of foreign elements, the information is, for the most part drawn from tests made on the several grades as manufactured.

The principal non-metallic elements combined in iron are carbon, silicon, sulphur, phosphorus and oxygen.

Carbon.—When practically free from other elements molten iron may be made to dissolve as much as 4.63 per cent. of its own weight of carbon. On cooling, some of this carbon is retained in combination with the iron, while the rest separates in scale-like crystals of free, graphitic carbon. Some of this graphitic carbon escapes during the cooling, but the larger part of it is incorporated in the mass of solidifying metal. Graphite obtained from pig iron is called "kish." That in the iron may easily be detected with the eye on a fractured surface. If the molten iron be cooled slowly the greater part of the carbon will separate in this way, while in rapid cooling most of the carbon is retained in the combined form. If iron saturated with combined carbon is subjected to prolonged heating at a temperature of about 700° C., dissociation takes place with the liberation of iron and graphitic carbon. Although the saturation point for total carbon in iron, as determined by experiment, is 4.63 per cent., it is rare that iron is made to contain more than 3.50 per cent., unless some other substance is present, which raises the saturation point. The saturation point is raised by some and lowered by the presence of other elements.

Graphitic carbon imparts to iron a dark-gray color, furnishing a most ready means of detection. It renders the fracture coarse, presenting the faces of graphitic scales, often one-fourth inch across. These destroy, to a large extent, the continuity of the metal, impairing its strength. The tenacity, elasticity, toughness, malleability and ductility are diminished; the hardness is not much altered; the fusion point is lowered, and welding is made difficult or impossible. The presence of graphitic carbon in iron prevents to a large extent the occlusion of gases. It is rarely found in any other than cast iron. Those containing a high percentage of graphitic carbon are known in commerce as gray irons.

Combined carbon exerts a more profound influence upon the properties of iron than that of any other element. The relation of carbon to iron has been studied exhaustively from both the scientific and practical points of view. The fracture of carbon iron varies from fibrous or hackley, the fracture of pure iron, to fine granular, the fracture of high carbon steel. So marked is this effect in iron which does not contain interfering elements, that an experienced observer can estimate the carbon to within a few hundredths per cent., from the appearance of the fracture. The effect of combined carbon, in general, is to increase tenacity, elasticity, and hardness. The maximum tensile strength, and the highest limit of elasticity are gained with about one per cent. of carbon. The hardness is increased by adding carbon until the saturation point is reached. At this point iron is so brittle that it can be powdered. Carbon lowers the fusion point, and interferes with welding. Iron containing a high percentage of carbon can not be welded by the usual method. High carbon iron is used for making permanent magnets, since it will remain magnetized indefinitely. The permanence and efficiency of steel magnets is increased by adding carbon up to 0.85 per cent. (Met-calf). It is possible that carbon forms a number of definite compounds with iron, the composition of these varying with the amount of carbon or other elements present and the heat treatment. The probable number of carbides and their composition are unsettled questions, only one having been isolated.

This was discovered by Abel, and corresponds to the formula, Fe_3C . The effect of carbon is governed to a large extent by the presence of other elements in iron and most profoundly by heat treatment. The study of this subject is continued under the heat treatment of steel (pp. 218-221).

Silicon.—Like carbon, silicon may exist in iron in both the free and combined state. Free silicon, however, separates only under peculiar conditions, and is rarely ever present. It is probable that silicon combines with iron in different proportions, depending upon temperature conditions and the presence of other elements. The silicide is more soluble in molten iron than the carbide, and the presence of silicon causes carbon to precipitate from iron. If as much as seven per cent. of silicon is present all of the carbon will be in the form of graphite. In iron and steel manufacture *ferro-silicon* is used. This material is made in blast furnaces or electric furnaces, and may contain upwards of 60 per cent. of silicon. Commercial iron rarely carries more than four per cent. of silicon, and in the purer irons and soft steel not more than a few thousandths per cent. is present. The fracture of high silicon iron is bright and crystalline, becoming coarser with the higher percentages. Silicon develops hardness and elasticity in iron, but it diminishes the tensile strength and ductility and renders the metal unworkable. Spring steel may contain as much as two per cent. with the carbon as low as half a per cent. The most useful effects of silicon are obtained when it is added to iron as it is cast. The fusion point is lowered and occlusion, so far as oxygen is concerned, may be almost entirely prevented. At the temperature of the molten bath, silicon combines with both the free, dissolved oxygen and a part of that which is in combination with the iron. The resulting compound, silica, forms a fluid slag, ferrous silicate, with the excess of ferrous oxide present, and this rises to the surface of the bath. Steel makers almost invariably add a small amount of silicon in some form when casting steel.

Sulphur.—This element is found in all grades of iron except that made from very pure ore, and smelted with charcoal. It ex-

ists as FeS , which is readily dissolved in molten iron. Sulphur is a most objectionable element in the purer irons. A few hundredths of a per cent. may cause iron to crack while it is being forged at red heat. This failing is termed "red-shortness." The effect of sulphur is less marked in iron containing a high percentage of manganese. The effect on finished iron is not considered serious if not over 0.06 per cent. is present.

Phosphorus.—The phosphide of iron, like the compounds above, is readily diffused in the metal. There are probably several phosphides of iron, though their composition has not been determined. *Ferro-phosphorus*, containing as much as 25 per cent. of phosphorus, is now manufactured. Phosphorus lowers the melting point and conduces to smoothness of surface in cast iron, which may carry as much as 1.5 per cent. of this element. In the purer irons phosphorus is a dangerous ingredient. The metal containing it may be quite easily forged, showing no sign of weakness while hot, but when cold the toughness, malleability and ductility are impaired. As much as half a per cent. would render iron very brittle when cold, though it shows no signs of failure while hot. Phosphorus is practically eliminated from some grades of iron. The highest grades of steel made for structural purposes carry from 0.010 to 0.035 per cent., and a great many carry from 0.035 to 0.10 per cent. The effect of phosphorus is but slight under 0.03 per cent.

Oxygen.—The scale of oxide that forms when iron is burnt is not dissolved or diffused in the molten metal as the above compounds are. A chemical analysis, however, will generally show in iron treated by any refining process, a small quantity of oxide. These mechanically incorporated particles weaken the metal in proportion to their number and size. If scale is left on surfaces to be welded, it will either prevent the pieces from uniting altogether, or make the point of union weak.

The principal metallic elements alloyed with iron are manganese, nickel, chromium, tungsten, molybdenum, titanium, vanadium and aluminum.

Manganese.—After carbon, manganese is the most important

element that is added to iron. It is smelted for this purpose and marketed under the names *spiegel-eisen* and *ferro-manganese*. These are rich alloys with iron, the former containing about 25 and the latter about 80 per cent. of manganese. The low carbon or soft steels are made to contain from 0.30 to 0.50 per cent. of manganese, and the high carbon steels from 0.60 to 1.25 per cent. As much as two or three per cent. produces extreme brittleness. When carbon and other elements are present, the effect of manganese is largely counteracted, and its presence is highly beneficial. Thus, in cast iron it is said to act as a softener and in the carbon irons or steels it may be said to intensify the effect of carbon. The chief value of manganese lies in its indirect influence upon the properties of iron. On account of the readiness with which it diffuses with iron, and its stronger affinity for oxygen and sulphur, it has proved an excellent agent for the removal of these impurities from iron, promoting soundness and freedom from red-shortness.

If more than seven per cent. of manganese is added to iron, remarkable toughness and hardness are developed. The famous Hadfield steels contain about 13 per cent. of manganese, and are at once so tough and so hard that they can not be machined.

Nickel.—The extreme toughness of nickel, its high melting point, and its resistance to oxidizing agents would seem to recommend it as an ingredient in iron. Nickel increases tenacity and elasticity in iron, and to some extent hardness. Welding is made more difficult and conductivity is diminished. When the nickel is increased beyond 20 per cent. the properties become impaired. The well-known nickel steels contain about three per cent. of nickel. Larger quantities are sometimes added to iron to render it non-corrodible.

Chromium.—This metal is manufactured chiefly from chrome-iron ore which yields an alloy, *ferro-chromium*, containing upwards of 65 per cent. of chromium. In this form it is added to steel to improve its wearing and cutting power. The tensile strength and elastic limit are raised in iron by the presence of chromium. In pure iron the hardness is not much affected, but

in high carbon iron two per cent. of chromium develops extreme hardness. It is believed that the hardness of chrome steels is due to the fact that chromium raises the saturation point of iron for carbon, the alloy holding more carbon in the hardening form than it is possible for iron alone to hold. Chrome steel is readily forged, though difficult to weld. The tenacity and elasticity of iron may be increased by adding chromium up to five or six per cent. The hardest and best wearing steels contain chromium in addition to nickel, tungsten, vanadium or other alloying metal.

Tungsten.—The use of this metal is more limited, it being rarer than either of the last two. *Ferro-tungsten* is prepared from wolframite, and contains a high percentage of tungsten (about 75 per cent.). The metal is usually added to iron in this form. Like chromium, tungsten exerts its most remarkable influence upon the properties of iron in the presence of carbon. When alloyed with high carbon iron, hardness is developed, which may exceed even that of chrome-steel. Tungsten steels are known as “self-hardening,” because they do not require tempering. Tungsten steels are difficult to forge and can not be worked at all when cold. A small percentage of tungsten is said to improve magnetism in steel. The famous Mushet steel contains about two per cent. of carbon and about eight per cent. of tungsten. Other steels are made richer in tungsten, and are consequently harder and more brittle.

The temper of steel that is hardened with tungsten is not impaired like that of ordinary carbon steel by heating. It appears that the carbon is the real hardening element and that the action on the tungsten is to hold the carbon in solution. Some evidence of that is found in the following experiment which was first observed by Langley. If a piece of carbon steel be held against a revolving emery wheel a shower of tiny stars of great brilliancy is produced, due to the explosive combustion of the particles of carbon. If, however, the steel contains three per cent. of tungsten the sparks emitted are mostly of a dull-red color, and a red band is seen to cling to the periphery of the wheel.

Chrome-tungsten steel has the peculiar and valuable property known as "self hardening," and is used for high speed cutting tools. These tools will hold an edge when heated to dull redness.

Molybdenum is similar to tungsten in its relation to iron. About half as much molybdenum as tungsten, however, is required to produce the same result. In other words, approximately the same result may be obtained by adding tungsten or molybdenum to iron in the ratio of their atomic weights, the atomic weight of tungsten being 184 and that of molybdenum being 96. These metals are also added together and with chromium to iron.

Titanium.—This element is rarely ever found in iron in the free state, and it has not been shown that it imparts any valuable properties as an alloying ingredient. It is manufactured by an electric furnace process in the form of *ferro-titanium*, carrying 10 to 15 per cent. of titanium, and in this form it is added to molten iron to prevent unsoundness resulting from occluded gases. Titanium combines readily with oxygen and, unlike other cleansing elements, it has a strong affinity for nitrogen.

Vanadium.—This metal has until recent years been too rare and costly to permit an extensive use in the manufacture of industrial alloys. The most important results with vanadium have been gained when other metals and carbon are present. In some alloy steels the addition of a small amount of vanadium greatly increases the tensile strength and resistance to shock. The influence of vanadium is remarkable in that a few tenths per cent. only is required, from two to six tenths being present in vanadium steels. On account of the readiness with which it oxidizes vanadium is an excellent cleanser for molten iron.

Aluminum.—It has not been shown that aluminum by direct influence imparts any useful properties to iron. It appears to increase the solubility of iron for some gases, thereby offsetting the deleterious effect of occluded gases. It is an excellent deoxidizer for molten iron, and is extensively used for this purpose.

Other Metals, including copper, cobalt, tin, arsenic, antimony,

bismuth and the precious metals are sometimes present as impurities or may be intentionally added. Copper, cobalt and the noble metals render iron less corrodible, and if the proper heat treatment is given there is an increase in the tensile strength.

Gases.—The property of occlusion, or the solution of gases is important in the metallurgy of iron. In all processes wherein iron is melted, the air or other gases which come in contact with it will be absorbed to a certain extent. The larger part of this gas passes out of solution and is expelled during cooling. Some becomes entrapped, forming cavities, separates in globules (blow-holes) while the metal is in the semi-solid condition, and that which remains is held in the metal as a solid solution, *i. e.*, forming no visible cavities, but diffusing or alloying with the metal. As a rule, the purer iron is, the less will be its solvent power for gases. Aside from the weakening effect of blow-holes, it is impossible to state fully and accurately the effect of dissolved gases on iron. But it is recognized in the refining of iron that the best results are gained under those conditions which permit the least amount of occlusion. It is possible that many cases of red-shortness and failures of various kinds in both hot and cold iron are due to occluded gases. Oxygen, nitrogen and hydrogen gases are dissolved by iron, and carbon monoxide and carbon dioxide are said to be dissolved under certain conditions. Thomas Baker¹ heated cast steel in a vacuo in a glazed porcelain tube, and obtained gas of the following composition:

CO ₂	CO	H ₂	CH ₄	N ₂
0.48	48.05	49.62	0.40	1.45

Chemical Properties of Iron.—Iron combines with all the non-metallic elements, generally forming two or more distinct compounds with each. It is dissolved by all the mineral acids with which it forms well known salts. In dry air at ordinary temperatures iron undergoes no change, but when moisture and carbon dioxide are present it rusts, *i. e.*, it is slowly converted into a hydrated oxide, similar in composition to some hematites. Finely divided iron burns freely in air, and when heated in mass the

¹ Met. & Chem. Eng., VIII, 285.

outer skin burns, forming what is known as "scale". This is the magnetic oxide, corresponding to the natural compound Fe_3O_4 . Ferrous oxide (FeO) is not known in the isolated state, owing to the readiness with which it combines to form higher oxides and salts. It is a transitional product in the reduction of higher oxides and in the oxidation of metallic iron. It is basic in character, forming easily fused compounds with silica. It combines also with phosphoric and other acid radicles. The magnetic oxide (Fe_3O_4) is theoretically made up of one molecule each of the protoxide and the sesquioxide (Fe_2O_3). Iron sesquioxide is partially reduced to the magnetic oxide by heat, and both oxides are reduced to metallic iron by carbon and reducing gases at a temperature far below the melting point of iron. When melted or heated above redness iron will decompose water with the liberation of hydrogen. Some fearful explosions have resulted from spilling molten iron into water. The carbonate of iron (FeCO_3) is decomposed by heat with the liberation of carbon dioxide, the residue being ferric oxide. Iron and sulphur combine to form ferrous sulphide (FeS) when heated together or when iron is heated with the sulphide of another metal which has less affinity for sulphur. When ferric sulphide (FeS_2) is roasted ferrous sulphide is formed, but sulphur may be completely liberated from iron by heating under oxidizing influences. Ferrous sulphide is also decomposed at a high temperature by the action of certain other metals or bases which have greater affinity for sulphur. Practical examples are afforded in the substitution of manganese and calcium sulphides in steel refining and of copper sulphide in copper smelting. The phosphide of iron is decomposed at a moderately high temperature by a strong base such as lime or ferrous oxide, the base forming a phosphate. The carbide and silicide of iron are decomposed by direct oxidation or by the action of oxides at furnace temperatures.

CHAPTER IX

IRON SMELTING—CHEMISTRY OF THE BLAST FURNACE PROCESS

Pig Iron.—This term originated with the method of casting iron from blast furnaces in sand beds. See p. 146. Pig iron is the product of the blast furnace process which has not been refined. It therefore signifies no special quality or composition. In all civilized countries iron is first smelted in this impure form, and the purer irons are prepared from this by separate refining processes. This seems illogical in view of the fact that pure iron may be made and is made directly from the ore, but the reasons for the existing methods are economic ones.

Preliminary Description of the Blast Furnace Process.—The drawing (Fig. 36) represents in section a blast furnace, without the accessory apparatus. The foundation is laid in concrete and masonry, and upon this a circle of cast iron columns is placed to support the superstructure. The walls of the furnace above the region of the bosh are encased in boiler plates riveted together, and the bosh walls are reenforced with heavy iron bands. The walls and hearth of the furnace are thickly lined with fire-brick, and in the region of the bosh and hearth the walls are water-cooled. The blast is introduced into the furnace through a number of openings near the bottom, one of which is shown in the drawing. The bustle-pipe, which branches from the blast main, surrounds the furnace, and to this the pipes delivering the air into the furnace (blow-pipes) are connected by means of goose-necks. The gases are taken from the furnace through one or more openings at the top. The furnace has two hoppers, the bottoms of which are closed by means of conical castings known as bells. The bells are hung on counterpoised beams and are lowered when the hoppers are to be emptied. All the older furnaces have but a single bell and hopper. For further descriptions see Chapter X.

The components of the blast furnace burden are the ore, flux and fuel, and the air supply is known as the blast or the wind.

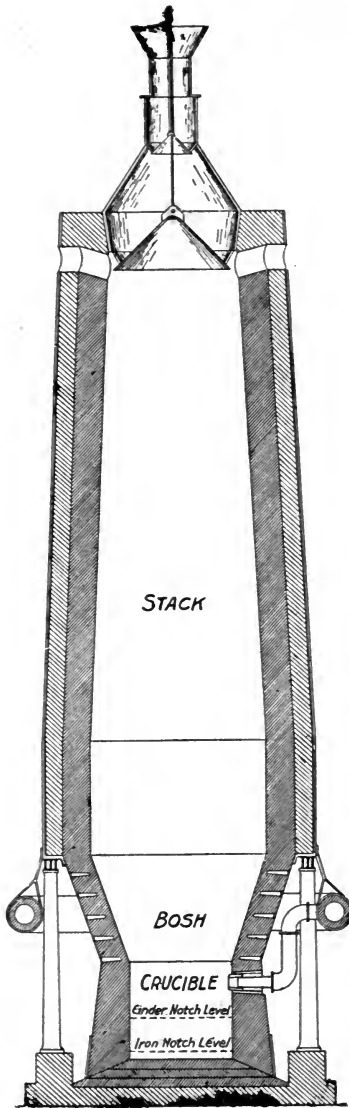

Fig. 36.

The gangues of iron ores in this country are generally silicious, and are fluxed with alumina, lime and magnesia. Lime is generally added as limestone, the other bases being supplied by the ore itself and by the stone and fuel. The common fuel is coke, though charcoal and anthracite are used in some localities. The blast is heated in regenerative chambers called stoves before it is delivered into the furnace, the combustible gas taken from the top of the furnace being utilized for this purpose. Under normal working conditions the furnace is kept almost full, and the blast is maintained at as near a uniform temperature and pressure as possible. The blast, at the moment it enters the furnace, reacts with the fuel and is largely converted into a reducing gas, which in passing upward through the mass of ore, reacts with it and sets the metal free. The first reaction of the blast with the fuel together with the initial heat carried in by the former, creates a very high temperature in the bosh of the furnace. This facilitates the final reductions, the formation of slag and the fusion of the iron. The metal and slag, being completely liquidized, run down into the crucible of the furnace, the slag floating on the metal as oil floats on water. These are tapped out when they have accumulated in sufficient quantity. Since the ascending current of gases is in contact with coke all the way to the top, the gases taken from the furnace are largely combustible. They are utilized for heating the blast, generating steam, and for other purposes.

Chemical Changes in the Blast Furnace.—The reactions occurring in a blast furnace are exceedingly intricate, and beyond the reach of a thorough investigation. The more important reactions may be known, and the ultimate changes can be ascertained with exactness by an examination of all the raw materials and the products, but the transitional changes can not be observed. Furthermore the conditions existing in a blast furnace can not be reproduced on the experimental scale, these being dependent in a measure upon the large quantities of substances treated. The blast introduces the elements, oxygen, nitrogen and hydrogen into the furnace, the hydrogen being combined in water vapor, which is always present in the air. The action

of the principal elements of the blast and burden may be outlined as follows:

Oxygen.—The oxygen of the blast, being already at a high temperature, and coming in contact with a large excess of glowing coke, becomes saturated almost instantly with carbon—

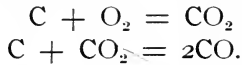

Nitrogen.—The nitrogen of the blast is for the most part inert and may be said to play no economic part in the process. It is an interesting fact, however, that the conditions necessary for the formation of cyanide exist in the blast furnace. The alkali which is derived from the ash of the coke, is reduced by carbon, and nitrogen is added—

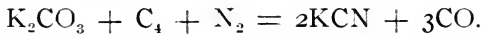

It has been suggested that this reaction is responsible for the reduction of a large portion of iron, but this would seem hardly possible from the small amount of cyanide that is known to be formed.

Hydrogen is formed by the decomposition of water vapor as in the gas producer. It would seem to play some part in the reduction of iron oxide, thus—



But the water formed would again be decomposed, and though this would restore the hydrogen for further action, the net result would be a loss of heat, as explained on p. 63.

The principal solid substances in the burden which enter into the chemistry of the process are carbon, iron, manganese, phosphorus, sulphur, silicon, lime, alumina and magnesia.

Carbon.—In addition to the reactions with oxygen, as given above, carbon reacts directly with the oxides of iron, manganese, silicon and phosphorus, reducing them completely—

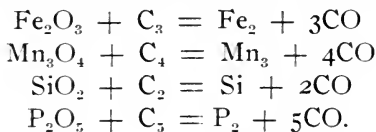

Some of the carbon enters into combination with the iron, as shown below, and a smaller portion is cemented into the lining of the furnace, as will be explained later.

Iron.—The iron is almost completely reduced by the action of carbon and carbon monoxide. Where rich ores are smelted, not more than 0.01 per cent. of the total iron in the charge should escape reduction. The reduction begins with the descent of the ore and is finished above the region of the bosh. Upon reaching the bosh the iron is in the form of a spongy mass or a black powder. It now takes up carbon, fuses and trickles down into the hearth of the furnace. It is at this time that phosphorus and silicon combine with the iron, and manganese is alloyed with it. The small amount of ferrous oxide that is not reduced is combined with silica in the slag.

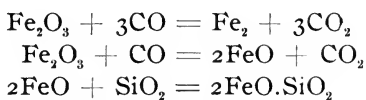

Manganese, which occurs in iron ores chiefly as the sesquioxide and the dioxide, requires a higher temperature than iron does for its reduction. Generally, about half that is in the ore is reduced, the rest acting as a basic flux. Manganese is desirable in the blast furnace for its desulphurizing effect on the iron. The reduction of manganese is analogous to the reduction of iron.

Phosphorus is completely reduced by carbon, and passes immediately into the iron. Only traces of phosphorus are to be found in the slag. The reduction seems to take place only in the hottest part of the furnace and in the presence of a large amount of silica. Phosphorus is present in the raw materials chiefly as phosphates of iron and calcium.

Sulphur is always present in coke and not infrequently in iron ores as pyrite. A part of this is absorbed by the iron as the monosulphide. The larger part is taken into the slag as calcium sulphide—



The conditions favoring the absorption of sulphur by the slag

are a high temperature of working and a high percentage of bases in the charge. A very liquid slag in large bulk naturally promotes the removal of sulphur from the iron.

Silicon is reduced only in the hottest part of the furnace, and by solid carbon. The larger part of the silica in the charge reacts with lime and other basic oxides to form the slag. The silica, always retaining its two atoms of oxygen, combines in different proportions with the bases, which are either in the protoxide or the sesquioxide state. These proportions are expressed by the ratio of the oxygen in combination with the base to that in combination with the silica. The ratio in blast furnace slags is generally 1 to 1, or, representing the metal by M, the general formula for the slag would be

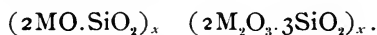

Lime and Magnesia.—These substances act similarly in the blast furnace, the one replacing the other in the charge. They are formed by the calcination of the raw stone, which is usually brought about inside the furnace—



A note on the use of previously burnt lime as a flux will be found on pp. 138, 139. Lime is the chief basic flux in the blast furnace, uniting with the silica of the charge as monosilicate. If this ratio is changed the slag becomes less fusible, absorbs more heat, and the temperature of the furnace is raised. The silicate of lime alone is difficultly fusible and would not be fluid at the temperature of the furnace hearth, but the fusion point is lowered by the presence of other bases, and especially by alumina.

Aluminum is in no wise reduced, but it enters into combination with silica as the sesquioxide (alumina), forming the monosilicate. Gredt has found that a mixture of alumina, lime and silica is most fusible when the proportion is 1.07 parts Al_2O_3 , 1.75 parts CaO , and 1.87 parts SiO_2 .¹

Other Metals.—The metals titanium, zinc, copper, arsenic and chromium are sometimes present in blast furnace charges in

¹ Stahl und Eisen, 9, 756.

sufficient quantity to affect the working of the furnace or the quality of the iron produced.

Titanium is scarcely, if at all, reduced, unless present in considerable quantity. Being a highly refractory substance, titanitic oxide may render the slag difficult to fuse, unless the proper mixtures are used in the charge to flux it. High titanitic ores have been smelted successfully in blast furnaces by allowing the titanitic oxide to replace silica in the slag.¹ An interesting compound of titanium with carbon and nitrogen, known as cyanonitride of titanium, is often found in the hearth and wall accretions of blast furnaces. It is in the form of small cubes, which are very hard and look strikingly like copper.²

Zinc, if reduced, does not reach the hearth of the furnace, owing to its volatility. Any zinc vapor becomes oxidized in the cooler part of the furnace, probably by the action of carbon dioxide. The oxide is deposited on the upper walls of the furnace and in the stoves and flues. Some enters the slag, rendering it less fusible.

Arsenic is almost totally reduced, entering the iron as arsenide or arsenate.

Copper is reduced and alloyed with the iron.

Chromium is more difficult to reduce than iron, but it may be reduced in considerable quantity if a high temperature is employed. Owing to the refractory nature of chromium oxide, special fluxes are required for smelting chrome-iron ores in blast furnaces.

Blast Furnace Slag.—It is seen from the foregoing that blast furnace slag is a mixture of the silicates of alumina, lime and magnesia, the silicates of iron, manganese and other bases being present in smaller quantities, or as impurities. Sulphur is present, chiefly as sulphide of calcium. It has also been shown that the composition of slags varies with that of the raw materials and with the temperature at which they are formed. Otherwise expressed, the slag is an indicator of the condition of the fur-

¹ Paper on the smelting of titaniferous ores by A. J. Rossi. *Trans. Amer. Inst. Min. Eng.*, 21, 832.

² Percy, "Iron and Steel," pp. 163, 510.

nace. Some idea of the composition of a slag may be gained from its viscosity while fused and from its appearance after cooling. For example, a slag of the proper composition will flow neither too sluggishly nor too readily, but in a manner well known to the trained observer. Too much silica in the slag will be indicated by free flowing, and too much lime by the reverse. The fracture of a high silica slag is glassy, while a limy slag presents a granular or stony fracture with a dull-gray color. Siliceous or "lean" slags are apt to contain a good deal of iron, which may render them dark-brown in color, or even black. If much manganese is present the color will be green. A siliceous slag indicates that the furnace is working at a low temperature, and the iron is likely to be high in combined carbon and high in sulphur. No fixed rule can be laid down for these indications, since the condition of the furnace is subject to irregularities, the effect of which on the product is indeterminate.

TYPICAL BLAST FURNACE SLAG

SiO ₂	Al ₂ O ₃	MnO	FeO	CaO	MgO	CaS	P ₂ O ₅	K ₂ O, TiO ₂ , etc.
43	14.50	1	0.25	34	3.50	2	0.05	2.70

Wall Accretions.—Particles of coke, lime, ferrous oxide and other refractory substances are agglomerated and cemented to the walls of the furnace by a slag. The deposited material increases to some thickness and forms a protective coating over the lining. It extends all the way from the upper limit of fusion in the furnace to the crucible, its composition varying with the conditions at different heights. Aside from the beneficial result of wall accretions, there is danger of an irregular growth on the walls of blast furnaces. The accretion may extend inward for a considerable distance around the furnace and form a "scaffold." With this as a starting point the stock may arch above the melting zone and hang for some time. This is followed by a "slip," which is the falling and settling of the burden. This upsetting of the furnace burden is a most undesirable occurrence, being specially disastrous to the working of tall furnaces. Hanging and slipping are not, however, always to be attributed to wall accretions. Abnormal accretions or scaffolds are less likely to

form in furnaces that are charged and blown with regularity and in which regularity of working is aided by an even distribution of the stock. Accretions may be removed by increasing the temperature at that point. This may be done by introducing a special tuyere or injecting oil in the region of the obstruction.

Blast Furnace Gas.—The composition of blast furnace gas is about the same as unenriched producer gas, the conditions under which it is formed being similar. The analysis here given may be taken as typical for gas from a coke-burning furnace.

Nitrogen	Carbon dioxide	Carbon monoxide	Carburets	Hydrogen
60	14	24	1	1

Flue Dust.—Along with the gas a quantity of fine particles of solid matter are carried over. The nature and quantity of these vary with the character of the burden and the blast pressure. Generally speaking, flue dust is made up of coke and ore. Zinc oxide is present if the ores smelted carry zinc, and volatile metals in general or those whose compounds are volatile will be concentrated in the flue dust.

CHAPTER X

IRON SMELTING—THE BLAST FURNACE PLANT AND PROCESS

Description of the Plant.—The principal parts of a blast furnace plant are shown in the plan drawing (Fig. 37). This with the accompanying legend shows the relation of the different parts of the plant to each other and their essential functions. Detailed descriptions follow.

The Furnace Stack.—The drawing on p. 115 shows the lines of a typical American furnace. The quality of the ore and fuel and the output are governing points in the construction of blast furnaces. A furnace that is rather low (not over 75 feet) and wide at the bosh seems to be most suitable for smelting lean ores, since it affords a high temperature and a large melting area in that region. Tall stacks (such as the drawing represents) are suitable for rich ores and are necessary to the greatest yields of iron. As large producers of iron, they require a firm coke, to withstand the weight of the burden and a high pressure of blast. The well or crucible of a furnace with a high stack is made larger in proportion, and the bosh walls are made steeper, for the reduction and fusion zones are higher than in low stacks, and the burden is thus made to descend more rapidly.

While building a furnace some special precautions are taken in constructing the bosh walls. These are subjected to greater wear from the stock than the upper walls, since their slope is outward, and with the higher temperature and scouring slag they are more rapidly fluxed away. The life of the bosh walls is greatly lengthened by water cooling. This is accomplished by introducing hollow blocks of cast iron or bronze into the walls, in the manner shown in Fig. 38 and causing water to circulate through these. The hearth of the furnace is cooled by allowing the water which is discharged from the coolers to circulate in a trench, which surrounds the furnace at the base. Gayley's bosh-cooling bronze plate is represented by Fig. 39. The water is admitted through one of the openings and discharged through

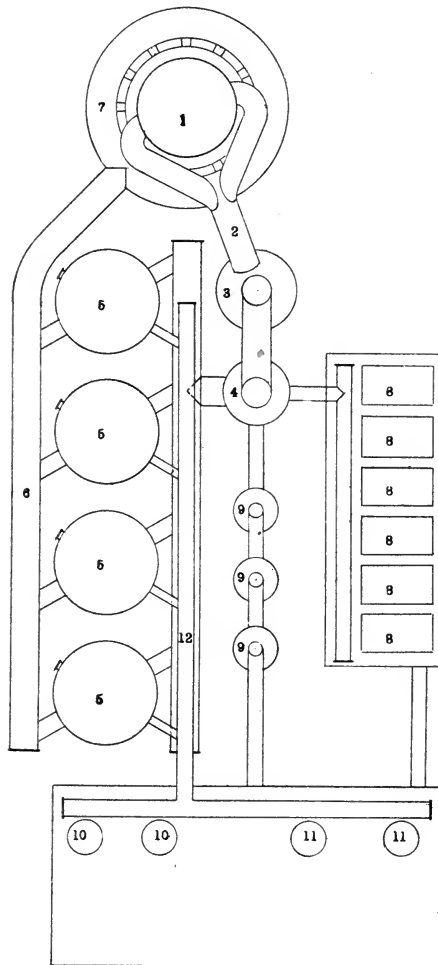

Fig. 37.

1—Furnace stack.
2—Downtake.
3—Dust catcher.
4—Primary washer.

5—Stoves.
6—Hot blast main.
7—Bustle pipe.
8—Boilers.

9—Secondary washers.
10—Gas blowing engines.
11—Steam blowing engines.
12—Cold blast main.

SCOTT'S PATENT BOSH PLATE.

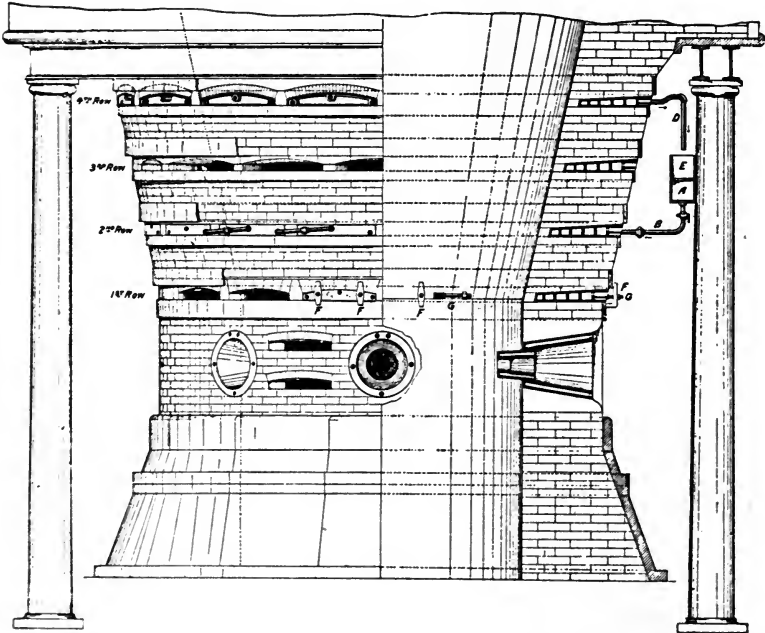
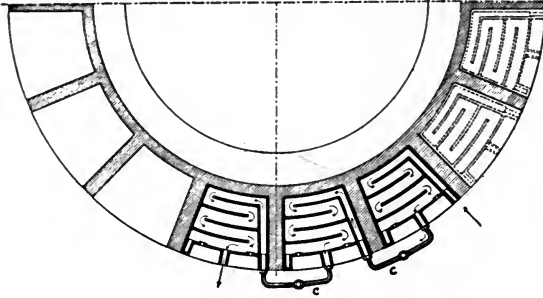

Fig. 38.—Showing Arrangement of Cooling Plates and Tuyeres.
(Best Manufacturing Co.)

the other, having but the one course. The webs inside the plate permit of its being made light without danger of crushing in the furnace wall. The plate is cast smooth on the top and bottom and is wedge-shaped, so that it can easily be inserted in the furnace wall or removed when renewal is necessary. Furnaces recently built at Bethlehem are provided with water jackets in the boshes instead of plates. This is a new departure in iron blast furnace construction.

The tuyeres, or openings through which the blast enters, are also water-cooled. The general arrangement is shown in Fig. 40. The tuyere, into which the blast pipe is fitted, projects

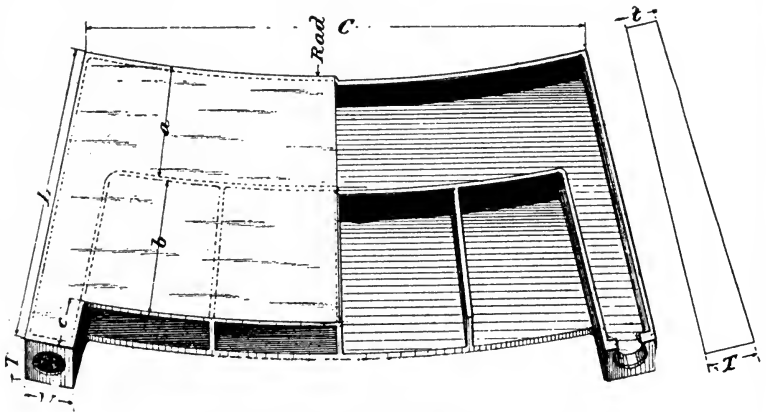

Fig. 39.—Gayley plate. (Best Manufacturing Co.)

through the wall of the furnace to the interior, as shown in Figs. 36 and 38. The tuyere, in turn, fits into the larger cooler in the manner shown. The large cooler is a protection to the brick work, since it does not have to be renewed often, and in drawing and inserting tuyeres the bricks are not disturbed. Water is circulated through the tuyere and cooler by means of separate supply and waste pipes.

The number and size of the tuyeres is largely a matter of judgment. Within certain limits, the fewer the number of tuyeres and the larger their diameter, the greater will be the penetrating power of the blast, while with a larger number of tuyeres,

the blast is more evenly distributed. The number of tuyeres at different furnaces varies from 8 to 16, 12 being common.

Charging Apparatus.—At the older plants the stock is raised to the level of the furnace top by means of elevators or platform hoists, the materials having been loaded into barrows and weighed, and from these it is wheeled by laborers and dumped into the furnace hopper.

The modern blast furnace charging apparatus consists of the bell and hopper, and often a special device for distributing the materials in the hopper. The materials are hoisted by means

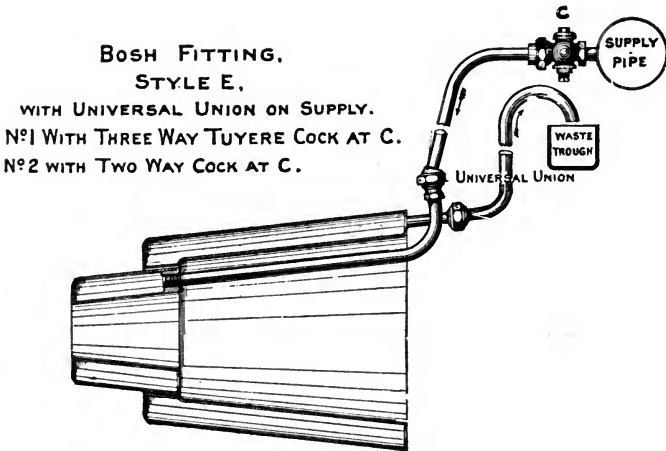

of a skip car or bucket traveling over an inclined track from the stock bins to the furnace top. From the drum of the hoisting engine on the ground level a wire rope is passed over a sheave on the top of the furnace, and fastened to the car. At most plants a double skipway with two cars is employed, the loaded car being hoisted while the empty is returning.

Among the first successfully operated, mechanical hoists are those of the Carnegie Steel Company's furnaces at Duquesne, Pa. This hoist consists of a bucket suspended from a truck which traverses the track. The bucket is filled by running in

the materials from opposite bins, thus effecting a good mixing. The bottom of the bucket is closed by a cone or bell, which can be lowered to empty it. The material is therefore not dumped but discharged around the bell after the bucket has been hoisted and placed in position over the furnace hopper.

The charging bells are hung on counterweighted beams, and are operated by means of steam cylinders on the ground level. The size of the lower bell is important in effecting the proper distribution of the stock. If it is too large in diameter the material is thrown to the sides and the lumps roll back to the center; if the diameter is too small the material forms a circular pile away from the walls, causing the lumps to roll both to the center and to the walls.¹ In either case the tendency is toward an unequal distribution of the ascending current of gases, since channels are at once formed by the large lumps. Such conditions lead to irregular reduction and fusion.

Fig. 41 represents a blast furnace recently built at Bethlehem, Pa. It is equipped with a double skip hoist and automatic distributor. The skip cars are operated by means of a motor at the ground level and the usual rope arrangement. The bells are hung on counterweighted beams, and are operated by rope connections to compressed air cylinders, as shown. The distribution of the stock is effected by the movement of the beam which supports the small bell. The bell is attached to a long sleeve, and inside of this the rod which supports the large bell is suspended. The sleeve is supported from the beam by hangers and a spanner with a ball-bearing arrangement which permits the sleeve with the bell and deflecting plate to revolve. The segmental deflecting plate has a sharp incline, so that the material is diverted to one side of the hopper, and consequently when the bell is lowered the material is discharged to one side of the main hopper. As the bell is raised it is revolved through a slight angle by means of a crank shaft and rod attached to the beam, causing the next load to be dropped at a different place in the hopper. The angle is gaged to prevent dumping in the

¹ Trans. Amer. Inst. of Min. Eng., 35, pp. 224 and 553.

same position when the bell and deflector have made a complete revolution.

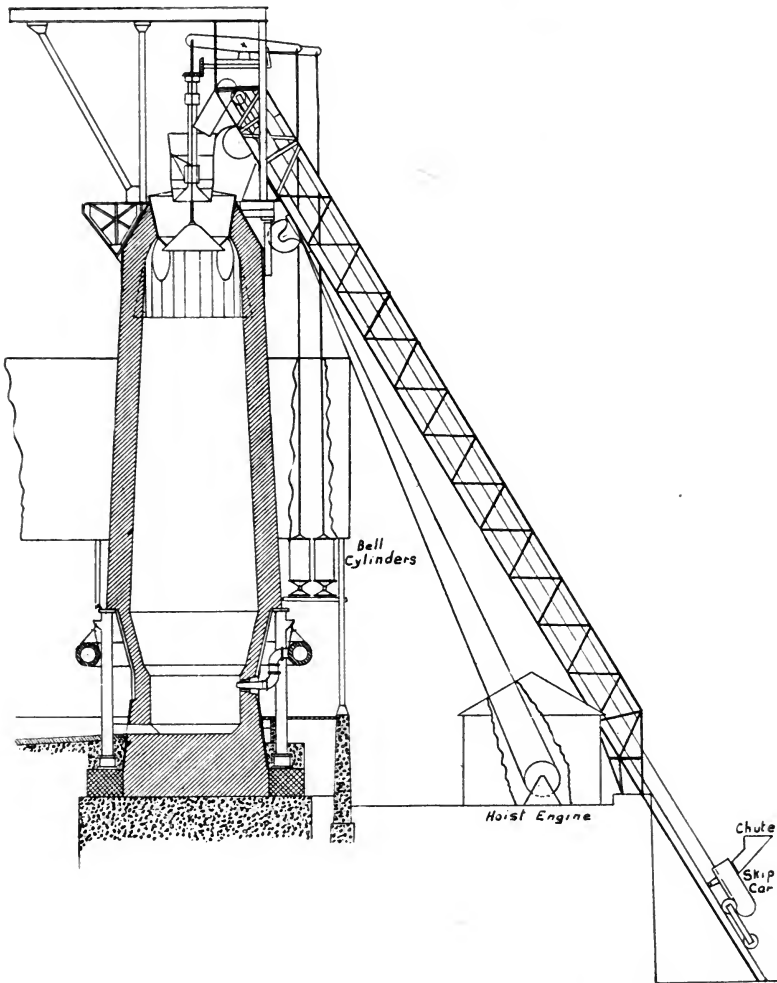

Fig. 41.—Blast Furnace and Hoist. (Bethlehem Steel Co.)

Dust Catchers.—A large part of the dust that is carried over with the gases from the top of the furnace is detained by checking the velocity of the current and leading it abruptly in a dif-

ferent direction. A form of dust catcher is shown in Fig. 42. It is a cylindrical vessel with a hopper bottom, and provided with an opening in the bottom for letting out the accumulated dust. The opening is closed by means of a counterweighted cone. The

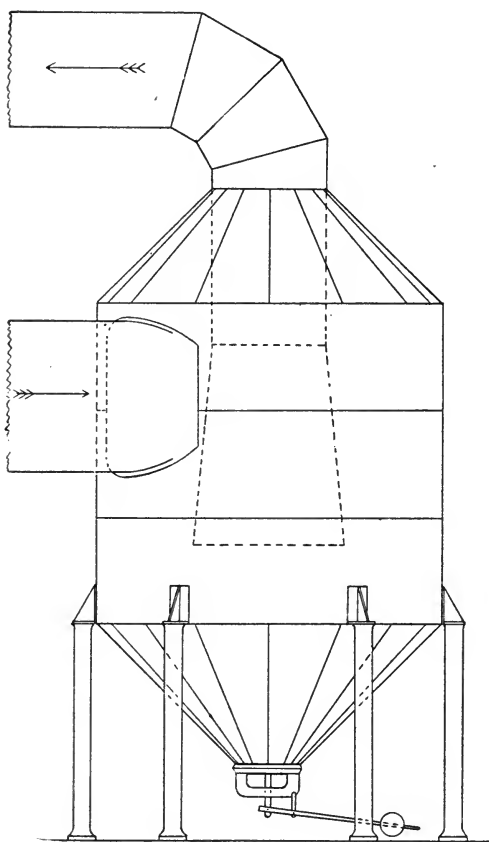

Fig. 42.

vessel is constructed of boiler plates and lined with fire-brick, and is supported on cast iron columns. As indicated by the arrows the gas enters the side of the vessel and is withdrawn at the top, the head of the outlet pipe being situated below the

center of the chamber. The gas enters the chamber at a tangent, swirls around, and the dust loses momentum by friction against the walls. Moreover, the current loses head by reason of the enlargement of the conduit. The dust settles in the hopper, from which it is removed periodically. Other types of dust catchers take the gas in at the top and deliver it at the side, but the above type has been found to be more efficient, especially for fine dust. If a more thorough cleaning is required the gas is sprayed or led through scrubbers.

Stoves.—The introduction of the hot blast by Neilson in 1828 marked a new era in blast furnace construction and practice. While the inventor realized that by heating the air beforehand he could intensify the heat of combustion, his methods were crude and wasteful, employing solid fuel and in no way utilizing the waste gases from the furnace. Neilson's invention led to the construction of many forms of appliance for heating the blast, and finally to the utilization of the gases, which had before been allowed to burn at the top of the furnace.¹ Of the earlier forms of blast heaters or stoves, there is but one survivor in this country. It consists of a rectangular, brick chamber through which the blast is conducted in numerous cast iron tubes. The gas is burned in the chamber and heat is transmitted to the blast through the walls of the tubes. The very high temperatures now carried in the blast were never possible with the old style of heater, but were attained after the regenerative system of firing was applied. The first regenerative stove put into successful operation was built by Cowper in 1860.

A stove of the Cowper type is shown in section in Fig. 43. It is essentially a fire-brick chamber, cylindrical in shape, and encased in iron plates. The combustion chamber, C, is located at the side or center and the rest of the space is filled with the division walls and vertical flues, F. The flues are open at both ends and communicate with the combustion chamber at the top. The space underneath the flues and the combustion chamber

¹ Aubertot is said to have been the first to utilize blast furnace gas, employing it for roasting ore in 1814.

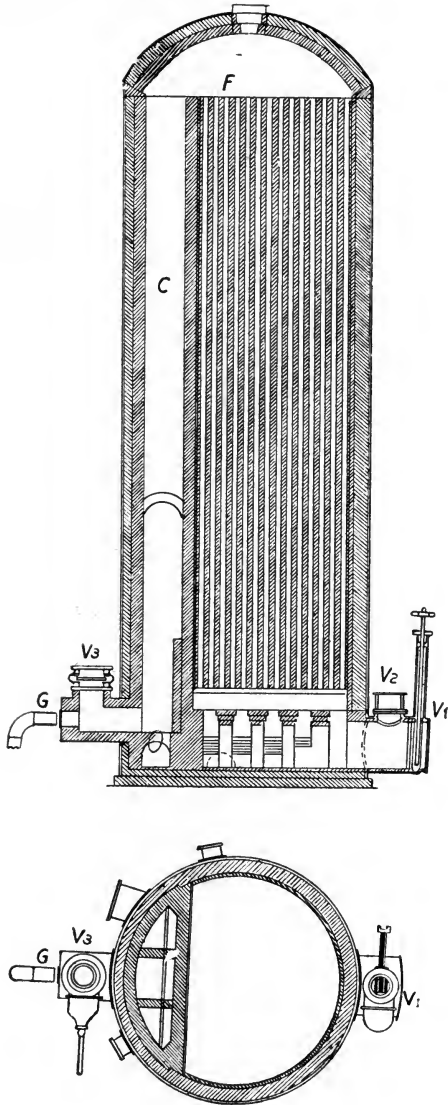

Fig. 43.

communicates with conduits leading from the stove at the base, as shown.

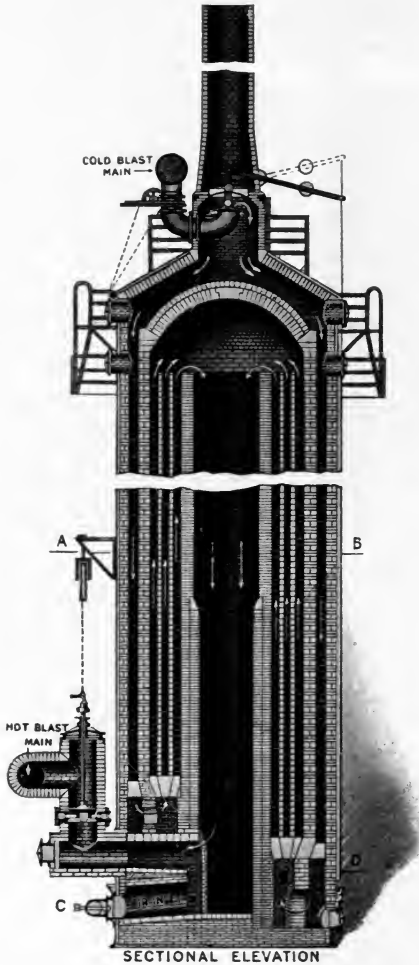

Fig. 44.—McClure Stove (Courtesy of Harbison-Walker Refractories Co.).

The gas enters the stove through the pipe, G, air being admitted for its combustion. The flame and products of combustion pass upward through C and downward through the flues, F,

and heat is absorbed by the large mass of brick work. The valve, V_1 , being open, the products of combustion pass into the tunnel or flue by which they are conducted to the chimney. When the stove has been heated the gas is shut off, and air is admitted from the cold blast main through the valve, V_2 , the chimney valve being now closed. The air takes the opposite direction of the gas through the stove and becomes heated by contact with the hot bricks. It passes into the hot blast main through the valve, V_3 .

All stoves are now provided with individual chimneys instead of connecting them with a flue leading to a chimney common to all, as was done in older construction. Each stove is, therefore, an entirely separate and independent piece of apparatus. Fig. 44 represents an improved and very efficient type of stove, having a central combustion chamber and heating flues around this. The gas and products of combustion take the opposite direction indicated by the arrows. These show the direction taken by the air, which is introduced through the valve at the base of the chimney.

Blast Apparatus.—Steam blowing engines have been used more than any other appliance for supplying air to blast furnaces. Both the horizontal and the vertical types are in common use. Gas blowing engines have been installed at many of the large plants. These are driven with the furnace gas, which of course, is thoroughly cleaned beforehand. The gas cleaning apparatus is costly to build and operate, but this is offset by dispensing with the boiler plant.

Centrifugal blowers are in successful operation at several blast furnace plants. It seems probable that this type of blower will be more generally used, in view of its remarkable adaptability.

Blowing In.—The starting of the blast furnace process is known as “blowing in” the furnace. With a new furnace the lining must be thoroughly dried and heated up gradually before the regular charging is begun. James Gayley has described a method of blowing in furnaces as used at the Edgar Thomson Works.

“In placing the wood in the furnace the practice is to support on posts a platform about two feet above the tuyere arch, and under the bottom of each post to place a piece of fire-brick, on which is a sheet of thick asbestos. The wood is put on in the morning, the firing being stopped the evening before, so that the brick work will be partially cooled. After the skeleton parts of the scaffold are in, a charge of coke is made, sufficient to fill the hearth up to the bottom of the cinder-notch opening. On the platform planks are placed sufficiently close to prevent the cord wood from falling through. Above the platform three lengths of cord wood (hard wood is preferred) are placed on end, with a cribbing in the center to allow space for the workmen to pass up the wood. On top of the wood a blank charge of 250 barrows of coke is put in. With this coke there is charged sufficient limestone to flux the ash, and in addition a few barrows of spiegel-eisen or ferro-manganese slag. The regular charges consist of 12 barrows of coke, 12 barrows of ore and 6 barrows of limestone. The weight of a barrow of coke is 830 pounds. To the first few charges an extra barrow of slag is often added. The space between the scaffold above and the bed of coke beneath is then filled with kindling wood, and the furnace is ready for lighting. In addition to lighting the wood at the cinder-notch, red-hot bars are thrust in at each tuyere to start the combustion uniformly. When the scaffold has burned away, allowing the stock to settle gently, and bringing hot coke or charcoal in front of all the tuyeres, the blast is put on. The time from lighting to turning on the blast varies from six to ten hours. The blast is put on slowly at first, and increased hourly until the volume of air is one-half the normal quantity, at which point it is held until the first cast of iron is made. In order to avoid explosions, which frequently happen at the start, the valves in the boiler and stove gas mains are closed, and all the gas is allowed to escape until after the first cast is made.”

Burdening the Furnace.—The furnace burden consists of a number of charges, each charge in turn consisting of weighed amounts of fuel, ore and flux. The charging is practically con-

tinuous, except in case of accident or other interruption, until the furnace is "blown out." The term "damping down" means the shutting off of the air from the furnace and filling it with coke, a scheme that is resorted to when the process has to be suspended for a few days. The furnace fire may be held for a considerable length of time in this way.

The mixtures for blast furnace charges can easily be calculated from the compositions of the materials to be used. Suppose, for example, that a furnace is to be burdened for the reduction of 1,000,000 pounds of iron in a day of 24 hours, and that the daily burden is to consist of 100 charges. Each charge must then contain 10,000 pounds of iron. Further, suppose that the conditions require a pound of coke for each pound of iron reduced, and that the analyses of the coke, ore and stone are as follows:

	Fe Per cent.	Mn Per cent.	SiO ₂ Per cent.	Al ₂ O ₃ Per cent.	CaO Per cent.	MgO Per cent.
Coke.....	1.00	0.00	4.00	2.00	0.00	0.00
Stone.....	0.50	0.00	5.00	0.50	50.00	1.00
Ore No. 1 ...	45.00	1.00	18.00	2.00	0.50	0.50
Ore No. 2 ...	55.00	0.70	8.00	3.00	1.00	0.50
Ore No. 3	58.00	0.40	3.00	1.00	0.00	0.00
Ore average ..	53.60	0.70	9.00	2.40	0.70	0.40

The average composition of the ores is based upon a mixture of the three in which one part of No. 1, three parts of No. 2 and one part of No. 3 is used. The composition of the charge is then computed upon this average and the separate analyses of the other materials.

	Stock lbs.	Fe lbs.	Mn lbs.	SiO ₂ lbs.	Al ₂ O ₃ lbs.	CaO lbs.	MgO lbs.
Coke.....	10,000	100	400.00	200.00
Ore mixture....	18,470	9,900	129.29	1,662.30	443.28	129.29	73.88
Stone.....	5,963	30	298.15	29.82	2,981.50	59.63
Totals.....	34,438	10,030	129.29	2,360.45	673.10	3,110.79	133.51

The 10,000 pounds of coke in the charge yields 100 pounds of iron, leaving 9,900 pounds to be supplied by the ore. Since the mixture of ores yields 0.536 pound of iron for each pound of ore, the amount of the mixture required is $9,900 \div 0.536 = 18,470$ pounds.

The weights of silica and bases in the coke and ore are now

computed and the deduction made for self-flux. Using the ratios given on p. 119, the weight of silica which 1 pound each of the bases will flux is found by the following proportions:

$$2\text{Al}_2\text{O}_3 : 3\text{SiO}_2 :: 1 : x = 0.8823 \text{ pound SiO}_2$$

$$2\text{CaO} : \text{SiO}_2 :: 1 : x = 0.5357 \text{ pound SiO}_2$$

$$2\text{MgO} : \text{SiO}_2 :: 1 : x = 0.7500 \text{ pound SiO}_2$$

Multiplying the weights of the bases by these factors the total silica is found to be—

$$\text{By Al}_2\text{O}_3, 643.28 \times 0.8823 = 567.57 \text{ pounds SiO}_2$$

$$\text{By CaO}, 129.29 \times 0.5357 = 69.26 \text{ pounds SiO}_2$$

$$\text{By MgO}, 73.85 \times 0.75 = 55.41 \text{ pounds SiO}_2$$

$$\text{Total} = 692.24 \text{ pounds SiO}_2$$

The weight of silica that remains to be fluxed by the stone is $2,062.30 - 692.24 = 1,370.06$ pounds.

The fluxing power of the stone is found by subtracting the silica in 1 pound from the total amount of silica that would be satisfied by the bases in 1 pound of the stone—

$$\text{By Al}_2\text{O}_3, 0.005 \times 0.8823 = 0.00441 \text{ pound SiO}_2$$

$$\text{By CaO}, 0.50 \times 0.5357 = 0.26785 \text{ pound SiO}_2$$

$$\text{By MgO}, 0.01 \times 0.75 = 0.00750 \text{ pound SiO}_2$$

$$\underline{0.27976}$$

$$\text{SiO}_2 \text{ present} = 0.05000 \text{ pound SiO}_2$$

$$\text{Fluxing power} = 0.22976 \text{ pound SiO}_2$$

The amount of stone needed is found by dividing this factor into the weight of silica to be fluxed—

$$1,370.06 \div 0.22976 = 5,963.$$

These calculations are simplified by using the slide-rule, proposed by Jenkins.¹ As in most other metallurgical processes, more has been learned about burdening blast furnaces from practice than from theoretical reasoning. There are times when the furnace becomes irregular in its working, and the burden must be changed to suit the conditions. At such critical times the remedies lie entirely with the judgment of the manager.

The Fuels and Fluxes of the Blast Furnace Process.—The quantity of fuel used in the blast furnace is generally referred to the

¹ Jour. Iron and Steel Inst., 1891, 1, 151.

quantity of iron produced. For coke furnaces the consumption varies from 1,600 to 3,000 pounds per ton of iron, depending upon the purity of the raw materials, the humidity of the blast and the general efficiency of the plant. It is desirable to carry as little coke as possible in the burden, not only for economic reasons, but also for the sake of introducing the least amount of impurities into the iron. Coke is generally superior to most other fuels, though the sulphur and phosphorus it contains are often serious defects. The firm, hard varieties of coke are always preferred, since they sustain the weight of the burden and keep passages open for the circulation of gases. The coke and iron industries are indispensable to each other and are often controlled by the same interests. The remoteness of some of the great ore deposits in the United States from the supply of coke has been a hindrance to the growth of the iron industry, though it is largely responsible for the wonderful transportation facilities which now exist.

Charcoal is still used in some heavily wooded localities where coal does not abound, as in the Lake Superior district. The fuel consumption is lower in charcoal than in coke furnaces. A record given by J. C. Ford of a furnace in Michigan shows an average consumption of about 1,630 pounds to a ton of iron made.¹ Charcoal iron is prized for its purity, though it is not made to compete with ordinary pig.

Anthracite, though once extensively used in Eastern Pennsylvania, has been practically discarded as a blast furnace fuel. The old Lock Ridge furnace at Alburdis, Pa., property of the Thomas Iron Company, is now the only anthracite furnace in blast. Anthracite is inferior to coke on account of its dense structure and its tendency to split and crumble in the furnace.

The attempt has been made to substitute gas for solid fuel in the blast furnace, but without success.

Raw limestone, in conjunction with alumina, has been found to be the most satisfactory flux in the blast furnace. The fuel consumption may be lessened by using caustic lime or burnt

¹ Jour. U. S. Assoc. of Charcoal Iron Workers, 8, 272, 274.

limestone, but when the fuel used in burning the limestone and the extra labor are taken into account, there is very little if any economy. In the low English furnaces, smelting poor ores, there seem to be some advantages gained in the use of lime.¹

Magnesian limestone and dolomite are not uncommonly used. The prevalence of this character of stone in the Lehigh Valley accounts for its usage in that section. F. Firmstone has shown some results of his experience with magnesian stone. He favors its use, if the alumina is kept low (below 10 per cent.), having found that the slag is more fluid and that less sulphur passes into the iron.²

Management of the Blast.—The working of a blast furnace depends no more upon the manner in which it is burdened than it does upon the management of the blast. The efficiency of the accessory apparatus is proved by the condition of the blast in its four phases—temperature, pressure, volume and humidity.

Temperature.—The construction and management of the stove are explained on pp. 131-134. Four stoves are generally built with one furnace, the use of this number allowing three hours for heating the brick work, if the blast is kept on each for one hour. Some blowers prefer to use two stoves at once for heating the blast, one having been put on half an hour before the other. This of course involves the changing of stoves every half hour, since the blast is to be kept on no stove longer than an hour, but a more uniform temperature may be maintained by this method of heating. It is the aim not only to return all the heat possible to the furnace, but also to keep the temperature of the blast as nearly uniform as possible. By equalizing the temperature of the blast there will be less irregularity in the working of the furnace. Equalization may be accomplished by carefully admitting air from the cold blast to the hot blast main just at the time the stoves are changed, and gradually shutting off this air as the stove cools down. Another advantage may be gained by this practice from the fact that there is always a re-

¹ Jour. Iron and Steel Inst., 1894, 2, 38-57, and 1898, 1, 69-88.

² Trans. Amer. Inst. of Min. Eng., 24, 498.

serve of heat in the stoves which can be drawn upon in case of an emergency by shutting off the cold air entirely.

The temperature of the blast is generally taken just before it enters the bustle-pipe. The continuous recording pyrometer

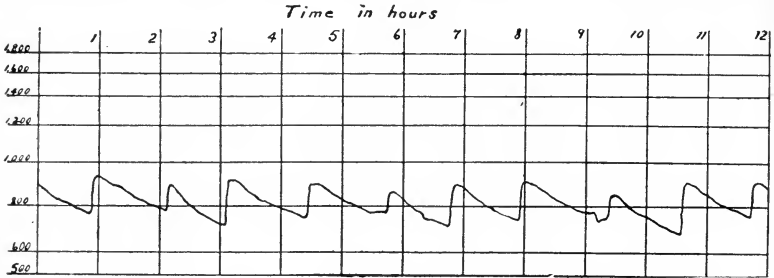

Fig. 45.

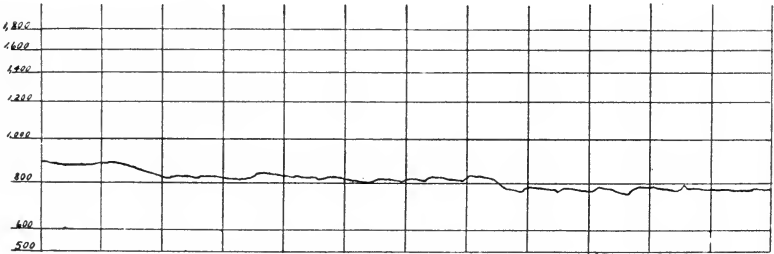

Fig. 46.

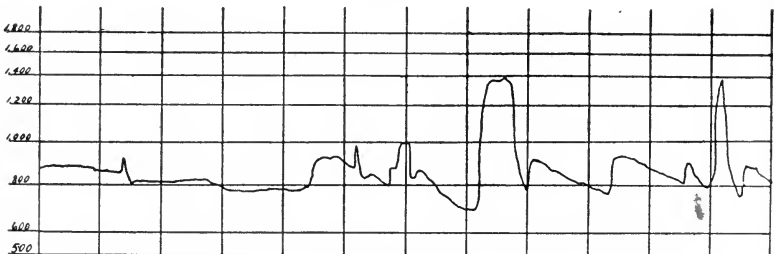

Fig. 47.

has largely displaced the older forms, from which only periodic readings can be obtained. The average temperature carried in the blast does not much exceed 750° C. at any furnace.

The pyrometer records here shown (Figs. 45, 46 and 47)

represent actual practice. The first one shows regular heating of the stoves, the temperature being taken from the hot blast main. The sudden rise and regular fall of the recording pen shows that the stoves were changed at the end of every hour, but that no attempt was made to equalize the temperature. At the time of the second record, however, the temperature was leveled in the way above described. The third record shows irregular heating, due to the condition of the gas.

The above method of leveling the blast temperature requires considerable skill and vigilance on the part of the blower, and it has not proved entirely satisfactory. Several forms of regenerative apparatus known as "equalizers" have been proposed, but their adoption does not as yet seem probable.

Pressure.—Increased pressure gives the blast greater penetrating power, facilitating more rapid combustion and consequently more rapid reduction and fusion. There are serious difficulties in the way of increasing the blast pressure beyond a certain limit, since it would cause more dust to be carried over with the gases, and would require additional blowing power and better construction throughout the entire system in which the pressure is to be withstood. The pressure at different furnaces varies from 8 to 15 pounds. Furnaces in the Pittsburg district not uncommonly carry 15 pounds, and some have been made to carry 20 pounds and more.

Volume.—The rate at which the furnace works is largely determined by the volume of the blast. This in turn is determined by the rate at which the blowing engines are driven and the capacity of the air cylinders. In practice the rate at which the engines are driven, *i. e.*, the number of revolutions the fly-wheel makes per minute, is recorded as expressing the volume of the blast at atmospheric pressure. This does not take into account any loss sustained through the working of the intake valves and leaking of the fittings. Large furnaces take upwards of 50,000 cubic feet of air per minute.

Humidity.—The effect of moisture in the blast upon the working of a furnace has long been a subject of discussion among

metallurgists. Attention was called to the subject at a meeting of British iron masters by Joseph Dawson in 1800.¹ It has been observed that furnaces work better in dry than in wet weather and that their condition is apt to be better in the winter months, when the humidity of the atmosphere is relatively low, than at other seasons. Taking the average amount of moisture in the air as 3 grains, it is seen that in a furnace taking 2,400,000 cubic feet of air per hour, in the same time 123 gallons of water must be decomposed. The effect of this would perhaps not be noticeable if it were not for the fact that the decomposition must take place in the bosh or melting zone of the furnace, any cooling of which has the most marked effect upon the working of the furnace. The irregularities caused by changes in the moisture in the air are well known to all furnace managers.

Some appliance for drying the air before it is used in the furnace has been advocated from time to time, but only recently the problem seems to have been successfully solved. A process looking to the partial or ultimate desiccation of air on the large scale has been worked out under the directions of James Gayley.² Mr. Gayley's first experiments along this line were conducted at the Lucy furnace, in Pittsburgh, and the first complete air drying apparatus was put into operation in connection with one of the furnaces at Etna, near Pittsburgh. The method, as there used, consists in freezing the moisture. Before it enters the cylinders of the blowing engine the air is led through a huge refrigerator—a large chamber almost filled with the cooling pipes. These pipes are cooled by means of ammonia and they expose a large surface area to the air. The moisture is deposited upon these as frost, which is removed after it has accumulated sufficiently by letting steam into the pipes. The results gained after using the dried blast in the above furnace from August 25th to September 9th were made public in October of 1904. These show an increase of 25 per cent. in the output after the application of the dry blast, with 20 per cent. decrease in the consumption of coke. These

¹ Reprint of Dawson's paper in *Jour. Iron and Steel Inst.*, 1907, 2, 221.

² For description and illustration of Mr. Gayley's invention, see *Trans. Amer. Inst. Min. Eng.*, 35, 746. Supplementary Paper, *Ibid.*, 36, 315.

figures were a great surprise to metallurgists both in this country and abroad. Later records, covering longer periods of time and including the winter months, show gains of from 10 to 20 per

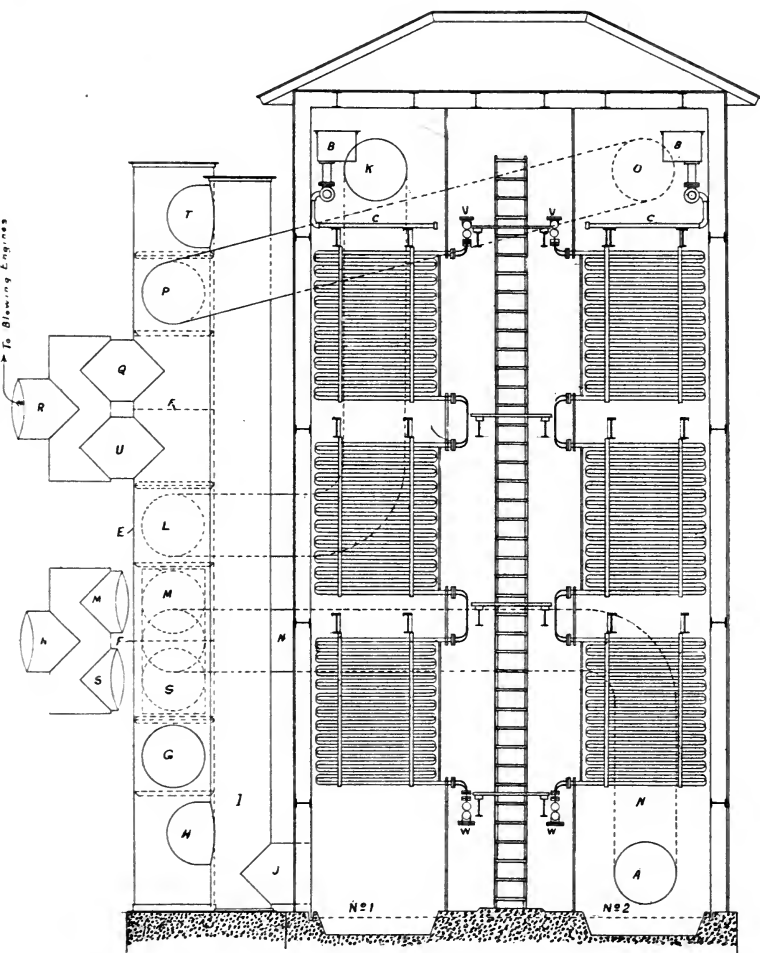

Fig. 48.

cent. in the product and an economy of 10 to 20 per cent. in the consumption of coke by the use of the dry blast.

Fig. 48 is a sectional elevation of the two-stage, reversible

drying chamber of the Gayley process. The structure is a rectangular, steel plate shell, insulated to maintain the low internal temperature, and re-enforced to resist the pulsations of pressure caused by the blowing apparatus. The chamber is divided by wooden partitions into three compartments as shown, Nos. 1 and 2 containing each three banks of pipe coil through which brine is circulated. In the middle compartment are galleries and a ladderway, giving access to all parts of the chamber. The air is cooled in two stages by spraying it with cold water in one compartment, and then bringing it in contact with the cold brine pipes in the other compartment. In order to prevent the clogging of the air passages by the accumulation of frost on the brine pipes and to keep the entire plant working, the courses of the air, brine and water are alternately reversed between the two compartments. The course of the air is controlled by means of the valve system, E, which is divided by the partitions, F, into three double-beat valves. Between the seats of each valve is an inlet pipe, and in addition, each valve controls two outlet pipes, one above its upper seat and one below its lower seat. The three valves are simultaneously changed to their upper or lower seats by the movement of a vertical stem to which all are attached. The movement of the stem is effected by means of a rope and pulleys and a wince at the ground level. The valves, as shown in the drawing, are lifted, admitting the air at G from an auxiliary fan, and allowing it to pass through HIJ into compartment No. 1. In passing upward among the pipes the air is quickly cooled by a shower of water, which is distributed over the coils by the perforated pipe, C. The water collects in the concrete basin under the coils, and is returned to the coolers and again pumped into the tank, B. The air passes from the top of compartment No. 1 through the outlet, K; is conducted to the multiple valve at L, and by way of the opening, M, it enters the pipe, N, and is conducted to the bottom of compartment No. 2. Entering at A, the rising column of air comes in contact with the brine-cooled pipes; is discharged through the outlet, O; enters the multiple valve at P, and by way of

Q and R is conducted to the blowing engines. The course of the air is reversed when the valves of the system, E, are seated. Entering at G, the air passes through S and N to compartment No. 2 into which the water has now been turned, the brine circulation having been stopped and started in the other compartment. Passing through O and P, the air is discharged from the multiple valve through T, entering compartment No. 1 through I and J. The air is returned to the multiple valve through K and L, and is discharged to the blowing engines through U and R. The brine is cooled by means of ammonia. It is supplied to the coils through the inlets, V, and is discharged through the outlets, W, and returned to the cooler.

About 80 per cent. of the drying by this process is effected in the water compartment. This means a considerable saving in power, since the temperature employed is much higher than that in the brine system, averaging about 4° C. The capacity of the above plant is 30,000 cubic feet of air per minute.

Casting.—From the position of the tap-hole (Fig. 36) it is seen that all the iron is never tapped from the furnace, a residue being left for the protection of the hearth and to prevent chilling. The iron does not run continuously, but is tapped at regular intervals, usually from four to six hours apart. The tap-hole is kept closed with clay or a mixture of clay and coke, which has been rammed in tightly to prevent the iron from breaking out. The clay bakes into a hard mass, which has to be drilled through when the furnace is to be tapped. After the drill has reached the softer interior a bar is driven through and the iron flows out when this is withdrawn. The iron is received first in a trough (Fig. 49) about 18 feet long, 22 inches wide at the top and 15 inches deep, and sloping slightly from the furnace. For a distance of about 12 feet from the furnace the trough is permanent, consisting of heavy castings, protected with sand. At the lower end of the trough is a dam, D, and the skimmer, S, is placed a few inches above this as shown. The iron, which is at first free from slag, flows from the dam, and soon rises to the level of the skimmer. Since the slag floats on the surface of the iron it is

prevented by the skimmer from passing on with the iron. Moreover, sand is thrown above the skimmer, and pressed down, and

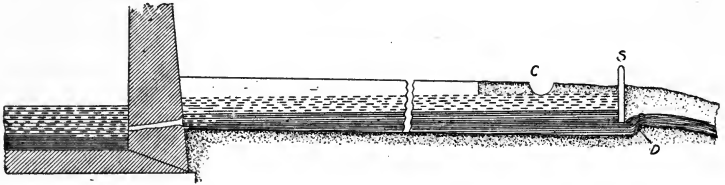

Fig. 49.

the skimmer itself is lowered as the level of the iron falls. The slag overflows into the trough, C.

If immediate use is to be made of the iron it is run into brick-lined ladles,¹ otherwise it is cast into "pigs." As a rule, the pigs

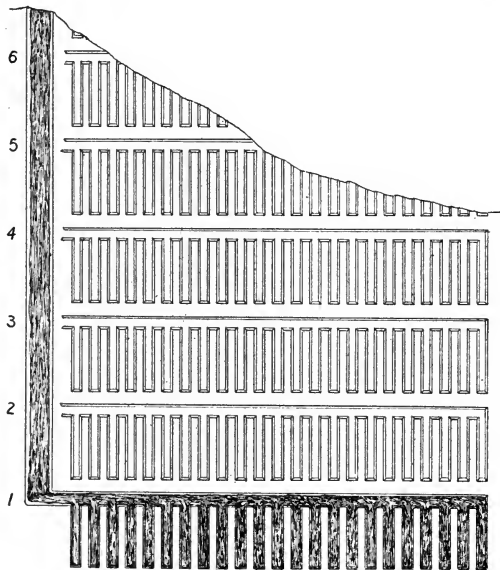

Fig. 50.

are molded in sand, the molds being prepared for each cast with the aid of wooden models. The arrangement of the casting bed is shown in Fig. 50. The main channel through which the iron is

¹ See p. 180.

led traverses the middle of the bed, and tributary channels lead the iron to the pig molds on either side. The lowest set of molds having been filled, the iron is turned into the other sets successively by placing dams at the points 2, 3, 4, etc., and cutting out the side of the main channel. After cooling the pigs with water they are broken from the "sows" by means of sledge hammers and taken out. The sows also are broken into lengths which can be handled.

Pig machines are used at the large plants, thus dispensing with laborers in the casting shed. In the type of machine now in general use the molds are of steel, and are carried on an endless belt which is slowly revolved over sprockets as the iron is poured in from a ladle. The iron is cooled by water, and is solid by the time it passes over the sprocket from which it falls to the ground or into railway cars.

Disposal and Use of the Slag.—The cinder-notch, or tap-hole for the slag is placed about 4 feet higher than the iron-notch, and at some distance around the furnace from it. The opening is through a water-cooled, bronze plate, and it is closed by means of an iron plug. The slag is tapped as often as is necessary to keep it well below the tuyere line. It is run into iron ladles, which are mounted on railway trucks, and are provided with the necessary mechanism for tilting them down on side when the slag is to be dumped.

Of the enormous quantity of blast furnace slag now produced yearly, the larger part goes to waste. It is being used, however, for road beds, and several railway companies have adopted it as a standard ballast. A very good quality of cement is now manufactured from slag.

Mineral wool is prepared by blowing a jet of steam through molten slag. As the steam escapes it carries out globules of slag to which are attached thin fibers or filaments. The material is drawn by suction through an iron pipe which is bent twice at right angles and exhausts into a large wire gauze enclosure. The turns in the pipe serve to break off the heads from the filaments, the former passing through the meshes of the gauze and the latter

being detained. Mineral wool is used as an insulating, non-inflammable packing.

The slag is granulated for various purposes by allowing it to fall into water.

Disposal of Flue Dust.—This has long been a difficult problem and one that has become more serious with the increased amount of dust produced in smelting fine ores. Operating necessities have forced smelters to separate the dust from the gas, and economic considerations demand its use, since it really is a valuable by-product. The best methods for utilizing flue dust yet devised are those in which it is converted into lump form by sintering or briquetting. It is then in proper shape to go back into the furnace.

Thermal Requirements and Economy of Fuel in the Blast Furnace Process.—The chief improvements in blast furnace practice have been in the way of increasing the output and lessening the fuel consumption. Until the year 1880 no furnace had been built to make more than 100 tons of iron in a day, even with the richest ores, and an average of about 3,000 pounds of coke per ton of iron was considered good practice. The output has now been increased in many plants to 600 tons per day, and a number of furnaces have made runs of more than 800 tons of iron in a day, with the ratio of 1,900 pounds of coke to the ton of iron produced. These economies have been attained by better management of the hot blast with the use of improved heating apparatus; rapid driving, which has been made possible by altering the shape of the furnace and increasing the pressure and volume of the blast, and finally by drying the blast.

In connection with the disbursement of heat in the blast furnace it may be interesting to note the requirements from a purely theoretical standpoint. Of the total amount of heat evolved by the combustion of the fuel, one portion is absorbed in bringing about the reduction and the fusion of the metal and slag; a second portion is lost to the process, being represented by the gas that is burned outside of the stoves, and a third portion is lost altogether through radiation and leakage. The amount of heat represented

in the first portion may be calculated from the composition of the charge, and that in the second portion may be calculated from the composition and volume of the gas. The amount of heat wasted can not be calculated at all with any degree of accuracy.

The calculations of Lothian Bell for the amount of heat required for smelting iron in the Cleveland district, England, may be studied with profit.¹ The example below is given to show how the heat units usefully applied may be calculated. The assumed conditions are that the iron is reduced from dry, hematite ore; that the ratio of iron to slag is 2 to 1.3, and that the iron has the following composition:

Iron	Manganese	Silicon	Phosphorus	Carbon
93	2	1.5	0.1	3.4

The heat units absorbed in smelting a ton of iron are found as follows:

	Weight of materials and changes wrought		Calories required per unit weight	=	Calories total
Iron reduced.....	1,860	×	1,780	=	3,310,800
Manganese reduced....	40	×	2,290	=	91,600
Silicon reduced.....	30	×	6,414	=	192,420
Phosphorus reduced....	2	×	5,747	=	11,494
Carbon absorbed.....	68	×	8,080	=	549,440
Metal fused.....	2,000	×	285 ²	=	570,000
Slag fused.....	1,300	×	500 ²	=	650,000
					<u>5,375,754</u>

Taking the average consumption of carbon as 1,750 pounds per ton of iron smelted, the heat units found in the above calculation represent 38 per cent. of the total heat derivable from the fuel.

¹ "Principles of the Manufacture of Iron and Steel," p. 95.

² Gredt's estimate.

CHAPTER XI

CAST IRON

Cast iron is, generally speaking, iron saturated with carbon, and containing other impurities in varying percentages according to the conditions of manufacture. Practically, it represents all the iron made in blast furnaces, which has not been submitted to a refining process other than remelting or annealing.

Properties and Uses.—The main properties to which cast iron owes its wide applications are its low fusibility, and the ease with which it can be molded into the shapes desired. In most other properties it is inferior to the other forms of iron, the tenacity, elasticity and malleability being very low, and it can not be forged or welded. The crushing strength is, however, greatest of all ordinary forms of metal. The cooling of fluid cast iron is attended, first by a slight expansion, but following this there is a contraction bringing the metal into smaller space than was originally occupied.

In making a casting a mold is first prepared, the interior of which bears the shape of the casting. The molten iron is poured in, and on expanding it is forced into every part of the space and reproduces the shape. The contraction or shrinkage follows, making the casting smaller than the pattern. Cavities are often formed in castings, and are known as “pipes” or “blow-holes,” according to their origin. Piping in castings is due to shrinkage. The metal coming in contact with the sides of the mold, forms a solid shell, while the interior of the mass is still liquid. Solidification now proceeds in lines perpendicular to the planes of the surfaces, broadly speaking. The outside being rigid, the contraction that takes place will result in the softer iron of the interior being drawn toward the outside, leaving a cavity near the middle. The middle and upper portion of the casting is the last to solidify, and there may be enough fluid metal above to fill the cavity, producing a depression in the top of the casting. Blow-holes are caused by dissolved gases. The greater portion of these gases passes out of solution during the cooling. This accumu-

lates in small bubbles, which gather into larger ones as they pass upward through the molten metal. While the metal is liquid they escape, but when the crust forms the bubbles are arrested, and they now accumulate and form cavities in the softest portions of the viscid mass. The prevention of these defects in castings will be studied in connection with steel casting.

Grading.—Like all other forms of iron the properties of cast iron depend principally upon its composition. It generally contains the elements, carbon, silicon, sulphur, phosphorus and manganese, which in their varying proportions to the iron, and to each other, afford the possibility of numerous varieties or grades, differing in properties. In the manufacture of castings for various purposes these different grades of iron are used. A great many manufacturers base their selection of pig iron for castings largely upon the appearance of the fracture, which is to a certain extent, an index to the composition and properties. This relates specially to carbon and silicon.

The analyses and properties of several commercial grades of pig iron have been given by J. M. Hartman,¹ as follows:

Grade	1	2	3	4	5	6
Iron	92.37	92.31	94.66	94.48	94.08	94.68
Graphitic carbon	3.52	2.99	2.50	2.02	2.02
Combined carbon	0.13	0.37	1.52	1.98	1.43	2.83
Silicon	2.44	2.52	0.72	0.56	0.92	0.41
Phosphorus	1.25	1.08	0.26	0.19	0.04	0.02
Sulphur	0.02	0.02	0.08	0.04	0.02
Manganese	0.28	0.72	0.34	0.67	2.02	0.98

No. 1.—Gray, with a large, dark, open-grain fracture; softest of all the numbers, and used exclusively in the foundry. Tensile strength and elastic limit very low.

No. 2.—Gray, with a mixed large and dark grain; tensile strength, elastic limit and hardness greater than No. 1, and the fracture smoother. Used exclusively in the foundry.

No. 3.—Gray, with a small close grain; tenacity, elasticity and hardness superior to No. 2, though more brittle. Used either in the rolling mill or the foundry.

¹ Jour. Frank. Inst., 134, 132-144.

No. 4.—White background, dotted closely with small spots of graphite (mottled iron), and little or no grain to the fracture. Tenacity and elasticity lower than *No. 3*, but hardness and brittleness increased. Used exclusively in the rolling mill.

No. 5.—White, with smooth grainless fracture; tenacity and elasticity much lower than *No. 4*, and still harder and more brittle. Used exclusively in the rolling mill.

No. 6.—Hardest, white iron.

The general effects of the common elements in cast iron may be summed up as follows: Carbon, in the combined form, imparts strength and hardness, excessive amounts causing brittleness. It lowers the melting point and produces a light, granular fracture. Silicon lowers the melting point and renders molten cast iron more fluid. It acts as a "softener" in white cast iron, in which it causes the precipitation of graphite. High percentages of silicon cause brittleness and weakness. Silicon conduces soundness and to a large extent prevents the formation of blow-holes in castings. Silicon irons have characteristic, crystalline fractures. Sulphur is generally very objectionable in cast iron, since it causes brittleness and general weakness. As much as 0.25 per cent. is usually allowable. Phosphorus in large proportions develops extreme brittleness and weakness. The shrinkage of cast iron during cooling is considerably lessened, and it remains fluid longer if much phosphorus is present. Greater smoothness may be brought about on the surface of castings by the use of phosphorus. The range of phosphorus in ordinary cast iron is from 0.05 to 1.5 per cent. Manganese, in the normal proportions of 0.2 to 1 per cent., is beneficial in cast iron, increasing its hardness and density and suppressing the formation of blow-holes. Excessive amounts of manganese develop brittleness. It should be borne in mind that none of the properties of cast iron are affected entirely by a single element. They may be influenced by the like or counter effects of two or more elements.

IRON FOUNDING

The art of casting iron into molds probably dates from the middle of the 15th century. It was about this time that the

process of smelting had been so far developed in Europe that iron was recovered in the fused condition, but iron founding had its precursor in the ancient art of casting the precious metals, bronze and other alloys. Modern foundry practice is a representative industry in which science and engineering skill have been most vital factors.

A complete foundry plant consists of a melting and pouring shop; a pattern shop, in which wooden patterns for the castings are made, and a machine shop, in which the castings are finished. Only a brief description of the methods of melting and casting falls within the scope of this book.

Melting.—Iron for castings is most commonly melted in a cupola. This is a small, cylindrical blast furnace, built of steel plates and lined with fire-brick. Fig. 51 represents a style of cupola in general use. It is provided with two working doors, tap-holes for the iron and slag and a double row of tuyeres, to which the air is supplied by way of an annular blast box. The walls are contracted at the top, the shaft terminating in a stack. Sufficient explanation of the details are given in the figure.

The cupola charge is made up of alternate layers of iron and fuel, generally coke, with enough limestone added to flux the ash. The blast is cold and at a pressure of but a few ounces. It is generally supplied by a fan or some kind of rotary blower. The ratio of coke to iron in the charge is quite variable, this being necessitated by differences in the quality of the materials and the efficiency of the equipment. One part of coke to seven of iron is average cupola practice. It is desirable to keep the fuel consumption as low as possible, for the sake of economy and to prevent, as far as possible, the further addition of impurities to the iron. The rate of melting depends upon the size of the cupola, the blast pressure and the composition of the iron.

The iron tapped from the cupola will not be the same in composition as the charge of pig iron. A part of the iron is oxidized before fusion takes place, and this takes some of the silicon with it into the slag. There is also a loss of manganese by oxidation, and the carbon may be largely changed from the

graphitic to the combined form. Sulphur and phosphorus may

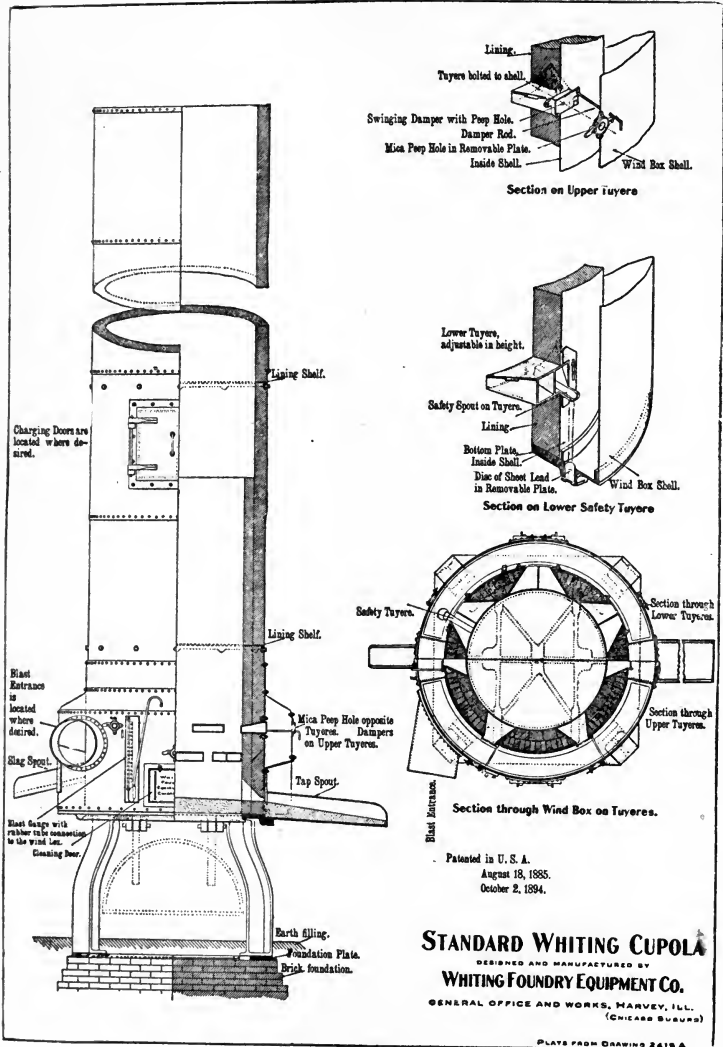

Fig. 51.

be partially removed, or more absorbed from the fuel, depending upon the conditions.

Reverberatory furnaces are used instead of cupolas in some foundries. Contamination from the fuel is thus avoided, and the entire charges being put in and tapped alternately, the iron can be mixed as desired and the composition controlled. The atmosphere of the furnace is made reducing by regulating the supply of air and directing the flame downward on the metal. The fuel may be either soft coal or gas. This way of melting iron is slow and expensive, the fuel consumption being very high.

Mixing Iron in the Foundry.—While it is true that the composition of iron may vary considerably without apparent loss of strength, the best castings are made from iron that is mixed to a definite composition, as the tests go to prove. The heavy strains to which castings are now often subjected calls for the best that can be made, and these to be the best must have the proper composition, as well as the proper shapes and thicknesses. It is not possible always to draw the supply of iron of the composition desired from a single source. Most foundrymen keep several brands in stock from which to make their mixtures. With the analysis furnished, the mixtures of the composition desired may be calculated, due allowance being made for the losses during fusion.

It not infrequently happens that the required amounts of silicon and manganese can not be maintained in the charge, owing to the loss of these elements in the cupola. The deficiency may be restored by adding these substances in the form of rich alloys after the iron has been tapped (see p. 192). As is well known, the very ingredients which give desirable properties to a metal are most injurious when present in excessive amounts. If in making a mixture of pig iron, it is found that there is too much impurity, this may be corrected by melting relatively pure iron with it. Old material such as rails, boilers and machinery is cut in pieces that can be handled and sold as "scrap." A quantity of such material may be judiciously used for the above purpose. The use of scrap is specially to be recommended with iron high in silicon.

Casting.—From the melting furnace the iron is carried in ladles and poured into the molds. The ladles are usually made

of iron and of such size as can be handled by one or two men. Cranes are employed for lifting the large ladles required for heavy work. The molds are most commonly made of sand or a mixture of sand and clay. These are known as green sand, dry sand, loam, etc. Iron molds are used for special work, and are generally called chills.

Green Sand Molds.—These are in most general use. They are the cheapest to prepare, and are suitable for making a great variety of castings. The term “green sand” does not imply any special composition or quality, but simply means that the sand as used is moist enough to cohere under slight pressure. The physical properties of molding sand are of great importance. The sharp sands are preferable, and for light work the grains should be fine. The sharp, coarse sands give greatest porosity and, generally, greatest permeability to the passage of gases. This property is necessary in green sand casting, since steam is generated when the hot metal comes in contact with the mold, and would enter the metal if easy passage through the walls of the mold were not provided. Just enough alumina should be present to make the bond, since alumina causes shrinkage in the mass and diminishes porosity. Other ingredients in sand are regarded as objectionable impurities. The sand from old molds is used over again, but through heating it has lost its cohesive property to a large degree and should have fresh sand mixed with it. In making a green sand mold a pattern in wood is prepared corresponding to the shape of the casting. Metal patterns are often used if a great number of molds are to be made from the same shape. The pattern is made larger than the casting on account of the shrinking of the iron.¹ The pattern is placed in the proper position and sand is carefully packed around it. Except in case the casting is to be a very large one, the sand is held in a portable frame or box, made of iron or wood and in sections which can be removed to take out the pattern. Air vents are necessary in such parts of the mold as would be blocked from communication with the mouth by the inflowing metal; otherwise

¹ The pattern maker uses a “shrink rule,” which is $\frac{1}{8}$ inch longer than the ordinary foot rule.

the expansive force of the air would destroy the mold. The part of the mold that projects inside to form the hollow of a casting is called the core. Ordinary, green sand may be used for making the cores, though often a purer sand with a special binding agent is used. The core may be suspended by wires or supported by a projection which forms a part of the mold

Fig. 52 shows the method of casting a rope wheel in sand. The upper figure is a section of the mold, which is made in two

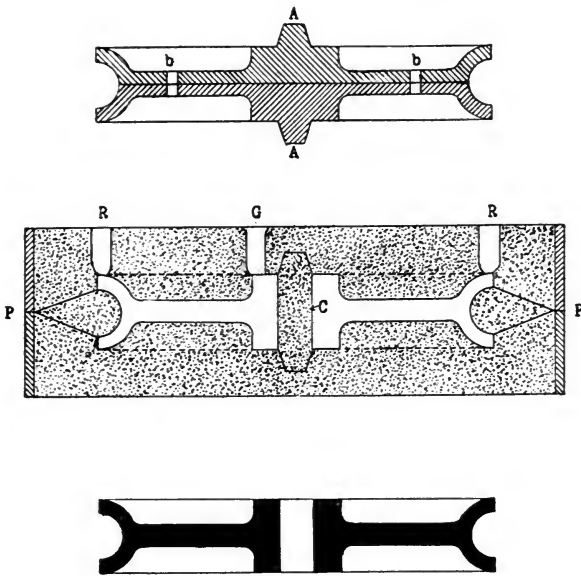

Fig. 52.

pieces and held together by inserting dowels in the holes, bb. The middle figure is a section through the flask or molding box after the pattern has been removed. In making up the mold the pattern is imbedded in the lower section of the box, parting surfaces being formed in the annular planes which slope from the juncture of the box sections, PP, to the edges of the peripheral groove on the wheel. The upper section of the box is then placed in position; blocks are set to form the pouring gate, G, and the risers, RR, and the box is tamped full of sand. The upper sec-

tion is now lifted off, receiving the imprint of one side of the wheel and parting the sand around the upper, annular plane. The upper half of the pattern is removed, and after replacing the top section of the box, the whole is inverted. The lower section is then lifted off, and after removing the other half of the pattern and dressing the surface of the mold, the core, C, is set, and the flask is put together and placed in a level position. It is observed that the recesses into which the core fits are formed by the hub projections, AA, on the pattern. The lowermost figure shows the wheel after the sink-heads have been removed.

Dry Sand Molds are prepared from sand containing enough clay to bind it into a hard mass when baked. The molds may be reinforced by imbedded nails or wires. After removing the pattern the mold is dried in an oven. Where special care is taken the molds are taken apart for inspection and repair if needed, and they may receive a coat of plumbago or special facing sand. Castings made in dry sand are generally of a better quality than those made in green sand and, of course, they are more costly.

Loam.—This is a clayey mixture to which carbon is often added. It cements much better than sand does when baked, and it is used in molds whose walls must be firm and which will not be eroded by the running metal. It is especially adaptable to the molding of large, hollow castings, when the metal has to travel some distance before reaching every part of the mold. They are used in the manufacture of sewer pipes. The molds are made by hand with the aid of some machinery, and are usually faced with a carbonaceous material.

Chills.—The conditions under which gray iron is changed to white iron are recognized in the manufacture of chilled castings. A chilled casting is made from gray iron, but the outer portion, or a part of it, is rapidly cooled to a certain depth, producing white iron in that portion. This is accomplished by using molds made of cast iron, which cools the surface by reason of its high conducting power.

The section (Fig. 53) shows the method of casting a roll from

the bottom, using chill plates for the body of the roll and sand for the ends.

The effect of the chill is shown by the sketch (Fig. 54) in which the graphite is represented by the pen dashes. The depth

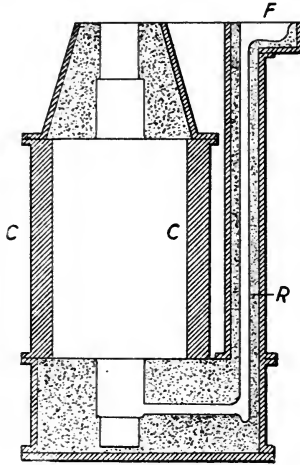

Fig. 53.

of the chill is determined somewhat by the composition of the iron. A deep chill is secured by using a mold with very thick walls. The uneven cooling of a roll sometimes causes internal stress sufficient to crack it.

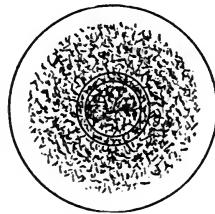

Fig. 54.

The chilling effect of the iron mold may be offset if the casting is removed from the mold while the interior is still molten. This fact has been made use of in the manufacture of special, high grade castings.¹

¹ Elec. Chem. and Met. Ind., VII, 353.

Malleable Castings.—By a special process of annealing, toughness and malleability may be developed to a remarkable degree in white cast iron. In this way castings are made to answer for forgings in many cases, the casting being cheaper to make. The castings must, in the first place, be of the proper grade of iron. The carbon must be almost or entirely in the combined form, and it should not fall below 1.50 per cent. The silicon should be below one per cent., the sulphur not over 0.025, and the phosphorus under 0.25 per cent.

The castings to be annealed are first cleaned of any adhering sand, and then carefully packed in iron boxes with hematite, iron scale or a slag rich in oxide of iron. The material should be fine but not powdered. The boxes are made with removable bottoms. The tops are covered with an iron lid or luted with mud. When packed the boxes are placed in the annealing oven, which is heated by a direct flame. The temperature of the oven is maintained at about 700° C. for three days, or longer, depending upon the size of the castings. Another day is required for cooling the oven, it being essential that the cooling proceed slowly.

The principal change that takes place in the annealing process is the conversion of combined carbon into graphite. The graphite is not, however, of the form observed in gray cast iron, the flakes being very small and evenly distributed. About 20 per cent. of the carbon is burnt out during the annealing, and some sulphur is eliminated. The iron oxide used in the annealing box is partially reduced, some being entirely spent in each operation. The wasting away of the box furnishes good packing material, which is utilized.

Testing Cast Iron.—With the increased knowledge of the properties of cast iron and the relation of these properties to its composition, and with the higher duty that is required of it in the progress of manufactures, naturally, the methods of testing it have been improved. It is recognized that the properties of cast iron are directly dependent upon its composition. Practically all the pig iron, that is made for foundry purposes, is graded by the smelter according to analysis, for he expects to sell his product in this way.

But the analysis does not reveal all. In many instances more practical knowledge of the quality of iron is gained from the mechanical test than could be interpreted from its composition. These tests are made, as far as possible, to imitate the stresses that will be put upon the iron in actual service. The strains that are exerted during the testing are measured and recorded. They are usually increased until the test-piece is broken, showing the ultimate resistance. The test is either made upon a finished casting, which represents a number of other similar ones, or upon a specially prepared piece of convenient form. In either case the specimen is taken from the same lot of iron as the castings which it represents. Testing by the first method gives a *direct* value, while the latter method gives only the *relative* value.

The tests most commonly applied to cast iron are two—transverse and impact.

Transverse Testing.—This shows the resistance of the metal to cross breaking. It represents a condition that is most common in actual service. It is conducted by supporting the test-bar at both ends, and applying stress in the middle until it is broken.

Impact Testing.—This shows the resistance offered to shocks or blows. It is applied both directly and indirectly. When the material in question is in the shape of castings from the same pattern, and such that can be submitted to the test, it is usually made directly. Otherwise a test-piece of convenient size and shape is used. The test is applied by allowing a hammer of definite weight to fall from a certain height, or if supported like a pendulum, to swing through a certain distance, and strike the iron. The distance of the fall is increased until rupture occurs.

The standard test for car wheels adopted by the American Society for Testing Materials is as follows:

“For each 103 wheels apparently acceptable, the inspector will select three wheels for the test. * * * One of these wheels chosen for this purpose by the inspector must be tested by drop test as follows: The wheel must be placed flange downward on an anvil block weighing not less than 1,700 pounds, set on rubble masonry two feet deep having three supports not more than five inches

wide for the flange of the wheel to rest on. It must be struck centrally upon the hub by a weight of 200 pounds, falling from a height of 12 feet. The end of the falling weight must be flat, so as to strike fairly on the hub. * * * Should the wheel stand without breaking in two or more pieces the one hundred wheels represented by it will be considered satisfactory as to this test. Should it fail, the whole hundred will be rejected."

In addition to the above tests for cast iron, tests of tension and compression are sometimes made. The tension test is chiefly used for iron made into steam or air cylinders. Compression tests are rarely needed, since cast iron is not often weak in this respect. The hardness is sometimes tested in iron that is to be machined. Turner's method of making this test is to determine the weight that must be brought to bear upon a standard diamond point to make it scratch upon the polished surface of the iron. See p. 11.

CHAPTER XII

WROUGHT IRON

Historical.—The origin of wrought iron is not known. It is probably the form in which the metal was first prepared, though the practice of hardening iron with carbon is also of unknown

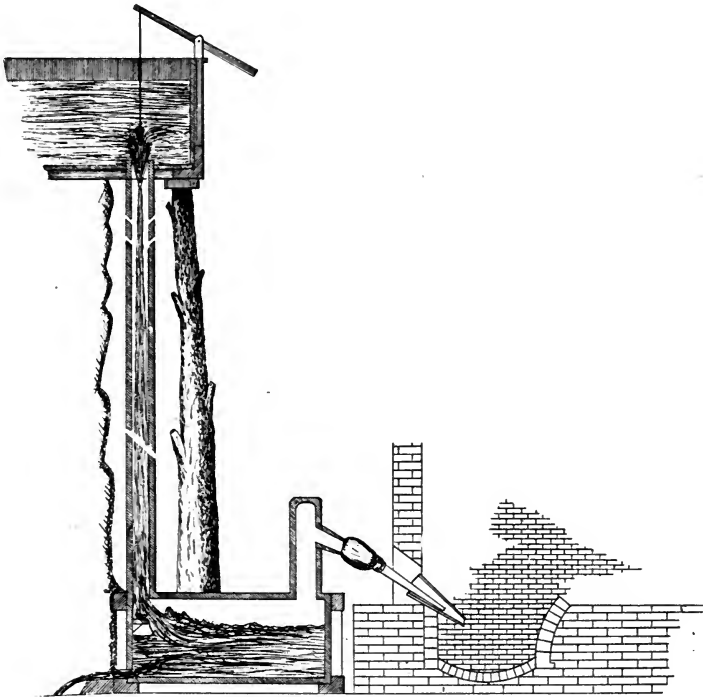

Fig. 55.

origin. So far as there is any evidence, the primitive method for making wrought iron was to reduce it with wood direct from the ore in small, rude furnaces. The air supply was furnished by natural draft, or by means of rawhide bellows operated by hand—a process still used in Africa and India by the savage tribes. Throughout civilized Europe, where the iron industry was really developed, various forms of forges were instituted, their product

being malleable iron. Most notable among these was the Catalan forge, which the illustration represents (Fig. 55). The term hearth is also used to designate this type of furnace. The fur-

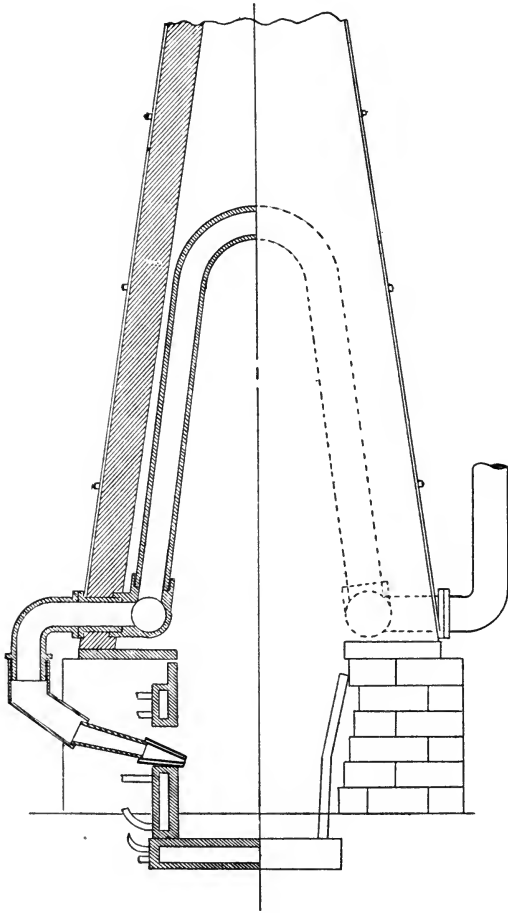

Fig. 56.

nace was built of brick in the form of a shallow hearth with no stack. A blast of air was supplied through a single tuyere, by means of a water blower known as the *trompe*. The water was allowed to fall from a reservoir, through a tall pipe, into a blast

box, as shown in the drawing. Small openings were made in the pipe near the top for the admission of air. The air was drawn in through these openings by the suction, and passing with the water into the box it was there slightly compressed. The air for the blast was drawn from the top of the box, and the water was allowed to flow through an opening at the bottom. The trompe was built almost entirely of wood. The ore mixed with burning charcoal was reduced to spongy iron.

The American bloomary is a more highly developed type of forge. Fig. 56 shows a bloomary half in section and half in elevation. The chief differences between this and the older forges are in the tall stack above the hearth and the arrangement for heating the blast. The hearth is enclosed partly by brick work and partly by water-cooled, iron blocks. The stack is built of brick and reenforced with iron. The blast is led through pipes (commonly three), which are bent to fit in the stack as shown. The blast may acquire a temperature of 400° C. or more. The blast is delivered to the hearth by a single tuyere. The iron ore is reduced in contact with burning charcoal, the iron being removed from the hearth in the form of a spongy mass or bloom. It is possible, however, by increasing the temperature to make cast iron in the bloomary.¹

Furnaces of the above type have also been used in Germany and other parts of Europe. They mark the transition between the forge and the modern blast furnace.

About the year 1784, Henry Cort invented the indirect or puddling process for making wrought iron from pig iron.

Properties.—The better grades of wrought iron represent the purest form of commercial iron. The properties, therefore, most nearly approach those of pure iron. It is recognized by its toughness, combined with softness, and especially by its fibrous fracture. The filaceous structure is developed during the forging of the iron by reason of intermingled slag.

Wrought iron is the smith's favorite, it being the easiest to

¹ The American bloomary is illustrated, and the process fully described by T. Egleston in *Trans. Amer. Inst. Min. Eng.*, 8, 515.

forge and weld. It is well adapted to the manufacture of thin sheets, owing to its malleability. It is said that wrought iron will not stand vibrations so well as iron containing carbon.¹

MANUFACTURE OF WROUGHT IRON

As was pointed out in the historical sketch, wrought iron may be prepared from the ore by a single operation, or from pig iron by a refining process. These are known as the direct and the indirect processes. The latter process is more commonly termed puddling. Direct processes have been practically abandoned, and no further space will be given to their description. It is worthy of mention in this connection, however, that pure iron and steel have been made directly from the ore in electric furnaces. Whether or not these experiments have any commercial value remains to be proved.

The Puddling Process.—A great deal of importance is attached to the process about to be described, not so much for its direct

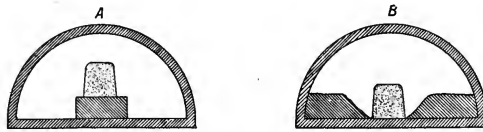

Fig. 57.

bearing on the metallurgy of iron, but because the principles involved are essentially those underlying all iron refining processes. A study of the simple experiment, as outlined below, will give the student the keynote to the theory of puddling.

The sections A and B (Fig. 57) represent the muffles of a small, gas-fired furnace. The atmosphere in these muffles is oxidizing, and the temperature can be raised above the melting point of pig iron. In muffle A, is placed a brick, and upon this is placed a piece of pig iron. In B another piece of pig iron is placed upon the bottom of the muffle, clay or sand being packed around the piece to form a basin as shown. The temperature of the muffles is now raised and kept just below the melting point of the iron. The surface of the pigs soon becomes coated with

¹ Trans. Amer. Inst. Min. Eng., 26, 1026.

oxide of iron. The silicon is also oxidized, and combines with the ferrous oxide forming a fusible slag (ferrous silicate). This runs away leaving the surface of the metal exposed to further action. The carbon in the iron is converted into carbon monoxide, and then into carbon dioxide which escapes. The manganese is oxidized like the iron and passes into the slag. Now it is seen that if there is enough silicon in the pig to combine with all the iron and form a fusible slag that will be the ultimate result of the experiment in muffle A. The result in muffle B will be different, since the slag covers the iron and protects it from further oxidation. If when enough slag has formed, the temperature is raised to melt the iron, the impurities will be removed by the oxidizing power of the slag. The slag is mingled with the metal so as to bring the impurities into contact with it. It must obviously become richer in silica and poorer in ferrous oxide than the slag in A. The carbon in the iron has a reducing action with the ferrous oxide in the slag. By virtue of this, the carbon is removed and the metallic content of the charge is increased. Since purification raises the melting point of iron the metal in B is left in a plastic state.

The essential difference between the above experiment and the puddling process, is that in puddling most of the oxide is supplied from another source and not derived from the iron.

Dry Puddling.—This name has been given to Cort's original process, because no slag forming substance was added with the metal charge. His furnace was a small reverberatory having a sand or silicious bottom. As would be expected, the hearth was badly fluxed with each heat. It was considered necessary that the iron be low in silicon. Such iron does not become so fluid in the puddling furnace, and much less slag is formed. Gray iron, high in silicon, was therefore subjected to a partial refining before puddling. The description given below of the refining process or "Running Out Fire," is taken from Percy's Metallurgy.

"The refinery consists essentially of a rectangular hearth, with three water tuyeres on each side inclining downwards. The

sides and back are formed of hollow iron-castings, called 'water-blocks,' through which water is kept flowing, the front of a solid cast iron plate containing a tap-hole, and the bottom of sand resting on a solid platform of brick work. Coke is the fuel used with cold blast at a pressure of three pounds per square inch."

"The refinery being in operation, the folding doors at the back are opened and coke is thrown in, the charge of about one ton or one ton, two cwts. of pig iron is placed upon it and heaped over with coke, after which the blast is let on. The operation is facilitated by the addition of 30 pounds of hammer-slag or scale. The metal, which melts in about one and one-half hours, is then exposed to the action of the blast, which is strongly oxidizing, notwithstanding the superincumbent layer of incandescent coke. A considerable quantity of cinder is formed, consisting for the most part of tribasic silicate of protoxide of iron. In about two hours after charging, tapping occurs, the blowing usually lasting about one-half hour. The consumption of coke is about four cwts. Cinder and the molten metal flow out together along the running-out-bed in front, the cinder, of course, forming the uppermost stratum. This bed being refrigerated, as previously stated, the metal is speedily consolidated. Water is copiously thrown over the whole, while the accompanying cinder is still liquid, when the latter puffs up into beautiful little volcano-like craters; and it is curious to watch the molten cinder and water dancing, at it were, together . . . The water, which may be conveniently applied in a strong jet, promotes the separation of the cinder from the metal. The cinder is thrown aside to be either smelted or used for certain other purposes; and the metal, usually about three inches in thickness, is removed and broken up in pieces of the proper size for puddling. The metal is white cast iron."

Pig Boiling Process.—This is the modern puddling process. It takes its name from the fact that the bath of metal and slag are very liquid at a certain stage, and the escape of gases gives the boiling effect. The chief difference between modern puddling and the older methods is in the use of a fettling of iron oxide on

the furnace hearth, from which oxide is supplied to the slag instead of its being supplied entirely by the oxidation of the metal. Credit for this invention is given to Joseph Hall, who is said to be the first to use the fettling (1830).

The sectional elevation of a common type of puddling furnace is shown in Fig. 58. This is a small, direct-fired reverberatory furnace. The grate, G, is rather large in proportion to the size of the hearth, H. The flame from the fuel bed passes over the fire-bridge, A, and is deflected upon the hearth by the low roof.

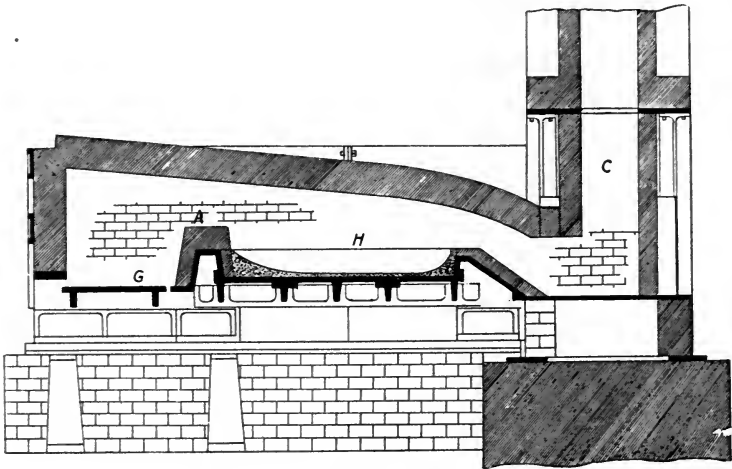

Fig. 58.

The products of combustion pass into the tall chimney, C, by means of which a strong draft is maintained. The furnace is provided with a single working door at the side, which serves both for introducing and withdrawing the charge. Puddling furnaces are sometimes fired with gas and oil, though the coal-fired type is the most common.

The hearth of the furnace is thickly lined with iron ore, roll scale or rich, ferruginous slag. The fettling, as it is called, extends up the sides from the hearth, so that it will be well above the surface of the bath when a charge has been melted. Before charging, the melter examines the hearth of his furnace and

makes the necessary repairs to the fettling. This must of necessity be renewed often, since it not only acts as lining, but is also the flux.

The furnace being ready, some slag from a previous operation is first charged. The charge of pig iron usually weighs about four and one-half tons and is charged cold. The process is described as progressing in four stages; viz., the melting down, the quiet fusion, the boiling and the balling up.

1. *The Melting Down.*—This begins soon after the iron has been charged, the temperature of the furnace being raised as rapidly as possible. Fusion is further hastened by turning the pigs over and stirring them in the slag that forms.

2. *Quiet Fusion.*—When fusion is complete the bath is thoroughly rabbled, bringing the metal into more intimate contact with the fettling. It is during this stage that the silicon is almost completely removed. No little skill is needed on the part of the melter in determining when the silicon has been completely transferred from the metal to the slag. He learns to judge this from the appearance of the bath. The manganese is also largely removed during this stage.

3. *The Boil.*—So far, most of the carbon has remained in the iron. Its removal is hastened by first cooling the furnace until the slag becomes more viscous and will not separate so quickly from the metal, and then by stirring the bath thoroughly to mix the slag with the metal. Since the slag is now rich in iron oxide, this reacts rapidly with the carbon, as is evident from the evolution of gases from the surface of the bath. The carbon monoxide that is formed takes fire with its characteristic pale-blue flame the instant it bursts from the surface of the slag. The reactions cause a rise in temperature and the slag becomes more liquid. The large amount of gas escaping during the removal of carbon gives rise to the boiling effect. There is also a swelling of the charge, the slag rising several inches up the sides of the furnace, and often flowing out the door. A quantity of slag may be drawn off at this time, and the difficulty in handling the metal at the end of the operation will be lessened if the bulk of slag is reduced to

the least that is necessary. The boiling diminishes with the removal of the carbon, and when the bath becomes quiet the operation is finished.

4. *The Balling Up*.—The iron is now in the form of a porous, unfused mass, in which a quantity of slag is still incorporated. The melter breaks up the cake of metal with a bar, and then manipulates the pieces on the hearth of the furnace until they become somewhat rounded or roughly shaped into balls. This is done for convenience in handling, the balls weighing about 75 pounds each. These balls of wrought iron, being now at the temperature for welding, are taken from the furnace, grasped with tongs suspended from an overhead carrier, and placed under the hammer or in the squeezer for removing the slag.

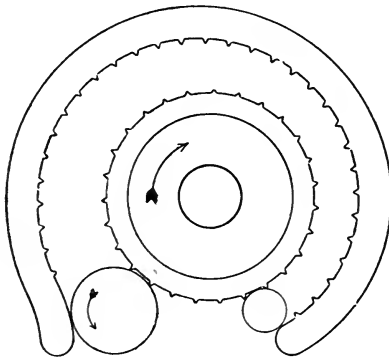

Fig 59.

The principle of the rotary squeezer for wrought iron blooms is shown in Fig. 59. A heavy cast iron cylinder revolving within an eccentric shield in the direction indicated by the arrow carries a ball around, revolving it in the opposite direction. The corrugated surfaces of the cylinder and shield prevent the ball from slipping while it is forced into the diminishing space.

The rolling of the bloom is conducted in a manner similar to the rolling of steel ingots (Chapter XVII).

Modifications of the Puddling Process.—Although permitting of many alterations, the practice of iron puddling, with the exception of one important advancement, has continued essentially the

same since its inception. The more common practice, just described, looks mainly to the removal of carbon, silicon, manganese and some phosphorus. In some special high grades of iron it is required that the phosphorus be practically eliminated. This is accomplished by the use of a basic slag. The slag may be rendered basic by increasing the percentage of ferrous oxide, or by adding lime.

Soda ash (impure carbonate of sodium) has been employed with small quantities of iron for the removal of phosphorus and sulphur. While iron may be desulphurized with mixtures containing soda ash, this material is far too expensive to use on the large scale.

A mixture of manganese dioxide and salt is sometimes added to the charge at the beginning of the heat. This renders the slag more liquid and more strongly oxidizing, favoring the removal of phosphorus and sulphur.

Mechanical Puddling.—Many attempts have been made to construct a puddling furnace which can be rocked, tilted or revolved by machinery, thus bringing about the disturbance of the bath instead of stirring it by hand. Such a furnace would be desirable from more than one point of view. The labor of a puddler is exceedingly severe and might well be dispensed with; the process might be cheapened by doing away with such expensive labor, and the output would be increased, assuming that more material could be treated at the same time. The mechanical furnace has not, however, proved entirely satisfactory, and most of the wrought iron is still made by the brawn and skill of the puddler. A mechanical furnace has been designed and used for some time by J. P. Roe, of Pottstown, Pa.¹

¹ Trans. Amer. Inst. Min. Eng., 33, 551, also Iron and Steel Inst. Jour., 1906, 3, 264.

CHAPTER XIII

STEEL—THE CEMENTATION AND CRUCIBLE PROCESSES

Definition.—When steel was manufactured solely by the cementation and crucible processes, it was understood as refined iron to which a definite amount of carbon had been added. If it contained less than 0.5 per cent. of carbon it was known as “mild steel,” while the hardest steel contained 1.50 per cent. of carbon. Since the introduction of the Bessemer and open hearth processes for making steel, the term has had a wider meaning. By these processes iron practically saturated with carbon, and iron that is almost free from carbon may be prepared, but the product is always designated as steel. Furthermore, there are now on the market a number of alloys of iron with other metals, all of which are known as steel, so that the term as now used does not signify any special composition. Since there are several distinct processes in use for its production, steel may be defined as iron that has been refined by one of these processes. The cementation, crucible, Bessemer, open hearth and electric are the standard processes.

THE CEMENTATION PROCESS

When iron and carbon are placed in contact and heated to about 600° C., they combine slowly, the carbon penetrating the iron to a greater depth as the heating is prolonged. This phenomenon is known as *cementation*. The process of cementation is one in which iron is heated without fusion in a suitably constructed furnace, and in contact with solid carbon, until the required amount of carbon has been absorbed.

The Furnace.—Fig. 60 shows the Sheffield type of cementation furnace in section. The rectangular converting pots or boxes, in which the iron is carburized, are built of fire-brick or stone. They are heated by means of flues, F, leading from the fire-place, G, underneath the boxes and up their sides. The flues terminate in the short chimneys, C. Air is excluded from the boxes by the arched roof of fire-brick, and the entire furnace is enclosed in a

conical stack. The manhole and the charging holes, H, are bricked up during the operation. The test bars are drawn from the boxes through the small ports, T.

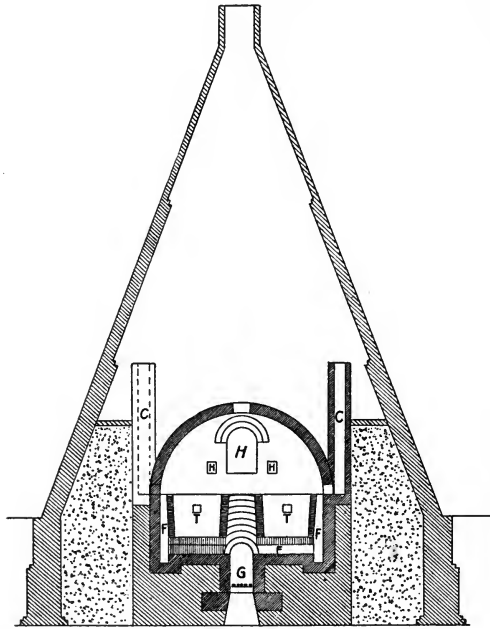

Fig. 60.

The Process.—The steel is made from selected bars of the purest commercial iron. Wrought iron is preferred, though Bessemer and open hearth steel are sometimes employed. The bars are placed in layers in the fire-brick boxes or pots, and between the layers charcoal free from dust is packed. Each set of bars is placed at right angles to those in the layer below, and a covering of charcoal is put over the last layer when the box is full. The boxes are made to hold from 10 to 15 tons of bars.

The boxes having been filled and air excluded from the charge, the fire is lighted and the temperature of the furnace is slowly raised until the maximum is reached. This requires about 48

hours. The heating is continued for from 4 to 10 days, depending upon the amount of carbon wanted in the steel. The degree of carburization is ascertained from time to time by taking out a bar through the port provided and examining its fracture. When the process has proceeded as far as desired, the fire is drawn, or allowed to die out, and the furnace cools slowly. Within five days the furnace may be entered and the bars, which are now carbon steel, are removed. The carbon, however, has not been uniformly distributed throughout the bars. The outer portion may be saturated, while the center is almost free from carbon. It now remains to convert these bars into steel of uniform composition. They are cut into convenient lengths, and these are bundled, heated to the welding temperature and forged into a single piece. The metal is first coated with a wash of clay and borax, which checks oxidation and serves as a flux, giving a clean surface for welding. Having been cut and welded once, the steel is known as "single shear." A higher grade of steel is made by cutting up the bar and welding as before, this being termed "double shear" steel. As some carbon is burnt out during the reheating, the bars which contain more carbon than is required in the finished product are selected to be sheared.

It is possible to combine a little over two per cent. of carbon with iron by cementation. A further addition would require a higher temperature, which would result in the fusion of the steel. It is not known whether the carbon diffuses through the iron as carbon, or as a carbide of iron. It is probably similar to the migration of carbon in other instances, wherein the conditions are different, as in chilled and malleable castings. The penetrating power of carbon is shown by the fact that it will enter and migrate through hot porcelain, glass and other dense substances. If the steel has been converted from wrought iron the surfaces of the bars, as they are drawn from the furnace, are covered with blisters. This has given rise to the term "blister steel." The cause of the blisters has been satisfactorily explained by Percy. The ferrous oxide, which is always present in wrought iron, is reduced by the carbon with the formation of carbon monoxide, and the gas, seeking its escape, distorts the plastic

metal. Cement steel that is made from iron containing no oxide or slag is not blistered.

The output of cement steel is relatively very small. The process still holds its own in the manufacture of some tools and machinery pieces, but aside from some special applications of the principle, it has declined as a method for making steel. The most famous works are at Sheffield, England.

THE CRUCIBLE PROCESS

Modern steel manufacture may be said to have begun with the crucible process. Although steel had been converted in a molten condition before this time, it had never been cast as is done in the crucible process, and other important details were lacking. The term "cast steel" was significant at the time when steel was made either in the cementation furnace or in the crucible. The crucible process is the invention of Benjamin Huntsman, an English manufacturer. His first plant was erected at Sheffield and put into operation about 1740.¹ The process was in every essential the same as it is to-day.

Crucibles.—Steel melting crucibles are generally manufactured from a mixture of clay and graphite. Graphite alone is not cohesive enough to make a strong crucible and is expensive, while clay crucibles have too great a tendency to shrink and crack when in use. Clay crucibles are preferable for soft steel since their walls do not give up carbon to the charge. As a rule, they do not last for more than one melting. The graphite crucibles are much more durable. A good crucible of American make contains about 50 per cent. graphite, 40 per cent. clay and 10 per cent. sand. Ceylon graphite is considered the best for crucibles. Other materials have been substituted for natural graphite. Kish and coke dust are used, and old crucibles are regularly ground and mixed with the new material.

The clay and the graphite for the crucibles are ground and then mixed. After making the clay into a thin paste with water the graphite and sand are sifted in. The thickened mass is then mixed in a pug mill and allowed to stand for a few days. By

¹ Jour. Iron and Steel Inst., 1894, 2, 224.

allowing it to stand, or tempering as it is called, the clay loses some water and incorporated gases and becomes stiffer. It is now ready to be turned into crucibles.

A lump of the clay is kneaded and thrown into a plaster of Paris mold, corresponding in shape to the outside of a crucible. The mold is centered on a potter's wheel, and as it revolves a knife blade is lowered into the clay to form the interior of the crucible. The knife is set at the proper angle to force the clay upward and against the walls of the mold. The top of the crucible is trimmed, and it is allowed to remain in the mold for about three hours. During this time the porous plaster absorbs so much water from the clay that it is left rigid enough to stand up. The crucible is dried for a week, and is then ready for firing. It is enclosed in a shell of two clay seggars and placed with other crucibles in a potter's kiln. Both the rise and fall of temperature during the firing are carefully controlled, as sudden changes would weaken or fracture the crucibles. The temperature of the kiln should be at least as high as that of the furnace in which the crucibles are to be used.

The Melting Furnace.—The furnaces used for melting steel in crucibles are often of very simple construction, consisting essentially of a melting hole in which the crucibles are placed, and in which coke is burned, and a tall chimney for creating a draft. The melting hole is covered with a fire-clay lid during the operation. Gas-fired furnaces employing regenerators are also in use.

The Process.—Each crucible receives a charge of from 60 to 90 pounds of metal. The materials converted are wrought iron or steel made by one of the cheaper processes and pig iron. The pig iron serves as the carburizer, though charcoal or anthracite may be used instead. A little oxide of manganese is usually added, and sometimes a "physic" such as salt, potassium cyanide, etc., is used. The crucible is covered and placed in the melting hole of the furnace. Some time after the charge has fused the melter takes off the crucible lid and examines the contents with the aid of a rod. From the appearance of the slag and certain other indications he determines when the crucible should be

withdrawn from the furnace. The crucible is lifted out by means of tongs, which are made to encircle it a few inches below its largest diameter, giving support to its sides. The steel is usually allowed to stand for a few minutes before pouring. This is termed "killing," as it serves to quiet the metal. The same result is arrived at by adding silicon or aluminum to the charge and pouring immediately. The steel is then slowly poured into the ingot molds, and the crucible is thrown aside for inspection. A crucible lasts for from four to six heats. The molds, just referred to, are commonly about 30 inches long and three inches square inside. They are made in two pieces, the joint running lengthwise, and held together with rings and keys. This mechanism facilitates the removal of the ingot after it has cooled. The large molds are of one piece. In case the contents of one crucible is not sufficient to fill a mold, two or more heats are poured at the same time. The ingots are reheated to the forging temperature and rolled or hammered into the shapes desired. About 10 per cent. of the steel is rejected in the mill on account of piping in the ingots.

It is not possible in the crucible process to determine the amount of carbon that should be added to a charge to produce the grade of steel desired, since the losses are not constant. It is therefore necessary to estimate the carbon in the steel after it is made and to grade it accordingly. The fracture test is here made use of to great advantage. The tops of the ingots are broken off and the fractures examined by a skilled inspector.

The superior quality of crucible steel is due to the selection of high grade materials to begin with as well as to the process itself. With so small an amount of metal, and that in a closed vessel, the composition of the charge and the temperature of working can be almost completely controlled. The occlusion of gases is largely prevented by these conditions and by the manner of pouring, which is to allow the metal to run in a very small stream. The crucible process is now giving way to the electric process.

CHAPTER XIV

STEEL—THE BESSEMER PROCESS

ACID

History.—The Bessemer process fittingly bears the name of the illustrious inventor, Henry Bessemer. The process is not, however, the invention of a single man, but of a number whose names should be as closely linked with it as that of Bessemer. The original idea was not to make steel directly by this process, but to make wrought iron, from which steel was to be converted. Wm. Kelly was the first to show that pig iron could be purified by blowing air through it while in a molten state. Kelly's invention was what he termed a "Pneumatic Process" for making malleable iron. He first carried out his idea at Eddyville, Ky., in 1847. About ten years later he built a tilting converter for the Cambria Steel Works, at Johnstown, Pa., where it has been preserved. His lack of financial backing prevented Kelly from making a commercial success of the process he had originated. However much may have been suggested to Bessemer, no one can doubt that the unique construction of plant and the details of the process were his own achievement. The result of Bessemer's experiments were first made public in a paper before the British Association, in 1856. He termed his invention "The Manufacture of Malleable Iron and Steel Without Fuel." The success of the process was no less a surprise to the inventor than it was to other metallurgists, though it had failed as yet to convert iron into steel. The product was simply iron from which the impurities, except sulphur and phosphorus, had been removed, and this was often red-short and difficult to work. After some unsuccessful efforts to remove phosphorus Bessemer abandoned the idea, since he was able to buy Swedish pig iron which was practically free from phosphorus. The other difficulties were overcome by adding spiegel-eisen to the iron after it had been blown, the manganese correcting the red-shortness and the carbon producing the necessary hardness and tenacity in the steel. This very essential improvement was suggested by

Mushet. The improvements in the building of Bessemer plants, and the development of the process are attributed largely to Alexander Holley, a famous American engineer.

The Iron Mixer.—At the large iron and steel plants the iron is delivered to the steel works in the molten condition. It is run directly from the blast furnace into brick-lined ladles, which are mounted on railway trucks, and conveyed immediately to the Bessemer or open hearth shop. It is obvious that a great saving must be realized by converting the iron without further handling or allowing it to cool. The ideal practice would be to pour all the iron directly from these ladles into the converters, and this would be done if the iron were always of the proper composition, but this is not the case. The silicon, in particular, is too high in some casts and too low in others, making it necessary to mix the different grades of iron to obtain one of the proper composition for blowing. Remelting cupolas are generally used in converting mills for the sake of having a reserve of hot metal. By skillful management it is possible to convert a good deal of iron "direct," the iron from the cupolas being mixed in the converters with the iron from the furnace. The difficulty is most completely solved, however, by the use of the hot metal mixer, an invention of W. R. Jones, of Braddock, Pa. The mixer is a large vessel, built of steel plates and lined with fire-brick. It has a circular bottom, and is mounted on rollers so that it can be revolved to pour out the contents. The iron is run in from a ladle through an opening near the top of the mixer, and is poured out from an opening on the opposite side. The capacity of the mixer is usually about 300 tons, which is the equivalent of three or four casts from a large blast furnace.

The Converter.—The section of a modern converter is shown in Fig. 61. The converter consists of an outer shell of heavy, cast steel plates and a thick lining of refractory material. It is mounted on hollow trunnions, through one of which connection is made for the passage of the blast. The converter is made in three sections, any one of which may be repaired independently. The top section is held to the middle section or body of the

vessel by means of bolts, and the bottom section is attached with hangers secured by keys, an arrangement which permits of the bottom being renewed in a very short time.

The converter is lined with ganister, mica-schist or other silicious material. The stone is ground and mixed with water for use as a mortar. The lining is made by setting the cut stone in the mortar, or by using the mortar exclusively. When the

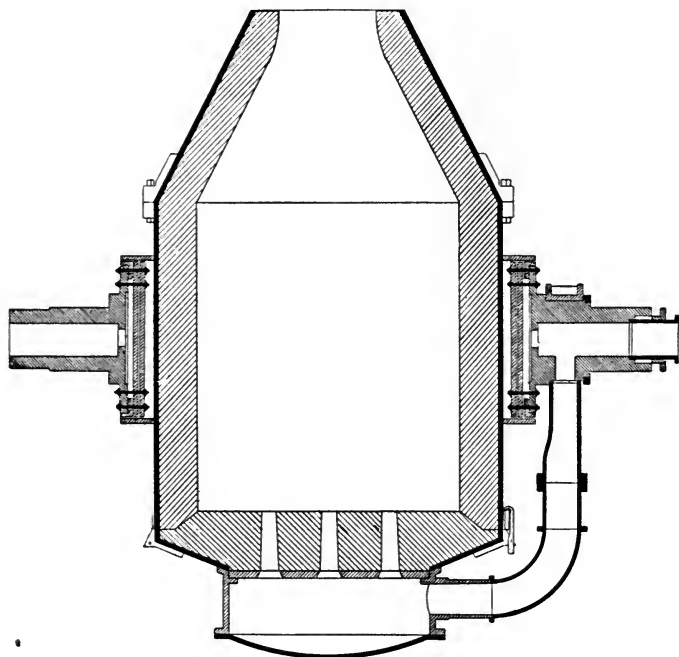

Fig. 61.

latter method is adopted the mortar is rammed in place after placing a wooden core to form the interior of the vessel. The lining is dried by a fire before the vessel is put into use.

The bottom is the weakest part of a converter. The lining in the upper and middle sections may need but slight repair during a year of constant running, while the bottom lasts but for a few heats, usually 15 to 20. A number of bottoms prepared

for immediate use are therefore kept on hand in converting mills. The construction of the converter bottom warrants special notice. As shown in the cut the blast is received in a cast iron box through a gooseneck, which is connected with the trunnion. The blast is let into the charge through a number of fire-brick tuyeres, which are set in openings in the metal top of the blast box and surrounded by the lining material. The tuyeres are perforated by numerous holes, about half an inch in diameter, through which the blast is delivered. In this way the blast is

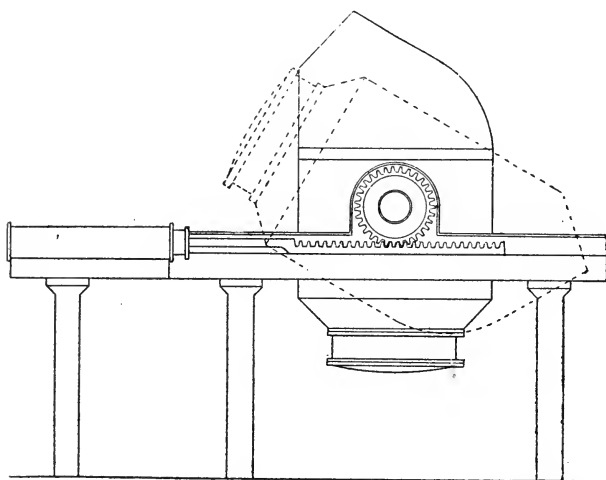

Fig. 62.

distributed through the charge at the moment it enters. Defective tuyeres are plugged by turning the vessel down, removing the blast box lid and tamping in clay from the bottom.

Fig. 62 shows the method of rotating a converter, the dotted outline indicating the position for charging. A sliding rack, driven by a double-acting, hydraulic ram, meshes with a pinion keyed to one of the trunnions on which the converter rotates. With this device the converter may be turned through an angle of 180° or more. A casing of iron prevents injury to the mechanism from slag ejecting during the blow.

The Process.—The vessel is turned down to the horizontal position and a charge of 8 to 15 tons of molten pig iron is run in. The blast is turned on as the vessel is raised to the vertical position. A cloud of dense, brown fume is evolved, followed by a shower of sparks. A voluminous flame also appears and vanishes with the cloud. This is followed by a shower of sparks, and then a short and not very luminous flame appears. As the temperature increases the flame grows in length and luminosity until at the end of about eight minutes it reaches the maximum of twenty feet or more, and is of dazzling whiteness. If the blow is continued the flame soon declines rapidly until it disappears. At the moment the flame drops, or before that time, the vessel is turned down and the blast is shut off. The ladle being in place, the mouth of the vessel is brought down until all the metal and most of the slag run out, and when the ladle is swung around the vessel is completely inverted to empty it of the remaining slag.

The blower is guided by the appearance of the flame in determining the time at which the blow should be ended. He watches it through stained glasses, and with remarkable precision he can tell when the carbon has been eliminated to the necessary degree. The usual practice is to stop the blow when the carbon has been diminished to 0.08 per cent., and if necessary, to add carbon to the steel after it has been poured into the ladle. The duration of a blow is from 7 to 14 minutes. The purer the iron and the higher the pressure of the blast the shorter will be the duration.

The manganese is added to the steel as it runs into the ladle, or if much is required, it is added during the blow from an overhead chute. To ordinary soft steel (0.07 to 0.09 carbon) about 0.4 per cent. of manganese is generally added, which is sufficient to prevent red-shortness. If higher carbon steel is wanted the carbon may be added to the ladle in the form of anthracite coal, or more commonly, the steel is carburized with pig iron.

The slag from the acid converter consists chiefly of the silicates of iron and manganese, silica being far in excess. The converter lining is gradually fluxed away, adding silica and alumina

to the slag. Any titanium present is oxidized and absorbed by the slag. Converter slag is often employed as a silicious flux in the blast furnace. It is difficultly fusible, being viscid at the temperature in the converter.

Converter dust is a mixture of slag and metallic oxide which is ejected during the blow. It also contains particles of iron. About 1.25 per cent. of the weight of a charge is thrown out with each blow.

	SiO ₂	FeO	MnO	Al ₂ O ₃	P ₂ O ₅	Fe (Metallic)
Converter slag ..	64.0	15.0	12.0	1.5	0.007	7.00
Converter dust ..	23.0	60.0	4.0	0.5	0.045	11.50

Chemistry of the Process.—The chemical changes that occur in the Bessemer converter, though proceeding much more rapidly, are similar to those of the puddling process. The air entering through the multiple tuyere openings is at once distributed throughout the charge, accounting for the rapidity with which the metalloids are removed. Carbon, silicon and manganese are almost completely removed, phosphorus and sulphur remaining with the iron. If the blow is continued until the flame drops only about 0.03 per cent. of carbon will be left.

The term "direct oxidation" is used in refining processes to distinguish between that which is brought about by the addition of oxides to the charge and that which is effected by the admission of air. Since the charge in the converter contains iron in so great an excess it stands to reason that iron is the principal substance that is oxidized, and that the impurities, for the most part, are oxidized by the ferrous oxide formed in the bath. In other words the iron is the carrier of the oxygen. So long as oxidizable substances come in contact with it ferrous oxide is reduced, and toward the end of the blow when the carbon and silicon have almost disappeared more ferrous oxide appears in the bath.

The heat generated by the oxidation of the metalloids is more than sufficient to keep the steel in a molten condition. Most of the heat is derived from the oxidation of the silicon on account of its high calorific power, and consequently, high silicon irons cause an overheating of the charge, leading to "wild heats."

This may be prevented by lowering the pressure of the blast or by diluting the charge with cold steel scrap. Steam is often introduced into the blast for the same purpose.

BASIC

Some of the foremost metallurgists were early led to attempt the dephosphorization of iron in the converter. Bessemer himself worked toward this end, though without success. The basic process, by which phosphorus may be practically eliminated, was finally worked out by Sidney Thomas with the assistance of Gilchrist, Martin, Stead and others.

The essential feature of all basic processes for refining iron is in the use of a basic slag, the lining of the furnace being necessarily of basic material. The basic converting plant is, in general construction and appointment, similar to the acid plant. The converter is of the same form, but is lined with dolomite instead of a silicious material. The dolomite is first thoroughly calcined, then crushed and mixed with hot tar. The mixture is either rammed into place, a core being used for shaping the interior, or it is pressed into bricks which are burnt at a low temperature and carefully set.

The Process.—The vessel is heated either from a previous charge, or if new, by means of a coke fire. Lime, equal in weight to about 15 per cent. of the weight of the charge, is first thrown in, then the metal is added and the blow follows. To all appearances the first part of the blow is in no way different from the same period in the acid process. It is seen, however, that there is more "boiling" and frothing of the charge from the amount of slag ejected. The blow is continued a few minutes after the flame drops, the oxidation of the phosphorus requiring a longer time than that of the silicon and carbon. The excess of lime absorbs the phosphorus rapidly, the phosphorus reactions being the main source of heat after the silicon is gone. With high silicon irons it is necessary to add more lime during the "after blow" to keep the slag sufficiently basic. As with the acid process the mixer is almost indispensable for keeping the iron of uniform

composition. The iron should contain not less than two per cent. of phosphorus, and the silicon should, of course, be low.

But few basic Bessemer plants have been built in America. Most American irons are comparatively low in phosphorus, and most of the high phosphorus iron is used in the foundry. Plants have been erected at Troy, N. Y., and at Pottstown, Pa. Neither of these is now in operation.

CHAPTER XV

STEEL—THE OPEN HEARTH PROCESS

History.—The work of William Siemens in England and of E. P. Martin in France was the foundation upon which open hearth practice has been built. Siemens was the first to employ a reverberatory furnace for melting and converting steel, the high temperature necessary being easily attained after he had developed the regenerative system of firing with gas. The principal feature in his process was the oxidation of the impurities in pig iron with iron ore, while that of Martin's method was in the use of soft iron or "scrap" with the charge of pig iron, and in making the necessary additions of carbon and manganese at the end of the operation. The work of these men was contemporary, having been begun in the early sixties, and the process which they put on so successful a basis, is rightly called the Siemens-Martin process.

The rapid growth of this method of steel making is due to the fact that high grade steel can be made from all grades of iron, and that the composition of the product is easily controlled. The open hearth process is divided, according to the practice, into the Acid and the Basic processes.

ACID

All open hearth furnaces are of the Siemens type. The sectional drawings (Figs. 63 and 64) show the principal parts of an ordinary open hearth furnace. The hearth is supported on I-beams resting on girders, which in turn, are supported on the masonry below. The regenerators, shown in Fig. 63, are for heating the air and gas before they enter the combustion chamber of the furnace. They are admitted into the regenerators on one side while the products of combustion are heating those on the opposite side. The products of combustion are led first into the dust chambers, which prevent the larger portion of the dust and slag, carried over by the draft, from clogging the checker-work. The products of combustion are led from the

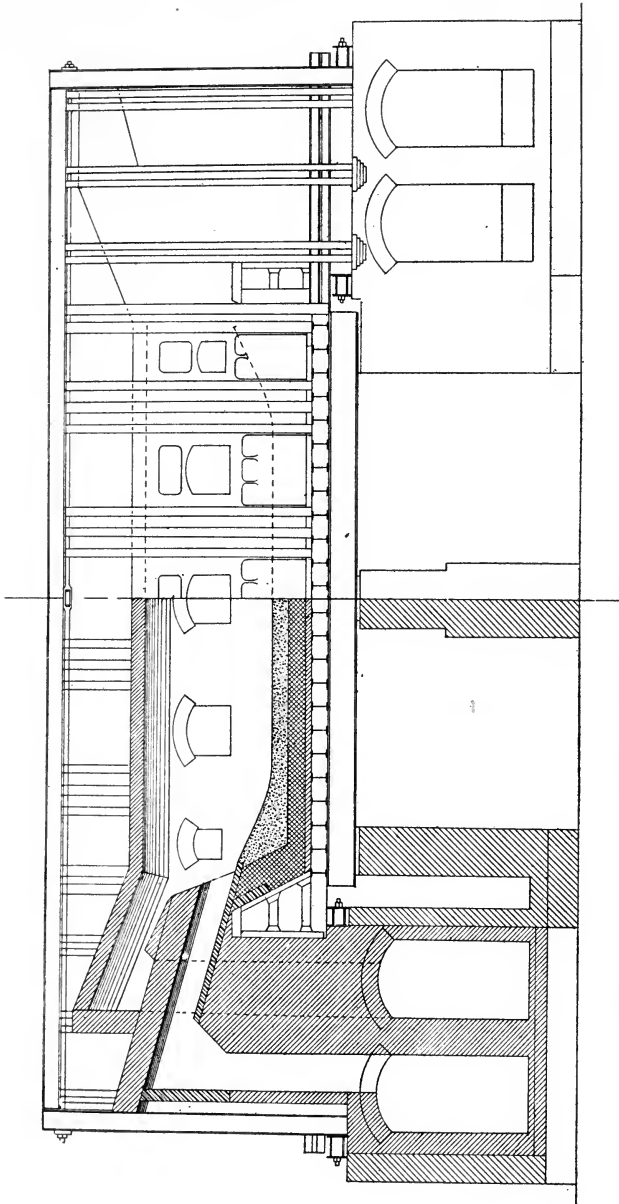

Fig. 63.—Basic Open Hearth Furnace (Bethlehem Steel Co.).

regenerators through horizontal flues to tall chimneys. The heat on the furnace hearth is intensified by the arched roof which acts as a reflector.

Open hearth furnaces are commonly built of silica brick set

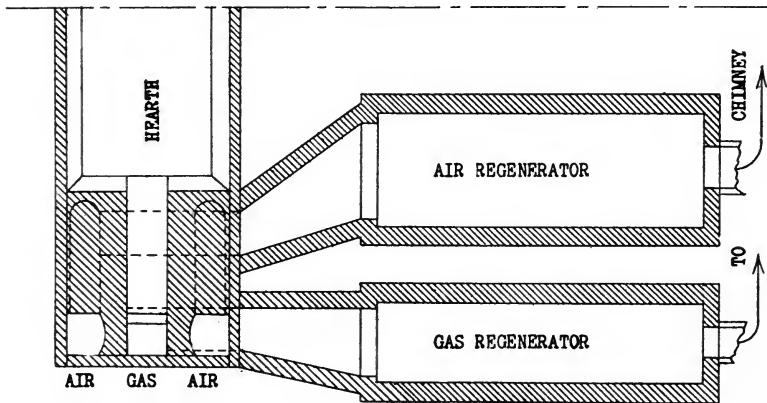
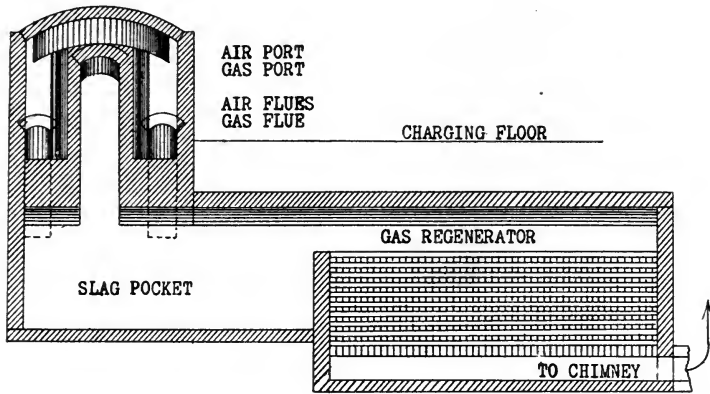

Fig. 64.

without mortar, the brick work being held together by means of T-rails, I-beams and tie-rods. Some of the older furnaces are almost entirely enclosed in plates of iron riveted together. The roof of the furnace is the weakest part, lasting on an

average for about 275 heats. The hearth of the acid furnace is thickly lined with sand.

Three doors are provided for introducing the charge. The doors are hollow, iron castings, water-cooled and lined with fire-brick. They are raised by hydraulic power. The furnaces are charged by means of electric machines, which operate on the floor in front of the furnaces. A number of furnaces are commonly built in line and worked together. The materials to be charged are loaded in iron boxes mounted on bogies. The bogies are drawn on a track in front of the furnaces so that the boxes can be handled by the charging machine. The tap-hole is at the back of the furnace. From this the steel is conveyed to the ladle in a detachable, clay-lined spout. The slag that overflows is received in the pit underneath the ladle.

The Process.—In early practice the amount of metal refined in the open hearth did not exceed 15 tons. From 30 to 60 tons and more are now treated in each operation. The charge may consist entirely of pig iron, or it may be made up largely of iron and steel "scrap."¹ The pig iron is charged either hot or cold. At some plants it is brought directly from the blast furnace. The use of the mixer is now common in open hearth practice. The advantages of the mixer have already been explained.

If the furnace is new the gas is kept on it for twenty-four hours before charging, so that the hearth and chambers will be thoroughly heated. The furnace is then given a light charge of finishing slag from a previous heat, and this is melted and swashed over the hearth, and then tapped. The grains of sand are now cemented together and a hard crust formed on the hearth which will the better withstand mechanical abrasion from the stock. The materials are loaded on the charging bogies and weighed, and charged in the following order: light scrap (tin

¹ The development of the open hearth process has furnished a ready market for the waste product of billet and finishing mills, and for old material of all kinds. There is, in fact, a steady demand for such material, and steel makers often stock quantities of scrap to draw upon in times of scarcity. A great deal of condemned steel is also worked up in the open hearth.

plate, etc.), then the heavy scrap, and lastly the pig iron. The following example may be taken to represent a charge for an acid furnace:

	Pounds
Low phosphorus pig (hot).....	31,000
Low phosphorus cast iron scrap (cold)	7,400
Steel scrap (cold)	93,900

The time required for charging with the improved machines is about 30-45 minutes. As an average, about 30 minutes are required for preparing the furnace bottom for another heat.

The time required for melting down the charge is of course considerably shortened if the pig iron is charged hot. Ordinarily about six hours would be required for the complete fusion of such a charge as the above. Until this stage is reached but little attention is needed on the part of the melter, except to reverse the gas and air valves at regular intervals. A thin slag forms at the beginning, and its volume increases rapidly during the progress of the heat. This slag consists of ferrous silicate and the silicates of any other basic oxides present. The silicon, manganese and some iron are thus transferred during the melting down stage, and the slag resulting soon forms a protecting layer which prevents further oxidation of the iron. As soon as the bath is in a liquid condition the melter throws in lumps of hematite ore to hasten the decarburization. The ore is added at intervals, between which tests are taken and their fractures examined, until the carbon is as low as desired. The bath "boils" soon after the first addition of ore on account of the quantity of carbon dioxide evolved. The frothing and swelling may cause an overflow of slag through the working doors. It is during this stage that the greatest skill is needed on the part of the melter: He should have the bath in proper condition for tapping as soon as the impurities are eliminated. By this is meant that the slag should be very liquid, so that it will separate well from the metal, and be as nearly neutral as possible at the time of tapping. The temperature should not be higher than is necessary to prevent viscosity in pouring. In case the slag has been made strongly oxidizing and the carbon has been "worked down" below the

required limit (the heat not being in condition for tapping) the carbon may be restored by adding pig iron. Tests are taken with which to ascertain the composition of the steel.

When a test is to be taken the bath is first stirred to establish uniformity. A long-handled, soft iron spoon is then thrust, first into the slag, and then into the metal. The coating of slag that chills on the spoon prevents the metal from sticking. The spoon, holding about two pounds of metal, is withdrawn quickly and the contents poured into a rectangular, cast iron mold. As soon as it is solid the test is knocked out, quenched under water and broken. From the appearance of the fracture the melters learn to estimate the carbon with remarkable accuracy when it is as low as 0.50 per cent.

When the heat is ready to tap, the ladle is placed in position to receive it, the spout being placed so as to throw the stream of metal a little to one side of the center of the ladle. This gives a whirling motion to the steel, and facilitates a thorough and uniform distribution of the substances added. The tap-hole is opened by two men working from the outside with a hand drill. A signal is given when a small stream of metal appears, and a heavy bar is thrust through from the inside of the furnace. This together with the rush of the metal so enlarges the opening that the furnace is emptied within a few minutes.

The substances to be added are thrown in with the steel as it runs into the ladle. Manganese is always added, since this element is wanted in the steel, the initial manganese having been transferred to the slag. Ferro-silicon and aluminum are also used to deoxidize and to "quiet" open hearth heats. "Wild heats," or those which are highly charged with occluded gases, occur in the open hearth as well as in the converter. They are said to have been held in the furnace too long and at too high a temperature. The milder steels are always more active while pouring. The common method of adding carbon is to throw crushed anthracite into the ladle. About 50 per cent. of the weight of coal added is lost. Some specifications call for an increase over the initial phosphorus and sulphur. The former is

added in the form of a rich iron phosphide (ferro-phosphorus), manufactured from apatite, and the latter in the form of stick sulphur or iron pyrites. All substances are added, so far as possible, before the slag comes, and they are generally in the form of small lumps. If a large quantity of manganese is to be added it is previously heated to insure complete absorption.

As soon as the furnace is empty the gas is shut off, and the hearth is prepared for the next heat. The tap-hole is closed by placing a rabble over the mouth and ramming in sand mixed with a little clay from the outside. A layer of sand is spread over the hearth and places that have been worn or fluxed out are patched with chrome ore. The further treatment of the steel is the same as that of Bessemer steel and is described in Chapter XVII.

BASIC

The acid and basic open hearth processes bear the same relation to each other as do the acid and basic Bessemer processes. The general construction of the basic furnace is identical with that of the acid, and the same materials are put into the upper walls, roof and flues. Magnesite brick are used in the hearth and lower walls, and chrome or other neutral brick are placed at the juncture between the basic brick below and the acid brick above. The hearth is thickly lined with dolomite which has been thoroughly calcined and crushed calcined magnesite is used in the same way. Referring again to Fig. 62, which represents a basic furnace, the location of the magnesite brick is shown by the areas in which the hatching is crossed, and the location of chrome brick is indicated by heavily shaded hatching.

Details.—The following represents the charge for a 50-ton furnace:

	Pounds
High phosphorus pig iron (hot).....	77,700
High phosphorus pig iron (cold).....	8,000
Heavy steel scrap (cold).....	41,900
Light steel scrap (cold).....	200
Limestone.....	9,000
Hematite.....	12,600

The limestone and ore are charged first so that the hearth will be protected from the acid slag which forms at the beginning, and so that their chemical action will begin as soon as the metal fuses and trickles down. The limestone is generally charged raw, the idea being that the carbon dioxide evolved from its decomposition assists chemical action by agitating the bath. The action of the lime is not pronounced during the first part of the melting down stage, but as the slag increases in volume and the temperature rises the lime reactions become more apparent. After the metal charge has melted the melters say that the lime "comes up," and this naturally does occur, for the limestone is the lightest substance in the furnace. There is much frothing of the bath at this stage, due to the decomposition of the stone and to the oxidation of carbon. The steel would be completely decarburized if left alone, but time is saved as in the acid process by adding lumps of ore. The tests are taken and examined as before described. If the steel is to contain more than 0.50 per cent. of carbon the Eggertz test is generally used. In some instances chemical tests are made for phosphorus and other ingredients, to determine the progress of the heat.

The fact that phosphorus as well as carbon is to be worked down generally means that the basic process requires more care and watching than the acid process. It is essential to the complete elimination of phosphorus that the slag be basic and at the same time liquid, and since a liquid slag will not stay mixed with the heavier metal, frequent stirring is required. Fluorspar is added if the slag becomes too thick from excess of lime. The melters gain some idea of the condition of the bath from the appearance of the slag. The bubbles of gas that escape during the period in which the limestone is decomposing are small and there is much frothing. Later on the bubbles become larger, and while the carbon is reacting with the ore there is likely to be violent boiling. The bath becomes tranquil at the time of tapping.

The basic heat is tapped in the same way as the acid, the taphole being made up and the hearth renewed with dolomite or magnesite.

CHEMISTRY OF THE OPEN HEARTH PROCESS

As has been said before the main difference between acid and basic processes, so far as the result is concerned, is that phosphorus is removed by the basic treatment. The reactions by which carbon, manganese and silicon are removed are alike in both processes, and are identical with those of the puddling process, except for the differences that are brought about by greater mass and higher temperature. It is to be borne in mind that a much larger quantity of metal is treated in the open hearth than in the puddling furnace, and that the temperature is so high that the metal is kept in a liquid state even after the impurities have been removed.

Silicon.—This element appears to be the most readily oxidized of all the impurities. In all refining processes it is to be observed that the silicon is first to disappear. The presence of basic ferrous oxide accounts for the removal of silicon during the beginning or melting down stage of the process. The ferrous oxide is formed in two ways—by the oxidizing flame sweeping over the exposed metal, and by the partial reduction of the ore—

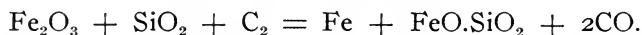
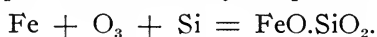

By the second reaction it is seen that so long as carbon is present there is a gain of metallic iron to the charge. Other bases such as lime and magnesia would effect the transfer of silicon to the slag, but their action is shown not to be considerable, from the fact that most of the silicon is in the slag before the lime reactions come into prominence. If the iron contains much manganese this element removes the silicon rapidly, since its oxides are strongly basic and readily formed. It is obvious that the more silicon that is present in the charge, whether combined with the metal or in the ore and flux, the greater will be the volume of slag, if a certain degree of basicity is to be attained. The percentage of silicon in the metal charge should not exceed 0.75 per cent. Of course pig iron, much richer in silicon, may be used if the heat be made up largely of steel scrap. Only very low silica ore and limestone are permissible.

Carbon.—The removal of carbon is effected chiefly by the oxides of iron. It is possible that the carbon dioxide from the limestone plays some part, that gas being reduced by carbon. The ore that is added should be in the form of large lumps, since fine stuff would float and be absorbed by the slag.

Phosphorus.—This element, like silicon, is acid forming and has strong affinity for basic oxides. These are neutralized by silica in the acid process, and therefore, phosphorus is not removed. Phosphorus is more easily reduced than silicon and it is not so readily eliminated from iron that is rich in carbon. The addition of carbonaceous material to the bath in a basic furnace will cause the reduction of phosphorus, and consequently an increase of the element in the metal. Phosphorus may be almost completely removed by using a clean, basic slag. The addition of fluor-spar serves to liquidate the slag when it becomes too stiff with the excess of lime.

Manganese.—In the acid furnace the manganese is practically eliminated, while under a basic slag a considerable portion may be retained in the iron. In the basic process the behavior of manganese appears somewhat erratic. The separation from the iron is confined, for the most part, to the melting down period. Later tests not infrequently show an increase of metallic manganese in the bath. It is probably reduced by carbon under the influence of a limy slag.

Sulphur.—This element may well be termed the greatest enemy to the steel maker. There is no reasonably cheap method by which it can be eliminated to any great extent. Manganese has been shown to be the best desulphurizer in the open hearth. High manganese irons always yield a product that is proportionately low in sulphur. It is probable that, since in an alloy of iron and manganese the sulphur combines with the latter rather than with the former, the sulphur is oxidized simultaneously with the manganese as it passes into the slag. Some of the sulphur is undoubtedly volatilized, since an analysis of the slag does not account for all that has been eliminated. A considerable amount of sulphur may be removed by continued stirring in the

basic process, but even under the conditions that seem to be most favorable the results are uncertain.

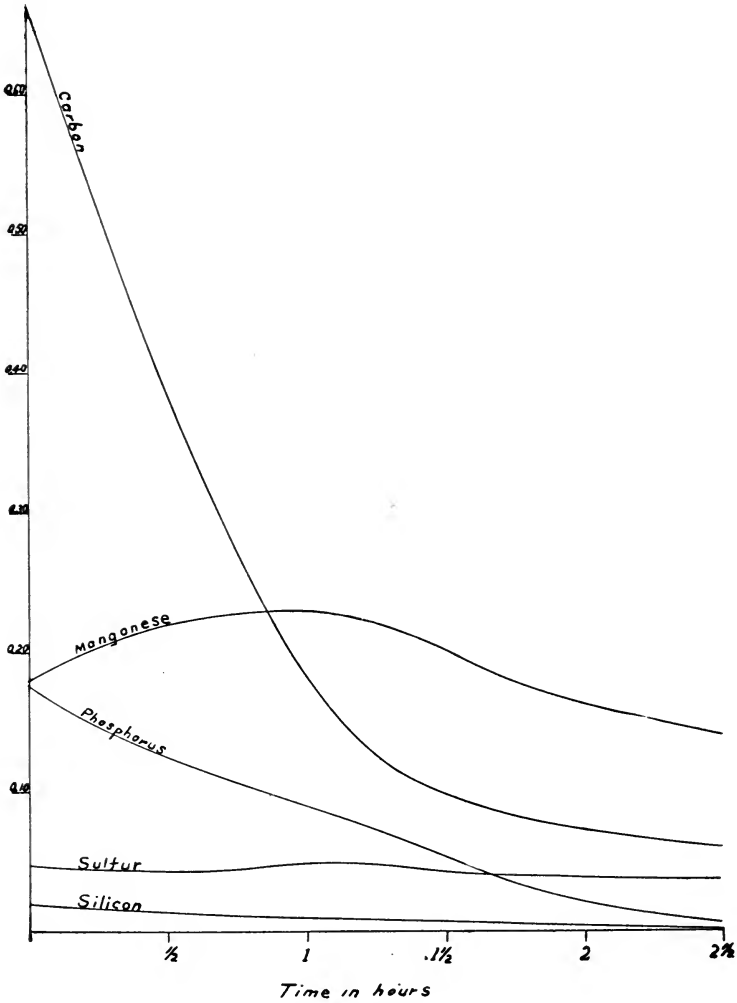

Fig. 65.

The figures below, taken from actual practice, show the history of an acid and a basic heat. The composition of the

charges before fusion is estimated, the other figures representing chemical analyses.

Metal				ACID HEAT					
C	Mn	S	P	Slag					
				SiO ₂	(FeOAl ₂ O ₃)	MnO	CaO	MgO	Time
0.80	1.00	0.030	0.065	3:35
0.75	0.003	0.026	0.064	45.11	38.98	15.15	0.60	0.10	10:30
0.76	0.003	0.023	0.074	48.25	34.70	16.41	0.48	0.09	11:00
0.59	0.003	0.033	0.068	11:15
0.58	0.003	0.027	0.070	51.20	32.64	15.65	0.41	0.09	11:30

Metal				BASIC HEAT						
C	Mn	S	P	Slag						
				SiO ₂	FeO	Al ₂ O ₃	MnO	CaO	MgO	Time
1.50	1.00	0.030	0.075	5:00
1.05	0.21	0.028	0.058	24.65	9.00	9.70	7.53	35.45	11.70	12:00
0.78	0.15	0.028	0.034	23.33	10.40	9.86	8.24	37.13	10.78	1:10
0.48	0.14	0.025	0.014	20.81	11.80	10.07	5.75	39.38	11.91	2:00
0.10	0.14	0.026	0.013	22.38	11.83	9.95	7.58	39.38	8.44	3:25

The diagram (Fig. 65) shows graphically the rate at which the impurities are eliminated in the basic process.

Open Hearth Slag is, in a large measure, discarded, though some is used in the blast furnace. It is valuable as a flux and for the iron and manganese it contains. Some basic slags, especially those that are rich in phosphorus, may be used for fertilizing purposes.

MODIFIED OPEN HEARTH PROCESSES

Tilting Furnaces.—The improvements in the open hearth process have been chiefly mechanical. The exceedingly laborious and expensive method of charging by hand has been superseded by machine charging, and the electric crane has been instituted for hoisting and moving materials about the plant. With the 75-ton ladle crane, the heat of steel is poured and removed from the shop within 15 minutes from the time of tapping. One of the most important inventions is the tilting furnace, which has paved the way to some remarkable improvements in recent practice. The Campbell furnace is mounted on rollers as shown in Fig. 66. The furnace is tilted for charging and pouring by means of a hydraulic ram. Aside from the mechanical feature

the furnace is similar in construction to the stationary hearth. The Wellman furnace is constructed and operated in somewhat the same manner as the Campbell furnace, except that it is

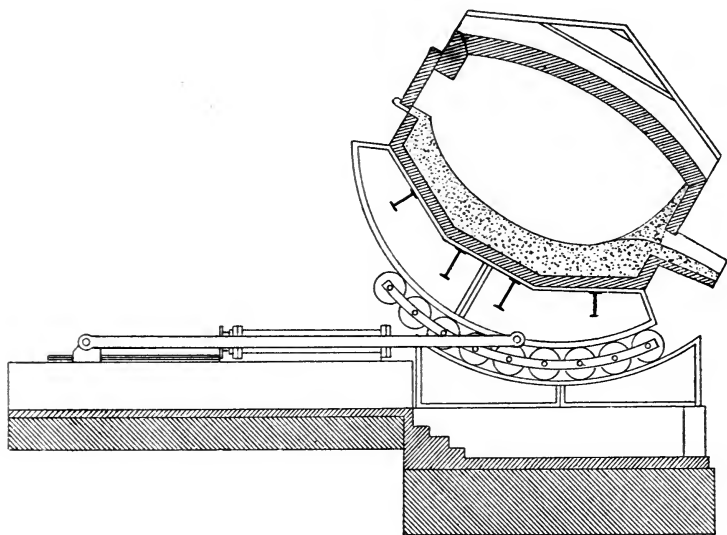

Fig. 66.

mounted on rockers instead of rollers, and when tilted the whole furnace moves forward, instead of rotating about its own axis.

The Talbot Process.—This process, the invention of Benjamin Talbot, has been in successful operation for several years. It is otherwise known as the “continuous” process. A tilting furnace of the Campbell or Wellman type is employed and the process is conducted as follows: The charge consists entirely of molten pig iron and limestone, and the heat is worked down in the usual way with the necessary additions of ore and stone. When finished the bulk of the slag is poured off and a part of the metal is taken. The larger portion of the metal is left in the furnace to which pig iron is immediately added until the weight of the metal charge is restored. A new slag is formed with the further addition of limestone and iron oxide, and the purification of the bath is continued as before. The large amount of refined iron

that is left in the furnace after each pouring takes the place of the steel scrap used in ordinary practice, while it protects the furnace hearth from the corrosive action of slags. The time required for tapping is saved, and there is a further gain of time in the charging and from the fact that no cold metal is used.

The Bertrand-Thiel Process.—This process as applied to the basic treatment employs two furnaces, the iron being charged into one furnace and transferred to the other after partial conversion. The primary furnace, or the one receiving the charge, is generally built on a higher level than the secondary furnace, so that the metal can be transferred by gravity.

The molten pig iron, limestone and ore are charged into the primary furnace, and treated in the usual way until the silicon and phosphorus are removed. The charge is then tapped into the secondary furnace, and the decarburization is finished under a new slag. The slag of the first operation is separated from the metal as far as possible before it is transferred. The decarburization is completed in a much shorter time with the foul slag thus disposed of, and further purification as regards other elements is more easily accomplished.

The Monell Process.—This is a basic process in which the iron oxide and lime are first charged into the furnace and heated to a high temperature. When the metal is charged the reactions take place more rapidly and the metal is kept in the furnace for a shorter interval of time than in the ordinary process.

The Duplex Process.—The time required for making basic open hearth steel may be shortened and the removal of phosphorus facilitated if the silicon and carbon are first removed in a separate furnace. The duplex process is a combination of the Bessemer and open hearth methods in which the iron is blown in an acid converter and finished in a basic open hearth. The silicon and carbon are not completely removed, so there is but little opportunity for oxidation of the metal; moreover, the harmful effect of blowing is offset in the open hearth. The duplex process is in operation at Ensley, Ala., and at Bethlehem, Pa.

CHAPTER XVI

STEEL—ELECTRIC PROCESSES

The most remarkable developments in steel manufacture in recent years have been in the successful working out of electric furnace methods of refining. The success of these is due to high efficiency in transforming electric energy into heat energy, to cheapening of current production, largely through the exploitation of water power, and to the superior quality of the product.

Both the arc and the induction principle are used in the construction of electric steel furnaces. The Stassano, Heroult and Girod furnaces are representatives of the arc class, and the Kjellin, Röchling-Rodenhouser and Frick furnaces are of the induction class.

The Stassano furnace is interesting as being the first electric furnace in which steel was made on the industrial scale. Its distinctive features are the closed chamber, in which a neutral atmosphere is maintained; the arrangement of the electrodes, of which there are commonly three, projecting almost horizontally into the furnace to form an arc between their terminals near the surface of the bath, and in some instances, the furnace is suspended in such a manner as to permit of its being revolved or gyrated to stir the bath. Stassano furnaces are in operation at Turin, Italy.

The Heroult furnace, aside from its electrical features, is constructed on the plan of the tilting open hearth. The section, B, of Fig. 67 shows the principle upon which it is constructed. The furnace is of the arc type, being provided with two or more (commonly three) vertical electrodes which form an arc circuit with the bath. The electrodes are of carbon, square in cross-section, and are suspended by an arrangement of clamps, chains and pulleys, being adjusted in small furnaces by hand and in large ones by motors acting automatically when the bath has been smoothed by fusion. The current enters the bath through one or a set of electrodes and passes out through the remaining one or ones. Either direct or alternating current may be used. The

heat is derived mainly from the areas over which the arcs are struck, but it is rapidly disseminated by conduction and radiation.

The **Girod** furnace resembles the Heroult structurally, but is of simpler design, and differs from it in the manner in which the current is applied. The smallest furnaces have one electrode through which the current enters, and the larger ones have two

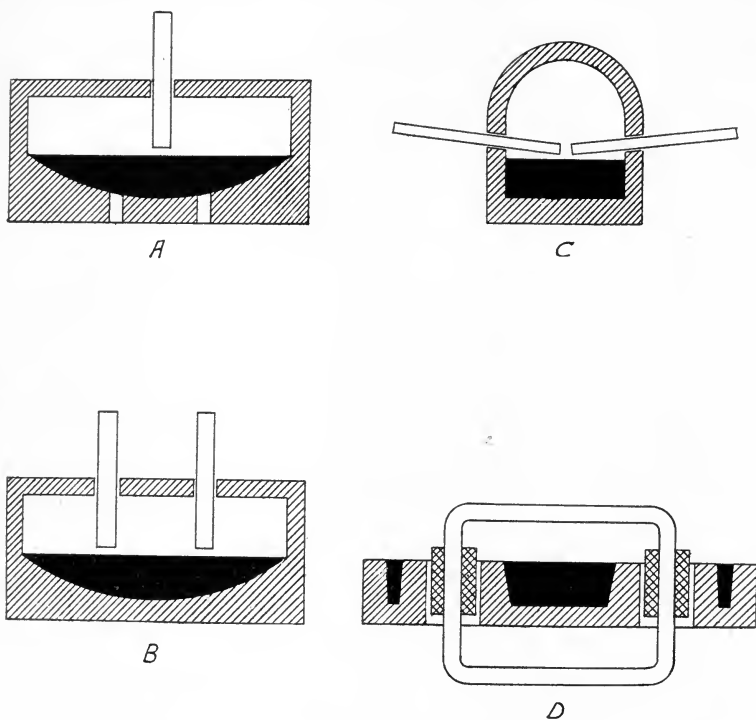

Fig. 67.

or more which are electrically parallel. The electrodes are suspended through the roof of the furnace in such positions as will give the most even distribution of heat. The current, after forming arcs above the surface, passes through the charge and out of the furnace through metal conductors. These pierce the hearth, making contact with the charge.

The **Kjellin** furnace was the first of the induction type to become commercialized. Its principal use has been in the production of tool steel. In principle this furnace is similar to the next one, which is in more general use.

The **Röchling-Rodenhouser** and **Frick** furnaces belong to the same class, the latter being a modification of the former. The construction of the single phase Röchling-Rodenhouser furnace is represented by section, D, Fig. 67. It involves the principle of a transformer in converting a high tension current into a dense current of low tension. In this type of furnace two coils of wire are wound around an iron core, and are surrounded by portions of the steel bath. The bath is represented by the black areas in the sketch. A plan section through the bath would take somewhat the shape of the figure 8. A high tension current in the coils sets up a high magnetic field in the core and a low voltage but high amperage current is induced in the bath. It is seen that the main part of the bath is between the coils, and that narrow loops surround the coils. It is the resistance offered by the loops of metal to the powerful current that causes the heat. In operating the furnace a small amount of metal is left after each heat to give a closed circuit around the coils. The refining is carried on in the main body of the bath between the poles.

Refining in the Electric Furnace.—Electric furnace processes, with a few exceptions, employ the same chemical principles as those of the older refining methods. Generally speaking, they most nearly simulate the open hearth process, the most important points of difference being the comparatively neutral atmosphere and the localized high temperature of the electric furnace. These two features make it practicable to deoxidize and desulphurize the steel more completely than is done in the open hearth. Oxides of iron, chromium, nickel, tungsten and other metals are reducible in the electric furnace by the addition of carbon, it being possible to practically eliminate ferrous oxide from the slag in this way. The slag thus cleansed is almost pure lime and silicate of lime, and is known as "white slag."

One peculiarity of this slag is that it quickly crumbles to powder while cooling. Acetylene gas is generated when it is put into water, showing the presence of calcium carbide.

The following history of a heat in the Heroult furnace may be taken as typical of electric furnace practice. Supposing the process to be basic and the metal to be charged cold, the charge is made up of steel scrap and pig iron, lime and iron ore. Soon after the current is turned on those pieces of metal which form the arcs with the electrodes begin to melt and run down, closing the spaces between the pieces below. As they settle down and the arc areas enlarge, little pools of molten metal form under the electrodes. These widen rapidly, and the melting is facilitated by attendants who push the cold pieces toward the electrodes. Further additions of iron oxide and lime are made as required. The first part of the heat may be termed the oxidizing period in which the carbon, silicon and phosphorus are, for the most part, removed as in the open hearth. The furnace is then tilted to pour off most of the foul slag. A clean slag is then made by adding lime, silica being supplied from the bath, or if need be, sand is added. Neutral flux also is added when it is necessary to thin the slag. It is under the influence of the intense heat and the basic slag that the sulphur is removed. Before tapping the slag is deoxidized with carbon and the metal with silicon, titanium or other material. Manganese and any other metal to be alloyed with the steel is added and the steel is poured immediately.

Relative Merits of Different Steel-Making Processes.—The fundamental consideration in the adoption of any process is an economic one. Different methods in steel manufacture differ in operating costs, but variations in the cost of raw materials and in the price which the products command serve to equalize the profits. The cheapest of all processes for making steel is the Bessemer, but the increased demand for better steel has stimulated the growth of the open hearth process, and the need for still better steel has kept alive the crucible process and brought into existence the electric processes.

As regards acid and basic methods, it costs more to convert steel in the basic furnace. The acid process can be more easily controlled, and there is more certainty as to the composition of the steel. The acid furnaces would undoubtedly predominate if the larger part of the iron supply was low in phosphorus. But such is not the condition in the United States. Most of the low phosphorus iron is treated in Bessemer converters, and the supply of Bessemer ores is rapidly being exhausted, unless new important discoveries are to be made. High phosphorus iron is cheaper and more abundant, and there is an ever increasing supply of scrap which is unsuitable for the acid treatment. Thus the higher cost of the basic process is offset. As to the quality of the steel, it may be said that while the stock is superior to begin with and the product more even in the acid process, just as good, and even better steel may be made by the basic process. The danger of overheating while the heat is prolonged for the removal of phosphorus may be guarded against by proper management. The basic furnaces now greatly outnumber the acid.

The future of the electric furnace in the iron and steel industries is highly problematical. Whether the electric refining process will become an entirely independent one or a finishing operation in a combination process will be determined by the quality of the product and, inevitably, by the cost of operation. The present demand for a better quality of steel for rails and the great importance of this commodity has led to the combination of the Bessemer and electric processes. Another combination is a gas and electric furnace, in which the attempt is made to cheapen the production without altering the quality of electric steel. Lastly, there is the possibility that the electric furnace may be used in making refined iron direct from the ore.

CHAPTER XVII

FURTHER TREATMENT OF IRON AND STEEL

The mechanical and heat treatment of steel are the subjects dealt with in this chapter. In this connection special reference is made to Bessemer and open hearth steel, since these represent so large a proportion of the total steel produced. The history of the steel is given, as it passes through the several mills which prepare it for the market.

Casting the Ingots.—Fig. 68 represents a steel-pouring ladle with a part of the wall cut away to show the interior. The

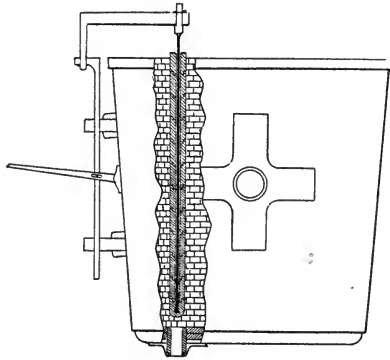

Fig. 68.

ladle is built of heavy, steel plates, riveted together, and lined with two courses of fire-brick. It is supported on trunnions projected from the sides slightly above the center of gravity. The hole through which the steel is poured is situated in the bottom and near the side. The flow of steel is controlled by means of a stopper which is carried on a sliding device attached to the outer wall of the ladle. The stopper is raised and lowered by aid of a hand lever. The rod which is suspended inside the ladle to carry the stopper is protected from the molten steel by a fire-clay sleeve which is made in sections. The sections fit one into the other, and the joints are sealed with clay.

The quality of steel depends very largely upon the conditions under which it is cast. The so-called "wild heats" are those which have been held in the furnace too long and poured at too high a temperature. A large quantity of gas is absorbed by the overheated steel, causing the motion in the ladle and molds, and resulting in red-shortness, blow-holes and general unsoundness. Very pure steel is specially liable to injury under such conditions. These defects may be largely diminished by pouring at the lowest temperature possible, and allowing the metal to run in a very small stream. It is not practicable, however, to resort to such measures with the quantities of steel to be handled from converters and open hearth furnaces, and special methods for treating ingot metal have been resorted to. The use of manganese, silicon and other deoxidizers has already been mentioned. Blow-holes and red-shortness may be almost completely eliminated by adding one of these substances while the steel is being poured.

The diagram (Fig: 69) represents an ingot that has been split lengthwise, showing the effect of cooling upon different portions. Since piping is due to contraction, and the ingot cools from the outside, piping will occur about the middle. The portion, A, is particularly subject to this defect, because settling takes place here as a result of the liquid metal below being drawn toward the surrounding, solid mass. Blow-holes are most abundant in the annular portion, B, which is thickened above where solidification proceeds more slowly and where the gases rise until entrapped. That part of the ingot which is last to solidify concentrates those constituents which become less soluble as the steel cools. Such constituents will be found in greater quantities in portion, C. The phenomenon here involved is known as segregation, liquation or selective freezing. The conical portion, D, is the soundest part of the ingot.

The closing of cavities in steel ingots by compression has been practiced for some time, though the cost of installing and operating compression machinery precludes its general use. In 1865 Whitworth subjected fluid ingots to a downward pressure of about six tons per square inch. The pressure is applied while

the ingot is cooling from the liquid state, and is exerted upon the ends or the sides. Lateral pressure would appear to be preferable for closing pipes and preserving the internal structure of ingots. The value of liquid compression has not been fully

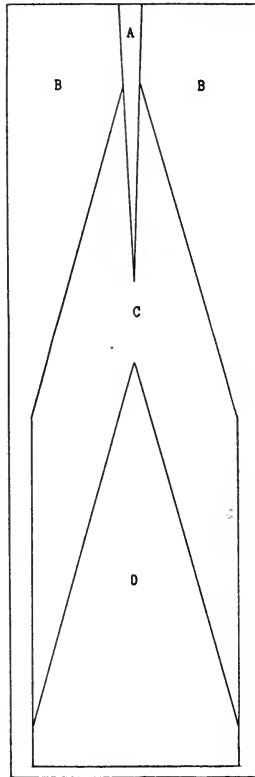

Fig. 69.

demonstrated. Cavities are closed and gases are expelled and the steel is made more compact, but weakness may remain from failure of the cavity walls to unite, as for example, if the surfaces are coated with oxide. M. Harmet, of France, has designed a fluid compression process which he calls "wire-drawing" compression, inasmuch as the ingot is squeezed into a tapered mold.

The ingot is pressed by hydraulic rams on both the top and the bottom, though the upper ram acts simply as a buffer to the lower one, and is slightly withdrawn from time to time as the ingot is pressed further into the mold. The pressure may be regulated to suit ingots of different sizes, forms and compositions. To aid the operator in determining the effect upon the ingot autographic apparatus is provided to register by a time-displacement curve the contraction due to longitudinal shrinkage. It is claimed that compression by this process expels more of the gas and goes further toward correcting the evils due to segregation than downward pressure methods do.

Instead of casting from the top, as is usually done, sounder ingots may be made by casting from the bottom, the tops of the molds being closed. This method of casting has only been used for small ingots, except in rare instances. Mention is also made of the method of preventing piping by keeping the upper part of the ingot hot during the cooling of the main portion, so that the pipe will be filled with molten metal.

Stripping the Ingots.—The train of bogies, each bearing two

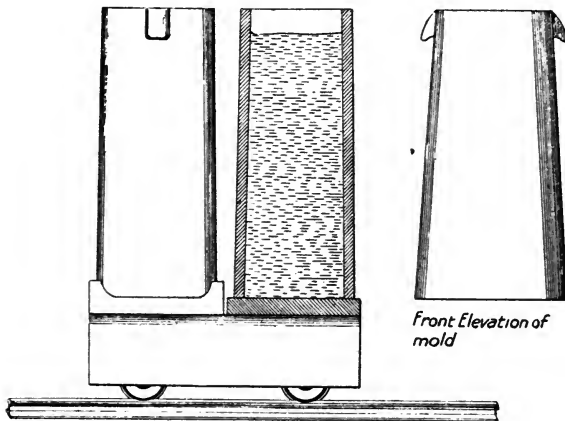

Fig. 70.

ingots in their molds, is brought from the Bessemer or open hearth shop directly to the stripper. Fig. 70 represents a bogie

with the ingots in position as they were cast. The bogie has a flat top and upon this rests the stool, or receptacle for the mold. One of the molds with the stool and ingot is shown in section. The stools are heavy slabs of cast iron with guards at the corners to hold the molds in position. The molds are also of cast iron, and are made in different sizes to hold from 2 to 4 tons and more of steel. They are tapered slightly toward the top and open at both ends, the bottom being closed when the mold is placed upright on the stool. Lugs are cast at the top of the mold for use in lifting it.

The usual style of stripper is an overhead crane, spanning two tracks, and provided with a traveling hoist. From the hoist are suspended two pairs of loops properly spaced for engaging the lugs of both molds as they stand on the bogie. The hoist is also provided with two rams, operated by water, and capable of striking heavy blows upon the heads of the ingots while they are suspended a short distance above the bogie. The crane and hoist are propelled by means of motors so that the stripping can be carried on with great rapidity. The loaded bogies are brought in on the one track, and the molds are lifted until they are clear of the tops of the ingots, and then placed on empty bogies on the other track. Any ingots that stick may be knocked out by means of the rams.

The Soaking Pits.—If the ingots were allowed to stand in the air they would at no time during the cooling be in the proper condition for forging. When the interior has become solid the outer portion will have become too cold. If the initial heat were evenly distributed the ingot could be forged without applying any external heat. It was in recognition of this fact that the first "soaking pits" were designed. They were simply brick-lined cells, built underground and adjacent, each cell or pit being large enough to hold one ingot. The cover for the pits, also lined with fire-brick, was mounted on wheels to facilitate opening and closing. On being placed in the pits, immediately after stripping, the rapid cooling of the ingot was arrested, heat being reflected upon its surface from the walls of the pit, and the heat

from the interior was given time to *soak* out. This kind of pit has gone out of general use, since it was found difficult to have the ingots in the proper condition at the time they were needed in the mill, and of course it was impossible to heat cold ingots to the rolling temperature.

The soaking pits as now used are arranged to be heated independently with coal or gas. Cold ingots may therefore be charged and brought to the rolling temperature and those directly from the stripper are quickly tempered. The pits are usually large enough to hold four ingots. The train of ingots is brought in from the stripper, and the ingots are placed in the pits by means of an overhead traveling crane. The ingot is seized near the top by tongs which are suspended from the hoist. The same crane is used for drawing the ingots from the pits when they are to be rolled.

Forging.—Steel is forged by rolling, hammering and pressing. The rolling process is the most used, being most economical and rapid. The other processes serve special purposes and will be described later. The ingot is rolled down to different sizes and shapes, depending upon the requirements of the finishing mills. If it is reduced to sizes less than six inches square and sheared, the pieces are called *billets*; if larger than that the pieces are *blooms*, and if rolled flat they are *slabs*. There are a number of types of rolling mills, each type being designed for special work. Mills take their names from their general construction, maximum size of the piece they will roll, manner of working and nature of the product. Brief descriptions of a few important types of mills are given below.

The Blooming or Slabbing Mill.—This mill is designed for reducing ingots to blooms or slabs. It may also be run as a billet mill. It commonly consists of two large rolls, driven by a reversing engine, and a series of “live rollers” for moving the steel. The succession of roller extends from both sides of the mill rolls in a horizontal plane. The rollers are revolved collectively, to move the steel in either direction, by means of a small, reversing engine. The mill rolls are of cast steel, which

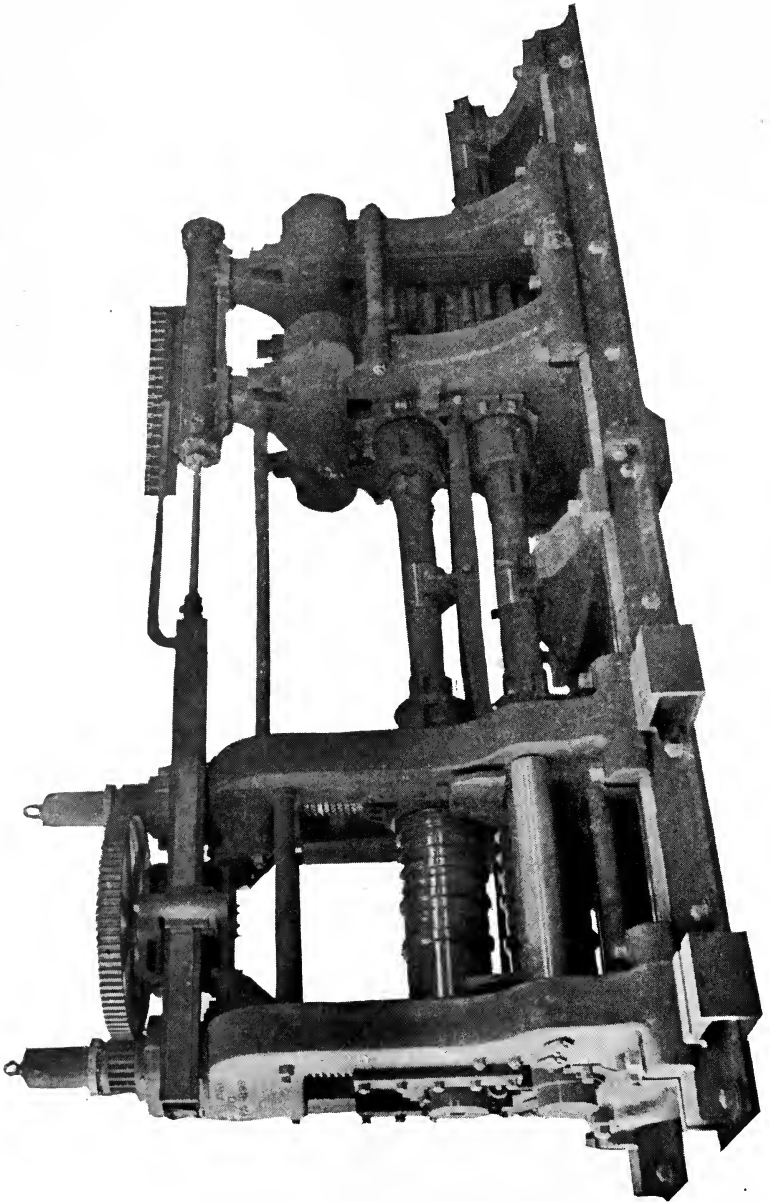

Fig. 71.—36-Inch Blooming Mill. (United Engineering and Foundry Co.)

is superior in strength to chilled, cast iron, of which most rolls are made. The bearings or chocks for the rolls are supported in heavy, cast iron housings. The upper roll, with its chocks, is adjustable to the thickness of the piece of steel.

A large blooming mill is shown in Fig. 71. The roll housings are at the right and the pinion housings at the left in the figure. The lower of the two pinions is geared to the shaft of the engine or motor which drives the mill. The pinions are split, and the two parts set so that the teeth are staggered. This gives steadier motion to the gearing and diminishes shock to the teeth.

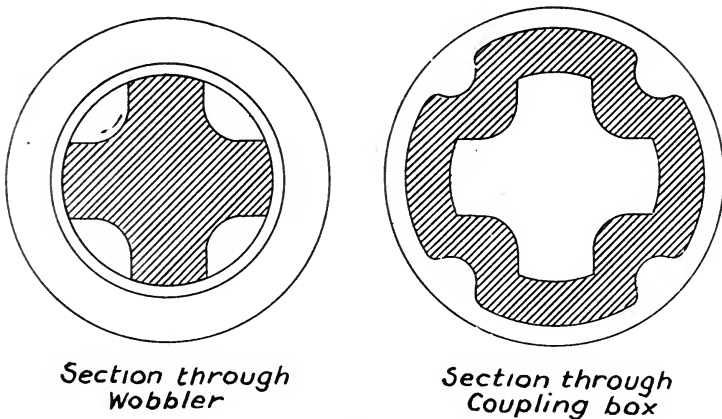

Fig. 72.

The pinions are coupled with the rolls by spindles with wobblers at both ends. The mechanism of these couplings will be understood from the cross-sections shown in Fig. 72. The ends of the spindles and of the roll necks are cast in the form shown in the section to the left. Three-lobed wobblers are also in use, but this is the most common form. The coupling box, shown also in cross-section, is a heavy, steel casting which fits loosely over the wobblers of the two members in line. In the union thus made there is considerable play when the mill is reversed. The ends of the spindle which drives the upper roll are tapered so that they can work freely in the coupling boxes when the roll is raised or lowered. The bearing for this spindle is sup-

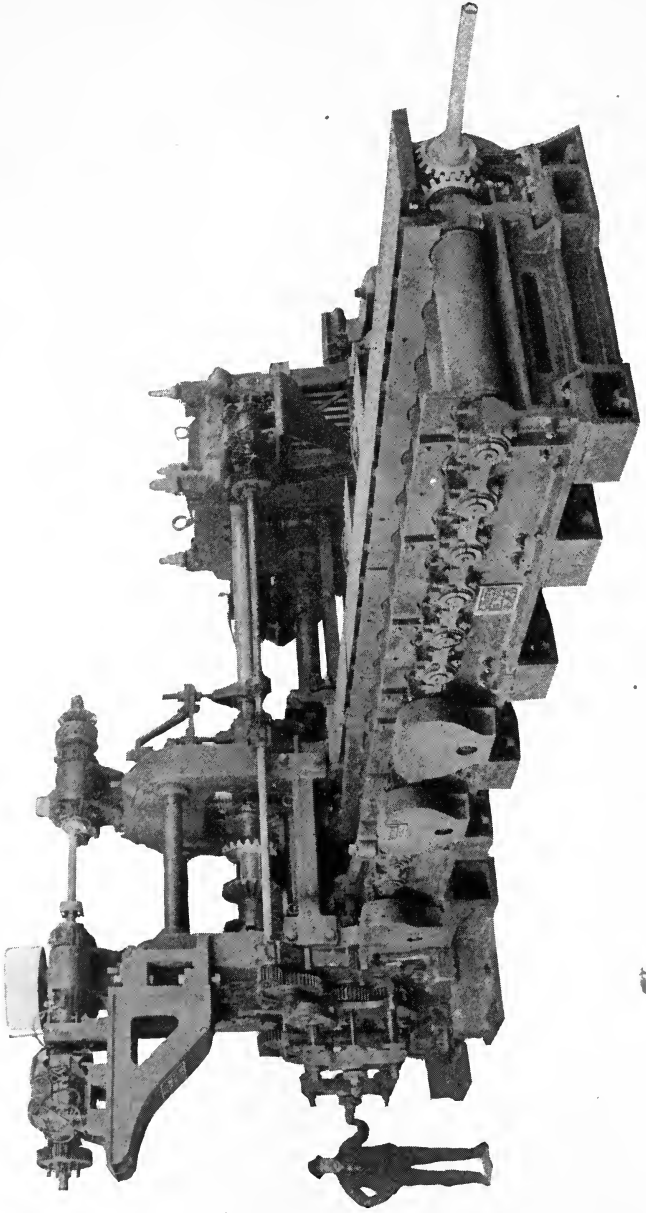

Fig. 73—30-Inch Universal Plate Mill. (United Engineering and Foundry Co.)

ported on beams which are hung from the pinion housing and the chock of the upper roll, so that it follows the spindle to any angle.

The upper roll of the mill is adjusted by means of a hydraulic rack and pinion device geared to the large screws which support the roll chocks. The scale and pointer for indicating the position of the roll are shown above the hydraulic cylinder. Rolls are also commonly set by motor-driven gear, as shown in the mill below (Fig. 73).

In reducing the size of the piece the pressure must be applied in two directions, so that the thickness both ways will be as desired, and the sides true. This is accomplished by turning the piece over between passes, or by employing, in addition to the usual, horizontal rolls, a pair of vertical rolls to act upon the piece at the same time. In the former type of mill, mechanically operated tilters are employed for turning the work over. The latter type, employing two sets of rolls, is known as the *universal mill*.

Fig. 73 illustrates a large, universal plate mill and a portion of the train of live rollers. In this mill both the vertical and the horizontal rolls are adjusted by motor driven gear, parts of which are seen in the cut, but the rolls are not visible.

The Three-High Mill.—This mill employs three horizontal rolls

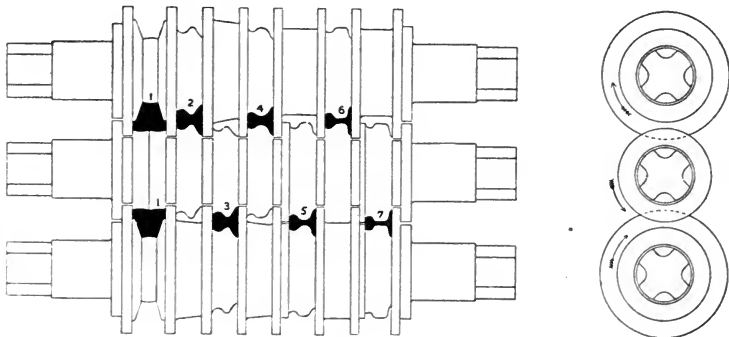

Fig. 74.

in vertical line as shown in Fig. 74, which represents the ar-

rangement of rolls in a rail mill. The end elevation to the right shows the directions in which the rolls turn. The mill is not reversed, but the piece, after passing between the middle and bottom rolls, is passed in the opposite direction between the middle and top rolls. The rolls are so cut as to give the proper openings for diminishing the cross-section and imparting the proper shape to the piece. This obviates the necessity of adjusting the rolls after each pass. Different sets of rolls are substituted for shapes that can not be rolled by the set in the stand.

The three-high mill was invented by John Fritz, and first operated in 1857, at the Cambria Steel Works, Johnstown. It was offered as an improvement over the old-fashioned "pull-over" mill, which had two rolls, and not being reversible, necessitated the return of the metal idle after each pass.

The Continuous Mill.—A very large percentage of the costs to manufacturers arises from the handling of material. The numerous shapes now in demand require as many different kinds of rolls, and in most instances the metal must be carried from the blooming or billet mill to the finishing mills. Here the piece must be reheated to the rolling temperature, adding another serious expense. The ideal in rolling mill practice is continuous rolling under the initial heat, not allowing the metal to stop in its course until finished. Continuous mills are now in use for manufacturing billets, rods, rails, angle-bars and other standard shapes. They consist of a series of rolls, working in pairs, and all driven by a single engine. Since the metal must travel faster in front of each pair of rolls, on account of the reduction in size, each pair of rolls must turn faster than the preceding pair to prevent the piece from buckling. "Flying shears," an ingenious device for cutting the metal while in motion, in pieces of any length, may be used if sawing can be dispensed with. Aside from the savings above noted, and a saving in labor, the "crop ends" are less when continuous rolling is practiced. The continuous mill can be made to pay only when there is a steady demand for the shapes which it is possible for it to make. The

cost of installation is high, though the output is correspondingly high.

Hammer Forging.—The steam hammer has supplanted the

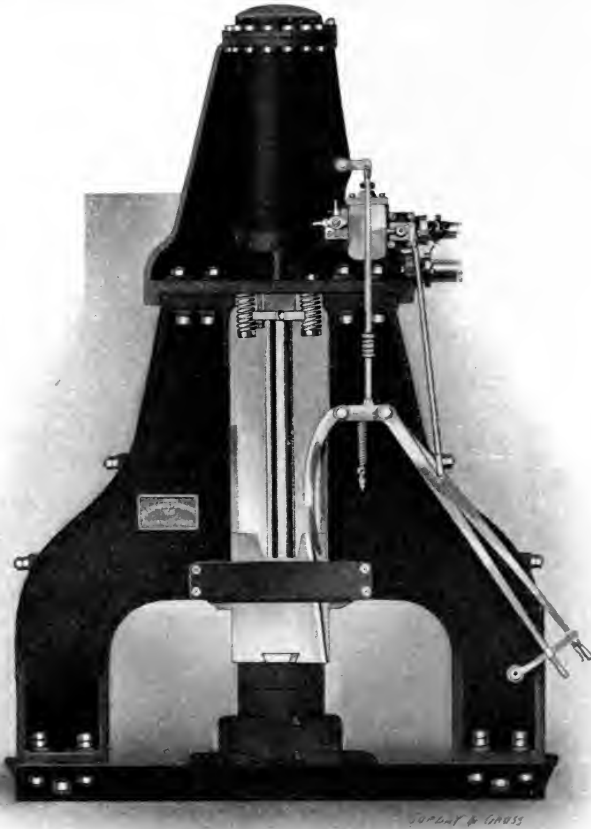

Fig. 75.—Double-Stand, Steam Hammer. (Alliance Machine Co.)

older forms. As seen from the illustration, Fig. 75, it consists of a steam cylinder mounted upon massive columns, the piston rod carrying the hammer, and the anvil in position to receive the impact. The structure is seated upon a rubble and concrete

foundation. The hammerman, in operating the steam valve, has such complete control of the machine that he can cause the hammer to exert a pressure of a few pounds upon the work or to strike a blow of many tons. The rapidity of the blows can also be regulated as desired.

Press Forging.—The forging of metal by continuous pressure differs from rolling in that the pressure is exerted over a larger area. It differs from hammering in the same respect and in that there is no sudden impact. The press is now used for heavy forging, especially in the manufacture of armor plates. Hydraulic presses are the most satisfactory, the pressure cylinders being made from solid steel castings. A pressure of several tons per square inch is exerted.

Of the three methods of forging iron and steel, rolling is by far the cheapest and most rapid. Hammered forgings are superior to rolled, being more compact and less liable to crystalline structure. There are many shapes which can not be formed between rolls, and for forgings of irregular shapes the hammer is indispensable. Still more compactness and uniformity of structure is gained in press forging, since the pressure is exerted more slowly and upon a larger bulk of metal.

In all forging operations the force of the pressure or impact should be sufficient to take effect with the particles of the interior of the piece as well as those of the exterior. If insufficient force is used, as by employing too light a hammer, the effect will be shown at the edge of the piece. This will appear concave, indicating that the interior of the piece has not been extended as much as the exterior. The failure of forgings has often been ascribed to this unequal working of the metal.

Reheating.—When a piece of steel is heated it begins to redden at about 400° C. As the temperature is raised bright redness develops, a further rise giving orange and yellow, and toward the point of fusion the color changes to almost whiteness. The temperature of the steel in the heating furnace is commonly estimated by the color as seen with the naked eye, but in careful work a pyrometer is employed. If the steel is heated at a con-

stant rate its rise in temperature will be practically uniform except at three points, which may be determined by aid of a pyrometer, where the rise is momentarily arrested. As indicated by a temperature recorder there are three lags in the curve. These occur respectively at near 700° , 760° and 840° C., varying somewhat with different kinds of steel. This phenomena is due to changes which the combined carbon and iron undergo and is known as *recalescence*. The recalescent points are otherwise known as critical temperatures. The changes are reversed when steel is cooled under uniform conditions through the critical range, and since the transformations are in this instance exothermic, they are indicated by jogs in the curve. This phenomena of cooling is known as *decalescence*. The decalescent points are slightly lower than the corresponding recalescent points. Steel is most plastic when heated to the temperature of recalescence, and therefore, in the best condition for forging. At a higher temperature, approaching the melting point, the steel passes into the granular or brittle state. This explains why ingots or any pieces to be forged should be thoroughly soaked in the heating furnace. The heaviest work should be done upon the metal while it is near the upper limit of the critical range, the light, finishing work being done while it is cooling below the lowest transformation temperature.

While reheating iron or steel for forging it should be shielded from the air. If exposed to oxidation red-shortness may result in addition to the injury of actual burning. These evils are avoided by maintaining a neutral or reducing atmosphere in the furnace. An excessive amount of fuel is used, which gives a smoky flame in the heating chamber.

The modern reheating furnace is fired with gas, and is of the reverberatory type. Billets are heated in a long, narrow chamber through which the flame passes. They are introduced at the flue end and advanced in succession toward the fire end from which they are discharged, the operation being continuous. By this method of heating the billets are raised gradually to the forging temperature, and all are exposed to the same conditions.

Annealing and Tempering.—The word temper, as applied to steel, denotes degree of hardness. It is unfortunately used in two senses. With the steel maker it often refers to different steels containing varying amounts of carbon, the hardening element, while the steel worker uses the same term in referring to the hardness of the same steel under different treatment, affecting the hardness. Carbon has the property, more than any other element, of imparting different degrees of hardness, tenacity, etc., under different conditions of heat treatment. Tempering, as here discussed, refers especially to the heat treatment of iron containing carbon. It is a subject that has directed attention from very remote times, and it is still an important one for experiment and research.

The hardness of steel containing less than 0.25 per cent. of carbon is not greatly altered under different conditions of cooling. The effect of heat treatment is most marked in steels containing from 0.80 to 1.25 per cent. of carbon. Such steels, though relatively very hard, still retain some toughness and malleability when slowly cooled from the critical temperature. If cooled suddenly they become exceedingly hard and brittle, the hardest steels often cracking from internal stresses. The properties of steel are, therefore, affected by the rate of cooling and the duration of the heating. A prolonged heating or toughening process is known as *annealing*, and a rapid cooling or hardening process is *quenching*. Steel to be annealed may be kept in the furnace in which it was heated, the temperature being slowly diminished, cooled in the air, or surrounded and cooled in lime, charcoal or other material of low heat conductivity. In quenching the heated steel is commonly plunged under water or oil.

One other point is to be considered in adjusting the temper of steel. Due regard has not only to be paid to the amount of carbon in the steel and to the rate of cooling, but also to the temperature from which the piece is cooled. The range of temperatures from which steel is quenched for the temper desired is between 220° and 350° C., the lowest temperature yielding the hardest steel. The common practice is to heat the hardened steel somewhat above the maximum temperature and to quench

at the proper stage of cooling. If the surface of the piece be brightened the changes of temperature will be indicated by the changes of color due to films of oxide. Though not always so convenient, better results may be obtained by raising the steel to the proper temperature, instead of to a higher temperature and cooling down. In careful work the pieces to be tempered are heated in a bath of oil or lead, the temperature of which is regulated by aid of a thermometer. In the table below are given the approximate temperatures and their characteristic colors above mentioned.

Deg. C.	Color
200	Yellow (hardest temper)
250	Brown
300	Light blue
350	Dark blue (softest temper)

The Development of Surface Hardness—Case Hardening.—By the process known as case hardening the surface only of a piece of iron is hardened with carbon, while the interior is soft and tough. The piece is finished in soft steel, which is then packed with nitrogenous, organic material in an iron box and heated for some time at redness. The materials commonly used are clippings of hoof, leather, and bone and cyanide of potassium. On heating, a destructive distillation takes place, and the carbon enters the iron by cementation. As the workman removes the piece from the box he drops it immediately into a quenching liquid, being careful to shield it from the air to prevent oxidation. By skilful manipulation, however, a beautiful mottled appearance may be secured from short, unequal exposure. Some parts of light machinery, and of firearms, which should be tough, and at the same time hard on the surface, are case hardened.

A process, similar to case hardening in principle, is in use on the large scale for improving armor plates. In this country it is known from the name of its inventor as the Harvey process, or as "Harveyizing." Two plates are placed one upon the other in a reheating furnace, a layer of charcoal being packed between so that it comes in contact with the surfaces to be

hardened. These surfaces are quenched with water after the plates have been taken from the furnace. Krupp's method is similar to this, except that hydrocarbon gases are led between the plates, the gases depositing carbon at the temperature required for cementation.

TESTING STEEL

In no branch of metallurgy are science and industry more closely linked than in the examination into and development of the properties of steel. More than half a century of exhaustive research, in which many of the world's foremost scientists have been engaged, has not only brought out the facts about the properties of steel and how they are affected, but it has also furnished or perfected the means of measuring or testing these properties. Recognizing the importance of scientific tests, progressive manufacturers have added well appointed testing departments to their steel plants, and instead of the conventional chemical laboratory are now to be found institutions equipped with apparatus for the complete investigation into the properties of steel and steel works materials. The testing of steel serves a twofold purpose. It enables the producer to control the process by which the steel is made and treated, and to the consumer it gives directly, and in many cases quantitatively, the properties or specific data concerning the properties of the steel.

The steel tests of greatest commercial importance are those which determine its tensile strength, elastic limit and toughness. Tests are frequently made for hardness, malleability, crushing strength and endurance, and besides, many tests for special purposes.

Specifications.—The International Association for Testing Materials has for its aim the perfection of methods for testing steel and the determination of the requirements that should be made of the different grades of steel for all important work. The American and foreign specifications differ somewhat, though the effort is being made to have standards adopted which will be accepted in all countries. Specifications are intended to cover the modes of manufacture, physical properties, composition, fin-

ishing, testing, branding and inspecting the steel. The requirements of course differ with steel intended for different purposes.

The following specifications for open hearth steel rails have been adopted by the American Society For Testing Materials:

COMPOSITION.

Pounds per yard	Carbon	Phosphorus	Silicon	Manganese
50 to 60	0.46-0.59	0.04 or less	0.20 or less	0.60-0.90
61 to 70	0.46-0.59	0.04 or less	0.20 or less	0.60-0.90
71 to 80	0.52-0.65	0.04 or less	0.20 or less	0.60-0.90
81 to 90	0.55-0.72	0.04 or less	0.20 or less	0.60-0.90
91 to 100	0.62-0.75	0.04 or less	0.20 or less	0.60-0.90

For each decrease of 0.003 per cent. in phosphorus down to 0.03 per cent. phosphorus, an increase of 0.01 carbon will be accepted.

Drop Test.—"One drop test may be made on a piece of rail not less than 4 ft. and not more than 6 ft. long, selected from each heat of steel.

The rails shall be placed head upwards on the supports, and the various sections shall be subjected to the following impact tests under a free falling weight:

Weight of rail per yard, lbs.	Height of drop in feet
50 to 60.....	15
61 to 70.....	16
71 to 80.....	16
81 to 90.....	17
91 to 100.....	18

If any rail breaks when subjected to the drop test, two additional tests will be made from the same heat of steel, and if either of these latter tests fails, all the rails of the heat which they represent will be rejected; but if both of these additional test pieces meet with the requirements all the rails of the heat which they represent will be accepted.

The drop-testing machine shall have a tup of 2,000 lbs. weight, the striking face of which shall have a radius of not more than 5 ins., and the test rail shall be placed head upwards on solid

supports 3 ft. apart. The anvil block shall weigh at least 20,000 lbs., and the supports shall be part of, or firmly secured to, the anvil. The report of the drop test shall state the atmospheric temperature at the time the test was made. The temperature of the test pieces shall be not less than 60° F. or greater than 120°."

CHAPTER XVIII

COPPER—ORES, PROPERTIES, ETC.

Historical.—Copper was the best known and the most abundant of the metals before the age of iron. Records show that it was manufactured and used in the remotest times. Numerous specimens of copper utensils and ornaments have been preserved, many of which are known to be thousands of years old. Ancient tools were made of copper, it being hardened by the presence of some impurity, probably oxygen. It was also employed by the ancients in alloys of brass and bronze. Perhaps the chief use of copper was in this capacity until electricity became known.

ORES

Native Copper occurs in many localities in small quantities, usually associated with other copper ores. The famous Lake Superior deposit, which is worked chiefly in Michigan, is the only one of metallurgical significance. It was the chief source of copper in this country until the Western mines became so productive. The lake ore is disseminated through silicious rock from which it is separated by stamping. Often large masses of tough metal are encountered, making the mining difficult.

Chalcopyrite (Cu_2S , Fe_2S_2) is a widely distributed and very important ore of copper. It commonly occurs in silicious and other crystalline rocks, and is rarely ever pure. The ratio of the iron to the copper is quite variable. Lead, zinc, nickel and the precious metals are sometimes associated with chalcopyrite. The copper deposits of the New England and Middle Atlantic States consist largely of chalcopyrite as do those of the Rocky and Sierra Nevada Mountains.

Chalcocite (Cu_2S), otherwise known as copper glance, is an exceedingly rich ore when pure, though it is usually mixed with other sulphides. It is commonly met with in the Montana mines, and it is now regarded as the most abundant ore of copper. Chalcocite is the original ore from which the others are derived.

Tetrahedrite, $(\text{Cu}_2\text{S}, \text{FeS}, \text{ZnS}, \text{AgS}, \text{PbS})_4 (\text{Sb}_2\text{S}_3, \text{As}_2\text{S}_3)$ is rarely ever a valuable ore of copper, though it often contains enough silver to pay for its treatment. It is sometimes an objectionable ingredient of other ores on account of the arsenic, antimony, etc. it contains. The more valuable occurrences of this ore are in Colorado.

Malachite, $(\text{CuCO}_3, \text{CuOH}_2)$ is relatively an unimportant ore, though a very valuable one when sufficiently pure. It is common in Arizona and New Mexico.

Cuprite and Melaconite, the oxides of copper, occur as products of the natural decomposition of sulphide ores, though in but small quantities. The most remarkable occurrences are in Virginia, North Carolina and Tennessee.

The leading copper-producing states are Arizona, Montana, Michigan and Utah. It is mined in almost every state of the West, and in many of the Eastern and Southern states, notably Tennessee and Virginia.

PROPERTIES

Pure Copper.—With but one exception, copper is the only metal with a distinct color. The fractured surface is pinkish-red, and a somewhat lighter color is developed when the surface is polished. The specific gravity is 8.945, according to Hampe. Owing to the porosity of commercial copper the specific gravity varies from 8.2 to 8.5. Copper ranks among the softer metals; it is exceedingly tough and tenacious, highly malleable and ductile. These properties may be illustrated in this way—a vessel of the shape desired and with very thin walls may be hammered from a solid block of the cold metal; a bar of iron plated with copper and drawn into a fine wire, is still coated with the red metal. The melting point of copper is $1,084^\circ \text{C}$. When molten it appears sea-green. Just before reaching the fusion point copper is so brittle that it may be powdered. While in the liquid state it will absorb most gases except carbon dioxide. Hampe states that with hydrocarbon gases only the hydrogen is absorbed, the carbon being liberated. Upon solidification the gases are released. For this reason sound copper

castings can not be made unless the operation be carried on in an atmosphere of carbon dioxide, or unless some substance is added to deoxidize or to hold the gas in solution. Magnesium being a powerful deoxidizer, may be used for this purpose. Boron or boron suboxide, added to the melting pot or to the copper after it is melted, will produce sound castings (Weintraub's method)¹

One of the most useful properties of copper is its electric conductivity, which is excelled only by that of silver. Copper diffuses readily with most of the common metals. Its alloys are numerous and widely used.

Effect of Impurities.—The properties of copper are greatly altered by the presence of foreign elements, some rendering it quite unfit for certain purposes even when present in minute quantities. Of the more important impurities that have to be dealt with are bismuth, arsenic, antimony, silicon, sulphur, phosphorus and oxygen.

Bismuth has been termed the copper maker's worst enemy, on account of its deleterious effects and the difficulty of eliminating it. The presence of but 0.05 per cent. of this element renders the metal both red-short and cold-short. Extreme brittleness is developed in copper containing more than 0.10 per cent. of bismuth.

Arsenic is the most objectionable impurity in conductivity copper. This property is greatly diminished if but a few hundredths of a per cent. of arsenic be present. The metal may be readily worked, however, if as much as 0.50 per cent. be present. A small amount of arsenic is said to increase the tensile strength of copper.

Antimony has a similar effect to that of arsenic. Its effect seems to be less pronounced with very small proportions, while with quantities exceeding 0.50 per cent. the effect is more marked than with that of an equal amount of arsenic.

Silicon lowers the conductivity of copper when as much as 0.50 per cent. is present. Three per cent. does not seriously impair the toughness and malleability. Larger proportions pro-

¹ Brass World, viii. 355.

duce brittleness. Silicon is always to be found in unrefined copper.

Sulphur is usually present in unrefined copper. It lowers the malleability, as much as 0.50 per cent. causing cold-shortness.

Phosphorus is not often present in sufficient quantity to injure the properties of copper. Red-shortness develops with as much as 0.50 per cent. of phosphorus.

Oxygen is always present. In small quantities it may be disregarded entirely. With increasing amounts above one per cent. the copper becomes harder and finally unworkable.

Compounds and Reactions Especially Useful in the Study of the Metallurgy of Copper.—Two oxides of copper are known—cuprous oxide (Cu_2O) and cupric oxide (CuO). Both of these compounds are formed when copper is heated in oxygen, the latter being the ultimate product of oxidation. The higher oxide is reduced to the lower when heated with metallic copper. Cuprous oxide is readily dissolved in all proportions by molten copper. Both oxides are reducible by carbon and both are soluble in mineral acids.

There are two sulphides of copper, analogous to the oxides. Cupric sulphide (CuS) is the form in which the metal is generally combined in its ores. One-half of this sulphur is evolved at a moderately high temperature, so that roasted ore contains cuprous sulphide (Cu_2S). Upon further heating in an oxidizing atmosphere cuprous sulphide is partially converted into the oxides, which in turn react with the sulphide, liberating copper and sulphur dioxide. Under certain conditions cuprous sulphide is changed by roasting to the sulphate. When roasted with salt cuprous and cupric chlorides are formed.

Silica reacts readily with cuprous oxide at furnace temperatures, forming a liquid slag. From cuprous silicate copper may be reduced by carbon, and cuprous oxide may be set free by the substitution of a stronger base such as ferrous oxide or lime.

Copper is precipitated from aqueous solutions of its salts by iron, aluminum and zinc, and by the electric current.

PRELIMINARY TREATMENT OF COPPER ORES

In an exhaustive study of the concentration of copper ores practically all ore dressing methods would be considered. The roasting process, only, is discussed here, since other methods are described in Chapter VI. Roasting bears a most vital relation to the smelting process, and the principles which govern roasting should be carefully studied. It is not practicable to separate copper from the ore by a single operation. There is usually a large amount of sulphur to be eliminated, and the large excess of mineral matter present would yield an overwhelming quantity of slag to entangle the metal. The usual practice is to first roast the ore, thereby getting rid of a large part of the sulphur and other volatile matter, and then to fuse the ore under proper conditions, when the heavier, metal-bearing portion separates from the barren gangue by gravity. This concentrated material is a mixture of copper and iron sulphides and is known as *matte* or *regulus*. A concentrate in which the sulphur is replaced by arsenic is called a *speiss*. Matte is further treated by fusion in an oxidizing atmosphere, the iron being oxidized first and fluxed out by means of silica, leaving the enriched sulphide of copper. This is known as *blue metal* if it still contains a considerable amount of iron and about 65 per cent. of copper. *White metal* is almost pure cuprous sulphide, and contains 75 per cent., or more, of copper. Upon further fusion in an oxidizing atmosphere metallic copper is obtained.

The roasting and smelting of copper ores depend upon two important principles; 1st, that copper has a stronger affinity for sulphur than the other metals associated with it have, therefore, it oxidizes less readily in the roasting; 2nd, that cuprous oxide and cuprous sulphide react upon each other at the high temperature of the smelting furnace with the evolution of sulphur dioxide and the liberation of metallic copper.

Heap Roasting.—This is the cheapest way in which ores are roasted. It requires the least amount of fuel and the minimum expenditure of labor, but it is not adaptable to all ores and is open to several objections. The ore must be for the most part

in lump form, and should contain at least 15 per cent. of sulphur. With ores lower in sulphur it is necessary to mix fuel through the heap to produce the necessary amount of heat. While heap roasting may be very efficient, it requires great care both in the building and firing of a heap to turn out a product that is up to present day requirements. The consequences of setting free so much sulphurous acid are to be considered. In many places the practice is prohibited by law.

The site for the operation should be sheltered from the winds, which would cause uneven burning. A spot is generally chosen which is large enough to accommodate a number of heaps. The heap is built upon a foundation of rock or slag. The dimensions of a heap are determined largely by the character of the ore. According to Peters a heap 24 by 40 feet at the base and 6 feet high contains about 240 tons of ordinary ore. In building a heap a layer of wood is first placed for kindling the ore. Several chimneys are set up along the middle line of the foundation, and canals are left in the layer of wood leading from the chimneys to the outside. This is done to facilitate the combustion of the ore by creating a draft and drawing air into the heap. The large lumps of ore are placed upon the wood, and the heap is finished with smaller lumps and covered with fine ore. A portion of the top and a space around the bottom are left uncovered so that the heap will be open enough for the circulation of air.

The heap may be fired at the outer openings of the canals, or in the chimneys. The aim is to effect a uniform kindling of the entire mass. During the first twenty-four hours of the burning the products of distillation from the wood are driven off with some sulphur, producing exceedingly foul odors. After the wood has been consumed the sulphur becomes the fuel and the combustion continues. The surface of the heap is examined at intervals for indications of local overheating. This is shown by the fumes, which issue from every opening, becoming thinner and rising more rapidly. The condition is brought about by too free a draft, leading to excessive combustion, and may re-

sult in actual fusion of the partially oxidized ore. The combustion is checked in such cases by throwing on some fine ore. In case the combustion is too much retarded at any point vents are made in the covering to admit air. The time required for roasting a heap of the above dimensions is about 70 days, depending upon the composition of the ore and the weather.

Stall Roasting.—Stalls are partial enclosures in which the ore is protected from the wind while burning. The common form is rectangular, three of the sides being permanent masonry. The floor is paved and the top is left open. A number of stalls are built adjacent, with the openings on the same side, an arrangement which facilitates the handling of the ore. For the building material either brick or stone is used. Stall roasting may be considered a step toward furnace roasting, though no more advantage can be claimed for the practice than that of roasting in heaps so far as the quality of the product is concerned. Stalls have not been favored in this country.

Furnace Roasting.—The largest proportion of ore by far is now roasted in furnaces. All classes of ores may be roasted more completely and in the manner desired in furnaces. Many styles of furnaces are in use, each kind being chosen for the particular grade or quality of ore to be treated. The ore must in all cases be in the pulverulent form. Rock breakers are used for crushing the large lumps and the finer crushing is done in stamp and roller mills. A description of crushing machinery is given in Chapter VI. The furnaces in use for roasting ores may be classed as hand reverberatory, mechanical reverberatory and shaft furnaces.

Hand Reverberatory Furnaces.—This style of furnace is altered to suit different grades of ore. The essential parts are the flat hearth for receiving the charge; the grate, which is separated from the hearth by a bridge wall; the side working doors, giving ready access to the hearth; the low, arched roof, constructed so as to reflect heat upon the hearth, and the tall flue. The furnace is commonly constructed with two or more hearths at different levels, the ore being raked from one down upon the

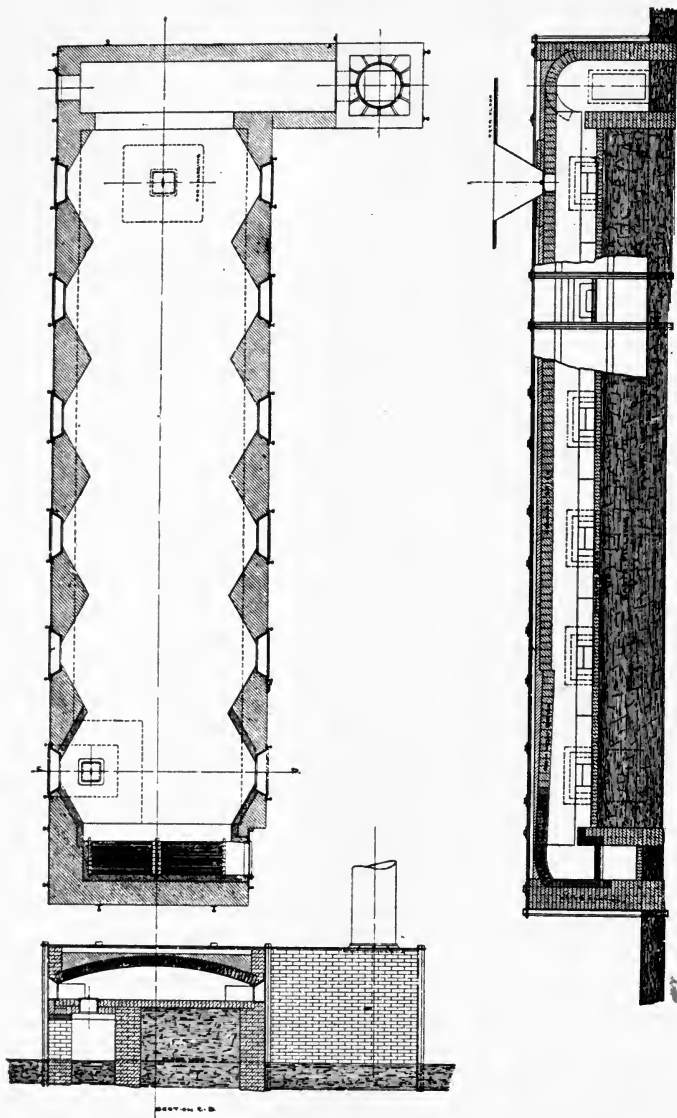

Fig. 76.—Hand-raked Reverberatory Roaster. (Allis-Chalmers Co.)

other, or the hearth is elongated on the same level for several times its width as shown in Fig. 76.

In the operation of this furnace the ore is charged on the upper hearth, or at the end farthest from the grate, and is raked successively to the hearths or portions of the hearth nearer the grate. The temperature of the roasting is therefore gradually raised, since the portion of the hearth nearest the grate is the hottest. The ore is left on the last hearth until it is roasted "dead," and then drawn. A furnace with two or three hearths is preferred for ores containing more than 10 per cent. of sulphur, and if the sulphur content exceeds 20 per cent. the four hearth furnace is found most satisfactory. The advantage of the long hearth lies both in economy and effectiveness of roasting, as may be understood from what has been said about roasting. If ore rich in sulphur is charged upon a hearth that is hot enough to kindle it, the ore roasts of itself, and the necessary heat is generated by the burning sulphur.

Mechanical Furnaces.—The cost of operating the hand reverberatory furnace is rather high on account of the labor required. The labor of moving the ore on the hearth and of discharging it from the furnace is dispensed with by the use of power-driven stirrers or furnaces which are rotated mechanically.

The Brückner and the White-Howell furnaces are common representatives of the rotating type. They consist of brick-lined cylinders, mounted upon friction rollers between a fire-place and flue. The cylinders are slowly revolved while an oxidizing flame passes into them, coming into intimate contact with the constantly moving ore. The Brückner furnace is charged from hoppers supported directly over the cylinder, the ore being charged and removed intermittently through manholes in the side of the cylinder. At some plants a number of furnaces are operated in line, and the fire-box is carried on a truck which runs on a track at right angles to the axes of the cylinders. After igniting the ore in one cylinder the fire-box is moved to another, leaving a free access of air to continue the roasting of the ignited ore.

In the White-Howell type of roaster the cylinder is slightly inclined toward the fire-box. The ore is fed in automatically at the flue end, and advanced toward the fire-box by the motion of the cylinder. The roasted ore drops between the end of the cylinder and the fire-box into a vault.

The McDougall Furnace (Fig. 77) is an improved form of roaster of the shaft type. It has a wide adaptability in the treatment of different kinds of ore. Externally the furnace consists

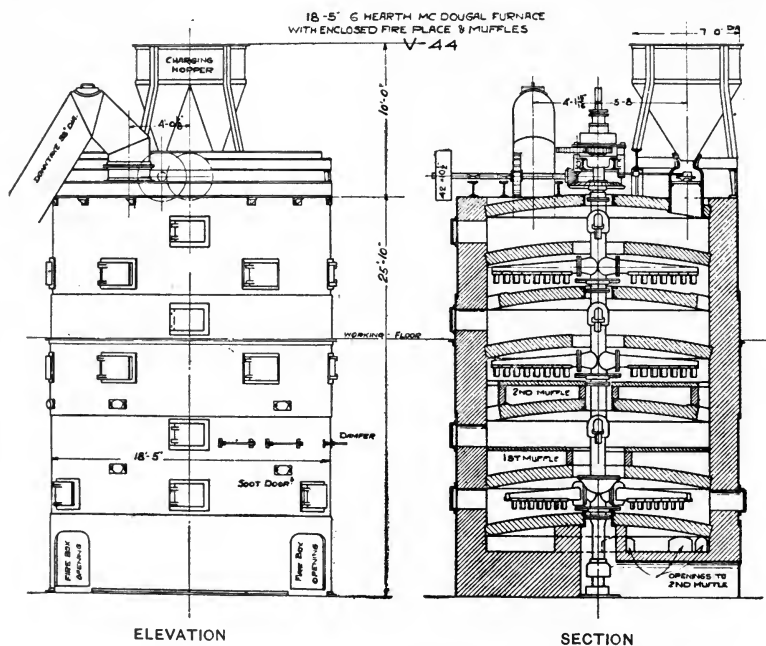

Fig. 77.—McDougall Roaster. (Allis-Chalmers Manufacturing Co.)

of a steel plate shell with a cast iron bottom, and it is usually supported on steel columns. Attached to the metal work are an automatic feed hopper and flue at the top and a discharge hopper and driving mechanism at the bottom. The furnace is thickly lined with brick, and from the walls, at intervals of about three feet, are sprung flat arches which form the roasting hearths. Beginning at the uppermost, there are alternately central and

peripheral openings through the hearths which permit the ore to pass downward and the gases to pass upward. A vertical shaft revolves in the middle of the furnace, carrying two or more cast iron arms over each hearth. Cast iron shoes are attached to the arms and set at such angles that they move the ore toward the openings. The ore drops from one hearth to another and finally into the hopper from the bottom hearth, and from this it is loaded into cars. The revolving shaft and arms are protected from overheating by a water or air cooling device. If they are to be used in connection with the recovery of sulphur dioxide and the manufacture of sulphuric acid McDougall furnaces are provided with muffle hearths.

Agglomeration of Fines.—Large quantities of finely divided ore concentrates and blast furnace dust are produced, and such material is generally improved for smelting purposes by some preliminary treatment. It may be suitable, from the standpoint of composition, but is physically unfit for blast furnace smelting. Fines may be agglomerated by one of the methods described on pp. 86-88, 272. The sintering process is in most general use.

Chemistry of Roasting.—The principal reactions which take place when copper ores are roasted may be represented thus:

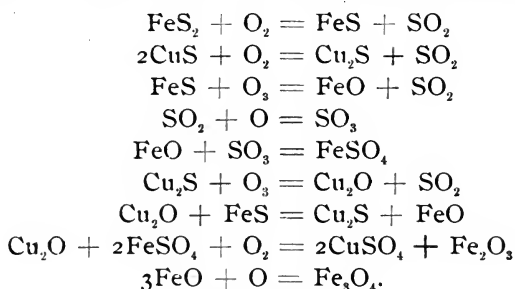

No elaborate or exact information has been gathered covering the many changes which take place from the time the ore is charged until it is withdrawn from the furnace, though some very valuable data has been obtained from the analysis of the ore at different stages of the operation. Iron pyrites is the first compound to give off sulphur. Cupric sulphide also decomposes

at a comparatively low temperature, giving up one atom of its sulphur and yielding cuprous sulphide. With an increase in temperature the monosulphide of iron is converted into the protoxide. This is either oxidized immediately to the higher form or combined with any acid present. The formation of sulphuric anhydride is believed to be due to the catalytic action of silica or other inert material in the ore with sulphur dioxide and oxygen. The sulphate of iron is formed in considerable quantity if the temperature is not too high. This is largely decomposed by cuprous oxide, copper sulphate resulting. It will be seen that the roasting and each succeeding operation in the smelting process depend largely upon the basic properties of copper. Having superior affinity for sulphur, it remains in combination with this element as the iron is being oxidized, and being fusible in this form, it is readily separated from the gangue or slag by gravity during the smelting process.

CHAPTER XIX

COPPER SMELTING

Copper smelting embraces all operations in which metallic copper or a concentrate is recovered in the fused state. A smelting process generally includes several operations, beginning with the fusion of the roasted ore or mixture of ores, the product of the first operation being a matte, and ending with the oxidizing fusion of matte, the product of the last operation being unrefined copper. The same general principles obtain in all processes of smelting sulphide ores, though the different processes with their technical details make the subject of copper smelting exceedingly intricate. For the convenience of the student the processes described are distinguished as reverberatory and blast furnace smelting, the latter being further divided into coke or cupola and pyritic smelting. This classification serves to emphasize the essential differences in practice, though it is to be understood that no such sharp divisions exist in the copper smelting industry. Many processes are so conducted as to embody features of all the different classes.

REVERBERATORY SMELTING.

This process was developed in England and Wales, and has undergone but few important changes. It is still in common use and is more adaptable to some grades of ore than any other. Reverberatory smelting consists of a series of fusions and roastings, each roasting eliminating sulphur and each fusion separating matte in a more concentrated form.

Fusion for Matte.—For this operation a large reverberatory furnace is used. A recently built furnace for matting copper ores is shown in plan and elevation in Figs. 78 and 79. The walls of the furnace are of red brick and the lining is of firebrick. The brick work is held together by steel rails and tie-rods. The hearth and lower walls of the furnace are protected by a lining or fettling of sand. The pear-shaped hearth is common in copper smelting furnaces. Since a high temperature is

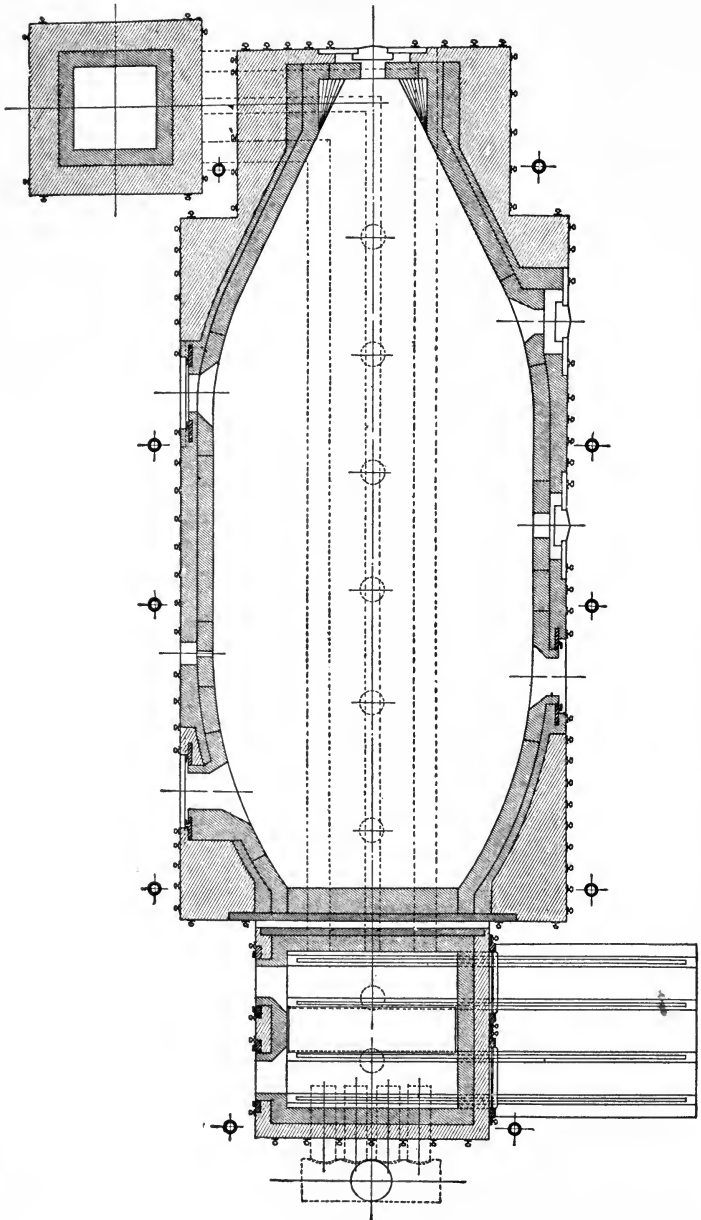

Fig. 78.—Plan of reverberatory smelting furnace. (Allis-Chalmers Manufacturing Co.)

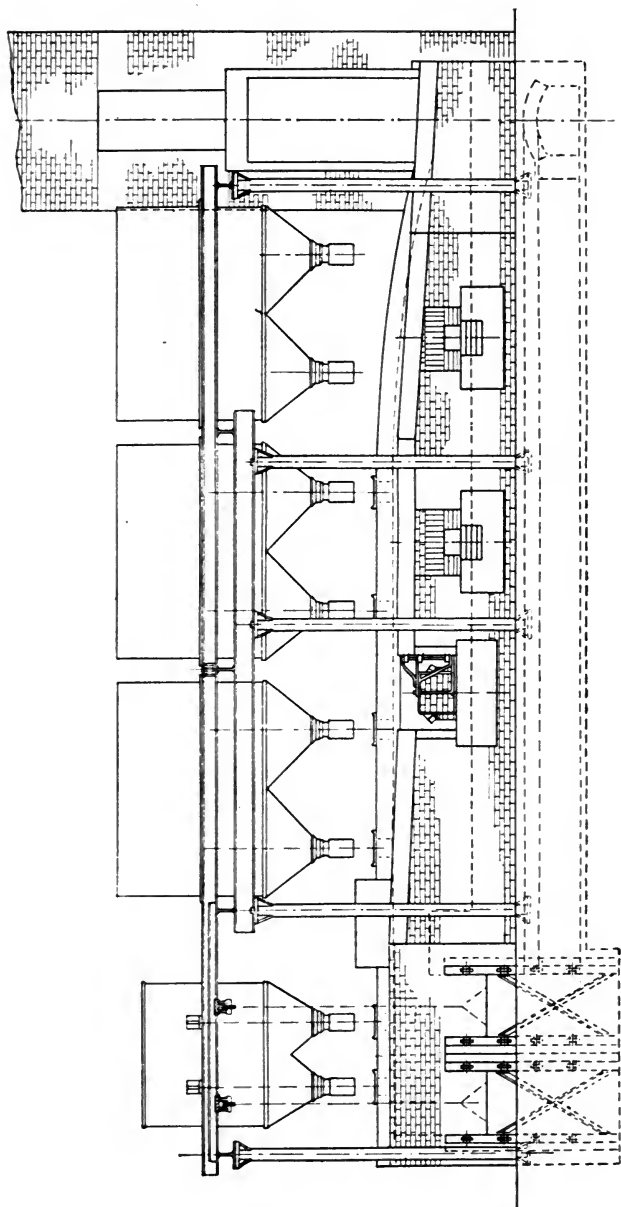

Fig. 79. — Reverberatory smelting furnace. (Allis-Chalmers Manufacturing Co.)

required in this furnace, the fire-box is large in proportion to the hearth area. The furnace is provided with skimming doors on both sides for removing the slag, and a tap-hole for drawing off the matte. The ore is charged through circular openings in the roof of the furnace from three double hoppers. The coal is likewise let into the fire-box through the funnels of one double hopper. A tall chimney carries away the sulphurous smoke and maintains a steady draft.

The charge is made up of roasted and raw ore, slag from refining furnaces, etc., mixed to produce the matte and slag of the proper compositions. After leveling down the charge the temperature of the furnace is raised rapidly. Within a few hours time the ore is completely fused. A quantity of slag is formed and a portion of the sulphur is evolved. The bath is well rabled, and after it becomes tranquil it is left undisturbed for half an hour to allow the matte to settle. The slag is then skimmed off through the working doors, and the matte is tapped. Enough matte is left in the furnace to protect the hearth from sudden cooling and from the corrosive action of fresh ore. The ferrous oxide and other bases exert a constant scorification of the hearth lining or fettling, and this must be frequently renewed.

Fusion for Blue or White Metal.—If the matte from the above operation is a rich one it may be converted by a single fusion into white metal, otherwise it yields the intermediate product, blue metal. If very poor the matte is roasted before fusion. It is first granulated by running it into water directly from the furnace, or by grinding it in a mill, so that the roasting will be more effective. During the fusion the iron is fluxed out by adding some silicious slag from a previous operation, or by means of raw ore or other material. The furnace used for the fusion of mattes is similar in construction to the one above described. It is generally smaller and the fire-place is larger in proportion to the hearth. A higher temperature is employed than is needed in the fusion for matte, but the operation is very similar. At the end of the operation the enriched copper sulphide forms the lower layer in the bath, and the oxidized slag floats on top. After skimming the slag the product is tapped and run into molds.

Fusion for Blister Copper.—This operation is conducted in a furnace of somewhat the same construction as the matting furnace, except for the increased grate capacity. The hearth is well soaked before use with high grade matte, and upon this a layer of copper is melted. This protects the hearth from the corrosive action of the charge. The white metal is charged in the form of pigs, and the temperature is raised slowly, air being freely admitted. The oxidation proceeds rapidly, and the escape of sulphur dioxide causes “boiling” after the bath has become liquid. A much smaller amount of slag is formed than in the preceding operation, and the slag is much richer in copper. This is skimmed from time to time. When tests show the proper degree of purity the copper is tapped and run into molds, or transferred at once to the refining furnace. Metal that is allowed to cool becomes covered with blisters from the escaping sulphur dioxide—hence the term “blister copper.” There is one per cent. or more of impurity in reverberatory-smelted copper.

Chemistry of Reverberatory Smelting.—The separation of the matte from the ore gangue is largely mechanical. The most important reactions are in the fluxing of the iron oxide by silica—

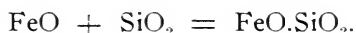

Of course the same reactions that occur during the roasting are largely repeated here. The final reactions by which copper is liberated may be expressed thus—

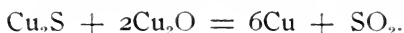
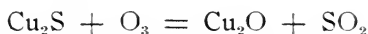

The following table, prepared by E. D. Peters, Jr., from his own experiments, shows the rate of matte oxidation in reverberatory furnaces.

TABLE OF MATTE CONCENTRATION BY OXIDATION FUSION—PERCENTAGES OF COPPER IN FRACTIONS OMITTED

Charged	Melted	No. of hours in furnace																	
		6	7	8	10	12	14	16	18	20	22	24	26	28	30	32	34	36	48
0	5																		
16	16	17	16	19	20	20	21	22	21	23	23	25	29
21	23	22	25	27	27
33	37	41	..	39	..	41	41	44	49
41	45	47	..	53	54	58
50	55	57	..	59	61	61	64
58	62	62	62	61	61	62	..	65	..	65	..	67	68
63	67	70	..	72	75	78	84
69	73	73	74	74	77	78	77	82	85	89	94	..	98
74	82	84	..	88	94	99
80	86	89	..	93	..	98
86	94	99
92	96	96	98	99	99
96	98	..	99

COMPOSITION OF COPPER AND SLAG IN ROASTING-SMELTING FOR BLISTER COPPER

	Welsh "roaster" slag	Kaafjord
Silica	47.5	36.0
Protoxide of iron	28.0	7.0
Alumina	3.0	6.0
Cuprous oxide	16.9	43.2
Lime	2.7
Magnesia	0.8
Nickel and cobalt oxides	0.9	4.9
Oxide of tin	0.3	0.6
Oxide of zinc	2.0	3.2
	Welsh blister copper	Kaafjord
Copper	99.2-99.4
Iron	0.7-0.8	0.1- 0.2
Nickel and cobalt	0.3-0.9	0.2- 0.3
Zinc	0.0- 0.2
Tin	0.0 0.7	..
Arsenic	0.4-1.8	..
Sulphur	0.1-6.9	0.1- 0.12

BLAST FURNACE SMELTING

Blast furnaces for smelting copper ores were first used in Germany. They have been successfully introduced in all important copper producing countries, and have been specially

favored in the United States. The evolution of the copper furnace has been quite as remarkable as that of the iron furnace, leading to large output and high efficiency. There are a number of styles of furnaces in use for the treatment of copper ores, the differences being brought about by the varying character of the ores, fuel and other conditions.

The Blast Furnace and Accessories.—Fig. 80 represents the round style of furnace commonly used in the West. It is built of steel plates, riveted together, and is supported on four cast iron columns. The annular base plate is also of cast iron. In the center of this is a large, circular opening which is closed by two drop doors. The crucible is lined with fire-brick, and the bottom is tamped with clay. The walls above the crucible are water-jacketed almost to the level of the charging door. These jackets consist of outer and inner walls of steel plates riveted or welded together to form a shell through which the water is circulated. The inner wall of the jacket is often made of copper, since copper is not so readily corroded by the charge as steel is. At the top the furnace walls are contracted to form a hood, which terminates in the stack. The outline in the region of the hood shows the location of the charging door.

The Blast is commonly furnished by rotary piston blowers. These have generally replaced the fan, which is incapable of giving sufficient pressure to the blast furnace. Turbo blowers have also been introduced with satisfactory results.

The blast is received in a box surrounding the furnace, and is delivered to the charge through tuyeres which pierce the water-jacket. Access to the tuyeres is gained from the outside through small openings in the blast box. The openings are closed with sliding doors. The location of the slag spout is shown in section, and the matte spout is shown in outline. These furnaces are used both with and without the forehearth.

The Trap Spout is modified from the ordinary tapping spout, and is designed to prevent the escape of gas from the furnace when the liquid contents has settled to the level of the tap-hole. Its essential feature is a dam, which holds back the flow of metal from the furnace so as to keep the tap-hole submerged.

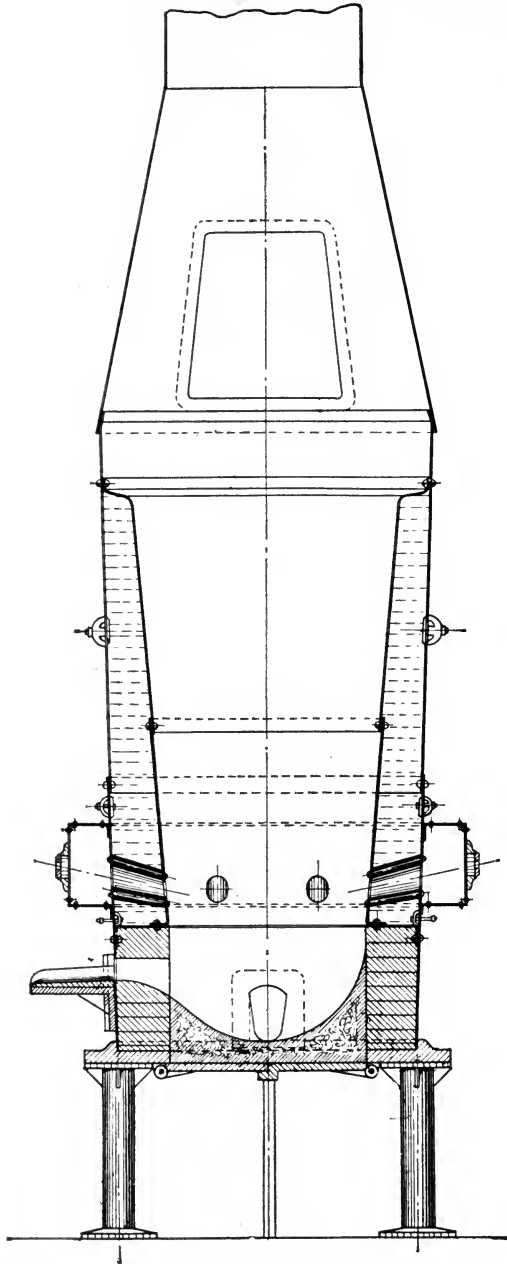

Fig. 80.—Section through Round, Copper Blast Furnace. (Allis-Chalmers Mfg. Co.)



Fig. 81.—Round Copper Blast Furnace.

Forehearths.—Copper blast furnaces are usually equipped with forehearths, the duty of which is to take the slag and matte

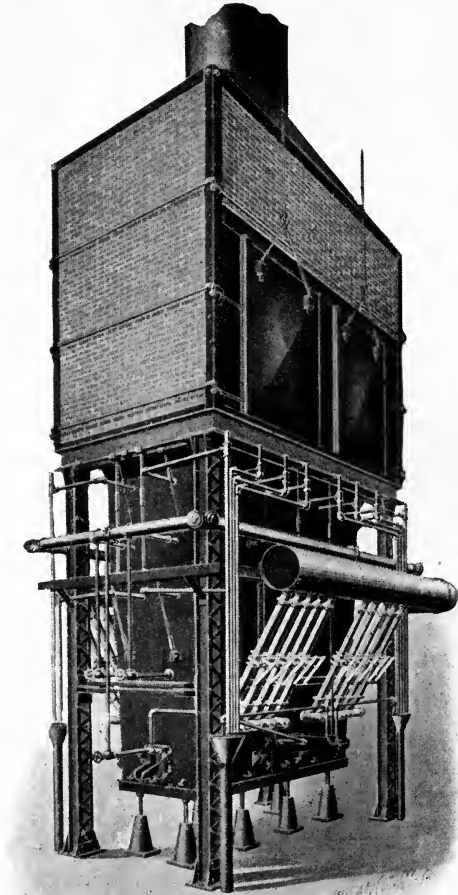

Fig. 82.—Rectangular, Copper Blast Furnace. (Allis-Chalmers Manufacturing Co.)

from the furnace as fast as it accumulates. In other words, the forehearth is an outside crucible which relieves the inner crucible

or furnace hearth of the scorifying melt. The forehearth is lined with fire-brick or water-jacketed, and is provided with a spout at the top for the overflow of slag and a top-hole for drawing off the matte. It is usually kept covered to prevent the rapid cooling and crusting of the contents. The forehearth is mounted on wheels so that it can quickly be replaced by a new one when disabled.

In order to increase the capacity of the copper furnace the crucible is widened. Since it is necessary for the blast to penetrate the charge, after reaching a certain diameter the crucible is enlarged in one direction only, leaving opposite tuyeres the same distance apart. The result has been the development of the elliptic and rectangular styles of furnace. The photographic view (Fig. 82) shows a rectangular furnace of recent construction. It is water-jacketed up to the brick superstructure. The water-jackets are supported from a mantel frame of heavy beams and channels, the entire weight of the furnace walls being carried on four structural columns. The bottom plate is supported on jack-screws, an arrangement which facilitates its replacement. The tap-holes and spouts are shown at the front and end of the furnace. The upper walls of the furnace are brick reinforced with steel plates and rods, brick being less destructible than metal in this part of the furnace. The charging doors are shown at the base of the brick work. The hood is made of cast iron or steel, and it terminates in the stack and downtake pipes, which are steel.

Blast Furnace Processes.—These represent the most diverse and extensive operations in the metallurgy of copper. Practice is so variable, and yet in some respects, different processes are so related as to defy classification. The main difference in what may be termed the extreme variations in blast furnace practice lies in the fact that oxidation of the charge may or may not be effected. The simplest blast furnace process is that in which the ore and flux are melted, the matte separating from the slag by gravity. In this instance the furnace simply plays the role of a melting cupola, since the products formed depend upon a proper

mixture in the burden. The reactions are essentially endothermic, and the necessary heat is derived from the coke carried in the burden. A clearer idea will be gained by an inquiry into the nature of the materials that are charged into the furnace and the conditions to which they are subjected. The copper carrying materials may consist of raw and roasted ores, slags and other metallurgical products. Disregarding for the present any other constituents of the burden except the copper and iron compounds, silica and coke, the chief chemical and physical changes are rendered more obvious. Enough coke is present and the temperature is sufficient to reduce the higher oxides of iron to the protoxide, in which state it is most active in forming silicates. To some extent the iron blast furnace process is simulated, for a part of the iron is actually reduced to the metallic state. The conditions, however, change at this point, due to the action of sulphur. Any iron reduced combines with sulphur, fuses and mingles with the copper sulphide, which is unaltered chemically, to form the matte. It is, therefore, the liquidation of the substances into matte and slag that prevents further chemical action, increments in temperature effecting an increase in the rate of melting, the fused products passing out of the zone of chemical activity. The amount of matte produced depends upon the amount of sulphur in the burden, and the richness of the matte in copper depends upon the extent to which the ore was oxidized. In other words, the sulphur combines first with all of the copper, having greater affinity for that metal, and the remaining sulphur, excepting so much as may volatilize, combines with the iron. From this it is seen that the ore mixture can be so regulated as to produce the kind of matte desired. In practice the furnace charges are calculated upon the basis of the analysis of all the materials. In making his calculations for matte the metallurgist has in view the requirements of the converters in which the matte is to be smelted. There is generally not enough iron oxide in the gangue to combine with all of the silica and additional flux is needed. Limestone is used for this purpose.

Combustion of the coke takes place principally in the bosh, and

here a small amount of the sulphur is oxidized. The fused substances trickle down through a bed of incandescent coke into the hearth, from which they flow continuously into the fore-hearth. Here liquation of the matte takes place, and actual separation is easily effected by means of an overflow spout for the slag and a tap-hole for the matte.

Pyritic Smelting.—This term has been used loosely with reference to several quite different processes. In the restricted sense it refers to those methods of smelting ores in which no fuel is used save the sulphur which the ore contains. All processes, to a certain extent, utilize the heat from the oxidation of the sulphur in the ore or matte, but additional heat is supplied from extraneous sources in all processes heretofore studied. Theoretically, it is possible to smelt some ores to the production of blister copper without extra fuel, and in practice this has been accomplished to the extent of reducing the fuel cost to insignificance. Copper metallurgists have devoted a great deal of attention and energy of late years toward the perfection of such a process, and much has been gained as the result of experimental practice.

In the ideal pyritic process the furnace burden consists simply of the raw ore, containing principally sulphides of iron and copper and a silicious gangue. Having started a blast furnace with coke, this is discontinued, and the process is maintained altogether by the heat derived from the burning sulphur. It was pointed out under the subject of heap roasting that too free a draft in some portion of the heap would lead to fusion of the ore by the excessive heat generated from the rapid combustion of sulphur. This very condition is purposely brought about and intensified in pyritic smelting. The combustion is localized near the tuyeres, and since the oxygen becomes saturated with sulphur here, there is no combustion higher up in the stack. The volatile sulphur is, however, driven off during the descent to the oxidizing zone. It is in this comparatively small space that the iron sulphide is oxidized and the slag is formed by the reaction of ferrous oxide on silica. In no instance is the superior affinity

of copper for sulphur better illustrated than in the one under consideration. Both iron and copper sulphides are brought under the powerful influence of the blast, and the iron sulphide is largely oxidized, but the copper sulphide settles, practically unaltered, as matte. The process is an exceedingly delicate one, and the success of it depends largely upon the skill of the manager in properly adjusting the pressure of the blast to the burden and to the size of the furnace. The greater the proportion of iron pyrites in the burden the larger should be the volume of blast and the higher should be the furnace.

Blast furnace smelting, as it is generally conducted, is neither coke or cupola smelting nor strictly pyritic smelting. It embodies features of both in variable degrees. The practice at any particular place is determined by the nature of the ore and fuel, economic considerations and local conditions.

Treatment of Matte in Converters.—This process was invented in 1880 by John Holloway, of England, and was introduced into the United States shortly afterwards. The idea was borrowed from Bessemer's patent, the general form of the converter and the handling of it being similar.

The barrel type of converter having the mouth opening midway between ends has been used very extensively. This is built in the form of a short cylinder, the outer shell of which is of steel plates and the lining of crushed quartz or silica in other form and a clay bond. The cylinder is mounted horizontally on four friction rollers, and is rotated by means of a vertical rack and hydraulic power. The rack is held against a spur gear on the head of the vessel. The blast conduit is attached to the converter shell longitudinally, supplying air to a row of tuyeres, which are above the bottom of the vessel when it is in the upright position. Connection is made with the blast pipe from the blowing engines in line with the axis of the converter, so that it does not interfere with the rotation of the latter. Since the level of the tuyere openings is above the bottom of the converter, the metal that settles to the bottom during a blow is not disturbed by the blast.

The Process.—Before charging the first time the converter is heated by means of a coke fire. It is turned down to the horizontal position and the molten matte is run in. At the same time a light blast is turned on, and this is increased to the full pressure as the converter is raised to the upright position. Desulphurization begins at once and proceeds rapidly as shown by the rise of a bluish-white flame from the mouth of the converter. The blow is continued until all the iron is oxidized and fluxed, a point which can only be ascertained from experience. The blower is guided by the appearance of the flame, the border of which is greenish while the iron is being oxidized. The appearance of the flame is altered by such volatile impurities as lead, zinc and arsenic. If much slag forms it is poured off before the blow is finished. Being so much lighter than the copper sulphide, the slag separates in a distinct layer, and it is poured off by tilting the vessel. The slag generally retains too much copper to be discarded, and it is returned to the matte smelter. The residue in the converter is almost pure cuprous sulphide. The blowing is continued until the sulphur is practically removed, leaving the copper from 97 to 99 per cent. pure. The copper is cast into pigs or into anode plates, according to the way in which it is to be refined.

In theory the converter process is similar to other processes by which blister copper is made, the main difference being in the rate of desulphurization. The reactions are accelerated by the high temperature developed and by the permeating blast, which speedily supplies oxygen to the entire charge. The first reaction that takes place is the oxidation of ferrous sulphide. This would be further oxidized as in roasting but for the ready supply of silica with which it combines to form a thin slag. With the elimination of most of the iron sulphide and the rise in temperature the decomposition of copper sulphide proceeds rapidly. The cuprous oxide reacts with cuprous sulphide until the latter is exhausted, forming sulphur dioxide and liberating metallic copper.

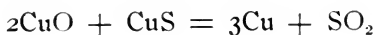

A part of the cuprous oxide is fluxed and carried into the slag, but most of it is dissolved by the copper itself.

A quantity of dust passes out of the mouth of the converter with the flame. This contains the oxides of such volatile impurities as lead, zinc, arsenic, etc., some copper and not infrequently gold and silver. The higher the percentage of volatile matter the greater will be the loss of precious metals. Peters gives the following analyses of flue dust from two different works:

	(1)	(2)
Silver (oz. per ton).....	21.6	58.0
Copper (per cent.).....	33.1	57.9
Lead (per cent.).....	10.4	...
Zinc (per cent.)	7.8	...

The time required for converting a 55 per cent. matte is about one hour.

The following analyses given by W. R. Vanliew, show the rate of oxidation in a converter charge:¹

Time	Cupola tap	10 min.	20 min.	30 min.	40 min.	70 min. blister copper
Copper per cent....	49.72	50.20	56.88	64.60	76.37	99.120
Iron per cent.....	23.31	23.15	17.85	10.50	2.40	0.038
Sulphur per cent...	21.28	20.95	19.74	18.83	16.30	0.159
Zinc per cent.....	1.19	1.20	0.84	0.70	0.45	0.090
Arsenic per cent...	0.11	0.09	0.08	0.08	0.08	0.0012
Antimony per cent.	0.14	0.12	0.10	0.13	0.13	0.006
Silver ounces.....	44.20	42.90	51.40	55.80	70.00	90.800
Gold ounces.....	0.16	0.14	0.20	0.24	0.32	0.350

Basic-Lined Converters.—It is logically unsuitable to use a silica-lined vessel for blowing copper mattes. Efforts have been made to substitute a basic lining ever since the beginning of converter practice. The first commercially successful, basic-lined converter, was built at Baltimore under the direction of Smith and Pierce. The Pierce-Smith converter, which has come into general use, is of the horizontal type, and is lined with magnesia brick. Meanwhile, the upright style has been developed at Great Falls, and the rapidity with which basic-lined converters have been installed would indicate a general displacement of the acid-lined

¹ Trans. Amer. Inst. Min. Eng., 34, 418.

vessel. The Great Falls converter is represented pictorially in Fig. 83.

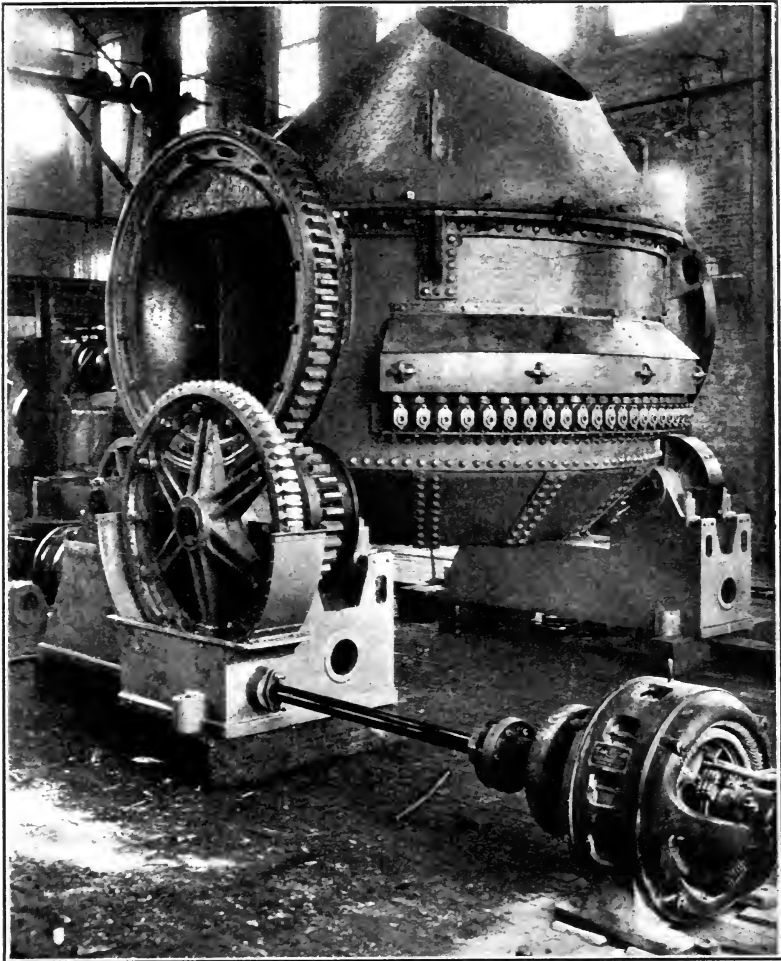

Fig. 83.—Great Falls Converter. (Allis-Chalmers Manufacturing Co.)

In conducting the process in a basic converter only a portion of the charge is put in at first, and to this is added some dried

silicious ore. The vessel is then tilted to bring the tuyeres under the surface of the matte, and a light blast is turned on, the pressure of the blast being increased as the ore is absorbed. When all the silica has been fluxed the slag is poured off, and an additional charge of matte and ore is introduced. The operation is repeated until as much concentrated matte as can be handled has accumulated. The blowing of this concentrate to blister copper is then done in the usual way.

The temperature attained in the basic is lower than that of the acid converter, and consequently more difficulty is experienced in keeping the tuyeres open. The reason for the lower temperature is that the reactions do not take place so rapidly, and there is a greater radiation loss because the basic lining is thinner and it is a better conductor of heat than silica is. Another disadvantage of the basic converter process is the large amount of dust that is blown out. Its great advantage lies in the durability of the magnesia lining.

The Fink Smelter.—Some interesting results have been obtained in smelting refractory ores containing copper, lead and zinc with a furnace recently brought out by Edward Fink.¹ The furnace embodies features of blast roasters and matte converters, and is capable of smelting raw ore to blister copper, expelling lead and zinc, for the most part, as oxides. The smelter is cylindrical in shape, tapered at both ends, and carried on friction wheels. Ore, in a pulverized condition, is fed into the furnace from an overhead hopper through a pipe to which compressed air is supplied for keeping the pipe clear and cool. Fuel is supplied from an oil or gas jet, and hot air is blown in to effect combustion and to roast the ore. The air enters the furnace by way of a number of tuyeres through a circular, stationary box, through which also pass the ore and fuel pipes. In the centers of the tuyeres are peep-holes for observing the interior working of the furnace. The tuyere box has a tight, gliding contact with the end ring of the furnace, and is held in place by two arms attached to the charging platform. The other end of the furnace

¹ Min. and Eng. World, XXXVII, 797; XXXVIII, 953.

is open. The furnace is further equipped with several horizontal rows of tuyeres, one of which is shown in the sectional drawing, with its connection to the annular blast box.

Having introduced the charge and brought the furnace to a smelting temperature with the auxiliary burner, the reactions proceed rapidly as in any converter process. But unlike other converters, this one makes complete revolutions, the rows of tuyeres being brought successively under the charge and the blast being almost entirely shut off automatically as they emerge. This feature lengthens the life of the lining about the tuyeres where the activity of iron oxide is greatest. The lining is further saved by the addition of silicious ore. If reduction in the charge is required coal or coke is added, and any desired slag condition may be brought about by adding the proper flux. Zinc is reduced by the action of sulphides in the charge, volatilized and instantly oxidized by the atmosphere of the furnace. Lead is oxidized and volatilized, and is carried with the zinc oxide out of the furnace with the current of gases, and may be recovered by one of the processes for treating smelter fume.

The chief advantage in the Fink smelter lies in its rotary motion by which the charge is quickly, and when desirable, continuously mixed.

Elimination of Impurities in Copper Smelting.—A complete study of the metallurgy of copper would involve not only the processes by which copper itself is extracted, but also those by which various other metals, associated with copper ores, are recovered. For example, some ores carry nickel as well as copper in workable quantity, and it is not infrequent that gold and silver are present in sufficient amounts to justify more expensive methods of treating the ores in order to recover them. Furthermore, there are often objectionable impurities in copper ores which require special care for their removal. The most important of the foreign elements met with, and their behavior during the smelting, are summarized below.

Silicon.—This element occurs as silica and silicates in the ore. It is fluxed (as silica) by any basic, metallic oxides present, lime

being added as a special flux to prevent its combination with cuprous oxide. In the blast furnace some silicon is reduced and some of this may escape oxidation and be found in the blister copper.

Sulphur, owing to its affinity for copper, is not eliminated until the concentrated cuprous sulphide is obtained. It is finally separated by oxygen at the high temperature of the converter or the reverberatory furnace.

Iron exists chiefly as a sulphide in the ore. It mixes as such with cuprous sulphide in the matte smelting. In an oxidizing atmosphere iron parts with its sulphur at a comparatively low furnace temperature, and it is readily fluxed and separated from cuprous sulphide by means of silica. A small amount of iron is reduced, and alloyed with the copper.

Arsenic should be, for the most part, removed from the ore during the roasting, being volatile. Most of the arsenic that is left in the ore is retained by the copper, either as arsenide or arsenate.

Antimony is similar in its behavior to arsenic. It is concentrated like arsenic in the matte or speiss. Antimony is less volatile than arsenic, and is more difficult to remove from the ore by heating.

Nickel behaves much like copper during the roasting and fusion. But nickel matte is heavier than copper matte, and when a sufficient amount is present it may be separated by liquation. See nickel smelting, p. 343.

Zinc is oxidized during the roasting, and in the fusion a large portion passes into the slag as silicate, often causing annoyance to the smelter on account of its infusibility. In a reducing atmosphere some of the zinc is reduced and volatilized. It is again oxidized upon reaching the upper part of the furnace and the flues, where it is deposited.

Lead, if present in any considerable quantity in the ore, will be found in every product of the smeltery. A large part of it is reduced in the matte, and most of this is subsequently volatilized during the fusion for blister copper. A smaller portion

remains alloyed with the copper. It should be understood that lead is not volatilized like zinc, as a metal, but in the form of oxide and sulphide.

Silver and Gold are almost entirely retained in the matte if it is made under a very liquid slag. During the conversion of the copper some of the precious metals escape with the slag, and in the dust of the converter, but the larger portion remains alloyed with the copper.

EXTRACTION OF COPPER IN THE WET WAY

In the so-called wet or hydro-metallurgical processes the copper compound is dissolved by water or by some chemical and subsequently precipitated in the metallic state or as a compound. A great deal of copper is recovered in this way from low grade ores and metallurgical products with values too low for profitable treatment by other means.

Solution of the Copper.—The problem of converting the ore into such chemical and physical condition as will facilitate the solution of the copper is generally the most serious one that confronts the hydro-metallurgist. The copper compound must be soluble in water or in a chemical of permissible cost, and the ore should be sufficiently fine and porous to give easy access to the solvent. Instances in which the ore requires no treatment prior to the application of the solvent are rare. A large quantity of copper, however, is annually recovered from ores that receive no more specific treatment than that of weathering. The copper in the ore is most commonly converted into sulphate. This may be brought about by the natural action of the atmosphere or by roasting. In localities where fuel is dear and the ore is too low in copper to pay for transportation a slow weathering process may be resorted to. The ore is exposed to the weather in heaps which are arranged over a floor of clay or some material that will not soak up water. Ditches are led from the piles to a pond in which the drainage is collected. As the oxidation proceeds by natural processes, the rains leach out the ferric and cupric sulphates, and this solution is caught and poured over the piles repeatedly. Finally the ore is leached with clear water, and the

combined solution is evaporated, and the copper is precipitated. This crude method is of minor importance in this country, though a considerable quantity of copper is annually recovered from mine dumps and concentrator tailings. In the Butte district alone more than 700,000 pounds per month are recovered.¹

The more usual method of oxidizing ores is by roasting them at a low temperature. With proper care almost the entire content of copper in the ore may be converted into sulphate by roasting, and into chloride by roasting with salt. Copper may be brought into solution from oxidized ores (oxides and carbonates) by lixiviation with hydrochloric and sulphuric acids, iron salts of these acids, ammonia and compounds of the alkalis.

The solution of the copper from ores that have received special treatment is generally effected in large vats of wood or masonry construction. If the ore has been roasted advantage may be taken of the disintegrating effect of throwing it into the vats while hot. Steam is also used, and the liquid is often agitated to aid the solution.

Precipitation of the Copper.—From chloride and sulphate solutions copper is commonly precipitated by iron—

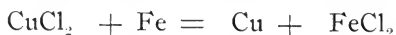

From which it is seen that it is most economical to precipitate from cuprous chloride so far as the consumption of iron is concerned. The copper is sometimes precipitated as sulphide with hydrogen sulphide gas. If the copper has been extracted with ammonia it may be precipitated as black oxide by heating the solution to drive off the ammonia. The copper residue is never pure. It contains particles of iron and salts of associated metals. It is washed and smelted.

Electro-Methods.—The electrolytic principle (pp. 262-264) may be used in precipitating copper from solutions of the chloride or sulphate. In the Siemens and Halske process copper in sulphide ores is dissolved by an acid solution of ferrous sul-

¹ Met. and Chem. Eng., viii, 614.

phate with the formation of cupric and ferrous sulphates. This solution is electrolyzed, the copper being deposited upon cathodes of sheet copper and the SO_4 radical being formed at the anodes which are carbon. The SO_4 attaches to ferrous sulphate, regenerating ferric sulphate for further solution of the copper. The cycle of reactions is kept up by circulating the solution from the ore to the electrodes. A porous diaphragm is placed between the electrodes to prevent interference with the reactions peculiar to each. The chemistry of the process may be represented as follows:

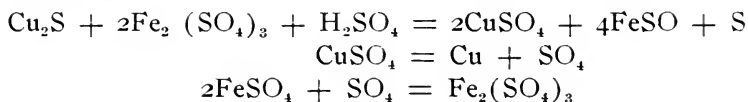

A process, embodying the above principles, has been designed for treating mattes. The matte is cast in the form of slabs over a core of copper and suspended as anodes in the electrolytic bath, the copper serving as a means of suspension and as a conductor. The solvent for the copper sulphide is obtained by treating sulphate-roasted matte with sulphuric acid.

CHAPTER XX

COPPER REFINING

As has been stated, the properties of copper are influenced by the presence of very small amounts of impurities. The purification of copper for the market must therefore be most thorough. It is said that in this country a rather high ideal exists on account of the remarkable quality of Lake Superior copper. No doubt the phenomenal growth of the refinery has been largely due to the competition between the copper producers of this and other localities. Two distinct processes are in use for the purification of blister copper—the furnace and the electrolytic processes.

THE FURNACE PROCESS

The furnace used for the melting and refining of native and blister copper is a large reverberatory. It is provided with doors for charging and tapping, and a large grate for maintaining a high temperature. Gas furnaces are also in use. The hearth is well soaked with copper by melting down successively small charges which have been spread over the surface. Pure metal should be used for this purpose, since it stands the wear better, and besides, impure metal would be the means of contaminating many charges after they had been refined.

The furnace, having been made ready, is charged with blister copper. The doors are closed and the charge is melted down under a reducing flame. The thin slag which forms is skimmed off, and the furnace doors are opened to expose the surface of the metal to the air. A coating of cuprous oxide is formed at once, and this gives rise to more slag by its fluxing action on the impurities. Such action is hastened by skimming off the slag at intervals of an hour. The escape of sulphur dioxide has the beneficial effect of agitating the bath, thus bringing the oxidizing medium into more intimate contact with the impurities. After the bath becomes more quiet and the slag is rich in cuprous oxide it is rabbled continuously for a period of about two hours. The copper now becomes “dry” from the absorption

of cuprous oxide, and a test shows the characteristic brick-red color. The foreign matter has been removed, and it now remains only to reduce this oxide. This is accomplished by the method known as "polling." A long pole of green timber, as large as can be managed, is thrust into the bath. The hydrocarbon gases and other agents reduce the copper, the surface of the bath being covered with fine charcoal to prevent further oxidation. Tests are taken and submitted to mechanical treatment, and when these show the properties of pure copper the metal is tapped and cast into pig molds for the market. The slag is returned to the smelter.

Elimination of Impurities.—Metals of low melting point may be separated from copper by heating the alloy to a temperature insufficient to fuse the copper but considerably above the fusion point of the other metal.¹ The older process for separating gold and silver was to melt the copper with lead, the bulk of the lead separating from the copper by liquation and carrying with it the heavy metals. The recovery of the precious metals from the lead is explained under the metallurgy of lead. The elements which are most completely removed in the refinery are sulphur, iron, silicon, arsenic, antimony, bismuth and oxygen; also lead and zinc, when present in small quantity. Copper of less than 96 per cent. purity is treated in a separate furnace. Sometimes a small quantity of white metal is added at the beginning of the operation to aid in the elimination of arsenic and antimony.

The impurities are oxidized in the refinery, and are either transferred to the slag or volatilized. The copper itself acts as a carrier of the oxygen. This is shown by the fact that a much more rapid elimination of the impurities results from mixing cuprous oxide with the metal.

The oxygen is not completely removed from the bath by polling. According to Egleston it can not be reduced to 0.1 per cent. About 4 to 6 per cent. of the total charge of copper is removed in the slag of the refinery.

¹ See p. 285.

A tilting furnace operated like the tilting furnaces of the steel maker, has been recently introduced for melting copper and matte. With such a furnace there is a great saving of labor, since both the slag and the metal are discharged mechanically.

THE ELECTROLYTIC PROCESS

The fact that copper can be precipitated from aqueous solutions by means of an electric current has been known for more than a hundred years, though it had but few practical applications until after Faraday's discoveries (1833). Following these were the inventions of electrotyping and electroplating. The refining of copper by solution and precipitation is suggested from the fact that practically pure copper may be precipitated from solutions containing other metals. The art was introduced by Elkington, and his first commercial refinery was built at Pembry, Wales, in 1869. It is interesting to compare this date with that of the advent of the dynamo (1867). So great an undertaking as electric refining on a large scale could never have been continued had not the dynamo been invented and the cost of the electric current greatly lessened. The demand for highly purified copper and the price it commands have more than justified the cost of refining it by electrolysis. Electrolytic refining is now practiced in all copper producing countries, being most adaptable to copper containing arsenic, antimony, bismuth and the precious metals. In the United States more than 80 per cent. of the entire output is refined in this way, the cost having been reduced to four or five dollars a ton.

General Principles of Electrolysis.—In the drawing (Fig. 84) are represented two copper plates, A and C, immersed in a dilute solution of sulphuric acid. To the heavy plate, A, is attached a wire, which is connected with the positive terminal of a direct current generator. The wire from C is connected with the negative terminal. If no current connection were made the copper of both plates would be slowly dissolved, the acid being decomposed—

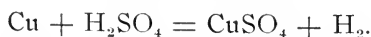

But copper sulphate, according to the theory of Arrhenius, is dissociated in an aqueous solution into copper and SO_4 ions, and the current in passing through the solution gives direction to these ions, causing copper to form at the negative and SO_4 at the positive plate—¹



The positive plate is thus exposed to the action of the acid radical as long as the process of electrolysis is continued. If the SO_4 is not immediately combined it breaks up into sulphur trioxide and oxygen. Both of these products may be detected at the positive plate. The chemical action, resulting from the

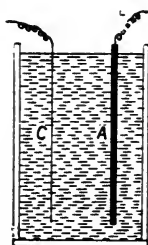

Fig. 84.

solution of the copper in the positive plate, largely neutralizes the back pressure that is set up as the current passes through the solution. For this reason a lower pressure is needed to drive the current through the solution than would be required if the plate were insoluble in the acid. The proportion of acid in the solution gradually diminishes, while the copper sulphate increases.

In the application of the principle of electrolysis on the large scale the impure copper is the positive plate, and the pure copper is deposited on the negative plate. The positive plate is called the *anode*, and the negative plate is the *cathode*. Collectively they are spoken of as *electrodes*, and the solution is the *electrolyte*. The amount of current that passes through the

¹ Z. phys. Ch., 1887, 1, 631.

electrolyte is measured in units called *amperes*. One ampere is the amount of current that will precipitate 1.18656 grams of copper in an hour. The electromotive force, or pressure under which the current is used is measured in *volts*, and the unit of resistance that is offered to the passage of the current is the *ohm*. In conducting the process of electrolysis on the commercial scale a number of electrodes are placed in each vessel holding the solution, and they are arranged close together to minimize the resistance. Since the amount of copper deposited is directly proportional to the current density or amperage, as much current as is practicable is employed. This is limited by the increase in the cost of generating the current and by the condition of the electrolyte. Other metals in solution with the copper may likewise be deposited on the cathode, depending upon the current strength and the condition of the electrolyte. Practically, about one ounce of copper is deposited in 24 hours for each ampere of current.

The Refining Plant and Process.—The refinery consists essentially of the power house; the tank house, containing the tanks for supporting the electrodes in the solution, also the appliances for regenerating the electrolyte; remelting furnaces, and other equipment for working up the products.

The tanks for holding the electrolytes are constructed of wood, and lined with lead or other acid-proof material. The larger tanks measure 10 feet in length, 3 feet in width and $4\frac{1}{2}$ feet in depth. Double tanks are commonly used, the two being separated by a longitudinal wall.

The anodes are of cast copper from the smeltery. They are of the shape shown in Fig. 85. The rectangular dimensions are about 30 inches x 24 inches and the thickness $1\frac{1}{4}$ inches. The arms at the top support the anode in the tank. The cathodes are of electrolytic copper, rolled down to $\frac{7}{32}$ inch thickness and cut in the same rectangular dimensions as the anodes. The cathodes are supported from copper rods passing through loops, which are riveted on in the manner shown. The drawing is a section through a double tank in which copper is refined.

The plan of a double tank with the current connections is shown in Fig. 86. The heavy lines represent the anodes and the narrow lines the cathodes. The direction of the current is indicated by the arrows.

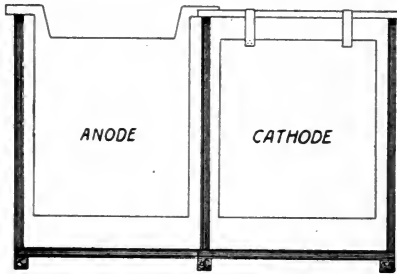

Fig. 85.

The strength of current employed in American refineries is 12 to 15 amperes per square foot of cathode surface. The voltage is increased with the number of tanks in series. As there is danger of loss from leakage under high voltage it is not safe to supply a large number of tanks from a single feed wire. The

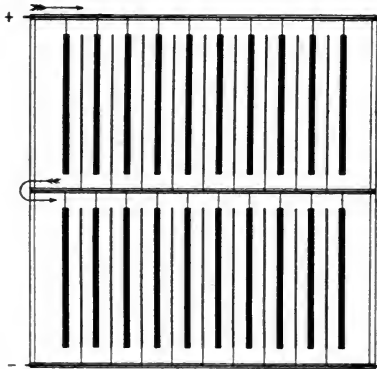

Fig. 86.

theoretical pressure of 1.16 volts required to precipitate copper from the sulphate solution is reduced in practice to $1/6-1/3$ volt, by virtue of the soluble anode. The electrodes may be

come short circuited in one of two ways. The growth of copper on the cathode may be irregular, accretions or crystals extending to the anode, or, the deposit of "anode mud" on the bottom of the tank may accumulate more rapidly than was expected, and touch both electrodes. Frequent inspection is needed to remove these obstructions, since electrolytic action ceases as soon as a short circuit is established.

Under normal conditions the electrolyte contains about 19 per cent. of copper sulphate, 6 per cent. of sulphuric acid and 75 per cent. of water. The solution is frequently tested for free acid and the necessary amount is restored. The circulation of the solution keeps its composition uniform, but the impurities and the excessive amount of copper sulphate must be removed from time to time.

Purification of the Electrolyte.—The components of the anode are transferred to the cathode; dissolved and precipitated as chemical compounds; dissolved and kept in solution, or left undissolved altogether. The heavy, undissolved matter falls to the bottom of the tank, forming what is termed anode mud or slime. It is the aim to keep the composition of the solution and the strength of the current such that only the copper will be electrolyzed. In this brief outline of the methods of treating the electrolyte, the history of the several impurities of the anode may be followed.

A part of the electrolyte is drawn off for treatment. The copper sulphate, which is all the time increasing in the solution, is removed by crystallization, special tanks being provided for this purpose. Cuprous oxide and cuprous sulphide go into the slime, but they are to a certain extent decomposed and added to the solution.

Gold and silver fall down with the anode mud.

Iron, zinc, nickel and cobalt dissolve and remain in the solution.

Bismuth is dissolved and partly precipitated as the sulphate.

Arsenic dissolves and precipitates as an arsenite as the solution becomes more saturated. If the bath is deficient in acid or copper, arsenic will be added to the cathode. According to

Emrich, arsenic does not deposit if the electrolyte contains about 140 grams of copper sulphate and not more than 17 grams of arsenic per liter.

Antimony is dissolved and partly precipitated as a basic sulphate. Like arsenic it follows the copper if the electrolyte becomes neutral or low in copper.

Lead is precipitated as the sulphate, most of which settles with the slime.

The soluble impurities must be removed, as noted above, since pure copper can not be precipitated from a solution which is heavily charged with other metals. A portion of the solution is therefore under treatment all the time, and after purification it is returned to the circulation. The purification of the solution is quite an intricate process in itself, some of the methods of treatment being kept secret. The iron, nickel and cobalt may be removed by crystallization. Arsenic, antimony and bismuth are precipitated by oxidizing the hot solution by means of fine streams of air, and by neutralizing the acid with scrap copper. These operations are carried on in lead-lined vats or tanks.

Treatment of the Anode Mud.—This is removed from the tanks once a month, or as often as necessary, and treated for the recovery of silver and gold. It is first boiled with sulphuric acid to dissolve most of the base metals, and after decanting off the acid the residue is washed with water. The residue is dried and smelted in a small furnace with soda-ash and sand. The silver obtained carries both copper and gold. It is refined by one of the usual methods. See p. 321.

CHAPTER XXI

LEAD—ORES, PROPERTIES, ETC.

History.—The date of the discovery of lead is not known. It was employed by the Egyptians, Greeks and Romans long before the Christian Era. The Romans opened mines in Britain, Saxony and Spain, some of which are still operated. Lead was one of the first metals mined in this country, though it is probable that in the treatment of lead ores by early American prospectors silver was the metal sought. Mines were operated before the Revolution in the states of New York, Virginia and North Carolina, and in the Mississippi Valley. The Rocky Mountain deposits came into prominence in 1867, and the lead industry has grown rapidly in the West since that time. The West now leads in the production of lead.

ORES

Galena (PbS).—This is by far the most important ore of lead. It occurs both crystalline and massive, associated with dolomite, limestone and silicious rocks. Galena is not infrequently associated with pyrites and ores of zinc and silver. It may also contain arsenic, antimony and other impurities in smaller quantities.

Cerussite (PbCO_3) is an important ore in the West, occurring but sparingly elsewhere. It is usually impure, and carries other oxidized forms of ore, such as the sulphate and oxide.

Pyromorphite ($\text{PbCl}_2 + 3\text{Pb}_3\text{P}_2\text{O}_8$) is met with, but it is not an important ore.

Lead ores occur but sparingly in the Eastern states, though some of the mines in the Appalachian region are still productive. Next to those of the Rocky Mountains the Mississippi Valley deposits are the most important. Idaho, Colorado, Utah, Missouri and Kansas are the leading lead-producing states.

PROPERTIES

Pure lead is of a bluish-gray color and highly lustrous. It does not ordinarily present a crystalline structure to the naked

eye, but under proper conditions of cooling from the molten state it solidifies in octahedrons. The principal properties to which lead owes its usefulness, are its malleability, flow and density. Lead melts at 327° C., and boils at about $1,500^{\circ}$. It alloys readily with arsenic, antimony and tin, less readily with copper, gold and silver, and with zinc it is said to form no true alloy.

Effect of Impurities.—The impurities more commonly met with in commercial lead are antimony, arsenic, bismuth, copper, iron, zinc and silver.

Antimony.—This metal is frequently associated with lead ores. If a large proportion is present the ore yields an alloy of the two metals. This is known as “hard lead.” Besides hardening lead and destroying its malleability, antimony has the peculiar property of causing the alloy to expand when cooling from the molten state.

Arsenic is also frequently associated with lead ores and its effect upon the properties of lead is similar to that of antimony, rendering it hard and brittle.

Bismuth is much less frequently met with and is not often present in sufficient quantity to injure lead. It lowers the melting point, and renders the lead hard and crystalline.

Copper is a very common impurity in unrefined lead, and is often added in the manufacture of certain alloys. The small amount that is left in refined lead is not sufficient to interfere with its working properties.

Silver in small quantities is a very common ingredient of lead ores, and is therefore to be expected in the lead as it comes from the smelter. Silver-lead alloys that are purposely made in the extraction of silver are known as “work lead.” Small percentages of silver lower the melting point of lead, and large quantities harden it and raise the melting point.

Iron alloys with lead only under special conditions, and is never an interfering element. Commercial lead contains but a few hundredths of a per cent. of iron.

Zinc is not a common impurity in lead. It imparts a lighter color and renders lead hard and brittle.

Chemical Properties.—The chemical properties of special interest in the metallurgy of lead are its action toward oxygen and sulphur, its basic character, and the ease with which it is reduced from all its compounds. When exposed to moist air, or when heated in air just above the fusion point, lead becomes coated with a dull-gray film of suboxide (Pb_2O). At a higher temperature litharge (PbO) is formed, and at a still higher temperature litharge is further oxidized to red lead (Pb_3O_4). The most important of these oxides in metallurgy is litharge. This melts at $906^\circ C.$, and is very volatile at higher temperatures. It is strongly basic, forming an easily fusible slag with silica. The oxides of lead are reducible with carbon.

Lead combines with sulphur at a moderately high temperature, forming a lustrous, brittle, gray mass (PbS). This is also volatile at furnace temperatures, fusing at $935^\circ C.$ ¹ Heated in the air lead sulphide is converted into the oxide and sulphate. If either the sulphide or the sulphate is fused with the oxide, decomposition of both compounds takes place with the liberation of sulphur dioxide and lead. Roasted galena contains all three of these compounds. The sulphide of lead is also decomposed when heated with some metals, notably iron, and with strong basic oxides such as lime. Lead compounds in general are decomposed by fusion with strong bases. The sulphate is soluble in alkaline acetate solutions, and from these lead may be precipitated by electrolysis.

Lead is not readily acted upon by either sulphuric or hydrochloric acid, but it is freely dissolved by nitric acid.

PREPARATION OF LEAD ORES FOR SMELTING

The oxidized ores are easily reduced with carbonaceous fuel and require no special treatment beforehand, other than some separation from the gangue. Galena, to which attention is here directed, may be further concentrated with great advantage by roasting. The ores of lead are extremely variable in composition,

¹ Chemical News, xxi, 292.

and their treatment for the recovery of lead and other metals presents one of the most complicated problems in metallurgy. The first operation is to separate, as far as possible, the lead-bearing mineral from the vein stuff or from other associated ores. Copper and iron pyrites and zinc blende are often present. A good deal of concentrating may be done at the mine by hand picking. Further concentration is effected by washing, the jig being specially adapted to washing lead ores. A process employing magnetic machines for concentrating pyritous ores of zinc and lead is outlined on p. 295.

Roasting.—There are but few instances in which lead ores are not roasted before smelting. The roasting process is, however, often inseparable from that of smelting, both being performed in the same furnace.

If the ore is rich in sulphur and in lump form it may be roasted in heaps or stalls, but open air roasting is rarely, if ever, resorted to in this country. The ore is usually fine, crushed if necessary, and is roasted in some form of reverberatory furnace. The hand reverberatory, described on pp. 231-233 is the most common. Mechanical roasters, and in a few instances, shaft furnaces are employed.

The roaster is often heated by means of waste heat from the smelting furnace, the two furnaces being under the same roof, and the hearth of the smelting furnace being situated on a lower level than that of the roaster, and close to it. With such an arrangement there is a considerable saving in the handling of the ore. In connection with the roaster, chambers or flues are built for settling the fume. The subject of lead fume will be dealt with in the next chapter.

The Process.—The ore is charged through a hopper in the roof of the furnace and leveled down over the hearth. It is charged at the cooler end of the hearth and during the roasting it is turned and moved toward the fire-bridge. The furnace temperature is regulated and the ore is frequently stirred to prevent fusion. It is readily seen how fusion or caking would check oxidation. The temperature employed and the extent of

the roasting depend upon the nature of the ore and the way in which it is to be smelted. As a rule, the ore is allowed to sinter but slightly on the finishing hearth. As it is withdrawn the roasted ore contains lead sulphate, oxide and unaltered sulphide, with possibly some metallic lead. The analyses below show the composition of an ore before and after roasting.

	Pb	Fe	Zn	SiO ₂	S	SO ₃	O
Raw ore	47.29	20.36	0.67	0.49	29.86
Sintered ore	54.27	24.06	0.87	0.80	2.72	2.25	13.41

Agglomerating processes are frequently used in preparing lead fines for the blast furnace. The material may be briquetted, though more often it is sintered. The latter process has been otherwise known as "pot roasting," owing to the fact that a bowl or pot-like furnace was employed. The Huntington-Heberlein process represents the oldest of the pot roasting methods and in its various modifications the most used of the up-draft sintering processes. The blowing operation is conducted in a bowl or pot-shaped vessel, the blast being introduced through a segmental, cast iron grating under a pressure of from six to eight ounces. The ore is put into the pots in a hot and partially roasted condition, the necessary mixture having been made, so that the mass will form a coherent cake when incipient fusion has taken place. The oxidation reactions take place rapidly with the development of all the heat required for sintering. The blast pressure is diminished as combustion progresses to the surface of the charge. A thin layer of the material on the surface does not sinter, and must be mixed with the charge of another operation. The sintered cake is dumped out and broken to the proper size for the blast furnace.

The above process was originally designed for treating lead ore fines, but its application has been extended to the treatment of copper-bearing material and various metallurgical products. The Dwight-Lloyd sintering apparatus is described on pp. 87, 88,

CHAPTER XXII

LEAD SMELTING

Lead is at once a very easy metal to reduce from its ores and one of the most difficult to recover completely. Unless properly guarded against, serious losses will result from volatilization and from the tendency of lead compounds to enter the slags. The subject being a very complex one, only typical processes will be described in this text. The subject will be studied under three heads, according to the types of furnaces employed.

REVERBERATORY SMELTING

Though not so much used in America, reverberatory furnaces are favored among foreign smelters. They belong to older prac-

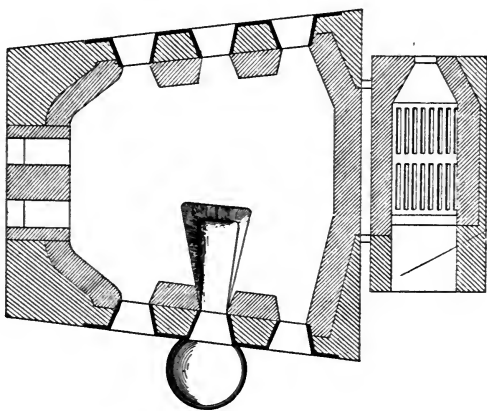

Fig. 87.

tice, but in many cases they are undoubtedly more adaptable to the localities in which they are used than any other furnace. They are cheaper to construct and make purer lead than is made in blast furnaces, but their output is smaller and they are not so well suited for ores of low or irregular grades.

As a representative of this style the typical English reverberatory may be taken. The main differences in the construction of this and other reverberatory furnaces, designed for smelting purposes, may be understood from the hearth plan (Fig. 87).

The fire-box is shown at the right of the drawing and the flue entrances to the stack at the left. The furnace has three working doors on both sides and a charging hole in the roof. It is built of common brick and lined throughout with fire-brick. The walls are held together with buckstaves and tie-rods. The bottom is built up with fire-brick, giving the proper slope from both ends and the back toward the front of the furnace. Upon the brick work is laid a deep lining of sand and slag from previous operations. The hearth slopes toward the middle door on the front side of the furnace, and in the lowest part there is a sump or well in which the lead accumulates. A tap-hole is provided for drawing off the lead from the well, and an iron pot is placed outside to receive it.

The Process.—About one ton of fine ore is charged and spread over the hearth. The ore begins to decrepitate at once, since the furnace is preheated. The temperature of the furnace is kept low at first and the atmosphere strongly oxidizing. Should any ore begin to fuse it is raked away to a cooler part of the hearth. The ore is turned and stirred on the hearth to facilitate even and complete roasting. The roasting requires about two hours, at the end of which time the doors are closed and the fire is urged, to bring on the melting stage. A quantity of lead now runs from the ore and collects in the well from which it is tapped into the pot outside. Some undecomposed galena also melts and forms a layer on top of the lead. This is "set up" by mixing it with lime, and the now stiffened mass is raked back on the upper part of the hearth with the ore. This is followed by another roasting and fusing, which results in the liberation of most of the remaining lead. If a large amount of galena still remains more lime is added, and the roasting and fusing are repeated. The lead is protected by a covering of slack while in the well. After tapping into the pot it is ladled and cast into molds. The slag contains too much lead to be rejected, and is smelted in a separate furnace. This process is only suitable for smelting rich sulphides. It belongs to those known as the "air reduction" or "reaction" processes, in which no reducing agent is

added, the lead being liberated by the double decomposition of its own compounds.

With silicious ores the treatment is different. Formerly the roasted ore was fused with scrap iron in a reverberatory furnace (Cornish process). The ore is first roasted somewhat as above described, until the residue yields no more lead. The residue is then mixed with coal, spread over the furnace hearth and the iron is added. The temperature is then raised very high, the air being excluded. The lead and a small amount of unaltered sulphide run out, leaving a slag which is almost free from lead. The process has been practically abandoned in favor of hearths and blast furnaces.

HEARTH SMELTING

The ore hearth in lead smelting may be considered as intermediate between the reverberatory and the blast furnace. The style of hearth used in England, better known as the Scotch hearth, is described by Percy.¹ In this the ore is roasted and fused simultaneously, but the furnace can not be operated continuously on account of overheating. The hearths used in this country work on the same principle except that the process is not interrupted, the hotter portions of the furnace being water-cooled.

The hearth consists essentially of a rectangular, cast iron box, set in masonry, and above this a rectangular enclosure formed by water-cooled blocks of cast iron, with one of the longer sides left open. This is the front side of the hearth from which the lead flows over an inclined plate when the box or well is full. The blast is supplied from three tuyeres passing through the back wall. A hood communicating with a stack is placed directly over the hearth for carrying away the fumes.

The Process.—A new hearth is heated for some time with a good fire before any ore is charged. The first charges are light and consist largely of silicious slag. The ore, mixed with lime, is increased to the normal charge and is covered with a layer of fuel. The blast in playing upon the burning fuel brings the

¹ Metallurgy of Lead, pp. 278-289.

entire mass to a glowing heat. The lead is rapidly reduced and trickles down into the basin and overflows through the spout. The slag accumulates on the ash bed until it is tapped.

The hearth is well suited for smelting coarsely crushed ores. The lead made by this process may be of a high degree of purity, but the slags are not clean. They are usually smelted in a specially constructed blast furnace.

BLAST FURNACE SMELTING

Blast furnaces have practically superseded all others in this country for smelting lead ores. They have been found to be

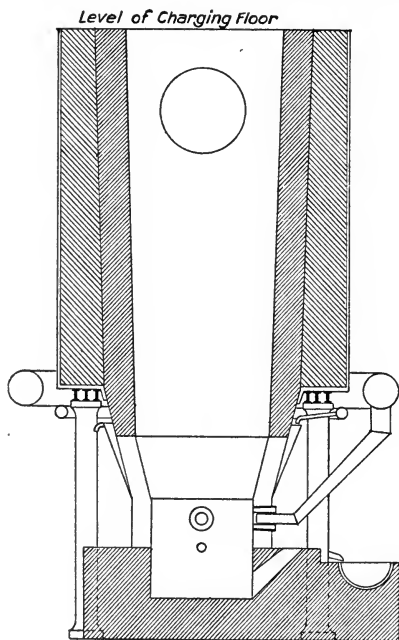

Fig. 88.

the most suitable, largely on account of the non-uniformity of the ores that have to be treated at the same smeltery. The blast furnace is of German origin, though it has undergone many changes since it was introduced into this country.

Fig. 88 represents a modern, American furnace for smelting

lead ores. This furnace is rectangular in cross-section, and in some respects it resembles the rectangular copper cupola. The bosh walls are water-jacketed, and the upper walls are built of common brick with a lining of fire-brick. These walls are very thick especially toward the base, and are supported on cast iron columns. In this style of furnace the shaft terminates at the level of the charging floor, the top being covered with cast iron or steel plates. The fumes and products of combustion are led downward through a steel pipe to dust chambers. The entrance to the downtake is below the level of the charging floor as shown by the circular outline.

The crucible of the furnace is lined with fire-brick. Since these are penetrable by molten lead, a bottom plate is placed directly under the hearth to prevent wasting of the lead. The lead runs from the furnace automatically through a siphon tap from which it flows into an outside retainer. Above the level of the lead in the furnace there is a tap-hole for the slag. A small, easily installed furnace is shown in Fig. 89. This furnace is of the round type, and is specially designed for small operations in remote places.

The Process.—The furnace is carefully heated with a wood fire followed by coke and light charges of slag. The blast is turned on and increased as required. Ore is introduced and the amount is gradually increased to the normal charges. The slag is carefully watched, this being the best indicator of the condition of the furnace. Fluor-spar is sometimes of use in rendering slags more liquid. It may be added with advantage to charges containing zinc or too much lime.

The furnace having been started, the regular charging is continued. The materials are loaded in barrows, weighed and charged by hand. Materials classed as ores consist of raw and roasted ores and slags. The fuel is generally coke, though charcoal and wood are used in some places. Iron and iron oxide are added as reducing and fluxing agents. Lime is added as a flux and a desulphurizer. In regular working the analysis of the materials is made the basis for calculating the charges. The

condition of the slag is the constant means of knowing how the furnace is working. The smelter, noting its appearance as it runs



Fig. 89.—Round Type of Lead Blast Furnace. (Allis-Chalmers Manufacturing Co.)

from the furnace and cools, is warned of trouble which he may avert by altering the blast or the burden. Experience has taught him to estimate roughly the composition of a slag and to ascertain

the presence of abnormal ingredients in it, from the physical state. The example below is of a typical blast furnace charge.¹

Material	Lbs.	SiO ₂		FeO		CaO		ZnO	
		Per cent.	Lbs.	Per cent.	Lbs.	Per cent.	Lbs.	Per cent.	Lbs.
Coke ash.....	15	40.3	6.04	26.5	3.97	10.26	1.54
Slag	100	30.0	30.00	40.0	40.00	20.0	20.00
Lead ore	510	32.6	166.26	19.1	97.41	10.16	51.82	2.4	12.2
Iron ore (SiO ₂)..	185	4.3	7.95	74.1	137.08	3.0	5.73
Iron ore (As,S)..	75	4.3	3.22	74.1	4.29	3.1	2.32
Limestone	115	2.7	3.10	4.5	5.17	53.9	62.05
Total.....	1,000	..	216.57	..	287.92	..	143.46	..	12.2

Material	Al ₂ O ₃		Ag		Pb		As		Cu		S	
	Per cent.	Lbs.	Per ton	Ozs.	Per cent.	Lbs.	Per cent.	Lbs.	Per cent.	Lbs.	Per cent.	Lbs.
Coke ash.....	20.4	3.06
Slag
Lead ore	2.5	12.75	50.5	12.8	20.7	102.5	0.5	2.5	2.9	14.8	4.4	22.4
Iron ore (SiO ₂)
Iron ore (As,S)
Limestone....
Total	15.81	..	12.8	..	102.5	..	2.5	..	14.8	..	22.4

Most of the lead in the blast furnace burden is liberated. It accumulates in the crucible of the furnace until of sufficient height to flow through the channel into the well. Some molten lead is left in the furnace all the time as a safeguard against "freezing." The lead is ladled and cast into pig molds, automatic devices being used at some works. It is known as base bullion and is to be refined.

Along with the lead are melted the matte and slag, and sometimes a speiss. The lead separates almost completely from the other fused substances, but there is never a perfect separation of matte and slag in the furnace. The non-metallic substances are therefore tapped together into a ladle in which they are given time to separate. The ladle usually has the form of a paraboloid, and is carried on a two-wheel truck. It is provided with a tap-hole a few inches above the bottom. The mixture of matte and slag is allowed to stand until the matte settles to the bottom. The tap-hole is then opened to draw off the slag. Another method

¹ Hofman's "Metallurgy of Lead," p. 215.

of handling the melt is to allow the slag to overflow the pot or ladle.

The gases passing from the top of the furnace carry with them small particles of ore and coke together with a quantity of lead fume. The coarse particles are detained in chambers situated near the furnace, and the fume is deposited and recovered by one of the methods described at the end of this chapter. Five per cent. or more of the weight of ore charged may be carried over as flue dust.

Chemistry of Lead Smelting.—The principal chemical changes occurring during the smelting of lead ores may be expressed in the following equations:

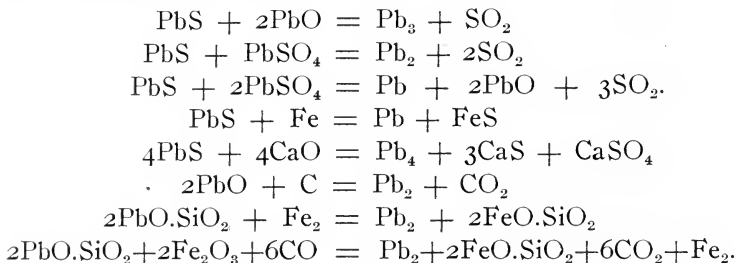

The first three equations represent the principal chemical changes in the air reduction process. The others belong more particularly to the blast furnace process. The relation of the more important substances in lead smelting may be studied separately with advantage.

Iron and Manganese Oxides act as oxidizers and as fluxes with the silicious gangue of the ore. Some of the iron is reduced by carbon and carbonic oxide, in which state it is a powerful reducer with the compounds of lead. There is an advantage in using iron ore in the blast furnace rather than metallic iron, because the ore mixes more intimately with the charge.

Lime and Magnesia act as desulphurizers and basic fluxes. If lime were not added to high silica charges the iron oxide would be drawn upon so heavily as to lessen the available metallic iron for reduction. Limestone is usually cheaper than the high grade iron ore which the smelter uses. Some lime is

very desirable in blast furnace slags, as it favors the separation of the matte, but an excessive amount raises the fusion point and renders the slag too stiff.

Zinc Blende is a most troublesome substance to lead smelters. In the roasted ore it is largely converted into the oxide. It is also oxidized in the blast furnace, chiefly by iron and manganese oxides. The zinc oxide enters the slag rendering it stiff and very difficult to fuse. Crusts or accretions may result from the presence of zinc, causing a choking of the blast and retarding the descent of the charge. Some zinc is reduced in the lower part of the blast furnace and volatilized. This is oxidized and deposited in the upper part of the furnace and in the dust chambers.

Copper in the lead blast furnace goes entirely into the matte, unless there is not enough sulphur to combine with it. Where this is the case copper will be reduced and alloyed with the lead.

Arsenic is partly volatilized and partly reduced and alloyed with the lead. A still larger portion is alloyed or combined with iron in a speiss. The speiss is rather difficult to fuse, and may form accretions in the lower part of the furnace. It retards the separation of lead from the matte.

Antimony is, for the most part, reduced and alloyed with the lead. If the charge is poor in iron a larger amount is volatilized than under normal conditions in the blast furnace.

Products of the Lead Blast Furnace.—There are a number of these, and they are of importance for the relation they bear to the recovery of other metals beside lead.

Base Bullion.—Practically all lead from a blast furnace contains silver, and often gold is present. It is known as base bullion in contradistinction to gold and silver bullion. The lead may be purified to some extent at the smeltery by melting it and skimming off the dross that forms. It is shipped to the refinery.

Matte.—The matte from lead blast furnaces is principally sulphide of iron. It also contains practically all of the copper that may be present and, of course, lead sulphide. Gold and silver are always present if they were in the ore. The values are re-

covered by roasting and smelting the matte. It may be crushed or granulated, then roasted and smelted in a reverberatory or agglomerated and smelted in a blast furnace.

Speiss.—This product may be similar in composition to matte except that sulphur is, for the most part, replaced by arsenic. It may be treated for the recovery of silver and gold by first roasting to volatilize as much of the arsenic as possible, and then smelting the residue with rich pyrites or copper matte. Another process consists in melting a quantity of lead with the roasted speiss. The lead is recovered carrying most of the silver and gold.

Slag.—Monosilicate slags are the most common ones of the lead blast furnace. If the temperature runs very high bisilicate slags are formed. The essential constituents are silicates of iron and calcium. These may be replaced to a certain extent by compounds of other metals, notably manganese, magnesium, aluminum, barium and zinc. A small amount of lead is always present and sometimes enough precious metal to pay for further treatment. The slag is usually allowed to solidify in the pot, after which it is dumped out and broken to pieces. This is done in order to recover globules of matte or speiss that may be present. The slag is the least fluid of all the products from the furnace.

Flue Dust and Fume.—With any furnace in which a quantity of lead-bearing material is treated, some appliance is needed for recovering the fume. The method for recovering fume depends upon its composition, quantity, temperature, etc. The only method in common use until recently was to conduct the furnace gases through long horizontal flues, the gases being cooled in this way and the velocity checked until the solid matter was deposited. Some of the flues at the older, English smelteries were more than two miles in length. Those of the present time are much shorter, the settling of the fume being effected in a different way. Metal and reenforced concrete have been substituted for brick in the construction of the flues, and some water-cooled flues are in use for quickly cooling the gases. The velocity may

be checked in a shorter distance by enlarging the flue at intervals or by partitioning it into chambers so that the gases must pass from one to the other. Precipitation of fine dust and fume is further augmented by increasing the surface inside the flues, thereby creating more friction. This has been accomplished by suspending metal plates and wires in the flues.

The method of condensing fume by forcing it through water or by spraying it with water has had but little application on account of the difficulties in the management and the cost of the apparatus.

The method of filtering through cloth, better known as the Lewis and Bartlett process, has been in use many years for collecting lead and zinc oxides in the manufacture of paint pigments. A description of the process and its application in hearth smelting is given by F. P. Dewey¹. This process is now successfully used in connection with blast furnaces. It consists in forcing the cooled, fume-laden gases through muslin or wooden bags, some 30 feet in length, and 18 inches in diameter. The large volume of gases from a blast furnace plant is necessarily distributed to a great number of these bags. The bags are distended by the pressure from within, and the gases pass freely through the meshes of the cloth, but the fume is retained. The attempt has been made to use bag filters for recovering the fume from lead roasters, but so far none have been made to withstand the action of the acid vapors. It has been found that cloth which is dyed with titanium chloride lasts for a much longer time.

Experiments have been made with the electrostatic process. The interest that the Cottrell process has awakened, and the measure of success it has attained in the precipitation of cement dust and smoke, warrants some notice here.

Electrical Precipitation.—While the idea is not new, the successful application of electric current discharges for fume precipitation has but recently been accomplished. The process which

¹ Trans. Amer. Inst. Min. Eng., 18, 674.

has been worked out under the direction of F. G. Cottrell¹ has given satisfactory results, having been used for settling dust, fume and smoke. The principle of the process is that of the attraction of bodies charged with electricity of opposite signs. A simple experiment will show that if suspended matter is brought into the field in which a direct current of electricity is being discharged from a pointed to a flat electrode the suspended particles are drawn toward the flat surface, and may be actually deposited there. In order to apply the principle on the large scale, a great number of electrodes are placed in the flue through which the fume-laden gases are conveyed. The application of a high tension, direct current to these electrodes results in the instant precipitation of solid or liquid matter from the gases.

The dust and fume from lead furnaces are briquetted, or otherwise agglomerated, and returned to the blast furnace.

The figures below represent typical analyses of products from the lead blast furnace:

	Pb	Cu	Fe	S	As	Sb	Zn	Ag	SiO ₂	FeO	CaO
Bullion.	99	0.05	..	0.05	..	0.3	..	0.6
Matte..	9	20.0	42	25.0	0.1	0.05	2
Speiss .	2	2.0	60	5.0	30.0	0.05
Slag	35	45	18

¹ The inventor has given the history of electrical precipitation and of his process in T. A. I. M. E., 1912, p. 667.

CHAPTER XXIII

LEAD REFINING

Lead for the market must be practically pure. Aside from the worthless impurities it may contain valuable metals such as antimony and the precious metals. The refining may therefore be not only a necessity but also a clear gain. The separation of the base impurities from lead is commonly termed *softening*. It precedes the process of *desilverizing*.

SOFTENING

This process consists in melting a large quantity of lead in a reverberatory furnace, and exposing it to an oxidizing atmosphere until the impurities separate in a dross or by volatilization. The lead is sometimes melted outside and poured into the furnace, but it is usually charged cold. It is melted down slowly to facilitate oxidation and the separation of metals of a higher melting point than lead. The dross which forms at first is dark in color and contains much of the copper, arsenic, sulphur and, in general, those substances which do not alloy readily with lead and which oxidize most easily. The dross is skimmed off from time to time so that a fresh surface will be exposed and a clean scum of lead oxide formed. After the first skimming the temperature is raised to a full red heat, and if the dross fuses, lime is added. The process is sometimes shortened by adding litharge. Oxidation is further hastened by stirring the bath. Very efficient stirring is effected by blowing dry steam from a jet held under the surface of the lead, but the practice is unusual.

Antimony, if present in considerable amount, is removed by cooling the bath until a crust of antimoniate of lead forms. The crust is removed and the operation is repeated.

Lead that is rich in copper is liquated before further treatment. The pigs of copper-lead are placed in a reverberatory furnace with a sloping hearth, the lower part being toward the fire-bridge. The lead is first subjected to a temperature that is

below its melting point, and is then moved down gradually into the hotter part of the furnace. The lead melts and runs away, leaving an impure, coppery residue. This method of separating metals of different melting points is called "sweating."

DESILVERIZING

1. By the Pattinson Process

Pattinson introduced his process for concentrating silver in lead in 1833. Before that time lead containing very small amounts of silver was not desilverized. The only method then known for separating the two metals was by cupellation, and this was too expensive for poor alloys. Pattinson's process is analogous to the well known methods of purification by crystallization in the manufacture of pure chemical salts. It depends upon the fact that alloys of lead containing less than 650 ounces of silver per ton (1.8 per cent.) melt at a lower temperature than pure lead does, in consequence of which the purer lead solidifies first when a molten mass of the alloy cools.

The original process as described by Pattinson, is given in Percy's "Metallurgy of Lead." The desilverizing plant consists of eight or more hemispherical, iron kettles, supported over independent fire-places. A truck, running on an overhead railway, or a crane is provided for supporting the ladle and moving it from one kettle to another. The ladle is for lifting out the lead crystals, the bottom being perforated to allow the liquid metal to run back.

In starting the operation six or more tons of base bullion are charged into the middle kettle. The kettle is heated until the lead is melted and covered with a scum of dross. The fire is then drawn and the dross is skimmed off. Cooling is hastened by sprinkling water over the surface of the metal, and any crusts that form are broken and pushed down to melt again. As the melting point of pure lead is reached the crystals of lead begin to form, and the cooling is allowed to proceed slowly. The crystals are skimmed off with the perforated ladle, and after draining, they are transferred to the next kettle which is already hot enough to melt them. The skimming is continued as the

crystals form until the silver has been concentrated sufficiently, when the enriched alloy is removed to the next kettle on the left, the lead crystals being moved to the right. The kettle thus emptied is charged with new lead and the operation is repeated, while the concentration is conducted in the same manner in the other kettles, the lead becoming purer with each crystallization and the alloy being enriched in silver at the same time. As the successive portions of the original charge become smaller, full charges for the kettles may be made up by combining any portions of the same tenor in silver, or portions from another lot of bullion. The purified lead, which contains but $\frac{1}{2}$ ounce of silver per ton goes to the market, and the enriched bullion is cupelled or further concentrated by the zinc process.

The Pattinson process is not used in this country. A modification, known as the "steam Pattinson process" has been introduced by Luce and Rozan, and adopted in many European works. This consists in melting the bullion and transferring it to a special form of crystallizer, from which both the enriched bullion and the lead are withdrawn in the molten condition. The crystallizer is a cylindrical, flat-bottomed vessel, heated independently and is provided with steam connection, doors at the top for introducing the charges and slide-valves at the bottom for emptying. It is covered with a hood which terminates in a flue for carrying off the fume. Two pans are used for melting the lead, and these are so placed that they can be tipped to transfer the contents to the crystallizer.

The charge having been received, a jet of steam under 45 pounds pressure is turned on the surface of the lead in the crystallizer. The steam cools the lead and causes a regular separation of crystals, besides aiding in the removal of impurities in the dross. When two thirds of the charge has been crystallized the steam is shut off and the liquid portion is drawn out. The crystals are then remelted and the deficiency in the charge is made up with lead of the same tenor in silver. The operation is repeated until the alloy is rich enough to cupel. Eleven crystallizations are required to render the lead sufficiently pure, if to begin with, it contains 146.12 ounces of silver per ton.

2. By the Parkes Process

In 1850 Alexander Parkes, of Birmingham, England, obtained a patent for separating silver from lead, which patent recognized the principles upon which this process is based. As has elsewhere been stated lead and zinc do not alloy in the true sense—from a molten mixture they separate almost completely. Silver alloys with zinc more readily than it does with lead; therefore, if zinc is melted with lead and silver, the zinc upon separating, carries most of the silver with it. These facts are made use of in the Parkes process, or as it is often called, the zinc process.

The arrangement of the refining and desilverizing plant is shown in Figs. 90 and 91. It consists essentially of softening

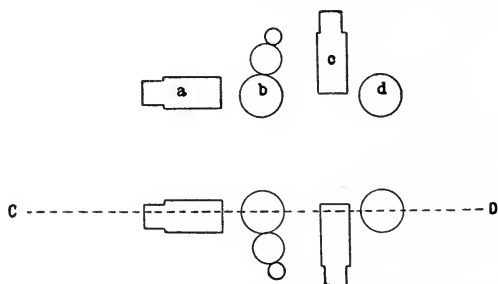

Fig. 90.—Plan of Parkes desilverizing plant. a, softening furnace; b, zincing and liquating kettles; c, refining furnaces; d, merchant kettles.



Fig. 91.—Section on CD.

furnaces, desilverizing and liquating kettles, refining furnaces, merchant kettles and accessory apparatus for handling the lead. With this terraced arrangement of the furnaces and kettles the lead is transferred after each operation by gravity.

Desilverization.—The lead is first softened in the usual way. It is essential that the lead and zinc too be fairly pure, the presence of any base metal interfering with the separation of silver. From the softening furnace it is tapped into the large 30 to 50 ton kettles. It is heated above the melting point of zinc, and

any dross that has formed is skimmed off. A definite quantity of zinc is now added, and when melted, thoroughly mixed with the lead by stirring. This requires about three-quarters of an hour and is very trying labor. Mechanical stirrers and steam are now used by many operators. The quantity of zinc added is gaged according to the content of silver. Roswag's formula calls for zinc as follows:

$$Z = 23.32 + 0.223 T.$$

Z stands for pounds of zinc and T for ounces of silver per ton of lead. After stirring in the zinc the bath is allowed to cool quietly for from two to three hours. The zinc gradually rises and forms a crust upon the surface of the lead. The crust is broken up and removed by means of a perforated skimmer, the lead being allowed to drain back into the kettle. An improved skimmer is now used at many works. It is cylindrical in shape and is fitted with a screw press for squeezing the lead out of the crusts. The perforated bottom is hinged so that it can be opened to discharge the crusts. The rich zinc crusts handled in this way may be distilled without any further liquation of the lead.

Unless the lead is very poor in silver one zincing will not be sufficient. To continue the desilverization the kettle is again heated and the operation is continued as before. Three or four additions of zinc may be necessary. The crusts from each zincing must obviously be poorer in silver than those previously obtained. Those of the last zincing may be used in the treatment of a fresh charge of lead. Samples of the lead are assayed before each addition to determine how much zinc is needed.

The zinc alloys first with gold and copper. No appreciable desilverization of the lead takes place until the other metals are taken up. It is possible by repeated additions of zinc to concentrate gold and copper in a separate crust.

Distillation.—The zinc crusts, if handled with the alloy press, are charged directly into the distillation furnace. A further separation of lead is necessary if they are taken from the kettle in the old way. They are heated in the smaller kettle above the

melting point of lead, and the lead runs away through an opening into the smallest kettle. The separation of the lead from the alloy is, of course, not complete. The liquated lead is returned to the desilverizing kettle and the alloy is distilled.

For the distillation of the zinc from the crusts a small retort furnace is used. The furnace consists of a cubic combustion chamber, in which a graphite retort is supported in the inclined position—mouth upward. The retort is pear-shaped, and it may be provided with a tap-hole in the bottom. The neck of the retort passes through the wall of the heating chamber and into the condenser, the joint between the two being carefully luted with clay. Old retorts and crucibles are commonly used as condensers. The furnace is held together by an iron frame and is swung on trunnions so that the contents of the retort may be poured out. Stationary furnaces are also in use. The furnace is commonly heated with gas or oil.

The zinc that is distilled from the crusts and condensed carries some lead and a small amount of silver with it. It is used again in the desilverizing kettle. The residue containing the lead and silver is tapped or poured from the retort, and the lead is separated by cupellation.

Cupellation.—The final separation of silver and lead is one in which the enriched alloy is melted in an oxidizing atmosphere,

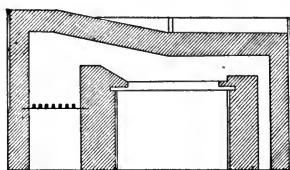

Fig. 92.

the lead being oxidized and the oxide removed by volatilization, absorption and skimming. Fig. 92 represents a cupellation furnace. It is a small, reverberatory furnace into which air is admitted freely with the flame. The hearth consists of a cast iron test-plate, having a concave bottom, and a lining of such materials as marl, mixtures of clay and limestone and

Portland cement. The older and more expensive hearths consisted of wrought iron plates and bone ash linings. The shape of the hearth varies from oval to rectangular and square. The roof of the furnace dips close to the hearth, and the flue leads directly downward. Air is blown in upon the charge to hasten oxidation.

The furnace being at a dull-red heat, the silver-lead alloy is charged and melted down. The blast is then turned on, and the lead oxide which rapidly coats the surface of the bath is driven forward. The fused oxide is drawn off into an iron kettle, and a portion of it is volatilized and carried down the flue which leads to fume chambers. The cupellation is usually finished and the silver refined in a separate furnace, the first operation being the concentration of the bullion to upwards of 70 per cent. of silver. The concentrating process is continuous, lead being supplied as fast as it is oxidized.

The lead, after it has been desilverized by the Parkes process, retains from 0.6 to 0.7 per cent. of zinc. With the plant arrangement above described it is siphoned from the kettles into the refining furnaces and refined in the usual way. Any copper and gold present will have been removed with the first zinc crusts. The zinc, arsenic and other impurities are separated with the dross of the refining furnace. The lead is finally tapped into the merchant kettles where, after cooling to the proper temperature for casting, it is cast into pig molds for the market.

ELECTROLYTIC REFINING

Lead may be purified to a very high degree by electrolysis. A number of processes, making use of this principle, have been proposed. One process, which has been used at Rome, New York, was designed for the treatment of work lead. The lead is cast into anodes, and these are suspended in a solution of lead sulphate in sodium acetate. The cathodes are of sheet brass. By the action of the current the lead is dissolved and deposited from the solution in almost a pure state. The silver and gold are left unattacked, and the other metals are either dissolved or

deposited in the anode mud. The anodes are usually enclosed in muslin bags to keep the precious metals from being carried away with the solution.

Lead is also refined electrolytically in a solution of lead fluosilicate containing free hydrofluoric acid. A large refinery at Trail, British Columbia, has been described by J. F. Miller.¹ The base bullion, containing about 97 per cent. of lead is cast into anodes weighing 400 pounds. Each tank holds 20 of these and 21 sheet lead cathodes alternating with them. The electrolyte contains 6 per cent. of lead fluosilicate and 12 per cent. of hydrofluoric acid. After electrolyzing for five days the cathodes are removed and new ones substituted. At the end of five more days the anodes have been reduced to about 15 per cent. of their original weight. They are then taken out, melted and recast. The cathode lead is melted and cast in merchant pig molds. It is of great purity, containing 99.998 per cent. of lead. The slime from the tanks is dried and melted in a reverberatory furnace, and is then known as doré metal. This is treated with hot sulphuric acid in iron kettles to dissolve the silver. Gold is recovered from the insoluble residue, and silver is precipitated from the solution with copper.

¹ Min. and Eng. World, XXXIX, 57.

CHAPTER XXIV

ZINC

History.—Zinc is generally considered as being among the modern metals, since but little was known of it as a distinct metal until the 16th century. It was used in making brass many years before it was recognized as a separate metal. The Chinese were perhaps the first to extract zinc from its ores. In fact, it is believed that the first process employed in Europe for smelting zinc was borrowed from China. The first important zinc works were erected by John Champion, an Englishman, his process continuing in use, with some modifications, until 1860. The Belgian process was originated by Dony, a Belgian chemist, in 1805. This process is now in general use. Zinc smelting was begun in the United States in 1850.

ORES

Sphalerite (ZnS), commonly known as Blende, is the most important ore of zinc. It occurs in rocks of all ages and is rarely ever pure. It is often associated with ores of lead and iron, more rarely with copper and silver.

Smithsonite ($ZnCO_3$) occurs usually in calcareous rocks, and is often associated with other zinc ores. It is widely distributed but is not often an abundant ore.

Willemite ($2ZnO.SiO_2$) is an important ore in some localities. Like smithsonite it is often associated with other ores.

Calamine is, strictly speaking, the hydrated silicate of zinc. It is commonly understood to include the carbonates and silicates of zinc, which are generally associated and of quite variable composition.

Franklinite is an ore occurring in New Jersey. It is a mixture of zincite (ZnO) with the magnetic oxide of iron and the corresponding oxide of manganese.

The principal known deposits of zinc in America are in the Middle states and New Jersey. The only other Eastern de-

posits that are mined are in Virginia and Tennessee. Kansas now leads all other states in the production of zinc, Illinois holding second place.

PROPERTIES

Zinc is of a bluish-white color and takes a high polish. The fracture is granular or highly crystalline, depending upon the manner of cooling. The tenacity, as given by Roberts-Austen, is from 7,000 to 8,000 pounds per square inch. Zinc is ductile and malleable at 100-150° C., though brittle at ordinary temperatures. It is even more brittle at a temperature just below the melting point. The melting point is 415° and the boiling point 920°. Zinc makes good castings, as it contracts but slightly on cooling and does not occlude gases to any great extent. It alloys readily with most metals except lead.

Chemical.—Zinc is unaltered in pure, dry air. In moist air containing carbon dioxide it becomes coated with basic zinc carbonate, which coating protects the metal from further action. The mineral acids dissolve zinc, and from some solutions it is precipitated by the electric current. All the common metals except iron and nickel are precipitated from their solutions by zinc. At a temperature slightly above its melting point zinc burns in the air, forming the well known oxide (ZnO). The oxide is infusible at furnace temperatures though it forms a slag with silica which fuses at a much lower temperature. Zinc oxide may be reduced with carbon, hydrogen and iron. The affinity of zinc for sulphur is not so strong as that of copper and iron. When zinc sulphide is roasted in air it is converted into the oxide and sulphate.

Impurities in Zinc.—Commercial zinc is known as "spelter." It is apt to contain lead, iron and cadmium, and often smaller quantities of arsenic, antimony and other elements. Lead is the most common impurity, a small amount in many cases not being objectionable, since it actually increases malleability and ductility. The presence of foreign elements in general renders zinc brittle, weak and unfit for the manufacture of alloys and for plating—its principal uses.

PREPARATION OF ZINC ORES FOR SMELTING

Mechanical Concentration.—Under this head may be mentioned washing and magnetic concentration, also crushing, which, if not essential to the process of dressing the ore, is always essential to smelting. Ores which contain light, earthy material may be washed, and those containing much iron oxide may be concentrated with magnetic machines.

Calcining and Roasting.—Oxidized ores are calcined to drive off water (water of hydration) and carbon dioxide. This practice is not followed, however, unless there is an abundance of the ore and it is to be smelted without the admixture of roasted ore. Water vapor and carbon dioxide are objectionable in zinc smelting as will be explained later.

Blende is always roasted before smelting. It is essential that the roasting be thorough, since the amount of zinc that is left in the residues after smelting is largely proportional to the amount of sulphur that is charged with the ore. Zinc ores are always roasted in the pulverized condition. Hand-raked and mechanically-raked reverberatory furnaces are generally employed. Revolving muffle and shaft furnaces are also in use.

W. P. Blake¹ has described a process by which he treats blende that is associated with iron pyrites and galena. After a preliminary crushing and concentrating with jigs the ore is carefully roasted to decompose the pyrite. The iron should be completely desulphurized, though the blende remains practically unaltered. The roasted ore is jigged again to separate the light oxide of iron from the blende and any galena.

Pyritous ores of zinc and lead may be concentrated by roasting at a low temperature to convert the iron into the magnetic form, and then passing the fine ore through magnetic machines.

Some zinc compounds are lost during the roasting, being carried away as dust with the smoke. For this reason the temperature is kept as low as possible, and the ore is not allowed to remain in the roaster any longer than is necessary. The dust is collected in chambers built between the furnace and the stack.

¹ Trans. Amer. Inst. Min. Eng., 22 569.

ZINC SMELTING

The Manufacture of Retorts and Condensers.—A pottery is built in connection with the zinc works. It is of prime importance that the clay for making the retorts be of the proper composition and texture. Besides its refractory qualities the retort must retain considerable tensile strength in the furnace, at the same time permitting the walls to be made thin enough to be easily permeable to heat, and they must be as non-porous as possible to prevent the escape of zinc vapors. The clays used in this country come mostly from New Jersey and Missouri, some analyses of which average as follows:¹

	SiO ₂	Al ₂ O ₃	Fe ₂ O ₃	CaO	MgO	K ₂ O.Na ₂ O	TiO ₂	H ₂ O
New Jersey..	45.0	37.5	0.7	1.0	0.3	0.5	1.5	13.5
Missouri	49.5	34.46	2.39	0.8	0.62		(Loss by ignition) 12.86	

On account of the high shrinkage of clay, retorts are not made of the raw material alone, but this is mixed with from 50 to 60 per cent. of old retorts or burnt clay (chamott). In preparing the material for the retorts the chamott and clay are separately crushed to the proper size and then mixed by shovelling on the floor. The mixture with just enough water to develop plasticity is fed into a mechanical mixer and pug mill. The pug mill is essentially a steel or cast iron cylinder in which a longitudinal shaft carrying knives revolves. The knives may be set at different angles to regulate the rate of pugging. The cylinder is stationary and is either in the horizontal or the vertical position. It is made in removable sections and is slightly contracted toward the discharge end. This feature effects some compression of the clay. The machine is provided with a hopper from which the clay is taken in by means of a screw, terminating with the first knife. The end of the cylinder at which the clay is discharged is bent at right angle, and the mouth is contracted to regulate the discharge. As the pugged clay flows from the mill an attendant breaks it in pieces which have approximately the weight of a retort.

¹ Ingall's "Metallurgy of Zinc and Cadmium."

Retorts are made almost entirely by machinery. The auger machine, or one of this type, is commonly used in this country. The clay is charged into an upright cylinder by means of a belt elevator. A revolving shaft passing through the cylinder carries knives which are so set that they force the clay downward as they revolve. The clay flows around a core, which is centered to form the interior of the retort tube. As the tube of clay is pushed downward out of the machine it is supported on a counterpoised pallet, which permits it to descend only so fast as it is finished. When enough of the tube has been made for a retort the machine is stopped and the tube is cut with a small wire. A wooden form is placed ready to receive the retort. The object in using the form is to support the walls of the retort and to prevent injury while it is being handled. The end of the retort is closed after it has been placed in the form by tamping in a disc of clay.

Retorts are now made in hydraulic machines at some works. These machines are more expensive but they make better retorts. The clay, being more compressed, is less porous and therefore less permeable to gases, which means greater economy in distilling. No form is needed for retorts made in high pressure machines.

Form and Size of Retorts.—The circular and elliptical retorts are the only styles used in this country. The circular ones are about 50 inches in length and 8 inches in diameter, and the elliptical ones about 54 inches in length and 8 x 10 inches in diameter. There is but little advantage of one form over the other. The elliptical shape obviously lends more transverse strength to the retort as it is supported in the furnace. Some smelters use both kinds, placing the round ones in the upper rows and the elliptical ones below, the idea being that in direct-fired furnaces the lower retorts are exposed to the highest temperature, and are therefore the more weakened, and that the round ones are easier to heat.

The clay for the condensers is prepared as above described, but the condensers are usually made by hand, with the aid of a

simple mold. The condensers are sometimes fitted with a cone of sheet iron, known as a prolong. The prolong is placed over the mouth of the condenser to collect escaping vapor of zinc.

Drying and Annealing.—After being removed from the forms, the retorts are left in the drying room for several weeks. It is essential that they dry slowly and evenly, since they are apt to crack at this tender stage if one part dries more rapidly, and consequently contracts more rapidly than another. The retorts are carefully annealed by heating them slowly to full redness and keeping them at this temperature for some time. The annealing furnace is similar to any ordinary pottery kiln, and it is built near the distillation furnace for convenience. At some plants the waste heat from the distillation furnaces is used for annealing.

The annealed retorts are put immediately into use. The condensers are similarly treated, though less care is necessary, as they are not exposed to such high temperatures in actual use.

The Distillation Furnace.—The fact that zinc is volatile at a comparatively low temperature suggests the best means of separating it from the ore gangue, viz., by distillation. Accordingly, all zinc smelting furnaces comprise some form of distilling apparatus. Of these many forms have been devised, but only one is in general use.

The Belgian process has been in use for more than a hundred years, and with whatever improvements that have been introduced, affecting economy and output, the principles are unchanged. Fig. 93 gives a vertical section through a Belgian retort furnace. This is the double furnace, a type that is much used in this country. The walls of the furnace are built of brick, fire-brick being used above the fire-places. The retorts are supported in the inclined position by shelves projected from the back walls and fire-clay tiles in the front walls. Each furnace carries seven horizontal rows, arranged in tiers, with 16 retorts in each row. The tiles in the front wall are held in position by a checkered, iron frame. The plates of which the frame is made are set edgewise so as to form continuations of

the fire-clay shelves holding the front ends of the retorts. The furnace is supported at the four corners by means of buck-staves and tie-rods. The flues, shown at the top, lead the products of combustion into the central chimney, which is partly shown in elevation.

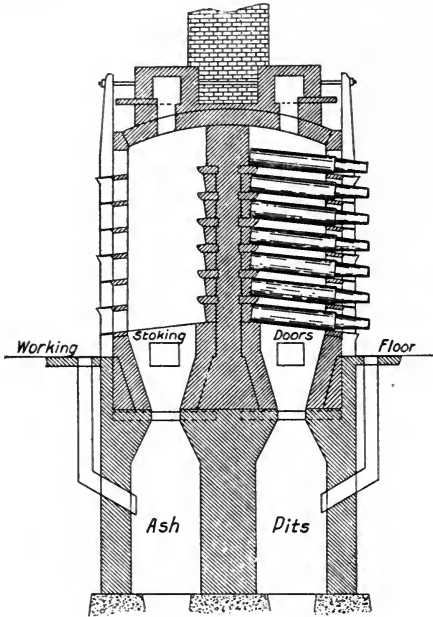

Fig 93.

Gas-fired furnaces, in connection with Siemens regenerators, are in very general use. In Kansas furnaces are built to burn natural gas.

The Distillation Process.—The retorts, being in position in the furnace and heated to redness, are charged with the ore mixture. This consists of the fine ore mixed with crushed anthracite.¹ The mixture is moistened just sufficiently to make it cohere while charging, and the retort is filled rather compactly. A small channel is made over the charge by thrusting

¹ Anthracite containing a high percentage of volatile matter is preferred. In localities remote from hard coal deposits, coke mixed with a small proportion of soft coal is used.

an iron rod to the back of the retort. This is for the escape of the first gases of distillation. The condensers are then placed in position and luted to the retorts. The mouth of each condenser is luted with a handful of brasque (moist slack). The retorts in the upper rows, or those in the cooler part of the furnace are charged with the less refractory ore.

The retorts need but little attention until the zinc appears. When sufficient time has elapsed for the gases inside to have accumulated with some pressure, a small opening is made through the mouths of the condensers, from which they escape and burn in the outer air. The flames which appear are at first yellowish, then bluish and finally whitish. Tinges of red, purple and green also appear. The luminous, yellow flame is due to the hydrocarbons evolved at the beginning. Carbon monoxide gives the pale-blue, and zinc the greenish-white flame appearing towards the end of the distillation. The smoke is generally of a light color. A brownish tinge indicates cadmium. The effort is made to keep the condensers cool enough to condense all the zinc vapor, but some invariably escapes. The prolong is sometimes put on to condense escaping vapor as before mentioned.

The zinc is tapped from the condensers three times in 24 hours. After this the retorts receive a fresh charge. To tap the zinc an iron kettle is supported under the mouth of the condenser and the metal is raked out. The zinc in the ladle is covered with coal dust to prevent oxidation. Any cinder or dross is skimmed off before pouring. The zinc is cast into flat molds. The spelter is generally pure enough for the market, though refining is necessary in some instances.

There are some features of the Belgian process which show poor economy if not absolute waste. At the beginning of the distillation, when the reducing gases are more or less diluted with carbon dioxide and oxygen some of the zinc becomes oxidized. Being in the form of vapor the zinc is deposited in the condenser as a powder (commonly known as "blue powder"). This powder assays about 90 per cent. metallic zinc, and while it is recovered, it is necessary to charge it again into the retorts. Some of the zinc vapor escapes and burns at the

mouths of the condensers, and a smaller amount diffuses through the walls of the retorts.¹ The residues left in the retorts contain variable amounts of zinc, which is expensive to recover. The tapping of zinc, cleaning the retorts and charging is exceedingly hard labor, and unhealthful as well. In the Belgian process the recovery of zinc may be as low as 85 per cent. or even lower. One of the main difficulties in zinc smelting is due to the fact that zinc vapor oxidizes at so low a temperature.

Many attempts have been made to construct an electric furnace for smelting zinc ores, but electric furnace processes are still in the experimental stage. Electrolytic processes have also been proposed, and these too have met with a measure of success.

Spelter of a high degree of purity was obtained by E. H. Hopkins who passed zinc vapor through an incandescent carbon filter. It is further claimed that the volatilization losses are lessened and the yield increased, since a higher temperature may be used in the retorts.²

Refining Spelter.—There is but one process in general use for refining spelter—that of liquation. Redistillation is generally unprofitable, resulting in a high loss of zinc. In Europe, where less pure spelter is made, and consequently more refining is practiced, the spelter is treated in a small reverberatory furnace, in the hearth of which is a sump or well.

The spelter is melted down slowly, and oxidation is prevented as far as possible by using just enough heat to effect the fusion, and by excluding air. The lead and some iron are liquated, and more impurity separates with the dross that forms. The zinc, which forms the upper metal layer, is ladled or drawn off, and the lead is taken out when it has accumulated in sufficient quantity. It may be necessary to further purify both the lead and the zinc by remelting and liquating. The lead should be brought down in the spelter to at least 1.50 per cent.

¹ An old retort contains from six to ten per cent. of zinc in its walls. At some works the retorts are glazed to prevent the absorption of zinc.

² *Met. and Chem. Eng.*, viii, 84.

CHAPTER XXV

TIN AND MERCURY

TIN

Cassiterite (SnO_2) is the only tin ore of metallurgical note. It is a hard, crystalline mineral, occurring in veins, usually in granite or other rocks. Iron, copper and arsenical pyrites, galena and wolfram are sometimes associated with tin ores. "Stream ore" is that which has been carried down from the eroded rocks by water. Tin ore is found in Malay Peninsula, Bolivia, the East Indies and England, and more sparingly in Germany, Russia, Spain and Mexico. The famous Cornwall deposits were perhaps the first to be worked, these having been visited by the Phœnicians before the time of Julius Caesar. No important deposits in the United States have yet been found.

Properties.—Tin has almost the whiteness of silver, with a faint tint of yellow. The tenacity is very low, the metal breaking under a load of a little more than 2,000 pounds per square inch. It is quite malleable, however, as may be seen from the thinness of tin foil. Tin produces a characteristic crackling sound when bent. This is known as the "cry," and is supposed to be due to internal friction. Tin melts at 230°C . It alloys with most of the common metals and most readily with lead. At high temperatures it is sensibly volatile. At very low temperatures it undergoes an allotropic change known as decay or "tin pest." The tin loses its characteristic whiteness and toughness and becomes gray and crystalline, sometimes crumbling to powder. White tin may be "infected" by bringing it in contact with "diseased" tin.

As to its chemical behavior tin may be said to be intermediate between the metals and the non-metals. It is basic, like most metals toward strong acids, replacing hydrogen, but it also combines with caustic alkalis, forming stannates. It is not appreciably dissolved by organic acids nor is it affected in dry or moist air at ordinary temperatures. It is oxidized by nitric

acid, and by air at temperatures above its melting point. The oxide is reduced by carbon at a moderately high temperature. Tin combines readily with sulphur, but the sulphide is decomposed by roasting, yielding stannic oxide and sulphur dioxide.

Smelting.—Tin ores usually require a good deal of concentration before they can be properly smelted. The ore is first crushed and washed, and then roasted to convert the heavy arsenides and sulphides into oxides and sulphates. The soluble sulphates are removed by leaching and the lighter oxides are separated from the heavy tin oxide by gravity washing. The concentrate thus obtained is known as "black tin."

If the ore contains tungsten in considerable proportion some special treatment is needed. The concentrate is heated with salt cake or soda ash in sufficient quantity to combine with all the tungsten. When the mass softens it is transferred without cooling to a lixiviating tank and thoroughly washed. The tungstate of soda, which was formed during the fusion, is dissolved, and the iron and manganese are thrown down as oxides with the tin. The oxides are separated as described above.

In England the reduction of tin is conducted in reverberatory furnaces. A mixture of about one ton of black tin with 400 pounds of anthracite is treated at one time. The proper fluxing agents are added and the furnace is made as nearly air-tight as possible during the heating to prevent oxidation of the tin. The charge melts down and the tin that is reduced collects under the slag. After several hours of heating the bath is well stirred, and the tap-hole is opened at the end of the operation, the tin being received in an outside kettle. If fairly pure the tin is refined in the kettle immediately, otherwise it is cast into molds and subjected to further treatment. The residue in the furnace generally contains too much tin to be thrown away and is resmelted.

Electric furnaces have recently been introduced for smelting tin.

Refining.—Two operations are in use for refining very impure tin. It is first "sweated" by a method similar in principle

to that for separating lead and copper. The pigs are carefully heated in a reverberatory furnace with a sloping hearth. The tin, being of the lowest fusion point, melts and runs away, leaving a more or less porous mass of unfused metals. This, of course, retains some of the tin, and is treated for the recovery of all valuable metals.

The second operation called "boiling" is conducted in an iron kettle. The tin is melted and agitated for several hours by "tossing" or by "polling." In the former method a portion of the tin is ladled out and poured back into the kettle; in the latter green timber is held under the surface of the metal, and the liberated gases effect the agitation. The scum which forms is skimmed off, and the process is continued until the tin is sufficiently pure. The principle of this treatment lies not so much in the oxidation of the other metals, for tin is more easily oxidized than most of them, as in the separation of the other metals with higher melting points than tin by surface chilling.

Uses.—The principal uses of tin are in the manufacture of alloys and for plating other metals, especially iron. The manufacture of tin plate is described in Chapter XXIX.

Detinning Scrap.—The high price of tin has led to various attempts to recover it from tin plate. The shearings from tinning mills are treated with caustic soda or other solvents, and the tin is recovered from the solution by precipitation. In the Goldschmidt process the scrap is bundled and exposed, in a suitable retainer, to the action of chlorine gas. The iron residues are removed after drawing out the dissolved stannic chloride. In the detinning process old material, including cans and all kinds of tinware, are treated.¹

MERCURY

This metal is often called "quicksilver" on account of its silvery whiteness and luster, and its mobility. It occurs native in amalgams or in globules, usually associated with other ores, and as the sulphide. Cinnabar (HgS) is the only important ore of mercury. It is of very irregular composition and is met

¹ Min. and Eng. World, xxxv, 1267.

with in Spain, South America, Mexico and the United States. The largest United States deposits are in California, though mercury ores are mined in Texas and other states.

Properties.—Mercury is a white metal of very high luster. It melts at -39° and boils at about 360°C . It is slightly volatile at ordinary temperatures. The alloys of mercury are called amalgams. These may be made directly with most of the common metals, though some can only be prepared by decomposing their salts. Silver and gold are especially active toward mercury. The low specific heat, mobility, conductivity and high specific gravity render mercury peculiarly fitted for the manufacture of many forms of scientific apparatus.

Mercury is not oxidized by dry air at ordinary temperatures, but when heated to 350°C . it is slowly converted into the red oxide (HgO). At higher temperatures it is reduced to metallic mercury. Nitric acid and hot sulphuric acid dissolve mercury readily, but hydrochloric acid has very little action with it. The sulphide of mercury is volatile and is readily decomposed by roasting, yielding metallic mercury and sulphur dioxide (the temperature being too high for the existence of mercuric oxide.) Cinnabar is more completely decomposed when heated with lime.

Smelting.—The extraction of mercury from its ores is theoretically a simple matter. It involves the decomposition of the ore by heat and the condensation of the mercurial vapors. The latter problem offers some difficulty. It is necessary that the condenser be spacious, for a very large volume of gases must be dealt with, and that it be impervious to the vapor of mercury, which is poisonous. The condensers can not be made of iron throughout, on account of the acid in the vapors. Any masonry employed must be most carefully constructed. Glazed earthenware and glass are used at some plants.

A great many styles of furnaces have been introduced, and a number are now in use for smelting cinnabar. The ore is commonly decomposed in shaft or reverberatory furnaces through which a forced draft is maintained to drive the products of

oxidation and distillation into suitable condensers. Shaft furnaces have generally met with favor because they are adaptable to the treatment of both coarse and fine ore. Externally heated retorts are seldom used. The Spirek furnace may be taken as a representative of modern furnaces.¹ It consists of a double shaft for decomposing the ore, and a condensing apparatus. The vertical section (Fig. 94) is through one of the shafts and one set of the condensers. The furnace proper is built of brick reinforced with iron. The furnace walls are supported on brick pillars resting on a concrete foundation. Sheets of iron turned up at the edges are placed underneath the pillars to catch mer-

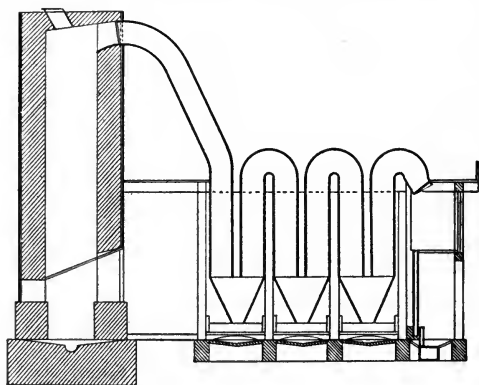

Fig. 94.

cury, and a drain is made in the foundation to prevent loss from leakage. The ore is charged into the furnace from a hopper at the top, a special device being used to prevent the escape of mercurial vapor. The charge is carried on sloping bars which can be removed for taking out spent residues.

Enough fuel is mixed with the charge to decompose the ore and volatilize the mercury. Air is drawn through the furnace by means of a fan. The mercury vapor together with a large volume of sulphur dioxide and other products of combustion is led through the downtake into the condenser. The

¹ The Min. Ind., 1902, 559.

condenser is of sufficient capacity to cool down the gases by contact with its walls until their temperature is below the liquefying point of mercury. It consists of a number of inverted U-tubes, arranged as shown, with the ends opening into hoppers, the funnels of which dip under water. The water is held in iron boxes. The condenser tubes are elliptical in cross-section, and are constructed of iron lined on the interior with concrete. When comparatively cool, the smoke is led into wooden flues in which soot is deposited, and from which a small amount of mercury is obtained. Doors are located at convenient points in the condensers for cleaning.

Mercury is refined by straining to separate undissolved matter, and by redistillation from dissolved metals. Small amounts may be purified by shaking with nitric acid.

Uses.—Mercury is shipped in screw-stoppered, iron flasks, usually weighing 75 pounds each. Its chief use is in the extraction of silver and gold. It is also used for coating mirrors, in amalgams and in the manufacture of scientific apparatus.

CHAPTER XXVI

SILVER

The Precious Metals in History.—Gold and silver are without doubt the first metals known to man. Their use and relative value among different peoples of antiquity would naturally depend upon the supply occurring close at hand, irrespective of the fortunes of conquest and trade. The precious metals were not only known to the old world countries, but were found in the possession of the aborigines of North and South America and many of the islands. The inhabitants of Mexico and South American countries obtained gold and silver in wonderful quantities. In Peru, gold was so abundant that it was far less valuable than copper and other metals. Being more widely distributed in the native state and more easily recovered, gold probably predates silver in the arts, and there is substantial evidence that it was the first metal used as money. Silver coins, dating back 4,000 years are mentioned in the Bible.¹

The most ancient method of recovering gold, and one that is still practiced is that of washing it from river sands and alluvium. The Phœnicians, East Indians and others employed also simple amalgamating methods for extracting gold. When iron tools came into use rock mining was made possible, and consequently, gold and silver were produced in larger quantities. The Egyptians mined gold extensively in the upper Nile region, but they got most of their silver from other countries. The Besharee gold mines of Egypt are among the oldest in the world.

ORES

Native.—Silver occurs native in small quantities, and as such is usually associated with other ores. It is found in Lake copper and, in general, it occurs in silicious rocks, not infrequently with a small amount of gold. Silver amalgam also occurs.

¹ Abram bought from Ephron the field with the cave of Machpelah in which to lay his dead. The price paid was 400 shekels of silver. Gen. xxiii, 16.

Argentite (Ag_2S) is the most common ore of silver. When isolated it is a grayish-black substance, sectile and readily fusible. It occurs in silicious and other rocks, and is often associated with pyrites, galena and other sulphides.

Horn Silver (AgCl) occurs in Mexico and South America, and is often a very valuable ore. The bromide and iodide are also met with.

Tetrahedrite was mentioned under the ores of copper. It is often worked for the silver value rather than for the copper.

Mexico is the leading silver producing country. Silver is mined extensively in the Western states, Colorado leading in output.

PROPERTIES

Silver, when pure, is the whitest of the metals, and it takes a very high polish. It is tenacious, highly ductile and malleable, being exceeded only by gold in the latter property. Being too soft when pure for most purposes, silver is commonly alloyed with copper. The melting point of silver is 950°C .; it alloys with most metals, and readily amalgamates with mercury. While in the molten state silver is capable of dissolving more than 20 times its own volume of oxygen. In conductivity it excels all other metals.

Chemical Properties Relating to Metallurgy.—Silver is not oxidized by air even at high temperatures, but the oxide (Ag_2O) may be formed by heating it with the higher oxides of lead, copper, manganese and other metals. It is precipitated from solutions of silver salts by the caustic alkalies. At 300°C . silver oxide decomposes. Silver is slowly dissolved by the alkaline cyanides. It is readily soluble in nitric acid and less readily in sulphuric acid. It is not appreciably attacked by hydrochloric acid, but silver chloride is formed by the double decomposition of a silver salt with the chloride of another metal or by the direct action of chlorine gas on metallic silver. Silver chloride is soluble in brine, in solutions of sodium or potassium thiosulphate and cyanide and in rather concentrated hydrochloric acid. Silver is reduced from the chloride by nascent

hydrogen, by certain metals and by fusion with carbonate of sodium. If to a solution of silver in sodium thiosulphate, sodium sulphide is added, silver sulphide is thrown down and the thiosulphate is regenerated. Silver has a strong affinity for sulphur. The sulphide is decomposed by oxidizing roasting, converted metallic silver resulting. In the presence of sulphur trioxide silver sulphate is formed. Silver sulphide is converted into chloride by roasting with salt or by treatment with a solution of copper chloride. It is slowly dissociated by cyanide solutions, the silver being dissolved.

EXTRACTION OF SILVER

The processes in use for extracting silver may be classified as follows: 1. Smelting Processes; 2. Amalgamating Processes; 3. Leaching Processes.

1. Smelting

This refers to the smelting of copper and lead ores which contain silver. The silver may be associated naturally and therefore be obtained as a by-product, or the other metals may be used as alloying and dissolving agents. The manufacture of "work lead" affords a good example of this practice. Silver ores are mixed with rich lead ores and the mixture is smelted for work lead, or rich silver ore may be melted with metallic lead. The recovery of silver as a by-product has been noted in the chapters on copper and lead refining.

2. Amalgamating

This method of treatment involves the amalgamation of the silver in the ore; the separation of the amalgam from the ore gangue, and the final separation of the silver from the mercury. Silver amalgam is made directly from the metal or from the chloride. It is necessary that the ore be in a very finely divided state, and in most cases the ore must be chloridized. There are two ways of chloridizing silver ores, viz., in the dry way by roasting with salt, and in the wet way by mixing with the ore a solution of copper chloride.

Crushing.—The ore is first reduced to small sizes in a rock

breaker, and is then subjected to finer crushing in stamp mills, Chilian mills, pans, etc. Descriptions of crushing machinery, other than are given in this chapter, will be found in Chapter VI.

Chloridizing in the Dry Way.—The ore for this method of treatment is prepared by dry stamping, or by pulverizing in other ways, and screening to separate coarse particles. It is charged into reverberatory furnaces and roasted to decompose the base sulphides, a low temperature being employed at first. The excessive sulphur being driven off, salt is added, and the roasting is continued until the silver has been converted, as far as possible, into the chloride. The roasted ore is again screened, and is then ready for amalgamation.

Of the special types of furnaces for chloridizing silver ores Stetefeldt's is the most important.¹ It is a shaft furnace heated by two fireplaces, the flues from which pass into the shaft near the bottom. A mechanical device is used for feeding in the ore at the top, and the bottom of the furnace terminates in a hopper for receiving the ore. The dust-laden gases pass from the top of the furnace into a capacious flue which is inclined at a steep angle. Through this the gases are led into dust chambers, which are also provided with hopper bottoms for discharging the accumulated dust. Salt is volatilized in the fireplaces and the vapors pass into the stack with the flame. The fine particles of ore are roasted and partially chloridized during the few seconds of the descent, though about half of the ore is carried over with the forced draft. A separate fireplace is provided for roasting the ore that is carried into the dust chambers.

Cylindrical roasters are also used for chloridizing silver ores, those of the Brückner and White-Howell types being most common.

Chloridizing in the Wet Way.—This deals with the conversion of silver sulphide into silver chloride by the reactions with cuprous and cupric chlorides. The copper chloride is generally

¹ Stetefeldt's paper, with illustrations—*Trans. Amer. Inst. Min. Eng.*, 43, 3.

made by treating copper sulphate with sodium chloride, the vitriol being contained in roasted or otherwise oxidized ores. The processes of wet chloridation and amalgamation are so closely linked that they are most conveniently studied together. They will be described under the two typical processes of treating silver ores—in the Patio and in the Amalgamating Pan.

The Patio Process.—This process originated in Mexico about the middle of the 16th century. It still survives in its primitive crudeness, owing to the peculiar conditions there. Some of the localities in which silver ore abounds are destitute of fuel and even of water, which could be utilized for power. Labor being exceedingly cheap and cheap transportation not being available to these localities, no more economic process could be substituted.

The ore is broken and crushed in a Chilian mill or stamp mill, and then pulverized in the arrastra. The arrastra consists of a circular, paved floor over which a heavy stone is dragged. The stone is attached to a horizontal beam by means of chains or straps, and the beam is carried on a post which revolves about a pivot in the center of the pavement. A stone curbing prevents the escape of material during the grinding. In some arrastras more than one stone is attached to the moving part. The mill is driven with mules or by water power, if available. Water is added with the ore until it is about the consistency of paste, and if gold is present, mercury is added during the grinding. When ground sufficiently fine, water is added, and the pulp is baled out into reservoirs, where it remains until a large amount of the water has been evaporated by the sun's heat. It is then taken to the amalgamating floor or patio.

The patio is a large, paved court with enough slope for drainage. The ore is spread on the patio in circular, flat heaps called *tortas*. The larger heaps are upwards of 1 foot in depth and 50 feet in diameter and contain 100 tons or more of ore. The heaps are prevented from further spreading by means of curbing. Salt is shoveled into the *torta* and the treading is be-

gun. A number of mules are driven around on the torta for several hours. The treading is resumed next day with the addition of magistral (copper sulphate) and mercury. The work is fatiguing to the animals, and is injurious to the feet. The time required to work off a torta is from 15 days to more than a month, depending on the condition of the ore. Some ores amalgamate naturally more freely than others, and the rate of amalgamation is greatly increased by increasing the temperature of the material. The torta is not heated artificially except by the chemical action of the substances added.

The next operation is the separation of the silver amalgam. A quantity of mercury is generally added to collect the hardened grains. The ore with the amalgam is then transferred to settling vats, where it is made thin with water and stirred to collect the amalgam. The gangue, which is the lighter material, is kept in suspension and is drawn off with the water. The amalgam is further cleansed of heavy particles of ore, and then strained and distilled.

Only about 75 per cent. of the silver in the ore is recovered by the patio process. The loss of mercury is high, some being lost mechanically and some by the chemical action of sulphides and chlorides in the ore. The amount of mercury to be used in each operation is determined by first amalgamating a small amount of ore, or better, by first assaying the ore for silver. A loss of mercury which would result from the addition of an excess of the chemicals may be prevented by adding lime to the torta.

The Washoe Process.—This process is operated on much the same principle as the patio process, but the ore is treated much more rapidly and with greater economy and efficiency. The work is done almost entirely by machinery, including the preparation of the ore and the final separation of the amalgam. The machinery consists chiefly of rock breakers, stamp mills, concentrators, amalgamating pans and settlers. The rock breaker and stamp mill are illustrated and described in Chapter

VI. The ore is crushed wet and to such a degree of fineness as will pass through a 30-mesh sieve.

The crushed ore is conveyed by the stream of water through the mortar sieves into settling tanks.¹ A series of these tanks is arranged in front of the stamps in sufficient number to take the entire output of pulp. After filling two or three tanks the stream of pulp is turned into another set, while the solid matter in the first slowly settles. The water is drawn off when it has cleared sufficiently, and the pulp is transferred to the pans for fine grinding and amalgamating.

The Amalgamating Pan is of the construction shown in Fig. 95. It is a circular vessel having an inside diameter of about five feet. The bottom is of cast iron, and the sides are constructed of wooden staves held at the bottom by the casting itself and above by iron hoops. Some smaller pans are made entirely of iron. A vertical shaft, having its bearings in a cast iron cone or cylinder bolted to the bottom of the pan, revolves and carries the agitating and grinding device known as the muller around with it. The muller is a flat, cast iron ring supported by spreading arms which are attached to the upper end of the shaft. The muller is adjustable at different distances from the bottom of the pan by means of the screw and hand wheels at the upper end of the shaft. The lower end of the vertical shaft carries a miter wheel which gears into a corresponding wheel on the horizontal driving shaft. If the pan is to be used for grinding, the muller is armed with adjustable and renewable shoes and the bottom of the pan with dies, which take the wear. A steam pipe is let into the side of the pan for introducing steam to heat the pulp. Some pans are provided with steam jackets underneath. The pan is covered and has an outlet from the bottom for drawing off the pulp.

As the pulp is charged into the pan, water is supplied from a hose. The muller is raised and revolved at the rate of 60 revolutions or more per minute, and is lowered as the ore be-

¹ Ores containing sulphides of iron, etc., or any which may be concentrated with advantage by washing are run over vanners before settling.

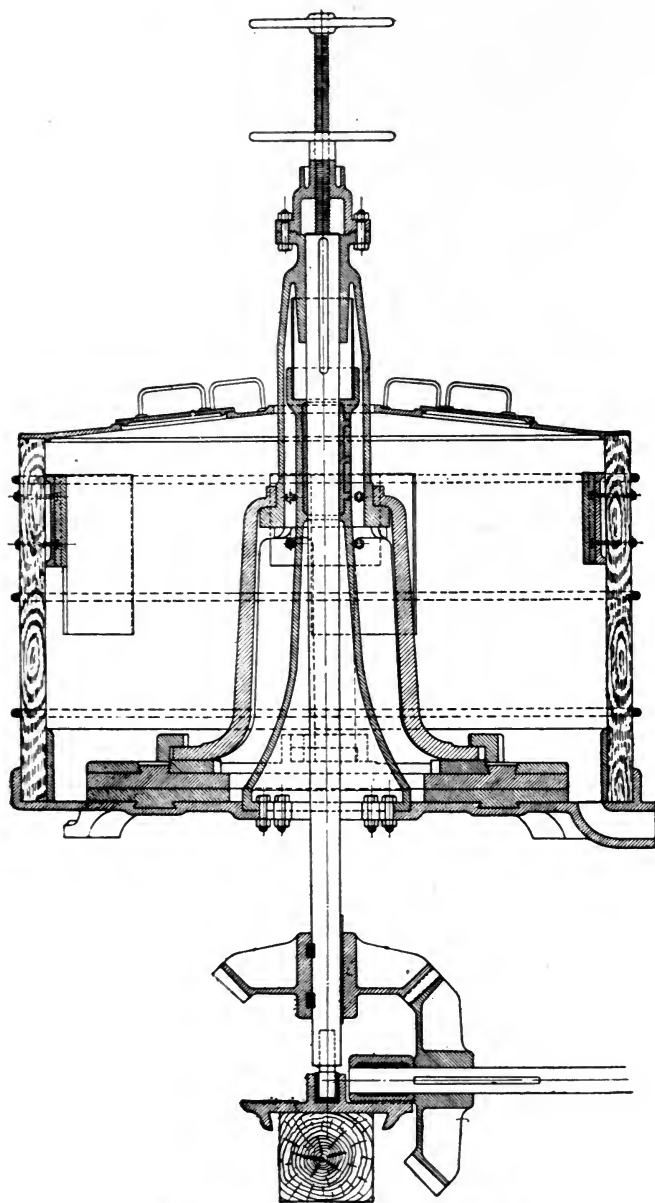

Fig. 95.—Amalgamating Pan. (Allis-Chalmers Manufacturing Co.)

comes finer. In the course of an hour or two the ore is fine enough for amalgamating. It is heated and mercury is added in sufficient quantity to alloy with all the silver and remain liquid. Copper sulphate and salt are added either at the beginning of the grinding or with the mercury. The muller is raised somewhat when the mercury is added to prevent "flouring," and the motion is maintained for two hours longer while the amalgamation is in progress. The speed of the muller is checked toward the end, and when the amalgamation is completed the pulp is drawn off into the separator.

The Settler or Separator is somewhat like the pan in construction, except that it is not designed for grinding. The bottom, which is of iron, slopes to one side to allow the mercury to collect. In the side of the settler and at different levels are holes for drawing off the pulp. These are closed with plugs when not in use. The settler is placed near the pan and on a lower level to facilitate the transfer of pulp.

The pulp in the settler is thinned with water and is stirred for some time with the muller. This effects a separation of the heavier particles, which settle and remain undisturbed on the bottom, while the lighter material is prevented from settling. The pulp is drawn off by removing the uppermost plug and the others successively, and finally the amalgam with the heavy particles of ore, is run out from the bottom. The pulp carries some silver and mercury, and is treated in secondary settlers ("agitators") or run over concentrating tables.

The amalgam is collected from a number of pans and settlers, and is further cleansed in a small pan (the "clean up pan") with the addition of more mercury and water. The amalgam is then strained through canvas bags and squeezed to remove the excess of mercury. The mercury contains silver and is returned to the pans. The solid amalgam cake is distilled.

The Retort for distilling the mercury is an iron cylinder, three to five feet long and one foot in diameter. It is supported vertically or horizontally in a suitable heating furnace. One end

of the retort is open to receive the charge, and is closed during the distillation by a close-fitting iron door. The other end communicates with an iron tube which carries away the mercury vapor. At a short distance from the furnace the tube is bent downward, and the end dips under water. The incline of the tube is cooled by passing it longitudinally through a larger tube in which water is kept circulating. By this arrangement air is prevented from entering the retort, and the mercury is condensed and received in the basin of water. The charge for a retort of the above dimensions is about 1,200 pounds, yielding about 200 pounds of silver.

The Washoe process is modified in different localities to suit the conditions. In this country the Boss process, which is one of recent development, has proved very successful. It is a continuous process, employing a series of pans for grinding the pulp from the stamps and another series of amalgamating pans and settlers, doing away with the tanks. Pan amalgamation is also practiced in connection with dry crushing and roasting. The ore having been chloridized in the dry way, is ground and amalgamated in pans as in the Washoe process. The yield of silver may be as high as 97 per cent., while 85 per cent. is considered the highest yield that can be reached with profit by the Washoe process.

Barrel Amalgamation.—The amalgamation of ores in barrels was begun in Europe more than a hundred years ago. It is still practiced, and is used to some extent in this country, chiefly for the treatment of roasted ore. The barrels are usually made of white pine, strengthened with iron, and lined on the inside with blocks of wood placed so that the wear is on the end of the fibers. The barrel is supported on trunnions, one of which is hollow for the admission of steam. It is rotated by water or other power. There is an opening in the side of the barrel for introducing and withdrawing the charge, the opening being closed with a wooden stopper when not in use.

A charge of a ton of ore, and usually some scrap iron in

small pieces are introduced with enough water to make the mass flow, and the barrel is driven at the rate of 15 revolutions per minute for two hours. Mercury is then added and the barrel is rotated for from 18 to 20 hours. The pulp is heated with steam to hasten amalgamation. A few hours after the operation is begun the charge is examined, and if necessary, water or roasted ore is added to bring it to the proper consistency. At the end of the operation water is added and the barrel is turned very slowly to allow the mercury to collect. The main portion of the amalgam can then be drawn off separately. The pulp is received in a large agitator, in which any remaining amalgam and mercury are separated. The treatment of the amalgam is the same as in other processes.

Chemistry of Chloridizing and Amalgamating Processes.—Considering first the conversion of the ore by roasting with salt, it is perhaps impossible to properly express the chemical changes here involved by equations. The reactions probably differ somewhat between slow and rapid conversion. If the salt is added after a preliminary roasting, as is generally done in reverberatory furnaces, there are two distinct stages in the conversion. First the base metals are converted into sulphates and oxides, and the silver into sulphate. During the second stage the sulphates react with sodium chloride, forming chlorides of the respective metals and sodium sulphate. Some of the sulphates decompose with the liberation of sulphur trioxide. This reacts with sodium chloride, forming chlorine, or if water is present, hydrochloric acid. The chlorine would attack any metallic silver with which it came in contact. The chloridizing may be finished in the furnace, though in rapid conversion the ore is exposed to actual furnace heat for but a few seconds. In the Stetefeldt furnace the chloridation of the ore is but little more than half completed during the descent. If it is withdrawn and allowed to cool gradually as much as 95 per cent. of the silver may be converted into chloride. (Schnabel.)

The following are essential chemical changes occurring during the wet chloridation of silver ore:

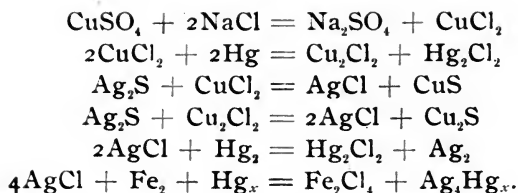

With the exception of the last, these reactions are common to all amalgamating processes. By the last reaction it is seen that there is a saving of mercury in the use of iron. Iron is purposely added in the barrel process, and in the pan process it is derived from the mortars, pans, etc. Egleston has estimated that for a ton of ore crushed $3\frac{1}{2}$ to $6\frac{1}{2}$ pounds of iron are worn from the battery and from $7\frac{1}{2}$ to 11 pounds from the pan.

3. Leaching

The leaching or so called *wet methods* depend upon the conversion of the silver, if necessary, into soluble form, leaching it from the ore, and subsequently precipitating it from the aqueous solution. They are used chiefly for ores containing large quantities of foreign sulphide. The processes are commonly named after their inventors or improvers.

Ziervogel Process.—The ore is carefully roasted, beginning with a low temperature, to convert the silver into sulphate. The roasted ore is lixiviated with water to dissolve the sulphate, and the silver is precipitated with copper, the copper being recovered by precipitation with scrap iron. This process is adaptable only to ores containing iron, copper or lead, since the sulphate of silver can not be readily formed directly by roasting.

Augustin Process.—The ore is roasted and chloridized with salt. It is then lixiviated with a saturated solution of salt which slowly dissolves the silver chloride. The silver is subsequently precipitated from the solution with copper. The process is seldom used.

Patara Process.—In this process the silver is chloridized by roasting with salt, the chloride is dissolved in a solution of

sodium or calcium thiosulphate, and silver sulphide is precipitated from this solution by adding sodium or calcium sulphide.

The ore is lixiviated in large wooden vats provided with false bottoms, over which filtering cloth is spread. The solution is conducted from the bottom of the vat into the precipitating tank by means of pipes. If the ore contains a large amount of foreign matter which is soluble in water it is first leached in the vat with cold water. The thiosulphate solution is run on the top and allowed to percolate through the mass of ore until the silver has been dissolved out as far as is practicable.

The precipitation of the silver sulphide is hastened by agitating the solution with wooden stirrers or by means of compressed air. The following equations show the principal chemical changes in the solution and in the precipitation:

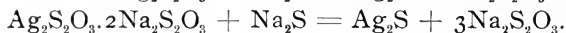
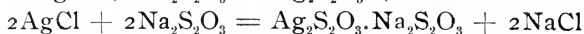

The strength of the thiosulphate varies from $\frac{1}{4}$ to $1\frac{1}{2}$ per cent. of the salt, depending upon the richness of the ore. Strong solutions are objectionable since they dissolve more of the base, metallic compounds in the ore.

The precipitate is separated by filtration, and is either dried and smelted, or dissolved in hot, concentrated sulphuric acid, from which solution the silver is precipitated with copper. (Dewey-Walter Process.)

The Russell Process is a modification of the Patera process. It is used in connection with the latter for recovering silver from incompletely roasted ores and for treating ores containing galena and blende.

The ore is chloridized and leached as in the Patera process. Without removing the ore from the vat it is further leached with a solution of copper-sodium thiosulphate which dissolves the undecomposed silver sulphide—

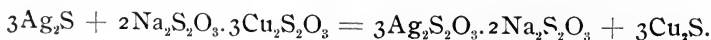

The solution of the double salt requires to be circulated through the ore for a long time as its action is very slow.

With ores containing galena the lead is dissolved by the thio-sulphate solution and appears with the silver in the precipitate, and subsequently in the bullion. Russell's method for getting rid of the lead is to add sodium carbonate to the thiosulphate solution, and to filter off the precipitated lead carbonate. This necessitates the use of the sodium salt in the solution of the ore, since calcium would be precipitated by sodium carbonate.

Zinc is dissolved in the preliminary, hot water leaching, being converted into sulphate by the roasting.

The Cyanide Process.—Cyanide of sodium or potassium may be used to dissolve metallic silver and most of its mineral compounds. A double cyanide of silver and the alkali metal, soluble in water, is formed, and from the solution the silver may be precipitated with zinc or other substances. The cyanide process is described in the chapter on gold.

SILVER REFINING

The silver which has been obtained by the distillation of amalgam or by the cupellation of the lead alloy is further purified by remelting with the proper fluxes for removing the base metals. The silver is melted in graphite crucibles, the crucible being heated in a muffle furnace. If base metals are present niter is added to oxidize them and the oxides are dissolved by adding borax. If lead is present it is removed by throwing some bone ash over the surface of the molten silver, the lead oxide that forms being absorbed. The bone ash with any dross is easily skimmed off without loss of silver by first fluxing it with borax. The silver is not kept in the furnace any longer than is needed as there would be loss from volatilization. It is cast into molds and kept covered with charcoal while cooling to prevent the absorption of oxygen. Electrolytic refining has been developed for the purification of silver and is now in general use. The process is given on p. 340.

CHAPTER XXVII

GOLD

Ores.—Gold is only known to occur native and in combination with tellurium. Telluride ores have been met with in various localities, but they are rarely of importance. Native gold is generally alloyed with silver and often occurs with pyrites, galena and other sulphides. It also occurs in oxidized ores, is often in quartz and in other rocks. Gold ores are either found in rock mass (reef gold) or beds of earth and gravel (alluvial gold). Alluvial deposits are commonly called *placers*. They have been carried down by water from disintegrated gold-bearing rocks. The gold is generally found in the form of small grains or scales, disseminated through the rock mass or mingled with the sands. The larger pieces sometimes found are called *nuggets*.

Gold has been mined in almost every country. The richest deposits so far known are those of Australia, South Africa and North America. Most of the gold in the Western Hemisphere has been found along the Pacific slope. It occurs all the way from Alaska to Chili, the richest deposits being in Alaska and California.

Properties.—Gold is easily recognized by its distinct yellow color, malleability and insolubility in acids. While of a yellow color in mass, finely divided gold or gold leaf shows colors in variation from green to blue and red by transmitted light. The tenacity of gold is about the same as that of silver, and in malleability and ductility it exceeds all other metals. A film of gold has been reduced to $1/870,000,000$ inch in thickness. The melting point, as determined by different experimenters, varies somewhat, the average falling a little below $1,100^{\circ}$ C. At high temperatures it is perceptibly volatile, the volatility being increased by the presence of other metals. Gold alloys with the common metals and is readily amalgamated. It absorbs various gases, even in the solid state, when heated to redness. It is a good conductor of heat and electricity. The specific gravity is 19.3.

The presence of but minute quantities of most metals renders gold brittle. The metals which have the most marked effect upon the properties of gold are lead, bismuth, arsenic, antimony and tin. Silver and copper and the metals of the platinum group harden gold but do not seriously affect its malleability when alloyed in small proportions. Copper is commonly alloyed to prevent the rapid wear of gold in jewelry, coins, etc.

Chemical Properties.—Two oxides of gold are known, but neither can be prepared directly from the metal and oxygen. The telluride of gold is decomposed by oxidizing roasting, gold being liberated and tellurium being evolved as oxide. Gold is not dissolved by any single acid, but it is dissolved in the presence of chlorine, bromine, thiosulphates and cyanides. Dry chlorine does not attack gold unless it be in the form of leaf or powder. Gold is readily precipitated from its solutions, and all its compounds are decomposed by heating in the air.

THE EXTRACTION OF GOLD

The metallurgy of gold is closely allied to that of silver. The methods for its extraction might well be classed in a similar way, an exception being allowed for the recovery of gold by simple washing processes.

I. Washing

Washing processes refer to the recovery of gold by settling it from a suspension of the ore in water. Such methods are not of much significance, though they are widely used by unprogressive people and serve to some extent the purposes of prospectors. Mention only is made of the washing in pans and by means of the cradle and the tom. The pan is usually a shallow, sheet iron vessel with a depression in the bottom for retaining the gold. The pan with the earth is held under running water and given a rotary motion. The gold settles and the lighter material is carried away with the stream.

The cradle is a trough-like box, mounted on rockers and inclined slightly. On the bottom of the box are riffles and above the bottom is a sieve. As the ore is thrown on the sieve with

water the fine material is washed through and flows down the inclined bottom. The earthy matter is carried over the riffles and the heavier gold particles are caught. The settling of the gold is aided by rocking the device.

The tom works somewhat on the same principle, though it is of different construction. It consists of two stationary, inclined troughs so placed that the one delivers the stream into the other. The upper trough, which receives the ore, is provided with a sieve at the lower end to prevent gravel from passing out. Sufficient water is run into the upper trough to sluice out the ore. The stream passes over riffles in the lower trough and deposits a part of the gold. The length of the tom varies, being upwards of 30 feet.

All purely washing methods are wasteful, often recovering only half of the gold. They are used by Chinese for working the tailings of some larger operations in California.

2. Smelting

Gold that is associated with the base metals, copper and lead, is recovered as a by-product when the ores of these metals are smelted. In some instances, gold ores are treated by mixing them with rich lead ore and smelting for work lead.

3. Amalgamating

The treatment of ores bearing precious metals varies greatly, owing to their variation in value and in physical condition. Gold and silver amalgamation processes are in many cases identical, but the amalgamation of gold is usually a less difficult problem, and may be accomplished by simpler means. Gold ores are classed as "free milling" and "refractory," the former being such as may be amalgamated without preliminary treatment other than crushing. Of the gold amalgamation processes the most important are those of hydraulic, dredging and milling.

Hydraulic.—This process comprises both the mining of the ore and the extraction of the gold. It consists in wearing down the bank of ore by means of a spray of water under powerful

pressure, and conducting the stream through sluices to deposit the gold. Mercury is placed in the bottom of the sluices to collect the gold.

The water for hydraulic mining is brought from upper country, often many miles distant, in conduits or flumes, and is delivered at the work in an iron pipe about 30 inches in diameter. The water is led to the proper position in smaller pipes which are provided with movable nozzles called "monitors" or "giants." The direction of the stream is determined by an attendant.

Sluices vary much in length. The average is about 1,200 yards, though some are several miles in length. The width is 3 to 6 feet and the depth about $2\frac{1}{2}$ feet. The sluice is built of plank and given an incline of about 6 inches for each 12 feet, or more for sluggish material. The bottom is paved with wooden blocks, or more commonly, with stone. The spaces between the stones are partly filled with fine gravel and upon this the mercury is poured. The stream runs through a grizzly to separate boulders which should not be carried into the sluice.

The greater part of the gold is retained in the first hundred feet of the sluice. At intervals the mercury is removed, and at long intervals the entire pavement is taken out and the mercury recovered. The amalgam is washed and the gold is separated by one of the usual methods.

Hydraulic mining has been stopped by law in many localities on account of the injury to agricultural interests. The chief damage has been due to the filling of river channels with the enormous quantity of tailings from the sluices, resulting in a submerging of the low lands. The practice has been followed chiefly in California.

Dredging.—This process, like hydraulic mining, is more of a mining than a metallurgical proposition. It has been substituted for hydraulic mining in some localities, being of more recent development, and is now managed so as not to seriously injure agricultural lands.

The dredge is a huge machine for raising, concentrating and amalgamating soft ores. The ore is raised by bucket belts, dip-

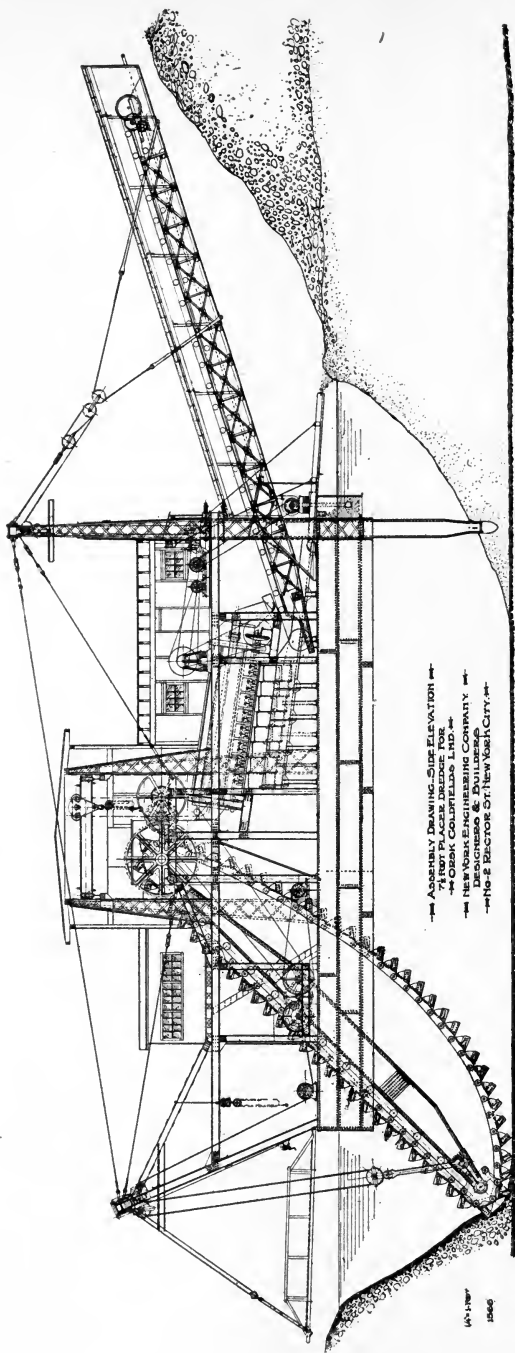

Fig. 96.—Gold Dredge (New York Engineering Co.)

pers or other means, and is delivered to the concentrating and amalgamating apparatus. The entire machinery is floated on a



Fig. 97.—Gold Dredge. (New York Engineering Co.)

scow, so that it is easily moved. The dredge can only be used on river bottoms or inland so far as it can dig its way and be fol-

lowed by the water. In some instances water is pumped to higher levels to float dredges.

Milling.—This has reference to those processes in which the ore is crushed before amalgamating. Of the different mills employed for crushing gold ores but two need be mentioned here—the stamp and the Huntington mills.

Stamp mills, designed especially for crushing gold ores, differ in but few details from those used for silver ores. With free milling ores amalgamated copper plates are fastened lengthwise and inside of the mortar, and the stream of pulp is led from the mortar over additional plate surface, and finally through sluices or concentrators. A small amount of mercury is usually fed into the mortar. The plates are prepared by rubbing mercury over the clean surface to form an amalgam. A better amalgamating surface is made by first plating the copper with silver. The plates are more effective after some gold amalgam has been formed. Brass plates, containing 60 per cent. of copper and 40 per cent. of zinc (Muntz metal), have been used lately with good results.

The first plate, which is necessarily the width of the battery, is called the "apron." It is contracted in width toward the lower end which is about 15 inches wide. The number of plates employed depends upon the capacity of the mill and the richness of the ore. The pulp passes from the plates into a sluice lined with amalgamated plates, and thence over riffles in which mercury is placed. The plates near the stamps are scraped at least once a day, and those farther down at longer intervals to remove the amalgam. They are cleaned afterwards with cyanide of potassium and rubbed with mercury.

The tailings from the sluices may be concentrated on tables or vanners and amalgamated in pans or by means of other amalgamating machinery. Vanners are commonly used for concentrating ores containing sulphides. Concentrates which can not be readily or profitably amalgamated may be treated by one of the leaching processes.

The gold amalgam, as obtained above, is first washed with

mercury, and then, after squeezing out the excess of mercury, it is retorted. The methods used are the same as those for treating silver amalgam.

The stamping of free milling ores is open to objections. The mineral matter is ground into the particles of gold, rendering them less readily absorbed by the mercury. This also causes a larger portion of the gold to float instead of coming in contact with the copper plates. Furthermore the loss of mercury is high, due to "flouring" and "sickening." By the former term is meant the loss of minute globules formed mechanically, and the latter term has reference to the darkening of the mercury due to a coating of mineral matter. These difficulties are overcome in a measure by crushing in roller mills. The Huntington mill has given satisfactory results, especially for the softer ores. For the illustration and description of this mill see p. 76.

4. Leaching

Plattner Process.—The gold is converted into a soluble chloride by the action of chlorine in the presence of moisture. This is leached from the ore with water, and the gold is precipitated with ferrous sulphate, charcoal, hydrogen sulphide or other agents.

The process is adaptable to many ores and concentrates which can not be treated by an amalgamating process on account of the impurities they contain. The ore is commonly calcined or roasted to render it more porous, or to oxidize sulphides, arsenides, etc., which cause a high consumption of chlorine by their reaction with it. Sintering of the ore is avoided as particles of gold would be enveloped in the inert mineral matter. Also, ores containing much silver are more difficult to treat, owing to the protective coating of silver chloride upon the gold.

The chlorine is either prepared in a generator from manganese dioxide, sodium chloride and sulphuric acid, or in the same vessel with the ore from chloride of lime and sulphuric acid. The former method is more common. The chloridizing vat is generally made of wood with a protective coating of tar. The vats hold from two to five tons of ore. Some are arranged for

agitating the ore and for maintaining it under pressure during the chloridizing. The action of the chlorine is thereby made more rapid and more complete. The moist ore is subjected to the action of chlorine for about two days, or less time if the ore is agitated. The vat is then uncovered, and after blowing out the excess of chlorine, the ore is leached with water which dissolves the chloride of gold. Any mineral matter which is carried through is removed by settling or by filtration, and the solution is run into the precipitating tank. The precipitating agents which have so far been used successfully are ferrous sulphate, hydrogen sulphide and charcoal.

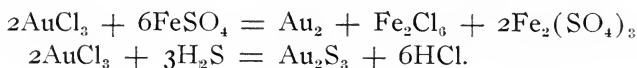

The reaction with charcoal is not understood, though it is supposed to be due to the reducing gases it contains. It is slower in its action than the other reagents and does not precipitate the gold at all in the presence of free chlorine. The solution is filtered through charcoal powder until the gold is exhausted. The charcoal is afterwards burnt, and the gold is recovered from the ashes.

Ferrous sulphate is added to the tank and thoroughly agitated with the solution. After standing, the supernatant liquid is decanted off and the gold residue is collected, washed and refined in crucibles. The liquid which is drawn off is allowed to stand for some time in a settling tank, since it will throw down more gold. It is finally filtered through sawdust or sand from which the gold is recovered.

The precipitation with hydrogen sulphide is a more recent practice, and is more rapid than the other methods. Free chlorine is first removed from the solution in the tank by passing through it a stream of sulphur dioxide, and this is followed by the hydrogen sulphide. Both reagents are generated at the plant and used in the form of gas. After settling, the bulk of the solution is decanted off, and the precipitate is recovered by filtration. The residue is dried and smelted.

The Cyanide Process.—It has been known for perhaps a century that gold is soluble in cyanide solutions. Considerable attention was given the subject by scientific investigators during the middle of last century, and about the same time Elkington patented a process for plating with cyanide solutions of gold and silver. The growing necessity for a more efficient method of treating low grade gold ores led to a great deal of experimenting and to many attempts to commercialize a cyanide process. The first successful process was worked out in Scotland by MacArthur and Forrest, their success being due to the efficiency of their method in the use of a weak solution and of fine zinc shavings for precipitating the gold. Since the first installation of the cyanide process under the MacArthur-Forrest patents in 1889 progress has been rapid, the process being now used in all gold-producing countries and in a large measure replacing other processes. Enormous quantities of low grade ores, which could not be successfully treated in any other way, are now leached with cyanide, and this method continues to grow in adaptability and importance.

The cyanide process may be employed, provisionally at least, for extracting gold and silver from all their ores, its limitation being determined by economic considerations. It is of primary importance that the gold be in the form of very thin flakes or fine grains, and that the ore be so finely ground or so porous as to expose the metallic particles to the action of the solution. It is very common practice to treat ores by combined amalgamating and cyanide processes.

The principal operations in the cyanide process may be stated as follows: Preparation of the ore, solution of the gold and silver, separation of the solution, precipitation of the gold and silver, smelting the precipitate. The flow sheet of a cyanide process is shown in Fig. 98.

Preparation of the Ore includes crushing and any dressing or concentrating process that may be employed prior to cyanidation. Rock breakers, stamps and the different types of mills equipped with rolls are used for crushing and pulverizing the ore. Both

dry and wet crushing are in practice, the latter being much more common. The crushing is not infrequently performed in a cyanide solution, the time required for treating the ore being shortened by this practice, and there is the further advantage that the solution applied later is not diluted as is the case after

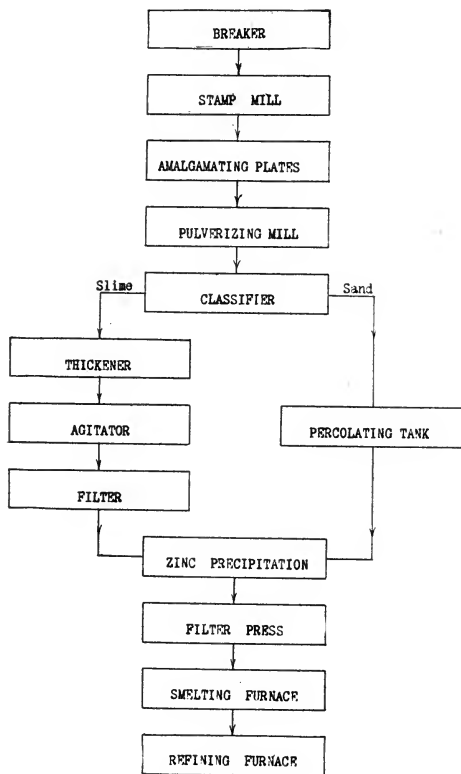

Fig. 98.

crushing in water. Sometimes the ore is calcined or roasted. Heating clayey or talcose ore gives it a more granular and porous texture, which may greatly facilitate the leaching operation. The removal of sulphur by roasting shortens the time required for leaching, and may increase the yield of values considerably. Telluride of gold and sulphide of silver are decom-

posed, and in general, the precious metals are liberated from refractory compounds in which they are intimately held chemically or mechanically. But roasting methods have been dispensed with in many instances in which very fine grinding is practiced. Roasted ores or those that have been subjected to atmospheric oxidation usually contain acid salts of base metals which would react with the cyanide reagent and destroy its useful work. Such ores are given a preliminary washing with water or lime may be added to neutralize any acid or cyanide present.

Hard ores which crush to sands are more readily leached by percolation, while soft ores which form slimes can be leached more advantageously by lixiviation. A great many ores are composed of both sand and slime-forming materials. After grinding these are classified, and the products are treated separately by the appropriate methods. If enough free-milling gold is present the pulp is caused to flow over amalgamating plates before leaching.

Solution of the Gold and Silver.—Since the solution of gold in potassium cyanide is not rapid, the ore is kept in contact with the solution for a considerable length of time. The reaction is hastened by introducing air with the cyanide. Oxygen is essential, as has been demonstrated both by experiment and in practice. According to Elsner the essentials of the reaction are as follows:

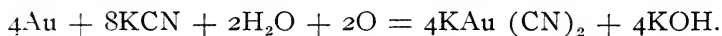

Chemical oxidizing agents such as the chlorates, peroxides and the halogens may be used with good effect. The solution of metallic silver is analogous to that of gold. The solution of silver sulphide may be expressed as follows:

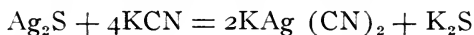

There are two distinct methods of applying the cyanide solution to the ore, *viz.*, by percolation and by lixiviation.

Percolation is effected in wood or steel tanks varying in capacity from 5 to 500 tons or more. Shallow tanks are favored, since in deep ones many ores would pack and become impervious. The ore is supported on a false bottom upon which is laid cocoa

matting and upon this a filter cloth is spread. The tank is provided with a drain pipe, which is fitted with a regulating valve, and in some instances compressed air is used for agitating and aerating the charge. The ore is leached by covering it with the solution and drawing this off after giving it time to dissolve the gold and silver. Oxidation is effected by introducing compressed air or by drawing off the solution to allow air to enter by the pores thus opened. It is essential that the ore be evenly distributed in order that percolation shall be uniform. If the tank is filled with wet pulp some device is needed to offset the sorting action of water. A common and effective distributor consists of a revolving, funnel-shaped vessel, which is suspended centrally over the tank, receiving the pulp and discharging it through a number of projecting arms of different lengths. At their discharging ends these arms or pipes are bent at right angles, and the revolving motion is given the distributor by the pressure of the outflowing pulp against the atmosphere. The surplus water is removed from the pulp, and it is leached first with a strong solution, containing 0.2 per cent. or more and then with a weak solution, containing 0.1 per cent. or less of cyanide. Each solution acts as a wash for the previous leaching, and the successive leachings are continued so long as it is profitable.

With ores that are crushed and put into the tanks dry there is obviously no separation of sand from slime, and if much slime is present the ore may be improved for percolation by mixing sand with it. The first solution is generally added to a dry-filled tank from the bottom, since by this method there is less tendency toward the formation of channels with the attendant irregularities, and besides, time is saved, for the solution may be let in at the beginning and be well up to the surface of the ore when the tank is filled.

Lixiviation methods are used with slimes and ores which contain much alumina or other matter which makes percolation difficult. Lixiviation is favored at the present time as is shown by the rapid development of the "all sliming" processes. In these the ore is completely reduced to slime and leached by lixiviation

exclusively. In order that the cyanide solution may not be diluted too much, the slime from the classifier is thickened by removing the excessive amount of water. A number of methods for agitating the pulp with the solution have been devised. In some it is effected by means of compressed air, and in others the solution is circulated. Mechanical stirring is also common.

Separation of the Solution from the spent ore is accomplished in the percolation tank by gravity flow through the filter bed provided, and no special accessory apparatus is required. The nature of slimes renders the separation from them more difficult. The solution is separated from this class of material by decantation and filtration, often by a combination of the two methods. The filter press was introduced in early practice, and it is still extensively used, but the leaf filter is now more common. The feature that is common to the many different makes of this appliance is the filter leaf. This is a stout frame over which filter cloth is stretched and through which the solution is forced by suction or pressure. A filtering appliance makes use of a number of these leaves, which in some are stationary and in others movable. In either case the filter leaf is submerged in the solution and pulp while the suction or pressure is exerted to force the solution through. A cake of pulp forms upon the leaf, and before this becomes too thick and impervious the filtering operation is interrupted, wash water is drawn through it, and then the cake is detached and discarded.

Precipitation of the Gold and Silver.—The precipitant most commonly employed is zinc either in the form of fine shavings or smelter dust.¹ The shavings are cut on a lathe from the edges of plates of zinc, which are held together while being turned. The shavings are supported on wire screens in compartment boxes as shown in Fig. 99. The boxes are made of wood and painted on the inside with paraffine. The solution is supplied through the pipe shown at the left. It passes under the first partition and overflows the next, and so on, rising through each compartment in which the shavings are contained. The

¹ See p. 300.

spent solution is carried away through the overflow pipe shown at the right. For drawing off the precipitate and cleaning up, each compartment is provided with a drain pipe in the bottom.

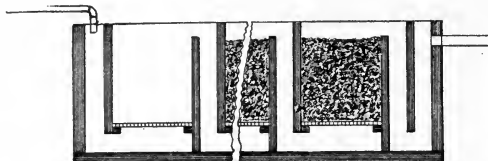

Fig. 99.

The gold is precipitated in the form of a black powder adherent to the zinc. This falls down to the bottom of the boxes with particles of zinc as slime. Metallic silver also is precipitated with the gold.

There is some doubt as to the changes involved in the precipitation of gold, though it is supposed to be electrolytic. That it is not simply a substitution of zinc for gold is shown by the fact that the weight of zinc dissolved is not a chemical equivalent of the gold precipitated. The substitution would be as follows:



In practice about 12 ounces of zinc are required for 1 ounce of gold deposited. The gold is never recovered completely though as little as four per cent. may be left in the solution. Impurities affect the precipitation, and when the solutions become heavily charged they are purified or rejected. Copper in the solution is deposited upon the zinc, retarding the deposition of gold. Since strong solutions react with the zinc more rapidly than weak ones do, cyanide is sometimes added to the solution as it comes from the leaching vat. It is essential that the zinc be in finely divided form, hence the use of thin shavings. Furthermore, the action is not rapid until the surface of the zinc has become etched by the solution.

The use of zinc dust was proposed early in cyanide practice, and though the results were unsatisfactory at first, it is now in

general use. The dust is emulsified with water, and is mixed with the solution as it flows to the filter press. Practically complete precipitation takes place immediately. Dust has the advantage over shavings of mixing more quickly and intimately with the solution, insuring rapid and complete precipitation, and the harmful effect of the copper coating is offset by the constant supply of fresh zinc.

Another substitute for zinc shavings is the zinc-lead couple, prepared by immersing the shavings in a dilute solution of lead acetate. The lead-coated shavings are transferred immediately after preparation to the gold solution. This method has the advantage of being very rapid and of not precipitating copper. The gold residue contains a large amount of lead, which is objectionable.

Electricity in the Cyanide Process.—Electrolytic methods are of later origin, but they are being used quite successfully. Two processes will be noted.

The Siemens-Halske process, which has been used chiefly in South Africa, is applicable solely to the treatment of the gold solution. The ore is leached as in the ordinary cyanide process, and the solution is electrolyzed in wooden boxes 18 feet long, 7 feet wide and 3 feet deep. In these are suspended 89 sheet iron anodes and 88 cathodes of sheet lead. As the solution is circulated through the boxes it is subjected to the action of the current, and the gold is deposited upon the lead. The anodes are enclosed in canvas to hold the compounds that are formed by the action of the cyanide on the iron.

In the Pelatan-Clerici process, developed in this country, the solution is electrolyzed while it is in contact with the ore. The process is therefore a single operation. The ore is mixed in the vat with enough water to make it quite liquid, and it is stirred while solution and precipitation are in progress. A rotating agitator is employed, to the arms of which the iron anode plates are attached. The cathode is a circular plate of copper, covered with mercury, and it is supported horizontally a few inches below the anode. Besides the cyanide certain

chemicals are added to aid in the solution. About three tons of ore are treated at once, and the precipitation proceeds very rapidly. The gold and silver are deposited as amalgams. The exhausted material is drawn from the bottom of the vat and run into a settler from which the solution is recovered.

Explanations of the electrochemical changes of the cyanide process are largely conjectural. Potassium cyanide in solution is decomposed into cyanogen and potassium, and water into hydrogen and oxygen. Potassium and water combine to form caustic potash, with the liberation of hydrogen, while hydrogen and cyanogen form hydrocyanic acid. The double cyanide of gold and potassium is split up into cyanide of gold and potassium hydroxide, and gold is precipitated, probably by the action of hydrogen—

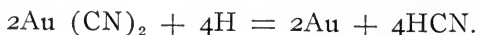

Potassium cyanide may be regenerated by the reaction of hydrocyanic acid and potassium hydroxide. According to the theory of electrolysis the gold is dissolved only at the anode, though solution may take place away from the anode by independent chemical action. The fact that oxygen is liberated at the anode gives ground for the view that chemical action is assisted by the current, thus:

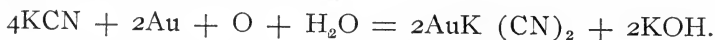

The solution of the gold is much more rapid in the electrocyanide process than by the action of cyanide alone.

The chief advantages of the electrolytic methods are that time and labor are saved, the cyanide is economized and zinc is dispensed with entirely. The gold residue is much cleaner than that obtained by zinc.

Among the various other substances that have been used to precipitate gold and silver from cyanide solutions are zinc amalgam, aluminum, charcoal and cuprous salts.

The spent cyanide solution is pumped into a storage tank and restandardized for further use.

Treatment of the Auriferous Residues.—Gold that is de-

posited upon zinc is removed, as far as possible, by shaking the shavings in water and sifting. The residue is dried and smelted, or first treated with dilute sulphuric acid to dissolve the zinc and other impurities. It is then washed with hot water, and after decanting the washings, the remaining liquid is separated by filtration, and the residue is melted for bullion.

THE REFINING OF GOLD

The purification of gold involves the separation of base impurities and desilverization. The latter process is called *parting*. In rarer instances the metals of the platinum group are to be separated. The base metals are usually almost completely removed before parting. This is done by fusing the gold in crucibles with borax, niter, sulphur, or whatever chemical substance is needed to combine with and flux the metals present. Alloys rich in copper are fused with sulphur, whereby the copper is separated as cuprous sulphide (Roessler's method). The parting of gold and silver may be effected in many ways. The more important only need be noted here.

Chlorine Parting.—The alloy is melted in a clay crucible with a small quantity of borax. Dry chlorine gas is passed through the charge by means of a clay pipe until the silver and any base metals are converted into chlorides. Gold may be rendered almost absolutely pure in this way, but the method is expensive.

Sulphuric Acid Parting.—This is one of the cheapest and most common methods of parting. Gold-silver alloys are either mixed or more silver is added to an alloy until the mixture has the proper proportion of the two metals for the action of the acid. Adding the silver is termed *inquartation*. The alloy is then converted into a thin slab or granulated by pouring it from the crucible into cold water. This is done to bring a large surface area in contact with the acid. The silver is dissolved by digesting the granules in an iron pot with hot sulphuric acid. The solution is drawn off and the gold is treated repeatedly with hot, concentrated sulphuric acid. Further purification may be effected by fusing potassium bisulphate with the gold

and leaching out the silver sulphate with water. The parting may also be done with nitric acid, but this is not much used now.

Aqua Regia Parting.—The highest degree of purity is obtained by Roessler's method which consists in dissolving the otherwise partially purified gold with aqua regia. The silver is converted into insoluble chloride, and the gold is precipitated from the solution with ferrous sulphate. The gold may be 999 9/1000 pure.

Electrolytic Parting and Refining.—Though comparatively new, electrolytic methods are in general use among refiners and at the mints. In parting gold and silver by electrolysis the silver is recovered in a pure condition. If more than 40 per cent. of gold is present silver is added. The impure alloy is cast in the form of thin plates to be used as anodes. The anodes are enclosed in muslin bags and suspended in a solution containing about three per cent. of silver nitrate and two per cent. of nitric acid. The electrolyte is held in porcelain or stone-ware vessels, and is agitated to keep it uniform in composition. The silver dissolves and is precipitated by a dense current on cathodes of pure rolled silver. Mechanical scrapers are employed to prevent the growth of silver crystals from causing short circuits. The electrolyte is treated from time to time as it becomes contaminated and impoverished in acid. It is generally discarded after precipitating the silver from it with copper. The gold is recovered in the bags, and may be purified by boiling with acids or electrolytically as outlined below.

In the final purification of gold by electrolysis it is cast into wedge-shaped anodes which are suspended in a solution containing 30 grams of gold chloride per liter and a small amount of free hydrochloric acid. Pure gold cathodes are used, and the vessel for holding the electrolyte is of porcelain. The gold is deposited as a spongy mass, the silver being precipitated as chloride and the base metals going into solution. The silver chloride has a tendency to stick to the cathodes, and must frequently be removed. This has recently been effected by using

an alternating current in connection with the direct current, which gives a pulsating effect. The strength of the direct current is about 70 amperes per square foot. The electrolyte is purified at intervals. In addition to the base metals it may contain metals of the platinum group. Platinum may be precipitated by adding ammonium chloride, forming ammonium-platinum chloride, and palladium by adding potassium chloride and potassium permanganate, which precipitates red ammonium-palladium chloride.

CHAPTER XXVIII

NICKEL, ALUMINUM, MANGANESE AND RARER METALS

NICKEL

Ores.—Nickel occurs chiefly as silicate, sulphide, and arsenide. The principal ores are Garnierite, occurring in silicious rocks, and magnetic pyrites. The ore usually contains more iron or copper than nickel, but the nickel represents the main value in most cases. Arsenic is also frequently found with nickel and also small quantities of antimony and chromium. The amount of nickel in different ores is exceedingly variable, ranging from less than 1 to more than 50 per cent. The largest known deposits are in New Caledonia and Sudbury, Canada.

Properties.—Nickel is of a grayish-white color and is highly lustrous. It is exceedingly tenacious and tough, and is both malleable and ductile. It is harder than iron or copper and in malleability it is inferior to these metals. The melting point is $1,600^{\circ}$ C. Nickel alloys readily with most metals and it may be welded to itself and to iron. When in the molten condition nickel occludes carbon monoxide and other gases. In conductivity it ranks next to zinc. It is slightly magnetic.

In both its physical and chemical properties nickel appears to be intermediate between iron and copper. It is unchanged in either dry or moist air at ordinary temperatures. It is readily dissolved by nitric and slowly by hydrochloric and sulphuric acids. There are two oxides of nickel of which the monoxide (NiO) is the more important. This may be formed directly by heating metallic nickel, or by heating either the sulphide or the arsenide in an oxidizing atmosphere. Both the oxides are reducible by carbon at a temperature below the melting point of nickel. With silica nickelous oxide forms a fusible silicate. Nickel sulphide occurs naturally and it may be prepared by heating nickel with sulphur or certain other sulphides, and by reducing the sulphate with carbon. It may be decomposed by heating with it metallic copper, the products being nickel and cuprous sulphides.

By melting together the sulphides of nickel, copper and iron with sodium sulphate or sulphide, the copper and iron sulphides form a readily fusible mixture with the alkaline salt, while the nickel sulphide is fused with more difficulty. In consequence of this the copper matte separates more or less completely from the heavier nickel matte. By roasting these sulphides with salt the copper may be chloridized and the nickel with the iron converted into oxide. Nickel combines readily with arsenic. The artificially concentrated arsenide is known as nickel speiss.

Extraction of Nickel.—A number of methods have been proposed for the recovery of nickel from its ores and furnace products. These fall under the general heads of smelting, wet and electrolytic methods. The general run of nickel ores yield most readily to smelting, though the other methods have been practiced quite successfully. The usual smelting process consists in concentrating the nickel into a matte or a speiss by roasting and fusing, then roasting the concentrate to free it from sulphur or arsenic, and finally reducing the nickel with carbon. The character of the ore, of course, largely determines the method of treatment. In most ores the content of nickel is very small, often below five per cent. Iron and usually copper are present in sulphide ores, and in silicious ores an overwhelming mass of silica must be dealt with. The metallurgy of nickel is often associated with that of other metals, and the operations pending its final isolation may be long and tedious.

1 Sulphide ore is roasted in a reverberatory furnace to expel the excess of sulphur, leaving enough to form the matte. If copper is not present the iron is fluxed with silica and the nickel matte separates. The smelting of the matte may be conducted in a reverberatory furnace, hearth or Bessemer converter, the silica being supplied from the ore itself or from the lining of the furnace. If copper is present the treatment thus far is similar. But the matte contains, beside the nickel, most of the copper and some iron. The bulk of the iron is separated by an oxidizing fusion with a silicious flux. The residue is then fused with an alkaline salt such as soda ash or salt cake, which serves to dis-

solve or absorb the sulphides of copper and iron. The nickel sulphide, being heavier, settles to a lower level, and the two masses may be separately tapped. The concentrated nickel matte is roasted in a reverberatory furnace. The product is nickel oxide, since the oxide and sulphide of nickel do not react to liberate the metal as the corresponding compounds of copper do. The oxide is charged into crucibles or muffles with carbon and smelted for nickel.

Oxidized or silicious ores are sometimes smelted directly in blast furnaces with coke to produce an alloy of nickel and iron. A process has also been in use for making nickel steel, in which the nickel ore is charged with the iron into an open hearth furnace.

Wet and electrolytic processes are also in use for the extraction of nickel. These, though rarely ever adaptable to raw ores, on account of the impurities and the low content of nickel, have had considerable application in working up nickel-bearing products. Wet methods usually look to the solution of the nickel in hydrochloric or sulphuric acid, its subsequent precipitation and final smelting. Having obtained the solution, the metals of the copper group may be separated by means of hydrogen sulphide. Iron may then be separated by oxidizing the solution and adding calcium carbonate. This also throws down any arsenic. The nickel is recovered from the solution by crystallizing it as the sulphate, or by precipitation with calcium hydroxide or soda.

Electrolytic methods have been successfully used for extracting nickel, especially from alloys or mattes containing copper. Ulke has described a process for treating a matte containing about 40 per cent. each of nickel and copper. The matte is cast directly into anodes, and the electrolyte is an acid solution of nickel sulphate. The cathodes are of sheet copper. Upon these the copper is deposited from the solution as the anodes are dissolved. The nickel sulphate is recovered from the solution by crystallization when it has accumulated in sufficient quantity; or instead, it may be precipitated as above or by electrolysis.

If electrolysis is adopted the solution is rendered slightly ammoniacal, and anodes of carbon or lead are introduced. The nickel is deposited upon cathodes of sheet nickel.

Nickel, as it comes from the smelter, is never pure. One of the more usual methods of refining consists in fusing it in crucibles and adding magnesium. This reduces any oxides present, the magnesium burning away or entering a slag. Manganese is employed to remove sulphur from nickel.

Cobalt is often associated with nickel, and it is recovered by similar methods. It somewhat resembles nickel in its properties, and though comparatively rare its use is being extended.

ALUMINUM

History.—The existence of aluminum was suspected some time before it was actually discovered. Davy, in 1807, prepared aluminum chloride, and then attempted to isolate the metal, with the aid of electricity, having already succeeded in separating the alkali metals in this way. Though this experiment was not successful, it is an interesting fact that electrical methods are now used exclusively in the manufacture of aluminum for the market, yet in the meantime it was manufactured by purely chemical processes. It is believed that Oersted succeeded in preparing aluminum amalgam, in 1824. His experiment consisted in heating aluminum chloride with potassium amalgam. This led to Wöhler's experiment (1827) in which he decomposed anhydrous aluminum chloride with potassium and obtained small globules of aluminum. The same principle was made use of by Deville, Percy and others who developed processes for manufacturing aluminum. The fluoride of aluminum was substituted for the chloride and sodium was used instead of potassium, as it was cheaper. The manufacturing cost was greatly lessened by Castner, who cheapened and improved the processes for making aluminum chloride and sodium. The isolation of aluminum by electrolysis was accomplished in 1854 by Bunsen and Deville, who worked independently of each other.

They used the double chloride of aluminum and sodium, which they electrolyzed while in a fused condition.

Ores.—Though aluminum is the most abundant metal in nature, the materials from which it can be economically prepared are at present limited. The only ores of importance are Bauxite and Cryolite. The former is a mixture of the hydrated oxides of iron and aluminum and the latter is the double fluoride of sodium and aluminum.

Bauxite is prepared for smelting by grinding and dissolving the alumina with caustic soda, the precipitated iron oxide being filtered off. The aluminum is precipitated as hydrate by agitating the solution. The precipitate is recovered by filtration, and is dried and calcined to alumina.

Properties.—Aluminum has almost the whiteness of silver, though a slight tinge of blue is generally present, due to impurity or to forging. The tensile strength of cast aluminum is 17,042 pounds per square inch, elongation three per cent. The tenacity is improved by working. The pulling strength of a wire which was warmed was 35,500 pounds (Schnabel). Aluminum can be worked cold, its best forging temperature being about 200° C. It becomes brittle at higher temperatures and melts at 625° C. (Le Chatelier). It is volatile at still higher temperatures. Aluminum alloys with most metals. The specific gravity is 2.58.

Aluminum is not appreciably oxidized in either dry or moist air at ordinary temperatures. At high temperatures it becomes coated with oxide, and if the finely divided metal is kindled it burns with great brilliancy. Under such conditions if it be in contact with certain metallic oxides such as those of iron, manganese, copper, lead and chromium, the aluminum is converted into alumina and the other metal is reduced. The oxide of aluminum is not reduced by carbon except in the electric furnace. Aluminum is not precipitated from any aqueous solution by any metal or by the electric current, but it is precipitated electrolytically at a temperature of 900 to 1,000° C. from a bath of cryolite

to which alumina has been added. The melted cryolite dissolves the alumina.

Aluminum is difficult to weld on account of a film of refractory oxide that forms when it is heated. It may be welded autogenously by using a flux that will form an easily fused compound. The alkaline chlorides have been found to answer this purpose when used in connection with the oxy-acetylene flame.

Aluminum Smelting.—Since the development of electric processes the reduction of aluminum by sodium has been abandoned. Two processes have been used in this country for the production of aluminum on the large scale—The Cowles Brothers' process and the Hall process. The Cowles Brothers' process was patented in 1885, and their first plant was put into operation in Cleveland, Ohio. The process consists in reducing aluminum from the oxide in the presence of another metal, which metal absorbs the aluminum at the moment of its liberation. The product is therefore an alloy. The original furnace is a rectangular box lined with fire-clay, through the opposite sides of which the current is conducted. Into this a mixture of alumina and charcoal with the alloying metal is charged. The conductors for the current terminate in bundles of carbon sticks, which are placed near each other and imbedded in the charge. A powerful current being turned on, the carbons first become heated and then heat is generated in the mixture, due to the resistance. Reduction and fusion follow, carbon monoxide being liberated. The alloy is tapped from the furnace, and more aluminum or more of the other metal is added to bring it to the composition desired. The extent to which electrolysis takes place in this process is not known, but the reduction is supposed to be almost entirely chemical.

In the Hall process aluminum is reduced from alumina in a molten bath of cryolite, and deposited by electrolysis. The alumina is dissolved in the cryolite, salts of the alkalis being added to make the bath more liquid. The furnace used is of the crucible form, and the heat is generated by the electric resistance in the bath. The anodes, which dip into the bath from

above, are of specially prepared carbon, and the crucible itself is the cathode. The carbon from the anodes combines with the oxygen from the alumina, the weight of carbon consumed being about equal to the weight of aluminum deposited. As the bath becomes impoverished alumina is added.

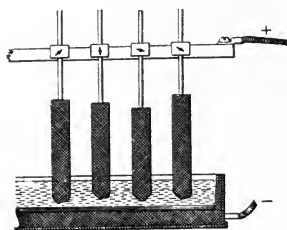

Fig. 100.

Fig. 100 shows the arrangement of an aluminum reduction furnace. It consists of an iron box lined with graphite, forming the cathode, and graphite anodes supported on a metal conductor as shown.

MANGANESE

Manganese was discovered in 1774 by Scheele, a Swedish chemist. It was not, however, until the early part of last century that much attention was called to it. Heath appears to have first manufactured manganese for the purpose of alloying it with iron, and to appreciate in a scientific way its value in steel making. It was not, however, until after the introduction of the Bessemer process for making steel that the manufacture of manganese on the large scale was begun.

Ores.—The only ores of manganese of importance are the oxides. These are known as Pyrolusite (MnO_2), which is also called black oxide of manganese, and Hausmanite ($2MnO + MnO_2$). Manganese ores are widely distributed though not abundant. They are mined in the Eastern states and in Canada. The main supply to this country comes from Brazil and Cuba.

Properties.—Manganese has a light-gray color, and the fracture shows a fine granular structure. It is hard and brittle

and can not be forged. It fuses at about $1,900^{\circ}$ C. and alloys readily with most metals.

Manganese has strong affinity for oxygen and sulphur, with which elements it combines in different proportions. Manganous oxide forms silicates analogous to the silicates of iron. The oxides of manganese are reduced by carbon at high temperatures.

Smelting.—Since the ores of manganese always carry iron and the separation of the two oxides is not practicable, both metals are reduced during the smelting and the product is a ferro-alloy. That which is manufactured to contain up to 30 per cent. of manganese is known commercially as spiegel-eisen, and the higher grades are ferro-manganese. The latter may run as high as 87 per cent. or even higher in manganese. In addition to the iron, manganese alloys carry carbon, silicon and other impurities absorbed during the smelting.

Manganese ore is now regularly smelted in coke blast furnaces, and these are operated essentially in the same way as in iron smelting. A higher temperature is required for the reduction of manganese, and a much larger percentage of coke is used in the burden. The slag is more basic.

Ferro-manganese is now manufactured in the Pittsburgh District and in almost every large steel center. At Palmerton, Pa., the New Jersey Zinc Company operates blast furnaces producing spiegel. The residues obtained after smelting Franklinite ore for zinc are smelted for the iron and manganese they contain.

RARER METALS

The metals noted below are not in all instances rare as to their occurrence, but their present applications are so limited as to warrant but little space in this treatise.

Chromium.—This metal occurs as the oxide (Chromite), mention of which is made under the head of Refractory Materials. It is met with in the Eastern states and California. The most important deposits are in Asia Minor, Greece, Silesia and

New Caledonia. Chromium was discovered by Vauquelin, of France, in 1797.

Chromium may be prepared by electrolysis of the chloride in aqueous solution, by reduction in a crucible with aluminum or carbon and in other ways. It is usually manufactured for the market as ferro-chrome by smelting the iron-bearing ores in electric furnaces. Alloys containing upwards of 40 per cent. of chromium may be made in a blast furnace. The richer alloys may be prepared in crucibles, by reduction with carbon or aluminum.

Tungsten.—This metal occurs as the oxide in the mineral Wolframite, being associated with other metals (CaWO_4 , FeWO_4 and MnWO_4). It is also found in tin ores. Tungsten has been found in almost all of the Western states and it has been imported from South America and the East.

Tungsten has a bright-gray color and high luster, is hard and brittle and practically infusible. An annealing process by which tungsten is made ductile has been worked out in the laboratory of the General Electric Company. The wires, thus prepared, are used in the manufacture of electric light filaments.

Tungsten, finding its chief application in the manufacture of tool steel, is generally prepared as an alloy with iron. The ore is mixed with carbon and smelted in an electric furnace.

Molybdenum occurs chiefly as the sulphide in the mineral Molybdenite (MoS_2). It is also found as the oxide in smaller quantities. Molybdenum ores are found in Arizona, California, and other Western states. The ore is also imported.

In its properties molybdenum resembles tungsten, being of a light-gray color, hard and brittle, and of high melting point. Molybdenum is used like tungsten, in the manufacture of special steels. It is prepared by similar methods.

Vanadium occurs as the oxide, associated with iron, lead, zinc, copper and other metals. Deposits of vanadium have been found in Arizona, Mexico, Argentine Republic and elsewhere.

The color of vanadium is light-gray, and it is slightly crystalline. It is hard and unworkable, and melts at about $1,700^\circ \text{C}$.

It oxidizes spontaneously in the air and rapidly at high temperatures. At a red heat it combines with nitrogen.

Vanadium is usually prepared as an alloy with iron. This is done by reducing the oxide in an electric furnace with carbon. Molten iron is added to prevent oxidation of the vanadium. It may also be reduced in a crucible with aluminum, the principle being the same as that used in Goldschmidt's experiment. (See p. 368).

Bismuth is found sparingly in the native state and alloyed with gold. Among the numerous combinations in which it occurs are the oxide, sulphide, carbonate, selenide, telluride, vanadate and uranate.

Bismuth is a lustrous, light-gray metal with a pinkish tint. It somewhat resembles antimony, but has a decidedly different fracture and is both crystalline and sectile. The specific gravity is 9.83 and the melting point 270° C. On cooling from the melted state it expands to about 2.3 per cent. of its volume. Bismuth alloys with most metals, is constant in dry air and at a red heat it burns with a bluish flame to the yellow oxide.

In the preparation of bismuth the ores are crushed and washed or concentrated by other methods, ores containing sulphur, arsenic or antimony being roasted. The concentrate is smelted in crucibles or small reverberatories with coke. Soda or some other easily fused flux is added to combine with the gangue and obviate the necessity of prolonged and high heating, which would cause serious loss by volatilization. The reduction is effected at a dull red heat, after which the temperature is raised quickly to melt the entire charge. After pouring the crude bismuth is separated from the slag and possible secondary products. Either matte or speiss would contain bismuth, which may be separated by roasting and smelting as with ore.

Bismuth is also recovered in the wet way by digesting the ore with strong hydrochloric acid, and after filtering off the insoluble gangue, adding iron to precipitate metallic bismuth, or the oxychloride may be precipitated by diluting the solution with water.

The refining of bismuth somewhat resembles lead refining. Owing to its weak affinity for oxygen bismuth may be purified by heating it in an oxidizing atmosphere, when the impurities are separated in a dross or by volatilization.

The chief applications of bismuth are in the manufacture of alloys, special mention of which is made on p. 366.

Platinum.—The only ore of platinum is native. . It is usually alloyed with the other metals of the platinum group. Among these the best known are iridium, rhodium, palladium and osmium. Platinum is usually recovered from alluvium, in which a natural concentration has taken place. It has been found in the gold-bearing sands of California, Canada, Mexico and elsewhere. By far the most important deposits of platinum yet discovered are in the Ural Mountains.

The chief properties to which platinum owes its applications are its high fusion point, malleability and its inertness toward chemical agents in general. It is about as hard as copper and can be worked cold. The melting point is about $1,775^{\circ}$ C. Platinum is not oxidized at any temperature nor is it acted on by any single acid. It is attacked and dissolved by aqueous solutions containing chlorine.

In the extraction of platinum the ores are concentrated by washing, and then smelted or treated by a leaching process. If the former method is used the ore is smelted in crucibles with lead or lead-bearing material, and the work-lead obtained is cupelled. With sufficiently high temperatures, as are attainable in electric furnaces and with the oxy-hydrogen flame, platinum may be removed from the ore gangue by simple fusion. The usual method for extracting it is to treat the ore with aqua regia, which converts the metal into a soluble chloride. After prolonged digestion the liquid is separated from the gangue and ammonium-platinic chloride is precipitated by adding ammonium chloride. The precipitate is dried and the platinum is recovered from it in an electric or oxy-hydrogen furnace.

CHAPTER XXIX

ALLOYS

The manufacture of alloys is a very ancient art and one which has been known even to uncivilized people. No doubt many of the ancient alloys, of which preserved specimens bear record, were supposed to contain but one metal, or else no method was known by which the components could be separated. The existence of some alloys might be accounted for by the smelting of mixed ores or ores containing more than one metal. Brass was made long before zinc was recognized as a separate metal by smelting together ores of copper and zinc. Bronzes and alloys of the precious metals are common examples of early manufacture. The Phœnicians traded in bronze many centuries before the Christian Era. They produced alloys of fine quality and in wonderful quantities. Excellent alloys for fine art work have been made in China and Japan for untold generations. While the manufacture of alloys for ornamental purposes has been handed down from the ancients, the development of the more useful properties in metals by alloying is peculiarly a modern practice.

Properties.—The great alterations in the properties of metals when alloyed has been previously shown. It has also been shown that many of the most useful properties may be developed in this way. Some idea of the possibilities along this line may be formed by considering the great number of mixtures of the common metals that are possible if the ratios be varied. The properties of an alloy can not be anticipated from a consideration of the properties of its constituents. In binary alloys some of the properties may be intermediate between those of the two metals, while the other properties differ entirely from those of either. The color is in some instances what would be expected from the colors of the separate metals, but there are numerous instances in which the color bears no relation at all to that of either constituent. The tenacity, elasticity, ductil-

ity and hardness may fall between or be either greater or less than those properties in the single metals. The fusion point is usually lower than the mean of the two and often below that of the more fusible metal. Electric conductivity is generally diminished by alloying, sometimes to a remarkable degree.

In respect to their chemical nature the most important property of alloys is their resistance to corroding agencies. A relatively cheap metal having desirable physical properties may be protected by alloying a more permanent metal with it. As viewed from the other standpoint, a metal may become less resistive to the attack of chemicals when alloyed with an electro-positive metal, provided actual diffusion has taken place. If liquation has occurred the attack upon the electronegative metal is accentuated by electrolysis. Practical illustrations of this are found in alloys which have become pitted on exposure to the atmosphere, salt water or chemicals. But it does not follow that the durability of alloys under different conditions is determined by their durability under definite conditions. The acid test may serve a useful and specific purpose, but it is highly irrational to suppose that such a test will determine the relative durability of metals or alloys under atmospheric or other varying conditions. The practical resistivity of metals is often greatly increased by an adherent, insoluble coating, itself the product of corrosion.

Conditions Under Which Alloys Are Formed.—The most familiar method of alloying metals is that of melting them together. It is not always necessary that both be fused, because the fluid metal may dissolve the solid one. Mercury, for example, will alloy with gold or silver in all proportions without the aid of heat, forming solid or liquid amalgams. Many alloys have been made, sometimes accidentally, by smelting together ores of different metals, alloys in a few instances resulting from the mingling of metal vapors or from the contact of vapor and solid.

The union of metals may be brought about at ordinary temperatures by compression. Lead and tin unite under comparatively light pressure, while such brittle metals as antimony and bismuth may be alloyed by subjecting them to powerful

pressure. This does not seem surprising in view of the property of flow which is thus brought into play.¹ That metals possessing the property of flow to a high degree will alloy at ordinary temperatures and without pressure has also been shown. Roberts-Austen determined the rate of diffusion between gold and lead at different temperatures, and obtained the following figures:

Diffusibility of gold in fluid lead at 550°	3.19
Diffusibility of gold in solid lead at 251°	0.03
Diffusibility of gold in solid lead at 200°	0.007
Diffusibility of gold in solid lead at 165°	0.004
Diffusibility of gold in solid lead at 100°	0.0

Discs of gold and lead which had been clamped together for a period of four years were found to be united, and assays of the lead showed that it contained gold in diminishing amounts with the depth at which samples were taken.

Alloys may be made by the simultaneous precipitation of metals from their solutions by electrolysis. This method has but limited application, since there are but few groups of metals that are precipitated under the same conditions. The common method of plating with brass is by the electro-deposition of copper and zinc from their solutions.

Constitution of Alloys.—Careful and exhaustive research has brought out much interesting and useful information regarding the nature of alloys. The views now generally accepted were advanced by a number of investigators since the middle of last century, and the present development of the science of alloys is due largely to the work of Roberts-Austen whose memoir was published in the *English Institute of Mechanical Engineers, Proceedings of the Royal Society* and elsewhere.²

It is observed that in alloys the identity of the constituent metals is lost, and in effect, new metals are formed with properties which may bear no relation to the individual metals. In some instances there is a blending of the properties, representing

¹ See p. 4.

² His principal work, "Introduction to the Study of Metallurgy," was first published in 1890.

somewhat a mean between those of the separate metals, but this is not the rule. The best available explanation of the phenomena which alloys present is implied in the word *diffusion* and in its antonym *liqutation*. This view was given in 1860 by Matthiessen, who concluded after long experimental research that "most alloys are merely a solution of one metal in another; that only in a few cases may we assume chemical combinations." Having regarded metals as possessing properties in common with liquids, the analogy between alloys and aqueous or other solutions is but logical. A substance in aqueous solution disappears so completely as not to be recognized by the highest magnification, and it can not be separated from the solution by mechanical means other than crystallization, which may be accomplished by cooling or evaporating the solution. No constituent of a true alloy can be separated by mechanical means other than crystallization, to use the term in a broad sense, and no individual metal in a true alloy can be recognized by the highest magnifying power. Reasoning from the theoretical standpoint, ionization should take place in metal solutions just as in aqueous solutions, but experiments have so far failed to indicate that it does. Attempts have been made to precipitate metals from molten alloys or fluid amalgams, but in no instance have these solutions conducted the current as electrolytes do but rather after the manner of single metals. Nor has any separation been observed.

The phenomena attending cooling and freezing present the most striking analogy between alloys and other solutions. If an aqueous solution, containing 23.6 per cent. of salt, is cooled no freezing takes place until a temperature of -22° C. is reached, when the water and salt separate and crystallize, forming a conglomerate mass of thin plates of salt and ice. If a more dilute solution is cooled ice begins to form at a temperature lower than, but approaching, the true freezing point of water as the dilution is increased. The crystallization of water continues until the temperature -22° is reached, at which point the solution is concentrated to the ratio of 23.6 per cent. of salt, and freezing of the entire mass occurs as above described. If a more

concentrated solution is cooled crystallization of the salt takes place until, at -22° the 23.6 ratio is established, and the separation and freezing occur as before. It is observed that the composition of the mother liquor at the freezing point is constant regardless of the initial composition of the solution, and that the freezing point of the mother liquor is constant. When it freezes its constituents are in the eutectic ratio, the frozen mother liquor being called a *eutectic*. This term was introduced by Guthrie to indicate the constituent in a solution which has the lowest freezing point of the series. When alloys are cooled from the liquid to the solid state one or more constituents may separate with the formation of a conglomerate, or there may be no separation, the result being a solid solution. When separation takes place freezing begins with the constituent having the highest melting point and ends with the freezing of the eutectic or the constituent having the lowest melting point. The freezing points of the constituents that separate are lowered as in aqueous solutions and the eutectic freezes at a constant temperature. The composition of the eutectic in alloys is also definite, but this bears no relation to atomic ratios. In aqueous solutions the eutectic is the solidified mother liquor; in alloys it is the solidified mother metal, and may consist of a single metal, of metals or compounds interstratified or of metals or compounds in solid solution.

In view of their commercial aspect it is difficult to lay down a comprehensive definition for alloys, since these must include mixtures of metals and of metals and compounds in which:

First, solution is complete, no constituent having separated when the alloy became solid. This class represents the true alloys and those of the highest degree of uniformity in composition, though the composition may vary as it does with diffused liquids and even gases;

Second, solution is incomplete, free metal, solution or compound having separated during the solidifying process. As a rule, these alloys are less useful than those of the first class, being lower in tensile strength, ductility and malleability.

The separation of a substance from solution in an alloy is known as liquation, segregation or selective freezing, and is due to insolubility. Since the solvent power of metals diminishes with their temperature, alloys are very apt to change in composition while cooling, the constituents separating in the reverse order of their solubility and solidifying in the order of their fusibility. The two properties here involved bear no relation to each other, some metals of widely differing melting points being readily diffusible and others, which melt at near the same point, have but little alloying affinity.

When liquation takes place the behavior of the different constituents is determined by such properties as fusibility, viscosity, specific gravity and crystallizing tendency.¹ Some practical applications of the principles here involved may be cited as illustrations. In the Pattinson desilverizing process pure lead crystallizes from the bath in which silver is dissolved, and by reason of its lower specific gravity rises to the surface. The separation of lead and zinc is almost completely accomplished by slowly cooling a fused mixture of the two metals, the zinc composing the upper stratum. It is the practice in mints to sample alloys of gold and silver while in the molten state in order to prevent error due to liquation. When liquation has taken place between metals of widely differing melting points their actual separation may be accomplished by heating at a temperature slightly above the melting point of the more fusible metal, as is done in the so called "sweating processes." The liquation or segregation of dissolved metals and compounds in steel ingots has long been recognized as the disturbing factor to uniformity of composition and properties. In meteorites and other native ores splendid examples of liquation are afforded.

Temperature Curves.—One of the best methods for investigating the nature of alloys is that of determining their rate of cooling. The temperature of a cooling or heating mass of alloy is affected by any physical or chemical change that takes place

¹ Perfect crystals are rarely formed owing to the viscosity of metal masses.

within it, and this may be shown graphically by means of a continuous curve which represents the rate of cooling or heating. The cooling curve only is discussed here, because it is in more general use and is more easily obtained than the heating curve. The most accurate curves are made with the aid of a recording thermometer or pyrometer, though they may be plotted satisfactorily without the use of recording apparatus by marking the temperature units as ordinates and the time units as abscissas on

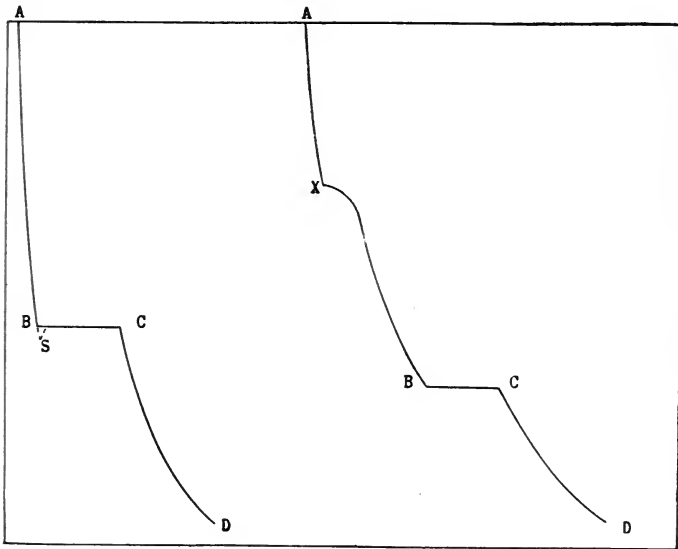

Fig. 101.

Fig. 102.

cross-ruled paper. If the temperature readings are marked at short intervals of time a fairly accurate curve may be plotted by connecting these points.

When a substance which does not undergo physical or chemical change is cooled from a state of fusion to the freezing point the line of cooling is plotted as a continuous curve, like the line AB in Fig. 101, which represents the cooling of a pure metal. Freezing being an exothermic change, further cooling is checked until the entire mass has solidified, and the line takes the hori-

zontal direction, BC. Cooling below the freezing point gives the smooth curve, CD. It often happens that a substance will not begin to solidify until it has cooled somewhat below its freezing point, and in such cases the temperature rises to the normal when freezing begins. This phenomenon is known as *surfusion*. In Fig. 101 surfusion is indicated by the dotted line, S. Fig. 102 represents the cooling of an alloy, containing two metals, *a* and *b*. The smooth curve is interrupted at *x* when *a* begins to freeze.

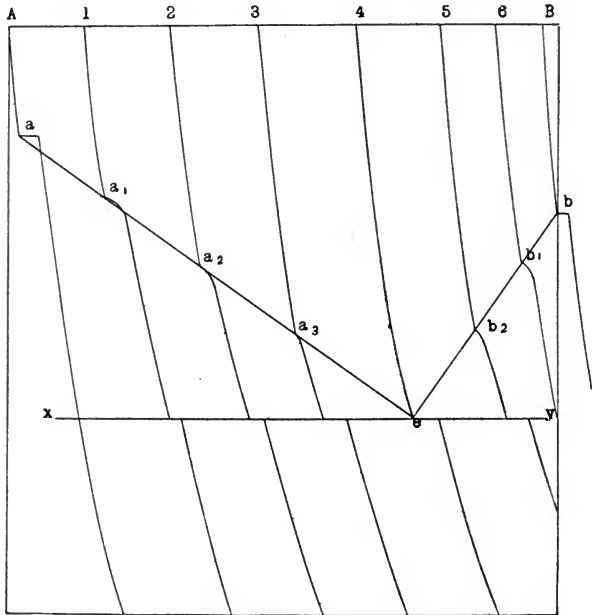

Fig. 103.

This point is determined by the solubility of *a* in *b*. It is raised or lowered as the proportion of *b* in the alloy is increased or diminished, and since the proportion of *b* begins to increase from the moment *a* begins to freeze the solubility of *a* is progressively increased, *i. e.*, its freezing point is progressively lowered. The effect of the freezing of *a* is, therefore, most marked at first, and is indicated by a jog in the line, but the heat evolved is not suf-

ficient to counterbalance the loss of heat from the alloy, and its influence becomes more and more feeble as the proportion of a diminishes. The result is further indicated by a sharp reversal of the curve, followed by a straightening and then the resumption of the normal slope. The freezing of the mother metal or eutectic is indicated by the line, BC, and the cooling of the solid alloy by the line, CD.

When it is desirable to study the relation of a series of alloys containing the same metals in different proportions the freezing points in the series may be plotted in a curve with composition and temperature as co-ordinates. Fig. 103 shows the cooling and freezing point curves of a series of binary alloys. The curves, A and B, indicate the cooling of the pure metals, and the intermediate curves indicate the cooling of the alloy series. The proportion of b is increased in each alloy of the series, beginning with l . The temperatures at which a begins to freeze are indicated at a_1 , a_2 , and a_3 . When the proportion of b exceeds the eutectic ratio that metal is the first to crystallize in the process of cooling, as is indicated by the points, b_1 and b_2 . By connecting all these points the freezing point curve for the series, aeb , is obtained. Curve 4 indicates that the metals are in the initial eutectic ratio. The straight line, xy , represents the constant freezing point of the eutectic.

Chemical and Microscopical Examination.—In the investigation of alloys accurate chemical analysis is indispensable. By this means not only is the composition determined, but in addition, the extent to which the composition may vary, as by liquation, may be ascertained. Analyses of separated constituents can, of course, only be made when it is possible to obtain separate samples. This is generally difficult or impossible owing to the minuteness of the liquated or segregated masses. In some cases it is possible to separate the constituents of alloys by taking advantage of their different solubilities in chemical reagents. When actual separation can not be made the structure of metals and alloys and some idea of their composition may be ascertained by aid of the microscope. For microscopical examination a

specimen of metal is prepared by polishing and etching a flat surface. Relief polishing may be resorted to with alloys containing hard and soft constituents, but the usual method is to give the surface a mirror polish, and then to treat it with some chemical which dissolves the constituents with unequal rapidity, thus bringing the less soluble ones in relief. Another frequent and useful effect of the chemical is the development of colors with the different constituents. Heat tinting is sometimes employed for imparting color by the formation of thin films of oxide. By examining the etched or tinted surface under magnification the observer may determine whether or not the alloy is a solid solution by the presence or absence of crystals. From the size, shape and arrangement of crystals knowledge is gained of the properties of the metal or alloy and of the treatment it has received. The study of the microstructure of metals was developed to a science by Sorby and Martens, who worked independently, during the sixties and seventies of last century. Reaumur described the microstructure of cast iron as early as 1722. The modern science of the properties of metals is termed *Metallography*. Microscopic methods are chiefly used in metallographic study and research.

THE MANUFACTURE OF ALLOYS

Alloys are prepared commercially by the fusion method, which is simplest and most effective. The two or more metals may be melted together or melted separately and then mixed. A flux or covering is used with oxidizable metals, and in some instances measures must be taken to prevent volatilization and the absorption of gases. Processes in which one or more of the metals are smelted and simultaneously alloyed are common. On account of the difficulty with which some metals are made to unite and the tendency toward segregation, it is impossible to make some alloys homogeneous throughout. The rapid growth of manufactures and the high duty now required of metals are directly responsible for the large number of alloys which the market affords, as well as for their quality.

In the following notes attention is called to some of the more important industrial alloys. A classified list of typical alloys is given on pp. 365-366. In this classification alloys are described or listed under the names of the principal metals in the different groups.

Iron Alloys.—The principal alloys of this class are the steels, which have already been described. The ferro-alloys may be mentioned here, though iron is a minor constituent in most of these. Impure iron alloys are made on the large scale in blast furnaces by the reduction of mixed ores, and the more refined alloys are prepared in reverberatory, crucible and electric furnaces and by the thermit process. Alloy steel is commonly made by adding the other metal to the molten steel. With so large a quantity of steel as is treated in the open hearth or converter, the other metal may be thrown into the ladle as the steel is tapped. This method has the advantage that less of the alloying metal is oxidized, though it may be necessary, for the sake of producing a uniform alloy, to mix the metals in the furnace. Alloy steel is also made from mixed ores containing the required metals, or by reducing oxides of the alloying metals in contact with a heat of steel in the open hearth or electric furnace. Chrome, nickel and other alloy steels may be made in this way. The electric furnace is peculiarly adapted to this method.

Copper Alloys.—Brass and bronze are the most important alloys of this class. Pure brass contains copper and zinc and pure bronze copper and tin. Both are survivors of antiquity, and are as much prized now as ever for their fine appearance and useful properties.

Brass is used extensively in the form of both castings and forgings. The "low" brasses, containing less than 60 per cent. of copper are chiefly used in casting and for hot forging, and the "high" brasses, which contain upwards of 70 per cent. of copper, may be used for cold rolling, drawing and spinning. Frequent annealing is necessary in cold working, otherwise internal strains are set up. These strains may lead to "season cracking," which has frequently been the case with brass goods many months

after manufacture. In the manufacture of brass the copper is first melted or heated to near the melting point, and then the zinc is added. The melting is commonly done in graphite crucibles and under a cover of fused glass, fluorspar borax or other flux. Magnesium, phosphorus and other deoxidizers are used to give soundness to castings. Phosphorus is generally added in the form of phosphor-copper, which may be prepared by plunging stick phosphorus into a bath of molten copper. The compound, Cu_3P , soluble in copper, is formed.

Bronze is prepared by melting the copper and tin separately, pouring them together, and stirring the mixture to give uniformity. Practically all brasses and bronzes contain small amounts of lead and other impurities, and there is a large number of important alloys of this class to which other metals are purposely added. Some of these are listed in the table below.

Monel metal is an alloy of copper and nickel containing also a small amount of iron and other impurities. It is prepared by smelting the copper-nickel ores abounding in the Sudbury district, Canada. When cast Monel metal has a tensile strength averaging about 80,000 pounds, and when rolled the tensile strength may exceed 100,000 pounds per square inch. The alloy is also highly elastic, ductile and malleable, and it compares with bronze in its resistance to corrosion. It has found application as a roofing metal and for the manufacture of seamless tubes and boilers in the construction of automobiles and other motor-propelled craft. Combining as it does, strength and resistivity, Monel metal makes excellent propeller blades.

Tin and Lead Alloys.—The most important among these are bearing and type metals, solder and pewter. These alloys are usually prepared by fusing and stirring the metals together in iron pots. Copper is introduced into alloys intended for heavy machinery bearings to increase the compression strength, hardness and general rigidity when heated. In most bearing metals there are hard compounds of tin and antimony, tin and copper, copper and phosphorus or other compounds, which separate from a softer matrix consisting of a single metal or a solid solution.

In the following tables are given typical analyses of representative alloys.

IRON ALLOYS.¹

Composition			Other metals	Remarks
C	Ni	Cr		
0.3	3.5	—	—	Ordinance
0.8	25.0	—	—	Resistance wire
0.15	46.0	—	—	Platinite
0.5	2.5	0.5	—	Armor plate
0.8	2.0	2.0	—	Projectile
0.5	—	3.7	W 10.8	Tool
0.5	—	3.0	Mo 4.3	Tool
0.3	—	1.0	Va 0.2	Gear and shaft
0.15	—	—	Cu 4.0	J. I. S. Inst., 1907, 2, 1
1.0	—	—	Mn 12.0	Hadfield
2.0	—	—	W 8.0	Mushet tool
0.2	22.0	—	Cu 0.9	Met. & Chem. Eng., VIII, 452, 527
0.2	45.0	—	Cu 20.0	

COPPER ALLOYS.

Cu	Zn	Sn	Other metals	Remarks
20.0	80.0	—	—	White button metal
29.0	—	—	Ni 70.0, Fe 1.0	Monel metal
33.0	67.0	—	—	Brass solder
50.0	20.0	—	Ni 30.0	German silver
55.0	45.0	—	—	Low brass
60.0	40.0	—	—	Muntz metal
65.0	35.0	—	—	Mosaic gold
65.0	—	5.0	Pb 30.0	Ajax "plastic bronze 'A'"
67.0	21.0	—	{ Al 5.0, Mn 3.0 } { Fe 2.0, Pb 1.5 }	Cramp's special bronze ²
70.0	30.0	—	—	High brass
74.0	10.1	1.0	Pb 15.0	Chinese art
75.0	—	—	Ni 25.0	U. S. coin
76.5	—	23.5	—	Bell metal
77.0	—	8.0	Pb 15.0	P. R. R. "B" bearing metal ³
80.0	—	10.0	Pb 9.0, P 1.0	Phosphor bronze
82.0	2.0	16.0	—	Heavy bearing
88.0	—	10.0	Mn 2.0	Manganese bronze
90.0	—	—	Al 10.0	Aluminum bronze
91.0	—	9.0	—	Gun metal
95.0	2.5	2.5	—	U. S. coin

¹ All in this group are special steels. The percentage of iron is not given, but it is found approximately by subtracting the sum of the constituents given from 100. The common impurities of steel are usually present.

² This remarkable alloy has a tensile strength of about 125,000 pounds and an elastic limit of about 90,000 pounds. It was used for turning discs in the emergency dams at the Panama Canal.

³ The Master Car Builders standard alloys for car and locomotive bearings have compositions varying between this and that of the Ajax Metals Company's "plastic bronze," given above.

METALLURGY

TIN-LEAD ALLOYS.

Sn	Pb	Sb	Other metals	Remarks
3.0	82.0	15.0	—	Type metal
4.75	80.0	15.0	Bi 0.25	Magnolia metal
40.0	55.0	5.0	—	Antifriction metal
45.5	40.0	13.0	Cu 1.5	Babbitt ¹
50.0	50.0	—	—	Soft solder
80.0	20.0	—	—	Pewter
82.0	—	12.0	Cu 6.0	White metal ¹
90.0	—	10.0	—	Brittania metal
—	99.7	—	As 0.3	Shot

BISMUTH ALLOYS.

Bi	Pb	Sn	Cd	Remarks
50.0	31.25	18.75	—	Melts at 95° C. (Newton)
50.0	25.0	25.0	—	Melts at 93° C. (Darcet)
50.0	27.0	13.0	10.0	Melts at 60° C. (Lipowitz)

SILVER ALLOYS.

Ag	Cu	Other metals	Remarks
57.0	28.0	Zn 11.0, Sn 4.0	Soft solder
80.0	13.0	Zn 7.0	Hard solder
90.0	10.0	—	U. S. coin
95.0	—	Cd 5	Jewelry

GOLD ALLOYS.

Au	Cu	Remarks
50.0	50.0	12 carat
66.7	33.3	16 carat
75.0	25.0	18 carat
90.0	10.0	U. S. coin

PLATINUM ALLOYS.

Pt 25.0	Ag 75.0	Dental alloy
Pt 34.0	Ag 66.0	Standard resistance
Pt 90.0	Ir 10.0	Thermo-couple
Pt 90.0	Rh 10.0	Thermo-couple

WELDING

The operation of welding is based upon the diffusibility of metals. As a rule, soft metals are easily welded, sometimes without the aid of heat, and any metals that will alloy may be welded to each other. As usually conceived welding consists in heating the pieces to render them plastic, and then joining them under pressure. In many of the more recent processes of weld-

¹ The composition of these alloys is quite variable.

ing heat is so concentrated as to fuse the points of contact. Such processes are termed *autogenous* welding.

Pressure Welding.—In the ordinary welding operation the pieces to be united are heated in a furnace to the proper temperature, and then pressed together by hammering or rolling. It is necessary that the surfaces to be welded be free from scale or other foreign matter in the solid form. Borax, ammonium chloride or other flux may be used to dissolve oxides, the slag formed being squeezed out in the operation of welding. In a “butt” welded joint the contact faces are perpendicular to the surface of the work and correspond to the thickness of the metal. In a “lap” welded joint the pieces are scarfed to give a greater area of contact.

Flame Welding.—The use of the blow-pipe has become quite common in autogenous welding. The mixture of hydrogen, acetylene and other gases with oxygen gives an intensely hot flame which will quickly melt all but the most refractory metals. The acetylene flame is favored in iron and steel work, having wide application in cutting, joining and closing cavities. The supply of air and gas are regulated so as to produce an outer, oxidizing flame of intense heating power and an inner, reducing flame. By skillful manipulation the surface of the metal to be welded is brought quickly to a state of fusion, and where there is a space to be filled metal of similar composition, in the form of wire or rod, is fused in. Excessive oxidation from the outer flame is to be avoided on the one hand and occlusion of reducing gases from the inner flame on the other. Reducing and fluxing agents in the form of powder are added to decompose refractory oxides.

Electric Welding.—The electric current may be used different ways in welding operations. In one method the metal is heated to the welding temperature by conducting a high amperage current through it, the heat being generated by the resistance to the current, in another method, making use of the electric arc, the pieces to be joined are gripped by bronze clamps, which are connected with the terminals of a dynamo. One of the clamps

moves with the piece, so that any required space can be opened between the surfaces to be joined. The surfaces having been properly prepared, are held in contact, and the current is turned on. The movable piece is drawn back to form the arc. The heat developed brings the surfaces to the required temperature, when they are pressed together. Arc welding methods in which one of the electrodes is detached from the work, so that it can be held in any desired position, are the most common, being more readily adapted to general requirements. Having the work connected with one of the wires of the current and the movable electrode with the other wire, the circuit is first closed on the work, and then the electrode is withdrawn to form the arc. By moving the electrode about the operator concentrates the heat at any point desired. Both carbon and metal rods are used for electrodes. When carbon is used metal is supplied for filling cavities from a separate wire or rod held in the proper position to be fused. With the metal electrode a deposit is obtained from the electrode itself, and this gives great flexibility to the process, making it comparatively easy to weld over head or in inaccessible places.

Thermit Welding.—This process is the invention of Goldschmidt. It employs a mixture of iron oxide with pulverized aluminum, to which the inventor gave the name "Thermit." In the welding operation the thermit is supported above the work in a funnel-shaped crucible, and a sand mold is fitted about the pieces to be joined so that the liquid iron which fills it will come in contact with enough area of both pieces to make a strong union. The thermit is kindled with a mixture of aluminum-barium peroxide and the aluminum continues to burn with great intensity to alumina, and reduces the iron. A small amount of metallic iron is sometimes added to the thermit to prevent the temperature from running too high. The iron is tapped into the mold, and coheres to the pieces which themselves become softened on the surface by the heat. The thermit process is used for welding rails and large forgings and castings that have been fractured. The latter application is especially useful in cases

where other methods of welding would require the dismantling of cumbersome machinery.

PLATING

Base metals and those which are corrodible are covered with a more expensive metal for the purpose of ornament or for protection against rust. The thin sheet of metal does not adhere to the other metal as paints do, but it forms a surface alloy or molecular union, which cements the two metals together. Such plating will not scale off. The metals copper, nickel, silver and gold are chiefly employed for ornamental work, and for protection against rust, zinc and tin are most commonly used. Lead, copper, nickel and brass are also used for protective plating.

The necessary conditions in any plating process are that the surface of the metal to be plated be clean, and that the metal to be deposited be pure and in the proper physical condition for forming an alloy with the other metal. These conditions are brought about in two ways on the industrial scale. The metal to be plated is either dipped in a molten bath of the other metal or placed as a cathode in a solution, from which the other metal is deposited by the aid of an electric current. These are known as dipping and electrolytic processes.

Tin Plating.—The most important industry of this class is the plating of sheet iron for the manufacture of roofing and tin ware. The sheet iron or steel, having been rendered hard by cold rolling, is toughened by annealing. The annealing is done in a closed chamber to check oxidation. The sheets are then immersed in dilute sulphuric or hydrochloric acid to remove the scale. This is termed "pickling." The last trace of acid is washed from the sheets after immersing them in lime water and rinsing, and they are now ready for plating.

The tin is melted in a deep pot, a section of which is shown in Fig. 104. In the opening by which the sheet is introduced the tin is covered with a flux of zinc chloride and a small amount of ammonium chloride. The direction which the sheet takes is indicated by the lines with the arrow heads. The sheet

is turned and lifted by aid of the tool until it is gripped by the first pair of rolls. Four pairs of rolls are arranged as shown in the upper part of the pot. These rolls, revolving in the directions indicated, carry the sheet out of the bath, and give an even coat of tin. The rolls are surrounded by molten grease.

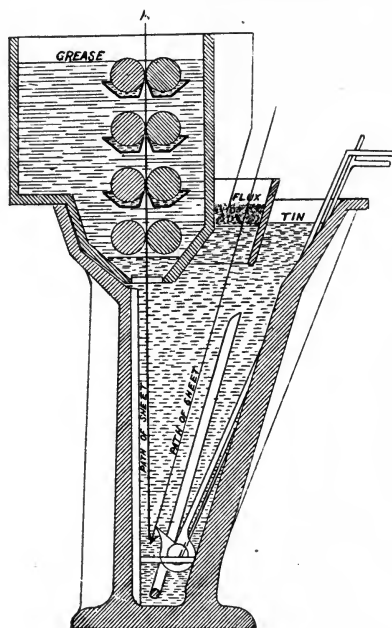

Fig. 104.—Tinning Pot. (Harbord and Hall.)

The flux of zinc and ammonium chlorides, through which the sheet passes as it is introduced into the tinning pot, serves to cleanse the surface of the iron and to remove oxides from the bath. The grease, through which the sheet passes as it leaves the bath, does not mix with the tin, but prevents exposure while the excess of tin is being removed by the rolls. The sheets are cleansed by passing them through wheat bran and then brushing. This is done entirely by machinery in modern plants.

Zinc Plating.—The process of plating with zinc is commonly called “galvanizing,” from the fact that iron and zinc together

form a galvanic couple. Zinc is the opposite of tin in its being electronegative to iron. For this reason it is attacked first when the two metals are exposed to corrosive agents, and the iron is preserved. Zinc plate has now largely superseded tin plate for outside work, but it can not be used for cans in which food is stored, since meat and vegetable acids attack zinc and the salts formed are poisonous. Zinc plate is manufactured both by the dipping and the electrolytic processes.

The Dipping Process.—The iron or steel sheets are prepared as for tin plating. The zinc is melted in a vessel constructed of soft iron plates. It is covered with a flux of ammonium chloride, which serves as a protective coating and to dissolve oxides. The sheets are introduced into the bath and carried through by means of guide rolls, the speed of which determines the length of time that the iron is kept in contact with the zinc. With the thicker sheets a longer time will be required, since it is necessary for the iron to attain the temperature of the zinc before the latter will adhere perfectly.

The Electrolytic Process.—This process, which is otherwise known as “cold galvanizing,” is now carried on so successfully as to compete with the dipping process. Points in favor of cold galvanizing are that the toughness of the iron is not impaired as is done by dipping it in the hot zinc, and that the plate generally adheres better. The electrolytic process is, however, slower and more costly than dipping, and it is not so suitable for plating articles of irregular shapes, since as cathodes they cause unequal resistance of the current in the electrolyte and consequently an uneven deposition of the zinc.

The electrolyte used in galvanizing is a solution of zinc sulphate or chloride containing an excess of the acid. The anodes are cast from spelter. In early practice much difficulty was met with in obtaining an even and adherent coating on account of the electrolyte becoming impoverished in zinc. A uniform composition with the required amount of zinc could not be maintained by any arrangement of the anodes. The difficulty was overcome by Cowper-Coles, whose process consists in

pumping the electrolyte through tanks containing zinc dust. A large amount of zinc is thus added to the solution and its composition is kept uniform by the circulation.

Sherardizing.—This process, which was first described by Cowper-Coles, has been applied principally to plating iron. Zinc dust is heated below its melting point in contact with the other metal, resulting in the formation of homogeneous plate, the thickness of which depends upon the temperature and the length of time employed. Iron articles to be sherardized are pickled to remove oxide, and to prevent oxidation the process is conducted in a closed iron drum from which the air is exhausted. The drum is revolved to keep fresh zinc in contact with the surfaces to be plated. A point in favor of this process over dipping is that a lower temperature is employed, consequently the physical properties of the iron are not altered to so great a degree.

Copper Plating.—The electro-deposition of copper is one of the oldest of electrolytic processes. It has wide application in the plating industries, being generally adaptable for the production of a thin plate. The electrolyte used is an acid solution of copper sulphate. The principles of copper precipitation have already been discussed on pp. 262-264.

Several processes have been devised for encasing iron with a heavy sheath of copper in such a manner as to permit of hot forging or cold drawing without rupturing the contact between the two metals. A notably successful process is that of Monnot, by which the commercially styled "copper clad" products are prepared. A round billet of steel, free from scale, is heated in a mold through which producer gas is passed to prevent oxidation. The billet and mold are lowered into a bath of copper which is heated far above its melting. This gives a very thin coat of copper but a strongly adherent one, since the alloy penetrates the surface of the billet deeply by reason of the high temperature. The mold is opened in the bath and closed as the billet is withdrawn, allowing the copper to run out. The billet and mold are then lowered into a second bath in which

the copper is heated but slightly above its melting point. The mold is opened and closed in the bath and kept closed until after it is withdrawn and the copper has set. The copper-enclosed billet is then removed from the mold, reheated and rolled into wire rod or other shapes. Another method for producing heavy copper plates consists in first electroplating the billet, and then forging on a seamless copper tube, made to fit.

The Spray Process.—A method of depositing metallic vapor or powder under blast pressure has been invented by M. U. Schoop, of Switzerland.¹ The metal may be in the form of powder, which is heated by the blast, or melted from a strip or wire and “atomized” at the same moment. The spray is driven by compressed air against the surface to be coated, forming a coherent and adherent deposit which may actually alloy with the surface of metals.

¹ Met. & Chem. Eng., viii, 404 ; xi, 89.

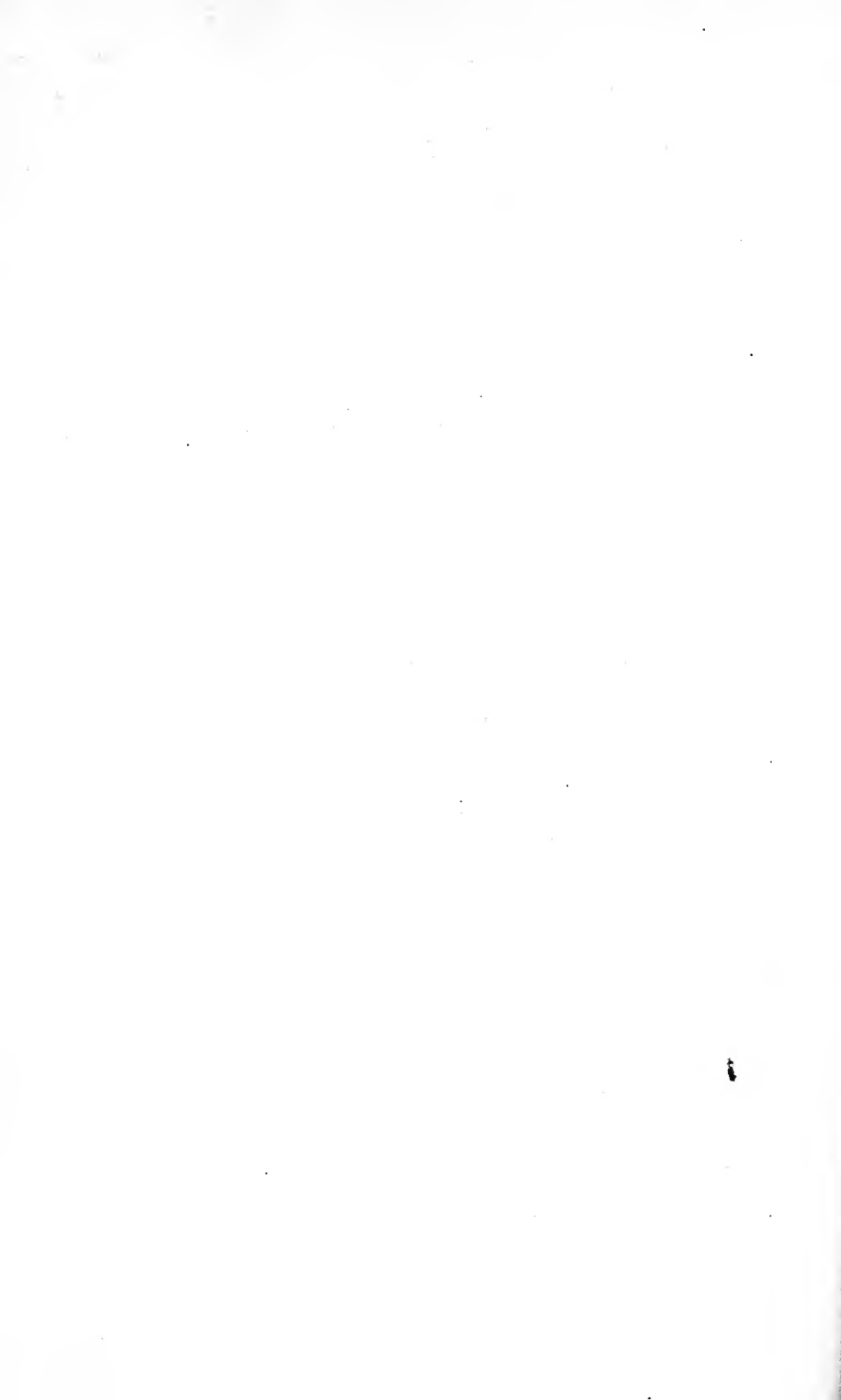

INDEX

	PAGE
Agglomerating ore	86-88, 272
Air reduction process	274
Ajax "plastic bronz"	365
Alloys	6. 353-373
constitution	355-358
history	353
manufacture	362-364
tables of composition	365, 366
Alumina as a refractory.....	17
in iron blast furnace.....	119
Aluminum	345-348
bronze	365
in iron	111
Amalgamation of gold	324-329
of silver	310-319
American bloomary	164-165
American Society for Testing Materials.....	161, 223
Annealing clay retorts	298
iron castings	160
steel	220
Anthracite	46, 47
as blast furnace fuel.....	138
Antimony in copper	227, 256, 267
in lead	269, 281
Argentite	309
Arsenic in copper	227, 256, 266
in iron	120
in lead	269, 281
Augustine process	319
Autogenous welding	367
Bag filters for fume.....	283
Barrel amalgamation	317, 318
Base bullion	281
Bauxite	17, 346
Beehive coke oven	52, 53
Belgian process	298-301
Bell metal	365
Bertrand-Thiel process	200
Bethlehem iron furnace	127

	PAGE
open hearth furnace	188
Bessemer converter	180-182
process, acid	183, 184
process, basic	185, 186
Billet mill	211-215
steel	211
Bismuth	351, 352
alloys	366
in copper	227, 266
in lead	269
Bituminous coal	46
Black tin	303
Blake ore crusher	70, 71
Blast apparatus	93-99
Blast furnace	91
copper	242-247
iron	114, 115, 123-129
lead	276-278
Blende	293
Blister copper	241
steel	175
Bloom, steel	211
wrought iron	171
Blooming mill	211-215
Blow-holes	7, 150, 207, 208
Blowing engine	93-96
Blue metal	229, 240
powder	300
Bomb calorimeter	27
Bosh, iron blast furnace	115
plates	123, 125, 126
Boss process	317
Brass	363, 365
Breaking ore	69-73
Briquetting ore	86, 87
Bristol pyrometer	33, 34, 38, 39
Brinell test	11
British thermal unit	25
Brittleness of metals	4
Brückner roaster	233
Buddle	80
Burdening iron blast furnace	135-137
By-product coke oven	54-59

	PAGE
Caking coal	47
Calamine	293
Calcination	86
Calculation, efficiency of gas producer.....	62-65
iron blast furnace burden.....	135-137
fuel in iron blast furnace.....	148, 149
Calorific intensity	28
Calorimetry	25-28
Campbell open hearth furnace.....	198, 199
Cannel coal	46
Carbon in Bessemer process.....	184
in iron	105-107
in iron blast furnace process.....	117
in open hearth process.....	196
in puddling process	167, 170
Case hardening	221, 222
Cast iron	150-162
properties	150-152
testing	160-162
Catalan forge	163, 164
Cementation	173, 221
Cement carbon	173
Centrifugal blower	97-99
Cerussite	268
Chalcocite	225
Chalcopyrite	225
Chamott	296
Charcoal in iron blast furnace.....	138
manufacture	49-51
Charging apparatus for iron blast furnace.....	127-129
Chilian mill	75, 76
Chilled castings	158, 159
Chloridizing roasting	86
Chromite	18
Chromium	349, 350
in iron	109, 110, 365
in iron blast furnace process.....	120
Cinder	18
Cinabar	304
Classifying ore	78
Clay	14-16, 296
Coal	45-48

	PAGE
Coke	45, 51-59
in iron blast furnace process.....	138
quenching machine	56, 57
Cobalt	345
in electrolytic copper refining.....	266
Cold bending test	10
Combustion	24
Compression of fluid ingots	207-209
tests	10
Concentration (See ore dressing)	
Conductivity of metals	7
Converter, Bessemer	180-184
copper	250-253
dust	184, 252
slag	184
Continuous gas producer	61, 62
heating furnace	219
open hearth process	199
rolling mill	216
Cooling curves	358-361
Copée coke oven	54
Copper	225-267
alloys	363, 365
extraction	237-259
history	225
in iron blast furnace.....	120
in lead	269, 281, 285
ores	225, 226
plating	372, 373
properties	226-228
refining	260-267
Cottrell process	283, 284
Cowper stove	131-134
Cradle for washing gold.....	323
Cramp's special bronze	365
Crucible furnace	92, 177, 348
steel process	176-178
Crushing tests for metals.....	10
ores	69-73
Cryolite	346
Crystallization of metals	358, 362
Cupellation	290, 291

	PAGE
Cupola, copper	243-247
iron	153, 154
Cuprite	226
Cyanide process	331-339
Damping down iron blast furnace.....	136
Decalescence	219
Density of metals	7
Desilverizing lead	286-291
Destructive distillation	49
Diffusion of metals	6, 354, 355
Dipping process for plating.....	369-371
Distillation furnaces	290, 298, 306, 316, 317
Distributor for iron blast furnace.....	128
Dolomite	17
in iron blast furnace.....	139
in open hearth	193
Doré	292
Drawing metals	5
Dredging gold ore	325-327
Drop forging	5
test for metals	161, 162, 223, 224
Dry blast apparatus	141, 145
puddling	167
sand molds	158
Ductility of metals	5, 8
Duplex steel process	200
Duquesne blast furnace hoist.....	127
Dust catcher	129-131
Dwight-Lloyd process	87, 88
Elasticity of metals	3, 10
Electric furnaces	92, 93, 348
furnaces, steel	201-203
furnaces process, steel	203, 204
resistance pyrometer	30-32
welding	367, 368
Electro-cyanide process	337, 338
Electrolytic copper refining	262-269
gold and silver refining.....	340, 341
lead refining	291, 292
plating	371, 372

	PAGE
Electrostatic ore separation	85
fume settling	283, 284
Endothermic reactions	25
Eutectic, definition	357
Evaporative power	28
Exothermic reactions	25
Fan blowers	96
Ferro-chrome	109
manganese	109
phosphorus	108
silicon	107
titanium	111
tungsten	110
vanadium	111
Fery pyrometer	34
Fettling for puddling furnace	169
Fink smelter	254, 255
Fire-clay	14, 15, 296
Flotation of ores	83
Flouring of mercury	316, 329
Flow of metals	4, 5
Flue dust, iron blast furnace	122, 148
dust, lead blast furnace	282, 283
Fluid compression of steel ingots	207-209
Fluorspar	19
Fluxes	18
Flying shears	216
Fore hearths	246, 247
Forges	91, 163-165
Forging iron and steel	211-218
Founding iron	152-159
Fracture of metals	1-2
tests	2, 178, 192
Fuels	43-66
in iron blast furnace	137, 138
Furnaces	89-93
Fume, recovery of lead	282-284
Fusibility of metals	6
of slags and refractories	21, 22
Fusion point pyrometer	37
Galena	268
Galvanizing	371
Gangue	67

	PAGE
Ganister	14, 181
brick	15
Garnierite	342
Gas as fuel	43
iron blast furnace	122
producers	59-65
pyrometer	29, 30
Gayley bosh plate	126
dry blast apparatus	142-145
German silver	365
Girod electric furnace	202
Goethite	102
Gold	322-341
alloys	366
dredge	325-327
extraction	323-339
history	308
in copper	256, 266
in lead	289, 355
ores	322
properties	322, 323
refining	339, 340
Goldschmidt process	368
Grading pig iron	151, 152
Graphite	17, 18
crucibles	176
Graphitic carbon	105, 106
Gray iron	106
Great Falls converter	253
Green sand molds	156-158
Grizzly	77
Gun metal	365
Gyratory crusher	71-73
Hadfield steel	109
Hammer forging	217
Hand picking ores	69, 104
reverberatory roaster	231-233
Hardness of metals	ii, 12
Harveyizing armor plates	221
Hausmanite	348
Heap roasting	229-231
Hearth (see forges) lead	275

	PAGE
Heat conduction pyrometer	30
regenerators	56, 93, 131-134
treatment of steel	218-222
Hematite	101
Heroult furnace	201
Hoists for iron blast furnace.....	128, 129
Horn silver	309
Hot blast stoves	131-134
Huntington Heberlein process	272
mill	76, 77
Hydraulicizing	324, 325
Hydrogen in iron	112
in iron blast furnace.....	117
Hydro-metallurgy	257, 258
Ilmenite	103
Impact tests	161, 162
Ingots, steel	207, 211
Inquartation	339
Iron	100, 224
alloys	363-365
blast furnace plant	123, 124
extraction	114-149
founding	152-162
history	100, 101
in copper	256, 266
in lead	269, 275, 280
mixer	180
ores	101-103
properties	104-113
Isbel vanner	82, 83
Jaw crusher	70, 71
Jig	79, 80
Kilns	90, 91
Kish	105
Kjellin electric furnace	203
Krupp process	222
Ladle, lead	279
steel	206

	PAGE
Langley's experiment with tungsten steel.....	110
Leaching process, copper	257, 258
process, gold	329-339
process, nickel	344
process, silver	319-321, 329-339
Lead	268-292
alloys	366
extraction	273-284
fume	282-284
history	268
in copper	256, 267
ores	268
properties	268-270
refining	285-292
Lechatelier pyrometer	32
Leeds & Northrup pyrometer.....	39-42
Lewis & Bartlett process.....	283
Lignite	44, 45
Lime	17
in cyanide process	333
in iron blast furnace.....	119, 138, 139
in lead blast furnace.....	280
Limonite	102
Liquation	6, 356, 358
Loam molds	158
Lodes, ore	68
Log washer	79
Luce & Rozan process.....	287
Magnesia	16, 17
in iron blast furnace.....	119, 139
Magnetic separation	84, 85
Magnetism of metals	7
Magnetite	102
Malachite	226
Malleability of metals	4, 8
Malleable castings	160
Manganese	348, 349
bronze	365
in iron	108, 109
in iron blast furnace.....	118
in open hearth furnace.....	196
steel	109, 365

	PAGE
Matte, copper	229
lead	281
nickel	343
smelting, blast furnace	247-250
smelting, reverberatory	237-240
McClure stove	133, 134
McDougal roaster	234, 235
Mechanical puddling	172
Melaconite	226
Melting point pyrometer	37
Metal expansion pyrometer	30
Mercury	304-307
in gold extraction	328, 329
in silver extraction	312-319
Micaceous ore	101
Mica schist	181
Mild steel	173
Mineral wool	147
Mixer for iron	180
Modulus of elasticity	3, 10
Moisture in hot blast	141-145
Molds, ingot	209, 210
in iron founding	156-159
Molybdenum	350
in iron	111
Monell process	200
Monel metal	364, 365
Morgan gas producer	60-62, 64
Mosaic gold	365
Mottled iron	152
Muffle furnaces	92, 166
Muntz metal	328, 365
Mushet steel	110
Native copper	225
gold	322
iron	101
mercury	304
silver	308
Natural gas	48

	PAGE
Nickel	342-345
in copper	256, 266
in iron	109
steel	109, 365
Nitrogen in iron	112
in iron blast furnace.....	117
Nodulizing ores	87
Occlusion in metals.....	7, 112, 207, 226, 227, 309
Open hearth furnace	188, 189, 199
hearth process, acid	187-193
hearth process, basic	193-198
Optical pyrometers	34-37
Ore dressing	67, 69-88
dressing, copper	229-236
dressing, iron	103, 104
dressing, lead	270-272
dressing, tin	303
dressing, zinc	295
Ores, classification	67, 68
Otto-Hoffman coke oven	55, 56
Oxidizing roasting	86
Oxygen in copper	228
in iron	108
in iron blast furnace.....	117
Panning gold ore	323
Parkes process	288-291
Parr calorimeter	25-27
Parting gold and silver.....	339, 340
Patera process	319, 320
Patio process	312, 313
Pattinson process	286, 287
Peat	43, 44
Pelatan-Clerici process	337
Phosphor-copper	364
Phosphorus in alloys	364, 365
in copper	228
in iron	108
in iron blast furnace.....	118
in open hearth furnace.....	196
Physical properties of metals.....	1-12

	PAGE
Pig boiling process	168-172
iron	114
machine	147
Piping in castings	150, 207, 208
Placers	322
Plasticity in metals	3
Plating	369-373
Platinum	352
alloys	366
Platinite	365
Plattner process	329
Pneumatic ore concentration	86
Pocket ores	68
Polling copper	261
tin	304
Positive blower	96, 97
Pot roasting	272
Press forging	218
Producer gas	59-65
Puddling process	166-172
Pullover mill	216
Pulverizing ores	73-76
Pyrite	103
Pyritic smelting	249, 250
Pyrolusite	348
Pyrometry	29-42
Quartzite brick	14
Quenching steel	220, 221
Quicksilver	304-307
Radiation pyrometer	34
Rail mill	215, 216
steel specifications	223
Reaction process	274
Recalescence	219
Recording pyrometers	38-42
Red fossil ore	102
shortness	108
Reduction	24
Refinery, for white iron	167, 168
Refractories	13-23
tests	20-23

	PAGE
Regenerators, heat	56, 93, 131-134
Regulus	229
Reheating steel	218, 219
Retort furnaces	92
Belgian	298, 299
mercury	316, 317
zinc	296-298
Reverberatory furnaces	91
copper	231-235, 237-242
iron puddling	169
lead	273-275
steel	198, 199
Roasting	86
copper ores	229-236
lead ores	270-272
silver ores	311
zinc ores	295
Röchling-Rhodenhouser furnace	203
Rotary piston blower	96, 97
Running out fire	167, 168
Russell process	320, 321
Sand as a refractory	14
in ore dressing	80
molds	156-158
Scaffold in iron blast furnace	121
Scale, iron	108
Sclerometer	11
Scleroscope	12
Scott bosh plate	125
Scrap, steel	190
Screening ores	77, 78
Seger cones	15, 21
Segregation	19, 207, 358
Self-hardening steel	110
Separator or settler, amalgam	316
Shear steel	175
Sherardizing	372
Sickening of mercury	329
Siderite	102
Siemens gas producer	60
and Halske process	337

	PAGE
Silica	14
brick	14
Silicon in copper	227
in iron	107
in iron blast furnace	119
in open hearth furnace.....	195
in puddling furnace	170
Silver	308-321
alloys	366
extraction	310-321
history	308
in copper smelting and refining.....	256, 266
in lead	269, 286-292
parting from gold	321, 340
properties	309, 310
Sintering ores	87, 88, 272
Sizing ores	76-78
Skimmer, pig iron	145, 146
Slabs, steel	211
Slag	18-20
Slime, copper anode	266
ore	80
Sluice, gold	325
Smelting	18
Smithsonite	293
Soaking pits	210, 211
Softening lead	285
Specifications, standard car wheels.....	161, 162
standard steel rails	222-224
Specific heat pyrometer	30
Specular ore	101
Speiss	282
Spelter	294
Sphalerite	293
Spiegel-eisen	109
Spinning metals	5
Spirek furnace	306
Spray process	373
Squeezer for wrought iron bloom.....	171
Stall roasting	231
Stamp mill	73-76
Stassano furnace	201
Steel	173-224

	PAGE
Stetevelt furnace	311
Stone, refractory	14
Stripping ingots	209, 210
Sulphate roasting	258, 319
Sulphur, effect on copper	228
effect on iron	107, 108
in coke	57
in copper smelting	256
in iron smelting	118
in lead smelting	280
in open hearth furnace	196
in electric steel furnace	204
Surfusion	360
Sweating processes	285, 303, 304, 358
Table concentrator	81, 82
Talbot process	199, 200
Tapping iron blast furnace	145
open hearth furnace	192
Taylor gas producer	62
Temperature records of hot blast	140
curves	358-361
Tempering steel	220
Tenacity of metals	2, 7, 8
Tensile tests	8
Testing cast iron	160-162
coal	45, 46
metals	8-12
steel	222-224
refractories	20-23
Tetrahedrite	309
Thermit process	368
Thermo-electric pyrometer	32
Three-high mill	215, 216
Tin	302-304
alloys	366
plating	369, 370
Titanium, effect on iron	111
in iron blast furnace	120
Tom, washer for gold	324
Toughness of metals	4
Transverse tests	10
Trap spout	243

	PAGE
Trommel	78
Tungsten	350
effect on iron	110, 111
Turbo-blowers	99
Tuyeres for iron blast furnace	126
Universal mill	212, 215
Vacuum furnace	92
Vanadium	350, 351
in iron	111
Veins, ore	68
Volatility of metals	6
Washing gold ore	323, 324
ores	79-83
Washoe process	313-317
Water gas	65, 66
jackets	89, 126, 243, 277
Weathering ores	69
Wedgewood's pyrometer	30
Welding	6, 366-368
Wellman furnace	199
Wetherill separator	84, 85
White-Howell furnace	233
White iron	152
metal	229, 240
Wild heats	207
Wilfley table	81, 82
Willemite	293
Wire drawing	5
Wolframite	350
Wood	43
Work lead	310
Wrought iron	163-172
Ziervogel process	319
Zinc	293-301
alloys	363, 365
dust	300, 336
extraction	296, 301
history	293

	PAGE
Zinc in copper smelting	256
in copper refining	266
in cyaniding	335-337
in iron blast furnace.....	120
in lead blast furnace.....	281
in Parkes process	289
ores	293
plating	370-372
properties	294
refining	301

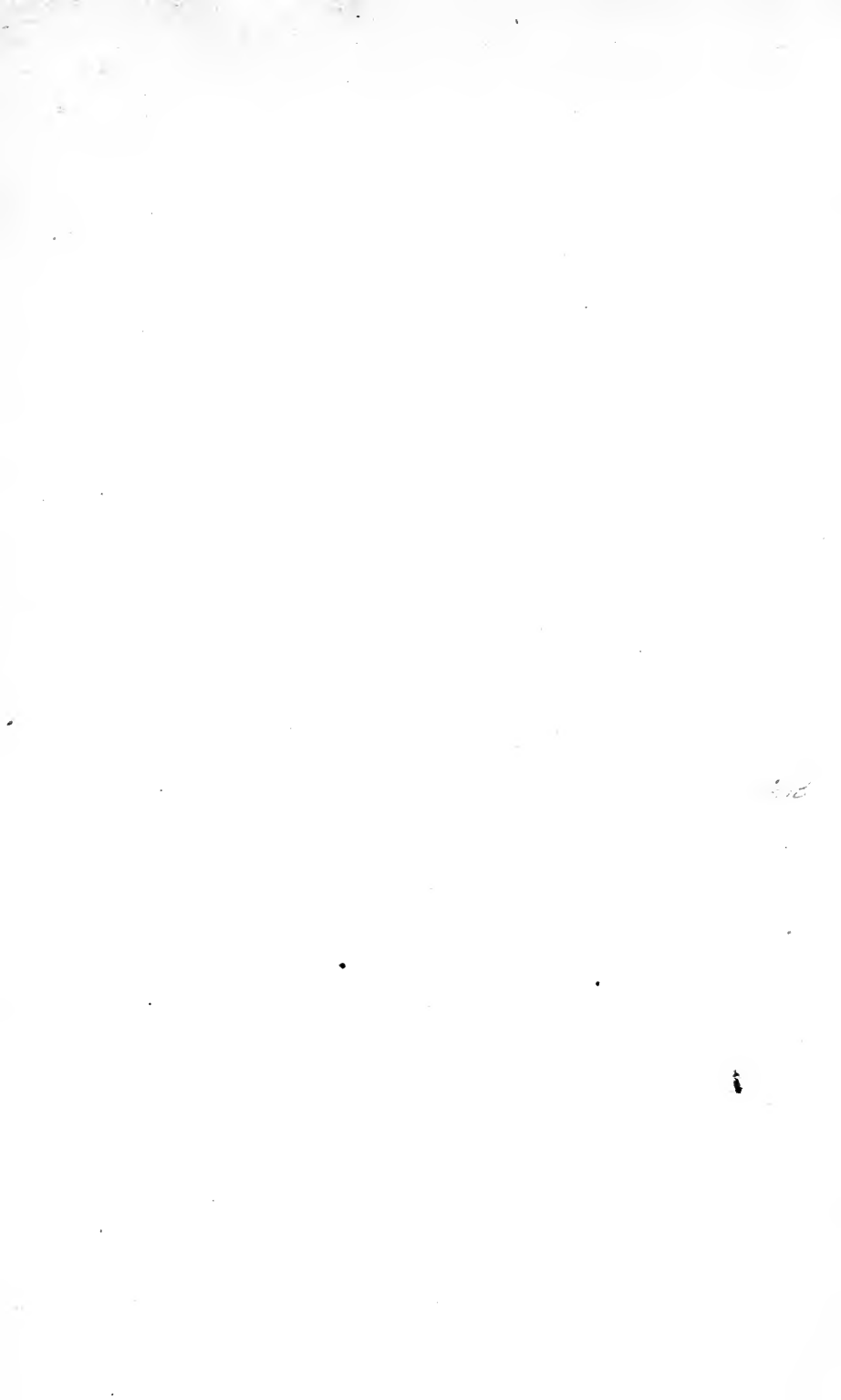



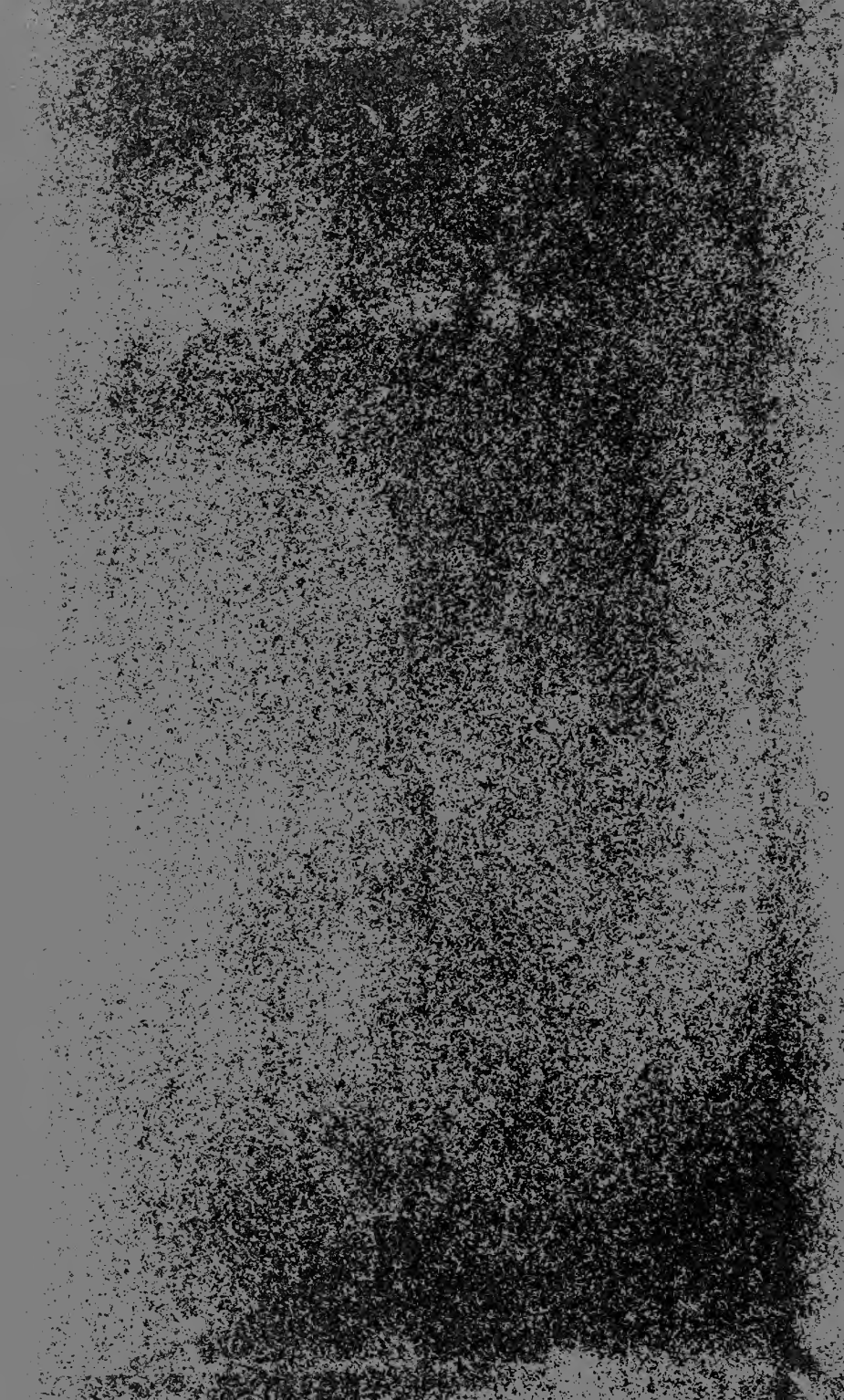

UNIVERSITY OF CALIFORNIA LIBRARY
BERKELEY

Return to desk from which borrowed.
This book is DUE on the last date stamped below.

DEC 18 1947

LD 21-100m-9,'47(A5702s16)476

YC 68437

68437

TN

305

WE

21A

THE UNIVERSITY OF CALIFORNIA LIBRARY

