

5 0.573

ZOOLOGICA

SCIENTIFIC CONTRIBUTIONS
of the
NEW YORK ZOOLOGICAL SOCIETY

VOLUME 31

1946-1947

Numbers 1-13



Published by the Society
The Zoological Park, New York

21

NEW YORK ZOOLOGICAL SOCIETY

General Office: 630 Fifth Avenue, New York 20, N. Y.
Publication Office: The Zoological Park, New York 60, N. Y.

OFFICERS

FAIRFIELD OSBORN, *President*
ALFRED ELY, *First Vice-president*
LAURANCE S. ROCKEFELLER, *Second Vice-president*
HAROLD J. O'CONNELL, *Secretary*
CORNELIUS R. AGNEW, *Treasurer*

SCIENTIFIC STAFF

General

JOHN TEE-VAN, *Executive Secretary*
WILLIAM BRIDGES, *Editor and Curator of Publications*
MYRTICE BLATCHLEY, *Associate in Charge, Education*

Zoological Park

LEE S. CRANDALL, *General Curator & Curator of Birds*
LEONARD J. GOSS, *Veterinarian*
BRAYTON EDDY, *Curator of Reptiles and Insects*
GRACE DAVALL, *Assistant to General Curator*

Aquarium

CHRISTOPHER W. COATES, *Curator and Aquarist*
ROSS F. NIGRELLI, *Pathologist*
MYRON GORDON, *Assistant Curator*
C. M. BREDER, JR., *Research Associate in Ichthyology*
G. M. SMITH, *Research Associate in Pathology*
HOMER W. SMITH, *Research Associate in Physiology*

Department of Tropical Research

WILLIAM BEEBE, *Director*
JOCELYN CRANE, *Research Zoologist*
HENRY FLEMING, *Entomologist*
WILLIAM K. GREGORY, *Associate*
GLORIA HOLLISTER, *Associate*
JOHN TEE-VAN, *Associate*
MARY VANDERPYL, *Associate*

Scientific Advisory Council

A. RAYMOND DOCHEZ
ALFRED E. EMERSON
ALAN GREGG
K. S. LASHLEY
JOHN S. NICHOLAS
GEORGE M. SMITH

Editorial Committee

FAIRFIELD OSBORN, *Chairman*
WILLIAM BEEBE
WILLIAM BRIDGES
CHRISTOPHER W. COATES
LEE S. CRANDALL
LEONARD J. GOSS
JOHN TEE-VAN

CONTENTS

Part 1. April 29, 1946

	PAGE
1. Notes on the Taxonomy of the Birds of Malaysia. By JEAN DELACOUR.	1
2. A New Name for a Philippine Flowerpecker. By ERNST MAYR.....	8
3. Further Notes on Display Forms of the Long-tailed Bird of Paradise, <i>Epimachus meyeri meyeri</i> Finsch. By LEE S. CRANDALL. Plates I-III.....	9
4. Field Notes on the Snakes of Kartabo, British Guiana, and Caripito, Venezuela. By WILLIAM BEEBE. Plates I-XIII; Text-figures 1-4...	11

Part 2. August 20, 1946

5. Eastern Pacific Expeditions of the New York Zoological Society. XXXIV. Mollusks from the West Coast of Mexico and Central America. Part III. By LEO GEORGE HERTLEIN & A. M. STRONG. Plate I.	53
6. Introgressive Hybridization in Domesticated Fishes. I. The Behavior of Comet—A <i>Platypoecilus maculatus</i> Gene in <i>Xiphophorus hellerii</i> . By MYRON GORDON. Plates I-III.	77
7. Spontaneous Neoplasms in Fishes. I. Osteochondroma in the Jewelfish, <i>Hemichromis bimaculatus</i> . By ROSS F. NIGRELLI & MYRON GORDON. Plates I-V; Text-figures 1 & 2.....	89

Part 3. December 5, 1946

8. Eastern Pacific Expeditions of the New York Zoological Society. XXXV. Mollusks from the West Coast of Mexico and Central America. Part IV. By LEO GEORGE HERTLEIN & A. M. STRONG. Plate I.	93
9. Effects of Sex Hormones on the Development of the Platyfish, <i>Platypoecilus maculatus</i> . By HERMAN COHEN. Plates I-V; Text-figure 1	121

Part 4. February 21, 1947

	PAGE
10. Eastern Pacific Expeditions of the New York Zoological Society. XXXVI. Mollusks from the West Coast of Mexico and Central America. Part V. By LEO GEORGE HERTLEIN & A. M. STRONG. Plate I.	129
11. Eastern Pacific Expeditions of the New York Zoological Society. XXXVII. Deep-sea Ceratioid Fishes. By WILLIAM BEEBE & JOCELYN CRANE. Plates I-III; Text-figures 1-19.....	151
12. Spontaneous Neoplasms in Fishes. II. Fibro-carcinoma-like Growth in the Stomach of <i>Borophryne apogon</i> , A Deep-sea Cera- tioid Fish. By ROSS F. NIGRELLI. Plates I-IV.....	183
13. Studies on the Genus <i>Hirudinella</i> , Giant Trematodes of Scom- briform Fishes. By ROSS F. NIGRELLI & HORACE W. STUNKARD. Plates I-VIII.....	185
Index to Volume 31.....	197



590.573

ZOOLOGICA

SCIENTIFIC CONTRIBUTIONS

of the

NEW YORK ZOOLOGICAL SOCIETY

VOLUME 31

Part 1

Numbers 1-4



Published by the Society
The Zoological Park, New York
April 29, 1946

CONTENTS

	PAGE
1. Notes on the Taxonomy of the Birds of Malaysia. By JEAN DELACOUR.	1
2. A New Name for a Philippine Flowerpecker. By ERNST MAYR.....	8
3. Further Notes on Display Forms of the Long-tailed Bird of Paradise, <i>Epimachus meyeri meyeri</i> Finsch. By LEE S. CRANDALL. Plates I-III.....	9
4. Field Notes on the Snakes of Kartabo, British Guiana, and Caripito, Venezuela. By WILLIAM BEEBE. Plates I-XIII; Text-figs. 1-4.....	11

1.

Notes on the Taxonomy of the Birds of Malaysia.

JEAN DELACOUR.

New York Zoological Society and American Museum of Natural History.

In the preparation of a handbook of the birds of Malaysia, I have naturally used as a basis "A handlist of Malaysian Birds" by F. N. Chasen (*Bull. Raffles Museum*, Singapore, No. 11, December, 1935), an excellent and most reliable work. But a number of additions have been made, and new facts have been brought to light since its publication. Furthermore, considerable changes have taken place in the nomenclature, mostly as a result of several revisions of families or smaller groups recently conducted by E. Mayr, D. Amadon, H. G. Deignan, S. D. Ripley, C. Vaurie, and myself. All these alterations of Chasen's nomenclature have been incorporated in the forthcoming handbook. I thought it useful to point out the most important of them in the present paper. A bibliography of the Malaysian Avifauna since 1935 will be found at the end of these notes. In most cases, no attempt has been made to revise subspecies, for lack of time. Reasons for their adoption, rejection or addition are not discussed unless they prove of special interest. The same applies to extension or modification in ranges. Particularly the reader is referred to "Notes on the Taxonomy of the Birds of the Philippines" by Jean Delacour and Ernst Mayr, *Zoologica*, 30 (12), November 15, 1945, pp. 105-117, for all changes applying equally well to Malaysian birds, as they will not be discussed here again.

I am much indebted to the curators of the U. S. National Museum, Washington, and of the Academy of Natural Sciences, Philadelphia, for the loan of valuable material, and to my friend Dr. Ernst Mayr for much useful information and help.

Grebes (Podicipidae).

Podiceps novae-hollandiae javanicus has been added to the list. Found in Java. Mayr has discussed the distribution of *novae-hollandiae* and *ruficollis* (*Emu*, 43, 1943, pp. 3-7; 44, 1945, pp. 231-233).

Ducks (Anatidae).

The Australian pochard (*Aythya australis*) has been found in Java, where it seems to be a rare resident in the eastern part of the island (Hiang Plateau). Mayr (*Amer. Mus. Novit.* No. 1056, p. 7, 1940)

has shown that the proposed race *lebeboeri* (Bartels and Frank, *Treubia*, 16, p. 337, 1938) is not acceptable. The Javan specimens belong to the nominate race.

Game Birds (Phasianidae).

I do not consider that all Malaysian forms of *Arborophila*, except *charltoni* and races, can be considered subspecies of *brunneopectus* (= *javanica*), as proposed by Chasen. Differences in pattern and general coloration are too great. The Malaysian group form a superspecies which can be listed as follows: *A. brunneopectus: campbelli, rolli, sumatrana, orientalis*; *A. javanica: javanica, bartelsi*; *A. hyperhythra (erythrophrys* is but a color phase).

In the general study of the kalij and fire-back pheasants which I have recently effected in the preparation of a new monograph, I have been compelled to admit that no natural generic divisions exist among these birds. Characters such as the general color pattern, the shape of the crest or its absence in one or both sexes, the shape and development of the tail feathers, do not show sufficient consistency for clear distinctions. The species *inornatus, imperialis* and *edwardsi* are providing links between the different groups to such a degree that no satisfactory divisions can stand. Therefore the generic names *Gennaeus, Hierophasis, Delacourigallus, Houppifer, Chalcocornis* and *Diardigallus* are synonyms of *Lophura*, the oldest in date.

Although the species *calchurum* is very distinct in shape, display and voice, it cannot be separated from other *Polyplectron*, as *inopinatum* supplies a perfect intermediate.

Pigeons (Columbidae).

Mayr ("The Birds of Timor and Sumba," *Bull. A. M. N. H.*, 83 (2), 1944, pp. 147-148) has pointed out that the subspecies *Ducula aenea aenea* occurs only in the Lesser Sunda Islands, being larger, more vinaceous than the Malaysian population. The oldest name available for the latter is *consobrina* (Salvadori, 1887, Nias).

Cuckoos (Cuculidae).

We have shown (*Zoologica*, 30 (12), p. 107) that the generic names *Rhopodytes*,

Rhinortha and *Zanclostomus* are synonyms of *Phoenicophaeus*. It follows that *P. curvirostris borneensis* (Blasius and Nehr Korn, 1881) is antedated by *P. diardi borneensis* (Salvadori, 1874). It must therefore be known as *P. c. microrhinus* (Berlepsch, 1895).

Hornbills (Bucerotidae).

Two very similar pied hornbills are found in India and Ceylon: *coronatus* in the south and west and *malabaricus* in the northeast. Both coexist in part of their range (Chota Nagpore and western Bengal) and therefore must be considered two different species. There is a great deal of difference in the shape of the casque, which is narrow, compressed, with flat sides in *coronatus*; broad, swollen and convex on the sides in *malabaricus*. Furthermore, in *coronatus* there is one large black patch on the bill, located on the terminal two-thirds of the casque, including the whole ridge. In *malabaricus*, there are two black patches, one on each side of the casque, leaving out the ridge which is always pure white; they are roughly triangular, extending from the tip of the casque downward to about one-half of the bill and encroaching on the sides of the mandible itself. In *coronatus*, all the lateral tail feathers are white, the central pair alone being black. In *malabaricus*, the lateral feathers are black, with only the terminal quarter white. Farther east, a subspecies of *malabaricus* (*leucogaster*) ranges as far south as Perak in Malaya. Southern Malaya, Sumatra, Borneo and islands are the home of *convexus*, which again has the lateral tail feathers entirely white, as in *coronatus*. All the same, *convexus* is a subspecies of *malabaricus*, not of *coronatus*, as the casque is of identical shape and pattern. This characteristic is much more important than the variation in the color of the tail feathers. As it could be expected from the geographical distribution of these hornbills, the similarity of *coronatus* and *convexus* in this particular point can only be interpreted as a result of convergence, without any phyletic significance.

Barbets (Capitonidae).

The barbets have been revised recently by Ripley (*Auk*, 62, 1945, pp. 542-563). His general conclusions have been adopted, with the following exceptions:

I consider *Megalaema armillaris* (+ *baliensis*), *M. henrici* (+ *brachyrhyncha*), and *M. pulcherrima* as three different species, forming a superspecies, as the differences in pattern are too great, in my opinion, to warrant specific lumping. *M. eximia* (+ *cyanea*) is so different in pattern, coloration and size of rictal bristles from *M. australis* (+ *duvauceli* and races) that they should be considered as two distinct and not very closely related species.

Woodpeckers (Picidae).

The generic names *Callolophus* and *Chrysophlegma* are considered synonyms of *Picus*, no sufficiently important characteristics being found in the different species to warrant generic splitting.

The Malaysian pigmy woodpeckers of the genus *Dendrocopos*¹ belong to two distinct species: *canicapillus* (gray-headed) and *moluccensis* (brown-headed), which coexist in numerous localities. (See Greenway, *Auk*, 60, 1943, pp. 564-574). The Philippine forms belong to a different species: *maculatus*. The three species are very similar, but can be fairly easily distinguished.

The two three-toed species, *javanense* and *rafflesi*, are certainly to be regarded as congeneric, as they have very similar pattern and colors, the differences in the bill (culmen straighter and more angulate, and base covered by short plumes in *rafflesi*) being of specific significance only. Therefore *Chloropicoides* (1847) becomes a synonym of *Dinopium* (1814). It follows that *D. rafflesi borneonensis* (Hesse, 1911) is antedated by *D. javanense borneonensis* (Dubois, 1897). I propose to name it:

Dinopium rafflesi dulitense

nom. nov. for *Gauropicoides rafflesi borneonensis*, Hesse, Orn. Monatsber. 19, 1911, p. 192: Mt. North Sarawak, Borneo.

Pittas (Pittidae).

I consider *Pitta schneideri* as a full species, as it is too different in colors from *P. nipalensis*, in both sexes and at different ages. *P. venusta* and *P. ussheri*, both with the crown black, are considered subspecies of the red-crowned *P. granatina* (+ *coccinea*) as none of the forms appear to overlap. *Venusta* inhabits western Sumatra; *coccinea*, Malaya and northwestern Sumatra; *ussheri*, northwestern Borneo; *granatina*, northeastern and southern Borneo. Stresemann (*Temminckia*, 3, 1938, Leiden, pp. 124-125) mentions intermediates in adjoining areas of distribution in Borneo.

Cuckoo-Shrikes (Campephagidae).

In examining the numerous species so far distributed among the "genera" *Coquus*, *Pteropodocys*, *Coracina*, *Volvocivora*, *Edolisoma*, I fail to see how they can be divided according to any important and stable groups of characteristics. Difference in the size and proportions of the body, bill, wings and tail, or in color pattern, are combined in all sorts of ways, none being of any great significance. It is therefore advisable to include them all in the genus *Coracina*.

On the other hand, the genus *Lalage* is quite distinct, if restricted to the slender species *nigra*, *sueuri*, *melanoleuca*, *leuco-*

¹ *Dendrocopos* Koch, 1816, replaces *Dryobates* Boie, 1826. Not antedated by *Dendrocopus* Vieillot, 1816.

pygia, *aurea*, *atrovirens*, *leucomela*, *maculosa* and *sharpai*. The genera *Campephaga*, *Chlamydochera*, *Campochera*, *Pericrocotus*, *Hemipus* and *Tephrodornis* complete the family.

Leafbirds (Aegithinidae).

Aethorhynchus is a synonym of *Aegithina*. The only species assigned to it, *lafresnayei*, is but a larger edition of *Aegithina tiphia*, with a longer bill. Both species have the same color pattern, and both have two moults in the year, the male assuming a breeding plumage for the mating season. They are obviously so closely related that a generic distinction between them appears to be absurd.

Bulbuls (Pycnonotidae).

A new arrangement of the subspecies of crested bulbuls of the genus *Criniger* has been adopted. It is a little different from that previously proposed in my "Revision of the Genera and Species of the Family Pycnonotidae" (*Zoologica*, 28 (4), 1943, p. 26), and very similar to that recently proposed by H. G. Deignan (The Birds of Northern Thailand, *U. S. Nat. Mus. Bull.* 186, 1945, p. 338).

It now seems to me that these puzzling bulbuls, all very similar, can be divided into two species:

1. *Criniger tephrogenys*—Crest and tail relatively short. Living at lower altitudes in the southern part of the range, where both species coexist. It includes the following subspecies: *xanthizurus*, *balicus*, *frater*, *gut-turalis*, *tephrogenys*, *robinsoni*.

2. *Criniger ochraceus*—Crest and tail relatively long, living at higher altitudes in the southern part of the range, with the following subspecies: *flaveolus*, *burmanicus*, *griseiceps*, *pallidus*, *henrici*, *annamensis*, *ochraceus*, *cambodianus*, *sacculatus*, *sumatranus*, *ruferrissus*.

In both groups we find birds with bright yellow, dirty yellow and pale brown underparts, and many intermediates. The extent and intensity of the yellow pigment is only of subspecific significance.

Old World Insect-eaters (Muscicapidae).

I. ROBINS, CHATS AND THRUSHES (TURDINAE).

Like *Kittacincla*, *Trichixos* Lesson, 1839, is a synonym of *Copsychus* (see "Notes on the Taxonomy of the Birds of the Philippines," *Zoologica* 30 (12), 1945, p. 112). The unique species *pyrrropygus* is very close to *sularis* in shape, and to *malabaricus* in habits and voice.

The new name *ater* proposed in the same paper for *Copsychus sularis niger* (Sharpe) is unnecessary, as there is an older name available for the subspecies, so far overlooked: *Copsychus adamsi* Elliott, *Auk*, VII,

1890, p. 348. In a further note, *Auk*, VIII, 1891, p. 117, Elliott recognizes that *adamsi* is a synonym of *niger*.

II. BABBLERS (TIMALIINAE).

The heterogeneous medley of species variously assigned to the babbler group since the beginning of the last century have been a puzzle to ornithologists until the present days. For many years the present writer has studied them extensively in museums, in captivity and in nature, having observed and collected many different forms in French Indo-China, the richest country in the Orient as far as these birds are concerned. During the last few years, Mayr and I have been preparing a detailed study of the Timaliinae which we hope to have published shortly.

I only want to give here a brief and tentative survey of the principal results and their repercussion on the nomenclature of Malaysian Timaliinae. We have found that there are five distinct groups, or tribes, with or without links between themselves or with the other subfamilies of insect-eaters:

A. Ground babblers (Cinchlosomatini) inhabiting the Australian Region, only one reaching Malaysia (*Eupetes*); a primitive tribe.

B. Jungle babblers (Pellorneini) including the following Malaysian genera and species: *Pellorneum*: *ruficeps*, *capistratum*; *Malacocincla*: *tickelli*, *pyrrhogenys*, *malacensis*, *cinereiceps*, *rostrata*, *bicolor*, *sepiaria*, *abboti*; *Malacopteron*: *magnum*, *cinereum*, *maguirostre*, *affine*, *albugulare*.

The generic names *Aethostoma*, *Anuroptis* and *Erythrocincla* are considered synonyms of *Malacocincla*. The species *tickelli* belong to that genus, not to *Pellorneum*. *M. vanderbilti* is probably an altitudinal race of *sepiaria*. Examination of available series shows that the birds named *Elocincla aenigma* by Riley are identical with those named *rufiventris* by Salvadori. As they agree with the description of the mysterious *perspicillata* Bonaparte, this last name must be used.

Ophrydornis is a synonym of *Malacopteron*.

Through *Pellorneum*, on the one hand, and such birds as *Megaralurus mariei*, *bivittata* (New Caledonia and Timor) and *Ortygocincla rubiginosa* (New Britain), and *Bradypterus*, on the other, this tribe is connected with the Sylviinae.

C. Scimitar and wren babblers (Pomatorhinini), forming a separate tribe with little connection with any others. The Malaysian representatives are: *Pomatorhinus*: *montanus*, *hypoleucos*; *Rimator*: *malacoptilus*; *Ptilocincla*: *leucogrammica*, *falcata*; *Kenopia*: *striata*; *Turdinus*: *marmoratus*, *macroactylus*, *brevicaudatus*, *epilepidotus*; *Pnoepyga*: *pusilla*.

Napothera is considered a synonym of *Turdinus*, as *brevicaudatus* differs from *macroductylus* by the size only, the different races of both species showing a strikingly similar variation. Contrary to R. M. de Schauensee's opinion (*Proc. Acad. Nat. Sci.*, Philadelphia, 1940, 91, pp. 352-354), I believe that all the forms of the smaller *Turdinus* can be referred to the one species *epilepidotus*, those found in the same area being altitudinal races, not really coexisting anywhere.

The Annamese genus *Jabouilleia* provides a perfect link between *Pomatorhinus* and *Rimator*.

D. Tit babblers (Timaliini). A large tribe, perhaps connected with the titmice (Paridae) through the so-called longtailed tits (*Aegithalos*, *Psaltria*, *Psaltriparus*), the parrotbills (*Paradoxornis*), the reedlings (*Pauurus*), the American wren tits (*Chamaea*), the oriental genera *Moupinia*, *Chrysomma*, *Dunetia* and *Timalia*.

The following occur in Malaysia: *Macromus: flavicollis, gularis, ptilosus*; *Stachyris: nigriceps, poliocephala, grammiceps, nigricollis, leucotis, maculata, striolata, thoracica, erythroptera, rufifrons, chrysaea, melanothorax*; *Timalia: pileata*; *Psaltria: exilis*.

The genus *Cyanoderma* is considered a synonym of *Stachyris*, as the presence, extent or absence of the naked skin behind the eye vary throughout the whole group in a way which is not consistent with other characteristics.

E. Song babblers (Turdoidini). The most differentiated tribe, which appears to be connected with the jungle babblers through *Gampsorhynchus* and *Malacopteron*, and also perhaps to the wren babblers through *Turdoides* (including *Argya*) and *Pomatorhinus*. They are numerous in Malaysia, but the Himalaya-Indo-China country is their stronghold: *Garrulax: lugubris, palliatus, rufifrons, leucolophus, mitratus, erythrocephalus*; *Leiothrix: argentauris*; *Cutia: nipalensis*; *Pteruthius: erythropterus, melanotis, aenobarbus*; *Alcippe: castaneiceps, nipalensis, pyrrhoptera*; *Siva: strigula, cyanuroptera, castaneiceps*; *Yuhina: xantholeuca*; *Gampsorhynchus: rufulus*; *Crocias: guttatus*; *Heterophasia: picaoides*.

Melanocichla and *Rhopocichla* are obviously generic synonyms of *Garrulax*. We also consider *Mesia* a synonym of *Leiothrix*, and *Erpornis* of *Yuhina*.

There has been in the past some confusion between the small species of *Pteruthius*; *tahanensis*, from Malaya, is a subspecies of *melanotis*, not of *aenobarbus*, the nominate form of which inhabits Java.

III. FLYCATCHERS (MUSCICAPINAE).

The reasons for lumping several genera of flycatchers into the genus *Muscicapa* have

been previously given (*Zoologica*, 30 (12), p. 113). The genus *Niltava* must be added to the synonymy of *Muscicapa*, as no clear line can be drawn between the various forms with and without blue patches on the neck of the females. Generic distinction between such species as *sundara*, *davidi*, *vivida*, *cyanomelana*, *concreta*, etc., is unsound. *Oreicola* is also a synonym of *Muscicapa*. *Drymophila* is apparently a monarch flycatcher, related to *Terpsiphone* and to *Monarcha*.

Flowerpeckers (Dicaeidae).

The group of flowerpeckers (*Dicaeum*) with dark metallic upperparts and partly red underparts, found from S. E. Asia to Australia, is puzzling. One would be tempted to regard them all as geographical subspecies, but two forms coexist in certain places, such as Timor (*maugei maugei* and *sanguinolentum hanieli*). When carefully examined, they are really more different than they appear to be at first sight.

It seems, therefore, necessary to maintain several species. In Malaysia, I consider that *monticola* (bluish above), *sanguinolentum* (purplish), and *ignipectus* (greenish) are separate species; *beccarii*, with no red on the breast, is a race of *ignipectus*, close to *camבודianum* from Indo-China.

Dicaeum agile sumatranum (*Piprisoma modestum sumatranum* Chasen, *Treubia*, 17, afl. 2, 1939, p. 184; Pendeng, Atjeh, N. Sumatra) is antedated by *Dicaeum cruentatum sumatranum* Cabanis, *Journ. f. Orn.*, 1878, p. 101, Sumatra. I propose for it the new name of:

Dicaeum agile atjehense

All the races of thick-billed gray flowerpeckers belong to the species *agile*; I agree with Deignan (*Birds of Northern Thailand*, pp. 550-551) in this point, and also in referring the Malayan population to the subspecies *modestum*, described after specimens from southern Tenasserim.

White-eyes (Zosteropidae).

The species *javanica* and *squamifrons* are so different from other *Zosterops*, all very similar in a general way, that it seems better to refer them to the genus *Apoia*, the type of which is *A. goodfellowi*, from Mindanao.

Finches (Fringillidae).

The species *estherae* is certainly not referable to the genus *Serinus*, but to *Carduelis*, its nearest relative being *C. (= Hypacanthis) monguilloti* from the mountains of southern Annam.

Drangas (Dicuridae).

This isolated family is now in the course of revision by Dr. C. Vaurie. Dr. Mayr and I are in accord with him in recognizing only two genera of drongos, for the 18 species of

that family: *Dissemurus*, for the species with the external rectrices greatly elongated, the long bare shafts terminated into a spatula; and *Dicrurus*, for all the other species with a more normal tail. *Bhringa* becomes a synonym of *Dissemurus*, and *Chaptia* of *Dicrurus*.

BIBLIOGRAPHY OF MALAYSIAN BIRDS.

1936-1946

ALLIN, A. E.

1941. Notes on some Malayan Bitterns and the Yellow Bulbul. *Malayan Nat. J.*, Kuala Lumpur, 1, pp. 110-112.

AMADON, D.

1942. Notes on some non-passerine birds (*Phalacrocorax melanoleucus*, *Nycticorax caledonicus*). *Amer. Mus. Novit.*, No. 1175, pp. 1-11.
1943. Notes on some non-passerine genera (*Anas superciliosa*). *Ibid.*, No. 1237, pp. 1-22.
- Two interesting Pipits from Labuan Island, Borneo. *Ibis*, 85, p. 215.
- Notes on a collection of Birds from Sebatik Island, Borneo. *Ibid.*, 85, pp. 331-333.
- The genera of Starlings and their relationships. *Amer. Mus. Novit.*, No. 1247, 31, pp. 1-16.
1944. The genera of Corvidae and their relationships. *Ibid.*, 1251, 22, pp. 1-21.

BANKS, E.

1937. The distribution of Bornean Birds. *Sarawak Mus. J.*, 4, pp. 453-496.
- Birds from the highlands of Sarawak. *Ibid.*, 4, pp. 497-518.
- Seasonal variation in the "white" edible birds' nest. *Ibid.*, 4, pp. 519-522.

BARTELS, M.

1937. Zwei für Java neue Brutvögel. *Ornith. Monatsb.*, 45, pp. 16-19.
- *Zosterops m. melanura*, *Z. m. gallio*, *Z. m. unica* drei verkannte Vertreter des Rassenkreises *Zosterops palpebro-sa*. *Ibid.*, 45, pp. 85-86.
- Uit het leven de Neushoorvogels. *Trop. Natuur Weltevreden*, 26, pp. 117-127, 140-147, 166-173.

EN BOUMA, P. J.

- Keerkringvogels en Slechtvalken aan Java's zuidkust. *Ibid.*, 26, pp. 108-111.
1938. *Charadrius asiaticus veredus* bij Batavia waargenomen. *Charadrius asiaticus veredus* bij Batavia verzameld. *Ardea*, 27, pp. 172-174.
- Notizen über einige *Batrachostomus* arten. *Jour. für. Ornith.*, pp. 244-247.
- Ornithologischer Brief aus Java. *Ornith. Monatsb.*, 46, pp. 76-79.
- Zwei neue Drosseln aus Java. *Ibid.*, 46, pp. 113-115.
- Eine neue Rasse von *Arborophila brunneopectus* aus Java. *Treubia*, 16, pp. 321-322.

— Einige Bemerkungen über die Differenzierung des Rassenkreises *Alcedo euryzona*. *Ibid.*, 16, pp. 335-336.

UND FRANK, P. F.

- Eine neue Ente aus Java. *Ibid.*, 16, pp. 337-338.
1939. De avifauna van Batavia en omstreken. *Ardea*, 28, pp. 6-27.
1941. Noogmaals: De avifauna van Batavia en omstreken. *Avoca*, 29, pp. 147-151.

BASTIDE, J. G. DE LA

1941. De Kameelkleurige reiger (*Ixobrychus cinnamomeus*). *Irena*, 1, pp. 22-24.

BEMMEL, A. C. V. VAN

1938. Twee Snippen. *Trop. Natuur Weltevreden*, 27, pp. 138-140.
1940. Ornithologisch Notizen. I-III. *Treubia*, 17, pp. 333-335.
- Een zeldzame trekvogel (*Crocethia alba*). *Trop. Natuur Weltevreden*, 29, pp. 35-36.
- De Vogels van het Tenggergebte. *Ibid.*, 29, pp. 93-101.

AND HOOGERWERF, A.

- The Birds of Goenoeng Api. *Ibid.*, 17, pp. 421-472.

BERLIOZ, J.

1936. Notes ornithologiques au cours d'un deuxième voyage en Malaisie. *L'Oiseau*, 6, pp. 28-56.

BERWICK, E. J. H.

1941. Notes on the Long-Tailed "Tailor Bird" and an unusual Shama's nest. *Malayan Nat. J.*, 1, pp. 2-4.
- Notes on two Malayan Flycatchers. *Ibid.*, 1, pp. 91-94.

BOUMA, P. J.

1936. Broedtijden in de houtvesterij Tjiledoek (Java). *Ardea*, 25, pp. 100-107.

BROMLEY, E. H.

1941. Notes on Malayan Birds. *Malayan Nat. J.*, 1, pp. 140-146.

CRAMER, E. D. H.

1941. Notes on the nesting of a Woodpecker. *Malayan Nat. J.*, 1, pp. 138-139.

CHASEN, F. N.

1936. New name for *Stachyris nigriceps dilutus*. *B. O. C. Bull.*, 56, p. 115.

H. C. ROBINSON AND

- The Birds of the Malay Peninsula. III, Sporting Birds. Birds of the shore and estuaries. pp. xix-264. Witherby, London.
1937. The Birds of Billiton Island. *Treubia*, 16, pp. 205-238.
- On a Collection of Birds from Krakatao group of islands, Sunda Strait. *Ibid.*, 16, pp. 245-259.
1938. Vier neue Vogelrassen aus Malaysia. *Ornith. Monatsbr.*, 46, pp. 5-8.

1939. The Birds of the Malay Peninsula. IV. The Birds of the low-country jungle and scrub. pp. xxviii—485. Witherby, London.
- Preliminary diagnoses of new birds from North Sumatra. *Treubia*, 17, pp. 137-138, 183-184.
- Preliminary diagnoses of new birds from Malaysia. *Ibid.*, 17, pp. 205-206.
1940. A new race of Rock-Thrush from the Malay States. *B. O. C. Bull.*, 60, pp. 97-98.
- A new Woodpecker from Sumatra. *Treubia*, 17, p. 261.
- Notes on some Javan Birds. *Ibid.*, 17, pp. 263-266.
- AND HOGERWERF, A.
1941. The Birds of the Netherlands Indian Mt. Leuser Expedition, 1937, to North Sumatra. *Ibid.*, 18, Supp. 1941, pp. 1-125.
- COOMANS DE RUITER, L.
1936. Oologische en biologische aantekeningen van einige roofvogels in de Westerafdeeling van Borneo. *Orgaan Cl. ned Vogelk.*, 9, pp. 34-52.
1938. Oologische en biologische aantekeningen van einige pitta's of prachtlijsters in de Westerafdeeling van Borneo. *Limosa*, 11, pp. 35-45.
- Over Oorultjes en Vischuilten. *Trop. Natuur Weltevreden*, Jubileum No. 1936, pp. 74-76.
- Het goed verborgen nest van del Geelromp Bastaard Honingvogel (*Anai-mos xanthopygius*). *Ibid.*, pp. 132-133.
- DEIGNAN, H. G.
1938. A review of the southern (*melanostigma*) group of the Red-headed Laughing Thrush, *Garrulax erythrocephalus*. *Proc. Biol. Soc. Washington*, 51, pp. 87-92.
1942. Nomenclature of certain Pycnonotidae. *Auk*, 59, pp. 313-315.
- A revision of the Indo-Chinese forms of the Avian Genus *Prinia*. *Smiths. Misc. Coll.*, 103, 3, pp. 1-12.
1945. The Birds of Northern Thailand. *U. S. Nat. Mus. Bull.*, No. 186, pp. 1-616.
1946. A new *Pitta* from the Malay Peninsula. *Proc. Biol. Soc. Washington*, 59, p. 256.
- DELACOUR, J.
1941. On the species *Otus scops*. *Zoologica*, 26, pp. 133-142.
1942. The Bush Warblers of the genera *Cettia* and *Bradypterus*. *Ibis*, pp. 509-519; 1943, pp. 27-40, 343.
- The Whistling Thrushes (genus *Myiophoneus*). *Auk*, 59, pp. 246-264.
1943. A revision of the genera and species of the family Pycnonotidae (Bulbuls). *Zoologica*, 28, pp. 17-28.
- A revision of the subfamily Estrildinae of the family Ploceidae. *Ibid.*, 28, pp. 69-86.
1944. A revision of the Family Nectariniidae (Sunbirds). *Ibid.*, 29, pp. 17-38.
- AND MAYR, E.
1945. The family Anatidae. *Wilson Bull.*, 57, pp. 5-55.
- AND MAYR, E.
- Notes on the Taxonomy of the Birds of the Philippines. *Zoologica*, 30, pp. 105-117.
- DUNSELMAN, J.
1937. Iets over Neushoornvogels i Borneo. *Trop. Natuur. Weltevreden*, 26, pp. 16-19.
- Bij het nest van *Caprimulgus macrurus*. *Ibid.*, 26, pp. 92-95.
- De Goudplevier en andere trekkens en Borneo's binnenland (*Charadrius apricarius fulvus*). *Ibid.*, 26, pp. 201-202.
- FLUITER, H. J. DE
1939. Het vogelleven in de Rawa Meleman (Java). *Levende Nat. Amsterdam*, 44 pp. 55-59, 89-94, 120-125.
- GOODFELLOW, W.
1937. Familiar birds of Singapore. *Avicult. Mag.*, (5), 2, pp. 194-206.
- GREENWAY, J. C.
1943. Oriental forms of the Pigmy Woodpecker. *Auk*, 60, pp. 564-574.
- HOGERWERF, A.
1936. Voorkomen van *Nycticorax caledonicus* (Gm.), *Plegadis falcinellus* subsp. en *Phalacrocorax ater territorii* (Mathews). Broedvogels in Oost Java. *Ardea*, 25, pp. 170-171.
- Waarneming van *Pelecanus philippensis* Gm., aande kust bij Batavia. *Ibid.*, 25, 171-172.
- On nidification of some Javan Birds. *Bull. Raffles Mus.*, 12, pp. 118-124.
- Neues von Java. *Ornith. Monatsb.*, 44, pp. 25-26.
- EN RENGERS-HORA-SICCAMA, G. F. H. W.
1937. De avifauna van Batavia en oms-treken. *Ardea*, 26, pp. 1-51, 116-159.
- Enkele biogische aantekeningen over de kleine zilverreiger *Egretta gazetta nigripes*. *Limosa*, 10, pp. 1-11.
- Uit het leven der witte ibissen, *Threskiornis aethiopicus melanocephalus*. *Ibid.*, pp. 137-146.
- Bij het nest van *Sterna albifrons sinensis*. *Trop. Natuur Weltevreden*, 23, pp. 151-153.
- Broedende Witte Ibissen in West Java. *Ibid.*, 24, pp. 163-171.
- Vogels, die van verre komen. *Ibid.*, 25, pp. 11-18, 21-29.

- Waarnemingen bij het nest van den Koereiger (*Bulbulcus ibis coromandus*). *Ibid.*, 25, pp. 79-84.
- *Haliaeetus leucogaster* de schrik der blauwe Reigers. *Ibid.*, 25, pp. 135-139.
- Een stukje levens — geschiedenis van der Nachtreiger (*Nycticorax nycticorax*). *Ibid.*, 25, pp. 167-173.
- Hoe ik het nest de Griele vestoorde. *Ibid.*, 26, pp. 40-45.
- Nestlende Karekieten (*Acrocephalus stentoreus*) bij Batavia. *Ibid.*, 26, pp. 157-160.
1938. Vogels van Enggano voorloopige determinatie. *Natuurk. Tijdschrift Ned. Ind.*, 98, pp. 44-45.
- EN RENGERS-HORA-SICCAMA, G. F. H. W.
- De Avifauna van Batavia en omstreken. *Ardea*, 27, pp. 41-92.
- EN SICCAMA, G. F. H. W. R.
1939. De avifauna van Batavia en omstreken. *Corrigenda. Ibid.*, 28, pp. 80-89.
- Waar stoere vliegers samenkommen. *Trop. Natuur Weltevreden*, 28, pp. 27-158.
1940. Een nieuwe stormvogel voor den O. indischen Archipel. *Ibid.*, 29, p. 34.
- Enkele bijzonderheden van de hop het Vulcanheiland Goenoeng Api levende Oceanvogels. *Limosa*, 12, pp. 43-79.
- JACOBSEN, E.
1937. The Alovot, a bird probably living in the island of Simalur (Sumatra). *Temminckia*, 2, pp. 159-160.
- JUNGE, G. C. A.
1936. Fauna simalurensis. *Aves. Temminckia*, 1, pp. 1-74.
1937. Further notes on the Birds of Simalur. *Ibid.*, 2, pp. 197-202.
1938. On a collection of Birds from Engano. *Treubia*, 16, pp. 339-356.
- Remarks on *Chalcites malayanus*. *Zool. Meded. Leiden*, 20, pp. 237-239.
1940. Description of a new bird from Simalur. *Ibid.*, 22, p. 120.
- KOOIMAN, J. G.
1940. Mededeelingen over het voorkomen in oost-Java van enkele voor dit gewest nog niet in de litteratuur genoemde vogels. *Ardea*, 29, pp. 98-108.
- Vogels van het Sjang-Hoogland, Java. *Irena*, 1, pp. 9-18.
- KURODA, N.
1936. A glimpse of bird life in the Dutch East Indies. *Tori*, 9, No. 42, pp. 155-180.
- Birds of the Island of Java. Vol. II, *Non-Passeres*. Tokyo. pp. vi+371-794.
- LONSAIN, A. J. R.
1941. Enkele vogels en vogelgeluiden des Tjibodas. *Trop. Natuur Weltevreden*, 30, pp. 20-23.
- MADOC, G. C.
1936. On the nidification of some Malaysian birds. *Bull. Raffles Mus.*, 12, 36, pp. 124-133.
- MAYR, E.
1936. Notes on a collection of Birds from South Borneo. *Bull. Raffles Mus.*, 14, 5-46.
1937. Notes on New Guinea Birds. I. (*Collocalia*). *Amer. Mus. Novit.*, No. 915, pp. 1-19.
- AND RIPLEY, S. D.
1941. Notes on the genus *Lalage*. *Ibid.*, No. 1116, pp. 1-18.
- Uber einige Raubvögel der Kleinen Sunda-Inseln. *Ornith. Monatsb.*, 49, pp. 42-47.
- AND AMADON, D.
- Geographical variation in *Demigretta sacra*. *Amer. Mus. Novit.*, No. 1144, pp. 1-11.
1942. *Stachyris leucotis obscurata*, new subsp. *Auk*, 59, p. 118.
1943. Notes on the generic classification of Swallows. *Ibis*, 85, pp. 334-339.
- Remarks on *Nyroca australis* in Java. *Amer. Mus. Novit.*, No. 1056, p. 7.
- Notes on Australian Birds. Description of *Podiceps novae-hollandiae javanicus*; *Butorides striatus*. *Emu*, 43, pp. 3-17.
1945. The Birds of Timor and Sumba. *Bull. A. M. N. H.*, 85, pp. 129-194.
- NEUMANN, O.
1937. New Birds from Sumatra and the Mentawi Archipelago. *B. O. C. Bull.*, 57, pp. 151-154.
1941. Neue subspecies von vogeln aus Niederländisch-Indien. *Zool. Meded.*, 23, pp. 109-113.
- PETERS, J. L.
- 1937-1945. Check-list of Birds of the World. III, 1937, pp. xiii-311; IV, 1940, pp. xii-291; V, 1945, pp. xi-306. Harvard Univ. Press, Cambridge.
1941. Birds from Mt. Kina Balu, North Borneo. *Bull. Mus. Comp. Zool.*, 87, pp. 195-211.
- PIJL, L. VAN DER
1937. Disharmony between Asiatic Flowerbirds and American Flowerbirds. *Ann. Jard. Bot. Buitenzorg*, 48, pp. 17-26.
- Brilvogels en Ganitri (*Zosterops*). *Trop. Natuur Weltevreden*, 25, pp. 119-121.
- Dieren die zich niet aan regels storen. *Ibid.*, 26, pp. 104-108.
- RILEY, J. H.
1937. Three new birds from the Malaysian Subregion. *Proc. Biol. Soc. Washington*, 50, pp. 61-62.
1938. Birds from Siam and the Malay Peninsula in the U. S. Nat. Mus. collected by Drs. Hugh M. Smith and William

- L. Abbott. *Bull. U. S. Nat. Mus.*, 172, pp. iv+581.
- Three new Birds from Banka and Borneo. *Proc. Biol. Soc. Washington*, 51, pp. 95-96.
1939. A genus and three new forms of Birds from Borneo. *Jour. Wash. Acad. Sci.*, 29, pp. 39-41.
- RIPLEY, S. D.
1941. Notes on the genus *Coracina*. *Auk*, 58, pp. 381-395.
- A new race of *Ceyx erithacus*. *Proc. New England Zool. Cl.*, 19, pp. 15-16.
- Notes on Malaysian Cuckoos. *Auk*, 59, pp. 575-576.
1942. The species *Eurystomus orientalis*. *Proc. Biol. Soc. Washington*, 55, pp. 169-176.
- A Revision of the Kingfishers, *Ceyx erithacus* and *rufidorsus*. *Zoologica*, 27, pp. 55-59.
- Notes on Malaysian Cuckoos. *Auk*, 59, pp. 575-576.
1944. The Bird Fauna of the West Sumatra Islands. *Bull. Mus. Comp. Zool.*, 94, No. 8, pp. 307-430.
1945. The Barbets. *Auk*, 62, pp. 542-563.
- ROORDA, P.
1937. Broedende vogels in beplante sawah. *Trop. Natuur Weltevreden*, 23, pp. 67-68.
- SCHAUENSEE, R. M. DE
1939. Notes on *Cyornis banyumas*. *Notul. Nat. Philadelphia*, 7, pp. 1-3.
- Preliminary report on the Birds of the George Vanderbilt Sumatran Expedition 1939. *Ibid.*, 18, pp. 1-2.
1940. Second preliminary report on the birds of the George Vanderbilt Sumatran Expedition 1939. *Ibid.*, 20, pp. 1-2.
- The Birds of the Batu Islands. *Proc. Acad. Nat. Sci. Philadelphia*, 92, pp. 23-42.
- AND RIPLEY, S. D.
- Zoological results of the George Vanderbilt Sumatran Expedition 1936-1939. Pt. 1. Birds of Atjeh. *Proc. Acad. Nat. Sci. Philadelphia*, 91, pp. 311-368.
1940. Zoological results of the George Vanderbilt Sumatran Expedition 1936-1939. Pt. III. Birds from Nias Island. *Ibid.*, 91, pp. 339-413.
- SNOUCKAERT VAN SCHAUBURG, R. C. E.
1936. De Geographische verbeiding der Pycnonotidae van Azië en den Indischen Archipel. *Orgaan Cl. ned. Vogelk.*, 9, pp. 52-67.
- SODY, H. J. V.
1941. De beide javaansche boschkippen. *Trop. Natuur Weltevreden*, 30, pp. 38-40.
- STRESEMANN, E.
1938. *Spizaetus alboniger* (Blyth) und *Spizaetus nanus* Wallace' Zwei falschlich vereinigte Arten. *Jour. für Ornith.*, 86, pp. 425-431.
- Vogel vom Fluss Kajan (Nordost-Borneo) gesammelt von Baron Victor von Plessen. *Temminckia*, 3, pp. 109-136.
1939. *Zosterops siamensis* eine gellbouichige Rasse von *Zosterops palpebrosa*. *Jour. für Ornith.*, 87, pp. 156-164.
- 1939-1941. Die Vogel von Celebes. *Ibid.*, 87, pp. 312-425; 88, pp. 1-135, 389-487; 89, pp. 1-102.
1940. Zur kenntnis der Wespen-bussarde (*Pernis*). *Arch. Naturges.*, N. F., 9, pp. 137-193.
- YOUNG, C. G.
1941. Notes on some migratory Birds in Malaysia. *Malayan Nat. J.*, 1, pp. 149-156.
- ZIMMER, J., AND MAYR, E.
1943. New species of birds described from 1938 to 1941. *Auk*, 60, pp. 249-262.

2.

A New Name for a Philippine Flowerpecker.

ERNST MAYR.

*American Museum of Natural History.**Dicaeum hypoleucum pontifex* Mayr.

New name for *Dicaeum everetti* Tweeddale, 1877 (late), *Ann. & Mag. Nat. Hist.*, (4) XX, p. 537, not *Prionochilus everetti* Sharpe, 1877 (early), *Ibis*, p. 16. As stated previously (Delacour and Mayr, 1945, Notes on the Taxonomy of the Birds of the Philippines, *Zoologica*, 30 (12), 1945, p. 114) there

is no reason for excluding the species *agile* (of which *P. everetti* Sharpe is a subspecies) from the genus *Dicaeum*. *Dicaeum hypoleucum pontifex* Mayr is exactly intermediate between *obscurum* (Luzon) and *hypoleucum* (Sulu-Mindanao). It resembles *obscurum* in the color of the upperparts, but differs by the whitish gray underparts and the dark brown legs.

3.

Further Notes on Display Forms of the Long-tailed Bird of Paradise,
Epimachus meyeri meyeri Finsch.

LEE S. CRANDALL.

(Plates I-III).

In a previous paper¹ three distinct display forms of the Long-tailed Bird of Paradise, *Epimachus meyeri meyeri* Finsch, were described. Later, a second male presumed to be of the same subspecies was received at the New York Zoological Park. Variants of the display forms of this specimen have been noted and are recorded in the present paper.

The bird referred to in the original paper was collected at Deva-deva, Central Division, Papua, in October, 1928, by Mr. J. A. Ward and the author. Immature at the time of capture, the bird assumed full male plumage in September, 1931. Three distinct display forms were noted: pumping, horizontal, (referred to in the original paper as inverted) and upright. This bird died September 18, 1936.

The second bird, an adult male still living in the New York Zoological Park, was received in 1937, from a collection obtained by Mr. Shaw Mayer, in the Waria River area² of Southeast New Guinea. While the points of origin of these two birds could hardly be more than fifty air miles apart, they are separated by the formidable ramparts of the Wharton Range. After differences in display form had been noted, the possibility of subspecific difference came naturally to mind. This was suggested to Dr. A. L. Rand, who at that time was occupied with a study of New Guinea birds at the American Museum of Natural History. Following is a quotation of a letter from Doctor Rand, written under date of October 31, 1940, after examination of available material had been completed:

" . . . Now about *Epimachus*. I have just gone over what material we have from north

of the Range in southeast New Guinea. We have only three specimens with undoubted localities. They are definitely smaller than the average from south of the Range but still fall within the limits of variation. There seem to be no other differences of taxonomic importance, and on the basis of the material we have here, at least, it would not be possible to separate them. Greenway, studying the collection from near Wau, came to the same conclusion some years ago . . ."

Since it appears that, at least in the light of present knowledge, the two birds in question are subspecifically identical, no explanation of difference in display form is offered.

The "pumping" form, seen only once in the first bird, has not been noted in the second. The "horizontal" or "inverted" form, with pectoral shields concealed, used frequently by the first, is seen rather rarely in the second but in identical manner. It is in the upright form that striking differences occur.

In the first bird, at the climax of the upright form, the pectoral shields were thrown upward, like two arms, the narrow tips being separated by an inch or more. The tail was held completely rigid and compressed. In the second bird, the shields are joined at the top, forming a broad fan, giving a quite different appearance. At the same time, the short outer tail feathers are rapidly opened and closed, the long central ones remaining quiescent. All other parts of the ritual are identical with those originally described.

While these variations have been noted seasonally since 1937, publication has been withheld pending availability of suitable photographs of the second bird. These have now been obtained through the skill and patience of Mr. Samuel Dunton, staff photographer, and are presented herewith.

¹ *Zoologica*, Vol. XI, No. 7, Dec. 3, 1932, pp. 82-84.

² N. Wharton-Tigar, *Avicultural Magazine*, Fifth Series, Vol. II, June, 1937, p. 182.

EXPLANATION OF THE PLATES.

PLATE I.

Fig. 1. *Epimachus meyeri meyeri* in normal position.

Fig. 2. Raising the pectoral shields for display. This position approximates the climax of the form originally described.

PLATE II.

Fig. 3. Shields fully expanded and tightly closed above.

Fig. 4. The outer tail feathers are rapidly opened and closed.

PLATE III.

Fig. 5. At the full climax, with plumes expanded and body flattened, the curved beak is opened to show the yellow interior of the mouth.



FIG. 1.



FIG. 2.

FURTHER NOTES ON DISPLAY FORMS OF THE LONG-TAILED BIRD OF PARADISE
EPIMACHUS MEYERI MEYERI FINSCH.



FIG. 3.



FIG. 4.

FURTHER NOTES ON DISPLAY FORMS OF THE LONG-TAILED BIRD OF PARADISE
EPIMACHUS MEYERI MEYERI FINSCH.

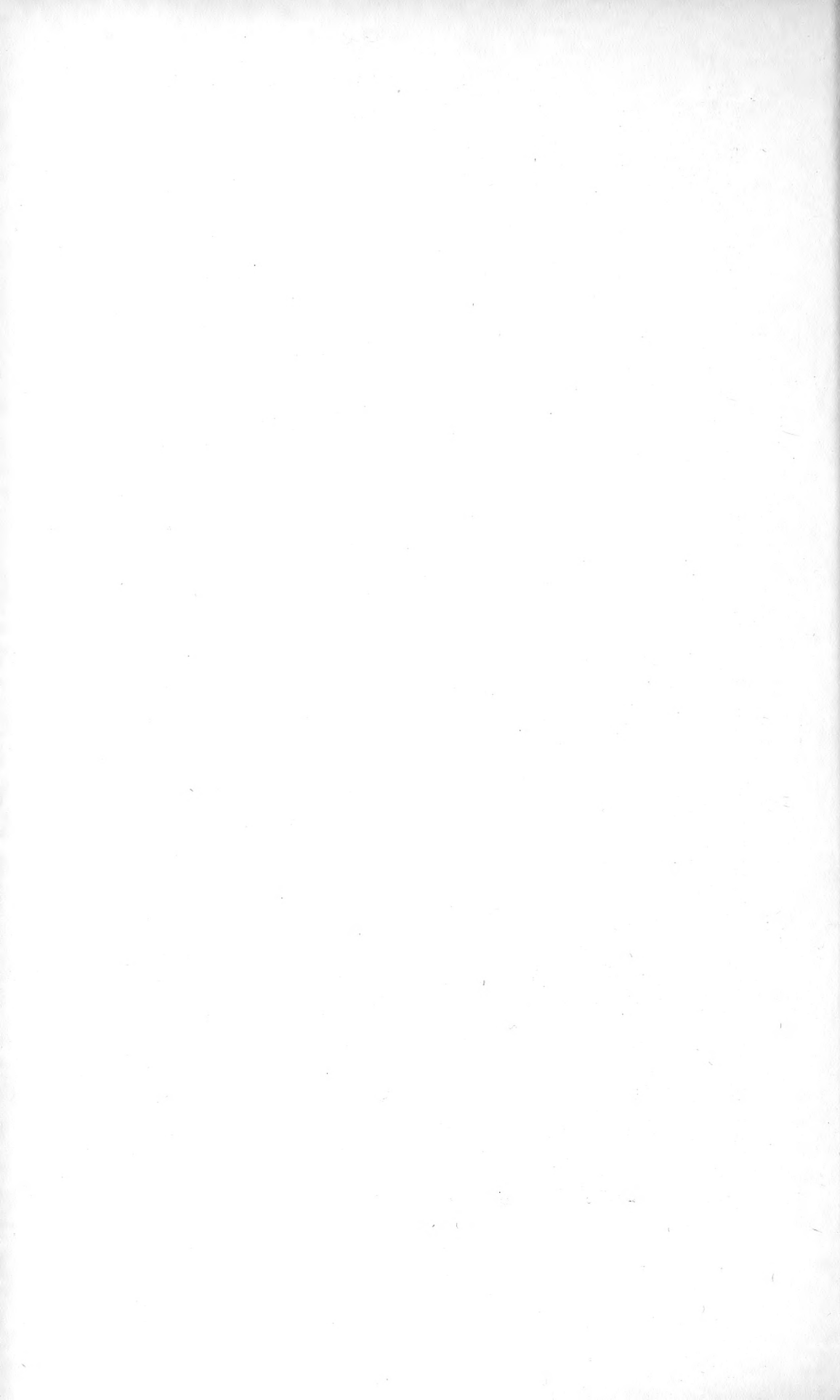



FIG. 5.

FURTHER NOTES ON DISPLAY FORMS OF THE LONG-TAILED BIRD OF PARADISE
EPIMACHUS MEYERI MEYERI FINSCH.



4.

Field Notes on the Snakes of Kartabo, British Guiana, and Caripito, Venezuela.

WILLIAM BEEBE.

*Director, Department of Tropical Research,
New York Zoological Society.*

(Plates I-XIII; Text-figs. 1-4).

[This contribution¹ is a result of various expeditions of the Department of Tropical Research of the New York Zoological Society to British Guiana and to Venezuela, all made under the direction of William Beebe. The Guiana expeditions were made during the years 1909, 1916, 1917, 1919, 1920, 1922, 1924 and 1926, and the Venezuelan trips in 1908 and 1942. The latter was sponsored by grants from the Committee for Inter-American Artistic and Intellectual Relations and from four trustees of the Zoological Society, George C. Clark, Childs Frick, Laurance S. Rockefeller and Herbert L. Satterlee, and by invaluable assistance from the Standard Oil Companies of New Jersey and Venezuela.]

CONTENTS.

	Page
Introduction	11
Family Leptotyphlopidae	12
<i>Leptotyphlops albifrons</i> (Wagler)	12
<i>Leptotyphlops septemstriata</i> (Schneider)	13
Family Typhlopidae	14
<i>Typhlops reticulatus</i> (Linnaeus)	15
Family Iniliidae	16
<i>Inilius scytale</i> (Linnaeus)	16
Family Boidae	16
<i>Boa canina</i> Linnaeus	16
<i>Boa endris cookii</i> (Gray)	17
<i>Constrictor constrictor constrictor</i> (Linnaeus)	18
<i>Epicrates cenchrus cenchrus</i> (Linnaeus)	19
<i>Eunectes gigas</i> (Latreille)	20
Family Colubridae	21
<i>Atractus trilineatus</i> Wagler	21
<i>Chironius carinatus</i> (Linnaeus)	21
<i>Chironius fuscus</i> (Linnaeus)	22
<i>Cloelia cloelia cloelia</i> (Daudin)	23
<i>Dipsas catesbyi</i> (Sentzen)	24
<i>Dipsas indica</i> (Laurenti)	24
<i>Dipsas variegata</i> (Dumeril and Bibron)	25
<i>Dryadophis boddaerti boddaerti</i> (Sentzen)	25
<i>Drymarchon corais corais</i> (Boie)	26
<i>Erythrolamprus aesculapii</i> (Linnaeus)	27
<i>Helicops angularis</i> (Linnaeus)	28
<i>Hydros triangularis</i> (Wagler)	28
<i>Imantodes cenchoa</i> (Linnaeus)	29
<i>Leimadophis reginae</i> (Linnaeus)	29
<i>Leimadophis taenurus bipræocularis</i> (Boulenger)	30
<i>Leimadophis typhlus</i> (Linnaeus)	30
<i>Leptodeira annulata annulata</i> (Linnaeus)	31
<i>Leptodeira rhombifera</i> Günther	32
<i>Leptophis ahaetulla ahaetulla</i> (Linnaeus)	32
<i>Leptophis ahaetulla ortonii</i> (Cope)	34
<i>Leptophis caerulescens</i> Oliver	34
<i>Liophis breviceps</i> Cope	34
<i>Liophis cobella cobella</i> (Linnaeus)	35
<i>Lygophis lineatus</i> (Linnaeus)	35
<i>Oxybelis aeneus aeneus</i> (Wagler)	35
<i>Oxybelis fulgidus</i> (Daudin)	36
<i>Oxyrhopus petola petola</i> (Linnaeus)	37

<i>Philodryas viridissimus</i> (Linnaeus)	38
<i>Pseudoboa coronata</i> Schneider	38
<i>Pseudoboa neuweidii</i> (Dumeril and Bibron)	39
<i>Pseustes poecilonotus polyplepis</i> (Peters)	39
<i>Pseustes sulphureus sulphureus</i> (Wagler)	41
<i>Siphopholis cervinus cervinus</i> (Laurenti)	42
<i>Spilotes pullatus pullatus</i> (Linnaeus)	42
<i>Tantilla longifrontale</i> (Boulenger)	42
<i>Tantilla melanocephala</i> (Linnaeus)	43
<i>Trypanurgos compressus</i> (Daudin)	43
<i>Xenodon colubrinus</i> (Günther)	43
<i>Xenodon severus</i> (Linnaeus)	44
Family Elapidae	45
<i>Micrurus lemniscatus</i> (Linnaeus)	46
<i>Micrurus psypes</i> (Daudin)	46
Family Viperidae	47
<i>Lachesis muta</i> (Linnaeus)	47
<i>Bothrops atrox</i> (Linnaeus)	48
<i>Bothrops bilineatus</i> (Wied)	50
Family Crotalidae	51
<i>Crotalus durissus terrificus</i> (Laurenti)	51

INTRODUCTION.

In the year 1909, and from 1916 to 1926, eight expeditions went out from this department to British Guiana, and in 1908 and again in 1942 field work was carried on in Venezuela.

Throughout the course of these expeditions many field notes, color plates and photographs were made of tropical vertebrates, and the object of this present series of papers is to assemble and publish these notes and illustrative material. Any change or alteration of the original notes is placed between brackets. The chief value of these data is that they are concerned with living or recently killed specimens.

The observations in Guiana were made in one-quarter of a square mile of jungle at Kartabo, and those in Venezuela at or close to Caripito, which is only 528 kilometers northwest of Kartabo.

In addition to numerous technical papers in *Zoologica* and several popular volumes, there have been published the following general ecological summaries: *Zoologica*: (Kartabo) Vol. II, No. 7, 1919, pp. 205-227; Vol. VI, No. 1, 1925, pp. 1-193; (Caripito) Vol. XXVIII, No. 9, 1943, pp. 53-59. Also see "Tropical Wild Life in British Guiana" by Beebe, Hartley and Howes, published by the New York Zoological Society, 1917, pp. 1-504.

¹ Contribution No. 735, Department of Tropical Research, New York Zoological Society.

My hearty thanks go to Dr. Charles M. Bogert of the American Museum of Natural History for many identifications and for bringing up to date my out-worn names of many years ago.

My original field numbers and other data have been appended to descriptions, breeding and other notes. These specimens are either in the collection of the Department of Tropical Research or in those of the American Museum. In the latter case the original field numbers are still attached with the additional catalogue numbers of the museum.

In the strictly limited localities at Kartabo and Caripito, we collected eight families of snakes, comprising thirty-six genera and fifty-four species. Six of these species were missing from Kartabo, in each case the snake being exceedingly rare at Caripito, represented by only a single individual. There were absent from Caripito twenty-two species or 40 per cent. of the total number. This lack was in line with many other groups of organisms, a comparative paucity of fauna due apparently to the extremes of dry and rainy seasons, these factors resulting on a considerable percentage of terrestrial or low-climbing forms finding life difficult or impossible at the heights of drought or of inundation.

Early in March, 1919, at Kartabo, we collected many specimens of an eel-like fish, *Synbranchus marmoratus*, the Marbled Eel-fish. These lived in leaf-choked creeks or in swamps and varied in length from 60 to 900 mm. They fed on small crabs and fish and possessed considerable powers of terrestrial locomotion, making their way across many yards of dry land from one body of water or swamp to another. In the laboratory they frequently made their escape from a pail and flipped about all night, taking no harm, although coated for many hours with a thick layer of dust and dirt. This introductory paragraph is to detail an important factor in the following complex.

The casual hoeing of an Akawai Indian was the direct cause of our discovery of a remarkable concentration of snakes. Within a period of eleven days, from March 20th to April 1st, 1919, from a marshy field given over for several years to the cultivation of rice, we obtained seventeen Tricolored Coral Snakes, *Micrurus lemniscatus*, varying in length from ten to thirty inches. Every one of these, with one exception, had swallowed a Marbled Eel or *Synbranchus*, almost exactly ten inches long. The seventeenth snake had two eels in its stomach, whose lengths, 7.5 and 2.5 inches, absurdly enough totalled ten inches.

The men with the hoes were provided with containers and with promised rewards, and the resultant serpentine fauna of this

marshy field comprised six species. Five of these were colubrine and the sixth was the above-mentioned species of coral snake. All these were united by several more or less unrelated factors: first an apparent preference for a wet, swampy terrain, combined with fossorial or nocturnal habits. In the case of four species they were associated by a pronounced diet of *Synbranchus*. Finally, and rather abstractly, we observed the presence in each of considerable scarlet in scale coloring.

The following is a résumé of this unusual aggregation of snakes, all taken in the single rice field.

Micrurus lemniscatus: Seventeen taken from rice field in late March, each individual feeding on a single 10-inch *Synbranchus*. *Color*: banded with black, white and scarlet.

Erythrolamprus aesculapii: Three of these coral snake mimics were collected, one feeding on a small real *Micrurus*, and two on *Synbranchus*. *Color*: black, white and scarlet banded.

Hydrops triangularis: Eight of these snakes from the rice field were all crammed with *Synbranchus*, one of these latter being only 70 mm. in length. *Color*: red above, white below, with many dark cross-bands.

Liophis breviceps: One from the same field with several earthworms and a 150 mm. *Synbranchus* in its stomach. *Color*: dark above, scarlet below with black cross bands.

Oxyrhopus petola: Two caught in rice field. Stomachs empty. *Color*: black, with numerous scarlet and yellow bands.

Pseudoboa coronata: One from rice field with a half-digested *Synbranchus* in its stomach. *Color*: scarlet, with black and white banded head.

Without the accident of hoeing in this particular spot, these six species and more than thirty-five individual snakes would never have been discovered.

FAMILY LEPTOTYPHLOPHIDAE.

Two species out of the forty-odd accredited to the single genus in this family were found at Kartabo and one of these at Caripito. These small snakes are doubtless much more common than captures indicate, the apparent rarity being due both to a nocturnal and fossorial life, and to their being frequently mistaken for earthworms.

Superficially they are not unlike the members of the succeeding family, but differ in character of dentition, osteology and scalation. There are only fourteen rows of body scales.

Leptotyphlops albifrons (Wagler, 1824).

Names: Worm Snake, Yellow-faced Worm Snake, Ant-nest Worm. Sabbai-ballu, "one

who lives in cushie ant nest" (Akawai Indian).

Range: From Mexico throughout almost all South America and in many of the West Indies.

General Account: These worm-like snakes just miss being lizards, for beneath their scales are the remains of very distinct hind limbs, bits of all three pelvic bones as well as traces of femurs. They are essentially burrowing and nocturnal, and spend most of their time in or near the nests of ants and termites. By their hard, impenetrable scalation they are protected from the attacks of these insects, and feed almost wholly upon them, their eggs and pupae. Especially during the rainy season they creep about the jungle floor, sometimes covering considerable distances and even climbing to moderate heights. Their teeth are few and delicate and confined to part of the lower jaw. They show unexpected power in pushing through jungle débris and termite nests, aided by a hard, pointed, caudal spine, and are exceedingly difficult to hold in the hand. They are probably the smallest of all snakes and the largest I ever measured was less than eight inches over all.

Both at Kartabo and Caripito we found them fairly common and were it not for their fossorial and nocturnal habits many more would doubtless have been seen.

I find scattered notes on fourteen specimens of this species:

Spec. No. 1: Kartabo, June 10, 1919, length 142 mm., diameter 3.2 mm. This snake was found in the course of digging a pit in the jungle in rolling, sandy soil. The tiny animal was two feet beneath the surface, and ten or fifteen yards from the nearest ant or termite nest. It was very active and its tongue played continually. It escaped from our hands three times, before we could secure it, forcing its head between our fingers. The general color was dark brown, hardly any lighter below, with the edges of the scales barium yellow, the spot on the snout reed yellow and the tail tip amber yellow.

Spec. No. 2 (Cat. No. 249): Kartabo, June 23, 1919, length 180 mm. Caught in daylight, coiled around a live bamboo twig close to the ground and the laboratory door. In the same clump a swarm of *Attas* were crowding into a hole, probably the reason for the presence of the snake, especially as two crushed *Atta* workers were found in its stomach.

Spec. No. 3: Kartabo, June 23, 1919, length 135 mm. Taken in a nest of *Attas* or leaf-cutting ants by our Indian hunter.

Spec. No. 4: Kartabo, July 4, 1920, Color Plate 153, length 143 mm., weight 1.1 gram. Body unusually dark brown, almost black,

head and tail creamy white. A half-digested mass of ant legs and heads was ready for ejection.

Spec. No. 5: Kartabo, August 31, 1920. Snout and tail dull olive yellow. Caught on a dead twig in a trail with swarms of termites in all directions after a nocturnal attack by a tamandua anteater on their low-swung nest. Watched the snake for half an hour, during which time it climbed eighteen inches up the rough bark of a half dead tree, winding in and out of crevices toward the damaged termite nest. I caught it when it had only three feet more to go to reach the nest. The termites ran past and over it, with neither snake nor insects paying any attention.

Spec. No. 6: Kartabo, June 10, 1922, length 170 mm. A single oval egg with half-formed shell found in oviduct.

Spec. Nos. 7, 8 and 9: Kartabo, All taken on March 1, 1924, in daytime, within an area of six feet on the surface of a jungle trail, during a light rain. Two of the snakes had been feeding on the cocoons of ants, the contents having been squeezed out and the husks about to be extruded.

Spec. No. 10: Kartabo, April 29, 1924, total length 162 mm., tail 10 mm., diameter 3 mm., weight 1.4 gram. Caught in heavy rain, creeping across trail.

Spec. Nos. 11 and 12 (Cat. No. 2884): Kartabo, May 23, 1924, lengths 100 and 150 mm. Both were taken near the entrance of a large *Atta* nest. The tongue of one was brilliant scarlet.

Spec. Nos. 13 and 14 (Cat. No. 30132): Caripito, June 8, 1942, lengths 125 and 195 mm.

Leptotyphlops septemstriata

(Schneider, 1801).

(Plate I, Fig. 1).

Name: Seven-lined Worm Snake.

Range: The Guianas and Amazonia.

General Account: Habits in general like those of *albifrons*. In appearance this species lacks the pale head and tail, and the body color varies from pale lilac to rich golden orange with seven to nine dark lines down back and sides. In most specimens the lowermost line is broken or reduced to a fine thread of pigment. The average size is larger than in *albifrons*, the largest reaching a length of nine inches.

This small snake can traverse considerable ground. One individual on a cloudy day covered eighteen feet over damp, forest débris in forty-eight minutes and then vanished forever. The seven-lined is less common than the other species. We did not find it at Caripito, and I have records of only twelve at Kartabo, with notes on two of these.

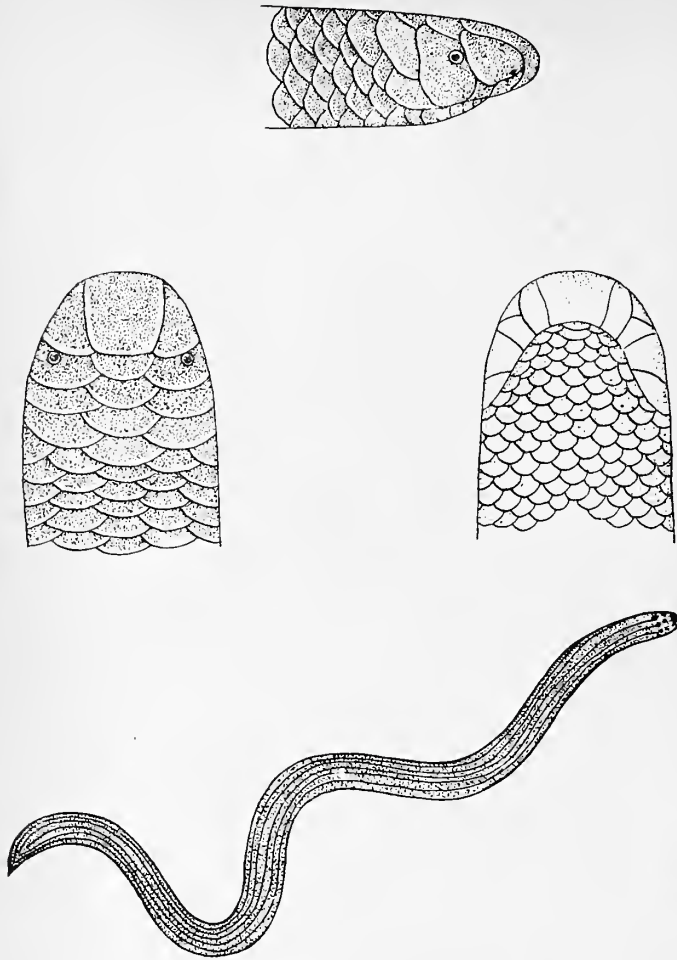

TEXT-FIG. 1. *Leptotyphlops septemstriata*. Lateral, dorsal and ventral views of head, and entire snake.

No. 343: Color Plate 243, October 6, 1920, length 170 mm., tail 6, body width 5, height 4 mm., weight 1.7 gram. Found in a small termite nest, under the spathe of a palm at the edge of the jungle. In its stomach were the remains of five mangled termite workers. The general color, above and below, was pale lavender with a silvery sheen. It showed seven lines with traces of two more. These were olive brown, beginning back of the head. The eye showed a round pupil of unusually large diameter, the narrow iris being pale pink.

On smooth ground the snake progressed slowly with vigorous undulations of the body, getting as much leverage from the lateral curves as from the pointed tail. It was absolutely smooth and slippery, difficult to hold. No effort at biting was observed even under provocation.

No. 504: Color Plate 325, February 24, 1922, length 215 mm., tail 6.5, body width 5.3, height 4.5 mm., weight 3.7 grams.

Found in a ground termite nest, one hundred yards back in the jungle. When held in the hand the edges of the scales could be distinctly felt and seemed to be an effective aid in pushing. The body was golden orange, deepening to tawny red toward head and tail. Seven longitudinal lines of dark brown, turning to black toward head and tail, and two other, very faint lines, making nine in all, extended down back and tail. The ventral scales were dark golden yellow. In some lights the entire snake shone like burnished gold. The small eye was distinctly pinkish.

FAMILY TYPHLOPHIDAE.

Only a single genus and species out of the five genera and more than twenty neotropical forms contained in this family were observed by us in the survey of the localities included in this paper. These burrowing snakes are larger than those of the preceding family and have twenty or more rows of body scales.

Typhlops reticulatus (Linnaeus, 1758).

(Plate I, Figs. 2 and 3).

Names: Burrowing Snake, Two-colored Ant Snake, Spine-tailed Blind Snake.

Range: North and central South America.

General Account: These burrowing snakes frequently found in ant and termite nests are in general larger than the worm snakes, but show the same blunt head, spiny tail and firm, close-fitting, hard scalation. The eye is small and counter-sunk, and the mouth is edentulous except for a few teeth in the upper jaw.

Fifteen were recorded at Kartabo and three at Caripito, although others were reported at both places. The pattern and colors were varied. Six or seven were jet black above, several more dark brown, and one pale brown above. As to the ventral surface the black specimens usually showed contrasting white, while the dark brown snakes were pink below. The head and tail showed decided asymmetrical variation in pattern.

Cat. No. 232: Kartabo, July 30, 1920, length 255 mm., tail 10.5, body width 11.2, height 10, head length 4, eye diameter 1 mm., weight 16 grams. Most of dorsal area shining jet black, but head pale, immaculate back to end of rostral. Third dorsal scale white. Tail black, but with a seven-scale-wide white break, beginning with the eighth scale from the caudal end, broken only by the twelfth and thirteenth dorsal scales which are black. White below. In stomach two *Atta* workers.

Cat. No. 241: Kartabo, September 3, 1917, length 170 mm. Found in small termite nest near ground with no apparent exit of sufficient size. This individual was the palest worm snake of this species found at Kartabo. Pale tawny brown above and creamy white below. It was extremely sensitive to a sudden light flashed on it after dark.

Cat. No. 260: Kartabo, August 7, 1919, length 230 mm., snout 3.5, eye diameter 1 mm., weight 19 grams. Burnished dark brown above, pale salmon below. In preservative the latter has turned to rich chestnut. The rostral and nasal scales were dark salmon, with an irregular black blotch on the latter.

Cat. No. 263: Kartabo, Photograph 909, September 8, 1919, length 330 mm., weight 26 grams. Caught in early evening creeping over jungle leaves. On a smooth board this snake progressed very slowly, less by the rapid, lateral undulations of the whole body than by the constant sticking in and pushing with the short, stout caudal spine. Repetition of this movement was constant, and seemed certainly to be the chief function

of this organ. The food was a mass of about twenty termites, well crushed, and mixed with bits of nest débris.

Cat. No. 581: Kartabo, May 8, 1922, length 365 mm., tail 14 mm., weight 40 grams. Caught when crawling out of the ground, ten feet from an *Atta* nest. I followed it as it crept for fifteen or twenty feet to a sandy bit of the jungle, when it burrowed so fast that it was necessary to dig it from a depth of about eighteen inches. It was brownish-black above, pinkish below. The latter color changed in preservative to cinnamon buff. The rostral was wholly pink and the nasals partly and asymmetrically of the same color. From the eye to the back of the head the dorsal black extends well down on the sides. At the tail a broad band of the ventral color stretches clear across the dorsal black.

Cat. No. 30113: Caripito, May 20, 1942, length 200 mm. Brownish-black above, lemon yellow below.

Cat. No. 30113a: Caripito, May 20, 1942, length 230 mm., weight 10 grams. Caught in Pit No. 12, in open llanos, thirty feet from low jungle. Brownish-black above, lemon yellow below. Head black with four, short, broad bands of buff down rostral and nasals, to tip of snout which is all buff. Below lemon yellow on fore body, paling back of this area. The dorsal black extends around on to the ventral side at the level of the posterior part of the head, but does not meet on the mid-ventral line. The same pattern holds for the tail, the black almost meeting on the ventral line a short distance from the tail tip. The scales are so hard and close fitting that it seems as if no ant or termite could penetrate them. I tested this later with another specimen by dropping it into a mass of angry *Atta* ants. It suffered no harm from the workers although they did their best, and in spite of being badly bitten myself I could not persuade the giant-headed soldiers of the home guard to attack the reptile.

A half grown worm snake dropped in a tangle of army ants had short shrift, and a dozen of the insects fixed their jaws into the unfortunate snake before I could retrieve it and drop it into alcohol.

Every structure of this snake is adapted for burrowing; the mouth is shark-like, far overhead by the snout, the eye is small and under the scales, the mouth is small with slight ability of mastication, either merely crushing or swallowing its ant food whole. In a specimen taken soon after the present one were the remains of 36 termites and even a recognizable guest staphylinid. These snakes show great resistance to death by drowning, surviving in water for an hour or more with no access to air.

FAMILY INILIIDAE.

This is another primitive family of degenerate eyed, burrowing snakes. The eyes are very small and sunken beneath the scales, while the dorsal and ventral scales are all small and sub-equal. The coloration is brilliant, pink and yellow, with numerous, broad, irregular cross-bands of black. A single genus and species is known from South America.

Inilius scytale (Linnaeus, 1758).

(Plate I, Figs. 4 and 5).

Names: False Coral Snake, Scarlet Ground Snake, Chain Snake. Sarree-booh, "love on the leaves" (Akawai Indian).

Range: Northern South America, east of the Andes.

General Account: This is a strange snake. It is the only neotropical representative of its family, it has pelvic vestiges connecting it with the worm snakes and boas, and it is brilliantly colored although in structure as well as in habits it is decidedly fossorial. It was not rare and we caught a considerable number at Kartabo, but did not find it at Caripito. I noted no habits of especial interest.

Eight specimens of these brightly colored burrowing snakes were found from April to July 1916, and three others in June and July, 1920, in a deserted rice field, where we also captured twenty true coral snakes (*Micrurus lemniscatus*).

Coll. No. 227: May 30, 1919, length 560 mm. Found among the decayed mould of a fallen tree. This individual possessed fifty-one black bands, of which sixteen are semi-bars. All of these latter are uniformly alternate, ending abruptly at the mid-line. The ground color is coral red, with the head brownish. The small eyes are in the center of a single scale, close to the anterior edge of the first black bar. In the stomach were three small *Typhlonectes* and four crushed Orthoptera.

Coll. No. 240a: Color Plate 268, November 8, 1920, length 660 mm., tail 27, body width 12, height 10, head length 13, width 11.5 mm., rows of scales 21, ventrals 225, subcaudals 13. This snake has forty-four black cross bars on its coral red background, of which eleven are Y-shaped, being double on one side. The lower sides and ventral surface are pale straw yellow. In life the eye has a large, round pupil, with a narrow pink iris, the whole flat and under scale. In preservative, after twenty-four years the black has changed to pale cinnamon brown, and the red to creamy white.

Coll. No. 3516 (body) and 3517 (skin): Female breeding, Color Plate 771, June 21, 1924, length 530 mm., tail 20, body width 13, height 12, head length 14, width 9.5,

eye diameter 1 mm., scale rows 21, subcaudals 14, weight 38.5 grams. The colors are bright scarlet, jet black, and clear, strong lemon yellow below. After the color plate was made, the snake was skinned and mounted on a sheet of pasteboard. Today, in 1946, twenty-two years afterwards, the colors of the skin are exactly as in life. There are forty black bands, whole or broken, of which twenty-three are complete, a few are Y-shaped, and others are alternate, crossing each other in mid-back.

FAMILY BOIDAE.

Among boas we find the largest and most powerful of serpents. Like the preceding families they are primitive, and possess the remains of a pelvis, while some even have an external claw altered from its original use as an aid in locomotion in lizard-like ancestors to a sexual function. Cretaceous fossil boa-like creatures which lived fifty million years ago are so much like living species that we may assume that little evolution has taken place throughout this long period.

In South America there are seven genera and about fifteen species. Of these, four genera and five species were recorded in the course of our studies in British Guiana and northeastern Venezuela.

Boa canina Linnaeus, 1758.

(Plate II, Figs. 6 and 7).

Names: Green Tree Boa, Dog Boa, Yellow-faced Boa, Parrot Snake. Yea-tah-yahmo (Akawai Indian).

Range: Northern and central South America.

General Account: No tree boas were seen at Caripito, and only five taken at Kartabo. Others were probably often in full view but unobserved owing to their quiescent habits in the daytime and their protective coloring. In general the color is bright green above, spotted and narrowly banded with white, with much of the head and the under parts yellow. This ruptive patterning, combined with the spots of sunlight on the jungle foliage, renders the snake all but invisible.

We found it usually bunched or draped in a more or less compact ball or closely wound series of coils. It was not vicious, and after a preliminary fight for freedom, seemed to accept captivity with a sort of watchful waiting.

Coll. No. 228: Color Plate 36, Pelvis KOH 19123, May 25, 1919. Length 1540 mm. (5 feet), weight 910 grams (2 pounds). General color above peacock green with the usual irregular white cross bands, and olive yellow below, this latter color extending over much of the face and all labials. Iris light orange brown. This pigmentation

made the snake darker than any other specimen.

Found on a branch six feet up, and it made no effort to escape until seized, when it struck viciously and constricted with all its force. It soon relaxed and clung closely but not too tightly to my hand and arm as I carried it to the laboratory.

Coll. No. 559: Color Plates 373 and 374, Photographs 1740, 1754, 1755, 1756, 1757 and 1762. April 23, 1922. Length 1330 mm. (4 feet, 4 inches), tail 200 mm., head length 52, width 40, body width 24, height 34, eye diameter 7 mm., weight 437 grams.

Colors: General color of head above parrot green, lighter on snout and around eye; the deeply pitted upper labials light viridine yellow with pinkish shading on their most recessive parts. Lower labials pale greenish-yellow shaded with light viridine yellow. Body above parrot green anteriorly shading through calliste green to yellow green on the tail. Starting on neck are scattered transverse markings, sometimes joined, sometimes alternating, one to five or six scales wide on median line, tapering on upper sides. These markings are white, more or less clouded with gray. They are vaguely bordered with a wide clouding of dark ivy green, these borders being very wide anteriorly, sometimes running into each other, while posteriorly they are sparse. Sides of body yellow green, lighter toward tail. There are a few small touches of empire yellow here and there along the sides, and one large one about mid-body. Extreme lower sides of body empire yellow anteriorly the remainder being faintly mottled with the same color, while glaucous blue scales appear here and there along the area of greatest girth and toward the tail. Here there are also a few splotches of pinkish-white at long intervals. Chin and ventrals naphthaline yellow, while a faint lateral stripe of empire yellow extends down the tail.

Pupil vertical, the line of the pupil extended up and down by a deep groove heavily stippled with dark gray. Iris straw yellow with faint gray stippling all over, which becomes more dense and arranged in the form of two crescents on the sides of the pupil, leaving narrow lines of clear straw yellow next to the pupil. Veins in iris and its periphery faintly tinged with orange. Mouth inside lavender tinged with bluish-white. Predominating colors of universal sheen over whole body are bengal green, chrysophrase and golden orange.

Boa endris cookii (Gray, 1842).

Names: Yellow-marbled Tree Boa, Brown Tree Boa. Ya-mung (Akawai Indian); Macaurel, Oroya (Spanish).

Range: Northern South America, Panama, Lesser Antilles and Trinidad.

General Account: Six of these tree boas were recorded from Kartabo and two from Caripito. The variation in both ground color and pattern is very considerable, and is most confusing for ocular field identification. But a tree snake with vertical pupils, plain gray or brown, or with intricate dull yellow mottlings will probably be this species.

This boa is essentially arboreal and nocturnal, although they seem at times to descend to the ground as is proved by two specimens of the terrestrial frog *Elachistocleis ovalis bicolor* which I took from the stomach of one boa. Trust in immobility and their resemblance to branches and twigs seems reflected in the ease with which they can be approached in daylight and seized. Poor eyesight may also have something to do with this.

Coll. No. 349: Kartabo, June 3, 1920, length 650 mm. *Color in Life*: Unmarked buffy-brown, and only slighter lighter below. It was coiled in a tree, and when seized by the neck managed to get two of its long anterior teeth into my finger, at the same time vibrating its tail against the twigs so that I was startled by the rattling. The Indians are in deadly fear of this boa, and with more superficial reason than in the case of colubrine tree snakes. The number and length of the anterior fang-like teeth, the swollen posterior portion of the head, the vertical pupils, and the unusually loud hiss of the buffy tree boa, all have sinister appearances. But the teeth and mouth are always clean and the bite innocuous.

Coll. No. 2677: Kartabo, Color Plates 683 and 684, April 5, 1924. Total length 1200 mm. (4 feet), body 940 mm., tail 260, body width 16, height 26.5, head length 29.5, width 19, eye diameter 4 mm., rows of scales 58, ventrals 276, subcaudals 120, weight 172.2 grams. *Color in Life*: General color of body light grayish-olive, with many alternating patches, some complete, some broken, on each side of dorsal aspect, olive brown. These darken dorsally and fade downward into very much broken perpendicular lateral streaks and markings of buffy olive which reach to the edge of the ventrals. The dorsal markings are darker toward the head and the tail. Also toward the head and tail they take on the appearance of the Greek letter omega, at mid-body looking like thick, downward-pointing crescents. All these markings have a faint center of cream color, and are rimmed above with the same. The space between is filled with a mottling of grayish-olive, with a few dark splotches, forming a more or less continuous wavy line down the dorsal

ridge. Head, labials and anterior chin cream color, with an area in front of eye light grape green. Head above covered with finely interwoven pattern of dark brown lines, which leave still finer lines of the cream between. One heavy lateral dark streak backward from the eye, a narrower one from eye forward and up over snout; two from upper part of eye backward, small spot and a few crescentic markings on nuchal region. Neck and posterior chin and anterior ventrals tinged with tea green; remaining ventrals pale olive buff, each tinged with creamy buff along posterior edge, and with very fine stippling of grayish-olive, which becomes pronounced toward tail, where there is a mass of confused mottling. A few dark spots on snout and lower labials. Posterior upper labials with deep notches. Iris dull cream color with fine gray stippling, pupil rim more brilliant, and an area of dark sepia stippled around the vertical pupil.

Coll. No. 30059: Caripito, April 20, 1942, Total length 1880 mm. (6 feet, 2 inches), tail 370 mm. *Color in Life*: Above uniform olive green, changing posteriorly into pale brown, with more and more black encroaching on the scales from well before the anus to tail tip. Below creamy white, each scale washed with a sheen of lavender. Along both sides of the ventrals from a distance before anus equal to the length of the tail, there is an irregular series of black spots, becoming larger and extending clear across ventrals under the tail. The tail ends in a sharp spine. In preservative the colors change to olive buff above, and warm antimony yellow below. This boa was caught coiled among the small branches of a low tree at the edge of the savanna. It allowed itself to be grasped around the neck, when it coiled and uncoiled like lightning, hissing loudly.

Coll. No. 30150: Caripito, June 22, 1942, length 700 mm. *Color in Life*: Light red-brown, appearing uniform at first glance, but after being grasped, a series of faint, but dark markings became apparent, quite distinct on the tail, in general pattern recalling those on No. 2677, but in only two indistinct shades of brown. There was a slight but definite color change, the dark markings remaining after death. Below pale yellow brown. The eye with its vertical pupil appeared large and conspicuous in life, and was of such a rich orange brown that until killed and identified we labelled this specimen the Orange-eyed Tree Boa.

Constrictor constrictor constrictor
(Linnaeus, 1758).

(Plate III, Figs. 8, 9 and 10).

Names: Boa Constrictor. Land Camoodie (Creole).

Range: Northern and central South America, east of the Andes.

General Account: The boa constrictor is a fairly common snake both at Kartabo and Caripito. At the latter place we found only small and medium specimens but at Kartabo, among the twenty or thirty collected, eight were from eleven feet to twelve feet six inches in total length, measured when still alive, before shipping north to the New York Zoological Park.

The pattern and color of this snake are too well known to make it worth while to reproduce my detailed notes. At Kartabo there were two more or less distinct and definite color phases, independent of age or sex. One was characterized by rich, warm hues of chestnut and browns, and the other was darker and colder in general color, with drab and olive greens replacing the warmer tones. Invariably the body colors increase in brilliancy and contrast throughout the length of the tail, but in spite of this apparent conspicuousness these serpents were exceedingly difficult to discover in daylight when they were draped over a fallen tree, or coiled in the crotch of a branch.

The eyes, which would be revealing characters, are always obliterated by two to four black or brown marks radiating forward, down and back. The one from the nostril back to the eye bisects the iris, thus destroying all appearance of regularity of outline. (Plate III, Fig. 8).

In greater detail, the iris is rather abruptly, pigmentally divided transversely just above its equator. When the eye is at rest this line coincides exactly with the sharp division of color which separates the pale brown of the upper head from the black line extending along the upper side of the head and face. The eyeball has sufficient mobility at times slightly to disrupt the exact continuity of this pattern of iris and scales. The upper part of the iris is pale smoky gray, sparsely and irregularly flecked with dark; the lower portion is fuscous, obscurely mottled, and paling at the very bottom (quite invisible most of the time) and near the pupil. This latter results in a bright thread-width line around the pupil. The pupil is narrow and vertical, extending almost across the entire iris, and coming to a sharp point above and below.

Most of our specimens were taken at night, as they crawled along the trails or crept over low branches. A small boa was captured in the thatched roof of an Indian benab just as it was seized by a six foot black jungle racer (*Cloelia c. cloelia*). This was the only enemy of the boa constrictor I recorded. Three stomachs contained the following: Cat. No. 692, one large *Ameiva* and a small *Cnemidophorus*; No. 2757, an

Ameiva tail, a large antbird, a spiny rat; No. 2876, one large *Ameiva*, a spiny rat, which in turn contained four embryos.

Eighty per cent. of our boa constrictors were captured at the height of the long rainy season, May through July. Like other boas these snakes put up a strong fight when first caught, then give up and in most cases can be handled at will thereafter without showing any resentment or attempt at attack.

On June 28, 1922, our Indian hunter Degas reported a large land camoodie coiled near his village. We found a boa of large size wound over a fallen log with a burrow of sorts just beneath. It had been there at least five days and the brilliancy of its skin seemed to indicate a recent shedding. We rushed it and took it home and with some difficulty found that it measured at least twelve feet, six inches over all.

The next day when I was preparing to remove the boa from its cage for the purpose of photography I was surprised by a loud hiss which lasted so long that I sent for a stop watch. I pounded on the cage wire, the snake struck short, and laying its head flat on the ground it hissed steadily for 25 seconds. In response to intermittent pounding on the wire it hissed 17 times with an average of 20 to 30 seconds each time. The intervals lasted from five to ten seconds and during these short periods the air rushed into the lung and the body visibly swelled. The sound was exactly like steam escaping from a radiator. The hiss did not seem particularly loud, yet was distinctly audible 100 feet away.

A few days later I held its head for a water color portrait and found that I needed all my strength to uncoil its tail when that organ once got a twist around my body. When first caught it gave forth a most nauseous odor but this was not noticed again. In handling it many times I never saw it make a swift motion.

Four boas were measured immediately after death, as follows:

Cat. No.	692	692a	2757	2876
Total length	880 mm.	910 mm.	1345 mm.	1650 mm.
Tail	96	105	155	190
Eye diameter	4.4	5	6	7
Body width	23	23	50	53
Body height	34	34	70	76
Rows of scales.....	91	96	93	95
Ventrals	237	239	243	239
Sub-caudals	58	63	57	60
Weight	277 grams	309 grams	4 lbs.	7.5 lbs.

Epicrates cenchrus cenchrus (Linnaeus, 1758).
(Plate IV, Figs. 11, 12 and 13).

Names: Rainbow Boa, Ringed Boa, Peacock-eyed Boa. Aboma (Creole).

Range: Northern and central South America.

General Account: The rainbow boa is not rare; at Kartabo we took 12 individuals, and two at Caripito. The Kartabo snakes occurred from March to May. None of these specimens showed the uniform coloration ascribed to some captured in other parts of Venezuela. All of our snakes had the rings and ocelli well developed. Three, however, showed a general pale brown and orange pattern with little iridescence, while all the others were of rich dark colors, with pronounced yellows and were brilliantly iridescent. Most of these boas were coiled on branches in the daytime, or moving slowly on the ground in twilight or moonlight. Two were captured as they were trying to rob hen roosts near Indian benabs.

Coll. No. 315: Kartabo, March 5, 1921, Color Plate 314, total length 914 mm., rows of scales 52, ventrals 250, subcaudals 63. This was one of the pale types with very little iridescence, not typical of the majority of the specimens. The iris reflected this diminishing or lightening of pigment, and was pale silvery, densely shot with a maze of fine black veins. The pale clay color of the interior of the fifty-odd dorsal circles made these stand out much more strongly than in the darker individuals. The post ocular black band was very prominent.

This boa had devoured an antbird and a pullet, the latter from the coop of our Akawai Indian hunter, where the snake was captured.

Coll. No. 732: Kartabo, May 10, 1922, Color Plate 381, Photograph 1802, total length 1828 mm. This boa was the most beautiful specimen we saw, its steel-blue iridescent markings contrasting strongly with the rich orange background. *Color in Life:* In detail it was orange brown above, shading through ochraceous tawny and tawny to cinnamon brown on lower sides. Ring markings on back alternating with large oval splotches of dark blue-black on lower sides. These side markings have a small crescent of warm buff above their center, topped with a larger crescent of shining

blue. Head above, pecan brown with darker markings. Sides of face livid brown. Labials vinaceous fawn clouded with deep purplish-gray. Ventrals light buff tinged with pink. Ground color of tail pale reddish, the markings clouded with gray. Claw ivory

yellow. Rainbow-like iridescence over the whole snake, the sheen over the ground color mainly golden, green and orange, over the markings chiefly indigo, greenish-blue and violet. Iris very dark brown, a little lighter in a faint border around the vertical pupil, but everywhere veined with black.

One day when I lifted this six-foot boa by the neck it threw three coils around my wrist and lower arm and twisted the tail across the coils in a strong tight overlapping lock. The head and neck remained limp in my hand but the rest of the body began a slow, rhythmic pressing, tighter and tighter. This turned to a throbbing which I soon found was the beating of my own blood. My hand became reddish, then bluish, and the veins stood out strongly. After taking movies of this effect I was glad to unwind the boa as the pain was considerable. Traces of the compression were visible the following day.

Coll. No. 2635: Kartabo, March 3, 1924, Color Plate 652, total length 1600 mm. (5 feet, 3 inches). Rows of scales 48, ventrals 274, subcaudals 61, weight two and one-half pounds. The background of dark brown shows little iridescence, but the rings and ocelli are ablaze with shining ultramarine, and the dorsal crescents of the lateral ocelli are brilliant gold. The labials, chin and under surface are mouse gray.

Coll. No. 2867: Kartabo, May 20, 1924, total length 1360 mm., tail 194, body width 36, eye diameter 5.2 mm., rows of scales 51, ventrals 276, subcaudals 61, weight two and one-quarter pounds. This boa was caught in the chicken coop of our Indian hunter, but its stomach was still empty.

Coll. No. 30173: Caripito, July 31, 1942, total length 1200 mm. Captured at dusk stalking a large frog which seemed unaware of its enemy's approach. *Color in Life*: Background above down to lower sides chestnut brown, below pale orange yellow. Dorsal pattern a series of more or less regular, contiguous rings formed of narrow, blue black lines. Some of the markings fail to extend across the back, resulting in hour-glass rather than paired rings. On the sides in the concavity patterns formed by the junction of the dorsal rings is a series of ornamental ocelli, each a large, round, iridescent blue spot, bordered on the dorsal half by a wide crescent of yellowish-white, and above this a second, similar but narrower boundary of blue black. Alternating with and below these ocelli are two series of irregular and less distinct roundish or oval spots. The ventral scales are immaculate. In this four-foot boa there are 56 of the rings and ocelli from head to tail tip.

Eunectes gigas (Latreille, 1802).

(Plate V, Figs. 14, 15 and 16).

Names: Anaconda. Water Camoodie (Creole). Ow-oo-rah, Sal-ur-ring-mah, "quick runner" (Akawai Indian).

Range: South America east of the Andes.

General Account: The anaconda is the giant among American serpents with an accredited length of 29 feet, but the largest taken by us was close to Kartabo, where one of these boas measuring 17 feet, two inches was shot from a branch overhanging the water a mile down river.

Eleven were taken and others seen at Kartabo, and two small ones at Caripito. This is essentially a water snake and from three stomachs we took 27 fish, including sharp-spined catfish and four species of armored catfish. Occasionally they were found in the jungle but never very far from the river, and more often coiled on a branch over the water or on the sandy shore.

The following individual will serve as typical of the species;

Coll. No. 540: Kartabo, May 27, 1922, Color Plates 371, 372, Photographs 1742, 1743, total length 917 mm. (three feet), tail 90, eye diameter 5 mm., weight 280.4 grams. Another young anaconda only two-thirds (665 mm.) as long as the present one, weighed only one-quarter (69 grams) as much.

Color in Life: Top of head dark olive, almost black on orbits; side of face in front of eye, upper labials and post oculars dark olive. A broad cinnamon band equal in width to eye extends from eye to posterior point of jaw, becoming darker and narrower on side of neck. This cinnamon band is bounded below by a narrowed band of black which extends along the neck. Back olive green with many alternately placed, irregular, large, round and oval black spots. Sides buffy brown with smaller, more crowded spots of orange yellow, edged with black. The lowermost of these are much broken and extend in places over the ventrals. Chin pale pinkish-cinnamon flecked laterally on the throat with gray and black. Ventrals warm buff with exceedingly variegated markings composed of small, black, geometrical patches, which frequently form two broken, longitudinal lines. Pupil vertical, much shorter than in the boa constrictor. Also it is not double pointed but rounded above and below, and with a slight median constriction. Iris dark citrine with faint dark mottlings.

This, like a number of other specimens, was taken on the sandy beach in front of Kartabo on a moonlight night. It was so lethargic that it allowed me to pick it up, whereupon it put up the usual, brief boine fight. It is difficult to distinguish anacondas

when they lie motionless, for they rest so flatly on the sand that they scarcely cast a shadow, and when they move, it is so silently and in so straight a line that the ear and eye give little warning. More than once I have attempted to catch a snake and have seized only sand, the serpent having vanished without my sensory knowledge, leaving only the faint shadow of a shallow depression in the sand.

FAMILY COLUBRIDAE.

This family contains the great majority of living serpents, but satisfactory characters for sub-division are still to be found. In the present paper twenty-five genera are included, leaving only eleven belonging to all the other families, and 39 species as compared with only fifteen representing the remaining families of serpents. With the exception of the worm snakes, boas and such poisonous forms as the coral, fer-de-lance, bushmasters and rattlers, all others are classified as colubrine.

Atractus trilineatus Wagler, 1828.

(Plate VI, Figs. 17 and 18).

Names: Stub-tailed Snake, Three-lined Worm Snake.

Range: Guianas, Eastern Venezuela and Trinidad.

General Account: This is a small, round, stocky snake, with small pointed head and very short, stubby tail adapted for burrowing. The eye is small with round pupil. It is dark brown above, with three longitudinal black lines, and usually lemon yellow below. It is fairly common both at Kartabo and Caripito, but discoverable chiefly by digging. In the dim light of the jungle it may, at first sight, be mistaken for *Leptotyphlops*.

In a dozen specimens the total lengths varied from 112 to 256 mm. They were taken from March through August. *Atractus* is a rather slow moving snake, never biting, but pushing continually with both head and tail. The latter has a sharp pointed tip which is used with considerable force as in *Leptotyphlops*, driving the creature ahead through one's fingers. When placed on soil it at once burrows out of sight. A female of 250 mm., had three eggs in the oviduct, two complete with leathery shells ready for deposition. They were oblong, equal-ended and measured 20 by 8 mm.

Coll. No. 525: Kartabo, April 3, 1922, Color Plate, total length 235 mm., tail 14, head length 6, eye diameter .9 mm., ventrals 139, subcaudals 15, weight 5.6 grams. *Color in Life:* Head above cinnamon brown with distinct asymmetrical mottlings of mummy brown. Back hazel brown with three longitudinal stripes of dark clove brown. Upper labials citrine yellow. The upper side of

body below the lateral dorsal stripes, tawny olive and below this a faint, narrow line of brown. Lower labials, chin and anterior ventrals lemon yellow. Remaining ventrals mustard yellow with pinkish tinge. Iris dark cinnamon brown.

Coll. No. 246: Kartabo, August 31, 1920, length 256 mm., tail 14.7, head length 6.5, body width and height 6 mm., ventrals 150, subcaudals 13, weight 5.6 grams. In life this specimen was fuscous above, with the three lines brownish-black. The ventral surface pinkish-buff, which deepened to tawny olive on lower sides. Iris very indistinct, with black mottling.

A young specimen taken March 6, 1924, only 165 mm. in length, had a tail of 14 mm., ventrals 135, subcaudals 19 and a weight of 2.7 grams. This was taken from the stomach of an *Erythrolamfrus aesculafti*.

All of the *Atractus* taken at Caripito were considerably lighter in color than the Kartabo ones, with the ventrals creamy white. Two out of five (Nos. 30070, 30122) were found in Pit 13, the only one dug outside of the jungle proper, a few yards from the nearest trees, at the edge of the open savanna.

Chironius carinatus (Linnaeus, 1758).

Names: Golden Tree Snake, Yellow-lipped Tree Snake, Yellow-belly (Creole). Sipo (Native).

Range: Northern South America to Brazil and Bolivia.

General Account: This is a rather slender snake, essentially arboreal, either sage green above and bright yellow below, or blackish-brown above and steel blue below. It is usually found draped among dense foliage or creeping slowly along. When frightened it can move faster than the eye can follow. It is nervous and vicious in disposition and can seldom be caught without getting in at least one bite. Its enormous gape gives it an especially alarming appearance although it is quite harmless. The eye is unusually prominent with a round pupil.

About 25 specimens were taken and others seen, from March through August at Kartabo. We did not find it at Caripito. In length our captives varied from 600 mm. (two feet) to 2850 mm. (nine feet, four inches), this being, I think, the record for the species.

Colors in Life: Coll. No. 2612: Young snake. Pale blue above with wide white vertebral stripe. Pale yellow below.

Coll. No. 2814: 900 mm. Dark olive green above, picric yellow below.

Coll. No. 2822: 1249 mm. Dark olive green above with a purplish tinge, pale yellow below.

Coll. No. 2802: 957 mm. Color Plate 133, head and body above grayish-olive, with a

light vertebral band. Below empire yellow on labials, fading down neck to pale lemon yellow, into the general ventral color of light greenish-yellow. Tail lemon yellow below. Eyes very prominent; iris inner half brackish-brown, changing rather abruptly with a concentrated stippled margin into pale silvery yellow on the outer half. Pupil surrounded by a very narrow yellow ring. Tongue long, slender, shooting out 20 mm., rich dragon's-blood red.

Coll. No. 2801: 741 mm. Very young snake. Top of head saccardo umber, back brownish-olive, russet on snout. Upper labials, throat and first few ventral strontian yellow, shading through green to honey yellow under tail. Sides of body sage green. Outer edge of iris colonial buff flecked with orange. Dark patch around pupil brown, flecked with gold.

Coll. No. 2668: 1020 mm. Like No. 2802, but with two bright lateral yellow stripes along tail.

Coll. No. 2764: On the dark brown of the back, at mid-body, this individual has a number of oblique markings, angled, pointing backward, narrow bands in pairs, the width of the pair equalling the interspaces. These are composed of broken lines of lemon yellow spots, much smaller than the scales on which they occur. The ventrals of the anterior half of the body are colored steel blue and lemon yellow in equal proportions. On the posterior half of the body the blue dominates, but on the tail the yellow again appears abruptly and eliminates the blue. The upper labials, chin and throat are immaculate golden yellow. After 22 years, the skin of this snake, mounted on cardboard, shows no change of color whatever.

Coll. No. 2855: 1420 mm. Color Plate 1176, sage green above, the pale vertebral stripe scarcely visible. Upper labials, chin and anterior ventrals chalcidony yellow with faint gray line down center, brightening to empire yellow under tail.

Food: One snake was caught with quite half of its body wedged between the wire meshes of a cage in the laboratory holding five *Hyla maxima*. Another was captured while climbing up to a nest of two nestling antbirds. A third had swallowed a large *Leptodactylus* frog.

Measurements of freshly killed specimens:

Coll. No.	2801	2940	2802
Total length (mm.) ...	741	903	957
Tail (mm.)	201	328	257
Jaw length (mm.)	21.5		25
Eye diameter (mm.) ...	4	5.5	6
Rows of scales.....	12	12	12
Ventrals	151	190	
Subcaudals	140	180	
Weight (grams).....	6.8	19	13

Chironius fuscus (Linnaeus, 1758).

(Plate VI, Fig. 19).

Names: Red-fronted Tree Snake; Green Tree Snake. Cow-um-bung, "one who lives in high bush" (Akawai Indian).

Range: Northern and equatorial South America.

General Account: A long, well-built, constricting arboreal snake. Typical pattern brown above with numerous, well-spaced, pale, dark-edged, double cross bands, below yellowish-white mottled with brown, head with black posterior eye streak, reddish on snout, labials and anterior ventrals. Two vertebral lines of black along dorsal keels. Individually the cross bands may be wholly lacking in both young and adults, or the entire snake may be green, deeper above and pale below. We saw none of the green phase longer than 535 mm. Besides the possession of 10 rows of scales (instead of 12 as in *C. carinatus*), the iris in this species is characteristic. In the green phase the dark mottling covers almost the entire iris evenly, but in all brown forms the only part of the iris free from the solid brown is the periphery of the upper fifth of the visible eye, this being pale gold. (Plate 0, Fig. 0). All the various color phases were taken within the quarter square mile of jungle at Kar-tabo. We did not find this snake at Caripito.

Of the 24 specimens captured, more were taken on the ground than was the case with *C. carinatus*. Three of these were of the green phase. All were active and vicious, striking at every opportunity.

Colors in Life: Col. No. 3294: Rich red brown above, salmon below. Col. No. 3554: June 12, 1919. Liver brown above, covered with a purplish sheen, ferruginous below.

Coll. No. 2669: Color Plate 151, 1242 mm. General color above cinnamon brown, with two dark brown vertebral stripes. Faint oblique cross bands of fuscous about an inch apart, each with a broken border before and behind of the dark color. Top of head chestnut brown, changing to russet anteriorly. Upper labials white, the anterior three, and the upper parts of all cinnamon rufous. Ventrals white heavily tinged with pale ochraceous salmon toward head, mottled thickly toward tail with vinaceous and dusky. Lower three-fourths of iris dark brown ground color, heavily marbled and mottled with gold and black. Upper one-fourth pure gold,

Coll. No.	2801	2940	2802	2668	2764	2855	2922	320
Total length (mm.) ...	741	903	957	1020	1125	1420	2320	2850
Tail (mm.)	201	328	257	420	395	500	883	950
Jaw length (mm.)	21.5		25	29	33	39	42.5	46
Eye diameter (mm.) ...	4	5.5	6	6	6.5	8	8.5	10
Rows of scales.....	12	12	12	12	12	12	12	12
Ventrals	151	190		150	159	154	184	184
Subcaudals	140	180		146	139	129	190	194
Weight (grams).....	6.8	19	13	52	68.5	180	1 lb.	1½ lbs.

streaked upward and toward the edge with flecks of black. Very narrow unbroken pupil ring, gold on upper fourth, and orange on lower three-fourths. A broad streak for 10 mm., back of eye bluish iridescent black. From gape and back along the upper edge of the ten anterior ventrals a series of large spots of bright red.

Coll. No. 3112: 2350 mm. This large specimen is very dark red, with all labials and chin shields red, the post ocular black streak lost in the dark red, and the pale upper part of the iris darkened to a grayish-cream.

Coll. No. 527: 535 mm. Head and back chromium green, becoming dark greenish-glaucous on sides of body and malachite on sides of face, and cobalt on upper labials. First few lower labials touched with beryl green, remainder of lower labials and chin bluish-white. Ventrals pale Nile blue, becoming deeper and strongly tinged with olive toward the tail. All body scales edged with translucent dark gray. Pupil rim brilliant buffy white. Iris, cartridge buff above, much whiter and more brilliant below. Anterior of iris covered with brownish stippling, arranged in faint streaks. This stippling irregularly surrounds the pupil, resolving into upwardly-converging streaks above, and irregularly streaking below.

Coll. No.	3294	3554	2669	624	2798	3112
Total length (mm.).....	340	512	571	1270	1370	2350
Tail (mm.)	124	165	221	380	410	755
Jaw (mm.)	10		18.5	29	32	40
Eye diameter (mm.).....	2.5	7		7	7	9
Ventrals		165	150	147	147	164
Subcaudals	137	122	132	95	101	121
Weight (grams)	2.5		11.2	233.5	277	

Coll. No. 2669: 571 mm. This young specimen is colored almost like No. 2669 except that the vertebral stripes are almost invisible, only a faint, much broken line. All the labials are much whiter and the gold of the upper iris is much more diffused. In the present snake the cross bands begin 110 mm. back of the snout, and end 100 mm. from the tip of the tail. There are 30 of these pale centered marks, but on the tail they become very broken and irregular. The skin of this snake was mounted on cardboard on the day it was collected, April 1, 1924, and now, 22 years later, every pattern and color is clear and unaffected.

Coll. No. 3554: 512 mm. Peacock green above, lichen green under chin, and glaucous green on the ventral surface. Gold streaking of iris is very much diffused.

Coll. No. 821: Color Plate 348, 950 mm. There are 38 cross bands on this brown snake, and the anterior red is very strong on chin and sides of anterior body. The ventrals elsewhere are quite white.

Optical Fundus: Dr. Casey Wood analyzed

the fundus of the right eye of snake No. 2669 as follows:

Eye-ground dark blue gray covered with uneven, brilliant silvery dots. The optic disc is large, round, dirty white, with moss green edges. Only a faint suggestion of opaque nerve fibers is apparent. There is one large vein running from the lower periphery straight up into the papilla where it disappears from view. Two smaller veins, one on either side of it converge and join over the lower end of the disc and then continue as one across the center of the disc to near the upper edge where it again divides, this time into three branches. Near the lower edge of the papilla, under a spot where the two small veins join, is a round dark area which may be a depression in the disc.

Food: The stomach contents of five snakes are as follows: (1) A pullet just swallowed in the coop of our Indian hunter, where the snake was captured. (2) One medium *Leptodactylus caliginosus*. (3) Bones of a jungle mouse or young rat. (4) Full-grown *Anolis* and several small mollusks, probably the food of the lizard. (5) A large *Leptodactylus mysticenus*, 53 mm. in length.

Measurements of freshly killed specimens:

Cloelia cloelia cloelia (Daudin, 1803).

(Plate VI, Fig. 20).

Names: Black Tree Snake. Masurana (Indian Name).

Range: Northern and central South America.

General Account: A large, round-bodied, strong and active, arboreal snake. Black or dark gray or reddish-brown above, white or yellowish-white or rarely salmon colored below. Fourteen taken at Kartabo but none at Caripito. These fearless snakes feed on lizards and both poisonous and harmless snakes. They seem equally at home among branches and on the ground.

Coll. No. 643: Kartabo, July 1, 1922, total length 2145 mm. *Color in Life*: Olive brown above, anterior upper labials and below pale salmon. Pupil a wide vertical, iris brown mottled with darker.

Coll. No. 250: Kartabo, September 1, 1920, total length 1595 mm. *Color in Life*: Brownish-gray above, upper labials and below creamy white. Coll. No. 3274: Kartabo, Color Plate 230, July 23, 1922, *Color in Life*:

Above slaty black, upper labials slightly paler. Below yellowish-white. Pupil a wide, vertical slit, iris rich coral red, mottled with darker red.

Food: The stomach contents of five snakes were as follows: (1) When chloroformed this individual disgorged a 300 mm. *Ameiva* in general appearance uninjured. (2) Nothing but its own shed skin. (3) One large *Ameiva*. (4) Caught in the act of killing a small *Constrictor constrictor* in the roof of an Indian benab near the laboratory. (5) Two small fer-de-lance in stomach, one partly digested, the other fresh.

Measurements of freshly killed specimens:

Coll. No.	3528	3278	250	643	3274
Total length (mm.).....	1322	1470	1595	1870	2030
Tail (mm).....	272	260	276	275	430
Eye diameter (mm.).....	3.5	4.5	4	4	4.5
Rows of scales.....	19	19	19	19	19
Ventrals	216	235	240	220	220
Subcaudals	83	78	72	60	72
Weight (grams).....	381.5	330	1 1/4 lbs.	1.5 lbs.	2.5 lbs.

Dipsas catesbyi (Sentzen, 1796).

(Plate VI, Fig. 21).

Name: Catesby's Snake, Brown-saddled Snake.

Range: Guianas, Colombia, Ecuador, Brazil, Peru and Argentina.

General Account: A gentle, rather deliberate snake, slender, with rounded head and long tail. Above cinnamon brown with numerous black half-bands, bounded with white on the sides. The markings may be alternate rounded spots, or opposite, or assume saddle shapes. The body is much compressed, strongly keeled along the mid-back. Eye very large and protuberant. Iris black. Half a dozen were taken at Kartabo, but none seen at Caripito. All were climbing among slender branches in low jungle growth. In size we found it ranging only between 530 and 645 mm. over all.

Measurements and Color in Life: Coll. No. 240b, Kartabo, April 27, 1919, total length 590 mm., tail 150 mm., ventrals 173, subcaudals 97. In preservative this individual has changed to light brown saddles and pale pinkish flesh color elsewhere.

Coll. No. 3293: Kartabo, August 31, 1920, total length 600 mm., tail 176 mm., ventrals 178, subcaudals 94, weight 15.4 grams. In this specimen the dark bands are reddish chestnut.

Coll. No. 149: Kartabo, American Museum 18153, Color Plate 176, July 23, 1920, total length 620 mm., tail 150 mm., eye diameter 3, body width 7.8 mm., body height 11 mm., ventrals 180, subcaudals 91, weight 15 grams. The head is black with irregular bluish-white markings, with a narrow nuchal band just back of gape snuff brown. Dorsal surface tawny brown with about 40 half-bands of blackish-slate. Most of these

bands alternate with each other, but some are opposite but do not join. Ventrals white with large longitudinal, irregular blotches of dark reddish-brown, cleanly outlined. The iris is quite indistinguishable from the jet black pupil.

Coll. No. 3253: Kartabo, May 10, 1920, total length 630 mm., tail 187 mm., ventrals 206, subcaudals 123.

Coll. No. 226: Kartabo, American Museum 18154, July 30, 1920, total length 660 mm., tail 215, head length 9.5, eye diameter 3.5, body width 6, body height 8 mm., ventrals 209, subcaudals 125, upper labials, right 9, left 10, weight 11.5 grams.

Color in Life: The head is variegated with white, chiefly in the form of an imperfect band around the snout and a collar back of the parietals. Much of the side of the face is white, also chin and throat except 3d, 4th, 5th and 6th lower labials and two central spots which are black. The first three narrow dorsal bands, dividing the very elongate black saddles, are white, and in the next four the bands become medially tinged more and more strongly with brown, until from the 8th on the usual pattern of a white-edged brown band is seen. There are 41 black saddles altogether. Below, brownish-white, marked with irregular, longitudinal spots of brown. The dorsal saddles, in this specimen, result in a close approach to the pattern of *Dipsas indica*.

Food: The food of No. 243 consisted of three small snails and an equal number of newly emerged, soft-bodied wood roaches.

Dipsas indica (Laurenti, 1768).

(Plate VII, Figs. 22 and 23).

Name: Snail-eating Snake.

Range: Guianas, Colombia, Ecuador, Peru, Bolivia, Paraguay, Brazil and Argentina.

General Account: Only three specimens of this little snake were taken at Kartabo and none at Caripito. It is a slender, narrow-necked, round-headed serpent, with many black saddles along the body framed in tawny brown, and a black and white head. It is slow in movement and with large eyes, active both in daylight and at night. In disposition it is exceedingly gentle and wholly unresentful of handling. All were taken among branches in second growth jungle.

Measurements and Color in Life: Coll. No. 76, Kartabo, American Museum No. 18179, May 12, 1916, total length 648 mm., ventrals 205, subcaudals 120. Above, this specimen was brownish-gray, whiter toward head, with numerous very large saddles of black.

Coll. No. 2678: Kartabo, Color Plates 685 and 686, April 8, 1924, total length 620 mm., tail 190, head length 11.5, head width 7.5, eye diameter 2.6, body width 5.5, body height 9 mm., rows of scales 13, ventrals 198, subcaudals 115, weight 7.7 grams.

Food: (1) 5 small land snails, swallowed whole with a few bits of shell. (2) A mass of soft tissue, probably slugs, and 2 ants.

Dipsas variegata

(Dumeril and Bibron, 1854).

(Plate VII, Figs. 24 and 25).

Name: Many-banded Snake.

Range: Guianas, Colombia and Brazil.

General Account: Only four of these little snakes were taken at Kartabo, and none at Caripito. All were found coiled up in the day time low down in the debris of bamboo clumps. They are light brown above and creamy white below, with numerous, broken dark brown or black bands extending almost around the body. On the lower sides

Coll. No.	2670	247	528	787	2743	301	283
Total length (mm.)	385	451	475	618	1190	1352	1410
Tail (mm.)	100	96		138	320	310	290
Eye diameter (mm.)	2.5	3.5			5	5	6
Rows of scales	17	15	17	17	17		
Ventrals	175	174	176	188	182		
Subcaudals	99	95	97	108	101		
Weight (grams)	5.2			50	155	87.3	115.6

each of these expands into a large, rounded spot occupying a lateral third of one or two ventrals. The eye is very characteristic. The pupil is a broad vertical oval. The iris is greenish-yellow, heavily dotted with reddish-brown on the upper half, less densely below.

Measurements and Color in Life: Coll. No. 347, Kartabo, Color Plate 292, January 13, 1921, total length 300 mm., tail 75, head length 7, head width 6, body width 6, body height 8 mm., ventrals 180, subcaudals 84. General color above and half down sides mouse gray with two black patches on back of head. Upper head scales mottled with black. Labials and face scales edged irregularly with black. Entire length of body banded with about 50 transverse bands, some broken, considerably separated on ventral surface. Between these are fainter, more broken series of black spots. On the lower lateral surface all these end in a black spot. Ventral surface pale yellow becoming whitish toward tail.

Eye: Pupil broadly vertical, less slit-like than in wholly nocturnal snakes. A pale gold rim around pupil. Iris with a ground color of ivory yellow or gold, lighter toward outer rim. This is heavily dotted with red brown on the upper half, dying out toward the lower part of the iris and internally, leaving considerable clear yellow on the inner and lower portions of the iris.

Coll. No. 649: Kartabo, male, August 18, 1922, total length 637 mm., eye diameter 3.2 mm, ventrals 175, subcaudals 89, weight 22.3 grams.

Dryadophis boddaerti boddaerti

(Sentzen, 1796).

(Plate VII, Figs. 26 and 27).

Names: Checkered Jungle Snake (young), Brown Lined Snake (adult).

Range: Northern half of South America.

General Account: Medium-sized, slender snake, almost altogether terrestrial. Young, brown or gray, checkered on back and sides, and with variegated pattern on head. Adult, plain brown or gray above with two longitudinal pale lines. Iris golden in upper fourth. Not rare; active and in captivity biting at every opportunity.

Measurements of freshly killed specimens:

Color and Pattern in Life: Young checkered snakes are brown or grayish-black above, with many cross bands of white or pale drab on the body, tail uniform. These bands are narrower than the inter-spaces and confined to the dorsal scales. On the sides there is a corresponding series of white bands, but alternating with the dorsal ones. The top of the head is mottled with light and dark brown, and the labials and anterior lateral scales are boldly marked with black and white. Below, whitish mottled on anterior ventrals and on sides of remainder. Iris mottled red or red brown on the lower three-fourths, golden or pale orange above. Total lengths 285 to 450 mm.

Individuals of intermediate size have the dorsal pattern more or less distinct, giving way to a uniform brown or grayish-brown, with traces or a half-developed pale lateral lines.

In the adult snake the pattern is a uniform brown or gray brown above with two distinct paler lateral lines extending the full length of the body. Whitish or grayish-

white below in Kartabo specimens. In all Caripito adults the ventrals are sulphur or bright yellow.

Individual Patterns.

Coll. No. 247: Kartabo, Color Plate 192, August 6, 1920, total length 451 mm. Top of head bone brown, each scale narrowly margined with dark apple green, sides of head lighter green shading to bluish-white on upper labials. First to fifth upper labials irregularly edged with black along posterior borders, a large round spot on posterior half of sixth and anterior half of seventh. A wide band of brown on eighth extending upward to black center of occipitals. Chin shields and ventral surface bluish-white, anterior half of every ventral pearl gray. Dorsal body brown with 39 narrow, transverse bands of cinnamon buff edged with black, ending abruptly at tail. Tail fuscous above, smoke gray below. Iris, lower four-fifths rich red brown, upper fifth lumiere green.

Coll. No. 30, 196: Caripito, August 21, 1942, total length 285 mm. Quite similar to No. 247, except that it wholly lacks the cephalic green, the top and sides of head being coarsely mottled in shades of brown. A continuous but irregular band of white extends from eye to gape.

Coll. No. 2636: Kartabo, Color Plate 650, March 1, 1924, total length 375 mm. Differs from typical juvenile pattern of No. 247 in lacking all green on head, and in having body pattern strongly contrasting brownish-black and white, and in having the superior fourth of iris silvery.

Coll. No. 2670: Kartabo, April 1, 1924. Differs from No. 247 in having essentially seal brown ground color with pale brown markings. Throat heavily mottled, and checkered pattern more of squares than of narrow bands and rectangles. The dorsal cross bands become more narrow and irregularly oblique on posterior third of body. The preserved skin mounted on cardboard has altered in no way from the colors of life as recorded 22 years ago.

Intermediate Pattern.

Coll. No. 528: Kartabo, Color Plate 351, April 1, 1922, total length 475 mm. The head is olive brown above, deepening on sides to sepia along top line of upper labials. All labials and chin bluish-white, while the anterior upper and all lower labials are edged with slate color. Sixth to ninth upper labials have irregular splotches of gull gray, which shade into burnt umber on upper edges of eighth and ninth. Top and sides of body hair brown, with faint transverse bands almost as wide as inter-spaces, of snuff brown which terminate along a pale gray lateral line, and alternate with similarly colored square patches on lower sides.

All body markings faintly edged with black anteriorly. The lateral line dies out at mid-body. Ventrals dirty white toward neck, shading back through smoke gray to pinkish-buff. Pupil rim flame scarlet, iris pale gold on upper quarter.

Coll. No. 787: Kartabo, April 19, 1922. General color above saccardo umber, faint drab cross markings, shading to hair brown. Pale lateral line well developed, olive buff on tail. Upper fourth of iris golden, remainder burnt umber mottled with darker.

Adult Pattern.

Coll. No. 2743: Kartabo, April 27, 1924, total length 1190 mm. Seal brown above with single pair of pale lateral lines. Throat mottled, and extreme anterior and posterior ventrals dominately grayish-blue, with considerable olive buff on mid-body ventrals. In the stretched and preserved flat skin faint traces can be seen on the interscale area of the juvenile dorsal pattern, but this is absolutely invisible in the living snake.

Coll. No. 301: Kartabo, July 23, 1920. Similar to No. 2743 except that there is a faint tinge of greenish-buff on anterior ventrals.

Coll. No. 283: Kartabo, Color Plate 138, June 12, 1920, total length 1410 mm. General color above brown, with a broad stripe down each side of light drab. Upper half of head uniform brown, upper labials light mineral gray, under parts grayish-white. Pupil ring rufous turning to gold at the top. Lower three-fourths of iris pecan brown, upper fourth antimony gold flecked with darker.

Four Caripito adults (No. 30184, total length 880; No. 30275, total length 1055; No. 30276, total length 970; No. 30278, total length 955 mm.) show almost identical patterning and coloring. Uniform seal brown above with faint pale lateral line. Labials and ventrals sulphur or bright yellow, with considerable lateral marking of blue gray. Subcaudals with or without central, irregular dark mottling. Chin and throat with more or less blue gray edging to scales. Black band nostril to eye and eye to gape present or absent.

Food: Five of these snakes had eaten the following: (1) One small frog. (2) A very young *Ameiva*. (3) 4 unidentifiable reptile eggs. (4) This snake captured at the base of a stub from which it had just caught and eaten a nesting *Glyphorhynchus*. (5) 3 small frogs and a large scarlet-winged grass-hopper.

Drymarchon corais corais (Boie, 1827).

(Plate VIII, Figs. 28 and 29).

Names: Yellowtail, Tiger Snake, Rat Snake, Black-and-yellow Jungle Snake. Cribo, El Tigre, Raba Amarilla (Native).

Range: South America, south to tropical Brazil, Paraguay, northern Argentina and Bolivia.

General Account: A large, fierce, terrestrial snake, black variegated posteriorly with yellow. Rare at Kartabo where we recorded only three in eight years. More common at Caripito where 12 came to our attention and six were captured. Several were killed on the road by cars. In the jungle it was necessary to fire instantly to obtain a specimen, for otherwise the speed of the reptile gave but a moment's glimpse. Several snakes were longer than eight feet, and the largest measured nine feet, eight inches. A shed skin, complete except for part of the tail, was a full eight feet six inches. In eastern Venezuela there is a wide-spread belief that if a pregnant woman encounters one of these snakes she will be beaten by its tail and her child will be delivered at once.

Coll. No. 30086: Caripito, Color Plate 1567, May 5, 1942, total length 2540 mm. (8 feet, 4 inches), head 62, eye diameter 8, snout 22 mm., weight 8 pounds. *Color in Life:* Above blue black as far back as 600 mm. before the tail, when the dorsal ground color changes to empire yellow and then to warm orange. The black is continued in this yellow area as paired bands. After four of these pairs, the bands begin to degenerate, diminishing in width and purity, but they continue in a succession of about 30 to the tip of the tail. The rostral, nasals, internasals, loreals and all the upper labials are ivory white, with a flecking of black on the loreals and 6th, 7th and 8th labials. This white color continues on the chin, throat and ventrals, each of the latter with an invasion of black from each side, never meeting in the middle. The subcaudals are yellow orange like the upper side. The iris is dragon's blood red with a gold pupil ring.

Coll. No. 30144: Caripito, June 18, 1942, total length 1448 mm. (four feet, 9 inches). The pattern and color in general are very similar to those of No. 30086, but there is less white on the snout and upper labials.

Food: Five yellowtails had eaten the following: (1) A medium sized opossum and 2 *Ameivas*. (2) 2 young opossums and an eighteen inch fer-de-lance. (3) 3 *Leptodactylus* frogs. (4) 1 *Bufo marinus* and a spiny rat. (5) 2 spiny rats.

Erythrolamprus aesculapii (Linnaeus, 1758).
(Plate VIII, Figs. 30, 31 and 32).

Names: False Coral Snake, Necklace Snake.

Range: Northern and central South America.

General Account: Brilliantly hued, tri-colored snakes of rather small size, found

crawling through the jungle or occasionally dug up a foot or more beneath the surface. Not nearly as common as the true coral snakes which they so much resemble. In three instances *Erythrolamprus* was taken within a few feet of a *Micrurus* individual. Typical coloring of a dozen or more Kartabo snakes, a succession of 13 to 18 tri-annuli (two black and one white ring), separated by scarlet. The white bands are narrow and of even width, the black bands are wide above and narrow below, the scarlet bands are narrow above and wide below. I found none with single black bands, and no yellow ones. All the snakes taken at Caripito had each black band split in two by intrusive white bands, sometimes equal to the black in width, and the scarlet bands were much wider than in the Kartabo specimens. The largest snake of this species was 26 inches in total length. Individuals varied greatly in disposition, some being active and irritable, and others quiet, permitting any amount of handling.

Measurements of freshly killed specimens:

Coll. No.	259	258	2973	254	256
Total length (mm.)	253	393	540	545	545
Tail (mm.)	31	52	90	66	74
Eye diameter (mm.)	2.5	2.5	3	3	3
Ventrals	189	189	187	186	191
Subcaudals		49	46	42	45
Weight (grams)...	4.6	12.8	56.5	33	30.2

Coll. No. 256: Kartabo, Color Plate 160, figs. a and b, July 2, 1920, total length 545 mm. *Color in Life:* Fourteen scarlet bands, each set off by a pair of black and a pair of white. The bands are ivory white and flame scarlet. Black and scarlet equal in width above (about 12 mm.), white narrower (about 5 mm.). Iris blackish-brown, almost indistinguishable from pupil.

Coll. No. 258: Kartabo, Color Plate 160, fig. c, July 16, 1920, total length 393 mm. *Color in Life:* Thirteen scarlet bands, equal to the black above (about 9 mm.) and widening to twice that width below. White bands 4 mm. above, slightly wider below. Black 9 mm. above narrowing to 4 mm. below.

Coll. No. 254: Kartabo, August 24, 1920, total length 545 mm. *Color in Life:* Thirteen scarlet bands, and a scarlet tail tip. Scarlet very wide, 15 mm. above, 20 to 23 mm. below, wider than black. White strongly black-tipped. Rostral, anterior labials and chin shields tinged with apricot buff.

Coll. No. 259: Kartabo, April 16, 1922, total length 253 mm. *Color in Life:* Thirteen scarlet bands, and thirteen black-bounded white bands excluding the incipient one on the head. Head black with broad band of pale grass green from gape almost to orbits, extending clear across head above.

Snout buffy brown, first two labials and anterior chin shields warm buff. The usual white bands are, on this individual, grass green tipped with gray. Iris dark cinnamon brown.

Coll. No. 2973: Kartabo, Color Plate 767, June 17, 1924, total length 540 mm. *Color in Life*: Fifteen pairs of black paired bands, wide above, narrowing below to two to four ventrals. These black bands are separated by narrower bands of pale grass green, somewhat wider on the ventral surface (one and a half to three scales wide), and above with jagged edges dovetailing with the black. The inter-spaces are orange red, narrower than the black rings dorsally, but below, widening out abruptly to a maximum of seven ventral scales. The cephalic black pair is incomplete, the pale central band covering the occiput, and dying out at the labials, the anterior black ring being very small, extending across the orbits and ending in an irregular line along the mouth. The snout, all lower labials except the posterior two and under chin and neck are solid orange red. The pale ring of the thirteenth pair covers the anal region, the fourteenth the central portion of the stumpy tail, and the last, very much reduced, extends almost to the tip, leaving a tiny speck of scarlet at the extreme end. Iris very dark rich brown.

Coll. No. 334: Kartabo, May 28, 1920, total length 456 mm. 18 annuli. No. 335: Kartabo, June 21, 1920, total length 475 mm. Very dark specimen, all red scales black tipped. 18 annuli. No. 335a: Kartabo, June 25, 1920, total length 502 mm. 18 annuli. A scattering of whitish scales mixed with some of the black.

Coll. No. 30008: Caripito, Color Plate 1511, March 10, 1942, total length 524 mm. 15 annuli. Black bands split into equal parts by intrusive white bands. No. 30143; Caripito, June 18, 1942, total length 365 mm. 16 annuli. Black bands equally divided by white, making four black and three white to each annulus. Very dark colored snake.

Food: (1) Remains of small snake, 2 large crickets. (2) 150 mm. *Atractus trilineatus* in fairly good condition; indeterminate mass which may have been an amphibian. (3) Very small *Micrurus* half digested. (4) Small lizard too far gone for identification. (5) Half digested *Tantilla longifrontale*, and two small *Synbranchus*.

Helicops angulata (Linnaeus, 1758).

Name: Brown-banded Water Snake, Water Labarria.

Range: Northern half of South America.

General Account: *Helicops* was not found at Caripito, and was rare or else difficult to detect at Kartabo as only four are in the records. It is apparently rather aquatic in habits as two were seen swimming in the

Cuyuni River. A third was captured in 1916 and sent north to the Zoo. A fourth killed in the jungle had an indeterminate mass of fish scales in its stomach.

Coll. No. 3266: Kartabo, May 10, 1922, total length 870 mm., tail 225 mm. In general its pattern was olive gray above with numerous wide, dark brown transverse bands. Below it was straw yellow with a checker-board pattern of alternate squares of dark brown.

Hydrops triangularis (Wagler, 1824).

Names: Red-and-black Banded False Coral Snake. Pung-gak, "living in ground" (Akawai Indian).

Range: Guianas, Amazon valley, southern Colombia.

General Account: Small burrowing snake, red-and-black banded above, white below, living in close association with *Erythrolamprus* and *Micrurus*. Several were caught crawling through jungle in the rainy season, and eight were taken in a single rice field, in company with the two above mentioned species. All were feeding on *Synbranchus*. Locally common at Kartabo, but not observed at Caripito. These are slow moving, non-biting, dark-loving snakes.

Coll. No. 244a: Kartabo, Color Plate 88, March 24, 1919, total length 440 mm., ventrals 171, subcaudals 60. *Color in Life*: Seventy-three series of patterns. Below, the ground color is pure white, with two series of dark brown blotches close together, sometimes opposite, sometimes alternate. These narrow suddenly and extend upward as scale-width vertical bands, not quite meeting on the mid-back. The back is red brown, while between each of the lateral, vertical lines is a conspicuous spot of bright coral red, suffusing from three to five scales over two rows.

The head has four irregular cross bands of black, with inter-spaces, counting from the snout backward, of pale brown, dark brown, dark red and bright red. The succeeding nuchal band of black almost meets above, and is the broadest on the whole snake. The head is small and the eyes inconspicuous, the iris reddish. The general impression of the lateral pattern is of successive layers of red-brown, bright red and white, cut by numerous vertical black bands.

This and seven other specimens were captured in one ploughed, marshy rice field. In the present specimen there were two *Synbranchus* in the stomach, one partly digested and the other quite fresh and 70 mm. in length. All eight *Hydrops* had from one to three *Synbranchus* eels in their digestive tract.

Coll. No. 3261: Kartabo, March 26, 1919, total length 385 mm., tail 83 mm., eye diam-

1.2 mm. *Color in Life*: Seventy-one black annuli, some alternate, some joined to make a "Y." Rufous red above changing to bright red on the sides and to white below. The black bands are narrow above and widen abruptly below, where the white interspaces are of only two scales width.

Coll. No. 3292: Kartabo, March 26, 1919, total length 427 mm., tail 80 mm. *Color in Life*: Reddish above, changing into coral on sides. The dorsal markings are rather atypical of this species, consisting of alternate narrow black bands which barely reach the middle line. Each band widens on the sides and below, until the ventral aspect is of alternate triangles of black, two scales apart, and with bases separated from each other and across the mid-line by white. The ventral aspect of this snake is decidedly darker than the dorsal.

Imantodes cenchoa (Linnaeus, 1758).

(Plate VIII, Figs. 33 and 34).

Names: Thread Snake, Night Climber, Chunk-headed Snake.

Range: Mexico and Central America and South America south to Paraguay and northern Argentina.

General Account: A very long, attenuated snake, with short, thick, enlarged head and enormous golden eyes with vertical slit pupil. Pinkish-brown with numerous large saddles of dark brown. The eye has a decided forward and downward slant, the angle with the mid-snout line being 43 degrees, doubtless an adaptation for nocturnal pursuit. None seen at Caripito, five at Kartabo. Found by accident coiled in masses of leaves or debris in parasitic plants. Active at night, twice entering laboratory, once in pursuit of a *Hyla rubra*.

When caught it was very active, tying itself into knots, and with considerable power of compression. It gave forth, from the anus, a most evil-smelling liquid.

Coll. No. 329: Kartabo, Color Pate 232, August 7, 1920, total length 1025 mm. (40.5 inches), tail 255, head length 12, head width 9, neck width 4, body width 5, eye diameter 3.5 mm., weight 18.5 grams. *Color in Life*: General color above sandy brown, snout and sides of head vinaceous buff with a slight yellowish tinge. Six or eight large, symmetrical patches on top of head, and about seventy large, diamond-shaped dorsal body saddles of chocolate brown. On the posterior half of the body these break on each side into a small lateral spot. Throat and lower labials pale grayish-buff, becoming speckled on the ventrals and shading to gray on the tail. Pupil a narrow, almost vertical slit, with a backward superior inclination. Iris golden, with irregular indistinct fleckings and streaks of orange and golden

brown. Two narrow lines of light yellow along both sides of the pupil, and a small patch of dark brown at top and bottom.

Coll. No. 346: Kartabo, August 16, 1922, total length 1190 mm. (47 inches), tail 380 mm., head length 14.5, head width 8.5, eye diameter 4 mm., rows of scales 17, ventrals 286, subcaudals 168. This specimen had ninety-eight brown saddles. A much darker snake than No. 329.

Leimadophis reginae (Linnaeus, 1758).

(Plate IX, Fig. 35).

Names: Reticulated Snake.

Range: Panama, Colombia, Ecuador, Peru, Venezuela, Guianas, Trinidad and Brazil.

General Account: Found both at Caripito and Kartabo, four specimens at the former, and six at the latter locality. It is an active snake of medium size, well able to climb but usually found on the ground. Olive or bright green or lemon yellow above, with black edges to the scales giving a strong reticulated appearance. Below pale buffy yellow or bright empire yellow (Kartabo), or dominately scarlet (Caripito), both phases strongly and irregularly marked with black spots.

In temperament this snake is usually timid, making no effort to bite, but with ceaselessly flowing tongue. It is strong for its size and when its head was being drawn never ceased to constrict with its entire body. When angered, the head is raised and the neck flattened and widely expanded, becoming a cobra in miniature.

Coll. No. 270: Kartabo, Color Plates 126 and 132, June 7, 1920, total length 580 mm. (23 inches), tail 155 mm., weight 26.7 grams. *Color in Life*: Above serpentine green, brightening to light cress green toward head, with large, indistinct, dark reticulations along the back, and a line of large, distinct dark spots down each side, merging into a solid, black, lateral line from 50 mm. in front of vent to tail tip. Beneath, the head is light buffy yellow, deepening to mustard yellow below tail. From the neck to vent, a series of transverse, blue black bands or half-bands occupies the entire width of the ventrals. An average of every fourth scale is clear, unmarked yellow, and a larger number of half, alternating bands than of whole ones. Ventral tail unmarked yellow. Iris, lower four-fifths light mahogany red, mottled and lined with darker. Upper fifth, slightly forward of center, capucine yellow almost clear.

Coll. No. 284: Kartabo, July 20, 1920, total length 608 mm. *Color in Life*: General color above olive, reticulated with dark brown. Top of head fuscous, head markings

cedar green, lateral neck scales parrot green. Labials, chin, throat and anterior ventrals pale ochraceous buff. Posteriorly the ventrals are mottled more and more with pale salmon, deepening and changing to aniline yellow on subcaudals.

Coll. No. 291: Kartabo, October 6, 1920, total length 811 mm. *Color in Life*: Head brownish-olive, deepening toward snout. Two median patches of dark lettuce green directly back of eyes, below which are patches of cinnamon brown. A narrow line of black extends along top of upper labials, and back from eye to point of mouth, and down a few scales of the neck. Labials, throat and anterior neck pale ochraceous buff ground color, shading through buffy olive to grayish-olive on tail. Down the back are faint criss-cross markings of dark brown, surrounding faint, irregular whitish spots, which extend in a double dorsal row. Sides tinged with gray and with about 53 spots of dark brown, which merge into a narrow lateral line on tail. Ventrals salmon buff with blue-black markings; subcaudals chamois. Iris with upper fourth straw yellow, lower three-fourths mottled pecan brown. Pupil rim gold above, orange rufous below.

Coll. No. 2976: Kartabo, June 17, 1924, male, total length 2320 mm., tail 60, eye diameter 2.5, body width 6 mm., rows of scales 17, ventrals 139, subcaudals 49, weight 6.5 grams. *Color in Life*: Although only nine and a quarter inches in length this young snake is exactly like No. 291, except that the body and tail above are bone brown throughout, and the faint dorsal spottings are very obscure. Also the anterior ventral scales are pinkish-buff, shading back to cinnamon on posterior half of body, and to honey yellow under tail.

Coll. No. 30075: Caripito, Color Plate 1562, April 30, 1942, total length 570 mm., tail 85, head 16.2, snout 6.5, eye diameter 4.5 mm., weight 52 grams. *Color in Life*: Above dull lemon yellow on basal half of each scale, with the distal half or a very wide margin black. Some scales marked with lateral margins of scarlet. Below, from the tip of lower jaw to the ninth ventral bright lemon yellow, from the ninth back gradually replaced from the center outward with bright flame scarlet, the yellow on the extreme lateral edges soon merging with the greenish or lemon of the dorsal scales. The ventral scarlet irregularly marked laterally with black lines, not quite forming cross hands. At irregular intervals an entire scale may be pearl gray, about ten of these in all. Just before the anus the black dies out and the scarlet persists to the tip of tail. Top of head olive green, variegated with black, a broad band of black extending back from the eye to the last head scale. Upper labials

bright yellow, extending back beneath the lateral black head band. Iris gold on upper fourth, rich chestnut below, marked laterally with black. It was a female and contained many small, undeveloped eggs, about 1 mm. across. In the body cavity was a four-inch tapeworm.

Coll. No. 30131: Caripito, June 8, 1942, total length 506 mm., tail 148 mm. *Color in Life*: Above dark gray, edged on each scale with black, appearing wholly black in general. Labials, chin and anterior ten ventrals straw yellow. Rest of body ventrals coral red, changing under tail to rich salmon. Ventral chin, neck and tail immaculate. The rest with a black pattern of alternating squares of one scale width, with alternating transverse narrow lines, extending to right or left of the squares.

Coll. No. 30139: Caripito, June 3, 1942, total length 568 mm. *Color in Life*: Bright green and black above. Below red, with the black markings limited to narrow cross lines, except on posterior half of body where a medium black thickening on the ventrals is seen.

Coll. No. 30216: Caripito, May 3, 1942, total length 195 mm., tail 51 mm. *Color in Life*: Almost uniform brown above. Red collar across nape and an imperfect collar-like marking from eye obliquely back from gape. Pink below, irregularly marked.

Food: No. 291 had swallowed two frogs and a small bird. No. 2976 was caught attempting to eat a very small, 28 mm., frog with half-absorbed tail which it had just caught in a jungle pool. No. 30075 had eaten a *Hyla rubra*. No. 30139 had a 190 mm. *Ameiva* in its stomach.

Leimadophis taeniurus bipraeocularis

(Boulenger, 1903).

Names: Side-spotted Snake.

Range: Colombia and Venezuela.

General Account: This species is represented by a single, very young specimen picked up in a jungle trail at Caripito on June 24, 1942. In total length it is only 125 mm., with a tail of 27 mm. It is red brown above, with rostral, labials and all under parts pale yellow. There is a deep yellow scallop on the side of the neck which bites into the dorsal brown, and back of this a round spot is pinched off from the dorsal color. These spots continue posteriorly, spaced closer and closer together until, on the posterior third of the body and on the tail, they merge and form a solid, distinct lateral line.

***Leimadophis typhlus* (Linnaeus, 1758).**

Names: Pink Ground Snake.

Range: South America in general.

General Account: A short, thickish snake,

dark green above and lemon yellow below, or dull pink above and bright pink below. I have observed no gradations in life between these phases. In preservative the colors alter radically or are completely lost, and even in dried skins the green changes to dark olive. From the point of view of human observation this is a gentle snake, allowing handling and not attempting to bite. When striving to escape or when teased, it raises the head to some distance and flattens the neck, making it look twice natural size. Even when thoroughly alarmed it progresses only by rather slow undulations, as we might expect from the short, thick body. I have never been able to persuade it to any swiftness or quickened progress. This is one of the very few jungle snakes which are terrestrial and yet, at least in one color phase, green in color. *L. typhlus* was not observed at Caripito, but seven were collected at Kartabo, three in the green phase, four in the pink.

Measurements of freshly killed specimens:

Coll. No.	2785	2834	332	624
Total length (mm.)	175	425	545	585
Tail (mm.)	38	102	106	100
Eye diameter (mm.)	3	4.5	4.5	5
Rows of scales....	19	19	19	19
Ventrals	167	145	140	147
Subcaudals	53	53	53	50
Weight (grams)...		44	44.2	85

Coll. No. 332: Kartabo, Color Plate 233, September 14, 1920, total length 545 mm. *Color in Life*: Above elm green, shading laterally through parrot green to lemon yellow. Upper labials mineral green, shading back to chalcedony yellow. Lower labials and throat strontian yellow. Ventral surface primuline yellow, with a light grayish-pink reflection. Iris, upper fifth pinkish-buff with dark brown flecks, remainder dark red brown. Distinct pupil rim bittersweet orange, with upper fifth orange buff.

Coll. No. 624: Kartabo, June 17, 1922, total length 585 mm. A female containing five eggs, apparently full sized but without shell, round-ended ovals, 7 by 17 mm. This snake was in the pink phase.

Coll. No. 2642: Kartabo, Color Plate 654, March 15, 1924. *Color in Life*: General color above dull pink. Head above brown with a greenish cast, snout and sides of head olive. Lower labials pale pink. The dorsal pink shades laterally into vinaceous, with the ventrals a brighter pink than the back. Faint dark, oblique stripes show here and there along the sides as the snake bends laterally. The center scales of the distensible hood on the neck have half hidden white streaks on their anterior edges, set off by similar streaks of salmon. Iris brilliant orange in upper quadrant, the rest dark brown with a red tinge.

Coll. No. 2834: Kartabo, May 21, 1924, total length 425 mm. Adult male in breeding condition, testes 21 mm. *Color in dried skin*: The mounted skin of this specimen has altered from the living green to olive green above. The anterior three-fourths of the body has been stretched in mounting and this artificial distension reveals a pattern, wholly concealed in the living snake. This pattern consists of about thirty inverted Vs with the arms directed backward from the mid line. These are made by the separation of scale rows in pairs, two rows of the olive green scales set in dark skin background, then two rows set in yellow skin bases. The stretching is to the extent of one-fifth, the total length in the freshly killed snake being 425 mm., and in the mounted skin 530 mm. The V-shaped marks become visible in the living snake only when it distends its neck in the terrifying attitude which it assumes when thoroughly frightened.

Food: Three of these snakes had fed on frogs, one on a 47 mm. *Leptodactylus mystacinus*. No. 2834 had swallowed a small frog and, rather surprisingly, a mass of more than one hundred good-sized ants, not the disturbed food of the frog.

Leptodeira annulata annulata

(Linnaeus, 1758).

(Plate IX, Fig. 36).

Names: Saddle-back Snake, Annulated Night Snake.

Range: South American south to and including Paraguay and northern Argentina.

General Account: One of the commonest small snakes at Kartabo, where upward of two dozen were observed. Only two were collected at Caripito. One specimen measured 900 mm., but all others were well under this measurement. This snake is nocturnal, as indicated by its narrow, vertical pupil. When disturbed or alarmed it gives off a very offensive odor, but almost never attempts to bite on capture. It spends the day curled up under the loose bark of fallen logs or in crevices of bark as high as six feet from the ground. It seems to prefer swampy localities and several times I found it actually in jungle pools.

In general the color above is pale cinnamon buff with a series of large irregular spots down the back. These are found in all shapes, sometimes fairly evenly rounded, or confluent in zigzags or actual cross bands. Every type may be found in one snake. A black post orbital band and buffy or whitish ventrals are generally characteristic. The number of saddle markings varies from 38 to 76.

Measurements of freshly killed specimens:

Coll. No.....	235a	347	235b	2875	333
Total length (mm.)	210	312	375	470	900
Tail (mm.).....	50	75	100	148	225
Eye diameter (mm.)	2	3	3	4	5
Rows of scales....	21	23	19	21	21
Ventrals	192	201	193	196	189
Subcaudals	83	91	100	87	88
Weight (grams)...	2.2	3.5	6.5	29	48

Coll. No. 347: Kartabo, Color Plate 140, figs. a and b, June 12, 1920, total length 312 mm. *Color in Life*: Darker than the general run of this species. Head above olive brown, body tawny olive, spots blue-black. Throat, chin and a few anterior ventrals gray, remainder of ventrals vinaceous buff. Series of dorsal spots round and oval, four or five merged together or alternate, about 76 in all. A line of small, round, black dots down each lateral line, alternating with the dorsal saddles. Pupil a narrow, vertical slit. Iris pecan brown flecked with gold. Caught in tent pursuing a small frog.

Coll. No. 235a: Kartabo, June 27, 1920, total length 210 mm. Much paler and grayer than usual. General color above pale drab, ventrals lighter. Top of head and dorsal spots dark gray. About 62 spots, saddles and bands along back. Iris gray. Taken in shallow water in an old tank, sharing the space with hundreds of very small tadpoles.

Coll. No. 333: Kartabo, Color Plate 140, fig. c, September 24, 1920, total length 900 mm. *Color in Life*: Above cinnamon brown with about 62 blue-black markings, mostly saddle-shaped, occasionally joined together. Sides of head and snout tawny with a streak of mummy brown from eye to angle of jaw. Below this a streak of orange buff, tinging the upper part of the anterior ventrals. Labials, throat and ventral surface light buff with faint mottlings of mineral gray. Iris orange rufous, lighter around the pupil and streaked with dusky. Caught under bark, six feet from ground. It was coiled in intimate association with a mass of termites and a large whip scorpion.

Coll. No. 30,152: Caripito, June 24, 1942, total length 585 mm. *Color in Life*: Pale brown above with dorsal markings of dark brown. On the nape there are two short, thick, longitudinal bands, then four pairs of alternating short bands, changing into more or less rounded spots. Some of these are double, others dumbbell-shaped, a few yoked three together. They continue to the tip of the tail but are fainter beyond the anus. Sides with a series of faint, brown, short, longitudinal lines. Below pale yellow brown. Iris dull golden brown. Caught swimming across a small jungle pool.

Food: Three stomach contents were: (1) 2 frogs and 8 tadpoles. (2) 1 tadpole, 1 small *Hyla rubra*. (3) Bones, probably of amphibians, 1 small lizard.

***Leptodeira rhombifera* Günther, 1872.**

Name: White-bellied Night Snake.

Range: Mexico to northern South America.

General Account: A single specimen taken at Caripito represents this species. It was found coiled in a mass of leaves at the base of a jungle tree.

Coll. No. 30,143: Caripito, June 19, 1942, total length 465, tail 90 mm. *Color in Life*: Hair brown above with 42 dark brown spots, large, mostly round or oblong, several yoked together down back of body. These are continued on the short tail but indistinctly. The brown of the sides pales abruptly into the ventral aspect which is immaculate pure white.

Leptophis ahaetulla ahaetulla

(Linnaeus, 1758).

(Plate IX, Fig. 37).

Names: Whip Snake.

Range: Northern South America.

General Account: A long, slender, tree-climbing snake, green or blue, rarely brown above, with usually a dorsal and two broad lateral yellow-brown stripes. Below white anteriorly, changing into pale brown posteriorly, or everywhere below bright yellow (large, Caripito specimens). A black line through sides of head divides the dorsal and ventral colors. Eye golden yellow, with fore and aft black areas continuing the lateral black line of head.

Thirteen specimens taken at Kartabo, two at Caripito and two others seen. All the Kartabo snakes were relatively small, only one reaching 1200 mm., brightly colored above, dull below, and exceedingly slender. All the four Caripito snakes were very large, the two captured being six feet, and seven feet, eight inches respectively. All were dull colored above and brilliant below, and relatively heavy-bodied.

These snakes are excellent climbers and often rest quietly for hours draped over branches and twigs. Six of those taken at Kartabo, however, were hunting on the ground. One had just caught a leopard *Hyla*. It relinquished its hold on the frog in the excitement of being captured, but ten minutes later when placed in a wire cage with the still unhurt frog, it again attacked and this time swallowed the unfortunate amphibian. Two were caught in the laboratory when they dropped from the rafters to the floor.

The small Kartabo specimens were nervous and bit at every opportunity. No. 245, with a total length of 975 mm., when set at liberty for an hour in the laboratory compound, made straight for the nearest bamboo stem and would not be turned aside. It

climbed the stem, which was six inches thick and exceedingly smooth, ascending rapidly by throwing S-shaped coils around half the circumference, and holding on by pressure on opposite sides of the stem. It soon shifted to an adjoining shrub, climbing easily among the slender branches, holding the head and neck raised stiffly, and occasionally swaying them from side to side.

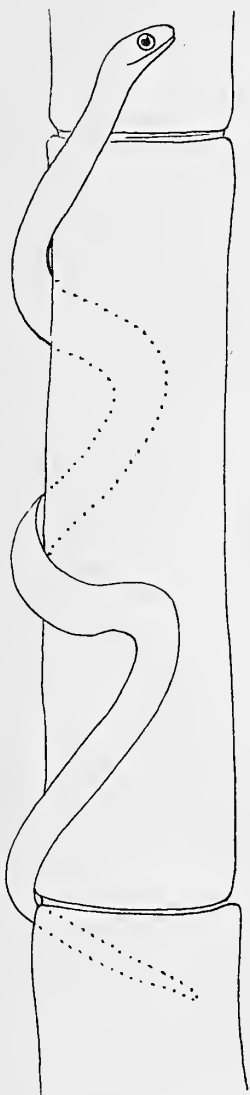

TEXT-FIG. 2. *Leptophis a. ahaetulla*. Snake climbing bamboo.

This head-rearing seems to be a habit. From a level of foliage in a bush-covered clearing a single object projected, and closer examination showed this to be six inches of head and neck of a brilliant green and white

whip snake. It permitted me to approach and actually grasp its neck, but instantly the little serpent became a fiend, seized my finger and so jerked its head from side to side that its teeth tore the flesh and caused a few drops of blood to escape. Unlike the boas it fought until I shut it tightly in a snake bag.

Color in Life: Coll. No. 609, Kartabo, Color Plate 398, June 10, 1922, total length 1030 mm., weight 27.6 grams. Head grass green with an indistinct, oval, dark grayish blotch on top, between and slightly back of orbits. Back generally grass green with a median dorsal line of cadmium yellow, beginning narrowly on the back of the neck and widening and shading to old gold on tail. All the back scales are shaded on the outer edges with black and are turquoise green on the inner edges, giving a brilliant blue green tinge to the general color. Side of head tinged with chrysochrome and paling to light green about the super orbitals. There is a narrow, lateral, preocular line of black faintly shaded below with gold, running through the base of eye. Behind the eye this becomes wider and stronger and the gold almost covers the eighth labial. The upper labials below this lateral line are bluish-white. The lateral line becomes indistinct black and gold stippling on the side of the neck, widening and becoming light cadmium on anterior sides, widening and deepening again to a broad line of bronze on posterior body and tail. Chin and under neck white with pinkish tinge, becoming more and more heavily shaded with pale pinkish lavender and deepening through buff to dull brownish-lilac on posterior ventrals and tail.

Iris strongly empire yellow around pupil, becoming lighter and greenish toward periphery. Two patches of olive green stippled with darker, small and barely touching iris on left, larger and wider on right, both sides fraying out downward in bright crescents. These dark marks continue the black, lateral head line through the orbit.

The colors of this specimen after twenty-four years of preservation have all gone. It is now dark brownish-black above, leaden blue below, labials, chin and throat pale pink.

The dullest, darkest Kartabo specimen was No. 2763, with a total length of 1132 mm., in which the back was hair brown, with the top of the head, a narrow vertebral line, and two broad lines on the lower sides greenish-blue. The chin and throat were white, and all ventrals steel blue.

Coll. No. 30174 was a six-foot specimen taken in Caripito. I pulled it down as it rested sprawled across the branches of a low jungle growth. When dragged free it struck at me several times but was not

nearly as antagonistic as the smaller Kartabo snakes. It was dark olive green above, with a paler green vertebral line, shading down the sides to the same apple green of the vertebral line, and on down to chalcidony yellow on the ventrals. Below, this color deepened to bright yellow chrome on the whole lower head, the labials, the chin and anterior neck and under tail. In preservative the colors are altered to a uniform brown above, greenish-yellow below.

Measurements of freshly killed specimens (all from Kartabo except the two largest):

Total length (mm.)	356	1035	1132	1252	1310	1835	2340
Tail (mm.)	100	480	460	510	490	690	865
Eye diameter (mm.)	3	4.5	4.5	5	5	9	9
Ventrals	156	152	168	164	153	182	182
Subcaudals	171	170	165	167	161	184	172
Weight (grams)	2.1	25	30	55	55	384	219

***Leptophis chaetulla ortoni* (Cope, 1875).**

Name: Keeled Whip Snake.

Range: Venezuela and Colombia.

General Account: A single specimen taken at Caripito represents this subspecies. It was climbing slowly and apparently had its eye on a small *Anolis*. Coll. No. 30163; Color Plate 1618, July 1, 1942, total length 1587 mm. (five feet), tail 553 mm. In brilliancy of the upper surface it resembles the small specimens of *Leptophis ahaetulla ahaetulla* taken at Kartabo, but in brightness of ventral yellow it recalls the large specimens of *ahaetulla* captured at Caripito.

In general color above it was turquoise blue from snout to tail tip. The lowermost two or three scales throughout the body, from the gape to the vent, were bright orange, while the labials, chin, throat and ventrals to vent were white. The orange spreads across all subcaudals as well as the sides of the tail. A narrow, preocular black line is continued pigmentally through the iris itself, and on to a stronger black line along the side of the head to the last upper labial. The top and bottom of the iris are bright yellow.

In this specimen, after four years in preservative, all color is lost, the dorsal scales being brown, and ventrals steel blue.

***Leptophis caeruleodorsus* Oliver, 1942.**

Name: Blue-back Yellow-belly.

Range: Northeastern coast of Venezuela, Trinidad and Tobago.

General Account: This is the only specimen taken of this species. Coll. No. 30,280: Caripito, July 1, 1942, total length 1216 mm., tail 490 mm. Turquoise blue above, lemon yellow below.

***Liophis breviceps* Cope, 1860.**

Name: Red-bellied Burrowing Snake.

Range: Guianas and Ecuador.

General Account: A small, thick-set snake, with short tapering tail and small head and eyes, and burrowing habits. The largest captured measured 22 inches in length. Dark above with many faint, yellow cross bands, red below with numerous black, scale-wide cross bands. Little variation among individuals. Four were taken at Kartabo and one at Caripito. One of the former was four inches under ground in

a marshy rice field in company with many *Micrurus* and *Erythrolamprus*, feeding on earthworms. Others were taken among jungle débris, burrowing at the first hint of danger. When handled it was unexpectedly quick and active in motion.

Coll. No. 338: Kartabo, adult female, October 9, 1920, total length 560 mm., tail 95, eye diameter 2 mm., ventrals 161, subcaudals 54, weight 56 grams. *Color in Life:* Dorsal surface brownish-black with about 90 narrow, faint, irregular transverse bands of pale vinaceous buff. Labials, chin, throat and subcaudals creamy white, the latter heavily marked with alternating spots of black. The ventrals are coral red with about 36 broad, black, disjointed cross bands. They are of two or three scales width, and are rarely unbroken, but usually disjointed at the center. Eye small, pupil round and large; no visible pattern on iris. This female contained eight large, oblong, shell-less eggs.

Coll. No. 30,146: Caripito, June 19, 1942, taken on the ground in jungle, starting to burrow at first alarm, total length 206 mm., tail 43 mm. *Color in Life:* Black above with faint yellow markings in indefinite bands. Below, throat pale yellow, changing gradually into bright coral red, paling again at the tail. Black cross bands on ventrals exactly as in No. 338. Very active and quick when alarmed and in the hand.

In this same specimen, when preserved after four years, all the yellow and red colors have vanished.

Food: No. 338 had devoured one large and a second smaller earthworm. Another snake had eaten three earthworms, two medium myriapods and a 150 mm. *Synbranchus*.

Liophis cobella cobella (Linnaeus, 1758).

Names: Banded Tricolored Snake, Red-bellied Ground Snake.

Range: Guiana, Venezuela, Trinidad, Colombia and Brazil.

General Account: A small black snake with imperfect, narrow white dorsal bands, scarlet below with broad bands of black; head and tail below whitish, the latter with imperfect black bands. A second color phase is brown above, salmon below, with very faint white and scarlet bands.

Six of these small snakes were taken at Kartabo, the largest eighteen inches in length, and the smallest and most brilliantly colored less than eight. One specimen was captured at Caripito. Few observations in life were made. It is a ground snake, found in the jungle or among bamboo clumps, diurnal, and feeds on small frogs and lizards. The remains of bones alone, prevented any more definite identifications. One specimen (No. 166), under eight inches, was remarkably strong for its size, making no attempt to bite, but pulling hard with its curved tail. When set temporarily at liberty, instead of trying to crawl to safety it actually twisted up the posterior part of the body into a tight, overhand knot, although it was quite uninjured.

Color in Life: Coll. No. 166, American Museum No. 18159, Kartabo, June 10, 1920, Color Plate 134, figs. a and b, total length 192 mm., tail 29, head length 8.2, eye diameter 1.75 mm., weight 1.8 grams.

Above blue-black with several complete, narrow whitish bands across the neck, all the ones on the body fainter and hardly meeting. These bands widen abruptly on the sides and change at once to the double ventral coloration, a broad band of carnelian red about three scales wide, succeeded by a black band averaging two scales in width, and so on. Not counting an abortive black band which stops on the posterior side of the head, there are 34 of these black bands. On the tail are 21 imperfect bands of black. The red fades out to seashell pink on chin, throat and lower labials, and the tail becomes abruptly grayish-white. There are 65 dorsal bands of white, including one on the mid-head which ends in two whitish spots on the anterior part of the parietals. Pupil round, iris very dark russet brown, hardly distinguishable from the pupil black.

Coll. No. 219: Kartabo, June 22, 1920, total length 200 mm., tail 41, head length 8.5 mm., weight 2.6 grams. The coloring of this small specimen is very unlike that of No. 166. General color above saccardo brown, more or less regularly barred broadly with dots of black. All labials and throat pale ochraceous buff, shading on ventrals to light salmon, and this on all the main body ventrals to coral red. This fades posteriorly to

buff again. Instead of wide ventral red bands, both the red and the black are narrow and irregular, often only a single scale in width, and usually alternate, not meeting in the middle. The iris has a broad irregular inner band of vinaceous tawny, shading externally to roods brown.

Coll. No. 165: Kartabo, September 14, 1919, Color Plate 254, total length 450 mm., tail 92 mm., weight 26 grams. Head and back above dark olive with faint bands of violet gray, upper labials, chin and throat pale pinkish-buff, ventral surface salmon shading to deeper pink toward head and tail, with about 75 alternating and broken bands of violet gray.

Coll. No. 224: Kartabo, October 12, 1920, Color Plate 134, fig. c, total length 480 mm., tail 90, head length 14, head width 10.3, eye diameter 3, body width 9 mm., ventrals 153, subcaudals 57, weight 24.2 grams. General color above buffy brown flecked with olive brown, paling to deep olive buff on sides. Back with very faint markings of dark brown. Upper labials grayish-olive edged with black. Throat and lower neck pale pinkish-buff with scattered fleckings of black. Ventrals apricot buff paling to colonial buff on tail, and crossed with numerous irregular bands of violet gray. Iris brown near pupil, mottled with dark on outer area.

Coll. No. 30,287: Caripito, April 14, 1942, total length 206 mm. Independent description corresponds exactly with that of No. 166, except that the scarlet is more intense.

Lygophis lineatus (Linnaeus, 1758).

Name: Red-striped Snake.

Range: Guiana, Venezuela, Colombia, Brazil, Paraguay and Argentina.

General Account: A single specimen caught as it was swimming a jungle pool near the Kartabo laboratory. It had eaten three *Hyla rubra*, all very young specimens with tail barely absorbed.

Coll. No. 3563: Kartabo, September 3, 1924, male, total length 453 mm., tail 142 mm. *Color in Life:* Dark brown on head becoming paler toward tail. Three longitudinal stripes, one vertebral, two lateral, bright red extending full length of snake. A bright red brown band from snout through eye to lateral neck. Salmon below.

Oxybelis aeneus aeneus (Wagler, 1824).

(Plate IX, Figs. 38 and 39).

Names: Ashy Tree Snake. Whip Snake, Lizard Snake (Creole).

Range: Mexico, Central and northern South America.

General Account: A very long and slender tree snake, ashy white above, brown below, dark line through eye, throat white. Iris sage green in front and back, white above and below. Fairly common at Kartabo where

a dozen specimens were taken and others seen. Also found at Caripito.

In size my specimens varied from three feet to six feet, three inches. All were found among slender branches in open jungle or near the rivers. The extreme slenderness and the reversed, dorso-ventral pattern of coloring, combined with the irregular draping of the body over branches, and complete immobility, all make them extremely difficult to detect. When disturbed they vanish almost between winks, and the instantaneous dash twenty or thirty feet away leaves the eye completely baffled.

Birds' eyes detect them better than humans', and one snake in tall bamboo was so mobbed by small birds and jays that it fell thirty feet to the ground close to me.

A curious habit is that of protruding the tongue full length, about equal to the length of the head, and holding it motionless. It is lemon yellow for three-fourths of its length and dark at the tip. Whether this slight addition to the serpent's resemblance to irregular twigs is the origin or stimulus of this phenomenon, I cannot say, but I observed it at various times in the same snake and in three other individuals. On April 3, 1922, I caught an ashy tree snake back of the laboratory. Whenever it squeezed a few inches of the attenuated neck free of my hand its tongue appeared full length and "froze" in that position, simultaneously putting an end to all struggling. When several feet of the tail were at liberty, this end of the snake slowly reared upward, and curved around into an amazingly large and complete circle, a full eight inches in diameter. The slender muscles supported the two free and elevated body lengths without apparent effort.

These snakes never made any attempt to bite, but when first caught they frequently emitted from the anus a clear fluid, giving off a most peculiar and pungent odor, most difficult to wash off.

Measurements: Coll. No. 2966, Kartabo, June 17, 1924, male, gives, in the flesh, the following measurements: total length 1360 mm., tail 560, jaw 29, head width 10, body width 6, eye diameter 4 mm., rows of scales 17, ventrals 196, subcaudals 184, weight 30 grams.

Color in Life: Coll. No. 231, American Museum No. 18179, Kartabo, August 8, 1920, Color Plate 196, total length 1720 mm., weight 24 grams. There is little variation among these snakes so this description may be taken as typical. Top of head sepia. An indefinite streak along side of head which deepens to a narrow band of black just above the upper labials, and continues across the iris in two areas of dark green. The second to fifth upper labials with narrow shading of black along upper edge. A

streak of pale vinaceous buff extends across the top of the preocular, tinging the lower portion of the supra ocular and continuing in a horizontal line a little back of eye, where it deepens to umber. Upper labials pale yellow, shading downward to bluish-white. Throat bluish-white with faint tinge of pink. Body above light ashy, ventral surface dark vinaceous brown. A narrow rim of picric yellow extends around the lower four-fifths of the pupil, widening toward the top and shading to silver white, which extends over all the upper part of the iris. Large irregular patches of parrot green lie on either side of pupil flecked with black. The lower part of iris is silvery white flecked with maize yellow.

Food: Some of the hunting of this snake must take place on the ground as shown by certain stomach contents. Here is the food of four individuals: (1) A medium-sized *Ameiva*. (2) Two *Anolis chrysolepis*. (3) Two small treefrogs, one a *Hyla rubra*. (4) *Hyla rubra* and a female manakin.

Parasites: A five-foot snake captured on February 24, 1922, had three large ticks fastened tightly to the head, one of which, on the left lower side of the jaw, had worked half-way back from the tip of the mandible, inducing such severe injuries that the entire lower jaw was shrunken and distorted.

Breeding: No. 2648, a six-foot female captured on March 17, 1924, contained three fully formed eggs measuring 7 by 17 mm.

Oxybelis fulgidus (Daudin, 1803).

(Plate IX, Fig. 40).

Names: Green Whip Snake, Emerald Tree Snake, Parrakeet Snake (Creole). Wah-cooqua-malee, A-di-a-mung, "living with leaves" (Akawai Indian).

Range: Mexico and Central America, south to Bolivia and northern Argentina.

General Account: This is a large, slender tree snake, with long, pointed, overhanging snout, dark green above, yellow green below, with a narrow white lateral line. It is about as common at Kartabo as its relative, *Oxybelis a. aeneus*, and has very similar habits. Twice, when disturbed, I saw these snakes puff out the anterior portion of the body, thus bringing into full view the orange and yellow colors usually concealed beneath the scales, and described below.

Seven feet, one inch, was the largest snake captured. In ten specimens, none under four and a half feet in length, the ventrals varied from 200 to 214, the subcaudals from 150 to 162. A 1608 mm. total length specimen weighed 89 grams, and another 2063 mm. over all, weighed 224 grams or one-half pound. In most individuals the sharp tip of the snout overhangs the lower jaw by 4 or 5 mm.

No. 532 was shot as it was creeping slowly along some slender branches toward a male Gold-headed Manakin. I watched it for many minutes as it slowly reached forward with its chin and neck, testing every dead twig with flickering tongue, and laying the trail for the five feet of following body and tail. I only discovered it because a cluster of leaves moved slightly when there was no wind. Twice when I took my eyes away I lost it completely although it had not moved in the interim. The extremely slow forward motion conveyed to my eye below no sense of movement, and the tail was so slender and tapered so gradually that it was difficult to determine whether one saw it or not. The color of the belly was exactly that of sunlit leaves from below. In the preserved specimens the greens have all turned to blue.

As I watched I was suddenly aware that the snake was observing me, although it was directly overhead. My glasses focussed on the ventral view of the head showed the eyes so twisted out and down that more than half of the iris and pupil were clearly visible, directed straight downward each side of the head. The eyeball must have been rotated a full ninety degrees downward. When I remained quiet for a few minutes the eyes disappeared and the snake began its insensible forward motion toward the bird. I shot it when it was almost within striking distance.

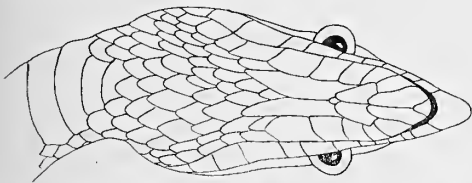

TEXT-FIG. 3. *Oxybelis fulgidus*. Head from below showing ventral vision.

Measurements: Coll. No. 2854, Kartabo, May 29, 1924, adult male, total length 1610 mm., tail 550, jaw length 42.5, eye diameter 6 mm., ventrals 205, subcaudals 161, weight 136.2 grams.

Color in Life: There is very little variation in pattern and color among these snakes, so the following may be considered typical. Coll. No. 523, Kartabo, March 1, 1922, Color Plate 320, total length 1608 mm., tail 530 mm., weight 142.5 grams. Head above dark forest green. Side of face the same with a loreal streak of chalcidony yellow. Upper and lower labials, chin and ventrals dominantly yellow green. Body above forest green, while sides of body and upper corners of ventrals are stone green. Lateral line pinkish-white, which, cutting ventrals close to upper border, becomes

deep yellow toward neck. All scales of labials, chin and ventrals edged with pinkish flesh color. Pupil rim golden yellow. Pupil slightly pulled out at upper posterior corner, where the rim pigment widens, becoming yellowish-white, then tawny. A patch of thick golden buff in upper anterior edge of iris, also an irregular crescent of buff to the left of center, below which it widens to the right along the base of iris. Remaining iris is dark brown, flecked in the upper posterior corner with large patches of orange buff, and fewer patches of pale buff toward the front. The skin under many of the scales is apricot orange.

Dermal Coloring in Life: Coll. No. 708, Kartabo, August 19, 1922, Color Plate 669, adult female, total length 2063 mm., weight 194 grams. In life, ordinarily, the close fitting, tile-like, overlapping scales of the neck show only the scale color of dark green above and yellow green on the lateral rows. Several times when alarmed, these snakes were seen to distend their neck, cobra-wise, when the green colors of the seventeen rows of scales became subordinated to the broad bands of orange which cover the skin between the scales. In a dead snake, when the skin was stretched laterally, these wide bands were seen to alternate with equally wide bands of pale yellow.

An emerald tree snake with a normal neck width of 16 mm. permits lateral stretching to 70 mm. Except in the case of the several extreme dorsal rows of scales, the lateral relation of scales to intervening expanse of skin is 4 to 8 mm., or twice as much colored skin as scale. These alternating yellow and orange bands are directed obliquely forward from their apex on the vertebral line. They are dominantly dorsoventral in extent, as horizontally the scales are less capable of separation.

Food: Three snakes had eaten the following: (1) Remains of a small lizard, probably *Anolis*. (2) Two medium *Anolis chrysolepis*. (3) Bones of a small bird.

Breeding: No. 708, collected August 19th, contained six fully-formed but shell-less eggs, even-ended oblongs, 10.5 by 22.5 mm.

***Oxyrhopus petola petola* (Linnaeus, 1758).**

Name: Narrow-banded False Coral Snake.

Range: Mexico south to Brazil and Argentina.

General Account: This is a small snake, black with many rather narrow, more or less imperfect, transverse rings of white and red. It is semi-fossorial in habits and nocturnal, although the rather vertical pupil is very broad. Only four specimens were taken at Kartabo, two of which were uncovered in the same rice field which had yielded many *Micrurus*, *Hydrops*, *Erythrolamprus*, *Liophis*, etc.

It is a gentle snake, showing no resentment at being handled. One died after a half hour's accidental exposure to the sun.

Color in Life: Coll. No. 92, Kartabo, March 26, 1919, total length 260 mm., tail 64 mm., upper labials 8, entering eye fourth and fifth, ventrals 214, subcaudals 90, weight 3.2 grams.

Ground color above shining purplish-black, cut by 45 bands, several of which are broken and do not meet, the others extending clear across. The widest is that on the hinder part of the head. This is creamy white as are the succeeding seven or eight, then a pink tinge becomes apparent and this increases posteriorly, until the bands on the tail are coral red. The ventral scales are white. In preservative after twenty-seven years, this same snake had become pale white, with dorsal bands of light brown. Removed from preservative, and with excess moisture shaken off, the weight is 3.1 grams, as compared with 3.2 grams immediately after death.

Coll. No. 508: Kartabo, March 1, 1922, Color Plate 326, total length 250 mm., tail 65 mm., weight 3 grams. This individual differs from No. 92 chiefly in having almost double the number of dorsal cross bands in a jet black ground color. These are so narrow that they should be called lines instead of bands. On the back of the head behind the gape there is a broad band of scarlet. The next few rings and those of the lower back and upper tail are arranged in a more or less definite succession of a band of scarlet between two narrow creamy white rings, but throughout all the rest of the dorsal surface there is no regularity. Complete and incomplete whitish lines alternate with corresponding scarlet ones, in no regular order. After the anal area of greater regularity, the tail ends in a succession of regular white bands. The labials, chin, throat and the ventrals, back to the sixteenth, are all slate gray, the rest of the under side being creamy white.

Philodryas viridissimus (Linnaeus, 1758).

Name: Two-colored Green Tree Snake.

Range: Guianas, Brazil, Colombia, Ecuador, Peru and Bolivia.

General Account: A tree snake of medium size, dark green above, yellow green below, iris brown with gold dots over upper portion. Rare at Kartabo where only two specimens were taken.

Color in Life: Coll. No. 3264, Kartabo, June 19, 1920, Color Plate 148, total length 910 mm., tail 230, eye diameter 4, body width 11, body height 15 mm., weight 57 grams. General body color lettuce green above, shading laterally to greenish-yellow on ventral scales. Top of head parrot green, two black spots on scales in front of eye and

three behind, forming a broken facial band. Upper labials emerald green, shading posteriorly to light yellow green. Lower labials, chin and throat pale greenish-gray touched with pale cinnamon pink. Scales back of gape, along lateral neck and forming anterior border of the first fifty ventrals, beryl green, which in spite of its name in Ridgway's Key appears a most delicate blue. This color occurs sporadically on other ventral scales and on all the caudal ventrals.

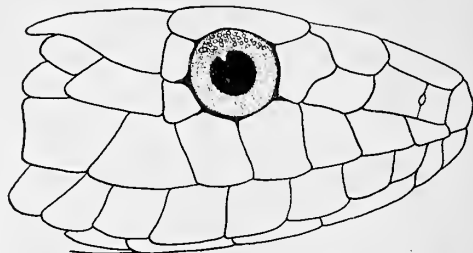

TEXT-FIG. 4. *Philodryas viridissimus*. Eye in detail.

Pupil round. Iris a tangled mesh of dark cinnamon brown with a sparse but conspicuous flecking of gold dots across the upper portion. Inside of mouth pallid blue violet, tongue blue green, tipped with violet and black. Caught at dusk, draped quietly over foliage.

Coll. No. 3557: Kartabo, July 1, 1924, male breeding, total length 1195 mm., tail 315, jaw length 28, eye diameter 4, body width 14, body height 19 mm., rows of scales 19, ventrals 217, subcaudals 121. Caught in low bush while it was being mobbed by three hummingbirds.

Pseudoboa coronata Schneider, 1801.

Name: Black-headed Scarlet Snake.

Range: Venezuela, Guianas and Brazil.

General Account: Only two specimens, the larger twenty inches in length, were taken at Kartabo. The first, No. 507, caught on the ground near the laboratory, was described, painted, and then made its escape the same night, and was never seen again. Two weeks later, on March 15, 1922, a second specimen, No. 3287, identical in coloring and 455 mm. in length, was found in the same rice field as all the other real and false coral snakes, a half-digested eel in its stomach. At Caripito only a single specimen was taken.

Measurements and Color in Life: Coll. No. 507, Kartabo, March 2, 1922, Color Plate 324, total length 485 mm., tail 105, head length 9, head width 7, eye diameter 1.5, body width 7, body height 8 mm., rows of scales 17, upper labials 7, ventrals 174, subcaudals 89, weight 10.5 grams.

Dorsal head scales and band on neck black. Sides of face and lower labials dull gray, shaded with darker. Band of yellowish-white at back of head with two pink lateral patches. This band widens on sides of head and joins the general whitish tone of the chin and throat. Body above coral red, each scale tipped slightly with dark gray. Ventrals yellowish-white, tail grayish. Iris dark.

This species seems equally rare at Caripito where a single one was collected as it was making its way slowly across a trail. Coll. No. 30,112: Caripito, May 21, 1942, total length 296 mm., tail 70 mm. Its color was exactly like that of No. 507 except for an irregular series of very faint dusky, short, cross lines at intervals down the back. The pupil was very slightly vertically oval.

Pseudoboa neuwiedii

(Dumeril and Bibron, 1854).

Name: Brown and Yellow Snake.

Range: Guianas, Trinidad, Venezuela, Colombia, Panama and Costa Rica.

General Account: Two specimens only from Caripito, not found at Kartabo. Both were taken on the ground and put up a lusty fight when seized. Both were identical in coloring, light sepia or seal brown above with the head definitely darker, almost black. Below yellowish-orange. Coll. No. 30,135: Caripito, June 13, 1942, total length 906 mm., tail 196 mm., weight 151 grams. No. 30,162: Caripito, July 2, 1942, total length 793 mm., tail 222 mm.

Pseustes poecilonotus polylepsis (Peters, 1867).

(Plate X, Figs. 41, 42 and 43).

Names: Liana Snake, Bird-eating Snake.

Range: Venezuela, the Guianas and Brazil.

General Account: I know of no Creole or Indian name for this well-known snake, and the variety of pattern and coloring defy usual adjectives. In the field we called it the Liana Snake owing to its astonishing imitation of a monkey ladder, and the Bird-eater on account of the dominant nature of its food. At Kartabo we found it common and at least two dozen specimens were encountered in the quarter square mile of jungle. These varied from seventeen inches to five feet, while at Caripito the only specimen obtained measured a full six feet.

The majority of the snakes were seen or taken on the ground, but three times I saw them in trees. A male in full breeding condition was captured as it was swimming the Mazaruni River where the stream was almost a mile in width. The adult snakes from 1100 mm. (about three and a half feet) upward are monochrome above and below in two phases, one a deep olive green with lemon yellow lower head, chin and throat, and the other a rich red brown with yellowish-orange anterior lower parts. In the

young, at least from 446 mm., the variation is still more extreme, the basic colors being red brown, or gray or olive above, banded with darker shades of the ground color, with face and throat black-marked white or green-marked yellow. The iris is the most stable character and almost always offers a reliable, superficial means of field identification. In general the iris is mottled silvery, with dark pigmented areas fore and aft, which are crossed with about three, distinct, white, vein-like lines, radiating from a narrow area on the anterior and posterior equator of the pupil, extending out to the external rim of the iris.

Individuals differ from one another as much in their emotional display as in their pattern and pigmentation. No. 336, definitely a young snake, was very strong in its constricting ability, but in spite of much handling made no attempt to bite. Nos. 2667 and 2727, approaching adult size and patterning, were extremely vicious, striking repeatedly and vibrating their tails with great vigor.

One outstanding habit which, in my experience is confined to this and to a congeneric species, is that of contorting the entire body and tail into a series of rigid undulations. In a four foot snake there was about twenty of these successive half curves on each side of the body. When lying on the ground in this condition the snake's resemblance to a short extent of the common monkey ladder is startling. Three times on the ground, twice among branches, I have seen this effect. For example on March 23, 1922, I wrote, "I caught a three foot Liana Snake (No. 521) wholly reddish-brown, at the entrance of Puruni Trail. It lay across the trail rigid as an iron rod, with every inch regularly bent and waved, as if a section of liana had recently fallen. Snakes of all species look much like this when they have been killed with chloroform. This individual never moved even when my hand approached within an inch of his head. Not until I pressed down on his neck and gripped him, did he 'break trance' and coil around me like a flash. From this moment on he fought all the way home.

Measurements and Color in Life: Coll. No. 334, Kartabo, October 2, 1920, Color Plate 229, fig. a, a young male, total length 446 mm., tail 125, eye diameter 4 mm., ventrals 198, subcaudals 131, weight 7.5 grams. A specimen in the yellow brown phase, with typical eye pattern, but somewhat browner. Pinkish-buff above shading to tawny olive toward head and tail. Lace-like pattern on head and face markings dark snuff brown. About 42 irregular, broken bands on dorsal orange cinnamon, becoming grayer and indefinite toward tail. These bands are stippled along their edges with umber. Sides of body

stippled with hair brown and deep orange. Ventrals white, mottled heavily with fuscous, which becomes an almost solid color toward tail. Upper edges of ventrals with 40 patches of chestnut brown, each of which covers three ventral scales.

Coll. No. 78a: Kartabo, September 10, 1919, total length 609 mm., weight 16 grams. General color light grayish-olive, with broad, irregular bands of dark grayish-olive. Beneath, ivory white anteriorly, becoming more and more suffused with olive until it is concolorous with the back. Pupil a longitudinal, very broad, oval. Iris dull yellow buff, with a suffusion of dark brown in front and back, reaching the pupil. A few transverse white lines across these dark areas.

Coll. No. 251: Kartabo, August 23, 1920, Color Plate 229, figs. b and c, total length 615 mm., tail 176, eye diameter 5.5 mm., ventrals 191, subcaudals 125, weight 18.4 grams. General color above light grayish-olive with broken irregular mottling of fuscous and hair brown on head. Three short, black bands project down over the white upper labials, the central one extending straight down from the eye and covering a lower labial. A faint dark stripe of mottling extends along side of face. The body shows 40 wide, diagonal, rather irregular, transverse bands of deep grayish-olive, sometimes narrowly split in two. The anterior scales of these bands are touched with black. The throat is white with black marks. Ventral surface white on neck, becoming more and more thickly stippled with dark brown which coalesces near the tail. The lower parts are also flecked with hair brown. Pupil slightly ovate horizontally. Iris pinkish-buff, finely stippled with white. Three spots of snuff brown in front, behind and below, and three irregular white lines radiating toward pupil from anterior and posterior outer rims.

Coll. No. 2727: Kartabo, March 29, 1924, total length 953 mm., tail 260 mm., ventrals 200, subcaudals 126, weight 75.5 grams. A specimen with distinct dorsal markings and with the typical white streaks in the iris but fainter than usual. Head above grayish-olive with symmetrical lighter and darker markings, and a dark streak running diagonally across eighth labial to eye. Upper labials amber yellow with patches of lime green. Lower labials pinkish-white with a large patch of lime green below eye, and a speckled area of the same color around snout. Large lateral patch of orange scales just back of and below point of jaw. Ventrals and scales of three lower rows, for about four inches from head, edged anteriorly with apricot yellow.

General body color violet brown with fine speckling of green, shading to clouded hazel on mid-body, and russet on tail. More than

half of the entire length has eighteen irregular, dorsal, faintly crescentic markings, composed toward the head, of red-edged, dark-mottled, green scales with a few scattered brown spots, backed with coral pink skin. The remaining markings on the rest of the body are extremely faint and on their way toward obliteration. Ventrals pale mottled buff toward head, shading backward to fawn color. Iris light pinkish-cinnamon, with brilliant white pupil rim, broken before and behind. Dark patches of sepia at each side of pupil, and white radiating veining.

Coll. No. 521: Kartabo, March 22, 1922, Color Plate 349, total length 1565 mm., tail 355, eye diameter 6.2 mm., weight 136 grams. This snake is almost solid red brown above. In detail head above walnut brown, with shadings of burnt umber on orbits. Snout vinaceous tawny, upper sides of head brownish-olive, paling laterally where the color passes through eye. Below this line the upper labials are light cadmium touched with orange. The scales around nostril and snout are vinaceous tawny. Body above red brown, becoming more thickly flecked with terra cotta toward ventrals. The part of the ventrals which extend up the sides are of this same terra cotta. Lower labials, chin and under neck are buffy yellow touched with darker yellow and reddish toward snout, with a few whitish streaks under the neck which merge backward with large mottlings of pale rose, into the main ventral color of dark orange red. Toward the tail the ventrals acquire a bloom of pale violet gray. Pupil rim broken at both sides, of brilliant ivory. Iris light buff, with sparse black stipplings above, which are denser below. Two solid patches at each side of iris dark brown, fraying out at edges and shot with a few silvery white veins.

Coll. No. 336: Kartabo, October 2, 1920, Color Plate 245, total length 1310 mm., weight 111 grams. Solid dark olive green above. Wax yellow on labials, chin and throat, becoming mottled posteriorly with olive green on a few anterior ventrals, until the whole is concolorous. Iris, lower three-fourths buffy-brown, upper fourth sandy, with fine white stippling. Strong pupil rim of clear buff, two or three radiating lines silvery white, from anterior and posterior outer iris edge almost to pupil. After twenty-six years in preservative the whole snake is vinaceous brown.

Coll. No. 30,175: Caripito, July 15, 1942, female breeding, total length 1806 mm., tail 463 mm., weight 490 grams. Plain olive green above, below bright chrome yellow on chin, throat and jaw scales upper and lower. From here back, the bright color dulls within a few inches to the general color of the ventral surface, olive buff. Iris dark hazel

brown with silvery veins as usual, silvery white above and below.

In full grown monochrome snakes, long after the dorsal, transverse bands of the juvenile pattern have disappeared from the scales, these bands reappear in strong outline when the skin is stretched. On the skin between the scales they are etched throughout life, although under no stress of danger or excitement have I ever seen this species distend its neck as other serpents do.

Food: No. 2665 had swallowed two eggs of a seedeater, with sufficient shell for at least this identification. In the stomachs of three other snakes were the bones of small birds, and in one the bones of a small hawk, probably the Bat Falcon (*Falco ruficularis*).

Breeding: No. 30,175, Caripito, July 15, 1942, total length 1806 mm., was a female weighing 490 grams. There were eleven eggs in the oviduct, shell-less oblong yolks, each 15 by 45 mm.

Pseustes sulphureus sulphureus

(Wagler, 1824).

(Plate X, Figs. 44 and 45).

Names: Puffing Snake, Black-tailed Golden Snake. Yellow-belly (Creole). Sal-la-bu (Akawai Indian).

Range: Guianas, Trinidad, Venezuela, Peru, Ecuador and equatorial Brazil.

General Account: This large powerful constrictor was as common at Kartabo as its congener, *P. poecilonotus polylepis*, and its pattern and color variation were even more confusing. While the dorsal coloring may be monochrome, olive, brown or yellow, this is not an adult pattern but may occur in an individual only one-third grown. The usual pattern shows a series of conspicuous dorsal cross markings, crescents or bands, single or double, or even more intricate figures. The general tendency is a gradual change from yellow background with black markings on the head and anterior body, to black with corresponding yellow markings posteriorly. A nine-foot snake taken at Caripito was larger than any captured at Kartabo. This snake in pattern was curiously like a very large *Drymarchon c. corais* but with completely reversed color pattern. Concealed dermal markings are very characteristic and correlated with an optical defense mechanism. Also the rigid, liana-like habits are as strongly developed as in the preceding *P. polylepis*. Both of these habits were exhibited in an individual Yellow-belly which I caught on May 10, 1924, near the laboratory at Kartabo. My journal note reads as follows:

"May 10, 1924. Worked among the branches of a giant fallen jungle tree near the Cuyuni River for three hours, and later while running home before a threatened

heavy rain, I leaped over a bit of monkey ladder lying directly on the trail. After I had gone on some distance I seemed to remember a curious regularity about the stick and went back. It was a splendid *Phrynonax sulphureus* (No. 2857) lying flat, stiff and straight but strongly and evenly waved. The snake moved only a fraction of an inch as I slowly brought the gun barrel across its neck, but then it struck viciously and threw its coils tightly about the gun and my leg. I was loaded down with birds and an aguti and could not free the coils, and so limped home. In a vivarium the snake gave a magnificent exhibition of puffing, the entire anterior third swelling up as if filled with two or three hen's eggs. As the skin of the throat and anterior body rose, swelled and expanded, the inter-scale golden skin color leaped into view, merging with the scales themselves. On each side of the posterior throat conspicuous streaks of purplish-black appeared. It presented a truly fearsome sight, and simultaneously the tail quivered and rattled noisily against whatever object was within reach." (Plate X, Figs. 44 and 45).

With all the bewildering array of pattern and color variations, it is especially valuable in the field to find one character of satisfactory reliability, which delineates this species: The iris has a remarkably consistent pattern, the background brownish-black, with a fine mist of paler brown lines radiating outward from the bright silver pupil ring to the outermost borders of the visible eyeball. It thus differs radically from the iris of the congeneric species, *Pseustes polylepis*.

Measurements and Color in Life (in order of size): Coll. No. 15, Kartabo, June 15, 1919, total length 890 mm., weight 56.2 grams. A dull, olive brown snake with faint oblique markings on anterior two-thirds of back dull yellow. This color occurs between the scales so that when they are completely in place the snake is uniformly olive brown. Beneath pale lemon yellow, gradually becoming smoky brown on the posterior third, both above and below. Iris clove brown, with a regular dense mesh of olive brown, and a narrow bright gold pupil ring.

Coll. No. 2691: Kartabo, April 9, 1924, skin preserved, Color Plates 690, 691 and 692. Head isabella color, shaded with olive and black. General body color olive brown shading to tawny on posterior third, and gray on tail. Thirty-six arrow-shaped, forward pointing black-edged dorsal markings which become broken toward ventrals. These are buffy brown shading to dark wine color posteriorly and very dark gray on under surface of tail. The dorsal markings are narrow on the anterior body, leaving large interspaces with a faint stripe between. The interspaces became narrow toward tail

where they exist as faint rings. As the dorsal markings become larger they acquire a light central streak and the stripe between them becomes stronger. Scales of the body color, especially on the dorsal area, have partially concealed edges of apricot yellow, posteriorly becoming more orange. Scales in the center of the mid-body dorsal markings have white edges. The anterior lateral scales have lemon yellow edges which make the body appear to shade into the citron yellow of the forward ventrals, which become mottled on mid-body with dull brown. They turn vinaceous gray and then almost black on tail.

There is a dark streak backward from the eye extending the length of the head along the side of the neck, becoming broader and broken laterally. The scales in the center of this have white edges. The skin under this marking is velvet black, as also are several large scale spots under the chin. Labials, chin and neck bright yellow, the five posterior upper labials and four lower just under the eye with black rear edges. The eye and iris are typical of the species.

Coll. No. 2733: Kartabo, April 16, 1924, skin preserved, total length 812 mm., tail 201, jaw length 27, eye diameter 5.5, body width 12, body height 16 mm., rows of scales 21, ventrals 224, subcaudals 142, weight 39.5 grams. This specimen is duller in every way than No. 2691. The black under-neck skin marks are very faint, occurring as a broken line instead of forming large blotches as in other individuals.

Coll. No. 238: Kartabo, August 27, 1920, Color Plate 213, total length 1342 mm., tail 242, eye diameter 6 mm., ventrals 219, subcaudals 144, weight 93.5 grams. Head above is buffy olive green, back the same, shading on posterior third to brownish-olive. Tail wholly black. Anterior half of body indistinctly banded with dusky, posterior half with 12 or 13 bands of hazel. Upper labials and ventral head empire yellow, shading posteriorly through olive yellow to light brownish-olive, and to purplish-black on tail.

Coll. No. 2857: Kartabo, male, May 10, 1924, total length 2060 mm., tail 550, eye diameter 9, body width 26, body height 41 mm., ventrals 222, subcaudals 135, weight 679 grams (1.5 pounds). This snake was very fierce when first caged and puffed out all along the body for a distance of at least twenty inches, the largest swelling being near the neck, a full three inches from side to side. The head seemed small and shrunken in its sunken position in the large bulging mass.

Coll. No. 30,281: Caripito, July 1, 1942, total length 2752 mm. (nine feet), tail 756 mm., ventrals 221, subcaudals 143, weight 1472 grams (3.25 pounds). Above pale olive green, head plain with a narrow black line

from the eyes back to three-fourths length of head behind. A series of dorsal V-shaped, black marks; narrow arms leading obliquely back from the apex. These marks become thicker as to arms and closer together, until at mid-body they merge and the pattern becomes solid black with well separated, double, vertical bands of sulphur yellow. These die out after four or five faint double lines on the tail. All of the remaining tail is jet black. Below, pale sulphur yellow, with a lateral series of freckled black spots, beginning at three feet from the head. These become more numerous, forming a checker-board pattern with the sulphur yellow. About five feet back of the head, the black becomes dominant on the belly, leaving a lateral series of bright yellow spots which die out at the vent. Iris hazel with the usual outwardly directed series of fine dark brown lines.

Food: Consisting wholly of birds. (1) A domestic chicken and the feathers of some small bird. (2) Bones of birds. (3) Caught while being mobbed by a pair of kiskadees, with the head of the snake almost at the nest which contained three nestlings, twenty-five feet above the ground.

Sipholophis cervinus cervinus

(Laurenti, 1768).

Name: Yellow Frog Snake (Creole).

Range: Guianas, Trinidad and Brazil.

General Account: In 1916 and in 1920 I took three specimens of this snake, sent them north alive to the New York Zoological Park, where they were named by Dr. G. K. Noble. No. 182a was taken on December 20, 1920, and was 810 mm. over all. I find no further data.

Spilotes pullatus pullatus (Linnaeus, 1758).

(Plate X, Fig. 46).

Name: Tiger Snake.

Range: Mexico south to northern Brazil and Argentina.

General Account: Three specimens were caught at Kartabo in 1919, and two others at Guanoco, Venezuela, in 1922. All were sent alive to the New York Zoological Park. A sixth snake found half-devoured by vultures had the remains of a bird in its stomach. All these Tiger Snakes were brilliantly colored with contrasting black and yellow, and none were under five feet in length. No other notes were made.

Tantilla longifrontale (Boulenger, 1896).

Name: Black-headed Snake.

Range: Venezuela and Colombia.

General Account: This species was not found at Kartabo. The only specimen from Caripito was taken from the stomach of an *Erythrolamprus aesculapii*, which was 410

mm. in total length. The latter snake was uncovered in a patch of sand and leaves inside high jungle.

This little black-headed snake was quite perfect anteriorly, but having been swallowed tail first, the posterior part of its body and its tail were half-digested. It is Coll. No. 30,145 and was taken with its devourer on June 18, 1942, and measures approximately 124 mm. over all.

The entire top of the head and nape is black except for a pale band across the nostrils and two large patches, side by side, on the nape. Laterally on the head, there is much less black around the eyes than in *T. melanocephala*, and considerably more white pigment back of the gape.

Tantilla melanocephala (Linnaeus, 1758).

(Plate X, Fig. 47).

Name: Pink-headed Snake.

Range: Central and South America south to Argentina.

General Account: A small dark brown snake, the head about the same size as the body, with no appreciable neck, tapering gradually to tail. Head darker, body lighter brown, snout, chin, throat, two nuchal bands and sides of body pinkish. Ventrals pale green.

Six specimens were taken at Kartabo but none at Caripito. Several of these were sent north alive, but on two, some detailed notes were made. All were found on the surface of the jungle floor except one which was burrowing. They were gentle snakes, almost never striking, and were delicate as well as timid, and did not survive long in captivity.

Measurements and Color in Life: Coll. No. 236, Kartabo, Color Plate 205, August 19, 1920, total length 328 mm., tail 66, head length 7.5, eye diameter 1.5, body width 5.5, body height 4.5 mm., rows of scales 15, ventrals 144, subcaudals 61, weight 3.3 grams. Head bone brown, snout dark russet brown and two narrow cross bands back of head pink. Back russet with three lateral lines of pink, separated by a broader upper and a narrower line of mottled black. Sides of head buffy pink. The brown of the head extends downward in three rather regular curves, one enclosing the eye, a second touching the gape and a third on the lateral scales of the neck, immediately in front of the lateral lines. Eye, pupil very large and round. Iris narrow and brilliant scarlet, rather dusky antero-posteriorly.

Coll. No. 325: Kartabo, September 12, 1920, total length 296 mm., tail 60 mm., weight 2.2 grams.

Food: Two specimens had eaten small insects, including two wood roaches.

Trypanurgos compressus (Daudin, 1803).

(Plate X, Fig. 48).

Name: Red-headed Water Snake.

Range: Guianas, Trinidad, Venezuela, Colombia, Bolivia and Brazil.

General Account: Two specimens were taken at Kartabo, one of which is No. 18,151 in the American Museum of Natural History. Not seen at Caripito. This is a slender, oval-headed snake, head and iris pink, a narrow pale yellow nuchal band, then an inch of black. The rest of the snake is red with about 45 black bands or alternate spots one-third as wide as the interspaces. Whitish below.

One of the snakes was taken near the river, the second, No. 3267, November 20, 1920, total length 570 mm., became tangled and drowned on the submerged rope hawser of our motor boat, tied up at the Kartabo laboratory wharf. It must have become entangled in attempting to climb up from the water.

Measurements and Color in Life: Coll. No. 200, Kartabo, Color Plate 122, June 6, 1920, total length 450 mm., tail 105, eye diameter 2.3 mm., weight 6.5 grams. Head dark carnelian red, iris the same, pupil broadly vertically elliptical. Posterior head dull sulphur yellow. Body brownish-red with black markings. Below pinkish-white. Width of yellow collar 3.5 mm., black zone 16 mm. Forty-seven irregular markings of black along back and sides, extending from the black collar to the 15 mm. of tail tip, which are black. Of these markings 13 are complete bands, the rest being two rounded spots, alternating with each other. The relative widths are, black bands 3 mm., red spaces 8 mm.

Xenodon colubrinus (Günther, 1858).

(Plate XI, Fig. 49).

Name: False Fer-de-lance, Frog-eating Snake. False Labaria (Creole).

Range: Central America, Colombia, Peru, Bolivia, Brazil and British Guiana.

General Account: A heavy, thickset snake with very short tail. Adult usually mottled reddish-brown or grayish-black above with many indistinct cross bands of gray. Face and snout black, below mottled pale buff. Pupil round with scarlet ring, iris dark mottled. The young have twelve or more five-banded dorsal figures of gray and black on red brown background; white and mottled below. This terrestrial species was found occasionally at Kartabo, but not seen at Caripito. It occurred in marshy localities or wet jungle. No. 253 was caught when swimming a half-mile-wide river. The young are remarkably like fer-de-lance in pattern, color and movements, especially striking posture.

Measurements and Color in Life: Coll. No. 652, Kartabo, April 29, 1922, young male, total length 445 mm., tail 60, head length 14, body width 12.5, body height 11 mm., ventrals 153, subcaudals 45, weight 33.5 grams. This young snake closely resembles a fer-de-lance except for the lack of a lemon yellow tail. The dorsal series of black and gray V-bands have the apices touching each other on the mid-dorsal line, unlike the condition in No. 240.

Coll. No. 240; Kartabo, Color Plate 212, August 20, 1920, total length 450 mm., tail 65, eye diameter 4.8 mm., ventrals 148, subcaudals 49, weight 26.3 grams. Head mottled with varying shades of pinkish-brown, pale on sides with brown blotches. There is a fairly distinct black line or band from snout above the nostrils back to eye, and from posterior eye to gape. The markings of the back are in the form of successive angled bands. The sequence of these, proceeding posteriorly, is as follows: a wide, red brown interspace, V-shaped gray band and black band pointing posteriorly, a narrow red brown band or interspace, V-shaped black band and gray band pointing anteriorly, another wide red brown interspace, etc. There are 12 of these five-banded figures distributed along the body, giving place on the tail to faint, indefinite gray and black markings.

The chin and throat are immaculate white. Sides of body whitish, interrupted with large spots of brownish-black. These have a regular relation to the dorsal markings, there being one for each of the wide interspaces, and one for each of the four boundary bands of the narrow brown interspace. The mid-portion of the ventrals is mottled buff and olive brown, beautifully iridescent in strong contrast to the upper dull brown and gray surface. The eye is silvery with this color almost obliterated by a tangle of red brown threads radiating more or less regularly outward in all directions from the pupil. The ring around the latter is lemon yellow.

Coll. No. 735: Kartabo, male, August 29, 1922, total length 610 mm., tail 91, eye diameter 15.5 mm., ventrals 146, subcaudals 54, weight 36.5 grams.

Coll. No. 253: Kartabo, Color Plate 174, July 20, 1920, American Museum No. 18173, total length 970 mm., tail 125, head length 23, eye diameter 7 mm., weight 152.4 grams. Back reddish-brown with about 35 faint, irregular cross bands surrounded by brownish-black. Scales flecked with olive buff and mottlings of warm red brown, becoming redder near ventrals. Top of head brown, flecked with buff, the flecks increasing and merging to form a pale temporal band. Snout, face and ventral surface of head black, with scattered irregular spots of pink-

ish-buff. Ventrals buffy pink mottled with rose and brownish-olive. Iris dark brown finely flecked with gold, pupil round, with a bright red outer ring.

Food: (1) Large *Bufo marinus*. (2) A 55 mm. *Bufo typhonius*. (3) 3 *Microhyla microps*. (4) 27 tadpoles and half-tailed young frogs. (5) 1 young *Bufo guttatus*.

***Xenodon severus* (Linnaeus, 1758).**

(Plate XI, Figs. 50 and 51).

Names: Frog Snake. Crapeau or Mattopi Snake (Creole).

Range: The Guianas, Venezuela, Colombia, Ecuador, Peru and Brazil.

General Account: A very poisonous-looking snake, with flat head, expansive neck, thick body and short, stubby tail. It is, however, a rapid mover. It was fairly common at Kartabo but not taken at Caripito.

The variety of pattern and coloring is almost indescribable. The adult snake tends to be monochrome, green, brown, black or rufous, and yellowish or gray below. But dorsal bands or spots may persist in large specimens, black-edged scales or more definite bands. The young usually have a complex angular pattern of bands and hour-glass figures. One fairly consistent mark is a large central nuchal patch of pink, red, orange or rufous, surrounded by one or more concentric bands of the same color. This becomes very conspicuous when the snake flattens its neck, cobra-like. When dozens of detailed kodachrome photographs are available of individuals carefully measured and sexed, some semblance of order may emerge from the infinite variety of pattern and pigmentation. I present seven descriptions.

Most of these snakes were taken in bamboo clumps or when they were crawling across trails or over the jungle floor. Their pattern made them almost invisible when not in motion. No. 77 when frightened took to the water at once and swam to a floating bush. No. 65 was caught when swimming far from land, well out in the river. It swam very high, compressing the body as the boat approached and thus bringing all the concealed markings into view. It tried to climb aboard and when netted flattened its head and struck repeatedly. The markings were so much like those of a fer-de-lance that for a time we did not dare handle it.

No. 510 was one of the most nervous and irascible snakes I have ever seen, striking at the least annoyance, and spreading its neck to an astonishing width and flatness. This was done apparently by means of the ribs, and the conscious object was always to keep the flattened side toward the object of rage or fear, exactly as a male golden pheasant orients its ruff and body plumage broadside to the hen. At times, as I walked around the displaying snake, it would slowly

revolve its expanded neck, and even fold up one side to keep it broadways toward me. Attempts to take motion pictures were very difficult as the snake tired almost at once and after several short displays attempted only to escape.

Measurements and Color in Life: Coll. No. 344, Kartabo, Color Plate 256, October 12, 1920, half-grown male, total length 342 mm., tail 38, head length 15, eye diameter 5, body width 16, body height 10 mm., rows of scales 21, ventrals 139, subcaudals 34, weight 22.8 grams. This young snake differs in pattern from most adults. General color above dark brown, lighter on sides. There are twelve backward-pointing, broad, transverse-angled bands of pale wood brown, edged with darker, diminishing in width toward the tail, and breaking up into small, dark patches along the sides. The first of these bands lengthens out into an irregular head marking, back of the eyes. General color of head hair brown, with narrow transverse bands of gray across top of snout and between eyes, also a broad black velvety stripe backward from eye. Upper labials and sides of neck pale brownish-pink. Lower labials and chin creamy white. Ventral surface gray, with quite regular square pink patches along sides, which merge above abruptly with the wood brown of the sides. Iris, upper fifth pinkish-buff, the rest brown stippled with black. A narrow pupil ring of buff.

Coll. No. 2734: Kartabo, April 22, 1924, preserved skin, total length 485 mm., tail 50, jaw length 29, eye diameter 5.5, body width 19, body height 14 mm., ventrals 139, subcaudals 41, weight 24.5 grams. Dark brown with eight very wide pale brown, slightly angled bands, Ventrals dark gray edged with yellow. A large central nuchal area, and a broad anterior, triangular crescent pink, visible in the stretched skin.

Coll. No. 510: Kartabo, Color Plate 322, March 2, 1922, total length 640 mm. Above dark ferruginous brown, becoming more red laterally, and changing beneath to pale reddish-ochre. Under surface of head orange buff. The background of the iris is tawny brown, except for lower right hand quarter, which is light buff, quite reddish at the bottom. The whole iris is finely stippled with dark brown; the narrow pupil rim is cinnamon.

Coll. No. 65: Kartabo, September 11, 1919, total length 711 mm., weight 80.5 grams. General color above dark ochraceous brown, with 12 to 15 angular, irregular, darker areas occupying the entire width of the dorsal surface and dying out toward the tail. Each dark area is bordered anteriorly and posteriorly with an irregular connected series of large spots of brownish-black. Beneath pale cream color, suffused with pale brown, becoming gray mixed with red on

tail, and yellowish beneath the head. Sides of body with equally spaced dark reddish-brown spots, confluent with the darker color of the sides and of upper surface. Posteriorly these spots are connected with much broken bands of the same color. General color of head cinnamon brown. Labials, loreals, nasals and rostral yellow green, irregularly spotted with fine brown spots, confluent along the joinings of labial scales. A narrow line of the green from nostrils through the eye to angle of jaw. Another line just above this from center of eye light olive brown, fading posteriorly into general body color. A dark brown spot on prefrontals, extending to the anterior portion of frontal.

Coll. No. 608: Kartabo, Color Plate 333, fig. a, March 10, 1922, total length 810 mm. Head above olive green, sides paler. Neck when distended and flattened with a central solid patch of bright grenadine pink, surrounded at a distance by a larger, diamond-shaped band of the same color. This in turn is framed in a large patch of dark olive green. The extreme edges of the flattened nuchal hood are bright lemon yellow. Body generally deep olive green, with indistinct cross bands and diagonal markings of every conceivable kind, olive brown becoming darker toward the short tail. Lower labials and chin olive buff. Ventrals olive buff with irregular cross bands of light gray. Iris buffy brown with dark stippling toward the outer edge.

Coll. No. 3132: Kartabo, June 6, 1920, total length 1031 mm., fully adult snake. General color dark reddish-pink, shading to rich rufous on the tail, where there are large blotches of black.

Coll. No. 3133: Kartabo, October 2, 1920, total length 1503 mm., above blue black, with numerous, irregularly scattered scales of grass green. Ventral surface grass green.

Coll. No. 77: Kartabo, June 3, 1919, total length 1530 mm. (5 feet, 2 inches), body width 50 mm., weight 1245 grams (2¾ pounds). The largest of this species taken. Above dark olive buff, under surface straw yellow. Iris buckthorn brown.

Food: (1) Caught near laboratory attacking a small domestic chicken, while it had just swallowed a small marine toad. (2) Just caught a marine toad, 130 mm. long, still alive. Partly digested was a large frog buried in a mass of round worms. (3) 1 grasshopper, 1 *Atta* soldier, 2 large black ants, 1 small spider, 2 leaves. (4) 2 large *Leptodactylus* frogs, 1 *Ameiva*. (5) Small *Ameiva*.

FAMILY ELAPIDAE.

Coral snakes, while claiming close kin with forms such as the common and king cobras and kraits, are far less dangerous

because of their small size and relatively short fangs. Most are characterized by brilliancy of coloring such as many successive bands of red, black and yellow. They are closely mimicked by several unrelated, harmless snakes.

They are burrowers and usually nocturnal, and feed on small lizards, frogs and insects. In the localities under consideration I found only two species although locally these snakes were almost abundant.

Micrurus lemniscatus (Linnaeus, 1758).

(Plate XI, Figs. 52 and 53).

Names: Tricolored Coral Snake. Hot Bead Snake (Creole). Koo-mung, "one who lives in the ground" (Akawai Indian).

Range: Northern and central South America.

General Account: Locally abundant at Kartabo, but in general, both there and at Caripito found only occasionally. About 35 were collected in all. Those snakes not actually dug up were found as they crawled slowly through the jungle, usually on overcast days.

The typical color pattern of the common Kartabo coral snake is a black snout, white loreal band and a broad scarlet complete band on the back of the head and nape. These are followed by the first of 14 to 17 body and tail pattern sequences, a large black area trisected by two narrow bands of white, followed in turn by a second scarlet interspace. The scarlet occasionally has the scales tipped with black, producing a dulling of the color, or very rarely there is a tinge of yellow on the white bands, but in no coral snake from British Guiana did I see true yellow bands. Considerable variation occurs in the pattern of the extreme head and tail, but it is always a regular carrying out and continuation of the somatic pattern sequence.

Measurements of three coral snakes of varying lengths are as follows: Coll. No. 825, total length 245 mm.; No. 236a, length 630; and No. 3552, length 900 mm. Tail respectively 20.7, 55 and 80 mm., ventrals 228, 254 and 226, subcaudals 34, 36 and 33, weights 3, 19.8 and 75 grams.

Color in Life: Among the 17 snakes taken from a single field there were only two noticeable variations. In one individual all the white bands were themselves bisected or split with narrow lines of black.

Coll. No. 230; March 27, 1919, total length 555 mm. Very aberrant in pattern, for while the white bands are very wide and conspicuous ventrally, they are almost absent on the back. The exact opposite is true of the red bands which are deep in color, with considerable black edging to the scales, and yet below there is hardly a trace of this color. Hence this individual is black above

with strong red bands at wide intervals. Beneath it is black with twice as many broad white bands.

Coll. No. 3552: male, 900 mm. total length, June 30, 1924. This snake showed only ten sets of patterns on both body and tail, all the bands red, black and white being of unusual width and the white very heavily edged with black. Twenty-two years later in the dried, well-preserved skin all the whites are changed to bright yellow, the scarlet and black being unaltered.

Of the 35 specimens taken at Kartabo, 17 were captured in a single marshy field of some three acres extent, all within eleven days, from March 20 to April 1, 1919. Others were taken in the same field on May 20 of the same year. They were all uncovered while the field was being hoed. In total length the first 17 coral snakes measured from 241 mm. (9.5 inches), to 787.4 mm. (31 inches), the average being 577 mm. (22.5 inches). I also counted the scarlet bands on these snakes, including that on the head and that near the tip of the tail. Of two snakes with 14 red bands the average length was 591 mm. (23.25 inches). Seven with 15 bands averaged 628 mm. (24.7 inches), 3 with 16 bands averaged 530 mm. (20.8 inches), and 4 specimens with 17 red bands showed an average length of 534 mm. (21 inches). So age has nothing to do with the number of pattern series.

We found coral snakes much more violent and aggressive than we had been led to expect. When captured they twisted and fought and struck, until allowed to bury themselves in débris in vivariums. The tail seemed to have the ability to flatten itself slightly and when excited was often held upright and twisted about in its own orbit.

Micrurus psypes (Daudin, 1803).

(Plate XII, Figs. 54 and 55).

Name: Bicolored Coral Snake.

Range: Guianas and northeastern Venezuela.

General Account: This snake is found occasionally both at Kartabo and Caripito. About a dozen specimens were taken at the former place, none of which were associated with the concentrations of *Micrurus lemniscatus*. Without exception this species seemed more quiet and less aggressive than the congeneric form, almost never making any resistance at capture.

As will be seen from the various descriptions, the pattern shows considerable variation, the two most common phases being black above, with many pale yellow, narrow rings, or alternate broad bands of dark red and black throughout body and tail.

Measurements and Color in Life: Coll. No. 633, Kartabo, July 10, 1922, total length 250 mm., weight 4.5 grams. Black with 51

narrow white bands completely around body, and 5 wider ones on tail.

Coll. No. 2660: March 25, 1924, total length 295 mm., tail 35.8, eye 1.5 mm., ventrals 195, subcaudals 49, weight 6.2 grams.

Coll. No. 30,105: Caripito, May 17, 1942, total length 390 mm., tail 48 mm. On the body are 35 complete black bands, averaging three scales in width, bounded dorsally by single scale lines of white. The black bands are separated at equal distances by broad bands of pale red much dulled by black on the distal half of each scale, producing a checkered appearance. The black spots die out at the edge of the pale salmon ventrals. The red interspaces are about three times the width of the black bands.

Coll. No. 3263: Kartabo, March 16, 1921, total length 400 mm., tail 60 mm. Latero-ventral head band red, then a black nuchal band, next the first somatic red, black-tipped band. Twenty-four black bands on body separated by red interspaces, each of the latter four times as wide as the black. No segregation into pairs is observable. The red is very much dimmed by the half black scales. Ventrally, the red interspaces are immaculate. The tail has a wholly different pattern, being black above with eight pairs of single scale width, broken pink lines. Ventrally these widen, and broad, black subcaudal bands alternate with red spaces, with a mottling of black in the center of the latter.

Coll. No. 640: June 30, 1922, Color Plate 416, total length 425 mm., tail 40 mm., ventrals 213, subcaudals 32, weight 11 grams. This specimen has 35 red bands on the dorsal surface and an equal number of dark red ones.

Coll. No. 2735: April 4, 1924, total length 453 mm., tail 41, head length 12, eye 2.3 mm., ventrals 200, subcaudals 30, weight 15.5 grams. Black above with faint blue sheen and slight iridescence all over in the sunlight. There are 58 narrow rings of dull white, grouped in pairs on each side of interspaces which are narrower and darker than the spaces between the pairs. These rings are broken above, but form wider, well defined bands across the ventral surface. A broad band of pale yellowish-white diagonally forward across side of face. Four of the rings which occur on the tail have a yellowish tinge and are wider than the somatic white rings.

Coll. No. 3265: June 15, 1922, total length 465 mm., tail 63 mm. The pale body rings are very narrow and broken above, widening below where they can be observed to form rather indefinite pairs, covering one or two ventrals as compared with three or four ventrals between. The usual latero-ventral cephalic band. The first body pair of white lines, while very narrow above, are wide

and actually fuse below, and the second pair almost joins ventrally. Altogether the 66 rings on body form 30 pairs. There are nine wide, unpaired white rings on the tail.

Coll. No. 634: September 10, 1919, total length 480 mm., tail 40 mm. Above iridescent dark steely blue, with about a dozen narrow, very faint cross bands on the anterior third of the body. From here back none are visible. Below we find the same iridescence, with 59 more or less regular cross bands of creamy white, usually covering half of two adjoining ventrals. The bands occur on about every fourth ventral, the anterior ten occurring over an area of 37 scales. A 60th band is found on the side of the head, beginning behind the eye and extending down across both jaws. The eye is small but well developed, the iris being dark brown.

Coll. No. 632: March 10, 1921, Color Plate 464, total length 400 mm., tail 50 mm. This specimen is unique in its pattern which closely resembles that of *Micrurus lemniscatus* although the coloring is quite different. The head is black except for a broad post-ocular, complete band of buffy yellow. There follows a wide area of black, trisected with two narrow, white lines. This black, white and yellow pattern is repeated ten times on the body and tail.

Food: The following are the contents of three stomachs: (1) Insect remains and a few quartz crystals. (2) A small snake. (3) Two small lizards, probably *Anolis*.

Breeding: The body of coral snake No. 640 was slightly enlarged posteriorly, and when it died two days after capture on June 22nd, two eggs were found, shell-less but almost full sized, elongate, measuring 7 by 25 mm.

FAMILY VIPERIDAE.

Lachesis muta (Linnaeus, 1758).

(Plate XII, Fig. 56).

Names: Bushmaster. Coonocooshe (Creole). Pah-tie-ee-sack (Awakai Indian).

Range: From Panama throughout northern and central South America.

General Account: The bushmaster is not rare at Kartabo but much less common than the fer-de-lance, whereas the opposite is true at Caripito where one encounters many more of the present species than fer-de-lance snakes. We seldom found a bushmaster in motion, but always coiled in a tight mat in a game trail. One of the first found was also the largest, No. 199, measuring 2596 mm., or eight feet, six inches over all. I have given an account of the capture of this giant in "Jungle Peace," pp. 188 to 195. It was sent north alive to the New York Zoological Park on April 10, 1916.

In the case both of the bushmaster and the fer-de-lance we wondered why our eyes

were so often drawn to the coiled serpent before we were near enough to step on it. Experimenting with freshly caught specimens of both species I found that when I was tightly blind-folded I was aware of a distinct odor, even when six to ten feet away. This was especially true of the bushmaster, the odor being musky and very unpleasant. Unless we stopped and consciously sniffed, when our eyes were open other interfering sense impressions reduced the olfactory ones to only subconscious effect.

Twice I found large bushmasters closely associated in pairs, both times in spiny palm scrub.

Measurements and Color in Life: Coll. No. 199, eight feet, six inches over all, Color Plate 181, fig. b, had more lilac and violet in its coloring than usual, and the iris was straw yellow instead of reddish. The large dorsal markings were dark lilac with black borders and outer frames of pale violet.

Coll. No. 3275: A male, July 24, 1920, Plate 181, fig. a. Total length 1038 mm. (45 inches), tail 92, head length 46, eye 4.5, body width 30, body height 27 mm., ventrals 220, subcaudals 40, weight one pound. The top of head was seal brown, mottled with paler. Body with wide diamond-shaped markings beginning at back of neck. Black lateral cephalic band running into a curved band from eye almost to first ventral. Above this a band of light brown, then a narrow, broken line of black. Tawny olive on upper neck. Upper labials and side of face pale buff, deepening to buffy brown on snout. Lower labials and throat white tinged with pinkish-buff. Iris flame scarlet, coarsely blotched and mottled with dark brown toward the outer rim, leaving a wide area immaculate around pupil. Pupil a rather wide vertical ellipse.

Coll. No. 656: Kartabo, July 7, 1922, Color Plate 421. Total length 1070 mm. (five feet, seven inches), tail 165, head length 70, head width 48, eye 6, body width 50, body height 45 mm., weight four and a half pounds. This was essentially a yellow brown phase and complete with the pattern of jungle débris when coiled as we first found it. The eye was scarlet, the head and much of the sides of the body pale wood brown. The postocular black band was very strongly marked. The dorsal diamonds were almost solid black, with a few rufous scales at their center, and

each banded with a narrow frame of pale buff. The ventrals were yellowish-brown, and the dorsal markings became very irregular and whitish on the tail.

Food: Spiny rats seem to be the favorite diet of bushmasters both at Kartabo and Caripito. Five individuals were found feeding on these rodents.

Breeding: One female taken at Kartabo on April 6 contained seven nearly formed eggs, each three inches in length, and another snake captured on May 19 at Caripito had a 2½-inch shell-less yolk.

Bothrops atrox (Linnaeus, 1758).

(Plate XII, Figs. 57, 58 and 59).

Names: Fer-de-lance. Labaria (Creole). Sah-ru-rima (Akawai Indian).

Range: Mexico south to northern and central South America. Martinique and Tobago.

General Account: The fer-de-lance is a common snake at Kartabo but rather rare at Caripito. Between forty and fifty were taken alive and sent north or preserved. Young ones were frequently found in the bamboo clumps near the Kartabo laboratory and the larger ones on the deeper jungle floor. The fer-de-lance is nocturnal, but occasionally is active on overcast days. A full time embryo measured 10½ inches and the largest snake we saw, a female, was a little more than 4 feet, 3 inches over all.

Boulenger's color descriptions (Catalogue of Snakes of British Museum) are usually from preserved specimens, and wholly unlike those of living snakes, but the following characterization of this species is perfect: "Coloration very variable; gray, brown, yellow, olive or reddish above, uniform, or with more less distinct dark spots or crossbands, or with dark triangles on the sides inclosing pale rhombs. Lower parts yellowish, uniform or powdered or spotted with brown, or brown with light spots."

The only two really characteristic patterns which seem always to be present, are the dark band extending on the side of the head from the eye to the gape, and the conspicuous whitish or lemon yellow color of the tail.

Comparative measurements of 11 individuals, from 268 to 1290 mm. total length, are as follows:

Coll. No.	221a	3134	2762	2794	3531	2988	2788	221	3255	613	3121
Total length (mm.)....	268	320	346	422	557	1040	1110	1120	1159	1228	1290
Tail (mm.).....	38	42	46	62	72	153	150	120	159	168	165
Eye diameter (mm.)....	3	3	3.5	3.5	3.9	5	5	5	5	5	6
Ventrals	204	201	200	191	207	205	203	196	204	195	206
Subcaudals	69	65	64	65	73	70	64	62	67	70	66
Weight (grams).....	3.3	8.5	10.2	21	25	342	380	292	370	384	373

The head length in the two extremes of the embryo and the 1290 mm. specimen are 10 and 41 mm. The weight of the unborn embryo when the yolk sac is included, is increased from 3.3 to 10 grams.

Color in Life: Coll. No. 221a, Kartabo, nearly born embryo, length 268 mm., Color Plate 234, September 25, 1920. This one of eight nearly full-developed embryos was the offspring of No. 221. It was very active, dragging about its yolk-sac which weighed three times as much as itself. It showed two shades of lilac, very pale and darker, the two being arranged in a series of equally wide bands down the back. The characteristic dark eye to gape band, and the pale tail are both in evidence. The iris is much darker than in the usual fer-de-lance, and the wide pupil is vertical, not directed slightly forward as in older snakes.

Coll. No. 3100: young snake of 305 mm. length, June 14, 1919. Strong reddish-brown above with cross bands of dark olive, each constricted at mid-back. Whitish below, thickly checkered with pinkish-brown. Iris golden yellow, covered with a vertically striated mesh of black.

Coll. No. 2794: length 422 mm., May 11, 1924. Looked down upon as on a flat skin, the pattern is of a series of transverse, broad, hour-glass figures separated by narrow diamond interspaces. The boundaries are formed by narrow, yellowish-white lines. The anterior half of the body is of a general pale brown, the posterior half being much darker with a thick scattering of round, blackish-brown spots. Black, lateral head line and pale yellow tail as usual. Ventrals dominately black with many yellow spots.

Coll. No. 2827: length 465 mm., May 16, 1924. Similar to No. 2794, except that throughout, the hour-glass pattern is very dark, and the ventrals dominately yellow with dark lateral checkers.

Coll. No. 3258: length 615 mm., Color Plates 97 and 111, August 12, 1919. An extremely dark phase. Dark purplish-brown above, coarsely mottled with black. Tail very conspicuously lemon yellow, and ventrals bright salmon red, checkered with black. Head dark brown above, black on sides and below, with large patches of pink-bounded gray in the centers of 6 upper and 5 lower labials. Loreal scales pink, and iris pale gold with three broad antero-posterior bands of pinkish-red. Pupil, as in all fer-de-lance of this length and larger, tipped obliquely forward about twenty degrees.

Coll. No. 2788: female breeding, May 6, 1924, Color Plate 731, length 1110 mm. General color above hair brown with the typical *Bothrops atrox* markings showing as rhomboidal patches of dark brown, enclosing the lighter tone. These markings however are

very faint. The top of the head has a faint greenish tinge. The labial region is light olive buff with very dark lateral facial line of broken streaks, which occur strongly on the keels of the scales, running from the eye back and obliquely downward. Ventrals cream buff shading to olive toward tail, and with touches of carnelian red on sides of the first few ventrals. Ventrals mottled, strongly toward tail, with light gray.

Coll. No. 221: female breeding (parent of No. 221a), length 1120 mm., Color plate 234, September 25, 1920. Head purplish gray, paler at the posterior sides and pinkish at snout. Sides of head also purple, all labials thickly mottled with dark brown, and the usual lateral dark line. Body purplish-gray with dark, transverse triangular markings of dark lilac, edged with smoke gray. Chin light buff tinged with purplish, ventrals Naples yellow, upper edges with touches of pink, fading to cream color, and mottled more and more thickly with bluish-gray toward tail. Iris warm yellow with dense flecking of dark gray and brown all over, except for pupil rim.

Coll. No. 613: length 1228 mm., Color Plate 400, June 14, 1922. General color of head and back hair brown, entire length with evenly spaced transverse bands of dark olive, over an inch in width at mid-body, all widely edged and blotched with black. The interspaces are edged with light grayish-olive and have a large, indistinct central diamond patch and lateral shading of brownish-black. Sides of head and lower labials bluish-gray with black loreal streak, and a few irregular black spots. Chin smoke gray anteriorly, becoming lighter under neck and merging into the general bright Naples yellow of the ventral ground color. On the lateral portion of the ventrals is a series of large, irregular, roundish black spots, each separated by about two ventrals. Tail dull lemon yellow, inconspicuous. Iris ground color maize yellow, very heavily streaked and stippled with black, with a faint streak of red through the obliquely vertical pupil and a touch of red about the pupil rim.

Coll. No. 3121: length 1290 mm., Color Plate 180, July 25, 1920. Top of head brownish-black with supraoculars and keels of scales mouse gray. Loreals pink. Side of face antimony yellow, with three perpendicular marks on upper labials of black. Broad oblique band extending from eye almost to fourth ventral black. Body above with broad transverse bands of dusky violet edged narrowly with brown. Ventrals amber yellow deepening to apricot yellow on upper edges, mottled more and more thickly toward tail with black. Pupil a moderately wide, oblique ellipse. Iris pale yellow gold flecked with ochraceous orange, with three zones of

mottling of dark brown, one at either end of pupil, and a broad band horizontally across the middle.

Food: Seven stomach contents were as follows: (1) A large *Leptodactylus pentadactylus*. (2) Remains of two mice. (3) In this snake, 887 mm. over all, was a spiny rat 410 mm. in length. (4) Two medium Ameivas. (5) 2 young spiny rats. (6) Unidentified lizard, small snake and the fur of some small mammal. (7) Shot while stalking a manakin.

Breeding: No. 2788, Kartabo, 1110 mm. long, taken on May 9, contained 16 eggs about half-developed. No. 2988, Kartabo, 1040 mm., taken on June 19, 9 large eggs almost ready for deposition, measuring 20 by 30 mm. No. 221, Kartabo, 1120 mm. total length, captured on September 25, contained 8 young snakes almost ready for birth; No. 221a, 268 mm. long is one of these. No. 3249, Kartabo, 1140 mm., taken October 20, contained 11 large embryos.

Bothrops bilineatus (Wied, 1825).

(Plate XIII, Figs. 60 and 61).

Names: Tree Fer-de-lance, Green Fer-de-lance. Green Labaria (Creole). Eye-dee-ah-mo (Akawai Indian).

Range: Guianas, Brazil, Peru, Bolivia and Ecuador.

General Account: A rare snake at Kartabo, only three specimens being taken. It may well be more common than we think, owing to the difficulty of detecting it among the same colored jungle foliage. Except for the general green color it differs little from *atrox*, having even the lateral facial oblique band and the conspicuous, self-colored tail. It is pale leaf green above, uniform or sparsely spotted with darker, and yellow below. In the late *atrox* embryo the tail is 14 per cent. of the total length, and in the largest *atrox* taken it is 12 per cent. In the present species the tail is slightly longer, 15 to 16 per cent. of the length.

All three specimens were taken among the branches of low jungle shrubs. No. 354 was only five feet from the ground. I walked within a foot of the snake, and it made an abortive attempt at my face, striking the rim of my hat before I saw it and broke its back with my gun barrel.

Measurements and Color in Life: Coll. No. 345, Kartabo, April 4, 1920. Total length 540 mm., tail 80, head length 18, width 12, eye diameter 3, body width 12, body height 13 mm., rows of scales 33, ventrals 202, subcaudals 76, weight 38.2 grams. General color above lichen green, shading to grass green toward tail, which changes abruptly to pale pinkish-buff near the tip. Lateral line on side of head and about 40 sets of alternating, irregular, short, transverse dor-

sal marks light cadmium yellow, edged with black. Side of head greenish-yellow, shading into a wide patch of picric yellow on the side of the neck, which in turn merges into the lateral body line of straw deepening to citron toward the tail. Ventrals pale lumiere green lighter toward tail, touched with lighter greenish-yellow on the lateral edges of the ventrals. Iris light yellow green flecked with darker green, paler toward pupil. The character of this marking is of a maze of indistinct fibers, extending more or less up and down. Pupil is an oblique vertical wide slit.

Coll. No. 2671: Kartabo, April 3, 1924, Color Plates 675 and 676. Total length 752 mm., tail 115, head length 26, eye 4, mm., rows of scales 31, ventrals 208, subcaudals 77, weight 39.4 grams. General color of head and back leaf green, dulled on head and anterior body by fine black dots which are larger and closer on the head. A lateral body stripe of chalcidony yellow extends along the outermost row of scales formed by the solid color of these scales and a small triangle at the edge of the ventrals. This yellow line is edged below by a narrow line of dark green along the ventrals. A band of ochraceous orange with faint black streaks extends from the eye to angle of mouth. This streak is broken in this individual snake on the left side by the intrusion of a single green scale. A few small markings of the same orange color occur at intervals along each side of the mid-back. Upper labials and a slight shading on the lower, lime green with scattered black dots. The remainder of the labials and chin pale lemon yellow which joins a lateral line on the side of the neck. Ventrals primrose yellow, paler toward tail, the tip of which for an inch is solid purplish-pink. Iris chalcidony yellow with fine stippling of jade green everywhere except at the top.

In 22 years this snake has changed to grayish-blue above, and the ventral yellow has become straw.

Coll. No. 267: Kartabo, November 5, 1920, Color Plate 262, total length 424 mm. Head above and back pale turquoise green with many irregular short markings down each upper side, each of which is orange framed with black dots and dashes. Scales of supra- and preocular areas of head pale greenish dotted with large black spots. Labials pale buffy yellow with considerable blotching of rich green. Postocular oblique band orange, spotted with black. Iris a maze of dark green fibrous markings. Chin and throat yellowish-white changing gradually into the general ventral color of immaculate pale blue green.

Food: No. 345 had swallowed a large *Hyla maxima*, 180 mm. over all. No. 267 had made

a meal of four large Hylas and two anolid lizards.

FAMILY CROTALIDAE.

Crotalus durissus terrificus (Laurenti, 1768).
(Plate XIII, Figs. 62 and 63).

Names: Green Rattlesnake. Jungle Rattlesnake. Cascabel (Spanish). Sak-kah-sak (Akawai Indian).

Range: Guianas, Venezuela and Colombia, to northern Argentine. Paraguay and south Brazil.

General Account: Very rare in the jungle at Kartabo where only three specimens were seen or taken during eight seasons. At Caripito not rare in the open llanos or savannas. One Kartabo snake had swallowed a large spiny rat.

Coll. No. 556: Kartabo, April 29, 1922, Color Plate 548. This was taken at night while crawling along a jungle trail near the laboratory. The tail was injured and there were only six remaining rattles. Like the other Kartabo specimens this rattler was green in general coloring, with variegated shades from pale to deep forest green, with irregular dorsal markings of black. The eyes were connected by a black band, and from the eyes back, two broad bands of dark brown extended along the body for some

distance. The iris was green with two large vertical patches of brown mottling on the central three-fifths. The rather narrow pupil was vertical, not oblique as in the fer-de-lance. Below, the ventrals were creamy white, anteriorly deepening into greenish posteriorly.

Coll. No. 30058: Caripito, taken on the open savanna. It measured 740 mm. over all and was found on April 20, 1942. This and five others seen or taken were wholly brown of varying shades with black markings. The head was pale brown with a brownish-black band from the snout back over the mid-crown on to the nape. Two indistinct bands of dull reddish extended from the lateral head along the back. A postocular band of black extended back to the gape, then turned forward along the line of the mouth, covering first the lower labials and then passing on to the upper ones, and swinging up and back to the anterior aspect of the eye. It actually joined the postocular streak by a broad central brown band across the iris itself. The rest of the iris was deep orange. A series of very distinct black diamonds, bounded with pale buff, extended down the back, with irregular lateral streaks posteriorly along the sides. The ventral surfaces were pale brown.

EXPLANATION OF THE PLATES.

(The black-and-white figures in the Plates are reproductions of color paintings by Isabel Cooper and Helen Tee-Van. Photographs are by William Beebe and John Tee-Van).

PLATE I.

- Fig. 1. *Leptotyphlops septemstriata*
Life size photograph.
Typhlops reticulatus
Fig. 2. Head.
Fig. 3. Entire.
Inilius scytale
Fig. 4. Head and fore body.
Fig. 5. Mounted skin. Photograph.

PLATE II.

- Boa canina*
Fig. 6. Boa in tree. Photograph.
Fig. 7. Head. Photograph.

PLATE III.

- Constrictor c. constrictor*
Fig. 8. Head of adult.
Fig. 9. Entire snake.
Fig. 10. Twelve-foot boa on ground. Photograph.

PLATE IV.

- Epicrates c. cenchris*
Fig. 11. Head.
Fig. 12. Entire snake.
Fig. 13. Boa constricting on arm.

PLATE V.

- Eunectes gigas*
Fig. 14. Entire snake.
Fig. 15. Head of adult.
Fig. 16. External hind claw.

PLATE VI.

- Atractus trilineatus*
Fig. 17. Head.
Fig. 18. Entire snake.
Chironius fuscus
Fig. 19. Head.
Clelia c. clelia
Fig. 20. Head.
Dipsas catesbyi
Fig. 21. Entire snake.

PLATE VII.

- Dipsas indica*
Fig. 22. Head and fore body.
Fig. 23. Entire snake.
Dipsas variegata
Fig. 24. Head.
Fig. 25. Entire snake.
Dryadophis b. boddaerti
Fig. 26. Head.
Fig. 27. Head of young snake.

PLATE VIII.

- Drymarchon c. corais*
Fig. 28. Entire snake.
Fig. 29. Head.

- Erythrolamprus aesculapii*
Fig. 30. Head and fore body.
Fig. 31. Entire snake.
Fig. 32. Entire snake, variation.
Imantodes cenchoa
Fig. 33. Head.
Fig. 34. Entire snake.

PLATE IX.

- Leimadophis reginae*
Fig. 35. Head.
Leptodeira a. annulata
Fig. 36. Head.
Leptophis a. ahaetulla
Fig. 37. Head.
Oxybelis a. aeneus
Fig. 38. Head.
Fig. 39. Entire snake.
Oxybelis fulgidus
Fig. 40. Head.

PLATE X.

- Pseustes poecilonotus polylepis*
Fig. 41. Head.
Fig. 42. Head and fore body.
Fig. 43. Snake mimicking liana.
Pseustes s. sulphureus
Fig. 44. Snake puffing, side view.
Fig. 45. Snake puffing, front view.
Spilotes p. pullatus
Fig. 46. Head.
Tantilla melanocephala
Fig. 47. Head.
Trypanurgos compressus
Fig. 48. Head.

PLATE XI.

- Xenodon colubrinus*
Fig. 49. Head.
Xenodon severus
Fig. 50. Entire snake.
Fig. 51. Snake flattening head and neck.
Micrurus lemniscatus
Fig. 52. Head.
Fig. 53. Entire snake.

PLATE XII.

- Micrurus psypes*
Fig. 54. Head.
Fig. 55. Entire snake.
Lachesis muta
Fig. 56. Head.
Bothrops atrox
Fig. 57. Head, adult male.
Fig. 58. Head, adult female.
Fig. 59. Heads and coiled embryos.

PLATE XIII.

- Bothrops bilineatus*
Fig. 60. Head.
Fig. 61. Entire snake.
Crotalus durissus terrificus
Fig. 62. Entire snake.
Fig. 63. Head.

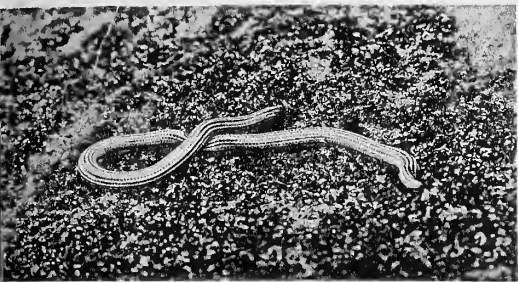

FIG. 1.

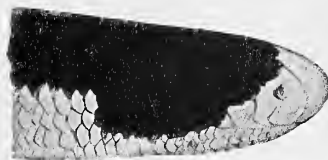

FIG. 2.



FIG. 3.

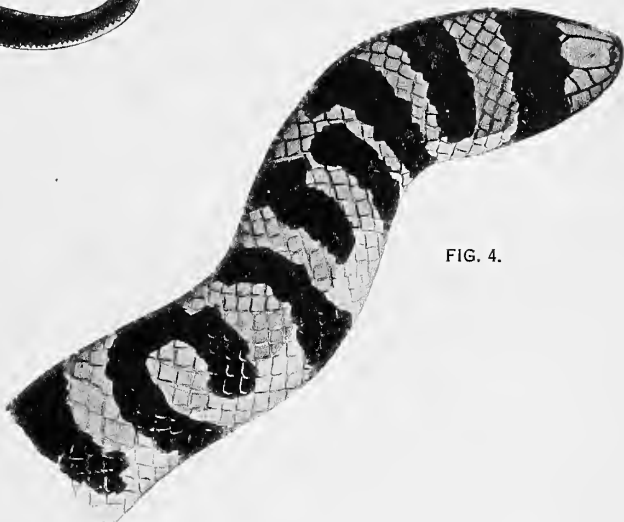

FIG. 4.

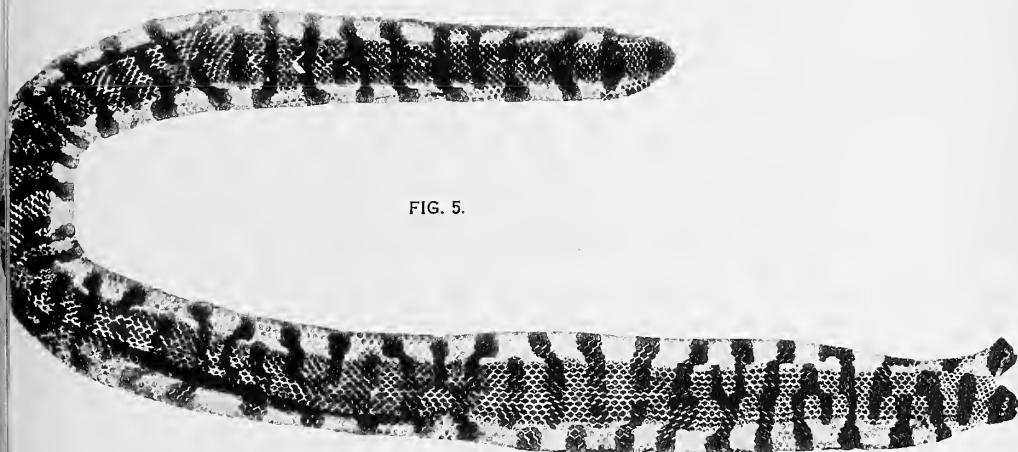

FIG. 5.

FIELD NOTES ON THE SNAKES OF KARTABO, BRITISH GUIANA,
AND CARIPITO, VENEZUELA.



FIG. 6.

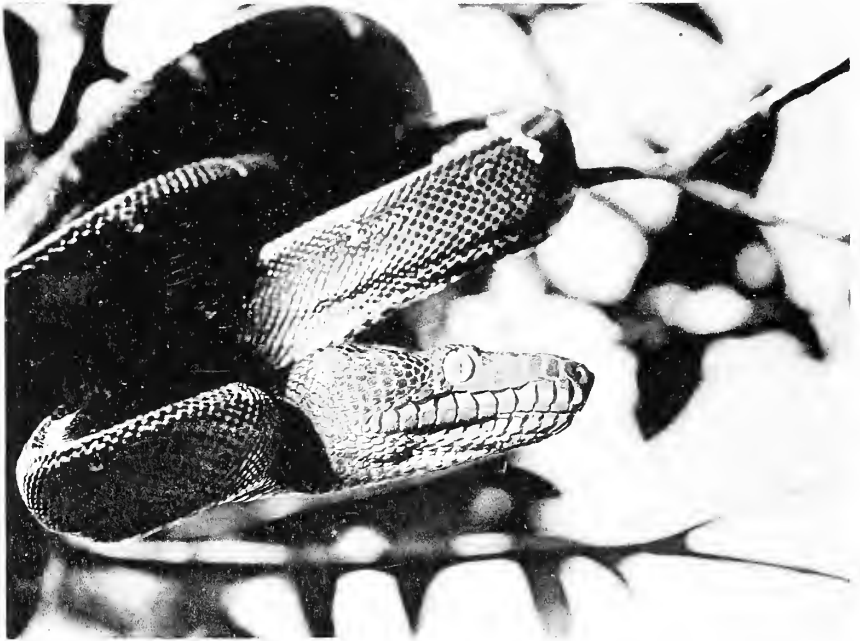

FIG. 7.

FIELD NOTES ON THE SNAKES OF KARTABO, BRITISH GUIANA,
AND CARIPITO, VENEZUELA.

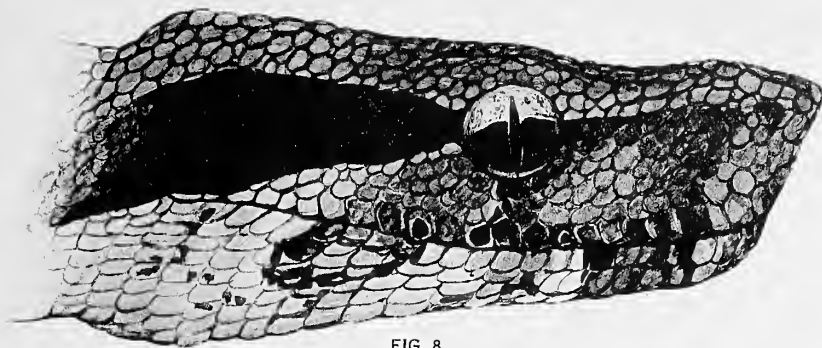

FIG. 8.



FIG. 9.

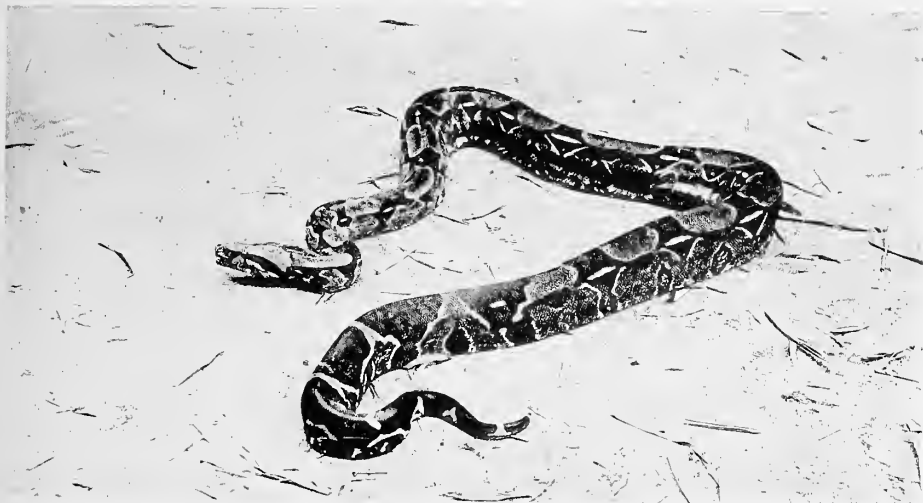

FIG. 10.

FIELD NOTES ON THE SNAKES OF KARTABO, BRITISH GUIANA,
AND CARIPITO, VENEZUELA.



FIG. 11.



FIG. 12.



FIG. 13.

FIELD NOTES ON THE SNAKES OF KARTABO, BRITISH GUIANA,
AND CARIPITO, VENEZUELA.

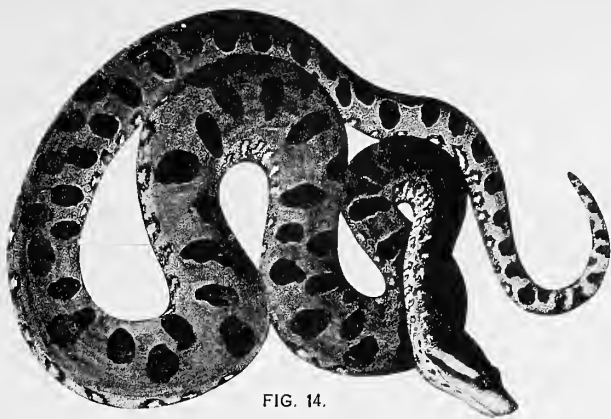

FIG. 14.



FIG. 15.



FIG. 16.

FIELD NOTES ON THE SNAKES OF KARTABO, BRITISH GUIANA,
AND CARIPITO, VENEZUELA.



FIG. 17.



FIG. 18.



FIG. 19.

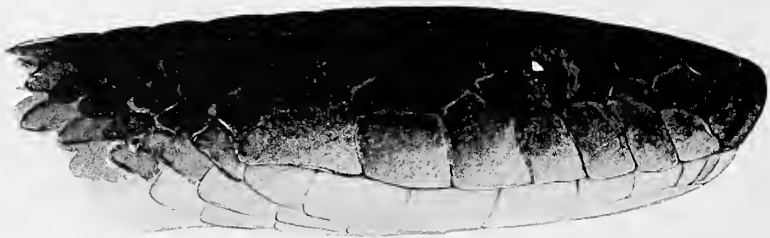

FIG. 20.



FIG. 21.

FIELD NOTES ON THE SNAKES OF KARTABO, BRITISH GUIANA,
AND CARIPITO, VENEZUELA.

FIG. 22.

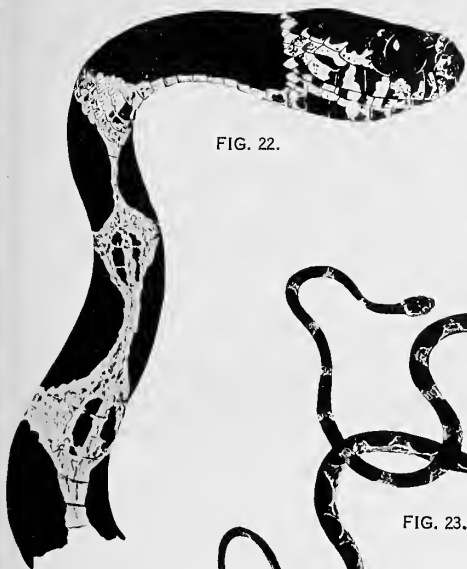

FIG. 24.

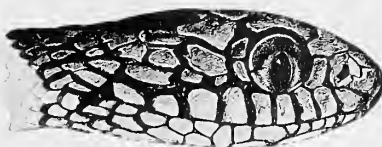

FIG. 23.



FIG. 25.

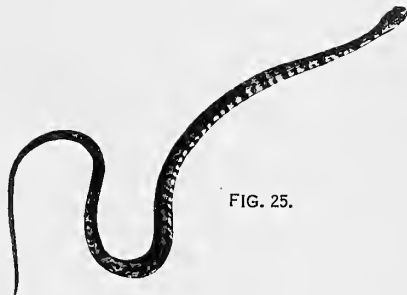

FIG. 26.

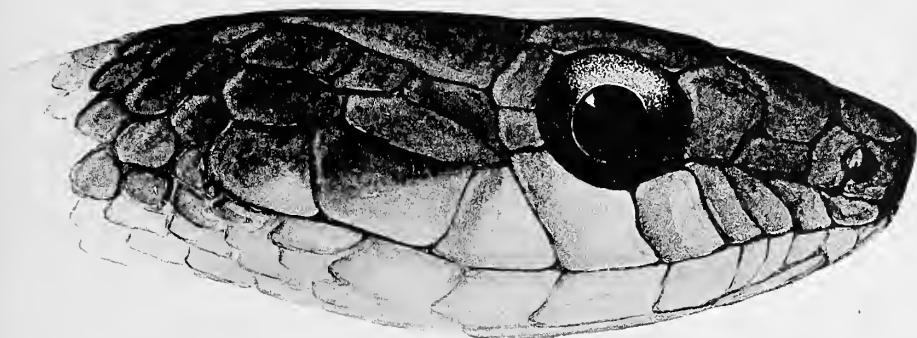
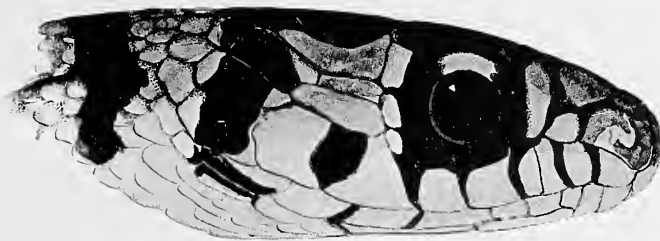

FIG. 27.



FIELD NOTES ON THE SNAKES OF KARTABO, BRITISH GUIANA,
AND CARIPITO, VENEZUELA.



FIG. 28.



FIG. 29.



FIG. 30.



FIG. 31.



FIG. 33.



FIG. 32.

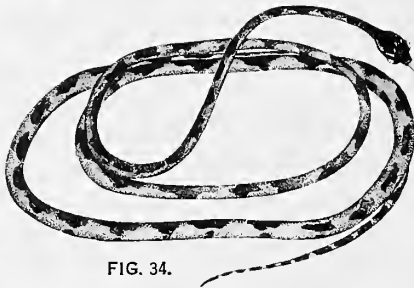

FIG. 34.

FIELD NOTES ON THE SNAKES OF KARTABO, BRITISH GUIANA,
AND CARIPITO, VENEZUELA.



FIG. 35.



FIG. 36.



FIG. 37.



FIG. 38.

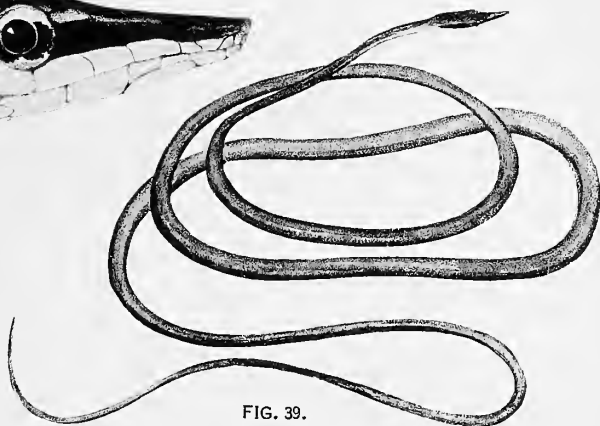

FIG. 39.



FIG. 40.

FIELD NOTES ON THE SNAKES OF KARTABO, BRITISH GUIANA,
AND CARIPITO, VENEZUELA.



FIG. 41.



FIG. 42.



FIG. 43.

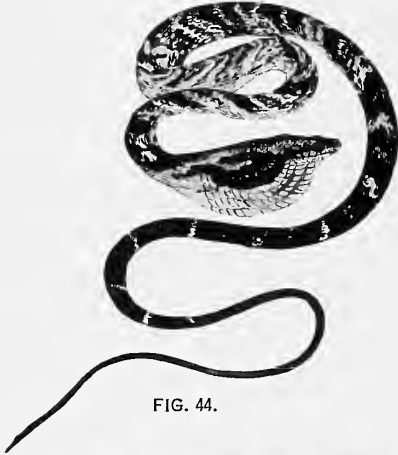

FIG. 44.

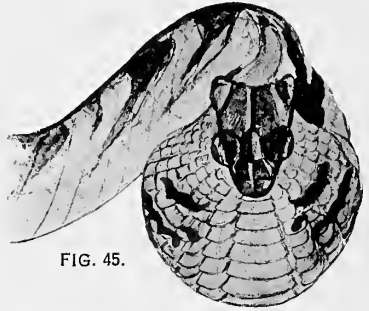

FIG. 45.

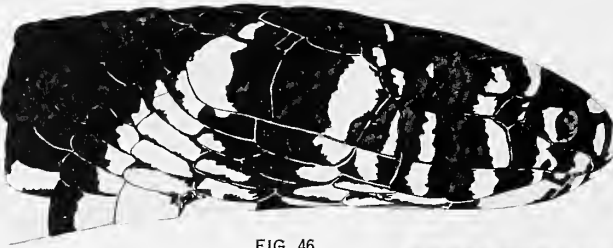

FIG. 46.

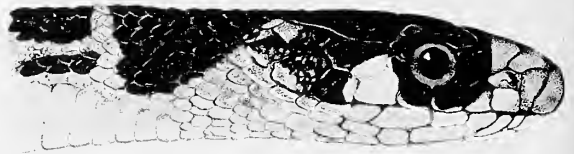

FIG. 47.



FIG. 48.

FIELD NOTES ON THE SNAKES OF KARTABO, BRITISH GUIANA,
AND CARIPITO, VENEZUELA.



FIG. 49.

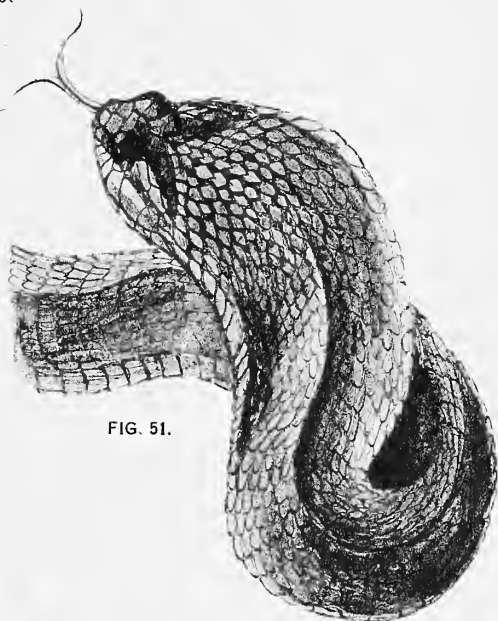

FIG. 51.

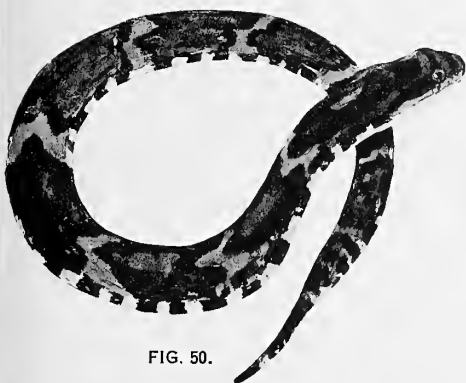

FIG. 50.



FIG. 52.

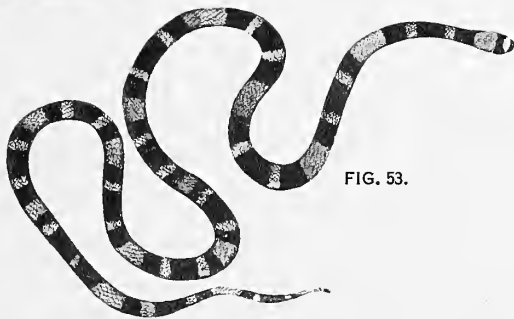

FIG. 53.

FIELD NOTES ON THE SNAKES OF KARTABO, BRITISH GUIANA,
AND CARIPITO, VENEZUELA.



FIG. 54.

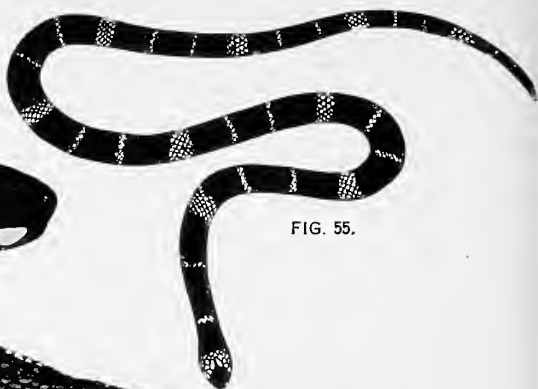

FIG. 55.

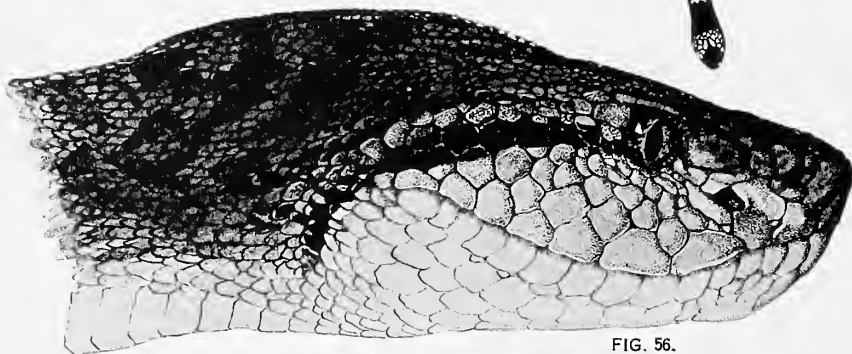

FIG. 56.



FIG. 57.



FIG. 58.

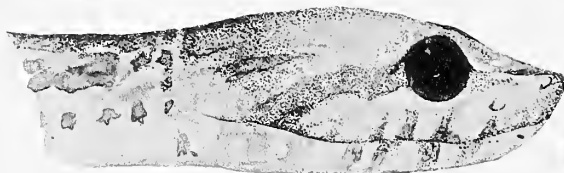

FIG. 59.

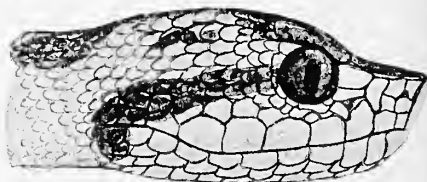



FIG. 60.



FIG. 61.

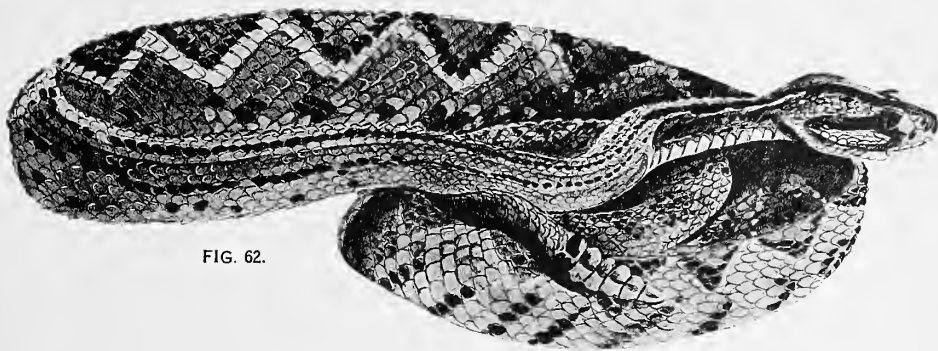

FIG. 62.

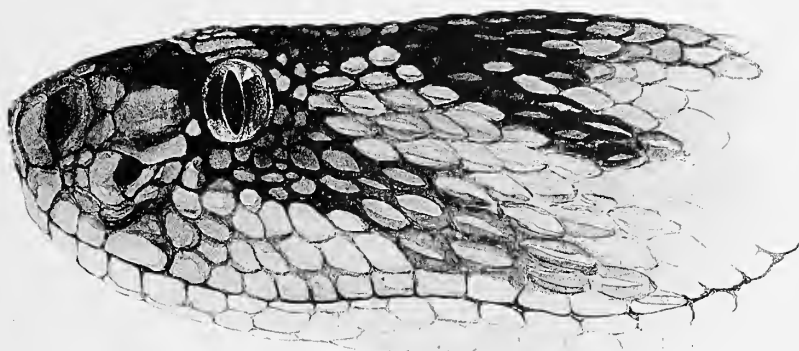

FIG. 63.

FIELD NOTES ON THE SNAKES OF KARTABO, BRITISH GUIANA,
AND CARIPITO, VENEZUELA.



90.573

ZOOLOGICA

SCIENTIFIC CONTRIBUTIONS
of the
NEW YORK ZOOLOGICAL SOCIETY

VOLUME 31

Part 2

Numbers 5-7



Published by the Society
The Zoological Park, New York
August 20, 1946

CONTENTS

	PAGE
5. Eastern Pacific Expeditions of the New York Zoological Society. XXXII. Mollusks from the West Coast of Mexico and Central America. Part III. by LEO GEORGE HERTLEIN & A. M. STRONG. Plate I.	53
6. Introgressive Hybridization in Domesticated Fishes. I. The Behavior of Comet—A <i>Platyocilus maculatus</i> Gene in <i>Xiphophorus hellerii</i> . By MYRON GORDON. Plates I-III.	77
7. Spontaneous Neoplasms in Fishes. I. Osteochondroma in the Jewelfish, <i>Hemichromis bimaculatus</i> . By ROSS F. NIGRELLI & MYRON GORDON. Plates I-5; Text-figures 1 & 2.	89

5.

Eastern Pacific Expeditions of the New York Zoological Society. XXXIV.
Mollusks from the West Coast of Mexico and Central America. Part III.¹

LEO GEORGE HERTLEIN & A. M. STRONG.

(Plate I).

[This is the thirty-fourth of a series of papers dealing with the collections of the Eastern Pacific Expeditions of the New York Zoological Society made under the direction of William Beebe. The present paper is concerned with specimens taken on the Templeton Crocker Expedition (1936) and the Eastern Pacific Zaca Expedition (1937-1938). For data on localities, dates, dredges, etc., refer to *Zoologica*, Vol. XXII, No. 2, pp. 33-46, and Vol. XXIII, No. 14, pp. 287-298.]

CONTENTS.

	Page
Introduction	53
Superfamily Ostracea	54
Family Ostreidae	54
Genus <i>Ostrea</i> Linnaeus	54
<i>Ostrea columbiensis</i> Hanley	54
<i>Ostrea fisheri</i> Dall	54
<i>Ostrea iridescens</i> Gray in Hanley	55
<i>Ostrea megodon</i> Hanley	55
<i>Ostrea palmula</i> Carpenter	55
Superfamily Pectinacea	56
Family Pectinidae	56
Genus <i>Pecten</i> Müller	56
Subgenus <i>Pecten</i> s.s.	56
<i>Pecten (Pecten) diegensis</i> Dall	56
<i>Pecten (Pecten) sericeus</i> Hinds	56
<i>Pecten (Pecten) vogdesi</i> Arnold	57
Subgenus <i>Chlamys</i> Bolten	57
<i>Pecten (Chlamys) lowei</i> Hertlein	57
Subgenus <i>Plagiocentium</i> Dall	57
<i>Pecten (Plagiocentium) circularis</i> Sowerby	57
Subgenus <i>Lyropecten</i> Conrad	58
<i>Pecten (Lyropecten) subnodosus</i> Sowerby	58
<i>Pecten (Lyropecten) subnodosus intermedius</i> Conrad	58
Subgenus <i>Mesopeplum</i> Iredale	59
<i>Pecten (Mesopeplum) fasciculatus</i> Hinds	59
Subgenus <i>Leptopecten</i> Verrill	59
<i>Pecten (Leptopecten) latiauratus</i> Conrad	59
<i>Pecten (Leptopecten) latiauratus monotimeris</i> Conrad	60
<i>Pecten (Leptopecten) tumbezensis</i> d'Orbigny	60
<i>Pecten (Leptopecten) velero</i> Hertlein	60
<i>Pecten (Leptopecten) velero biolleyi</i> Hertlein & Strong, subsp. nov.	60
Subgenus <i>Delectopecten</i> Stewart	61
<i>Pecten (Delectopecten) arces</i> Dall	61
Subgenus <i>Cyclopecten</i> Verrill	61
<i>Pecten (Cyclopecten) catalnensis</i> Willett	61
<i>Pecten (Cyclopecten) pernominus</i> Hertlein	61
Family Spondyliidae	62
Genus <i>Spondylus</i> Linnaeus	62
<i>Spondylus princeps</i> Broderip	62
Genus <i>Plicatula</i> Lamarck	63
<i>Plicatula penicillata</i> Carpenter	63
<i>Plicatula spondyloopsis</i> Rochebrune	63
Family Dimyidae	64
Genus <i>Dimya</i> Rouault	64
<i>Dimya californiana</i> Berry	65
Family Limidae	65
Genus <i>Lima</i> Cuvier	65
Subgenus <i>Lima</i> s.s.	65
<i>Lima (Lima) tetrica</i> Gould	65
Subgenus <i>Promantellum</i> Iredale	65

<i>Lima (Promantellum) pacifica</i> d'Orbigny ..	66
Subgenus <i>Limaria</i> Link	66
<i>Lima (Limaria) hemphilli</i> Hertlein & Strong, sp. nov.	66
<i>Lima (Limaria) orbignyi</i> Lamy	67
Subgenus <i>Limatula</i> Wood	68
<i>Lima (Limatula) subauriculata</i> Montagu ..	68
Superfamily Anomiacea	68
Family Anomiidae	68
Genus <i>Anomia</i> Linnaeus	68
<i>Anomia peruviana</i> d'Orbigny	68
Genus <i>Pododesmus</i> Philippi	68
<i>Pododesmus macrochismus</i> Deshayes	68
Genus <i>Placunanomia</i> Broderip	69
<i>Placunanomia cumingii</i> Broderip	69
Superfamily Mytilidae	69
Family Mytilidae	69
Genus <i>Mytilus</i> Linnaeus	70
Subgenus <i>Mytilus</i> s.s.	70
<i>Mytilus (Mytilus) californianus</i> Conrad ..	70
Subgenus <i>Chloromya</i> Mörch	70
<i>Mytilus (Chloromya) palliipunctatus</i> Dunker ..	70
Genus <i>Brachidontes</i> Swainson	70
Subgenus <i>Hormomya</i> Mörch	70
<i>Brachidontes (Hormomya) adamsianus</i> Dunker	70
Genus <i>Septifer</i> Recluz	71
<i>Septifer zeteki</i> Hertlein & Strong, sp. nov.	71
Genus <i>Volsella</i> Scopoli	72
Subgenus <i>Volsella</i> s.s.	72
<i>Volsella (Volsella) arciformis</i> Dall	72
<i>Volsella (Volsella) capax</i> Conrad	72
<i>Volsella (Volsella) guyanensis</i> Lamarck ..	72
<i>Volsella (Volsella) salvadorica</i> Hertlein & Strong, sp. nov.	73
Subgenus <i>Amygdalum</i> Megerle von Mühlfeld ..	73
<i>Volsella (Amygdalum) pallidula</i> Dall	73
<i>Volsella (Amygdalum) speciosa</i> Dunker	73
Genus <i>Botula</i> Mörch	74
Subgenus <i>Adula</i> H. & A. Adams	74
<i>Botula (Adula) falcata</i> Gould	74
Genus <i>Lithophaga</i> Bolten	74
Subgenus <i>Myoforceps</i> Fischer	74
<i>Lithophaga (Myoforceps) aristata</i> Dillwyn ..	74
Subgenus <i>Labis</i> Dall	74
<i>Lithophaga (Labis) attenuata</i> Deshayes ..	74
Subgenus <i>Diberus</i> Dall	75
<i>Lithophaga (Diberus) plumula</i> Hanley	75
Genus <i>Crenella</i> Brown	75
<i>Crenella divaricata</i> d'Orbigny	75

INTRODUCTION.

This is the third of a series of papers dealing with collections of mollusks taken on the Templeton Crocker Expedition (1936) and the Eastern Pacific Zaca Expedition (1937-1938). The general plan of presentation followed in the present contribution is that mentioned in Part II of this series of papers². Formal headings and keys are given only for the species collected by the Expeditions of 1936 and 1937-1938.

² Hertlein, L. G. and Strong, A. M. Eastern Pacific Expeditions of the New York Zoological Society. XXXII. Mollusks from the West Coast of Mexico and Central America. Part II. *Zoologica*, New York Zool. Soc., Vol. 28, Pt. 3, December 6, 1943, pp. 149-168, pl. 1.

¹ Contribution No. 737, Department of Tropical Research, New York Zoological Society.

Acknowledgment is due Dr. G. D. Hanna, Curator, department of Paleontology of the California Academy of Sciences, for assistance and suggestions. Acknowledgment is also due Dr. A. Myra Keen of Stanford University, Mr. A. G. Smith, Berkeley, California, Mr. George Willett of the Los Angeles County Museum of History, Science and Art, and Mr. C. G. Abbott, director of the San Diego Society of Natural History. The preparation of photographs by Mr. Frank L. Rogers is here acknowledged; his work was accomplished during the course of Federal Works Progress Administration Project Number 8569.

CLASS PELECYPODA.

Order Prionodesmacea.

Superfamily Ostracea.

FAMILY OSTREIDAE.

Genus *Ostrea* Linnaeus.

Key to the species of *Ostrea*.

- A. Margin with denticles or transverse striae
- a. Margin plicated
- b. Upper valve flat, fitting into the lower *palmula*
- bb. Upper valve arched, interlocking with the lower
- c. Shape arcuate, with 4 or 5 large corrugations; denticles along dorsal half of margin..... *megodon*
- cc. Shape round or subrounded; transverse striae on margin just below hinge..... *fisheri*
- aa. Margin usually not plicated; interior iridescent, burnished bronze, or white *videscens*
- B. Margin without denticles or transverse striae *columbiensis*

Ostrea columbiensis Hanley.

Ostrea columbiensis Hanley, *Proc. Zool. Soc. London*, for 1845 (issued February, 1846), p. 107. "Hab. St. Elena, West Columbia, adhering to the rocks at half-tide (Cuming)".—Sowerby, *Conch. Icon.*, Vol. 18, *Ostraea*, January, 1871, species 10, pl. 7, figs. 10a, b. "St. Helena, Cuming. Mazatlan. Lower California".

Type Locality: Santa Elena, Ecuador, adhering to rocks at half-tide.

Range: San Bartolome [Turtle] Bay, Lower California, and the Gulf of California, to Coquimbo, Chile.

Collecting Station: Nicaragua: Isla Encantada, Corinto.

Description: Shell varying in shape from suborbicular to oblong, often about 3 inches long; lower valve usually attached by its entire lower surface; the upper valve fits into the lower and is continued by lamellae to

the margin which often expands into wavy foliations; upper surface often rayed with purple on a white ground; the interior of the valves white; margin not dentate; scar reniform in shape; the margin as well as the muscle scar is usually colored purple.

Ostrea columbiensis never attains the size or thickness of *O. chilensis* Philippi. It also differs in the purple margin and in the presence of yellow or purple rays ornamenting the upper valve.

Distribution: This species occurs from Lower California to Chile and is usually found adhering to rocks or mangroves. It is gathered and sold for food in the markets of Peru.

Ostrea fisheri Dall.

Ostrea jacobaea Rochebrune, *Bull. Mus. Nat. Hist. Nat. Paris*, Vol. 1, 1895, p. 241. "Iles de la Baie de la Paz."—Contreras, *An. Inst. de Biología*, Vol. 3, No. 3, 1932, p. 210, figs. 22 and 23. Islands of San Jose and Espiritu Santo, Gulf of California.

Ostrea fisheri Dall, *Nautilus*, Vol. 28, No. 1, May, 1914, p. 1. "Gulf of California." New name for *Ostrea jacobaea* Rochebrune, not *O. jacobaea* Linnaeus.

Type Locality: Islands in the Bay of La Paz, Lower California.

Range: San Luis Gonzaga Bay, Gulf of California, to Panama and the Galápagos Islands.

Collecting Station: Mexico: Santa Inez Bay, Gulf of California.

Description: Subcircular or rounded in outline, thick, valves gently arched, externally colored blackish-purple or dark red; margin often but not always with 6 to 8 plications which in some specimens give rise to irregular hollow tubercles; margin without denticles; ligamentary pit triangular and small in proportion to the size of the shell; transverse striations occur along the margin just below the ligamentary pit; interiorly the margin and the muscle scar are colored purple and in some specimens nearly all the interior is colored blackish-purple but in others the earlier portion is white. A large specimen from La Paz, Lower California, in the collections of the California Academy of Sciences, measures approximately 172 mm. from beak to base.

Ostrea fisheri bears a resemblance to *O. hyotis* Linnaeus, an Indo-Pacific species, and also to *O. sinensis* Gmelin, described from China. It also resembles *O. thomasi* McLean,³ a species living off Florida, and *O. tamiamiensis* Mansfield from the Pliocene of Florida.

Distribution: *Ostrea fisheri* occurs at

³ *Ostrea (Ostrea) thomasi* McLean, *Not. Nat. of Acad. Nat. Sci. Philadelphia*, No. 67, January 14, 1941, p. 7, pl. 3, figs. 1, 2, pl. 4, figs. 1, 2. The type was "dredged off Palm Beach, Florida, in 300 feet of water. It was firmly attached to a piece of coral. . . ."

various localities from the Gulf of California to the Galápagos Islands but so far as known it appears to be abundant only in the southern part of the Gulf of California. It is known to occur from Pliocene to Recent.

***Ostrea iridescens* Gray in Hanley.**

Ostrea iridescens Gray, M.S. in Hanley, Conch. Miscell., *Ostrea*, 1854, pl. 2, figs. 6 and 7—Contreras, *An. Inst. de Biología*, Vol. 3, No. 3, 1932, p. 194, figs. 1 and 2. San Lucas; Mazatlan to Panama. [Not all the synonymy. Not the record "la costa occidental de Africa."]

Ostraea spathulata Lamarck, Sowerby, Conch. Icon., Vol. 18, *Ostraea*, 1871, species 13, pl. 8, fig. 13. "Guacomayo, Co. of America".

Not *Ostrea spathulata* Lamarck, *Hist. Nat. Anim. s. Vert.*, Vol. 6, 1819, p. 206.

Type Locality: Reef at Panama City, Panama (here designated).

Range: La Paz, Lower California, to Panama.

Collecting Stations: Mexico: Banderas Bay, shore; Tenacatita Bay, shore; Port Guatulco, shore; Santa Cruz Bay, shore; Tangola-Tangola Bay, shore; El Salvador: Conchagueta Island, Gulf of Fonseca; Nicaragua: Potosi and Monypenny Point, Gulf of Fonseca; Costa Rica: Gulf of Dulce; Port Culebra.

Description: Shell elongately rectangular, with laminated structure, hinge long and square; large denticles occur along the margin below the hinge, and these fit in corresponding sockets in the opposite valve; the color of the interior is sometimes white but is usually beautifully iridescent and often of a brownish metallic luster; the muscle scar is large, reniform and variable.

This species has sometimes been cited under the name of *Ostrea prismatica* Gray, a South African species.

Distribution: *Ostrea iridescens* occurs from the Gulf of California to Panama and is often observed on rocks exposed between tides. The species is known to occur in the Pleistocene of Mexico and Ecuador and it probably occurs in the Pliocene of Peru.

***Ostrea megodon* Hanley.**

Ostrea megodon Hanley, *Proc. Zool. Soc. London*, Pt. 13, for 1845 (issued February, 1846), p. 106. "Hab. Peru (Cuming). Mus. Cuming."—Sowerby, Conch. Icon., Vol. 18, *Ostraea*, 1871, species 24, pl. 12, figs. 24a, 24b. Peru.

Type Locality: Peru.

Range: Scammon Lagoon, Lower California, and the Gulf of California, to Paita, Peru.

Collecting Station: Costa Rica: 14 miles S.E. of Judas Point (214-D-1-4), 42-61 fathoms, mud, shell, rocks.

Description: Shell arcuate, usually at-

tached by the tip of the umbo; margin folded into 4 or 5 large rounded plications and occasionally with additional smaller folds posteriorly; a row of denticles usually occurs along the margin from the hinge to about half the length of the shell; interior white with green or whitish-green margin.

Related species occur in the Miocene of the Caribbean region.

Distribution: This species occurs from Lower California to Peru. It usually occurs in fairly shallow water. The specimens in the present collection were dredged in 42-61 fathoms. The species is known from Pliocene to Recent.

***Ostrea palmula* Carpenter.**

Plate I, Figure 14.

Ostrea ? conchaphila, var. *palmula* Carpenter, Cat. Mazatlan Shells, March, 1856, pp. 163, 550. "Mazatlan; extremely rare; L'pool Col. S. W. Mexico, P. P. C.—Upper California, Nuttall."

Ostraea mexicana Sowerby, Conch. Icon., Vol. 18, *Ostraea*, 1871, species 35, pl. 16, figs. 35a, b, c. "Tehautepec, Mexico."

Type Locality: Mazatlan, Mexico.

Range: San Ignacio Lagoon, Lower California, and the Gulf of California, to Tumaco, Colombia, and the Galápagos Islands.

Collecting Stations: Mexico: Concepcion Bay, Lower California, 2½ to 4 fathoms, attached to calcareous material; Port Guatulco; Nicaragua: San Juan del Sur; Costa Rica: Port Parker; Colombia: Gorgona Island.

Description: Attached by the lower valve which turns up forming a cup-shaped depression; upper valve nearly flat and fitting into the upturned lower valve; margin usually plicated, sometimes with as many as 15 foliaceous plications; the exterior is usually some shade of green or purplish-blue; interiorly the margin is ornamented by a row of fine denticles which fit into corresponding sockets in the opposite valve; the margin is colored a dark purplish-blue, the muscle scar may be dark bluish-purple or light olive in color and the remainder of the interior may be white, olive, or bluish in color.

Ostrea palmula is a variable species and has been described under several different specific names in the literature. It is characterized by the flattish upper valve which fits into the plicate lower valve, and by the purplish-blue dentate margin. The form cited under this name from California and Washington can be referred to *Ostrea lurida laticaudata* Carpenter.

Distribution: *Ostrea palmula* occurs abundantly between tides at many localities from Lower California to Panama and the Galápagos Islands. It is usually attached to rocks or to mangroves and occurs abundantly on reefs exposed to the surf. It is known to

occur in the Pleistocene and probably occurs from Pliocene to Recent in the Gulf of California region.

Superfamily Pectinacea.

FAMILY PECTINIDAE.

Genus *Pecten* Müller.

Key to the subgenera of the Pectinidae.

- A. Right valve arched, left valve flat or nearly so *Pecten* s.s.
 B. Both valves convex
 a. Shell corrugated, usually thick, strongly sculptured, usually brightly colored
 b. Ribs and interspaces strongly radially striated
 c. Shell large, very thick, ribs 9-12, often noded *Lyropecten*
 cc. Shell smaller, thinner, ribs 5-7, not noded *Mesopeplum*
 bb. Ribs and interspaces without strong radial striae
 d. Ears nearly equal in length
 e. Shell small, oblique, thin *Leptopecten*
 ee. Shell large, less oblique, thick, very convex *Plagioctenium*
 dd. Ears unequal in length, the right markedly the longer... *Chlamys*
 aa. Shell not corrugated, very thin, glassy, delicate sculpture, colored wholly or partly white
 f. Both valves with radial or reticulate sculpture *Delectopecten*
 ff. Right valve with concentric, the left with radial, sculpture *Cyclopecten*

Subgenus *Pecten* s.s.

Key to the species of *Pecten* s.s.

- A. Right valve very highly arched; about 19-20 low rounded ribs *vogdesi*
 B. Right valve gently arched; about 22-23 radial ribs
 a. Ribs high, squarish, interspaces flat-bottomed *diegensis*
 aa. Ribs lower, broader, and these as well as bottoms of interspaces often somewhat triangular in cross section *sericeus*

Pecten (Pecten) diegensis Dall.

Pecten floridus Hinds, Zool. Voy. *Sulphur*, Moll., Pt. 3, 1844 (dated January, 1845, on cover of Pt. 3), p. 60, pl. 17, figs. 6, 6a. "Inhab. San Diego, California. In five fathoms, among mud."

Not *Ostrea* [= *Pecten*] *florida* Gmelin, 1790.

Pecten (Pecten) diegensis Dall, *Trans. Wagner Free Inst. Sci.*, Vol. 3, Pt. 4, April, 1898, p. 710. "Pleistocene of San Diego; Hemphill. Living on the adjacent shores

from Monterey, California, southward." A new name for *Pecten floridus* Hinds, 1844, not *Ostrea* [= *Pecten*] *florida* Gmelin, 1790. —Arnold, U. S. Geol. Surv., Prof. Paper 47, 1906, p. 127, pl. 51, figs. 1, 1a, 1b. Monterey to San Diego, and in the Pleistocene of San Diego, California.

Type Locality: San Diego, California, in 5 fathoms, mud.

Range: Cordell Bank, California, to Gorda Banks, off Cape San Lucas, Lower California.

Collecting Stations: Mexico: East of Cedros Island (126-D-3, 10, 11, 12), 40-60 fathoms, mud, crushed shell, eel grass; Gorda Banks (150-D-2), 75 fathoms, sand.

Description: Right valve convex, ornamented by 22 or 23 flat-topped ribs which are generally longitudinally ridged or sulcated on top. Left valve flat or nearly so, and ornamented by 21 or 22 prominent, narrow, convex-topped ribs.

Distribution: This species is often dredged off southern California in 10 to 30 fathoms. It apparently occurs in deeper water further south. The present record of specimens dredged on Gorda Banks in 75 fathoms is an extension south in the known range of the species. It is known to occur north to Cordell Bank, California.

Pecten (Pecten) sericeus Hinds.

Pecten sericeus Hinds, Zool. Voy. *Sulphur*, Moll., Pt. 3, 1844 (dated January, 1845, on cover of Pt. 3), p. 60, pl. 17, figs. 1, 1a. "Inhab. Bay of Panama. In fifty-three fathoms, on a muddy floor".

Pecten (Pecten) sericeus Hinds, Hertlein, *Proc. Calif. Acad. Sci.*, Ser. 4, Vol. 21, No. 25, 1935, p. 303, pl. 18, figs. 14, 15; pl. 19, figs. 3 and 4. Various localities cited, from east of San Jose del Cabo, Lower California, to Panama.

Type Locality: Bay of Panama, in 53 fathoms, muddy bottom.

Range: Santa Inez Bay, Gulf of California, to Panama. Also Maria Madre Island, Clarion Island, and Cocos Island.

Collecting Stations: Mexico: Arena Bank, Gulf of California (136-D-1, 4, 26, 27, 31), 35-50 fathoms, mud, *Arca* conglomerates, sand, crushed shell, calcareous algae, rock; Santa Inez Bay (147-D-2), 60 fathoms, mud, crushed shell; Gorda Banks (150-D-9), 50-60 fathoms, muddy sand; 3 miles off Pyramid Rock, Clarion Island (163-D-2), 55 fathoms, rock, coral; Costa Rica: Port Parker (203-D-3), 12 fathoms, shelly mud; Panama: Hannibal Bank west of Coiba Island, 35 fathoms, rocks, mud, coral.

Description: Right valve gently arched, the ribs are lower, broader, and are separated by slightly wider interspaces than are those of *P. diegensis*. Some of the large specimens reveal the presence of shallow

grooves separating three minor riblets on top of each rib, the middle riblet the highest of the three. In some cases a single riblet occurs directly in the center of the rib. The ribs on the flattened left valve are less prominent and wider spaced than are those of *P. diegensis*. On the ventral portion of some large left valves a faint riblet occurs in the interspaces between the ribs. The largest specimen of *Pecten sericeus* in the present collection measures 63 mm. from beak to base. On one of the specimens a *Capulus californicus* Dall is attached to the anterior side of the umbo of the right valve in exactly the same position as it occurs on some specimens of *Pecten diegensis*.

Distribution: This species occurs from the southern part of the Gulf of California to Panama, and off Maria Madre Island, Clarion Island and Cocos Island.

Pecten (Pecten) vogdesi Arnold.

Pecten (Pecten) vogdesi Arnold, U. S. Geol. Surv., Prof. Paper 47, 1906, p. 100, pl. 33, figs. 1, 1a; pl. 34, fig. 1. "The type of this species (a right valve) is from the upper San Pedro formation at San Pedro, California, Pleistocene. Also other localities.—Hertlein, *Proc. Calif. Acad. Sci.*, Ser. 4, Vol. 21, No. 25, 1935, p. 304, pl. 19, figs. 16 and 17. Various localities from Magdalena Bay, Lower California, and the Gulf of California, south to Paita, Peru. Pliocene and Pleistocene of California and Lower California.

Type Locality: Upper San Pedro formation (Pleistocene), San Pedro, California.

Range: Magdalena Bay, Lower California, and the Gulf of California, to Paita, Peru.

Collecting Stations: Mexico: Arena Bank (136-D-13, 23, 30), 35-85 fathoms, mud, sand, *Arca* conglomerate, weed; Ceralbo Island; Ceralbo Channel (137-D-30), 46 fathoms, rock; Santa Inez Bay (141-D-2, 3, 4), 10-20 fathoms, sand, crushed shell, weed, also on shore; Arena Point area; Gorda Banks (150-D-6), 60 fathoms, muddy sand, rocks; Manzanillo (184-D-1, 2), 25-30 fathoms, sand; Tenacatita Bay; Port Guatulco (195-D-19-20), 17-23 fathoms, gravel, mud, crushed shell; Costa Rica: Port Parker (203-D-1-2-3) 10-15 fathoms, sand, mud, crushed shell; Port Culebra; Golfito, Gulf of Dulce; Panama: Gulf of Chiriqui, David Bay and Isla Parida to Bahia Honda (221-D-1-5), 35-40 fathoms, sandy mud.

Description: Right valve highly arched and ornamented by 19 to 20 low rounded ribs. Left valve gently concave, and ornamented by about 22 low, square ribs. The color of the shell is usually light brown or reddish-brown.

This species has also been recorded in west American literature under the names of *Pecten dentatus* G. B. Sowerby, *Pecten*

excavatus Anton and *Pecten cataractes* Dall.

Distribution: This species occurs fairly commonly from Magdalena Bay, Lower California, to Peru, from near shore to 50 fathoms. The deepest occurrence in the present dredgings was at 85 fathoms. *Pecten vogdesi* also occurs in the Pliocene and Pleistocene of California and Lower California.

Subgenus *Chlamys* Bolten.

Pecten (Chlamys) lowei Hertlein.

Pecten (Chlamys) lowei Hertlein, *Proc. Calif. Acad. Sci.*, Ser. 4, Vol. 21, No. 25, September 26, 1935, p. 308, pl. 19, figs. 1, 2, 7, 8. "From Carmen Island, Gulf of California, from a depth of 20 fathoms."

Type Locality: Carmen Island, Gulf of California, in 20 fathoms.

Range: Carmen Island, Gulf of California, and Clarion Island, to Panama and the Galápagos Islands. ?Santa Catalina Island, California.

Collecting Stations: Mexico: Arena Bank (136-D-4, 22), 45-55 fathoms, mud; 3 mi. off Pyramid Rock, Clarion Island (163-D-2), 55 fathoms, rock, coral; Manzanillo (184-D-2), 30 fathoms, gravelly sand; Costa Rica: Golfito, Gulf of Dulce (218); Panama: Hannibal Bank (224), 35-40 fathoms, rocks, coral, sand, shells, mud.

Description: Right valve with a well developed byssal notch under the right auricle. The valves are ornamented by 20 to 22 rounded triangular ribs upon which spinose riblets occur and a spinose riblet occurs in each interspace. The color is white or gray flecked with brown or on some specimens the greater part is orange or reddish-brown. One of the largest specimens in the present collection measures approximately 18.5 mm. from beak to base.

Distribution: This species is known from Carmen Island, Angel de la Guardia Island, and Arena Bank in the Gulf of California, off Cape San Lucas, Lower California, Manzanillo, Mexico, Gulf of Dulce, Costa Rica, Hannibal Bank, Panama, and the Galápagos Islands. A specimen possibly of this species was dredged off Catalina Island, California, but the occurrence of the species there is not positively known.

Subgenus *Plagiocentrum* Dall.

Pecten (Plagiocentrum) circularis Sowerby.

Pecten circularis Sowerby, *Proc. Zool. Soc. London*, October 9, 1835, p. 110. "Hab. ad Sinum Californiae. (Guaymas)". "Found in sandy mud at a depth of seven fathoms."

Pecten (Plagiocentrum) circularis Sowerby, Arnold, U. S. Geol. Surv., Prof. Paper 47, 1906, p. 125, pl. 42, figs. 3, 4, 5, 6; pl. 44, figs. 6, 6a, 6b, 7. Pliocene and Pleistocene. Recent from the Gulf of California to Santa Elena, Ecuador.

Type Locality: Guaymas, Mexico, 7 fathoms, sandy mud.

Range: Cedros Island, Lower California, and the Gulf of California, to Paita, Peru.

Collecting Stations: Mexico: East of Cedros Island (126-D-2), 38 fathoms, mud; Arena Bank (136-D-18), 40 fathoms, mud; Santa Inez Bay (143-D-3, also beach), 35 fathoms, mud, crushed shell; (145-D-1, 3), 4-13 fathoms, sand; Concepcion Bay, anchorage 1 mile south of San Domingo Point; Arena Point area; Gulf of California; Cape San Lucas; Banderas Bay; Chamela Bay; Tenacatita Bay (183-D-2, also beach), 30 fathoms, sandy mud; Manzanillo (184-D-1, 2), 25-30 fathoms, sand, gravelly sand; Port Guatulco (195-D-2, 9, 17, 19, 20, 21, also beach), 3-23 fathoms, sand, gravelly sand, crushed shell, mud; Tangola-Tangola Bay (196-D-6, 7, 8, 14, also beach), 5-9 fathoms, sand, crushed shell; Nicaragua: Corinto (200-D-1, 3, 16, 17, 19, also beach), 2-13 fathoms, mangrove leaves; Costa Rica: Port Parker (203-D-1, 2, 3, also beach), 10-15 fathoms, sandy mud, crushed shell, algae; Culebra Bay; Port Culebra (206-D-1, 2, 3, also beach), 14 fathoms, sandy mud; Piedra Blanca Bay (208-D-1-10), 2-6 fathoms, rocks, sand, algae; Cedro Island, Gulf of Nicoya (213-D-1-10), 8-10 fathoms, mud, sand, crushed shell; Golfito, Gulf of Dulce (218); Panama: Gulf of Chiriqui (221-D-1-5), 35-40 fathoms, sandy mud.

Description: Both valves strongly arched; ornamented by 19 to 21 ribs, those on the right valve squarish, close-set, smooth, and those on the left narrower, flat-topped and with sloping sides; color light to dark brownish-red. The coloration of *P. circularis* is much more vivid than the more northern subspecies *aequisulcatus* which reaches a larger size when adult, has a thinner and flatter shell and narrower ribs. The subspecies is often colored with some pattern of brown while *circularis* is often ornamented with some pattern of red coloration.

Distribution: *Pecten circularis* was taken at many localities from Cedros Island to Panama, on the beach and at depths of 2 to 40 fathoms.

Subgenus *Lyropecten* Conrad.

Key to the species of *Lyropecten*.

- A. Right valve with 11 or 12 ribs, left with 10 or 11 *subnodosus*
 B. Right valve with 10 ribs, left with 9; lighter colored *intermedius*

Pecten (Lyropecten) subnodosus Sowerby.

Pecten subnodosus Sowerby, *Proc. Zool. Soc. London*, October 9, 1835, p. 109. "Found in sandy mud and coral sand in from ten to seventeen fathoms." Three varieties; brownish-red with white striae, "ad Sinum Californiae"; var. variegated with brown

and white patches, "ad Insulam Platae, Columbiae Occidentalis;" var. with more depressed shell of a bright orange color, "ad Sinum Tehuantepec, Mexicanorum."—Reeve, *Conch. Icon.*, Vol. 8, *Pecten*, 1852, species 20, pl. 4, fig. 20. Mexico and west Colombia, in sandy mud and coral sand, at a depth of 10 to 17 fathoms.

Type Locality: Island of La Plata, Ecuador.

Range: Tres Marias Islands, Mexico, to Negritos, Peru.

Collecting Stations: Mexico: Banderas Bay; Chamela Bay, Passavera Island; Costa Rica: Port Parker; Culebra Bay; Panama: Bahia Honda, beach; Hannibal Bank, 35-40 fathoms, rocks, sand, coral, shells, mud, algae.

Description: Shell large, coarse, thick, right valve usually ornamented with 11 striated ribs, the left with 10, and occasionally there are 12 on the right valve and 11 on the left; the ribs are often nodose especially on the earlier part of the shell.

Distribution: This species occurs at various localities from the Tres Marias Islands to Paita, Peru. The exact northern limit is not known. It may occur in the Gulf of California but the form found there often has one less rib and is lighter colored.

Pecten (Lyropecten) subnodosus intermedius Conrad.

Lyropecten intermedius Conrad, *Amer. Jour. Conch.*, Vol. 3, Pt. 1, April 4, 1867, p. 7. "Cape St. Lucas, California."

Pecten (Lyropecten) subnodosus Sowerby, Arnold, U. S. Geol. Surv., Prof. Paper 47, 1906, p. 128, pl. 52, fig. 1; pl. 53, figs. 1, 1a. West coast of Mexico.

Pecten (Lyropecten) nodosus (Linnaeus) variety *intermedius* (Conrad), Grant and Gale, *Mem. San Diego Soc. Nat. Hist.*, Vol. 1, 1931, p. 181. Pliocene to Recent in the Gulf of California region.

Type Locality: Cape San Lucas, Lower California, Mexico.

Range: Scammon Lagoon to Cape San Lucas, and the Gulf of California; Clarion Island.

Collecting Stations: Mexico: Santa Inez Bay, beach; Arena Bank (136-D-6, 30), 35 fathoms, sand, weed; 3 miles off Pyramid Rock, Clarion Island (163-D-2), 55 fathoms, rock, coral.

Description: Shell usually with one rib less than that of *Pecten subnodosus*, lighter colored and often larger. There is some doubt as to the validity of this subspecies because the number of ribs is not constantly different from that of *P. subnodosus*. In general, however, the specimens from the west coast of Lower California and the Gulf of California show the features mentioned and for this reason the subspe-

cific name *intermedius* is retained at least for the present. A large specimen in the collections of the California Academy of Sciences from Scammon Lagoon, Lower California, measures 150 mm. from beak to base.

Distribution: This subspecies occurs at Scammon Lagoon, Cedros Island, Magdalena Bay and at Cape San Lucas, Lower California, as well as at many localities in the Gulf of California. The exact southern range is not known but it is known to occur as far south as Clarion Island and perhaps along the coast of Mexico some distance south of the Gulf of California. It occurs in shallow water.

Subgenus *Mesopeplum* Iredale.

Pecten (Mesopeplum) fasciculatus Hinds.

Pecten fasciculatus Hinds, Zool. Voy. *Sulphur*, Moll., Pt. 3, 1844 (date on cover of Pt. 3, January, 1845), p. 61, pl. 17, fig. 4. "West coast of Veragua. In seventeen fathoms among sandy mud."

Pecten (Pallium) miser Dall, *Bull. Mus. Comp. Zool.*, Vol. 43, No. 6, October, 1908, p. 401, pl. 8, fig. 6. "Gulf of Panama, in 182 fathoms, mud, bottom temperature 54°.1 F."

Pecten (Decadopecten) fasciculatus Hinds, Hertlein, *Proc. Calif. Acad. Sci.*, Ser. 4, Vol. 21, No. 25, September 26, 1935, p. 318, pl. 18, figs 1, 2. Earlier records cited.

Type Locality: West coast of Veragua, Panama, 17 fathoms, in sandy mud.

Range: Arena Bank, Gulf of California, to Panama.

Collecting Stations: Mexico: Arena Bank, Gulf of California (136-D-27, 28, 31) 35-85 fathoms, sand, muddy sand, rock, calcareous algae, weed; Gorda Banks, Gulf of California (150-D-4, 6, 16, 18, 23), 45-75 fathoms, muddy sand, sand, rocks, calcareous algae; Panama: Hannibal Bank (224), 35-40 fathoms, rocks, coral, sand, shells, algae.

Description: Shell with about a half dozen rounded ribs ornamenting each valve; ribs and interspaces ornamented by fine radial riblets, which are covered with fine concentric imbrications. In some specimens the ribs are flatter than in others. Color brownish-pink exactly as shown on the original illustration. Interiorly most of the specimens show vertical grooving along the hinge line and large specimens have well developed, grooved, cardinal crura. Irregular radial rounded riblets occur along the interior ventral margin. This margin is turned up especially in the right valve but sometimes that of the left is turned down to meet the right. The largest specimen at hand measures approximately 31.4 mm. from beak to base.

A study of these specimens leaves no doubt that the species described by Dall as *Pecten miser* is identical with *P. fasciculatus*.

The features of *Pecten fasciculatus* so closely resemble illustrations of *Mesopeplum caroli* Iredale,⁴ the type of *Mesopeplum*, that we have referred it to that subgenus. It also closely resembles *Notochlamys anguineus* Finlay, the type of *Notochlamys*, which is said to differ from *Mesopeplum* only in lacking concentric sculpture.

Distribution: The present record of the occurrence of this species in the Gulf of California furnishes a long extension north in the range. It has been recorded as occurring in depths from 17 to 182 fathoms.

Subgenus *Leptopecten* Verrill.

Key to the species of *Leptopecten*.

- A. Every third rib (especially on the left valve) raised above the others
 - a. Ribs 16 *velero*
 - aa. Ribs 12 *biolleyi*
- B. Ribs of about equal elevation
 - a. Ribs square or subangular
 - b. Shell moderately thick, ears squarely offset from submargins *tumbezensis*
 - bb. Shell thin, areas joining ears and submargins rounded *latiauratus*
 - aa. Ribs 12-16 rounded corrugations of the shell *monotimeris*

Pecten (Leptopecten) latiauratus Conrad.

Pecten latiauratus Conrad, *Jour. Acad. Nat. Sci. Philadelphia*, Vol. 7, 1837, p. 238, pl. 18, fig. 9. "Inhabits below the efflux of the tide near Sta. Diego and Sta. Barbara."

Pecten (Chlamys) latiauratus Conrad, Arnold, U. S. Geol. Surv., Prof. Paper 47, 1906, p. 115, pl. 46, figs. 2, 2a, 3, 3a. Monterey to San Diego, California. Also Pliocene and Pleistocene.

Type Locality: San Diego, California (according to I. S. Oldroyd, 1924).

Range: Off Point Reyes, California, to Cape San Lucas, Lower California.

Collecting Stations: Mexico: 5 miles west of San Jose Point, Lower California (175-D-1), 45 fathoms, slabs of slaty rock; east of Cedros Island (126-D-8, 9, 10, 11, 12, 15), 42-60 fathoms, mud, crushed shell and eel grass; also (127-D-1), 38 fathoms, mud.

Description: Shell small, thin, 12 to 16 square ribs; hinge line long, oblique; ears acutely pointed at termination of hinge line.

Distribution: This little pecten was dredged west of San Jose Point, at several localities east of Cedros Island, and a few were collected at Cape San Lucas, Lower California.

⁴ *Mesopeplum caroli* Iredale, *Rec. Australian Mus.*, Vol. 17, No. 4, September 4, 1929, p. 162, pl. 38, figs. 7-9. "Type trawled in 55-60 fathoms off Montague Island, New South Wales."

Pecten (Leptopecten) latiauratus monofimeris
Conrad.

Pecten monofimeris Conrad, *Jour. Acad. Nat. Sci. Philadelphia*, Vol. 7, 1837, p. 238, pl. 18, fig. 10. "Inhabits with the preceding" [=Inhabits below the efflux of the tide near Sta. Diego and Sta. Barbara]. "The young occasionally found attached to *Fuci* by a slender byssus."

Pecten (Chlamys) latiauritus var. *monofimeris* Conrad, Arnold, U. S. Geol. Surv., Prof. Paper 47, 1906, p. 131, pl. 46, figs. 4, 5, 5a. San Francisco and Santa Barbara to San Diego, California, Recent; also Pleistocene.

Type Locality: San Diego, California (according to I. S. Oldroyd, 1924).

Range: Monterey Bay, California, to Cape San Lucas, Lower California.

Collecting Stations: Mexico: East of Cedros Island (126-D-10), 60 fathoms, crushed shell and eel grass; Cape San Lucas.

Description: The rounded ribs which form broad corrugations of the shell, and the less acutely pointed ears, distinguish this subspecies from *P. latiauratus*.

Distribution: One specimen of *Pecten latiauratus monofimeris* was dredged east of Cedros Island and six typical specimens of this little kelp pecten were collected at Cape San Lucas, Lower California.

Pecten (Leptopecten) tumbezensis d'Orbigny.

Pecten tumbezensis d'Orbigny, *Voy. Amér. Mérid.*, Vol. 5, 1846, p. 663. Tumbez, Peru. New name for *Pecten aspersionis* Sowerby, not *P. aspersionis* Lamarck.

Pecten (Leptopecten) tumbezensis d'Orbigny, Hertlein, *Proc. Calif. Acad. Sci.*, Ser. 4, Vol. 21, No. 25, September 26, 1935, p. 314, pl. 19, figs. 11, 12. Gulf of California to Tumbez and Paita, Peru. Also Quaternary of Peru.

Type Locality: Tumbez, Peru.

Range: Gulf of California, to Paita, Peru.

Collecting Stations: Mexico: Manzanillo (184-D-2), 30 fathoms, gravelly sand; Santa Cruz Bay (195-D-21), 18 fathoms, mud; Tangola-Tangola Bay (196-D-17), 23 fathoms, mud; Guatemala: 7 miles west of Champerico (197-D-1-2), 14 fathoms, mud; El Salvador: La Libertad (198-D-1-2), 13-14 fathoms, mud; Meanguera Island, Gulf of Fonseca (199-D-1), 16 fathoms, sand, mud, crushed shell; Nicaragua: Corinto (200-D-19), 12-13 fathoms, mangrove leaves; Monypenny Point, Gulf of Fonseca; Costa Rica: 14 miles S.E. of Judas Point (214-D-1-4), 42-61 fathoms, mud, shell, rocks; Panama: Gulf of Chiriqui (221-D-1-5), 35-40 fathoms, sandy mud.

Description: Shell fairly thick in proportion to the size, usually somewhat expanded posteriorly; ornamented by about 14 square ribs. The right valve is usually at least

partly white in color but the left valve is usually ornamented by a sprinkling of light bluish dots on a slate-colored or brown background. A large valve from Monypenny Point, Nicaragua, in the Gulf of Fonseca, measures 31.2 mm. from beak to base and 33.9 mm. in length.

Distribution: This species was dredged at a number of localities from off Manzanillo, Mexico, to Panama, in depths from 12 to 61 fathoms. It ranges south to Peru.

Pecten (Leptopecten) velero Hertlein.

Pecten (Leptopecten) velero Hertlein, *Proc. Calif. Acad. Sci.*, Ser. 4, Vol. 21, No. 25, September 26, 1935, p. 316, pl. 19, figs. 13, 14. "Bahia Honda, Veragua, Panama, in three to nine fathoms."

Type Locality: Bahia Honda, Veragua, Panama, in 3 to 9 fathoms.

Range: Off Mazatlan, Mexico, to Panama.

Collecting Stations: Mexico: Manzanillo (184-D-2), 30 fathoms, gravelly sand; El Salvador: Meanguera Island, Gulf of Fonseca (199-D-1), 16 fathoms, sand, mud, crushed shell; Nicaragua: Corinto (200-D-1, 19), 6.5-13 fathoms, mangrove leaves.

Description: Shell small, ornamented by 16 ribs of which every third one is raised above the others, this is especially noticeable on the left valve. Toward the ventral margin of the right valve some specimens have well developed interribs and occasionally these also are present on the left valve.

Distribution: This species is known to occur off Mazatlan, Manzanillo, and Tres Marias Islands, Mexico, Meanguera Island, Gulf of Fonseca, El Salvador, Corinto, Nicaragua, and at Bahia Honda, Panama. It has been dredged in waters to a depth of 30 fathoms.

Pecten (Leptopecten) velero biolleyi

Hertlein and Strong, subsp. nov.

Plate I, Figure 6.

Shell small, rather thin, hinge long; color white and brown roughly arranged in concentric bands; anterior ear of right valve with large byssal notch and ctenolium, ornamented by three ribs; ventral margin broadly rounded; left ear large and broadly notched, ornamented by about four ribs; valve ornamented by about 12 to 13 rather high sharply triangular ribs which are separated by considerably wider interspaces, ribs and interspaces with strong, dense, fringing imbricating lamellae; when slightly worn the tops of the ribs are smooth; the ribs near the anterior and posterior margins are somewhat higher than the others and sometimes every third rib or pair of ribs is slightly raised; left valve similar to right except that it lacks the large byssal notch and the right ear is ornamented by about 4 or 5 ribs and the left ear is orna-

mented by 5 or 6 ribs; on some left valves every third rib is raised higher than the intervening ones. Length, 6.9 mm.; height, 6.6 mm.

Holotype, right valve, and paratypes (Calif. Acad. Sci. Paleo. Coll.), from Station 203-D-3, dredged in 12 fathoms (22 meters) in Lat. 10°55'45"N., Long. 85°49'05"W., Port Parker, Costa Rica, on bottom of sandy mud and crushed shells. Several small specimens were dredged near the same locality at Station 203-D-1.

This form is described as a subspecies of *Pecten velero* Hertlein because occasional left valves have every third rib raised similar to that species. The new subspecies differs from *Pecten velero* in possessing fewer, stronger ribs, 12 as compared to 16, and in that every third rib is less strongly raised in relation to the others. *Pecten velero biolleyi* resembles *P. bellilamellatus* Arnold⁵ a species described as a fossil from the Pliocene of California, but differs in possessing fewer ribs, only 12 or 13 as compared to 15 or 16. Our specimens bear a remarkable resemblance to Arnold's illustrations of *P. bellilamellatus* and possibly this new subspecies might be considered to be a living representative of that species. Arnold's species however, was described as possessing about 16 ribs whereas the present form is constant in its small size and in its ornamentation of 12 or occasionally 13 ribs. Compared to *Pecten latiauratus delosi* Arnold,⁶ the new subspecies has fewer, wider spaced ribs.

This new subspecies is named for Paul Biolley, former professor of Natural History at San Jose de Costa Rica.

Subgenus *Delectopecten* Stewart.

Pecten (Delectopecten) arces Dall.

Pecten (Pseudamusium) arces Dall, *Proc. U. S. Nat. Mus.*, Vol. 45, June 11, 1913, p. 592. "Off Santa Barbara, California, in over 500 fathoms, muddy bottom."

Pseudamusium arces Dall, *Proc. U. S. Nat. Mus.*, Vol. 66, Art. 17, 1925, p. 24, pl. 27, fig. 4. "Off Santa Cruz Island, Calif., in 534 fathoms."

Type Locality: Off Santa Barbara, California, in over 500 fathoms, mud.

Range: Off Santa Cruz Island, California, to off Cedros Island, Lower California.

Collecting Station: Mexico: East of Cedros Island (126-D-12), 45 fathoms, crushed shell, mud.

Description: Shell small, thin, ornamented

⁵ *Pecten (Chlamys) bellilamellatus* Arnold, U. S. Geol. Surv., Prof. Paper 47, 1906, p. 108, pl. 41, figs. 6, 6a, 7, 7a. "San Diego formation (Pliocene), Pacific Beach, San Diego County, Cal."

⁶ *Pecten (Chlamys) latiauritus* Conrad var. *delosi* Arnold, U. S. Geol. Surv., Prof. Paper 47, 1906, p. 130, pl. 46, figs. 9, 9a, 10, 10a. "San Pedro formation (lower portion), Pleistocene, Deadman Island, near San Pedro, Los Angeles County, Cal." Also Recent.

by reticulated radial and concentric sculpture which where crossing forms a tiny spinule. The posterior ear forms an oblique angle with the hinge line similar to that of *Pecten randolphi* Dall rather than a nearly square angle as is the case in *P. vancouverensis*. Two left valves in the present collection appear to be the young of this species.

Distribution: This species has been recorded from off Santa Cruz Island and San Nicolas Island, California. The present specimens extend the known range of the species south to Cedros Island, Lower California.

Subgenus *Cyclopecten* Verrill.

Key to the species of *Cyclopecten*.

- A. Right ear of each valve with fine reticulate sculpture *pernomus*
- B. Right ear of each valve without reticulate sculpture *catalinensis*

Pecten (Cyclopecten) catalinensis Willett.

Pecten (Cyclopecten) catalinensis Willett, *Nautilus*, Vol. 45, No. 2, October, 1931, p. 65, pl. 4, figs. 1 and 2. "Taken by the writer in 100 fathoms off White's Landing, north side of Catalina Island, California."

Type Locality: Off White's Landing, Catalina Island, California, in 100 fathoms.

Range: Catalina Island, California, to Cedros Island, Lower California.

Collecting Station: Mexico: East of Cedros Island (126-D-10), 60 fathoms, crushed shell and eel grass.

Description: Shell small, shining transparent, very fragile; right valve white, ornamented only by fine concentric lines of growth; the left valve with lines of growth which are crossed in the umbonal region by very fine wavy striae, also ornamented by irregular brown radial rays, in the type specimen about 20, in the present specimen about 15; ears on both valves nearly equal in size and ornamented by concentric lines of growth. A single small left valve in the present collection appears to be referable to this species.

The shell of *Pecten catalinensis* has more nearly equal ears, lacks the posterior sulcation and has different color markings from that of *P. cocosensis* Dall. Characters which assist in separating *P. catalinensis* from *P. pernomus* are the concentric rather than reticulate sculpture of the right ear of each valve, also the faint rather than well developed radial sculpture of the left valve.

Distribution: One valve of *Pecten catalinensis* was dredged by the Expedition east of Cedros Island, Lower California, in 60 fathoms. This is an extension south in the known range of the species.

Pecten (Cyclopecten) pernomus Hertlein.

Pecten (Cyclopecten) rotundus Dall, *Bull.*

Mus. Comp. Zool., Vol. 43, No. 6, October, 1908, p. 404. "Panama Bay, in 29½ fathoms; also at station 2784, in 194 fathoms, mud, bottom temperature 51°. 9 F."

Pecten (Cyclopecten) pernomus Hertlein, *Proc. Calif. Acad. Sci.*, Ser. 4, Vol. 21, No. 25, September 26, 1935, p. 320, pl. 18, figs. 11, 12, 13. New name for *Pecten (Cyclopecten) rotundus* Dall, not *P. rotundus* von Hagenow.

Type Locality: Panama Bay, in 29½ fathoms, mud.

Range: Cedros Island, Lower California, to Panama.

Collecting Stations: Mexico: East of Cedros Island (126-D-10, 12), 45-60 fathoms, crushed shell, eel grass, mud; Arena Bank (136-D-29), 70 fathoms, rock, weed; Manzanillo (184-D-2), 30 fathoms, gravelly sand; Port Guatulco (195-D-19), 17 fathoms, green mud, crushed shell; Costa Rica: Port Parker (203-D-1, 3), 12-15 fathoms, sandy mud, crushed shell, shelly mud.

Description: The shell of this species is small, thin, suborbicular, with sub-equal ears. The right valve is ornamented by concentric striations; the anterior ear is ornamented by fine reticulate sculpture, a byssal notch is present, the posterior ear smooth; valve colored white or ornamented by small white and brown spots. The left valve is radially striated, the striae bifurcating toward the ventral margin; the ears are subequal, the left the larger of the two, both finely radially striated and crossed by fine concentric sculpture; color white and often ornamented by brownish spots or by large V-shaped brownish areas pointing toward the beaks.

A study of the specimens in the present collection and of those collected by George Willett from off western Mexico has convinced us that these should be referred to *Pecten pernomus* Hertlein. The records from California Academy of Sciences localities numbers 23,779, 23,804, 25,527, 27,581, 27,584, 27,587, cited by Hertlein (1935) under *Pecten (Cyclopecten) cocosensis* Dall, can be referred to *P. pernomus*. The suborbicular shape and absence of the posterior sulcation as well as the larger ears and strong radial ornamentation of the left valve all serve to separate this species from *P. cocosensis* Dall.

Distribution: This species occurs fairly abundantly at some localities off southern Mexico and off Nicaragua. It occurs as far north as Cedros Island and south to the bay of Panama. Dall mentioned that a single valve from near the Straits of Magellan was apparently identical with *Pecten rotundus* Dall [= *pernomus*]. We have not seen specimens from that region but it seems unlikely that the species occurs that far south.

FAMILY SPONDYLIDAE.

Key to the genera of the Spondylidae.

- A. Shell with auricular areas each side of umbo *Spondylus*
 B. Shell without auricular areas each side of umbo *Plicatula*

Genus *Spondylus* Linnaeus.

Spondylus princeps Broderip.

Spondylus princeps Broderip, *Proc. Zool. Soc. London*, May 17, 1833, p. 4. "Hab. ad Insulam Platam Columbiae Occidentalis." "Found attached to coral rocks at the depth of seventeen fathoms."—Reeve, *Conch. Icon.*, Vol. 9, *Spondylus*, 1856, species 9, pl. 2, fig. 9. Original locality cited.

Spondylus leucacantha Broderip, *Proc. Zool. Soc. London*, May 17, 1833, p. 5. "Hab. ad Insulam Platam."—Reeve, *Conch. Icon.*, Vol. 9, *Spondylus*, 1856, species 6, pl. 2, fig. 6. Original locality cited.

Type Locality: Island of Plata, Ecuador, in 17 fathoms, attached to coral rocks.

Range: Scammon Lagoon, and the Gulf of California, to Negritos, Peru.

Collecting Stations: Mexico: Arena Bank (136-D-2, 4, 11), 30-45 fathoms, mud, Arca conglomerate, rock; Santa Inez Bay; Costa Rica: Port Culebra; Piedra Blanca; Panama: Bahia Honda; Colombia: Gorgona Island.

Description: Shell with radial rows of long spines; color white with red near the umbos, orange, or entirely red, interior white, border sometimes red or orange.

There is some doubt as to the earliest correct name for this species. It has generally been attributed to *Spondylus crassi-squama* Lamarck⁷. Lamarck referred to Recent specimens stated to occur in "les mers de l'Inde" and to fossil forms from "Fossil à Carthage d'Amérique." Favre⁸, who has given illustrations of Lamarck's fossil specimens, stated that Lamarck's Recent specimens can be referred to *S. pictorum* Chemnitz but that the name *crassi-squama* should apparently be restricted to the fossil form from Colombia. *Spondylus pictorum* Chemnitz⁹ has been considered by some authors to be the earliest name for the Recent west American form but the type locality of the species is given as the Mediterranean Sea and the Aegean

⁷ *Spondylus crassi-squama* Lamarck, *Hist. Nat. Anim. s. Vert.*, Vol. 6, February-June, 1819, p. 191. "Habite les mers de l'Inde." Also "On le trouve fossile à Carthage d'Amérique." References to "Rumph. Mus. t.48, fig.1." and "Encyclop. pl.192. f.2." Also "[b] *Squamis palmatis*. Seba, Mus. 3. t.88. f.10."

⁸ Favre, J., *Mus. d'Hist. Nat. Genève Cat. Illustr. Coll. Lamarck, Conch. Monoyraires foss. 1918, II Sec.*, pl. 12, figs. 39a, 39b, 39c. "Le *S. pictorum* semble être une mutation plus ornémentée du *S. crassi-squama* fossile, et il paraît indiqué de restreindre au type éteint le nom que Lamarck avait appliqué indistinctement aux deux formes parentes."

⁹ *Spondylus pictorum* Chemnitz, *Neus Syst. Conch.-Cab.*, Bd. 7, 1784, p. 94, suppl. pl. 69, figs. E. F. "Sie wohnt im mittelländischen Meere, und vorzüglich nach Aristotelis Aussage im ägeischen Meere, welches heut zu Tage der griechische Archipelagus heist."

Sea. Pfeiffer¹⁰ referred Chemnitz's figures "E." and "F." of *Spondylus pictorum* to *Spondylus gaederopus* of Gmelin. Some writers do not accept as valid the names of species proposed by Chemnitz.* However, his names appear to deserve acceptance far more than those of some authors whose names have been accepted but whose strict use of binomial nomenclature may be open to question. In any case the name *Spondylus princeps* Broderip without doubt was applied to the Recent west American *Spondylus* which also has been cited in the literature as *S. dubius* Broderip and *S. leucacantha* Broderip. D'Orbigny (1846) considered *S. leucacantha* to be only an adult variety of *S. princeps*. *Spondylus limbatus* Sowerby, erroneously cited from the Gulf of California by some authors, was originally described from the Persian Gulf.

Spondylus calcifer Carpenter¹¹, the only other species of *Spondylus* living in west American waters, possesses a very thick shell which is less coarsely spinose than that of *S. princeps*, and is colored along the interior margin by a deep reddish-purple band. It has been reported to range from Concepcion Bay in the Gulf of California to Panama. It is sometimes burned for lime in regions where it is abundant.

Distribution: *Spondylus princeps* occurs at various localities from Scammon Lagoon, Lower California, to Peru. Most of the specimens in the present collection were worn beach specimens or imperfect dredged specimens.

Genus *Plicatula* Lamarck.

Key to the species of *Plicatula*.

- A. Shell small, thin, finely radially ribbed *penicillata*
 B. Shell large, thick, coarsely radially plaited *spondylopsis*

Plicatula penicillata Carpenter.

Plicatula penicillata Carpenter, Cat. Mazatlan Shells, February, 1856, p. 155. "Hab.

¹⁰ Pfeiffer, L., Kritisches Register zu Martini und Chemnitz's Syst. Konch.-Kab., p. 73, (Kassel), 1840.

* Since this paper was submitted for publication the International Commission on Zoological Nomenclature has ruled against acceptance of the specific and subspecific names in Volumes 1-11 of Martini and Chemnitz, Neues Systematisches Conchylien-Cabinet, Nürnberg, 1769-1795. (See "Opinions and Declarations rendered by the International Commission on Zoological Nomenclature", Vol. 3, Pt. 3, Opinion 184. Summary, p. 27. "No new specific or subspecific trivial name published in these volumes has any status in nomenclature." Also p. 34. Issued October 17, 1944).

¹¹ *Spondylus calcifer* Carpenter, Cat. Mazatlan Shells, February, 1856, p. 152. "Hab.—Bay of Panama, in a few fathoms of water, Cuming; C. B. Adams.—La Paz; Lieut. Green.—Mazatlan; not uncommon."

This species appears to be the one illustrated by Reeve under the name *Spondylus radula* (Conch. Icon., Vol. 9, *Spondylus*, May, 1856, species 52, pl. 14, fig. 52. "Hab. Tehuantepec, West Mexico; Captain Dare.") The combination of names *Spondylus radula* was used by Lamarck in 1806, therefore Reeve's species was renamed *Spondylus smithi* by Fulton (Journ. Conch., Vol. 14, No. 12, October 1, 1915, p. 357).

—Bay of Fonseca, Cuming.—Mazatlan; extremely rare, on shells."—Sowerby, Conch. Icon., Vol. 19, *Plicatula*, 1873, species 3, pl. 1, fig. 3. North America.

Type Locality: Mazatlan, Mexico (here designated). Gulf of Fonseca also originally cited.

Range: Gulf of California to Panama.

Collecting Stations: Mexico: Port Guatulco (195-D-9), 7 fathoms, sand, crushed shell; Nicaragua: Corinto (200-D-19), 12-13 fathoms, mangrove leaves.

Description: Shell small, suborbicular or irregular in shape, thin, finely ribbed or sculptured by fine radial rows of hollow spines; some specimens are ornamented exteriorly by small brown spots; the interior of the shell is often colored by dark brown spots or stripes especially around the margin, which is denticulated. A large specimen measures approximately 15 mm. from beak to base.

Distribution: This species has been recorded between Cape Pulmo and Cape San Lucas, Lower California, Mazatlan, Mexico, Nicaragua, and Panama. Specimens in the present collection were dredged at depths of 7 to 13 fathoms.

Plicatula spondylopsis Rochebrune.

Plate I, Figures 15 and 16.

Plicatula spondylopsis Rochebrune, Bull. Mus. Nat. Hist. Nat. Paris, Vol. 1, 1895, p. 242. "Lagunes des îles de San Jose." Gulf of California.—Lamy, Jour. de Conchyl., Vol. 83, No. 1, 1939, p. 23. Lower California.

Type Locality: San Jose Island, Gulf of California, in lagoon.

Range: San Jose Island, Gulf of California, to Ecuador, and the Galápagos Islands.

Collecting Stations: Arena Bank (136-D-5, 26), 33-45 fathoms, sand, weed, crushed shell; Gulf of California.

Description: Shell roughly trigonal in shape, thick, ornamented by coarse radial plaited sculpture, which however may be partially or almost wholly absent on some specimens; two hinge teeth in each valve. In perfect shells the exterior is colored purple and the interior white, with dark spots around the corrugated margin. Muscle scar nearer the posterior margin. A very narrow space between the valves is occupied by the animal.

Plicatula ostreivaga Rochebrune is a synonym.

This species has been cited from west American waters under the name *Plicatula dubia* Hanley. At the time of original description *Plicatula dubia*¹² was cited from both the Philippine Islands and from the

¹² *Plicatula dubia* Hanley in Sowerby, Thes. Conch., Vol. 1, p. 437, pl. 90, fig. 12?; pl. 91, fig. 19, 1847. "Collected by Mr. Cuming at the Island of Samar, and at the Island of Cana, West Colombia."

Island of "Cana," west Colombia. Later writers including Hanley¹³, Sowerby¹⁴, Hidalgo¹⁵, and Lamy considered it to be a Philippine species. Lamy¹⁶ pointed out that an island of the name of "Cana" occurs in the Philippine Archipelago but that no island of that name is known from western South America. There is, however, an island of "Cano" in the Gulf of Nicoya and another island of the same name in the Gulf of Dulce, Costa Rica. It is uncertain whether either of these may have been the island to which Hanley referred. It appears then that the correct name for the west American species considered here is *Plicatula spondyloopsis* Rochebrune.

Plicatula spondyloidea Meuschen¹⁷, a Caribbean species, is very similar to the west American form.

Distribution: Plicatula spondyloopsis occurs from the Gulf of California to Ecuador and the Galápagos Islands, in rather shallow water. It also occurs from Pliocene to Recent in the same region.

FAMILY DIMYIDAE.

Genus *Dimya* Rouault.

Dimya Rouault, *Mem. Soc. Geol. France*, Ser. 2, Vol. 3, Pt. 2, 1848, p. 470 (Mem. No. 7, p. 14). Sole species, "*Dimya Deshayesiana*, Nob.", p. 471 (Mem. No. 7, p. 15), pl. 15 (Mem. No. 7, pl. B), figs. 3, 3a, 3b. "Bos d'Arros," France, Eocene.—Stoliczka, *Mem. Geol. Surv. India. Palaeont. Indica*, Ser. 6, Cret. Fauna South. India, Vol. 3, 1871, pp. XXII, 397. "Type, *D. Deshayesiana* Rouault, from Eocene beds at Bos d'Arros, France."—Dall, *Bull. Mus. Comp. Zool.*, Vol. 12, No. 6, 1886, p. 227. "Type *Dimya Deshayesiana* Rouault."

Not *Dimya* Menke, *Syn. Meth. Moll.*, 1830, p. 101. "Subordo 2. *Dimya*. (*Dimyaires*, Fér.)" Not *Dimya* F. Moore, 1881. *Lep. Noctuid*.

Margariona (Dall MS), Kobelt, *Nachrichtsbl. Malakozool. Gesell.*, Vol. 14, Nos. 11 and 12, November-December, 1882, p. 186. [No species cited, but it was placed in the synonymy of *Dimya* by Dall in 1886].

Deuteromya Cossmann, *Rev. Crit. de Paleozool.*, Vol. 7, 1903, p. 68. A new name for *Dimya* Rouault, not *Dimya* Menke.—Cossmann and Peyrot, *Act. Soc. Linn. Bordeaux*, Vol. 68, 1914, p. 409. "(G.-T.: *Dimya Deshayesiana* Rouault, Eoc.)"

Type (by monotypy): *Dimya deshayesiana* Rouault. Eocene of France. Illustrated

¹³ Hanley, S., *Cat. Rec. Biv. Shells*, 1856, p. 289. "Philippines."

¹⁴ Sowerby, G. B., *Conch. Icon.*, Vol. 19, *Plicatula*, 1873, species 13, pl. 4, fig. 13. "Hab. Isl. Samar, Philippines."

¹⁵ Hidalgo, J. G., *Cat. Mol. Test. Islas Filipinas*, 1904-1905, p. 385.

¹⁶ Lamy, E., *Journ. de Conchyl.*, Vol. 83, No. 1, 1939, p. 17.

¹⁷ See Lamy, E., *Journ. de Conchyl.*, Vol. 83, No. 1, 1939, p. 19.

by Rouault, 1848, pl. 15, figs. 3, 3a, 3b. Also, Tryon, *Struct. and Syst. Conch.*, Vol. 3, 1884, p. 281, pl. 132, figs. 80 and 81. Eocene; Pau.—Fischer, *Man. de Conchyl.*, 1886, p. 936, fig. 704.

Shell small, irregularly orbicular, adhering by the right valve which is larger than the left, compressed, externally nacreous, internally porcellanous; umbones slightly projecting, subcentral; surface smooth or with fine radial ornamentation or sculptured similar to the object to which it adheres; external ligament slender, linear; interior ligament in a small triangular pit. Interior white; anterior and posterior muscle scars present, the posterior one larger and double; pallial line simple; inner margin radiately wrinkled.

We have used the genus name *Dimya* Rouault although the name *Dimya* was also used by Menke in 1830 as a name for a suborder as follows: "Subordo 2. *Dimya*. (*Dimyaires*, Fér.)" If *Dimya* is not available as a generic name then the name *Margariona* Dall in Kobelt is applicable. Kobelt in 1882 mentioned that Dall intended to name a genus *Margariona* for a species of Dimyidae dredged in the Caribbean region. No species was cited by Kobelt and *Margariona* was thus originally a genus without species. In 1886 Dall placed *Margariona* in the synonymy of *Dimya* whose type was cited as *Dimya deshayesiana* Rouault. If *Dimya* Rouault proves to be invalid, Dall's action would make *Margariona* Dall in Kobelt a valid genus with the same type, *Dimya deshayesiana* Rouault. Cossmann in 1903 proposed *Deuteromya* as a new name for *Dimya* Rouault (not *Dimya* Menke). There is also a *Dimya* F. Moore, 1881, in Lepidoptera. *Dimyarina* Iredale has been proposed with the type, *Dimya corrugata* Hedley, a Recent species from Australia.

Species referred to the genus *Dimya* have been described from beds of Cretaceous age in Africa and in Mexico. Probably most of the forms which have been attributed to *Dimya* in the earlier Mesozoic belong to other genera such as *Dimyodon* Munier-Chalmas, the type of which is *D. schlumbergeri* Munier-Chalmas. That genus as pointed out by Dall "is characterized chiefly by its undivided posterior adductor scar, the tooth-like crura being present though feeble in the typical *Dimya*." *Dimyopsis* Bittner with the type *Dimyodon intusstriata* Emmrich is a related genus in the Triassic.

Species of *Dimya* have been described from the Tertiary of Australia, New Zealand, East Indies and Europe. The genus is represented at the present time in the waters of Australia, New Zealand, East Indies, Philippine Islands, Japan, Hawaii, southern California and northern Mexico, and the Caribbean Sea.

Dimya californiana Berry.

Plate I, Figure 17.

Dimya californiana Berry, *Proc. Malac. Soc. London*, Vol. 22, Pt. 3, November 14, 1936, p. 126, pl. 13B, figs. 1, 2, 3, 4. "100 fathoms, off Santa Monica, California; specimen obtained from a stone taken by fishermen (W. H. Golisch, summer 1918)."

Type Locality: Off Santa Monica, California, in 100 fathoms, on a stone.

Range: Santa Monica, California, to Ceralbo channel, Gulf of California.

Collecting Station: Mexico: Ceralbo channel, Gulf of California (137-D-2), 46 fathoms, rock.

Description: Shell small, suborbicular, rather flat, outer surface irregularly laminated somewhat like mica; cardinal crura continuous above a small, roundly-triangular pit-like socket for the resilium; a line of denticles occurs just inside of where the valves impinge upon each other.

A single left valve of a *Dimya* dredged in Ceralbo channel in the Gulf of California agrees with the description and illustrations of *Dimya californiana* Berry. Somewhat similar species are *Dimya filipina* Bartsch and *D. lima* Bartsch, from the Philippine Islands, and *D. mimula* Dall, Bartsch & Rehder, from the Hawaiian Islands. Berry has recently described *Dimya corallotis* from southern California (*Proc. Malacol. Soc. London*, Vol. 26, Pt. 1, May 4, 1944, p. 25, figs. 1-4).

Distribution: The single specimen of this species dredged in 46 fathoms in Ceralbo channel in the Gulf of California is the only record of this species from Mexican waters.

FAMILY LIMIDAE.

Genus *Lima* Cuvier.Key to the species of *Lima*.

- A. Shell large, thick, with coarse radial ribs *tetrica*
- B. Shell small, thin, with fine radial ribs
 - a. Shell with a central longitudinal sulcus *subauriculata*
 - aa. Shell without a central longitudinal sulcus
 - b. Shell narrowly elongate, slightly convex, widely gaping on both sides *pacifica*
 - bb. Shell ovately elongate, decidedly convex, gaping wider anteriorly than posteriorly
 - c. Widest part of shell at about the middle of the anterior margin *orbigny*
 - cc. Widest part of shell above the middle of the anterior margin *hemphilli*

Subgenus *Lima* s.s.*Lima (Lima) tetrica* Gould.

Lima tetrica Gould, *Proc. Boston Soc. Nat. Hist.*, Vol. 4, November, 1851, p. 93. "Gulf of California, La Paz. Maj. Rich."—Gould, *Boston Jour. Nat. Hist.*, Vol. 6, 1857, p. 405, pl. 16, fig. 6. La Paz, Gulf of California.

Type Locality: La Paz, Lower California, Mexico.

Range: Espiritu Santo Island, in the Gulf of California, to Gorgona Island, Colombia.

Collecting Stations: Mexico: Port Guatulco (195-D-9), 7 fathoms, gravel, sand and crushed shell; Tangola-Tangola Bay (196-D-14, 15), 5 fathoms, crushed shell; Costa Rica: 14 miles S. × E. of Judas Point (214-D-1-4), 42-61 fathoms, mud, shell, rock.

Description: Shell obliquely ovate, triangular, thick, dull white, with eighteen radiating ribs covered with long, semi-erect, muricated scales, longest at the posterior margin. The muscle scar is nearer the posterior margin. The shell attains a height of at least 50 mm.

Lima tetrica belongs to a group of species which occur in the warm marine waters of the world. This group is typified by *Lima lima*, the type of the genus which is probably a Mediterranean species.

Distribution: *Lima tetrica* occurs in comparatively shallow water, from the Gulf of California to Colombia. It is also known to occur in the Pleistocene of Oaxaca, Mexico.

Subgenus *Promantellum* Iredale.

Promantellum Iredale, *Brit. Mus. (Nat. Hist.) Great Barrier Reef Exped.* 1928-1929. *Sci. Repts.*, Vol. 5, No. 6, Moll., Pt. 1, February 25, 1939, p. 385. "Type: *P. parafragile* sp. nov.," p. 386, pl. 6, figs. 10, 10a. "Low Isles," Great Barrier Reef, Australia.

Type (by original designation): *Promantellum parafragile* Iredale.

Shell very thin and oblique, flattened, equivalve, inequilateral, widely gaping both anteriorly and posteriorly, hinge line oblique and short, ears small, the anterior the larger and pointed; sculpture of low, sharp, slightly scaly, radial ribs which are separated by wider interspaces; ligament short and broad; free swimming. Exteriorly the general characters of the shells of *Promantellum* are somewhat like those of *Limatulella* Sacco¹⁸, but the valves gape widely while those of *Limatulella*, which is typified by *Lima loscombi* Leach in Sowerby, gape only slightly along the upper anterior dorsal margin.

¹⁸ *Limatulella* Sacco, *Moll. Piemonte e Liguria*, Pt. 25, August, 1898, p. 16. "(tipo *L. Loscombi* (Sow.))." ["*Lima Loscombi*, Leach," G. B. Sowerby, *Gen. Shells*, Vol. 1, 1823, *Lima*, pl. 99, fig. 4 (cited on plate as *L. loscombi*). Coast of Devonshire, England. Also illustrated by Forbes & Hanley, *Hist. Brit. Moll.*, Vol. 2, 1853, p. 265, pl. 53, figs. 1, 2, 3. Various localities about Gt. Britain. Ranges throughout the European seas.]

***Lima (Promantellum) pacifica* d'Orbigny.**

Lima arcuata Sowerby, Thes. Conch., Vol. 1, 1843, p. 86, pl. 22, figs. 41 and 42. [The date on the title page is 1842, but according to Sherborn this part was issued prior to June 23, 1843]. "at Panama in sandy mud; at Guayaquil Bay; at Guacomayo, under stones, etc. by Mr. Cuming." [Not the record "Found at Lord Hood's Island, under coral rocks," but it does occur at Hood Island, Galápagos group].

Not *Lima arcuata* Geinitz, 1840.

Lima pacifica d'Orbigny, Voy. Amér. Mérid., Vol. 5, 1846, p. 654. "M. Cuming l'a rencontrée près de Guayaquil, république de l'Équateur, et à Panama." New name for *Lima arcuata* Sowerby, not *Lima arcuata* Geinitz.

Type Locality: Panama, in sandy mud (here designated as type locality). Bay of Guayaquil, Ecuador, Guacomayo, and Lord Hood's Island also cited originally.

Range: Punta Penasco, Sonora, Mexico, to Negritos, Peru, and the Galápagos Islands.

Collecting Station: Costa Rica: Piedra Blanca.

Description: Shell thin, rather narrowly elongate, and somewhat expanded ventrally, widely gaping, the valves in contact only along the hinge and base; ornamented by about 30 to 35 fine, slightly wavy, radial ribs which bear very fine scales; the ribs become finer and more closely spaced anteriorly and posteriorly. A fairly large valve measures approximately: height 27 mm., length 17 mm., convexity (one valve) 5 mm.

Lima galapagensis Pilsbry and Vanatta¹⁹ appears to be identical with this species.

Distribution: *Lima pacifica* is found occasionally from the Gulf of California to Peru and the Galápagos Islands. It occurs under rocks at extreme low tide.

Subgenus *Limaria* Link.

Limaria Link, Beschreib. Nat.-Samml. Univ. Rostock, Abt. 3, May 17, 1807, p. 157. —Winckworth, Proc. Malacol. Soc. London, Vol. 19, Pt. 3, November, 1930, p. 116. "I here choose *inflata* as type . . ."

Type (by subsequent designation): *Limaria inflata* of Link founded on Chemnitz, Conchyl.-Cab., Bd. 7, 1784, pl. 68, fig. 649a [cited as 641a by Link]. From the "Küste von Guinea und an den Stranden der westindischen Zuckerinseln."

Shell moderately thin, oblique, somewhat produced anteriorly toward the ventral margin, submargins not impressed, usually somewhat inflated and gaping; ornamented by rather fine ribs of variable strength,

often scaly; ligament pit broadly triangular; foot without byssus or retractor.

Limaria is available for most of the species formerly attributed to *Mantellum* Mörch which is not available due to earlier use of that name by Bolten.

Winckworth designated *Lima inflata* of Link as type, based on fig. 649a [cited as 641a by Link] of Chemnitz. Iredale rejected this selection, stating that *vulgaris* of Link (based on fig. 651 of Chemnitz, and under which Link included as a synonym *Ostrea lima* Linnaeus) should be the type by tautonymy, thus making *Limaria* a synonym of *Lima*. However, according to the rules of the International Commission on Zoological Nomenclature (Article 30(m)) it is recommended that names such as *vulgaris*, *communis*, etc., in the original list of species accompanying a genus, should be given preference but it is not stated that they must be selected as type.

Ostrea lima Linnaeus is cited in the synonymy of *vulgaris* Link, but the specific name *lima* is not absolutely tautonymous with *Limaria* but only virtually tautonymous. According to the rules of nomenclature a type by subsequent designation takes precedence over designation by virtual tautonymy. For these reasons we have retained *Limaria* with the type *inflata* based on Chemnitz's figure 649a as designated by Winckworth.

Iredale pointed out that *Lima inflata* of Gmelin, based on Chemnitz's figure 649b, represents a different species (*bullata* Born).

Species of *Limaria* have been recorded from the Neocomian, lower Cretaceous, to Recent. At the present time species occur at various depths in the waters of the temperate and tropical latitudes.

Lima (Limaria) hemphilli

Hertlein & Strong, sp. nov.

Plate I, Figures 3 and 4.

Lima dehiscens Conrad cited in west American records. Not *Lima dehiscens* Conrad, 1837. Island of Fayal, Azores.

Description: Shell obliquely elliptical, equivalve, inequilateral, moderately convex, broadly gaping especially along the anterior dorsal margin, posteriorly narrowly gaping; hinge short, anterior ear the larger, pointed, and beneath which a notch is present; the maximum width of the anterior margin is above the middle of the shell; between the widest portion and the hinge the margin shows two vague angulations; ventral margin elliptical, posterior margin very gently rounded; the anterior umbonal slope of the valves is gentle, the posterior slope is rather abrupt; valves ornamented by fine irregular radial ribs which are crossed by very

¹⁹ *Lima galapagensis* Pilsbry & Vanatta, Proc. Washington Acad. Sci., Vol. 4, September 30, 1902, p. 556, pl. 35, fig. 4. "Tagus Cove, Albemarle" Island, Galápagos Islands.

fine imbricating lirae; anterior and posterior submargins smooth. Height 23 mm., length 16.4 mm., convexity (both valves) approximately 12 mm.

Holotype and paratype (Calif. Acad. Sci. Paleo. Type Coll.) from Loc. 5955 (C.A.S.), San Diego, California; Henry Hemphill collector.

This species has been cited in the west American records as *Lima dehiscens* Conrad²⁰, a species originally described from the island of Fayal in the Azores. Sowerby²¹ later considered Conrad's species to be synonymous with *Lima fragilis* Chemnitz²² which was described originally from the coast of Nicobar.

Carpenter²³ in 1864 cited *Lima orientalis* Adams and Reeve from California and cited Cooper as authority that the species was identical with *Lima dehiscens*. *Lima orientalis* Adams and Reeve²⁴ was originally described from the Philippine Islands and is a distinct species.

From a consideration of the facts it appears to us that the west American species is without a valid name. It is here named in honor of Henry Hemphill who made extensive collections of mollusks in western North America.

Lima hemphilli greatly resembles the east American species generally referred to *Lima inflata* Lamarck²⁵. The west American form appears to be wider in proportion to the length in comparison with the east coast specimens which we have seen, but they are very similar.

Compared to *Lima hians*, the width of *L. hemphilli* is proportionally greater, the widest part of the shell is somewhat farther above the middle and there are two vague angulations along the anterior dorsal outline rather than a correspondingly straight marginal outline in *L. hians*. Furthermore the anterior slope in *L. hemphilli* is steeper than that of *L. hians*.

Compared to *Lima hemphilli* the shell of *L. hirasei* Pilsbry²⁶ is flatter, the radial sculpture is finer, and the anterior and

posterior dorsal margins are flattened and gently upturned. Thiele²⁷ considered *L. hirasei* to be only a variety of the West American species.

Range: Monterey, California, to Acapulco, Mexico.

Distribution: *Lima hemphilli* occurs from Monterey, California, to off western Mexico in waters from 10 to 50 fathoms and perhaps at greater depths. A single specimen of this species was dredged by the Crocker-Beebe expedition southeast of Cedros Island, in the channel, (126-D-19), in 25 fathoms, rocks, algae. It is also known from Pliocene to Recent and a similar or identical form has been recorded from the upper Miocene of southern California.

Lima (Limaria) orbignyi Lamy.

Lima angulata Sowerby, Thes. Conch., Vol. 1, 1843, p. 86, pl. 22, figs. 39, 40. [The date on the title page is 1842 but according to Sherborn this part was issued prior to June 23, 1843]. "Found by Mr. Cuming at Panama and the Bay of Caracas, in sandy mud, 10 to 12 fathoms."—Prasad, Siboga Exped., Monogr. 53c, Lamell., 1932, pp. 125-126 (in text), pl. 3, figs. 34, 35. Panama.

Not *Lima angulata* Münster, 1841.

Lima (Mantellum) orbignyi Lamy, Jour. de Conchyl., Vol. 74, No. 3, November 29, 1930, p. 180. New name for *Lima angulata* Sowerby, not *L. angulata* Münster.

Type Locality: Panama, in 10 to 12 fathoms, sandy mud (here designated). Bay of Caracas, Ecuador, also cited originally.

Range: Punta Penasco, Sonora, Mexico, to Juan Fernandez Island, and the Galápagos Islands.

Collecting Stations: El Salvador: La Union, Gulf of Fonseca (199-D-8, 22), 3-6 fathoms, mud, mangrove leaves on bottom; Nicaragua: Monypenny Point, Gulf of Fonseca (199-D-6), 4 fathoms, mud; Potosi Island; Costa Rica: Port Parker (203-D-3), 12 fathoms, shelly mud.

Description: Thin, striated, ventricose, slightly gaping on both sides, obliquely oval, with a posterior angle between the lateral and ventral margin, hinge narrow, auricles small, nearly equal (Sowerby). The valves gape widest along the dorsal portion of the anterior margin.

A large specimen of this species from Panama in the collection of Stanford University measures approximately 32 mm. in altitude and 24 mm. in width.

Lima orbignyi in some cases has been cited from west American waters under the name of *Lima orientalis* Adams and Reeve. The species described by Adams and Reeve

²⁰ *Lima dehiscens* Conrad, Jour. Acad. Nat. Sci. Philadelphia, Vol. 7, 1837, p. 247, pl. 19, fig. 7. "Inhabits the rocky coast of the island of Fayal; rare."

²¹ Sowerby, Jun., G. B., Thes. Conch., Vol. 1, *Lima*, 1843, p. 86.

²² *Pecten fragilis*, Chemnitz, Conchyl.-Cab., Vol. 7, 1784, p. 349, pl. 68, fig. 650. "Diese seltene Muschel ist an den Nicobarischen Stranden gefunden worden."

²³ Carpenter, P. P., Rept. Brit. Assoc. Adv. Sci. for 1863 (issued August, 1864), pp. 612, 645. Reprint in Smithsonian. Miscell. Coll., No. 252, 1872, pp. 98, 131.

²⁴ *Lima orientalis* Adams and Reeve, Zool. Voy. Samarang, August, 1850, Moll., p. 75, pl. 21, fig. 7. "Hab. Philippine Archipelago."

²⁵ See Perry, L. M., Bull. Amer. Paleo., Vol. 26, No. 95, August 12, 1940, p. 44, pl. 6, fig. 31. Florida.

²⁶ *Lima hirasei* Pilsbry, Proc. Acad. Nat. Sci. Philadelphia, Vol. 53, May 7, 1901, p. 209. "Hirado, prov. Hizen, Kiusiu, Japan (Mr. Hirase)."—Pilsbry, Proc. Acad. Nat. Sci. Philadelphia, Vol. 53, p. 402, pl. 19, fig. 12 (as *Lima hians* Gmelin var. *hirasei* Pilsbry).

²⁷ Thiele, J., Martini—Chemnitz Conchyl.-Cab., Bd. 7, Abt. 2a, Heft 22, 1920, Limidae, p. 32, pl. 5, fig. 4. Pacific Ocean (Kiusiu, Japan).

occurs in the East Indies and is distinct from the west American shell.

Distribution: This species occurs from the Gulf of California to Juan Fernandez Island. Specimens in the present collection were dredged from depths of 3 to 13 fathoms and some were found along the beach.

Subgenus *Limatula* Wood.

Lima (Limatula) subauriculata Montagu.

Pecten subauriculata Montagu, Suppl. to Test. Brittanica [Vol. 3], 1808, p. 63, Tab. 29, fig. 2. On the coast of Devon, in deep water.

Lima subauriculata Montagu, Forbes & Hanley, Hist. Brit. Moll., Vol. 2, 1853, p. 263, pl. 53, figs. 4 and 5. Numerous localities cited in British Isles. Also said to range along all the coasts of Europe.

Type Locality: On the coast of Devon, England, in deep water.

Range: Izhut Bay, Afognak Island, Alaska, to Cape San Lucas, Lower California; northern Europe; North Atlantic; in West Atlantic south to Porto Rico; White Sea; circumboreal.

Collecting Stations: Mexico: east of Cedros Island (126-D-9,12), 45-56 fathoms, crushed shell, mud; Cape San Lucas.

Description: Shell ovate-oblong, pellucid, white, equilateral, equivalve, furnished with small, equal, angular projections, or subauricles, and wrought with numerous longitudinal striae that slightly crenulate the margin; along the middle are two striae that appear more conspicuous than the rest by being opaque and are equally evident on the inside; a character constant in several specimens examined. Length a quarter of an inch; breadth half its length (Montagu).

The two prominent riblets ornamenting the center of the valves of *Lima subauriculata* border a sulcus visible both exteriorly and interiorly. On the species described as *L. attenuata* by Dall, a sulcus is said to show only on the inside of the valves, while *L. similis* Dall is said to lack a sulcus.

Distribution: The distribution of *Lima subauriculata* is very wide. It is circumboreal and occurs in both the North Atlantic and Pacific waters. Woodring²⁸ has questioned the identity of the species cited under this name from western North America. Carpenter²⁹, however, stated that a specimen from California "Exactly agrees with British specimens," and Dall and others have considered the west American shells to be identical with those from northern European waters. It has been recorded from various localities from later Tertiary to Recent.

²⁸ Woodring, W. P., U. S. Geol. Surv., Prof. Paper 190, 1938, pp. 49-50.

²⁹ Carpenter, P. P., Rept. Brit. Assoc. Adv. Sci. for 1863 (issued August, 1864), p. 612. Reprint in Smithsonian Miscell. Coll., No. 252, 1872, p. 98.

Superfamily Anomiacea.

FAMILY ANOMIIDAE.

Key to the genera of the Anomiidae.

- A. Hinge with cardinal crura. *Placunanomia*
 B. Hinge without cardinal crura
 a. Imperforate valve with 1 large and two small muscle scars *Anomia*
 aa. Imperforate valve with 1 large and 1 small muscle scar *Pododesmus*

Genus *Anomia* Linnaeus.

Anomia peruviana d'Orbigny.

Anomia peruviana d'Orbigny, Voy. Amér. Mérid., Vol. 5, 1846, p. 673. "environs de Payta (Pérou)," Recent.—Philippi, Abbild. u. Beschreib. Conchyl., Bd. 3, Heft 8, 1850, p. 131, *Anomia*, Tab. 1, figs. 2 and 3. Peru.—Grant and Gale, *Mem. San Diego Soc. Nat. Hist.*, Vol. 1, 1931, p. 240, pl. 12, figs. 2 and 5. Earlier records cited. Pliocene to Recent.

Type Locality: Paita, Peru.

Range: Monterey Bay, California, to Paita, Peru, and the Galápagos Islands.

Collecting Stations: Mexico: Santa Inez Bay (143-D-1, also beach; 144-D-2; 145-D-1, 3; 147-D-2), 2½-60 fathoms, mud, crushed shell, weed, sand, rocks; Cape San Lucas; Chamela Bay; Tenacatita Bay; Nicaragua: Monypenny Point, Gulf of Fonseca (199-D-1, 12, 22, also beach), 3-29 fathoms, sand, mud, crushed shell, mangrove leaves; Corinto (200-D-19) 12-13 fathoms, mangrove leaves; Panama: Gulf of Chiriqui (221-D-1-5), 35-40 fathoms, sandy mud.

Description: Shell variable in shape due to situs, generally fairly thin, partly translucent, smooth, radiately costate, or with irregular sculpture, often colored orange or yellowish-green, attached by a byssus which passes through a notch in the right valve; in the interior of the left valve there is a large scar below which there are two subequal scars, one just below the large upper scar, the other farther out and offset.

A number of species described by Gray, such as *Anomia alectus*, *A. fidenas*, *A. hamillus*, *A. lampe*, *A. larbas*, and *A. pacilus*, are now considered to be identical with *A. peruviana*. *Anomia simplex* Rochebrune is another synonym.

Distribution: This is a common species and ranges from Monterey Bay, California, to Paita, Peru. It occurs between tides or in shallow water attached to rocks or other objects. It is also known to occur from Pliocene to Recent in Southern California, Lower California, Panama, and in northern South America.

Genus *Pododesmus* Philippi.

Pododesmus macrochisma Deshayes.

Anomia macrochisma Deshayes, *Rev. Zool. Soc. Cuvierienne*, December, 1839, p. 359.

"Kamtschatka."—Deshayes, *Guerin's Mag. Zool.*, 1841, pl. 34.

Placunanomia macrochisma Deshayes, Reeve, *Conch. Icon.*, Vol. 11, *Placunanomia*, 1859, species 7, pl. 2, fig. 7. "Hab. Onalaska; Cuming. Kamtschatka; Deshayes."

Pododesmus macrochismus Deshayes, Grant and Gale, *Mem. San Diego Soc. Nat. Hist.*, Vol. 1, 1931, p. 241, pl. 12, figs. 3, 4a, 4b. Earlier records cited. Pliocene to Recent.

Type Locality: Kamchatka.

Range: Kamchatka to Cape San Lucas and Santa Inez Bay in the Gulf of California. Also to Japan.

Collecting Stations: Mexico: Arena Bank (136-D-4, 5, 6, 30), 33-55 fathoms, mud, sand, weed; Arena Point area; Santa Inez Bay (141-D-1-4) 7-20 fathoms, sand, sandy mud, crushed shell, weed, calcareous algae.

Description: Shell ovate, rather solid, somewhat pearly, ornamented by rude, irregular, radiating ribs; colored yellowish or greenish-white, inner surface green; upper valve with one large scar, sometimes striated, which is in contact with a smaller, lower, offset scar; lower valve with a large byssal orifice. Large specimens attain an altitude of about 100 mm.

Pododesmus macrochismus differs from the generally more southern *P. foliatus* Broderip³⁰, in the coarser ribbing and in that the color of the interior is green rather than brown.

Distribution: This species occurs from Kamchatka to Santa Inez Bay in the Gulf of California and west to Japan. It occurs between tides or in shallow water attached to rocks or other objects. It is also known to occur from Pliocene to Recent in California.

Genus *Placunanomia* Broderip.

Placunanomia cumingii Broderip.

Placunanomia cumingii Broderip, *Proc. Zool. Soc. London*, April 21, 1832, p. 29. "Hab. ad oras Americae Centralis. (Gulf of Dulce, Province of Costa Rica)." "Dredged from a muddy bottom, at a depth of eleven fathoms, attached to dead bivalve shells and dead coral."—Reeve, *Conch. Icon.*, Vol. 11, *Placunanomia*, 1859, species 3, pl. 1, figs. 3a, 3b. original locality cited.

Type Locality: Gulf of Dulce, Costa Rica, in 11 fathoms, attached to shells and corals on a muddy bottom.

Range: Carmen Island, Gulf of California, to Ecuador.

Collecting Stations: Mexico: Arena Bank (136-D-5, 6, 30), 33-35 fathoms, sand, weed,

³⁰ *Placunanomia foliata* Broderip, *Proc. Zool. Soc. London*, May 14, 1834, p. 2. "Hab. in sinu Guayaquil Columbae Occidentalis. (Isle of Muerte)." "Dredged up attached to a dead *Pinna* from a bottom of sandy mud, at the depth of eleven fathoms."—Reeve, *Conch. Icon.*, Vol. 11, *Placunanomia*, August, 1859, species 5, pl. 1, fig. 5. Original locality cited.

mud; Santa Inez Bay (141-D-1-4, also on shore), 7-20 fathoms, sand, sandy mud, crushed shell, weed, calcareous algae; Arena Point area; Costa Rica: Port Parker (203-D-3), 12 fathoms, shelly mud.

Description: Shell smooth, somewhat pearly, folded into three or four subangular plications which extend about two-thirds the distance to the beaks; color olive-white, especially interiorly; right valve with sub-central adductor scar and above this the closed (in adult) byssal scar; two prominent elevated ridges converge at the cardinal margin of the valve, these fit into a corresponding bipartite socket in the left valve; left valve with prominent byssal and adductor scars.

Placunanomia plicata Tuomey and Holmes described from the Miocene of South Carolina and *P. panamensis* Olsson³¹ from the Pliocene of Panama are similar species.

Distribution: This species is found occasionally in comparatively shallow water from the Gulf of California to Ecuador, and it may occur as far south as Peru. It is also known to occur in the Pliocene and Pleistocene of the Tres Marias Islands, Mexico, and of Ecuador, and in the Pleistocene of Peru.

Superfamily Mytilacea.

FAMILY MYTILIDAE.

Key to the genera of the Mytilidae.

- A. Teeth on anterior part of hinge;
beaks terminal or nearly so
- a. Shell with internal deck below
beaks *Septifer*
- aa. Shell without internal deck
below beaks
- b. Shell not over 3 mm. from
beak to base; oval, with fine
divaricate sculpture *Crenella*
- bb. Shell large, over 3 mm.
from beak to base.
- c. Shell with crenellated margin
posterior to the ligament;
radial sculpture *Brachidontes*
- cc. Shell without crenellated
margin posterior to the
ligament *Mytilus*
- B. Without teeth on anterior part of hinge;
beaks not terminal
- a. Shell subcylindrical or rhombic
in cross-section
- b. Posterior end attenuated and
wedge-shaped *Lithophaga*
- bb. Posterior end not
wedged-shaped *Botula*

³¹ *Placunanomia panamensis* Olsson, *Bull. Amer. Paleol.*, Vol. 27, No. 106, December 25, 1942, p. 183 (31), pl. 14 (1), figs. 1, 4, 5. "Quebrada Rabo de Puerco," Panama. Pliocene.

- aa. Shell obliquely oblong; strong umbonal inflation and often compressed dorsally *Volsella*

Genus *Mytilus* Linnaeus.

Key to the subgenera of *Mytilus*.

- A. Anterior ventral margin strongly incurved forming a shelf in adult; no anterior adductor muscle scar *Chloromya*
- B. Anterior ventral margin not incurved to form a shelf; anterior adductor scar present *Mytilus* s. s.

Subgenus *Mytilus* s.s.

Mytilus (Mytilus) californianus Conrad.

Mytilus californianus Conrad, *Jour. Acad. Nat. Sci. Philadelphia*, Vol. 7, 1837, p. 242, pl. 18, fig. 15. "Inhabits on rocks, near Sta. Diego and Sta. Barbara, as well as at Monterrey," California.—I. S. Oldroyd, *Stanford Univ. Publ. Univ. Ser. Geol. Sci.*, Vol. 1, 1924, p. 66, pl. 27, fig. 2. Unalaska, Aleutian Islands, to Socorro Island, Mexico. Also Pliocene and Pleistocene of southern California.

Type Locality: San Diego, California. [Stated to be the type locality by I. S. Oldroyd, 1924, and accepted as such by the present writers.]

Range: Unalaska, Aleutian Islands, Alaska, to Socorro Island, Mexico.

Collecting Station: Mexico: Middle San Benito Island, Lower California.

Description: Shell large, thick ovately elongated, inflated; ventral margin nearly straight; ornamented by a few (sometimes a dozen) fairly broad, subdued radial ribs which occur on the median portion of the shell.

Distribution: This species occurs commonly from Alaska to Lower California, Mexico. It is found abundantly between tides attached to rocks or other objects. It is also known to occur in the Pliocene and Pleistocene of southern California.

Subgenus *Chloromya* Mörch.

Mytilus (Chloromya) palliopunctatus Dunker.

Mytilus palliopunctatus Dunker, in Carpenter, *Cat. Mazatlan Shells*, December, 1855, p. 118. "Mazatlan," Mexico.—Reeve, *Conch. Icon.*, Vol. 10, *Mytilus*, 1857, species 19, pl. 5, fig. 19. Mazatlan. [Not the record "California," but it does occur in Lower California.]

Type Locality: Mazatlan, Mexico.

Range: Magdalena Bay, Lower California, to Corinto, Nicaragua.

Collecting Stations: Mexico: Cape San Lucas, Lower California; Chamela Bay; Tenacatita Bay.

Description: Shell elongately ovate, pointed anteriorly and usually rubbed at various

angles; incurved along anterior ventral margin; periostracum dark, shell light purple in color, and with very fine radial striations; interior purple but white near the beak, and much of the surface finely punctate.

Distribution: This species is known to occur from Lower California to Nicaragua. It occurs between tides attached to rocks or other objects.

Genus *Brachidontes* Swainson.

Key to the subgenera of *Brachidontes*.

- A. Dorsal margin angulated *Brachidontes* s.s.
- B. Dorsal margin rounded *Hormomya*

Subgenus *Hormomya* Mörch.

Brachidontes (Hormomya) adamsianus Dunker.

Mytilus adamsianus Dunker, *Proc. Zool. Soc. London*, 1856 (issued May 8, 1857), p. 360. "Hab. ad Isthmum Panamense (Cuming)." —Reeve, *Conch. Icon.*, Vol. 10, *Mytilus*, January, 1858, species 55, pl. 11, fig. 55. Panama.

Type Locality: Isthmus of Panama.

Range: Santa Barbara, California, to Panama, and the Galápagos Islands.

Collecting Station: Costa Rica: Piedra Blanca, beach.

Description: Shell small for the genus, externally similar to *Septifer bifurcatus*; sloping steeply dorsally from the umbo; ornamented on the umbo by coarse radial bifurcating ribs and along the ventral margin by finer ribs. The shape and ribbing of this species is extremely variable. It may be narrow or wide and the ribbing may be coarse or fine and in some specimens coarse radial ornamentation changes abruptly to fine.

Mytilus stearnsi Pilsbry and Raymond³² was described from San Diego, California. There do not appear to be any constant characters by which the form from southern California can be distinguished from the form described as *Mytilus adamsianus*.

There has been confusion regarding the identification of *Brachidontes adamsianus* and the species described as *Mytilus multififormis* Carpenter; in fact, Carpenter (1864) believed the two were identical. *Mytilus multififormis* Carpenter³³ was described from Mazatlan, Mexico, in 1855. A study of specimens from Mazatlan, as well as Carpenter's original description has led us to consider *Mytilus multififormis* to be a distinct species

³² *Mytilus stearnsi* Pilsbry & Raymond, *Nautilus*, Vol. 12, No. 6, October, 1898, p. 70, pl. 4, figs. 1-3. Type from "San Diego," California.

³³ *Mytilus multififormis* Carpenter, *Cat. Mazatlan Shells*, December, 1855, p. 118. "Mazatlan; jun. abundant, rare adult, among sea weeds on Chamae, Spondylii, Ostreae, Patellae, etc., or in the cavities of dead Lithophagi or Balani."

characterized by its smaller size, *Volsella*-like shape, usually smooth umbos and with very fine ribbing. Furthermore it occurs in mats of moss on rocks while *adamsianus* usually occurs in crevices in rocks or on the under sides of rocks. Haas³⁴ and Chace³⁵ have recently discussed these two species.

Distribution: Brachidontes (Hormomya) adamsianus occurs from southern California to Panama and the Galápagos Islands. It is often found between tides occurring in crevices or attached to the under sides of rocks, where only the end of the shell is exposed to the waves.

Genus *Septifer* Recluz.

Septifer Recluz, *Rev. Zool. Soc. Cuvierienne*, 1848, Vol. 11, p. 277.—Stoliczka, *Mem. Geol. Surv. India. Palaeont. Indica*. Ser. 6, Cret. Fauna South. India, Vol. 3, 1871, pp. XXI, 366. "Type, *S. bilocularis*, Linn."—Grant and Gale, *Mem. San Diego Soc. Nat. Hist.*, Vol. 1, 1931, p. 247. Type: *Mytilus bilocularis* Linnaeus.—Lamy, *Journ. de Conchyl.*, Vol. 80, No. 3, September 1, 1936, p. 239.

Type (designated by Stoliczka): *Septifer bilocularis* Linnaeus [Syst. Nat., ed. 10, Vol. 1, 1758, p. 705. "Habitat in O. Indico." Illustrated by Chemnitz, *Conchyl.-Cab.*, Bd. 8, 1785, p. 155, pl. 82, figs. 736a, 736b (as *Mytilus nicobaricus*) and p. 157, pl. 82, fig. 737 (Nos. 1, 2, 3) (as "Varietas mytili Nicobarici viridescens"). Nicobar Islands.—Prashad, Siboga Exped., Monogr. 53c, Lamell., 1932, p. 69, pl. 2, figs. 21-24. East Indies.]

The shell of *Septifer* may be separated from those of *Mytilus* or of *Brachidontes* by the presence of a small deck in the anterior end of the shell just below the hinge. The genus *Septifer* has been recorded from upper Cretaceous to Recent. Lamy³⁶ has given a discussion of a number of Recent species of *Septifer*.

Septifer zeteki Hertlein and Strong, sp. nov.

Plate I, Figures 1 and 2.

Septifer cumingii Recluz, cited from west American localities. Not *Septifer cumingii* Recluz from the island of Annaa.

Mytilus cumingianus cited from west American localities. Not *Mytilus cumingianus* Reeve.

Description: Shell small, subtriangular in outline, inflated, expanded posteriorly, colored green; umbos small, anterior dorsal margin nearly straight, posterior margin rounded, the upper part broadly, the ventral part less so, ventral margin slightly im-

pressed and gaping toward the anterior end, a light brown colored byssus projects through the opening; the ventral part of the valve slopes steeply from the umbonal ridge but the dorsal part slopes more gently; surface of shell ornamented by fine radial ribs which in many cases become divaricate toward the posterior, the ribs are finely decussated by impressed concentric lines of growth; a septum is present interiorly just below the beaks, and is nearly straight across at the free end; the margin of the shell is crenulated; the interior of the shell is bluish colored or tinged with green. Length 6.8 mm., greatest height 4.1 mm., convexity (both valves) 3.5 mm.

Holotype and two paratypes (Calif. Acad. Sci. Paleo. Type Coll.) from off Taboga Island, Panama, in 25 fathoms, dredged by James Zetek. Paratype from Station 195-D-9, Port Guatulco, Mexico, dredged in 7 fathoms.

Range: Gulf of California to Panama and the Galápagos Islands.

Collecting Station: Mexico: Port Guatulco (195-D-9), in 7 fathoms, green sand and crushed shell.

This species has been cited from west American localities under the name of *Septifer cumingii* Recluz,³⁷ a species originally described from "les côtes de l'île Annaa (près le détroit de Panama), dans l'océan Pacifique." Reeve later described and illustrated a species under the name of *Mytilus cumingianus*³⁸ and cited the locality as Panama, and indicated that the specimen was collected by Cuming. The citation of this locality by Reeve probably influenced authors in accepting the name *Septifer cumingii* for a west American species.

E. A. Smith³⁹ later considered the problem of the identification of *Septifer cumingii* and stated that there was no reason to doubt the original locality of Recluz cited as the Island of Annaa, in Polynesia, and pointed out that Cuming collected at that island.

He also pointed out that Reeve was mistaken in his reference, orthography of the specific name, and the locality. After a comparison of the type of *Septifer cumingii* with specimens of *S. bilocularis* Linnaeus, the type of the genus, he concluded that there were no grounds for separating them.

After a consideration of the facts we have concluded that it is necessary to assign a new name to the west American form. The species is named in honor of Dr. James Zetek, Balboa, Canal Zone, Panama.

³⁴ Haas, F., *Nautilus*, Vol. 56, No. 1, July, 1942, pp. 31-32.—Haas, *Field Mus. Nat. Hist.*, Zool. Ser., Vol. 29, No. 1, 1943, pp. 16-17.

³⁵ Chace, E. P., *Nautilus*, Vol. 56, No. 2, October, 1942, p. 43.

³⁶ Lamy, E., *Journ. de Conchyl.*, Vol. 80, No. 3, 1936, pp. 239-252.

³⁷ *Septifer cumingii* Recluz, *Rec. Zool. Mag. Guérin*, Ser. 2, Vol. 1, 1849, p. 132.

³⁸ *Mytilus cumingianus* Recluz, MS., Reeve, *Conch. Icon.*, Vol. 10, *Mytilus*, January, 1858, species 52, pl. 11, fig. 52. "Hab. Panama."

³⁹ Smith, E. A., *Rept. Sci. Res. Voy. Challenger*, Zool. Vol. 13, 1885, p. 271.

Septifer zeteki resembles *S. bilocularis*, the type of the genus, but never attains the size of that species. It also somewhat resembles *Septifer bryani* Pilsbry,⁴⁰ originally described from the Hawaiian Islands, but the ribs appear to be coarser and less numerous than those of the Hawaiian species.

Genus *Volsella* Scopoli [= *Modiolus* Lamarck].

Key to the subgenera of *Volsella*.

- A. Shell inflated, posterior dorsal area without zigzag markings.....*Volsella* s.s.
- B. Shell weakly inflated, narrow, posterior area with zigzag markings*Amygdalum*

Subgenus *Volsella* s.s.

Key to the species of *Volsella* s.s.

- A. Shell arcuate, narrow..... *arciformis*
- B. Shell not arcuate, broad
 - a. Shell with raised concentric sculpture especially posteriorly *guyanensis*
 - aa. Shell with fine equal concentric lines of growth
 - b. Posterior end subquadrate *salvadorica*
 - bb. Posterior end gently truncated and roundly attenuated..... *capax*

Volsella (Volsella) arciformis Dall.

Plate I, Figure 5.

Modiolus arciformis Dall, *Proc. U. S. Nat. Mus.*, Vol. 37, 1909, pp. 152, 258, pl. 28, fig. 2. "Huaquilla on the Ecuador border; apparently from a shellheap."

Type Locality: Huaquilla, Ecuador, apparently from a shellheap.

Range: La Union, El Salvador, to Huaquilla, Ecuador.

Collecting Stations: El Salvador: La Union, Gulf of Fonseca (199-D-16), 6 fathoms, mud; Nicaragua: Monypenny Point, Gulf of Fonseca.

Description: Shell rather narrow and decidedly arcuate in outline after attaining a length of 40 mm. This feature is not pronounced in young specimens. A decided umbonal ridge is present, due to the compressed character of the ventral part of the shell. The interior of the shell is pearly and of a purplish color.

Distribution: The discovery of the occurrence of this species in the Gulf of Fonseca, extends the known range north to El Salvador.

Volsella (Volsella) capax Conrad.

Modiola capax Conrad, *Journ. Acad. Nat. Sci. Philadelphia*, Vol. 7, 1837, p. 242. "In-

habits marshes and muddy shores about Sta. Diego." [California].—Reeve, *Conch. Icon.*, Vol. 10, *Modiola*, 1857, species 11, pl. 3, fig. 11. "Hab. Galapagos Islands; Cuming. California; Nuttall. Mazatlan; Carpenter."

Type Locality: San Diego, California, in marshes and on muddy shores.

Range: Santa Cruz, California, to Paita, Peru.

Collecting Stations: Mexico: Santa Inez Bay, east coast of Lower California, beach; Cape San Lucas, beach; Chamela Bay, beach; Costa Rica: Port Parker, beach; Cedro Island, Gulf of Nicoya, beach.

Description: This species is easily recognized in the southern fauna by the large, thick shell and by the brick red color which is often present on worn surfaces.

Volsella capax differs from the generally more northern *V. modiolus* in possessing a heavier, more inflated shell which has a more depressed area between the umbos.

Distribution: This species occurs quite commonly from southern California to Peru.

Volsella (Volsella) guyanensis Lamarck.

Modiola guyanensis Lamarck, *Anim. s. Vert.*, Vol. 6, February-June, 1819, p. 112. "Habite les mers de la Guyane."—Delessert, *Rec. Coq. dérites par Lamarck et non encore figurées*, 1841, pl. 13, fig. 9. Original locality cited.

Modiola brasiliensis Chemnitz, Reeve, *Conch. Icon.*, Vol. 10, *Modiola*, August, 1857, species 17, pl. 4, fig. 17, Guayaquil; pl. 6, fig. 31. Brazil.

Type Locality: Guiana.

Range: San Ignacio Lagoon, Lower California, and the Gulf of California, to Paita, Peru. Also from Trinidad to Brazil on the Atlantic coast.

Collecting Stations: Nicaragua: Potosi and Monypenny Point; Isla Encantada, Corinto; Costa Rica: Ballenas Bay.

Description: This handsome shell is ornamented by well developed raised concentric growth lines which are especially pronounced posteriorly. The anterior part of the shell is usually colored some shade of brown while the posterior part is green, blackish-green, or in some cases the entire shell may be colored brownish-black.

Carpenter described "*Modiola ?Brasiliensis*, var. *mutabilis*"⁴¹ from Mazatlan, Mexico. He considered it as possibly representing a rough water form of *brasiliensis*. The margins of this form were described as less straight and angular and the diagonal keel less impressed than that of the typical species. This subspecies is of doubtful value.

⁴⁰ See Dall, W. H., Bartsch, P., and Rehder, H. A., *Bernice P. Bishop Mus.*, *Bull.* 153, July 25, 1938, p. 51, pl. 9, figs. 1-4. Cited from various localities in the Hawaiian Islands.

⁴¹ *Modiola ?Brasiliensis*, var. *mutabilis* Carpenter, *Cat. Mazatlan Shells*, January, 1856, p. 122. "Mazatlan," Mexico.

Volsella guyanensis (= *Volsella brasiliensis* Chemnitz) is one of the species which occurs in both east and west American waters and there seems to be no positive method by which specimens from the two regions can be separated. A certain amount of variation might be expected in a species occurring over such a wide range.

Distribution: This species has a wide distribution. It occurs in shallow water from the Gulf of California to Peru and on the Atlantic coast from Trinidad to Brazil.

Volsella (Volsella) salvadorica

Hertlein and Strong, sp. nov.

Plate I, Figures 7 and 11.

Shell thin, subquadrate, moderately inflated, smooth; hinge line almost straight, with the beaks at about one-fourth the distance from the anterior end; beaks pointing forward and almost resting on the hinge; dorsal margin nearly straight; ventral margin with a slight concavity in the middle; anterior end rounded; posterior end sloping obliquely from the dorsal margin and rounded at the dorsal and ventral margins; umbonal ridge well developed; a slight convexity anterior to the ridge begins on the beaks and continues to the ventral margin; the dorsal posterior part of the valve is subalate; color of exterior of shell grading from light to chocolate brown, interior light purple and somewhat iridescent. Length 23.6 mm., height 13.9 mm., diameter (one valve) 5.8 mm.

Holotype, left valve (Calif. Acad. Sci. Paleo. Type Coll.), from Station 198-D-2, Lat. 13°27'20"N., Long. 89°19'20"W., dredged in 14 fathoms (25 meters) off La Libertad, El Salvador. Paratype, right valve, from Station 199-D-6, Lat. 13°02'30"N., Long. 87°29'30"W., dredged in 4 fathoms (7.2 meters) off Monypenny Point, Gulf of Fonseca, Nicaragua. One small specimen from Station 199-D-1, Lat. 13°08'N., Long. 87°43'W., dredged in 16 fathoms (29 meters), off Meanguera Island, Gulf of Fonseca, El Salvador.

Volsella salvadorica sp. nov. differs from *V. capax* in the straighter, longer hinge line, and much more quadrate shape.

Subgenus *Amygdalum* Megerle von Mühlfeld.

Key to the species of *Amygdalum*.

- A. Posterior end of shell evenly rounded, colored yellowish-white *pallidula*
 B. Posterior end of shell obliquely truncated, colored yellowish-green *speciosa*

***Volsella (Amygdalum) pallidula* Dall.**

Modiolus (? *politus* Verrill var.) *pallidulus* Dall, *Proc. U. S. Nat. Mus.*, Vol. 52, De-

ember 27, 1916, p. 404. "Off San Luis Obispo Bay, in 77 fathoms."

Type Locality: Off San Luis Obispo Bay, California, in 77 fathoms.

Range: Bodega Head, California, to Acapulco, Mexico.

Collecting Station: Mexico: East of Cedros Island (126-D-10, 12), 45-60 fathoms, crushed shell, eel grass, mud.

Description: Shell small, thin, brilliantly polished, a large translucent dorsal area with whitish colored zigzag reticulations, and a smaller, opaque, white ventral area.

Volsella polita Verrill and Smith,⁴² from the Atlantic and *V. sagittata* Rehder⁴³ from the Gulf of Mexico are similar species, as is *V. peasei* Newcomb⁴⁴ from the Hawaiian Islands.

Distribution: This species is known to occur from Bodega Head, California, to Acapulco, Mexico. It has been dredged usually in depths of 45 to 75 fathoms, or even in deeper water.

***Volsella (Amygdalum) speciosa* Dunker.**

Modiola speciosa Dunker in Reeve, *Conch. Icon.*, Vol. 10, *Modiola*, October, 1857, species 35, pl. 7, fig. 35. "Hab. Tumbez, Peru; Cuming."

Type Locality: Tumbez, Peru.

Range: Magdalena Bay, Lower California, to Paita, Peru.

Collecting Station: Nicaragua: Monypenny Point, Gulf of Fonseca (199-D-3, 4, 5), 6-7 fathoms, mud.

Description: Shell elongate, slender, smooth; the periostracum of the anterior ventral region is light brown in color and the dorsal posterior portion is ornamented with fine dashes and zigzag brown lines which are separated upon a bright green ground color. The largest specimen in the present collection measures approximately 56.9 mm. in length.

Compared to *Volsella speciosa*, *V. tumbezensis* Pilsbry and Olsson,⁴⁵ also described from Peru, is said to possess a smaller shell which is wider posteriorly.

Distribution: *Volsella speciosa* is not a common species but is found occasionally from Magdalena Bay, Lower California, to Paita, Peru.

⁴² *Modiola polita* Verrill and Smith, *Amer. Jour. Sci.*, Ser. 3, Vol. 20, November, 1880, p. 400. From Lat. 39°56' 30"N., Long. 70°59'45"W., in 238 fathoms.—Verrill, *Trans. Connecticut Acad. Sci.*, Vol. 6, 1884, p. 281, pl. 30, fig. 12 (as *Modiolaria polita*).

⁴³ *Modiolus (Amygdalum) sagittatus* Rehder, *Nautilus*, Vol. 48, No. 4, April, 1935, p. 127, pl. 7, figs. 11, 12. Type "from the Gulf of Mexico, off Cape San Blas, Florida." Also from off Cape Florida.

⁴⁴ *Volsella (Amygdalum) peasei* Newcomb, Dall, Bartsch and Rehder, *Bernice P. Bishop Mus.*, Bull. 153, 1938, p. 45, pl. 8, figs. 11-14. Cited from various localities off the Hawaiian Islands, in 4 to 50 fathoms.

⁴⁵ *Modiolus (Modiolus) tumbezensis* Pilsbry and Olsson, *Nautilus*, Vol. 49, No. 1, July, 1935, p. 16, pl. 1, fig. 5. "Beach at Puerto Pizarro, northern Peru."

Genus *Botula* Mörch.Key to the subgenera of *Botula*.

- A. Beaks subterminal; posterior umbonal area rounded.....*Botula* s.s.
 B. Beaks between center and anterior end; posterior umbonal area angulated*Adula*

Subgenus *Adula* H. & A. Adams.*Botula (Adula) falcata* Gould.

Lithodomus falcatus Gould, *Proc. Boston Soc. Nat. Hist.*, Vol. 4, November, 1851, p. 92. "Monterey, in indurated marly clay."—Gould, *Boston Journ. Nat. Hist.*, Vol. 6, October, 1853, p. 403, pl. 16, fig. 9. Original locality record cited.

Botula falcata Gould, I. S. Oldroyd, *Stanford Univ. Publ. Univ. Ser. Geol. Sci.*, Vol. 1, 1924, p. 71, pl. 21, figs. 8, 9. Coos Bay, Oregon, to San Diego, California.

Type Locality: Monterey Bay, California, in indurated marly clay.

Range: Coos Bay, Oregon, to Cape San Lucas, Lower California.

Collecting Station: Mexico: Cape San Lucas, Lower California.

Description: Shell subcylindrical, falcate, fragile, beaks about one eighth the length from the anterior end; a strongly marked angle occurs from the beaks to the base of the posterior extremity; ornamented by vertical wrinkles posteriorly, and these are somewhat divaricate anteriorly; periostracum thick, chestnut colored.

The vertical sculpture, larger and more elongate valves, are characters which serve to separate *Botula falcata* from *B. californiensis* Philippi.

Distribution: The discovery of the occurrence of *Botula falcata* at Cape San Lucas, Lower California, is an extension southward in the known range. It bores into rocks and attaches itself by a byssus to the sides of the burrow.

Genus *Lithophaga* Bolten.Key to the subgenera of *Lithophaga*.

- A. Calcareous prolongations of shell crossed at posterior end.....*Myoforceps*
 B. Calcareous prolongations of shell not crossed at posterior end
 a. Calcareous incrustation of shell smooth*Labis*
 aa. Calcareous incrustation with divaricate plumose pattern posteriorly*Diberus*

Subgenus *Myoforceps* Fischer.*Lithophaga (Myoforceps) aristata* Dillwyn.

Mytilus aristatus Dillwyn, *Descript. Cat. Rec. Shells*, Vol. 1, 1817, p. 303. "Inhabits the coasts of Senegal burrowed in the shells of Balani. Adanson. In calcareous rocks. Sowerby." Reference to Adanson, *Hist.*

Nat. Senegal, 1757, p. 267, pl. 19, fig. 2; *Encycl. Meth.*, pl. 221, fig. 8; *Linn. Trans.*, Vol. 8, pl. 6, fig. 2.

Lithophaga aristata Dillwyn, I. S. Oldroyd, *Stanford Univ. Publ. Univ. Ser. Geol. Sci.*, Vol. 1, 1924, p. 73, pl. 39, fig. 2. La Jolla, California, to Peru. Also Atlantic.

Type Locality: Coast of Senegal, Africa, in shells of Balani, also in calcareous rocks.

Range: La Jolla, California, to Peru. Also in the Atlantic; world wide.

Collecting Stations: Mexico: Punta Arena area; Pulmo Reef; Port Guatulco (195-D-15), 1.5 fathoms, coral; Acapulco; Tangola-Tangola Bay, on beach; Costa Rica: Port Parker, on beach; Cedro Island, Gulf of Nicoya (213-D-4-15), 5-40 fathoms, mud; Colombia: Gorgona Island.

Description: Shell subcylindrical, fairly straight, smooth, thin; a whitish calcareous coating usually covers the yellowish periostracum at the posterior end and extends beyond the shell in two narrow beak-like prolongations which cross as in the blades of a pair of scissors. Lamy has discussed this species and its synonymy (*Journ. de Conchyl.*, Vol. 81, 1937, pp. 169-174).

Distribution: This species is found from southern California to Peru, in holes which it has bored into rocks. It also occurs in the Atlantic and world wide in tropical seas. Dall recorded the species from the lower Miocene of Ballast Point, Tampa Bay, Florida, and the present authors recorded its occurrence in the Pleistocene of the Galápagos Islands.

Subgenus *Labis* Dall.*Lithophaga (Labis) attenuata* Deshayes.

Modiola attenuata Deshayes, *Lamarck's Anim. s. Vert.*, Vol. 7, 1836, p. 28. "Habite au Pérou, au Chili, dans les pierres." Ref. to "*Lithodomus caudigerus* var.," Sowerby, *Gen. Shells*, [Vol. 2, pl. 135] fig. 3.—Philippi, *Abbild. u. Beschreib. Conchyl.*, Bd. 2, Heft 5, *Modiola*, October, 1846, p. 148 (2), tab. 1, fig. 6. "Patria: Litus Peruviae et Chili."

Lithophaga attenuata Deshayes, I. S. Oldroyd, *Stanford Univ. Publ. Univ. Ser. Geol. Sci.*, Vol. 1, 1924, p. 73, pl. 39, fig. 10. Lower California.

Type Locality: Peru and Chile.

Range: San Ignacio Lagoon, Lower California, to Chile.

Collecting Station: Costa Rica: Port Parker.

Description: Shell characterized by its slender produced form. The beaks are appressed, smooth, and the entire inner surface is hollow. This species is the type of the subgenus *Labis* Dall, which "has on each valve a semicylindrical smooth appendage of which the distal end is internally flattened and somewhat separated from the

appendage of the opposite valve, the ends being rounded."

Distribution: This species has been cited as occurring as far south as southern Chile. We have not seen specimens from north of San Ignacio Lagoon, Lower California. Like others of the genus it bores into rocks.

Subgenus *Diberus* Dall.

Lithophaga (Diberus) plumula Hanley.

Plate I, Figure 10.

Lithodomus plumula Hanley, *Proc. Zool. Soc. London*, July, 1844, p. 17. "Hab. Panama, in *Spondyli*."—Reeve, *Conch. Icon.*, Vol. 10, *Lithodomus*, 1857, species 23, pl. 4, fig. 23. Original locality cited.

Modiola (Lithodomus) plumula Hanley, *Cat. Rec. Bivalve shells*, pl. 24, fig. 23, 1856. [Not the record p. 240, "Philippines"].

Lithophagus calyculatus Carpenter, *Cat. Mazatlan Shells*, January, 1856, p. 124. "Hab.—Mazatlan; 1 sp. in *Spondylus calceifer*."

Type Locality: Panama, in *Spondyli*.

Range: San Ignacio Lagoon, Lower California, to Peru.

Collecting Stations: Mexico: Pulmo Reef, Arena Point, Lower California; Costa Rica: Port Parker; Colombia: Gorgona Island.

Description: The characteristic features of this species were mentioned by Hanley as follows: "The calcareous cellular coating of the umbonal ridge, resembling a ruffled feather in its arrangement, being composed of elevated thin ridges which slope anteriorly and diverge from their point of junction, one half to the anterior dorsal, the other to the ventral margin."

Carpenter's description of *Lithophaga calyculata* agrees exactly with that of Hanley for *L. plumula* and is therefore placed in the synonymy of Hanley's species in the present paper.

Specimens from San Diego and north to Duxbury Reef, Mendocino county, California, which have been referred to *Lithophaga plumula*, usually differ from typical forms of that species in that the calcareous incrustation usually lacks the definite arrow-head pattern of a central ridge from which lines point toward the vertex of the triangle of incrustation (see Plate I, Figures 8 and 9). For the California form we propose the subspecific name *Lithophaga plumula kelseyi*. (Calif. Acad. Sci. Paleo. Type Coll.) from Loc. 5865 (C. A. S. Coll. H. Hemphill collector), San Diego, California.

Distribution: *Lithophaga plumula* occurs fairly commonly at certain localities along the west coast from Mexico to Peru where

it is found between tides in rocks into which it has bored.

Genus *Crenella* Brown.

Crenella divaricata d'Orbigny.

Plate I, Figures 12 and 13.

Nuculocardia divaricata d'Orbigny, in Sagra, *Hist. Cuba*, Moll., Vol. 2, 1845, p. 311, atlas, pl. 27, figs. 56, 57, 58, 59. "Se trouve dans presque toutes les Antilles; au moins l'avons-nous de la Martinique, de la Guadeloupe, de la Jamaïque et de Cuba."—Chenu, *Man. de Conchyl.*, Vol. 2, 1862, p. 154, fig. 754.

Crenella divaricata d'Orbigny, Maury, *Bull. Amer. Paleo.*, Vol. 10, Bull. 42, 1925, p. 247 (95), pl. 29 (18), fig. 13. Springvale, Trinidad. Miocene.

Type Locality: Cuba (here designated). Martinique, Guadeloupe, Jamaica and Antilles also cited originally.

Range: Guadalupe Island, off Lower California, Mexico, and the Gulf of California, to Ecuador. Also Atlantic, from North Carolina to Venezuela.

Collecting Stations: Mexico: Santa Inez Bay (145-D-1, 3), 4-13 fathoms, sand; Manzanillo (184-D-2), 30 fathoms, gravelly sand; Port Guatulco (195-D-9), 7 fathoms, green sand, crushed shell; Costa Rica: Port Parker (203-D-1, 3), 12-15 fathoms, sandy mud, crushed shell, shelly mud.

Description: Shell small, elongately oval in shape, colored yellowish-white, ornamented by fine radial divaricate striations which are decussated by concentric sculpture; margins crenellated; a single strong crenellated denticle is present on the hinge.

A study of the literature and of the museum material available has led us to accept the conclusion of Dall that these tropical west American specimens can be referred to d'Orbigny's species *Crenella divaricata* which was originally described from the Caribbean region. The species has been cited from various geologic formations back to the Miocene.

Crenella ecuadoriana Pilsbry and Olsson,⁴⁶ described from the Pliocene of Ecuador, appears to be identical except for the slightly larger size of the fossil form.

Another name for the recent species is *Crenella inflata* Carpenter,⁴⁷ originally described from Cape San Lucas, Lower California.

We have not noticed any occurrence of *Crenella divaricata* north of Mexico. Specimens which we have studied from southern California are referable to *Crenella decussata* Montagu and appear to be identical with specimens from England and from the

⁴⁶ *Crenella ecuadoriana* Pilsbry and Olsson, *Proc. Acad. Nat. Sci. Philadelphia*, Vol. 93, September 9, 1941, p. 55, pl. 18, figs. 2 and 3. "Canoa formation, Punta Blanca," Ecuador, Pliocene.

⁴⁷ *Crenella inflata* Carpenter, *Ann and Mag. Nat. Hist.*, Ser. 3, Vol. 13, April, 1864, p. 313. "Cape St. Lucas,"

Lower California. Reprint in *Smithson. Miscell. Coll.*, No. 252, 1872, p. 211.

Not *Crenella inflata* Müller, *Holzappel, Palaeontographica*, Bd. 35 (Moll. Aachner Kreide. Abt. 2), 1889, p. 220, pl. 25, figs. 17, 18. Cretaceous of Germany. [Originally described as *Mytilus inflatus*].

Atlantic coast of the United States. The shells of *Crenella divaricata* are more inflated, more elongately oval in outline, and the hinge is more strongly developed in comparison with that of *C. decussata*.

Crenella megas Dall⁴⁸ described from Panama possesses a larger, thinner, delicately ornamented shell which is more pointed posteriorly in comparison with that of *C. divaricata*.

Distribution: *Crenella divaricata* occurs fairly commonly in west American waters at depths of 5 to 50 fathoms from Guadalupe Island, Mexico, to Ecuador, and along the Atlantic coast from North Carolina to the West Indies. It has been recorded from Miocene to Recent in the Caribbean region and is at present known from Pliocene to Recent on the Pacific coast.

EXPLANATION OF THE PLATE.

PLATE I.

- Fig. 1. *Septifer zeteki* Hertlein & Strong, sp. nov. Paratype, right valve, from Station 195-D-9, dredged in Lat. 15°44'28"N., Long. 96°07'51"W., off Port Guatulco, Mexico, in 7 fathoms (12.6 meters). Length (beak to base) 6 mm. P. 71.
- Fig. 2. *Septifer zeteki* Hertlein & Strong, sp. nov. View of the interior of the specimen shown in Figure 1.
- Fig. 3. *Lima hemphilli* Hertlein & Strong, sp. nov. Holotype, left valve, from Loc. 5955 (Calif. Acad. Sci.), San Diego, California, Henry Hemphill collector. Altitude 23 mm., length 16.4 mm. P. 66.
- Fig. 4. *Lima hemphilli* Hertlein & Strong, sp. nov. Holotype, right valve. View of interior of right valve of specimen shown in Figure 3.
- Fig. 5. *Volsella (Volsella) arciformis* Dall. Hypotype, right valve, from Monypenny Point, Nicaragua. Length 41 mm., greatest width approximately 16.5 mm. P. 72.
- Fig. 6. *Pecten (Leptopecten) velero biolleyi* Hertlein & Strong, subsp. nov. Holotype, right valve, from Station 203-D-3, dredged in Lat. 10°55'45"N., Long. 85°49'05"W., near Port Parker, Costa Rica, in 12 fathoms (22 meters). Length 6.9 mm., altitude 6.6 mm. P. 60.
- Fig. 7. *Volsella (Volsella) salvadorica* Hertlein & Strong, sp. nov. Holotype, left valve, from Station 198-D-2, dredged in Lat. 13°27'20"N., Long. 89°19'20"W., off La Libertad, El Salvador, in 14 fathoms (25 meters). Length 23.6 mm., height 13.9 mm. P. 73.
- Fig. 8. *Lithophaga plumula kelseyi* Hertlein & Strong, subsp. nov. Holotype, from Loc. 5865 (Calif. Acad. Sci.), San Diego, California, Henry Hemphill collector. Length 57.2 mm., greatest height approximately 14 mm. P. 75.
- Fig. 9. *Lithophaga plumula kelseyi* Hertlein & Strong, subsp. nov. Side view of left valve of specimen shown in Figure 8.
- Fig. 10. *Lithophaga (Diberus) plumula* Hanley. Hypotype, right valve, from Port Parker, Costa Rica. Length 48.2 mm., height 14 mm., convexity (both valves) 14.3 mm. View of exterior of right valve. P. 75.
- Fig. 11. *Volsella (Volsella) salvadorica* Hertlein & Strong, sp. nov. View of interior of specimen shown in Figure 7.
- Fig. 12. *Crenella divaricata* d'Orbigny. Hypotype, left valve, from Station 145-D-1, dredged in Lat. 26°52'N., Long. 111°53'W., Santa Inez Bay, east coast of Lower California, in 13 fathoms (24 meters). Height (beak to base) approximately 3 mm., length approximately 2 mm. P. 75.
- Fig. 13. *Crenella divaricata* d'Orbigny. View of the interior of the specimen shown in Figure 12.
- Fig. 14. *Ostrea palmula* Carpenter. View of interior of upper valve of holotype from Mazatlan, Mexico. Original measurements given as "Long. 2.3, lat. 1.6, alt. .54" poll. Carpenter at the time of descriptions of species in 1865 (*Journ. de Conchyl.*, Vol. 12 (Ser. 3, Vol. 5), April, 1865, p. 133 (footnote). Reprint in *Smithson. Miscell. Coll.*, No. 252, 1872, p. 301) stated that the unit "poll." used in the descriptions was 2.53 cm. in length. Dr. Teng-Chien Yen who, while at the British Museum of Natural History, investigated this unit of measurement, stated that the length of a pollex is approximately 2 cm.
- This photograph was obtained from authorities of the British Museum of Natural History by Dr. U. S. Grant, IV, who kindly permitted us to use it to illustrate the species. P. 55.
- Fig. 15. *Plicatula spondylopsis* Rochebrune. Hypotype, left valve, from the Gulf of California, without exact locality but probably from Arena Bank. Height (beak to base) approximately 52.6 mm., length approximately 38 mm., convexity (both valves) approximately 25 mm. P. 63.
- Fig. 16. *Plicatula spondylopsis* Rochebrune. Hypotype, left valve, from station 136-D-26, dredged in Lat. 23°27'N., Long. 103°24'W., Gorda Bank, Gulf of California, in 45 fathoms (82 meters). Height (beak to base) 53.6 mm., length 40.5 mm. P. 63.
- Fig. 17. *Dimya californiana* Berry. Hypotype, left valve, from Station 137-D-2, dredged in Lat. 24°11'N., Long. 109°59'W., Ceralbo Channel, Gulf of California, in 46 fathoms (84 meters). Length 10.8 mm., height (beak to base) 8.7 mm., convexity (one valve) approximately 1.8 mm. P. 65.

All the specimens illustrated on this Plate are in the type collection of the Department of Paleontology of the California Academy of Sciences.

⁴⁸ *Crenella megas* Dall. *Proc. U. S. Nat. Mus.*, Vol. 24, March 31, 1902, p. 559. "Dredged at station 2795, in Panama Bay, at a depth of 33 fathoms, sand, bottom temperature 64 F."—Dall, *Proc. U. S. Nat. Mus.*, Vol. 26, 1903, p. 950, pl. 62, fig. 4.

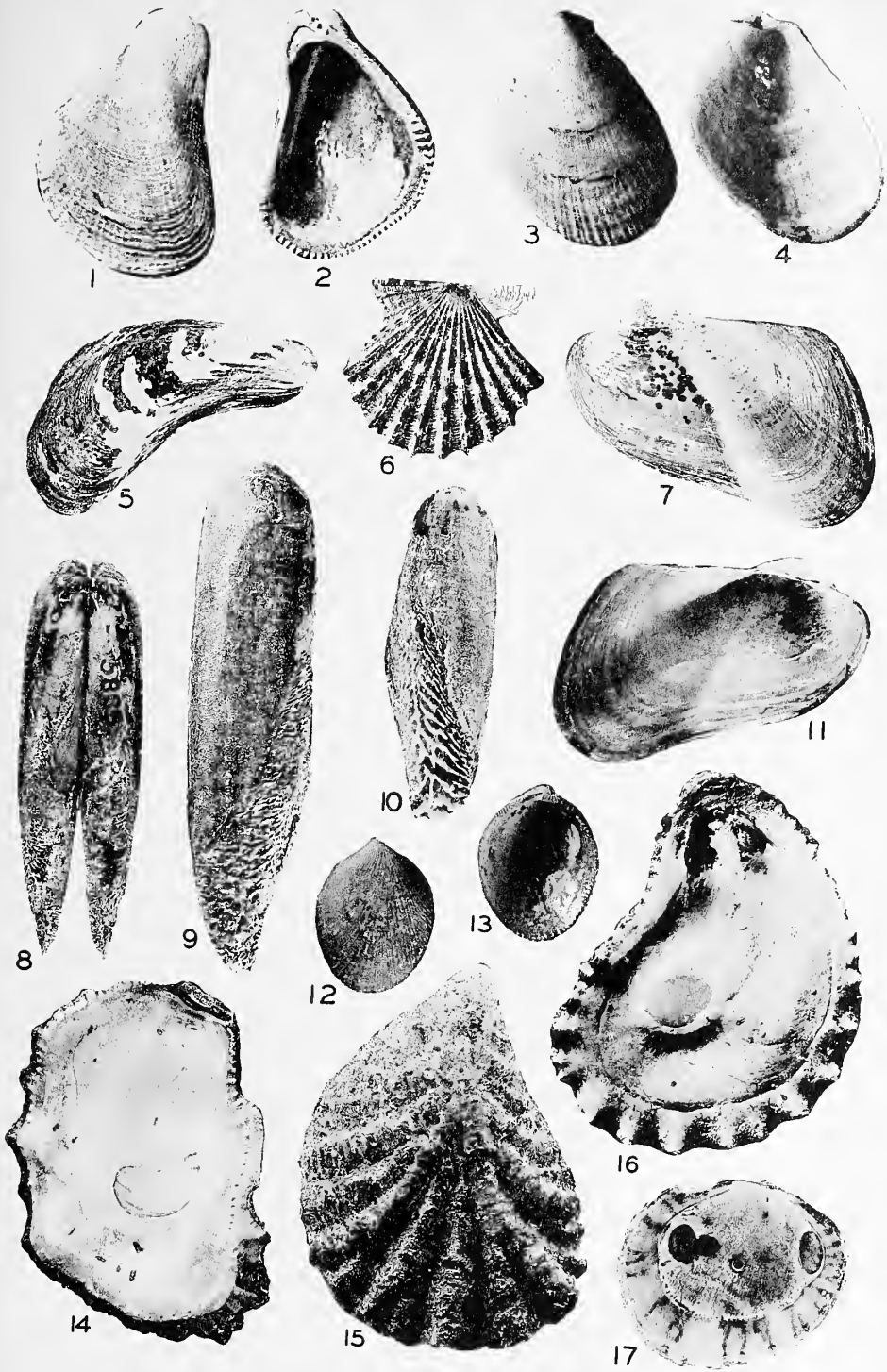

MOLLUSKS FROM THE WEST COAST OF MEXICO AND CENTRAL AMERICA.



6.

Introgressive Hybridization in Domesticated Fishes.

I. The Behavior of Comet A *Platypoecilus maculatus* Gene in *Xiphophorus hellerii*.MYRON GORDON.¹*New York Aquarium, New York Zoological Society.*

(Plates I-III).

The platyfish's comet gene PC^o was found in 1932 among the wild population of *Platy-poecilus maculatus* in a tiny pool within the bed of a tributary stream of the Rio Tonto in the State of Oaxaca, Mexico. In 1939 two more populations containing the PC^o gene were found in the Rio Jamapa, Veracruz, and in several of the Rio Papaloapan tributaries in Oaxaca. The comet is one of a galaxy of genes in the natural populations of the platyfish, the most variable vertebrate, with respect to color pattern polymorphism, in North America. The comet gene PC^o belongs to an autosomal series of seven, dominant, multiple alleles, which include onespot, PO ; moon, PM ; moon complete with satellites, PM^c ; crescent, PC ; crescent complete, PC^c ; twinspace, PT ; and the universal recessive +.

During the study of this series of wild alleles, the comet-marked platyfish was mated in some instances to members of its own wild population and then, in contrast, to a number of domesticated breeds of the same species. A comparison of the results of these two types of matings was quite startling and unexpected. An entirely new pattern was created, known popularly among fish fanciers as the *black wagtail*. It resembles the color scheme in the Himalayan rabbit and Siamese cat, in which the extremities are much darker than other parts of the body.

Owing to the ease in which *P. maculatus* hybridizes with *Xiphophorus hellerii*, a mating between a wild comet platyfish and a wild swordtail was attempted and accomplished. As a result, the hybrids carrying the comet gene showed up with the same wagtail response. By repeated backcrosses of the wagtail platy-swordtail hybrid to the swordtail, a stock was developed indistinguishable from the *X. hellerii* configuration but containing the PC^o gene of *P. maculatus*. The wagtail swordtail so produced is now

well established in the trade devoted to aquarium fishes.

Every step in the production of this new wagtail swordtail is known in this instance, and this will be described in detail. There are many colorful swordtails on the aquarium fish market most of which, if all the facts were known, could be traced back to one or more wild platyfish genes introduced into the swordtail by the process of introgression. This type of hybridization is the basis, also, for the development of melanomas in platyfish-swordtail combinations. Essentially the malignant tumors depend upon the interactions of the platyfish genes for macromelanophores Sp or N in association with a number of swordtail genes. With every backcross of the melanotic hybrid to the swordtail, the characteristic contours of the swordfish are more closely approached, while at the same time the severity of the melanoma is enhanced.

The process of introgression is often reversed; that is, a few swordtail genes may modify the basic platyfish genes. This is probably the explanation for the wagtail platyfish and for a number of the brilliant red, black and other domesticated varieties of the platyfish.

THE COMET PATTERN.

The comet is a simple pattern in wild platyfish. It consists of two straight black lines, one on the upper and one on the lower border of the tail fin. These dual black streaks are not parallel but flare slightly in conforming to the broadening of the caudal fin. This has the appearance of a conventionalized comet's train. A microscopic examination of the black lines of the comet reveals that they are composed of hundreds of tiny pigmented cells or micromelanophores concentrated along the upper and lower margins of the tail fin. The rest of the fin, in contrast, is transparent although there are scattered micromelanophores over all of it. The pigmented cells of the comet,

¹ Aided in part by a grant from the Anna Fuller Fund and by the facilities of the American Museum of Natural History.

of the tail fin proper, and of the body proper are similar morphologically. These micromelanophores are similar, too, to the pigmented cells which compose the other six patterns of the tail and caudal peduncle. When the micromelanophores are scattered, they produce an olive gray appearance; when concentrated they produce a jet black effect.

THE COMET REACTION IN WILD POPULATIONS.

Two distinct geographical populations of *P. maculatus* containing the comet platy were tested. The Rio Tonto population belongs to the Rio Papaloapan drainage system and in this system the comet gene is present in 8% of all platyfish. The second group belongs to the Rio Jamapa system, being collected at Plaza de Agua near El Tejar, a few miles west of the city of Veracruz. This area marks the most northern limit of the species as far as known; here 5% of the platyfish population carry the gene P^{Co} . The same species is known from two other great river systems, the Rio Coatzacoalcos and the Rio Usumacinta, but no comets have been reported, as yet, from them. An analysis of speciation in this fish by the use of pattern gene frequencies, including P^{Co} , is being prepared by Gordon (1946a).

In the paper just mentioned genetic evidence will be presented showing the relation of the P^{Co} gene to the others of its allelic series. When a comet platy is mated to any other member of its wild population, their offspring will display the comet pattern unchanged, regardless of the presence of any of the other markings. Natural combinations such as $P^{Co}P^O$, $P^{Co}P^M$, $P^{Co}P^Mc$, $P^{Co}P^C$, $P^{Co}P^{Co}$ and $P^{Co}P^T$ have been observed. In addition, single and duplex combinations have been seen with the sex-linked genes: Sp , Sr , Sd and N in more complex arrangements of patterns. However, no matter what other wild patterns a platyfish may have, the comet, if present, is visible and remains phenotypically unchanged.

THE COMET REACTION IN DOMESTICATED POPULATIONS.

When a wild platyfish carrying the comet gene was mated to several different domesticated breeds of the same species, the F_1 hybrids carrying P^{Co} showed an entirely new phenotypic expression of it. When quite young the comet hybrids appeared in their conventional pattern, but as they continued their growth, the intensity of the black pigmentation of the upper and lower margins of the tail fin spread to the intermediate regions of that fin. At the same time the dorsal, the anal, the ventral and even the pectoral fins became darker too. Finally when the hybrid fish reached maturity, the micromelanophores in great concentrations blackened all the fins, and in addition they darkened the

upper and lower jaws and the edges of the operculum. Expressing this reaction in short: all extremities were darkened. The resulting pattern is somewhat similar to the color scheme seen in Siamese cats, Himalayan rabbits, great Dane dogs, Dorset sheep and others in which the exposed parts, the muzzle, the ears, the digitory areas and the tail are strikingly darker than the rest of the body.

The action of the gene P^{Co} for comet was apparently modified in F_1 hybrids by a gene or genes contributed to the hybrid by the domesticated platyfish. The reaction of the comet with its modifier was first detected when the comet fishes of the Rio Papaloapan system were mated to the aquarium-bred variety known as the goldplaty. Later the same reaction was rediscovered when a wild comet platy from the Rio Jamapa was mated to several domesticated varieties.

THE GENETIC NATURE OF THE COMET MODIFIER.

In *P. maculatus*, prior to the discovery of the P^{Co} modifier gene, E , three linkage groups were known: a sex-linked group with seven dominant genes, an autosomal allelic series with seven dominant genes and another autosomal group containing the one "domesticated" recessive golden, st . This platy has 24 haploid chromosomes according to Ralston (1934) and Friedman and Gordon (1935).

The following is an analysis of the genetic association of the E gene. The presentation of the following data and their analyses are not necessarily given in the chronological order in which the experiments were conducted.

$$\begin{array}{l} \text{"Domesticated" } \text{\textcircled{f}} \qquad \qquad \qquad \text{"Wild" } \text{\textcircled{m}} \\ 1. \quad \frac{Dr \ st \ + \ E}{+ \ st \ + \ E} \quad \times \quad \frac{+ \ + \ P^{Co} \ +}{+ \ + \ P^{Co} \ +} \end{array}$$

In the above and succeeding formulae of genetic constitutions, Dr represents the gene for a red-dorsal fin, shown by Kosswig (1931) to be dominant and sex-linked. This was confirmed independently by Gordon (1931) who at one time used the symbol Rf for this gene. In domesticated females its chromosome associations are $(Z)Dr (W)+$.

The recessive st represents few or no micromelanophores and the absence of these black cells reveals the many underlying xanthophores which give this fish variety its golden coloring.

P^{Co} represents the comet pattern and E refers to its specific modifier which, as will be seen, is present in most domesticated stocks in a homozygous state. The $+$ refers to universal recessive of the allelic series and to the "neutral wild type."

Together with this first mating, two others may be presented and discussed at the same

time because in each case the female parents had the same genotypes, and the males, too, were for the most part similar genetically for the characters under analysis. The second male differed only in that the P^{Co} gene was associated with another one of the dominant alleles, the gene P^O for onspot while the third male had the allele P^C for crescent as its P^{Co} associate. Their genotypes are given below:

$$\begin{array}{r}
 \text{2.} \quad \begin{array}{c} \text{Females} \\ \frac{Dr\ st + E}{+ st + E} \end{array} \times \begin{array}{c} \text{Males} \\ \frac{+ + P^{Co}}{+ + P^O} \end{array} \\
 \\
 \text{3.} \quad \begin{array}{c} \text{Females} \\ \frac{Dr\ st + E}{+ st + E} \end{array} \times \begin{array}{c} \text{Males} \\ \frac{+ + P^{Co}}{+ + P^C} \end{array}
 \end{array}$$

It is clear from the results indicated in Table I that the sex-linked factor Dr was transmitted from the mothers to all their sons in the conventional manner according to (Z) Dr (W) + chromosome sex-determining mechanism. But Gordon (1946c) has indicated that the wild platyfish male has the XY chromosome arrangement. Thus it may seem from these experiments that among the F_1 , (X) + (W) + and (Y) + (W) + are female while (Z) Dr (X) + and (Z) Dr (Y) + are male. A further discussion of this phase of the problem in matings of "wild" and "domesticated" platyfish is treated in another paper by Gordon (1946b).

All the F_1 of the three matings were olive gray, showing complete and uniform dominance of the "wild" St (or +) over the recessive "domesticated" golden gene st .

The first "wild" male comet platy (1-38) was apparently homozygous for P^{Co} as all of the F_1 had this factor but its phenotype ex-

pression modified by extensor gene E was changed into the wagtail pattern.

The offspring of the second (1-39) and the third (1-40) males show that the presumed modifier E acts on P^{Co} but not on P^O or P^C , and we have additional data at this time showing that E does not act on P^C , P^M , P^{Mc} or P^T , the remaining members of the series, and E has no discernible phenotype by itself. Only the combination $P^{Co} E$ produced the wagtail reaction.

Matings 1, 2 and 3, taken individually or together, clearly show that E is not sex-linked, for while Dr is transmitted from the mother to her sons only the wagtail reaction $P^{Co} E$ is visible in the sons and daughters.

Further evidence of the autosomal nature of the P^{Co} modifier may be seen in matings listed in Table II. In mating 4 the broods of two genetically similar females were pooled, and the observed results are apparently consistent with the theoretical values expected if E is considered independent of the two known autosomal factors in the mating, P^{Co} and St . Previous work (Gordon, 1927) has shown that the number of golden st is usually deficient, the deficiency being due to differential viability of st in contrast with the wild allele St . If E were linked to P^{Co} we might have expected that the ratio between $P^{Co} E$ and E would have been less than 3:1, since linkage, if it existed, would have been in the repulsion series; actually the number of $P^{Co} E$ was slightly greater than expected on the basis of a 3:1 ratio.

The independence of E and P^{Co} with respect to their linkage relations is clearly demonstrated in mating 5. Here approximately equal numbers of modified comets $P^{Co} E$, and non-comets, + E , (20:15) were found, whereas if E were linked with P^{Co} ,

TABLE I.

MATING NO.	1		2		3	
CULTURE NO.	31		32		33	
P ₁ PEDIGREE NO.	♀ 9A1	♂ 1-38	♀ 9A2	♂ 1-39	♀ 9A3	♂ 1-40
P ₁ PHENOTYPES	Dr st + E	+ + P ^{Co} +	Dr st + E	+ + P ^{Co} P ^O +	Dr st + E	+ + P ^{Co} P ^C +
F. PHENOTYPES	♀	♂	♀	♂	♀	♂
Dr + P ^{Co} E	0	12	0	5	0	14
+ + P ^{Co} E	9	0	6	0	10	0
Dr + P ^O E			0	7		
+ + P ^O E			8	0		
Dr + P ^C E					0	10
+ + P ^C E					15	0
Totals	9	12	14	12	25	24
χ ² values	0.428		0.768		1.693	

TABLE II.

MATING	4		5		6		7	
CULTURE No.	53		59		55		54	
P ₁ PEDIGREE No. P ₁ PHENOTYPES	♀ 31-1, 2 ++P ^{Co} E	♂ 31-11 Dr+P ^{Co} E	♀ 9A2-1 Dr st+E	♂ 31-11 Dr+P ^{Co} E	♀ 31-3, 4 +P ^{Co} E	♂ 12-11 +++	♀ 53-1 st P ^{Co} E	♂ 53-11 st P ^{Co} E
F ₁ PHENOTYPES	♀	♂	♀	♂	♀	♂	♀	♂
Dr + P ^{Co} E	14	8	3	6				
++ P ^{Co} E	13	12	4		14	11		
Dr st P ^{Co} E	3	2	2	4				
+ st P ^{Co} E	2	1	1				14	18
Dr + P ^{Co}	4	5						
++ P ^{Co}	4	3			11	8		
Dr st P ^{Co}	1	0						
+ st P ^{Co}	0	1					4	6
Dr + + +	6	8	2	5				
+ + + +	3	2	4		28	24		
Dr st + +	2	1	1	3				
+ st + +	1	0	0				8	8
Totals	53	43	17	18	53	43	26	32
χ ² values	12.764		8.267		1.417		0.237	

then one might have expected only one *P^{Co} E* in four individuals (1:3). Independence of these genes is fully substantiated by the results of mating 6, where the male parent, being a "wild" individual and presumably homozygous recessive for the *P^{Co}* modifier *e*, produced when mated to an F₁ *P^{Co} E* approximately equal numbers of *P^{Co} E* and *P^{Co} +*. If *P^{Co}* were closely linked to *E*, no *P^{Co} E* would have been expected; if linked but separated moderately, a few *P^{Co} E* might have been expected as crossovers; but the data (25:19) indicate independence. The results shown in mating 7, where golden wagtails (*P^{Co} E*) were inbred, indicate a similar conclusion.

The data presented in Table III indicate further evidence that domesticated stocks of *P. maculatus* carry *E* (the dominant modifier of *P^{Co}*), in a homozygous state. All four golden platyfish of culture 9A listed in Table II were of this type; and the spotted female, 8 C1, and golden male, 9A21, listed in Table III, were homozygous for *E* too. In mating 8, the spotted female carried the pattern gene on its W chromosome, (Z)+ (W)*Sp*. This accounts for the mother-to-daughter type of inheritance of the *Sp* gene. (Again although XY represents the P₁ wild male (No. 1-39), in the F₁, XW and YW apparently determine femaleness and ZX and ZY determine maleness). Again, *E* apparently has no effect on the phenotypic expression of the allele *P^{Co}*.

Further consideration of the sex-linked

factors *Sp* and *Dr* in linkage relations to *E* seem unnecessary. Additional data are available of the linkage independence of *E* with respect to *St* and *P^{Co}*. In matings listed under No. 9 representing broods 46, 47 and 48, there were 146 *P^{Co} E*, 41 *P^{Co} +*, and 55 ++. The theoretical expectancy if *P^{Co}* and *E* are independent is as follows: 125 *P^{Co} E*, 45 *P^{Co} +*, and 60 ++, which is a significantly good fit. The X² value in this mating results with regard to *st*, *P^{Co}* and *E* is P = 31.

The results of mating 9 show that it is not likely that *E* is linked to *St* for when *P^{Co} E* was crossed with + *P^{Co} E*, 12 were *st P^{Co}* out of 242 offspring. On the basis of three independent factors 11.4 or 3/64 of the total were expected theoretically. All the other phenotypes appear in proportions appropriate to the theoretical values expected upon the same basis.

Further confirmation of the independence of *St*, *P^{Co}* and *E* is presented in the results from matings 10 and 11. If *P^{Co}* and *P^{Co}* were linked to *E*, one ought not to get any *P^{Co} P^{Co} E* in mating 11, yet 19 were observed; and 17 would be expected on the three independent factor basis. If *E* were linked to *St*, no *st P^{Co}* or *P^{Co} P^{Co} E* would be expected, yet both types were present.

THE DISTRIBUTION OF THE *E* GENE IN XIPHOPHORIN SPECIES.

Tests for the presence of the *E* gene in some of the wild xiphophorin species were

TABLE III.

MATING No.	8		9		10		11	
CULTURE No.	44		46-47-48		49-50		51-52	
PEDIGREE No. GENOTYPES	♀ 8C1 Sp st +E + st +E	♂ 1-39 ++P ^{Co} + ++P ^O +	♀ 44-1,2,3 +P ^{Co} E st + +	♂ 44-11,12 +P ^{Co} E st + +	♀ 44-4, 5 +P ^{Co} E st + +	♂ 9A21 ++E ++E	♀ 44-6, 7 +P ^O E st + +	♂ 44-13 +P ^{Co} E st + +
F. PHENOTYPES	♀	♂	Obs.	Exp.	Obs.	Exp.	Obs.	Exp.
Sp + P ^{Co} E	7	0						
+ + P ^{Co} E	0	7						
Sp + P ^O E	6	0						
+ + P ^O E	0	9						
+ P ^{Co} E			121	101.8	28	22.8	14	12.6
st P ^{Co} E			25	34.2	21	22.8	3	4.2
+ P ^{Co} +			29	34.2			5	4.2
st P ^{Co} +			12	11.4			2	1.4
+ +			42	45.4	24	22.8	15	16.8
st +			13	15.2	18	22.8	4	5.6
+ P ^{Co} P ^O E							17	12.6
st P ^{Co} P ^O E							2	4.2
+ P ^{Co} P ^O +							2	4.2
st P ^{Co} P ^O +							1	1.4
+ P ^O							20	16.8
st P ^O							5	5.6
Total	13	16	242	242.2	91	91.2	90	89.6
X ² values	0.812		7.163		1.265		5.583	

made by mating wild comet-carrying *P. maculatus* to *Xiphophorus hellerii*, *P. xiphidium* and *P. couchianus*. Tests were made also in three domesticated varieties of the swordtail: the albino, the red, and the golden tuxedo.

In Table IV the various interspecific matings are listed. The first-generation hybrids between *X. hellerii* and *P. maculatus* are designated as *XP*. When this hybrid is backcrossed to *X. hellerii*, the offspring are indicated as *XPX*, and when *XPX* is backcrossed again to *X. hellerii*, their offspring are designated as *XPXX*. The *XPXX* hybrids are not all alike, nor would they all pass as swordtails (see discussion). In 12 to 15, the results of crossing four wild *P. maculatus* comets, *P^{Co}*, with two albinos, one red and one wild female *X. hellerii*, show that the *E* modifier was present in a homozygous state in all of the swordtails, since the wagtail reaction rather than the unmodified comet pattern appeared in half of the hybrids. When the hybrids of mating 12 were inbred (mating 16), the number of wagtails (*P^{Co} E*), comets (*P^{Co}*), and neutrals (+) showed up approximately in the ratio of 9:3:4. This ratio represented the distribution of the three phenotypes in matings 16 and 17, too. Summing matings 16

through 18, there were 70 *P^{Co} E*, 15 *P^{Co}*, and 37+, while the expected ratio was 68.4 *P^{Co} E*, 23 *P^{Co}*, and 30.4 +. This summary does not, of course, include a number of presumably *P^{Co} E*, *P^{Co}*, and + in combination with the homozygous recessive *ii* for albinism, because the melanin pigment inhibitor *i* suppresses all melanic patterns. The fact that the albinos appear in far fewer numbers than the theoretical expectancy, has previously been noted by Gordon (1942).

When the species hybrids were backcrossed to the swordtail in an effort to re-create the body configuration of the swordtail and at the same time to retain the wagtail pattern (matings 19 through 23, and 25), all the domesticated and wild *X. hellerii* used proved to be homozygous for the *E* modifier in the backcross generation. When, however, the *F*₁ hybrid was backcrossed to a wild *P. maculatus* which introduced the non-modifier (mating 24), an 8 *P^{Co} E* to 4 *P^{Co}* to 10 + ratio was observed, and 5.5 to 5.5 to 11.0 ratio was expected on the basis of 1:1:2 ratio and 22 individuals.

With each backcross of the wagtail platyswordtail hybrid to the *X. hellerii*, the resulting broods contains individuals that approach the swordtail more perfectly in body type, but there are many swordtail-platyfish

hybrids in the *XPXX* category that have many combinations of hereditary factors; some of them indeed may be compared to the F_1 or *XP*.

When a comet *P. maculatus* was mated with a *P. xiphidium*, the wagtail reaction was weakly evident. A similar *P. maculatus* mated with *P. couchianus* produced a more definite wagtail hybrid. Since one mating each was tried, the distribution of the *E* gene in xiphophorins other than *X. hellerii* is still incompletely known.

DISCUSSION.

THE CONDITIONS IN NATURAL POPULATIONS.

Wild swordtails are quite uniform with respect to color patterns whereas wild platyfish are extremely variable. In over 10,000 specimens of both species taken over their entire range in southern Veracruz and Oaxaca in Mexico and in British Honduras and Guatemala, not a single hybrid was found, yet at eight localities in this range the two species may be found side by side. Some of the isolating mechanisms such as psychological and ecological have been suggested previously by Gordon (1943, 1946a) to account for lack of natural hybridization. In the laboratory or home aquaria these barriers to hybridization are easily overcome. In a historical account of the early domestication of these species Gordon (1934) has found that the platy was first imported, probably from the Rio Coatzacoalcos, in 1907, and the swordtail followed in 1909, probably from the same river. Only two years later, 1911, hybrids between the species were recorded by aquarists writing in the *Blätter* and in the *Wochenschrift für Aquarien und Terrarienkunde*.

At present the tropical-fish dealers' catalogues list a dozen or more color varieties of the swordtail, only one of which, the albino, may have definitely arisen by the process of mutation. The other domesticated varieties, including such types as golden, red, black, tuxedo, "montezuma helleri" and their combinations, may be traced to introgressive hybridization of the many individual types of platyfish with the swordtail. Since the wagtail swordtail was produced in the laboratory, every step in its development has been recorded. Evidence of the origin of many other domesticated swordtails is now available also and will be presented in a series of papers.

The introgressive process is much clearer in the development of domesticated swordtails than in domesticated platyfish, but the same process has been going on in both. It seems to be clearest in the production of the wagtail platy. Since wild *P. maculatus* do not carry the *E* factor and wild *X. hellerii* do, it is likely that *E* was transferred to domesti-

cated platies during the many matings made between these species.

An alternative suggestion may be made in accounting for the presence of the *E* factor in domesticated stocks. The early importations of platyfish were probably made from the Rio Coatzacoalcos, according to the analysis made by Gordon (1946a). The P^{Co} factor does not occur (as far as our data show) in the platyfish population of this river but the *E* factor may be present and it may have been transmitted in domesticated stocks generation after generation from 1907 to the present time. The former suggestion seems more plausible at this time.

MODIFYING FACTORS AND QUANTITATIVE CHARACTERS.

From his analyses of natural fish hybrids and particularly from his laboratory studies of species hybrids in *Mollienisia* and related forms, Hubbs (1940) has become convinced that in species hybrids systematic characters of fishes generally show blending inheritance and that simple Mendelian segregation very seldom results; and this seems to apply to hybrids of subspecies and races. Hubbs finds that the characters which distinguish species and subspecies behave in hybridization experiments "in such strict conformance with the Galtonian scheme of inheritance that one can, for instance, compute rather precisely the number of dorsal rays in the final multiple hybrid by striking theoretical averages through the complex mating chart, starting only with the known average value of each form as it is introduced into the multiple matings. Such characters as position of fins, form of body and coloration appear to show a similar type of inheritance."

Kosswig (1931-39) and Gordon (1931-37) have long held that multiple genetic factors may account for the striking modifications in coloration in species hybrids between a particular *P. maculatus* and *X. hellerii*. Gordon (1937), for instance, suggested that the swordtail carries two sets of dominant modifying factors which act upon the spotting (*Sp*) gene of the platyfish. *Sp* is the gene that governs the development of specific pigment cells, the *macromelanophores*, which produce an irregular spotted pattern—a normal condition found in wild stocks as well as in domesticated ones. Thus the following formulae were used to represent the species:

$$\begin{array}{l} \text{Swordtail} \quad \times \quad \text{Platyfish} \\ ++ \text{ AA BB} \times \text{ SpSp} ++ ++ \end{array}$$

The first generation hybrids are all $Sp+ A+ B+$. The interaction of *A* and *B* with *Sp* produces a state of melanosis which frequently is so intense that it leads directly to the development of melanomas.

The reality of these modifiers *A* and *B* may be evaluated in the two opposing types

of backcrosses, one to the platyfish, the other to the swordtail:

BACKCROSS OF F₁ HYBRIDS.

To the Platyfish

Spotted platyfish × Melanotic hybrid
 $Sp+ ++ ++$ × $Sp+ A+ B+$

Backcross hybrids

NORMALS	MELANOTIC
$SpSp ++ ++$	$SpSp A+ B+ (2)$
$Sp+ ++ ++$	$Sp+ A+ B+ (2)$
$++ A+ B+$	$SpSp A+ ++ (1)$
$++ A+ ++$	$Sp+ A+ ++ (1)$
$++ ++ B+$	$SpSp ++ B+ (1)$
$++ ++ ++$	$Sp+ ++ B+ (1)$

BACKCROSS OF F₁ HYBRIDS.

To the Swordtail

Melanotic hybrid × Normal swordtail
 $Sp+ A+ B+$ × $++ AA BB$

Backcross hybrids

NORMALS	MELANOTIC
$++ AA BB$	$Sp+ AA BB (4)$
$++ A+ BB$	$Sp+ AA B+ (3)$
$++ AA B+$	$Sp+ A+ BB (3)$
$++ A+ B+$	$Sp+ A+ B+ (2)$

Assuming that each dominant intensifying factor of the swordtail has the value of *one* (1) the degree of melanosis, or shift of the normal spotted pigment pattern to an intense blackening, is indicated by the values within the parentheses: *A* or *B* equals 1, together *A* and *B* equal 2, and so on.

When the melanotic (*Sp A B*) hybrid is backcrossed to the spotted platyfish (*Sp++*), the darkest backcross hybrids are rarely blacker than their melanotic parent which have an intensity value of *two* (2). There are four genotypic hybrids which have a melanotic intensity value of *one* (1), while two spotted genotypes have the normal pattern; these are listed under *normals*.

In the backcross to the swordtail, the severity of melanosis is enhanced in some backcross hybrids owing to intensity factors which reach the value of *four* (4) in 12½% of the brood; the value of *three* (3) in 25%; and the value of *two* (2) in 12½%. Fifty per cent. or remainder of the brood are normal, for they do not carry the essential *Sp* gene.

When the backcross hybrid members of this brood are again backcrossed to the swordtail, the results depend upon the specific genotype of the particular hybrid used. Hybrid $Sp+ AA BB$ by a $++ AA BB$ swordtail produces black offspring essentially of the same intensity as its hybrid parent. Hybrid $Sp+ AA B+$ by $++ AA BB$ swordtail produces two grades of melanotic offspring while hybrid $Sp+ A+ B+$ by a $++ AA BB$ swordtail produces three grades of melanotic

offspring. In this analysis it has been assumed that *A* has the same value as *B*. If modifying factors *A* and *B* had different values, or if there were more than two modifiers involved, far more divergent groups of hybrids might be expected.

In some of the matings between two swordtail species the degree of diversity in the coloration of various types of hybrids closely resembles, particularly in the first generation, the type of "blending" mentioned for "good" systematic characters. It was found that when the wild spotted type of *Xiphophorus montezumae* was mated with the wild *X. hellerii*, the degree of spotting in the hybrids fell to about 50% of normal; but when the weakly spotted hybrid was backcrossed to *X. hellerii*, the backcross offspring had hardly any spots at all. (These statements are based on Gordon's unpublished data.)

ORIGIN OF RED SWORDTAIL; A STUDY IN INTROGRESSION.

The example given by Hubbs (1940) to illustrate the distinction "between the systematic characters showing blending inheritance on one hand and the phase characters with a simple genetic basis on the other," concerns the origin of the red swordtail. (Incidentally, this is another good example of introgressive hybridization under domestication). According to Hubbs, "no red phase of the swordtail genus *Xiphophorus* [*hellerii*] has been taken in nature and none seems to have originated by mutation in captivity, but the red phase does occur in the related genus *Platypoecilus* [*maculatus*], which hybridizes rather freely with *Xiphophorus*. The hybrids produced by mating a *Xiphophorus* with a red *Platypoecilus* are, in part, of an undiluted red, though intermediate in the ordinary systematic characters, such as form, number of rays, and structure of the gonopodium. Red hybrids mating back to *Xiphophorus* produce three-quarter hybrids of which, however, a certain proportion is red. One or two backcrossings then reconstruct the swordtail, in all respects other than the red clothing."

First the comments concerning the coloration of the wild swordtail and wild platyfish may be discussed because subsequent color responses in their hybrids depend upon the interaction of *all* the color and color modifying genes involved (and possibly some of these genes may be linked to those affecting systematic characters). The wild swordtail has some red coloring of its own: a strong row of erythrophones runs along its lateral line in a zigzagging pattern. Also many red patches of grouped red cells are scattered in the dorsal fin. The red zigzag row of chromatophores of the wild *X. hellerii* is subject to modification; for instance, it may be intensified in a species hybrid by

genes contributed to the hybrid by a non-red species, *X. montezumae*.

Some wild platyfish may have light orange-red dorsal fins; some have brighter coloration about their throat and belly regions. But the reddest of the wild platyfish could not match the brilliant over-all red coloration of the commercially cultivated red platy. We must first explain the process by which the domesticated red platy got so red. The detailed explanation cannot be given adequately on this occasion, but briefly stated, there has been a reciprocal interchange of modifying genes—an example of *reciprocal introgressive hybridization*. The red swordtail has the red gene or genes of the platyfish, *Dr* or *Rt* or both plus its own modifiers of *Dr* and *Rt*. The process involved is essentially the same as that given for the *Sp* gene in this discussion. The brilliant red platyfish of the aquarist has the swordtail gene modifiers of *Dr* or *Rt* plus its own red genes. This has been attained by selection of the desirable combination on the part of the fish fanciers.

The fact that the red phase may have a number of genetic modifiers does not make it any less Mendelian in its mode of inheritance. It does indicate that the red characteristic is as sensitive to quantitative expression (which is the basis of the apparent blending inheritance) as characters that are often used in taxonomy.

In actual practice many subspecies are more easily distinguished on the basis of their distinctive colorations or color patterns than by slight average differences of body proportions or of skeletal elements. In the speciation process at the lowermost level of differentiation (and perhaps at somewhat higher levels as well) the evaluation of the patterns formed by pigment cells may be compared upon equal terms, at least, with patterns formed by bone, muscle or other groups of cells.

Just as we find a number of genetical systems controlling chromatic patterns in hybrids (for instance, one factor for stippling, *St*; or for *one-spot*, *O*; or for crescent complete, *Cc*; and for some others; two factors, *Co* and *E* for wagtail; three, for intense melanosis, and each dominant factor has a specific value, *Sp AA BB*, etc.) so other body structures may each have a special genetic basis and in addition there may be interactions between the genes in these restricted systems. In illustration of this latter point, Gerschler (1912), in studying the inheritance of the length of sword in swordtail-platyfish hybrids, found that at least three dominant factors were required to account for the results he obtained: *AA BB CC* where *AA* have the value of 2, *BB* have the value of 4 and *CC* have the value of 6. In addition, Gerschler found that the platyfish carries

dominant genes for some body features while the swordtail carries dominant genes for other groups of structures.

OTHER INSTANCES OF INTROGRESSION IN DOMESTICATED FISHES.

As indicated on several previous occasions, there are many good examples of introgressive hybridization in xiphophorin fishes—a complex of seven species. The papers of Kosswig (1929, 1937) and of his associate Breider (1937, 1938) contain detailed accounts of the behavior of specific genes of one species in the germ plasm of a related species. For the most part these are valid but many so-called *X. hellerii* genes such as *Mo*, *Rb* and *Sn* are all probably traceable to *P. maculatus*. Further discussion of these papers will be reserved for future occasions when related data on these specific color genes are presented. One comment may be made at this time: certain patterns of the platyfish have become associated so completely with the swordtail body form, and have been modified so thoroughly in the process, that part of their platyfish origin was not suspected. This is particularly true of the "*Mo*" character of the swordtail (*X. hellerii*) which now turns out to be due to the striped *Sr* pattern of wild platyfish. (This statement is based on unpublished data on the mating of wild platyfish of many different genotypes and wild swordtails.)

INTROGRESSION IN GENERAL.

In his treatment of natural polymorphism in relation to geographical variation, Mayr (1942) discusses the apparent rapid spread of a black mutation from one population having a high concentration of that particular mutation to other nearby populations where that mutation had been rare or absent. He states that this phenomenon, which looks like introgressive hybridization in geographical races, may possibly be explained on the basis of the great phylogenetic antiquity of certain alleles in related groups and species. In commenting upon the introgressive process, Mayr regards it as theoretical and unproved in animals. Anderson and Hubricht (1938) and other botanists have pointed out that introgressive hybridization is more likely to occur in localities which have come under man's management (or mismanagement) and in plants that may have escaped from cultivation. Dobzhansky (1941) states that while it is impossible to appraise the evolutionary role of introgressive hybridization, it may, in some organisms, result in the emergence of superior genotypes. For example of introgression in animals he cites the work of Boettger and of Franz on mollusks and that of Blair on toads and states that this phenomenon appears to be much more common in plants than in animals. It occurs

to me that if the origin of our domesticated animals were more precisely known many additional examples might be put forward in this group of organisms.

FISHES AND COTTON PLANTS.

Genetic conditions somewhat similar to those reported in this paper for xiphophorin fishes may be found among the species of cottons, studies upon which have been under way for many years by Harland (1936, 1939) and associated workers of the Imperial Cotton Growing Corporation, Hutchinson, Silow and Stephens. By planned hybridization between *Gossypium barbadense* and *G. hirsutum* and backcrossing of the hybrids to the original species, they have extracted hybrid compounds having predominantly the gene system of *G. barbadense* with a few genes of *G. hirsutum*, or conditions may be reversed. In the practical application of genetic research, plant and animal breeders are constantly trying to combine the desirable features of one organism with those of another. In some instances a high yielding plant is subject to a specific disease. A search is made among its wild relatives to find a disease-resistant strain and attempts are then made to combine the high yielding qualities of one with the disease-resisting qualities of the other. In effect, this, too, is introgression—if it is shown that the traits combined have a hereditary basis and separate origins.

GENES AND THE RATE OF DEVELOPMENT.

Changes in developmental rates by regulation of the external temperatures during specific periods of embryonic growth have altered the attainment of the usual number of vertebrae (and possibly dorsal fin-ray counts) in fishes. Hubbs and others have discovered this phenomenon; recently Gabriel (1944) has demonstrated it experimentally in developing *Fundulus*, and Gordon and Benzer (1945) have reviewed its significance in problems of speciation in xiphophorin fishes. Gabriel found that some strains of *Fundulus* were temperature labile, while others were genetically unalterable with regard to the number of vertebrae they attain.

In this connection, the work of Ford and Huxley (1929) on the attainment of definitive eye colors in *Gammarus* is suggestive. (A comprehensive discussion on the subject has recently been presented by Huxley, 1944). The eyes of the shrimp are usually black but mutants with eye colors of red, brown and dark brown are known. The eyes of the young stages of the normal shrimp are red but they gradually become darker. In the red-eyed mutant adult they never get darker; in other mutants they stop at the brown or darker stages. Huxley believes that genes produce their effect by influencing the rate of development of various substances

involved in pigment formation. This interpretation may be applied to the possible manner in which the modifying genes *A* and *B* of *X. hellerii* act upon the *Sp* gene of *P. maculatus* to produce melanosis in the F_1 hybrids ($Sp+ A+ B+$) and to produce severe melanosis in the backcross (to *X. hellerii*) hybrids ($Sp+ AA BB$). In the latter, the degree of melanosis which is usually attained by the F_1 hybrid in adult life is attained, according to Gordon (1937), in the backcross hybrid on the day of birth. A reversal of this trend may be seen in the inhibitory action of *X. hellerii* factors on the macromelanophore gene of *X. montezumae*.

The concept of the influence of genes on the rate of development has been used by Goldschmidt for the interpretation of sex attainment and other features. It may also apply, possibly, to vertebrae number, fin-ray count and other "taxonomic" characters.

SUMMARY.

1. The Mexican platyfish gene PC^o , one of seven dominant, multiple, autosomal alleles, produces a simple comet-like pattern in the tail fin in wild *Platypoecilus maculatus*. Representatives of the comet gene PC^o are found in natural populations of the platyfish in the Rio Jamapa and Rio Papaloapan but not in the Rio Coatacoalcos and the Rio Usumacinta.

2. When a "wild" *P. maculatus* carrying PC^o is mated with "domesticated" platyfish or with "wild" *Xiphophorus hellerii* the phenotype of the hybrids show all the fins considerably darker, producing a new variety termed the *wagtail*. The modified effect of PC^o from the comet to the *wagtail* is due to a specific factor *E* which has no visible effect of its own. *E* is autosomal and independent of the PO , PM , PM^c , PC^o , PC , PC^c , PT series and of *st*.

3. It is suggested that "domesticated" stock of *P. maculatus* acquired the *E* factor by a process of introgression.

4. The Platyfish gene PC^o was transferred by hybridization to platyfish-swordtail hybrids. By a series of backcrosses of the hybrids to the swordtail, fish were bred having the configuration of *Xiphophorus hellerii* but containing PC^o of *Platypoecilus maculatus*. This new variety is called the *wagtail swordtail* among fish fanciers. The establishment of this new stock is an example of introgressive hybridization under conditions of domestication. Hybridization under natural conditions has not been known to take place.

5. The domesticated red swordtail of aquarists is considered and its origin is traced to "red" gene of *P. maculatus* modified by intensification by at least two *X. hellerii* genes. These effects resemble the behavior of taxonomic characters in species crosses. Taxonomic characters at the lower-

most levels, sub-species and perhaps species, are compared genetically with color pattern characters.

6. A number of genetic similarities and parallelisms of introgressive hybridization in cotton plants and xiphophorin fishes are indicated.

REFERENCES CITED.

- ANDERSON, E., AND L. HUBRICH.
1938. Hybridization in Tradescantia. The evidence for introgressive hybridization. *Amer. Jour. Botany*, 25: 396-402.
- BREIDER, HANS, AND R. SEELINGER.
1938. Die Farbzellen der Gattungen Xiphophorus und Platypoecilus und deren Bastard. *Zeit. f. wissen. Zool.*, 151: 243-285.
- DOBZHANSKY, TH.
1941. Genetics and the Origin of Species, 2nd Ed., New York, Colum. Univ. Press.
- FORD, E. E., AND J. S. HUXLEY.
1929. Genetic rate factors in Gammarus. *Arch. f. Entw. Mech.*, 117: 173.
- FRIEDMAN, H., AND MYRON GORDON.
1934. Chromosome numbers in xiphophorin fishes. *Amer. Nat.*, 68: 446-455.
- GABRIEL, M. L.
1944. Factors affecting the number and form of vertebrae in *Fundulus heteroclitus*. *Jour. Exp. Zool.*, 95: 105-147.
- GERSCHLER, W.
1912. Über alternative Vererbung Kreuzung von Cyprinodontiden-Gattungen. *Zeit. f. Induk. Abstamm. u. Vererb.*, 12: 73-96.
- GORDON, MYRON.
1931. Hereditary basis of melanosis in hybrid fishes. *Amer. Jour. Cancer*, 15: 1495-1523.
1937. The production of spontaneous melanotic neoplasms in fishes by selective matings. *Amer. Jour. Cancer*, 30: 362-375.
1942. Mortality of albino embryos and aberrant Mendelian ratios in certain broods of *Xiphophorus hellerii*. *Zoologica*, 27: 73-74.
1943. Genetic studies of speciation in the swordtail-platyfish group and of the experimentally produced hybrids. *Trans. of N. Y. Acad. Sci. Ser. II*, 5: 63-71.
1946a. Speciation in fishes. Distribution in time and space of seven dominant multiple alleles in *Platypoecilus maculatus*. *Advances in Genetics*, 1: (in press).
1946b. Interchanging genetic mechanisms for sex determination in fishes under domestication. *Jour. of Heredity*, 37: (in press).
- 1946c. Genetics of *Platypoecilus maculatus* IV. The sex determining mechanism in two wild populations of the Mexican platyfish. *Genetics*, 31: (in press).
- HARLAND, S. C.
1936. The genetic conception of the species. *Biol. Reviews*, 11: 83-112.
1939. Genetical studies in the Genus *Gossypium* and their relationship to evolutionary and taxonomic problems. Pro. 7th. Intern. Genetic. Congr., Edinburgh, 138-143.
- HUBBS, C. L.
1940. Speciation of fishes. *Amer. Nat.*, 74: 198-211.
- HUXLEY, J. S.
1942. Evolution, The Modern Synthesis. New York, Harper & Brothers.
- KOSSWIG, CURT
1931. Über Geschwulstbildungen bei Fischbartarden. *Zeit. f. Induk. Abstamm. u. Vererb.*, 59: 61-76.
1939. Die Geschlechtsbestimmung in Kreuzungen zwischen *Xiphophorus* und *Platypoecilus*. *Rev. Faculte Sci. l'Univer. d'Istanbul*, 4: (No. 1/2) 1-54.
- MAYR, ERNST
1942. Systematics and the Origin of Species. New York, Colum. Univ. Press.
- RALSTON, E. M.
1934. A study of the chromosomes of *Xiphophorus*, *Platypoecilus* and of *Xiphophorus-Platypoecilus* hybrids during spermatogenesis. *Journ. Morphology*, 56: 423-433.

EXPLANATION OF THE PLATES.

PLATE I.

Fig. 1. The wild color types in natural populations.

There are many pools in Mexico, particularly in the Rio Papaloapan drainage area, in which most or all of the color types shown here may be found living side by side.

The first column represents the two forms of the swordtail (*Xiphophorus hellerii*). The upper one represents a weakly spotted type which is very rare, occurring in wild populations in a frequency of less than one-half of one per cent.

The second column represents the tail markings of the platyfish (*Platypoecilus maculatus*). These form a series of autosomal, dominant, multiple alleles. Reading from top to bottom: one-spot, PO ; twin-spot, PT ; single crescent, PC ; complete crescent, PCc ; moon, PM ; moon complete, PMc ; and comet, PCo . There is a universal recessive shown at the top of the next column, usually referred to as the + gene. Of all the seven dominant alleles, only the comet, PCo , reacts to the presence of the E modifier.

The third column shows, in addition to the universal recessive, on top, the five sex-linked patterns: striped-sided, spot-sided, spotted dor-

sal, black-bottomed and the black-banded. These patterns are formed by macromelanophores. The series in the column to the left are formed by micromelanophores.

The fourth column shows the three red colored varieties: the red-dorsal, the red anal-fin and the bleeding heart. These are sex-linked and are formed by erythrophores.

Fig. 2. *The Introgression of the Platyfish Gene Comet (Co) Into the Germ Plasm of the Swordtail.*

The series of matings shown in this chart begins in the upper left hand corner. A wild swordtail (*Xiphophorus hellerii*) is mated with a wild comet-marked platyfish (*Platypoecilus maculatus*). The mating of these distinct species is effective under conditions of domestication in an aquarium where one female and one male are placed in a single container. Under conditions in nature, these two species, which are often found living side by side, apparently do not hybridize. In more than 10,000 specimens caught in nature, and examined, no hybrids were found between them.

The "domesticated" hybrids are shown in the lower left. The comet pattern of the platyfish is transformed into the wagtail; note the shortening of the sword compared with its normal length in male wild swordtails shown elsewhere in the chart. There is a blend of body configurations and some color patterns in the hybrids.

If one of the wagtail platyfish-swordtail hybrids is selected and mated to a pure wild swordtail male as indicated in the pair in the lower right hand corner, the body contours, the length of the tail and other features in some of the resulting offspring resemble that of the wild swordtail, but the wagtail pattern in their make-up is a sign of the fact that at least one gene, the comet gene (*Co*) of the platyfish, is present in the domesticated and reconstructed swordtail. Thus the presence of a platyfish gene in the germ plasm of the swordtail is a result of *introgressive hybridization*.

PLATE II.

Fig. 3. *The Development of the Golden Wagtail Platyfish.*

The golden wagtail platyfish was developed by mating a domesticated golden platyfish with a wild, gray-green comet. In the first generation all the offspring were gray-green, owing to the fact that the wild type gene *St* for micromelanophores is dominant to the golden, or non-micromelanophore type. The wagtail reaction is evident in the F_1 owing to the interaction of the wild comet gene (*Co*) with its modifier *E*. When the gray-green wagtail F_1 are inbred, six phenotypes appear in the next generation. Reading down by columns, the column on the extreme left: gray, comet; gray; golden, comet. The second column: gray, wagtail; golden; golden, wagtail. The third and fourth columns represent

the males and the number of phenotypes in them is the same as in the females just enumerated.

When two golden wagtails are selected from the second generation offspring and mated, if by chance these individuals were homozygous for the comet (*Co*) and for the extensor of comet gene (*E*), then a pure breeding line of golden wagtail platyfish may be established as indicated in the chart.

The presence of the modified gene *E* in domesticated platyfish may be explained by suggesting that *E* is found in natural populations of the related species, the swordtail (*Xiphophorus hellerii*), and it has infiltrated by introgressive hybridization into the germ plasm of the domesticated platyfish (*Platypoecilus maculatus*).

PLATE III.

Fig. 4. *The Early and the Perfected Wagtail Platyfish.*

In some of the early matings between the "wild" comet platyfish (*Platypoecilus maculatus*) with the "domesticated" strains, the red, black-spotted type of female was used. In some instances the *R* and *Sp* genes were carried by the *W* chromosomes, thus producing red, black-spotted daughters and recessive, gray sons. One of the spotted daughters and one of the gray males are shown in this plate facing to the right; both of them carry the modified form of the comet pattern known as wagtail. The fish facing to the left was obtained by use of the golden domesticated strain and a wild comet platy. It represents one of the second generation young, in which the color is bright yellow, but the fins are blackened by the interaction of the comet gene (*Co*) with a modifier, *E*, the extensor of the comet.

The wagtail pigmentation reaction involves more than the deepening color of the fins: the snout and parts of the operculum are blackened by small melanophores. These pigmented cells are found in the integumentary tissues surrounding the region of the premaxillaries; they are found in the tissues surrounding the region of the dentary and continue from this point caudally along a line formed by the ventral margin of the articular, quadrate and preopercular; then the line forms an upwardly directed angle following the posterior margin of the preopercular. Photographs by S. C. Dunton.

Fig. 5. *Wagtail Swordtails.*

This pair of swordtails have all the external attributes of swordtails, *Xiphophorus hellerii*, except for the black coloring of the fins. This color pattern is the result of the interaction of a platyfish gene comet (*Co*) with a specific modifier (*E*). These swordtails are the product of introgressive hybridization. In the course of their genetic history, a *Platypoecilus maculatus* gene, *Co*, has been incorporated into the germ plasm of the swordtail. Photographs by S. C. Dunton.

WILD COLOR TYPES CAUGHT IN THE SAME POOL IN MEXICO

SWORDTAILS

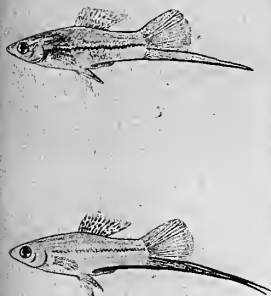

PLATYFISH

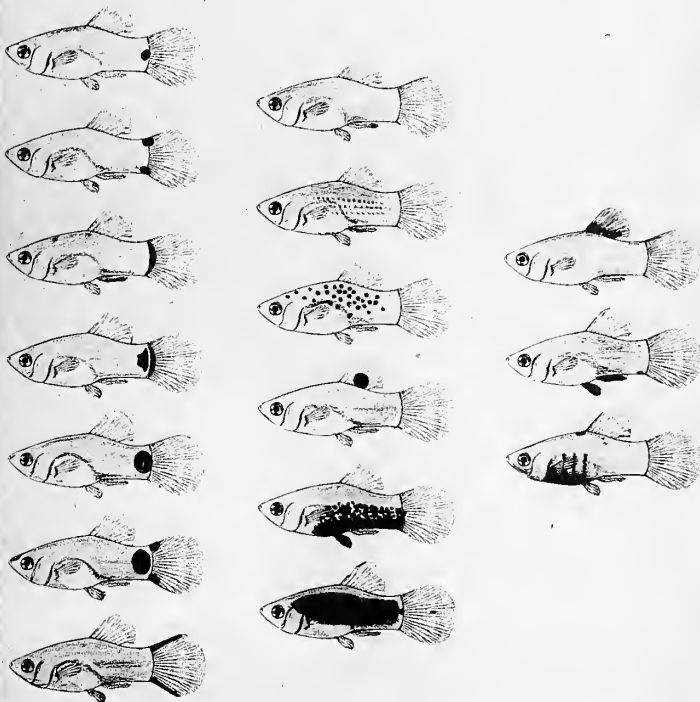

FIG. 1.

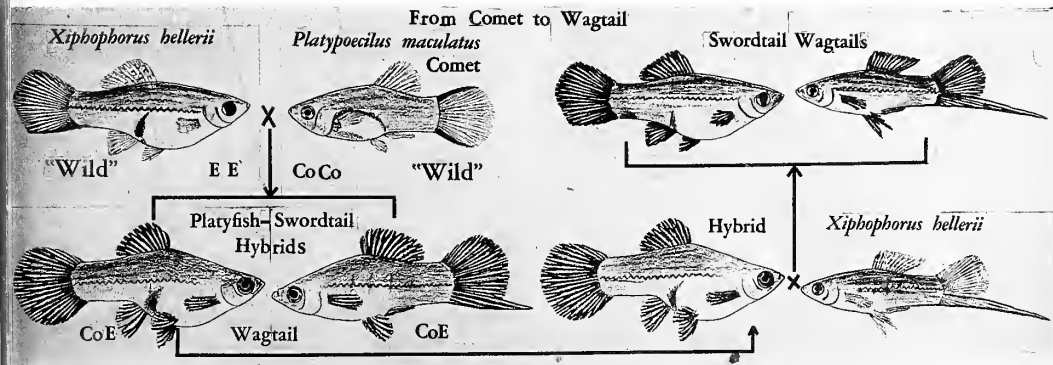

FIG. 2.

INTROGRESSIVE HYBRIDIZATION IN DOMESTICATED FISHES.
I. THE BEHAVIOR OF COMET—A PLATYPOECILUS MACULATUS GENE IN XIPHOPHORUS HELLERII.



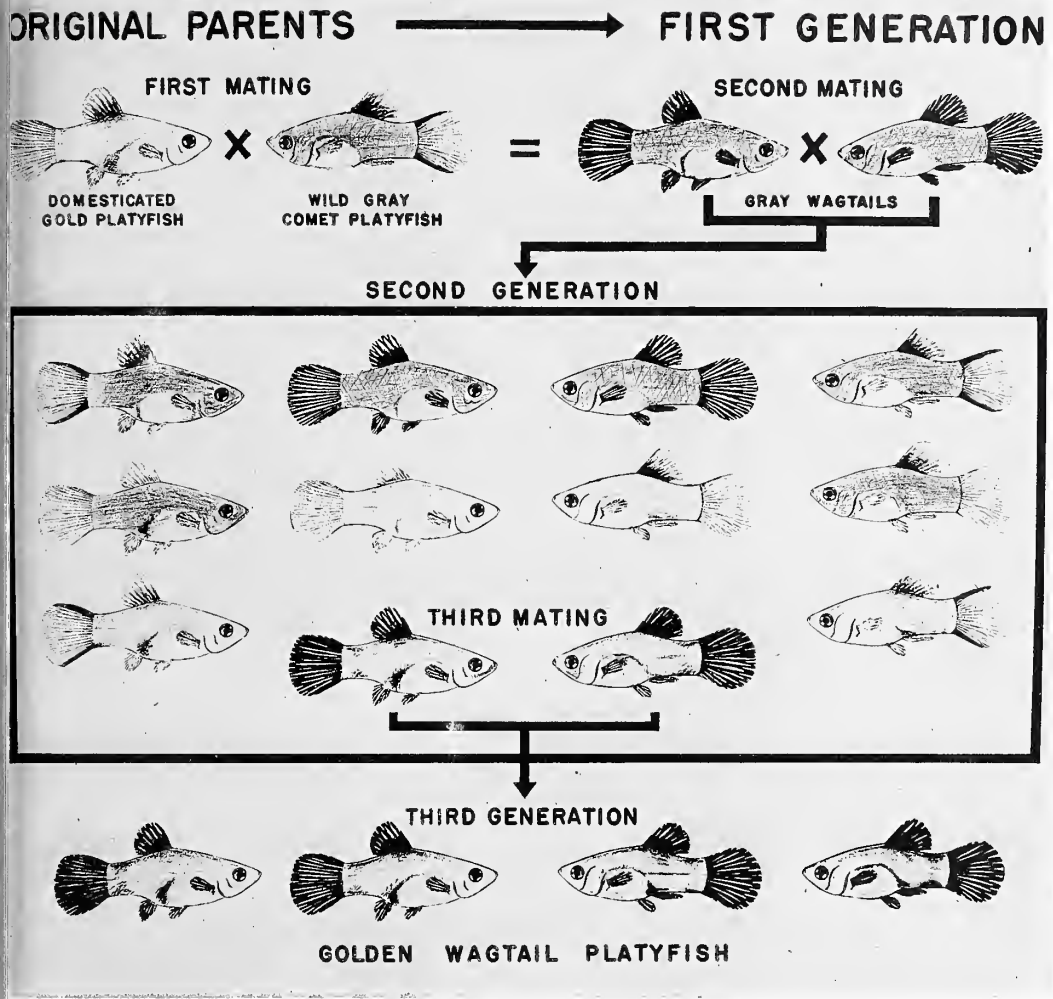

FIG. 3.

INTROGRESSIVE HYBRIDIZATION IN DOMESTICATED FISHES.

I. THE BEHAVIOR OF COMET—A *PLATYPOECILUS MACULATUS* GENE IN *XIPHOPHORUS HELLERII*.



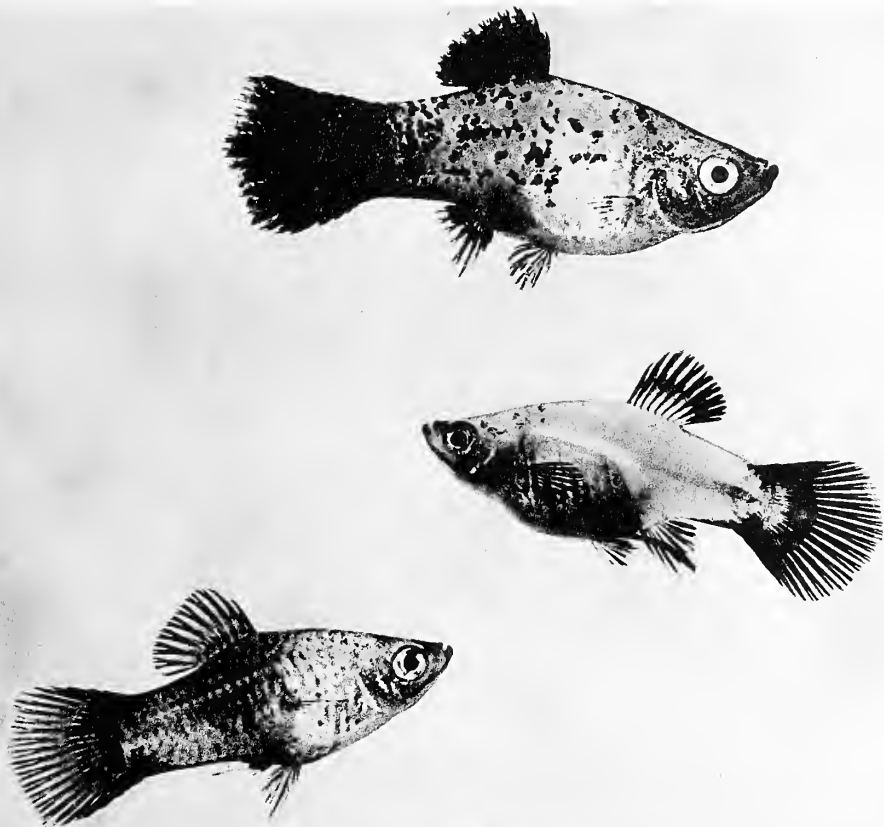

FIG. 4.

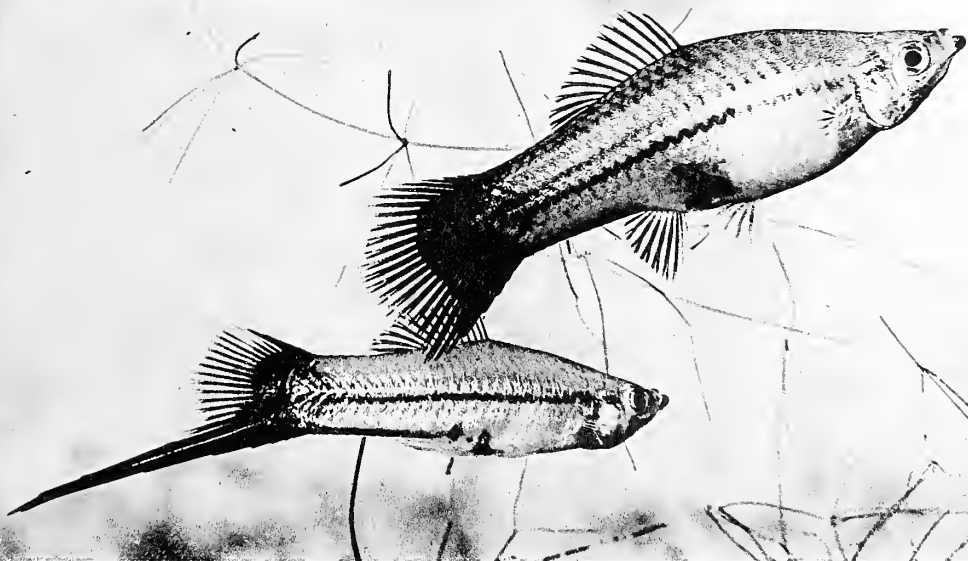

FIG. 5.

INTROGRESSIVE HYBRIDIZATION IN DOMESTICATED FISHES.
I. THE BEHAVIOR OF COMET—A *PLATYPOECILUS MACULATUS* GENE IN *XIPHOPHORUS HELLERII*.

7.

Spontaneous Neoplasms in Fishes. I. Osteochondroma in the Jewelfish, *Hemichromis bimaculatus*.¹

ROSS F. NIGRELLI & MYRON GORDON.

New York Aquarium, New York Zoological Society.

Plates I-V; Text-figures 1 & 2.

INTRODUCTION.

Only a few chondromas and related tumors have been reported, all in European-bred fishes. Fiebiger (1909) described a massive osteochondroma on a carp (*Cyprinus*) which grew into the cranial cavity, causing the brain to be compressed and laminated. Although no functional disturbances were noted in the live fish, Fiebiger reported that the olfactory lobes, certain cranial nerves and hypophysis were missing. A chondroma, also in a carp, was reported and figured (credited to Muslow) by Plehn (1924). A longitudinal section of the head showed the tumor extending ventrally over the roof of the mouth and posteriorly against the brain, causing it to be deflected upward and at right angles to the brain stem. Thomas (1931), in his excellent review on fish tumors, recorded two cases described by Surbeck in 1917 and 1921. The first was an enchondroma which developed in a barbel (*Barbus*) as a bilobed structure between the maxilla and the right operculum. The second was a chondrofibroma which was attached to the belly of a pike. This growth was a massive, pediculated, saccular tumor larger than two fists and weighing 800 grams.

No detailed histological or cytological descriptions were given of the tumors reported above. Neither was there any information given as to the possible cause or causes of the growths. The present contribution is concerned with gross and histological descriptions of an osteochondroma on the operculum and adjacent structures of an aquarium-bred African jewelfish, *Hemichromis bimaculatus*. This fish was found among about 100 normal jewelfish in a 150 gallon aquarium in the Department of Animal Behavior of the American Museum of Natural History. We are indebted to Dr. Lester R. Aronson for this specimen.

GROSS DESCRIPTION OF THE TUMOR.

When the tumor was first observed it appeared as a small swelling at the anterior edge of the right operculum. The growth was comparatively rapid, for within two months it attained the large size shown in Text-figure 1 and Plate I, Figure 1. The fish was a male and measured 52 mm. in standard length; the tumor mass measured 13 mm. long, 6 mm. at its widest part and from 3 to 4 mm. high. When examined with the low power binocular, the surface of the growth was more or less smooth and richly supplied with branches of the right first afferent artery (Text-figure 1). The structures involved were the opercle, subopercle, peropercle, interopercle, brachioistegals, inferior parts of the maxillary and cheek bones. The anterior-most gill-raker of the first gill arch also had a smaller but separate cartilaginous nodule, which measured about 3 mm. in diameter. It was uncertain whether this separate growth arose *de novo* or whether some infiltration had taken place, either directly or through the blood stream.

HISTOLOGICAL DESCRIPTION OF THE TUMOR.

The tumor, together with the adjacent structures, was extirpated and pieces were fixed in Zenker's. They were embedded in paraffin, sectioned at four microns and stained with iron-hematoxylin with and without eosin, Delafield's hematoxylin with eosin, Mallory's triple stain, Giemsa's stain, and with methylene blue.

The tumor was an osteochondroma, the major part of which consisted of hyalin cartilage arranged in a more or less irregular pattern. (Plates I-V). The typical arrangement of cartilage cells with opposed surfaces was not evident. Some transformation into osteoid tissue had taken place (Plate II, Figure 6). The tissue was well supplied with nourishment from the numerous blood vessels which accompanied its fibrous stroma (Plate IV, Figure 9). The

¹ This work was supported in part by grants from the Anna Fuller Fund and The American Cancer Society, on the recommendation of the Committee on Growth of the National Research Council.

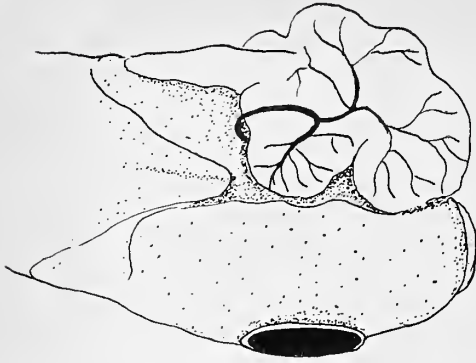

TEXT-FIGURE 1. Sketch of the ventral-lateral aspect of the head of the jewelfish showing the blood vessels on the surface of the osteochondroma. The main branch emerging from the branchial region is derived from the right first afferent artery. Enlarged about 4 X.

intercellular substance was variable, being very dense in some areas and light in others (Plate I, Figure 3). In regions where the cartilage cells appeared to be dividing rapidly, there was little intercellular material and the isogenic groups of tumor cells were closer (Plate II, Figures 5 and 6). Both interstitial and appositional growth took place to form the tumor.

The epithelium overlying the growth was still intact, slightly thickened in some areas, but otherwise normal in appearance (Plate I, Figure 2). The corial layer was edematous and contained only a few melanophores.

The thickened periosteum was basophilic (Plate I, Figure 2) while the subperiosteum was mainly acidophilic (Plate II, Figure 4). Numerous large and small, thin and thick walled blood vessels were present in the subperiosteal layer. The vessels, however, were never completely engorged and often contained granular debris. The transformation of the cellular elements of the subperiosteum into typical chondrocytes at the periphery of the tumor was evident. Such cells were responsible for the appositional growth. In some regions the gradual transition from collagenous fibers, made up of spindle-shaped cells (fibroblasts), into cartilage was visible (Plate IV, Figure 10). In other and more highly vascularized areas the various cellular stages in bone formation were found. The elements involved in the process were stellate-shaped (osteoblasts) which passed from the subperiosteal layer into the tumor mass. These cells (Text-figure 2, n; Plate V, Figures 11 and 12), interconnected by their dendritic processes, formed a network. They laid down a hyalin-like ground substance, which, however, was not calcified. (Such tissue is referred to as

osteoid. In fishes osteoid tissue enters into the composition of scales and in other structures of the head, including the operculum).

The fully developed cartilage cells (Plate II, Figures 5 and 6) were irregular in shape, size and in their mass arrangement. In some areas the cells were large with clearly defined capsules and had a great deal of intercellular substance between them. In other areas, particularly at the periphery of the tumor, the cells were smaller and isogenic groups were more clearly separated from each other (Plate II, Figure 6). There was marked evidence of cellular activity (interstitial tissue growth), although no mitotic figures were noted. Many cells were binucleated (Text-figure 2, k) and in some cases two or even three cells were present within the same territorial matrix. Although the majority of cells were spherical many variations were found. Those toward the periphery of the tumor were more or less flattened in a plane parallel with the surface. On the borderline of the cartilage and periosteum there were intermediate forms between the cartilage cells and the fibroblasts (Plate III, Figure 8). The body of the cartilage cells, in the fixed and stained sections, did not always fill the cartilage cavity which it occupied in the interstitial substance. A few cells had dendritic processes (Text-figure 2, i; Plate IV, Figure 9) but whether or not these processes extended into the interstitial substance was not determined, although the indication was that they did.

The nuclei of the mature chondrocytes were comparatively large and usually vesicular (Text-figure 2; Plates I-V). The cytoplasm was granular and in the region surrounding the nucleus was denser and often contained minute vacuole-like structures which in some cells were small and numerous and in others larger and few (Plate II, Figure 5; Text-figure 2). These vacuoles were present in all preparations, regardless of fixative or stain used. It is believed that the presence of these vacuoles indicates the secretory activity of the cell, the contents of the vacuole passing into the interstitial area. Other cells contained comparatively large concretions (chondrin?) (Text-figure 2, c) which stained similar to the intercellular material.

DISCUSSION.

The osteochondroma of the jewelfish is strikingly similar histologically to comparable growths in man (see Ewing, 1940). The cause of the tumor on the fish was not determined. It was the only abnormal specimen in about a hundred of the same species

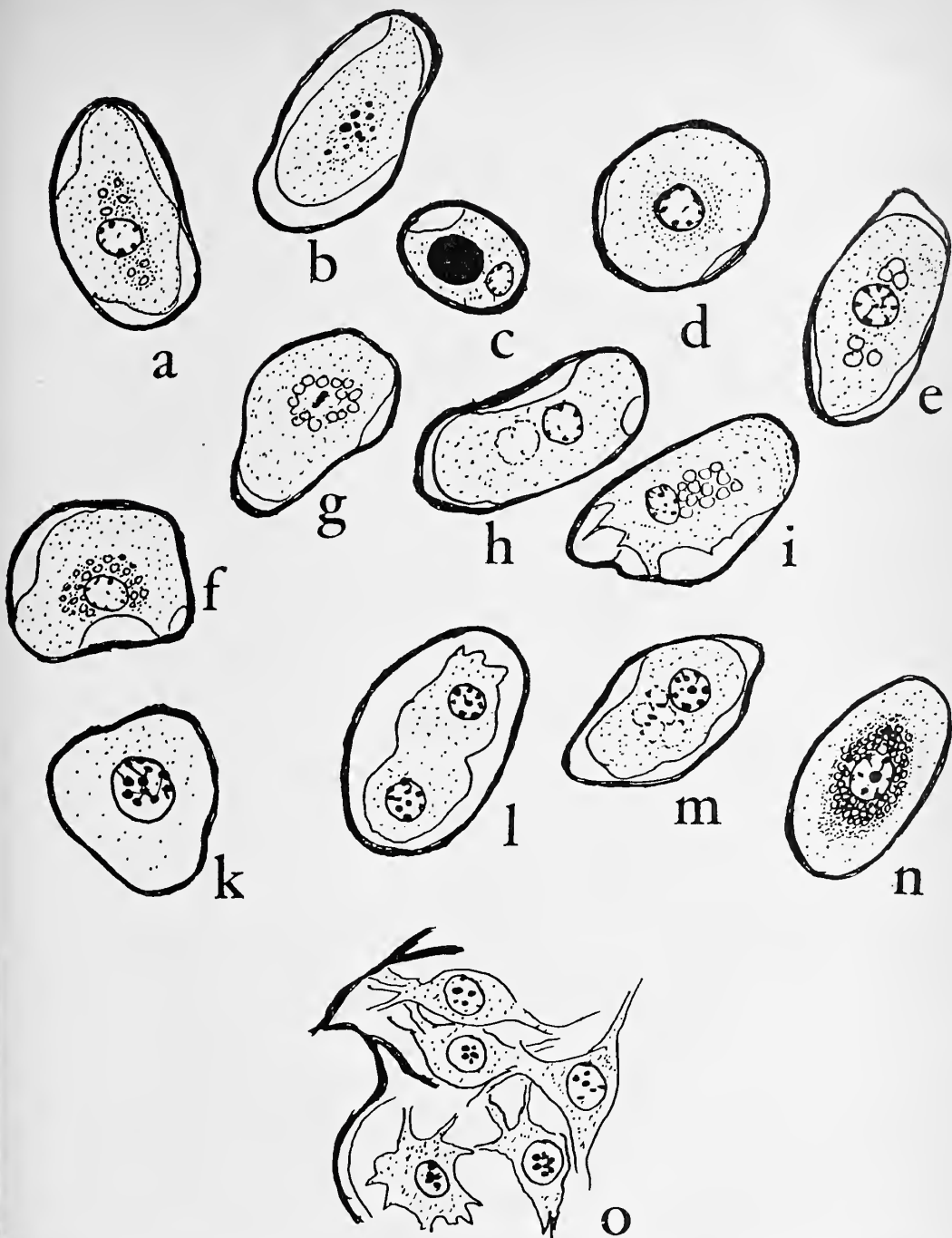

TEXT-FIGURE 2. Figures a-i inclusive are chondrocytes stained with Giemsa's stain: a, e and f-i show different manifestations of the nucleus together with the vacuole-like structures around it; b, cell with basophilic staining granules which may be chromatin; c, cell with concretion (chondrin?) that stains like the intercellular substance. Figures k-n inclusive were stained with iron-hematoxylin: k, a typical chondrocyte; l, binucleate cell within the same capsule; m, cell with five vacuole-like structures in the region of the nucleus; n, cell with dense cytoplasm, containing many minute vacuole-like structures, surrounding the nucleus. Figure o, a group of osteoblast cells. Note the beginning of bone formation. About 800 X.

and strain that were kept in a 150 gallon aquarium at the Department of Animal Behavior of the American Museum of Natural History. In all other respects the fish appeared to be in good health; the gills and internal organs showed no obvious disturbances. There was no evidence that heredity, hormonal disturbance, nutritional deficiency, virus, bacteria or other plant and animal parasites were involved as possible causative agents of this osteochondroma. However, the tumor may have resulted from traumatic response following an injury to the fish's operculum earlier in life. Periosteum is readily capable of producing cartilage whenever new formation of this tissue is required, and cartilaginous tumors might possibly arise from cells which produce bone by way of cartilage.

SUMMARY.

A spontaneous osteochondroma on the right operculum and associated structures of a jewelfish, *Hemichromis bimaculatus*, was composed of irregularly arranged hyalin cartilage and osteoid tissue. It was well supplied with blood vessels. Both interstitial and appositional cell growth were responsible for the increase in size of the tumor. The transformation of the cellular elements of the connective tissue in the subperiosteal region into chondrocytes at the periphery of the tumor was clearly evident. In several regions stellate-shaped cells (osteoblasts) passed into the mass of the tumor from the subperiosteal layer and formed a network around which hyalin-like osteoid material was deposited. The major part of the tumor consisted of hyalin cartilage. Cytological details of the chondrocytes were given. The causative agent of the osteochondroma was not determined but it may have resulted from a fractured operculum in early life.

REFERENCES.

- EWING, JAMES.
1940. Neoplastic Diseases. 4th Edition; 1160 pp., 581 illustrations. Philadelphia and London. W. B. Saunders Co.
- FIEBIGER, J.
1909. Ueber Hautgeschwülste bei Fischen, nebst Bemerkungen über die Pockenkrankheiten der Karpfen. *Zeitschr. f. Krebsforsch.* 7: 165.
- PLEHN, M.
1924. *Practicum der Fischkrankheiten.* 179 pp., 21 pls., 173 text-figures. Stuttgart. E. Schweizerbart.
- THOMAS, L.
1931. Les Tumeurs des Poissons (Etude Anatomique et Pathogenique). *Assoc. Francaise pour L'Etude du Cancer.* 20: 703.

EXPLANATION OF THE PLATES.

PLATE I.

- Fig. 1. Osteochondroma on the right side of the head of a live aquarium-bred male jewelfish, *Hemichromis bimaculatus*. Enlarged about one-third. Photograph by S. C. Dunton, New York Zoological Society.
- Fig. 2. Photomicrograph showing section of the osteochondroma taken through the operculum. Note the thickened band of periosteal (p) material growing out from the surfaces of this structure. The epithelium (e) varies in thickness but otherwise is normal in appearance. The corial (c) layer is edematous and shows no melanophores. The chondrocytes (Cc) show an irregular pattern and the amount of intercellular substance varies considerably in density. Delafield's hematoxylin-eosin. About 75 X.
- Fig. 3. Section stained with Giemsa's. Note the varying density of intercellular material. P, Periosteum; i, intercellular material. About 75 X.

PLATE II.

- Fig. 4. Section through the subperiosteal region showing blood vessels and fibrous material. Note the granular debris within the larger blood vessel. Mallory's Triple stain. About 160 X.
- Fig. 5. A group of cells from the osteochondroma. Vacuole-like cytoplasmic structures are present similar to those shown in Text-figure 2. Giemsa's stain. About 335 X.
- Fig. 6. Iron-hematoxylin treated section showing osteoid tissue staining black. Smaller isogenic groups of cartilage cells may be seen at the periphery. About 75 X.

PLATE III.

- Fig. 7. Note the variability in size and shape in the structure of the chondrocytes. Giemsa's stain. 675 X.
- Fig. 8. Region of periosteum and subperiosteum. Transformation of the fibroblastic-like cells into chondrocytes is taking place, producing growth by apposition. Hematoxylin-eosin. 675 X.

PLATE IV.

- Fig. 9. Connective tissue layer extending into the tumor forming the supporting stroma which provides the pathway for the blood vessels and other cellular elements. Giemsa's stain. 675 X.
- Fig. 10. Periphery of tumor showing collagenous fibers with spindle-shaped cells. Note transformation into chondrocytes. Giemsa's stain. About 675 X.

PLATE V.

- Fig. 11. Osteoid tissue. Note the network of osteoblasts around the periphery of this tissue. Delafield's hematoxylin. About 675 X.
- Fig. 12. Same as Figure 11, showing details of osteoid formation. Delafield's hematoxylin. About 675 X.



FIG. 1.

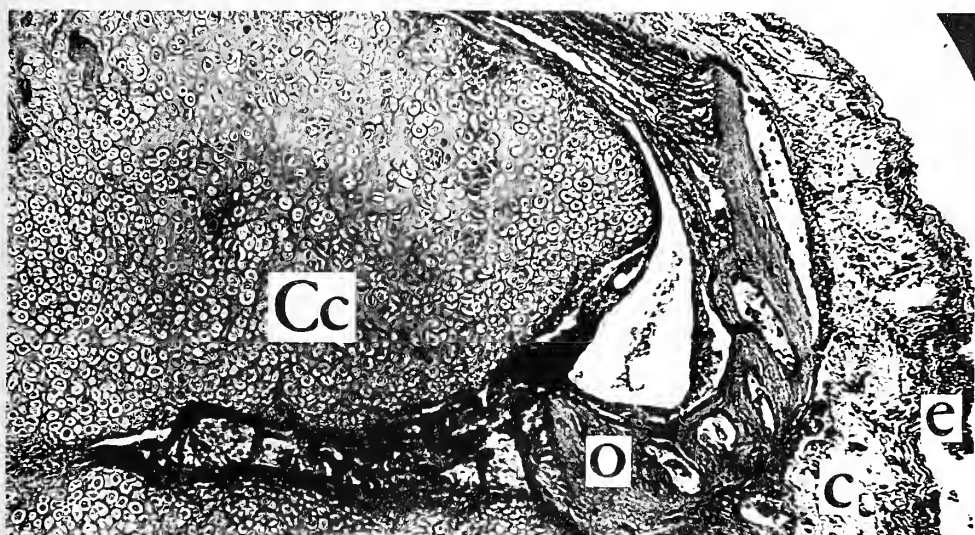

FIG. 2.

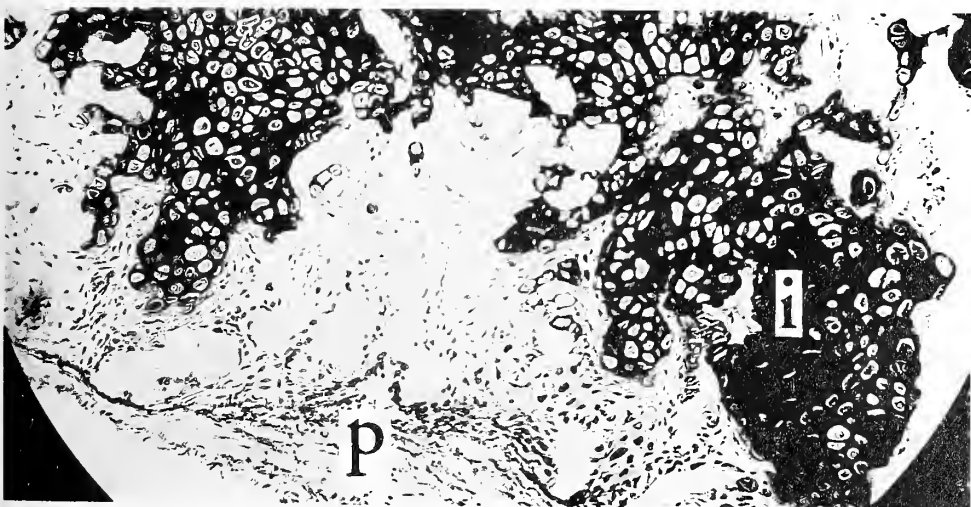

FIG. 3.

SPONTANEOUS NEOPLASMS IN FISHES. I. OSTEOCHONDROMA
IN THE JEWELFISH, *HEMICHROMIS BIMACULATUS*.



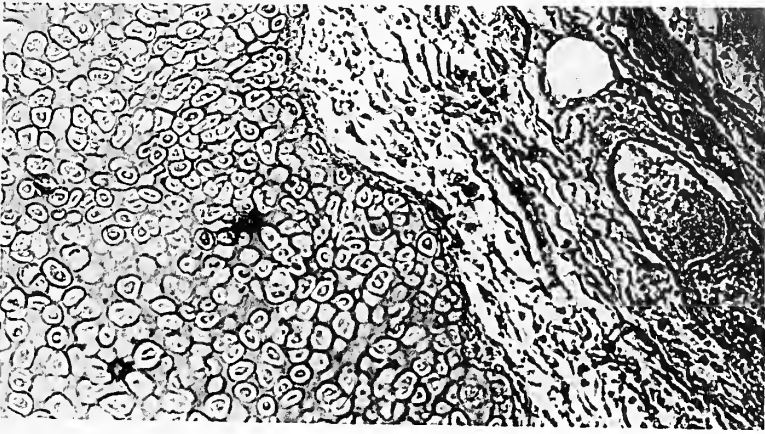

FIG. 4.

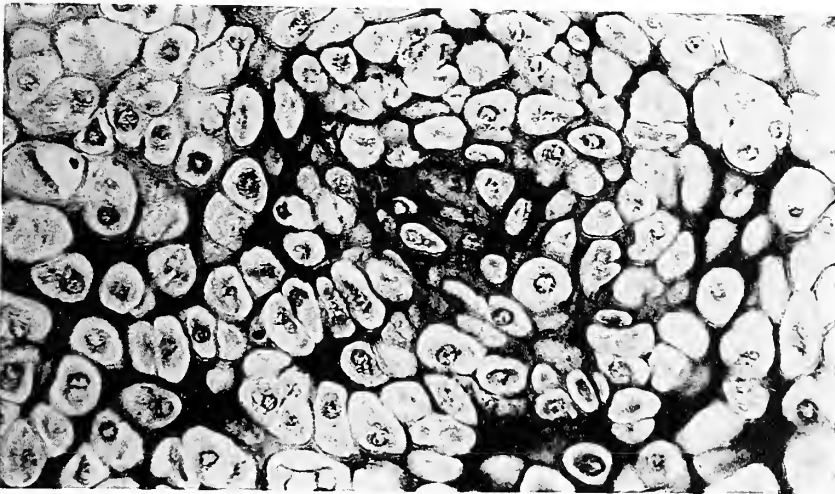

FIG. 5.

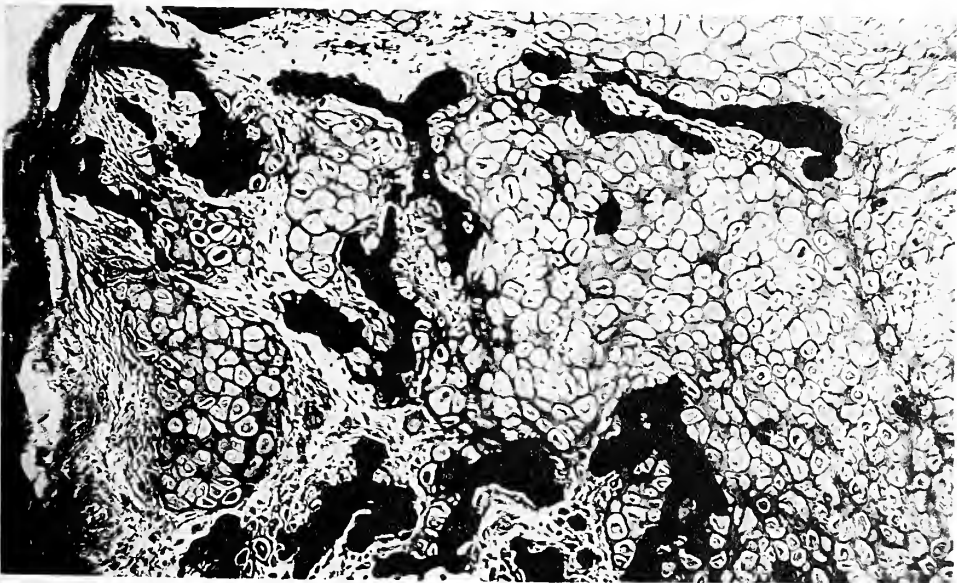
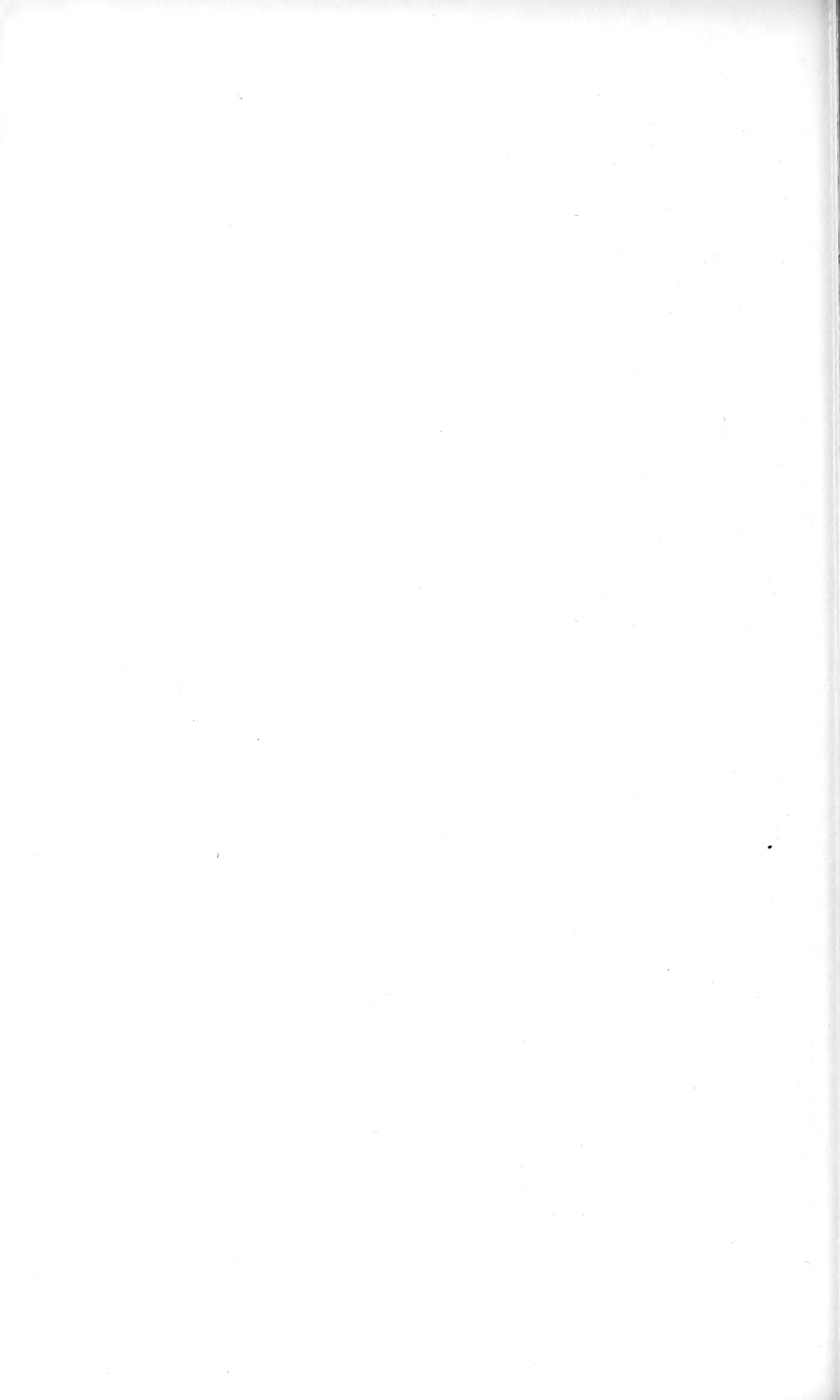

FIG. 6.

SPONTANEOUS NEOPLASMS IN FISHES. I. OSTEOCHONDROMA
IN THE JEWELFISH, *HEMICHROMIS BIMACULATUS*.



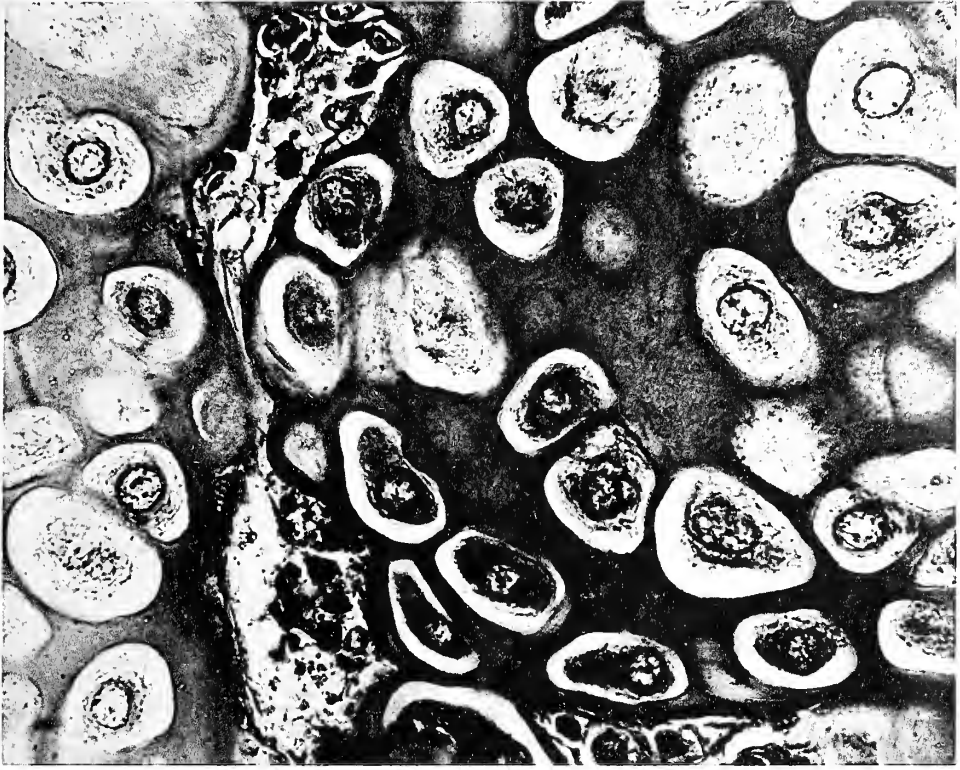

FIG. 7.

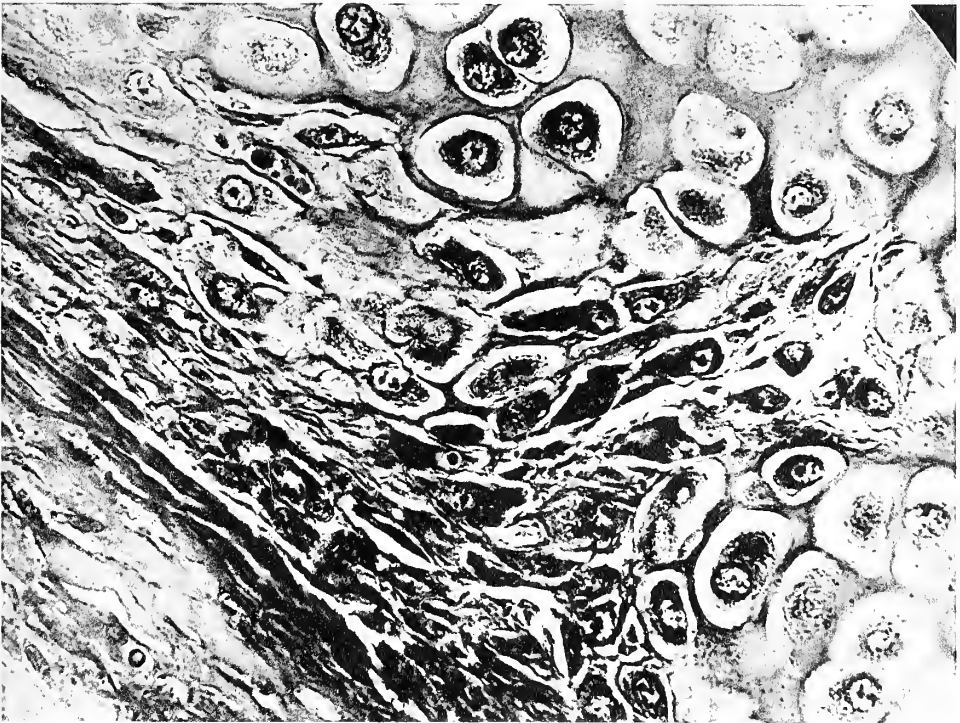

FIG. 8.

SPONTANEOUS NEOPLASMS IN FISHES. I. OSTEOCHONDROMA
IN THE JEWELFISH, *HEMICHROMIS BIMACULATUS*.



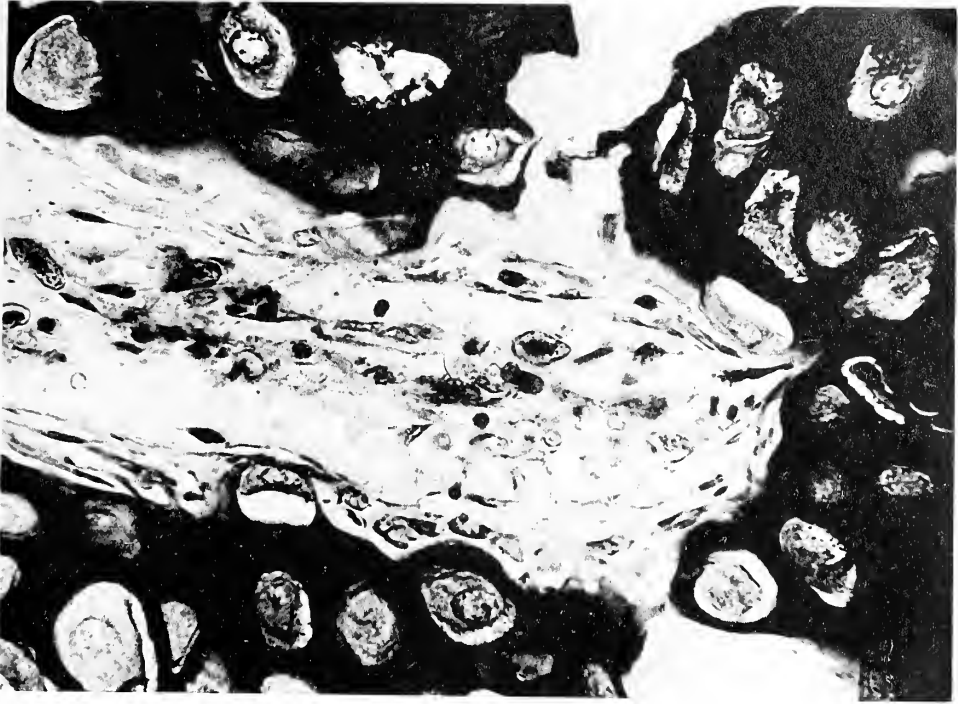

FIG. 9.

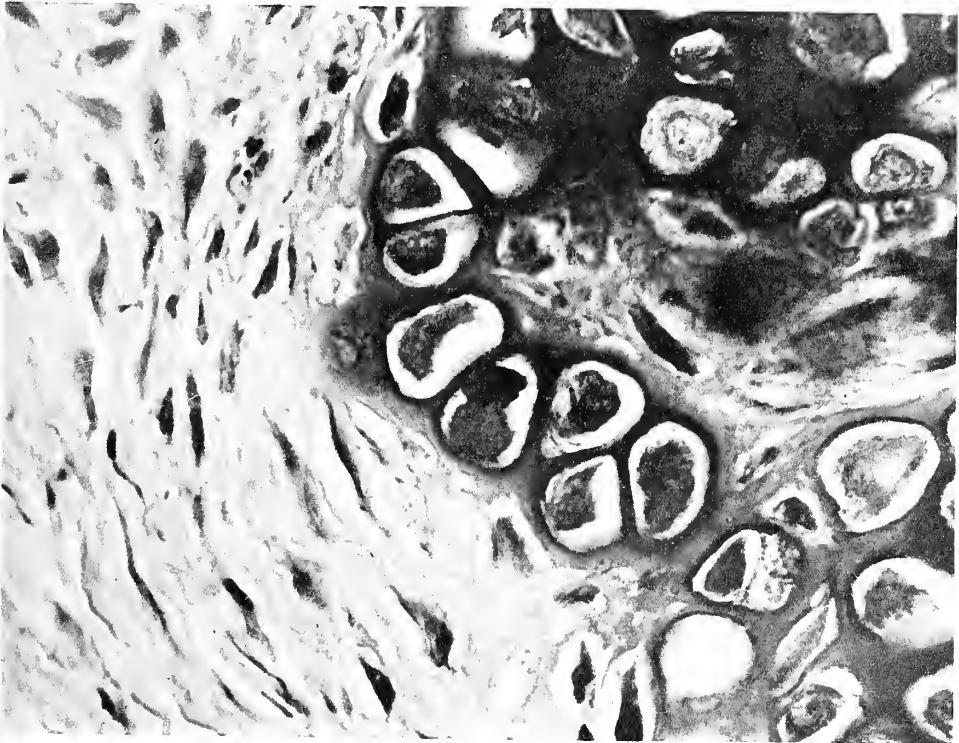

FIG. 10.

SPONTANEOUS NEOPLASMS IN FISHES. I. OSTEOCHONDROMA
IN THE JEWELFISH, *HEMICHROMIS BIMACULATUS*.



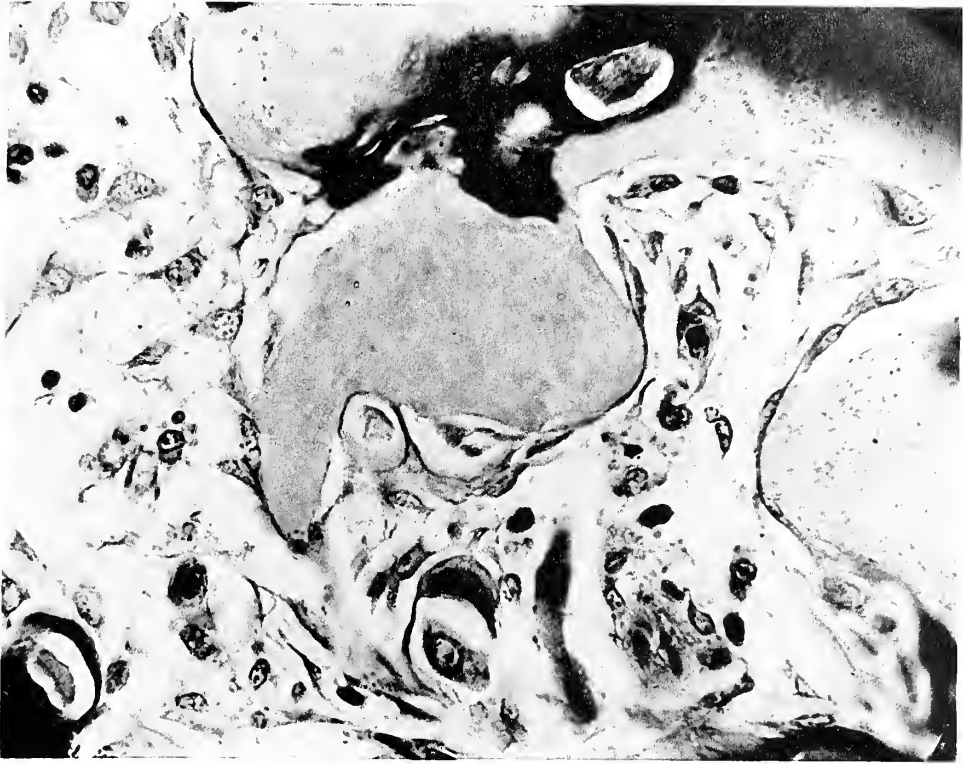

FIG. 11.



FIG. 12.

SPONTANEOUS NEOPLASMS IN FISHES. I. OSTEOCHONDROMA
IN THE JEWELFISH, *HEMICHROMIS BIMACULATUS*.



ZOOLOGICA

SCIENTIFIC CONTRIBUTIONS
of the
NEW YORK ZOOLOGICAL SOCIETY

VOLUME 31
Part 3
Numbers 8-9



Published by the Society
The Zoological Park, New York
December 5, 1946

CONTENTS

	PAGE
8. Eastern Pacific Expeditions of the New York Zoological Society. XXXV. Mollusks from the West Coast of Mexico and Central America. By LEO GEORGE HERTLEIN & A. M. STRONG. Plate I.	93
9. Effects of Sex Hormones on the Development of the Platyfish, <i>Platypoecilus maculatus</i> . By HERMAN COHEN. Plates I-V; Text-figure 1	121

8.

Eastern Pacific Expeditions of the New York Zoological Society. XXXV.
Mollusks from the West Coast of Mexico and Central America. Part IV.¹LEO GEORGE HERTLEIN & A. M. STRONG.
California Academy of Sciences.

(Plate I).

[This is the thirty-fifth of a series of papers dealing with the collections of the Eastern Pacific Expeditions of the New York Zoological Society made under the direction of William Beebe. The present paper is concerned with specimens taken on the Templeton Crocker Expedition (1936) and the Eastern Pacific Zaca Expedition (1937-1938). For data on localities, dates, dredges, etc., refer to *Zoologica*, Vol. XXII, No. 2, pp. 33-46, and Vol. XXIII, No. 14, pp. 287-298.]

CONTENTS.

	Page		Page
Introduction	94	Family Verticordiidae	102
Class Pelecyopoda	94	Genus <i>Verticordia</i> S. Wood	102
Order Anomalodesmacea	94	Subgenus <i>Trigonulina</i> d'Orbigny	102
Superfamily Laternulacea	94	<i>Verticordia (Trigonulina) ornata</i>	102
Family Periplomatidae	94	Order Teleodesmacea	102
Genus <i>Periploma</i> Schumacher	94	Superfamily Astartacea	102
<i>Periploma carpenteri</i> Dall	94	Family Crassatellidae	102
<i>Periploma discus</i> Stearns	94	Genus <i>Crassatellites</i> Krüger	102
<i>Periploma stearnsii</i> Dall	95	Subgenus <i>Hybolophus</i> Stewart	102
<i>Periploma teevani</i> Hertlein & Strong, sp. nov.	95	<i>Crassatellites (Hybolophus) digueti</i>	102
Family Thraciidae	95	Lamy	102
Genus <i>Thracia</i> Leach in Blainville	95	<i>Crassatellites (Hybolophus) gibbosus</i>	103
<i>Thracia curta</i> Conrad	95	Sowerby	103
Genus <i>Cyathodonta</i> Conrad	96	Genus <i>Crassinella</i> Guppy	103
<i>Cyathodonta dubiosa</i> Dall	96	<i>Crassinella pacifica</i> C. B. Adams	103
<i>Cyathodonta lucasana</i> Dall	96	<i>Crassinella pacifica mexicana</i> Pilsbry & Lowe	104
<i>Cyathodonta undulata</i> Conrad	96	<i>Crassinella varians</i> Carpenter	104
Family Pandoridae	96	Superfamily Carditacea	104
Genus <i>Pandora</i> Hwass in Chemnitz	96	Family Carditidae	104
Subgenus <i>Pandora</i> s.s.	97	Genus <i>Cardita</i> Bruguière	104
<i>Pandora (Pandora) uncinifera</i> Pilsbry & Lowe	97	<i>Cardita cuvieri</i> Broderip	105
Subgenus <i>Kennerlia</i> Carpenter	97	<i>Cardita grasi</i> Dall	105
<i>Pandora (Kennerlia) bilirata</i> Conrad	97	<i>Cardita megastrophia</i> Gray	106
<i>Pandora (Kennerlia) conveca</i> Dall	97	<i>Cardita spurca</i> Sowerby	106
Subgenus <i>Clidiophora</i> Carpenter	98	<i>Cardita tricolor</i> Sowerby	106
<i>Pandora (Clidiophora) cristata</i> Carpenter	98	Subgenus <i>Carditamera</i> Conrad	107
Subgenus <i>Foveadens</i> Dall	98	<i>Cardita (Carditamera) affinis</i> Sowerby	107
<i>Pandora (Foveadens) panamensis</i> Dall	98	<i>Cardita (Carditamera) radiata</i> Sowerby	108
Family Lyonsiidae	98	Superfamily Chamacea	108
Genus <i>Lyonsia</i> Turton	98	Family Chamidae	108
Subgenus <i>Lyonsia</i> s.s.	98	Genus <i>Chama</i> Linnaeus	108
<i>Lyonsia (Lyonsia) californica</i> Conrad	98	<i>Chama chinata</i> Broderip	108
<i>Lyonsia (Lyonsia) gouldii</i> Dall	98	<i>Chama frondosa</i> Broderip	109
Subgenus <i>Entodesma</i> Philippi	99	<i>Chama pellucida</i> Sowerby	109
<i>Lyonsia (Entodesma) inflata</i> Conrad	99	<i>Chama sordida</i> Broderip	109
Superfamily Poromyacea	99	<i>Chama squamuligera</i> Pilsbry & Lowe	110
Family Poromyacidae	99	Genus <i>Pseudochama</i> Odhner	110
Genus <i>Poromya</i> Forbes	99	<i>Pseudochama saavedrai</i> Hertlein & Strong, sp. nov.	110
Subgenus <i>Dermatomya</i> Dall	99	Genus <i>Echinochama</i> Fischer	111
<i>Poromya (Dermatomya) tenuiconcha</i> Dall	99	<i>Echinochama californica</i> Dall	111
Family Cuspidariidae	100	Superfamily Lucinacea	111
Genus <i>Cuspidaria</i> Nardo	100	Family Thyasiridae	111
Subgenus <i>Cuspidaria</i> s.s.	100	Genus <i>Thyasira</i> Leach in Lamarck	111
<i>Cuspidaria (Cuspidaria) apodema</i> Dall	100	<i>Thyasira excavata</i> Dall	111
Subgenus <i>Cardiomya</i> A. Adams	100	Family Lucinidae	111
<i>Cuspidaria (Cardiomya) dulcis</i> Pilsbry & Lowe	100	Genus <i>Lucina</i> Bruguière	112
<i>Cuspidaria (Cardiomya) pectinata</i> Carpenter	101	Subgenus <i>Bellucina</i> Dall	112
Genus <i>Leiomya</i> A. Adams	101	<i>Lucina (Bellucina) cancellaris</i> Philippi	112
Subgenus <i>Plectodon</i> Carpenter	101	Subgenus <i>Cavilinga</i> Chavan	112
<i>Leiomya (Plectodon) scabra</i> Carpenter	101	<i>Lucina (Cavilinga) lampra</i> Dall	112
		<i>Lucina (Cavilinga) linguialis</i> Dall	113
		Subgenus <i>Here</i> Gabb	113
		<i>Lucina (Here) excavata</i> Carpenter	113
		Subgenus <i>Luciniscia</i> Dall	113
		<i>Lucina (Luciniscia) fenestrata</i> Hinds	113
		<i>Lucina (Luciniscia) liana</i> Pilsbry	114
		<i>Lucina (Luciniscia) nuttalli</i> Conrad	114
		Subgenus <i>Lucinoma</i> Dall	115
		<i>Lucina (Lucinoma) annulata</i> Reeve	115
		Subgenus <i>Miltha</i> H. & A. Adams	115
		<i>Lucina (Miltha) xantusi</i> Dall	115
		Subgenus <i>Parvilucina</i> Dall	115
		<i>Lucina (Parvilucina) approximata</i> Dall	115
		<i>Lucina (Parvilucina) mazatlanica</i> Carpenter	116
		Subgenus <i>PleuroLucina</i> Dall	116
		<i>Lucina (PleuroLucina) leucoceymoides</i> Lowe	116
		Genus <i>Anodontia</i> Link	117
		<i>Anodontia edentuloides</i> Verrill	117
		Genus <i>Codakia</i> Scopoli	117
		<i>Codakia distinguenda</i> Tryon	117
		Genus <i>Ctena</i> Mörch	118
		<i>Ctena chiquita</i> Dall	118

¹Contribution No. 743, Department of Tropical Research, New York Zoological Society.

CONTENTS (CONTINUED)

<i>Ctena clarionensis</i> Hertlein & Strong, sp. nov.	118
<i>Ctena clippertonensis</i> Bartsch & Rehder.	118
<i>Ctena mexicana</i> Dall	119
Genus <i>Divaricella</i> von Martens	119
<i>Divaricella lucasana</i> Dall & Ochsner	119

INTRODUCTION

This is the fourth of a series of papers dealing with collections of mollusks taken on the Templeton Crocker Expedition (1936) and the Eastern Pacific *Zaca* Expedition (1937-1938). The general plan of presentation followed in the present contribution is that mentioned in Part II of this series of papers². Formal headings and keys are given only for the species collected by the Expeditions of 1936 and 1937-1938.

Acknowledgment is due Dr. G. D. Hanna, Curator, department of Paleontology of the California Academy of Sciences, for assistance and suggestions. Acknowledgment is also due Mr. A. G. Smith of Berkeley, California, Dr. A. Myra Keen of Stanford University and Mr. George Willett of the Los Angeles Museum of History, Science and Art for assistance in various ways. The preparation of most of the photographs by Mr. Frank L. Rogers is here acknowledged; his work was accomplished during the course of Federal Works Progress Administration Project Number 8569. We also wish to express our appreciation to Mr. Cecil Tose for the photographs of the new species of *Periploma*.

CLASS PELECYPODA.

Order Anomalodesmacea.

Superfamily Laternulacea.

FAMILY PERIPLOMATIDAE.

Genus *Periploma* Schumacher.Key to the species of *Periploma*.

- A. Beaks central or nearer the posterior end
 a. Beaks nearly central..... *discus*
 aa. Beaks nearer the posterior end
 b. Shell orbicular *stearnsii*
 bb. Shell elongately oval *teevani*
- B. Beaks nearer the anterior end;
 rostrum only slightly marked off
 from the disk *carpenteri*

Periploma carpenteri Dall.

Periploma carpenteri Dall, *Proc. U. S. Nat. Mus.*, Vol. 18, April 23, 1896, p. 20. Dredged "in 210 fathoms, mud, in the Gulf of Panama."—Dall, *Bull. Mus. Comp. Zool.*, Vol. 43, No. 6, October, 1908, p. 426, pl. 16, fig. 8. Same locality record as originally cited.

Type Locality: Gulf of Panama, in 210 fathoms, mud.

²Hertlein, L. G., and Strong, A. M. Eastern Pacific Expeditions of the New York Zoological Society. XXXII. Mollusks from the West Coast of Mexico and Central America. Part II. *Zoologica*, New York Zool. Soc., Vol. 28, Pt. 3, December 6, 1943, pp. 149-169, pl. 1.

Range: La Union, El Salvador, to Panama.

Collecting Station: El Salvador: La Union, Gulf of Fonseca (199-D-22), 3 fathoms, mud, mangrove leaves on bottom.

Description: Shell suborbicular, thin, pearly, beaks slightly nearer the anterior end; surface ornamented by fine crowded granules which on some parts of the shell are arranged in extremely fine radial rows. The present specimen measures 21.5 mm. in length and 19 mm. in height.

The more anteriorly situated beaks, the lack of or very fine radial arrangement of the crowded granules, larger pallial sinus and the fact that the rostrum is less distinctly marked off from the arch of the base, all serve to separate *Periploma carpenteri* from *P. stearnsii* Dall.

It is possible that the specimen here referred to *Periploma carpenteri* may be a young form of *Periploma alta* Adams,³ a species originally described from Panama, the type specimen of which has not been illustrated. Adams' species is said to be similar to *Periploma discus* but differing in the outline of the posterior portion of the shell.

Distribution: A single right valve of *Periploma carpenteri* was dredged in the Gulf of Fonseca. This furnishes an extension northward of the known range of the species.

Periploma discus Stearns.

Periploma discus Stearns, *Proc. U. S. Nat. Mus.*, Vol. 13, September 16, 1890, p. 222, pl. 16, figs. 1 and 2. "San Pedro, Long Beach, etc., Los Angeles County, California."—I. S. Oldroyd, *Stanford Univ. Publ. Univ. Ser. Geol. Sci.*, Vol. 1, 1924, p. 82, pl. 43, figs. 1 and 3. San Pedro to San Diego, California.

Type Locality: Long Beach, California (cited as type locality by I. S. Oldroyd and accepted as such by the present authors).

Range: Monterey Bay, California, to La Union, El Salvador.

Collecting Station: El Salvador: La Union, Gulf of Fonseca (199-D-11), 5 fathoms, mud.

Description: One small specimen measuring approximately 16 mm. from beak to base is in general features similar to *Periploma discus*. It is slightly less circular in outline than adult specimens but this feature seems to be characteristic of young forms of this species. A narrow and well marked rostrum is present. The valves are ornamented by fine granular sculpture which on some parts of the shell is arranged in fine radial rows. Pallial sinus short and rather narrow.

³*Anatina alta* C. B. Adams, *Ann. Lyceum Nat. Hist. New York*, Vol. 5, July, 1852, pp. 518, 547 (separate pp. 294, 323). "Panama".

Periploma alta C. B. Adams, Pilsbry & Lowe, *Nautilus*, Vol. 47, No. 3, 1934, p. 85.

Distribution: The present record of *Periploma discus* from the Gulf of Fonseca is an extension southward in the known range. Pilsbry and Lowe have cited the species from La Paz, Lower California, Mexico. It is known to occur north to Monterey Bay, California.

Periploma stearnsii Dall.

Periploma stearnsii Dall, *Proc. U. S. Nat. Mus.*, Vol. 18, April 23, 1896, p. 19. Dredged "in 24 fathoms, mud; off Point Fermin, at the head of the Gulf of California."—Dall, *Bull. Mus. Comp. Zool.*, Vol. 43, No. 6, 1908, p. 426, pl. 16, fig. 5. Original locality cited.

Type Locality: Off Point Fermin, head of the Gulf of California, in 24 fathoms, mud.

Range: Head of the Gulf of California to San Lucas Bay, Lower California.

Collecting Station: Mexico: San Lucas Bay (135-D-2), 8-16 fathoms, sand.

Description: Shell orbicular, thin, pearly, beaks nearer the posterior end; rostrum rather wide and well marked off by a groove; surface ornamented by fine radial rows of granules separated from each other by a clear space. A right valve in the present collection measures approximately 34.8 mm. in length and 29.6 mm. in height.

The shell of *Periploma stearnsii* differs from that of *P. discus* in the more compressed form, wider rostrum, wider pallial sinus, and in that the beaks are more posteriorly situated.

Distribution: *Periploma stearnsii* heretofore has been known only from the head of the Gulf of California and the present record extends the known range south to Cape San Lucas Bay at the southern end of the Gulf of California.

Periploma teevani Hertlein & Strong, sp. nov.

Plate I, Figures 2 and 6.

Shell elongately roundly oval, thin, fragile, pearly, valves gently convex and gaping posteriorly; beaks nearer the posterior end, opisthogyrate, acutely pointed, fissured; anterior dorsal margin gently rounded, sloping and merging into the rounded anterior end, ventral margin gently rounded, posterior dorsal margin nearly straight sloping gently down to the subtruncated and nearly straight steeply sloping posterior end of the shell; surface of shell covered by fine concentric lines of growth, the basal half sculptured by fine, weak, radial rows of pustules; on the rostrum these are developed into fine but strong dense closely spaced radial rows; a narrow shallow groove runs from the beak to the anterior basal margin; internally the chondrophore is directed slightly anteriorly, and posteriorly is supported by a thin rounded buttress; a lithodesma is present anterior to the chondrophore; faint radial lines show through on the interior of the shell; pallial sinus short

(about one-fourth the length of the shell) not reaching a vertical with the hinge. Length, 23 mm.; height, 19 mm.; convexity (both valves), 10 mm.

Holotype, from Station 196-D-19, Lat. 15°44'N., Long. 96°05'W., Tangola-Tangola Bay, Oaxaca, Mexico, dredged in 30 fathoms (55 meters), mud.

Compared to *Periploma planiuscula* Sowerby⁴, a species which ranges from Point Concepcion, California, to Negritos, Peru, the new species is comparatively higher in proportion to the length, the rostrum is shorter and wider and the shell is ornamented by radial rows of pustules which in Sowerby's species are irregularly arranged. These same characters serve to separate it from *Periploma venezuelana wiedenmayeri* H. K. Hodson⁵ from the Miocene of Venezuela.

This species is named for Mr. John Teevan, a member of the scientific staff on the *Zaca* during the eastern Pacific Expeditions.

FAMILY THRACIIDAE.

Key to the genera of the Thraciidae.

- A. Shell ornamented by prominent oblique concentric undulations *Cyathodonta*
 B. Shell ornamented only by concentric lines of growth *Thracia*

Genus *Thracia* Leach in Blainville.

Thracia curta Conrad.

Thracia curta Conrad, *Jour. Acad. Nat. Sci. Philadelphia*, Vol. 7, 1837, p. 248, pl. 19, fig. 8. "Inhabits the coast of California, near Sta. Barbara."—I. S. Oldroyd, *Stanford Univ. Publ. Univ. Ser. Geol. Sci.*, Vol. 1, 1924, p. 84, pl. 43, fig. 6. Icy Cape, Arctic Ocean, Bering Sea, to San Diego, California.

Type Locality: Near Santa Barbara, California.

Range: Icy Cape, Alaska, to Punta Penasco, Sonora, Mexico, in the Gulf of California, Mexico. To Ecuador (E. K. Jordan).

Collecting Station: Mexico: SE. of Cedros Island, in channel (126-D-19), 25 fathoms, rocks, algae.

Description: Shell roundly quadrate, anterior and ventral margins rounded, posterior end truncated; on large specimens a distinct carina marks off the rostrum from the remainder of the shell. A specimen collected at San Diego, California, by Henry Hemphill measures 42 mm. in length.

⁴ *Periploma planiuscula* Sowerby, *Proc. Zool. Soc. London*, October 25, 1834, p. 87. "Hab. ad Sanctam Elenam."—Grant & Gale, *Mem. San Diego Soc. Nat. Hist.*, Vol. 1, 1931, p. 255, pl. 13, figs. 1a, 1b. [Not all of the synonymy.] Pliocene to Recent.

⁵ *Periploma venezuelana wiedenmayeri* H. K. Hodson, *Bull. Amer. Paleol.*, Vol. 16, No. 59, October 1, 1931, p. 7, pl. 1, figs. 3, 5, 7. From "2 kilometers south and 600 meters east of La Compana, District of Democracia, State of Falcón. (La Compana is 11.5 kilometers east and 2 kilometers south of Urumaco)." Venezuela. Lower middle Miocene.

The shell of this species is more roundly quadrate in outline and the rostrum is much less expanded in comparison to that of *Thracia trapezoides* Conrad.

Distribution: A single right valve of this species was dredged in the channel southeast of Cedros Island, Lower California. It has been recorded as occurring from Alaska to the Gulf of California and south to Ecuador. We have not seen specimens from south of Cape Lucas, Lower California.

Genus *Cyathodonta* Conrad.

Key to the species of *Cyathodonta*.

- A. Shell ornamented by radiating rows of granules.....*undulata*
- B. Shell ornamented by granules arranged in irregular concentric lines
 - a. Shell elongately ovate; beaks decidedly nearer the posterior end*lucasana*
 - aa. Shell higher; beaks only slightly nearer the posterior end.....*dubiosa*

Cyathodonta dubiosa Dall.

Cyathodonta dubiosa Dall, *Proc. U. S. Nat. Mus.*, Vol. 49, November 27, 1915, p. 445. "Type locality, off La Paz." Range: San Pedro to San Diego, California, and to La Paz, Lower California.—I. S. Oldroyd, *Stanford Univ. Publ. Univ. Ser. Geol. Sci.*, Vol. 1, 1924, p. 86, pl. 9, fig. 5. Original locality records cited.

Type Locality: Off La Paz, Lower California, Mexico.

Range: San Pedro, California, to Champerico, Guatemala.

Collecting Station: Guatemala: 7 miles W. of Champerico (197-D-2), 14 fathoms, mud.

Description: The specimen which is here referred to *Cyathodonta dubiosa* differs from *C. undulata* in the character of ornamentation pointed out by Dall, "the granulation is in somewhat irregular concentric lines and not radially distributed." It measures 19.8 mm. in length and 16 mm. in height.

Distribution: A single left valve of *Cyathodonta dubiosa* was dredged off Champerico, Guatemala, in 14 fathoms. The species has also been reported as occurring in the Pleistocene of Lower California and Panama.

Cyathodonta lucasana Dall.

Plate I, Figures 4 and 9.

Cyathodonta lucasana Dall, *Proc. U. S. Nat. Mus.*, Vol. 49, November 27, 1915, p. 445. "Type locality, Cape St. Lucas, Lower California, Xantus."

Type Locality: Cape San Lucas, Lower California, Mexico.

Range: La Paz, Lower California, to Port Guatulco, Mexico,

Collecting Station: Mexico: Port Guatulco (195-D-9), 7 fathoms, green sand, crushed shell.

Description: A single left valve in the present collection dredged off Port Guatulco, Mexico, is identified as *Cyathodonta lucasana* Dall. It is elongately ovate in shape, the anterior end the longer. The plications are few and sparse. In the original description of the species Dall stated that no granulation was perceptible on the type specimen which was 7.5 mm. long and 5 mm. high. The present specimen shows only fine granulation toward the base at that size but after attaining a height of 8 mm. shows well developed irregular concentric granulations. It measures: length, 21 mm.; height, 14 mm.; convexity (one valve), 3.4 mm.

Distribution: The discovery of the occurrence of this species at Port Guatulco, Mexico, is an extension southward of the known range.

Cyathodonta undulata Conrad.

Cyathodonta undulata Conrad, *Proc. Acad. Nat. Sci. Philadelphia*, Vol. 4, 1849, p. 156. [Title of article states "Shells from the coasts of Lower California and Peru"].

Thracia plicata Deshayes, Reeve, *Conch. Icon.*, Vol. 12, *Thracia*, November, 1859, species 7, pl. 2, figs. 7b, 7c. California. [Not *Thracia plicata* Deshayes, Reeve, pl. 2, fig. 7a].

Type Locality: East coast of Lower California, (here designated as type locality). Peru also cited originally.

Range: Gulf of California to Peru.

Collecting Stations: Mexico: Arena Bank (136-D-15), 40 fathoms, mud, crushed shell; Santa Inez Bay (145-D-1, 3), 4-13 fathoms, sand; anchorage 1 mile south of San Domingo Point, Concepcion Bay; Nicaragua: Corinto (200-D-4, 7), 1/2-2 fathoms, mangrove leaves; Costa Rica: Golfito, Gulf of Dulce.

Description: Shell elongate, ornamented by concentric ripples and by fine rows of granules radiating from the umbos. It attains a length of 50 mm. or more.

Cyathodonta magnifica Jonas, from the east coast of Honduras, is a similar species.

Distribution: *Cyathodonta undulata* has been recorded from a number of localities from the Gulf of California to Peru. It also has been reported from the Pliocene and Pleistocene of Lower California, and from the Pleistocene of southern California and Panama.

FAMILY PANDORIDAE.

Genus *Pandora* Hwass in Chemnitz.

Winckworth⁶ has recently presented reasons for abandoning the genus name *Pandora* in favor of *Calpodium* Bolten⁷. The

⁶ Winckworth, R., *Jour. Conch.*, Vol. 20, No. 2, 1934, pp. 52-53.

⁷ Bolten, J. F., *Mus. Bolt.*, Pt. 2, 1798, p. 166.

latter name was proposed for *C. albidum* Bolten, in the synonymy of which was included *Tellina inaequivalvis* with a reference to Chemnitz, *Conchyl.-Cab.*, Vol. 6, pl. 11, figs. 106a, b, c, d [= *Tellina inaequivalvis* Gmelin]. *Calpodium* is thus certainly available if *Pandora* is considered to be invalid. We have hesitated to make this change until it is certain that the well known name *Pandora* must be abandoned.

Key to the subgenera of *Pandora*.

- A. Right valve with 2 cardinal teeth
 a. Left valve with 1 tooth or none
 b. Lithodesma present *Kennerlia*
 bb. Lithodesma absent... *Pandora s.s.*
 aa. Left valve with 3 cardinal teeth *Foveadens*
 B. Right valve with 3 cardinal teeth *Clidiophora*

Subgenus *Pandora s. s.*

Pandora (Pandora) uncifera Pilsbry & Lowe.

Pandora uncifera Pilsbry & Lowe, *Proc. Acad. Nat. Sci. Philadelphia*, Vol. 84, May 21, 1932, p. 104, pl. 17, figs. 17, 18, 19. "Acapulco, 20 fathoms, type loc.," also from Manzanillo, Mexico, in 20 fathoms.

Type Locality: Acapulco, Mexico, in 20 fathoms.

Range: Gorda Banks off Cape San Lucas, Lower California, to Port Parker, Costa Rica.

Collecting Stations: Mexico: Gorda Banks (150-D-?); Port Guatulco (195-D-9), 7 fathoms, green sand, crushed shell; Tangola-Tangola Bay (196-D-6, 7, 14, 15) 5-7 fathoms, sand, crushed shell; Costa Rica: Port Parker (203-D-3), 12 fathoms, shelly mud.

Description: Shell elongate, small, of about the same size and general features of *Pandora brevifrons* Sowerby⁸ but proportionately shorter. Furthermore the anterior dorsal margin of the shell is hooked, a feature entirely lacking in the species described by Sowerby. Length about 12.5 mm.

Distribution: *Pandora uncifera* was dredged abundantly off Port Guatulco, Mexico, in 7 fathoms. The present records of the species north to Gorda Banks in the Gulf of California and south to Port Parker, Costa Rica, are extensions of the known range.

Subgenus *Kennerlia* Carpenter.

Key to the species of *Kennerlia*.

- A. Outline elongated; anterior area of left valve set off by an impressed line *bilirata*

⁸ *Pandora brevifrons* Sowerby, *Proc. Zool. Soc. London*, September 25, 1835, p. 93. "Hab. apud Panamam." "Obtained from a sandy bottom, at the depth of ten fathoms."—Sowerby, *Spec. Conch.*, Vol. 1, Pt. 2, 1855, *Pandora*, pl. [not numbered], figs. 25, 26. —Sowerby, *Conch. Icon.*, Vol. 19, *Pandora*, 1874, species 12, pl. 2, fig. 12, "Hab.—?"

- B. Outline semicircular; anterior area of left valve not, or only weakly, set off by an impressed line..... *convexa*

Pandora (Kennerlia) bilirata Conrad.

Pandora bilirata Conrad, *Proc. Acad. Nat. Sci. Philadelphia*, Vol. 7, 1855, p. 267. California.—Conrad, *U. S. Pac. R. R. Repts.*, Vol. 6, 1857, *Geol. Rept.*, p. 73, pl. 5, fig. 25. "Santa Barbara, Cal."

Pandora (Kennerlia) bicarinata Carpenter, Arnold, *Mem. Calif. Acad. Sci.*, Vol. 3, 1903, p. 123, pl. 18 fig. 2. Lower San Pedro series of Deadman Island, San Pedro, California, Pleistocene. Also Recent.

Pandora (Kennerlia) bilirata Conrad, I. S. Oldroyd, *Stanford Univ. Publ. Univ. Ser. Geol. Sci.*, Vol. 1, No. 1, 1924, p. 89, pl. 53, figs. 8 and 9. Range, Forrester Island, Alaska, to Point Abreojos, Lower California.

Type Locality: California.

Range: Drier Bay, Prince William Sound, Alaska, to Point Abreojos, Lower California.

Collecting Station: Mexico: East of Cedros Island (126-D-10, 12), 45-60 fathoms, crushed shell, eel grass, mud.

Description: Right valve concave, left convex; anterior margin contracted in the middle, base convex; posterior end truncated; left valve with two carinated ribs radiating dorsally from the beak to the posterior margin, also ornamented by a few very fine and rather widely spaced raised lines extending to the ventral margin posterior to the anterior contraction. Length about 16 mm.

Distribution: This species is often dredged on muddy or on fine sandy bottoms from Alaska to Lower California.

Pandora (Kennerlia) convexa Dall.

Plate I, Figure 5.

Kennerlyia convexa Dall, *Proc. U. S. Nat. Mus.*, Vol. 49, November 27, 1915, p. 449. "Type locality, Ballenas Lagoon, Lower California, in 48 fathoms."

Type Locality: Ballenas Lagoon, Lower California, in 48 fathoms.

Range: Ballenas Lagoon to Cape San Lucas, Lower California, Mexico.

Collecting Station: Mexico: Cape San Lucas, Lower California.

Description: The single specimen in the present collection referred to *Pandora convexa* is approximately 13.5 mm. in length as compared to the unfigured type of the species which was 21 mm. long. Compared to *P. bilirata* Conrad the shell of Dall's species is more semicircular in outline and the anterior area of the left valve is less distinctly set off by an impressed line.

Distribution: The present record of *Pandora convexa* at Cape San Lucas, Lower California, is an extension south of the known range of the species.

Subgenus *Clidiophora* Carpenter.*Pandora (Clidiophora) cristata* Carpenter.

Clidiophora cristata Carpenter, *Proc. Zool. Soc. London*, November 22, 1864, p. 597. "Hab. in sinu Californiensi."

Pandora cristata Carpenter, Sowerby, *Conch. Icon.*, Vol. 19, *Pandora*, 1874, species 1, pl. 1, fig. 1. "Hab.—?"

Type Locality: Gulf of California.

Range: Gulf of California to La Libertad, El Salvador.

Collecting Stations: Guatemala: 7 miles west of Champerico (197-D-1, 2), 13-14 fathoms, mud; El Salvador: La Libertad (198-D-1, 2), 13-14 fathoms, mud.

Description: The shell of this species may be distinguished from that of other similar forms of the genus by the presence of triangular serrations along the anterior dorsal margin. A large specimen measures approximately 26 mm. in length.

Distribution: The discovery of the occurrence of *Pandora cristata* as far south as La Libertad, El Salvador, is an extension of the known range of the species.

Subgenus *Foveadens* Dall.*Pandora (Foveadens) panamensis* Dall.

Foveadens panamensis Dall, *Proc. U. S. Nat. Mus.*, Vol. 49, November 27, 1915, p. 451. "Type locality, beach at Old Panama."

Type Locality: Old Panama, on beach.

Range: El Salvador to Panama.

Collecting Station: El Salvador: Meanguera Island, Gulf of Fonseca (199-D-1), 16 fathoms, sand, mud, crushed shell.

Description: A single somewhat worn right valve dredged in the Gulf of Fonseca off El Salvador seems to fit the description given by Dall for *Pandora panamensis*. This flat, white, pearly valve is slightly concentrically undulated, and possesses two diverging teeth and a low ridge extending from the apex of the hinge to the anterior adductor scar. Length, 33.5 mm.

Distribution: The present record of this species in the Gulf of Fonseca is an extension north of the known range.

FAMILY LYONSIIDAE.

Genus *Lyonsia* Turton.

Key to the subgenera of *Lyonsia*.

- A. Shell regular, not distorted;
radial sculpture *Lyonsia s.s.*
B. Shell irregular, distorted;
smooth *Entodesma*

Subgenus *Lyonsia* s. s.

Key to the species of *Lyonsia s.s.*

- A. Umbos inflated; shell often
arcuate *californica*
B. Umbos only slightly inflated; shell
smaller, less arcuate *gouldii*

Lyonsia (Lyonsia) californica Conrad.

Lyonsia californica Conrad, *Jour. Acad. Nat. Sci. Philadelphia*, Vol. 7, 1837, p. 248, pl. 19, fig. 20 [erroneously cited in text as fig. 21]. "Inhabits the coast of California, near Sta. Barbara."—I. S. Oldroyd, *Stanford Univ. Publ. Univ. Ser. Geol. Sci.*, Vol. 1, 1924, p. 91, pl. 27, fig. 3. Type locality cited. Range, Puget Sound to Todos Santos Bay, Lower California.

Type Locality: Near Santa Barbara, California.

Range: Southeastern Alaska (Lat. 56°N.) to Lat. 24°S., Lower California.

Collecting Station: Mexico: East of Cedros Island (126-D-4), in 40 fathoms, mud.

Description: Shell elongate, thin, pearly, usually more or less arcuate, umbos inflated, ornamented by fine radial sculpture. Fresh specimens are always more or less covered with adhering sand grains.

The subspecies *Lyonsia californica haroldi* Dall, a generally larger shell from central California, is not arcuate and is nearly cylindrical in form. *Lyonsia californica nesiotis* Dall from southern California possesses a small, thin shell in which the beaks are much nearer the anterior end than in the typical species.

Distribution: A single specimen of *Lyonsia californica* was dredged in the channel east of Cedros Island, Lower California, in 40 fathoms. It is commonly found in the waters off California but is much less commonly found off Lower California.

Lyonsia (Lyonsia) gouldii Dall.

Osteodesma nitidum Gould, *Boston Jour. Nat. Hist.*, Vol. 6, April, 1852, p. 390, pl. 15, fig. 6. "Inhabits Santa Barbara."

Lyonsia gouldii Dall, *Proc. U. S. Nat. Mus.*, Vol. 49, November 27, 1915, p. 453. "San Francisco Bay, California, and south to Point Abrejos, Lower California." New name for *Osteodesma [Lyonsia] nitidum* Gould, 1851, not *Mya [=Lyonsia] nitida* Fabricus, 1798.

Type Locality: Santa Barbara, California.

Range: San Francisco Bay, California, to Acapulco, Mexico.

Collecting Stations: Mexico: Off Cedros Island; E. of Cedros Island (126-D-4), in 40 fathoms, mud; Santa Inez Bay, Gulf of California (145-D-1, 3), 4-13 fathoms, sand.

Description: Shell small, slender, pearly, umbos gently convex, ornamented by fine raised radial lines, posterior end truncated. Length about 16 mm.

The shell of *Lyonsia gouldii* is smaller, less arcuate in outline, and the umbos are much less inflated than those of *L. californica*.

Distribution: *Lyonsia gouldii* is said to range north to San Francisco Bay, California, but apparently it occurs more commonly

farther south off San Diego, California, and in west Mexican waters.

Subgenus *Entodesma* Philippi.

Lyonsia (*Entodesma*) *inflata* Conrad.

L. [yonsia]. inflata Conrad, *Jour. Acad. Nat. Sci. Philadelphia*, Vol. 7, 1837, p. 248, pl. 19, fig. 10. "Inhabits Guayaquil."—I. S. Oldroyd, *Stanford Univ. Publ. Univ. Ser. Geol. Sci.*, Vol. 1, 1924, p. 93. Type locality cited. Range, in sponges from Vancouver Island, British Columbia, to Guayaquil, Ecuador.

Type Locality: Guayaquil, Ecuador.

Range: Vancouver Island, British Columbia, to Guayaquil, Ecuador (Dall).

Collecting Station: Mexico: Santa Inez Bay, Gulf of California (144-D-2), 2½ fathoms, mud, crushed shell.

Description: Shell irregularly oval in shape, smooth, attaining a length of about 20 mm.; anterior end short.

There is some doubt as to whether *inflata* is the correct specific name to apply to the present specimens. They agree quite well with the general features of *Lyonsia inflata* shown in the original figure, but possess a more angulated anterior margin. In comparing *Lyonsia* (*Entodesma*) *chilense* Philippi with *L. (E.) inflata*, Dall⁹ stated that "these mollusks are nestlers" but in the discussion of *L. inflata* he stated that it is "usually found living in sponges or the mass of compound ascidians, and they differ from the rock nestlers in their polished smooth surface and normal shape."

Lyonsia diaphana Carpenter¹⁰ was originally described from Mazatlan, Mexico. In an early paper Dall¹¹ stated that Carpenter's specimens appeared to be quite different from the original figure of *L. inflata* given by Conrad but in a later paper (1915) he considered *L. diaphana* to be a young form of Conrad's species. The illustration of "*Mytilimeria*" *diaphana* given by Sowerby¹² is similar in general characters to that of the original figure of *Lyonsia inflata* except that it is narrower and more elongated. We have not seen convincing evidence that the specimens from the Gulf of California really differ from the more southern forms, hence we have applied the earlier name proposed by Conrad.

Distribution: *Lyonsia inflata* has been recorded as occurring from Forrester Island, Alaska, to Ecuador. The more northern part of the range may perhaps be open to question but the present record from the Gulf

of California would appear to be well within the range of the species.

Superfamily Poromyacea.

FAMILY POROMYACIDAE.

Genus *Poromya* Forbes.

Poromya Forbes, 13th Rept. Brit. Assoc. Adv. Sci., (Cork, 1843), (issued 1844), pp. 143, 191. Sole species, *Poromya anatinoides* Forbes. "Asia Minor, Cyclades."

Type (by monotypy): *Poromya anatinoides* Forbes [= *Corbula granulata* Nyst & Westendorp. See illustration by Chenu, *Man. de Conchyl.*, Vol. 2, 1862, p. 49, fig. 206].

Shell small, ovate, subequilateral; sculpture of fine granules in radial series; hinge of right valve with a strong cardinal tooth in front of a wide chondrophore; hinge of the left valve with a small cardinal tooth behind and above the chondrophore.

Questimya Iredale¹³ is a similar genus.

Subgenus *Dermatomya* Dall.

Dermatomya Dall, *Bull. Mus. Comp. Zool.*, Vol. 18, May 20, 1889, pp. 448, 452. Sole species, *Poromya (Dermatomya) mactroides* Dall.

Type (by original designation): *Poromya (Dermatomya) mactroides* Dall. Illustrated in *Proc. U. S. Nat. Mus.*, Vol. 12, 1889, p. 291, pl. 8, fig. 8. West coast of Patagonia, in 122, 348 and 449 fathoms. Also off the coast of Ecuador.

The shell of *Dermatomya* differs from typical *Poromya* in the absence of superficial granulations, in the presence of a deep and strong pallial sinus, and in that the hinge is very coarse and strong.

Poromya (Dermatomya) tenuiconcha Dall.

Poromya (Dermatomya) tenuiconcha Dall, *Proc. U. S. Nat. Mus.*, Vol. 45, June 11, 1913, p. 596. "In deep water off Monterey Bay, California."

Dermatomya tenuiconcha Dall, *U. S. Nat. Mus., Bull.* 112, 1921, p. 27, pl. 3, fig. 10. Alaska Peninsula to Coronado Islands, in deep water [*Dermatomya* used as a subgenus of *Poromya*].

Type Locality: Off Monterey, California, in deep water.

Range: Alaska Peninsula to off San Jose Point, Lower California (Lat. 31° 25' N.).

Collecting Station: Mexico: 5 miles W. of San Jose Point, Lower California (175-D-1), 45 fathoms, slabs of slaty rock.

Description: Shell small, thin, smooth, subtriangular, umbos inflated, anterior end rounded, posterior end roundly truncated,

⁹ Dall, W. H., *Proc. U. S. Nat. Mus.*, Vol. 49, 1915, p. 455.

¹⁰ *Lyonsia (Osteodesma) diaphana* Carpenter, *Proc. Zool. Soc. London*, February 5, 1856, p. 228. "Hab. Mazatlan."

¹¹ Dall, W. H., *Amer. Jour. Conch.*, Vol. 7, Pt. 2, 1871, p. 143.

¹² Sowerby, G. B., *Conch. Icon.*, Vol. 20, *Mytilimeria*, 1875, species 2, pl. 1, fig. 2. "California."

¹³ *Questimya* Iredale, *Rec. Austral Mus.*, Vol. 17, No. 9, June 27, 1930, pp. 389, 406. "Type *Poromya undosa* Hedley and Petterd," *Rec. Austral Mus.*, Vol. 6, No. 3, June 19, 1906, p. 224, pl. 38, figs. 16, 17. "Two odd valves from two hundred and fifty fathoms, and fragments of larger specimens from three hundred fathoms," off Sydney, Australia.

the area set off by a low angulation anterior to which is a shallow groove; interior pearly; hinge of left valve with a small internal resilium on an inconspicuous oblique chondrophore, and immediately in front of this a small notch; fitting into this is a projecting denticle on the opposite valve. The present specimen measures approximately: length, 11.9 mm.; width, 9.8 mm.; convexity (both valves), 7.6 mm.

The shell of *Poromya tenuiconcha* differs from that of *P. trosti* Strong & Hertlein, in the more trigonal form and in that the posterior margin is more distinctly truncated.

Distribution: A single specimen of this species was dredged in 45 fathoms west of San Jose Point, Lower California.

FAMILY CUSPIDARIIDAE.

Key to the genera and subgenera of the Cuspidariidae.

- A. Hinge with a posterior lateral tooth in right valve
- a. Surface smooth or with faint concentric sculpture...*Cuspidaria s. s.*
 - aa. Surface with radial ribs...*Cardiomya*
- B. Hinge with both posterior and anterior lateral tooth in right valve
- a. Surface granulated*Plectodon*
 - aa. Surface smooth (or with concentric growth lines only).....*Leiomya*

Genus *Cuspidaria* Nardo.

Subgenus *Cuspidaria s. s.*

Cuspidaria (Cuspidaria) apodema Dall.

Cuspidaria apodema Dall, *Proc. U. S. Nat. Mus.*, Vol. 52, No. 2183, December 27, 1916, p. 407. "Station 2859, southwest of Sitka Bay, Alaska, in 1,569 fathoms."—Dall, *U. S. Nat. Mus., Bull.* 112, 1921, p. 28. Off Sitka, Alaska, and south to Panama Bay, in deep water.

Type Locality: Southwest of Sitka, Alaska, in 1,569 fathoms.

Range: Sitka, Alaska, to Panama Bay, in deep water.

Collecting Station: Mexico: Cape San Lucas, Lower California.

Description: Shell small, white, umbos inflated, beaks about 5 mm. from the anterior end, hinge line nearly straight; anterior end rounding into the semicircular base which is suddenly constricted posteriorly at the rostrum; smooth except for incremental lines and wrinkles on the dorsal side of the rostrum.

A single worn specimen from Cape San Lucas, Lower California, in the present collection, approximately 12.6 mm. long and 7.5 mm. high, appears to be referable to *Cuspidaria apodema*. Dall stated that his species is similar to *C. obesa* Lovén, an At-

lantic species. Our specimen does resemble somewhat the illustration of that species given by Sars¹⁴.

Possibly the specimen from Cape San Lucas could be a worn valve of *Cuspidaria panamensis* Dall¹⁵ but the smaller size and rather straight hinge line agree more nearly with Dall's description of *C. apodema*. Dall mentioned that the rostrum of *C. panamensis* is short and somewhat recurved and that the ligamentary nymph is very large and tooth like.

Distribution: Only a single valve of this species was taken by the expedition at Cape San Lucas, Lower California.

Subgenus *Cardiomya* A. Adams.

Key to the species of *Cardiomya*.

- A. Right valve with about 8 ribs, these are partly twinned on the left valve *dulcis*
- B. Right and left valves with about 12 to 15 ribs *pectinata*

Cuspidaria (Cardiomya) dulcis Pilsbry & Lowe.

Cuspidaria (Cardiomya) dulcis Pilsbry & Lowe, *Proc. Acad. Nat. Sci. Philadelphia*, Vol. 84, May 21, 1932, p. 104, pl. 17, figs. 20, 21, 22. "Mexico: Acapulco, in about 20 fathoms," type. Also San Juan del Sur, Nicaragua.

Type Locality: Acapulco, Mexico, in about 20 fathoms.

Range: Punta Penasco, Sonora, Mexico, to Taboga Island, Panama.

Collecting Stations: Mexico: Cape San Lucas; Santa Inez Bay, Lower California (145-D-1,3), 4-13 fathoms, sand; Manzanillo (184-D-2), 30 fathoms, gravelly sand; Port Guatulco (195-D-19), 17 fathoms, green mud, crushed shell; Costa Rica: Port Parker (203-D-1,3), 12-15 fathoms, sandy mud, crushed shell.

Description: Shell small, right valve ornamented by about 8 radiating, high, narrow ribs; on the left valve these are partly twinned; two weak radial threads occur on the rostrum but are often lacking on empty shells. Length about 8 mm.

The shell of *Cuspidaria dulcis* appears to differ from that of *C. costata* Sowerby¹⁶ in the twinning of the ribs on the left valve and in the possession of two radial threads on the rostrum. Neither of these features is

¹⁴ See *Neaera obesa* Lovén, Sars, *Moll. Reg. Arct. Norvegiae*, 1878, p. 86, pl. 6, figs. 4a, b, c.

¹⁵ *Cuspidaria panamensis* Dall, *Bull. Mus. Comp. Zool.*, Vol. 43, No. 6, October, 1908, p. 432, pl. 16, fig. 2. "U. S. S. 'Albatross,' station 3394, in the Gulf of Panama, in 511 fathoms, mud, bottom temperature, 41° 8 F. U. S. N. M. 122,937."

¹⁶ *Anatina costata* Sowerby, *Proc. Zool. Soc. London*, October 25, 1834, p. 87. "Hab. ad Sanctam Elenam." "A single specimen was found in sandy mud at a depth of six fathoms."

mentioned in the original description of Sowerby's species.

Distribution: This species occurs from the Gulf of California to Panama. In the present collection it is represented most abundantly by specimens from Port Parker, Costa Rica, in 14 fathoms. It is also known to occur in the Pleistocene of Magdalena Bay, Lower California.

Cuspidaria (Cardiomya) pectinata Carpenter.

Neaera pectinata Carpenter, *Rept. Brit. Assoc. Adv. Sci.* for 1863 (issued August, 1864), pp. 602, 637. Puget Sound; Santa Barbara, and Santa Barbara Islands, California. Reprint in *Smithson. Miscell. Coll.*, No. 252, 1872, pp. 88, 123.—Carpenter, *Proc. Acad. Nat. Sci. Philadelphia*, Vol. 17, 1865, p. 54. "Hab. In sinu Pugetiano." Also "apud insulam catalinam et Sanct. Barbaram adultam piscavit Cooper."—Arnold, *Mem. Calif. Acad. Sci.*, Vol. 3, 1903, p. 181, pl. 18, fig. 11. Lower San Pedro Series at Deadman Island, San Pedro, California, Pleistocene.

Type Locality: Puget Sound, Washington (cited as type locality by I. S. Oldroyd, 1924, and accepted as such by the present authors).

Range: Puget Sound to [?] Panama.

Collecting Station: Mexico: East of Cedros Island (126-D-12), 45 fathoms, crushed shell and mud.

Description: Shell with about 12 to 15 sharp radiating ribs which vary in size. The rostrum was originally described as lacking radial sculpture; this feature however, appears to be variable. Length about 8 to 11 mm.

The type of this species appears to have come from Puget Sound. Carpenter considered shells from Santa Catalina Island, California, to be identical with those from Puget Sound. Specimens from Puget Sound in the collection at Stanford University are fully twice as large as those from off California. Other than size there is no apparent difference. The ribs vary considerably, depending on the size of the shell.

Cuspidaria californica Dall,¹⁷ described from Catalina Island, California, was described as differing from *C. pectinata* in possessing a smaller and proportionally longer and less inflated shell, with more numerous ribs, and straighter rostrum which is ornamented with two strong radiating lirae. In a series of specimens the characters enumerated seem variable and it seems likely that *C. californica* is hardly more than a subspecies of *C. pectinata*.

Distribution: *Cuspidaria pectinata* Carpenter has been reported as ranging from

Puget Sound to Panama. The specimens in the present collection, dredged east of Cedros Island, appear to be referable to Carpenter's species but we have not seen specimens from more southern localities.

Genus **Leiomya** A. Adams.

Leiomya A. Adams, *Ann. & Mag. Nat. Hist.*, Ser. 3, Vol. 13, 1864 [prior to April], p. 208. Sole species, *Leiomya adunca* Gould.

Type (by monotypy): *Leiomya adunca* Gould [= *Neaera adunca* Gould, *Proc. Boston Soc. Nat. Hist.*, Vol. 8, March, 1861, p. 24. "Inhabits Kagosima Bay, sandy mud, 12-15 fathoms."]

A posterior and an anterior lateral tooth are present in the right valve of *Leiomya*, whereas in *Cuspidaria* only a posterior lateral tooth is present.

Subgenus **Plectodon** Carpenter.

Plectodon Carpenter, *Rept. Brit. Assoc. Adv. Sci.*, for 1863 (issued August, 1864), pp. 611, 638. Sole species, *Plectodon scaber* Carpenter. Reprint in *Smithson. Miscell. Coll.*, No. 252, 1872, pp. 97, 124.—Dall, *Bull. Mus. Comp. Zool.*, Vol. 12, No. 6, 1886, p. 299.

Type (by monotypy): *Plectodon scaber* Carpenter.

Dall (1886) described the differences between *Plectodon* and *Leiomya* as follows: "It differs in the insertion of the cartilage behind and under the beaks, instead of on the hinge-margin or in a fossette; in having, rather than a true tooth upon the margin, a tooth-like prominence formed by the spiral twisting under the beaks of the hinge-margin itself, upon and over which, in *P. scaber*, there is a minute external ligament; lastly in *Plectodon* there is a granulated surface much as in *Poromya*."

Dall regarded *Plectodon* as "a mere section of *Leiomya*." We have not seen specimens of *Leiomya adunca*, the type of *Leiomya*, for comparison with *L. scabra*, but the differences in the hinge and exterior ornamentation described for the two has led us, at least for the present, to retain *Plectodon* as a subgenus of *Leiomya*.

Leiomya (Plectodon) scabra Carpenter.

Plectodon scaber Carpenter, *Rept. Brit. Assoc. Adv. Sci.* for 1863 (issued August, 1864), pp. 611, 638. "Cat. Is.; 2 similar valves, 40-60 fm." Reprint in *Smithson. Miscell. Coll.*, No. 252, 1872, pp. 97, 124.—Carpenter, *Proc. Calif. Acad. Sci.*, Vol. 3, 1865, p. 207. Hab. Catalina Island, California, in 40-60 fathoms.

Leiomya scabra Carpenter, I. S. Oldroyd, *Stanford Univ. Publ. Univ. Ser. Geol. Sci.*, Vol. 1, 1924, p. 103, pl. 54, fig. 10 [not fig. 4 as cited]. "Type locality, Catalina Island in 40-60 fathoms." Range, Puget Sound to San Diego, California.

¹⁷ *Cuspidaria (Cardiomya) californica* Dall, *Bull. Mus. Comp. Zool.*, Vol. 12, No. 6, September, 1886, p. 296 (footnote). "Habitat, Catalina Island, California, dredged in 16 fms., mud; Dall, and previously Cooper, who founded it, following Carpenter, with *pectinata*."

Type Locality: Catalina Island, California, in 40-60 fathoms.

Range: Catalina Island, California, to Santa Inez Bay, east coast of Lower California.

Collecting Stations: Mexico: East of Cedros Island (126-D-10, 12), 45-60 fathoms, crushed shell, eel grass, mud; Cape San Lucas; Arena Bank (136-D-22), 45 fathoms, mud; Santa Inez Bay (147-D-2), 60 fathoms, mud, crushed shell.

Description: Shell elongate, rostrate, covered by fine pustules giving the effect of a granular surface; color dingy white, umbonal area pink. Length about 24 mm.

Leiomya (Plectodon) granulata Dall¹⁸ described from the Caribbean is a similar species. "*Cuspidaria (Plectodon) cf. granulata* Dall" has been cited by Gardner from the Shoal River formation, lower Miocene of Florida.

Distribution: The records of the occurrence of *Leiomya (Plectodon) scabra* in Mexican waters is an extension south of the known range of the species.

FAMILY VERTICORDIIDAE.

Genus *Verticordia* S. Wood.

Subgenus *Trigonulina* d'Orbigny.

Verticordia (Trigonulina) ornata d'Orbigny.

Plate 1, Figure 7.

Trigonulina ornata d'Orbigny, in Sagra, Hist. Phys. Polit. et Nat. Cuba, Moll., Vol. 2, 1846, p. 292, pl. 27, figs. 30-33. "Nous l'avons découverte dans le sable de la Jamaïque."—Chenu, Man. de Conchyl., Vol. 2, 1862, p. 169, fig. 843.

Verticordia ornata d'Orbigny, H. & A. Adams, Gen. Rec. Shells, Vol. 2, 1858, p. 532, pl. 124, figs. 2, 2a.—I. S. Oldroyd, *Stanford Univ. Publ. Univ. Ser. Geol. Sci.*, Vol. 1, 1924, p. 103, pl. 54, figs. 15, 16, 17, 18. San Pedro, California. Range, Catalina Island, California, to Panama Bay. Also Japan and the Antilles.

Type Locality: Jamaica, in sand.

Range: Monterey Bay, California, to Panama. Also eastern America from Rhode Island to Jamaica and Barbados, Bermuda, and St. Helena.

Collecting Stations: Mexico: Manzanillo (184-D-2), 30 fathoms, gravelly sand; Costa Rica: Port Parker (203-D-3), 12 fathoms, shelly mud.

Description: Shell small, nacreous, with about 8 or 9 prominent radial ribs on the anterior two-thirds of the shell. The average length is about 4 mm.

Distribution: This species occurs on both the Pacific and Atlantic coasts of America.

¹⁸ *Leiomya (Plectodon) granulata* Dall, *Bull. Mus. Comp. Zool.*, Vol. 9, 1881, p. 111.—Dall, *Bull. Mus. Comp. Zool.*, Vol. 12, No. 6, 1886, p. 300, pl. 3, fig. 8. Off Sombrero, in 54 and 72 fathoms; off Barbados, in 76 and 100 fathoms; off Dominica, in 118 fathoms.

It is known from Monterey Bay, California, to Panama on the Pacific coast. It also has been reported from the Pleistocene of California.

Order Teleodesmacea.

Superfamily Astartacea.

FAMILY CRASSATELLITIDAE.

Key to the genera and subgenera of the Crassatellitidae.

- A. Shell large (over 10 mm. in height); thick
 a. Margin crenulated. *Crassatellites* s.s.¹⁹
 aa. Margin smooth *Hybolophus*
 B. Shell small (less than 10 mm. in height); thin *Crassinella*

Genus *Crassatellites* Krüger.

Subgenus *Hybolophus* Stewart.

Key to the species of *Hybolophus*.

- A. Posterior end of shell pointed..... *gibbosa*
 B. Posterior end of shell truncated.... *digueti*

Crassatellites (Hybolophus) digueti Lamy.

Crassatella undulata Sowerby, *Proc. Zool. Soc. London*, June 5, 1832, p. 56. "Hab. ad Puerto Portrero, Americae Centralis." "Dredged from sandy mud in eleven fathoms water."—Reeve, *Conch. Icon.*, Vol. 1, *Crassatella*, 1843, species 2, pl. 1, figs. 2a, 2b. Original locality cited.

Not *Crassatella undulata* Lamarck, *Ann. Mus. Hist. Nat.* (Paris), Vol. 6, 1805, p. 408. Not *Crassatella undulata* Say, *Jour. Acad. Nat. Sci. Philadelphia*, Vol. 4, 1842, p. 142, pl. 11, fig. 2(a, b).

Crassatella digueti Lamy, *Journ. de Conchyl.*, Vol. 62, No. 4, February 15, 1917, p. 217. "Ile Ceralbo," Gulf of California. New name for *Crassatella undulata* Sowerby, not *Crassatella undulata* Lamarck.

Crassatellites laronus E. K. Jordan, *Nautilus*, Vol. 46, No. 1, July, 1932, p. 9. "Near salt works at San José Island, Gulf of California."—E. K. Jordan, *Contrib. Dept. Geol. Stanford Univ.*, Vol. 1, No. 4, 1936, p. 124, pl. 17, figs. 6, 7. Type locality cited. Also Angeles Bay, Lower California; Gulf of California and Central America. Also Magdalena Bay, Lower California, Pleistocene.

Type Locality: Puerto Potrero, Costa Rica, in 11 fathoms, sandy mud.

Range: Gulf of California to Gorgona Island, Colombia.

Collecting Stations: Mexico: Arena Bank (136-D-30), 35 fathoms, sand, weed; Port Guatulco (195-D-9), 7 fathoms, green sand, crushed shell; Costa Rica: Port Parker (203-D-3), 12 fathoms, shelly mud.

Description: The shell of *Crassatellites digueti* may be easily separated from that of *C. gibbosa*, the only other species of the

¹⁹ Not represented in the present collection.

genus living in west American waters, by the less rostrate form and by the truncated posterior end. A large specimen from the Gulf of California in the collections of the California Academy of Sciences measures 92 mm. in length.

Distribution: Shells of *Crassatellites digueti* were dredged at depths of 7, 12 and 35 fathoms. The species is known to occur from the Gulf of California to Colombia. It also occurs in the Pleistocene of Magdalena Bay, Lower California.

***Crassatellites (Hybolophus) gibbosus* Sowerby.**

Crassatella gibbosa Sowerby, *Proc. Zool. Soc. London*, June 5, 1832, p. 56. "Hab. ad oras Americae Meridionalis. (St. Elena and Xipixapi)." "Dredged from sandy mud in eleven fathoms water."—Reeve, *Conch. Icon.*, Vol. 1, *Crassatella*, 1843, species 1, pl. 1, figs. 1a, 1b. Original locality cited.

Crassatellites rudis Li, *Bull. Geol. Soc. China*, Vol. 9, No. 3, 1930 [received at library of California Academy of Sciences May 2, 1931], p. 257, pl. 3, fig. 16. Dredged in Panama Bay. "Horizon: Gatun formation." [= *Crassatellites gibbosus* Sowerby. See Pilsbry, *Proc. Acad. Nat. Sci. Philadelphia*, Vol. 83, 1931, p. 429, pl. 41, figs. 9, 10.]

Type Locality: Santa Elena and Xipixapi, Ecuador, in 11 fathoms, sandy mud.

Range: Gulf of California to Paita, Peru.

Collecting Stations: Mexico: Arena Bank (136-D-30), 35 fathoms, sand, weed; Santa Inez Bay (143-D-1, 3), 29-35 fathoms, mud, crushed shell, weeds; Gorda Banks (150-D-23), 45 fathoms, sand, calcareous algae; Chamela Bay (182-D-2), 12 fathoms, sand, algae; Tangola-Tangola Bay (196-D-17), 23 fathoms, mud; El Salvador: La Libertad (198-D-1, 2), 13-14 fathoms, mud; Costa Rica: Port Parker (203-D-3), 12 fathoms, shelly mud; 14 mi. S. × E. of Judas Point (214-D-1, 4), 42-61 fathoms, mud, rocks.

Description: Shell elongately trigonal, the posterior end rostrate and pointed; early part of shell flattened and ornamented by concentric wrinkles. The posterior end of the shell of this species is narrower and more pointed than that of *C. digueti*. Specimens dredged off western Mexico measure 51 mm. in length.

Distribution: *Crassatellites gibbosus* was dredged at several localities from depths of 12 to 61 fathoms, mostly on sandy or shelly mud bottoms. It is known to occur from the Gulf of California to Peru and is also known to occur in the Pliocene of Costa Rica, and in the Pleistocene of Panama and Magdalena Bay, Lower California.

Genus *Crassinella* Guppy.

Key to the species of *Crassinella*.

A. Shell with usually 8-12 concentric ribs

- a. Anterior dorsal margin strongly concave *pacifica*
- aa. Anterior dorsal margin weakly concave *mexicana*

B. Shell with usually more than 12 concentric ribs which are finer and closer; shell smaller *varians*

***Crassinella pacifica* C. B. Adams.**

Gouldia pacifica C. B. Adams, *Ann. Lyceum Nat. Hist. New York*, Vol. 5, July, 1852, pp. 499, 545, (separate pp. 275, 321). "Panama."—H. & A. Adams, *Gen. Rec. Shells*, Vol. 2, 1858, p. 484, pl. 115, figs. 7a, 7b.

Type Locality: Panama.

Range: Gulf of California to Panama.

Collecting Stations: Mexico: Port Guatulco (195-D-9), 7 fathoms, gr. sand, crushed shell; El Salvador: Meanguera Island, Gulf of Fonseca (199-D-1), 16 fathoms, sand, mud, crushed shell; Nicaragua: Corinto, beach drift; Costa Rica: Port Parker (203-D-1, 3), 12-15 fathoms, sandy mud, shelly mud, crushed shell.

Description: Shell subtriangular, but with the ventral margin well excurved: the color varying in different specimens from dingy white to pale brown, often tinged with red about the beaks, with some narrow rays of brown, and rarely with short irregular lines of brown; with eight to twelve stout subequal concentric ridges; sometimes radially striated; beaks very acute and closely approximate; posterior area moderately depressed; lunule defined by a well impressed line, rising at the margin of the valves; margin of the interior not crenulate. It is closely allied to *G. parva* Ad. Length, .22 inch; height, .19 inch; breadth, .09 inch (C. B. Adams).

The type specimens of *Crassinella pacifica* have never been illustrated. H. & A. Adams give figures of the species but whether the specimen represented was from the type lot is not known. Specimens from the Gulf of California to Panama seem to agree with Adams' description. They also bear out Carpenter's conclusion that the West Indian *C. guadalupensis* d'Orbigny,²⁰ which species according to Lamy is identical with *C. parva* C. B. Adams (1845), is "the exact analogue of *Gouldia pacifica*." He also added that *C. martinicensis* d'Orbigny is intermediate between *C. pacifica* and *C. varians*.

The specific name *pacifica* is the earliest name available for specimens of the genus *Crassinella* found at Panama and it appears applicable to shells north to the Gulf of California. When a large series is examined it is apparent that there is so much variation in the size, shape, and amount of ribbing,

²⁰ *Crassatella guadalupensis* d'Orbigny, in Sagra, *Hist. Cuba, Moll.*, Vol. 2, 1845, p. 289, Atlas, pl. 27, figs. 24, 25, 26.

that we are inclined to question whether more than one species, or at most one species and a subspecies, occurs in this region.

Distribution: Specimens of *Crassinella pacifica* were collected on the beach and dredged abundantly at depths of 7 to 16 fathoms, from Port Guatulco, Mexico, to Port Parker, Costa Rica. This species has also been reported as occurring in the Pliocene of Ecuador.

***Crassinella pacifica mexicana* Pilsbry & Lowe.**

Crassinella mexicana Pilsbry & Lowe, *Proc. Acad. Nat. Sci. Philadelphia*, Vol. 84, May 21, 1932, p. 103, pl. 14, figs. 8, 9. "Mexico: Guaymas, in about 20 fathoms (Lowe)."

Type Locality: Guaymas, Mexico, in about 20 fathoms.

Range: Cedros Island to the Gulf of California.

Collecting Station: Mexico: East of Cedros Island, Lower California (126-D-12), 45 fathoms, crushed shell and mud.

Description: According to Pilsbry & Lowe *Crassinella mexicana* is very similar to *C. pacifica* C. B. Adams but "it differs chiefly by being relatively high and short, the posterior and anterior dorsal margins meeting in a smaller angle." Externally there are about 12 concentric ribs. The measurements given for the type were: length, 3.4 mm.; height, 3.3 mm.; diameter, 1.8 mm.

There appears to be but few if any constant characters by which this form differs from the variable *C. pacifica*. The large size and less concave anterior dorsal margin may be distinguishing characters but it is not at all certain that these can be relied upon to separate the form *mexicana* as a distinct species or subspecies.

Specimens dredged by the expedition east of Cedros Island resemble so closely the illustrations of *Crassinella mexicana* given by Pilsbry & Lowe that we have assigned the shells to that form which we consider to be a subspecies of *C. pacifica*, at least until more is known regarding the relationship between it and the type specimens of *C. pacifica*.

Distribution: The discovery of the presence of this form off Cedros Island in 45 fathoms is an extension north of the known range.

***Crassinella varians* Carpenter.**

Gouldia varians Carpenter, *Cat. Mazatlan Shells*, October, 1855, p. 83. "Mazatlan." See also pp. 86 (footnote), 549.

Crassatella pacifica C. B. Adams, var. *varians* Carpenter, Lamy, *Journ. de Conchyl.*, Vol. 62, No. 4, 1917, p. 248. Bay of La Paz, Lower California, and Panama.

Type Locality: Mazatlan, Mexico.

Range: Gulf of California to Panama.

Collecting Stations: Mexico: Santa Inez Bay, Gulf of California (145-D-1, 3), 4-13 fathoms, sand; Nicaragua: Corinto (200-D-19), 12-13 fathoms, mangrove leaves.

Description: "It has the general size and appearance of *Astarte triangularis*." "It has concentric ribs either near the umbo, all over the shell, or not at all." "Even in its most ribbed form, it differs from *G. pacifica* in being very much smaller, not so flat, with umbos more spirally projecting, and with the anterior dorsal margin less concave, as well as in having the ribs smaller, and closer." (Carpenter).

As indicated by the specific name *varians* and by Carpenter's discussion, this is a very variable form. Specimens from the Gulf of California and south to Panama show great variation and certain ones could be picked out which could be assigned to *C. varians*, *C. pacifica* or *C. pacifica mexicana*. In the absence of any illustration of Carpenter's type and in view of the known variation of specimens of *Crassinella* from Mazatlan, the type locality of *C. varians*, and from Panama, the type locality of *C. pacifica*, the present authors question whether two distinct species exist in that region.

Apparently the chief characters which Carpenter relied upon to separate *C. varians* from *C. pacifica* were: the smaller size, more numerous and more closely spaced ribs and less concave anterior dorsal margin. Some specimens from Santa Inez Bay in the Gulf of California and others from Corinto, Nicaragua, seem to answer that description and have been referred to *C. varians*. They bear some resemblance to *C. goldbaumi* E. K. Jordan²¹ from the Pleistocene of Magdalena Bay, Lower California, but we are inclined to refer them to Carpenter's species. *Crassinella haylocki* Pilsbry & Olsson²² from the Pliocene of Ecuador appears to be a similar form, as does *Crassinella quintinensis* Manger²³ from the Pleistocene of San Quintin Bay, Lower California.

Distribution: The distribution of this species appears to be the same as that of *Crassinella pacifica*; that is, the Gulf of California to Panama.

Superfamily Carditacea.

FAMILY CARDITIDAE.

Genus *Cardita* Bruguière.

Key to the species of *Cardita*.

²¹ *Crassinella goldbaumi* E. K. Jordan, *Contrib. Dept. Geol. Stanford Univ.*, Vol. 1, No. 4, November 13, 1936, p. 126, pl. 18, figs. 4, 5. Magdalena Bay, Lower California, Pleistocene.

²² *Crassinella haylocki* Pilsbry & Olsson, *Proc. Acad. Nat. Sci. Philadelphia*, Vol. 93, September 9, 1941, p. 57, pl. 18, figs. 7, 8. "Canoa formation, Punta Blanca." Ecuador, Pliocene.

²³ *Crassinella quintinensis* Manger, *Johns Hopkins Studies in Geol.*, No. 11, 1934, p. 298, pl. 21, figs. 1, 2. "San Quintin Bay, Lower California." Pleistocene.

- A. Shell high, quadrate or trigonal; hinge without distinct anterior lateral tooth..... (genus) *Cardita*
- a. Shell roundly trigonal in outline
- b. Shell large, very thick, ribs broad and rounded.... *megastropha*
- bb. Shell small (15-20 mm. long), ribs narrow and bearing a row of pustules..... *spurca*
- aa. Shell subquadrate in outline
- c. Posterior end broadly rounded *grayi*
- cc. Posterior end obliquely truncated
- d. Dorsal area offset: interspaces between ribs narrow *cuvieri*
- dd. Dorsal area not offset; dorsal slope steep; interspaces two-thirds to three-fourths as wide as the ribs *tricolor*
- B. Shell laterally elongated; hinge with a distinct anterior lateral tooth (subgenus) *Carditamera*
- a. Posterior ventral and dorsal margins nearly parallel; spines on early portion of posterior ribs *affinis*
- aa. Posterior ventral and dorsal margins not parallel; spines only on rib next to posterior dorsal margin *radiata*

***Cardita cuvieri* Broderip.**

Venericardia crassicostata Sowerby, Cat. Shells Tankerville, Ap., 1825, p. IV. [No locality cited].—Hanley, Cat. Rec. Bivalve Shells, 1856, p. 129, pl. 17, fig. 56.

Not *Cardita crassicostata* Lamarck, 1819.

Cardita cuvieri Broderip, *Proc. Zool. Soc. London*, June 5, 1832, p. 55. "Hab. in Sinu Fonseca, Americae Centralis." "Dredged from sandy mud in eleven fathoms water, about seven miles from the shore."—Reeve, *Conch. Icon.*, Vol. 1, *Cardita*, 1843, species 24, pl. 5, fig. 24. Original locality cited. Also "Acapulco."

Cardita varia Broderip, Reeve, *Conch. Icon.*, Vol. 1, *Cardita*, 1843, pl. 5, fig. 25b [not 25a].

Cardita michelini Valenciennes, *Voy. Venus*, Zool., 1846, pl. 22, fig. 5 [two figs.]. [No locality cited.]

Type Locality: Gulf of Fonseca, Central America, in 11 fathoms, sandy mud.

Range: Gulf of California to Zorritos, Peru.

Collecting Stations: Mexico: Cerralbo Island, Gulf of California; Port Angeles; Port Guatulco; Colombia: Gorgona Island.

Description: Shell large (attaining a length of 66 mm.), subquadrate in outline,

thick, dorsal area strongly set off from remainder of valve; ornamented by about 14 broad, square, nodulous ribs which are separated by very narrow channelled interspaces; about a half dozen smaller ribs occur on the dorsal area; color reddish or orange brown.

The subquadrate shape and square ribs easily serve to separate this species from *C. megastropha* which possesses a rounded trigonal shell with rounded ribs. The closer set ribs and offset dorsal area are characters which assist in separating *Cardita cuvieri* from *C. tricolor*. *Venericardia hadra* Dall, the type of *Glyptactis* Stewart, and *Venericardia himerta* Dall, described from the lower Miocene of Florida, are somewhat similar to *C. cuvieri*. *Cardita umbonata* Sowerby, described from Sierra Leone, West Africa, is said to be similar in form to *C. cuvieri*.

Distribution: Specimens of *Cardita cuvieri* in the present collection were collected on the beaches in the Gulf of California, along the mainland of western Mexico, and at Gorgona Island, Colombia. The species is known to occur from the Gulf of California to Peru. It also is known to occur in the Pleistocene of Oaxaca, Mexico, and Ecuador.

***Cardita grayi* Dall.**

Cardita crassa G. B. Sowerby I, *Zool. Beechey's Voy.*, 1839, p. 152, pl. 42, fig. 4 [two figures]. "Inhab. Found at Acapulco."—Reeve, *Conch. Icon.*, Vol. 1, *Cardita*, 1843, species 34, pl. 7, fig. 34. Original locality cited.

Not *Cardita crassa* Lamarck, 1819.

Cardita grayi Dall, *Proc. Acad. Nat. Sci. Philadelphia*, Vol. 54, January 20, 1903, p. 706. "Cape St. Lucas, the Gulf of California and south to Panama and the Galapagos Islands." New name for *Cardita crassa* Gray," not *C. crassa* Lamarck.

Type Locality: Acapulco, Mexico.

Range: Gulf of California to Guayaquil, Ecuador, and the Galapagos Islands.

Collecting Stations: Mexico: Chamela Bay, beach; Port Guatulco, beach; Tangola-Tangola Bay, beach.

Description: Shell trapezoidal, inflated, posterior dorsal margin broadly rounded; a broad shallow depression occurs from the beak to the base slightly anterior to the center; ornamented by 15 or 16 fairly broad rounded ribs which are separated by much narrower interspaces. A large specimen measures 33 mm. in length and 28 mm. in height.

The rounded posterior portion of the shell, rounded ribs, broad sulcus and less strongly developed central cardinal tooth, easily separate *Cardita grayi* from *C. tricolor* Sowerby.

A. M. Keen has pointed out that in so far as the hinge is concerned this species might well be referred to the genus *Beguina* Bolten (see Min. Conch. Club South. Calif., No. 39, September, 1944, p. 12).

Distribution: A few specimens of this species were collected on the beaches of Mexico. It ranges south to Ecuador.

***Cardita megastrophia* Gray.**

Venericardia megastrophia Gray, *Ann. Phil., New Ser.*, Vol. 25, February, 1825, p. 137, two figs. p. 138. [Not the locality "New Holland?"]—Lamy, *Journ. de Conchyl.*, Vol. 66, No. 4, 1922, p. 294, two text figs. p. 296. Lower California; Acapulco, Mexico.

Venericardia flammea Michelin, *Mag. de Zool.*, Vol. 1, 1831, Moll., pl. 6. [Locality unknown].

Cardita tumida Broderip, *Proc. Zool. Soc. London*, June 5, 1832, p. 56. "Hab. ad Americae Centralis et Meridionalis oras." "Found in a young state at Puerto Portrero, at a depth of eleven fathoms, in fine sand and gravel; and in a full-grown state at the Isle of Plata, in coral sand, at the depth of seventeen fathoms."—Reeve, *Conch. Icon.*, Vol. 1, *Cardita*, 1843, species 26, pl. 5, fig. 26. Original locality cited.

Cardita varia Broderip, *Proc. Zool. Soc. London*, June 5, 1832, p. 56. "Hab. ad insulas Gallapagos." "Dredged in fine sand at the depth of six fathoms."—Reeve, *Conch. Icon.*, Vol. 1, *Cardita*, 1843, species 25, pl. 5, fig. 25a [not 25b]. Original locality cited.

Type Locality: La Plata Island, Ecuador, in 17 fathoms, coral sand (here designated as type locality). ["New Holland?" originally cited].

Range: Gulf of California to La Plata Island, Ecuador, and the Galápagos Islands.

Collecting Stations: Mexico: Arena Bank (136-D-30), 35 fathoms, sand, weed; Ceralbo channel, Gulf of California (137-D-3), 46 fathoms, rock; Ceralbo Island, beach; 3 mi. off Pyramid Rock, Clarion Island (163-D-2), 55 fathoms, rock, coral; Port Guatulco (195-D-9), 7 fathoms, gr. sand, crushed shell; Santa Cruz Bay, Costa Rica: Port Parker, beach; Colombia: Gorgona Island, beach.

Description: Shell roundly trigonal with prominent curved beaks, ornamented by about 12 broad, rounded, often somewhat nodulous ribs, and additional finer ones which occur along the gently offset dorsal area; the ribs nearly merge one into the other at their bases but often they are separated by a shallow incised line; color usually brownish-red flecked with white or yellowish spots. A large specimen from Gorgona Island, Colombia, measures 54 mm. in altitude.

The shell of *Cardita megastrophia* is easily separated from that of *C. cuvieri* by the more trigonal form, more projecting beaks, and broad rounded ribs. *Venericardia terryi* Olsson from the Miocene of Costa Rica and *V. terryi brassica* Maury from the Miocene of Trinidad are similar forms.

Distribution: Specimens of *Cardita megastrophia* in the present collection were dredged from depths of 7 to 55 fathoms, and empty shells were found on beaches. The species is known to occur from the Gulf of California to Ecuador and the Galápagos Islands. It is also known to occur in the Pliocene and Pleistocene of Lower California.

***Cardita spurca* Sowerby.**

Cardita spurca Sowerby, *Proc. Zool. Soc. London*, for 1832 (issued March 13, 1833), p. 195. "Hab. ad oras Peruviae." "Dredged among coarse sand and gravel, in from six to ten fathoms, at Iquiqui, in Peru."—Reeve, *Conch. Icon.*, Vol. 1, *Cardita*, 1843, species 32, pl. 7, fig. 32. Original locality cited.

Type Locality: Iquique, Chile, in 6 to 10 fathoms, sand and gravel.

Range: Mazatlan, Mexico, to Chile and Straits of Magellan.

Collecting Station: Mexico: Manzanillo (184-D-2), 30 fathoms, gravelly sand.

Description: Shell small, ovately oblong, anterior margin rounded, posterior dorsal area subangulated; ornamented by about 18 nodulous, radiating ribs; shell white or with brown spots, covered by an olivaceous periostracum; interiorly the dorsal area just beneath the beaks is often colored pink.

The specimens in the present collection agree so perfectly with the descriptions and illustrations of *Cardita spurca* that we have assigned them to that species. One of the largest specimens measures approximately 18 mm. in length and 16 mm. in height.

Cardita velutina E. A. Smith from Chile and the Strait of Magellan is a somewhat similar species.

Distribution: *Cardita spurca* is here recorded for the first time from west Mexican waters. It has previously been reported from Peru, Chile, and south to the Straits of Magellan. If our specimens are really *C. spurca* it has a long range. We have not seen specimens of the species from Chile and hence some doubt exists as to the identity of the present specimens from off Mexico.

***Cardita tricolor* Sowerby.**

Cardita tricolor Sowerby, *Proc. Zool. Soc. London*, for 1832 (issued March 13, 1833), p. 194. "Hab. Americâ Centrali." "Found among sand and mud, at a depth of ten fathoms, in the Bay of Guayaquil."—Lamy, *Journ. de Conchyl.*, Vol. 66, No. 3, 1922, p.

248. [Lower] California; Guaymas; Acapulco; Panama.

Cardita laticostata Sowerby, *Proc. Zool. Soc. London*, for 1832 (issued March 13, 1833), p. 195. "Hab. Americâ Centrali (Guacomayo)." "Found in sand, at a depth of from six to twelve fathoms, at St. Elena, Panama, and Real Llejós."—Reeve, *Conch. Icon.*, Vol. 1, *Cardita*, 1843, species 36, pl. 7, figs. 36a, 36b, 36c.

Cardita laticostata Sowerby var. B, Reeve, *Conch. Icon.*, Vol. 1, *Cardita*, 1843, species 36, pl. 7, fig. 36d. [Ref. to *Cardita tricolor*]. Original locality records of *C. tricolor* cited.

Cardita arcella Valenciennes, *Voy. Venus*, *Zool.*, Atlas, 1846, pl. 22, fig. 1 (two figures).

Cardita reeveana Clessin, Martini-Chemnitz *Conchyl.-Cab.*, Bd. 10, Abt. 1, *Carditacea*, 1888, p. 37, pl. 13, figs. 1 and 2 [not pl. 15, figs. 6 and 7].

Type Locality: Bay of Guayaquil, Ecuador, in 10 fathoms, sand and mud.

Range: Gulf of California, to Paita, Peru, and the Galápagos Islands.

Collecting Stations: Mexico: Port Guatulco (195-D-15), 1.5 fathoms, coral; Santa Cruz Bay, beach; Guatemala: 7 miles west of Champerico (197-D-1, 2), 14 fathoms, mud; Nicaragua: Potosi and Monypenny Point, beach; Costa Rica: Port Parker, beach; Piedra Blanca Bay (200-D-1, 10), 2-6 fathoms, rocks, sand, algae; Panama: Isla Parida, beach; Bahía Honda, beach.

Description: Shell fairly large, thick, subquadrate, ornamented by about 22 or 23 high, square ribs, of these 5 or 6 on the steeply sloping posterior margin are much smaller; ribs crossed by strong raised lines; periostracum black or brownish colored with raised concentric lines, sometimes with bands of bluish-white. The color varies, the anterior and posterior portions or in some cases concentric bands may be orange colored. A large specimen in the collection from Port Parker, Costa Rica, measures approximately 60 mm. in length and 52 mm. in height.

A study of a series of specimens reveals that there are no constant characters which can be relied upon to separate *Cardita tricolor* from *C. laticostata*. The specific name *tricolor* has page priority over that of *laticostata* and for that reason we have accepted Lamy's choice of that name for the species.

Large shells of *Cardita tricolor* are somewhat similar to those of *C. cuvieri* but can be easily separated from that species by the narrower ribs, wider interspaces, flatter umbos, and by the steeply sloping posterior area. Heilprin compared *Cardita serricosta* from the Tampa Silex beds of Florida with *C. laticostata*. *Cardita tricolor* bears some resemblance to *C. floridana* Conrad of the Caribbean region, but the posterior area

of the west American form slopes more steeply and it lacks the strong lateral teeth of the Floridan species. Other than the cardinals, the hinge of *C. tricolor* has only what Dall referred to as a lunular pustule.

Distribution: Specimens of *Cardita tricolor* in the present collection were found on beaches and dredged at depths of 1.5 to 14 fathoms. The species is known to occur from the Gulf of California to Peru. It also has been recorded as occurring in the Pliocene of Costa Rica and in the Pleistocene of the Tres Marias Islands.

Subgenus *Carditamera* Conrad.

Cardita (Carditamera) affinis Sowerby.

Cardita affinis Sowerby, *Proc. Zool. Soc. London*, for 1832 (issued March 13, 1833), p. 195. "Hab. in Americâ Meridionali." "Dredged from sandy mud, at a depth of from six to twelve fathoms, in the Bay of Montejo and Gulf of Nocoia."—Reeve, *Conch. Icon.*, Vol. 1, *Cardita*, 1843, species 6, pl. 1, fig. 6. [No locality cited].

Type Locality: Bay of Montijo, Panama, in 6 to 12 fathoms, sandy mud, (here selected as type locality). Gulf of Nicoya, Costa Rica, also cited originally.

Range: Pequeña Bay, Lower California, to the Gulf of California and south to Santa Elena, Ecuador.

Collecting Stations: Mexico: Santa Inez Bay, east coast of Lower California; Cape San Lucas, Lower California; Chamela Bay; Port Guatulco (195-D-9), 7 fathoms, gr. sand, crushed shell; Guatemala: 7 mi. W. of Champerico (197-D-2), 14 fathoms, mud; El Salvador: La Union, Gulf of Fonseca (199-D-22), 3 fathoms, mud, mangrove leaves; Nicaragua: Potosi and Monypenny Point, beach; Corinto (200-D-2), 5.3 fathoms, mangrove leaves; San Juan del Sur, beach; Costa Rica: Port Parker (203-D-1), 15 fathoms, sandy mud, crushed shell; Port Culebra, beach; Culebra Bay, beach; Piedra Blanca, beach; Golfito, Gulf of Dulce, beach.

Description: Shell elongately rectangular in shape, anterior end projecting and rounded, basal margin and posterior dorsal margin nearly parallel, posterior end rounded or obliquely truncated, posterior umbonal area angulated or rounded; ornamented by about 15 ribs, the anterior ones flattened and lacking scales and in some cases more crowded, while those on the posterior portion of the valves are convex, squamose on young specimens but later become smooth or bear a varying number of scattered scales. The shell is colored brownish-white anteriorly and olive brown posteriorly; interiorly the posterior dorsal area is brown as is the anterior dorsal margin; the remainder is white. Length often less than 50 mm.

The smaller size, more scaly and spinose character of the posterior ribs and often

more contracted anterior end, seem to be about the only differences between *Cardita affinis* and its subspecies *californica*.²⁴ The subspecies attains a much larger size (a large specimen from the Gulf of California measures 82 mm. in length), the anterior end is broader with the ribs less crowded, and the posterior ribs almost or entirely lack spines, but in a large series there appears to be complete gradation between this form and *C. affinis*. The subspecies *C. affinis californica* is restricted to a more northern range and is particularly abundant in the Gulf of California. This appears to be the form illustrated by Reeve²⁵ as *Cardita pectunculus*.

Cardita gracilis Shuttleworth of the Caribbean region is similar to *C. affinis*.

Distribution: *Cardita affinis* was collected at many localities from the Gulf of California to Costa Rica, on beaches and dredged at depths of 3 to 15 fathoms. It is also known to occur in the Pleistocene of San Ignacio Lagoon and Magdalena Bay, Lower California, and of Oaxaca, Mexico.

Cardita (Carditamera) radiata Sowerby.

Cardita radiata Sowerby, *Proc. Zool. Soc. London*, for 1832 (issued March 13, 1833), p. 195. "Hab. ad Salango, Columbiae Occidentalis, et ad Panamam." "Found in muddy sand at from six to twelve fathoms."—Reeve, *Conch. Icon.*, Vol. 1, *Cardita*, 1843, species 5, pl. 1, fig. 5a [not fig. 5b]. Original locality cited.

Lazaria radiata Sowerby, H. & A. Adams, *Gen. Rec. Shells*, Vol. 2, 1858, p. 489, pl. 116, figs. 4, 4a.

Lazaria observa Mörch, *Malakozool. Blätter*, Bd. 7, 1861, p. 199. (Proposed for Reeve's pl. 1, fig. 5a). "Puntarenas." Costa Rica.

Type Locality: Salango, Ecuador, in 6 to 12 fathoms, sandy mud (here selected as type locality). Panama also cited originally.

Range: San Juanico, Lower California (Stearns); Petatlan Bay, Mexico, to Negritos, Peru.

Collecting Stations: Nicaragua: Potosi and Monypenny Point, beach; Corinto (200-D-10, 16, 19), 4-13 fathoms, mangrove leaves; Costa Rica: Port Parker (203-D-3), 12 fathoms, shelly mud.

Description: The shell of *Cardita radiata* is somewhat similar to that of *C. affinis* but the ribs numbering about 17 are but little reduced anteriorly and scales occur only on the rib just below the posterior dorsal mar-

gin. The posterior end of *C. radiata* is more elongated, becomes gradually narrower and is usually somewhat pointed, and the two ribs at the posterior ventral margin are often projecting somewhat farther than the others. The color pattern of *C. radiata* is more spotted in effect, the ground color is yellowish-brown and on this are dark spots or narrow bands. The hinge of *C. radiata* is weaker and the left anterior cardinal tooth slopes much less steeply anteriorly than does that of *C. affinis*.

Distribution: Specimens of *Cardita radiata* in the present collection were found on beaches and dredged at depths of 4-13 fathoms, but not as abundantly as *C. affinis*.

Superfamily Chamacea.

FAMILY CHAMIDAE.

Key to the genera of the Chamidae.

- A. Nearly equivalve; with lunule; regular radial rows of long spines....*Echinochama*
- B. Usually not equivalve; without lunule; concentric scaly laminae or spines
 - a. Beaks turned to the right.....*Chama*
 - aa. Beaks turned to the left *Pseudochama*

Genus *Chama* Linnaeus.

Key to the species of *Chama*.

- A. Interior of adult shell entirely white
 - a. Shell with concentric lamellae or dense spines
 - b. Shell large; concentric scaly lamellae; exterior white and rose*pellucida*
 - bb. Shell small, rounded; dense short white spines...*squamuligera*
 - aa. Shell with irregularly scattered spines; color pink.....*sordida*
- B. Interior of adult shell dark red, purple or partly white
 - a. Hinge bright coral red.....*echinata*
 - aa. Hinge white; exterior with radially striated, expanded, frondose lamellae*frondosa*

Chama echinata Broderip.

Chama echinata Broderip, *Proc. Zool. Soc. London*, for 1834 (issued April 3, 1835), p. 150. "Hab. in Americâ Centrali. (Puerto Portrero)." "Found at low water attached to rocks."—Broderip, *Trans. Zool. Soc. London*, Vol. 1, 1835, p. 305, pl. 39, figs. 5-7.—Reeve, *Conch. Icon.*, Vol. 4, *Chama*, 1847, species 35, pl. 7, fig. 35. Original locality cited.

Chama coralloides Reeve, *Conch. Icon.*, Vol. 4, *Chama*, December, 1846, species 18, pl. 4, fig. 18. "Hab. Porto Portrero, Central America (found attached to rocks at low water); Cuming."

²⁴ *Cardita californica* Deshayes, *Proc. Zool. Soc. London*, 1852 (issued May 23, 1854), p. 100. "Hab. Gulf of California."

²⁵ *Cardita pectunculus* Reeve, *Conch. Icon.*, Vol. 1, *Cardita*, June, 1843, species 4, pl. 1, fig. 4. [Not the record "Madagascar".]—Mabille, *Bull. Soc. Philomath. Paris*, Ser. 8, Vol. 7, 1895, p. 74. Gulf of California; Lower California; coasts of Central America.

Type Locality: Puerto Potrero, Costa Rica, attached to rocks at low water.

Range: Magdalena Bay, Lower California, and the Gulf of California to Paita, Peru, and the Galápagos Islands.

Collecting Stations: Mexico: Gallito Point at entrance to Concepcion Bay, E. coast of Lower California; Port Guatulco; Nicaragua: Isla Cardon, Corinto.

Description: The purple interior and the bright coral red color of the hinge are characteristic features of the shell of this species.

Distribution: *Chama echinata* is commonly found attached to rocks at low tide along the west Mexican coast. It ranges south to Peru and the Galápagos Islands. It has also been reported from the Pleistocene of Oaxaca, Mexico.

Chama frondosa Broderip.

Chama frondosa Broderip, *Proc. Zool. Soc. London*, for 1834 (issued April 3, 1835), p. 148. "Hab. ad Insulam Platam Columbiae Occidentalis." "Dredged up from a rock of coral, to which it was adhering, at a depth of seventeen fathoms."—Broderip, *Trans. Zool. Soc. London*, Vol. 1, 1835, p. 302, pl. 38, figs. 1, 2.—Reeve, *Conch. Icon.*, Vol. 4, *Chama*, 1846, species 1, pl. 1, fig. 1a. Original locality cited.

Type Locality: Island of La Plata, Ecuador, in 17 fathoms, attached to coral.

Range: Gulf of California to Guayaquil, Ecuador, and the Galápagos Islands.

Collecting Station: Mexico: Santa Inez Bay, Gulf of California (143-D-1), 29 fathoms, mud, crushed shell, weeds.

Description: The shell of *Chama frondosa* is ornamented by striated frondose laminae each of which, when perfect, is shaped like a broad fan-shaped leaf. The exterior is usually of a beautiful saffron color while most of the interior is white with purplish colored finely denticulated margins.

A single specimen in the present collection from Santa Inez Bay in the Gulf of California appears to have grown without attachment of any kind.

The subspecies *Chama frondosa mexicana* Carpenter has shorter, less frondose, more numerous and irregularly distributed lamellae and the exterior is colored purplish-red as is the margin of the interior. It is the form represented on Reeve's plate 1, figure 1b. It occurs commonly along the west coast of Mexico and ranges from Magdalena Bay, Lower California, and the Gulf of California to Panama and the Galápagos Islands. This subspecies attains a large size and is often so covered by marine growths that the original sculpture is not visible.

Distribution: *Chama frondosa* occurs from the Gulf of California to Ecuador but

it appears to be much less commonly found in the northern part of its range. We have not seen specimens from the west coast of Lower California north of Cape San Lucas. It also occurs in the Pliocene of Lower California.

Chama pellucida Sowerby.

Chama pellucida Sowerby, *Proc. Zool. Soc. London*, for 1834 (issued April 3, 1835), p. 149. "Hab. ad Peruviam. (Iquiqui)." "Dredged up attached to stones, *Mytili*, and turbinated shells, at a depth varying from nine to eleven fathoms, from a bottom of coarse sand, and also found under stones at low water mark."—Broderip, *Trans. Zool. Soc. London*, Vol. 1, 1835, p. 302, pl. 38, fig. 3.—Reeve, *Conch. Icon.*, Vol. 4, *Chama*, 1847, species 32, pl. 6, fig. 32. Original locality cited.

Type Locality: Iquique, Chile, in 9 to 11 fathoms, attached to stones and *Mytili*; also under stones at low water mark.

Range: Oregon (Lat. 44° N.), to Mejillones and Cobija, Chile, and Juan Fernandez Island.

Collecting Station: Mexico: Off Cedros Island, Lower California.

Description: Shell translucent, exteriorly white or waxy white rayed with rosy streaks; spines irregular in size; interior white, margin very finely denticulated.

The spines of *Chama pellucida* are not expanded, frondose and striated as are those of *C. frondosa*.

Distribution: *Chama pellucida* was dredged by the expedition off Cedros Island, Lower California. It has been recorded as occurring from Oregon to Chile but we have not seen specimens from south of Cedros Island. It occurs fairly commonly along the coast of southern California. It has also been recorded as occurring from upper Miocene to Recent in California.

Chama sordida Broderip.

Chama sordida Broderip, *Proc. Zool. Soc. London*, for 1834 (issued April 3, 1835), p. 151. "Hab. in America Centrali. (Isle of Cuña)." "Dredged up from a depth of eighteen fathoms, attached to rocks."—Broderip, *Trans. Zool. Soc. London*, Vol. 1, 1835, p. 309, pl. 39, figs. 8 and 9. Original locality cited.—Reeve, *Conch. Icon.*, Vol. 4, *Chama*, 1847, species 23, pl. 5 fig. 23. Original locality cited.

Type Locality: Island of Cuña, Central America, in 18 fathoms, attached to rocks. [We have not noticed any South American island of this name in the atlases which we have consulted. There is, however, an island of "Caño" in the Gulf of Nicoya and another island of the same name in the Gulf of Dulce.]

Range: Carmen Island, Gulf of California, to Gorgona Island, Colombia.

Collecting Station: Mexico: Arena Bank (136-D-13), 45 fathoms, mud, *Arca* conglomerate.

Description: Shell of moderate size, lower valve deeply concave, upper valve gently convex, ornamented by short, sparse, irregularly scattered spines and by fine radial sculpture, color pale coral-red; interior white with finely crenulated margins. The short sharp rugosity in the hinge is finely serrated on some specimens. The original description mentions that the shell of this species varies much according to its age. The present specimen measures approximately 36.5 mm. from beak to base, and the convexity (both valves), 25.5 mm.

Apparently the record of *Chama iostoma* Conrad cited by Tomlin²⁶ from Gorgona Island, Colombia, can be referred to *Chama sordida*. Conrad's species was originally described from Hawaii.

Distribution: The present record is the second of *Chama sordida* from the Gulf of California. It occurs south to Colombia but is not a common species.

Chama squamuligera Pilsbry & Lowe.

Chama spinosa Broderip cited by authors from West American waters.

Not Chama spinosa Broderip, 1835.

Chama squamuligera Pilsbry & Lowe, *Proc. Acad. Nat. Sci. Philadelphia*, Vol. 84, May 21, 1932, p. 103, pl. 14, fig. 10. "Nicaragua: San Juan del Sur," type. Also, Manzanillo, Tres Marias, Cape San Lucas, and Mazatlan, Mexico.

Type Locality: San Juan del Sur, Nicaragua.

Range: San Martin Island, Lower California, to San Juan del Sur, Nicaragua, and the Galápagos Islands.

Collecting Stations: Mexico: Port Guatulco (195-D-9), 7 fathoms, gr. sand, crushed shell; also on beach; Tangola-Tangola Bay.

Description: Shell small, round, both valves moderately arched, the lower more so, attached by nearly one half of the surface of the lower valve; whitish colored; sculpture consisting of dense, small, projecting scales which are more or less united into irregularly concentric frills. Interior white, margin fringed with scales, extremely finely crenulated and on large specimens granulose. Usually not over 20 mm. in altitude but sometimes specimens attain a height of 30 mm. from beak to base.

The shell of *Chama squamuligera* is very similar to that of the species described by Broderip as *Chama spinosa* from Lord

Hood's Island, a species referred by Lamy to *C. asperella* Lamarck. The white interior makes it possible to easily separate *Chama squamuligera* from the young of *C. echinata* in which the interior is brightly colored purple and the hinge red. Young specimens of *Chama pellucida* are more strongly and less densely spinose, often colored some shade of rose, and the margin has not the same granulose character as that of *C. squamuligera*.

Distribution: A few specimens of *Chama squamuligera* in the present collection were dredged in 7 fathoms at Port Guatulco, Mexico, and others were collected on the beach at Tangola-Tangola Bay, Mexico. It occurs south to the Galápagos Islands and has been recorded from the Pleistocene of Maria Magdalena Island, Tres Marias group.

Genus *Pseudochama* Odhner.

Pseudochama saavedrai Hertlein & Strong, sp. nov.

Plate I, Figures 1, 3, 8 and 10.

Shell ovately circular; color light yellowish-brown exteriorly; lower valve gently convex, beaks turned to the left, ornamented by rather appressed lamellae, which develop one strong and one weak row of scales toward the posterior margin; interior white, margin denticulate, one tooth on hinge; upper valve moderately inflated, ornamented similar to lower valve but with two well developed rows of scales; posterior to the scales the shell is ornamented only by the edges of close-set concentric lamellae; the concentric lamellae and scales on both valves are ornamented by radiating striae; interior white, margin denticulated. Length, 40.5 mm.; height, 46 mm.; convexity (both valves), approximately 30 mm. Holotype, from Station 184-D-1, dredged in 25 fathoms (45 meters), Lat. 19° 03' 45" N., Long. 104° 20' 45" W., off Manzanillo, Mexico. A paratype was collected by Fred Baker in 1921 at Puerto Ballandra, Carmen Island, in the Gulf of California.

Pseudochama saavedrai n. sp. seems to possess characters which separate it from all described west American species. The white interior of the shell, denticulate margin, and two radial rows of scales on the upper valve are characteristic features. The new species resembles *Pseudochama panamensis* Reeve²⁷ but the upper valve is more inflated and is ornamented by stronger concentric sculpture as well as by two radial

²⁶ Tomlin, J. R. leB., *Jour. Conch.*, Vol. 18, No. 7, May, 1928, p. 193. "Gorgona Is. on shore, common living; dead shells from Albarmar Is."

²⁷ *Chama panamensis* Reeve, *Conch. Icon.*, Vol. 4, *Chama*, January, 1847, species 45, pl. 8, fig. 45. "Hab. Panama (attached to stones); Cuming."—Clessin, Martini-Chernitz *Conchyl.-Cab.*, Bd. 10, Abt. 1, *Chama*, 1889, p. 32, pl. 13, fig. 5.—Lamy, *Journ. de Conchyl.*, Vol. 71, No. 4, 1928, p. 330. Panama and La Paz.

Pseudochama panamensis Reeve, Pilsbry & Lowe, *Nautilus*, Vol. 47, No. 3, 1934 p. 84. Panama.

rows of lamellae on the posterior half of the shell in comparison to the rudely fimbriated sculpture of Reeve's species. Furthermore Reeve stated that the margin of *P. panamensis* is smooth while in the new species it is denticulated.

This species is named for Alvaro de Saavedra Cerón²⁸ who had charge of the first ship built on the west American coast and sailed from a west American port across the Pacific Ocean.

Genus *Echinochama* Fischer.

Echinochama californica Dall.

Echinochama californica Dall, *Proc. U. S. Nat. Mus.*, Vol. 26, July 10, 1903, p. 950, pl. 62, fig. 5. "From off Cerros Island, Lower California, in 25 fathoms."—Dall, *Trans. Wagner Free Inst. Sci.*, Vol. 3, Pt. 6, October, 1903, p. 1404, 1406 (in text). Lower California.

Type Locality: Off Cedros Island, Lower California, Mexico, in 25 fathoms.

Range: Cedros Island, Lower California, to Coiba Island, Panama.

Collecting Station: Costa Rica: Port Parker (203-D-3), 12 fathoms, shelly mud.

Description: Shell roundly trigonal, beaks turned to the left; a depressed lunular area present; color yellowish-white; about 20 to 21 ribs ornamented by long hollow spines; between the ribs there is a criss-cross granular sculpture; interior white, border finely crenulated; hinge rugosity serrated. Specimens attain an altitude of at least 40 mm. from beak to base.

Echinochama californica is similar to *E. arcinella* Linnaeus, a Caribbean species, but has larger, flatter and more quadrate valves, the beaks are less prominent, the lunule is less depressed and the ribs are more numerous and the spines are longer. According to Dall & Simpson the east American species is usually detached before it becomes adult. The same appears to be true of *E. californica*.

Distribution: Two specimens of *Echinochama californica* were collected by the expedition. One was dredged in 12 fathoms at Port Parker, Costa Rica, and the other was without locality information. The species is known to occur from Cedros Island and the Gulf of California to Panama.

Superfamily Lucinacea.

FAMILY THYASIRIDAE.

Genus *Thyasira* Leach in Lamarck.

Thyasira excavata Dall.

Thyasira excavata Dall, *Proc. U. S. Nat. Mus.*, Vol. 23, August 22, 1901, pp. 790, 818, pl. 39, figs. 12, 15. "Dredged by the U. S.

Fish Commission in the Gulf of California, between San Marcos Island and Guaymas, in 1,005 fathoms; bottom temperature, 37°. 6 F. Also off Tillamook, on the coast of Oregon, in 786 fathoms, mud; bottom temperature, 37.3 F."

Type Locality: Between San Marcos Island and Guaymas, in the Gulf of California, in 1,005 fathoms.

Range: Tillamook, Oregon, to the Gulf of California, in 43 to 1,005 fathoms.

Collecting Station: Mexico: Arena Bank, Gulf of California (136-D-20, 22), 43-45 fathoms, mud.

Description: This species is markedly characterized by the deeply excavated and sharply bounded escutcheon and lunule, in which respect it is not closely approached by any other (Dall). In each valve there are three sharp and two or three obscure radial ridges.

Two specimens in the collection from Arena Bank show the rather deeply excavated lunule and escutcheon and radial ridges mentioned as characteristic of *Thyasira excavata*. The larger of the two measures approximately 9.3 mm. in altitude.

Wilckens²⁹ mentioned that *Thyasira townsendi* White from the Cretaceous of the Antarctic region possesses a lunule similar to that of *T. excavata*.

Thyasira tomeana Dall described from Chile bears some resemblance to *T. excavata* but differs somewhat in shape, is not as deeply furrowed posteriorly, and lacks strong radial ridges.

Distribution: The present specimens of *Thyasira excavata* from the Gulf of California appear to be the first found since those mentioned in the original description. According to Dall the species occurs to depths of 1,005 fathoms in the Gulf of California and ranges north to Oregon.

FAMILY LUCINIDAE.

Key to the genera and subgenera of the Lucinidae.

- A. Hinge with teeth
 - a. Sculpture divaricate *Divaricella*
 - aa. Sculpture not divaricate
 - b. Hinge with cardinal teeth, laterals absent
 - c. Valves equally convex; strong concentric lamellae... *Lucinoma*
 - cc. Valves unequally convex; concentric sculpture of growth lines only..... *Miltha*
 - bb. Hinge with both cardinal and lateral teeth

²⁸ Regarding this voyage by Alvaro de Saavedra Cerón, see I. S. Wright, *Geogr. Rev.*, Vol. 29, No. 3, July, 1939, pp. 472-482, 1 fig. [map].

²⁹ *Thyasira townsendi* White, Wilckens, *Wiss. Ergeb. Schwed. Südpolar Exped. 1901-1903*, Bd. 3, Lief. 12, 1910, p. 53, pl. 2, figs. 31a-c; pl. 3, fig. 1. Snow Hill, Seymour Island, Antarctica, Cretaceous.

- d. Surface with concentric sculpture only
- e. Shell globose; lunule deeply impressed*Here*
- ee. Shell compressed, obliquely elongate*Cavilinga*
- dd. Surface with concentric and radial sculpture
- f. Radiating ribs divaricate*Ctena*
- ff. Radiating ribs not divaricate
- g. Shell large, thick, anterior lateral close to cardinals*Codakia*
- gg. Shell smaller, thinner, anterior lateral not close to cardinals
- h. Radial sculpture of 1 to 3 very broad ribs*PleuroLucina*
- hh. Radial sculpture of 10 or more ribs
- i. Radial and concentric sculpture about equal, strong
- j. Sculpture with spines; many radial ribs
Lucinisca
- jj. Sculpture without spines; usually 10 to 12 ribs
Bellucina
- ii. Radial and concentric sculpture unequal, feeble
Parvilocina
- B. Hinge without teeth*Anodontia*

Genus *Lucina* Bruguière.

Subgenus *Bellucina* Dall.

Lucina (Bellucina) cancellaris Philippi.

Lucina cancellaris Philippi, *Zeit. f. Malakozool.*, February, 1846, p. 21. "Patria: Mazatlan". Mexico.

Phacoides (Bellucina) cancellaris Philippi, Dall, *Proc. U. S. Nat. Mus.*, Vol. 23, 1901, pp. 814, 829, pl. 39 fig. 11. "Cerro Island, west of Lower California, and south to the Gulf and to Panama, in 5 to 30 fathoms."

Type Locality: Mazatlan, Mexico.

Range: Cedros Island, Lower California, and the Gulf of California to Panama, in 4 to 40 fathoms.

Collecting Stations: Mexico: Santa Inez Bay, Gulf of California (145-D-1, 3), 4-13

fathoms, sand; Tenacatita Bay (183-D-3), 40 fathoms, sandy mud; Manzanillo (184-D-2), 30 fathoms, gravelly sand; El Salvador: Meanguera Island, Gulf of Fonseca (199-D-1), 16 fathoms, sand, mud, crushed shell; Costa Rica: Port Parker (203-D-1, 3), 12-15 fathoms, sandy mud, crushed shell, shelly mud.

Description: Shell small, obliquely roundly trigonal, number of ribs variable, but usually there are from 10 to 12 fairly broad, radial ribs which are wider than the interspaces and are crossed by weaker concentric sculpture forming a cancellated pattern. Large specimens attain a height of 6 mm.

Lucina amianta Dall, which occurs from North Carolina to Brazil, and *L. tuomeyi* Dall from the upper Miocene of Florida, are similar species.

Distribution: *Lucina cancellaris* was dredged at a number of localities from depths of 4 to 40 fathoms, from Santa Inez Bay in the Gulf of California, where it was quite abundant, to Port Parker, Costa Rica. It also occurs in the Pleistocene of Magdalena Bay, Lower California, Maria Magdalena Island of the Tres Marias group and in the Pliocene of Ecuador.

Subgenus *Cavilinga* Chavan.

Key to the species of *Cavilinga*.

- A. Shell longer than high*lampra*
B. Shell with length and height about equal*lingualis*

Lucina (Cavilinga) lampra Dall.

Phacoides (Cavilucina) lamprus Dall, *Proc. U. S. Nat. Mus.*, Vol. 23, August 22, 1901, pp. 811, 827, pl. 39, fig. 9. Type locality, "La Paz, Lower California."

Lucina lampra Dall, E. K. Jordan, *Contrib. Dept. Geol. Stanford Univ.*, Vol. 1. No. 4, 1936, p. 130. Magdalena Bay, Lower California, Pleistocene. Also Gulf of California, Recent.

Type Locality: La Paz, Lower California.

Range: Gulf of California, to Santa Cruz Bay, Mexico.

Collecting Stations: Mexico: Cape San Lucas, beach; Manzanillo (184-D-2), 30 fathoms, gravelly sand; Port Guatulco (195-D-2, 6), 3 fathoms, sand, algae, crushed shell, also on beach; Santa Cruz Bay, beach.

Description: Shell of Dosinioid form, nearly orbicular, rather thick; beaks subcentral, lunule small, excavated, and nearly equally divided between the two valves; a broad shallow flexuosity is present along the posterior dorsal area but is sometimes nearly obsolete; sculpture of fine, low, rather sharp, concentric threads with occasional well marked sulci; microscopic radial striations sometimes present; internal margins

very finely crenulated in perfect specimens; color of shell white, yellow or pink. The largest specimens in the collection are about 21 mm. in length.

E. K. Jordan pointed out that the lunule in *Lucina lampra* is usually equally divided between the two valves, while in *L. californica* it is chiefly in the right valve. *Lucina lampra* is more circular in outline than the similar species *L. prolongata* Carpenter or *L. lingualis* Carpenter. Jordan also pointed out that the shell of *L. lampra* is longer than high, in *L. lingualis* the two dimensions are about equal, while that of *L. prolongata* is higher than long and pronouncedly oblique. The color of *Lucina lampra* varies from white to yellow or pink. All other species of the genus from the west coast are usually pure white.

Distribution: Specimens of *Lucina lampra*, most of them empty shells, were collected by the expedition at several localities from Cape San Lucas to Santa Cruz Bay, Mexico, on the beach and dredged to a depth of 30 fathoms. The discovery of the occurrence of this species at Santa Cruz Bay, Mexico, is an extension south of the known range. It also has been recorded as occurring in the Pleistocene of Magdalena Bay, Lower California.

Lucina (Cavilinga) lingualis Carpenter.

Lucina lingualis Carpenter, *Ann. & Mag. Nat. Hist.*, Ser. 3, Vol. 13, April, 1864, p. 313. Cape St. Lucas. Reprint in *Smithson. Miscell. Coll.*, No. 252, 1872, p. 211.—E. K. Jordan, *Contrib. Dept. Geol. Stanford Univ.*, Vol. 1, 1936, p. 131. Magdalena Bay, Lower California, Pleistocene. Gulf of California to Acapulco, Mexico, Recent.

Phacoides (Cavilucina) lingualis Carpenter, Dall, *Proc. U. S. Nat. Mus.*, Vol. 23, 1901, p. 827, pl. 39, fig. 7. Gulf of California.

Type Locality: Cape San Lucas, Lower California.

Range: Magdalena Bay to the Gulf of California and south to Acapulco, Mexico.

Collecting Stations: Mexico: Cape San Lucas, beach; San Lucas Bay (135-D-25), 7 fathoms, sand; Santa Inez Bay (145-D-1, 3), 4-13 fathoms, sand.

Description: The shell of this species resembles that of *Lucina lampra* but is higher and somewhat produced below; the height and length are about equal. A large right valve of this species from Magdalena Bay, Lower California, in the collections of the California Academy of Sciences, measures 13 mm. in height.

Distribution: Specimens of *Lucina lingualis* were collected by the expedition on the beach at Cape San Lucas and dredged at depths of 4-13 fathoms in the Gulf of California. It has been reported to range south to Acapulco and as occurring in the

Pleistocene at Magdalena Bay, Lower California.

Subgenus *Here* Gabb.

Lucina (Here) excavata Carpenter.

Lucina excavata Carpenter, *Cat. Mazatlan Shells*, November, 1855, p. 98. "Mazatlan."

Phacoides (Here) richthofeni Gabb, Dall, *Proc. U. S. Nat. Mus.*, Vol. 23, 1901, pp. 810, 827, pl. 40, figs. 7 and 9. Catalina Island to the Gulf of California, in 16 to 66 fathoms.

Type Locality: Mazatlan, Mexico.

Range: San Pedro, California, to Mazatlan, Mexico, in 16 to 66 fathoms.

Collecting Stations: Mexico: Santa Inez Bay, Gulf of California (142-D-3, 4), 40-50 fathoms, sand, weed, (146-D-1), 35 fathoms, mud, crushed shell; Gorda Banks (150-D-6) 60 fathoms, muddy sand, rocks.

Description: Shell globose, inflated; ornamented by concentric ridges and a deeply depressed lunule. A specimen from Santa Inez Bay in the Gulf of California measures approximately 23.5 mm. in altitude.

Lucina (Here) iduna Olsson from the Miocene of Peru has been compared to *L. excavata*.

Distribution: A few specimens of *Lucina excavata* were dredged at depths of 35 to 60 fathoms, from Cape San Lucas to Santa Inez Bay in the Gulf of California. It has also been recorded occurring as a fossil in California as far back as the middle Miocene.

Subgenus *Lucinisca* Dall.

Key to the species of *Lucinisca*.

- A. About 18 major ribs *liana*
- B. More than 18 major ribs
 - a. Ribs equal, regularly spaced. *nuttalli*
 - aa. Ribs unequal, not regularly spaced, shell flatter *fenestrata*

Lucina (Lucinisca) fenestrata Hinds.

Lucina fenestrata Hinds, *Zool. Voy. Sulphur*, Moll., Pt. 3, 1844 [January, 1845, on cover of Pt. 3], p. 66, pl. 19, fig. 2. "Inhab. Monte Christi; San Blas. In seven to fourteen fathoms."

Lucina (Lucinisca) fenestrata Hinds, Dall, *Proc. U. S. Nat. Mus.*, Vol. 23, 1901, p. 811. Lower California to Panama (and Tumbes, Peru?). [Not *Lucina muricata* mentioned in the text].

Type Locality: Montechristi, Ecuador, in 7 to 14 fathoms (here designated as type locality). San Blas, Mexico, also cited originally.

Range: Cedros Island, Lower California, and the Gulf of California, to Salinas, Ecuador. Peru (Dall; Carpenter).

Collecting Stations: Mexico: East of

Cedros Island (126-D-2), 38 fathoms, mud; Arena Bank (136-D-15), 40 fathoms, mud, crushed shell; Santa Inez Bay (143-D-1, 2, 3, 4), 25-35 fathoms sand, weed, rocks.

Description: Shell resembling that of *Lucina nuttalli* but much larger. One valve in the present collection measures 44 mm. in altitude. The narrow elongate lunule appears to be about equally divided between the two valves. The sculpture is coarser and more rasp-like, the radial ribs are more unequal, smaller, and wider spaced in proportion to the size of the shell than are those of *L. nuttalli*. The major ribs of *L. fenestrata* are greater in number, finer, and more closely spaced than are those of *L. liana* Pilsbry. *Lucina (Luciniscia) fausta* Pilsbry & Olsson³⁰ from the Pliocene of Ecuador is a similar species.

Distribution: A number of specimens of *Lucina fenestrata* were dredged east of Cedros Island, on Arena Bank and in Santa Inez Bay at depths of 25 to 40 fathoms. It is much less commonly taken than the somewhat similar species *L. nuttalli*.

Lucina (Luciniscia) liana Pilsbry.

Lucina muricata Chemnitz, Reeve, Conch. Icon., Vol. 6, *Lucina*, June, 1850, species 46, pl. 8, fig. 46. "Hab. Tumbez, Peru (in soft mud at a depth of eleven fathoms); Cuming."

Not *Lucina muricata* Chemnitz, 1795. An east American species.

Phacoides (Luciniscia) hispaniolana Maury, Li, *Bull. Geol. Soc. China*, Vol. 9, No. 3, 1930 [received at the library of the California Academy of Sciences May 2, 1931], p. 258, pl. 3, fig. 20. "Gatun Stage, Port Limon, Costa Rica." "Gatun formation." Dredged in the Bay of Panama.

Not *Phacoides (Luciniscia) hispaniolana* Maury 1917. Santo Domingo, Miocene.

Phacoides (Luciniscia) liana Pilsbry, *Proc. Acad. Nat. Sci. Philadelphia*, Vol. 83, November 13, 1931, p. 435, pl. 41, fig. 3. "Panama Bay, a mile out in 10-40 ft." [Rectification of the record cited by Li].

Type Locality: Panama Bay, 1 mile out, in 10-40 feet.

Range: Santa Inez Bay, east coast of Lower California, to Tumbez, Peru.

Collecting Stations: Mexico: Arena Bank (136-D-15, 22), 40-45 fathoms, mud, crushed shell; Santa Inez Bay (143-D-1), 29 fathoms, mud, crushed shell, weed; Port Guatulco (195-D-2), 3 fathoms, sand; Guatemala: 7 mi. W. of Champerico (197-D-1, 2), 14 fathoms, mud; El Salvador: La Libertad (198-D-1, 2), 13-14 fathoms, mud; Meanguera Island, Gulf of Fonseca (199-D-1), 16 fathoms, sand, mud, crushed shell;

Panama: Gulf of Chiriqui (221-D-1), 35 fathoms, sandy mud.

Description: Shell rounded, white; the upper anterior area ornamented by a few irregular ribs, the upper posterior area with 3 or 4 radial ribs followed by about the same number in a shallow groove, the remainder of the shell ornamented by about 18 major slightly wavy ribs between which there are smaller riblets, usually one or two toward the anterior end and 3 along the ventral margin; ribs and riblets ornamented by projecting points or scales where the ribs are crossed by rather widely spaced, thin concentric ridges. Hinge similar to *L. muricata*. Large specimens attain a length of 19.5 mm.

The unequal size between the major and minor ribs is a character which easily serves to separate *Lucina liana* from *L. nuttalli centrifuga* Dall. The major ribs of *L. liana* are much less numerous than those of *L. fenestrata* Hinds. *Lucina roigi* Maury from the Pliocene of Trinidad is another species of the *L. muricata* group to which *L. liana* belongs.

Distribution: The discovery of the occurrence of *Lucina liana* in the Gulf of California is an extension north of the known range of the species. It also has been recorded as occurring in the Pliocene of Panama and Ecuador.

Lucina (Luciniscia) nuttalli Conrad.

Lucina nuttalli Conrad, *Journ. Acad. Nat. Sci. Philadelphia*, Vol. 7, 1837, p. 255, pl. 20, fig. 2. "Inhabits California."

Lucina (Myrtea) nuttalli Conrad, Grant & Gale, *Mem. San Diego Soc. Nat. Hist.*, Vol. 1, 1931, p. 288, pl. 14, figs. 4a, 4b, 18. Earlier records cited. Upper Miocene to Recent.

Type Locality: California.

Range: Santa Barbara, California, to Manzanillo, and the Tres Marias Islands, Mexico.

Collecting Stations: Mexico: Arena Bank (136-D-22), 45 fathoms, mud; Santa Inez Bay (145-D-1, 3), 4-13 fathoms, sand; Tenacatita Bay (183-D-3), 15 fathoms, sand; Manzanillo (184-D-2), 30 fathoms, gravelly sand.

Description: Shell orbicular, ornamented by even, strong, cancellate sculpture; the ribs are nearly equal in strength but there are some finer ones interspersed; ribs more widely spaced toward the anterior and posterior margins. The lunule usually lies chiefly in the left valve. Large specimens attain a height of 25 mm.

The subspecies *Lucina nuttalli centrifuga* Dall, a form with widely spaced concentric lamellae described from the Gulf of California, intergrades completely with specimens of *L. nuttalli* from that region. The sub-

³⁰ *Lucina (Luciniscia) fausta* Pilsbry & Olsson, *Proc. Acad. Nat. Sci. Philadelphia*, Vol. 93, September 9, 1941, p. 58, pl. 17, figs. 3, 6. "Canoa formation, Punta Blanca." Ecuador, Pliocene.

species has not been reported outside the Gulf of California except as a fossil in southern California.

Distribution: *Lucina nuttalli* occurs commonly from southern California to the Gulf of California. The present record of the species from Manzanillo, Mexico, is an extension south of the known range. It is also known to occur from upper Miocene to Recent in California.

Subgenus *Lucinoma* Dall.

Lucina (Lucinoma) annulata Reeve.

Lucina annulata Reeve, Conch. Icon., Vol. 6, *Lucina*, May, 1850, species 17, pl. 4, fig. 17. "Hab. California?"

Phacoides annulatus Reeve, I. S. Oldroyd, *Stanford Univ. Publ. Univ. Ser. Geol. Sci.*, Vol. 1, 1924, p. 126, pl. 33, figs. 5a, 5b. Port Althorp, Alaska, to the Coronado Islands, Lower California. Also upper Miocene, Pliocene and Pleistocene of California.

Type Locality: California.

Range: Port Althorp, Alaska, to Santa Inez Bay, east coast of Lower California.

Collecting Stations: Mexico: East of Cedros Island (126-D-2, 9, 12), 38-56 fathoms, crushed shell, eel grass, mud; Santa Inez Bay (142-D-4), 40-50 fathoms, sand.

Description: Shell suborbicular, often large, posterior dorsal margin straight; posterior sulcus slight; ornamented by fairly regular, sharp, raised concentric lamellae between which there are a number of low concentric threads; cardinal teeth well developed, lateral teeth weak.

The largest specimen in the present collection is about 26 mm. in altitude and appears to be typical of the species. Large specimens of *Lucina annulata* attain an altitude of 55 mm.

Distribution: The present records of *Lucina annulata* from off Cedros Island and from Santa Inez Bay in the Gulf of California furnish an extension south of the known range of the species. It is also known to occur in the Pliocene and Pleistocene of California.

Subgenus *Miltha* H. & A. Adams.

Lucina (Miltha) xantusi Dall.

Plate I, Figure 13.

Phacoides (Miltha) xantusi Dall, *Nautilus*, Vol. 18, No. 10, February, 1905, p. 111. "Cape St. Lucas." Lower California.

Type Locality: Cape San Lucas, Lower California.

Range: Gulf of California.

Collecting Stations: Mexico: Cape San Lucas; Arena Bank (136-D-5), 33 fathoms, sand, weed.

Description: Shell large, ovately rounded, produced ventrally, rather flat, right valve more convex than the left; ornamentation

consists of concentric lines of growth and radial striae; posterior sulcus present, ornamented by one radial ridge; lunule chiefly in the right valve, depressed; two cardinal teeth, the right anterior and left posterior tooth bifid; ligamental groove, long, posterior; muscle scars, especially the anterior one, large; inner surface of valve scatteringly pitted; margin smooth.

The specimen from Arena Bank measures 68 mm. in length, 71.2 mm. in height, and convexity (both valves), 23 mm. This is almost the same size as the type specimen described by Dall. Young specimens are rounder in outline. This species is very close to *Lucina (Miltha) joannis* Dall described from the Pliocene of Lower California. According to Dall the margin of the lunule of *L. joannis* is more deeply infolded, the shell heavier, more elongately oval and about one-fourth smaller than that of *L. xantusi*. The measurements given for *L. xantusi* are 71 mm. in height and 65 mm. in width as compared to 55 mm. in height and 51 mm. in width for *L. joannis*. These measurements do not indicate that the shell of *L. joannis* is more elongate in proportion to the width as compared to that of *L. xantusi*. The illustration given by Hanna³¹ of a fossil shell from Imperial County, California, which he referred to *L. xantusi*, represents a rather round form which may perhaps be referable to *L. joannis*.

Lucina (Miltha) childreni Gray from Brazil is a similar species and there are other similar forms which occur in the late Tertiary of the Caribbean region.

Distribution: *Lucina (Miltha) xantusi* is a rare species. The two specimens taken on the expedition from the southern part of the Gulf of California from Cape San Lucas and Arena Bank are from the same region where it has been found previously by collectors.

Subgenus *Parvilucina* Dall.

Key to the species of *Parvilucina*.

- A. Concentric lamellae strong and dense;
lunule deep *mazatlanica*
B. Concentric lamellae weaker;
lunule shallower *approximata*

Lucina (Parvilucina) approximata Dall.

Phacoides (Parvilucina) approximatus Dall, *Proc. U. S. Nat. Mus.*, Vol. 23, August 22, 1901, pp. 813, 828, pl. 39 fig. 4. "From the Gulf of California, in 26 fathoms, sand." Also cited from Catalina Island, California, and south to Panama, in 5 to 40 fathoms.

Lucina (Myrtea) tenuisculpta Carpenter

³¹ *Phacoides xantusi* Dall, Hanna, *Proc. Calif. Acad. Sci.*, Ser. 4, Vol. 14, No. 18, 1926, p. 475, pl. 28, fig. 7, pl. 29, fig. 1. Coyote Mountain, Imperial County, California, Pliocene.

var. *approximata* Dall, Grant & Gale, *Mem. San Diego Soc. Nat. Hist.*, Vol. 1, 1931, p. 289, pl. 14, figs. 8a, 8b. Earlier records cited. Pleistocene and Recent.

Type Locality: Gulf of California, in 26 fathoms, sand.

Range: Monterey, California, to Panama.

Collecting Stations: Mexico: East of Cedros Island (126-D-12), 45 fathoms, crushed shell, mud; Nicaragua: Corinto (200-D-19, also beach), 12-13 fathoms, mangrove leaves; Costa Rica: Port Parker (203-D-1, 3, also beach), 12-15 fathoms, sandy mud, crushed shell, shelly mud.

Description: Shell small, usually not exceeding 6 mm. in length, nearly equilateral, tumid, lunule lanceolate in shape and depressed; sculpture of numerous fine radial ribs separated by narrow interspaces, radial sculpture absent on the dorsal areas, ribs crossed by distant elevated concentric lines which are feebly lamellose on the dorsal areas; margin crenulated. The measurements given for the type specimen of this species were, length, 6.3 mm.; height, 6.5 mm.

The shell of *Lucina approximata* is very similar to that of the generally more northern *L. tenuisculpta* but is smaller, more delicate, has stronger radial sculpture and lacks the right anterior cardinal tooth of the northern form. The radial ribbing tends to become obsolete in the northern part of its range and the two species are scarcely separable in southern California.

Lucina crenella Dall from the Atlantic coast is a similar species.

Distribution: *Lucina approximata* occurs fairly abundantly from southern California to Panama. It was dredged abundantly off Cedros Island and was taken by the expedition as far south as Costa Rica. It is also known to occur in the Pleistocene of southern California and Lower California.

Lucina (Parvilucina) mazatlanica Carpenter.

Lucina mazatlanica Carpenter, *Cat. Mazatlan Shells*, November, 1855, p. 99. "Mazatlan," Mexico.—E. K. Jordan, *Contrib. Dept. Geol. Stanford Univ.*, Vol. 1, No. 4, 1936, p. 130. Magdalena Bay, Lower California, Pleistocene. Recent in the Gulf of California.

Phacoides (Here) mazatlanicus Carpenter, Dall, *Proc. U. S. Nat. Mus.*, Vol. 23, 1901, p. 811. Mazatlan.

Type Locality: Mazatlan, Mexico.

Range: Gulf of California to Panama.

Collecting Station: Mexico: Santa Inez Bay, E. coast of Lower California (145-D-1, 3), 4-13 fathoms, sand.

Description: Shell small, tumid, nearly equilateral; lunule rather large and depressed; sculpture of numerous fine,

rounded riblets separated by narrow interspaces, weak or absent on the early part of the shell; concentric sculpture of elevated laminae which are very dense on the early part of the shell but are less pronounced on later stages; basal margin crenulated.

Lucina mazatlanica resembles *L. approximata* Dall and *L. tenuisculpta* Dall but average specimens (about 4.5 mm. in length) are smaller than either of these species. The lunule appears to be deeper and the concentric lamellae stronger and denser in comparison to young forms of *L. approximata*.

There is doubt regarding the exact identification of *Lucina mazatlanica* because, as mentioned by Dall (1901) "Carpenter's specimens are so small that it is difficult to be certain about them," furthermore, no illustrations of them have been published. Dall thought the species might be allied to *L. sombreroensis*, a Caribbean species. In the original description of *Lucina sombreroensis*³² no mention was made of any radial sculpture on that species. Carpenter definitely mentioned radial sculpture on *L. mazatlanica* which would seem to place it near *L. approximata* Dall.

Distribution: Specimens referred to *Lucina mazatlanica* were dredged in 4 to 13 fathoms in Santa Inez Bay, in the Gulf of California. It also has been reported as occurring in the Pleistocene of Magdalena Bay, Lower California.

Subgenus *Pleurolucina* Dall.

Lucina (Pleurolucina) leucocymoides Lowe.

Phacoides (Pleurolucina) leucocymoides Lowe, *Trans. San Diego Soc. Nat. Hist.*, Vol. 8, No. 6, March 21, 1935, p. 17 pl. 1, fig. 4. "Tres Marias" Islands, (type). Also from Carmen Island in 20 fathoms, and Angel de la Guardia, in 20 fathoms, Gulf of California.

Type Locality: Tres Marias Islands, Mexico.

Range: Angel de la Guardia Island, Gulf of California, to Manzanillo, and Tres Marias Islands, Mexico.

Collecting Stations: Mexico: Arena Bank (136-D-15, 22, 23), 40-45 fathoms, mud, crushed shell, sand; Santa Inez Bay (142-D-3, 4), 40-50 fathoms, sand, weed, also (147-D-2), 60 fathoms, mud crushed shell; Gorda Banks (150-D-9), 50-60 fathoms, muddy sand; Manzanillo (184-D-2), 30 fathoms, gravelly sand.

Description: Shell with a single wide costa which occupies the entire middle half

³² *Lucina sombreroensis* Dall, *Bull. Mus. Comp. Zool.*, Vol. 12, No. 6, September, 1886, p. 264. "Off Sombrero in 72 fms., two valves; West Florida, 50 fms., one small valve."—Dall, *Proc. U. S. Nat. Mus.*, Vol. 12, 1889, p. 263, pl. 14, fig. 13. Off Cape Florida, in 84 to 85 fathoms, sand and mud. "Also in the Gulf of Mexico and off Sombrero Island, West Indies, by the *Blake*, in 50 to 72 fathoms."

of the shell and is bounded on either side by a channeled groove; concentric sculpture of reflexed concentric lirae; lunule large, heart-shaped, equally divided between each valve, shallowly depressed. The shell of adult specimens is quite thick. Hinge with two cardinals and divided laterals. Inner margin finely crenulated. The shell of this species attains a height of 20 mm.

Lucina leucocyma Dall of the Atlantic coast is a similar species.

Lucina undatoides Hertlein & Strong (*Lucina undata* Carpenter³³, not *L. undata* Lamarck) is ornamented by three or four broad costae, and by finer concentric sculpture, and the shell is longer and less convex than that of *L. leucocymoides*.

Distribution: The present record of the occurrence of *Lucina leucocymoides* at Manzanillo, Mexico, is an extension south of the known range of the species. It is also known to occur in the Pleistocene of Albemarle Island, Galápagos group, where it was found by Professor Nicolas Reformatzky.

Genus *Anodontia* Link.

Anodontia edentuloides Verrill.

Loripes edentuloides Verrill, *Amer. Jour. Sci.*, Ser. 2, Vol. 49 (whole No. 99), No. 146, March, 1870, p. 226. "La Paz,—J. Pedersen. One specimen."

Lucina edentuloides Verrill, Dall, *Proc. U. S. Nat. Mus.*, Vol. 23, 1901, p. 802. Magdalena Bay, Lower California and the Gulf of California.

Anodontia edentuloides Verrill, Grant & Gale, *Mem. San Diego Soc. Nat. Hist.*, Vol. 1, 1931, p. 292. Earlier records cited. Pliocene and Recent.

Type Locality: La Paz, Lower California.

Range: San Clemente Island, California (Dall), and Cedros Island, Lower California, to the Gulf of California, and south to Tenacatita Bay, Mexico.

Collecting Stations: Mexico: East of Cedros Island (126-D-2), 38 fathoms, mud; Arena Bank (136-D-4, 13, 14, 20, 22), 43-55 fathoms, mud, *Arca* conglomerate; Santa Inez Bay (143-D-1, 2, 3, 4, 5), 18-35 fathoms, mud, crushed shell, weed, sand; Tenacatita Bay (183-D-3), 40 fathoms, sandy mud.

Description: Shell subglobose, beaks subcentral, ornamented by irregular lines of growth and submicroscopic radial striae; hinge without teeth. The largest specimen taken by the expedition measures approximately 43 mm. in length but the species attains a larger size.

³³ *Lucina undata* Carpenter, *Proc. Zool. Soc. London*, 1865, p. 279. "Hab. Gulf of California (teste Rowell)." Not *Lucina undata* Lamarck, 1819. Due to the fact that the combination of names *Lucina undata* proposed by Carpenter had already been used by Lamarck, the name *Lucina undatoides* was proposed by Hertlein & Strong for the species described by Carpenter (*Nautilus*, Vol. 58, No. 3, January, 1945, p. 105).

Young shells about 10 mm. in length, from Arena Bank, have two cardinals and one lateral tooth in the left valve and one cardinal and one lateral in the right valve. Apparently these teeth become covered as growth proceeds. Exteriorly these young shells are sculptured by concentric lines of growth and fine radial striation exactly as in large specimens of *Anodontia edentuloides*. These features as well as the exact shape of that species have led us to refer these young shells to Verrill's species.

The shell of *Anodontia edentuloides* is very similar to *A. chrysostoma* (Meuschen) Philippi, a Caribbean species, but the beaks are more centrally located on the west American shell which also appears to be slightly more elongated in proportion to the height.

Distribution: Specimens of this species were found off Cedros Island, in the southern part of the Gulf of California, and at Tenacatita Bay. The present record of the occurrence of the species at Tenacatita Bay, Mexico, is an extension south of the known range. It has also been recorded from the Pliocene of Imperial County, California.

Genus *Codakia* Scopoli.

Codakia distinguenda Tryon.

Lucina (Codakia) distinguenda Tryon, *Proc. Acad. Nat. Sci. Philadelphia*, Vol. 24, September 3, 1872, p. 130, pl. 6, fig. 3. "Gulf of California."

Codakia colpoica Dall, *Proc. U. S. Nat. Mus.*, Vol. 23, August 22, 1901, pp. 801, 821, pl. 41, fig. 4. "Gulf of California."

Type Locality: Gulf of California.

Range: Magdalena Bay, Lower California, and the Gulf of California to Panama.

Collecting Stations: Mexico: Ceralbo Island, beach; Port Guatulco (195-D-10, also beach), 4 fathoms, gravelly sand, crushed shell, coral; Costa Rica: Port Parker, beach; Panama: Bahia Honda, beach.

Description: Shell large, orbicular, thick, white exteriorly, interiorly reddish colored around the margin and hinge and cream colored in the central part of the valve; ornamented exteriorly by many narrow fairly regular, radial ribs; lunule small, depressed, mostly confined to the right valve. A large specimen from the Gulf of California measures 140 mm. in length.

The shell of this species is very similar to that of the east American *Codakia orbicularis* Linnaeus, but the valves of the west American species are more depressed, the posterior dorsal area is straighter and longer, the inner margin of the hinge is usually reddish colored and the exterior is usually tinted faintly pinkish-white rather than the usually pure white of *C. orbicularis*.

A study of a series of specimens suggests that there is little to separate the form

described as *C. pinchoti* Pilsbry & Lowe³⁴ from *C. distinguenda* or from *C. recta* Dall & Ochsner which was originally described from the Pliocene of the Galápagos Islands.

Distribution: *Codakia distinguenda* occurs fairly commonly in the Gulf of California and 15 valves were taken by the expedition at Ceralbo Island. It was also collected at Costa Rica and Panama. It is also known to occur from Pliocene to Recent in the Gulf of California region.

Genus *Ctena* Mörch.

Key to the species of *Ctena*.

- A. Radial sculpture present on dorsal areas
- a. Radial sculpture much heavier than the concentric
 - b. Ribs fine, numerous.....*mexicana*
 - bb. Ribs coarse, less numerous*galapagana*³⁵
 - aa. Radial sculpture only slightly heavier than or equal with the concentric
 - c. Transversely oval or sub-circular; anterior end broadly rounded*clippertonensis*
 - cc. Obliquely transversely ovate; anterior end narrower*clarionensis*
- B. Radial sculpture not present on dorsal areas*chiquita*

Ctena chiquita Dall.

Codakia (Jagonia) chiquita Dall, *Proc. U. S. Nat. Mus.*, Vol. 23, August 22, 1901, pp. 801, 823, pl. 39, fig. 1. "On the west side of the lower end of the peninsula of Lower California, nearly abreast of La Paz, in 66 fathoms."

Type Locality: Off the west coast of Lower California, nearly abreast of La Paz, in 66 fathoms.

Range: West coast of Lower California in about Lat. 24°18'N., and the Gulf of California to La Libertad, El Salvador.

Collecting Stations: Mexico: Manzanillo (184-D-2), 30 fathoms, gravelly sand; Santa Cruz Bay, beach; Tangola-Tangola Bay (196-D-6, 7), 6-7 fathoms, sand, crushed shell; El Salvador: La Libertad (198-D-2), 14 fathoms, mud.

Description: Shell small, suborbicular, flattish, color yellowish-white, sculpture of fine nearly obsolete radial threads which often bifurcate toward the ventral margin, less prominent on the middle of the valves and absent along the dorsal margin, radials crossed by regular, concentric, crowded threads; lunule small, depressed, nearly

equally divided between the two valves. A large specimen from off Lower California measures 13.5 mm. in length.

The shell of *Ctena chiquita* is less elongate, and the radial sculpture is finer than that of *C. mexicana* Dall and is lacking on the dorsal areas.

Distribution: The present record of *Ctena chiquita* from La Libertad, El Salvador, is an extension southward of the known range of the species. It has not been recorded previously from south of the Gulf of California.

Ctena clarionensis Hertlein & Strong, sp. nov.

Plate I, Figures 11, 12 and 14.

Shell small, solid, plump, obliquely ovately quadrate, with the beaks nearer the posterior end; without posterior or anterior areas; sculptured with many, fine, close, rounded threads which are notched by somewhat wider spaced radial lines, giving the whole surface a finely beaded appearance; lunule narrow, moderately long, well impressed, equally divided between the two valves; growth stages distinctly marked, particularly the last three; interior with the muscle scars distinct, about equal in size; interior basal margin with fine radial ridges extending to the pallial line; cardinal teeth small, the right valve with a strong, distant anterior lateral and a smaller, closer, posterior lateral tooth; left valve with a weak posterior cardinal and a low projection which may represent a broken anterior cardinal, one small anterior lateral and socket and one posterior lateral and socket present; above each socket there is a faint lateral. The type measures: longitudinal diameter, 13.8 mm.; vertical diameter, 12.5 mm.; convexity (both valves), 8.2 mm.

Holotype, from Sulphur Bay, Clarion Island, collected by the Templeton Crocker Expedition of the New York Zoological Society.

The unique type is white with the anterior end and posterior edge dark reddish-brown but this color may be a stain. The new species resembles *Ctena clippertonensis* Bartsch & Rehder³⁶ described from Clipperton Island, but the present species is more oblique in outline, the anterior end is narrower and the sculpture is coarser. The new species has much finer sculpture than *C. mexicana* Dall.

Ctena clippertonensis Bartsch & Rehder.

Ctena clippertonensis Bartsch & Rehder, *Smithson. Miscell. Coll.*, Vol. 98, No. 10, (Publ. 3535), June 13, 1939, p. 13, pl. 3, figs.

³⁶ *Ctena clippertonensis* Bartsch & Rehder, *Smithson. Miscell. Coll.*, Vol. 98, No. 10, (Publ. 3535), June 13, 1939, p. 13, pl. 3, figs. 1, 2, 3, 4, 5. "It was collected on Clipperton Island, on rocks to the south of the landing place."

³⁴ *Codakia pinchoti* Pilsbry & Lowe, *Proc. Acad. Nat. Sci. Philadelphia*, Vol. 84, May 21, 1932, p. 103, pl. 14, figs. 1 and 2. "Panama City, on the reef off 'French Plaza'."

³⁵ Not represented in the present collection.

1-5. "It was collected on Clipperton Island, on rocks to the south of the landing place."

Type Locality: Clipperton Island, on rocks.

Range: Maria Madre Island, Mexico, to Hannibal Bank, Panama, and Clipperton Island.

Collecting Station: Panama: Hannibal Bank (Sta. 224), 35-40 fathoms, rocks, dead coral, mud, sand, shells, algae.

Description: Left valve, white, transversely oval to subcircular, moderately inflated, beaks back of the center; ends broadly rounded; ornamented by fine radial riblets crossed by concentric lamellae of nearly equal strength which give the ribs a nodulose character; lunule, well defined, narrow, elongately lanceolate; hinge with an anterior cardinal and a smaller grooved posterior cardinal tooth, lateral teeth paired, the larger pointed one of each pair occurs on the inside and the smaller one near the margin.

The present specimen measures: length, 15.2 mm.; height, 13.8 mm.; convexity (one valve), 3.8 mm.

The broadly rounded anterior end of the present specimen as well as its other characters appear to be those of *Ctena clippertonensis* Bartsch & Rehder.

Distribution: A single left valve of this species was dredged by the expedition on Hannibal Bank, Panama, in 35-40 fathoms. This is an extension south of the known range of the species.

Ctena mexicana Dall.

Codakia (Jagonia) mexicana Dall, *Proc. U. S. Nat. Mus.*, Vol. 23, August 22, 1901, pp. 801, 822, pl. 40, fig. 6. "Gulf of California" (figured specimen). Range cited as Gulf of California to Panama and Guacomaayo.

Lucina (Jagonia) mexicana Dall, Lamy, *Journ. de Conchyl.*, Vol. 65, No. 3, 1921, p. 253. Colombia; Lower California.

Type Locality: Gulf of California.

Range: Gulf of California, to Santa Elena, Ecuador. Galápagos Islands (Tomlin).

Collecting Stations: Mexico: Arena Bank (136-D-1), 45 fathoms, mud, *Arca* conglomerates; Santa Inez Bay (143-D-1), 29 fathoms, mud, crushed shell, weed; also (145-D-1, 3), 4-13 fathoms, sand; also beach; Port Guatulco (195-D-9), 7 fathoms, gr. sand, crushed shell; Nicaragua: Corinto (200-D-11, 19), 8-13 fathoms, mangrove leaves; Costa Rica: Port Parker (203-D-1, 3), 12-15 fathoms, sandy mud, crushed shell.

Description: Shell small, usually somewhat elongated, ornamented by numerous well developed but fairly fine radial ribs which usually bifurcate toward the ventral margin; these are decussated by fine fairly regular concentric threads; lunule lanceolate moderately depressed. A large specimen

measures 22 mm. in length and 19.4 mm. in height.

The shell of *Ctena mexicana* is quite similar to that of the east American *C. imbricatula* C. B. Adams but the sculpture of the west American form is generally a little finer and more regular and the lunule is a little longer and less deeply impressed. The ribbing of the species in this group is variable.

Distribution: This species was collected by the expedition at various localities from the Gulf of California to Costa Rica. It occurs South to Panama and Ecuador. It has been cited as occurring in the Pleistocene of Magdalena Bay and the Tres Marias Islands.

Genus *Divaricella* von Martens.

Divaricella lucasana Dall & Ochsner.

Lucina eburnea Reeve, *Conch. Icon.*, Vol. 6, *Lucina*, June, 1850, species 49, pl. 8, fig. 49. "St. Elena, West Columbia and Panama (in sandy mud at a depth of eleven fathoms); Cuming."

Not *Lucina eburnea* Andrzejowski, Deshayes, *Bull. Soc. Geol. France*, Ser. 1, Vol. 6, 1835, p. 321. Miocene of Poland. [*Nomen nudum*].

Divaricella lucasana Dall & Ochsner, *Proc. Calif. Acad. Sci.*, Ser. 4, Vol. 17, No. 4, June 22, 1928, p. 122, pl. 2, figs. 17, 21, 24. "1½ miles northeast of Vilamil, Albemarle Island, Galapagos Group. Probably Pleistocene." New name for *Lucina eburnea* Reeve, not *L. eburnea* Deshayes, 1835.

Divaricella columbiensis Lamy, *Bull. Mus. Nat. Hist. Nat. Paris*, Ser. 2, Vol. 6, No. 5, October, 1934, p. 433. Colombia. New name for *Lucina eburnea* Reeve, not *Venus eburnea* Gmelin, 1790 (which = *Codakia (Jagonia) jagon* Adanson); not *Lucina eburnea* Andrzejowski, Deshayes, 1835; not *Loripes eburnea* Conrad, 1847.

Type Locality: 1½ miles northeast of Vilamil, Albemarle Island, Galápagos Islands, Pleistocene. Of *Lucina eburnea* Reeve, Santa Elena, Ecuador, in 11 fathoms, sandy mud (here designated as type locality). Panama also cited originally.

Range: Magdalena Bay, and the Gulf of California, to Mancora, Peru.

Collecting Stations: Mexico: Cape San Lucas, beach; Arena Point area, beach; Santa Inez Bay (143-D-1), 29 fathoms, mud, crushed shell, weed, also (144-D-2), 2½ fathoms, sand, weed, rocks, also (145-D-1, 3), 4-13 fathoms, sand; Manzanillo (184-D-2), 30 fathoms, gravelly sand; Port Guatulco (195-D-2), 3 fathoms, sand; Nicaragua: Corinto (200-D-17, 19), 7-13 fathoms, sand, mangrove leaves, also beach.

Description: Shell round, nearly equilateral, inflated, with divaricate sculpture.

Shells of the species attain a height of 25 mm.

The name *Divaricella lucasana* was proposed by Dall & Ochsner because of the citation of *Lucina eburnea* Andrzejowski by Deshayes. So far as we have been able to ascertain the name cited by Deshayes is a *nomen nudum* and if the species was not formally described it does not invalidate the use of the same combination of names by Reeve. However, Lamy (1931) also considered Reeve's species to be nomenclatorially invalid and proposed a new name for it. Whether or not Reeve's name must be abandoned appears to be open to question. We have, at least for the present, used the name applied to the species by Dall & Ochsner.

Dall proposed the name *Divaricella parvula* for *Lucina pisum* Philippi, 1850, not *L. pisum* Sowerby, 1837. According to Dall *Divaricella parvula* differs from *D. eburnea* [= *lucasana*] in that it possesses a smaller shell which is ornamented by weaker external sculpture. There is variation in the size of the shell and in the sculpture of *Divaricella lucasana* and it seems doubtful whether two distinct species of *Divaricella* occur in this region.

Divaricella quadrisulcata d'Orbigny, which occurs in the Caribbean region, is a similar species.

Distribution: *Divaricella lucasana* was taken by the expedition at various localities from Santa Inez Bay in the Gulf of California to Nicaragua, on the beach and at depths of 2½ to 30 fathoms. It was found abundantly on the beach at Cape San Lucas and at Corinto, Nicaragua. It is also known to occur in the Pliocene and Pleistocene of the Gulf of California region and in the Pleistocene of Oaxaca, Mexico, and the Galápagos Islands.

EXPLANATION OF THE PLATE.

- Fig. 1. *Pseudochama saavedrai* Hertlein & Strong, sp. nov. Holotype, left valve, from Station 184-D-1, dredged in Lat. 19° 03' 45" N., Long. 104° 20' 45" W., off Manzanillo, Mexico, in 25 fathoms (45 meters). Approximately natural size. View of the interior. P. 110.
- Fig. 2. *Periploma teevani* Hertlein & Strong, sp. nov. Holotype, right valve, from Station 196-D-19, dredged in Lat. 15° 44' N., Lon. 96° 05' W., Tangola-Tangola Bay, Oaxaca, Mexico, in 30 fathoms (55 meters). Length, 23 mm.; height, 19 mm. View of the exterior. P. 95.
- Fig. 3. *Pseudochama saavedrai* Hertlein & Strong, sp. nov. Holotype. View of the

exterior of the specimen shown in Fig. 1.

- Fig. 4. *Cyathodonta lucasana* Dall. Hypotype, left valve, from Station 195-D-9, dredged in Lat. 15° 44' 28" N., Long. 96° 07' 51" W., Port Guatulco, Mexico, in 7 fathoms (12.6 meters). Length, 21 mm.; height, 14 mm.; convexity (one valve), 3.4 mm. P. 96.
- Fig. 5. *Pandora (Kennerlia) convexa* Dall. Hypotype, left valve, from Cape San Lucas, Lower California, Mexico. Length, approximately 13.4 mm., height, 8.2 mm.; convexity (both valves), 2.5 mm. P. 97.
- Fig. 6. *Periploma teevani* Hertlein & Strong, sp. nov. Holotype. View of the interior of the left valve of the specimen shown in Fig. 2.
- Fig. 7. *Verticordia ornata* d'Orbigny. Hypotype, right valve, from Station 203-D-3, dredged in Lat. 10° 55' 45" N., Long. 85° 49' 05" W., Port Parker, Costa Rica, in 12 fathoms (22 meters). Length, approximately 3.2 mm.; height, approximately 3 mm. P. 102.
- Fig. 8. *Pseudochama saavedrai* Hertlein & Strong, sp. nov. Holotype. View of the interior of the right valve of the specimen shown in Fig. 1. Length, 40.5 mm.; height, 46 mm.
- This specimen is attached to the shell of a gastropod shown in the upper left part of the figure.
- Fig. 9. *Cyathodonta lucasana* Dall. Hypotype. View of the exterior of the specimen shown in Fig. 4.
- Fig. 10. *Pseudochama saavedrai* Hertlein & Strong, sp. nov. Holotype. View of the exterior of the specimen shown in Fig. 8.
- Fig. 11. *Ctena clarionensis* Hertlein & Strong, sp. nov. Holotype, right valve, from Sulphur Bay, Clarion Island, Revillagigedo Islands, Mexico. Length, 13.8 mm., height, 12.5 mm. P. 118.
- Fig. 12. *Ctena clarionensis* Hertlein & Strong, sp. nov. Holotype, right valve. View of the exterior of the specimen shown in Fig. 11.
- Fig. 13. *Lucina (Miltha) xantusi* Dall. Hypotype, right valve, from Station 136-D-5, dredged in Lat. 23° 31' N., Long. 109° 27' 30" W., Arena Bank, southern part of the Gulf of California, in 33 fathoms (60 meters). Length, 68 mm.; height, 71.2; convexity (both valves), 23 mm. P. 115.
- Fig. 14. *Ctena clarionensis* Hertlein & Strong, sp. nov. Holotype. View of the interior of the left valve of the specimen shown in Figs. 11 and 12.

All the specimens illustrated on this plate are in the type collection of the Department of Paleontology of the California Academy of Sciences.

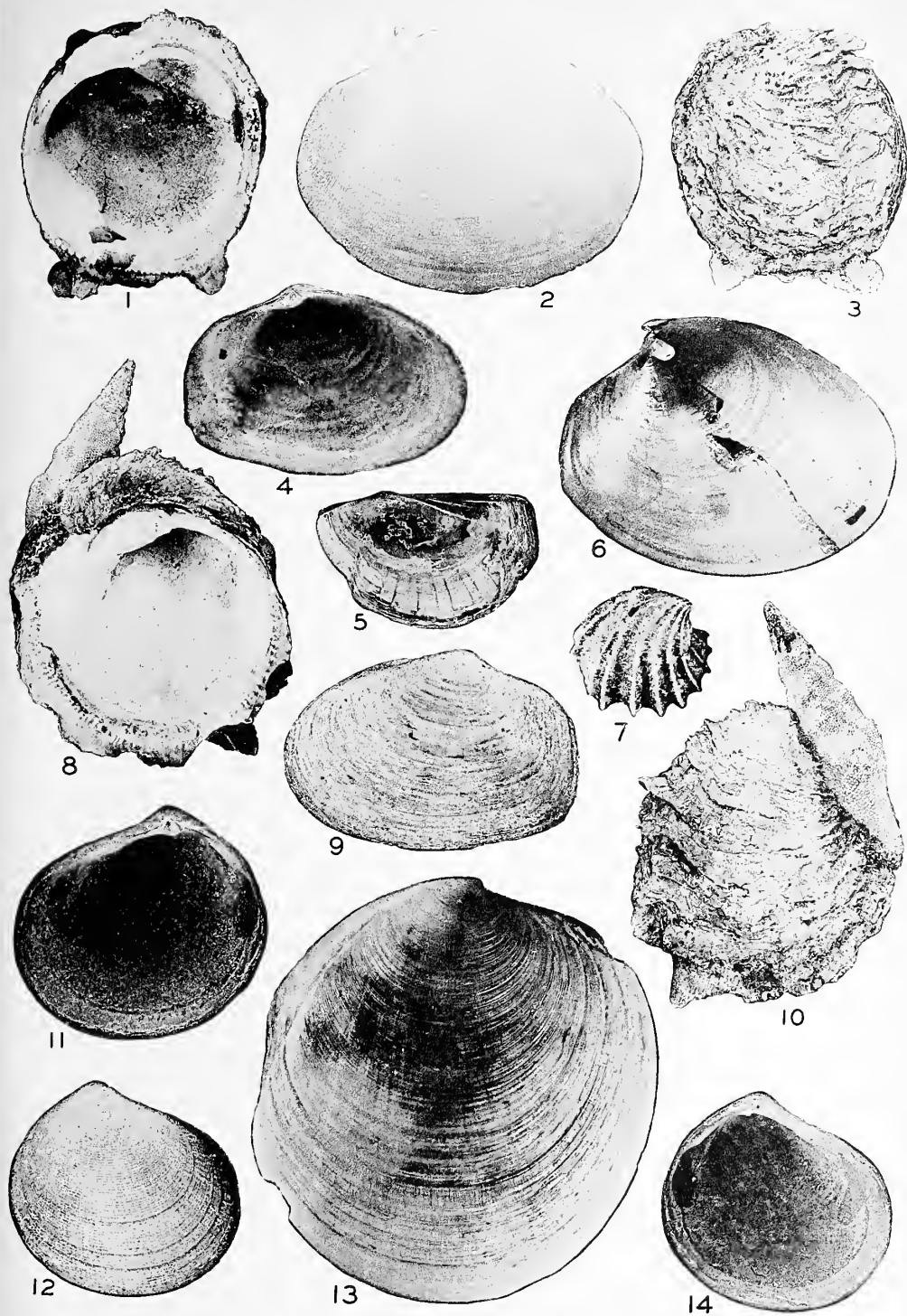

MOLLUSKS FROM THE WEST COAST OF MEXICO AND CENTRAL AMERICA.



9.

Effects of Sex Hormones on the Development of the
Platyfish, *Platypoecilus maculatus*¹.HERMAN COHEN²

Department of Biology, Washington Square College of Arts and Sciences, New York University.

(Plates I-V; Text-figure 1).

In a discussion of the relation of genic and endocrine factors in sex determination Danforth (1939) used the term *genic* to refer in a general way to the influences emanating from the nucleus and dependent upon its genetic constitution. To the term *environmental* he referred all influences reaching a cell from beyond the limits of its own cytoplasm. He suggested that hormones and organizers even when of autogenous derivation belong to the environmental group. However, he distinguished between the *internal* and *external* environmental agents depending on whether or not they normally arise within the individual.

In an effort to evaluate the part played by the environmental agents determining sex it is desirable to use an organism in which the genetical mechanism for sex determination and the embryological history of the germ cells are known. In the domesticated stocks of the Mexican viviparous platyfish, *Platypoecilus maculatus* Bellamy (1922, 1928), Gordon (1927, 1937), Fraser and Gordon (1929) and others showed that the chromosomal regulation of sex may be expressed by the formula: WZ = female, ZZ = male. The history of the platyfish germ cells from their earliest appearance in the 1.2 millimeter embryos through their post-embryonic development and adult stages were described in great detail by Wolf (1931). He pointed out that definitive ovaries and definitive testes were distinguishable on the day of the platyfish's birth.

The present study is concerned with the effects of the synthetic steroid, pregnenolone upon immature, but genetically determined female platyfish and the effects of the estrogenic substance alpha-estradiol benzoate on immature, but genetically determined male platyfish. Utilizing the genetic sex determining mechanism, we sexed the platyfish within two weeks after birth and applied the hormonal chemicals to the fish at this early age. This paper will describe, but only in a

preliminary manner, the effects of the hormones on the developing gonad, skeleton, and sexual behavior. Grobstein (1940, 1942) had previously used the platyfish in studying the effects of testosterone propionate on the normal and regenerating anal fins of adults. The experimental results reported in the present report are based upon the work of Cohen (1942).

Hormonal regulation of development in poeciliid teleosts, other than *Platypoecilus maculatus*, were studied by Berkowitz (1937, 1938, 1940), Eversole (1939) and Scott (1941, 1944), all of whom used the guppy, *Lebistes reticulatus*; Turner (1941, 1942) used *Gambusia affinis*; and Regnier (1937, 1938), Baldwin and Goldin (1940), Witschi and Crown (1940), Noble and Borne (1940) studied the swordtail *Xiphophorus hellerii*. Much of this and other work was summarized and discussed broadly by Witschi (1939, 1942).

MATERIAL AND METHODS³

The genetic method used to sex immature *Platypoecilus maculatus* for these studies was as follows: a black-spotted female of the domesticated stock, heterozygous for the pigmentation pattern, (W)+(Z)Sp, was mated to an unspotted, recessive male. (Z)+(Z)+. They produced black-spotted sons (Z)+(Z)Sp, and unspotted daughters (W)+(Z)+, see Text-figure 1. The spotted pattern which is made up of clusters of large melanophores was recognized readily within a week of the fish's birth.

Fraser and Gordon (1929) indicated that crossing-over of the sex chromosomes occurred at the rate of about one per cent and this value has been recorded by other geneticists. Thus any error in sex determination, due to genetic factors, could not have been of any consequence. Furthermore, only two instances of complete and functional sex reversals have been reported during 24 years of genetic work with these fish (Gordon, 1946).

¹ Aided by the staff and facilities of the New York Aquarium, New York Zoological Society.

² Present address: E. R. Squibb and Co., New Brunswick, N. J.

³ The hormones used in these studies were kindly supplied by Dr. Erwin Schwenk of the Schering Corporation, Bloomfield, New Jersey.

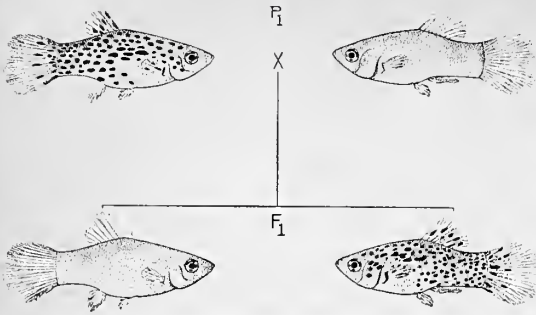

TEXT-FIG. 1. The genetic method that was used to sex immature domesticated *Platypoecilus maculatus*. A black-spotted female of the domesticated stock, heterozygous for the spotted pattern, was mated to an unspotted, recessive male. These are shown on the top line. They produced black-spotted sons and unspotted daughters, as shown on the second line. The spotted pattern may be recognized on the day of birth of the fish or within a week thereafter. (After Gordon, 1932).

Fifteen immature but genetically determined males were treated with one milligram of crystalline alpha-estradiol benzoate once a week; nineteen immature but genetically determined females were treated with five milligrams of the synthetic steroid pregnenolone once a week. Thirty-one fish were used as controls. The fish were kept in water, temperature at approximately 25°C., in three gallon glass aquaria, six animals to each tank. The hormonal substances were given to the fish beginning at an age of two weeks. Some of the animals were treated for eight weeks while others were given the hormones for twelve weeks, and still others received treatment for a maximum of twenty weeks. The fish swallowed many of the crystals as they fell through the water. Some of the crystals might have dissolved partially in the water and affected the fish directly.

All the fish were fed similarly with commercial fishfoods, dried shrimp, dried liver and occasionally they were given live tubifex worms. At the conclusion of the experiments the animals were fixed in Bouin's micro-formol fluid; the fish were measured, dissected, their gonads removed, sectioned and prepared for microscopical examination by staining with Harris' hematoxylin alum and eosin. When gonopodia were induced, these organs were removed and mounted for study in balsam or glycerin.

EXPERIMENTAL RESULTS

1. Effect of alpha-estradiol benzoate on gonads of immature, genetic male platyfish.

In the untreated, control males, the testes were found to be fused and relatively large. The sperm duct epithelial cells were cuboidal, the spermatophores were abundant and all the other stages in spermatogenesis were found. In the estrogen-treated males, the gonads were small, compact and appeared bi-

partite, the two lobes being separated by a membrane. The cells of the sperm duct epithelium were columnar; the interstitial tissue was profuse; a number of large ova were seen but spermatophores and spermatids were absent. The testicular elements that remained were spermatogonia. The general picture seen was one of a radical modification of development of the testes. As the treatment was continued the effects instead of continuing along the lines of greater modification, changed slightly in the direction of the controls. Thus after 20 weeks of treatment, the gonads were found to contain some spermatophores and none of them contained ova.

2. Effect of pregnenolone on gonads of immature, genetic female platyfish.

In the untreated, control females, the ovaries were fairly large, containing many oocytes and ova; the latter had abundant yolk material. In the pregnenolone-treated females, the ovaries were markedly changed; they were small and contained only a few oocytes. Mature ova with their usual complement of yolk were entirely wanting. The modified ovaries appeared definitely degenerate. With continuing treatment, up to 20 weeks, the conditions of gonadal degeneration were maintained. Within a single modified ovary a structure resembling a sperm duct was discovered (Fig. 8).

3. Effect of sex hormones on certain skeletal elements.

(a) Gonopodium, the modified anal fin.

In genetic males in which the testes had been modified by estrogenic substance to a point where no mature sperms or secondary spermatocytes were present, the anal fins were not transformed. However, in those fish where the treatment with estrogens did not completely inhibit spermatogenesis and mature sperm were present, perfect gonopodia were found.

Genetic females treated with pregnenolone for only two weeks developed gonopodia which, however, were aberrant in form. Similar abnormalities were described by Grobstein (1942) when he treated adult females with testosterone after removing their anal fins.

(b) Gonopodial Suspensorium.

Pregnenolone-treated females in which gonopodia were developed moved these fins just as normal males moved their gonopodia. Histological preparations of the internal skeletons of the modified females revealed that they had developed typical, male-like gonopodial suspensoria. The gonapophyses were well developed and the connections between these and the gonactinosts were present. The gonopodial muscle was strongly developed. The induced skeletal elements conformed to the descriptions of the species by Langer (1913) and by Gordon and Benzer (1945). Turner (1942) reported

TABLE I.

EFFECT OF ALPHA-ESTRADIOL BENZOATE ON GONADS OF DEVELOPING MALE PLATYFISH.

No.	Estrogen	Control	Estrogen	Control	Estrogen	Control
	4	4	5	5	6	5
Age	2 Weeks	2 Weeks	2 Weeks	2 Weeks	2 Weeks	2 Weeks
Duration	8 Weeks	8 Weeks	12 Weeks	12 Weeks	20 Weeks	20 Weeks
Gross Gonad	Small, bipartite, compact	Loose, fused	Small, bipartite, compact (fig. 3)	Large, loose, fused (fig. 1)	Small, bipartite, compact	Large, loose, fused
Sperm Duct Epithelium	Columnar	Low, cuboidal	Columnar	Low cuboidal almost squamous	Columnar	Low cuboidal
Interstitial Tissue	Profuse	Scant	Profuse (fig. 4)	Scant (fig. 2)	Profuse	Scant
Presence of Ova	Large ova (fig. 5)	Absent	Absent	Absent	Absent	Absent
Spermatophores	Absent	Profuse	Absent	Profuse (fig. 1)	Few	Profuse
Spermatids	Absent	Present	Absent	Present	Few	Few
Physiological Status	Inhibited	Active	Inhibited	Highly active	Slightly active	Highly active

similar results in treating female *Gambusia*, while Scott (1944) obtained them in *Lebistes*.

(c) *Caudal fin rays*.

In females treated with pregneninolone the shortening of the 7th, 8th and 9th caudal fin rays, and the lengthening of the 6th fin ray were induced. These changes produced a tiny sword-like extension on the tail fin, a feature which is characteristic of a related species, *Platypoecilus xiphidium*. In normal *P. maculatus* the caudal fins were symmetrical; in addition, the fin rays are strong and their terminal elements bifurcate at least once. The fin rays of treated females were not bifurcate at their tips and they were of a smaller dimension than those of the normal animals (Figs. 10, 11, 12).

4. *Effect of sex hormones on total body size and form*.

The females treated with androgens approached the body form and size of normal males (Table III). The males treated with estrogens resembled normal females. The values for body form were determined by dividing the value of their body length (not including tail fin; this is the standard length) by the value of their body width

(measured from the base of anterior margin of the dorsal fin to the mid-point between the origins of the pelvic fins).

Normal female platyfish exceeded the males in standard length. The treated females showed the generalized effects of the androgens by their relatively smaller size. On the other hand, the estrogen-treated males attained a size greater than did their controls. These results confirmed those obtained by Scott (1944) in *Lebistes*.

5. *Effects of sex hormones on sexual behavior*.

Masculinized females when placed in an aquarium with normal females were aggressive, pursued the normal females, thrust their gonopodia toward them and attempted to copulate with them.

Males feminized by treatment with estrogens for seven weeks when placed in an aquarium with normal females made no attempt to pursue or mate with them. Later when the normal females were removed and were replaced with normal males, the normal males pursued the feminized males and attempted to mate with them. These observations were carried out two or three times a week for a period of a month.

TABLE II.

EFFECTS OF PREGNENINOLONE ON GONADS OF DEVELOPING FEMALE PLATYFISH.

	No. of ♀	Duration of Experiment	Size of Gonad	Oocytes	Ova	Yolk Deposition	Physiological Status
Treated	19	5-20 Weeks	Very small (fig. 7)	Very few present	Absent	Inhibited	Inhibited (fig. 9)
Control	19	5-20 Weeks	Large (fig. 6)	Many present	Present	Active	Active

TABLE III.
FORM INDEX⁴.

Alpha-estradiol Benzoate-treated Males			Pregneninolone-treated Females		
Length Cm.	Width Cm.	Form Index	Length Cm.	Width Cm.	Form Index
1.95	.65	3.0	1.55	.45	3.4
2.2	.70	3.14	1.9	.50	3.8
2.4	.85	2.8	2.05	.65	3.18
2.35	.80	2.9	1.3	.40	3.25
2.3	.70	3.2	1.9	.50	3.80
1.9	.70	2.7	1.4	.40	3.50
1.7	.60	2.8	1.4	.40	3.50
2.2	.80	2.75	1.55	.45	3.40
1.75	.60	2.9	1.50	.45	3.33
1.85	.70	2.6	1.40	.40	3.50
Mean		2.90	Mean		3.50
					$t = 6.7$ $P < 0.001$
Normal Males			Normal Females		
1.75	.50	3.50	2.1	.74	2.8
2.20	.60	3.67	2.1	.75	2.8
1.73	.45	3.80	2.1	.75	2.8
1.75	.50	3.50	1.8	.70	2.56
1.75	.50	3.50	2.55	.85	3.00
1.73	.45	3.80	2.6	.90	2.90
1.75	.45	3.50	2.6	.90	2.90
Mean		3.61	Mean		2.82
					$t = 9.8$ $P < 0.001$

⁴ The data on form index differences in males and females were treated according to the methods described by Simpson and Roe in Quantitative Zoology (1939:210-211) for the comparison of the means of two small samples. The data are significant.

DISCUSSION

The newly born platyfish is about 6.5 mm. long. At this stage, according to Wolf (1931) who traced the history of their germ cells, sex differentiation has already occurred. In the immature female, the paired gonads are fused medially; the germ cells have multiplied, spread throughout the body of the gland and enlarged to two or three times their original size. A number of stroma cells surround them, forming oocytes, and this is the first indication of follicle formation. When pregnenolone is applied to two-week-old fishes, apparently oogenesis is inhibited beyond oocyte development for no ova were found after 5, 8, 11 and 20 weeks of treatment; in one female a sperm duct-like structure was found. The gonads of the control fish contained all stages of oogenesis including yolk-filled ripe ova. These results were similar, for the most part, to work on female swordtails and guppies.

The work of Vivian (1939) and Matthews (1939), who hypophsectomized *Fundulus* females and found that maturation of the primary oocytes was suppressed, and the work of Hasler, Meyer and Field (1939) on inducing trout to spawn prematurely with the aid of pituitary glands of the carp, are suggestive of the possibility that the pituitary function in female platyfish was inhibited by the application of pregnenolone. This appears

likely for not only were the oogenesis processes interrupted in treated platyfish, but the larger size of the normal female was never reached by pregnenolone-treated females.

In the early postnatal male platyfish Wolf found that the germ cells are pushed out to the periphery of the gland, so that the center of the embryonic testis is occupied by stroma cells only, and this condition he reported is similar to the one found in *Xiphophorus hellerii*. The stroma cells cluster to form a duct which is destined to be the sperm duct. In slightly older fish (9 to 12 mm.) Wolf found that the gonads are united and partially fused, but even the mature testis shows its bilateral origin in its bilobed contour, but it is not bipartite. In the normal 16 mm. or late juvenile testis, spermatocytes only are present; indeed, at this stage there seems to be a great deal of degeneration of the sex cells in the normal fish. This degeneration is attributed to the rapid proliferation of the germ cells with an inadequate blood supply for all of them. Wolf is convinced, however, that this degeneration of some germ cells has no significance in the history of the germ cells. In the definitive adult gonad, in *Platy-poecilus* and in *Xiphophorus*, Wolf found no seminiferous tubules. Acini form from pre-existing acini at the periphery of the testis, which in turn are descended from the primordial germ cells, and as they form they are

pushed in toward the center of the testis. Wolf is emphatic in his belief that neither the peritoneal covering of the testis, the stroma cells, nor the cells of the sperm duct transform into sex cells.

The generalized effects of treating genetically determined male platyfish with alpha-estradiol benzoate was the suppression of spermatogenesis beyond the spermatocyte stages and in the induction of ovo-testes in some instances. In males treated for 8 weeks large ova were found; in males treated for 12 weeks a few small oocytes were found, while in males treated for 20 weeks no oocytes or ova were seen. This indicates a lessening of effectiveness of the estrogen. In the early stages of the treatment an insufficient testicular secretion may have been overruled by the applied estrogen; in more mature males the normal testicular secretion may have been sufficient. The generalized inhibitory effects of normal testicular development by estrogens have been reported in the swordtail and guppy. However, the experiments of Crown (1941) described briefly by Witschi (1942) show that many *Xiphophorus* females may become masculinized by estrone, too. Their ovaries regress, the anal fin transforms incompletely into a gonopodium and the sword characteristic of the male tail fin begins to form. One might wish that the genetic sex determining mechanism in the swordtail was as clear as that in the platyfish. Nevertheless, we have one confirmatory fact to add in this connection. We had a gravid female platyfish which produced a brood under normal conditions. It was then subjected to alpha-estradiol benzoate treatment for three months; at frequent intervals it was allowed the company of a fertile male platy under normal conditions. After the three month period, the treatment was discontinued. While under the influence of the estrogen, it did not produce any further broods, but after the fourth month, six weeks after the treatment was over, it had another brood. In this instance the estrogenic hormones may have affected the sperm adversely within the oviduct, or they may have prevented oogenesis.

Gardner and Pfeiffer (1945) reviewed the subject of the influences of estrogens and androgens on the skeletal systems of higher vertebrates, but gave only passing attention to fishes. Grobstein (1941) found that gonopodia regenerated in place of normal anal fins in female platyfish when subjected to testosterone treatment, and similar results were found in *Gambusia* by Turner (1941, 1944) and in *Mollienisia* by Cummings (1943).

The gonopodium articulates with a complex internal skeletal and muscular mechanism which makes possible the movement of the copulatory fin. The hemal spines of

the first three caudal vertebrae become modified into gonapophyses and the anterior interhemal spines become modified into a series of fused gonactinosts; in addition, a powerful gonopodial muscle is developed in normal adult male platyfish. The skeletal gonopodial suspensorial elements in the male platyfish were first described by Langer (1913) and more recently in a comparative way by Gordon and Benzer (1945). Similar gonopodial suspensorial elements were induced in treating young females with pregnenolone. This androgen also modified the structures of the caudal fin, the most interesting effect being the induction of a tiny sword in female *Platypoecilus maculatus* which is taxonomically diagnostic of *Platypoecilus xiphidium*. This feature was discussed previously by Gordon, Cohen and Nigrelli (1943). In addition, we have found a specific effect of androgens in suppressing the tertiary bifurcation of the caudal fin rays and in reducing the calibre of the rays.

Berkowitz (1938) showed that estrogens increased the size of *Lebistes* males beyond that usually attained by them, and Eversole (1941) found that androgens reduce the size attained by female guppies. In our experiment, these general results were confirmed in the platyfish. In addition, the body contour characteristic of the normal female was induced in estrogen-treated males and that of the male was obtained in pregnenolone-treated females. Gerschler (1914) and Bellamy (1922) measured platyfish and found that the greatest depth divided into the standard length produced the body index value of 2.7 in both sexes, but Chambers (unpublished) found that females had a greater depth than the males, and our figures are in line with those of Chambers (1935).

Noble and Borne (1940) showed that androgens would elevate the rank of an individual swordtail in the social hierarchy of a group living under aquarium conditions. Androgen treatment caused female guppies to act like males in their great sexual drive, according to Eversole (1940, 1941). The difference in the sexual behavior in *Lebistes* is great; the females (according to Breder and Coates, 1935) show no response whatever, while the males are ceaseless in their courtship activities.

Braddock (1945) found that a social hierarchy is present in a group of platyfish. We found that the behavior patterns in platyfish may be reversed completely by the treatment of females with pregnenolone and the treatment of males with alpha-estradiol benzoate, and this is in line with the results of others working with many species of fishes and other vertebrates.

In summarizing the work on hormonal regulation of development in lower vertebrates, Witschi (1942) claimed that sex hormones

have relatively little to do with primary sex differentiation, and that the inductor substances, which play their roles at earlier stages of the ontogenetic process than sex hormones, belong to a separate class of chemical materials. It appears then in order to tackle this general problem of the influence and nature of the internal and external environmental agents in sex-determination, it is desirable to know accurately and in advance the genetic sex of an individual before treatment. For this purpose the platyfish, *Platypoecilus maculatus*, and their sex-linked characters might provide the suitable test animals.

SUMMARY.

Alpha-estradiol benzoate suppressed spermatogenesis but stimulated the development of connective and interstitial tissues in genetic, immature male *Platypoecilus maculatus*. The transformation of the anal fins into gonopodia was prevented. Young males treated for 8 to 12 weeks showed ova in ovo-testes; males treated 20 weeks showed no ova and indicated a falling off of the inhibiting effects of the estrogen.

Pregneninolone suppressed oogenesis and yolk formation in genetic, immature female platyfish. The effects did not diminish in animals treated for 20 weeks; on the contrary, the ovaries showed greater degeneration. The following male-like characters appeared: gonopodia, elements of the gonopodial suspensorium: gonapophyses and gonactinosts. In addition, tiny sword-like extensions appeared in the caudal fins. Bifurcations of the fin rays did not proceed beyond the primary stage.

Immature females treated with pregnenolone developed a body index and body size characteristic of normal males, while immature males treated with alpha-estradiol benzoate developed the body index and body size characteristic of normal females.

Pregneninolone-treated females developed courtship behavior patterns characteristic of males; they became aggressive; pursued and thrust their gonopodia toward and attempted to copulate with normal mature females. Estrogen-treated males behaved like females; they lost their aggressiveness and normal males pursued them. None of the sexually reversed males or females were fertile.

The use of genetic methods for the determination of the genic sex of the immature animal was suggested as a desirable tool in evaluating the effects of the environmental agents like sex hormones on sexual development.

REFERENCES

- BALDWIN, F. M., AND GOLDIN, H. S.
1939. Effect of testosterone propionate on the female *Xiphophorus helleri*. *Proc. Soc. Exp. Biol. and Med.*, 42:813.
- BELLAMY, A. W.
1922. Breeding experiments with the viviparous teleosts *Xiphophorus helleri* and *Platypoecilus maculatus*. *Anat. Rec.*, 23:98.
1928. Bionomic studies on certain teleosts (Poeciliinae). II. Color pattern inheritance and sex in *Platypoecilus maculatus*. *Genetics*, 13:226.
- BERKOWITZ, P.
1937. Effect of estrogenic substances in *Lebistes reticulatus*. *Proc. Soc. Exp. Biol. and Med.*, 36:416.
1938. Effect of estrogenic substances in *Lebistes reticulatus*. *Anat. Rec.*, 71:161.
1941a. The response of fish (*Lebistes reticulatus*) to mammalian gonadotropins. *J. Exp. Zool.*, 86:247.
1941b. Effect of estrogenic substances in the fish (*Lebistes reticulatus*). *J. Exp. Zool.*, 87:233.
- BREDER, C. M. AND C. W. COATES
1935. Sex recognition in the guppy, *Lebistes reticulatus*. *Zoologica*, 19:187.
- BRADDOCK, J. C.
1945. Some aspects of the dominance-subordination relationships in *Platypoecilus maculatus*. *Phys. Zool.*, 18:176.
- CHAMBERS, V. M.
1935. A statistical investigation of *Platypoecilus*. Cornell Univ. Library, Ithaca.
- COHEN, HERMAN
1942. Effects of androgens and estrogens on *Platypoecilus maculatus*. Master's Thesis in Washington Square College Library, New York Univ., New York.
- CUMMINGS, J. B.
1943. Quantitative studies on the induction of Gonopodia in females of *Mollienisia latipinna*. *J. Exp. Zool.*, 94:351.
- DANFORTH, C. H.
1939. The interrelation of genic and endocrine factors in sex. Sex and Internal Secretions, 2nd Edition, Baltimore. Williams and Wilkins.
- EVERSOLE, W. J.
1939. Effects of androgens upon the fish *Lebistes reticulatus*. *Endo.*, 25:328.
1941. Effect of pregnenolone and related steroids on sexual development in fish *Lebistes reticulatus*. *Endo.*, 28:603.
- FRASER, A. C., AND MYRON GORDON.
1929. The genetics of *Platypoecilus*. II. The linkage of two sex-linked characters. *Genetics*, 14:160.
- GARDNER, W. V., AND C. A. PFIEMER.
1945. Influence of estrogens and androgens on the skeletal system. *Physiol. Reviews*, 23:139.
- GRSCHLER, M. W.
1914. Über alternative Vererbung bei Kreuzung von Cyprinodontiden-Gattungen. *Ztsch. f. Ind. Abstam. u. vererb.*, 12:73.

- GORDON, M.
 1927. The genetics of a viviparous top-minnow *Platypoecilus*; the inheritance of two kinds of melanophores. *Genetics*, 12:253.
 1932. The scientific value of small aquarium fishes. *N. Y. Zool. Soc. Bull.*, 35:10.
 1946. Interchanging genetic mechanisms for sex determination in fishes under domestication. *Journal of Heredity* (in press).
- , AND P. BENZER.
 1945. Sexual dimorphism in the skeletal elements of the gonopodial suspensoria in xiphophorin fishes. *Zoologica*, 30:57.
- , H. COHEN AND R. F. NIGRELLI.
 1943. A hormone produced taxonomic character in *Platypoecilus maculatus* diagnostic of *P. xiphidium*. *Amer. Nat.*, 77:569.
- GROBSTEIN, C.
 1940. Endocrine and developmental studies of gonopod differentiation in certain poeciliid fishes. I. The structure and development of the gonopod in *P. maculatus*. *U. Calif. Publ. Zool.*, 47:1.
 1941. Effect of testosterone propionate on the regenerating anal fin of adult *Platypoecilus maculatus* females. *Proc. Soc. Exp. Biol. and Med.*, 45:484.
 1942. Endocrine and developmental studies of gonopod differentiation in certain poeciliid fishes. II. Effect of testosterone propionate on the normal and regenerating anal fin of adult *Platypoecilus maculatus* females. *J. Exp. Zool.*, 89:305.
- HASLER, A. D., R. K. MEYER AND H. M. FIELD.
 1939. Spawning induced prematurely in trout with the aid of pituitary glands of the carp. *Endo.*, 25:978.
- LANGER, W. F.
 1913. Beiträge zur Morphologie der viviparen Cyprinodontiden. *Morph. Jahrb.*, 47:193.
- MATTHEWS, S.
 1939. Relationship between the pituitary gland and the gonads in *Fundulus*. *Bio. Bull.*, 76:241.
- NOBLE, G. K. AND R. BORNE.
 1940. Effects of sex hormones on the social hierarchy of *Xiphophorus helleri*. *Anat. Rec.*, 78:147.
- REGNIER, M.
 1937. Action des hormones sexuelles sur l'inversion du sex chez *Xiphophorus helleri*. *C. r. Acad. Sci. Paris*, 205:451.
 1938. Contribution à l'étude de la sexualité des Cyprinodontes vivipares. *Bull. Biol. Fr. et Belg.*, 72:385.
- SCOTT, J.
 1941. The effect of steroid hormones upon the skeleton of *Lebistes reticulatus*. *Anat. Rec.*, 81:90.
 1944. The effects of steroids on the skeleton of *Lebistes reticulatus*. *Zoologica*, 29:49.
- TURNER, C. L.
 1941. Gonopodial characteristics produced in the anal fins of females of *Gambusia affinis* by treatment with ethynyl testosterone. *Bio. Bull.*, 80:371.
 1942. Morphogenesis of the gonopodial suspensorium in *Gambusia affinis* and the induction of the male suspensorial characters in the female by androgenic hormones. *J. Exp. Zool.*, 91:167.
- VIVIEN, J.-H.
 1939. Relations hypophyso-génitales chez quelques téléostéens et selaciens. *C. r. Soc. Biol.*, 131:1222.
- WITSCHI, EMIL.
 1939. Modification of the development of sex, in lower vertebrates and in mammals. *Sex and Internal Secretions*, 2nd Ed., Baltimore. Williams and Wilkins.
 1942. Hormonal regulation of development in lower vertebrates. *Symposia in Quantitative Biology (Cold Spring Harbor)* 10:145.
- , AND E. W. CROWN.
 1937. Hormones and sex determination in fishes and in frogs. *Anat. Rec.*, 70:121.
- WOLF, L. E.
 1931. History of the germ cells in the viviparous teleost *P. maculatus*. *J. Morph. Physiol.*, 52:115.

EXPLANATION OF THE PLATES

PLATE I.

- Fig. 1. *Testis of Normal Male, 12 Weeks Old.* This normal testis is fused with no evidence of an earlier developmental bipartite gonad. All stages of spermatogenesis including many spermatophores (*Sp*) are represented. The interstitial tissue is scant; the gonad as a whole is loosely constructed. 100X.
- Fig. 2. *Testis of Normal Male, 12 Weeks Old.* This is same as above but under greater magnification. The deeply staining ring-like structures are spermatophores (*Sp*) containing mature sperms, ripe and ready for ejaculation. The spermatids and other stages of spermatogenesis (*Sr*) are represented by the lighter-staining roundish masses. 440X.
- Fig. 3. *Testis of Estrogen-treated Male, 12 Weeks Old.* This testis of a treated male shows the bipartite structure (*P* to *P*). Spermatogenesis has only proceeded to the stage of formation of spermatogonia and spermatocytes (*Sr*). Spermatids, mature sperms and spermatophores are wanting. 100X.

PLATE II.

- Fig. 4. *Testis of Estrogen-treated Male, 12 Weeks Old.* This is the same as Fig. 3 but under greater magnification. The testis is compact with a greater amount of interstitial tissue (*N*) than is found in an untreated male. Spermatogonia and spermatocytes (*Sr*) are the prevailing germinal elements. 440X.
- Fig. 5. *Ovo-testis of Estrogen-treated Male, 8 Weeks Old.* An oocyte (*O*) is present in the upper left portion of the figure. The interstitial tissue is profuse throughout the gonad. 440X.

PLATE III.

- Fig. 6. *Ovary of Normal Female, 8 Weeks Old.* The ovary is large and occupies the greater portion of the abdominal cavity. The ova (*ov*) are well developed and well filled with yolk (*Y*). The smaller circular masses are oocytes (*o*). In sectioning the ovary, the yolk within the ova fragments. 100X.
- Fig. 7. *Ovary of Pregneninolone-treated Female, 8 Weeks Old.* The ovary is very

small and compact; compare this figure with Fig. 6 which is reproduced at the same magnification. The dominant germinal elements present are oocytes (*o*). No yolk is present. 100X.

- Fig. 8. *Ovary of Pregneninolone-treated Female, 8 Weeks Old.* This ovary is shown under higher magnification. It is a tubular structure which resembles a testicular sperm duct (*Sd*). Oocytes (*o*) are found throughout. 100X.
- Fig. 9. *Abdominal Region of a Pregneninolone-treated Female, 11 Weeks Old.* The ovary is represented by a few scattered oocytes (*o*) and these germinal elements do not contain yolk. Portions of the intestine (*i*) are shown. 100X.

PLATE IV.

- Fig. 10. *Caudal Fin Rays of Normal Female.* The fin rays near their origin have a greater diameter than those shown below. At their terminal points shown here, the fin rays show a secondary (2) bifurcation. The primary (1) bifurcation may be seen through the center of the figure. The dots represent the micromelanophores. 5X.
- Fig. 11. *Caudal Fin Rays of a Pregneninolone-treated Female.* The fin rays have a narrower diameter than those of the normal shown above. The rays show only a primary (1) bifurcation. Owing to the shortening of the 7th, 8th and 9th fin rays and a lengthening of the 6th, a tiny sword-like structure was induced (*S*), a feature which resembles the "sword" of a related species, *Platy-poecilus xiphidium*. See Fig. 12. 5X.

PLATE V.

- Fig. 12. *The Platyfishes: Platypoecilus maculatus and xiphidium.* The male *P. maculatus* is on the left and the female is on the lower right. *P. xiphidium* male is on the upper right. Note the short "sword" in *P. xiphidium* male. The fin rays of all the fishes have primary and secondary bifurcations. The male *P. maculatus* has no "sword". In this paper it has been shown that a "sword" may be induced in female *P. maculatus* by the application of the androgenic substance, pregnenolone.

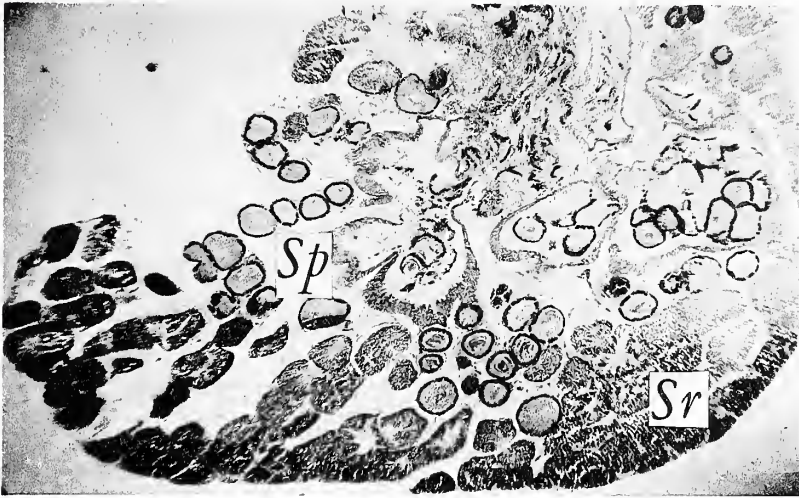

FIG. 1.

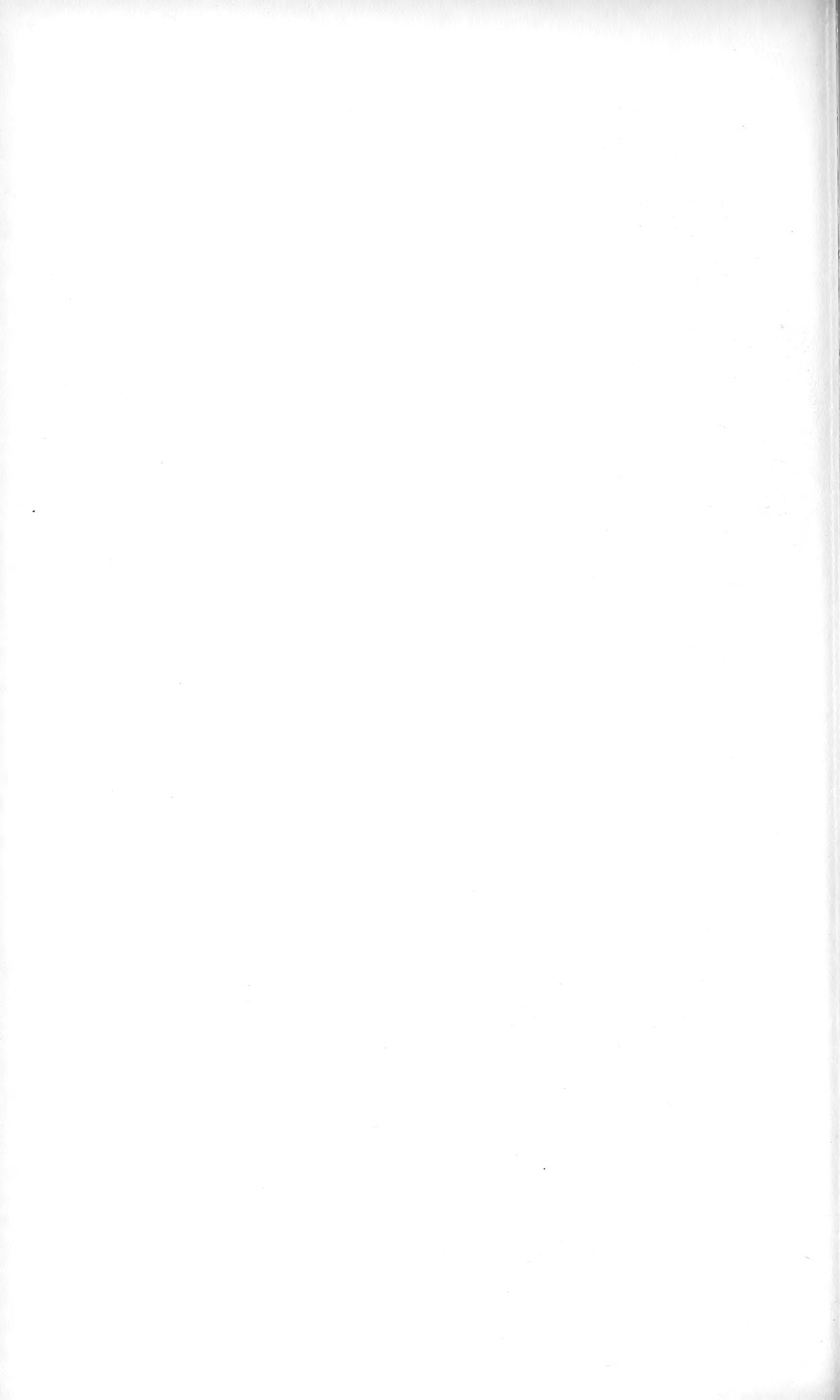

FIG. 2.



FIG. 3.

EFFECTS OF SEX HORMONES ON THE DEVELOPMENT OF THE
PLATYFISH, *PLATYPOECILUS MACULATUS*.



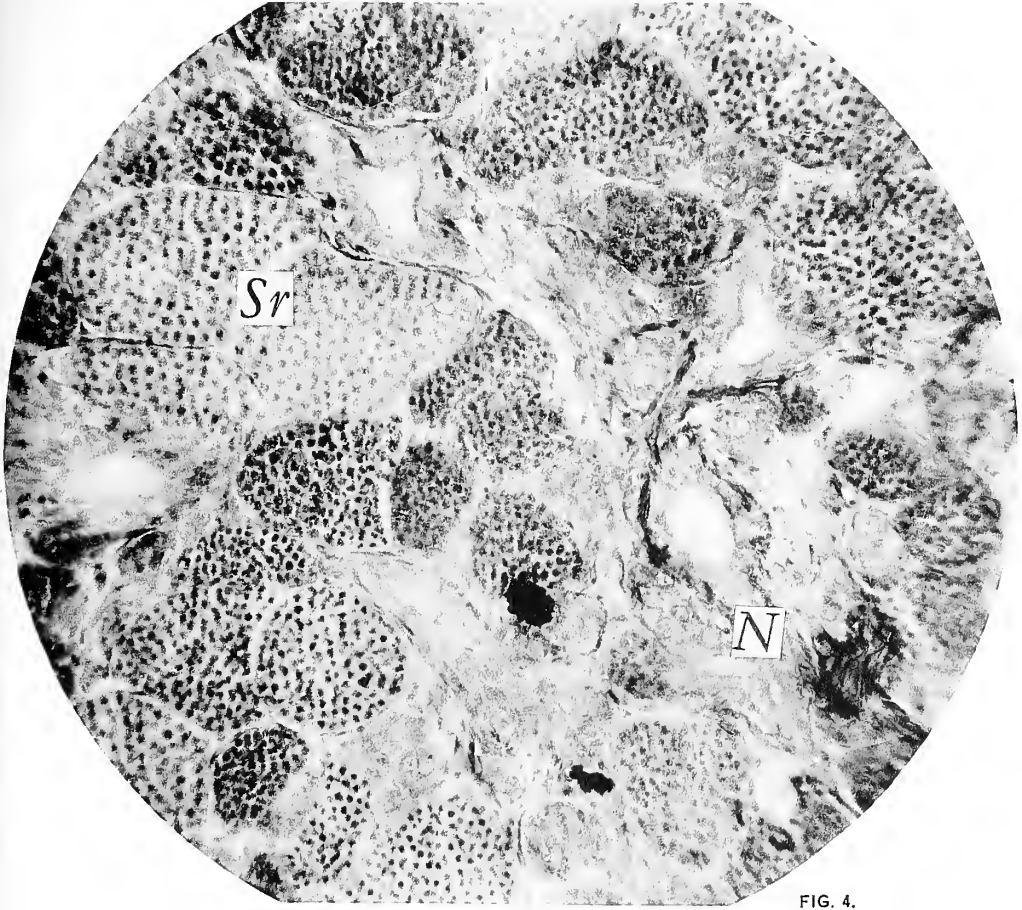

FIG. 4.

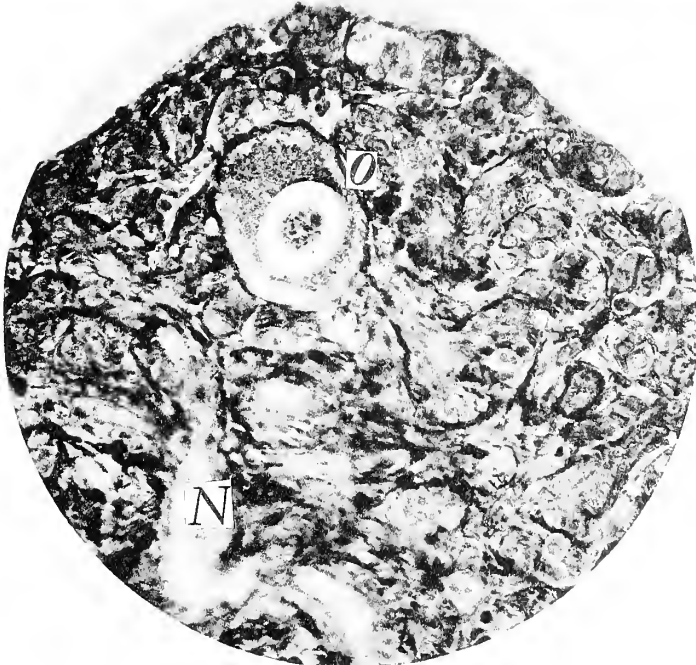

FIG. 5.

EFFECTS OF SEX HORMONES ON THE DEVELOPMENT OF THE
PLATYFISH, *PLATYPOECILUS MACULATUS*.



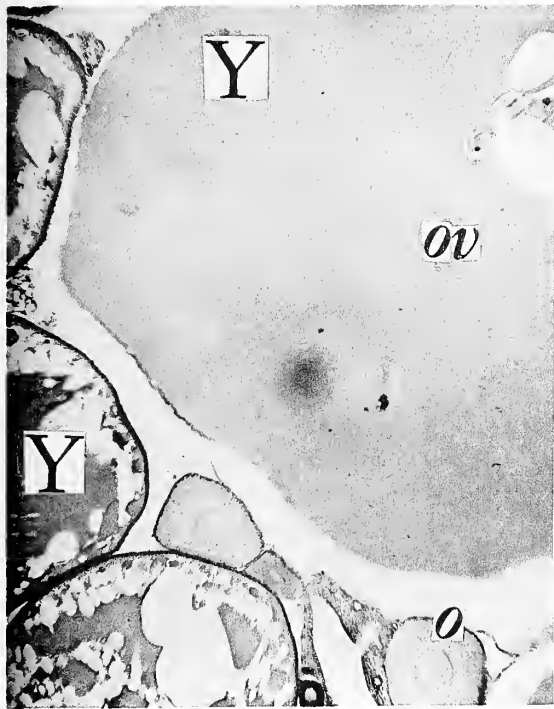

FIG. 6.

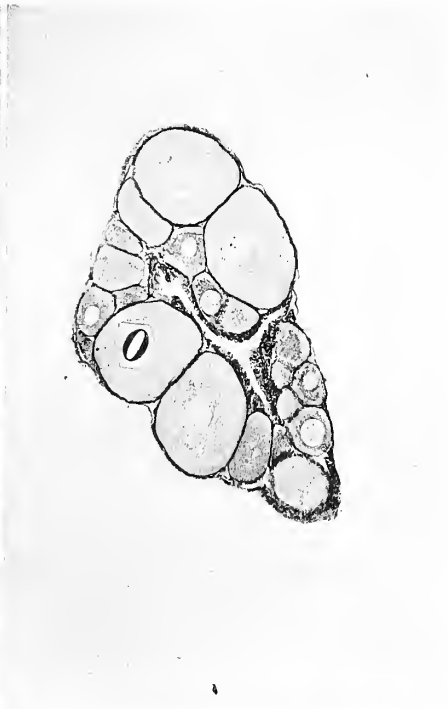

FIG. 7.



FIG. 8.

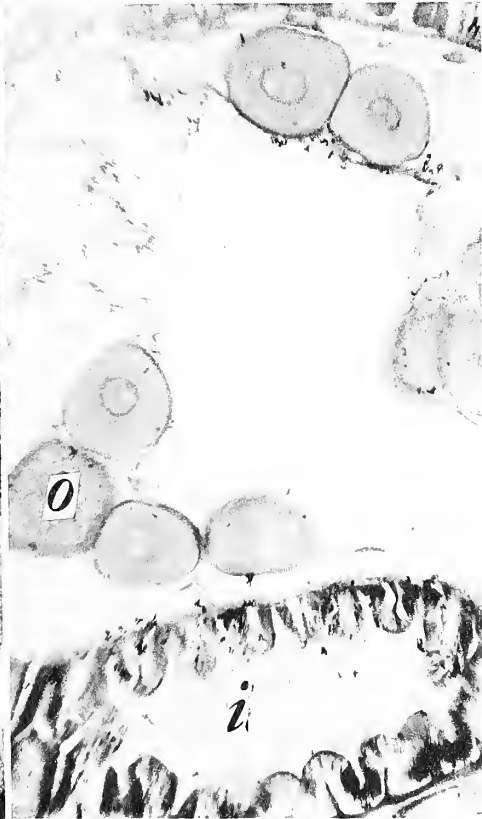

FIG. 9.

EFFECTS OF SEX HORMONES ON THE DEVELOPMENT OF THE PLATYFISH, *PLATYPOECILUS MACULATUS*.



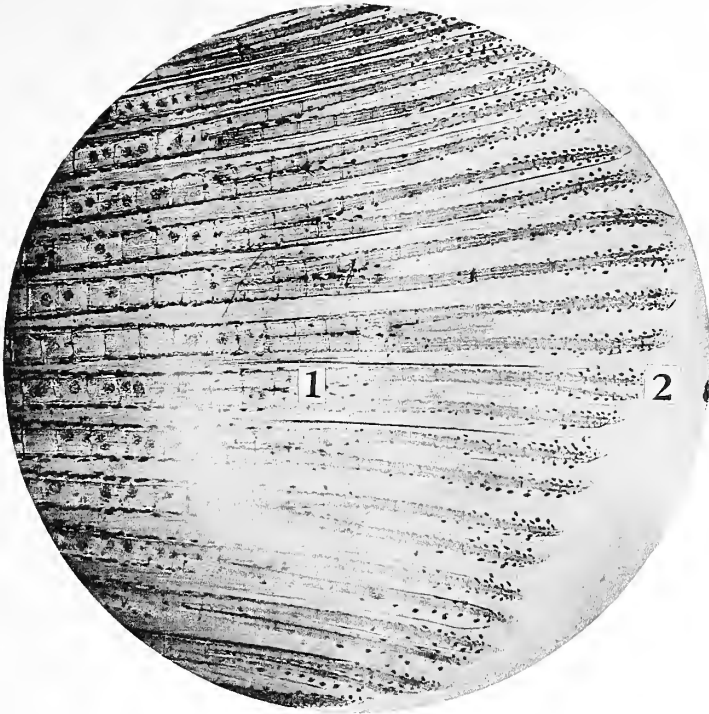

FIG. 10.

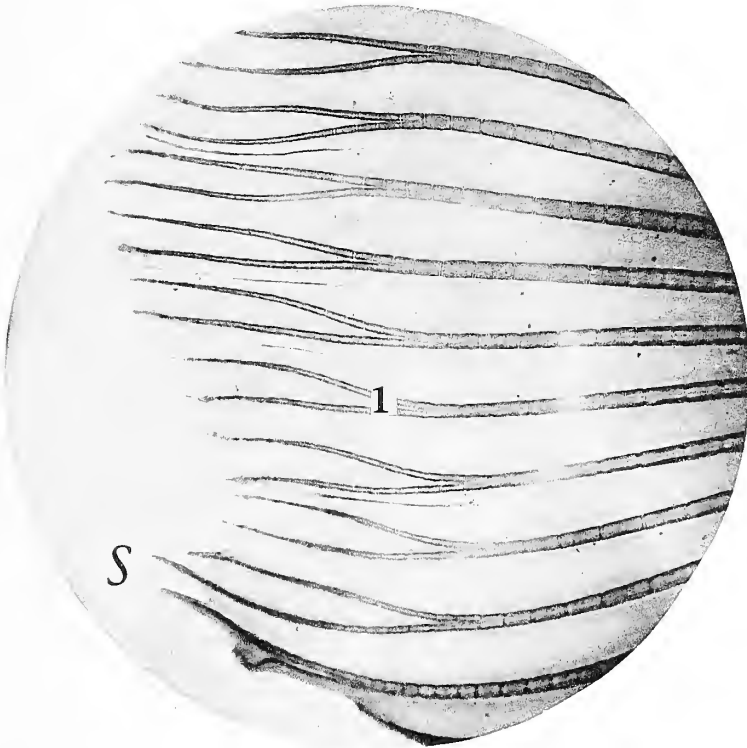

FIG. 11.

EFFECTS OF SEX HORMONES ON THE DEVELOPMENT OF THE
PLATYFISH, *PLATYPOECILUS MACULATUS*.

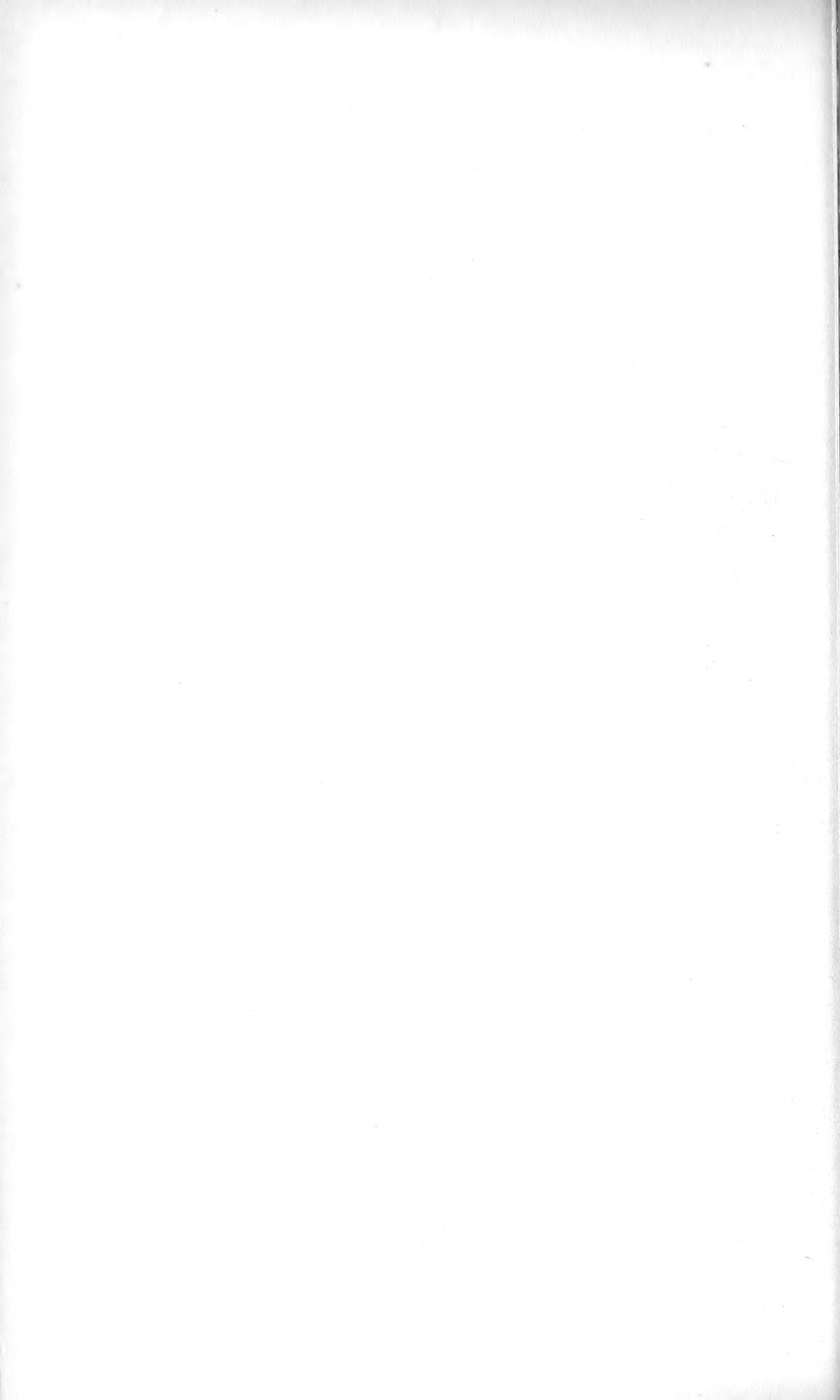

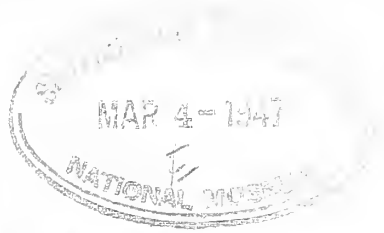

FIG. 12.

EFFECTS OF SEX HORMONES ON THE DEVELOPMENT OF THE
PLATYFISH, *PLATYPOECILUS MACULATUS*.



1565



ZOOLOGICA

SCIENTIFIC CONTRIBUTIONS
of the
NEW YORK ZOOLOGICAL SOCIETY

VOLUME 31
Part 4
Numbers 10-13

Published by the Society
The Zoological Park, New York
February 21, 1947

CONTENTS

	PAGE
10. Eastern Pacific Expeditions of the New York Zoological Society. XXXVI. Mollusks from the West Coast of Mexico and Central America. Part V. By LEO GEORGE HERTLEIN & A. M. STRONG. Plate I.	129
11. Eastern Pacific Expeditions of the New York Zoological Society. XXXVII. Deep-sea Ceratioid Fishes. By WILLIAM BEEBE & JOCELYN CRANE. Plates I-III; Text-figures 1-19.....	151
12. Spontaneous Neoplasms in Fishes. II. Fibro-carcinoma-like Growth in the Stomach of <i>Borophryne apogon</i> , A Deep-sea Cera- tioid Fish. By ROSS F. NIGRELLI. Plates I-IV.....	183
13. Studies on the Genus <i>Hirudinella</i> , Giant Trematodes of Scom- briform Fishes. By ROSS F. NIGRELLI & HORACE W. STUNKARD. Plates I-VIII.....	185
Index to Volume 31.....	197

10.

Eastern Pacific Expeditions of the New York Zoological Society. XXXVI.
Mollusks from the West Coast of Mexico and Central America. Part V.¹

LEO GEORGE HERTLEIN & A. M. STRONG.

California Academy of Sciences.

(Plate I).

[This is the thirty-sixth of a series of papers dealing with the collections of the Eastern Pacific Expeditions of the New York Zoological Society made under the direction of William Beebe. The present paper is concerned with specimens taken on the Templeton Crocker Expedition (1936) and the Eastern Pacific Zaca Expedition (1937-1938). For data on localities, dates, dredges, etc., refer to *Zoologica*, Vol. XXII, No. 2, pp. 33-46, and Vol. XXIII, No. 14, pp. 287-298.]

CONTENTS.

	Page
Introduction	129
Superfamily Lucinacea	130
Family Ungulinidae	130
Genus <i>Taras</i> Risso	130
Subgenus <i>Taras</i> s.s.	130
<i>Taras (Taras) inezensis</i> Hertlein & Strong,	
sp. nov.	130
<i>Taras (Taras) orbellus</i> Gould	130
<i>Taras (Taras) subquadratus</i> Carpenter	130
Subgenus <i>Felaniella</i> Dall	131
<i>Taras (Felaniella) obliquus</i> Philippi	131
<i>Taras (Felaniella) sericatus</i> Reeve	131
Subgenus <i>Phlyctiderma</i> Dall	132
<i>Taras (Phlyctiderma) semirugosus</i> Dall	132
Superfamily Leptonacea	132
Family Leptonidae	132
Genus <i>Erycina</i> Lamarek	132
<i>Erycina colpoica</i> Dall	132
Genus <i>Kellia</i> Turton	133
<i>Kellia suborbicularis</i> Montagu	133
Genus <i>Aligena</i> Lea	133
<i>Aligena cokeri</i> Dall	134
<i>Aligena nuca</i> Dall	134
Genus <i>Rochefortia</i> Vélain	134
<i>Rochefortia chalcidonica</i> Carpenter	134
<i>Rochefortia subquadrata</i> Carpenter	135
Genus <i>Pseudopythina</i> Fischer	135
<i>Pseudopythina chacei</i> Dall	135
Genus <i>Lasaea</i> Brown	135
<i>Lasaea petitianna</i> Recluz	136
Genus <i>Soecardia</i> Conrad	136
<i>Soecardia churnea</i> Conrad	136
Family Sportellidae	137
Genus <i>Basterotia</i> Mayer in Hörnes	137
<i>Basterotia peninsularis</i> Jordan	137
Genus <i>Sportella</i> Deshayes	137
<i>Sportella stearnsi</i> Dall	137
Superfamily Cardiacea	138
Family Cardiidae	138
Genus <i>Cardium</i> Linnaeus	138
Subgenus <i>Lophocardium</i> Fischer	138
<i>Cardium (Lophocardium) annettae</i> Dall	138
Subgenus <i>Papyridea</i> Swainson	139
<i>Cardium (Papyridea) aspersum</i> Sowerby	139
Subgenus <i>Phlogocardia</i> Stewart	140
<i>Cardium (Phlogocardia) belcheri</i> Broderip	
& Sowerby	140
Subgenus <i>Americardia</i> Stewart	140
<i>Cardium (Americardia) biangulatum</i> Broderip	
& Sowerby	140
<i>Cardium (Americardia) guanacastense</i> Hertlein	
& Strong, sp. nov.	140
Subgenus <i>Nemocardium</i> Meek	141
<i>Cardium (Nemocardium) centifolium</i>	
Carpenter	141
Subgenus <i>Mierocardium</i> Thiele	142
<i>Cardium (Mierocardium) pazianum</i> Dall	142
Subgenus <i>Mexicardia</i> Stewart	142

<i>Cardium (Mexicardia) procerum</i> Sowerby	142
Subgenus <i>Trigoniocardia</i> Dall	143
<i>Cardium (Trigoniocardia) graniferum</i>	
Broderip & Sowerby	143
<i>Cardium (Trigoniocardia) obovate</i> Sowerby	144
Subgenus <i>Laevicardium</i> Swainson	144
<i>Cardium (Laevicardium) clarionense</i> Hertlein	
& Strong, sp. nov.	144
<i>Cardium (Laevicardium) e'atum</i> Sowerby	145
<i>Cardium (Laevicardium) elenense</i> Sowerby	145
<i>Cardium (Laevicardium) elenense apicinum</i>	
Carpenter	146
Subgenus <i>Dinocardium</i> Dall	146
<i>Cardium (Dinocardium) robustum</i> Solander	146
Subgenus <i>Trachycardium</i> Mörch	147
<i>Cardium (Trachycardium) consors</i> Sowerby	147
Subgenus <i>Acrosterigma</i> Dall	147
<i>Cardium (Acrosterigma) pristipleura</i> Dall	147
Subgenus <i>Dillocardia</i> Stewart	147
<i>Cardium (Dillocardia) senticosum</i> Sowerby	147
Superfamily Cyrenacea	148
Family Corbiculidae	148
Genus <i>Polymesoda</i> Rafinesque	148
<i>Polymesoda anomala</i> Deshayes	148
<i>Polymesoda reclusii</i> Prime	148

INTRODUCTION.

This is the fifth of a series of papers dealing with collections of mollusks taken on the Templeton Crocker Expedition (1936) and the Eastern Pacific Zaca Expedition (1937-1938). The general plan of presentation followed in the present contribution is that mentioned in Part II of this series of papers². Formal headings and keys are given only for the species collected by the Expeditions of 1936 and 1937-38. Occasionally additional species are included in the keys for convenience but in such cases it is indicated which ones do not occur in the present collections.

Acknowledgment is due Dr. G. D. Hanna, Curator, Department of Paleontology of the California Academy of Sciences, and Mr. A. G. Smith, Berkeley, California, for their assistance and suggestions. Acknowledgment is especially due Dr. A. Myra Keen, Stanford University, California, for assistance in the identification of some of the species of Leptonidae and for suggestions regarding the classification of the Cardiidae. The preparation of the photographs by Mr. Frank L. Rogers is here acknowledged: his work was accomplished during the course of Federal Works Progress Administration Project Number 8569.

² Hertlein, L. G., and Strong, A. M. Eastern Pacific Expeditions of the New York Zoological Society. XXXII. Mollusks from the West Coast of Mexico and Central America. Part II. *Zoologica*, New York Zool. Soc., Vol. 28, Pt. 3, December 6, 1943, pp. 149-168, pl. 1.

¹ Contribution No. 744, Department of Tropical Research, New York Zoological Society.

MAR 4 1947

Superfamily Lucinacea.

FAMILY UNGULINIDAE [=DIPLodontIDAE].

Genus *Taras* Risso.Key to the subgenera of *Taras*.

- A. Sculpture concentric only
 a. Subglobose, nearly equilateral;
 white *Taras* s.s.
 aa. Compressed, inequilateral; a dark
 periostracum usually
 present *Felaniella*
- B. Sculpture concentric, also punctate,
 pustulate or subreticulate *Phlyctiderma*

Subgenus *Taras* s.s.Key to the species of *Taras* s.s.

- A. Shell globose
 a. Shell thick *orbellus*
 aa. Shell thin *inezensis*
- B. Shell subquadrate; thin *subquadratus*

***Taras (Taras) inezensis* Hertlein & Strong,**
sp. nov.

Plate I, Figures 1 and 4.

Shell a right valve, inflated, umbos projecting, anterior dorsal margin broadly rounded, posterior dorsal margin sloping obliquely, ventral half of margin suborbicular; hinge with anterior cardinal tooth and a posterior cardinal wide and strongly bifid in end and on top but not completely bifid in center. Length, 18.4 mm.; height, 16.9 mm.; convexity (one valve), 8 mm.

Holotype, right valve from collecting station 146-D-1, Lat. 26° 54' 20" N., Long. 111° 48' 45" W., Santa Inez Bay, east coast of Lower California, dredged in 35 fathoms (64 meters), Templeton Crocker Expedition, 1936. A small specimen of this species was dredged at Tenacatita Bay, Mexico, by the Templeton Crocker Expedition in 1932.

This new species differs from *Taras orbellus* Gould in the thinner shell, more strongly projecting beaks and umbos, the more steeply sloping dorsal margin, and in the character of the broad posterior cardinal tooth which is very strongly bifid, giving the appearance of two teeth.

The posterior dorsal margin of the shell of *Taras inezensis* is less projecting than that of *T. artemidis* Dall³ in which it is not only more projecting but subtruncate or very obliquely rounded.

***Taras (Taras) orbellus* Gould.**

Lucina orbella Gould, *Proc. Boston Soc. Nat. Hist.*, Vol. 4, November, 1851, p. 90. "San Diego, Lieut. Green."—Gould, *Boston Journ. Nat. Hist.*, Vol. 6, 1853, p. 395, pl. 15, fig. 3. "From San Diego. Lieut. Green. Santa Barbara. Col. Jewett."

³ *Diplodonta (Felaniella) artemidis* Dall, *Proc. U. S. Nat. Mus.*, Vol. 37, November 24, 1909, pp. 156, 263, pl. 28, fig. 8. "On the 'inside' or lagoon beach at Capon, in the sand." Peru.

Diplodonta orbella Gould, I. S. Oldroyd, *Stanford Univ. Publ. Univ. Ser. Geol. Sci.*, Vol. 1, 1924, p. 124, pl. 6, figs. 5 and 6. Type Locality cited. Range, Pribiloff Islands, Alaska, to the Gulf of California.

Type Locality: San Diego, California.

Range: Pribiloff Islands, Alaska, to the Gulf of California.

Collecting Stations: Mexico: East of Cedros Island (126-D-10), 60 fathoms, crushed shell and eel grass; Santa Inez Bay, Gulf of California (145-D-1-3), 4-13 fathoms, sand.

Description: The globose shell and the centrally situated inconspicuous beaks are characters which serve to separate *Taras orbellus* from other species of the genus in west American waters. This species sometimes forms a nest of sand cemented by mucus so that the shell is wholly concealed.

Distribution: Specimens of *Taras orbellus* in the present collection were dredged at depths of 4-60 fathoms, on a bottom of sand, crushed shell and eel grass. The species ranges from Alaska to the Gulf of California and also has been recorded from Miocene to Recent in western North America.

***Taras (Taras) subquadratus* Carpenter.**

Plate I, Figure 11.

Diplodonta subquadrata Carpenter, *Proc. Zool. Soc. London* for 1855 (issued February 5, 1856), p. 230. "Mazatlan." Recent.—Dall, *Proc. U. S. Nat. Mus.*, Vol. 23, 1901, p. 795. Catalina Island, California, south to Panama, in 16 to 36 fathoms.—Soot-Ryen, *Nyt Mag. Naturvid.*, Bd. 70 (Medd. Fra. Zool. Mus. Oslo, No. 27), 1932, p. 319, pl. 1, fig. 2. Floreana (Charles) Island, Galápagos Islands, Recent.

Type Locality: Mazatlan, Mexico.

Range: San Ignacio Lagoon, Lower California, to Gorgona Island, Colombia, and the Galápagos Islands.

Collecting Stations: Mexico: Arena Bank (136-D-30), 35 fathoms, sand, weed; Cerralbo Channel (137-D-3), 46 fathoms, rock; Santa Inez Bay (143-D-1), 29 fathoms, mud, crushed shell, weed, (145-D-1, 3), 4-13 fathoms, sand (146-D-1), 35 fathoms, mud, crushed shell; Gorda Banks (150-D-2, 24), 60-75 fathoms, sand, calcareous algae; Cape San Lucas, Lower California; 3 mi. off Pyramid Rock, Clarion Island (163-D-2), 55 fathoms, rock, coral; El Salvador: La Union, Gulf of Fonseca (199-D-12), 5 fathoms, mud; Nicaragua: Corinto (200-D-1-3, 16), 2-7 fathoms, mangrove leaves; Costa Rica: Port Parker (203-D-1, 3), 12-15 fathoms, sandy mud, crushed shell, shelly mud; Port Culebra (206-D-1, 2, 3), 14 fathoms, sandy mud.

Description: The shell of *Taras subquadratus* is thinner, much more compressed and quadrate in form than that of *T. orbellus*.

The cardinal teeth are less sloping than are those of *T. orbellus*, in which species they are more nearly parallel to the hinge line. The angularity of the outline of the shell of *T. subquadratus* is more pronounced in large shells. The largest specimen in the collection measures: length, 29 mm.; height, 25 mm.; convexity (one valve), 7.6 mm.

Distribution: Specimens of this species were dredged at depths of 2 to 75 fathoms. The greatest number of specimens was dredged off Port Parker, Costa Rica, in 12 fathoms. The species has been recorded from the Pleistocene of San Quintin, Lower California.

Subgenus *Felaniella* Dall.

Key to the species of *Felaniella*.

- A. Shell large, wide *sericatus*
 B. Shell small, narrow *obliquus*

Taras (Felaniella) obliquus Philippi.

Diplodonta obliqua Philippi, *Zeitschr. f. Malakozool.*, Jahrg. 3, February, 1846, p. 20. "Patria: Mazatlan."

Not *Lucina obliqua* Philippi, 1850.

Lucina calculus Reeve, *Conch. Icon.*, Vol. 6, *Lucina*, June, 1850, species 68, pl. 11, fig. 68. "Hab. Gulf of Nicoya (dredged from among coarse sand at a depth of from ten to thirteen fathoms); Cuming."

Diplodonta (Felaniella) obliqua Philippi, Dall, *Proc. U. S. Nat. Mus.*, Vol. 23, 1901, p. 796. Cape San Lucas, Lower California, to Guayaquil, Ecuador.

Type Locality: Mazatlan, Mexico.

Range: Cape San Lucas, Lower California, to Guayaquil, Ecuador.

Collecting Station: Nicaragua: Corinto (200-D-10, 11, 16, 19), 4-13 fathoms, mangrove leaves, sand.

Description: Shell small, narrow, oblique, rather compressed, polished, white.

The shell of this species differs from other west American species of the genus in the narrower, oblique form. It differs from *Lucina prolongata* Carpenter, which it somewhat resembles in shape, in possessing a thinner shell, and in lacking the depressed lunule which is present on Carpenter's species.

Taras (Felaniella) minor Dall from the Bowden Miocene of Jamaica is a somewhat similar species.

Distribution: Specimens of *Taras obliquus* were dredged by the Expedition in 4 to 13 fathoms off Corinto, Nicaragua, on a bottom of sand and mangrove leaves.

Taras (Felaniella) sericatus Reeve.

Plate I, Figure 10.

Lucina sericata Reeve, *Conch. Icon.*, Vol. 6, *Lucina*, June, 1850, species 55, pl. 9, fig. 55. "Hab.—?"—Adams & Reeve, *Voy. Samarang. Moll.*, 1848 (issued 1850), p. 80, pl.

24, fig. 6, [not the locality "Hab. Philippine Archipelago."]

Lucina cornea Reeve, *Conch. Icon.*, Vol. 6, *Lucina*, June, 1850, species 25, pl. 9, fig. 25. "Hab. Gulf of Nicoya (in coarse sand at a depth of from ten to thirteen fathoms); Cuming."

Lucina nitens Reeve, *Conch. Icon.*, Vol. 6, *Lucina*, June, 1850, species 50, pl. 9, fig. 50. "Hab. Isle of Muerte, Bay of Guayaquil (in sandy mud at a depth of about eleven fathoms); Cuming."

Diplodonta (Felaniella) sericata Reeve, Dall, *Proc. U. S. Nat. Mus.*, Vol. 23, 1901, p. 796. Lower California to Panama.

Taras parilis (Conrad) variety *sericatus* (Reeve), Grant & Gale, *Mem. San Diego Soc. Nat. Hist.*, Vol. 1, 1931, p. 295, pl. 14, figs. 12a, 12b. Earlier records cited. Pleistocene and Recent.

Type Locality: Gulf of Nicoya, Costa Rica (here designated as type locality). No locality originally cited.

Range: Monterey Bay, California (Burch); San Ignacio Lagoon, Lower California, to Guayaquil, Ecuador. [We have not seen specimens from north of San Ignacio Lagoon, Lower California.]

Collecting Stations: Mexico: Santa Inez Bay, Gulf of California (145-D-1-3), 4-13 fathoms, sand; Chamela Bay; Nicaragua: Corinto (200-D-10, 11, 16, 17, 19, also beach) 4-13 fathoms, mangrove leaves, sand; Costa Rica: Culebra Bay; Golfito, Gulf of Dulce; Panama: Gulf of Chiriqui (221-D-1-5), 35-40 fathoms, sandy mud.

Description: Shell thin, compressed, higher than long, obliquely produced posteriorly; semi-pellucid, white, covered by a pale-olive colored periostracum. A large specimen measures approximately 22 mm. from beak to base.

Large specimens of *Taras sericatus* are thicker and more quadrate in outline than juvenile forms.

The shell of this species is much wider and larger than that of *Taras obliquus*. *Taras camdeanus* d'Orbigny, which occurs in the Caribbean region, is a similar species.

The name *Lucina sericata* was originally proposed by Reeve for a specimen the locality of which was unknown. Later Adams & Reeve referred to the species and gave the locality as the Philippine Islands. Hidalgo⁴ later cited the species from the Philippine Islands and referred it to the genus *Lucina*. If this generic allocation is correct it would appear that the species referred to by Hidalgo is a different one from that described by Reeve which is a "*Diplodonta*," as pointed out by Lamy. Carpenter, Dall, Lamy and others have considered Reeve's species to be a west American shell. An additional reason for accepting this conclusion is that at least

⁴Hidalgo, J. G., *Cat. Mol. Test. Filoínas. Rev. R. Acad. Cienc. Madrid*, Vol. 3, 1905, p. 11. See also Lamy, E., *Journ. de Conchyl.*, Vol. 65, No. 4, 1921, p. 375.

three other species cited by Adams & Reeve from the East Indian region are now known to occur in tropical west American waters. These include "*Artemis dunkeri* Philippi, cited from "Eastern Seas," and *Conus borneensis*, cited from Borneo, but which is now thought to be identical with *Conus arcuatus* Sowerby, a west American species.

After a consideration of the facts relating to *Lucina sericata* we have, at least for the present, accepted it as the earliest name for the west American species discussed here. The names *Lucina cornea* Reeve and *Lucina nitens* Reeve were also applied to the same species as *L. sericata* Reeve.

Distribution: Specimens of this species were collected on the beach and dredged at depths of 4-40 fathoms from off western Mexico and Central America. It occurs south to Ecuador. We have not seen specimens from north of San Ignacio Lagoon, Lower California. It is known to occur in the Pleistocene of southern California and Lower California.

Subgenus *Phlyctiderma* Dall.

Taras (Phlyctiderma) semirugosus Dall.

Diplodonta semiaspera, ? Phil., Carpenter, Cat. Mazatlan Shells, November, 1855, p. 102. Mazatlan. Also other localities.

Not *Diplodonta semiaspera* Philippi, 1836.

Diplodonta (Phlyctiderma) semirugosa Dall, *Jour. Conch.*, Vol. 9, No. 8, October 1, 1899, p. 246. "Range. Gulf of California."—Dall, *Proc. U. S. Nat. Mus.*, Vol. 23, 1901, p. 796. Gulf of California to Panama.

Type Locality: Gulf of California.

Range: Gulf of California to Panama.

Collecting Stations: El Salvador: Meanquera Island, Gulf of Fonseca (199-D-1), 16 fathoms, sand, mud, crushed shell; La Union, Gulf of Fonseca (199-D-12), 5 fathoms, mud; Nicaragua: Corinto (200-D-10, 17), 7-10 fathoms, mangrove leaves, sand; Costa Rica: Port Parker (203-D-1, 3), 12-15 fathoms, sandy mud, crushed shell, shelly mud; Cedro Island, Gulf of Nicoya (213-D-1-10), 4-10 fathoms, mud, sand, crushed shell.

Description: Shell subrounded, moderately inflated, somewhat expanded anteriorly and posteriorly; in some specimens the posterior area is set off by a faint depression; surface ornamented by fine concentric sculpture and the entire surface is finely punctate. One of the largest specimens measures approximately 15 mm. (beak to base).

The smaller size, finer sculpture and more externally placed ligament are characters which serve to separate the shell of this species from that of *Taras caelatus* Reeve⁵.

⁵ *Lucina caelata* Reeve, *Conch. Icon.*, Vol. 6. *Lucina*, June, 1850, species 27, pl. 6, figs. 27a, 27b. "Hab. Island of Muerte, Bay of Guayaquil (dredged from a depth of about eleven fathoms); Cuming."

A specimen of Reeve's species was collected by the senior author at Sihuatanajo Bay, Mexico. *Taras semiasperus* Philippi, a West Indian species, is said to be less globose and to possess somewhat different sculpture than that of *T. semirugosus*.

Carpenter described a shell from Mazatlan under the name of "*Diplodonta ? semiaspera*, var. *discrepans*"⁶. According to Dall (1901), this is an indeterminable form and a pencil sketch of it made by Carpenter somewhat resembles a young *Taras orbellus*.

Distribution: Specimens of *Taras semirugosus* were dredged by the expedition from El Salvador to Costa Rica at depths of 5 to 16 fathoms.

Superfamily Leptonacea.

FAMILY LEPTONIDAE.

Key to the genera of the Leptonidae.

- A. Shell punctate; pallial line crenulated
- a. Adductor impressions lying entirely within the pallial line *Solecardia*
- aa. Adductor impressions not lying entirely within the pallial line *Bornia*⁷
- B. Shell not punctate
- a. Shell equilateral or nearly so
- b. Inflated; 1 cardinal tooth in right and 2 in left valve ... *Kellia*
- bb. Compressed; 1 cardinal tooth in each valve *Pseudopythina*
- aa. Shell inequilateral
- c. Right valve with cardinal teeth
- d. Lateral teeth present
- e. 2 anterior laterals in left valve; shell minute; hinge large *Lasaea*
- ee. 1 anterior lateral in left valve *Erycina*
- dd. Lateral teeth lacking *Aligena*
- cc. Right valve without cardinal teeth *Rochefortia*

Genus *Erycina* Lamarck.

Erycina colpoica Dall.

Erycina colpoica Dall, *Proc. U. S. Nat. Mus.*, Vol. 45, No. 2002, June 11, 1913, p. 595. "Beach at the head of the Gulf of California."—Dall, *Proc. U. S. Nat. Mus.*, Vol. 66, Art. 17, 1925, p. 16, pl. 27, fig. 2. "Gulf of California."

Type Locality: Beach at the head of the Gulf of California.

⁶ *Diplodonta ? semiaspera*, var. *discrepans* Carpenter, Cat. Mazatlan Shells, November, 1855, p. 103. "Hab. Mazatlan; 1 sp. in burrow from Chama." See also Dall, W. H., *Proc. U. S. Nat. Mus.*, Vol. 23, 1901, p. 797.

⁷ Not represented in the present collection.

Range: Gulf of California to Corinto, Nicaragua.

Collecting Stations: Mexico: Santa Inez Bay, Gulf of California (145-D-1-3), 4-13 fathoms, sand; Port Guatulco (195-D-9), 7 fathoms, gr. sand, crushed shell; Nicaragua: Corinto (200-D-19), 12-13 fathoms, mangrove leaves, also on beach.

Description: Shell small, white, equivalve, very inequilateral, the anterior end much the longer and somewhat expanded, posterior shorter and smaller, both rounded; the dorsal and basal margins slightly arcuate, subparallel; surface sculptured only with concentric incremental lines, covered with a thin, pale yellowish periostracum; beaks low, inconspicuous, valves rather compressed; interior polished, hinge formula lo.01.0lo

o1.10.1o1; chondrophore very narrow, oblique, and posteriorly directed. Length of shell, 10; of anterior part, 8.1; height, 6; diameter, 3.5 mm. (Dall).

Most of the specimens in the present collection measure about 6-8 mm. in length. Some show a tinge of salmon-yellow coloration.

Distribution: This species was dredged in Santa Inez Bay in the Gulf of California and was taken quite abundantly at Corinto, Nicaragua, in beach drift and at a depth of 12-13 fathoms. A few specimens, apparently the same species, were taken off Port Guatulco, Mexico, in 7 fathoms. The present record of occurrence at Corinto is an extension south of the known range of the species.

Genus *Kellia* Turton.

Kellia suborbicularis Montagu.

Mya suborbicularis Montagu, Test. Brit., Pt. 1, 1803, p. 39. "In hard lime-stone at Plymouth." Also "sometimes dredged up in Salcomb-bay"; Pt. 2, 1803, p. 564; Suppl., 1808, pl. 26, fig. 6.

Kellia suborbicularis Montagu, Forbes & Hanley, Hist. Brit. Moll., Vol. 2, 1849, p. 87, Vol. 1, pl. 0, figs. 4, 4a (animal), pl. 18, figs. 9, 9a, 9b, 1848. Various localities cited in northern Europe and south to the Mediterranean. [For dates of issue of this work see A. Reynell, *Proc. Malacol. Soc. London*, Vol. 13, 1918, pp. 25-26].—H. & A. Adams, Gen. Rec. Moll., Vol. 3, 1858, pl. 114, figs. 8, 8a, 8b, 8c.

Type Locality: Plymouth, England (cited as type locality by I. S. Oldroyd, 1924, and accepted as such by the present authors). Also cited originally from Salcomb Bay, England.

Range: Sitka, Alaska, to Peru. Also Atlantic.

Collecting Station: Mexico: Port Guatulco

(195-D-9), 7 fathoms, green sand, crushed shell.

Description: Shell small, thin, suborbicular or roundly subquadrate; ornamented by concentric lines of growth.

There appears to be no method by which the shells in the present collection can be separated with certainty from the European *Kellia suborbicularis* and we have therefore referred them to that species. One specimen is quite round and is similar to the figures of *Kellia bioculta* de Folin⁸ but the hinge agrees with *K. suborbicularis* rather than with the species described by de Folin.

Distribution: A few specimens of *Kellia suborbicularis* were dredged by the Expedition at Port Guatulco, Mexico, in 7 fathoms. It has been cited as ranging south to Peru. It also has been recorded as occurring in the Pliocene and Pleistocene of western North America and from Miocene to Recent in Europe. At the present time the species occurs from Alaska to Peru, and in the north and south Atlantic and is said to occur in other regions.

Genus *Aligena* Lea.

Burch⁹ has discussed and illustrated several west American species of *Aligena*. Orcutt¹⁰ cited "*Aligena cooperi* Dall" from Magdalena Bay, Lower California, but so far as we know this is a *nomen nudum*. *Aligena pisum* Dall¹¹, was described from the Strait of Magellan in 61 fathoms.

Key¹² to the species of *Aligena*.

- A. Shell with a median radial constriction *cokeri*
- B. Shell without a median radial constriction
 - a. Anterior portion of shell sloping steeply down *cerritensis*¹³
 - aa. Anterior portion of shell broadly rounded
 - b. Posterior portion of shell rounded, sloping gently down; left valve with a tooth *nucea*
 - bb. Posterior portion of shell nearly straight, sloping abruptly down; left valve edentulous *redondoensis*¹³

⁸ *Erycinu (Kellia) bioculta* de Folin, Les Méléagrini-coles, (Havre), 1867, p. 21, pl. 3, figs. 8, 9, 10, 11, 12. Cited on p. 9 as from "environs des Negritos" or "îles aux Perles dans la baie de Panama".—de Folin, Fonds de la Mer, Vol. 1, 1867-1871, p. 8 (as *Erycina bioculta*). "La baie de Panama."

⁹ Burch, T. A Survey of the West American Aligenas with a description of a new species. *Nautilus*, Vol. 55, No. 2, October, 1941, pp. 48-51, 1 pl.

¹⁰ Orcutt, C. R., *West American Sci.*, Vol. 21, No. 5 (Whole No. 169), May, 1919, p. 39.

¹¹ *Aligena pisum* Dall, *Bull. Mus. Comp. Zool.*, Vol. 43, No. 6, October, 1908, p. 413. "U.S.S. 'Albatross', station 2778, Magellan Strait, in 61 fathoms, mud, bottom temperature 48°F. U. S. N. Mus. 110,715."

¹² Adapted from T. Burch.

¹³ Not represented in the present collection.

***Aligena cokeri* Dall.**

Aligena cokeri Dall, *Proc. U. S. Nat. Mus.*, Vol. 37, No. 1704, November 24, 1909, p. 155, pl. 28, figs. 5 and 6. "Attached to worm tubes thrown upon the beach of the lagoon at Capon, Peru. The worms live in the beach."—T. Burch, *Nautilus*, Vol. 55, No. 2, October, 1941, p. 49. Original record cited.

Type Locality: Capon, Peru, beach of the lagoon, attached to worm tubes.

Range: Punta Penasco, Gulf of California, to Capon, Peru.

Collecting Stations: Mexico: Santa Inez Bay, Gulf of California (145-D-1-3), 4-13 fathoms, sand; Nicaragua: Corinto (200-D-16, 19), 4-13 fathoms, mangrove leaves, also on beach.

Description: Shell small, white, thin, fragile, roundly quadrate; a wide shallow radial furrow is present on the medial portion of the shell; beaks high, tumid, closely adjacent, slightly anteriorly directed and situated somewhat anteriorly; sculpture of concentric incremental lines and little elevated concentric threads; hinge edentulous, a small callosity present in front of the ligament; pallial line entire. A large specimen measures approximately: length, 9.5 mm.; height, 8 mm.; convexity (one valve), 4 mm.

The shell of this species is similar to that of *Aligena aequata* Conrad from the Miocene of Virginia. The presence of a medial radial furrow on *A. cokeri* easily serves to separate it from other west American species of *Aligena*. The present specimens appear to be identical with the shell from the Pleistocene of Magdalena Bay, Lower California, which was identified as *A. nucea* by E. K. Jordan.

Distribution: Two small valves of this species were dredged in Santa Inez Bay, Gulf of California, and three valves were dredged by the Expedition at Corinto, Nicaragua, in 4 to 13 fathoms. This is an extension north of the known range of the species.

***Aligena nucea* Dall.**

Aligena nucea Dall, *Proc. U. S. Nat. Mus.*, Vol. 45, No. 2002, June 11, 1913, p. 597. "Gulf of California."—Dall, *Proc. U. S. Nat. Mus.*, Vol. 66, Art. 17, 1925, p. 2, pl. 28, fig. 2. "Gulf of California."—T. Burch, *Nautilus*, Vol. 55, No. 2, 1941, p. 49, pl. 4, figs. 3 and 4. Original locality cited.

Type Locality: Gulf of California.

Range: Punta Penasco, Gulf of California, to Corinto, Nicaragua.

Collecting Stations: Mexico: Santa Inez Bay, Gulf of California (145-D-1-3), 4-13 fathoms, sand; Nicaragua: Corinto, beach.

Description: Shell small, white, rather solid, ovate, slightly inequilateral, moderately inflated; surface rather rude, with irregular, rather coarse incremental lines;

beaks full, somewhat posterior, the anterior end of the shell shorter; interior porcellanous, the muscular scars unusually large, the pallial line irregular, entire; hinge with a long, strong, narrow chondrophore, a small pustular projection in front of it, as usual in the genus. Length of shell, 4.0; of anterior portion, 1.75; height, 3.0; diameter, 2.2 mm. (Original description).

The gently sloping posterior portion of the shell and the presence of a tooth in the left valve of this species are characters which serve to separate it from *A. redondensis* T. Burch, dredged off Redondo Beach, California, in which the posterior margin slopes abruptly down and the hinge of the left valve is edentulous.

Distribution: Two single valves of this species were dredged in Santa Inez Bay in the Gulf of California in 4-13 fathoms and one valve was taken on the beach at Corinto, Nicaragua. This is an extension south of the known range of this species.

Genus *Rochefortia* Vélain.

Key to the species of *Rochefortia*.

- A. Shell oval; diaphanous *chalconica*
B. Shell subquadrate; opaque; umbos appressed *subquadrate*

***Rochefortia chalconica* Carpenter.**

?*Montacuta chalconica* Carpenter, Cat. Mazatlan Shells, April, 1857, p. 531. "Hab. —Mazatlan; 1 valve off frond of *Murex nigrinus*; L'pool Col."

Mysella chalconica Carpenter, Dall, *Proc. U. S. Nat. Mus.*, Vol. 21, No. 1177, 1899, p. 881. Mazatlan.

Type Locality: Mazatlan, Mexico, on *Murex nigrinus*.

Range: Santa Inez Bay, Gulf of California, to Mazatlan, Mexico.

Collecting Station: Mexico: Santa Inez Bay, Gulf of California (145-D-1-3), 4-13 fathoms, sand.

Description: "?M. t. tenuissimâ, interdum opacâ, interdum diaphanâ, castaneâ; ovali, marginibus regulariter excurvatis, umbone prominente; nitente, sed striulis tenuissimis, et concentricis, et radiantibus; valvâ alterâ dent. card. post. elongato, ant. evanescente, lat. nullis; alterâ. . . ." "Long. .02, lat. .028, alt. .006." (Original description).

The type of this species has never been figured but Carpenter's description fits the present specimens rather well. The thin, chalconic shell, as indicated by its specific name, is a characteristic feature of this species.

Distribution: A few single valves, here referred to this species, were dredged by the expedition in Santa Inez Bay in the Gulf of California, in 4-13 fathoms. This is the first record of the occurrence of this species outside of the type locality.

Rochefortia subquadrata Carpenter.

?*Montacuta subquadrata* Carpenter, Cat. Mazatlan Shells, December, 1855, p. 113. "Hab.—Mazatlan; off Chamae, extremely rare; L'pool Col."

?*Mysella subquadrata* Carpenter, Dall, *Proc. U. S. Nat. Mus.*, Vol. 21, No. 1177, 1899, p. 881. Mazatlan.

Type Locality: Mazatlan, Mexico, off Chamae.

Range: Santa Inez Bay, Gulf of California, to Mazatlan, Mexico.

Collecting Station: Mexico: Santa Inez Bay, Gulf of California (145-D-1-3), 4-13 fathoms, sand.

Description: "M. t. oblongâ, subquadrâtâ, solidiore, flavescente seu cinereâ; sulcis concentricis, creberrimis, rotundatis; umbonibus appressis, lunulâ excavatâ; valvâ alterâ dent. card. uno, inter fossas duas, dent. lat. longis, prominentibus; valvâ alterâ dent. card. uno, elongato, prope marginem, fossâ unâ, latâ; dent. lat. subobsoletis." "Long. .1, lat. .13, alt. .03." (Original description).

A left valve in the present collection agrees well with Carpenter's description of "?*Montacuta subquadrata*." The subquadrate outline, appressed umbos and excavated lunule mentioned by Carpenter are noticeable on the present specimen. Carpenter mentioned that "Outside it resembles in miniature some of the oval Oolitic Astartidae."

Distribution: One left valve of this species was dredged by the Expedition in Santa Inez Bay, Gulf of California, in 4-13 fathoms. This is the first record of the occurrence of this species outside the type locality.

Genus Pseudopythina Fischer.

Pseudopythina Fischer in Monterosato, *Nom. Gen. e Spec. Medit.* (Palermo), 1884, p. 17. Sole species cited, "*P. MacAndrewi*, Fischer (*Kellia*)—*Journ. Conchyl.* 1867, p. 194, t. 9, f. 1 (Coste del Portogallo)." Also "*Pythina* sp., M'Andrew—Rep. 1856 (Faro). Gibilterra (Hidalgo)."—Fischer, *Man. de Conchyl.*, 1887, p. 1026. Sole species, "*P. MacAndrewi*, Fischer."—Dall, *Trans. Wagner Free Inst. Sci.*, Vol. 3, Pt. 5, December, 1900, p. 1142. Type, *Kellia MacAndrewi* Fischer.

Type (by monotypy): *Pseudopythina macandrewi* Fischer [= *Kellia MacAndrewi* Fischer, *Journ. de Conchyl.*, Vol. 15, 1867, p. 194, pl. 9, fig. 1. "Hab. Nord de l'Espagne; bassin d'Arcachon (Gironde)"]].

Description: West American shells referred to this genus are elliptical, subquadrate, somewhat compressed, often slightly flattened medially, and possess 1 cardinal tooth in each valve. The type species of the genus is said to possess 2 cardinal teeth in each valve.

Pseudopythina chacei Dall.

Erycina chacei Dall, *Proc. U. S. Nat. Mus.*, Vol. 52, No. 2183, December 27, 1916, p. 410. "Station 4343, off the South Coronado Island, in 155 fathoms."

Pseudopythina chacei Dall, Keen in Burch, *Min. Conch. Club South. Calif.*, No. 40, October, 1944, p. 17, figs. pp. 12 and 18. Santa Rosa Island, California, to South Coronado Island, Mexico.

Type Locality: Off South Coronado Island, Mexico, in 155 fathoms.

Range: Santa Rosa Island, California, to Santa Inez Bay, Gulf of California.

Collecting Station: Mexico: Santa Inez Bay, Gulf of California (145-D-1-3), 4-13 fathoms, sand.

Description: Shell small, compressed, rounded-quadrate; nearly equilateral, the anterior end slightly shorter; beaks low, pustular, minute; dorsal margin nearly straight, basal margin gently arcuate; surface finely concentrically striate, whitish under a pale ashy periostracum, both ends nearly evenly rounded, hinge very feeble. Length, 5.3; height, 3.5; diameter, 1.8 mm. (Original description).

Two small left valves in the present collection agree well with Dall's description of "*Erycina*" *chacei*. A comparison of these specimens with a photograph of the type of Dall's species and with a drawing of the hinge in the possession of Dr. A. M. Keen, reveals only slight differences between these and the present shells. We have therefore, at least for the present, referred the specimens to Dall's species.

Judging from the description alone, it is possible that the present specimens may be referable to the species described as *Montacuta elliptica* Carpenter¹⁴ described from Mazatlan, Mexico. The type of that species has never been illustrated and we are uncertain whether or not our specimens could be referred to it.

Distribution: Two single valves of this species were dredged in Santa Inez Bay, Gulf of California, in 4-13 fathoms. This is an extension south of the known range of the species.

Genus Lasaea Leach in Brown.

A. M. Keen¹⁵ has discussed the genus *Lasaea* and cited the Recent species referable to it.

Key to the species of Lasaea.

A. Anterior dorsal margin broadly rounded; umbos very tumid; subquadrate

¹⁴ *Montacuta elliptica* Carpenter, Cat. Mazatlan Shells, December, 1855, p. 113. "Hab.—Mazatlan; off Chamae, extremely rare; L'pool Col."—Dall, *Proc. U. S. Nat. Mus.*, Vol. 21, 1899, p. 881 (as *Mysella elliptica*). Mazatlan.

¹⁵ Keen, A. M. New Pelecypod species of the genera *Lasaea* and *Crassinella*. *Proc. Malacol. Soc. London*, Vol. 23, Pt. 1, March 16, 1938, pp. 18-32, 1 pl. See also corrections in Vol. 23, Pt. 4, March 15, 1939, p. 252.

- a. Anterior end evenly rounded *cistula*^{15a}
 aa. Anterior end slightly obliquely rounded *petitiana*
 B. Anterior dorsal margin sloping obliquely; umbos less tumid; shell more elongate *subviridis*^{15a}

***Lasaea petitiana* Recluz.**

Poronia petitiana Recluz, *Rev. Zool. Soc. Cuvierienne*, Vol. 6, 1843, p. 175. "Hab. Callao de Lima, ou elle ne parait pas rare."
Lasaea petitiana Recluz, Keen, *Proc. Malacol. Soc. London*, Vol. 23, Pt. 1, March 16, 1938, pp. 19, 22. Original record cited.

Type Locality: Callao, Peru.

Range: Atacama, Chile, to the Galápagos Islands.

Collecting Station: Ecuador: Tower Island, Galápagos Islands, shore.

Description: "Testa ovata seu ovato-trigona, convexo-depressa, inaequilatera, antice producta, albido-rosea, transversum substriata; apicibus parvis, vix antice flexis utroque latere dentibusque roseo-pictis; fovea ligamentali latiuscula; marginibus valvarum acutiusculis." "Long. 2½ mill., larg. 3 mill., conv., 2 mill." (Original description).

The minute, inflated, subquadrate, often reddish-tinted shell of this species is much like that of *Lasaea cistula* Keen¹⁶ described from Halfmoon Bay, California, but the anterior dorsal margin appears to slope a little more obliquely. Compared to *L. subviridis* Dall, the anterior dorsal margin of the present species slopes much less steeply and the umbos are more tumid, as in *L. cistula*. Some of the largest specimens in the present collection are 2.5-2.75 mm. in length.

The exact synonymy and range of this species are uncertain. Dall¹⁷ considered it to be identical with *Kellia miliaris* Philippi¹⁸ which was described from the Strait of Magellan. Haas¹⁹ stated that specimens which he identified as *Lasaea miliaris* Philippi from Peru are hardly separable from *L. cistula* Keen.

Lasaea macrodon Stempell²⁰ was described from Juan Fernandez Island.

Distribution: Several specimens in the present collection, apparently referable to

^{15a} Not represented in the present collection.

¹⁶ *Lasaea cistula* Keen, *Proc. Malacol. Soc. London*, Vol. 23, Pt. 1, March 16, 1938, p. 25, pl. 2, figs. 7-9. "Type locality.—Moss Beach, Half Moon Bay, California—Sect. 4, T. 5 S., R. 6 W., Mount Diablo Meridian."

¹⁷ Dall, W. H., *Proc. U. S. Nat. Mus.*, Vol. 37, 1909, p. 264.

¹⁸ *Kellia miliaris* Philippi, *Archiv f. Naturgesch.*, Jahrg. 11, Bd. 1, 1845, p. 51. "Patria Fretum Magellanicum, Eagle Bay, frequens."—Philippi, *Reise durch die Wueste Atacama* (Eduard Anton: Halle), 1860, p. 175, pl. 7, figs. a [cited as d on pl.], b, c. Indicated as ranging from Cobija to the Strait of Magellan.

¹⁹ Haas, F., *Zool. Ser. Field Mus. Nat. Hist.*, Vol. 29, No. 1, 1943, p. 17. With *Mytilus granulatus* from rocks at Chincha Norte Island, Peru.

²⁰ *Lasaea macrodon* Stempell, *Zool. Jahrb.*, Suppl. Bd. 5, Fauna Chilensis, Bd. 2, December 20, 1899, p. 231, figs. 16, 17. "3 Exemplare aus der Bahia Padres auf Juan Fernandez."

this species, were collected, probably by William Beebe, on Tower Island, Galapagos Islands, in 1925. Although not a part of the present collections of the Expeditions of the *Zaca*, the species is recorded here for convenience of reference. The exact range of this species is uncertain. Dall recorded it as ranging south to the Strait of Magellan. The present shells appear to belong to the species cited by the present authors under the name of *Lasaea rubra* from the Pleistocene of the Galápagos Islands.

Genus *Solecardia* Conrad.

***Solecardia eburnea* Conrad.**

Solecardia eburnea Conrad, *Proc. Acad. Nat. Sci. Philadelphia*, Vol. 4, 1849, p. 155. Described under the title "Shells from the coasts of Lower California and Peru."—Conrad, *Jour. Acad. Nat. Sci. Philadelphia*, Ser. 2, Vol. 1, 1850, p. 279, pl. 39, fig. 1. Locality same as in preceding reference.—Dall, *Proc. U. S. Nat. Mus.*, Vol. 21, 1899, p. 875, 879, 884. "Cape St. Lucas to Panama."

Not *Scintilla eburnea* Mörch, *Journ. de Conchyl.*, Vol. 24, No. 4, 1876, p. 373. "Hab. Saint-Thomas," dredged. Renamed *Solecardia mörchi* Dall, *Proc. U. S. Nat. Mus.*, Vol. 21, June 26, 1899, p. 884.

Scintilla cumingii Deshayes, *Proc. Zool. Soc. London* for 1855 (issued January 5, 1856), p. 173. "Hab. ad littora Panamensia."—Sowerby, *Conch. Icon.*, Vol. 19, *Scintilla*, 1874, species 3, pl. 1, figs. 3a, 3b. Panama.

Type Locality: Lower California.

Range: Punta Penasco, Gulf of California, to Panama.

Collecting Station: Mexico: Santa Inez Bay, Gulf of California (144-D-2), 2½ fathoms, sand, weed, rocks.

Description: Shell ovately oblong, thin, punctate; hinge with 2 diverging teeth and a linear oblique cartilage pit between; pallial line entire. "In this singular bivalve the pallial impression shows no junction with the adductor impressions, but joins the extremities of the cardinal plate. The muscular impressions are as distinct on the exterior as on the interior" (Conrad).

A specimen in the present collection measures: length, 21.2 mm.; height, 14.3 mm.

The large size of the shell, for the family, and the close radial rows of fine pits on the outer surface, are very distinctive features of this species. It is the type of the genus *Solecardia*.

Wood²¹ mentioned a similarity between *Kellia ambigua* Nyst from the Crag Pliocene of England and *Solecardia eburnea* Conrad.

Some of the Hawaiian species originally referred to *Solecardia* have been placed in

²¹ *Kellia ambigua* Nyst, Wood, *Palaeontogr. Soc.*, Vol. 4, Mon. Crag Moll., Pt. 2, No. 1, Bivalves, for 1850 (issued June, 1851), p. 120, Tab. 12, figs. 11a, 11b.

the genus *Nesobornia* Dall, Bartsch & Reher, 1938, the type of which is *Solecardia ovata* Gould.

Distribution: A single valve of *Solecardia eburnea* was dredged by the Expedition in Santa Inez Bay in the Gulf of California. It has been recorded as ranging south to Panama.

FAMILY SPORTELLIDAE.

Key to the genera of the Sportellidae.

- A. Left valve with one cardinal tooth *Basterotia*
 B. Left valve with two cardinal teeth *Sportella*

Genus *Basterotia* Mayer in Hörnes.

Harlea Gray, Synop. Brit. Mus., 1842, p. 78. [No species cited]. See E. A. Smith, Proc. Zool. Soc. London, April 1, 1890, p. 303.

Eucharis Recluz, Journ. de Conchyl., Vol. 1, 1850, p. 164. Type, *Corbula quadrata* Rinds.—Fischer, Journ. de Conchyl., Vol. 34, No. 3, 1886, p. 198.

Not *Eucharis* Latreille, 1804.

Basterotia Hörnes, Verhandl. k. k. Zool.-Bot. Gesell. Wien, Bd. 9, 1859, Abh. p. 71. *Basterotia corbuloides* Hörnes cited and illustrated. [*Corbula quadrata* (as illustrated by Reeve, pl. 5, fig. 40) was mentioned as a similar species but it was not definitely referred to the genus *Basterotia*].

Not *Basterotia* Bayle in Jousseume, Bull. Soc. Zool. France, Vol. 9, 1884, p. 95. Gastro-poda.

Type (by Monotypy): *Basterotia corbuloides* Hörnes, Verhandl. k. k. Zool.-Bot. Gesell. Wien, Bd. 9, 1859, p. 71, [three figs.]. "Wiener Becken." See also Hörnes, Abhandl. k. k. Geol. Reichsanst., Bd. 4, 1860, p. 40, pl. 3, figs. 11a-g. Various localities cited in Vienna Basin, Austria. Miocene.

The species originally described as *Anisodonta peninsulare* by E. K. Jordan, from the Pleistocene of Magdalena Bay, Lower California, has been found among beach shells along the west coast of the tropical Americas. The species appears to be referable to the genus *Basterotia* Mayer in Hörnes which is known from Miocene to Recent. Species living in the present seas have been described from the south Atlantic, Caribbean, and western Pacific. The west coast of Mexico, Nicaragua, and the Galápagos Islands can now be added to the records of the distribution of the genus.

Lamy²² has cited the species referred to this genus.

Basterotia peninsularis Jordan.

Anisodonta peninsulare E. K. Jordan, Contrib. Dept. Geol. Stanford Univ., Vol. 1,

²² Lamy, E. Note sur le genre *Basterotia* Mayer, 1859 [Mollusques Lamellibranches]. Comp. Rend. Congrès des Soc. Savantes, Paris, 1925, pp. 503-508, 1 fig. in text.

No. 4, November 13, 1936, p. 147, pl. 18, figs. 11, 12. "Magdalena Bay, Lower California." "Pleistocene."

Type Locality: Magdalena Bay, Lower California. Pleistocene.

Range: Port Guatulco, Mexico, to Corinto, Nicaragua, and the Galápagos Islands.

Collecting Stations: Mexico: Port Guatulco (195-D-9), 7 fathoms, gr. sand, crushed shell; Nicaragua: Corinto, beach drift.

Description: Shell subquadrate, thin; umbos gently rounded, a broadly rounded shoulder on the posterior portion of the shell; anterior end short; a prominent cardinal tooth which is separated from the resilium pit by a distinct notch. Length, 15 mm.; height, 10.6 mm.; convexity of left valve, 4 mm. (Jordan).

A right valve in the present collection measures approximately: length, 13 mm.; height, 8 mm.; convexity (one valve), 3 mm.

Distribution: One fairly large valve of this species was found in the beach drift at Corinto, Nicaragua. Another very small valve also referred to this species was dredged in 7 fathoms at Port Guatulco, Mexico. This is the first record of the occurrence of the species living in west American waters. Heretofore it has been known to occur only in the Pleistocene of Magdalena Bay, Lower California. Specimens apparently referable to this species were collected by Professor Nicholas Reformatzky in the Pleistocene of Albemarle Island, Galápagos group. Dr. A. M. Keen of Stanford University, called our attention to the fact that this species also occurs in the Recent fauna of the Galápagos Islands.

Genus *Sportella* Deshayes.

Sportella Deshayes, Descript. Anim. s. Vert. bas. Paris, Vol. 1, 1858, p. 593. Type, *Psammotea dubia* Deshayes.—Dall, Trans. Wagner Free Inst. Sci., Vol. 3, Pt. 5, 1900, p. 1125. Type, *Psammotea dubia* Deshayes. [On p. 1125 as *Psammobia dubia* Deshayes].

Type (by original designation): *Psammotea dubia* Deshayes, Descript. Coq. Fos. env. Paris, Vol. 1, 1824, p. 76, pl. 10, figs. 13, 14. "Localité: Parnes, C. G."

Shell oblong, transverse, smooth, flattened, subequilateral, closed, margins simple and sharp. Hinge narrow bearing two unequal teeth diverging in the left valve, a single simple one in right valve. Muscular impressions large, oval, nearly equal. Pallial impression simple. Ligament external [translation from Deshayes, 1858].

Sportella stearnsii Dall.

Sportella stearnsii Dall, Proc. U. S. Nat. Mus., Vol. 21, No. 1177, June, 1899, p. 885, pl. 87, figs. 9, 12. "Gulf of California, exact locality unknown."

Type Locality: Gulf of California.

Range: Gulf of California to Corinto, Nicaragua, and the Galápagos Islands.

Collecting Stations: Mexico: Santa Inez Bay, Gulf of California (145-D-1-3), 4-13 fathoms, sand; Nicaragua: Corinto (200-D-17), 7-10 fathoms, sand, also in beach drift.

Description: Shell of moderate size for the genus, inequilateral, not very convex, white, with an almost imperceptible yellowish epidermis; anterior dorsal margin nearly straight, the base parallel with it, the ends bluntly rounded; surface nearly smooth, with faint incremental lines and microscopic sagrination; teeth normal, strong, the posterior cardinal prominent, vertical; ligament strong, external, on a nymph; resilium well developed, its area of attachment thickened; posterior adductor scar rounded, unusually large. Lon. 13.5, alt. 10, diam. 5 mm. (Dall).

A right valve from Corinto, Nicaragua, measures approximately: length, 14 mm.; height, 8.8 mm.; convexity (one valve), 3 mm.

Distribution: One valve of this species was dredged in Santa Inez Bay, Gulf of California, three single valves were found in the beach drift and one left valve was dredged in 7-10 fathoms at Corinto, Nicaragua. The occurrence here recorded from Corinto, as well as that from the Galápagos Islands, represents an extension south of the known range of this species.

Superfamily Cardiacea.

FAMILY CARDIIDAE.

A paper dealing with the nomenclature of the superspecific units of this family has been published by A. M. Keen²³.

Genus *Cardium* Linnaeus.

Key to the subgenera²⁴ of *Cardium*.

- A. Shell decidedly longer than high
 - a. Two distinct areas of sculpture; no lateral teeth *Lophocardium*
 - aa. Without distinct areas of sculpture; lateral teeth present *Papyridea*
- B. Shell decidedly higher than long, or round
 - a. Shell nearly smooth *Laevicardium*
 - aa. Shell strongly sculptured
 - b. Posterior area set off with strong concentric or scaly sculpture
 - c. All ribs and interspaces on posterior area crossed by strong concentric laminae

Nemocardium

- cc. Various ribs on posterior area with strong scales only

Microcardium

²³ Keen, A. M. Nomenclatural Units of the Pelecypod Family Cardiidae. *Bull. Mus. Roy. Hist. Nat. Belgique*, Tome 13, No. 7, March, 1937, pp. 1-22.

²⁴ The subgenus *Dinocardium* has been omitted from this key because it is believed that it does not occur in the west American fauna.

- bb. Posterior area not set off with strong concentric or scaly sculpture

- d. Umbos abruptly angulated posteriorly; posterior margin truncated
- e. Ribs beaded; anterior laterals crowded against cardinals; shell small

Trigoniocardia

- ee. Ribs with fine concentric imbrications; cardinals symmetrically spaced between anterior and posterior laterals *Americardia*

- dd. Umbos rounded or roundly angled posteriorly

- f. Ribs broad, flattish; smooth on top

- g. Very convex; ribs without scales ... *Mexicardia*

- gg. Gently convex; central ribs fringed with scales on anterior and posterior sides; elongate

Acrosterigma

- ff. Ribs narrow, well elevated; central ribs with scales or nodes on posterior side.

- h. Central ribs with scales on posterior side and arching over top

Trachycardium

- hh. Central ribs with a serrate ridge or nodes on posterior side only or nodes on both sides

- i. Central ribs with an elevated serrate ridge on posterior side *Phlogocardia*

- ii. Central ribs with diagonal nodes on posterior (and on some specimens also, to a lesser degree, on anterior) side

Dallocardia

Subgenus *Lophocardium* Fischer.

Cardium (Lophocardium) annettae Dall.

Plate I, Figures 3, 8 and 13.

Cardium (Lophocardium) annettae Dall, *Nautilus*, Vol. 3, No. 2, June, 1889, p. 13. "Dredged in 25 fathoms off the coast of Lower California, near Cerros Island."

Lophocardium annettae Dall, *Proc. U. S. Nat. Mus.*, Vol. 12, 1889 (issued March 7, 1890), p. 264, pl. 10, fig. 4. "Hab.—Coast of Lower California at station 2828 in north

latitude 24° 11' and west longitude 109° 55' in 10 fathoms; fragments were collected at Stations 2823 and 2826, in 8 to 27 fathoms, shelly bottom, within a few miles of the preceding and also in material dredged near San Clemente Island in 25 fathoms."

Protocardia (Lophocardium) annettae Dall, *Proc. U. S. Nat. Mus.*, Vol. 23, 1901, p. 392. Gulf of California, 6 to 24 fathoms.

Type Locality: Off the coast of Lower California, near Cedros Island, in 25 fathoms.

Range: San Clemente Island, California, to Port Culebra, Costa Rica.

Collecting Stations: Mexico: East of Cedros Island; Santa Inez Bay, Gulf of California (143-D-2, 4), 25-30 fathoms, mud, crushed shell, sand; Port Guatulco (195-D-21), 18 fathoms, mud; Costa Rica: Port Parker (203-D-1, 2, 3), 12-15 fathoms, sandy mud, crushed shell, shelly sand and mud, algae; Port Culebra (206-D-1, 2, 3), 14 fathoms, sandy mud.

Description: Shell elongated, thin, fragile, gaping posteriorly; color salmon pink to almost white, the color deepest on the posterior area; a raised radial lamina fringed with periostracum separates about five-sixths of the shell from the posterior area; the surface of this anterior area is finely reticulated; flat, little elevated, radial ribs become very weak and can be observed only with magnification on the anterior end, the radial sculpture is crossed by fine raised irregular concentric laminae; the posterior area is ornamented by well developed radials crossed by somewhat irregular laminae which are sparser and higher than the radials and much higher than on the anterior area; two pointed cardinal teeth are present in the right valve and one in the left but lateral teeth are absent; periostracum light brown in color. The largest specimen in the present collection is 46.8 mm. long and 38.7 mm. high.

A study of the series available suggests that there are not two species of this remarkable group of shells in the area, and were it not for Broderip's statement regarding *cumingii* that the lamina separating the posterior part of the shell from the remainder is *Mactra*-like, we would feel that the name *annettae* should be relegated to the synonymy of *Cardium cumingii*²⁵. L. C. Smith²⁶ discussed both species and stated that the lamina on *C. cumingii* is not made of shelly material.

Dall stated that the bounding ridge of the

type of *C. annettae* is notched and fringed with periostracum and much less prominent than that of *C. cumingii*. Specimens from as far south as Costa Rica show some variation in the height and character of the lamina and it is not certain that the specific name *annettae* can be retained for a form distinct from *C. cumingii*.

Distribution: Specimens of *Cardium annettae* were dredged at depths of 12 to 30 fathoms from Cedros Island to Costa Rica. It was not found abundantly at any locality and in some localities specimens of this fragile shell were broken into pieces.

Subgenus *Papyridea* Swainson.

Cardium (Papyridea) aspersum Sowerby.

Cardium aspersum Sowerby, *Proc. Zool. Soc. London*, September 8, 1833, p. 85. "Hab. ad Sanctam Elenam et ad Montem Christe." "Found in sandy mud at seven fathoms depth."—Sowerby, *Conch. Illustr., Cardium*, Cat., p. 2, 1840?, pl. 48, fig. 15, January, 1834. St. Elena.—Reeve, *Conch. Syst.*, Vol. 1, 1841, p. 99, pl. 75, fig. 15.

Type Locality: Santa Elena, Ecuador (here designated as type locality). Montecristi also cited originally.

Range: Manuela Lagoon, Lower California, and the Gulf of California, to Lobitos, Peru.

Collecting Stations: Mexico: Southeast of Cedros Island (126-D-19), 25 fathoms, rocks, algae; Cape San Lucas; Santa Inez Bay, Gulf of California (141-D-2), 10-15 fathoms, sand, weed; Port Guatulco; Nicaragua: Corinto (200-D-19), mangrove leaves; Panama: Hannibal Banks.

Description: Shell elongately oval, sub-equilateral, gaping; mottled with reddish-brown and light colored areas; ribs numerous, the anterior ones finer and crenulated, the central ones flattened, the posterior ones coarser and ornamented with short spines; the ends of the ribs form a serrated margin posteriorly.

Cardium aspersum is very similar to the Atlantic species *C. spinosum* Meuschen but the form from the eastern Pacific appears to have flatter ribs and less posterior elongation. The form described by Verrill as *Papyridea bullata* var. *californica*²⁷ has not been illustrated but is probably identical with the species described by Sowerby.

Distribution: *Cardium aspersum* was collected on beaches and dredged at depths of 10 to 25 fathoms from Cedros Island to Panama. It is also known to occur in the Pleistocene of Magdalena Bay, Lower California, of Oaxaca, Mexico, and the Galápagos Islands.

²⁵ *Cardium cumingii* Broderip, *Proc. Zool. Soc. London*, September 8, 1833, p. 82. "Hab. in America Centrali. (Gulf of Dulce)." "It was obtained from sandy mud, at a depth of twelve fathoms."—Reeve, *Conch. Icon.*, Vol. 2, *Caracum*, 1844, species 59, pl. 12, fig. 59. Original locality cited.

²⁶ Smith, L. C., *Mus. Comp. Zool., Occ. Papers on Moll.*, No. 4, July 30, 1945, p. 31-32.

²⁷ *Papyridea bullata* Sw. var. *californica* Verrill, *Amer. Jour. Sci.*, Ser. 2, Vol. 49, March, 1870, p. 225. "La Paz."

Subgenus *Phlogocardia* Stewart.*Cardium (Phlogocardia) belcheri* Broderip & Sowerby.

Cardium belcheri Broderip & Sowerby, *Zool. Jour.*, Vol. 4, January, 1829, p. 366, pl. 9, fig. 3. "Hab. in Oceano Pacifico." Dredged "to the northward of Isabella Island, at the entrance to the Gulf of California, in 15 fathoms."—Sowerby, *Conch. Illustr.*, *Cardium*, Cat., p. 3, No. 41, 1840?. "Coast of California and Panama" [Panama].—Reeve, *Conch. Icon.*, Vol. 2, *Cardium*, 1844, species 5, pl. 1, fig. 5. "Hab. California and Panama; Belcher."

Type Locality: North of Isabel Island, Mexico, at the entrance to the Gulf of California, in 15 fathoms.

Range: Cedros Island, Lower California, and the Gulf of California, to Panama.

Collecting Stations: Mexico: East of Cedros Island (126-D-2), 38 fathoms, mud; Arena Bank, Gulf of California (136-D-15), 40 fathoms, mud, crushed shell; Santa Inez Bay (141-D-1-4), 7-20 fathoms, sand, crushed shell, calcareous algae, weed, (142-D-2), 30-35 fathoms, muddy sand, crushed shell, (143-D-1-5), 18-30 fathoms, mud, crushed shell, sand, weed; Costa Rica: 14 miles S.E. of Judas Point (214-D-1-4), 42-61 fathoms, mud, shell, rocks; Panama: Gulf of Chiriqui (221-D-1-5), 35-40 fathoms, sandy mud.

Description: Shell elongately oval from beak to base, inflated; ornamented by about 24 triangular ribs which, on the posterior side, are surmounted by a narrow, serrated ridge. A large specimen measures approximately 53 mm. in altitude.

Cardium stiriatum Brown & Pilsbry from the Miocene of Panama, and *C. stiriatum leonense* Mansfield from the upper Miocene of Florida, are forms similar to *C. belcheri*. Other species of this group occur in the late Tertiary of the Caribbean region.

Distribution: *Cardium belcheri* was dredged at several localities between Cedros Island, Lower California, and Panama, at depths of 7 to 61 fathoms.

Subgenus *Americardia* Stewart.

Key to the species of *Americardia*.

- A. About 28 fairly broad, flat ribs; interior with brownish-red areas *biangulatum*
 B. About 30 narrow ribs; interior white *guanacastense*

Cardium (Americardia) biangulatum Broderip & Sowerby.

Cardium biangulatum Broderip & Sowerby, *Zool. Jour.*, Vol. 4, January, 1829, p. 367. "Hab."—Sowerby, *Conch. Illustr.*, *Cardium*, Cat., p. 7, 1840?, pl. 46, fig. 2, issued between July 19, 1833, and January, 1834. "St. Elena,

Mr. Cuming."—Reeve, *Conch. Icon.*, Vol. 2, *Cardium*, 1844, species 29, pl. 6, fig. 29. "Hab. St. Elena and Isle of Plata, West Columbia (found in coral sand at the depth of seventeen fathoms); Cuming."

Type Locality: Santa Elena, Ecuador (here designated as type locality). No locality cited originally but Santa Elena cited with first illustration of the species.

Range: Catalina Island, California, to Guayaquil, Ecuador.

Collecting Stations: Mexico: East of Cedros Island (126-D-2), 38 fathoms, mud; Santa Inez Bay (142-D-1-4), 30-50 fathoms, sand, crushed shell, muddy sand, weed, calcareous algae, (143-D-1), 29 fathoms, mud, crushed shell, weeds, (145-D-1, 3), 4-13 fathoms, sand, also at San Domingo Point and Monument Station; coast of Lower California; Arena Point; Cape San Lucas; Port Angeles; Port Guatulco (195-D-9, 10, also on shore), 4-7 fathoms, gray sand, crushed shell; Santa Cruz Bay; Tangola-Tangola Bay (196-D-6, 7, 14, 15), 5-7 fathoms, sand, crushed shell; Nicaragua: Corinto (200-D-19), 12-13 fathoms, mangrove leaves; Costa Rica: Port Parker (203-D-1, 3, also on shore), 12-15 fathoms, sandy mud, crushed shell, shelly mud; Cedro Island, Gulf of Nicoya (213-D-4-15), 4-40 fathoms, mud, sand, crushed shell; Golfo, Gulf of Dulce.

Description: Shell inflated, umbos abruptly angulated posteriorly, posterior end concavely flexed and truncated; ribs fairly broad, flattened, about 27-28 in number; color of exterior light brown with reddish-brown spots, interior white tinged with reddish-brown areas.

The shell of this species is proportionately broader, the ribs fewer and broader, and the interior is partially colored reddish-brown in comparison to that of *C. guanacastense*, which is white. *Cardium medium* of the Caribbean region is similar in shape but has more numerous and narrower ribs.

Distribution: *Cardium biangulatum* was collected at many localities from Cedros Island, Lower California, to Costa Rica, on beaches and dredged at depths of 4 to 50 fathoms. The largest number of specimens was found at Corinto, Nicaragua. The species is known to occur from Pliocene to Recent in the Gulf of California region and in the Pleistocene of the San Pedro region in southern California.

Cardium (Americardia) guanacastense

Hertlein & Strong, sp. nov.

Cardium planicostatum Sowerby, *Proc. Zool. Soc. London*, September 8, 1833, p. 83. "Hab. ad oras Americae Centralis. (Guacoma)." "Found in fine sand, at a depth of thirteen fathoms."—Sowerby, *Conch. Il-*

lustr., *Cardium*, Cat., p. 7, 1840?, pl. 50, fig. 25, February, 1834. "Guacomayo. Mr. Cuming."—Reeve, Conch. Icon., Vol. 2, *Cardium*, 1844, species 31, pl. 6, fig. 31. Original locality cited.

Not *Cardium planicostatum* Sedgwick & Murchison, 1829.

Cardium (Fragum) magnificum (Deshayes MS) in Carpenter, Dall, *Proc. U. S. Nat. Mus.*, Vol. 23, 1901, p. 390. Lower California to Paita, Peru, in 10 to 13 fathoms.

Not *Cardium magnificum* Deshayes in Carpenter, Rept. Brit. Assoc. Adv. Sci. for 1856 (issued 1857), p. 187. "Is. Plata, St. Elena," coral sand, in 17 fathoms. Reference to Plate 6, fig. 29 of Reeve [which represents *Cardium biangulatum* Broderip & Sowerby].

Type Locality: Culebra Bay, Costa Rica.

Range: Off San Jose del Cabo, Lower California, to Paita, Peru.

Collecting Station: Costa Rica: Culebra Bay.

Description: Shell somewhat cordate, the beaks somewhat attenuated, rounded anteriorly, truncated posteriorly, umbos angulated posteriorly and sloping abruptly downward, the median portion of the posterior area concave; sculptured with about 30 narrow, flat-topped ribs of which about 20 occur anterior to the posterior umbonal angulation and about 10 posterior to it, ribs and interspaces crossed by fine concentric imbrications; hinge with 2 cardinals, the anterior the larger, and 2 laterals which are double in the left valve; exterior yellowish-white and pinkish and with somewhat irregularly concentric blotches of brown, the interior white. The type measures: height (beak to base), 25 mm.; length, approximately, 22 mm. Another specimen, a right valve, measures: height, 46 mm.; length, 36 mm.

Holotype, left valve, in Calif. Acad. Sci. Paleo. Type Coll., from Culebra Bay, Province of Guanacaste, Costa Rica. A right valve, somewhat worn, also was collected at the type locality.

The shell of this species is in general shape similar to that of *Cardium biangulatum* but it is proportionately higher and narrower, has about 30 radial ribs which are narrower, and the interior is white rather than with reddish-brown areas.

The first citation of *Cardium magnificum* was by Carpenter (1857, p. 187) who stated "*Cardium biangulatum* [= *magnificum*, Desh.]" with a reference to Reeve's plate 6, figure 29, which represents *C. biangulatum*. Carpenter did not make any additional statement regarding *Cardium magnificum* in any subsequent publication. Dall, 1901, stated regarding *C. magnificum* "This is *Cardium planicostatum* Sowerby, 1833,

not of Sedgwick and Murchison, 1829." He also stated that Carpenter was mistaken in referring Deshayes' species to *Cardium medium*. Dall apparently referred to Carpenter's statement (1863, p. 364; 1864, p. 552. See *Smithson. Miscell. Coll.*, No. 252, 1872, pp. 38, 201) that a specimen identified by C. B. Adams as *C. planicostatum* Sowerby "may be a worn valve of *Hemicardia biangulata*, but more resembles a ballast specimen of the W. Indian *H. media*."

It seems reasonable to suppose that Deshayes intended to propose the specific name *magnificum* to replace the preoccupied name *planicostatum* of Sowerby. However, according to the rules of nomenclature, the name *Cardium magnificum* must be relegated to the synonymy of *Cardium biangulatum*. Sowerby's combination of names, *Cardium planicostatum*, had been used earlier by Sedgwick & Murchison; therefore a new name is required for *Cardium planicostatum* of Sowerby and the name *Cardium guana-castense* based upon a type from Culebra Bay, Costa Rica, is here proposed.

Cardium arrestum Dall from the Caloosahatchie Pliocene of Florida is a similar species.

Distribution: Two specimens of this species were collected by the Expedition at Culebra Bay, Costa Rica. The northernmost locality represented by specimens in the collection of the California Academy of Sciences is that of shells collected by the Templeton Crocker Expedition in 1932 off Mexico in Lat. 23° 03' N., Long. 109° 31' to 109° 36' W. The species also has been recorded as occurring in the Pliocene of Costa Rica, and in the Pleistocene of Ecuador.

Subgenus *Nemocardium* Meek.

Cardium (Nemocardium) centiflosum
Carpenter.

Cardium var. *centiflosum* Carpenter, Rept. Brit. Assoc. Adv. Sci. for 1863 (issued August, 1864), p. 611. "Cat. Is., 30-40 fm.," p. 642. Santa Barbara Islands. Reprint in *Smithson. Miscell. Coll.*, No. 252, 1872, pp. 97, 128.

Cardium (Protocardium) centiflosum Carpenter, Packard, *Univ. Calif. Publ. Zool.* Vol. 14, No. 2, 1918, p. 267, pl. 20, figs. 2a, 2b, 2c, 2d. Dredged in 40 and 46 fathoms on a bottom of fine dark green sand off the Farallon Islands, California.

Type Locality: Catalina Island, California, 30-40 fathoms.

Range: Farallon Islands, California, to Abreojos Point, Lower California.

Collecting Station: Mexico: Cedros Island (126-D-3, 6, 10, 12, 15), 40-60 fathoms, mud, crushed shell, eel grass.

Description: Shell small, roundly trigonal, ornamented by numerous fine radial ribs, the posterior ribs are coarser and are

crossed by raised concentric lamellae. Average specimens in the present collection measure approximately 15 mm. in height.

Cardium centiflosum richardsoni Whit-eaves, a northern form of this species, is generally a little larger and more coarsely sculptured.

Distribution: *Cardium centiflosum* was found in five dredge hauls in the channel east of Cedros Island, Lower California, from depths of 40-60 fathoms. The species has also been recorded from the Pliocene and questionably from the Miocene of California.

Subgenus *Microcardium* Thiele.

Cardium (Microcardium) pazianum Dall.

Plate I, Figures 9, 12, 15 and 16.

Protocardia paziana Dall, *Proc. U. S. Nat. Mus.*, Vol. 52, December 27, 1916, p. 412. "Off La Paz, Gulf of California, in 10 fathoms."

Type Locality: Off La Paz, Lower California, in 10 fathoms.

Range: Cedros Island, Lower California, to Santa Inez Bay in the Gulf of California, to Panama.

Collecting Stations: East of Cedros Island (126-D-10), 60 fathoms, crushed shell, eel grass; Arena Bank, Gulf of California (136-D-22, 24, 26, 29, 31), 35-70 fathoms, mud, *Arca* conglomerate, sand, crushed shell, rock, weed, calcareous algae; Santa Inez Bay (141-D-2), 10-15 fathoms, sand, weed, (142-D-2), 30-35 fathoms, mud, sand, crushed shell, (146-D-1), 35 fathoms, mud, crushed shell, (147-D-2), 60 fathoms, mud, crushed shell; Gorda Banks (150-D-8, 9), 40-60 fathoms, muddy sand; Manzanillo, (184-D-2), 30 fathoms, gravelly sand; Costa Rica: Port Parker (203-D-1, 3), 12-15 fathoms, sandy mud, crushed shell, shelly mud; 14 mi. S. E. of Judas Point (214-D-1-4), mud, shell, rocks; Panama: Gulf of Chiriqui (221-D-1-5), 35-40 fathoms, sandy mud.

Description: Shell small, thin, rounded, posteriorly somewhat obliquely produced and subtruncated; the anterior area ornamented by about 40 fine ribs which are finely nodulous where the concentric crosses the radial sculpture; posterior area with about 22 ribs which are minutely scaled, but interspersed in this series there are five or six with comparatively large scales; the color of the shell is yellowish-white, some specimens entirely so, but many are ornamented by vivid red and orange interiorly toward the hinge and occasionally there is exteriorly a narrow concentric band which is tinged with this color. A large specimen measures approximately 15.2 mm. in length and 15 mm. in height.

This species is very close to "*Protocardia*"

panamensis Dall²⁸, a Panamanian species, which was described as possessing a shorter shell with about 33 ribs and the interior whitish and polished. No mention was made at the time of description of any orange red color on the shell. From the illustration given by Dall there seems to be little to separate the two species except color. However, the coloration is variable and there is often variability in the proportion of length to height in the shells of *Cardium* and furthermore the presence of *C. pazianum* as far south as Panama leads us to doubt whether *C. pazianum* is really distinct from *P. panamensis*. We have for the present retained the name *pazianum* because of the color, the greater length in proportion to height, and because we have but one somewhat imperfect specimen from Panama for comparison, but even it shows a faint trace of pink above the hinge line. *Cardium (Microcardium) peramabile* Dall²⁹, the type of *Microcardium* and its subspecies *tinctum* Dall³⁰, are similar to the two west American species here mentioned.

Distribution: This species was dredged from east of Cedros Island, Mexico, to the Gulf of Chiriqui, Panama, at depths of 10-70 fathoms.

Subgenus *Mexicardia* Stewart.

Cardium (Mexicardia) procerum Sowerby.

Cardium procerum Sowerby, *Proc. Zool. Soc. London*, September 8, 1833, p. 83. "Hab. in Americâ Centrali. (Real Llejós)." "Found in coarse sand in from four to six fathoms water."—Reeve, *Conch. Icon.*, Vol. 2, *Cardium*, 1844, species 51, pl. 10, fig. 51. Original locality cited.

Cardium laticostatum Sowerby, *Proc. Zool. Soc. London*, September 8, 1833, p. 85. "Hab. in Sinu Xipixapi." "Found in sandy mud at the depth of eleven fathoms."—Sowerby, *Conch. Illustr.*, *Cardium*, Cat., p. 1, 1840?, pl. 51, fig. 30, February, 1834. "Xipixapi, West Colombia. Mr. Cuming."

Cardium panamense Sowerby, *Proc. Zool. Soc. London*, September 8, 1833, p. 85. "Hab. ad Panamam." "Found in sandy mud at a depth of ten fathoms."—Reeve, *Conch. Icon.*, Vol. 2, *Cardium*, 1844, species 56, pl. 11, fig. 56. Original locality cited.

Cardium subelangatum "Reeve," Valenciennes, *Zool. Voy. Venus*, 1846, Atlas, pl. 17, fig. 2.

²⁸ *Protocardia panamensis* Dall, *Bull. Mus. Comp. Zool.*, Vol. 43, No. 6, October, 1908, p. 415, pl. 18, fig. 1. "Gulf of Panama, in 182 fathoms, mud."

²⁹ *Cardium (Fulvia) peramabile* Dall, *Bull. Mus. Comp. Zool.*, Vol. 9, No. 2, 1881, p. 132. Various localities cited, Sigsbee, 119 fathoms, Barbados, 100 fathoms; off Sombrero, 54-72 fathoms; west of Florida. 50 fathoms, etc.—Dall, *Bull. Mus. Comp. Zool.*, Vol. 12, No. 6, 1886, p. 269, pl. 4, fig. 7.

³⁰ See *Microcardium tinctum* Dall, McLean, *Mem. Soc. Cubana Hist. Nat.*, Vol. 13, No. 3, 1939, p. 173, pl. 26, figs. 5 and 6. Key West, Florida, and the West Indies, in 7 to 100 fathoms.

Cardium rotundatum Carpenter, Rept. Brit. Assoc. Adv. Sci. for 1856 (issued 1857), pp. 247, 307. Mazatlan, Mexico; Gulf of California.—Carpenter, Cat. Mazatlan Shells, April, 1857, p. 531. "Mazatlan: extremely rare, off Spondylus."

Cardium eudoxia Dall, *Proc. U. S. Nat. Mus.*, Vol. 52, No. 2183, December 27, 1916, p. 412. "Station 3020 Gulf of California, in 7 fathoms."—Keen, *Min. Conch. Club South. Calif.*, No. 41, November, 1944, p. 25. "The holotype, from the Gulf of California, is a young *Trachycardium (Mexicardia) procerum*."

Cardium parvulum Li, *Bull. Geol. Soc. China*, Vol. 9, No. 3, October, 1930, p. 259, pl. 3, fig. 22. Panama Bay. "Probably Recent."

Type Locality: Real Llejos [near Corinto], Nicaragua, in 4 to 6 fathoms, sand.

Range: Lagoon Head (Lat. 28° 15' N., Long. 114° 07' W.), Lower California, to Lobos Islands, Peru.

Collecting Stations: Mexico: Santa Inez Bay, on beach, also at Monument Station; Banderas Bay; Chamela Bay; Tenacatita Bay; Santa Cruz Bay; Guatemala: 7 mi. W. of Champerico (197-D-2), 14 fathoms, mud; Nicaragua: Corinto (200-D-1, 3, 11, 19), 2-13 fathoms, mangrove leaves, also on beach, and at Isla Encantada; San Juan del Sur; Costa Rica: Port Parker; Port Culebra; Cedro Island, Gulf of Nicoya (213-D-1-10), 4-10 fathoms, mud, crushed shell; Golfito, Gulf of Dulce; Panama: Isla Parida; Bahia Honda.

Description: Shell elongately trigonal, somewhat oblique posteriorly, 22 to 25 smooth, flattish-topped, radial ribs, these are not strongly developed on the anterior slope of the shell but the posterior margin is serrated due to the projecting ends of the ribs which interlock with the opposite valve; externally brownish colored with a tendency toward yellowish or whitish colored concentric areas.

In the young stages up to about 35 mm. in length the shell is longer in proportion to the height while in the more adult stages the height is much greater than the length. The ribs are rounded in the younger stages up to 10 or 15 mm. in length but they gradually become broader, subtriangular and flatter and are separated by narrow and fairly deep interspaces. The rather considerable variation in shape during the growth has led to descriptions of this species under several different names, such as *Cardium laticostatum* Sowerby, which name was based on a young rounded stage of *C. procerum*. Large specimens of this species attain a height of more than 80 mm.

Distribution: *Cardium procerum* occurs commonly from the Gulf of California to Peru. It was collected from the Gulf of

California to Panama on the beaches and dredged at depths of 2 to 14 fathoms. The largest number of specimens of this species found at any locality was in the beach drift at Corinto, Nicaragua. The species is also known to occur in the Pleistocene of southern California, Lower California, Costa Rica and Panama, and in the Pliocene and Pleistocene of Ecuador.

Subgenus *Trigoniocardia* Dall.

Key to the species of *Trigoniocardia*.

- A. Shell subtrigonal; about 18 strongly noded ribs *graniferum*
 B. Shell subovate; about 21 finely noded ribs *obovale*

Cardium (Trigoniocardia) graniferum

Broderip & Sowerby.

Cardium graniferum Broderip & Sowerby, *Zool. Jour.*, Vol. 4, January, 1829, p. 367. "Hab. ad littora Oceani Pacifici." "Dug from a depth of about 6 inches in the mud of the Estero de Mazatlan."—Sowerby, *Conch. Illustr.*, *Cardium*, Cat., p. 3, 1840?, pl. 49, fig. 17, January, 1834. "Pacific Ocean. Mr. Cuming."—Reeve, *Conch. Icon.*, Vol. 2, *Cardium*, 1844, species 43, pl. 8, fig. 43. "Hab. Gulf. of Nicoya, Central America; and Xipixapi, West Columbia; Cuming."

Type Locality: Mazatlan, Mexico, in about 6 inches, mud.

Range: Gulf of California, to Zorritos, Peru.

Collecting Stations: Mexico: Santa Inez Bay, Gulf of California (145-D-1, 3), 4-13 fathoms, sand; San Domingo Point; Port Guatulco (195-D-19, 21), 17-18 fathoms, mud, crushed shell; El Salvador: Meanguera Island, Gulf of Fonseca (199-D-1), 16 fathoms, sand, mud, crushed shell; Nicaragua: Corinto (200-D-3, 10, 17, 19), 2-13 fathoms mangrove leaves, sand, also on beach; Costa Rica: Port Parker (203-D-1), 15 fathoms, sandy mud, crushed shell; Cedro Island, Gulf of Nicoya (213-D-1-10), 4-10 fathoms, mud, sand, crushed shell; Golfito Bay, Gulf of Dulce (218); Panama: Bahia Honda (222).

Description: Shell small, subtrigonal, there are about a dozen rather widely spaced, elevated, triangular, finely noded ribs followed by about 6 to 8 finer, closely spaced, noded ribs which occur on the steeply sloping posterior area; the interspaces are marked by deep narrow, transverse grooves. A large specimen measures approximately 15 mm. in altitude. Reeve has mentioned the *Trigonia*-like appearance of this shell.

Cardium haitense Sowerby from the Miocene of the Caribbean region is a similar species.

Distribution: Specimens of *Cardium*

graniferum were collected at various localities from the Gulf of California to Panama on beaches and dredged at depths of 4 to 18 fathoms. The largest number of specimens was found in the beach drift at Corinto, Nicaragua. It is also known to occur in the Pleistocene of Magdalena Bay, Lower California, and Panama and in the Pliocene of Ecuador. A fossil form cited as "*Cardium (Fragum) aff. graniferum Broderip*"³¹ has been recorded from Barbados Island.

***Cardium (Trigoniocardia) obovale* Sowerby.**

Cardium obovale Sowerby, *Proc. Zool. Soc. London*, September 8, 1833, p. 84. "Hab. ad oras Americae Meridionalis. (Xipixapi)." "Found in sandy mud at eleven fathoms depth."—Sowerby, *Conch. Illustr., Cardium*, Cat., p. 7, 1840?, pl. 46, fig. 4, issued between July 19, 1833, and January, 1834. "Xipixapi. Mr. Cuming."—Reeve, *Conch. Icon.*, Vol. 2, *Cardium*, 1845, species 117, pl. 21, fig. 117. Original locality cited.—Hertlein, *Bull. South. Calif. Acad. Sci.*, Vol. 33, Pt. 2, May-August (issued August 31), 1934, p. 62, pl. 21, fig. 14. Maria Magdalena Island, Tres Marias group, Mexico, Pleistocene.

Type Locality: Xipixapi (Jipijapa), Ecuador, in 11 fathoms, sandy mud.

Range: Magdalena Bay, Lower California, and the Gulf of California to Salinas, Ecuador.

Collecting Stations: Mexico: San Lucas Bay (135-D-2), 8-16 fathoms, sand; 17 mi. S. E. of Acapulco (189-D-3), 13 fathoms, mud; Guatemala: 7 mi. W. of Champerico (197-D-1, 2), 14 fathoms, mud; El Salvador: La Libertad (198-D-1, 2), 13-14 fathoms, mud; Nicaragua: Corinto (200-D-10, 11, 16, 19, 20-26), 1.5-13 fathoms, mangrove leaves, sand, also on beach; Panama: Gulf of Chiriqui (221-D-1-5), 35-40 fathoms, sand, mud.

Description: Shell small, subovate, oblique, fairly convex and peaked, ornamented by about 21 finely noded radial ribs, those anteriorly and posteriorly somewhat broadly and asymmetrically triangular, those along the posterior umbonal ridge higher and rounded, those on the posterior area, about 8 in number, flatter, narrower and closer together than those on the anterior area; interspaces transversely grooved. A large specimen in the collection of the California Academy of Sciences from near Isabel Island, west Mexico, measures, approximately, 20.5 mm. in altitude, 14 mm. in length, convexity (one valve) 8 mm.

Cardium ovuloides Reeve³², described without information as to the locality, ap-

pears to be similar to *C. obovale* but was described as possessing sculpture similar to that of *C. graniferum*. *Cardium (Trigoniocardia) cabopasadum* Pilsbry & Olsson³³ from the Pliocene of Ecuador and *Cardium (Trigoniocardia) spiekeri* Hanna & Israel-sky from the upper Miocene of Ecuador and Pliocene of Peru are other species of the *C. obovale* group.

Distribution: Specimens of *Cardium obovale* were collected from Cape San Lucas Bay, Lower California, to the Gulf of Chiriqui, Panama, on the beach and dredged at depths of 1.5 to 40 fathoms. The largest number found at any one locality was west of Champerico, Guatemala, in 14 fathoms on a muddy bottom. This species is also known to occur in the Pleistocene of the Tres Marias Islands, and in the Pliocene of Panama and Ecuador.

Subgenus ***Laevicardium*** Swainson.

Key to the species of *Laevicardium*.

- A. Shell large, very convex; radially grooved *elatum*
- B. Shell small, more compressed, oblique; smooth or with very fine nearly obsolete ribbing
 - a. Elongately trigonal; interior spotted, banded or entirely reddish-brown
 - b. Interior entirely reddish-brown or with concentric bands *elenense*
 - bb. Interior with reddish-brown spots; shell broader *apicinum*
 - aa. Elongately oblique; interior white with a yellow patch under the umbos *clarionense*

***Cardium (Laevicardium) clarionense* Hertlein & Strong, sp. nov.**

Plate I, Figures 5, 6, 7 and 14.

Shell very obliquely ovate, rather compressed, pointed at the beaks, very slightly gaping at the sides; smooth over most of the surface but with fine radial sculpture along the basal margin and at the edges of the resting stages, internally with the basal and the lower half of the anterior margin finely serrated; there is also a narrow posterior area defined by a slight angle exteriorly but scarcely visible internally; exterior light yellowish, variously maculated and spotted with brown, internally with a large yellow patch extending from the beaks to the middle of the shell, a broad white band along the margins; lateral teeth strong, cardinal teeth small, two in the left valve, one in the right. The type measures: maximum vertical diameter, 31.4 mm.; max-

³¹ *Cardium (Fragum) aff. graniferum Broderip*, Trechtmann, *Geol. Mag.*, Vol. 70 (Whole No. 823), 1933, p. 35. Fossil at Gun Hill, Barbados.

³² *Cardium ovuloides* Reeve, *Conch. Icon.*, Vol. 2, *Cardium*, March, 1845, species 126, pl. 22, fig. 126. "Hab.—?"

³³ *Cardium (Trigoniocardia) cabopasadum* Pilsbry & Olsson, *Proc. Acad. Nat. Sci. Philadelphia*, Vol. 93, September 9, 1941, p. 59, pl. 12, figs. 6, 7. "Jama formation, Puerto Jama." Ecuador, Pliocene.

imum longitudinal diameter, 23.9 mm.; convexity (both valves), 16.5 mm.

Holotype, (California Academy of Sciences Paleo. Type Coll.), from Station 163-D-2, dredged 3 miles off Pyramid Rock, south of Clarion Island, Lat. 18° 19' N., Long. 114° 45' W., in 55 fathoms (100 meters), rock and coral bottom. Two complete specimens and three odd valves were dredged at the same locality. Additional specimens were dredged as follows: one valve at Arena Bank (136-D-15), 40 fathoms, mud, crushed shell; one valve at Arena Bank (136-D-28), 85 fathoms, muddy sand; one specimen in Ceralbo Channel (137-D-1), 46 fathoms, rock; one specimen at Santa Inez Bay (143-D-3), 35 fathoms, mud, crushed shell, and two specimens from the same locality but without further information.

Range: Santa Inez Bay, Gulf of California, to Clarion Island, Revillagigedo group.

This species resembles in many ways the young of *Cardium elatum* Sowerby of the same size but is much more oblique and more compressed. It differs from *Cardium elenense* Sowerby in the larger size, more oblique shape and in the coloration, particularly the large internal yellow patch. The largest single specimen of the new species measures: maximum vertical diameter, 41 mm.; maximum longitudinal diameter, 32 mm.

***Cardium (Laevicardium) elatum* Sowerby.**

Cardium elatum Sowerby, *Proc. Zool. Soc. London*, September 8, 1833, p. 84. "Hab. ad Guaymas in Sinu Californiensi." "Found in sandy mud at low water."—Sowerby, *Conch. Illustr.*, *Cardium*, Cat., p. 5, 1840?, pl. 46, fig. 3, issued between July 19, 1833 and January, 1834. "California."—Reeve, *Conch. Icon.*, Vol. 2, *Cardium*, 1844, species 41, pl. 8, fig. 41. "Hab. Bay of California (found on mud-banks at low water)."

Type Locality: Guaymas, Sonora, Mexico, in the Gulf of California, at low water, in sandy mud.

Range: San Pedro, California, to Panama.

Collecting Stations: Mexico: Santa Inez Bay, Monument Station; 1 mile south of San Domingo Point, Concepcion Bay; Banderas Bay.

Description: Shell large, oval, somewhat oblique, very ventricose, yellow, with a thin brownish periostracum; surface ornamented by numerous shallow radiating grooves, but the anterior and posterior margins are smooth; ventral margin serrated and interlocking.

This is the largest Recent species of *Cardium* known. A large specimen from San Diego, California, in the collections of the California Academy of Sciences measures

approximately 170 mm. in altitude and Lowe has mentioned a specimen slightly larger (5½ inches long) from the Gulf of California.

Distribution: This species was taken in Santa Inez Bay in the Gulf of California, and at Banderas Bay, Mexico. It has been recorded as occurring south to Panama but we have not seen specimens from south of Tenacatita Bay, west Mexico. It is also known to occur in the Pleistocene of southern California and Lower California and in the archaeological ruins and middens of southwestern United States.

***Cardium (Laevicardium) elenense* Sowerby.**

Cardium elenense Sowerby, *Conch. Illustr.*, *Cardium*, Cat., p. 6 (*elenensis*), 8 (*elenense*), No. 73, 1840?, pl. 181, fig. 58, issued between June, 1839, and 1841. "St. Elena." [Shaw (*Proc. Malacol. Soc. London*, Vol. 8, 1909, p. 340) cited the date of issue of the Catalogue of *Cardium* in *Conch. Illustr.*, as "*Cardium*, Cat., pp. 1-8, with part 184? 1840?." Tomlin, 1928, cited the *Conch. Illustr.*, as the earliest reference to the present species].—Sowerby, *Proc. Zool. Soc. London* for 1840 (issued May, 1841), p. 109. "Hab. ad Sanctam Elenam. H. Cuming legit." Ref. to *Conch. Illustr.*, fig. 58.—Reeve, *Conch. Icon.*, Vol. 2, *Cardium*, 1845, species 104, pl. 20, fig. 104. "Hab. St. Elena, West Columbia (found in sandy mud at the depth of seven fathoms); Cuming."—E. K. Jordan, *Contrib. Dept. Geol. Stanford Univ.*, Vol. 1, No. 4, 1936, p. 134. Magdalena Bay, Santa Margarita Island and San Ignacio Lagoon, Lower California, Pleistocene. Recent, Gulf of California.

Type Locality: Santa Elena, Ecuador.

Range: Magdalena Bay and the Gulf of California, to Salinas, Ecuador, and the Galápagos Islands.

Collecting Stations: Mexico: Gulf of California; Arena Bank (136-D-6, 30), 35 fathoms, sand, weed; Santa Inez Bay (141-D-2), 10-15 fathoms, sand, weed, (142-D-4), 40-50 fathoms, sand, (143-D-1), 29 fathoms, mud, crushed shell, weed, (144-D-2), 2½ fathoms, sand, weed, rocks, (145-D-1), 13 fathoms, sand, also 1 mile off San Domingo Point, Concepcion Bay; Arena Point Area; San Lucas Bay, off west beach; Cape Santa Lucas; Port Guatulco (195-D-1, 2, 3, 6, 7, 13, 19), 2.5-17 fathoms, sand, algae, crushed shell, rocks, green mud; Tangola-Tangola Bay (196-D-14), 5 fathoms, crushed shell; Nicaragua: Corinto (200-D-3, 17, 19), 2-13 fathoms, mangrove leaves, sand, also on beach; Costa Rica: Port Parker (203-D-1, 2, 3, 4-15), 1-15 fathoms, sandy mud, crushed shell, shelly mud, algae, gravel, rocks, coral; Cedro Island, Gulf of Nicoya (213-D-1-10), 4-10 fathoms, mud, sand, crushed shell; Golfo, Gulf of Dulce (218-D-8), 6 fathoms,

mangrove leaves, mud, shells; Panama: Bahia Honda (222), 3-11 fathoms, rocks, coral, shells, green mud, leaves.

Description: Shell thin, smooth, oval, gently inflated, externally colored reddish-yellow and brown, with brown or purple dots, interiorly with reddish-brown bands or, in some specimens, almost completely reddish-brown. Weathered specimens usually show the presence of fine radial sculpture. Height about 20 mm.

Cardium elenense is very similar to the subspecies *C. elenense apicinum* Carpenter but appears to be narrower in form and is exteriorly ornamented by more color of yellow with reddish-brown bands on the beaks and the interior is more completely colored reddish-brown or with concentric bands rather than spotted and blotched as in *C. elenense apicinum*. *Cardium elenense* is similar to the generally more northern *C. substriatum* Conrad, from southern California, but is smaller and is colored reddish-brown exteriorly while Conrad's species never shows more than obscure markings upon a yellowish-gray background.

A number of species of this group occur both Recent and fossil in the Caribbean region.

Distribution: *Cardium elenense* was collected at many localities from the Gulf of California to Panama, on the beach and at depths of 1 to 50 fathoms. The largest number of specimens, approximately 200, were dredged in Santa Inez Bay in 13 fathoms on a sandy bottom. The species has also been cited as occurring in the Pleistocene of Lower California, the Tres Marias Islands and Panama, and in the Pliocene of Ecuador.

***Cardium (Laevicardium) elenense apicinum*
Carpenter.**

Levicardium apicinum Carpenter, *Ann. & Mag. Nat. Hist.*, Ser. 3, Vol. 13, April, 1864, p. 313. Cape St. Lucas, Lower California. Reprint in *Smithson. Miscell. Coll.*, No. 252, 1872, p. 211. See also pp. 23, 104, 261 (as *Liocardium apicinum*).

Cardium (Liocardium) apicinum Carpenter, Stearns, *Proc. U. S. Nat. Mus.*, Vol. 17, 1894, p. 151. Boca de las Piedras; Mulege Bay; Cape San Lucas; Mazatlan.

Cardium apicinum Carpenter, Strong and Hanna, *Proc. Calif. Acad. Sci.*, Ser. 4, Vol. 19, No. 3, 1930, p. 15. Maria Madre Island, Tres Marias Islands.

Type Locality: Cape San Lucas, Lower California.

Range: Gulf of California to Isla Grande, West Mexico, and probably to Peru.

Collecting Station: Mexico: Arena Bank (136-D-30), 35 fathoms, sand, weed.

Description: The form described as *Cardium apicinum* by Carpenter appears to inter-

grade with *C. elenense* Sowerby but some of the northern specimens appear to be separable as a subspecies. They are broader with more spotted coloring both exteriorly and interiorly. Specimens of *C. elenense* from Santa Elena, Ecuador, are externally more yellowish in color with reddish-brown concentric bands on the beaks and the interior is almost completely dark reddish-brown or with concentric bands of this color.

Distribution: Specimens of this subspecies were dredged by the Expedition on Arena Bank, in 35 fathoms, on a sand and weed bottom.

Subgenus *Dinocardium* Dall.

***Cardium (Dinocardium) robustum* Solander.**

Cardium magnum Born, *Mus. Caes. Vind.*, 1780, p. 46, pl. 3, fig. 5. "Habitat ad Jamaicam, Linnaeus."—Reeve, *Conch. Icon.*, Vol. 2, *Cardium*, 1844, species 20, pl. 4, fig. 20. "Hab. Gulf of Mexico."

Not *Cardium magnum* Linnaeus, *Syst. Nat.*, ed. 10, 1758, p. 680. "Habitat ad Jamaicam."

Cardium robustum Solander, *Cat. Portland Mus.*, 1786, p. 58, No. 1358, p. 162, No. 3517. "A large and fine *Cardium robustum*, S. from Florida, very scarce—Lister, 328. 165."

Cardium (Dinocardium) robustum Solander, McLean, *Mem. Soc. Cubana Hist. Nat.*, Vol. 13, No. 3, June, 1939, p. 163, pl. 24, figs. 10-11. Virginia to Belize, British Honduras and in the West Indies south to Jamaica.

Type Locality: Florida.

Range: Virginia to Belize, British Honduras, and in the West Indies south to Jamaica.

Collecting Station: Mexico: Santa Inez Bay, Gulf of California.

Description: One valve of *Cardium robustum* was collected at Santa Inez Bay. This is a Caribbean species and has not been recorded as occurring in the Gulf of California. The specimen was probably brought to the Gulf of California by some adventitious means. It is interesting to note that this species has been reported by Brand³⁴ as occurring in archaeological ruins and middens of southwest United States along with other undoubted east American shells. The shape, ribbing and color of the specimen is typical and agrees perfectly with specimens in the collections of the California Academy of Sciences which were collected in Florida by Henry Hemphill.

Distribution: *Cardium robustum* is a Caribbean species and occurs in that region from Virginia to British Honduras and in the West Indies to Jamaica. It has also been

³⁴ Brand, D. D., *Yearbook Assoc. Pac. Coast Geogr.*, Vol. 4, 1938, p. 5.

reported from upper Miocene to Recent in that region.

Subgenus *Trachycardium* Mörch.

Cardium (Trachycardium) consors Sowerby.

Cardium consors Sowerby, *Proc. Zool. Soc. London*, September 8, 1833, p. 85. "Hab. ad Sanctam Elenam et ad Guacamayo." "Collected in sandy mud at from six to eleven fathoms."—Sowerby, *Conch. Illustr.*, *Cardium*, Cat., p. 3, 1840?, pl. 47, fig. 8, issued between July 19, 1833, and January, 1834. Original locality cited.—Reeve, *Conch. Icon.*, Vol. 2, *Cardium*, 1845, species 86, pl. 17, fig. 86. Original locality cited.

Type Locality: Santa Elena, Ecuador, in 6 to 11 fathoms, sandy mud (here designated as type locality). "Guacamayo" also cited originally.

Range: Gulf of California to Guayaquil, Ecuador, and the Galápagos Islands.

Collecting Stations: Mexico: Arena Point (136-D-32), 42 fathoms, sand; Ceralbo Island; Santa Inez Bay, and at Monument Station; Chamela Bay (182-D-1), 8 fathoms, sand, algae; Sihuatanejo Bay; Port Guatulco (195-D-2, 3, 5, 8, 11, 19) 2-17 fathoms, sand, crushed shell, algae, green sand, green mud, also on beach; Tangola-Tangola Bay (196-D-6, 7, 8, 14, 15), 5-9 fathoms, sand, crushed shell; Costa Rica: Port Parker; Golfito; Panama: Bahia Honda.

Description: Shell elongately oval, very convex, thick, somewhat oblique and gaping posteriorly; ornamented by about 30 to 34 strong, elevated, radial ribs which bear strong, close-set squamose imbrications which are compressly flattened on the posterior side, extend over the top, but are absent on the anterior side of the ribs; colored yellowish-white stained with brown especially on the posterior portion, the interior colored reddish-purple with white along the margins. Large shells attain a height of about 75 mm.

A variety of this species said to be more elongated and with the imbrications rather distant from each other was named *laxum* by Dall³⁵. *Cardium isocardia* Linnaeus, which occurs in the Caribbean region, is similar to *C. consors*, as is *C. emmonsii* Conrad in the Pliocene of North Carolina.

Distribution: *Cardium consors* was collected at a number of localities from the Gulf of California to Panama on the beach and dredged at depths of 2 to 24 fathoms. It occurs commonly in that region. It is also known to occur in the Pliocene and Pleistocene of the Gulf of California region, and has been cited from the Quaternary of Manta, Ecuador.

³⁵ Dall, W. H., *Proc. U. S. Nat. Mus.*, Vol. 23, No. 1214, January, 1901, p. 389. Gulf of California.

Subgenus *Acrosterigma* Dall.

Cardium (Acrosterigma) pristipleura Dall.

Cardium maculosum Sowerby, *Proc. Zool. Soc. London*, September 8, 1833, p. 85. "Hab. ad Insulas Tres Marias, in Sinu Californiensi." "Found on the sands."

Not *Cardium maculosum* Wood, 1815.

Cardium maculatum Sowerby, *Conch. Illustr.*, *Cardium*, Cat., p. 4, 1840?, pl. 49, fig. 18, January, 1834. "California." New name for *Cardium maculosum* Sowerby, not *C. maculosum* Wood.—Reeve, *Conch. Icon.*, Vol. 2, *Cardium*, 1844, species 58, pl. 11, fig. 58. "Hab. Island of Tres Marias, Gulf of Mexico."

Not *Cardium maculatum* Gmelin, 1792.

Cardium (Trachycardium) pristipleura Dall, *Proc. U. S. Nat. Mus.*, Vol. 23, 1901, p. 389. "Range: Gulf of California (La Paz) and west coast of Middle America." A new name for *Cardium maculosum* Sowerby, 1833, not *C. maculosum* Wood, 1815. *Cardium maculatum* "Reeve" not *C. maculatum* Gmelin.

Cardium (Trachycardium) hornelli Tomlin, *Jour. Conch.*, Vol. 18, No. 7, May, 1928, p. 194. "Gorgona" Island, Colombia, on shore. A new name for *Cardium maculosum* Sowerby, not *C. maculosum* Wood; *C. maculatum* Sowerby, not *C. maculatum* Gmelin.

Type Locality: Tres Marias Islands, west Mexico, on the sands.

Range: Gulf of California to Guayaquil, Ecuador.

Collecting Stations: Mexico: Ceralbo Island, Gulf of California; Port Guatulco (195-D-6, 18), 3-6 fathoms, sand, algae, crushed shell; Tangola-Tangola Bay, on beach; Panama: Bahia Honda; Colombia: Gorgona Island.

Description: Shell elongately obliquely ovate, gently convex; ornamented by 34 to 39 flattened, laterally imbricated ribs; colored exteriorly whitish-yellow and reddish-brown, the interior white. Height about 60-70 mm.

Distribution: Specimens of this species were collected from west Mexico to Colombia, on the beach and dredged at depths of 3-6 fathoms, usually only one or two specimens at a locality.

Subgenus *Dallocardia* Stewart.

Cardium (Dallocardia) senticosum Sowerby.

Cardium senticosum Sowerby, *Proc. Zool. Soc. London*, September 8, 1833, p. 84. "Hab. ad Sanctam Elenam, Americae Meridionalis." "Found in sandy mud at from six to twelve fathoms depth."—Sowerby, *Conch. Illustr.*, *Cardium*, Cat., p. 3, 1840?, pl. 47, fig. 10, issued between July 19, 1833, and January, 1834. "St. Elena."

Cardium rastrum Reeve, *Conch. Icon.*, Vol. 2, *Cardium*, 1845, species 82, pl. 16, fig. 82.

"Hab.—?" Referred to *Cardium senticosum* in errata.

Type Locality: Santa Elena, Ecuador, in 6 to 12 fathoms, sandy mud.

Range: West coast of Lower California in about Lat. 24° N., and the Gulf of California, to Paita, Peru.

Collecting Stations: Mexico: Port Guatulco (195-D-7, 14), 4-4.5 fathoms, rocks, coral; Guatemala: 7 mi. W. of Champerico (197-D-1, 2), 14 fathoms, mud; El Salvador: La Libertad (198-D-1, 2), 13-14 fathoms, mud; Meanguera Island, Gulf of Fonseca (199-D-1), 16 fathoms sand, mud, crushed shell; Nicaragua: Potosi and Monypenny Point, Gulf of Fonseca (199-D-6), 4 fathoms, mud; Corinto (200-D-10, 11, 19), 7-13 fathoms, sand, mangrove leaves; Costa Rica: Cedro Island, Gulf of Nicoya (213-D-1-10), 4-10 fathoms, mud, sand, crushed shell; Jasper Island; Golfito Bay, Gulf of Dulce; Panama: Gulf of Chiriqui (221-D-1-5), 35-40 fathoms, sandy mud.

Description: Shell rounded, gently convex, ornamented with 36 to 39 ribs which in their earlier stages are subtriangular but later become subrounded; the ribs bear obliquely projecting scale-like imbrications which toward the ventral margin develop into oblique nodes; on the central ribs the nodes are strongly developed on the posterior side, although on some specimens, they are also present, but to a lesser degree, on the anterior side; on the anterior ribs nodes may be present on top or on the anterior side while on the posterior ribs they are strongly developed on the posterior side; exteriorly the color is brownish-white and banded or spotted with reddish-brown or purple, interiorly the portion under the umbones is usually reddish-purple; the remainder, and sometimes all of the shell, is white. The shell attains an altitude of 40 mm. Some specimens from off Guatemala in 14 fathoms on a muddy bottom are thinner and less colored than the other specimens.

Cardium muricatum Linnaeus from the western Atlantic is a similar species. Möricke has considered *Cardium auca* d'Orbigny from the Tertiary of Chile to be a subspecies of *C. senticosum*. We have not seen specimens of the fossil form from Chile.

Distribution: Specimens of *Cardium senticosum* were collected from West Mexico to Panama, on the beach and dredged from depths of 4 to 40 fathoms, mostly on muddy bottoms. The largest number of specimens was taken off Meanguera Island in the Gulf of Fonseca in 16 fathoms. This species is also known to occur in the Pleistocene of Maria Magdalena Island, Tres Marias group, also Panama and Ecuador.

Superfamily Cyrenacea.

FAMILY CORBICULIDAE.

Genus *Polymesoda* Rafinesque.

A monograph of the American Corbiculidae by Prime³⁶ is very useful as an aid in the identification of the American species of *Polymesoda*.

Key to the species of *Polymesoda*.

- A. Posteriorly attenuated and pointed
anomala
- B. Posteriorly subrounded and slightly truncated *recluzii*

Polymesoda anomala Deshayes.

Cyrena anomala Deshayes, *Proc. Zool. Soc. London* for 1854 (issued January 10, 1855), p. 21. "Hab. Bay of Caraccas; Peru."—Deshayes, *Cat. Conch. Bivalve Shells Brit. Mus.*, Pt. 2, 1854, p. 257. "Hab. Sinus Caraccasensis et ad oras Peruvianas. Coll. Cum- ing."—Prime, *Smithson. Miscell. Coll.*, Vol. 7, Article 5, No. 145, 1865, p. 30, fig. 24. "Hab. South America in Peru. (Cabinets of Cuming and Prime.)"—Sowerby, *Conch. Icon.*, Vol. 20, *Cyrena*, 1878, species 109, pl. 19, fig. 109. "Hab. Bay of Caraccas."

Cyrena peruviana Deshayes, *Cat. Conch. Bivalve Shells Brit. Mus.*, Pt. 2, 1854, p. 259. "Hab. Tumbez in littore Peruviano. Coll. Cuming."

Type Locality: Bay of Caraccas, Ecuador (here designated as type locality). Peru also cited originally.

Range: Corinto, Nicaragua, to Tumbez, Peru.

Collecting Stations: Nicaragua: Corinto, Castanones peninsular lagoon, also Isla Encantada; Colombia: Gorgona Island.

Description: Shell subtrigonal, thin, umbos inflated, anterior end rounded, ventral margin evenly rounded, posterior end attenuated and pointed, umbos with a carina posteriorly from which the shell slopes steeply to the margin; periostracum olive green in color and raised in crenulated, concentric lamellae; hinge area narrow; the hinge area, also the interior of the shell under the umbos, is purple, the remainder white.

Distribution: The present record of this species from Corinto, Nicaragua, is an extension north of the known range. It occurs in brackish water.

Polymesoda recluzii Prime.

Cyrena cordiformis Recluz, *Journ. de Conchyl.*, Vol. 4, December, 1853, p. 251, pl. 7, fig. 9. [No locality cited].—Deshayes, *Cat. Conch. Bivalve Shells Brit. Mus.*, Pt. 2,

³⁶ Prime, T. Monograph of the American Corbiculidae. *Smithson. Miscell. Coll.*, Vol. 7, Article 5, No. 145, December, 1865, pp. 1-XI, 1-80, 86 figs. in text.

1854, p. 259. "Hab.—?"—Sowerby, Conch. Icon., Vol. 20, *Cyrena*, 1878, species 27, pl. 8, figs. 27a, 27b. "Payta, Peru."

Not *Cyrena cordiformis* Deshayes, Dict. Class. Hist. Nat., Vermes, 1824, p. 290.

Cyrena reclusii Prime, *Smithson. Miscell. Coll.*, Vol. 7, Article 5, No. 145 (Mon. Amer. Corbiculidae), December, 1865, p. 24, fig. 19. "Hab. Central America. (Cabinet of Cuming.)"

Polymesoda inflata var. *cordiformis* Recluz, von Martens, Biol. Centrali-Americana, (Land and Freshwater Moll.), October, 1900, p. 549. "Hab. ?Central America."

Type Locality: Central America.

Range: Puntarenas, Costa Rica, to Paita, Peru.

Collecting Stations: Costa Rica: Puntarenas; Puntarenas Lagoon; Ballenas Bay, Gulf of Nicoya.

Description: Shell subtrigonal, heart-shaped, inflated, moderately thick; posterior angulation present, a gentle depressed or flattened area posterior to the angulation; exteriorly covered with a dark olive green periostracum raised in irregular concentric lamellae; hinge with three cardinals and two

right laterals, interior purple near the posterior margin, also small patches on posterior part of hinge and below beaks, the remainder white tinged with purple bands showing through from the other side.

"*Cyrena*" *maratima* C. B. Adams was considered to be identical with *Polymesoda reclusii* by von Martens. He also pointed out that *P. reclusii* differs from *P. panamensis* Prime³⁷ in that the shell is more angulated posteriorly below the furrow. Both *P. reclusii* (cited as *cordiformis*) and *P. panamensis* were considered by von Martens to be only varieties of *P. inflata* Philippi, a species in which it appears that the shell lacks a distinct posterior furrow. *Polymesoda isocardioides* Deshayes is very similar to *P. reclusii* but according to Prime it possesses a thinner shell, narrower hinge margin and smaller teeth.

Distribution: A few specimens of *Polymesoda reclusii* were collected by the Expedition at Puntarenas and at Ballenas Bay in the Gulf of Nicoya, Costa Rica. It occurs in brackish water and ranges south to Peru.

³⁷ Not to be confused with *Cyrenoida panamensis* Pilsbry & Zetek, *Nautilus*, Vol. 45, No. 2, October, 1931, p. 69, pl. 3, fig. 4. "Near Panama City."

EXPLANATION OF THE PLATE.

PLATE I.

- Fig. 1. *Taras (Taras) inezensis* Hertlein & Strong, sp. nov. Holotype, right valve, from Station 146-D-1, Santa Inez Bay, east coast of Lower California, Mexico. Lat. 26° 54' 20" N., Long. 111° 48' 45" W., dredged in 35 fathoms (64 meters). Length, 18.4 mm.; height, 16.9 mm. P. 130.
- Fig. 2. *Chama sordida* Broderip. Hypotype, lower valve, from Station 136-D-13, Arena Bank, Gulf of California, Lat. 23° 29' N., Long. 109° 24' W., dredged in 45 fathoms (82 meters). Height, 44 mm. (including *Arca* shell [shown on upper portion of figure] to which the *Chama* is attached).
This species was discussed in *Zoologica*, New York Zool. Soc., Vol. 31(8):109.
- Fig. 3. *Cardium (Lophocardium) annettae* Dall. Hypotype, left valve, from Station 143-D-2, Santa Inez Bay, east coast of Lower California, Lat. 26° 58' N., Long. 111° 56' 30" W., dredged in 30 fathoms (55 meters). Length, 41 mm.; height, 35.5 mm. P. 138.
- Fig. 4. *Taras (Taras) inezensis* Hertlein & Strong, sp. nov. View of the interior of the specimen shown in Figure 1.
- Fig. 5. *Cardium (Laevicardium) clarionense* Hertlein & Strong, sp. nov. Holotype, left valve, from Station 163-D-2, 3 miles off Pyramid Rock, Clarion Island, Lat. 18° 19' N., Long. 114° 45' W., dredged in 55 fathoms (100 meters). Length, 23.9 mm.; height, 31.4 mm. View of the interior. P. 144.
- Fig. 6. *Cardium (Laevicardium) clarionense* Hertlein & Strong, sp. nov. Holotype, left valve. View of the exterior of the specimen shown in Figure 5.
- Fig. 7. *Cardium (Laevicardium) clarionense* Hertlein & Strong, sp. nov. Holotype. View of the exterior of the right valve.
- Fig. 8. *Cardium (Lophocardium) annettae* Dall. Hypotype, left valve, from Station 143-D-4, Santa Inez Bay, east coast of Lower California, Lat. 26° 55' N., Long. 111° 54' W., dredged in 25 fathoms (46 meters). Length, 26.5 mm.; height, 22.3 mm. View of the exterior. P. 138.
- Fig. 9. *Cardium (Microcardium) pazianum* Dall. Hypotype, right valve, from Station 141-D-2, Santa Inez Bay, east coast of Lower California, Lat. 27° 01' N., Long. 111° 58' 30" W., dredged in 10-15 fathoms (18-27 meters). Length, 15 mm.; height, 14 mm. View of the exterior. P. 142.
- Fig. 10. *Taras (Felaniella) sericatus* Reeve. Hypotype, right valve, from Chamela Bay, Mexico. Length, 22.6 mm.; height, 22 mm. View of the exterior. P. 131.
- Fig. 11. *Taras (Taras) subquadratus* Carpenter. Hypotype, right valve, from Station 163-D-2, 3 miles off Pyramid Rock, Clarion Island, Lat. 18° 19' N., Long. 114° 45' W., dredged in 55 fathoms (100 meters). View of the exterior. Length, 29 mm.; height, 25 mm. This is an unusually large specimen of this species. P. 130.
- Fig. 12. *Cardium (Microcardium) pazianum* Dall. Hypotype, left valve of specimen shown in Figure 9.
- Fig. 13. *Cardium (Lophocardium) annettae* Dall. View of the interior of the specimen shown in Figure 3.
- Fig. 14. *Cardium (Laevicardium) clarionense* Hertlein & Strong, sp. nov. Paratype, right valve, from Station 143-D-3, Santa Inez Bay, east coast of Lower California, Lat. 26° 57' N., Long. 111° 56' W., dredged in 35 fathoms (64 meters). Height, 41 mm. View of the interior. P. 144.
- Fig. 15. *Cardium (Microcardium) pazianum* Dall. Umbonal view of specimens shown in Figures 9 and 12.
- Fig. 16. *Cardium (Microcardium) pazianum* Dall. View of the interior of the specimen shown in Figure 9.

All the specimens illustrated on this plate are in the type collection of the Department of Paleontology of the California Academy of Sciences.

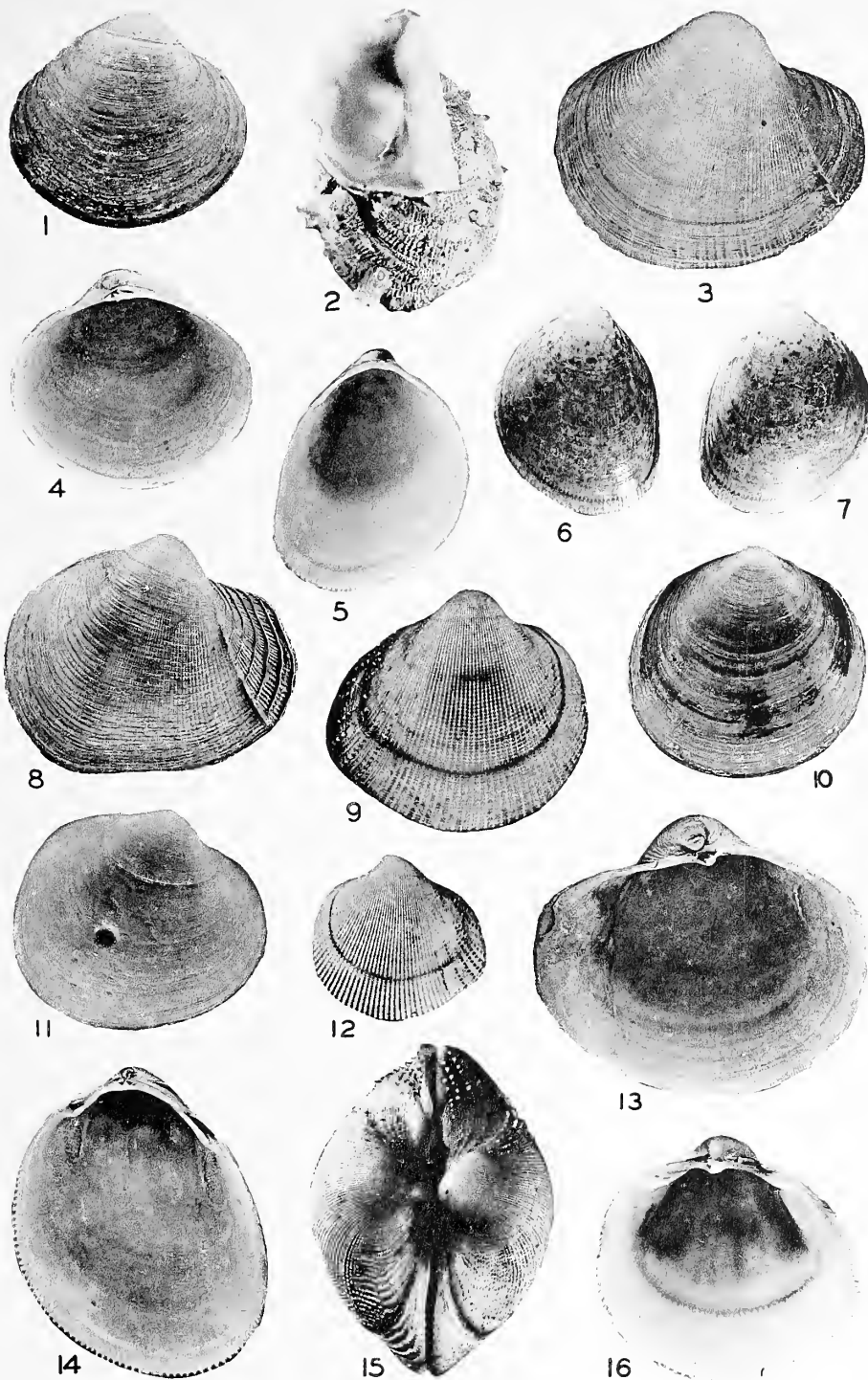

MOLLUSKS FROM THE WEST COAST OF MEXICO AND CENTRAL AMERICA.

II.

Eastern Pacific Expeditions of the New York Zoological Society. XXXVII.
Deep-sea Ceratioid Fishes¹.

WILLIAM BEEBE & JOCELYN CRANE.

Department of Tropical Research, New York Zoological Society.

(Plates I-III. Text-figures 1-19.)

[This is the thirty-seventh of a series of papers dealing with the collections of the Eastern Pacific Expeditions of the New York Zoological Society made under the direction of William Beebe. The present paper is concerned with specimens taken on the *Arcturus* Oceanographic Expedition (1925), the Templeton Crocker Expedition (1936) and the Eastern Pacific *Zaca* Expedition (1937-1938). For data on localities, dates, nets, etc., refer to *Zoologica*, Vol. VIII, No. 1, pp. 1-22; Vol. XXII, No. 2, pp. 33-46; and Vol. XXIII, No. 14, pp. 287-298.]

CONTENTS.

	Page
Introduction	151
Family Melanocetidae	152
<i>Melanocetus ferax</i> Regan	152
<i>Melanocetus johnsoni</i> Gunther	152
<i>Melanocetus megalodontis</i> sp. nov.	152
<i>Melanocetus niger</i> Regan	153
<i>Xenoceratias nudus</i> sp. nov.	155
Family Himantolophidae	155
<i>Himantolophus azurlucens</i> sp. nov.	155
Family Oneirodidae	158
<i>Chaenophryne parvicornis</i> Regan & Trewavas ..	158
<i>Dolopichthys luetkeni</i> Regan	159
<i>Dolopichthys implumis</i> Regan & Trewavas ..	160
<i>Dolopichthys pullatus</i> Regan & Trewavas ..	161
<i>Dolopichthys allector</i> Garman	161
<i>Dolopichthys atratus</i> Regan & Trewavas ..	162
Genus <i>Trematorhynchus</i>	162
<i>Trematorhynchus adipatus</i> sp. nov.	163
<i>Trematorhynchus moderatus</i> sp. nov.	164
<i>Trematorhynchus multilamellatus</i> sp. nov. ..	165
<i>Trematorhynchus multiradiatus</i> sp. nov. ..	166
<i>Trematorhynchus paucilamellatus</i> sp. nov. ..	166
Family Gigantactinidae	167
<i>Gigantactis perlatus</i> sp. nov.	167
Family Ceratiidae	168
<i>Cryptosparus normani</i> Regan & Trewavas ..	168
<i>Mancalias uranoscopus</i> (Murray)	169
Family Linophryniidae	170
<i>Acetrophryne longidens</i> Regan	170
<i>Borophryne apogon</i> Regan	171
<i>Linophryne arcturi</i> (Beebe)	173
<i>Linophryne quinqueramosus</i> sp. nov.	174
<i>Aceratias</i> spp.	176
Bibliography	180

INTRODUCTION.

The twenty-four species discussed in this paper include ten forms apparently new. In addition, a group of ten free-swimming linophrynid males are referred to *Aceratias* spp. because the inadequacy of present knowledge makes further division too tentative to be practicable. Rather, it seems more profitable to treat the group as a unit, suggesting the use of various hitherto unused characters as indices of either growth stages or specific distinctions.

¹ Contribution No. 745, Department of Tropical Research, New York Zoological Society.

With the possible exception of several *Dolopichthys*, the only specimens young enough to be referable to post-larvae and young adolescents are a few of these *Aceratias*. The indications of youth are very similar to those found in corresponding stages of other deep-sea fish previously studied (See especially *Zoologica*, Vol. XVI, No. 1, 1933, general discussion; and *Zoologica*, Vol. XXIV, No. 6, 1939, Melanostomiidae). The post-larvae are distinguished by the general character of imperfectly differentiated pectorals and/or the remains of larval finfolds and by the persistence of apparently larval teeth. Typically male ceratioid characters of this stage are great inflation of the dermal envelope, almost normal eyes and small nostrils.

Adolescence is distinguished by the general characters of disappearance of true finfolds and complete differentiation of pectorals, and by the male ceratioid characters of reduced inflation, eyes gradually revolving forward and down, expansion of nostrils, and the beginning of gonad growth.

The majority of the ceratioids in this paper, as usual in deep-sea fish collections, are transitional adolescents. That is, they are in the long period of pre-adult growth where practically adult appearance has been assumed, but with immaturity shown internally by the small size of the gonads and, in the case of males of parasitic families, by the non-degenerate digestive organs. Only two attached males were taken, each found on a large *Borophryne apogon*. Since both sexes of one pair were found to be very immature internally, attachment obviously cannot strictly speaking be called an indication of adulthood.

We wish to emphasize here the necessity of examining the internal organs of ceratioids, in order that growth characters may eventually be properly distinguished from those of taxonomic importance.

The field notes on color and luminescence were all made by the senior author on freshly caught specimens, only a few minutes after their removal from the net. In some cases, always specially mentioned in the text, the fish were still living.

FAMILY MELANOCETIDAE.

***Melanocetus ferox* Regan, 1926.**

Reference: *Melanocetus ferox* Regan, 1926, p. 33, pl. ix, fig. 1; Regan & Trewavas, 1932, p. 52, text-fig. 75.

Range: Eastern Pacific; Gulf of Panama. The present specimens are the first taken outside the Gulf.

Specimens Taken by the Eastern Pacific Expeditions: Two specimens, from 300 and 500 fathoms, off Costa Rica and Galápagos Islands, respectively; lengths 33.5 (22+11.5) mm. and 23.5 (15+8.5) mm.; young transitional adolescents.

Color (living specimens): Smaller brownish-black, larger pale brown; all fins, eye sockets, gill openings and illicium stem colorless to grayish-white; bulb black in smaller, dark blue in larger; envelope and distal, conical projection translucent white in smaller, translucent and colorless in larger.

Luminescence: The illicium bulb of the smaller fish gave off two weak flashes of whitish light in the dark room, when a few drops of weak formalin were added to the water. Both fishes died within a few minutes of capture.

Measurements: 23.5 mm. specimen: mandible 9.9 mm.; interorbital width 3.8; postorbital width 9.6; illicium length 6.4; longest fang 1.6. 33.5 mm. specimen: mandible 16.5 mm.; interorbital width 4.8; postorbital width 7.8; illicium length 9; longest fang 2.5.

Fins: Pectoral 19; dorsal 15; anal 4.

Remarks: These young fish, both of which are smaller than any of the three previously taken, differ from the latter chiefly in the teeth, which, as was to be expected, are weaker and smaller in the jaws and lacking on the vomer. It is interesting that the 23.5 mm. specimen had the pigment more highly developed than the 33.5 mm. example; in other respects, however, the larger was the more advanced.

Study Material: Cat. No. 6338; *Arcturus* Oceanographic Expedition; Sta. 86 T-8; 16 miles S.W. of Narborough I., Galápagos (0°42' N. Lat., 91°47' W. Long.); 500 fathoms; June 12, 1925; length 23.5 (15+8.5) mm.

Cat. No. 28,489; Eastern Pacific *Zaca* Expedition; Sta. 219 T-1; 25 miles W × N of Pt. Burica, Costa Rica (8°08' N. Lat., 83°17' W. Long.); 300 fathoms; March 10, 1938; length 33.5 (22+11.5) mm.

***Melanocetus johnsoni* Gunther, 1864.**

References: *Melanocetus johnsoni* Gunther, 1864, p. 301, pl. xxv; Regan & Trewavas, 1932, p. 50, figs. 72, 73.

Range: North Atlantic, Caribbean, Indian and Pacific Oceans. The present specimen extends the known Pacific range about 2,160 miles to the east.

Specimen Taken by the Eastern Pacific Expeditions: One specimen, Cat. No. 28,628; Station 227 T-1, Eastern Pacific *Zaca* Expedition; 20 miles southwest of Morro de Puercos, Panama (7°0' N. Lat., 80°40' W. Long.); 500 fathoms; March 21, 1938; length 46 (31+15) mm.; transitional adolescent with ovaries feebly developed.

Color (fresh specimen): Body brownish-black; fins white; illicium stem pigmented light brown, increasingly darker up to and around bulb; crest above bulb white with distal tubercle pigmented brown; peritoneum jet black.

Measurements: Illicium 12.5 mm.; mandible 21; interorbital width 5.6; postorbital head width 13.

Fins: Pectoral 20; dorsal 15; anal 4.

Food: Well digested, small myctophids.

Remarks: This specimen agrees perfectly with those of similar size described by Regan & Trewavas (1932).

***Melanocetus megalodontis* sp. nov.**

(Text-fig. 1).

TYPE.

(The unique specimen).

Department of Tropical Research No. 25,791; Templeton Crocker Expedition of the New York Zoological Society; Sta. 165 T-3; May 17, 1936; 500 fathoms; 145 miles north of Clarion Island (20° 36' N. Lat., 115° 07' W. Long.); total length 38.5 (27+11.5) mm.; a transitional adolescent with small ovaries.

DESCRIPTION.

With the characteristics of the genus.

Color (fresh specimen): Dark brownish-black; all fins and stem of illicium colorless; major illicium bulb blue-black, its translucent envelope and minor bulb colorless; peritoneum jet black.

Measurements and Proportions: Total length 38.5 (27+11.5) mm.; illicium length 13.5 (in length 2.9 or 35%); lower jaw 13 (in length 3.0 or 33.8%); postorbital width of head 9.1 (in length 4.2 or 23.6%); interorbital width 4.4 (in postorbital width of head 2.07 or 14.2% of length); length longest fang 5 (in interorbital width .88 or 13% of length).

Illicium: From the anterior distal portion of the major, pigmented bulb arises a much smaller bulb, round and unpigmented. Both bulbs are enclosed in a translucent envelope which is distinctly compressed longitudinally, arising considerably below major bulb, and projecting well beyond it anteriorly, dorsally and posteriorly, although it is stretched tightly over the distal half of the minor bulb; it shows no trace of distal pigmentation. Behind the minor bulb the envelope gives rise to two minute flaps, facing

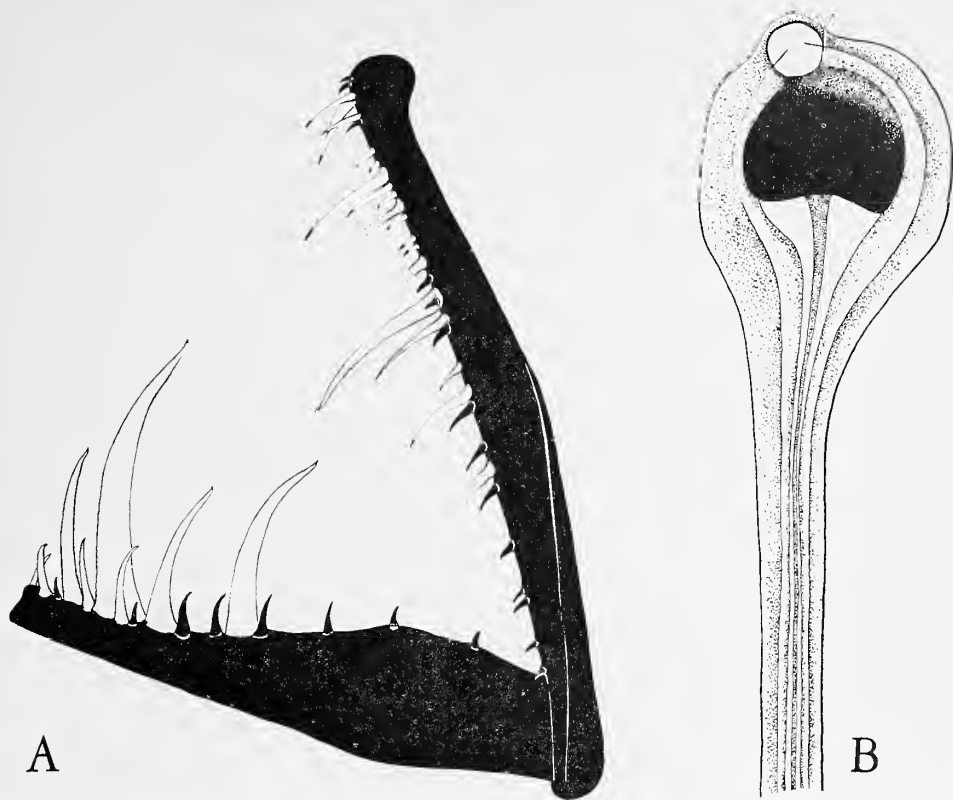

TEXT-FIG. 1. *Melanocetus megalodontis*, holotype. **A**, Dentition. Depressible teeth unshaded. **B**, Illicium.

anteriorly, side by side; the posterior part of the envelope shows several asymmetrically placed ribs or wrinkles not due to post mortem shrinkage.

Teeth: In each half of the upper jaw are 3 large fangs, the third longest, inserted near the inner margin of the jaw. External to these is a series of about 16 to 20 smaller teeth, including 4 or 5 which are moderately enlarged, the remainder being minute. In each half of the lower jaw are 4 or 5 fangs, the second of which is enormous, and 8 or 9 small teeth, most of them minute. Vomer with 4 teeth close together. Four pharyngeal teeth on each side.

Fins: Pectoral 19; dorsal 15; anal 14; caudal 10.

Food: Three scarlet-eyed euphausiids, packed together, each 25 mm. long. All have been identified by Dr. H. J. Hansen as male *Euphausia eximia*.

Behavior: The fish lived for two hours after which we preserved it. In the dark room we caught a fairly strong orange gleam, given forth three times, but could not be sure the illicium was the source. It swam actively but slowly about, with alternate movements of the pectorals. When the caudal moved from side to side it wagged the whole fish. When the gill opening closed the lower part

remained immovable, the upper portion pressing down obliquely, leaving much of the lower half wide open. The position in life was exactly like Brauer's old illustration of *Melanocetus krechi* (1906, Taf. 15, fig. 3).

DISCUSSION.

This proposed new species differs from all the others as follows: in the character of the illicium; in the great length and robustness of the fangs, the length of the largest being greater than the interorbital width; and in the shortness of the lower jaw, which in spite of the small size of the specimen is only about a third of the total length. The fish clearly belongs in the long-fanged group in the key given by Regan & Trewavas (1932, p. 49), and, among these, is perhaps most closely related to *M. murrayi* on the one hand and to *M. ferox* on the other.

***Melanocetus niger* Regan, 1925.**

References: *Melanocetus niger* Regan, 1925, p. 565; Regan, 1926, p. 33, plate VIII, fig. 1; Regan & Trewavas, 1932, p. 53, fig. 76B.

Range: Eastern Pacific: Gulf of Panama and 500 miles to the west near Cocos Island. The present specimens are the first to be taken outside the Gulf.

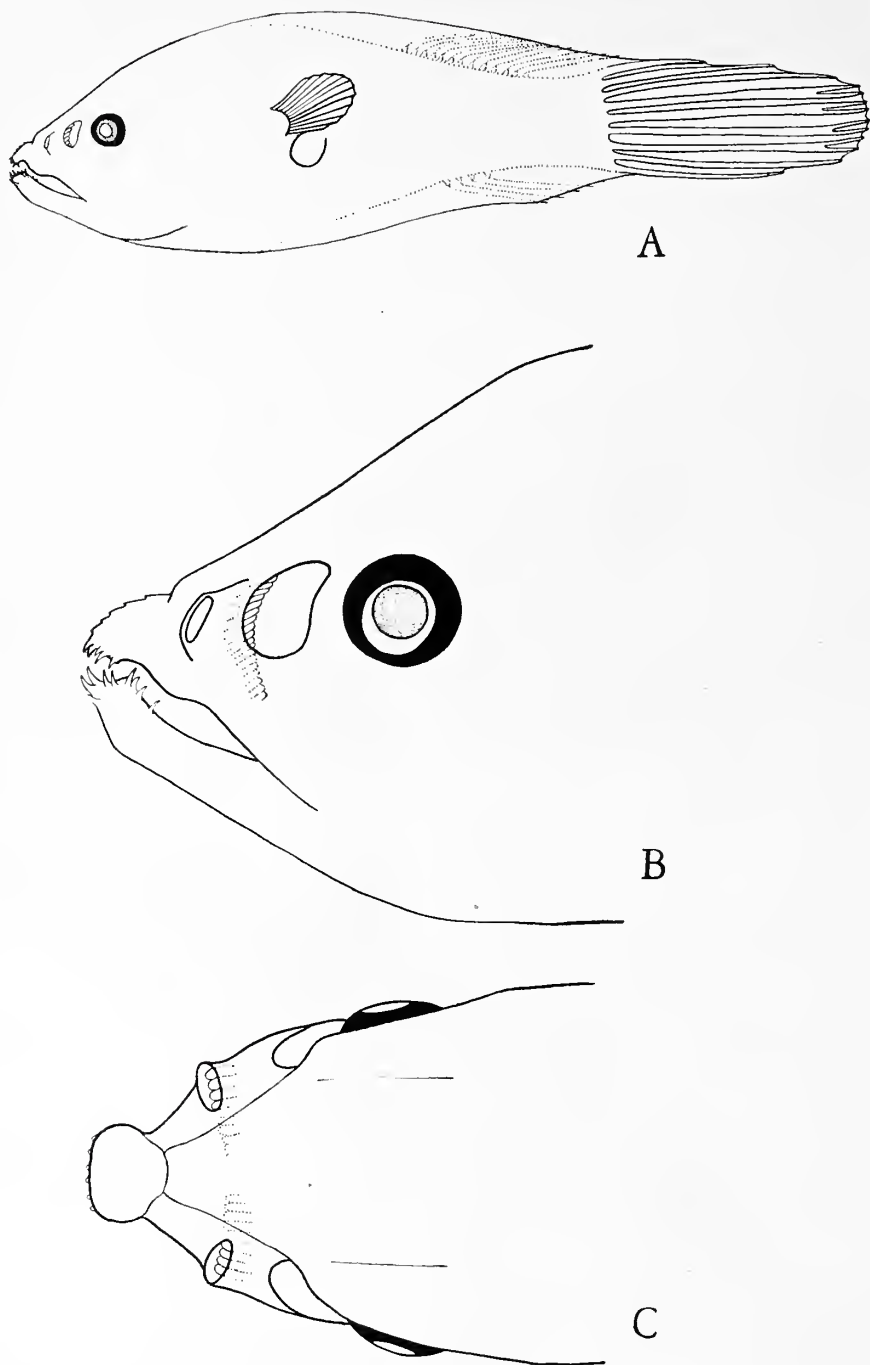

TEXT-FIG. 2. *Xenoceratias nudus*, holotype. **A**, lateral view. **B**, Head, lateral view. **C**, Head, dorsal view. Dotted lines indicate externally invisible lamellae.

Specimens Taken by the Eastern Pacific Expeditions: Four specimens, from 500 to 833 fathoms, off Gulf of Panama and Cocos Island, one adult, length 113 (85+28) mm.; three transitional adolescents 72 (52+20) mm., 23 (14+9) mm. and 20 (13+7) mm.

Color in Life: 72 mm. fish: black, fins colorless except for pale pigment on the caudal; illicium stem dark brown, the luminous bulb black on the proximal three-fourths, translucent white at the tip, enclosing a small, opaque black organ.

Counts and Measurements: The 113 mm. specimen is the largest recorded, and shows the following details of counts and size: Dorsal fin 14, anal 4, pectoral 20; length 113 (85+28) mm., maxillary 40, mandible 42, mouth width 61, illicium 30, postorbital 23, interorbital 15, longest tooth 4.

Ovaries: Typical of the ceratiid. 113 mm. specimen: ovaries dorsal, one considerably behind the other, much foliated, enclosed in lightly pigmented membrane; length 10 mm., anterior breadth 6 mm., tapering posteriorly, little compressed; eggs minute, closely packed, all about the same size; ovaries too small to be considered in breeding condition, though much better developed than in 72 mm. specimen.

72 mm. specimen: Ovaries parallel, posterior, between bladder and end of intestine, as in Regan & Trewavas, 1932, p. 15, fig. 22, of a young specimen. In the present example, however, they are relatively larger, as long as bladder; length 3.5 mm., maximum breadth 1 mm.

Food: The 23 mm. specimen contained two entire copepods.

Study Material: Cat. No. 5889 (KOH No. 18)²: *Arcturus* Oceanographic Expedition; Station 74 PT2; 60 miles south of Cocos Island (4° 50' N. Lat., 87° W. Long.); 600 fathoms; May 25, 1925; length 20 (13+7) mm.

Cat. No. 6332: *Arcturus* Oceanographic Expedition; Station 74 T76; same locality; 500 fathoms; June 3, 1925; length 23 (14+9) mm.

Cat. No. 6414 (KOH 34): *Arcturus* Oceanographic Expedition; Station 74 OT3; same locality; 833 fathoms; May 29, 1925; length 72 (52+20) mm.

Cat. No. 28,642: Eastern Pacific *Zaca* Expedition; Station 228 T1: 52 miles SE × E of Cape Mala, Panama (7° N. Lat., 79° 16' W. Long.); 500 fathoms; March 25, 1938; length 113 (85+28) mm.

Xenoceratias nudus sp. nov.

(Text-fig. 2).

TYPE.

(The unique specimen).

Department of Tropical Research No. 28,402; Eastern Pacific *Zaca* Expedition of the New York Zoological Society; Sta. 210T-8; Feb. 27, 1938; 500 fathoms; 20 miles south of Cape Blanco, Costa Rica (9° 12' N. Lat., 85° 10' W. Long.); total length 31.4 (21.4+10) mm., a transitional adolescent with moderately developed testicles (measuring about 3.5 × 2.4 mm. in length and breadth).

² Owing to catalogue confusion between regular and KOH numbers, this specimen was erroneously recorded as No. 6552 from Station 113, T35, 600 fathoms, in Hudson Gorge, Atlantic Ocean (*Zoologica*, VIII, No. 1, 1929, p. 18).

DESCRIPTION.

With the characteristics of the genus. Skin unpigmented, naked, slightly inflated. Depth of body in standard length 2.7. Snout moderately long, obliquely descending. Rostrum sharply defined, with a median series of rudimentary spinules, consisting of two minute ones anteriorly and, behind these, several subdermal ones clearly visible by substage lighting, indicated externally only by the pushing of the skin into minute serrations. Tip of rostrum with 10 curved denticles in an irregularly double series; denticles in front of lower jaw in the three series characteristic of the genus, although the posterior members of the median group are not separated from those of the lateral groups; the counts are as follows: left lateral 5, median 9 (three anterior followed by three pairs behind one another with several posterior individuals still subdermal), right lateral 4. Median prominence opposed to rostral denticles; lateral prominences erect, outside anterior ends of premaxillaries; premaxillary about reaching vertical from anterior of eye. Anterior nostril small, round on a separately inflated prominence; posterior nostril well separated from it and from eye; irregularly oval, its vertical diameter about twice that of anterior nostril and about equal to that of eye; 1/4 olfactory lamellae, the most dorsal one being very small, only the upper ones exposed. Testicles only partially developed, about 7 mm. in length. Dorsal 14 or 15; anal 4; pectoral about 18; caudal 9.

Affinities: Close to *X. longirostris* Regan & Trewavas, 1932, the only other member of the genus recorded from the Pacific. The proposed new species differs chiefly in the lack of body spinules and in the rudimentary condition of those on top of the rostrum. There are minor differences in the relative size of the nostrils, in the larger number both of lamellae, and of the denticles in front of lower jaw. All of these may prove to be merely growth characters and individual variation, but in view of the number of species of *Melanocetus* recorded from the Eastern Pacific area, it seems desirable to record the species as distinct.

FAMILY HIMANTOLOPHIDAE.

Himantolophus azurlicens sp. nov.

(Plate I, Figs. 1, 2; Text-figs. 3, 4).

TYPE.

(The unique specimen).

Department of Tropical Research No. 28,641; Eastern Pacific *Zaca* Expedition; Station 228, T-1 (7° N. Lat., 79° 16' W. Long.); 52 miles SE × E of Cape Mala, Panama; 500 fathoms; March 25, 1938; total length 123 (98+25) mm.

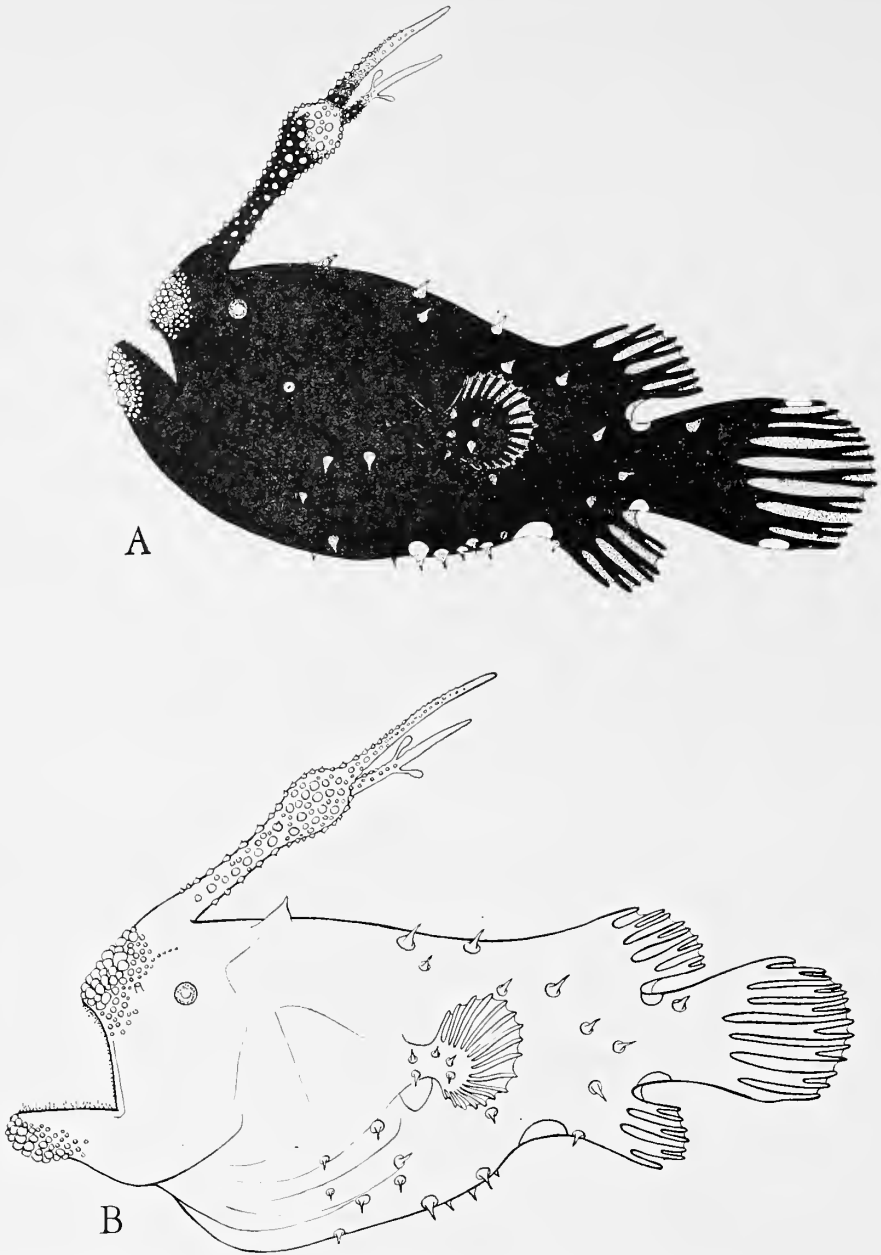

TEXT-FIG. 3. *Himantolophus azurlucens*, holotype. **A**, Freshly caught specimen, lateral view. **B**, Preserved specimen, showing distortion.

DESCRIPTION.

With the characteristics of the genus.

Color.: Jet black, paling to smoky gray in groove under illicium, and down the back to dorsal fin; also on flattened belly from chin to anal fin. All fin rays black, webs transparent. See additional color under *Luminescence*.

Luminescence: Body with conspicuous, sharp, sparsely scattered spines. Three of

these, two on the left and one on the right upper posterior back, have luminous turquoise blue bases. A patch, not a spine, of the same color on upper, and another on lower base of peduncle; five luminous-based spines in a loose group on belly in front of anal fin; a triangular patch at anterior base of anal fin; others on the upper and lower caudal rays and on the anterior anal ray. In daylight all are brilliant turquoise blue, and in

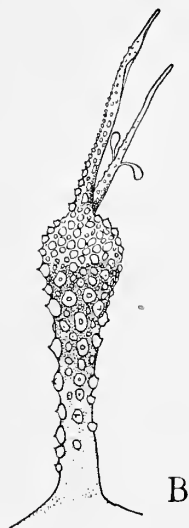
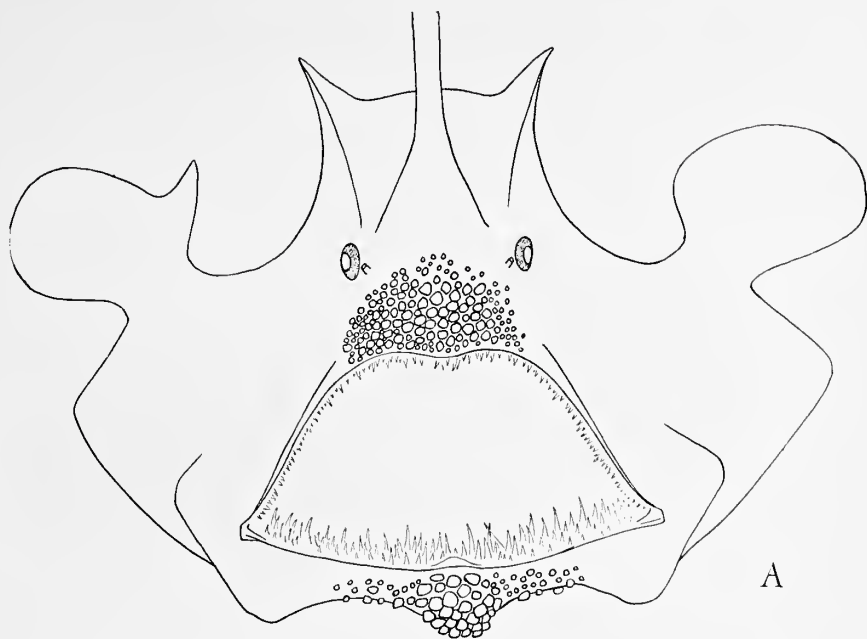

TEXT-FIG. 4. *Himantolophus azurlucens*, holotype. A, Preserved specimen, anterior view. B, Illicium.

base of illicium covered with a mass of rounded, tumid papillae of varying size, increasing in size as they approach the mouth. A few of these on the upper lip are pale gray. A second compact, swollen patch on lower lip very conspicuous, pinkish or fleshy white in daylight. Surrounding the periphery is a narrow zone of smaller papillae of a neutral gray.

Illicium: The large, complex illicium lies normally on and partly in the groove scooped out of the back. At least six or eight times, while the fish was swimming in a dish of iced water, the illicium was brought forward so far that the terminal tentacle overhung the mouth, well in advance of it. (We say tentacle because originally there were two, but when the fish was taken out of the net it had lost three-fourths of one tentacle. This was later found in the glass jar at the end of the net).

The main illicium stem is thick, black for about a fifth of its length, the distal five-sixths studded with round-based, low but sharp spines, all pale gray in color. The distal end of the stem is enlarged, club-like, on which the spines flatten out and merge into a solid pale gray. Yet the minute points are distinct even to the flat end and rim in the monocolored area.

The extreme tip of the stem is flattened and silvery white and it was this area which gave forth the strongest flashes of yellow light in the darkroom. From the flattened portion there arise, side by side, two silvery

the darkroom we got pale blue luminescence from several of the spine bases and from two of the patches. In the dead preserved fish all trace of blue color is lost, the areas being distinguishable only by a slightly paler color of the tissue. Much of the illicium and its tentacles and many of the snout and chin papillae were distinguishable as pale grayish-white in the dark, and several times before the fish expired we detected flashes of yellow light, possibly from the facial papillae and illicium stem, but strongly from the swollen distal end of the illicium club, at the base of the tentacles.

Cephalic Papillae: Upper lips, snout and

tentacles, rather thick at the base and tapering slightly to a slender, but blunt, finger-like tip. The tentacle which was torn away is shorter than its fellow, and bears two stemmed and lobed bodies half-way to the tip. These are absent from the other. Illicium base to bulb tip 31.5, longer illicium tentacle 31, illicium total length 62.5 mm.

Spinous Bony Plates: On each side of the body, from gill arches to base of caudal fin, there are 26 or 27 low sharp spines, each arising from a small, subdermal plate. They are not arranged in perfect symmetry on the two sides, although total counts and general positions correspond closely. Their location on each side is as follows: on skin covering gill arches, 5 and 6; anterior base of pectoral, 5 and 7; each side of midline of abdomen, 4 and 6; anterior base of anal, 1; lower part of side, 2 and 3; upper part of side, 7.

Teeth: Small, in series, all depressible, except smallest in outer rows particularly in premaxillary. Upper jaw teeth in two irregular rows, outer series with very small teeth, close-set, varying in size, extending entire length of mouth; inner row composed of larger teeth chiefly in anterior part, widely spaced and smaller posteriorly. Mandible with teeth larger and more numerous than in premaxillary, set in four or five rows, running entire length of jaw, in a somewhat quincunxial arrangement, increasing in size from outer to inner series.

Fin Counts: Dorsal 5 (last four bifid), anal 4 (last three bifid), pectoral 17, caudal 9 (seven bifid).

Ovaries: Posterior, parallel, small (9 by 6 mm.), compressed. Eggs minute, all same size. Judged by the ovaries, the fish would be classed as a transitional adolescent.

Food: 1 *Sternoptyx*, length 19 mm.; 4 *Cyathothone*, length 15-30 mm.; 1 *Melanphaes*-like fish, length 25 mm.; 1 adolescent myctophid, length 10 mm.; 1 adolescent squid, length 22 mm.; 2 euphausiids (possibly shrimps), 45 mm.; 3 small euphausiids, 15-20 mm.; 2 gammarid amphipods (possibly food of above food), 6 and 7 mm.; assorted small copepods (probably food of food); squid beak.

Behavior: This Blue-lighted Anglerfish was brought up at 2:30 p. m. and was very much alive, swimming around its large dish, keeping upright and twice biting the finger of the senior author as he turned it over. As we have said, the entire illicium was occasionally thrown forward, until the stem almost touched the snout, the slender remaining tentacle waving back and forth as the stem moved. It swam almost entirely by movements of the caudal fin but turned with the help of the pectorals. It lived until 5 o'clock in ice water, then expired slowly, and only lost its shape when put into pre-

servative. The stretched mouth and the greatly distended gill arches gave it a wholly abnormal contour.

Discussion: This new member, the fourth of the genus *Himantolophus*, is the most specialized as regards illicium, dermal tubercularity, armature and luminescence. The three most characteristic features are the spiny armed illicium, the non-spinous cephalic papillae of snout and chin, and the patches of brilliant turquoise blue luminescence on body and fins.

FAMILY ONEIRODIDAE.

Chaenophryne parviconus

Regan & Trewavas, 1932.

References and Synonymy: *Chaenophryne parviconus* Regan & Trewavas, 1932, p. 87, fig. 138; *Chaenophryne columnifera* l. c., p. 88, fig. 140; *Chaenophryne melanorhabdus* l. c., p. 98, fig. 143.

Range: Eastern Pacific, within an isosceles triangle bounded by the Gulf of Panama, Cocos and Galápagos Islands, and Cape Corrientes, Colombia.

Specimens Taken by the Eastern Pacific Expeditions: Six specimens, from 400 to 700 fathoms, off Gulf of Panama, Cocos and Galápagos Islands, total lengths 17.3 to 25 mm., young transitional adolescents.

Color and Luminescence: These small fish were jet black in life. No. 6226 in the dark room gave forth two rather long drawn out flashes of pale yellow light from the ball-like organ at the tip of the illicium, the second flash being the stronger. In daylight the rounded or, in other specimens, slightly elongated structure showed a strong iridescence in striking contrast with the jet black skin.

Development and Discussion: The six specimens of the present collection indicate that at least three of the species of *Chaenophryne* described as new by Regan & Trewavas, 1932, represent stages in development and should be synonymized. These three species are *parviconus*, *columnifera* and *melanorhabdus*, all from the Gulf of Panama. *C. parviconus* and *columnifera* are described from 9 and 3 specimens respectively, of similar size, 16 to 21 mm. in total length, while *melanorhabdus* is known from the unique holotype, 55 mm. long. Except for 6, not 7, rays in the dorsal of *melanorhabdus*, and 15, not 16 to 17, rays in the pectoral, all of the described differences separating the three species are in the illicium: In our series, 3 of the 5 specimens have 6 dorsal rays, the others 7. Pectoral counts are especially difficult in this group, and ours are uncertain, but appear to range from 14 to 17.

Two of the present six specimens, total lengths 17.3 and 24 mm., agree perfectly

with the description and illustration of *C. parviconus*, in which the illicium shows relatively simple development. The third and fourth, 18 and 19 mm. long, have the conical distal papilla of the bulb slightly longer than in *parviconus*, but not as long as in *columnifera*. The fifth and sixth specimens, 18.6 and 21 mm. long, have the distal papilla relatively as long as the 55 mm.-long *melanorhabdus*, but lack the anterior branched filaments, in this respect resembling *columnifera*. However, the filaments appear to be represented subdermally by a pair of rudimentary, tiny, curved, dark tentacles at the base of the distal papilla; it may be that the "basal pair of luminous patches" in Regan & Trewavas's description of *columnifera*, present also in our specimens, are also rudiments of tentacles. In any event, there now appears to remain no valid reason for maintaining the three species, and *parviconus*, by pagination priority, is accepted as the specific name.

The typically *parviconus*-like specimens appear more juvenile than the *columnifera-melanorhabdus*-like pair in development of teeth and in that of the base of the illicium, in addition to the simple character of the bulb already mentioned. In each of these four the basal bone is very short, and the tip of the bulb, when laid back, reaches no further than the vertical from the posterior edge of the eye. In the *melanorhabdus*-like 21 mm. specimen (taken in the same net with a *parviconus*-like stage) the basal bone is still short, but the entire illicium bulb lies beyond the level of the eye; in the 18.5 mm. example, the basal bone is as long as the illicium stem, the illicium, including bulb, measuring about one-fifth the length of the fish (as compared with two-sevenths in the 55 mm. type of *melanorhabdus*). The length of the fringes on the wings of the posterior bulb appendages vary regardless of age.

In deep-sea pediculates, as in other fish groups, shrinking occurs to variable degrees during metamorphosis (that is, in adolescence and early transitional adolescence). This is clearly evident in this series, where the 25 mm. fish is one of the youngest, judged by tooth and illicium development, and, of the two best developed examples, the 18.6 mm. specimen is younger than that of 21 mm. The latter shows youth also in its relatively greater depth, because of the juvenile fatty tissue. The stomachs (empty) of these two oldest samples are entirely unpigmented and the ovaries are minute. There is no doubt but that all the specimens are extremely immature, in spite of the fact that in life the exterior black pigment was fully developed.

Study Material: Cat. No. 5209; *Arcturus* Oceanographic Expedition; Station 33, PT-

1, 70 miles N.E. of Tower Island, Galápagos (0° 40' N. Lat., 88° 51' W. Long.); 700 fathoms; April 3, 1925; total length 19 (15+4) mm.

Cat. No. 5210; same station, net, locality, depth and date; total length 17.3 (13.6+3.7) mm.

Cat. No. 6226; Col. Pl. 2104; *Arcturus* Oceanographic Expedition. Station 84, T-8; one mile N. of Narborough, Galápagos (0° 17' S. Lat., 91° 34' W. Long.); 400 fathoms; June 9, 1925; total length 25 (19.3+5.7) mm.

Cat. No. 6645; Col. Pl. 2069; *Arcturus* Oceanographic Expedition; 74, T-78; 60 miles S. of Cocos Island (4° 50' N. Lat., 87° W. Long.); 700 fathoms; June 3, 1925; total length 18.3 (14+4.3) mm.

Cat. No. 28,766; Eastern Pacific Zaca Expedition; Station 233, T-1; 55 miles SSW Cape Corrientes, Colombia (4° 45' N. Lat., 78° 02' W. Long.); 500 fathoms; April 3, 1938; total length 18 (14.4+3.6) mm.

Cat. No. 28,767; same station, net, locality, depth and date; total length 21 (16.3+4.7) mm.

Dolopichthys luetkeni Regan, 1925.

References and Synonymy: *Dolopichthys luetkeni* Regan, 1925, p. 562; 1926, p. 27, pl. IV, fig. 2; Regan and Trewavas, 1932, p. 76, fig. 116; *Dolopichthys heteracanthus* Regan, 1925, p. 562; 1926, p. 28, pl. V, fig. 4; Regan & Trewavas, 1932, p. 77, fig. 117.

Range: Eastern Pacific; off Costa Rica from 9° 12' N. Lat. south, Gulf of Panama and off Cocos Island.

Color: Jet black. The outer sheath of illicium is colorless; terminal, rounded bulb encloses a lemon yellow body, topped by a cap and a slender, finger-like tentacle, all of glistening silver tissue. Behind these, a second candle- or finger-like tentacle arises, with an orange, flame-like appendage, topped by a short, very slender filament.

Discussion: We agree with Parr (1927, p. 15) in considering *D. heteracanthus* to be the immature form of *D. luetkeni*. Although in our series, composed entirely of small examples, the posterior appendage is smaller than the anterior, as in *heteracanthus*, there is considerable variation in its length and in other details of the bulb, the amount of fringing on the anterior flaps varying, as well as the position and subdivisions of the membranous appendages behind it. In our specimens these membranes are set at varying angles to the anterior flaps, but always are more nearly one above the other as in *luetkeni*, rather than one behind the other as in *heteracanthus*. All of the present specimens are clearly immature, with feeble teeth in varying stages of development, large articular spines, and basal bone much shorter than illicium.

Study Material: Cat. No. 5944; Col. Pl. 2103; *Arcturus* Oceanographic Expedition; Station 74, PT3; 60 miles south of Cocos (4° 50' N. Lat., 87° W. Long.); 620 fathoms; May 27, 1925; total length 25.5 (18.5+7) mm.

Cat. No. 6011; *Arcturus* Oceanographic Expedition; Station 74, OT4; 60 miles south of Cocos (4° 50' N. Lat., 87° W. Long.); 625 fathoms; May 30, 1925; total length 29 (22+7) mm.

Cat. No. 28,247; Col. Pl. Z185, fig. 1; Eastern Pacific *Zaca* Expedition; Station 210, T-1; 20 miles south of Cape Blanco, Costa Rica (9° 12' N. Lat., 85° 05' W. Long.); 300 fathoms; Feb. 7, 1938; total length 20.3 (14.3+6) mm.

Cat. No. 28,768; Eastern Pacific *Zaca* Expedition; Station 219, T-1; 25 miles W×N of Pt. Burica, Costa Rica (8° 08' N. Lat., 83° 17' W. Long.); 300 fathoms; March 10, 1938; 3 specimens, total length 18 (13.6+4.4); 19.3 (12.9+6.4) and 21 (14.7+6.3) mm.

Dolopichthys implumis

Regan & Trewavas, 1932.

(Text-fig. 5).

Reference: *Dolopichthys implumis* Regan & Trewavas, 1932, p. 78, fig. 122.

Range: Eastern Pacific: from Gulf of Panama north to 9° 15' N. Lat., off Costa Rica, and southwest to the Galápagos.

Specimens Taken by the Eastern Pacific Expeditions: Two specimens, both from 500 fathoms, off Costa Rica and Galápagos respectively; total lengths 18.7 and 20.2 mm.

Color: Jet black; bulb and short stem of illicium blue black, tentacles silvery, medium comb translucent white.

Discussion: Three small specimens have heretofore been recorded, all from the Gulf of Panama, by Regan & Trewavas. Although the top of the posterior appendage in our specimens is oblique, not horizontal as in their drawings, there is no other appreciable difference; the shape and height of our papillae vary even in our two specimens. There seems no reason why Regan & Trewavas's entire subgenus *Microlopichthys*, known solely from small specimens, will not prove to be composed merely of young forms of another group—very likely of the subgenus *Dolopichthys*. The vital factor in question is how fast and when the basal bone of the illicium is exerted and lengthens. We think this must be a suddenly accelerated character, and at the same time when it hurries up its growth, the bulb ornaments lose their simplicity. We can compare this with the sudden growth change in leptocephalids and some melanostomatids, where individuals of very different appearance occur of the same length, and others show a similar appearance but unequal lengths, during metamorphosis.

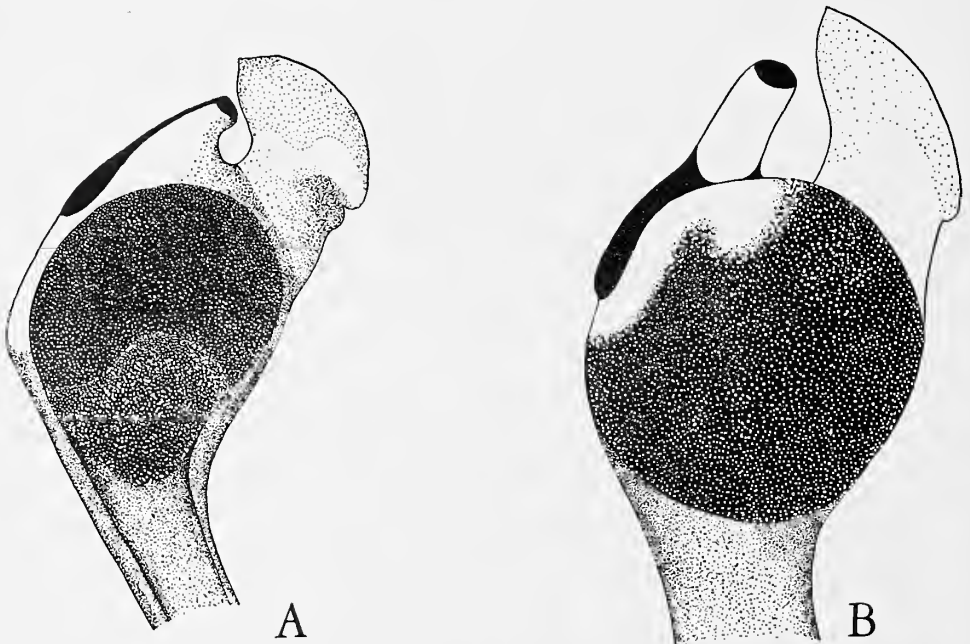

TEXT-FIG. 5. *Dolopichthys implumis* Regan & Trewavas. End of Illicium. **A**, Specimen No. 6286a. **B**, Specimen No. 28,401.

Study Material: Cat. No. 6286a, Col. Pl. 2099; *Arcturus* Oceanographic Expedition; Station 84, T-14; one mile north of Narborough, Galápagos (0° 17' S. Lat., 91° 34' W. Long.); 500 fathoms; June 9, 1925; total length 18.7 (14.7+4) mm.

Cat. No. 28,401; Eastern Pacific *Zaca* Expedition; Station 210, T-8; 20 miles south of Cape Blanco, Costa Rica (9° 12' N. Lat., 85° 10' W. Long.): 500 fathoms; Feb. 27, 1938; total length 20.2 (14.5+5.7) mm.

Dolopichthys pullatus

Regan & Trewavas, 1932.

(Text-fig. 6).

Reference: *Dolopichthys pullatus* Regan & Trewavas, 1932, p. 79. text-fig. 123, pl. III, fig. 1.

Range: Unique specimen previously known taken in the Moluccas.



TEXT-FIG. 6. *Dolopichthys pullatus* Regan & Trewavas. Illicium. Broken terminal flange indicated by dotted lines.

Specimen Taken by the Eastern Pacific Expedition: One specimen; Cat. No. 28,769; Station 233 T-1; Eastern Pacific *Zaca* Expedition; 55 miles SSW of Cane Corrientes, Colombia (4° 45' N. Lat., 78° 02' W. Long.); 500 fathoms; April 3, 1938; total length 23.6 (19.3+4.3) mm.; transitional adolescent.

Measurements: Illicium: basal bone 1.6 mm., stem 3.9; stem and bulb (without flange) 5.6; bulb alone 1.7; distal flange 1; mandible 8.

Teeth: Upper jaw with about 35; lower jaw, 44 or 45; all slender, close-set, in a single series, in successive groups of 3 or 4; the members of each group decrease pro-

gressively in size posteriorly; groups obsolete in posterior part of premaxillary, where teeth are short and irregularly spaced; 3 teeth on each side of vomer.

Fins: Pectoral 20 or 21; dorsal 6; anal 4.

Remarks: This specimen is referred with hesitation to *pullatus*, known from a single East Indian specimen twice its length; it agrees almost equally well with *D. mucronatus* Regan & Trewavas, 1932, and one or two others of the same subgenus, and is the first of its close relatives to be recorded from the Eastern Pacific. However, it agrees almost perfectly with *pullatus*, differing noticeably from the description and figures only as follows: the kidney-shaped bulb is almost vertical instead of horizontal; the exerted part of basal bone is shorter and the lower jaw is slightly longer (both characters to be expected in a younger fish) and there are a few more teeth in the lower jaw (about 45 instead of 40) and 3 instead of 2 teeth on each side of the vomer. Most of the posterior appendage, indicated by dotted lines in our Text-figure, was broken off and lost shortly after capture; however it was measured and a sketch made when the specimen was freshly caught.

Dolopichthys allector Garman, 1899.

(Text-fig. 7).

References: Garman, 1899, p. 81, plates XIII-XVI; Regan, 1926, p. 28 (part?); Regan & Trewavas, 1932, p. 80.

Range: Eastern Pacific: Gulf of Panama and off Galápagos Islands.

Specimen Taken on Eastern Pacific Expeditions: One specimen; Cat. No. 6394; *Arcturus* Oceanographic Expedition; Station 87 T-3; 21 miles NW of Narborough, Galápagos 0° 00', 91° 53' W. Long.); 450 fathoms; June 13, 1925; total length 25 (19+7) mm.; transitional adolescent.

Discussion: Regan, after accrediting nine small specimens in 1926 to *D. allector*, re-distributed 7 of them to other species in 1932, and makes no mention of the remaining 2 fish. Hence Garman's type of 72 mm. from the Gulf of Panama is left as the only certain representative before the present specimen. From the original type our fish differs in possessing a single tooth on one side of the vomer, and in the greater length of the illicium stem as compared with the basal bone. Instead of being equal in length, this stem is two and a half times as long (basal bone 2.8, illicium stem 5.3, bulb and tentacle 1.4 mm.). We have elsewhere discussed the probable unimportance of this acceleration of illicium stem growth.

The bulb itself is somewhat more like that of *danae* from the north than that of *allector*. The posterior tentacle arises from a rounded appendage of the bulb, this ap-

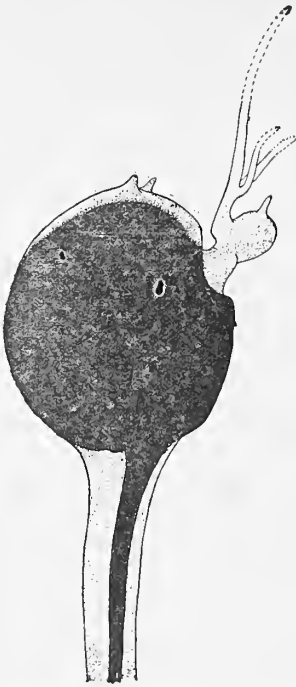

TEXT-FIG. 7. *Dolopichthys allector* Garman. End of illicium. Broken filaments indicated by dotted lines.

pendage having, in addition, a distal papilla. In Garman's type the tentacle appears to rise directly. Our tentacle has at least two marginal filaments, the basal appearing bifid.

Dolopichthys atratus

Regan & Trewavas, 1932.

References: Regan & Trewavas, 1932, p. 81, fig. 129.

Range: Eastern Pacific; Gulf of Panama and off Costa Rica and Cocos Island.

Specimens Taken on Eastern Pacific Expeditions: Two specimens, from 500 fathoms, off Costa Rica and Cocos Island, total lengths 25.7 and 41.7 mm.

Color: Jet black to the tip of all the fins. Basal bone dark brown, illicium stem pale brown, bulb blue and tentacle colorless.

Illicium: There is considerable variation in length and distribution of filaments on the distal tentacle of the illicium in the two fish. In the 41.7 mm. specimen the basal bone is 2.4, illicium stem and bulb 7.1, and tentacle 4.3 mm. In the smaller fish of 25.7 mm., the basal bone is practically sessile or subdermal, the stem and bulb 4.7 and the tentacle 3.5 mm. The teeth are more than twice as numerous in the lower jaw in the larger specimen.

Study Material: Cat. No. 6640, Color Plate 2070; *Arcturus* Oceanographic Expedition; Station 74, T-4; 60 miles south of

Cocos (4° 50' N. Lat. 87° W. Long); 500 fathoms; May 25, 1925; total length 41.7 (32.9+8.8) mm.

Cat. No. 28,274; Eastern Pacific *Zaca* Expedition; Station 210 T-6; 20 miles south of Cape Blanco, Costa Rica (9° 12' N. Lat., 85° 05' W. Long.); 500 fathoms; Feb. 7, 1938; total length 25.7 (20+5.7) mm.

Genus *Trematorhynchus*

Regan & Trewavas, 1932.

Six specimens in the present collection are male oneirodids. All possess the characters of the genus *Trematorhynchus*, as set up by Regan & Trewavas to receive the few known males in this diverse family of many genera and species. As in those previously recorded, all of our specimens have the skin naked, the snout short and somewhat decurved, the nostrils not raised, the anterior nostril opening forward near end of snout, teeth in both jaws lacking, and denticles present above and below, including an outer series on the chin.

They all fit well enough into the species framework of *T. leucorhinus* Regan & Trewavas (1925, p. 566; 1930, p. 44, fig. 25b; 1932, p. 91), having large nostrils of which the anterior are almost contiguous and the posterior set close to the eyes, while the nasal area is more or less pale. This species, described from the Atlantic and Indian Oceans and the Gulf of Panama, is also the only one which has been hitherto recorded from the Pacific. However, we agree with Parr (1934, p. 41) that sharper specific differences must be sought in the material upon which *leucorhinus* is based, and in the absence of a designated holotype, we are proposing five new species. Although it is likely that some of our material will prove to agree with some of Regan & Trewavas' Pacific examples, synonymy is impossible without comparison of specimens and, preferably, a large amount of new material.

In addition to the usual diagnostic characters of fin ray counts, curvature of snout, nostril shape, size and position, eye size and denticle number, arrangement and projection, the number of olfactory lamellae appears to be of value in this group. This character has already been used by Regan & Trewavas (1932) in the specific descriptions of *Xenoceratias*. Additional material will doubtless show that the shape of the individual lamellae also has importance. Eye diameter in length of dentary is sometimes a useful character. The amount of expansion of the dermal envelope will probably also prove to have a diagnostic value, although it is certainly also connected with development.

Judging by the rudimentary development of pigment and the small size of the testicles, none of the six specimens is adult; however,

the diagnostic characters mentioned above are so well developed that descriptions of these fish, as advanced transitional adolescents, appear warranted.

As Parr has indicated, there seems to be little use in erecting new genera for these males in our present state of ignorance, even though some of the differences obviously transcend generic boundaries.

The large nostrils at once distinguish all five of the proposed new species, as well as *leucorhinus*, from the other *Trematorhynchus* thus far described (*exiguus* and *obliquidens*, both of Regan & Trewavas, 1932, and *phyllodon* Parr, 1934, all from the Atlantic). The following key is given only to clarify the major distinctions in the present material.

- A. Lamellae 7; eye small (3.7 in dentary) *paucilamellatus*
- AA. Lamellae 11-15; eye large (2-2.2 in dentary)
- B. Rostral denticles 3; outer skin inflated; D. 5.....*adipatus*

- BB. Rostral denticles 5-9; outer skin scarcely inflated; D. 6-7
- C. P. 16-18; rostral denticles 5-6
- D. Lamellae 15
multilamellatus
- DD. Lamellae 11-12 *moderatus*
- CC. P. about 27; rostral denticles 9; lamellae 13....*multiradiatus*

***Trematorhynchus adipatus* sp. nov.**

(Text-fig. 8).

TYPE.

(Unique specimen).

Department of Tropical Research No. 28,770; Eastern Pacific *Zaca* Expedition of the New York Zoological Society; Sta. 230 T-1, 71 miles W×S of Cape Corrientes, Colombia; length 15 (10+5) mm.; transitional adolescent with minute testicles.

DESCRIPTION.

Skin lightly pigmented, naked, consider-

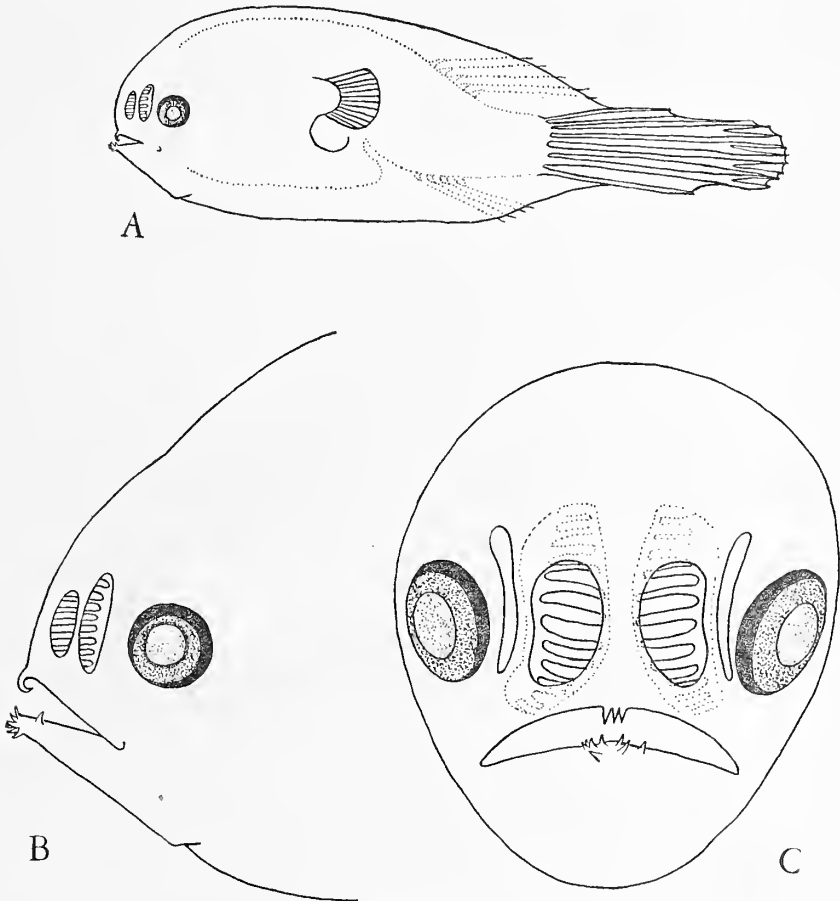

TEXT-FIG. 8. *Trematorhynchus adipatus*, holotype. **A**, Lateral view. **B**, Head, lateral view. **C**, Head, front view. Dotted lines indicate externally invisible lamellae.

ably inflated. Head (to gill opening) contained slightly more than twice in standard length; snout obtuse, the rostral portion almost vertical, but rounded, not straight, in profile. A close-set series of 3 rostral denticles, all long and slender and strongly hooked. Opposite these, in front of the mandible is a series of 8 denticles, long and slightly curved, in an irregular cluster. Maxillary reaching vertical from about middle of eye; posterior process of dentary not quite reaching that from posterior margin of eye.

Eye contained about twice in distance from symphysis to end of posterior process of dentary. Anterior nostril oval, about 4/5 as long as diameter of eye; posterior nostril narrow, its length about 1.2 times diameter of eye. Septa separating nostrils from each other narrow, and from eyes moderately broad. Twelve olfactory lamellae, of which 8 are visible in the posterior orifice in a lateral view.

Dorsal 5; anal 4; pectoral about 16; caudal 9.

DISCUSSION.

Distinguishing characteristics are the small number of rostral denticles (3) and the high degree of inflation. These may be merely signs of youth.

Trematorhynchus moderatus sp. nov.

(Text-fig. 9).

TYPE.

Holotype: Department of Tropical Research No. 28,771; Eastern Pacific Zaca Expedition of the New York Zoological Society; Sta. 230 T-1, 71 miles W×S of Cape Corrientes, Colombia; length 17 (11+6) mm.; transitional adolescent with testes about 1.2 mm. long.

Paratype: Department of Tropical Research No. 28,772: same station and net as holotype; length 14.5 (10+4.5) mm.; transitional adolescent, slightly less well developed than above.

DESCRIPTION.

Skin scarcely pigmented, naked, inflation very slight. Head (to gill opening) contained slightly more than twice in standard length; snout obtuse. A series of 6 rostral denticles, all curved, the outer and inner pairs most. Denticles in front of mandible consisting of 1 or 2 inner, 4 marginal and 3 outer ones, all moderately curved, less so than rostral series. Maxillary almost or quite reaching vertical from middle of eye; dentary scarcely beyond that from its posterior margin.

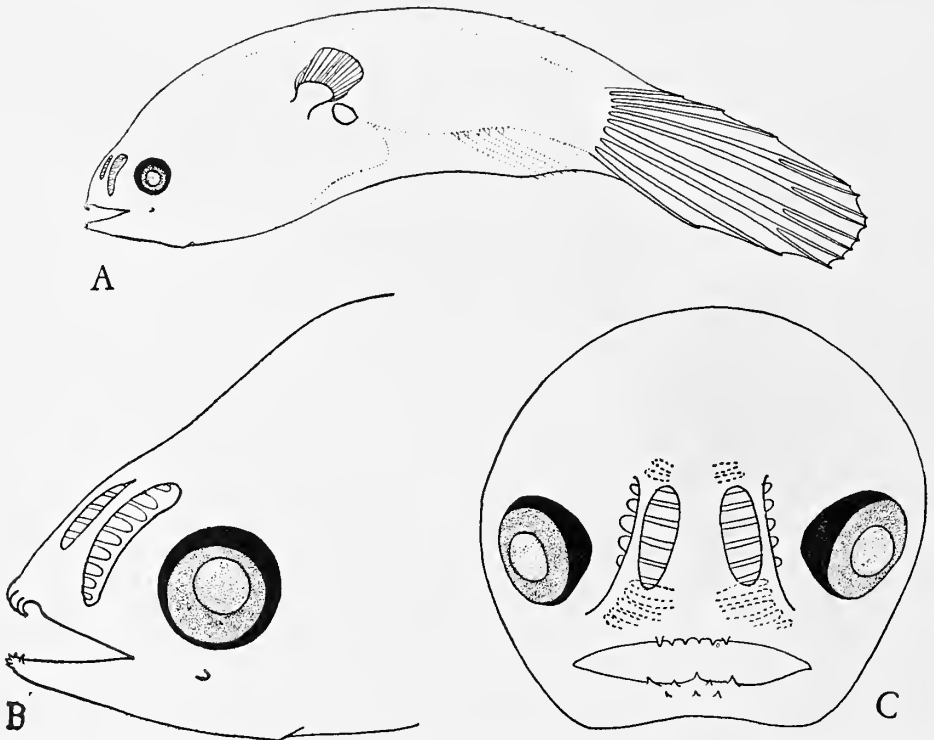

TEXT-FIG. 9. *Trematorhynchus moderatus*, holotype. A, Lateral view. B, Head, lateral view. C, Head, front view. Dotted lines indicate externally invisible lamellae.

Eye contained about twice in distance from symphysis to end of posterior process of dentary. Anterior nostril narrow, $4/5$ as long as diameter of eye; posterior nostril 1.25 times diameter of eye in holotype, but only $4/5$ times diameter in the younger paratype, narrow in both specimens. Septa separating anterior and posterior nostrils narrow, between anterior nostrils broad, and between posterior nostrils and eyes broad. Twelve olfactory lamellae in holotype, 11 in paratype; 9 of these are visible in the posterior orifice in a lateral view in holotype, about 6 in paratype.

Dorsal 6; anal 5; pectoral 17 or 18; caudal 9.

DISCUSSION.

In distinguishing this species, which has no striking characteristics, the combination of lamellae numbers, denticle arrangements and fin counts must be held of equal value.

Trematorhynchus multilamellatus sp. nov.

(Text-fig. 10).

TYPE.

(Unique specimen).

Department of Tropical Research No. 6321; *Arcturus* Oceanographic Expedition of the New York Zoological Society; Sta.

86 T-10; 16 miles southwest of Narborough I., Galápagos; length ca. 15.5 ($10.5 + ca. 5$) mm. transitional adolescent with minute testicles (about 1 mm. long).

DESCRIPTION.

Skin unpigmented, naked, slightly inflated. Head (to gill opening) contained slightly more than twice in standard length; rostrum practically vertical. A row of 5 denticles across tip of rostrum, the members of outer pair and median denticle most curved. Opposed to these in front of lower jaw is a row of 5 denticles, shorter and straight, and outside these a group of 5 minute spinules. Maxillary reaching verticle from middle of eye, and posterior process of dentary to slightly beyond eye's posterior margin.

Eye contained about 2.2 times in distance from symphysis to end of posterior process of dentary. Anterior nostril elongated, directed forward, its vertical axis slightly longer than diameter of eye; posterior broader, its vertical axis more than $1\frac{1}{2}$ times longer than eye. Septa, separating nostrils from each other and from eye, narrow. Fifteen olfactory lamellae, of which 12 to 13 are visible in the posterior orifice in a lateral view.

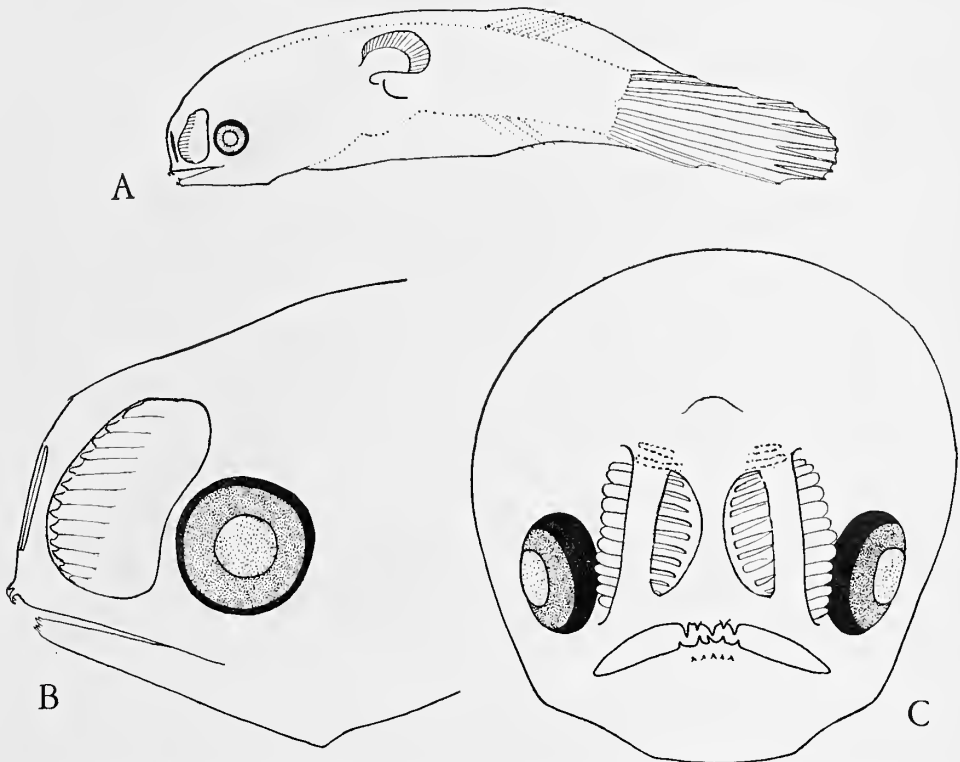

TEXT-FIG. 10. *Trematorhynchus multilamellatus*, holotype. **A**, Lateral view. **B**, Head, lateral view. **C**, Head, front view. Dotted lines indicate externally invisible lamellae.

Dorsal 7; anal 4; pectoral about 20; caudal ? (broken).

DISCUSSION.

The most noteworthy characteristic of this species is the great number of olfactory lamellae.

Trematorhynchus multiradiatus sp. nov.

(Text-fig. 11).

TYPE.

(Unique specimen).

Department of Tropical Research No. 28,773; Eastern Pacific Zaca Expedition of the New York Zoological Society; Sta. 225 T-1, 11 miles southwest of Jicaron Island, Panama; length 17.5 (11.5+6) mm.; transitional adolescent with minute testicles.

DESCRIPTION.

Skin scarcely pigmented, naked, slightly inflated. Head (to gill opening) contained twice in standard length; snout obtuse; a single row of 9 denticles across tip of rostrum, the outer pair strongly curved, the median denticle straight; the others asymmetrically straight and curved, in about equal numbers. Opposed to these, in front of lower jaw, is a row of about 8

denticles almost straight, and outside of these 3, wide-spaced, median, straight. Maxillary not reaching vertical from middle of eye; posterior process of dentary not quite reaching that from end of eye.

Eye contained about $2\frac{1}{2}$ times in distance from symphysis to end of posterior process of dentary. Anterior nostril small, oval, only two-thirds diameter of eye; posterior long, curving, about half again as long as diameter of eye. Septa separating nostrils moderate. Thirteen olfactory lamellae, of which 10 are visible in the posterior orifice in a lateral view.

Dorsal 7; anal 4; pectoral about 27; caudal 8 (2 lower rays broken off short).

DISCUSSION.

The great number of rays in the pectoral, combined with their insertion on the upper and distal margins of the elongated lobe, make it likely that this male belongs to the genus *Ctenochirichthys* Regan & Trewavas, 1932, known from the Gulf of Panama.

Trematorhynchus paucilamellatus sp. nov.

(Text-fig. 12).

TYPE.

(Unique specimen).

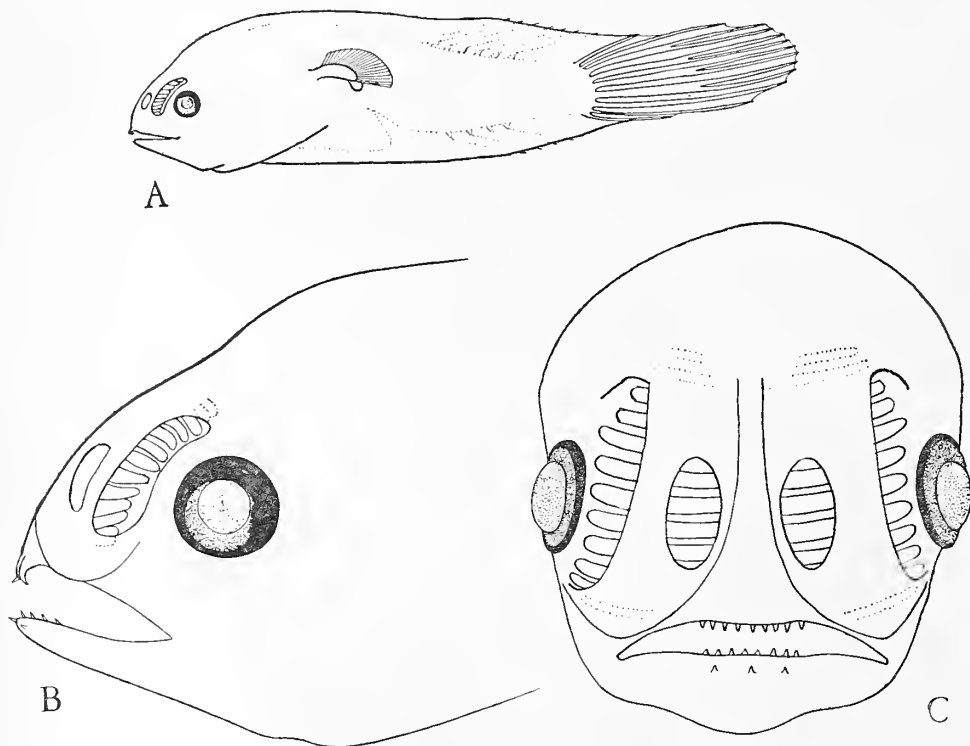

TEXT-FIG. 11. *Trematorhynchus multiradiatus*, holotype. A, Lateral view. B, Head, lateral view. C, Head, front view. Dotted lines indicate externally invisible lamellae.

Department of Tropical Research No. 28,-250. Eastern Pacific *Zaca* Expedition of the New York Zoological Society; Sta. 210 T-3, 20 miles south of Cape Blanco, Costa Rica; length 17 (11+6) mm.; transitional adolescent with minute testicles (2 mm. long).

DESCRIPTION.

Skin lightly pigmented, naked, scarcely inflated. Head (to gill opening) more than half standard length; snout strongly perpendicular distally. A single row of 8 denticles across tip of rostrum, the outer and inner ones most curved, those next to the innermost almost straight. Above these is a minute, median denticle. Opposed to these, in front of lower jaw, a row of about 8 denticles, less curved, and below them two others, median, almost straight. Two tiny teeth, apparently on mandible itself, at symphysis. Maxillary reaching vertical from middle of eye; posterior process of dentary reaching slightly beyond vertical from posterior margin of eye.

Eye very small, contained 3.7 times in distance from symphysis to end of posterior process of dentary. Both nostrils large and vertically oval. Vertical diameter of anterior nostril about two-fifths longer than that of eye, of posterior about two-thirds. Anterior nostril directed straight forward. Septa separating nostrils from eyes and

each other moderately narrow. Seven olfactory lamellae, all almost entirely exposed.

Dorsal 7; anal 4; pectoral 17; caudal 9.

DISCUSSION.

The most conspicuous characteristics of this fish are the small number of nasal lamellae and the small size of the eye.

FAMILY GIGANTACTINIDAE.

Gigantactis perlatus sp. nov.

(Plate II, Fig. 3; Text-fig. 13).

TYPE.

(The unique specimen).

Department of Tropical Research No. 28,621; Eastern Pacific *Zaca* Expedition; Station 225 T-1 (7° 08' N. Lat., 81° 57' W. Long.); 11 mi. SW×W of Jicarón Is., Panama; 500 fathoms; March 20, 1938; total length 42 (34+8) mm.

DESCRIPTION.

With the characteristics of the genus.

Color: Jet black except for bulb of illicium which, in the fresh specimen, was completely semi-translucent white, except for a small, black, subdermal body less than halfway from base to tip of bulb. In the preserved fish, this body is practically invisible, the bulb now being olive brown, opaque except at the very base, which is still pale.

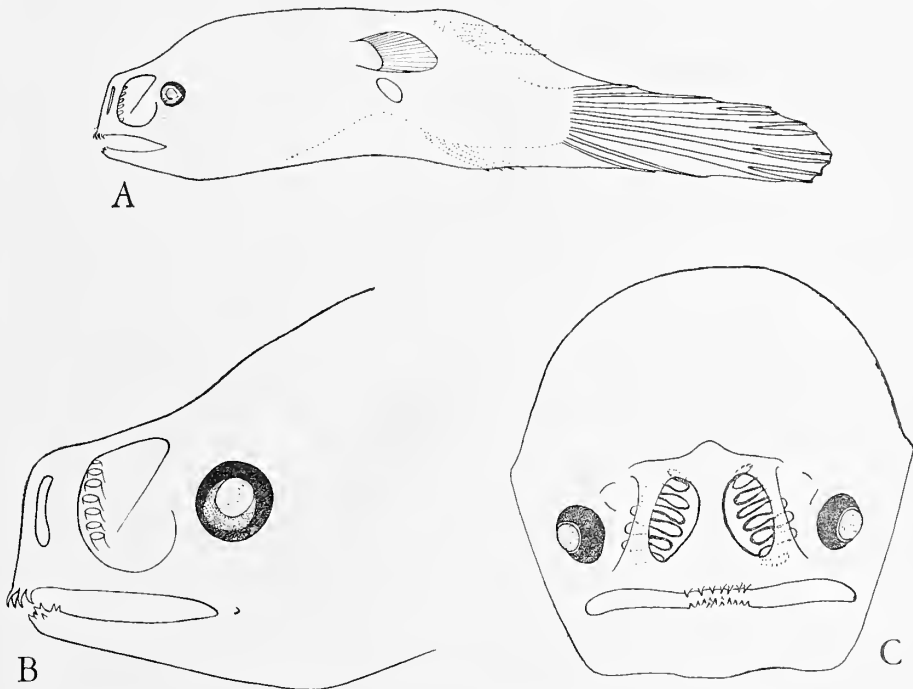

TEXT-FIG. 12. *Trematorhynchus paucilamellatus*, holotype. A, Lateral view. B, Head, lateral view. C, Head, front view. Dotted lines indicate externally invisible lamellae.

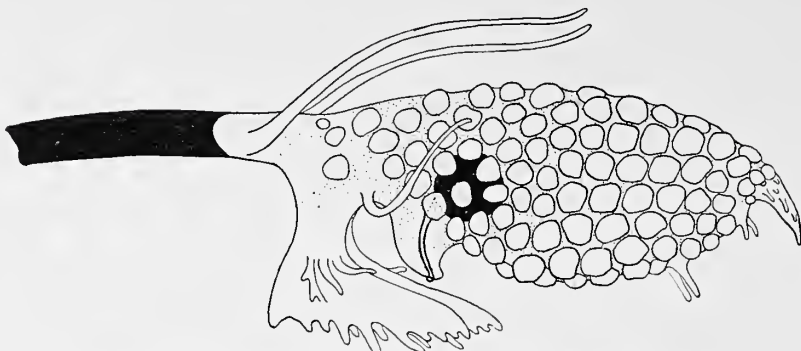

TEXT-FIG. 13. *Gigantactis perlatus*, holotype. End of illicium.

Proportions: Illicium longer than standard length, shorter than total (37 mm. to tip of bulb; bulb measures 3 mm.). Distance from last dorsal ray to caudal less than one-fourth length of fish. Eyes appear to be practically non-functional.

Illicium: The bulb is similar to that of *G. vanhoeffeni* Brauer, 1902 (1906, pl. XV) from the Indian Ocean, being elongate, unpigmented, covered with pearl-like nodules, furnished with a number of tentacles and papillae, and having a round subdermal, presumably glandular body in the proximal half.

The pearl-like nodules are oval, round or irregularly quadrilateral, and commence close to the base, although they are not closely set before the distal half of bulb. They total around 150.

The filamentous ornaments consist of a pair of long tentacles arising from the tip of the stem; a pair of winglike, posterior basal flanges, each with several external papillae and an irregularly fringed edge; a pair of shorter posterior tentacles; a large unpaired posterior tubercle arising distal to the flanges and surmounted by a pore; two pairs of small elongate posterior papillae near the bulb's tip; and finally, a tapering distal tubercle covered irregularly with elongate papillae.

As reported under *Color*, the small, round black subdermal body so conspicuous in the proximal half of the bulb is now almost invisible. It appears to give rise to a tubercle connecting with the posterior pore mentioned in the preceding paragraph.

Teeth: Upper jaw: 2 on each side, well separated but close to symphysis, small, slender, curved. Roof of mouth (on upper pharyngeals?): 6 larger teeth on right side, 5 on left. Lower jaw: 10 on each side, much larger than in upper; 4 in a regular outer row, 6 in an irregular inner line.

Fin Counts: Dorsal 5, anal 5, pectoral 18, caudal 8.

Ovaries: Minute, less than 1 mm. in length.

Food: 1 copepod (length 6 mm.)

Discussion: The proposed new species is very close to Brauer's *vanhoeffeni*, known from two examples from the Indian Ocean. Our example is of the same size as the holotype of *vanhoeffeni*, and so is directly comparable. Body proportions are similar, as is the general character of the bulb. The differences are as follows:

(1). The proximal bulb tentacles are differently arranged and more complex, including the presence of the pair of winglike flanges. (2). The distal bulb tentacles are fewer, shorter and more irregular. (3). The pearl-like papillae studding the bulb are much more close-set and numerous. (4). There are 5, not 6, dorsal rays. (5). There are 18, not 16-17 pectoral rays.

FAMILY CERATIIDAE.

Cryptosparus normani

Regan & Trewavas, 1932.

(Text-fig. 14).

References and Synonymy: *Cryptosparus couesii* (non Gill), Norman, 1930, p. 354, fig. 44. *Cryptosparus normani* Regan & Trewavas, 1932, p. 98.

Range: South Atlantic, off South Africa; Eastern Pacific, off Galápagos.

Specimens Taken by the Eastern Pacific Expeditions: Two specimens, from 300 and 600 fathoms, off Galápagos Islands, total lengths 14.3 and 66 mm., transitional adolescents.

Discussion: *Cryptosparus normani* known only from the holotype taken off South Africa, is distinguished from *couesii* by Regan & Trewavas by the fact that the pore in front of the dorsal caruncles is at the end of a short tentacle, or elongate papilla, instead of arising directly from the dorsal skin, or from a slight prominence. This papilla is very distinct in our larger speci-

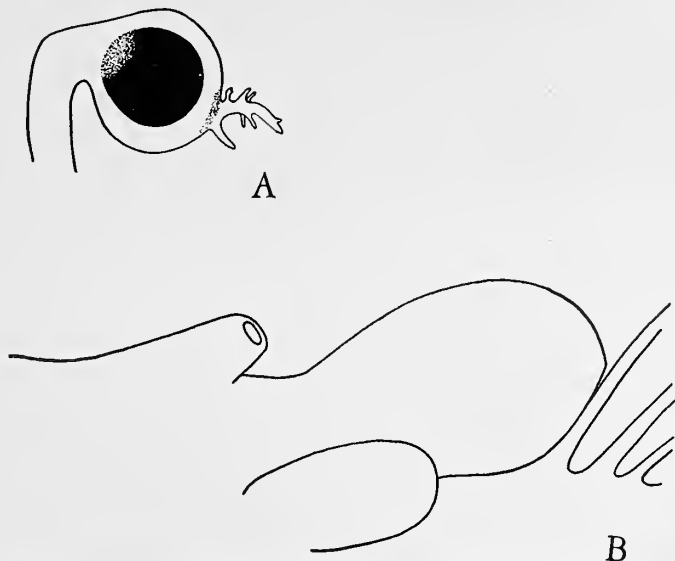

TEXT-FIG. 14. *Cryptosparas normani* Regan & Trewavas. A, End of illicium. B, Pre-dorsal caruncles.

men, and of approximately the same size as that in the holotype. In our small dried specimen it is also clearly present. In all our Bermuda specimens, on the contrary, the pore is invariably of the typical, inconspicuous *couesii* form. In addition, the illicium bulbs of our Eastern Pacific specimens agree with the figure of *normani* in having the tentacle shorter than in *couesii* and a series of branches along each side, similar to those found in *pennifer* Regan & Trewavas, 1932, from the north of New Zealand. It is possible that these differences may prove to be merely individual variation, but until more material is available it seems best to maintain the several species.

In our Eastern Pacific specimens of *normani* there are more epidermal papillae than the six mentioned by Norman, and they are scattered asymmetrically.

Food and Ovaries: The stomach is empty; intestine crammed with soft black detritus, probably squid. Ovaries of larger specimen, 12 mm. long, moderately developed.

Study Material: Cat. No. 6284; *Arcturus* Oceanographic Expedition; Station 84 T-10; one mile north of Narborough, Galápagos ($0^{\circ} 17' S. Lat., 91^{\circ} 34' W. Long.$); 300 fathoms; June 9, 1925; length 66 (52+15) mm.

Cat. No. 6346; *Arcturus* Oceanographic Expedition; Station 86 T-9; 16 miles SW of Narborough ($0^{\circ} 42' N. Lat., 91^{\circ} 47' W. Long.$); 600 fathoms; June 12, 1925; length 14.3 (10.3+4) mm.

***Mancallius uranoscopus* (Murray, 1878).**

References: *Ceratius uranoscopus* Murray, 1878, p. 67; Gunther, 1887, p. 54, pl.

XI, fig. C. *Mancallius uranoscopus*, Norman, 1930, p. 355; Regan & Trewavas, 1932, p. 99; Parr, 1932, p. 12.

Range: Atlantic, Indian Ocean, Western and Central Pacific Ocean; present specimens first from Eastern Pacific.

Specimens Taken by Eastern Pacific Expeditions: Four specimens from 500 to 750 fathoms, off Cocos and Galápagos Islands, total lengths 24, 24, 24 and 140 mm. respectively. All four appear to be transitional adolescents, even No. 5991 which, although nearly six inches long, has undeveloped ovaries only 7.7 mm. in length.

Remarks: These are the first Eastern Pacific specimens taken, the closest being the type of *Myopsarus myops* Gilbert from Hawaii which, like our large one, lacks the illicium. This is the case with four out of the sixteen previously known individuals.

Our 140 mm. specimen No. 5991 appeared quite dead when brought up, and its struggles in the net had considerably abraded its skin. That life was not wholly extinct, however, was shown a few minutes after it was placed in ice water, when both stalked caruncles waved slowly back and forth alternately. There was no current in the aquarium nor motion of the ship so this was purely a muscular movement.

In Specimen No. 6214, at the very base of the main stem of the illicium, and posterior to where it arises from the skin of the back, is a well developed caruncle. This is quite as large as the third of the posterior group, but is almost hidden from lateral view as it arises from the bottom of the illicial groove. Instead of two, as seems more usual in this species, there are three

caruncles in front of the soft dorsal fin, the third being median, anterior to the paired ones, and only about half their size.

In specimen No. 6286 the accessory caruncle near the illicium stem and the anterior of the posterior group are slightly less developed than in No. 6214, but still of good size and distinct to even a casual glance. The accessory caruncles and the narial spines are wholly absent from the large specimen No. 5991.

Specimen No. 6641 is identical in measurements with No. 6286. The post-illicial caruncle is better developed than in any of the others, but the anterior third dorsal one is absent, represented only by a pore, level with the surface of the skin. In the small individuals there is a short, curved keel along the basal half of the lowest caudal ray, and in No. 6214 this is developed into an incipient ray. If this were larger and slightly more distinct, we should have the ninth caudal ray which occurs normally in several related genera.

Mancalius uranoscopus typhlops Roule & Angel, 1933, 47 mm. in length, from near the Azores, has a stout, ray-like caruncle in front of the caruncles proper. This may be a young stage of *M. tentaculatus* Norman, 1932, 110 mm. long, or more probably, merely another variation in *uranoscopus*.

Study Material: Cat. No. 5991; Col. Pl. 2097; *Arcturus* Oceanographic Expedition; Station 74 OT-2; 60 miles south of Cocos (4° 50' N. Lat., 87° W. Long.) 750 fathoms; May 29, 1925; total length 140 (100 + 40) mm.

Cat. No. 6214; Col. Pl. 2094; *Arcturus* Oceanographic Expedition; Station 84 PT-1; one mile north of Narborough (0° 17' S. Lat., 91° 34' W. Long.); 500 fathoms; June 9, 1925; total length 24 (16.5 + 7.5) mm.

Cat. No. 6286; Col. Pl. 2076; *Arcturus* Oceanographic Expedition; Station 84 T-14; one mile north of Narborough (0° 17' S. Lat., 91° 34' W. Long.); 500 fathoms; June 9, 1925; total length 24 (17.5 + 6.5) mm.

Cat. No. 6641; Col. Pl. 6641; *Arcturus* Oceanographic Expedition; Station 74 T-78; 60 miles south of Cocos (4° 50' N. Lat., 87° W. Long.); 700 fathoms, June 3, 1925; total length 24 (17 + 7) mm.

FAMILY LINOPHRYNIDAE.

Acentrophryne ?longidens Regan, 1926.

(Text-fig. 15).

Reference: Regan, 1926, p. 3, pl. 1, fig. 2.

Range: Gulf of Panama, and off western Costa Rica.

Specimen Taken by the Eastern Pacific Zaca Expedition: 1 specimen; Cat. No. 28,411; Sta. 210 T-10; 20 mi. south of Cape Blanco, Costa Rica (9° 11' N. Lat., 85°



TEXT-FIG. 15. *Acentrophryne ?longidens* Regan & Trewavas. Illicium.

08° 30' W. Long.); 500 fathoms; Feb. 27, 1938; length 60 (42 + 18) mm; an abnormal, immature female with rudimentary ovaries.

Color: Head and body sooty black; stem of illicium, outer sheath of bulb, and terminal appendage rising from posterior tip of sheath, all translucent and colorless; bulb blue-black.

Measurements and Proportions: Snout to gill opening 26 mm. i. e., slightly less than one-half total length. Illicium, total length 15 mm.; bulb 2.9 mm.; terminal appendage .96 mm.

Teeth: In each half of upper jaw, 5 or 6 small unequal teeth in a single series; in each mandibular ramus, 5 small, unequal outer teeth plus 1 to 3 long, inner fangs near symphysis. No teeth on vomer or pharyngeals.

Fins: D. 3, A. 3, P. 18, C. 8.

Lateral Line System: The papillae on head and upper anterior side are similar to those of *Borophryne*, but the tags are all short, unpigmented, and less variable in length.

Remarks: Most of the body cavity of this specimen, including the inside of the expanded stomach, was filled with a tumor. Through the kindness of Dr. Ross Nigrelli, parasitologist of the New York Zoological Society, an account of the growth follows the present paper (*Zoologica*, Vol. 31, No. 12).

The fish agrees with *Acentrophryne*, previously known only from the 75 mm. type of *A. longidens*, from the Gulf of Panama,

in the following characters: preopercular spine lacking, although sphenotic and mandibular spines are well developed; teeth few; barbel lacking; illicium consisting of a stem with an ovate bulb and short terminal appendage; pectoral 18.

It differs from the description and figure of the type as follows: dorsal and anal each numbering 3 not 4; teeth weak and relatively short; vomerine teeth lacking; illicium only about half as long as in Regan's illustration, with a smaller bulb but longer terminal appendage. These distinctions could be due either to disease or youth. The former explanation is preferable, since the type was only slightly longer than the present specimen. Obviously, certain identification is impossible without further, normal material.

Borophryne apogon Regan, 1925.

(Plate II, Fig. 4).

References: *Borophryne apogon* Regan, 1925, p. 564; 1926, p. 23, pl. II, fig. 1; Regan & Trewavas, 1932, pp. 18, 106, text-figs. 7, 8.

Range: Tropical Eastern Pacific. The present series includes the first specimen taken outside the Gulf of Panama.

Specimens Taken by the Eastern Pacific Expeditions: Five specimens from 500 to 700 fathoms, taken from the vicinity of Cocos Island and of the Gulf of Panama. The series includes 2 large females, (total lengths 71 and 74.5 mm.), each with a male attached (18.3 and 17.4 mm. respectively), and 1 transitional adolescent female, (37 mm.).

Remarks on Females: Color: All three females, including a living large one with attached male, were jet black, the illicium filaments translucent milky white, and the heart of the bulb bluish-purple.

Luminescence: Female No. 28,707a came up alive and swam about strongly. In the darkroom there were occasional flashes of creamy white light, exact source undetermined, and now and then a purplish one from the bulb.

Teeth: Upper jaw: on each side, 5 or 6 long teeth with 8 to 10 small ones, of which some are close to the large teeth and are apparently of a replacement type. Lower jaw: on each side, 3 long teeth, of which the second is an enormous fang, and 8 to 11 small ones, some of a replacement nature. In both jaws the large teeth are interior to the others, which form a very irregular outer row. There is a pair of teeth on the vomer, with 2 subsidiary teeth in one specimen, 1 in the other, and a group of strong upper pharyngeal teeth, 4 or 5 on each side.

Fins: D. 3, A. 3, P. 15. In each female, the tips of all three rays barely project

externally, the sheath of dark skin extending to the tip, and the first two bound in a common skin almost to their ends.

Development: The 37 mm. transitional adolescent female differs from the two adults in having relatively longer sphenotic preopercular and mandibular spines, and somewhat fewer teeth in the jaws. The illicium is almost as well developed as in the adult.

Gonads: The two large females, although of similar size and appearance, and termed "adults" for convenience, show decided differences in the development of the ovaries. In 28,707a the ovaries measure about 15 × 9 mm.; the eggs are .38 mm. in diameter, and appear almost ripe. In 28,708a, the ovaries are only about two-thirds as large with the eggs only .10 mm. in diameter and obviously unripe. The attached males, though externally showing little difference, show similar development discrepancies internally, the physiologically younger male being attached to the corresponding female (see page 172). Incidentally it is the older female that has the longer tentacles on the illicium bulb.

Comparison with Type Description: These females differ from the description and figures of the type series, which are of comparable length, as follows: (1). The gill opening, even in the transitional adolescent, is well behind the middle of the length excluding the tail, though slightly in front of the middle of the total length. The type description, reads "gill opening about in the middle of the length," and the illustration shows it at the middle of the standard length. (2). There are subsidiary teeth on the vomer, instead of a single pair, and there are more jaw teeth, especially small ones, than are shown in the plate. (3). The illicium differs from the illustration in small details; the forked tip of the terminal tentacle is shorter than the stem giving rise to it, not longer; however, this is a variable character, not being identical in the two specimens at hand; in one, even the branches of the fork are of unequal length. Also the mass of filaments arising from the bulb are variable; in one case (No. 28,707a, with better developed gonads) they extend well beyond the forked branches when laid against the latter, while in the other they are considerably shorter than the branches; likewise, their number, arrangement, and degree of branching, although similar, are not identical. Unlike Regan's illustration, the filaments extend also on the sides of the bulb immediately underneath the terminal forked tentacles, in addition to those extending down, anteriorly and posteriorly, as shown in the plate. They are much more numerous and branch more complexly than in the neces-

sarily diagrammatic illustration. (4). Dissection and one cleared example show that there are definitely only 3, not 4, rays in both dorsal and anal fins. (5). The pale lateral line organs are on the dark "tags" described by Regan & Trewavas (1932, p. 24). It is to be noted, however, that in our specimens the peduncles are unequal in length, varying from almost sessile to .75 mm. long, and the organs of various sizes do not occur in the same positions in the two specimens. Number and distribution of the organs are also quite variable.

Remarks On Attached Males: Each of the adult females has a male attached slightly to the left of her ventral midline, a little behind the middle of the fish, one at a distance of 15 mm. in front of the anus and genital opening, the other at 10 mm. Both males are fastened upside-down, that is, the body trailing posteriorly with the ventral surface opposed to that of the female.

Each specimen is further along in the course of parasitism than the two described by Regan & Trewavas (1932, p. 18). Each is firmly attached by both jaws, instead of only the lower, so that attachment by a single jaw proves to be invalid as a distinction from *Linophryne*. There is free passage of water into the mouth between the two jaws. No denticles are visible externally and there is no trace of a lateral line, although the cephalic system is apparent. In one (28,708b) there is no external trace remaining of dorsal or anal fins, while in the other the extreme tips of 3 dorsal and 2 anal rays project. Unlike Regan & Trewavas' specimens, where the sphenotic spine does not appear on one side, they are present externally on both sides (although of unequal length) in 28,708b, and on neither side, being sheathed in skin, in 28,707b. Both males were jet black, with conspicuous white nasal areas, while one of the previously recorded males was unpigmented.

Parr (1934, p. 58) queried the validity of identifying as one species two such dissimilar males as those of Regan & Trewavas, on the basis of their being attached to similar females. The present two indicate that the differences, including degree of pigmentation, merely indicate difference in development stage, first, in ordinary growth progress, and second, in degree of parasitic degeneration. None of the free-swimming males probably referable to *Borophryne* (see page 176ff.) is pigmented, and it seems likely that attachment occurs well before adulthood. Our two attached males internally show decided differences in degree of development of the testicles and degeneration of the other organs, the

less advanced (No. 28,708b) being attached to the female with less well developed ovaries (see p. 171). In this male, the testicles measure about 3.5×1.34 mm. and are kidney shaped. The stomach measures 1.8 and is still conspicuous. In male No. 28,707b the testicles are more than half again as large, are much better developed, and are folded over on themselves, instead of being of the simple kidney shape. In this specimen, the organs were only exposed, not dissected, but it could be seen that the stomach and liver are both considerably smaller than in 28,708b.

In both males the eyes are directed forward and down which, in the attached position, is forward and up, toward the body of the female. There are 8 or possibly 9 nasal lamellae, apparently degenerating, and all except about 3 are invisible through the nostril. Dorsal 3; anal 3; pectoral about 15, the rays free in 24,708b, but almost sheathed in thick webbing in 24,707b. Caudal 8, the dorsal and ventral pairs completely skin-sheathed.

Male No. 28,708b, along with a small patch of the female abdominal skin to which he was attached, was cleared and stained by the potassium-hydroxide-alizarin method. All of the skeleton with the exception of the rostral denticles is strongly ossified. These denticles are scarcely stained and very soft, although deeply buried in the tissue of the female; they number 4, a fifth, between the outer and central denticles on the left side, being represented by a vestigial stump. The rostral bone itself is strongly ossified. The entire prementary bone is deeply stained, buried in female tissue. The typical *Aceratias*-type, forwardly-directed median denticle is present plus 4 strong, erect denticles on each side. Both jaws are toothless. The remainder of the skeleton agrees very well with the figure and description of *Aceratias indicus* given by Regan & Trewavas, 1932, p. 48, fig. 70.

In female No. 28,707a there are traces of what may be the result of recent abortive attempts of other males to attach themselves. One is about 5 mm. behind the male's present position, and is in the form of an oval, raw, skinless area, with even margins and a longitudinal diameter of 2.2 mm. There are two similar areas near the dorsal fin on the opposite side.

Remarks on Free-swimming Males. It appears certain that some of the *Aceratias* described on p. 176ff. are actually young free-swimming males of *Borophryne apogon*. However, until attached males of *Linophryne* and *Acentrophryne*, as well as large series of free-swimming young, can be studied exhaustively, internally and ex-

ternally, we think it would be premature to refer any of the specimens to particular genera. It appears more profitable to treat the entire series as a unit illustrating general principles of linophrynid male development.

Food: Both the large females had the stomachs greatly distended with food. No. 28,707a contained the much digested remains of a single fish which must have measured at least 60 mm. in length. No. 28,708a held 3 fish, each about 50 mm. long: a *Lampanyctus* freshly swallowed, most photophores and many scales remaining; another myctophid, partly digested; and a third fish almost wholly digested.

Behavior: No. 28,707a, one of the two females with attached males, was alive when it reached the surface, and in an aquarium swam strongly and easily, using the caudal for propulsion and the pectorals only for turning. Her eyes moved slightly as she turned. The illicium was usually extended well forward, but several times it was jerked back and forth, and once flattened into its groove. The jaws moved through a slight arc, but never closed on account of the length of the teeth. Under a hand lens slight muscular twitches could be detected on the part of the parasitic male attached to her ventral surface.

Study Material: Cat. No. 6642: *Arcturus* Oceanographic Expedition; Station 74 T-78; 60 miles south of Cocos (4° 50' N. Lat., 87° W. Long.); 700 fathoms; June 3, 1925; transitional adolescent female, total length 37 (25+12) mm.;

Cat. No. 28,707a, 28,707b; Eastern Pacific *Zaca* Expedition; Station 234 T-1; 24 mi. W × S of Pinos Pt., Panama (7° 24' N. Lat., 78° 35' W. Long.); 500 fathoms; April 4, 1938; female with parasitic male attached, total lengths 74.5 (51.5+23) and 17.4 (10.5+6.9) mm., respectively.

Cat. No. 28,708a, 28,708b; in same net as preceding; female with parasitic male attached, total lengths 71 (50+21) and 18.3 (10.8+7.5) mm., respectively.

Linophryne arcturi (Beebe, 1926).

(Text-fig. 16).

References: *Diabolidium arcturi*, Beebe, 1926, p. 80., fig. *Linophryne arcturi*, Regan & Trewavas, 1932, p. 107.

Range: Tropical Eastern Pacific.

Holotype, the Unique Specimen: Cat. No. 6333; *Arcturus* Oceanographic Expedition; Sta. 74 T-70; 60 miles south of Cocos Island, Costa Rica (4° 50' N. Lat., 87° W. Long.); 500 fathoms; June 2, 1925; length 38.6 (28.6 + 10) mm.; transitional adolescent female with ovaries little developed.

Color in Life: Brownish-black; illicium with basal bone, basal half of stem, upper

part of bulb and stem portion of distal appendage dark brown; distal portion of stem, outer sheath and basal part of bulb, and distal filament all translucent white; all except tip of barbel dark brown; distal 5 mm. translucent white.

Luminescence: The white base of the candle-like organ showed distinct luminescence in the dark room during the first three minutes after capture. In addition, all the larger fangs were dimly outlined with luminescence, apparently resulting from a mucous coating.

Measurements and Proportions: Length 38.6 (28.6+10) mm.; snout to gill-opening 15.7, or slightly more than half length without caudal fin; total length of barbel 33.6, slightly less than total length of fish; length of illicium stem 6.1, of bulb 3, of stem of distal projection 2.9, of distal tentacle 1.1; longest upper fang 3; longest lower fang 3.6.

Illicium: A candle-like structure as in illustration. Bulb within a translucent sheath having a small anterior and larger posterior flange, and a distal projection. The latter consists of a pigmented basal stem longer than the bulb and a shorter unpigmented terminal filament.

Barbel: The structure is almost as long as the fish, consisting of a single, long, undivided stem, with small, short off-shoots scattered sparingly. The first very minute branch is 6.4 mm. from base. There are no more for a considerable distance, and then 8 irregularly spaced throughout the remainder of the brown pigmented portion, which extends from the base to within 5 mm. of the tip. These nine are all small, the largest only .54 mm. in length, about the diameter of the barbel itself. In structure they consist of a short stem ending in a round bulb. In the colorless, distal 5 mm., the branches are closer together, about 9 or 10 in all, with very slender stalks. In two, there are subsidiary divisions from one of the branches, there being 3 bulbs close together. The barbel ends in a small branch and bulb. The longest of these terminal and subterminal branchlets is 1.1 mm.

Teeth: In each half of upper jaw, 7 to 8 teeth, of which the first and third are longest. In each mandibular ramus 6 or 7, of which the first and fourth are largest. A pair of long, curved vomerine teeth, and a group of 5 or 6 upper pharyngeals on each side.

Fins: D. 3, A. 3, P. 17, C. 8.

Behavior: This fish lived for ten minutes after being taken from the net. Luminescence was observed as described above.

Remarks: Text-fig. 16 is to replace the illustration published with the type description.

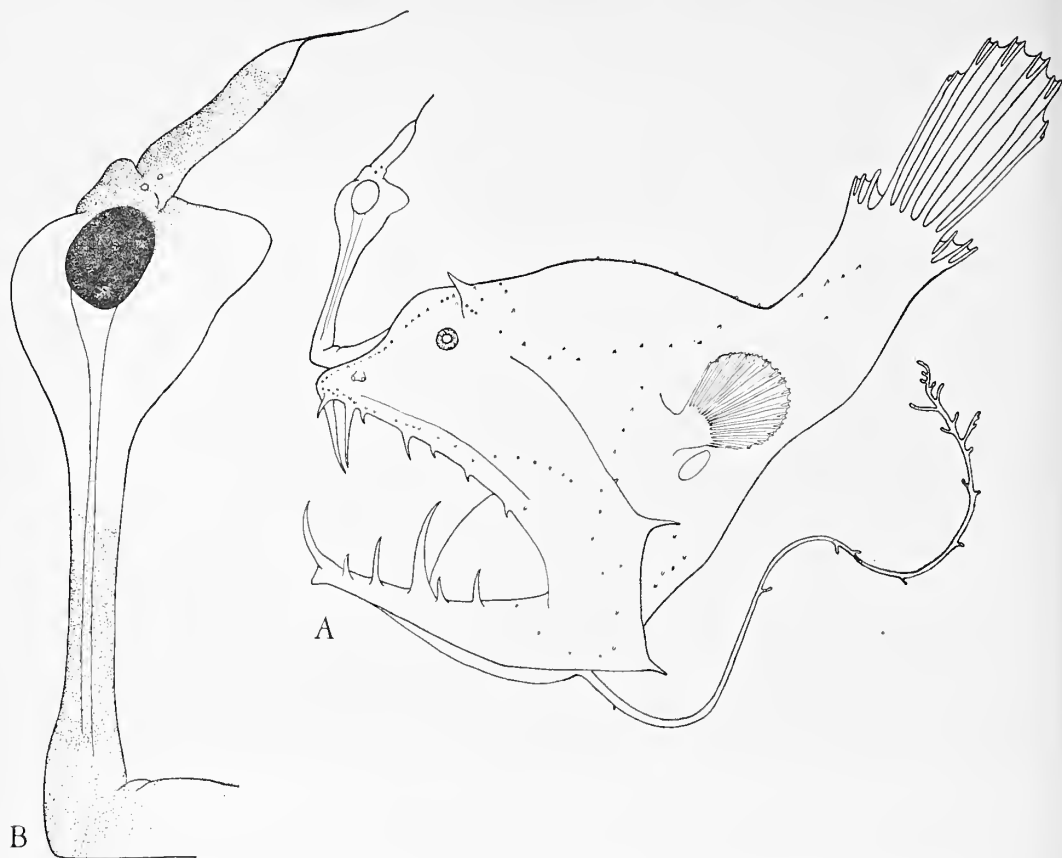

TEXT-FIG. 16. *Linophryne arcturi* (Beebe), holotype. **A**, Lateral view. **B**, Illicium.

***Linophryne quinqueramosus* sp. nov.**

(Plate III, Fig. 5; Text-fig. 17).

TYPE.

(The unique specimen).

Department of Tropical Research No. 28,-709; Eastern Pacific Zaca Expedition; Station 234 T-1 (7° 24' N. Lat., 78° 35' W. Long.); 24 miles W × S of Pinas Pt., Panama; 500 fathoms; April 4, 1938; total length 89 (62+27) mm.; ovaries minute with eggs scarcely developed.

DESCRIPTION.

With the characteristics of the genus.

Color: Jet black, except for white details of illicium and barbel, as noted below.

Measurements and Proportions: Snout to gill opening 36 mm., slightly more than half length of fish without tail. Illicium short, measuring 17.7 overall (stem 7.8, bulb 7.1, filament 2.8); longest barbel tentacles about 40; length longest fangs, upper jaw 7.5, lower jaw 8.2.

Illicium: The illicium arises from a deep groove on tip of snout, so deep that the base of this organ takes the place of the sym-

physis, the large upper teeth arising on each side. Stem short and thick, 15 mm. long, with a wide black basal zone, then a white band of equal width, followed by a second black area anteriorly. This stem expands abruptly, and encloses the blue black bulb. Distal to this posteriorly is a silver protuberance topped by a minute tubercle with a small longitudinal ridge or flange behind and below it. In front of the tubercle, on the distal ridge, is a tiny pore. From the anterior edge of the bulb sheath rises a flattened, transverse structure giving rise distally to a round, opaque, blunt finger, 7 mm. long; on the right side only of the base of this transverse structure are three minute tentacles.

Barbel: From the center of the throat there arise five long tentacles so close together that their bases touch. The proximal 10 mm. of the anterior pair are black; the remainder of this pair, all of the shorter central tentacle, and almost all of the posterior pair are translucent white. The details of the proportions and branching can best be seen from the figure. Each of the short tentacles ends in a shining, white, opaque bulbet, scarcely expanded.

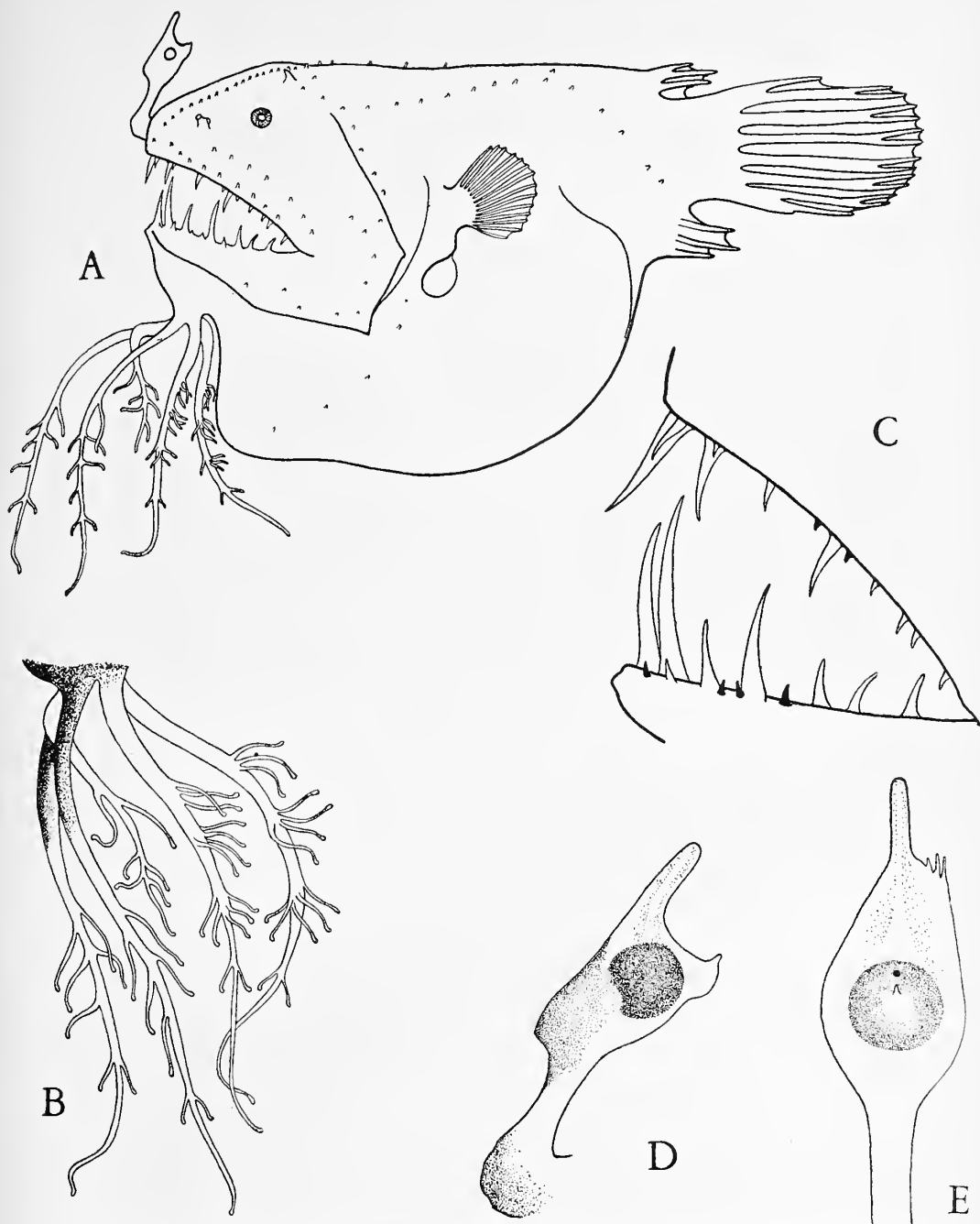

TEXT-FIG. 17. *Linophryne quinquerosus*, holotype. **A**, Lateral view. **B**, Barbel, left lateral view. **C**, Dentition. Depressible teeth unshaded. **D**, Illicium, left lateral view. **E**, Illicium, posterior view.

Teeth: 12 or 13 teeth in each half of the upper jaw and in each mandibular ramus, including long fangs, replacement teeth, small teeth, and several minute fixed teeth. A pair of teeth on the vomer and a series of 4 or 5 upper pharyngeals on each side.

Fins: D. 3, A. 3, P. 16, C. 8.

Food: The stomach was enormously distended with the following: 1 *Serrivomer*, 330 mm. long; 1 *Sternoptyx*, 25 mm.; 2 *Cyclothone*, 26 and 60 mm.; 5 shrimps, 12-30 mm.

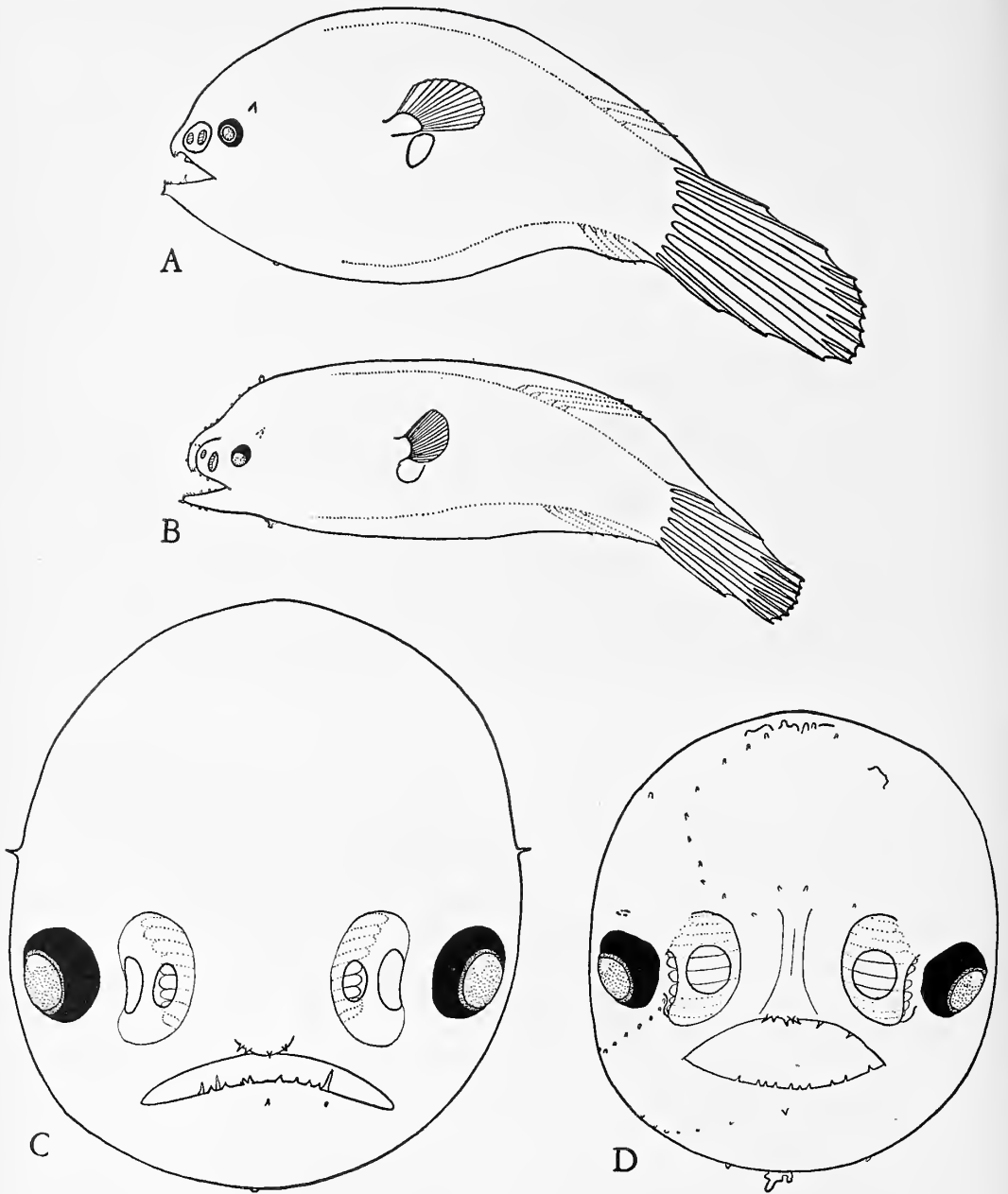

TEXT-FIG. 18. *Aceratias* spp. **A**, Post-larval (Cat. No. 28,756, "a" in text). **B**, Transitional adolescent (Cat. No. 28,763, "h" in text). **C**, Same specimen as A, front view. **D**, same specimen as B, front view. Note asymmetrical development of papillae.

Remarks: This specimen is perhaps closest to *L. macrodon* Regan, 1926, also from the Gulf of Panama. It differs, however, in the shorter, distally distinct illicium, in the branching of the barbel, and in the larger number of teeth.

***Aceratias* spp.**
(Text-figs. 18, 19).

Ten specimens of young, free-swimming linophrynid males were taken in or near the Gulf of Panama. All have the general char-

acters ascribed by Regan & Trewavas to *Aceratias*, having the characters of the family, no illicium or barbel, 3 to 5 rostral denticles united on a median bone, premaxillaries reduced to a pair of plates, jaws toothless or with only 1 or 2 on each side, and a well developed prementary bone bearing denticles in front of the lower jaw.

The genus at the present time, as revised by Regan & Trewavas, 1932, includes two species, *indicus* and *macrorhinus*, each obviously including more than one biological species, and probably more than a single genus. Parr, 1934, described an *Aceratias*-form of male as *Borophyrne masculina*, because of its close resemblance to the attached males of *Borophyrne apogon* recorded by Regan & Trewavas. On that basis, all of ours too are *Borophyrne*, but until other genera, particularly *Linophyrne*, can be shown to have a *Nannoceratias*-type, or other clearly marked form, as their male representative, we do not feel justified in referring any of this series to *Borophyrne*.

We are convinced, on the other hand, that more is to be gained by treating all ten as a single series. No two are identical, and yet a specific definition could be formulated to embrace all, no broader than that which now defines *A. indicus*. The truth probably is that four or five species and at least two genera are represented.

Since *Edriolychnus* has been found to have a *Haplophyrne*-type male (Regan & Trewavas, 1932), with many teeth in the jaws, and the attached males of *Borophyrne* are obviously of the *Aceratias*-type, it is practically certain that some of the 10 young in the present series belong to that genus. It seems almost equally probable that *Linophyrne*, and at least *Acentrophyrne* in addition are represented, all three of these genera being known from the Gulf of Panama region where the present males were taken. Only one male attached *Linophyrne* has so far been taken (Regan & Trewavas, 1932, p. 19), and this has not been described in detail. According to the authors, it resembles *Borophyrne* closely, even to the sphenotic spines, but neither the number of lamellae nor the denticle formula is known.

Repeated efforts to divide the present specimens into genera have been unsuccessful. The work is complicated by the following considerations, in addition to the obvious prime one of paucity of material.

1. General macroscopic characters, including the obvious ones of fin, lamella, and denticle counts, show slight or no differences.

2. Macroscopic differences, such as amount of inflation and eye rotation, are merely growth characters.

3. Other apparent differences, especially in the shape of the inflated envelope, of nos-

trils and of rostral profile, as well as the frequent lack of cephalic symmetry, (especially in eye size), are apparently due to varying effects of preservation.

4. Fundamentally reliable characters taxonomically are still unknown, and will probably prove to be such microscopic details as shape of individual lamellae and denticles.

5. It must be kept in mind that in these males there are two forces at work: the usual one of growth and normal development, and the second, specialized force of degeneration, associated with parasitism. This is visible in our material, not only in the attached *Borophyrne* males (see p. 172), but also in at least one (see below) of these free-swimming *Aceratias*. It seems probable that many individuals must fail to find females, in which case degeneration, at least of nostrils and eyes, proceeds unaccompanied by sexual development.

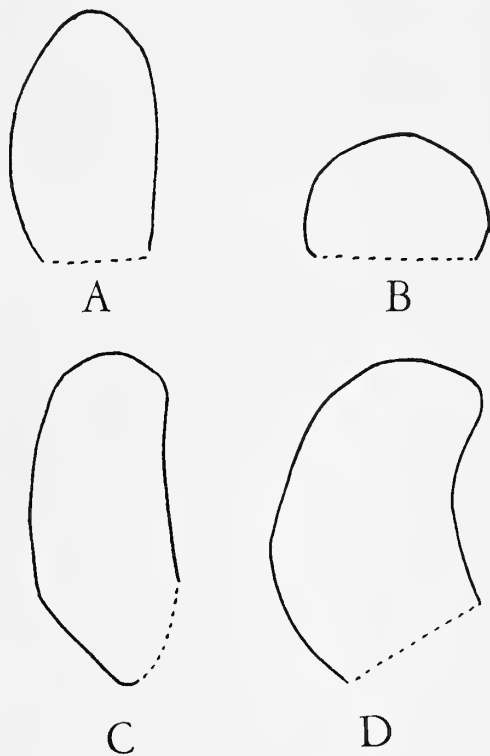

TEXT-FIG. 19. *Aceratias* spp. General types of lamellae. Each sample taken from middle of a series, where maximum development is attained. **A**, High, narrow type (from Cat. No. 23,761, "f" in text). **B**, Low, broad, split type (from Cat. No. 28,762, "g" in text). **C**, Very high, narrow type (from Cat. No. 28,763, "h" in text). **D**, High, curved, broad type (from Cat. No. 28,764, "i" in text). In each, exterior tip is uppermost and anterior edge toward the right.

TABLE I.

ACERATIAS SPP.

Principal Differences in 10 Specimens Arranged According to Apparent Age.

(Note: Trawling and other data given under Study Material, p. 180; see text for further discussion).

	No. 28,756 ("a")	No. 28,757 ("b")	No. 28,758 ("c")	No. 28,759 ("d")	No. 28,760 ("e")	No. 28,761 ("f")	No. 28,762 ("g")	No. 28,763 ("h")	No. 28,764 ("i")	No. 28,765 ("j")
Inflation	Great	Great	Medium	Medium	Medium	Medium	Medium	Slight	Slight	Slight
Stand. lgth. in depth at P.	63%	79%	57%	55%	50%	54%	54%	42%	42%	48%
Eye, rotation	Slight	Slight	Slight	Moderate	Moderate	Moderate	Moderate	Great	Great	Great
Eye-ball, diameter (% of largest)	75%	67%	58%	62%	79%	75%	71%	88%	100%	96%
Denticles, sheathed?	Mostly	Not	Partly	Not	Not	Mostly	Not	Not	Not	Not
Denticles, rostral	4	5	3	5	3	5	5	5	5	3
Denticles, predentary, r. lat.	4	3	3	4	4	3	3	4	3	4
Denticles, predentary, l. lat.	4	3	3	4	3	3	4	6	3	4
Denticles, predentary, shape	Short, thin	Long, thin	Long, wide bases	Long, medium	Medium, stout	Short, stout	Long, stout	Short, medium	Long, stout	Short, stout
Denticles, median predentary, shape	Short, thin	Broken?	Long, thin	Long, thin	Medium, stout	Medium, stout	Long, stout	Short, thin	Long, stout	Long, stout
Teeth, upper, r.	0	Points down?	0	0	0	0	0	0	0	0
Teeth, upper, l.	0	Jaw serrations	0	0	0	0	0	2	Several	0
Teeth, lower, r.	1	Jaw serrations	0	0	0	0	0	0	0	0
Teeth, lower, l.	2	Jaw serrations	0	0	0	0	0	0	0	0
Lamellae, number	9	Jaw serrations	0	9	9	9	9	9	9	8 or 9
Lamellae, shape (Text-fig. 19)	Low, broad, split	High, narrow	High, narrow	High, curved, broad	Low, broad, split	High, narrow	Low, broad, split	Very high, narrow	High, curved, broad	Low, broad, split
Lat. Line System Papillae	Tiny, few	Tiny, few	Tiny, few	Tiny, few	Small	Medium	Tiny, few	Well developed	Tiny, few	Small
Mental fringe	Rudimentary	None	None	None	None	Present	Present	Present	No	No
Subnotic spines, lgth., subdermal incl.	Medium	Short	Medium	Medium	Medium	Medium	Medium	Rudimentary	Medium	Long

Since profitable subdivision is not at present possible, the 10 young males are arranged in Table I in order from the apparently youngest to the apparently oldest. However, since various species are involved, the arrangement is only for convenience, and does not represent a truly linear sequence. The characters listed indicate the chief differences both of development and also those which are most likely to prove of taxonomic value. For the present discussion the specimens are lettered for easy reference. Corresponding catalogue numbers, with complete field data, will be found under Study Material. The entire series will be loaned on request to any investigator working on other collections.

In the following paragraphs, the likenesses, differences due apparently to growth, and differences probably of taxonomic importance, are summarized.

A. Similarities.

All 10 agree in the following respects:

1. *Size*: The range is only from 17.4 (11.1+6.3) to 21.3 (14.4+6.9) mm. The smallest and the largest are the two youngest specimens.

2. *Lack of Pigment*: Subdermal chromatophores are completely lacking, and only one example, *h*, has readily discernable external pigment; this consists of a faint wash of brown.

3. *General Denticle Arrangement*: 3 to 5 rostral; 3 or 4 preantary plus a median; sometimes 1 or 2 jaw teeth on either or both sides.

4. *Nostril Form*: Both fairly small, on a distinct prominence, with the jutting rostral eminence between. The anterior smaller, elongate, fairly close to the posterior; the latter at a considerable distance in front of the eye.

5. *Lamellae Count*: 9 except for *b*, which has 8, and *j*, which possibly has only 8. In the latter case the lamellae appear to be breaking down (preparasitic degeneration through failure to find female?); the specimen is well preserved.

6. *Fin Counts*: D. 3, A. 3, C. 1+3+3+1, P. 15-17.

7. *Sphenotic Spines*: Present, though of variable length, in all.

8. *General Body Proportions*: Excluding the highly variable depth, the general proportions and fin positions appear very similar, although these measurements, as usual in pediculates, are highly unsatisfactory.

B. Differences Due to Age.

The following distinctions we attribute to normal development pattern. Those assigned as characteristics of the youngest are found in fish which show the obvious, ichthyolog-

ical youth characters of persistence of vestigial finfolds near the vertical fins and imperfectly differentiated pectorals. It must be kept in mind that adequate life history data will doubtless show some of these characters to have specific as well as developmental significance. For example, though young animals are more inflated than old ones, some species will probably prove to show more inflation than others. The series on the basis of previously established definitions (see p. 151) may be divided into post-larvae, adolescents and transitional adolescents.

1. *Amount of Inflation*: The depth at pectoral fin ranges from almost four-fifths of the standard length in the youngest to less than half standard length in the oldest. (Standard length here is measured to end of myomeres, as seen by indirect lighting).

2. *Sheathing of Denticles*: Some of the younger have denticles skin-covered throughout much of their length.

3. *Teeth in Jaws*: It seems likely that these long, thin, loosely inserted, asymmetrical structures are temporary teeth, remaining from the larval stage, such as are found in other groups of fishes.

4. *Size of Nostrils*: The nostrils are smaller in younger fish, although the full quota of lamellae is present. Only 2 or 3 of the typical 9 are visible in the posterior orifices of younger, and around 6 in those of older specimens.

5. *Rotation of Eye*: In the youngest three, the eye is almost normal, scarcely turned; in the oldest three, it is revolved strongly forward and down. Intermediate specimens show intermediate grades of rotation.

6. *Diameter of Eyeball*: The actual size of the eyeball is distinctly larger in the oldest specimens, although specific differences are also probably involved. The regular eye diameter measurement appears, as usual in pediculates, to be totally useless.

7. *Lateral Line System Papillae*: In all except several of the older specimens, the papillae are few, rudimentary, and practically indistinguishable.

8. *Sphenotic Spines*: These spines, although well developed in all, scarcely protrude beyond the dermal envelope in the youngest.

C. Differences of Probable Taxonomic Value.

It appears highly probable that the following characters will prove of specific and/or generic value.

1. *Number of Rostral Denticles*: Six specimens have 5, 1 has 4, and 3 have 3 denticles each. However, at least in the case of *a*, having only 4, the fifth is clearly either to be developed or accidentally lost. Similarly, in the cleared and stained attached *Borophryne* (p. 172), 4 are present, with a degenerated (?) stump of a fifth. Regan &

Trewavas' attached *Borophryne* each had 5 denticles (1932, p. 18).

2. *Shape of Forwardly Directed Median Pre dentary Denticle*: Varies from short and thick to long and slender.

3. *Shape of Paired Pre dentary Denticles*: From triangular to slender; not correlated with shape of median.

4. *Shape of Individual Lamellae*: In one type (*a, e, g, j*), including both young and old individuals, each lamella appears double, like adjacent sections of orange, the two halves joined along a seam which tends to split. In another (*h*) the lamellae are elongate, the attached edge being the shorter.

5. *Lateral Line System Papillae*: In some older specimens, these tags in the future may furnish good taxonomic distinctions, although there is variation even in the attached *Borophryne* males (p. 172). Only in *f* and *h* of the present series are they moderately well developed.

6. *Mental Fringe*: In specimens *a, f, g* and *h*, there is a tiny, superficial, anomalous, variable, fringe-like structure corresponding in position to the base of the barbel in *Linophryne* females; *f* and *h* have in addition similar appendages in the midline of the top of the head, well behind the level of the sphenotic spines. Perhaps all of these merely represent irregularities in the lateral line papillae, which are highly variable in both sexes of the family Linophrynidae. However, the position of the mental fringes, because of their similarity to that of the *Linophryne* barbel, justifies special notice of their occurrence. As will be seen from the table, the four fish involved do not appear to be linked by other special characters, such as denticle peculiarities.

7. *Length and Shape of Sphenotic Spines*. The actual length of these spines is quite variable, irrespective of the length protruding externally from the envelope, and should prove to have some taxonomic significance. They also show varying degrees and directions of curvature, even on the two sides of the same individual.

STUDY MATERIAL.

All were taken on the Eastern Pacific *Zaca* Expedition.

a. Cat. No. 28,756; Sta. 225 T-1; 11 mi. SW × W of Jicaron I., Panama (7° 08' N. Lat., 81° 57' W. Long.); 500 fathoms; Mar. 20, 1938; post-larva; length 17.6 (11.5+6.1) mm.

b. Cat. No. 28,757; Sta. 227 T-1; 20 mi. S.W. of Morro de Puercos, Panama (7° 00' N. Lat., 80° 40' W. Long.); 500 fathoms; Mar. 21, 1938; post-larva; length 17.4 (11.1+6.3) mm.

c. Cat. No. 28,758; Sta. 230 T-1; 71 mi.

W × S of Cape Corrientes, Colombia (5° 10' N. Lat., 78° 42' W. Long.); 500 fathoms; Mar. 26, 1938; post-larva; length 21.3 (14.4+6.9) mm.

d. Cat. No. 28,759; Sta. 227 T-1; in same net with *b*; adolescent; length 18.7 (12.0+6.7) mm.

e. Cat. No. 28,760; Sta. 227 T-1; in same net with *b*; adolescent; length 19.7 (12.7+7) mm.

f. Cat. No. 28,761; Sta. 230 T-1; in same net with *c*; adolescent; length 19.5 (12.5+7) mm.

g. Cat. No. 28,762; Sta. 230 T-1; in same net with *c*; adolescent; length 18.9 (12.4+6.5) mm.

h. Cat. No. 28,763; Sta. 230 T-1; in same net with *c*; transitional adolescent; length 17.7 (11.5+6.2) mm.

i. Cat. No. 28,764; Sta. 225 T-1; in same net with *a*; transitional adolescent; length 20.3 (12.3+8) mm.

j. Cat. No. 28,765; Sta. T-8; 20 mi. S. of Cape Blanco, Costa Rica (9° 12' N. Lat., 85° 10' W. Long.); 500 fathoms; Feb. 27, 1938; transitional adolescent; length 18.7 (11.2+7.5) mm.

BIBLIOGRAPHY.

BEEBE, W.:

1926. A new ceratioid fish. *Bull. N. Y. Zool. Soc.*, Vol. XXIX, p. 80.

BRAUER, A.

1902. Diagnosen von neuen tiefseefischen, welche von der *Valdivia*-expedition gesammelt sind. *Zool. Anz.* V., Vol. XXV, No. 668.

1906. Die tiefsee-fische. I. Systematischer teil. *Wiss. Ergeb. Deutsch. Tiefsee-Exp. Valdivia.*, Vol. XV, Part 1.

GARMAN, S.

1899. The fishes. Report on an exploration . . . by the U.S. Fish Commission steamer *Albatross*, during 1891. *Mem. Mus. Comp. Zool. Harvard Coll., Cambridge, Mass.*, Vol. XXIV.

GUNTHER, A.

1864. On a new genus of pediculate fish from the sea off Madeira. *Proc. Z. S. London.*

1887. Report on the deep sea fishes collected by H.M.S. *Challenger*, during the years 1873-1876. *Report. Scient. Results Challenger, Zool.*, London, Vol. XXII.

MURRAY, J.

1878. (In Thomson, C. Wyville. *The Atlantic*, Vol. II).

NORMAN, J. R.

1930. Oceanic fishes and flatfishes collected in 1925-1927. *Discovery Reports, Discovery Committee, Colonial Office*, London, Vol. II.

PARR, A. E.

1927. Ceratioidea. Scientific Results of the Third Oceanographic Expedition of the "Pawnee," 1927. *Bull. Bing. Ocean. Coll.*, Vol. III, Art. 1.
1932. On a deep-sea devilfish from New England waters, and the peculiar life and looks of its kind. *Bull. Boston Soc. Nat. Hist.*, 63, 1932, 3-16.
1934. Report on experimental use of a triangular trawl for bathypelagic collecting. With an account of the fishes obtained and a revision of the family Cetomimidae. *Bull. Bing. Ocean. Coll.*, Vol. IV, Art. 6.

REGAN, C. T.

1925. New ceratioid fishes from the North Atlantic the Caribbean Sea and the Gulf of Panama, collected by the

"Dana." *Ann. Mag. Nat. Hist.*, ser. 9, 15, 1925, pp. 561-567.

1923. The pediculate fishes of the suborder Ceratioidea. Danish "Dana" Expeditions 1920-1922. *Ocean. Rep.*, 2, 1926, 45 pp., 13 pls., 27 text. figs.

REGAN, C. T. & TREWAVAS, E.

1932. Deep-sea angler-fishes (Ceratioidea). In: *The Carlsberg Foundation's Oceanographical Expedition Round the World 1928-30*, under the leadership of Professor Johannes Schmidt, Ph.D., D. Sc. Report 2: 1-113, 10 pl., 172 fig. C.A. Reitzels, Forlag; Copenhagen; Oxford Univ. Press; London, 1932.

ROULE, L. & ANGEL, F.

1933. Poissons provenant des campagnes du Prince Albert Ier de Monaco. *Res. des. Camp. Sci. Monaco.*, Vol. LXXXVI.

EXPLANATION OF THE PLATES.

PLATE I.

- Fig. 1. *Himantolophus azurlucens*. Holotype. Total length 123 mm.
Fig. 2. Same. Illicium, with single intact terminal tentacle (cf. Text-figs. 3, 4).

PLATE II.

- Fig. 3. *Gigantactis perlatus*. Holotype, freshly caught. Total length 42 mm. (Illicium tip in white circle)

- Fig. 4. *Borophryne apogon*. Freshly caught female with attached male (No. 28,707 a, b). Total length of female 74.5 mm.

PLATE III.

- Fig. 5. *Linophryne quinquerosus*. Holotype, freshly caught. Total length 89 mm. (Barbel not shown).



FIG. 1.

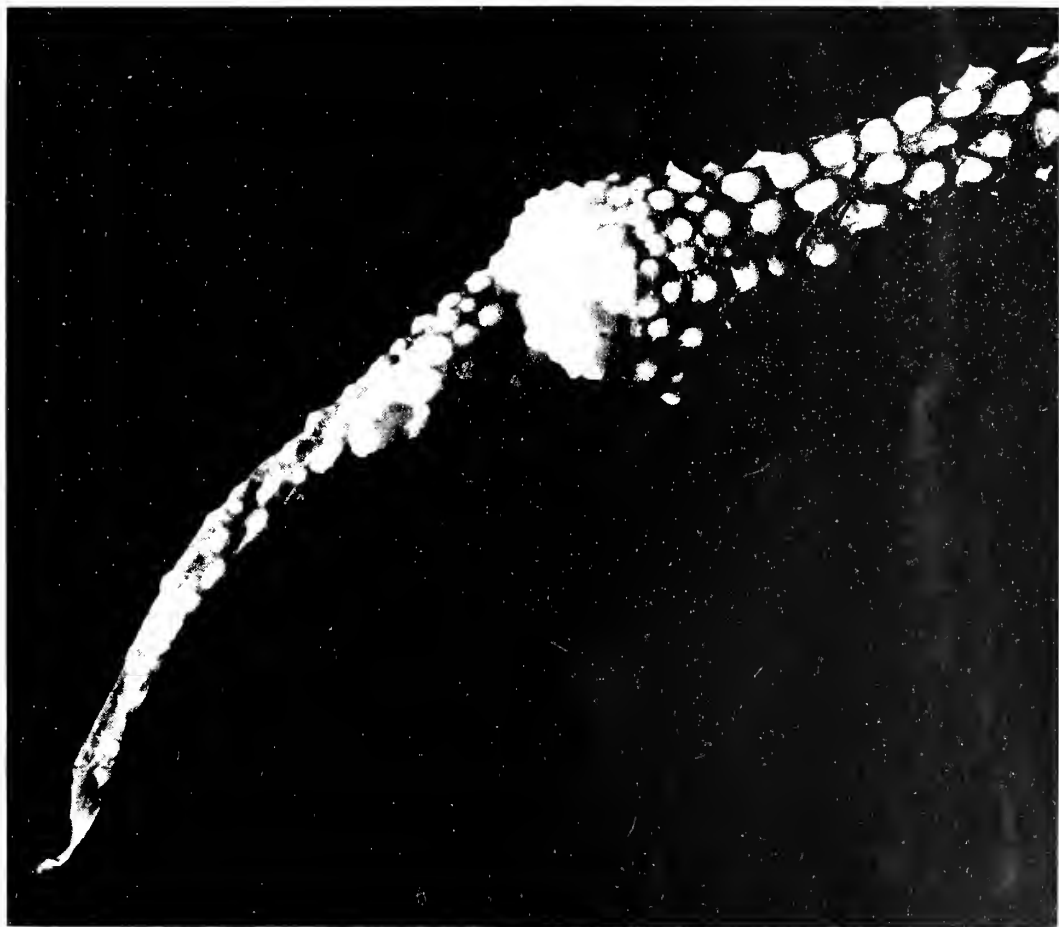

FIG. 2.



FIG. 3.

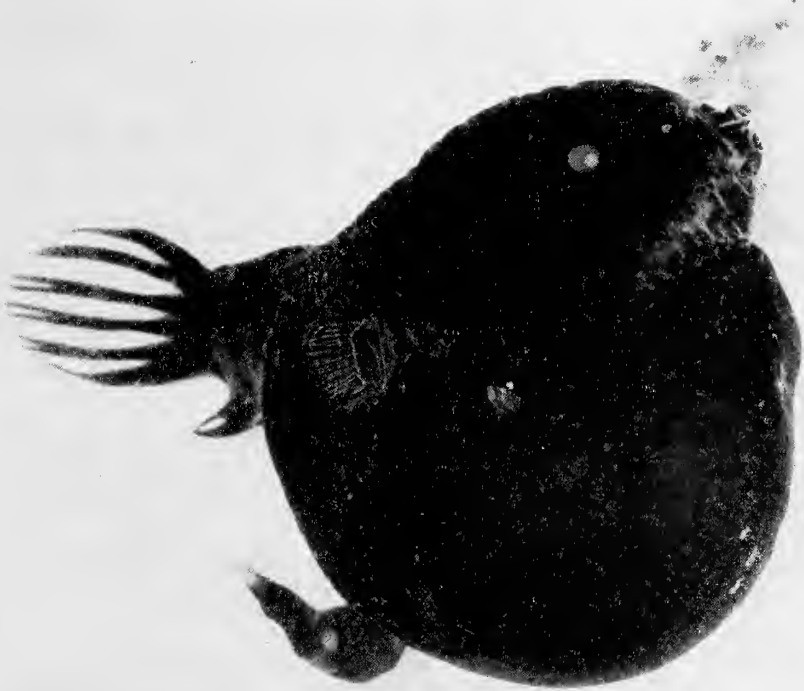

FIG. 4.

DEEP-SEA CERATIOID FISHES.

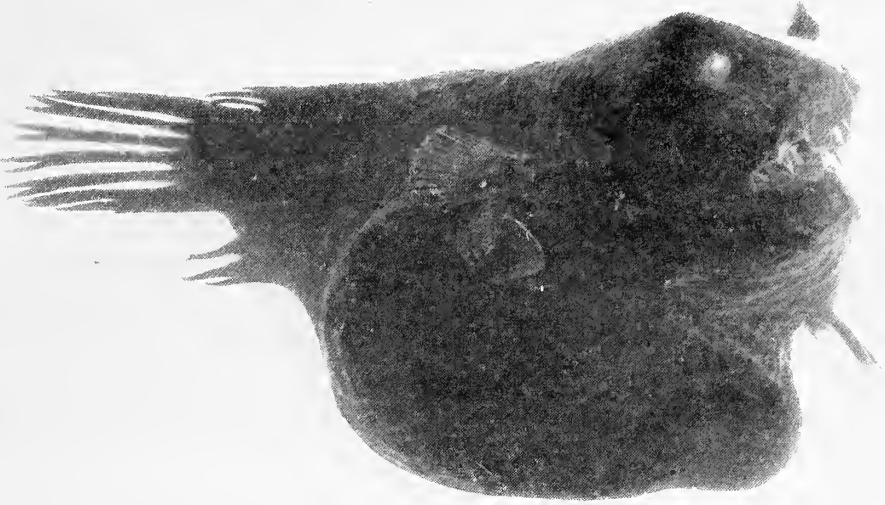

FIG. 5.

DEEP-SEA CERATIOID FISHES.

12.

Spontaneous Neoplasms in Fishes. II. Fibro-carcinoma-like Growth in the Stomach of *Borophryne apogon* Regan, A Deep-Sea Ceratioid Fish.

ROSS F. NIGRELLI.

New York Aquarium, New York Zoological Society.

(Plates I-IV).

Neoplastic growths in the stomach of fishes are exceptionally rare. Thomas (1931) listed the following cases recorded in the literature: fibromatas of the cod by Bland-Sutton, 1884-1885, and Johnstone (1924); leiomyomas in various parts of the stomach, by Plehn, 1906, for the trout; Pesce, 1907, for the carp; and Williamson, 1909, for the cod.

Insofar as is known, the neoplasia described below is the first disease to be reported from these interesting deep-sea forms in which the males are parasites on the females. The fish involved was a fully grown but sexually immature female measuring 37 mm. in standard length. It was taken from the Gulf of Panama in 500 to 700 fathoms (see Beebe and Crane, 1947). Externally the belly was swollen as if filled with food, but the autopsy revealed a comparatively large, solid growth in the region of the stomach.

The normal stomach, when filled with food, was a thin-walled translucent structure. Histologically it appeared as shown in Fig. 1. The mucosa was more or less flattened, consisting of a single layer of cells and saccular glands opening into shallow pits. The submucosa consisted of a delicate layer of connective tissue containing elastic fibers, fat and blood vessels. The muscularis and serous coats were also delicately developed. If the stomach were not dilated with food the rugae would be more pronounced.

The abnormal growth was removed from the fish, sectioned in paraffin at 6 and 10 microns, and stained with iron hematoxylin, Delafield's hematoxylin-eosin, Masson's and Mallory's polychrome stains, and Giemsa's stain.

The growth strikingly resembled the fibro-carcinoma reported for human stomachs (see Ewing, 1940). Histologically, it was characterized by a tremendous overgrowth of connective tissue elements and cells of the mucosa, with stenosis occurring particularly in the pyloric region. Epithelial-like cells scattered diffusely over some areas of the

submucosa indicated that it may be a carcinoma. As in human cases of fibro-carcinoma, it was very difficult to recognize the cellular elements since they were invariably atypical.

There was no evidence of granulation or inflammatory response. The much thickened submucosa was well supplied with thick-walled blood vessels. In every section examined, the cells within these vessels were predominantly lymphocytes.

The great proliferation of mucosal cells in some regions may be noted by examination of the photomicrograph shown in Fig. 2. All the cells here appeared to be of the mucus type. Higher magnifications of these cells are shown in Figs. 3 and 4. The separation from the basement membrane seen in Fig. 3 may be due to shrinkage. However, details of the proliferating cells are best seen in Fig. 4. The nuclei may be normal or pyknotic in appearance and there was some evidence of mitosis. The cells toward the center of the lumen have undergone a great deal of degeneration but much of the abnormalities in the cytological details were probably due to improper fixation. In other regions the glandular epithelial cells predominated. Still in other areas (Fig. 5) little change was noted for this region of the stomach.

The tremendous hypertrophy of the connective tissue layers of the stomach may be seen in Figs. 2 and 5 and especially in Figs. 6 and 7. The proliferation into the muscularis (Fig. 7) was especially striking. The serous coat was also involved but there was only a slight thickening of the mesothelium.

Just how the epithelial elements infiltrated into the connective tissue layers could not be determined. Fig. 8 shows the organization of mucosal material within this region. Higher magnification of the epithelial cells and the nature of the surrounding region is clearly shown in Fig. 9. The epithelial cells have undergone considerable modifications; the nuclei were varied in size and were hyperchromatic.

The diffusion of single tumor cells with hyperchromatic nuclei into the surrounding

regions of the submucosa is shown in Fig. 10. These cells also penetrated through the muscularis into the serosa.

There was no definite evidence as to what the causative factor or factors were, but it should be pointed out that a neosporidian infection was present in the liver and surrounding tissues. Whether or not these protozoan parasites produced the stimulus initiating this growth was difficult to say. However, it is known that parasites of this group are capable of inducing tumor formation (see Nigrelli & Smith, 1938, 1940).

SUMMARY.

A fibro-carcinoma-like growth in the stomach of *Borophryne apogon* Regan, a ceratioid fish taken from the Gulf of Panama in 500 to 700 fathoms of water, is described. Histologically the neoplasia is characterized by a tremendous overgrowth of connective tissue elements and cells of the mucosa. All the coats of the stomach wall are involved. The presence of epithelial-like cells scattered diffusely over some areas of the submucosa indicate that this growth may be carcinoma similar to the fibro-carcinoma reported for human stomachs.

REFERENCES.

- BEEBE, WILLIAM & CRANE, J.
1947. Eastern Pacific Expeditions of the New York Zoological Society. XXXVI. Deep-Sea Ceratioid Fishes. *Zoologica*, 31 (11): 151-182.
- EWING, JAMES.
1940. Neoplastic Diseases. 4th Edition; 1160 pp., 581 illustrations. Philadelphia and London. W. B. Saunders Co.
- JOHNSTONE, JAS.
1924. Malignant Tumors In Fishes. *Report for 1924 on the Lancashire Sea-Fisheries Laboratory*, No. 33. 105-106.
- NIGRELLI, R. F. & SMITH, G. M.
1938. Tissue Responses of *Cyprinodon variegatus* to the Myxosporidian Parasite, *Myxobolus lintoni* Gurley. *Zoologica*, XXIII (7): 195-202.
1940. A Papillary Cystic Disease Affecting the Barbels of *Ameiurus nebulosus* (Le Sueur), Caused by the Myxosporidian *Henneguya ameiurensis* sp. nov. *Zoologica*, XXV (8): 89-95.
- THOMAS, L.
1931. Les Tumeurs des Poissons (Étude Anatomique et Pathogénique). *Bulletin de L'Assoc. Française pour L'Étude du Cancer*, 20: 703.

EXPLANATION OF THE PLATES.

PLATE I.

- Fig. 1. Photomicrograph of section of normal stomach of *Borophryne apogon*. Stained with Delafield's hematoxylin and counter-stained with eosin. 100X.
- Fig. 2. Section through the main part of the stomach. Note the tremendous proliferation of epithelial cells of the mucosa and thickened submucosa. Mallory's. 100X.

PLATE II.

- Fig. 3. Higher magnification of epithelium of the mucosa shown in Fig. 2. Delafield's hematoxylin-eosin. 6.5X.
- Fig. 4. Cells of the epithelium showing proliferation. Note the differences in the staining reactions of the nuclei. The cells are smaller with the neat columnar pattern lost. Great activity is indicated. Delafield's hematoxylin-eosin. 675X.
- Fig. 5. Region of the submucosa showing great proliferation of connective tissue. Very few other cellular elements are present in this area and very little is left of the mucosa. Part of the muscular coat is also shown in this section. Mallory's. 100X.
- Fig. 6. Section of the stomach near the pylorus. The epithelium is separated from the basement membrane, probably due to shrinkage. No proliferation is present within the lumen but proliferating cells are present in the region which appears to correspond to the submucosa in the normal stomach. Mallory's. 100X.

PLATE III

- Fig. 7. Region of the muscularis. Connective tissue fibers have penetrated this region and the exact pattern of the muscle fibers has been disrupted. Delafield's hematoxylin-eosin. 157X.
- Fig. 8. Section through the main body of the tumor mass. Note the extent of connective tissue and the organization of mucosal material within it. Delafield's hematoxylin-eosin. 100X.

PLATE IV.

- Fig. 9. Higher magnification showing cellular details of region seen in center of Fig. 8. Epithelial cells have undergone certain changes. In some sections the infiltration of the cells into the connective tissue is well marked. Delafield's hematoxylin-eosin. 675X.
- Fig. 10. Details showing epithelial and epithelial-like cells scattered diffusely through the submucosa. Many of the cells are atypical and it is difficult to determine whether or not they are derived from the mucosa, although the evidence strongly indicates that they are. Masson's polychrome stain. 356X.

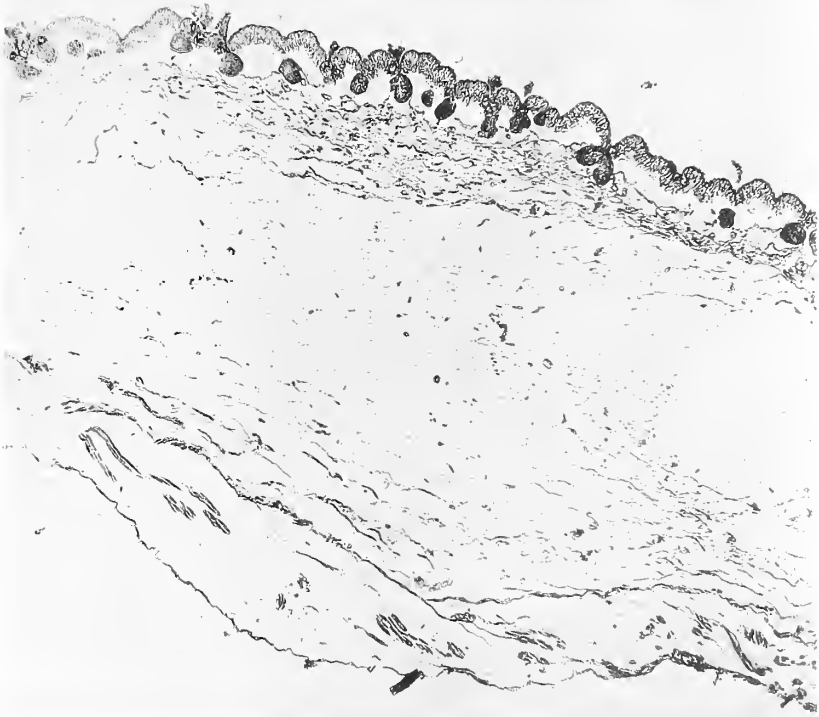

FIG. 1.

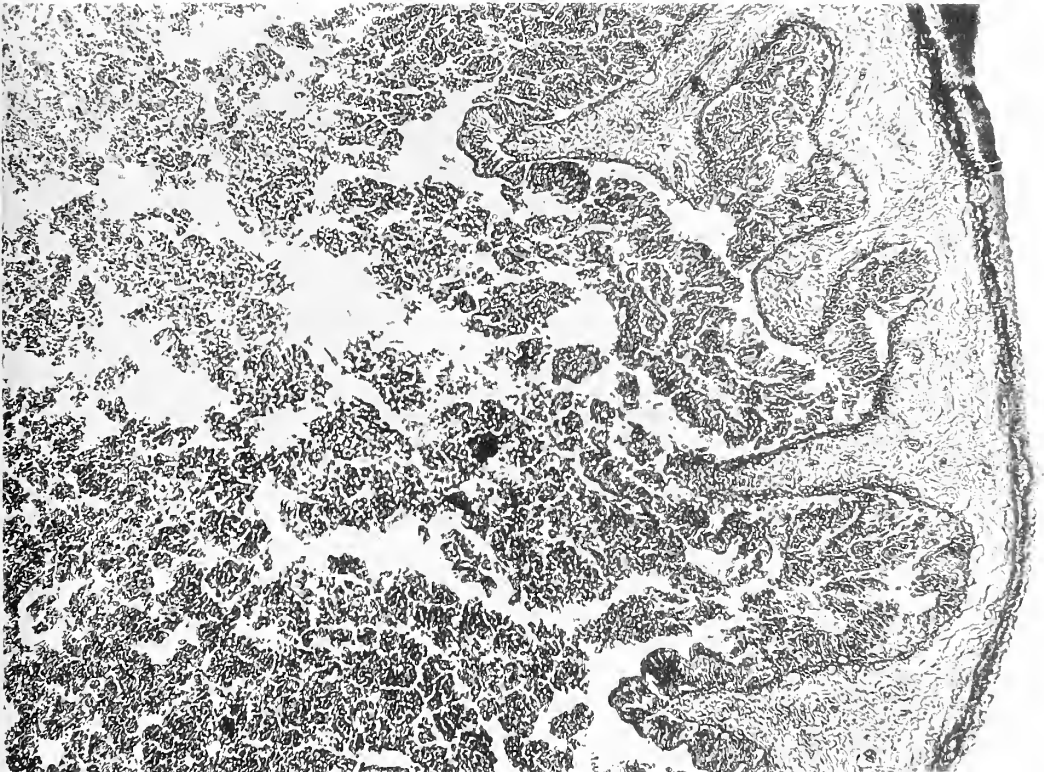

FIG. 2.

FIBRO-CARCINOMA-LIKE GROWTH IN THE STOMACH OF
BOROPHRYNE APOGON REGAN, A DEEP-SEA CERATIOID FISH.

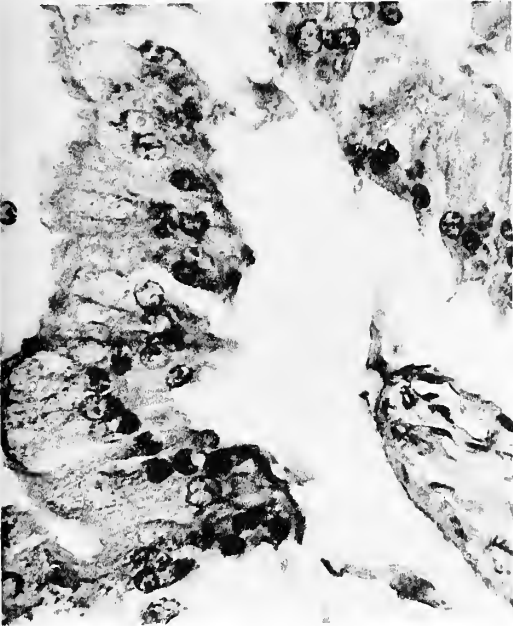

FIG. 3.

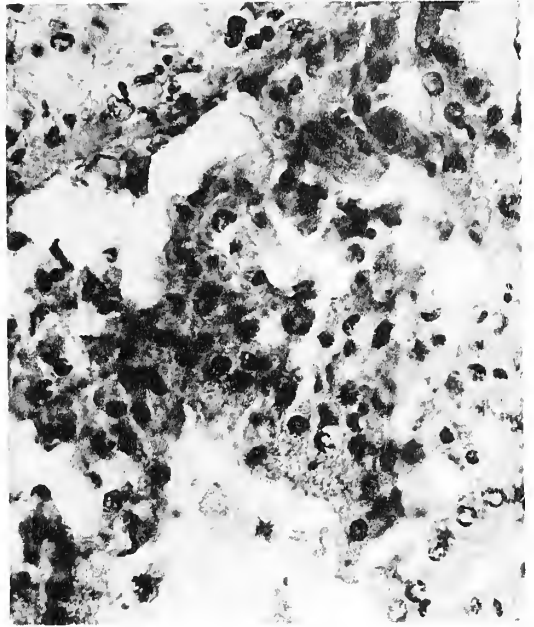

FIG. 4.

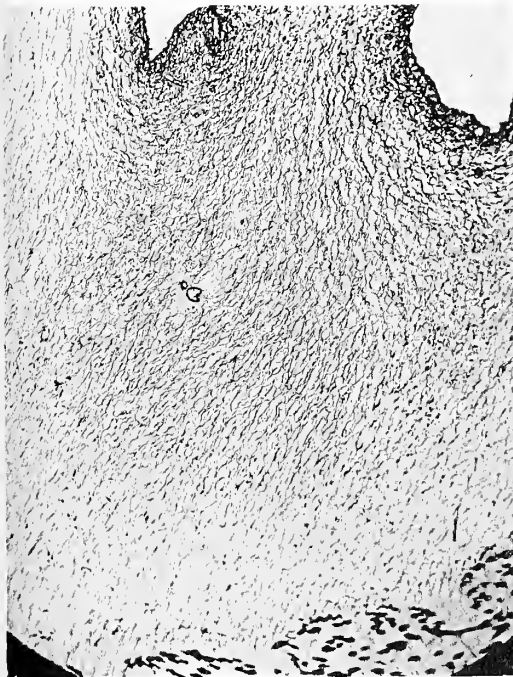

FIG. 5.



FIG. 6.

FIBRO-CARCINOMA-LIKE GROWTH IN THE STOMACH OF
BOROPHYRNE APOGON REGAN, A DEEP-SEA CERATIOID FISH.

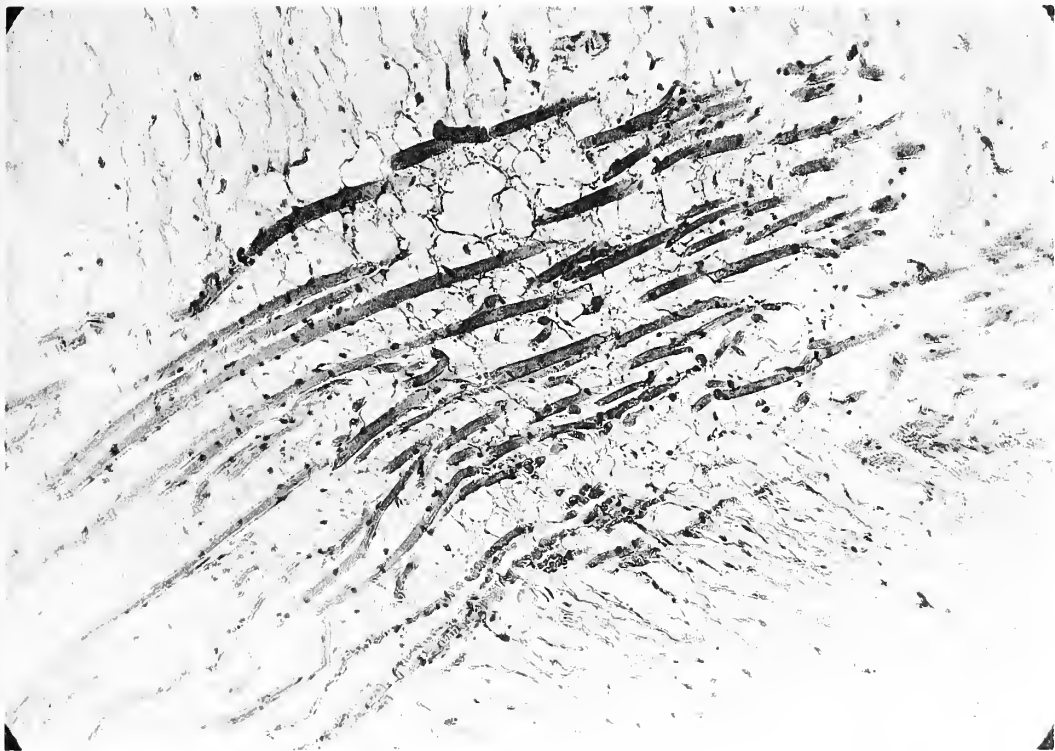

FIG. 7.

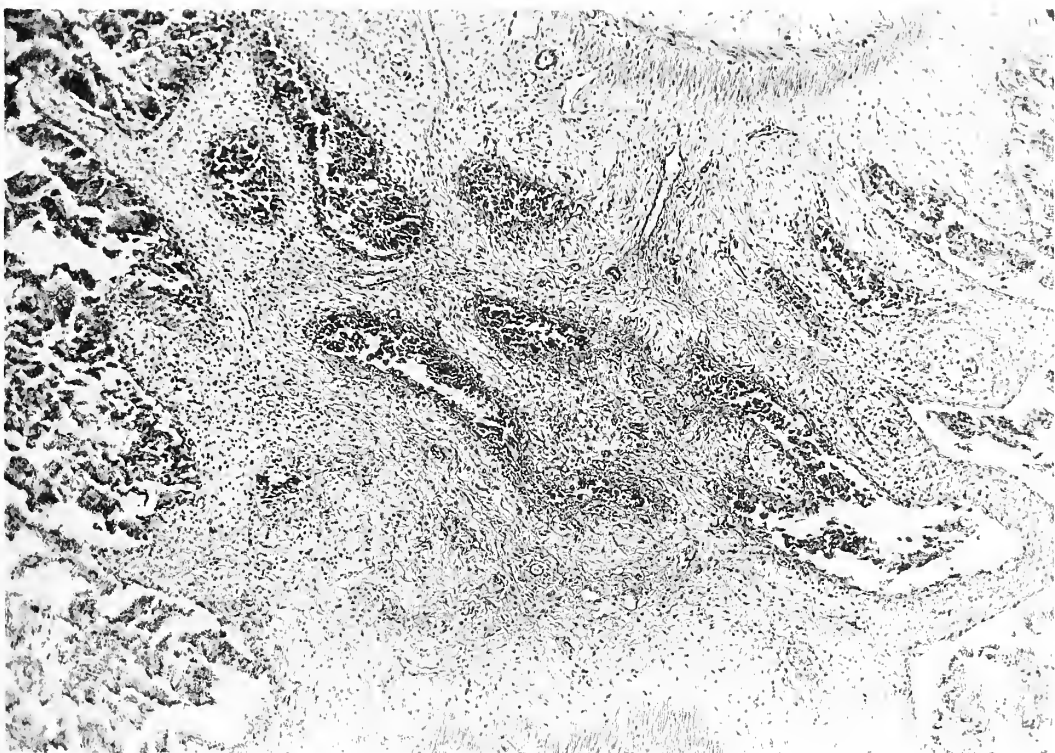

FIG. 8.

FIBRO-CARCINOMA-LIKE GROWTH IN THE STOMACH OF
BOROPHYNE APOGON REGAN, A DEEP-SEA CERATIOID FISH.

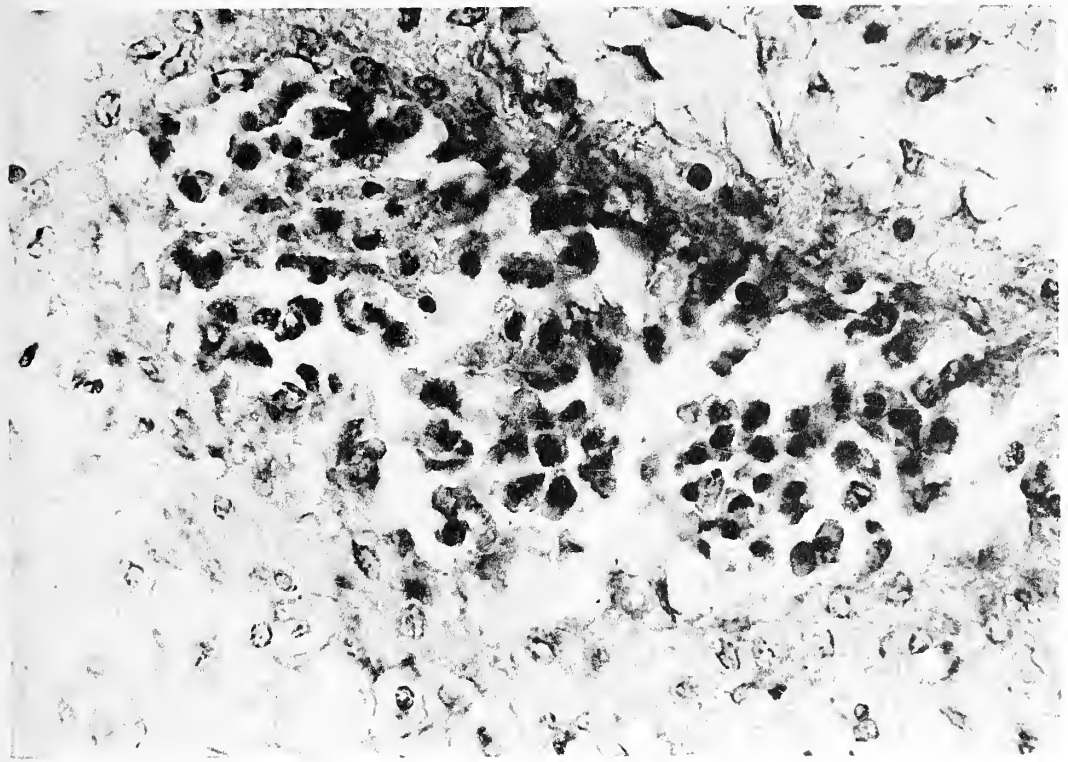

FIG. 9.

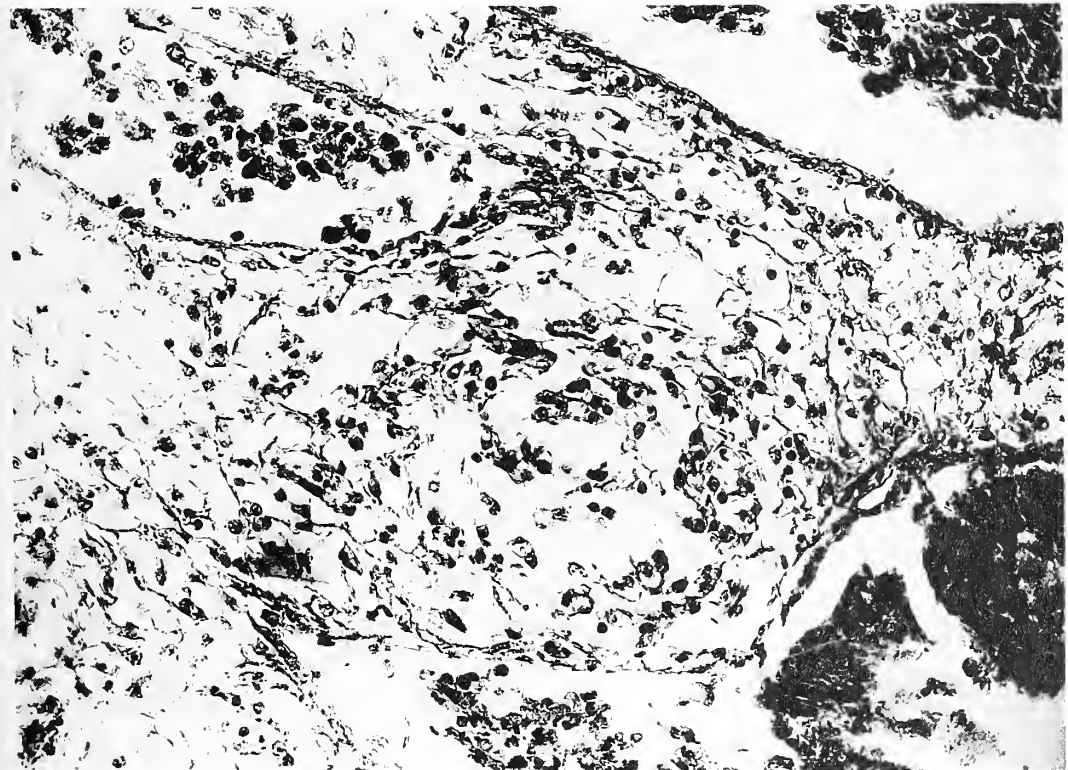

FIG. 10.

FIBRO-CARCINOMA-LIKE GROWTH IN THE STOMACH OF
BOROPHYNE APOGON REGAN, A DEEP-SEA CERATOID FISH.

13.

Studies on the Genus *Hirudinella*, Giant Trematodes of Scombriform Fishes.

ROSS F. NIGRELLI & HORACE W. STUNKARD.

New York Zoological Society and the Department of Biology, New York University.

(Plates I-VIII).

INTRODUCTION.

Nigrelli and Stunkard (1937) reported giant trematodes from the "wahoo," *Acanthocybium solandri*; they were referred without specific identification to the *Distoma clavatum* group of the Hemiuridae. These trematodes belong to the genus *Hirudinella* which Dollfus (1932) named as type of a new family in the Hemiuroidea. Members of *Hirudinella* infect fishes of the sub-order Scombroidei, in particular those of the family Scombridae, and a large number of species have been described. These parasites have been known for more than 200 years; with *Fasciola hepatica* and *Haplometra cylindracea* (Zeder, 1800), they are among the oldest known trematodes. Yet knowledge of the group is very incomplete and there is no agreement concerning the number of species or their differential diagnoses. This situation may be explained by several obvious facts: (1) the hosts are oceanic fishes which range through all tropical and temperate seas; (2) relatively few individuals have been recovered from any single host; (3) the location of the parasites, which usually occur in the stomach but have been found also in the intestine, on the gills and free in the plankton; (4) the early reports were made before there was any adequate knowledge of trematode morphology and consist merely of accounts of size and shape; and (5) the enormous size of the worms and their powerfully muscular bodies, which on contraction may assume unusual shapes and greatly modify the arrangement of internal structures. Combinations of these several features have made it difficult to measure individual variation or to form a definite concept of specific limitations.

Historical accounts of the genus and lists of species were given by Poirier (1885), Moniez (1886, 1891), Blanchard (1891), Buttell-Reepen (1902) and Mühlenschlag (1914). More recent papers include those of Manter (1926, 1940), Dollfus (1932, 1940), Chandler (1937), Guiart (1938) and Yamaguti (1938).

The earlier accounts were so inadequate that it is quite impossible to recognize the species from the descriptions and often the hosts were not designated or were listed by vernacular names which make positive identification difficult and uncertain. Many of the original specimens are no longer available and those that have been studied were in such poor condition that they contributed little to knowledge of the species. Moreover, the usual method of redescribing a species, by collecting new material from type hosts and localities, is quite inapplicable since the life cycles of the parasites are unknown, there is no assurance of host-parasite specificity, and the final hosts (the only ones known) have no type locality. As noted by earlier authors and discussed by Chandler (1937, p. 353), the features which have been used to distinguish species may be influenced very markedly by age, by different states of contraction and by different methods of preparation. As stated by Chandler, satisfactory studies can be made only on serial sections, which impose a difficult and tedious task. There is, accordingly, no adequate basis for recognizing the many species that have been included in the "*Distomum clavatum*" group of trematodes. A list of these species and their hosts is included in Table I.

MATERIAL AND METHODS.

During the past ten years, the writers have examined 56 specimens of *Hirudinella* taken from 9 different species of scombriform fishes from both the Atlantic and Pacific oceans. The specimens were studied by various methods; alive, as whole mounts, in serial sections or by needle dissections. We are indebted to Dr. William Beebe, Dr. Charles Breder, Jr., Dr. G. M. Smith, Dr. N. R. Stoll, John Tee-Van, Francesca Lamonte and W. W. Doxee for material collected on different expeditions. Through the kindness of Dr. William Beebe and Dr. A. C. Chandler, we have had the opportunity to study the slides of *H. beebei* Chandler, 1937, prepared by Professor Chandler. Most of the material came from *Acanthocybium*

TABLE I.

List of Species of *Hirudinella*.

SPECIES	HOST	LOCALITY
1. <i>Hirudinella marina</i> Garcin ¹ , 1730	<i>Scomber pelamys</i>	Atlantic
2. <i>Fasciola ventricosa</i> Pallas, 1774	Host not given	Amboyna
<i>Distomum ventricosum</i> (Pallas) Monticelli
<i>D. ventricosum</i> of the following
Braun, 1893
Stossich, 1900	<i>Pimelepterus</i> (<i>Kyphosus</i>)
<i>H. ventricosa</i> (Pallas) Baird, 1853
3. <i>Fasciola clavata</i> Menzies, 1791	<i>Scomber pelamys</i>	Pacific
<i>D. clavatum</i> of the following:
Baird, 1853
Barbagallo and Drago, 1903	<i>Pelamys sarda</i>	Catania
Beneden, van, 1870	<i>Thynnus vulgaris</i>	Atlantic
Le Billardière, 1801
Blanchard, R., 1891	<i>Thynnus vulgaris</i>	Atlantic
Brandes, 1891	<i>Pelamys sarda</i>	Atlantic
Braun, 1892, 1893a, b, c
Buttel-Reepen, 1900, 1902, 1904, 1905
Carus, 1884
Chatin, 1887
Cobbold, 1860
1867	<i>Xiphias gladius</i>	Atlantic
1879
Cooper, 1915	<i>Thunnus thynnus</i>	Atlantic
Creplin, 1837
Darr, 1902	"Diamantfisch"
Diesing, 1850	<i>Pelamys sarda</i>	Atlantic
1859	<i>Thynnus vulgaris</i>	Brazil
Dujardin, 1845	<i>Coryphaena hippuris</i>
Goto, 1891
Jackson, 1888
Jaegerskiold, 1900
Jourdan, 1881	<i>Thynnus</i>	Atlantic
Juel, 1889
Krøyer, 1838-1840	<i>Thynnus vulgaris</i>	Atlantic
Lander, 1904
Linton, 1898	<i>Thunnus thynnus</i>	Atlantic
1901	<i>Xiphias gladius</i>	Atlantic
Looss, 1894, 1895, 1896, 1899
Moniez, 1892
Monticelli, 1888, 1893
Olfers, 1816
Osbeck, 1765
Owen, 1835, 1837
Parona, 1887
Poirier, 1885	Ocean bonito (<i>S. pelamis</i>)	Atlantic & Pacific
Rudolphi, 1808
Shiple, 1910	<i>Coryphaena hippuris</i>	Atlantic
Siebold, von, 1835
Stiles, 1901
Stossich, 1886
Wagener, 1860
Ziegler, 1905
<i>H. clavata</i> (Menzies, 1791) Blainville, 1828
<i>H. clavata</i> (Menzies) of Manter, 1940	<i>Gymnosarda alletterata</i>	Galapagos (Pacific)

¹ Also spelled Garsin and Garzin in papers of later authors.

SPECIES	HOST	LOCALITY
4. <i>Fasciola fusca</i> Bosc, 1802	"Dorade" (<i>Coryphaena hippuris</i>)	Atlantic
<i>Distoma fuscum</i> (Bosc) Poirier, 1885
<i>D. fuscum</i> of the following:		
Braun, 1893
Buttel-Reepen, 1902
Mühlschlag, 1914
<i>H. fusca</i> (Bosc, 1802) Dollfus, 1932
<i>H. fusca</i> (Poirier, 1885) Manter, 1926	<i>Xiphias gladius</i>	Atlantic
<i>H. fusca</i> of the following:		
Guiart, 1938	"Germon" (tuna)	Atlantic
Legendre, 1940	<i>Thunnus thynnus</i>	Atlantic
Linton, 1940	<i>Thunnus secundadorsalis</i>	Atlantic
	<i>Trachurops</i>	
	<i>crumenophthalma</i>	Atlantic
	<i>Trichurus lepturus</i>	Atlantic
	<i>Xiphias gladius</i>	Atlantic
5. <i>Fasciola coryphaenae</i> Bosc, 1802	<i>Coryphaena hippuris</i>	Atlantic
<i>F. coryphaenae hippuridis</i> Tilesius (<i>in litteris</i> , Rudolphi, 1809)
<i>Distoma coryphaenae</i> (Bosc) Rudolphi
6. <i>Fasciola scombri pelamidis</i> Tilesius (<i>in litteris</i> , Rudolphi, 1809)	<i>Scomber pelamis</i>	Atlantic
7. <i>Distoma heurteli</i> Poirier, 1885	<i>Thynnus vulgaris</i>
8. <i>Distoma dactylipherum</i> Poirier, 1885	"un Argonaute d'espèce indeterminée."	Indian Ocean
9. <i>Distoma verrucosum</i> Poirier, 1885	<i>Thunnus</i> sp.	Atlantic
<i>D. verrucosum</i> of the following:		
Braun, 1892
Jaegerskiold, 1900
Lander, 1904
10. <i>Distoma personatum</i> Poirier, 1885	Gulf of Mexico
<i>D. personatum</i> of the following:		
Buttel-Reepen, 1902
Darr, 1902
Loennberg, 1891
11. <i>Distoma pallasii</i> Poirier, 1885 (<i>D. ventricosum</i> of Pallas renamed)	<i>Delphinus phocaena</i> (Dolphin)	"Indies"
<i>D. pallasii</i> of the following:		
Braun, 1892
Buttel-Reepen, 1902
Darr, 1902
Stossich, 1892	<i>Phocaena communis</i> (Porpoise)	Indian Ocean
12. <i>Distoma ingens</i> Moniez, 1886
<i>D. ingens</i> of the following:		
Blanchard, 1888
Braun, 1889, 1892, 1893
Buttel-Reepen, 1900, 1902
Hoyle, 1890
Monticelli, 1888
<i>H. ingens</i> (Moniez) Darr, 1902
<i>H. ingens</i> of the following:		
Mühlschlag, 1914	Albicore Fish	South Atlantic Indian Ocean
13. <i>Distoma poirieri</i> Moniez, 1891
<i>H. poirieri</i> (Moniez) Dollfus, 1935	"Germon" (<i>Thynnus alalonga</i>)	Atlantic
14. <i>Distoma siemersi</i> Buttel-Reepen, 1900	<i>Sphyræna barracuda</i>	Atlantic
<i>D. siemersi</i> of the following:		
Buttel-Reepen, 1902, 1904, 1905
Darr, 1902

SPECIES	HOST	LOCALITY
15. <i>Distoma ampullaceum</i> Buttel-Reepen, 1900 <i>D. ampullaceum</i> of the following: Buttel-Reepen, 1902, 1904, 1905 Darr, 1902 Mühlschlag, 1914	<i>Coryphaena</i> sp.	Indian Ocean
16. <i>Hirudinella beebei</i> Chandler, 1937 <i>H. beebei</i> of the following: Manter, 1940	<i>Acanthocybium petus</i> <i>Acanthocybium solandri</i>	Atlantic Pacific
17. <i>Hirudinella spinulosa</i> Yamaguti, 1938	<i>Thynnus alalonga</i>	Pacific
18. <i>Hirudinella oxyzoma</i> Guiart, 1938 <i>H. oxyzoma</i> of the following: Dollfus, 1940 (Dollfus incorrectly spelled the name <i>oxyzoma</i>).	"Germon" (<i>Thynnus alalonga</i>) <i>Thynnus thynnus</i>	Atlantic Mediterranean
19. <i>Hirudinella phalloidea</i> Guiart, 1938	<i>Coryphaena hippuris</i>	Atlantic
20. <i>Hirudinella bonnacouri</i> Guiart, 1938 (<i>D. fuscum</i> Poirier, 1885 renamed)

spp. from both Atlantic and Pacific, although we have made no attempt to distinguish between *A. solandri* (Cuvier and Valenciennes) and *A. petus* (Poey) since there is some doubt whether these names represent two distinct species. Our collection of *Hirudinella*, though limited, is probably the largest yet assembled and has provided the basis for an extended study of the genus, while comparison of our specimens with accounts in the literature permits a consideration of morphological features and specific determinations. Pertinent data on collection, and size of worms are presented in Tables II-V.

In the absence of information concerning the life cycle, host-parasite specificity and/or the possible influence of development in different fish hosts, the limits of specific variation can not be determined with certainty. It is impossible at present to characterize any species of *Hirudinella* completely or even adequately. This fact, however, does not justify the naming of a new species for a specimen which manifests some variation from previously published accounts. The size at which sexual maturity is attained may be a valid specific character, but it is possible that maturity may develop at different sizes in different hosts. It is possible, also, that in different hosts the same species may differ in the ultimate size attained and in the delicacy or coarseness of the various organs, e.g., one may compare gravid specimens of *Fasciola hepatica* from the livers of a guinea pig, a rabbit and a cow. As in many other trematode genera, egg-size in *Hirudinella* is too variable to serve as a reliable specific character. In general, as noted by Moniez (1891), the size of eggs is correlated with the size of the worm.

Our data indicate that the large, thick-bellied worms from *Acanthocybium* (Figs. 1-20, Tables II & III) which become gravid at a length of approximately 17 mm. and may attain a length of 70 mm., belong to one species which we identify as *H. ventricosa* (Pallas, 1774). Study of the morphology has disclosed no feature of difference that can not be explained by differences in degree of development or of muscular contraction. Length of a specimen is not a valid indication of size or degree of maturity as a specimen may extend to more than five times its contracted length. The specimen listed as Cat. No. 7 (Plate I, Fig. 1) was alive when removed from the stomach of a "wahoo" flown to the New York Aquarium. Extended, it measured 170 mm. long by 30 mm. wide and it contracted to a length of only 40 mm. It was purplish in color and the cuticula was so transparent that the internal organs were visible when the worm was compressed between glass plates. When the worm was held up by the anterior end, the cecal contents passed to the posterior end which swelled in balloon-like fashion. When placed in 10% formalin it contracted vigorously and when fixed it measured 98 by 40 mm. with dermal rugae and the shape characteristic of other worms from *Acanthocybium*.

Whether the worms from other fishes represent a different species can not be determined with certainty. With the exception of the two specimens from *Katasuwonus pelamis* taken at Bermuda (Cat. No. 10, Fig. 11) which were immature and may belong to *H. ventricosa*, they are smaller, differ in shape and in the position of the acetabulum, attain sexual maturity at a smaller size, have less powerful suckers and body walls and presumably belong to a dif-

TABLE II.

Hirudinella from *Acanthocybium*.

CAT. No.	COLLECTOR	NO. OF SPECIMENS	LOCALITY	FIGURE
1	Beebe	2	Long Key, Florida	9-10
2a	Beebe	2	Bermuda	...
2b	Beebe	5	Bermuda	4
2c	Beebe	1	Bermuda	...
2d	Beebe	2	Bermuda	5-6
3	Beebe (Antares Exp., 1933)	2	Pearl Island, Panama (Pacific)	...
4	Beebe (Templeton Crocker Exp.)	2	Mexico (Pacific) Clarion Island	7-8
5a	Breder (Atlantis Exp.)	4	Yucatan, (Atlantic)	3
5b	Breder	2	La Plata Islands, Equador (Pacific)	...
5c	Breder	3	Equador (Pacific)	...
6	Smith	6	Bermuda	...
7	Erl Roman Formerly of Miami Herald through Miss F. LaMonte	1	Bimini (Atlantic)	1
8	Stoll ²	1	Marianas Islands (Pacific)	2

² The host was listed as a "King Mackerel," possibly *Acanthocybium*.

ferent species. All of them appear to belong to a single species which we identify as *H. marina* Garcin.

Hirudinella marina Garcin³, 1730.
(Plate VII, Tables IV and V).

Fasciola clavata Menzies, 1791.

Distoma clavatum (Menzies, 1791)
Rudolphi, 1808.

Hirudinella clavata (Menzies, 1791)
Blainville, 1828.

Fasciola coryphaenae Bosc, 1802.

Distoma coryphaenae (Bosc, 1802)
Rudolphi, 1808.

Fasciola fusca Bosc, 1802.

Distoma fuscum (Bosc, 1802) Poirier,
1885.

Hirudinella fusca (Bosc, 1802) Dollfus,
1932.

Hirudinella fusca (Poirier, 1885) Manter,
1926.

Hirudinella bonnacouri Guiart, 1938.

Fasciola coryphaenae hippuridis Tilesius
in Rudolphi, 1809.

Fasciola poirieri pelamidis Tilesius in
Rudolphi, 1809.

Distomum dactylipherum Poirier, 1885.

Distomum heurteli Poirier, 1885.

Distomum verrucosum Poirier, 1885.

Distoma poirieri Moniez, 1891.

Hirudinella poirieri (Moniez, 1891) Doll-
fus, 1935.

Distoma siemersi Buttel-Reepen, 1900.

Hirudinella spinulosa Yamaguti, 1938.

Hirudinella oxysoma Guiart, 1938.

Hirudinella phalloidea Guiart, 1938.

Hirudinella ventricosa (Pallas, 1774)
Baird, 1853.

(Plates I-VI, Tables II and III).

Fasciola ventricosa Pallas, 1774.

Distomum ventricosum (Pallas, 1774)
Monticelli, 1893.

Distomum clavatum of Owen, 1834.

Distomum pallasii Poirier, 1885.

Distomum personatum Poirier, 1885.

Distoma ingens Moniez, 1886.

Distomum ingens of Mühlenschlag, 1914.
Distomum ampullaceum Buttel-Reepen,
1900.

Hirudinella beebei Chandler, 1937.

DISCUSSION.

The first of the giant trematodes from the stomach of scombriform fishes was found in *Scomber pelamys* of the Atlantic and was described by Garcin (1730), who named the parasite *Hirudinella marina*. His description was accompanied by a figure of the worm and supplemented by a second report, Garcin (1732), with a plate and 3 additional figures. The description is admittedly inadequate but was as good as that of many later specific descriptions that have been universally accepted. Pallas (1774) described a similar but larger and more robust parasite from an unnamed host in the Malay Archipelago and designated

³ Name spelled Garsin and Garzin by subsequent authors.

TABLE III.

Some Measurements of *Hirudinella* from *Acanthocybium*.
(In millimeters, except eggs, which are in microns).

CAT. NO.	LENGTH	GREATEST WIDTH	WIDTH AT ACETABULUM	DIAMETER ACETABULUM	DIAMETER ORAL SUCKER	O.S. TO G.P.	EGGS
1	58	22	13	7	3	5	35 × 23
	33	24	14	5.5 × 7.5	2.5	4	34 × 23
2a	38	21	10	4.5 × 5.5	..	4.5	31 × 21.5
	31	19	8	5 × 6	..	3.5	38 × 24
2b	57	23	10	4	2.5	2.5	36 × 25
	31	19	7	6	2	4	32 × 21
	44	19	10	6	2	4	32 × 22
	47	19	10	4 × 5	2	3	31 × 20
	31	19	7	6	3	2	35 × 22
2c	31	21	9	4 × 6	..	3.8	33 × 22
2d	32	20	9	6	..	1.3	34 × 21
	31	21	9	6	..	2	35 × 20
3	26	19	9	4	..	3	35 × 22
	28	17	10	3.5 × 4.5	..	2	35 × 22
4	44	23	10	5.5	4	8	34 × 25
	41	22	11	7	3	8.5	37 × 26
5a	52	sectioned, (mature)					
	50						
	19	whole mount					
5b	12	sectioned, (immature)					
	24	15	8				
	25	12	8				35 × 19.5
5c	31	14.5	9				
	32	18	9				
	32	15.5	8				
6	45	17	7	5	..	6	33 × 25
	44	17	7	7	..	6.5	32 × 23
	36	17	8	3	32 × 24
	15	9	6	3	immature
	12	3	2.5	immature
	19	10
7	98	40	(see description later)				
8	48	18	6	2	..

it *Fasciola ventricosa*. This species was transferred to the genus *Hirudinella* by Baird (1853) and to *Distoma* by Monticelli (1893). It was deliberately renamed *D. pallasi* by Poirier (1885). Menzies (1791) described specimens from *Scomber pelamys* taken in the Pacific Ocean as *Fasciola clavata*. This species was transferred by Rudolphi (1808) to *Distoma* and by Blainville (1828) to *Hirudinella*. Blainville (1828) designated *F. clavata* as type of the genus *Hirudinella*. Bosc (1802) described material from the "dorade," *Coryphaena hippuris*, taken in the Atlantic, as *Fasciola fusca*. Specimens assigned to this species were described by Poirier (1885) as *Distomum fuscum* and Manter (1926) transferred the *Distomum fuscum* of Poirier to the genus *Hirudinella*. Manter studied specimens from the swordfish, *Xiphias gladius*, which he regarded as identical with those described by Poirier. Dollfus (1932) transferred *F. fusca* of Bosc to *Hirudinella*.

The genus *Hirudinella* Garcin was pre-Linnaean and monotypic. According to Opinion 5 of the International Commission on Zoological Nomenclature, which deals with the "Status of Certain Pre-Linnaean Names Reprinted Subsequent to 1757," "A pre-Linnaean name, ineligible because of its publication prior to 1758, does not become eligible simply by being cited or reprinted with its original diagnosis after 1757. To become eligible under the code, such names must be reinforced by adoption or acceptance by the author publishing the reprint." Concerning *Hirudinella* of Garcin, Blainville (1824) stated specifically, "J'admets ce genre pour les fascioles cylindriques qui ont quelque ressemblance avec les sangsues, et entre autres le *Fasc. clavata* Linn." He later (1828, p. 586) designated *H. clavata* as type of the genus. But Art. 30c of the International Rules of Zoological Nomenclature states, "A genus proposed with a single original species takes that species as

TABLE IV.

Hirudinella from Scombriform Fishes Other Than *Acanthocybium*.

CAT. NO.	COLLECTOR	No. OF SPECIMENS	HOST	LOCALITY	FIGURE
9a	Beebe	1	Black Finned Tuna. <i>Parathunnus atlanticus</i> (Lesson)	Bermuda	Similar to Figs. 24-25
9b	Beebe	2	<i>Parathunnus atlanticus</i> (Lesson)	Bermuda	Similar to Figs. 24-25
9c	Beebe	4	<i>Parathunnus atlanticus</i> (Lesson)	Bermuda	Similar to Figs. 24-25
9d	Beebe	1	<i>Parathunnus atlanticus</i> (Lesson)	Bermuda	Similar to Figs. 24-25
9e	Beebe	1	<i>Parathunnus atlanticus</i> (Lesson)	Tobago	Similar to Figs. 24-25
10	Beebe	2	Ocean Bonito. <i>Katsuwonus pelamis</i> (L.)	Bermuda	11
11	Templeton Crocker Exp. (Beebe)	1	Little Tunny. <i>Euthynnus alletteratus</i> (Rafinesque)	C. San Lucas, Lower Calif. Pacific	Similar to 24-25
12	Templeton Crocker Exp. (Beebe)	3	California Yellowfin Tuna. <i>Neothunnus</i> <i>macropterus</i> (Temminck & Schlegel)	C. San Lucas, Lower Calif. Pacific	Similar to 24-25
13	Templeton Crocker Exp. (Beebe)	1	Pacific Swordfish. <i>Nakaira mitsukurii</i> (Jordan & Snyder)	C. San Lucas Lower Calif. Pacific	23
14	Templeton Crocker Exp. (Beebe)	1	Spanish Mackerel. <i>Scomberomorus</i> <i>maculatus</i> Mitchill	Port au Prince Bay Haiti	Similar to 11
15	Doxsee	6	Bluefin Tuna. <i>Thunnus thynnus</i> (L.)	Point Lookout, L. I.	24-25

type. (Monotypical genera.) (See opinions Nos. 6, 9, 22, 30, 42, 47)." In his paper Blainville (1824) formally validated the generic name *Hirudinella* and by the rules, *H. marina* must be the type species. Opinions 22 and 30, dealing with similar cases, reaffirm the principle that monotypic genera must retain the original species as type, and that the original type takes precedence over any later designated types. Accordingly, the acceptance by Blainville (1824) of *Hirudinella* as a valid generic name also validated *H. marina* as the type species and his later (1828) designation of *H. clavata* as type can not be accepted. A further attempt to designate a new type species was made by Blanchard (1891). Since *H. marina* Garcin is a pre-Linnaean name, Blanchard proposed that *F. ventricosa* (= *D. ventricosum*), the first post-Linnaean name, be accepted as type of the genus. But application of the International Rules renders Blanchard's proposal also untenable. By the Rules of International Nomenclature, the type of *Hirudinella* is *H. marina*. *Hirudinella* Gray, 1850, mollusk, and *Hirudinella* Muenster of Diesing, 1850, leech, are untenable homonyms.

Comparison of our material with accounts

in the literature shows that most if not all of the previously described species can be referred to one or the other of the two species we recognize. We have studied the sections of *H. beebeyi* (the species was described from this one specimen) and can not agree with Chandler's interpretation of certain structures. He stated, (1937, p. 350) "Near point where conical anterior part of body joins expanded posterior part, ceca begin branching in extremely complicated manner, with veritable maze of pockets and anastomosing, interlacing branches, which in cross-section give appearance of a reticulum. Near middle of hind-body a rather large expanded central lumen on each side, without much branching on medial sides, but with very complicated lateral and outer walls. As ceca proceed posteriorly they throw off laterally a series of backward-directed divisions, each with its complicated pockets and anastomosing branches. Longest divisions of ceca terminate at extreme posterior end of body" (See Plate VI, Figs. 16-19). While examination of single sections indicates branching and anastomosis of the intestinal ceca with the formation of a reticulum, careful reading of successive sections shows that the walls of the ceca are

TABLE V.

Measurements of *Hirudinella* from Scombriform Fishes Other Than *Acanthocybium*.

CAT. No.	LENGTH	GREATEST WIDTH	WIDTH AT ACETABULUM	DIAMETER ACETABULUM	EGGS
9a	15	5		5 × 4	34 × 23
9b	15	8	5	5	34 × 23
	8.5	2.5			immature
9c	28	6.5	5	5	38 × 23
	9.5	2	1.5		immature
	13	3	3		immature
	13.5	3.5	3.5		immature
9d	15	6	4	4 × 3	38 × 21
9e	17	5.5			immature
10	37	6	2.5	3 × 3	immature
	20	2			immature
11	16	3.5			immature
12	26	8	3.5	3 × 3	33 × 20
	17	5	3.5	5 × 4	35 × 22
	11	4	4	4 × 4	31 × 23
13	17.5	5	4.5	4.5 × 4.5	36 × 21 (see Fig. 21)
14	18	5	3	3 × 3	immature
15	21	6		5 × 4	} 44 × 26 (see Fig. 22)
	21	5		5 × 4	
	22	5		5 × 4	
	19	4		4 × 3	
	19	5		5 × 4	

collapsed in innumerable folds and plications, but that actual branching does not occur. The cavities of the supposed branches are parts of a continuous lumen and study of other specimens shows that when the ceca are filled, the plications disappear (Plate V, Fig. 14). In some of our sections small connections were found between the posterior ends of the ceca and the excretory vesicle and we believe that this condition is characteristic for the genus: None of the intestinal content, however, was observed in the excretory vesicle.

Furthermore, in specimens from both Atlantic and Pacific, which we identify as *H. ventricosa*, the vitelline follicles are intracecal as well as extracecal. As described for *D. ampullaceum* by Buttel-Reepen, (1902, p. 212), "In der oberen Partie liegen die Acini meist dicht zusammen (Fig. 28 *dodr*), während sie sich auf Querschnitten durch die untere Partie in dem spärlichen Parenchym überall zerstreut zeigen." Mühlenschlag (1914) reported that in both *D. fuscum* and *D. ingens*, the vitellaria are extracecal and extend from the level of the testes to the excretory vesicle. His figure shows the vitellaria in a cross-section taken near the middle of the body and at that level the vitellaria are always extracecal. In discussing the differences between the specimens he identified as *D. ingens* and those described as *D. ampullaceum* by Buttel-Reepen, Mühlenschlag (1914) pointed out that they might readily be regarded as identical,

and the features he cited to distinguish between them were either minor histological or positional ones that do not commend themselves as truly specific. All may be explained by differences in age, degree of development, functional activity or muscular contraction. Accordingly, the two features on which Chandler distinguished *H. beebei* from *H. ampullaceum* and *H. ingens*, viz., the form of the digestive system and distribution of the vitellaria, appear inadequate. We are unable to discover any sound morphological character or set of characters to separate these species and regard them as identical with *H. ventricosa*.

The various features used by previous authors to determine species of *Hirudinella* include host, size and shape of the digestive ceca and of the excretory bladder, relation of parts of the copulatory organs, presence of dermal rugae and papillae, thickness of the cuticula and body wall, size of suckers and their openings, position of the genital pore, details of histological organization and size of eggs. When these features concern true morphological differences, they constitute the basis for specific distinction, but when they are only manifestations of different physiological states, they cannot be criteria of specificity.

Study of our material shows that in most cases the reported differences are merely variations that have no specific value. As noted earlier, the hosts of *Hirudinella* are wide-ranging oceanic fishes and Manter

(1940, p. 536), in discussing the trematode parasites of marine fishes, included *H. clavata*, remarked on their wide distribution and stated, "their occurrence in both the Atlantic and Pacific may have no particular significance." In the absence of information concerning life histories, there is no ground for the assumption of host-parasite specificity. The only known life cycle of a marine hemiurid is that of *Lecithaster confusus*, traced by Hunninen and Cable (1943). This species has a cystophorous cercaria which develops into an unencysted metacercaria in the haemocoel of copepods, and adults occur in a large number of marine fishes, including *Scomber scomber*.

The report by Jourdan (1881), discussed by Poirier (1885), that specimens of *Hirudinella* were found on the gills of fishes and free in the floating material of the Sargasso Sea, may not be significant. The worms may survive for considerable time in sea water and if they had migrated or been regurgitated from the stomach, it is not surprising that they were found on the gills of the fishes or on adjacent vegetation. They are normal parasites of the stomach, but the observation of Jourdan may possibly explain the fact that they often occur singly and that so few individuals are present in a host.

These trematodes are enormous, powerfully muscular worms, capable of great variation as different sets of muscles contract; the motility of the preacetabular region was portrayed in the sketches by Garcin (1739); and like other hemiurid trematodes, discussed by Stunkard and Nigrelli (1934), they may be greatly distorted in the process of killing and preserving. This distortion may affect both the external form and the relations of internal structures. If the authors who have described preserved museum specimens had recognized this fact, the literature would not be burdened with several new species proposed on the differences in shape, in appearance of dermal plications, and other results of muscular contraction. The failure to distinguish between true morphological differences and physiological variation is commonplace and even modern authors are not exempt, as may be observed in the following quotation from Guiart (1938, p. 29), "Toutefois il n'existe certainement aucune relation entre ce Distome (*D. ventricosa*) à corps ovalaire lisse et à ventouse ventrale lisse et celui (*H. phalloidea*) que nous allons décrire, qui présente un corps globuleux très fortement plissé et une ventouse ventrale à bord mamelonné. Celui-ci constitue certainement une espèce nouvelle; en tous cas ses affinités seraient avec l'*Hirudinella bonnacouri* nom. nov., plutôt qu'avec l'*Hirudinella pallasii* Poirier 1885." And in a foot-

note on the same page the author makes the statement, "En 1885 Poirier a bien décrit sous le nom de *Distomum personatum* un *Hirudinella* à abdomen bilobé, récolté au Mexique par Geoffroy, sans indication d'hôte; mais ici l'abdomen est ovalaire et surtout la ventouse ventrale présente un bord lisse; donc rien de commun avec notre exemplaire." *Hirudinella phalloidea* was described from a single specimen, which in our opinion is specifically identical with *H. bonnacouri* and both names are synonyms of *H. marina* Garcin. These specimens are probably distinct from *H. ventricosa* (= *D. personatum*). It appears that certain investigators harbored the opinion that all members of a single species would be identical in morphological aspects, regardless of the manner in which they had been killed. The bulbous enlargement of the posterior portion of the body, so often figured and discussed, is explained by the text-figure of Darr (1902, p. 692) which shows the bending of the lateral excretory canals in this condition and by his Fig. 26, which shows the powerful longitudinal muscles which are inserted around the caudal tip of the body. Retraction of the posterior end of the body is characteristic of the hemiurid trematodes and finds its culmination in the so-called "appendiculate distomes." When living specimens of *Hirudinella* are suspended by the anterior end, if the digestive caeca are filled with blood, this fluid material flows downward and contributes to the caudal enlargement.

Another feature which has occasioned much confusion and discussion is the structure and relations of the musculature which surrounds and comprises the copulatory organs. In the hemiurid trematodes, where the terminal portions of both the male and female ducts are enclosed in a common muscular sac, the relations may be varied and perplexing. This muscular sac has a complex structure, is connected by muscle bands to the body wall at different places, and may be retracted or protruded, especially as the preacetabular portion of the body is extended and contracted. These relations were represented in Figures 6 and 9 of Buttel-Reepen (1900) and Figures F and H in his 1902 paper. If the musculature is retracted, the male and female ducts open into a long, deep and narrow genital sinus, whereas if the mass is protruded (Plate I, Fig. 2), the two ducts open through separate papillae on a common genital protuberance. These small papillae were figured by Bosc (1802) and discussed by Blanchard (1891). In different positions, the copulatory organs and especially the musculature associated with the male papilla manifest greatly altered relations, but these morphological variations have been observed in different individuals

of the same species and result merely from contractions of different sets of muscles. The specimens from *Xiphias gladius* described by Manter (1926) and identified by him as *H. fusca* (Poirier, 1885) agree in essential respects with those we recognize as *H. marina*. Manter distinguished between *H. fusca* and *H. clavata* on the location of the openings of the male and female genital ducts. Our observations show that the reported differences actually represent only differences in the state of contraction of the genital musculature. This musculature and its relation to the "cirrus sac" was discussed by Mühlschlag (1914) and Manter (1926). Mühlschlag (1914) described as *H. fusca* (Bosc, 1802) specimens presumably identical with those of Manter and all of them we regard as identical with *H. marina*. The specimens described by Buttler-Reepen (1903) as *D. siemersi* we assign to the same species, *H. marina*.

With slight emendations we are in accord with the conclusions of Moniez (1891, p. 116). This eminent helminthologist reviewed the descriptions and synonyms of *Distoma clavatum* and summarized the situation as follows, "Il result donc de tout ceci, ce que nous avons déjà exprimé, à savoir: (1) que le véritable *Dist. clavatum* est celui de Garcin et de Menzies, redécrit ensuite par Dujardin, Jourdan, Poirier, etc.: (2) que c'est par erreur qu'Owen a donné ce nom à une espèce tout différente, qui j'ai appelée plus tard *Dist. ingens*, nom qui doit être maintenu; (3) et comme conséquence qu'il n'y a pas identité entre les *Dist. clavatum* et *ingens*." In this same publication Moniez admitted the identity of *Dist. clavatum* of Owen and *Dist. ingens*. If the name *Hirudinella marina* is substituted for *D. clavatum* and the name *Hirudinella ventricosa* (Pallas, 1774) Baird, 1853, for *D. ingens*, our conclusions agree entirely with those of Moniez. Baird (1853) had predicated the identity of *D. clavatum* of Owen with *Fasciola ventricosa* Pallas, 1774. The two species recognized by Moniez were redescribed by Buttler-Reepen (1900, 1902) as *Dist. siemersi* and *Dist. ampullaceum*. The worms described by Buttler-Reepen (1900) as *D. ampullaceum* and by Mühlschlag (1914) as *D. ingens* are almost certainly conspecific with those we have studied and referred to *H. ventricosa*. *Dist. personatum* Poirier is probably identical, but his description is too incomplete to permit final identification.

Distomum megnini Poirier, 1885, was regarded by the author as a member of the *D. clavatum* group, but it is so different in internal structure that it cannot be retained in the genus *Hirudinella*. Monticelli (1893) considered it identical with *D. macrocotyle* Diesing, 1858, and included it in the subgenus *Accacoelium*, which was raised by

Looss (1899) to generic rank. Stossich (1898) transferred *D. macrocotyle* Diesing, 1858, to the genus *Podocotyle*.

Since both *H. marina* and *H. ventricosa* have been described previously under different names, (q.v., lists of synonymy), further detailed accounts are unnecessary. The data presented in Table II give measurements of our specimens and the morphology agrees essentially with previous descriptions.

We are not in agreement with the opinion of Dollfus (1932, 1940) who erected families to receive the genera *Hirudinella* and *Bathycotyle*. The hemiurid trematodes constitute a well-defined group in the Digenea; they are related to the Azygiidae, but other relationships are yet undetermined and until the life cycles and developmental stages are known, we prefer to regard the units as subfamilies, *Hirudinellinae*, *Bathycotylinae*, etc.

SUMMARY.

Examinations of specimens of *Hirudinella* from 9 different species of scombriform fishes, taken in both the Atlantic and Pacific Oceans, have disclosed the great variation in form and internal arrangements that may be manifested by these large, very muscular trematodes. All of our material is allocated to two species which we identify as *H. marina* Garcin, 1730, and *H. ventricosa* (Pallas, 1774) Baird, 1853. The validity of *H. marina* Garcin, 1730, and its status as type of the genus *Hirudinella*, are established. Comparison of our specimens with accounts in the literature indicates that most, if not all, other described species are merely variants of one or the other of the two species we recognize. The other designated species were described from a single or very few specimens, and are regarded as synonyms. Information is yet too incomplete to permit definitive taxonomic determination and we are not in accord with Dollfus (1932, 1940) in the erection of families for subgroups of the Hemiuriidae.

LITERATURE CITED.

BAIRD, WILLIAM

1853. Catalogue of the species of entozoa, or intestinal worms, contained in the collection of the British Museum. 132 pp. London.

BLAINVILLE, M. H. D. DE

1824. in, *Traité zoologique et physiologique sur les vers intestinaux de l'homme*. Traduit de l'allemand (Bremser, 1819) par Grundler; revu et augmenté de notes par M. de Blainville, pp. 501-553. Paris.

1828. Vers, in *Dict. d. sci. nat.*, 52; 365-625. Paris et Strasbourg.

- BLANCHARD, R.
1891. Notices helminthologiques (II^{me} sér.), *Mém. Soc. Zool. France*, 4: 468-478.
- BOSC, L. A. G.
1802. Histoire naturelle des Vers, contenant leur description et leurs moeurs. Paris.
- BUTTEL-REEFEN, H. VON
1900. Zwei grosse Distomen. *Zool. Anz.*, 23: 585-598.
1902. Zur Kenntniss der Gruppe des *Distomum clavatum*, insbesondere des *Dist. ampullaceum* und des *Dist. siemersi*. *Zool. Jahrb., Syst.*, 17: 165-236.
- CHANDLER, A. C.
1937. A new trematode, *Hirudinella beebei*, from the stomach of a Bermuda fish, *Acanthocybium petus*. *Trans. Amer. Micr. Soc.*, 56: 348-354.
- DARR, A.
1902. Über zwei Fasciolidengattungen. *Zeit. wiss. Zool.*, 71: 614-701.
- DOLLFUS, T. PH.
1932. Trématodes. Resultats scientifiques du voyage aux Indes Orientales Néerlandaises. *Mém. Mus. Hist. Nat. Belgique* (hors séries), 2 (fasc. 10): 1-18.
1940. Helminthes du Germon: Trématodes. *Ann. Inst. Océan. Monaco*, 20 (4): 276-279.
- GARCIN, —
1730. The *Hirudinella marina*, or sea leech. *Phil. Trans. Roy. Soc.*, London, 36: 387-384.
1732. Abstract of Garcin 1730, in *Hist. Acad. des Sci.*, Paris: pp. 43-44.
- GUIART, J.
1938. Trématodes parasites provenant des campagnes scientifiques de S.A.S., le Prince Albert I^{er} de Monaco (1886-1912). *Result. Camp. Sci.*, Fasc. C, pp. 1-73. Monaco.
- HUNNINEN, A. V. and CABLE, R. M.
1943. The life history of *Lecithaster confusus* Odhner (Trematoda: Hemiuridae). *Jour. Parasit.*, 29: 71-79.
- JOURDAN, ÉT.
1881. Note sur l'anatomie du *Distomum clavatum* Rud. *Rev. Sci. Montpellier*, 2 c Sér. 9: 438-448.
- LOOSS, A.
1899. Weitere Beiträge zur Kenntniss der Trematoden-Fauna Aegyptens, zugleich Versuch einer natürlichen Gliederung des Genus *Distomum* Retzius. *Zool. Jahrb., Syst.*, 12: 521-784.
- MANTER, H. W.
1926. Some North American fish trematodes. *Ill. Biol. Monogr.*, 10 (2): 1-138.
1940. The geographical distribution of digenetic trematodes of marine fishes of the tropical American Pacific. *Rep. Allan Hancock Pacific Exped.*, 2: 531-547. Univ. S. Cal. Pub.
- MENZIES, A.
1791. Descriptions of three new animals found in the Pacific Ocean. *Trans. Linn. Soc.*, London, 7: 181-188.
- MONIEZ, R.
1886. Description du *Distoma ingens* n. sp. et remarques sur quelques points de l'anatomie et de l'histologie comparée des Trématodes. *Bull. Soc. Zool. France*, 11: 531-543.
1891. Notes sur les Helminthes: sur l'identité de quelques espèces de Trématodes du type du *Distoma clavatum* (*Hirudinella*). *Rev. Biol. Nord France*, 4: 108-118.
- MONTICELLI, F. F.
1893. Studii sui Trematodi endoparassiti: Primo contributo di osservazioni sui distomidi. *Zool. Jahrb.*, Suppl., 3: 1-229.
- MÜHLSCHLAG, G.
1914. Beitrag zur Kenntnis der Anatomie von *Otodistomum veliporum* (Crepelin), *Distomum fuscum* Poirier und *Distomum ingens* Moniez. *Zool. Jahrb., Syst.*, 37: 199-252.
- NIGRELLI, R. F. and STUNKARD, H. W.
1937. Giant trematodes from the wahoo, *Acanthocybium solandri*. *Jour. Parasit.*, 23: 567.
- PALLAS, P. S.
1774. Spicilegia zoologica quibus novae imprimis et obscurae animalium species inconibus, descriptionibus atque commentariis illustrantur. Fasc. 10, Berlin.
- POIRIER, J.
1885. Contribution à l'histoire des Trématodes. *Arch. zool. expér. et gén.* (Sér. 2) 3: 465-624.
- RUDOLPHI, C. A.
1808. Entozoorum sive vermium intestinalium historia naturalis. Amstelaedami.
- STOSSICH, M.
1898. Saggio di una fauna elmintologica di Trieste e provinve contermini. 162 pp. Trieste.
- STUNKARD, H. W. and NIGRELLI, R. F.
1934. Observations on the genus *Sterrhurus* Looss, with a description of *Sterrhurus branchialis* sp. nov. (Trematoda: Hemiuridae). *Biol. Bull.*, 67: 534-543.
- YAMAGUTI, S.
1938. Studies on the helminth fauna of Japan. Part 24; Trematodes of fishes. *Jap. Jour. Zool.*, 8: 15-74.

EXPLANATION OF THE PLATES.

All photographs by S. C. Dunton, staff photographer of the New York Zoological Society.

Plates I-VI, *Hirudinella ventricosa* (Pallas, 1774) from *Acanthocybium* spp. taken from the Atlantic and Pacific Oceans.

PLATE I.

- Fig. 1. Living worm pressed between two glass plates. The parasite was taken from the stomach of a fish sent by air to the New York Aquarium from Bimini, W. I. When fully expanded it measured 170 mm. in length and 30 mm. in width. About natural size.
- Fig. 2. Parasite from the stomach of a "King Mackerel" (*Acanthocybium*?) taken off the Marianas Islands, Pacific. The specimen was sent by Dr. N. R. Stoll. Note the common genital protuberance with two separate papillae. About 3X.
- Fig. 3. Parasites from fish caught off the coast of Yucatan (Atlantic). Worms 1 and 4 were sectioned serially; worm 3 was stained and mounted *in toto*. The smallest form was immature. A little less than twice natural size.

PLATE II.

- Fig. 4. *Hirudinella ventricosa* from the stomach of *Acanthocybium* captured off Bermuda. A little less than natural size.
- Figs. 5-6. These worms were taken from fish caught off Bermuda. Note the numerous minute papillae, especially on specimen 5. These are artifacts formed in the process of fixing. They are rough to the touch and are similar to the structures Poirier (1885) found on the species he described as *D. verrucosum*. About 2X.
- Figs. 7-8. From fish taken off Clarion Island, Mexico (Pacific). Beebe-Templeton Crocker Expedition, 1936. Note the extent of contraction at the posterior end, smoothness of the anterior extremity and the terminal position of the oral sucker. About 1½X.

PLATE III.

- Figs. 9-10. Parasites, similar in appearance to 7 and 8, taken from fish caught off Long Key, Florida. About 1½X.
- Fig. 11. One of two specimens from the ocean bonito *Katsuwonus pelamis* (Linnaeus) taken off the coast of Bermuda. About 10X.

PLATE IV.

- Fig. 12. Gross dissection of a worm taken from *Acanthocybium*. Body wall deflected posterior to the acetabulum, showing musculature of the body wall and the bands which control move-

ments of the acetabulum, with external view of intestinal ceca. 3X.

- Fig. 13. Same structures as in Fig. 8, part of body wall removed to expose the testes. 3X.

PLATE V.

- Fig. 14. Interior of a single cecum with plicated wall, limits of uterus, ovary, Mehlis' gland, testes, copulatory organs and genital pore. 4X.
- Fig. 15. Further dissection of anterior portion, showing testes, ovary, and details of male and female genital ducts. 8X.

PLATE VI.

- Figs. 16-19. Photomicrographs of sections of *Hirudinella beebei* Chandler (1937) taken (16) near the middle region at about the end of the uterine coils, (18) midway between the region shown in 16 and posterior end of the body, and (19) at the posterior end. Figure 17 is an enlargement of the region indicated by arrow in Figure 16. These sections attempt to show the complicated nature of the ceca, which according to Chandler form a . . . "maze of pockets and anastomosing, interlacing branches, which in cross section give appearance of a reticulum." Our studies have shown that the walls of the ceca are collapsed in innumerable folds and plications, but that actually branching does not occur. When the ceca are filled, the plications disappear (see Plate III, Fig. 10). Photomicrographs by Dr. Chandler.

PLATE VII.

- Figs. 20-22. Photomicrographs of eggs from several specimens of *Hirudinella*. Fig. 20 from parasite found in *Acanthocybium*; Fig. 21, from parasite of the Pacific swordfish (see Fig. 20); Fig. 22 from one of the worms taken from bluefin tuna (see Figs. 24, 25). Each unit represents 7 microns.

Hirudinella marina Garcin, 1730, from other scombriform fishes.

- Fig. 23. Parasite from the stomach of the Pacific swordfish, *Makaira mitsukurii* (Jordan and Snyder). Note the nature of the acetabulum. About 3X.
- Figs. 24-25. Five of six specimens found in the stomach of a bluefin tuna, *Thunnus thynnus* (Linnaeus), caught off Point Lookout, L. I. About 1½X.

PLATE VIII.

- Fig. 26. Plate from Buttell-Reepen's (1902) paper in *Zool. Jahrb., Syst.*, Bd. 17, Taf. 6 showing drawings of species of *Hirudinella* described by various authors up to that time.



FIG. 1.

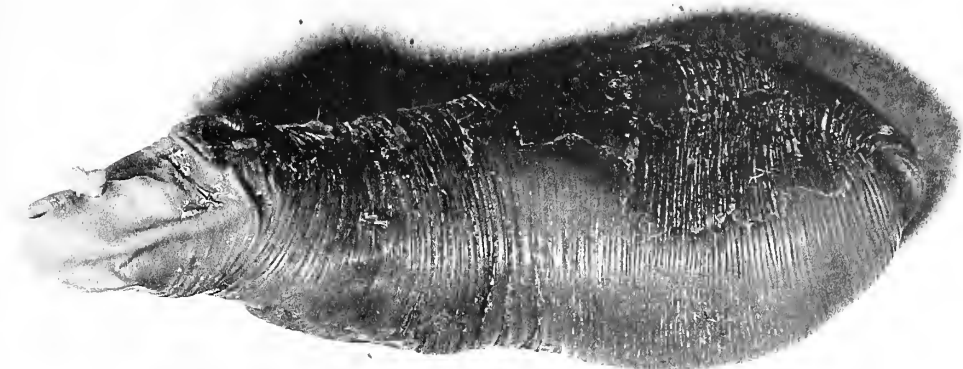

FIG. 2.

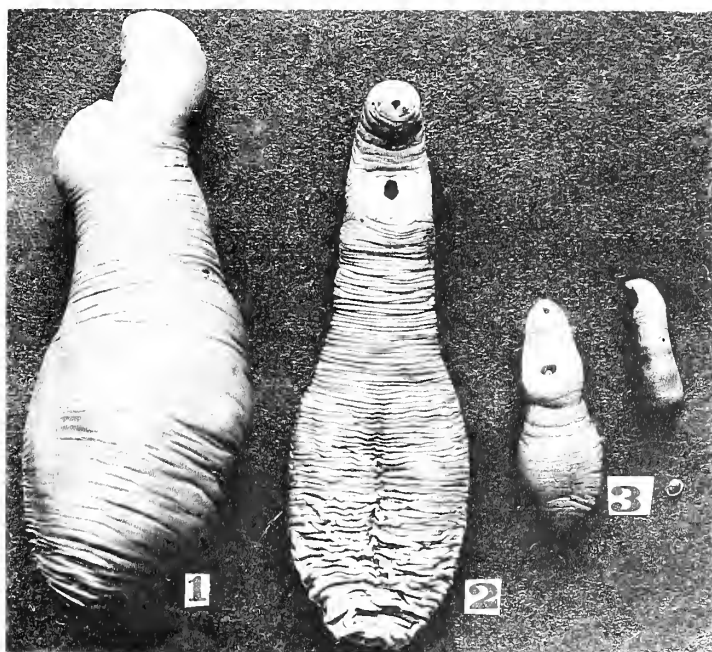

FIG. 3.



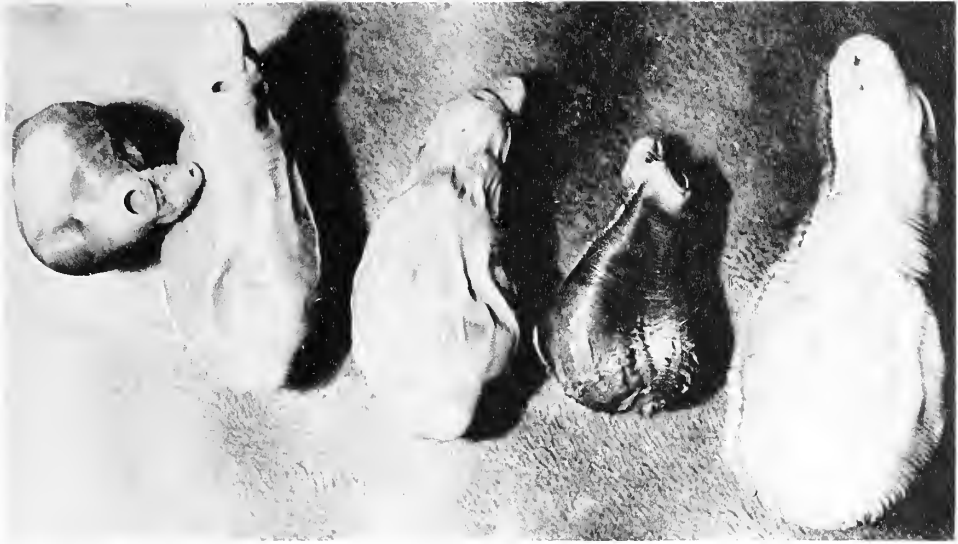

FIG. 4.



FIG. 5.



FIG. 6.



FIG. 7.



FIG. 8.

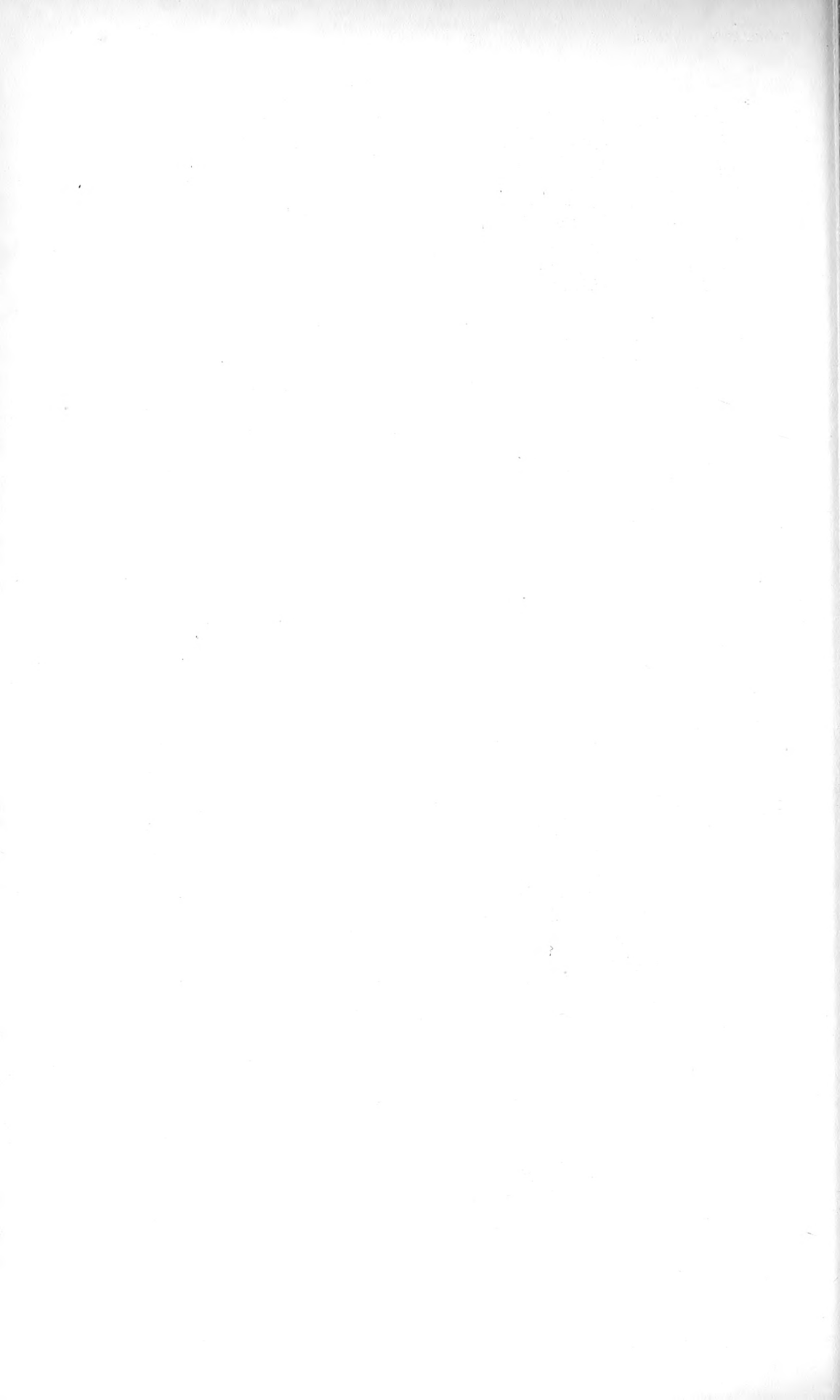



FIG. 9.



FIG. 10.



FIG. 11.

STUDIES ON THE GENUS *HIRUDINELLA*, GIANT TREMATODES OF SCOMBRIFORM FISHES.



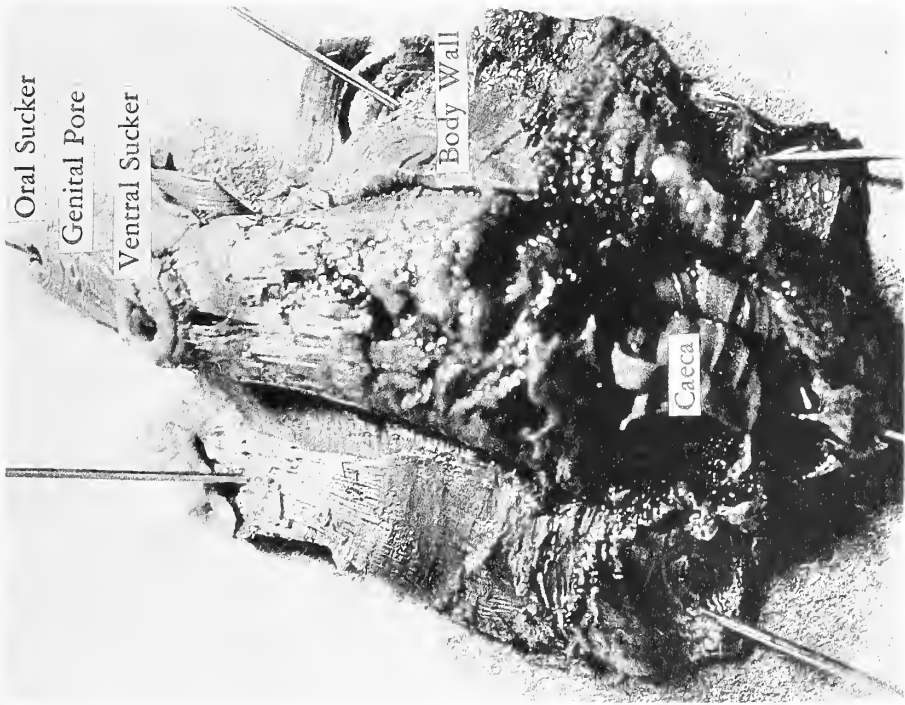

FIG. 12.

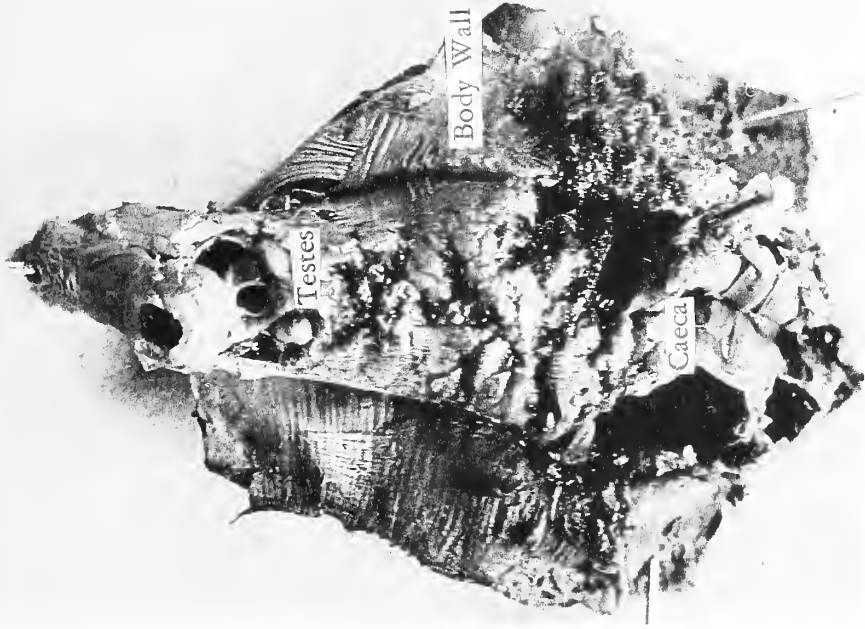
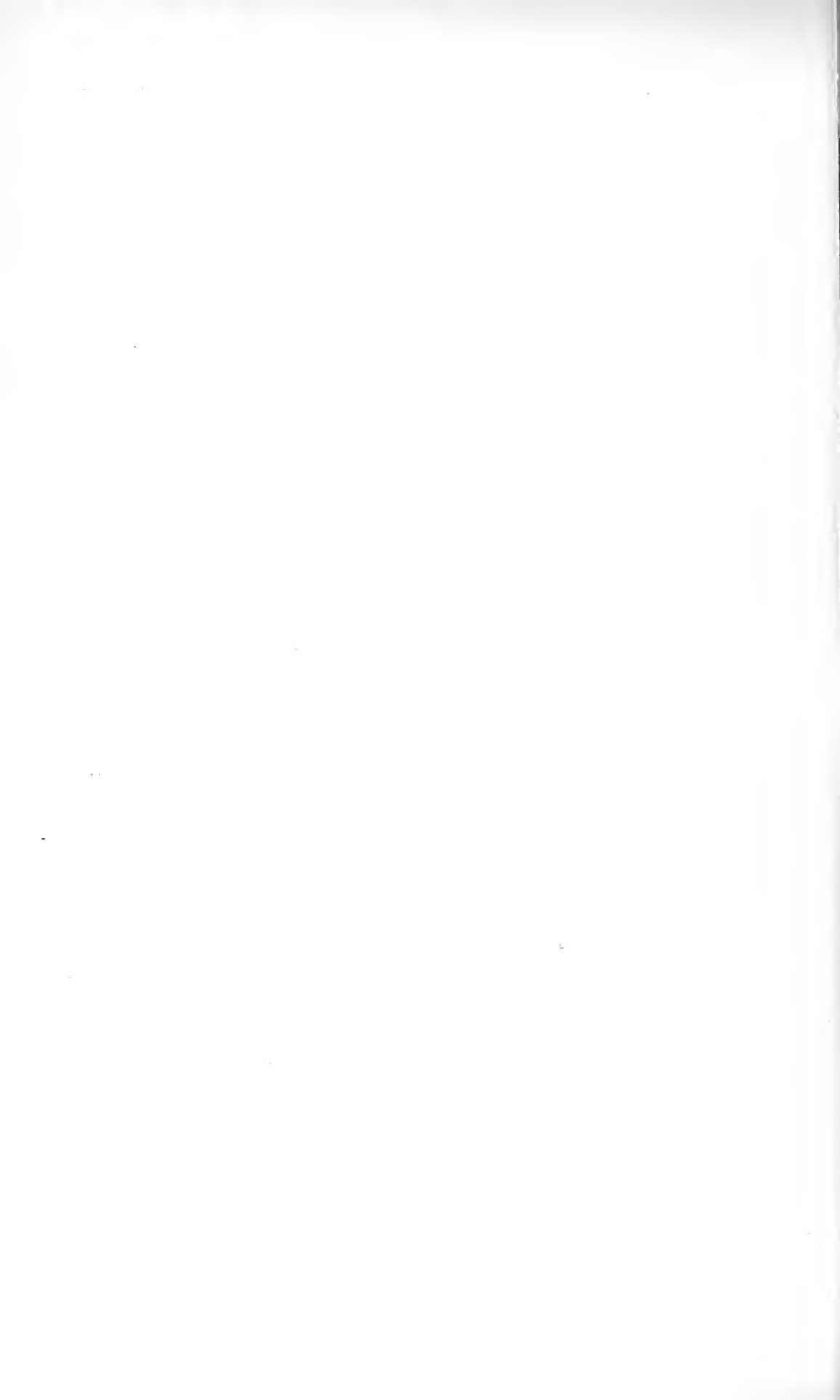

FIG. 13.

STUDIES ON THE GENUS *HIRUDINELLA*, GIANT TREMATODES OF SCOMBRIFORM FISHES.



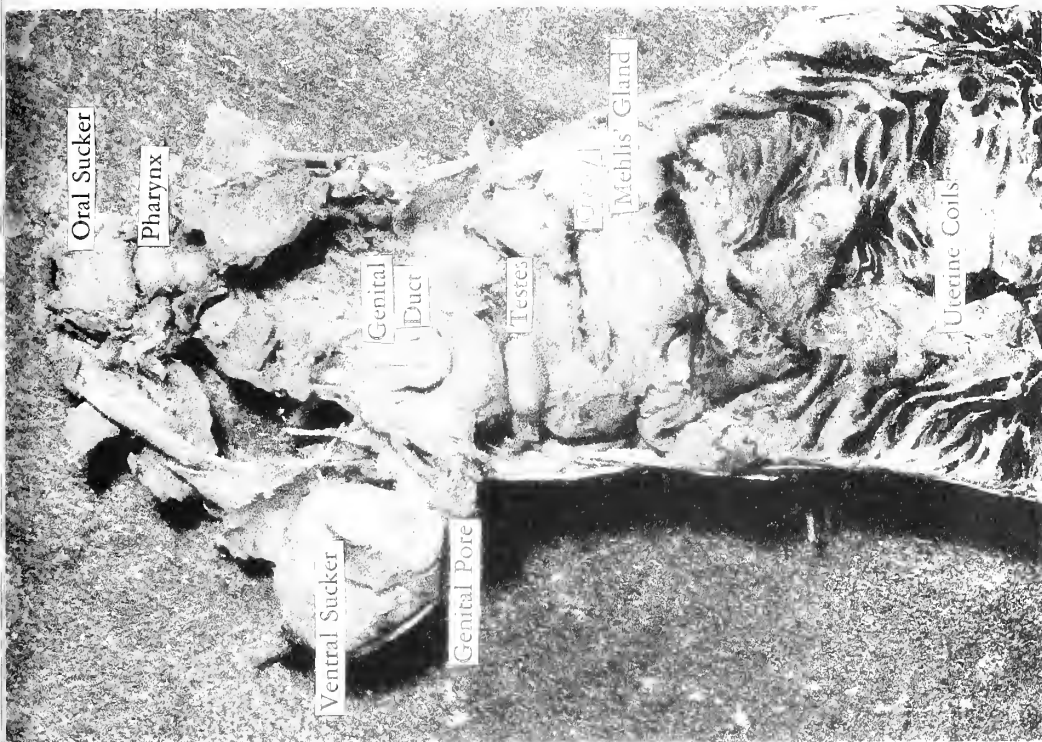

FIG. 15.

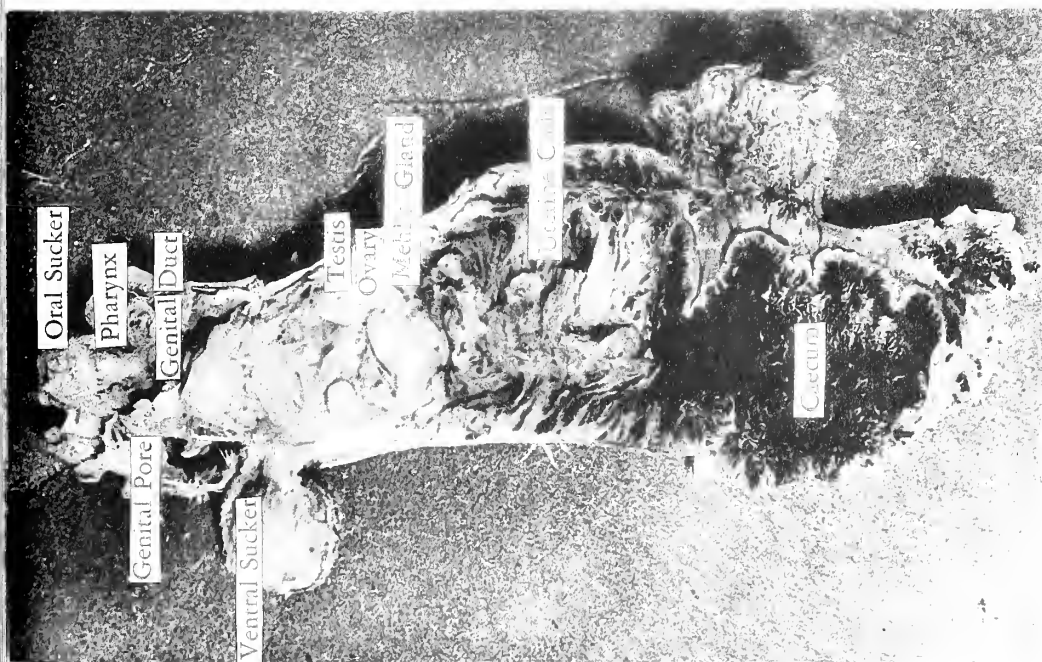

FIG. 14.

STUDIES ON THE GENUS HIRUDINELLA, GIANT TREMATODES OF SCOMBRIFORM FISHES.



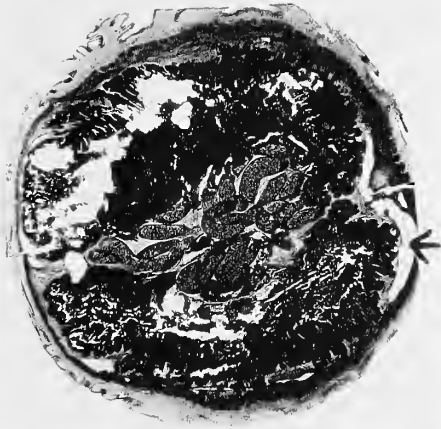

FIG. 16.

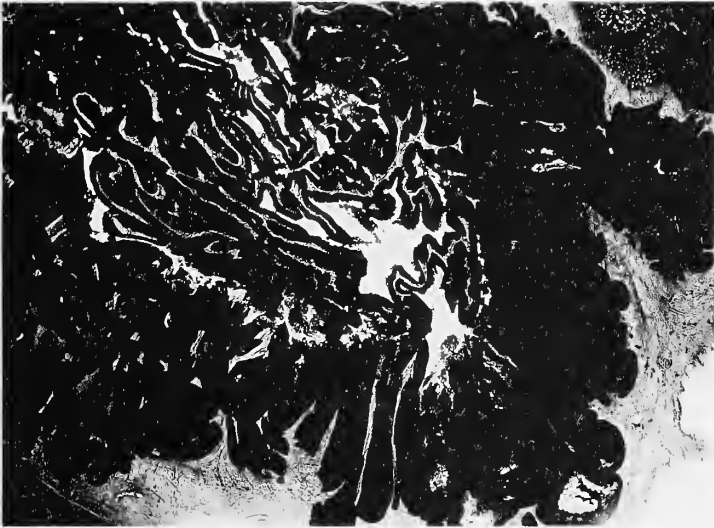

FIG. 17.



FIG. 18.



FIG. 19.



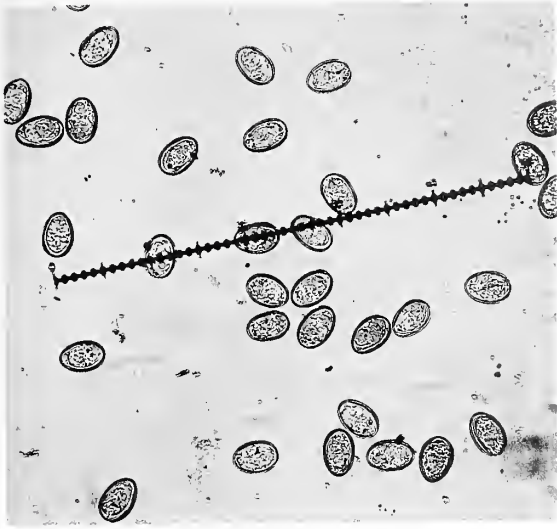

FIG. 20.

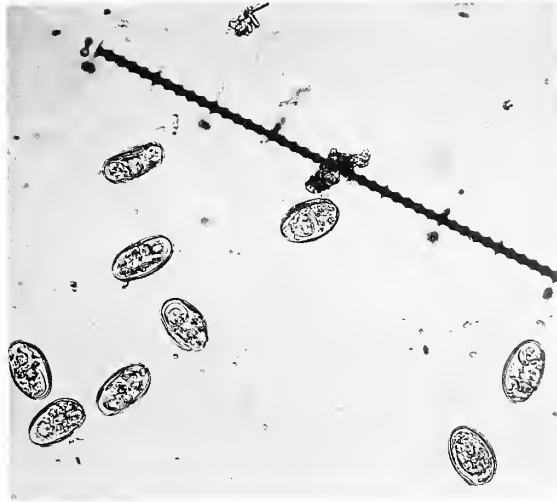

FIG. 21.

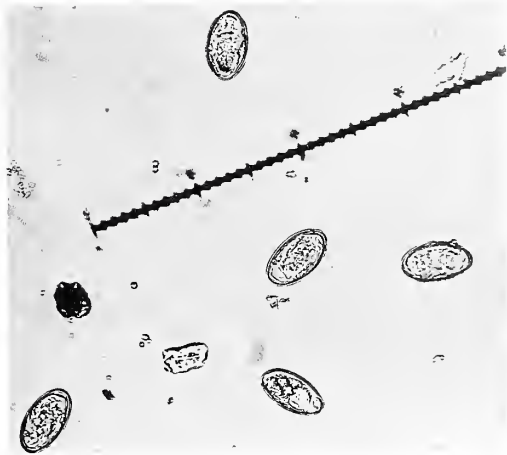

FIG. 22.



FIG. 23.

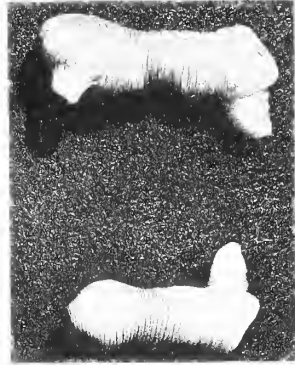

FIG. 24.

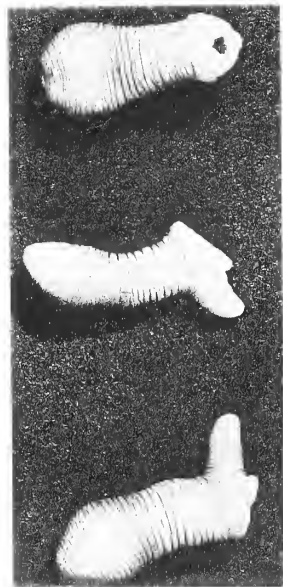
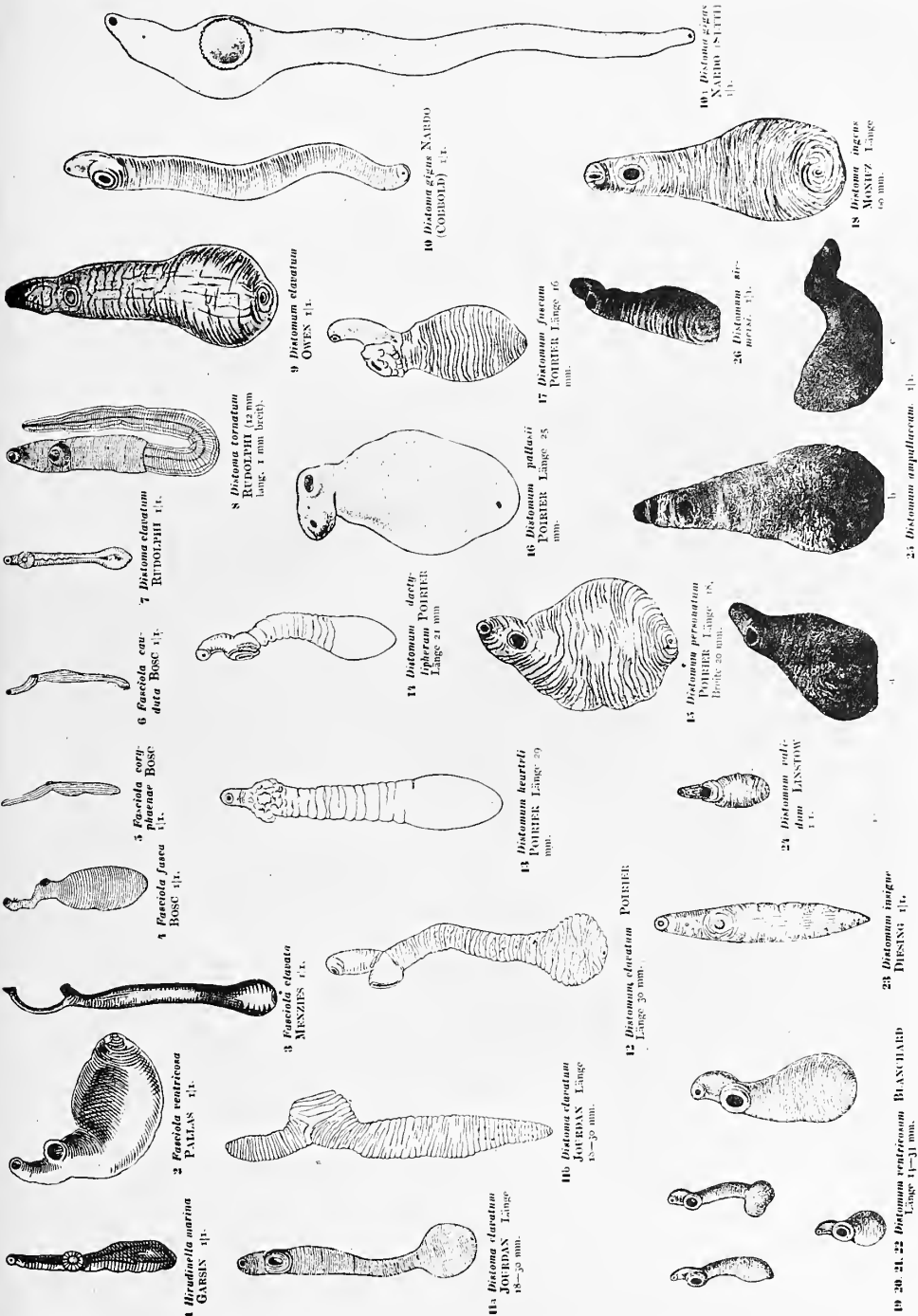

FIG. 25.





1 *Hirudinella marina* GARSIN 41b.

2 *Fasciola ventricosa* PALLIAS 41c.

3 *Fasciola elongata* MESZARIS 41d.

4 *Fasciola favea* BOSCH 41e.

5 *Fasciola coryi* BOSE 41f.

6 *Fasciola can- dita* BOSCH 41g.

7 *Distoma clavatum* RUDOLPHI 41h.

8 *Distoma toratum* RUDOLPHI 41i. (12 mm long, 4 mm broad).

9 *Distoma clavatum* OWEN 41j.

10 *Distoma gigas* NARDO (COMBOLBY) 41k.

11 *Distomum dentif- orbium* POISSON 41l. (Länge 24 mm).

12 *Distomum beerteli* POISSON 41m. (Länge 29 mm).

13 *Distomum patlovi* POISSON 41n. (Länge 25 mm).

14 *Distomum fascium* POISSON 41o. (Länge 16 mm).

15 *Distomum persianum* POISSON 41p. (Länge 20 mm).

16 *Distomum sub- versum* 41q.

17 *Distomum elongatum* POISSON 41r. (Länge 30 mm).

18 *Distomum clavatum* POISSON 41s. (Länge 11-21 mm).

19 *Distomum ventricosum* BLANCHARD 41t. (Länge 11-21 mm).

20 *Distomum imigru- ans* 41u.

21 *Distomum radi- dum* LINSLOW 41v.

22 *Distomum ampullaceum* 41w.

23 *Distomum agens* MANSER 41x. (60 mm).

24 *Distomum agens* NARDO (LUTTI) 41y.

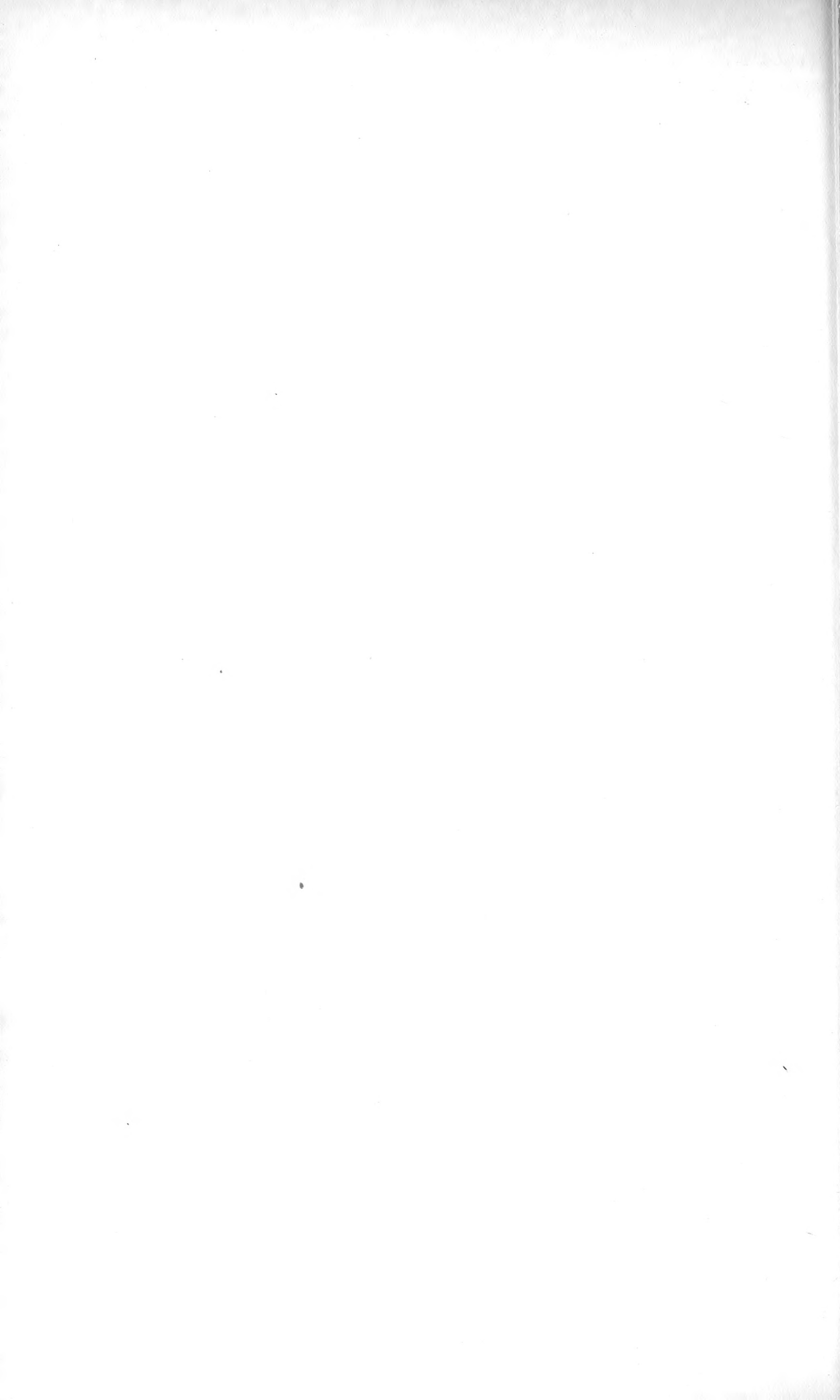

INDEX

Names in **bold face** indicate new genera, species or varieties; numbers in **bold face** indicate illustrations; numbers in parentheses are the serial numbers of papers containing the plates listed immediately following.

A

Acentrophryne ? longidens, **170**

Aceratias spp., **176, 177**

Aegintha, 3

Aethorhynchus, 3

Aethostoma, 3

Alcippe, 4

Aligena cokeri, 134

nucea, 134

Anodontia edentuloides, 117

Anomia peruviana, 68

Anuropsis, 3

Apoia, 4

Arborophila brunneopectus, 1

erythrophrys, 1

hyperhrythra, 1

javanica, 1

Atractus trilineatus, 21 (4) **Plate VI**

Aythia australis, 1

B

Basterotia peninsularis, 137

Bhringa, 5

Boa canina, 16 (4) **Plate II**

endris cookii, 17

Borophryne apogon, 171 (10) **Plate II**, 183 (12) **Plates I-IV**

Bothrops atrox, 48 (4) **Plate XII**

bilineatus, 50 (4) **Plate XIII**

Botula (Adula) falcata, 74

Brachidontes (Hormomya) adamsianus, 70

C

Callophus, 2

Cardita cuvieri, 105

grayi, 105

megastropa, 106

spurca, 106

tricolor, 106

(Carditamera) affinis, 107

radiata, 108

Cardium (Acrostigma) pristipleura, 147

(Americardia) biangulatum, 140

guanacastense, 140

(Dallocardia) senticosum, 147

(Democardium) robustum, 146

(Laevicardium) **clarionense**, 144 (10) **Plate I**

elatum, 145

elenense, 145

apicinum, 146

(Lophocardium) anettae, 138 (10) **Plate I**

(Mexicardia) procerum, 142

(Microcardium) pazianum, 142 (10) **Plate I**

(Nemocardium) centifilosum, 141

(Papyridea) aspersum, 139

(Phlogocardia) belcheri, 140

(Trachycardium) consors, 147

(Trigoniocardia) graniferum, 143

obovale, 144

Carduelis estherae, 4

Chaenophryne parviconus, 158

Chalcomomus, 1

Chama echinata, 108

frondosa, 109

pellucida, 109

sordida, 109

squamuligera, 110

Chaptia, 5

Chironius carinatus, 21

fuscus, 22 (4) **Plate VI**

Chloropicoides, 2

Chrysophlegma, 2

Cloelia cloelia cloelia, 23 (4) **Plate VI**

Codakia distinguenda, 117

Constrictor constrictor constrictor, 18 (4) **Plate III**

Copsychus, 3

adamsi, 3

sularis niger, 3

Coquus, 2

Coracina, 2

Crassatellites (Hybolophus) digueti, 102

(Hybolophus) gibbosus, 103

Crassinella pacifica, 103

pacifica mexicana, 104

varians, 104

Crenella divaricata, 75 (5) **Plate I**

Criniger ochraceus, 3

tephrogenys, 3

Crocias, 4

Crotalus durissus terrificus, 51 (4) **Plate XIII**

Cryptosparas normani, 168, 169

Ctena chiquita, 118

clarionensis, 118 (8) **Plate I**

clippertonensis, 118

mexicana, 119

Cuspidaria (Cardiomya) dulcis, 100

(Cardiomya) pectinata, 101

(Cuspidaria) apodema, 100

Cutia, 4

Cyanoderma, 4

Cyathodonta dubiosa, 96

lucasana, 96 (8) **Plate I**

undulata, 96

D

- Delacourigallus, 1
 Dendrocopos canicapillus, 2
 javanense, 2
 maculatus, 2
 moluccensis, 2
 rafflesi, 2
 Diardigallus, 1
 Dicaeum agile atjehense, 4
 agile sumatranum, 4
 cruentatum sumatranum, 4
 everetti, 5
 hypoleucum pontifex, 8
 Dicrurus, 5
 Dimya californiata, 65 (5) **Plate I**
 Dinopium, 2
 javanense borneonensis, 2
 rafflesi borneonensis, 2
 dulitense, 2
 Dipsas catesbyi, 24 (4) **Plate VI**
 indica, 24 (4) **Plate VII**
 variegata, 25 (4) **Plate VII**
 Dissemurus, 5
 Divaricella lucasana, 119
 Dolopichthys allector, 161, **162**
 atratus, 162
 implumis, **160**
 luetkeni, 159
 pullatus, **161**
 Dryadophis boddaerti boddaerti, 25 (4) **Plate VII**
 Drymarchon corais corais, 26 (4) **Plate VIII**
 Drymophila, 4
 Ducula aenea aenea, 1

E

- Echinochama californica, 111
 Edolisoma, 2
 Elocincla aenigma, 3
 perspicillata, 3
 rufiventris, 3
 Epicrates cenchris cenchris, 19 (4) **Plate IV**
 Epimachus meyeri meyeri, 9 (3) **Plates I-III**
 Erpornis, 4
 Erycina colpoica, 132
 Erythrocincla, 3
 Erythrolamprus aesculapii, 27 (4) **Plate VIII**
 Eunectes gigas, 20 (4) **Plate V**
 Eupetes, 3

G

- Gampsorhynchus, 4
 Garrulax, 4
 Gaupicoides rafflesi borneonense, 2
 Gennaeus, 1
 Gigantactis perlatus, 167, **168** (11) **Plate II**

H

- Helicops angulata, 28
 Heterophasia, 4

- Hierophasis, 1
 Himantolophus azurlucens, 155, **156**, **157** (11) **Plate I**
 Hirudinella marina, 189 (13) **Plate VII**
 ventricosa, 189 (13) **Plates I-VI**
 Houppifer, 1
 Hydrops triangularis, 28

I

- Imantodes cenchoa, 29 (4) **Plate VIII**
 Inilius scytale, 16 (4) **Plate I**

J

- Jabouilleia, 4

K

- Kellia suborbicularis, 133
 Kenopia, 3
 Kittacincla, 3

L

- Lachesis muta, 47 (4) **Plate XII**
 Lalage, 2
 Lasaea petitiana, 136
 Leimadophis reginae, 29 (4) **Plate IX**
 taeniurus bipraeocularis, 30
 typhlus, 30
 Leiomya (Plectodon) scabra, 101
 Leiothrix, 4
 Leptodeira annulata annulata, 31 (4) **Plate IX**
 rhombifera, 32
 Leptophis ahaetulla ahaetulla, 32, **33** (4) **Plate IX**
 ahaetulla ortonii, 34
 caeruleodorsus, 34
 Leptotyphlops albifrons, 12
 septemstriata, 13, **14** (4) **Plate I**
 Lima (Lima) fetrica, 65
 (Limaria) hemphilli, 66 (5) **Plate I**
 orbignyi, 67
 (Limatula) subauriculata, 68
 (Promantellum) pacifica, 66
 Linophryne arcturi, 173, **174**
 quinqueramosus, 174, **175** (11) **Plate III**
 Liophaga (Myoforceps) aristata, 74
 Liophis breviceps, 34
 cobella cobella, 35
 Lithophaga (Diberus) plumula, 75 (5) **Plate I**
 (Labis) attenuata, 74
 Lophura, 1
 Lucina (Cavilinga) lampra, 112
 (Cavilinga) lingualis, 113
 (Bellucina) cancellaris, 112
 (Here) excavata, 113
 (Lucinoma) annulata, 115
 (Lucinisca) fenestrata, 113
 liana, 114
 nuttalli, 114
 (Miltha) xantusi, 115 (8) **Plate I**
 (Parvilucina) approximata, 115
 mazatlanica, 116
 (PleuroLucina) leucocymoides, 116

- Lygophis lineatus*, 35
Lyonsia (*Entodesma*) *inflata*, 99
 (*Lyonsia*) *californica*, 98
 gouldii, 98
- M**
- Macronus*, 4
Malacocincla, 3
Malacopteron, 3
Mancalius uranoscopus, 169
Megalaema armillaris, 2
 australis, 2
 eximia, 2
 henrici, 2
 pulcherrima, 2
Melanocetus ferox, 152
 johnsoni, 152
 megalodontis, 152, 153
 niger, 153
Melanocichla, 4
Mesia, 4
Micrurus lemniscatus, 46 (4) **Plate XI**
 psyches, 46 (4) **Plate XII**
Muscicapa, 4
Mytilus (*Chloromya*) *palliopunctatus*, 70
 (*Mytilus*) *californianus*, 70
- N**
- Napothera*, 4
Niltava, 4
- O**
- Ophrydornis*, 3
Oreicola, 4
Ostrea columbiensis, 54
 fisheri, 54
 iridescens, 55
 megodon, 55
 palmula, 55 (5) **Plate I**
Oxybelis aeneus aeneus, 35 (4) **Plate IX**
 fulgidus, 36, 37 (4) **Plate IX**
Oxyrhopus petola petola, 37
- P**
- Pandora* (*Clidophora*) *cristata*, 98
 (*Foveadens*) *panamensis*, 98
 (*Kennerlia*) *bilirata*, 97
 convexa, 97 (8) **Plate I**
 (*Pandora*) *uncifera*, 97
Pecten (*Chlamys*) *lowei*, 57
 (*Cyclopecten*) *catalinensis*, 61
 pernomus, 61
 (*Delectopecten*) *arces*, 61
 (*Leptopecten*) *latiauratus*, 59, 60
 tumbezensis, 60
 velero, 60
 biolivi, 60 (5) **Plate I**
 (*Lyropecten*) *subnodosus*, 58
 intermedius, 58
- (*Mesopeplum*) *fasciculatus*, 59
 (*Pecten*) *diegensis*, 56
 sericeus, 56
 vogdesi, 57
 (*Plagioctenium*) *circularis*, 57
Pellorneum, 3
Periploma carpenteri, 94
 discus, 94
 stearnsii, 95
 teevani, 95 (8) **Plate I**
Philodryas viridissimus, 38, 39
Phoenicophaeus, 2
 curvirostris borneensis, 2
 microrhinus, 2
 diardi borneensis, 2
Picus, 2
Pitta granatina, 2
 nipalensis, 2
 schneideri, 2
 ussleri, 2
 venusta, 2
Placunanomia cumingii, 69
Platyopocilus maculatus, 121 122 (9) **Plates I-V**
Plicatula penicillata, 63
 spondylopsis, 63 (5) **Plate I**
Pnoepyga, 3
Podiceps novae-hollandiae javanicus, 1
Pododesmus macrochismus, 68
Polymesoda anomala, 148
 recluzii, 148
Pomatorhinus, 3
Poromya (*Dermatomya*) *tenuiconcha*, 99
Psaltria, 4
Pseudoboa neuweidii, 39
 coronata, 38
Pseudochama saavedri, 110 (8) **Plate I**
Pseudopythina chacei, 135
Pseustes poecilonotus polylepsis, 39 (4) **Plate X**
 sulphureus sulphureus, 41 (4) **Plate X**
Pteropodocys, 2
Pteruthius, 4
Ptilocichla, 3
- R**
- Rhinorhiza*, 2
Rhopocichla, 4
Rhopodytes, 1
Rimator, 3
Rochefortia chalcedonica, 134
 subquadrata, 135
- S**
- Septifer zeteki*, 71 (5) **Plate I**
Serinus estherae, 4
Sipholophis cervinus cervinus, 42
Siva, 4
Solecardia eburnea, 136
Spilotes pullatus pullatus, 42 (4) **Plate X**
Spondylus princeps, 62

Sportella stearnsii, 137
Stachyris, 4

T

Tantilla longifrontale, 42
melanocephala, 43 (4) **Plate X**
Taras (Felaniella) obliquus, 131
(Felaniella) sericatus, 131 (10) **Plate I**
(Phlyctiderma) semirugosus, 132
(Taras) inezensis, 130 (10) **Plate I**
orbellus, 130
subquadratus, 130 (10) **Plate I**
Thracia curta, 95
Thyasira excavata, 111
Timalia, 4
Trematorhynchus adipatus, 163
moderatus, 164
multilamellatus, 165
multiradiatus, 166
paucilamellatus, 166, 167
Trichixos, 3
Trypanurgos compressus, 43 (4) **Plate X**

Turdinus, 3
Typhlops reticulatus, 15 (4) **Plate I**

V

Verticordia (Trigonulina) ornata, 102 (8) **Plate I**
Volsella (Amygdalum) pallidula, 73
(Amygdalum) speciosa, 73
(Volsella) arciformis, 72 (5) **Plate I**
capax, 72
guyanensis, 72
salvadorica, 73 (5) **Plate I**
Volvocivora, 2

X

Xenoceratias nudus, 154, 155
Xenodon colubrinus, 43 (4) **Plate XI**
severus, 44 (4) **Plate XI**

Y

Yuhina, 4

Z

Zanclostomus, 2
Zosterops javanica, 4
squamifrons, 4

NEW YORK ZOOLOGICAL SOCIETY

General Office: 630 Fifth Avenue, New York 20, N. Y.
Publication Office: The Zoological Park, New York 60, N. Y.

OFFICERS

FAIRFIELD OSBORN, *President*
ALFRED ELY, *First Vice-president*
LAURANCE S. ROCKEFELLER, *Second Vice-president*
HAROLD J. O'CONNELL, *Secretary*
CORNELIUS R. AGNEW, *Treasurer*

SCIENTIFIC STAFF

General

JOHN TEE-VAN, *Executive Secretary*
WILLIAM BRIDGES, *Editor and Curator of Publications*
MYRTICE BLATCHLEY, *Associate in Charge, Education*

Zoological Park

LEE S. CRANDALL, *General Curator & Curator of Birds*
LEONARD J. GOSS, *Veterinarian*
BRAYTON EDDY, *Curator of Reptiles and Insects*
GRACE DAVALL, *Assistant to General Curator*

Aquarium

CHRISTOPHER W. COATES, *Curator and Aquarist*
ROSS F. NIGRELLI, *Pathologist*
MYRON GORDON, *Assistant Curator*
C. M. BREDER, JR., *Research Associate in Ichthyology*
G. M. SMITH, *Research Associate in Pathology*
HOMER W. SMITH, *Research Associate in Physiology*

Department of Tropical Research

WILLIAM BEEBE, *Director*
JOCELYN CRANE, *Research Zoologist*
HENRY FLEMING, *Entomologist*
WILLIAM K. GREGORY, *Associate*
GLORIA HOLLISTER, *Associate*
JOHN TEE-VAN, *Associate*
MARY VANDERPYL, *Associate*

Scientific Advisory Council

A. RAYMOND DOCHEZ
ALFRED E. EMERSON
ALAN GREGG
K. S. LASHLEY
JOHN S. NICHOLAS
GEORGE M. SMITH

Editorial Committee

FAIRFIELD OSBORN, *Chairman*
WILLIAM BEEBE
WILLIAM BRIDGES
CHRISTOPHER W. COATES
LEE S. CRANDALL
LEONARD J. GOSS
JOHN TEE-VAN

590573

ZOOLOGICA

SCIENTIFIC CONTRIBUTIONS
of the
NEW YORK ZOOLOGICAL SOCIETY

VOLUME 32

1947

Numbers 1-20



Published by the Society
The Zoological Park, New York

NEW YORK ZOOLOGICAL SOCIETY

General Office: 630 Fifth Avenue, New York 20, N. Y.
Publication Office: The Zoological Park, New York 60, N. Y.

OFFICERS

FAIRFIELD OSBORN, *President*
ALFRED ELY, *Vice-president*
LAURANCE S. ROCKEFELLER, *Vice-president*
DONALD T. CARLISLE, *Vice-president*
HAROLD J. O'CONNELL, *Secretary*
CORNELIUS R. AGNEW, *Treasurer*

SCIENTIFIC STAFF

General

JOHN TEE-VAN, *Executive Secretary*
WILLIAM BRIDGES, *Editor and Curator of Publications*
SAM DUNTON, *Photographer*

Zoological Park

LEE S. CRANDALL, *General Curator*
LEONARD J. GOSS, *Veterinarian*
BRAYTON EDDY, *Curator of Reptiles and Insects*
GRACE DAVALL, *Assistant to General Curator*

Aquarium

CHRISTOPHER W. COATES, *Curator and Aquarist*
JAMES W. ATZ, *Assistant Curator*
ROSS F. NIGRELLI, *Pathologist*
MYRON GORDON, *Geneticist*
C. M. BREDER, JR., *Research Associate in Ichthyology*
G. M. SMITH, *Research Associate in Pathology*
HOMER W. SMITH, *Research Associate in Physiology*

Department of Tropical Research

WILLIAM BEEBE, *Director*
JOCELYN CRANE, *Research Zoologist*
HENRY FLEMING, *Entomologist*
WILLIAM K. GREGORY, *Associate*
JOHN TEE-VAN, *Associate*
GLORIA HOLLISTER, *Associate*
MARY VANDERPYL, *Associate*

Scientific Advisory Council

A. RAYMOND DOCHEZ
ALFRED E. EMERSON
ALAN GREGG
W. A. HAGAN
CARYL P. HASKINS
K. S. LASHLEY
JOHN S. NICHOLAS
GEORGE M. SMITH

Editorial Committee

FAIRFIELD OSBORN, *Chairman*
WILLIAM BEEBE
WILLIAM BRIDGES
CHRISTOPHER W. COATES
LEE S. CRANDALL
BRAYTON EDDY
LEONARD J. GOSS
JOHN TEE-VAN

CONTENTS

Part 1. May 8, 1947.

	PAGE
1. Development of the Platyfish, <i>Platypoecilus maculatus</i> . By WILLIAM N. TAVOLGA and ROBERTS RUGH. Text-figures 1-25.....	1
2. A Study of the Oxygen Consumption of Blind and Eyed Cave Characins in Light and Darkness. By SYLVIA R. SCHLAGEL and C. M. BREDER, JR. Text-figures 1 & 2.....	17
3. Evidence for the Lack of a Growth Principle in the Optic Cyst of Mexican Cave Fish. By C. M. BREDER, JR. and PRISCILLA RASQUIN. Text-figures 1 & 2.....	29
4. Progressive Pigmentary Regression in Fishes Associated With Cave Environments. By PRISCILLA RASQUIN. Plate I; Text-figure 1.	35
5. Ecology of Rancho Grande, a Subtropical Cloud Forest in Northern Venezuela. By WILLIAM BEEBE and JOCELYN CRANE. Plates I-V; Text-figures 1-10.....	43
6. Two New Pseudoscorpions of the Subfamily Lamprochernetinae from Venezuela. By C. CLAYTON HOFF. Text-figures 1-5.....	61
7. A List of Mammals Collected at Rancho Grande, in a Montane Cloud Forest of Northern Venezuela. By G. H. H. TATE.....	65
8. A New Species of Hesperiidæ (Lepidoptera, Rhopalocera) from Venezuela. By ERNEST L. BELL. Text-figure 1.....	67

Part 2. July 31, 1947.

9. Eastern Pacific Expeditions of the New York Zoological Society. XXXVIII. Intertidal Brachygnathous Crabs from the West Coast of Tropical America with Special Reference to Ecology. By JOCELYN CRANE. Text-figures 1-3.....	69
10. The External Genitalia of the Gorilla, <i>Gorilla gorilla gorilla</i> (Savage & Wyman). By LEONARD J. GOSS. Plates I-IV.....	97
11. Spontaneous Neoplasms in Fishes. III. Lymphosarcoma in <i>Astyanax</i> and <i>Esox</i> . By ROSS F. NIGRELLI. Plates I-XI.....	101
12. Notes on the Hercules Beetle, <i>Dynastes hercules</i> (Linn.), at Rancho Grande, Venezuela, with Special Reference to Combat Behavior. By WILLIAM BEEBE. Plates I-IV.....	109

Part 3. November 12, 1947.

	PAGE
13. Notes on Ectoparasites from Venezuela (Siphonaptera and Acarina). By IRVING FOX. Text-figures 1 & 2.....	117
14. Preliminary Studies of the Effects of Sulfonamides on Fish and <i>Bacterium salmonicida</i> . By WALTER L. SMITH & ROSS F. NIGRELLI.....	121
15. <i>Nocomis</i> Nests Used by Other Breeding Cyprinid Fishes in Virginia. By EDWARD C. RANEY. Plate I.....	125
16. Sphingidae (Moths) of Rancho Grande, North Central Venezuela. By HENRY FLEMING.....	133
17. Scale Adaptation and Utilization in <i>Aesiocopa patulana</i> Walker (Lepidoptera, Heterocera, Tortricidae). By WILLIAM BEEBE. Plates I & II; Text-figures 1 & 2.....	147

Part 4. December 29, 1947.

18. Avian Migration at Rancho Grande in North-central Venezuela. By WILLIAM BEEBE. Plate I; Text-figure 1.....	153
19. <i>Endosphaera engelmanni</i> Endoparasitic in <i>Trichodina spheroidesi</i> Infecting the Puffer, <i>Sphaeroides maculatus</i> . By MORTON PADNOS & ROSS F. NIGRELLI. Plates I & II; Text-figures 1 & 2.....	169
20. Ithomiinae (Lepidoptera) of Rancho Grande, Venezuela, Including Two New Species. By RICHARD M. FOX & JEAN W. FOX. Plate I	173
Index to Volume 32.....	179



90.5 13

ZOOLOGICA

SCIENTIFIC CONTRIBUTIONS
of the
NEW YORK ZOOLOGICAL SOCIETY

VOLUME 32

Part 1

Numbers 1-8

Published by the Society
The Zoological Park, New York
May 8, 1947



CONTENTS

	PAGE
1. Development of the Platyfish, <i>Platypoecilus maculatus</i> . By WILLIAM N. TAVOLGA and ROBERTS RUGH. Text-figures 1-25.....	1
2. A Study of the Oxygen Consumption of Blind and Eyed Cave Characins in Light and Darkness. By SYLVIA R. SCHLAGEL and C. M. BREDER, JR. Text-figures 1 & 2.....	17
3. Evidence for the Lack of a Growth Principle in the Optic Cyst of Mexican Cave Fish. By C. M. BREDER, JR. and PRISCILLA RASQUIN. Text-figures 1 & 2.....	29
4. Progressive Pigmentary Regression in Fishes Associated With Cave Environments. By PRISCILLA RASQUIN. Plate I; Text-figure 1.	35
5. Ecology of Rancho Grande, a Subtropical Cloud Forest in Northern Venezuela. By WILLIAM BEEBE and JOCELYN CRANE. Plates I-V; Text-figures 1-10.....	43
6. Two New Pseudoscorpions of the Subfamily Lamprochernetinae from Venezuela. By C. CLAYTON HOFF. Text-figures 1-5.....	61
7. A List of Mammals Collected at Rancho Grande, in a Montane Cloud Forest of Northern Venezuela. By G. H. H. TATE.....	65
8. A New Species of HesperIIDae (Lepidoptera, Rhopalocera) from Venezuela. By ERNEST L. BELL. Text-figure 1.....	67

1.

Development of the Platyfish, *Platypoecilus maculatus*.BY WILLIAM N. TAVOLGA¹ AND ROBERTS RUGH.

Department of Biology, Washington Square College, New York University.

(Text-figures 1-25).

INTRODUCTION.

The platyfish is a valuable experimental animal being used in research on current problems in physiological and population genetics, chromosomal mechanisms in sex-determination, endocrinology, and in work on the relationship of atypical growth of pigment cells to the general problem of melanoma biology. In all of these problems the pigment cells and both the micro- and macromelanophores of the platyfish play an important part.

The purpose of this paper is to describe a graded series of embryos of *Platypoecilus maculatus* distinguishable on the basis of gross and superficial characters (including pigmentation patterns), and to present data on their developmental rate of growth. Such data may provide a basis of comparison with similar graded series of embryonic stages of the swordtail (*Xiphophorus hellerii*) and with those of their melanotic platyfish-swordtail hybrids. (Gordon, 1931 a & b, 1937).

It was recognized from the beginning that these embryological investigations would be extremely difficult because of the viviparous type of reproduction of the platyfish. Nevertheless, the importance of this species in studies on normal and atypical pigment cell growth has induced us to undertake the project. This paper represents the completion of only the first phase of the problem, namely: a description of a graded series in the early development of the normal, wild-stock platyfish.

The writers are indebted to Dr. Myron Gordon of the New York Aquarium, New York Zoological Society, for his advice and for the use of his facilities and material.

MATERIALS AND METHODS.

Source and Care of Material.

The fishes used in this work were from a foundation stock of *Platypoecilus maculatus* obtained in 1939 by Dr. Myron Gordon from the Rio Jamapa, Veracruz, Mexico.

¹Based on material submitted in partial fulfillment of requirements for the Master of Science degree at New York University.

Most of the strains used belonged to the broods having the New York Zoological Society Culture Numbers 159 and 167. The members of these and related broods have been studied genetically by Gordon (1947).

The adult platyfish, under laboratory conditions, were found to be hardy and adaptable to restricted quarters. Isolated females and mated pairs lived and bred, during the experimental period, up to four months in quart glass jars. Their small aquaria contained conditioned water and were planted with *Nitella* which provided hiding places for the newly born young. The management of mass cultures of platyfish was described by Gordon (1926). The fish were fed daily on a diet that was varied from day to day and consisted of powdered dried shrimp, a fresh liver-Seravim-cereal paste (Gordon, 1943) and living *Daphnia* and *Tubifex*.

The Reproductive Cycle.

The methods used to obtain the various developmental stages depended upon prior knowledge of the reproductive cycle of *Platypoecilus*. For this reason, the details of the cycle are presented below.

Platyfish attained sexual maturity in six to eight months at an average temperature of about 75° F. during the winter months and about 80° F. during the summer. They breed throughout the year and some broods are obtained during every month of the year. These broods are produced at intervals of about 28 days in normal, healthy females.

Young females, shortly after reaching maturity and mating, have broods ranging from one to eight young. The number born increases with the age and size of the mother, averaging 30 to 40 in fully mature fish. In old fish the brood numbers fall off. In a large, wild-caught female, 55 mm. in length, Gordon found 168 embryos, but this was an exception.

Mating and insemination are effected by the male's gonopodium, a sex hormone-induced modification of the anal fin. Females once inseminated and subsequently isolated from further contact with males are capable of producing four or more broods at intervals

of about 28 days. According to the observations of Gerschler (1914), Winge (1922), and Van Oördt (1929) on *Platypoecilus*, *Lebistes*, and *Xiphophorus*, sperm which have not fertilized ova do not die but remain viable within the folds of the oviduct for periods up to seven months, in some instances. It is because of this that the ova of isolated females are fertilized as soon as successive complements of ova mature.

Hopper (1943) found that there is an average seven-day interval between the birth of one brood and the fertilization of the next complement of eggs. During this interval, yolk is deposited and maturation takes place. Apparently all the ova do not mature, nor are they fertilized simultaneously. Consequently, the ages of the embryos in any one ovarian sac may vary considerably during early development. Regardless of age variability among the embryos during early development, parturition of an entire brood is accomplished within the space of one hour. During the latter half of the gestation period, then, the belated embryos either catch up to the average morphological age of the brood, or die and become resorbed. The latter possibility is substantiated by the discovery of dead and degenerating embryos after the first few days of the gestation period.

Fertilization of the ova and development of the embryos up to birth, takes place within the ovarian follicle which ruptures just prior to parturition. Toward the end of the gestation period, although the embryos vary somewhat in stages of development, there are no very young embryos in the follicles, nor are there any mature ova. Immediately after the birth of a brood, all the ova present are small and contain little or no yolk. In view of these details, it is clear that superfecundation, which occurs in many poeciliid fishes, is not characteristic of the reproductive behavior of the platyfish.

Collecting Developmental Stages.

In order to obtain a graded series of developmental stages in the young, platyfish virgin females were placed in aquaria containing males. Some females produced their first brood within the month while others did not have theirs for ninety days. After a birth of a brood, the females which were presumed to be gravid again were sacrificed at intervals of from 8 to 25 days and dissected. A total of 63 platyfish was examined and of these 55 carried embryos in various stages of development. The embryos, which were normally retained in the ovarian follicles until birth, were removed from the follicular membrane. They were first examined in 0.9% saline solution and later were preserved in 10% formalin. Counts were made of the number and particular devel-

opmental stages of the embryos within each female.

The drawings of the various embryological stages were made from living and preserved specimens. The measurements of the stages are of the total lengths of the embryos, uncurled from their position around the yolk sac.

DESCRIPTION OF NORMAL DEVELOPMENT STAGES.

Stage 1. *Mature Ovum* (Text-fig. 1).

The mature infertile ova, after the yolk has been deposited, average 1.5 mm. in diameter. They are of a clear yellow color with peripherally arranged fat globules of various sizes. These globules vary somewhat in size and number depending on the individual ovary. However, the eggs in any one ovary are all very similar in this character. When the egg is damaged, the globules are found to be adherent to the peripheral membrane; they are composed of a colorless fluid somewhat less viscous than the yellow colored matrix.

The germinal vesicle cannot be seen in the living egg, but it has been demonstrated by Hopper (1943) to be peripheral in position in sectioned material.

The vitelline membrane is probably present since a fertilization membrane is subsequently demonstrated. No tertiary membrane, such as is found in oviparous species, is present around the egg.

Immature eggs appear to be more opaque than mature fertilized ones. It may be that this change takes place at fertilization as it does in *Fundulus* (Oppenheimer, 1937), but in this viviparous species it is difficult to substantiate.

Stage 2. *Cleavage* (Text-fig. 2).

Cleavages may be seen only occasionally, and only in eggs preserved in formalin. The cleavage cells are very thin, broad and flat, and since they are not raised above the yolk surface to any visible extent, this stage is poorly distinguished from the previous one. Text-fig. 2 shows the cleavage stage more distinctly than it actually appears. Using a glass needle and a pair of sharpened watchmaker's forceps, the fertilization membrane can be removed from such eggs while in the saline solution, and the contents left in place. Such a membrane cannot be demonstrated around infertile ova. This fertilization membrane persists throughout the gestation period and is ruptured together with the follicle just prior to parturition.

Stage 3. *Compact Blastula* (Text-fig. 3).

This is the earliest stage which can be identified readily by gross study. The cells are small and tightly packed into a small

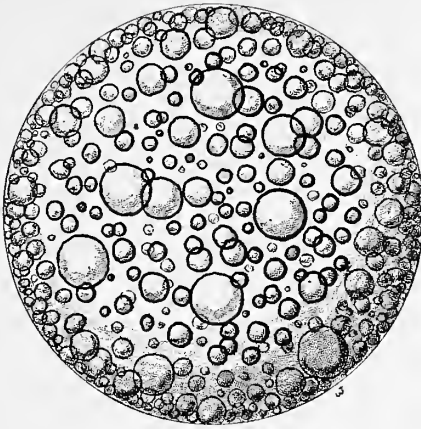

1.

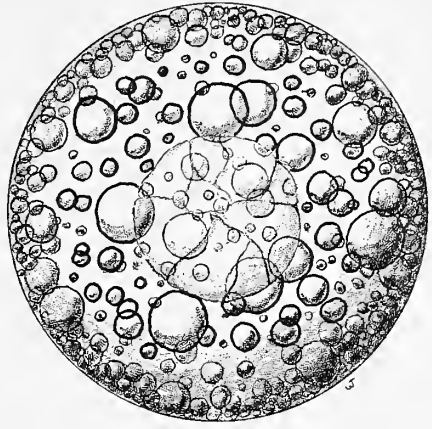

2.

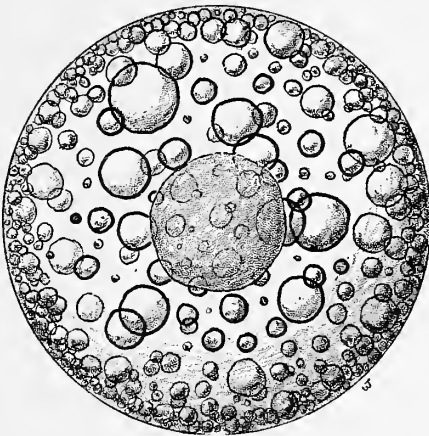

3.

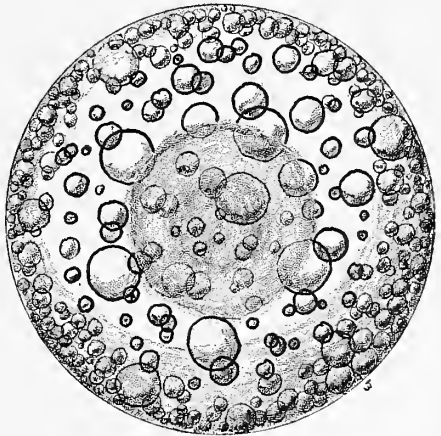

4.

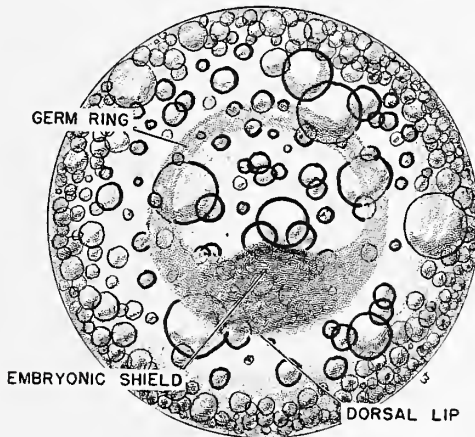

5.

TEXT-FIG. 1. Mature ovum. Stage 1. $\times 38$.

TEXT-FIG. 2. Cleavage. Stage 2. Polar view. $\times 38$.

TEXT-FIG. 3. Compact blastula. Stage 3. Polar view. $\times 38$.

TEXT-FIG. 4. Diffuse blastula. Stage 4. Polar view. $\times 38$.

TEXT-FIG. 5. Early germ ring gastrula. Stage 5. Polar view. $\times 38$.

grayish protoplasmic disc, which is slightly raised above the yolk surface. A segmentation cavity has been described beneath the disc (Hopper, 1943).

Stage 4. *Diffuse Blastula* (Text-fig. 4).

Gastrulation begins at this stage with the blastodisc flattening out into a thin membrane of cells. The periphery of the blastodisc is uniformly thickened, indicating the region of proliferation and probable involution.

Stage 5. *Early Germ Ring Gastrula* (Text-fig. 5).

Gastrulation continues during stage 5 with a peripheral spreading of the blastodisc in all directions. The embryonic shield is visible as a widening and thickening of a sector of the rim of the blastodisc.

Stage 6. *Late Gastrula—Early Neurula* (Text-fig. 6).

The embryonic shield takes on an elongate form and becomes raised from the yolk surface, indicating the antero-posterior axis of the developing embryo. The notochord is present, and the anterior end of the neural keel can be seen. The nerve cord is formed from a solid core of invaginating tissue; the neurocoele appearing after invagination is completed, as seen in sectioned material. This type of neurulation is typical of teleosts.

Stage 7. *Late Neurula* (Text-fig. 7).

The germ ring at this stage is somewhat below the equator and the embryo has become further elongated. Since elongation takes place principally in the posterior portion, a region roughly corresponding to the dorsal blastopore lip of amphibian gastrulae, the anterior end of the embryo lies in much the same position as did the original embryonic shield of stage 5.

The neural keel has invaginated throughout the greater length of the embryo, and a neurocoele is present in the anterior one-fourth.

Stage 8. *Head Fold* (Text-fig. 8).

A prominent head fold is present by stage 8. The neurocoele is open for about the anterior half of the length of the embryo. The optic buds are present and attached to the short, thin stalks, and they are, at this stage, without a cavity. Two pairs of rather diffuse somites are evident, but there is considerable variation in the time of their first appearance. Somites sometimes appear as early as stage 7.

Stage 9. *Optic and Otic Vesicles*; 1.1 mm. (Text-fig. 9),

The head fold has now begun to elongate anteriorly. The blastopore is still a wide open structure and the caudal end has not progressed back much farther than its position

in stage 8. The optic primordia now possess cavities, and are usually still attached to the prosencephalon by thin optic stalks. The brain is divided into three general regions: a narrow prosencephalon, a slightly wider mesencephalon, and a short rhombencephalon. Otic vesicles have invaginated at the level of the rhombencephalon, but are still connected to the exterior by the endolymphatic ducts. Usually, 7 pairs of somites are visible at this stage.

The pericardial sac, which develops very early, closely enfolds most of the head fold at this stage.

Stage 10. *Tail Bud*; 1.5 mm. (Text-fig. 10).

The optic vesicles are detached from the brain and are slightly flattened around the invaginating lens primordia. The mesencephalon and rhombencephalon have become widened and more thin walled. The otic vesicles are slightly ellipsoid and are completely cut off from the superficial ectoderm. There are ten pairs of compact somites visible. The tail bud has begun to form and extends slightly over the region of the dorsal lip of the open blastopore.

The region of the pericardial sac that is extra-embryonic is easily distinguishable, and, upon dissection, the heart can be found as a straight tube on the floor of the pericardial sac. The vascular system is apparently complete at this time, but the blood islands are never visible under gross examination. The heart exhibits no regular beat, only an occasional twitch.

Stage 11. *Pectoral Fin Buds* (Text-fig. 11).

The optic vesicles partially envelop the lens primordia. The prosencephalon shows little differentiation, but the mesencephalon has widened out considerably. Indications of neuromeres can be seen in the rhombencephalon. The entire brain possesses a thin roof, and this is especially true at the hind-brain level. In later stages, the roof of the mesencephalon becomes thickened, but that of the myelencephalon remains thin as the posterior tela chorioidea. The otic vesicles show little or no change, aside from a general growth, in this and several of the following stages. Text-fig. 11 shows the presence of the anterior fin buds.

Posteriorly, 18 to 20 small, compact somite pairs blend into a poorly differentiated region in the now prominent tail bud. It is noteworthy that, although a sizeable tail bud is present at this stage, the blastopore is open in the majority of the embryos. This is in contrast to the case in most teleosts, and even in the closely related *Fundulus*.

In the heart, the ventricular and atrial portions are distinct, and at the anterior end, the sinus venosus projects in front of the head. The heart exhibits a fairly rhythmic

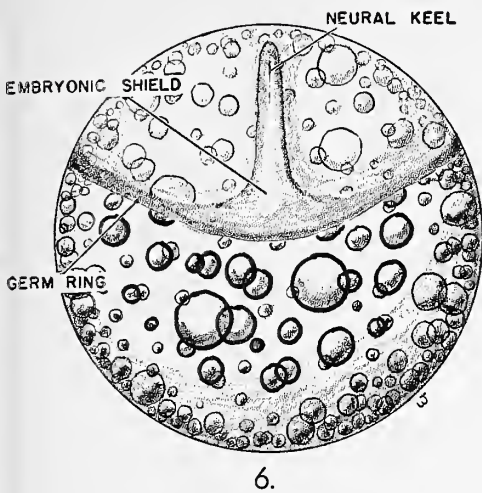

6.

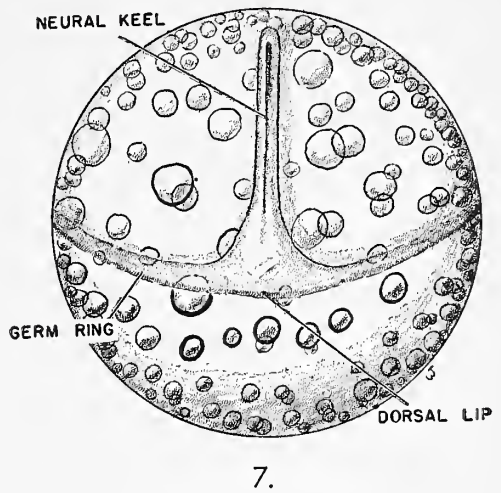

7.

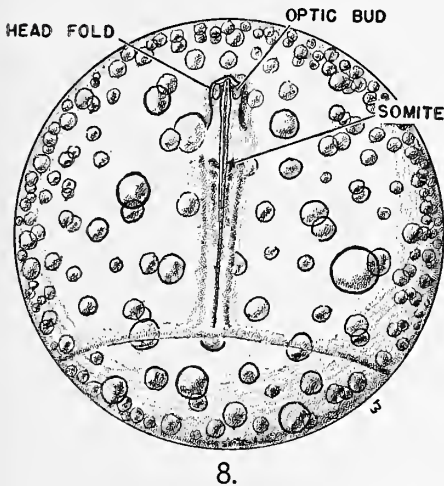

8.

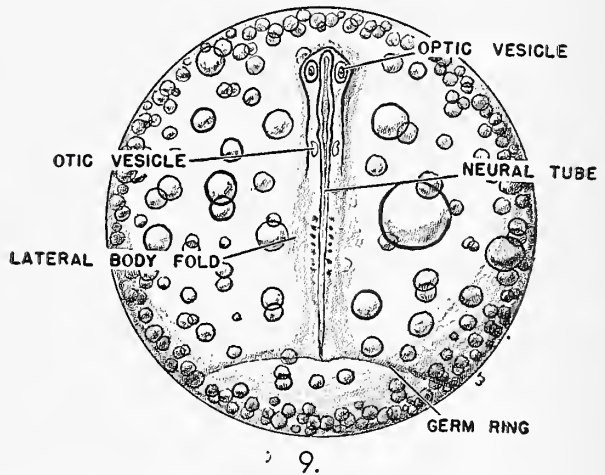

9.

TEXT-FIG. 6. Late gastrula—early neurula. Stage 6. Equatorial view. $\times 38$.

TEXT-FIG. 7. Late neurula. Stage 7. Equatorial view. $\times 38$.

TEXT-FIG. 8. Head fold. Stage 8. Dorsal aspect. $\times 38$.

TEXT-FIG. 9. Optic and otic vesicles. Stage 9. Dorsal aspect. $\times 38$.

mical beat at this time. The color of the blood is light pink, but barely perceptible.

Stage 12. *Regular Heart Beat*; 1.8 mm.
(Text-figs. 12, 13).

The optic cups envelop the lenses closely. Olfactory placodes are visible. The brain has undergone further development; the telencephalic region is slightly expanded; the mesencephalon has a thicker roof; the rhombencephalon is greatly widened.

The somites are more closely packed and less distinct. The vascularization of the pericardial membrane is in the form of small capillary-size vessels. The extra-embryonic circulation can be followed at this stage. The blood leaves the embryo through the ducts of Cuvier at the posterior ven-

tral margin of the pericardial membrane, drains into the yolk portal system and the vascularized pericardial membrane, and collects at the elongated sinus venosus.

The mid-gut is broad and extends under about one-third of the embryo. The hind-gut is short, and the fore-gut, upon dissection, is shown to possess a distinct first pharyngeal pouch and a corresponding visceral furrow.

Stage 13. *Early Retinal Pigment*; 2.1 mm.
(Text-figs. 14, 15).

Olfactory pits are distinct. Pigment can be seen in the retina as a thin gray band. The brain and the head are further enlarged. The pericardial sac has increased to its maximal size. In the future stages

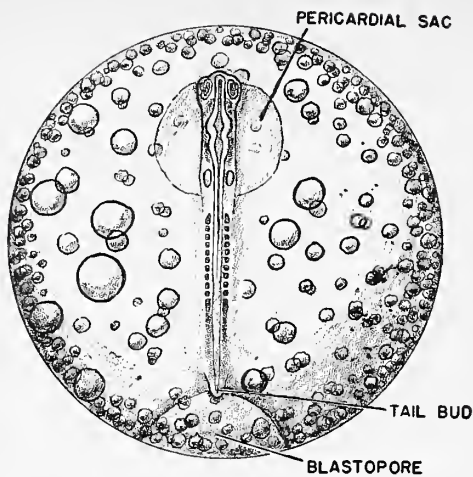

10.

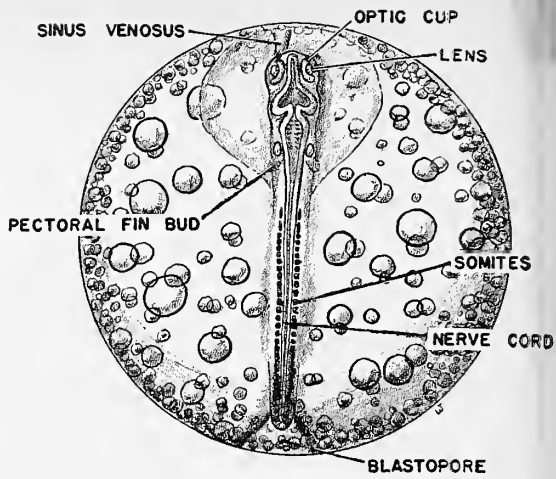

11.

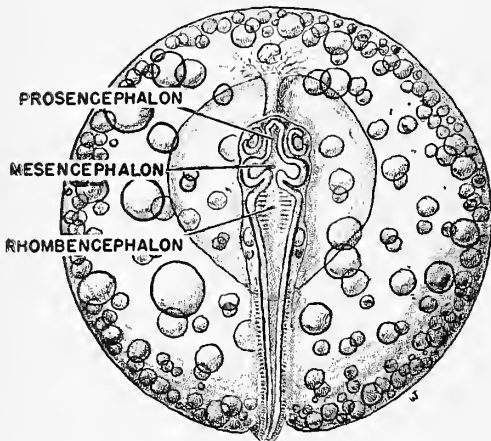

12.

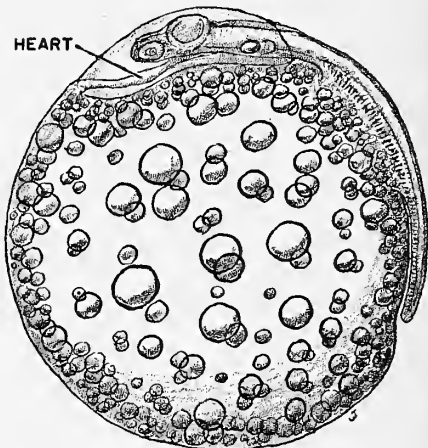

13.

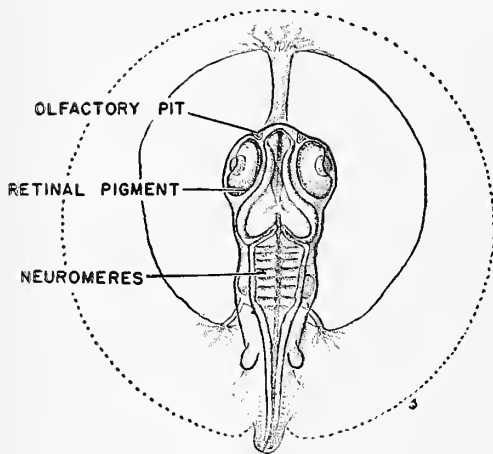

14.

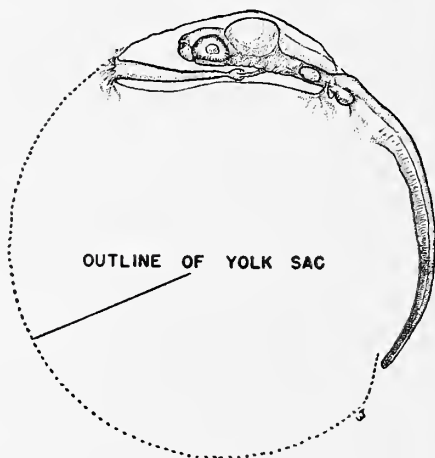

15.

TEXT-FIG. 10. Tail bud; 1.5 mm, total length. Stage 10. Dorsal aspect. $\times 38$.

TEXT-FIG. 11. Pectoral fin buds. Stage 11. Dorsal aspect. $\times 38$.

TEXT-FIG. 12. Regular heart beat; 1.8 mm. Stage 12. Dorsal aspect. $\times 38$.

TEXT-FIG. 13. Stage 12. Lateral aspect. $\times 38$.

TEXT-FIG. 14. Early retinal pigment; 2.1 mm. Stage 13. Dorsal aspect. $\times 38$.

TEXT-FIG. 15. Stage 13. Lateral aspect. $\times 38$.

the head enlarges to fill the serosa-like cavity and sinks down into the yolk mass. In side view, the stomodaeum, five gill clefts and the sixth furrow can be seen.

Stage 14. *Early Motility*; 2.8 mm.
(Text-figs. 16, 17).

The head is expanded to almost 0.5 mm. across the mesencephalon. The eyes exhibit more pigment and are pushed forward by the expanding mesencephalon. The latter possesses a thickened roof where the optic lobes are developing. The telencephalon has a somewhat rhomboidal-shaped cavity and the diencephalon is small and hardly distinct; this is typical of the teleosts. Both the metencephalon, which is poorly defined, and the myelencephalon have thin roofs. The neuromeres are still visible in the latter.

The heart possesses a long sinus venosus and a narrow atrium that has been twisted to the left of the thick-walled ventricle. The blood vessels of the pericardial membrane are enlarged to a size equal to almost one-half the diameter of the ducts of Cuvier.

The anterior fin-buds are club-shaped and rounded. The somites have taken the form of myotomes, and, when the living embryo is removed from its membranes, the posterior portion exhibits a slow twitching motion. The tail is conical and acuminate.

All six gill slits are distinct and open at this stage. The mid-gut is narrowed toward the posterior portion of the embryo, and fore-gut is an undifferentiated tube.

Stage 15. *Otoliths in Ear Vesicles*;
First Extra-ocular Melanophores;
3.1 mm. (Text-figs. 18, 19).

In this stage the telencephalic vesicles are beginning to show as lateral bulges. The diencephalon is shorter than the telencephalon and less distinct. The optic lobes possess a solid roof. The metencephalon is more distinct and thickened, and the myelencephalon is somewhat narrowed.

The eye pigment has become considerably darker and some iridiophores are present. The pupil is ellipsoidal. The olfactory bulbs have completely invaginated. The otic vesicles are enlarged and three crystal-like otoliths are present in each.

The fin buds are laterally flattened. The caudal tip of the notochord is slightly upturned and the tail tip is laterally compressed, exhibiting a rudimentary sign of a heterocercal type of tail structure.

A few stellate melanophores are usually found in the connective tissue above the mid-dorsal, posterior region of the mesencephalon. This is the first indication of extra-ocular melanophores.

The gut is completely separate from the yolk and the anterior intestinal portion is

twisted into two coils. The posterior portion is straight and ends in a somewhat long post-anal region. The gill slits, except the first, are beginning to sink into a common cervical sinus, the forerunner of the opercular cavity.

Stage 16. *Fin Rays*; 3.2 mm.

First indications of fin rays in the caudal and pectoral fins are present. Melanophores are spreading to the myelencephalon region.

Stage 17. *Anal and Ventral Fins*; 3.4 mm.

Anal fin and the skeletal elements of the ventral fins are beginning to appear. Smaller, dot-like, melanophores appear on the lateral body folds. Head is further enlarged and fills the entire pericardial membrane tightly. The operculum is formed at this time.

Stage 18. *Dorsal Fin*; 3.7 mm.

Primordium of dorsal fin becomes visible, but there are no skeletal elements within it. Melanophores have spread over the entire mid- and hind-brain regions. Embryos at this stage are capable of swimming about, although the yolk sac prevents them from rising from the substrate.

Stage 19. *Eyes and Mouth Mobile*; 3.9 mm.

Through the enveloping pericardial membranes, the eyes may be seen to move and the mouth to open. The operculum is functional here. Fascial and peritoneal melanophores appear as small black dots.

Stage 20. *Pericardial Sac Splitting*; 4.2 mm.

The pericardial extra-embryonic membrane begins to split down the dorsal midline, starting at the anterior margin just above the sinus venosus. (This is the first step in the formation of the "neck strap," described by Turner (1940a) in many viviparous cyprinodonts).

Stage 21. *Mouth Protruding*; 4.6 mm.

The pericardial sac has split open as far as the anterior margin of the eye, allowing the mouth to protrude. The peritoneal melanophores are more numerous and small fascial melanophores are concentrated around the notochord. Stellate cutaneous melanophores are very sparsely scattered over the entire embryo, and many are concentrated in the mid- and hind-brain regions.

Stage 22. *Broad "Neck Strap"*; 5.1 mm.
(Text-fig. 20).

The pericardial membrane has split as far back as the posterior third of the eye, exhibiting a broad, vascularized "neck strap." The appearance of sclerotomes is here accentuated by concentrations of small

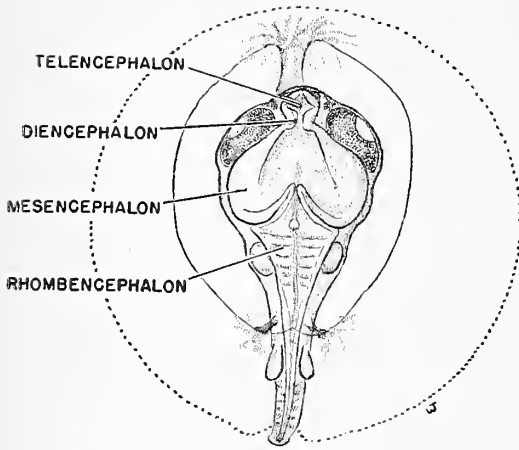

16.

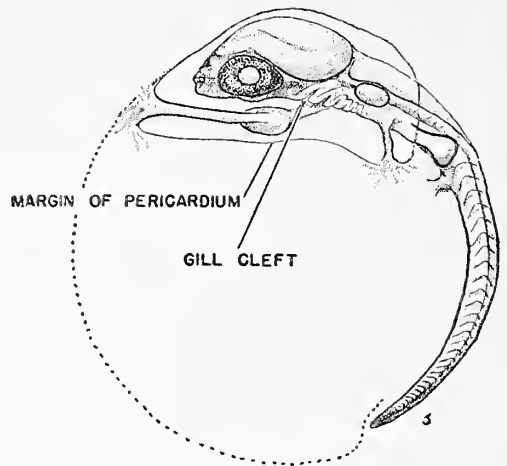

17.

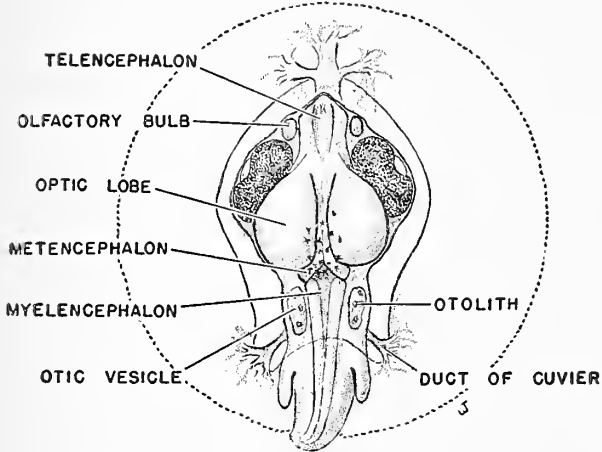

18.

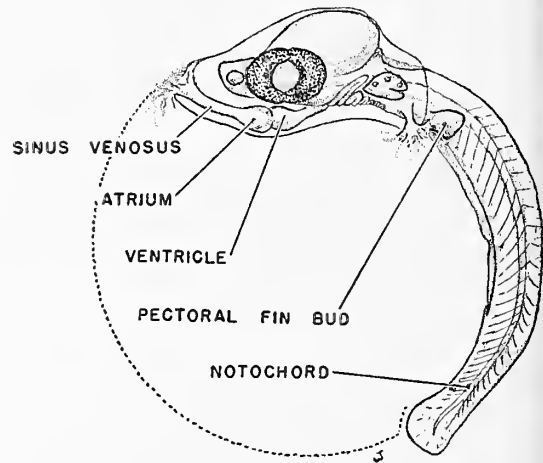

19.

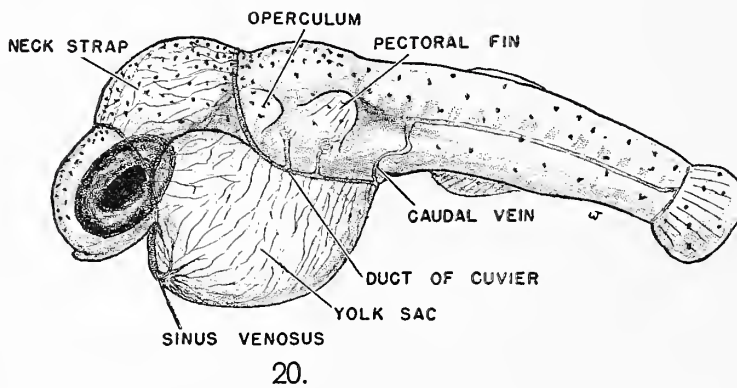

20.

TEXT-FIG. 16. Early motility; 2.8 mm. Stage 14. Dorsal aspect. $\times 38$.

TEXT-FIG. 17. Stage 14. Lateral aspect. $\times 38$.

TEXT-FIG. 18. Otoliths; Extra-ocular melanophores; 3.1 mm. Stage 15. Dorsal aspect. $\times 38$.

TEXT-FIG. 19. Stage 15. Lateral aspect. $\times 38$.

TEXT-FIG. 20. Broad "neck strap"; 5.1 mm. Stage 22. Lateral aspect. $\times 38$.

melanophores in the fascial tissue around them. Cutaneous melanophores are more numerous, sometimes present in the caudal fin rays.

Stage 23. *Fin Rays in Dorsal Fin*; 6.1 mm.

The "neck strap" (pericardial membrane) has been reduced to about one-half the width of the eye, and is situated back of the posterior margin of the eye. Fin rays begin to appear in the dorsal fin. Large cutaneous melanophores are thickly scattered over the entire embryo. The yolk sac begins to show a rapid reduction in size, measuring 1 mm. in diameter. It is noteworthy that the yolk sac begins to involute at about the same time that the pericardial membranes are in the process of accelerated regression.

Embryos at this stage, if removed from their mothers, will feed readily on small *Daphnia*.

Stage 24. *"Neck Strap" Breaking Down*; 6.5 mm.

The "neck strap" may be completely broken down at this stage, but it is sometimes present as a narrow band of tissue. The general shape of the embryo is determined by the condition of the "neck strap," the cephalic flexure straightening as the head lifts up into the main body axis. The melanophores in the dorsal head region are stellate and more closely packed.

Stage 25. *Pre-Parturition*; 6.9 mm.

The extra-embryonic membranes and the yolk flanges are absent. The yolk has been reduced to a mean diameter of .8 mm. No trace of the adult color pattern is yet visible, there being only a general increase in the number of melanophores on the peripheral areas. This is true even in embryos of Culture Nos. 187 and 195, where the adult pattern (induced by the gene *Sp* for spotting and *St* for stippling) is composed of large masses of macromelanophores and micromelanophores. Nor can these two types of melanophores be distinguished.

Stage 26. *One Hour after Birth*; 7.9 mm.

Birth activity begins with a rupture of the fertilization and follicle membranes by the violent movements of the embryos. The embryos break into the ovarian sac and then one by one they are extruded through the oviduct into the water.

In earlier stages, the heart extends forward from the conus, and the sinus venosus lies directly beneath the tip of the head. As the yolk mass becomes reduced, the heart pivots on the conus and the yolk sac portal system shrinks until the ducts of Cuvier drain directly into the sinus venosus, which eventually moves into place posterior to the conus.

Growth proceeds rapidly and within 24 hours after birth the young fry reach an average length of 8.7 mm.

RATE OF DEVELOPMENT.

In order to obtain some estimation of the developmental rate in *Platypoecilus maculatus*, records were kept on the number of embryos and their stages found in each timed gravid female. The morphological age of the embryos was determined by comparing each with the twenty-five established graded stages.

The following terms are used in this section: *Theoretical age* is the value determined for the entire embryonic brood from the date of the previous brood, less the seven day interval (as determined by Hopper, 1943). *Morphological age* for each embryo is established by comparison with the graded series of stages. *Chronological age* represents the actual developmental rate for each stage.

The theoretical age of all the members of a brood was determined by recording the date of birth of a previous brood. This is based upon the fact that fertilization of a successive complement of eggs within a gravid female takes place on about the seventh day after the birth of its previous brood (Hopper, 1943). Theoretically then, the embryos carried by a gravid female, which had dropped a brood eight days previously, are 24 hours old.

This theoretical age value, it must be noted, is only an approximation, since maturation and fertilization of a complement of eggs is spread apparently over a period of two or three days. The seven day interval, as determined by Hopper (1943), has been found to be only an average time lapse. The estimation of the true chronological age may be determined by comparing the theoretical and the morphological age values.

A reliable estimation of the theoretical age was obtained by study of those broods from fully matured females which contained 25 or more embryos, and which had given birth to at least two previous broods at an interval of approximately 28 days. Only 21 out of 55 females examined had these qualifications. Data on many young females were found to be unreliable since many of them had run highly irregular reproductive cycles, varying from 35 to 90 days between broods; and a large percentage of their embryos were dead or abnormal. For these purposes, too, data on exceptionally small embryonic broods (those containing less than 10 embryos) were not considered.

The chart (Text-fig. 21) summarizes the data on 21 embryonic broods plotted in the following manner: Each vertical bar

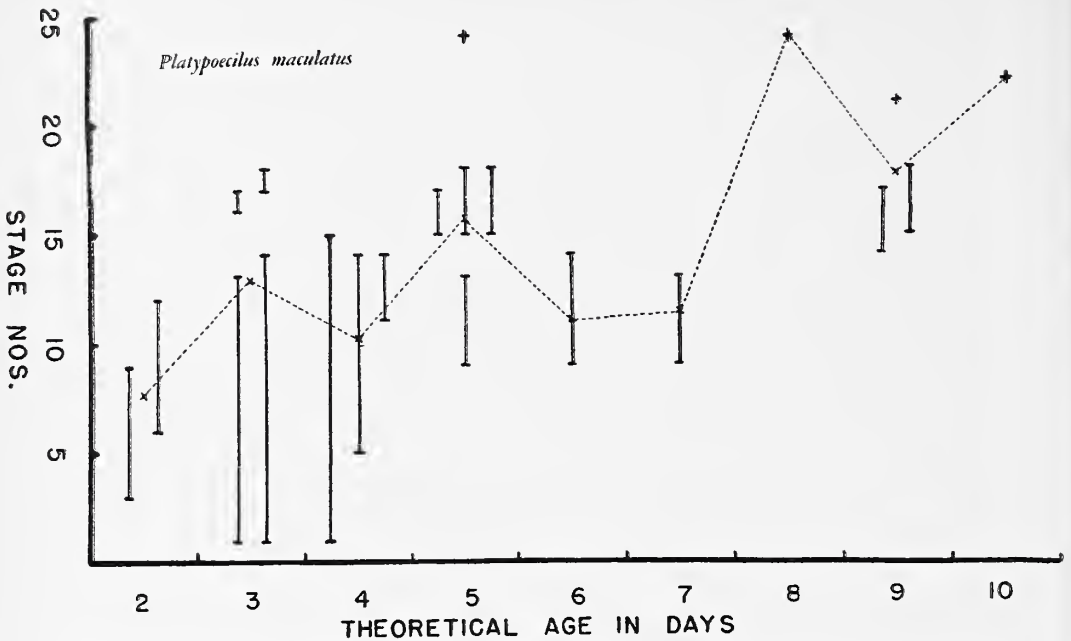

TEXT-FIG. 21. Chart showing age variations in 21 embryonic broods. Each vertical bar represents an entire brood removed from a female. Dotted line connects the mean morphological ages for each theoretical age group. (See detailed description in text.)

represents all the members of one entire brood carried by a single gravid female platyfish. The length of each vertical bar, projected on the ordinate, shows the range of morphological ages found in each embryonic brood. In some cases, especially during the later portion of the gestation period, the embryos are all of a single morphological age; these are represented by plus (+) signs.

The embryos are divided into theoretical age groups according to the number of days that have elapsed since the birth of the previous brood (less the seven day interval) and are arranged along the abscissa. Usually there is more than one brood in each age group.

The mean morphological ages for all the embryos of each theoretical age group are also plotted on the chart, and these values are connected by the dotted line.

From the chart, it may be seen that there are two kinds of variations. First, there is the wide range of morphological stages among the embryos found within any one gravid female; and second, the variations of the average morphological age of a brood with respect to its theoretical age.

The greater apparent spread of morphological stages in the earlier broods may be attributed to the unequal time lapse between stages distinguished on the basis of morphology alone.

Using the information described previ-

ously on the reproductive cycle of the platyfish, it was thought that not only a graded series of morphological stages but also a chronological series could be obtained. On the basis of these data, some estimations of the time of development of each stage could have been made. However, the variation, as demonstrated by the chart, proved to be so great that an estimation of the true chronological age was impossible.

DISCUSSION.

Adaptations for Viviparity in the Cyprinodonts.

The family Poeciliidae is one of several belonging to the teleostean order Cyprinodontes (killifishes or top-minnows, Hubbs, 1924). The type family, Cyprinodontidae, includes many oviparous forms such as the common coastal killifish (*Fundulus heteroclitus*) and the Japanese medaka (*Oryzias latipes*). The embryonic stages for these two fishes have been described by Oppenheimer (1937) and Rugh (1941), respectively.

The Cyprinodontidae are characterized by the possession of macrolecithal eggs, and an enlarged pericardial sac in the embryo, which is vascularized and serves, apparently, as an accessory respiratory organ.

The family Poeciliidae, which includes *Platypoecilus maculatus*, is composed of several viviparous species commonly used in home aquaria, such as the guppy (*Lebistes*

reticulatus), and the swordtail (*Xiphophorus hellerii*). In these viviparous forms, fertilization and development of the embryos take place within the ovarian follicle. The poeciliids also possess a greatly expanded pericardial sac which forms an enveloping extra-embryonic membrane, (see discussion on development of pericardium). Other poeciliids have evolved certain morphological adaptations for viviparity, which have been described by Turner (1940a). For instance, *Heterandria* has a highly developed extra-embryonic pericardium and a reduced yolk, and *Poeciliopsis* and *Aulophallus* have, in addition, a highly expanded coelom and a follicular pseudoplacenta. Superfoetation is exhibited to a high degree in these three.

The members of the Goodeidae are viviparous and their embryos develop within ovarian follicles. The size of the goodeid pericardial sac may vary but it never reaches the large proportions of that of the poeciliid (according to Turner, 1940b). The goodeid yolk sac is small and transient. Vascularized outgrowths of the cloacal lips (trophotaeniae) are present, and apparently these structures serve as organs for absorbing oxygen and nutriment from the maternal circulation. *Goodea* possesses a small rosette-shaped trophotaenia, and *Characodon* possesses two elongate trophotaeniae. These structures are larger in *Girardinus* and *Zoogeneticus*. In *Lermichthys*, the climax is reached with an early and extensive development of the trophotaeniae. These structures have been used by Hubbs & Turner (1937) as a basis for a taxonomic revision of the group.

In the family Anablepidae (according to Turner, 1940c) there is an enlarged pericardial sac and a highly developed follicular pseudoplacenta. The transient yolk sac is replaced early in the gestation period by an elongate and coiled mid-gut in *Anableps anableps* or a distended posterior intestine in *A. dowei*.

Turner (1940d) has also shown that the fishes of the family Jenynseidae differ from all of the above forms in that, although fertilization occurs in the follicle, most of the embryonic development takes place in the ovarian lumen. Here the yolk sac and the pericardial sac are ephemeral structures; the embryo absorbs nourishment through a flap of the ovarian tissue which enters the pharyngeal cavity of the embryo through one of its opercular clefts.

Although the adaptations described above are presumed to be for the purpose of obtaining nourishment from the maternal circulation, it has not been shown experimentally just what functions the various structures serve. Does absorption, for instance, take place through the walls of the ovarian blood vessels or directly from the coelomic fluid?

Scrimshaw (1944, 1945) has shown that many of these forms are truly viviparous, not ovoviviparous, by recording the dry weights of embryos at various stages of gestation. Species of *Xiphophorus*, *Lebistes*, *Gambusia* and many of the Goodeidae showed no loss in dry weight throughout the gestation period, indicating that there is a continuous replacement of nutrient materials and a draining of metabolic wastes. *Heterandria*, a known superfoetacious form, exhibited a notable increase in weight, indicating not only replacement but addition of growth-promoting substances.

In Stage 23 of *Platypoecilus* the yolk sac begins to involute coincidentally with the accelerated regression of the pericardial membranes. This may indicate a change in the mechanism by which the embryo obtains nutrient materials. In early development it presumably received them through the medium of the highly vascularized pericardial membranes. As the membranes became radically reduced after Stage 22, the embryo may obtain from the yolk the bulk of the nourishment it requires to complete its development.

Embryological Stages of Platypoecilus and Fundulus Compared.

The unfertilized mature egg of *Fundulus* differs from that of the platyfish in the possession of a thick tertiary membrane, i.e. the chorion, deposited by maternal tissues. The fat globules are clumped in the center of the egg, instead of being spread on the periphery as in the platyfish. Oppenheimer (1937) notes that the number and size of the fat globules are characteristic for each female; this is also true for the platyfish.

The cleavage cells of *Fundulus* eggs are globose and distinct, whereas those of the platyfish are thin, broad, and flat. The "expanding blastula" (stage 11 of *Fundulus*) is very similar to stage 4 of *Platypoecilus*. Stage 13 (*Fundulus*) is quite similar to stage 7 (platyfish). From here on, the differences become more marked.

In *Fundulus*, the blastopore is closed usually before somites or optic vesicles develop, but in *Platypoecilus* the blastopore remains open even up to tail bud formation (see Text-fig. 11).

Platypoecilus shows the development of cavities in the optic vesicles simultaneously with the invagination of the otic vesicles, at stage 9. In *Fundulus*, the optic vesicles are formed at stage 17, and otic vesicles are not present until the 20-25 somite stage (stage 20). However, stage 12 of *Platypoecilus* and stage 20 of *Fundulus* are superficially very similar.

Otoliths are first visible in *Platypoecilus* by stage 15, and by stage 23 of *Fundulus*. However, the general shape of the *Fundulus*

embryo at this stage closely resembles stage 13 of *Platypoecilus*.

In the platyfish, the first evidence of pigment is in the retina (stage 13), and the first extra-ocular melanophores appear in stage 15. In *Fundulus*, melanophores are first visible over the yolk in stage 19, simultaneously with the formation of the lens and olfactory pit, and retinal pigment first appears in stage 27 where cutaneous melanophores are already present.

The most striking difference between the two above forms is the presence of an enveloping pericardial sac in *Platypoecilus* which forms the extra-embryonic membranes, described below.

Development of Extra-embryonic Pericardium.

In the oviparous cyprinodonts, i. e. *Fundulus*, the pericardial sac develops early in ontogeny as an outgrowth of the somatopleure just ventral to the heart primordium (Turner, 1940a). It balloons out, carrying with it the posterior end of the network of blood vessels anastomosing to form the heart. By the time the heart has differentiated, the pericardium has expanded anteriorly beyond the head fold. The heart, then, is in

a reversed position at this stage, the sinus venosus being anterior and the conus posterior (Text-figs. 22, 23), and its entire length is suspended over the floor of the pericardium, i. e. yolk sac splanchnopleure. The head overlays this expanded pericardium and dips down into it. In *Fundulus* and *Oryzias*, the pericardial sac becomes vascularized, and serves, apparently, as an accessory respiratory organ.

In the viviparous Poeciliidae, the development of this sac is carried further. Turner (1940a), in describing the condition in *Heterandria*, shows that the pericardial sac expands over the anterior one-third of the embryo and enfolds it in a double-layered sac. The inner layer is thin and closely applied to the head, and the outer layer is vascularized and balloons out over the embryo. For the other, less specialized poeciliids, Turner describes a structure which he calls the "neck strap," that extends as a belt over the posterior head region of the embryo. He reports the presence of such a structure in species of *Platypoecilus*, *Xiphophorus*, *Gambusia*, *Lebistes* and other related genera. According to Turner, this "neck strap" originates from the yolk sac membrane and the yolk flanges. Our observa-

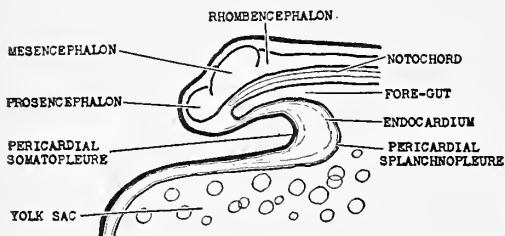

22.

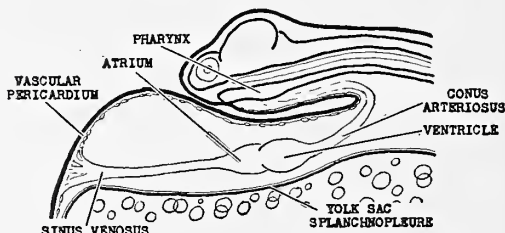

23.

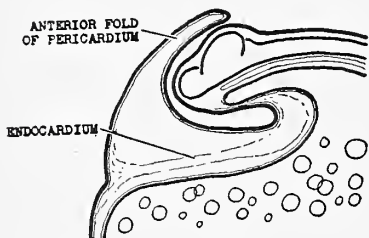

24.

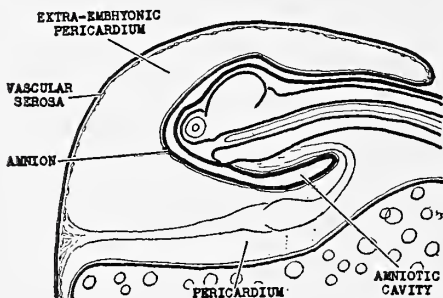

25.

TEXT-FIG. 22. Diagrammatic sagittal section of *Fundulus* embryo before development of pericardial sac.

TEXT-FIG. 23. Diagrammatic sagittal section of *Fundulus* embryo at maximum development of pericardial sac.

TEXT-FIG. 24. Diagrammatic sagittal section of *Platypoecilus* embryo at beginning of formation of extra-embryonic pericardium.

TEXT-FIG. 25. Diagrammatic sagittal section of *Platypoecilus* embryo at maximum development of the pericardial amnion and pericardial serosa.

tions indicate that the pericardial sac in *Platypoecilus* develops just as it does in *Heterandria*. During development of the embryo the pericardial sac is broken down by the enlarging head and at some stages an ephemeral "neck strap" appears (Text-fig. 20). A preliminary examination of the "neck strap" in early embryos of *Lebistes* and *Xiphophorus* shows the same changes. The pericardial sacs of all these fishes reach the same proportions in development as that of *Heterandria*. Turner's report on the platyfish, guppy, swordtail and other poeciliids, was apparently based on somewhat older embryos. An examination of comparable, early stages of the other genera mentioned by Turner may indicate a common developmental history of the pericardial sac in the poeciliids.

The pericardium of *Platypoecilus* begins its development as it does in *Fundulus*, but continues on to envelop the anterior one-fourth of the embryo in a two-layered sac (Text-figs. 24, 25). The mechanism of this overgrowth by the somatopleure is basically the same as the formation of the amnion and serosa of reptiles and birds. The development of extra-embryonic membranes in the Poeciliidae in a manner very similar to their derivation in the amniotes is an interesting example of parallelism in evolution. In both groups, the membranes are developed from somatopleure and may be considered homologous. Therefore, the terms "amnion" and "serosa" may properly be applied to the poeciliid membranes. However, "pericardial amnion" and "pericardial serosa" are suggested for the membranes of this group of fishes in order to avoid any possible confusion with the homologous membranes in the amniotes. Turner (1940a) had previously called the amnion of viviparous cyprinodonts "the pseudoamnion" and applied the term of "pseudochorion" to the cyprinodont serosa.

The term "chorion," as applied to avian and mammalian embryology, is synonymous with "serosa," for it is an extra-embryonic membrane derived from the somatopleure. However, the "chorion" in fishes is a tertiary membrane deposited around the eggs while in the ovary of oviparous species by the follicle cells. The use of the term "pseudochorion" for the extra-embryonic membrane in poeciliids might prove confusing, and it is felt that "pericardial serosa" should be used here, since there are no maternal tissues involved.

Development of Melanophores.

The earliest visible melanophores appeared during stage 13 and were found within the retina. The first visible extra-ocular melanophores appeared during stage 15 above the mid-dorsal, posterior region

of the mesencephalon. Gordon (1931a) had previously figured a 2 mm. stippled (wild-colored) platyfish showing that the ocular pigmentation was completed at this stage of development while the pigmentation over the brain had barely begun. In the brain region, the pigmentation was represented by about 15 irregular, stellate melanophores whose dendritic processes showed a series of anastomoses. In the 3.5 mm. embryos of the same genetic strain, the melanophores over the brain area had increased in numbers, in size and in melanin content; anastomoses of the irregular dendritic processes persisted. In the 4.5 mm. embryos, the long dendritic processes were reduced and the pigmented cells rounded up, taking the shape of discrete micromelanophores of which there were about 50 over the brain area. During the latter periods cutaneous melanophores gradually appeared over the rest of the body. (The measurements used by Gordon are "standard length," i. e. the tail fin length is not included.)

Finally, in the stage just prior to birth, in the 5.5 mm. embryo the number of definitive micromelanophores increased to over 250 in the brain area. Apparently, these pigment cells are perineural, rather than cutaneous melanophores, although they are morphologically similar, for they were lodged in the meninges around the brain. Owing to the thinness and transparency of the integument over the brain, the pigmentation of this region appears to be that of the skin, whereas it is that of the meninges.

At the time micromelanophore development was for the most part completed over the brain area, the condition of the pigment cells in the integument over the rest of the body was in the early or stellate stage. No evidence was offered, one way or the other, to show whether the "stellate" pigmented cells were transformed into definite micromelanophores or whether micromelanophores replaced the early appearing dendritic pigment cells.

In the present observations on the developmental stages, no recognizable macromelanophores could be detected in pure *Platypoecilus maculatus* embryos genetically constituted to have them. Gordon & Flathman (1943) were able to identify the larger melanophores in platyfish-swordtail hybrid embryos. And Gordon & Smith (1938) showed that in some back-cross hybrids (*Platypoecilus maculatus*-*Xiphophorus hellerii* × *Xiphophorus hellerii*) the macromelanophore growth had proceeded so rapidly in the melanotic embryos that these cells had invaded the subcutaneous areas where the destruction of muscle tissue was begun.

DuShane (1943) has shown experimentally that melanophores in amphibia arise

from the neural crest cells in early development and similar proof is available for the origin of melanophores in birds. DuShane credits Borcea (1910) with being the first to suggest that pigment cells have a neural crest origin and Borcea based this suggestion on his observations of the developing embryos of the pipefish, *Belone*. However, this conclusion has not as yet been proved experimentally in fishes.

The final statement concerning the point of embryonic origin of the melanophores in the platyfish must await the development of successful techniques for extra-ovarian culture of the early growth stages.

SUMMARY.

1. The female platyfish, *Platypoecilus maculatus*, once inseminated, will produce as many as four or more successive broods at 28-day intervals without further contact with males, the sperm being stored within the folds of the oviduct. Fertilization of the ova usually takes place seven days after the release of the previous brood. Broods were removed from females at various intervals after the birth of a brood, and the developmental stages were studied, described and classified.

2. There was found a considerable variation in the developmental stages among the embryos of a given gravid platyfish. Since all the embryos of a brood are born within a space of an hour, the belated embryos either die or catch up to the age of the brood as a whole. Considerable variation was found in the relation of the average morphological age of the embryonic broods with respect to their theoretical age (i. e. as determined by the date of birth of the previous brood).

3. The platyfish is truly viviparous. In early development, the pericardial membrane is very extensive and is presumed to be the main mechanism through which the embryo obtains nourishment from the mother. Later, the pericardial membrane regresses and it is assumed that the embryo then relies on the yolk as its main food source. Other mechanisms for attainment of food and oxygen are developed in other viviparous cyprinodonts.

4. *Platypoecilus* differs from *Fundulus* chiefly in the development of extra-embryonic membranes. In *Fundulus*, the highly vascularized pericardial sac serves as an accessory respiratory organ. In *Platypoecilus*, the development of this organ is carried further, enveloping one-fourth of the embryo, and it presumably brings nutrition to the embryo.

5. In the platyfish, the pericardial membranes, i. e. pericardial amnion and pericardial serosa, envelop the entire anterior

portion of the embryo during their maximal development. During the process of regression of these membranes, a temporary "neck strap" structure is formed. The mechanism of overgrowth of the platyfish membranes is basically the same as the formation of the amnion and serosa of reptiles and birds.

6. The development and distribution of melanophores in platyfish embryos is described. No differences could be noted between micro- and macromelanophores. Initial pigment distribution is the same in all the pattern strains of *P. maculatus* that were studied.

LITERATURE CITED.

- BORCEA, I.
1910. Sur l'origine du coeur, des cellules vasculaires migratrices et des cellules pigmentaires chez les Téléostéens. *Comp. Rend. Acad. Sci. Paris*, 149: 688-689.
- DUSHANE, G. P.
1943. The embryology of vertebrate pigment cells. I. Amphibia. *Quart. Rev. Biol.*, 18: 109-127.
- GERSCHLER, W. S.
1914. Über alternative Vererbung bei Kreuzung von Cyprinodontiden-Gattungen. *Zeits. induct. Abstammungs- und Vererbung*, 12: 73-96.
- GORDON, M.
1926. Tropical aquarium fish-culture in industry and scientific research. *Trans. Amer. Fisheries Soc.*, 56: 227-238.
1931a. Morphology of the heritable color patterns in the Mexican killifish, *Platypoecilus*. *Amer. Journ. Canc.*, 15: 732-787.
1931b. Hereditary basis of melanosis in hybrid fishes. *Ibid.*, 15: 1495-1523.
1937. The production of spontaneous melanotic neoplasms in fishes by selective matings. *Ibid.*, 30: 362-375.
1943. Feeding platyfishes and swordtails. *Aquarium*, 12: 86-88.
1947. Genetics of *Platypoecilus maculatus*. IV. The sex-determining mechanism in two wild populations of the Mexican platyfish. *Genetics*, 32: 8-17.
- GORDON, M. & F. FLATHMAN.
1943. Genetics of Melanoma in fishes. VI. Mendelian segregation of melanophore reaction types in embryos of a melanomatous mother. *Zoologica*, 28: 9-12.
- GORDON M. & G. M. SMITH.
1938. Progressive growth stages of a heritable melanotic neoplastic disease in fishes from the day of birth. *Amer. Journ. Canc.*, 34: 255-272.
- HOPPER, A. F., JR.
1943. The early embryology of *Platypoecilus maculatus*. *Copeia*, 1943: 218-224.

HUBBS, C. L.

1924. Studies of fishes of the order Cyprinodontes. *Univ. Mich. Mus. Zool., Misc. Publ.*, 13: 1-31.

HUBBS, C. L. & C. L. TURNER.

1939. Studies of the fishes of the order Cyprinodontes. XVI. A revision of the Goodeidae. *Univ. Mich. Mus. Zool., Misc. Pub.*, 42: 1-80.

OPPENHEIMER, J.

1937. The normal stages of *Fundulus heteroclitus*. *Anat. Rec.*, 68: 1-16.

RUGH, R.

1941. Experimental Embryology: A manual of techniques and procedures. N. Y. University. pp. 240-248.

SCRIMSHAW, N. S.

1944. Embryonic growth in the viviparous poeciliid fish, *Heterandria formosa*. *Bio. Bull.*, 87: 37-51.
1945. Embryonic development in poeciliid fishes. *Ibid.*, 88: 233-246.

TURNER, C. L.

- 1940a. Pseudoamnion, pseudochorion, follicular pseudoplacenta in poeciliid fishes. *Journ. Morph.*, 67: 59-89.
- 1940b. Follicular pseudoplacenta and gut modifications in anablepid fishes. *Ibid.*, 67: 91-103.
- 1940c. Pericardial sac, trophotaeniae and alimentary tract in embryos of goodeid fishes. *Ibid.*, 67: 271-289.
- 1940d. Adaptations for viviparity in jennynseid fishes. *Ibid.*, 67: 291-295.

VAN OÖRD, G. J.

1928. The duration of life of the spermatozoa in the fertilized female of *Xiphophorus helleri* Regan. *Tijd. Nederlandsch Dierkd. Vereen.*, 3rd Ser., 1 (2): 77-80.

WINGE, Ö.

1922. A peculiar mode of inheritance and its cytological explanation. *Journ. Genetics*, 12: 137-144.

2.

A Study of the Oxygen Consumption of Blind and Eyed Cave Characins in Light and in Darkness

SYLVIA R. SCHLAGEL

AND

C. M. BREDER, JR.

New York University and the American Museum of Natural History

(Text-figures 1 & 2.)

INTRODUCTION.

Certain features of the Mexican cave characins and their surface dwelling relatives make them particularly useful in studies of comparative behavior concerning the effects of vision or its lack. The normally blind cave form described as *Anoptichthys jordani* by Hubbs and Innes (1936) is genetically continuous with the deriving form, *Astyanax mexicanus* (Filippi), as has been indicated by Breder (1942). Laboratory studies by Breder and Gresser (1941a, 1941b) and Breder and Rasquin (1943) have shown that the locomotor activity of the eyed and blind fishes is distinctly different. Those with vision remain for the most part in a quiescent aggregation, while both the normally and operationally blind individuals maintain a continuous random wandering. The important role of vision in the schooling behavior of all fish species so far studied, is well known, as is the fact that the other senses provide for only a limited aggregating tendency.

The above-mentioned studies apply to fishes in the presence of light since it is manifestly impossible to make direct observations in total darkness. Since Breder and Gresser (1941a) have shown that the blind cave fish are negatively phototropic and Breder and Rasquin (1943) that blinded river fish take on the wandering characteristic of the normally blind cave fish, it becomes obviously desirable to obtain some estimate of what such fishes actually do in a locomotor sense in an environment of total darkness. It is the purpose of this study to determine whether or not there is a measurable differential in the activity of both blind and eyed fishes in light and in darkness. Since there is, in general, a proportionality between oxygen consumption and activity of a fairly sensitive degree, as has been indicated by Schlaifer (1938), a method comparable to his has been employed.

In addition to the above main purpose of the study it has also been possible to compare the behavior of such fishes alone and in groups. Some fishes have differing oxygen

consumption rates, dependent on their degree of isolation, as has been indicated by Schlaifer (1939). Furthermore, he was able to determine that goldfish have a distinctly higher rate of oxygen consumption in the light than in the dark. Shaw, Escobar and Baldwin (1938) showed that the locomotor activity of the goldfish is reduced over a period of 96 hours to one-half or one-third the usual rate by very low illumination.

The basic question concerned with whether there is a fundamental difference in the metabolic rate of the blind and eyed fish, or whether any detectable differences are merely referable to the presence or absence of vision, is covered by experiments involved in work on the preceding items. The results and their significance in terms of differences between these types of fishes, their comparison with goldfish and the problem of cave entry and establishment therein in ecological and evolutionary terms, is covered in the discussion.

The experimental part of this study was carried out in the laboratories of the Department of Animal Behavior of the American Museum of Natural History through the courtesy of the department's Chairman, Dr. Frank A. Beach.

MATERIALS AND METHODS.

Determinations of dissolved oxygen were made by means of the permanganate modification of the Winkler method. This modified technique, suggested by Allee and Oesting (1934) and described in the American Public Health Association Manual (1943), eliminates the error caused by nitrites in the water.

The apparatus devised for these tests is shown in Text-fig. 1, the structural details of which may be briefly summarized as follows. In use the test chamber E is filled with water from reservoir R. The animal undergoing test is introduced into chamber E and allowed to remain there for a minimum of 17 hours. This period enables the fish to acclimate itself to the experimental surroundings. Chamber E, which is a two liter jar, is then filled to overflowing and a

rubber stopper, through which pass three glass tubes, is inserted, making certain that no air bubbles are trapped. Needle valve N is set to admit air very slowly. With stop cocks 4 and 3 closed, 1 and 2 are opened. This causes balloon B to expand and drive water back into reservoir R. If an air bubble is accidentally caught in the glass tubing leading from the reservoir to the animal chamber, it is thus voided into the open reservoir. With cocks 2 and 3 closed, 4 and 1 are opened. This causes the balloon to deflate and water returns to E with no entrained air. With cocks 2 and 4 closed, 1 and 3 are opened. This causes a flow from R through E and out of the outlet tube. This flow is allowed to continue until E has cleared itself thoroughly.

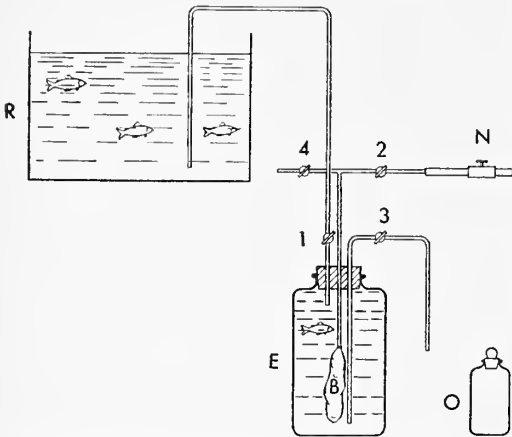

TEXT-FIG. 1. Diagram of apparatus used to determine oxygen consumption of blind and eyed characins. B = balloon, E = experimental chamber, N = needle valve, O = water sample bottle, R = reservoir of water supply, 1, 2, 3, 4 = glass stop cocks.

Samples of water for analysis are collected in 250 cc. bottles as suggested by American Public Health Association Manual (1943). To withdraw a sample the outlet tube is allowed to reach down to the bottom of bottle O. The first sample is collected after E is thoroughly cleared, by merely allowing the flow to continue from R through E and out of the outlet tube into the sample bottle. The water is allowed to overflow in the sample bottle in order to eliminate the surface water which is contaminated by the air that is present in the bottle before filling. All the stop cocks are then closed and the apparatus is in operating condition. To collect a sample at the end of the test period stop cocks 3 and 2 are opened so that the balloon expands slowly and water passes out of the outlet into the sample bottle. Before the sample is actually collected, however, a small amount of water is allowed to run to waste equal to that in the outlet pipe. To reset the

apparatus stop cocks 2 and 3 are closed whereas 1 and 4 are opened. When the balloon is deflated cock 4 is closed and 3 is opened in order to flush out the old contents of animal chamber E. The difference between the oxygen content of the water in the animal chamber at the start of the test and at the completion of the test is a measure of the oxygen consumption of the fish. The water in the reservoir was kept in a conditioned state throughout the experiment by using it as a storage space for reserve fish.

When the experiments were performed involving total darkness, test chamber E was placed in a tall can which had been painted black on the inside as well as the outside. A covering, made of several layers of heavy black cloth, was fitted over the can and designed to snugly enclose the top of chamber E. The stop cocks and glass tubing leading directly to and from the test chamber were completely covered with black tape. When the apparatus was in operating condition, a large piece of heavy black cloth was thrown over the entire apparatus. Thus light was effectively excluded without sacrificing any of the necessary controls.

This closed system type of respirometer was employed in spite of the objection that the closed method allows the products of metabolism to accumulate and the CO_2 tension to increase, thus modifying the oxygen consumption readings. The continuous flow respirometers used by Keys (1930), Etkin, Root and Mofshin (1940), Wells (1935), Adkins (1930), and others eliminate these uncertainties but similarly are not absolute measures of the oxygen consumption of the animal. In all of these latter methods the rate of flow varies according to the operator and the oxygen consumption reading is directly dependent upon how fast or how slow the water is allowed to circulate through the system. Thus the oxygen consumption reading is always a relative figure. Since both methods apparently possess their own peculiar disadvantages and advantages, it was decided to employ the much simpler closed system type of respirometer for the present work. The fact that the values obtained are not absolute is hardly important because the problem at hand involves only a comparison of oxygen consumption rates. Any modification in readings should be consistent throughout.

Schlaifer (1938) also employed the closed system type of respirometer in determining the oxygen consumption of goldfish. Heavy mineral oil was used by him to prevent the leakage of oxygen from the air into the water during the experiments. The main disadvantage of this method, as discussed by Schlaifer, is that mineral oil is not a perfect seal. He showed that there was a leakage of 1.15 per cent. to 1.55 per cent. of the total oxygen available in both his 6 liter and

12 liter tanks in three hours. However, since he was interested in comparative values, his conclusions were not altered. In the present work it was decided not to use this method, in spite of the fact that comparative data were also sought, since mineral oil might prove very costly to the test fish. If the animal swam to the interface between the oil and water, the gills could become clogged with oil and death might result.

The balloon, which is used in the present work to force the water into and out of the test chamber, seems to eliminate most of the disadvantages of previously used systems and in addition is much cleaner and more easily operated, the entire control being governed by five valves.

The fishes chosen for test were selected so as to be comparable in size and condition. Their length was between 4.2 cm. and 6.0 cm. in standard length, and their weight was between 2.7 g. and 5.6 g. Each fish was introduced into the test chamber at least 17 hours before respiration readings were begun. Each fish was starved for 17 hours before the test. The temperature throughout this work ranged from 22° to 29.5° C.; however, the great majority of the readings were taken at 27° C. Since the hydrogen ion concentration may affect the metabolism of fishes (Wells, 1935), the pH of the test water was maintained at 7 in all but a very few cases where it was 6.9.

Tests were planned as listed below on optically intact river fish.

1. One fish tested in daylight.
2. One fish tested in total darkness.
3. Two fish in daylight.
4. Two fish in total darkness.
5. Five immature optically intact fish, total weight 6.1 g., in daylight.
6. Five immature optically intact fish in total darkness.

A similar series of experiments was carried on with blind cave fish. The length of the test period in each case was two hours. This time limit was decided upon after carrying on a series of preliminary experiments on eyed and on blind specimens, for it was found that one hour readings obtained on the eyed river fish were too small to be entirely satisfactory but the two hour readings appeared to be adequate.

A blank test was run with each experiment in order to determine the biochemical demand of the conditioned water. Each experiment was repeated ten times and the values as finally used represent the means of these ten tests. In all 155 tests were made, representing a total of 301 hours measured as to oxygen consumption. In all nine eyed fish and eight blind fish were employed.

EXPERIMENTAL RESULTS.

While working with the eyed river fish two very distinct and sharply defined phases

of behavior were noted; a turbulent fighting state and a quiescent state. The probable explanation of this is given in the discussion. Oxygen consumption readings were obtained on a single fish (No. 1) in both the quiet and the excited states. This change, over a period of five days, is reflected in Table I. This fish continued to be restless and in a highly excited state, giving high oxygen consumption readings during the remainder of this work.

Effect of darkness on oxygen consumption of eyed fish.

Ten additional tests were performed on eyed fish No. 1 in the light and ten tests in total darkness. This fish was in an active state throughout this series of tests. It was the purpose of these experiments to discover the extent of activity in the dark. Evidently three possibilities are present. Darkness could cause the active eyed fish to return to the resting state. This would be indicated by a lowered oxygen consumption similar to the decrease obtained with goldfish by Schlaifer (1939). One other possibility is that the eyed fish, once unable to see,

TABLE I. EYED FISH NO. 1.

Transition from quiet to active state over a period of five days.

S. L. = 5.8 cm. WT. = 4.4 g.

Date	Temp.	Test Period Hours	Tested in daylight.	
			cc. O ₂ /1 Original Sample	cc. O ₂ /1 Consumed
7/30	27°	2	3.35	.49
7/30	27°	1	3.14	.14
7/30	27°	1	4.19	.28
7/31	26°	2	4.95	.76
7/31	26°	2	4.95	.62
7/31	26°	1	5.09	.41
8/1	25.5°	2	4.22	1.29
8/1	25.5°	2	4.05	1.19
8/1	25.5°	1	4.43	.84
8/1	26°	1	4.36	.52
8/2	25°	2	4.61	1.19
8/2	25.5°	2	4.22	1.43
8/2	26°	2	3.91	1.43
8/3	26°	2	3.63	1.40
8/3	26°	2	3.49	1.18
8/3	26°	2	3.42	1.33

would enter into the continuous wandering state characteristic of their blind relatives as found in blinded specimens by Breder and Rasquin (1943), or there finally could be the third alternative of no change whatsoever. The results of 20 oxygen consumption tests are shown in Table II, which indicates that less oxygen was consumed in the dark.

Schlaifer (1938) showed that two goldfish living together exhibit what has been called the "group effect." This is a condition

TABLE II. EYED FISH NO. 1 IN AN ACTIVE STATE.

S. L. = 5.8 cm. WT. = 4.4 g.

All tests run for 2 hours. pH 7 in all cases.

A. Tested in daylight.

Date	Temp.	cc. O ₂ /1 Original Sample	cc. O ₂ /1 Consumed in 2 Hours
8/8	25.5°	4.40	1.19
8/8	26°	4.12	.98
8/8	26°	4.19	.98
8/9	25.5°	3.70	1.03
8/9	26°	3.63	1.26
8/9	26°	3.70	1.12
8/10	26°	4.12	.98
8/10	27°	3.91	1.54
8/10	27°	4.19	.98
8/11	27°	4.19	1.40
Average		4.02	1.15
Average B.O.D. = + .03 cc. O ₂ /1			

B. Tested in total darkness.

8/25	22.5°	4.95	.83
8/25	22°	5.02	.55
8/27	22.5°	4.95	1.46
8/27	23°	4.75	.84
8/27	23°	4.89	.63
8/28	23°	4.89	.70
8/28	24°	4.89	.56
8/28	24°	4.95	.76
8/29	25°	4.19	1.40
8/29	26°	4.26	1.47
Average		4.77	0.92
Average B.O.D. = + .03 cc. O ₂ /1			

in which animal aggregations either in nature or in the confines of experimental apparatus show different physiological responses as compared with isolated animals of the same species. Escobar, Minahan and Shaw (1936), in their discussion of "group effect," point out that this phenomenon has been shown for differential growth rates, reproductive rates, conditioned learning times, locomotor activity, oxygen consumption rates, etc. Schuett (1933) showed that the oxygen consumption of a goldfish is higher when isolated in a given volume of water than when it is a member of a group of four in the same volume of water. Schuett (1934) corrected an error in his water analysis technique of 1933. Nevertheless conclusions similar to Schuett's 1933 work were drawn by Schlaifer (1938). In Schlaifer's experiments two goldfish living together consumed less oxygen per fish than when isolated. Escobar, Minahan and Shaw (1936) point out that the lowered oxygen consumption of a grouped fish is probably due to the fact that the activity of an isolated animal is greater than the activity of the same animal when grouped with other fish. Breder and Nigrelli (1938) confirmed this latter fact, using larger bodies of water.

An attempt was made to measure the oxygen consumption of two optically intact fish in order to determine whether they too exhibit the group effect. The animals chosen for test were those which were removed from the reserve tank and placed in individual tanks ten days previous because they were in an active fighting state. Throughout the ten-day isolation period they remained quiet in their respective tanks, resembling those in the quiescent state. They were placed in the respirometer for an acclimatization period. Although they were both of approximately the same size, one fish attacked the other and succeeded in killing it. A new pair of fish, which had been living in the same tank, undisturbed since hatching, was then placed in the respirometer. During the acclimatization period they too exhibited fighting qualities, pecking at and chasing each other. Since this was evidently leading to destruction, they were separated. Apparently the respirometer, which is a 2 liter chamber, brings the fish into too close confinement for them to establish normal social relationships. It was thus impossible to test two optically intact river fish in the light by means of this device. However, when two optically intact fish, which fought in the light, were placed in the same respirometer in total darkness the destructive activity was completely eliminated. They survived the four-day test period and at this writing are still living. When unable to see, they are likewise unable to destroy each other. These consumed a mean of 0.87 cc. O₂ per liter per fish. The results of ten respiratory metabolism tests on two optically intact river fish in complete darkness are shown in Table III.

A single optically intact fish, No. 4, which

TABLE III. TWO EYED FISH, NO. 2 AND NO. 3, IN AN ACTIVE STATE TESTED IN TOTAL DARKNESS.

No. 2: S. L. = 5.6 cm. WT. = 4 g.

No. 3: S. L. = 6.0 cm. WT. = 5.6 g.

All tests run for 2 hours. pH 7 in all but last which was 6.9.

Date	Temp.	cc. O ₂ /1 Original Sample	cc. O ₂ /1 Consumed
8/27	23°	5.16	1.25
8/28	23°	4.89	1.61
8/28	24°	4.54	1.54
8/28	24°	4.75	1.19
8/29	25°	4.54	1.96
8/29	26°	4.47	1.68
8/29	27°	4.40	1.54
8/29	27°	4.72	1.91
8/30	27°	3.84	2.10
8/30	27°	4.26	2.52
Average		4.56	1.73 = .87 per fish
Average B.O.D. = + .06 cc. O ₂ /1			

had been living alone since hatching, was tested in the respirometer. This fish remained in the normal quiescent state throughout the test period. It consumed a mean of 0.63 cc. O_2 per liter in the light and 0.73 cc. O_2 per liter in darkness, thus showing an increase in consumption. The results of ten tests in the light and ten tests in the dark are shown in Table IV.

Ten tests were performed on five immature optically intact fish in the light and ten tests in total darkness. It was possible to make such tests in the light because the fighting previously mentioned does not appear before maturity is reached. They consumed a mean of 0.22 cc. O_2 per liter per fish in the light and 0.28 cc. O_2 per liter per fish in darkness.

Effect of darkness on oxygen consumption of blind fish.

The respiratory metabolism of a single blind fish was taken in the daylight and in total darkness. This fish consumed a mean of 1.30 cc. O_2 per liter in the light and 1.02 cc. O_2 per liter in darkness. The results of ten tests in the light and ten tests in the dark are shown in Table VI.

Two blind fish were tested in the respirometer in daylight and in total darkness. Unlike

TABLE IV. EYED FISH NO. 4 IN A PASSIVE STATE.

S. L. = 5.5 cm. WT. = 3.8 g.

All tests run for 2 hours. pH 7 in all cases.

A. Tested in daylight.

Date	Temp.	cc. O_2 /1 Original Sample	cc. O_2 /1 Consumed
8/21	27°	3.14	.63
8/21	27°	3.42	.77
8/22	27°	3.70	.77
8/22	27°	3.35	.63
8/22	27°	3.98	.70
8/23	26.5°	4.19	.49
8/23	26.5°	4.95	.60
8/23	26.5°	4.75	.56
8/24	23°	4.75	.70
8/24	23°	5.23	.41
Average		4.15	.63

Average B.O.D. = + .03 cc. O_2 /1

B. Tested in total darkness.

8/25	22°	5.09	1.04
8/25	22.5°	5.02	.69
8/25	22°	5.02	.54
8/27	22.5°	5.16	.90
8/27	23°	4.89	.56
8/27	23°	5.09	.62
8/28	23°	4.95	.76
8/28	24°	5.16	.62
8/28	24°	4.89	.84
8/29	25°	4.47	.77
Average		4.97	.73

Average B.O.D. = + .03 cc. O_2 /1

TABLE V. TESTS ON FIVE IMMATURE OPTICALLY INTACT FISH.

Average S. L. = 3.0 cm.

Total WT. = 6.1 g.

All tests run for 2 hours. pH 7 in all cases.

A. Tested in daylight.

Date	Temp.	cc. O_2 /1 Original Sample	cc. O_2 /1 Consumed
8/23	26.5°	4.26	.98
8/23	26.5°	4.68	1.19
8/23	26.5°	4.61	.91
8/24	23°	4.54	1.05
8/24	23°	5.16	1.46
8/24	23°	5.51	.90
8/25	22°	5.16	1.11
8/25	22.5°	4.95	.83
8/25	22°	5.23	1.25
8/27	22.5°	5.02	1.18
Average		4.91	1.09

Average B.O.D. = + .03 cc. O_2 /1

B. Tested in total darkness.

8/29	27°	4.72	1.02
8/29	27°	4.95	.97
8/30	27°	4.33	1.26
8/30	27°	4.40	1.33
8/30	28°	4.75	1.26
8/30	29°	4.47	1.47
8/31	28°	4.61	1.75
8/31	29.5°	4.19	1.33
8/31	29.5°	3.91	1.40
9/ 1	28°	4.19	1.96
Average		4.45	1.36

Average B.O.D. = + .03 cc. O_2 /1

the paired eyed fish they were not at all disturbed in the 2 liter test jar. They consumed a mean of 0.98 cc. O_2 per liter per fish in the light and 0.93 cc. O_2 per liter per fish in darkness. The results are shown in Table VII.

Five immature blind fish, approximately the same size as the five immature eyed fish, were tested in daylight and in complete darkness. They consumed a mean of 0.27 cc. O_2 per liter per fish in the light and 0.24 cc. O_2 per liter per fish in darkness. The results are shown in Table VIII.

The minimum, maximum and mean values of Tables II to VIII are summarized in Table IX. A graphic presentation of the minimum, mean and maximum values is made in Text-fig. 2. This shows more clearly the relationships involved.

DISCUSSION.

During the early experiments the eyed river fish rested quietly in schools, showing no signs of movement other than those necessary to carry on the respiratory process. This quiescent state is normal to this species and is described in detail by Breder and Gresser (1941a). After several days of experimentation the reserve fish in the reservoir tank suddenly lost this quiet aggregat-

ing tendency. They chased each other about the tank and picked at one another. Their entire social attitude was altered. A few of these fish soon died. On examination it was found that the caudal fin was injured in a few cases and in others the gills were frayed. The remaining fish, which continued chasing one another, were separated into individual tanks to prevent further destruction. Nothing had been added to the tank and nothing had been changed. These reserve fish had been fed routinely each day. This same phenomenon was noted by Breder (1943) who wrote: "This school of fish [*Astyanax mexicanus* (Filippi)] grew and fed voraciously, showing full vigor until November 1. On routine examination of the aquaria it was found on the morning of the next day that most of the fish were dead and about half a dozen, still alive, were huddled in a tight school and very evidently in serious difficulty, showing their darkest phase. Later that day they too expired. On examination, each fish was seen to have its tail fin at least half gone. There was nothing else present in the aquarium except sand, aquatic plants and an aeration tube. Six other aquaria containing sibs of these, in greater or less numbers, were all in perfect order as all of them had been for months.

"Whatever happened in this aquarium is

TABLE VI. BLIND FISH No. 5.

S. L. = 5.3 cm. WT. = 3 g.

All tests run for 2 hours. pH 7 in all cases.

A. Tested in daylight.

Date	Temp.	cc. O ₂ /1 Original Sample	cc. O ₂ /1 Consumed
8/25	22°	5.16	1.18
8/25	22.5°	5.02	1.67
8/25	22°	4.95	1.11
8/27	22.5°	5.02	.90
8/27	23°	5.02	1.25
8/27	23°	4.89	1.40
8/28	23°	4.69	1.54
8/28	24°	4.89	1.40
8/28	24°	4.68	1.12
8/29	25°	4.54	1.40
Average		4.89	1.30

Average B.O.D. = + .03 cc. O₂/1

B. Tested in total darkness.

8/21	27°	3.49	.56
8/21	27°	3.33	.70
8/22	27°	3.63	.77
8/22	27°	3.35	1.12
8/22	27°	3.77	1.26
8/23	26.5°	4.19	1.40
8/23	26.5°	4.33	.63
8/23	26.5°	4.95	1.11
8/24	23°	4.68	1.26
8/24	23°	5.37	1.40
Average		4.11	1.02

Average B.O.D. = + .03 cc. O₂/1

TABLE VII. TWO BLIND FISH, No. 6,
AND No. 7

No. 6: S. L. = 4.9 cm. WT. = 2.7 g.

No. 7: S. L. = 6.0 cm. WT. = 4.2 g.

All tests run for 2 hours. pH 7 in all cases.

A. Tested in daylight.

Date	Temp.	cc. O ₂ /1 Original Sample	cc. O ₂ /1 Consumed
8/29	26°	4.47	1.61
8/29	27°	4.82	2.20
8/29	27°	4.61	1.12
8/30	27°	4.40	1.82
8/30	27°	4.26	1.75
8/30	28°	4.40	2.24
8/30	29°	4.26	2.24
8/31	28°	4.40	2.31
8/31	29.5°	3.70	2.24
8/31	29.5°	3.49	1.96
Average		4.28	1.95

Average B.O.D. = - .01 cc. O₂/1

B. Tested in total darkness.

8/22	27°	3.49	2.30
8/22	27°	2.79	1.88
8/22	27°	3.63	2.72
8/23	26.5°	3.97	2.09
8/23	26.5°	4.68	1.61
8/23	26.5°	4.89	1.26
8/24	23°	4.68	2.03
8/24	23°	4.89	1.47
8/24	23°	5.51	1.88
8/24	23°	5.02	1.32
Average		4.36	1.86

Average B.O.D. = + .02 cc. O₂/1

not entirely clear but it evidently triggered off something in the nature of a 'free for all' in which not a single fish triumphed or survived. There was no question of lack of food as they had been fed each day, including the morning of November 1. Although I have had a considerable experience with a wide variety of fishes in captivity no such sudden or complete self destruction had been previously experienced."

Since this same peculiarity was noted on two different occasions with no apparent reason, it may mean that this sudden appearance of fighting is inherent in the life cycle of the species under certain conditions or that they are so sensitive to slight disturbances that, as in the present case, transference to the reservoir tank from the tank in which they had been living since hatching initiated this change.

The mean daily readings of oxygen consumption of the specimen which was measured during its change from a passive to an active state, suitably adjusted, are given graphically in Text-fig. 2. It will be noted that the comparative means given for other fish show that this specimen passed, between the second and third day, from the range of eyed fish in the resting stage to the range of

TABLE VIII. FIVE IMMATURE BLIND FISH.

Average S. L. = 3.0 cm.

Total WT. = 2.1 g.

All tests run for 2 hours. pH 7 in all cases.

A. Tested in daylight.

Date	Temp.	cc. O ₂ /1 Original Sample	cc. O ₂ /1 Consumed
8/17	27°	3.77	1.12
8/17	27°	3.70	1.40
8/20	26.5°	3.84	.84
8/20	27°	3.56	.77
8/20	27°	3.98	1.05
8/21	27°	3.49	2.23
8/21	27°	3.35	2.02
8/21	27°	3.21	1.68
8/22	27°	3.63	1.19
8/22	27°	3.35	1.33
Average		3.59	1.36

Average B.O.D. = + .08 cc. O₂/1

B. Tested in total darkness.

8/29	26°	4.72	1.23
8/29	27°	4.89	.98
8/29	27°	4.89	.70
8/30	27°	4.19	.91
8/30	27°	4.61	1.12
8/30	28°	4.82	1.19
8/30	29°	4.61	1.26
8/31	28°	4.61	1.40
8/31	29.5°	4.33	1.54
8/31	29.5°	4.19	1.47
Average		4.59	1.18

Average B.O.D. = - .01 cc. O₂/1

not only other active eyed fish but also to that normal to the blind fish.

The data of Tables II and III indicate that darkness has a quieting effect on the eyed fish when they are in the highly active, turbulent state, similar to that on the blind fish. However, the oxygen consumption readings in the dark do not reach the low values characteristic of these fish in the normal resting state as is shown in Text-fig. 2.

Eyed fish No. 4, which remained in the "normal" quiescent state throughout the experiments, on the other hand, consumed more oxygen in the dark, as shown in Table IV, than in the light. This indicates that the eyed fish is swimming more actively in the dark in the absence of any possible visual fixation. Apparently the eyed fish, when unable to see, resort to a wandering motion characteristic of the blind individuals. Breder and Rasquin (1943) showed that eyed river fish in which the optic nerve had been severed took on the essential wandering behavior of the naturally blind fish. One may conclude from this that the contrasting locomotor behavior in the genetically related blind and eyed fish is a matter of vision and its lack. Schlaifer (1939) found that an isolated goldfish shows a higher rate of oxygen

consumption in the light than in the dark. The isolated animal, subjected to no stimuli from other fishes, is affected only by the change in illumination, and its activity in the dark is diminished. The effect of such a change in illumination on the eyed characins, under similar conditions, is exactly opposite. Evidently this difference is rooted in the inherent difference between the behavior of the two species, the characins normally remaining quiet and the goldfish generally moving about.

Table V shows that five immature optically intact fish consume more oxygen in the dark than in the light. This agrees with the results obtained in Table IV. When these fish are unable to see each other, they are likewise unable to form quiescent schools. This loss of visual inhibition of activity results in increased swimming and consequently greater oxygen consumption.

An analysis of the mean oxygen consumption values of Tables VI, VII, VIII and IX, B, for the blind characins shows a definite increase in oxygen uptake when these animals are tested in the light. This is clearly shown in Text-fig. 2. The means represent 60 tests on the blind animals and the daylight increase in oxygen consumption is consistent throughout. Since locomotor activity is proportional to oxygen consumption, thus evidently swimming speed is greater in the daylight than in the dark. This is consistent with the work of Breder and Gresser (1941b) who demonstrated by means of a gradient trough that the blind fish are slightly but significantly negative to light.

An examination of Text-fig. 2 indicates that in the active state the oxygen consumption values of eyed fish tend to approach that of their blind relatives, both in light and in darkness. This figure also indicates more clearly that light is an extremely important factor in determining the locomotor habits of the animal.

Also shown is the behavior of five immature optically intact fish and five immature blind fish. It will be noted that the two groups show opposite trends in reference to light and darkness. The increased consumption of the eyed fish in the dark is evidently due to a loss of the "group effect."

Text-fig. 2 also indicates that when the blind fish are tested in groups of two their oxygen consumption is lower than when tested individually and the difference between light and darkness is much less. Breder and Rasquin (1943) detected a slight "group effect" in the blind fish. This point is further supported by these lowered oxygen consumption results. Since the oxygen consumption of grouped animals is lowered both in the light and in the dark, it indicates that the "group effect" in the blind animals is due to factors other than light sensitivity. Determining the nature of these factors is beyond the scope of the present paper.

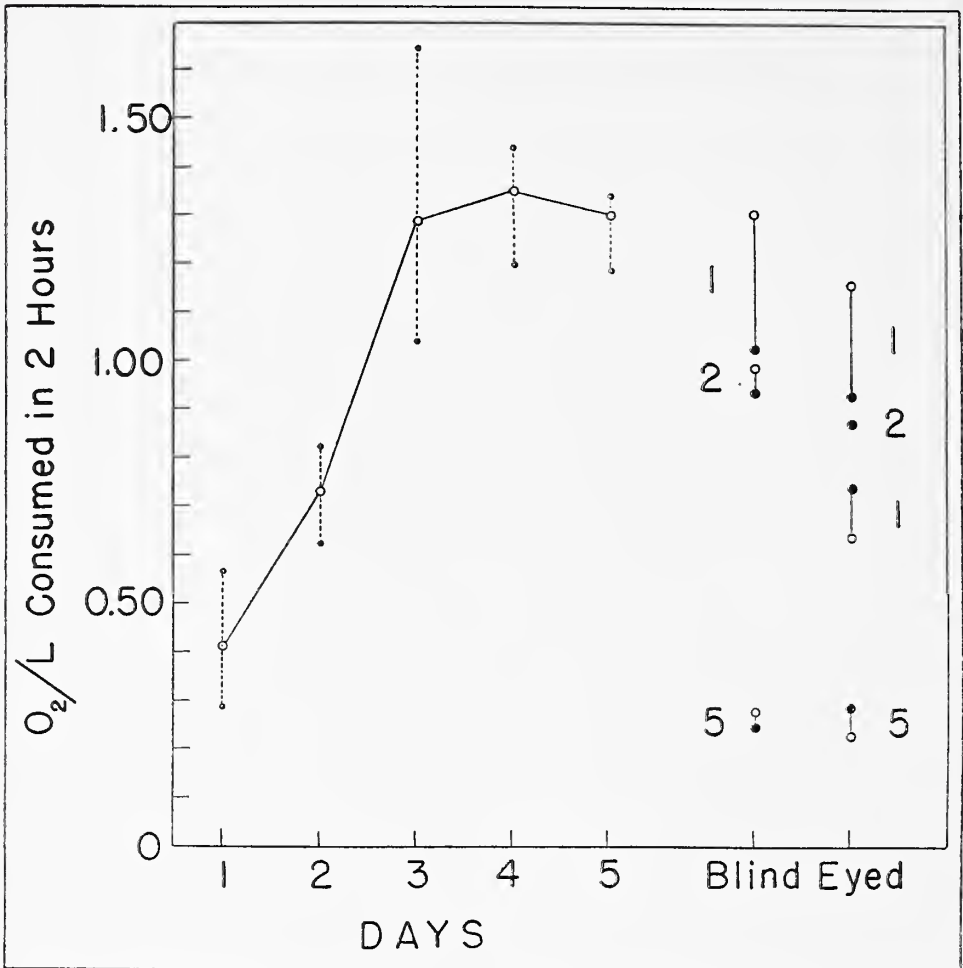

TEXT-FIG. 2. Oxygen consumption charts. The graph covering a five-day period is the data of Table I in which the hourly readings have been weighted to agree with those covering two hours. The large circles connected by a solid line represent the daily mean. The small circles connected by dotted lines represent the daily maximum and minimum reading. The light and dark circles over "Blind" and "Eyed" represent the mean values obtained in light and darkness respectively. In each case they are connected by a solid line. The large numerals indicate the number of fish present in the test chamber. The data are from Tables II to VIII inclusive.

The two optically intact and active fish tested in darkness and shown in Text-fig. 2 show less oxygen consumption than the lone one. This further supports the fact that eyed fish, in the dark, act like their blind relatives. The form of blind fish from Cueva de los Sabinos in which the optic nerve has disappeared and which is indifferent to light, Breder (1944), would be expected, on that basis, to show no change in oxygen consumption correlated with light and darkness. At the time the present experiments were made no specimens of this form were available.

A comparison of the various values obtained do not yield p values, in most cases, necessary to establish an unequivocal statistical separation. However, the biological and

statistical validity of these results may be checked in a quite different way, the actual meaning of the p value check in this case indicating that due to the relatively large amount of individual variation 20 tests are not sufficient to show unequivocally separation in that fashion. However, since we already know that eyed characins are largely quiescent in the light due to the principle of optical fixation and when blinded take on the active wandering of the normally blind fish, it is a foregone conclusion that the passive eyed fish would consume more oxygen in the dark than in the light, which they do according to these mean values. Contrariwise the blind and the active eyed fish all agree in reducing their oxygen consump-

TABLE IX. COMPARISON OF DATA.

A.	
Light	Dark
Eyed No. 4 (quiescent)	Eyed No. 4
Min. .41	Min. .54
Aver. .63	Aver. .73
Max. .77	Max. 1.04
Eyed No. 1 (fighting)	Eyed No. 1
Min. .98	Min. .55
Aver. 1.15	Aver. .92
Max. 1.54	Max. 1.47
	Two Eyed, Nos. 2, 3
	Min. 1.19 = (0.60) per fish
	Aver. 1.73 = (0.87) per fish
	Max. 2.52 = (1.26) per fish
Five Immature Eyed	Five Immature Eyed
Min. .83 = (0.17) per fish	Min. .97 = (0.19) per fish
Aver. 1.09 = (0.22) per fish	Aver. 1.38 = (0.28) per fish
Max. 1.46 = (0.29) per fish	Max. 1.96 = (0.39) per fish
Blind No. 5	Blind No. 5
Min. .90	Min. .56
Aver. 1.30	Aver. 1.02
Max. 1.67	Max. 1.40
Two Blind Nos. 6, 7	Two Blind Nos. 6, 7
Min. 1.12 = (0.56) per fish	Min. 1.26 = (0.63) per fish
Aver. 1.95 = (0.98) per fish	Aver. 1.86 = (0.93) per fish
Max. 2.31 = (1.16) per fish	Max. 2.72 = (1.36) per fish
Five Immature Blind	Five Immature Blind
Min. .77 = (0.15) per fish	Min. .70 = (0.14) per fish
Aver. 1.36 = (0.27) per fish	Aver. 1.18 = (0.24) per fish
Max. 2.23 = (0.45) per fish	Max. 1.54 = (0.31) per fish

B.

Comparison of mean values.

Figures in parentheses represent the average per fish of specimens in groups.

EYED				
Fish No.	Light	Dark	Difference	
4	0.63	0.73	+ 0.10	
1	1.15	0.92	- 0.23	
Means	0.89	0.83	- 0.06	
2, 3	—	1.73 (0.87)	—	
five immature	1.09 (0.22)	1.38 (0.28)	+ 0.29 (0.06)	

BLIND				
Fish No.	Light	Dark	Difference	
5	1.30	1.02	- 0.28	
6, 7	1.95 (0.98)	1.86 (0.93)	- 0.09 (0.05)	
five immature	1.36 (0.27)	1.18 (0.24)	- 0.18 (0.02)	

Comparison of like groups.

Group Size	Light		Dark		Difference	
	Eyed	Blind	Eyed	Blind	Eyed	Blind
1 fish	1.15		0.92		- 0.23	
	0.89	1.30	0.83	1.02	- 0.06	- 0.28
	0.63		0.73		+ 0.10	
2 fish	—	0.98	0.87	0.93	—	- 0.05
5 imms.	0.22	0.27	0.28	0.24	+ 0.06	- 0.03

tion in dark. Since there are six separate sets of paired experiments in each case the random chance of reaching this agreement is of inconsequential size. Furthermore, there is an acceptable value for p when the passive eyed fish are compared with either the active eyed and the blind fish and of course with the juveniles, on a size basis.

Hyman (1940) discusses at length the fact that many types of invertebrates show negative phototaxis. A brief survey of invertebrate classes as discussed by Hyman shows that (1) non-green protozoa are negative to light, (2) many medusae indicate perception of light intensity by avoidance of bright sunlight. They appear at the surface in the morning or late afternoon and descend in midday. Clouding of the sky may bring them to the surface at any time. (3) Light accelerates the pulsation rate in normal specimens of *Aurelia* but has no such action after extirpation of the eye spots. (4) Many hydromedusae are indifferent to light, but some have definite responses, accelerating their swimming and exhibiting increased activity in the daylight although avoiding direct sunlight. The blind characins exhibit reactions to light which would seem to be not dissimilar in a broad sense, especially in reference to item 4.

The negative phototaxis exhibited by the blind characins, characterized by an increased oxygen consumption and increased swimming speed, would seem to be a factor leading to cave entry. Since the blind fish swim faster in the light than in the dark, they would automatically gravitate to dark places such as caves and tend to stay there, considering only the mechanical results of such reactions. Since the opposite is true of the eyed fish when in the normal non-fighting condition, they in turn, on the same basis, would tend to stay out of caves.

Obviously in a state of nature the situation would involve many other factors. Thus the coming of night would equalize the light differential within and without caves. This in fact may be an important effect in the entry of eyed fishes into caves with a subsequent inability to find their way out. The presence of predators in the outside waters and their evident absence in caves and numerous other factors increase the complications to be expected in a state of nature but do not override the basic importance of the differentials in locomotor behavior between the seeing and the blind fish as here demonstrated.

SUMMARY.

1. The eyed river fish exhibit two very distinct phases of behavior, a turbulent fighting state and a quiescent state.

2. In light the blind cave fish, due to a constant wandering activity, consume more oxygen than eyed river fish, when the latter are in a quiescent schooling state.

3. In total darkness, eyed fish in the resting state increase their oxygen consumption to a point where it approaches that of the blind fish. The above is interpreted to indicate that eyed fish assume the wandering behavior of the blind animals when in the dark.

4. Eyed fish in the highly active state consume less oxygen in the dark than in the light. The decreased oxygen consumption in the dark approaches the values obtained for the blind fish.

5. The contrasting locomotor behavior of the eyed and blind fish, as evidenced by their differential locomotor activity, is clearly based on vision and its lack.

6. The blind fish consume more oxygen in the light than in the dark. This indicates a greater swimming speed in the light which would tend to cause these fish to spend more time in the dark. This would seem to be a factor in cave entry and cave retention. The eyed fish, when in the non-fighting condition, show opposite effects with an opposite relationship to cave entry.

7. Two blind fish, in a given volume of water, consume less oxygen than when tested individually in the same volume of water thus evidencing the "group effect" common to other forms and indicating the extent of these effects on each other.

8. It is impossible to test two optically intact fish in the same chamber, since they destroy each other, evidently because of too great a constrained association.

BIBLIOGRAPHY.

ADKINS, M.

1930. A method for determining basal metabolism of fishes. *Proc. Soc. Exp. Biol. Med.*, vol. 28, pp. 259-263.

ALLEE, W. C., AND R. OESTING

1934. A critical examination of Winkler's method for determining dissolved oxygen in respiration studies with aquatic animals. *Physiol. Zool.*, vol. 7, pp. 509-541.

AMERICAN PUBLIC HEALTH ASSOCIATION

1943. Standard methods for the examination of water and sewage. Eighth edition. New York, xiv + 309 pp.

BREDER, C. M., JR.

1942. Descriptive ecology of La Cueva Chica, with especial reference to the blind fish, *Anoptichthys*. *Zoologica*, New York, vol. 27, pp. 7-15.

1943. A note on erratic viciousness in *Astyanax mexicanus* (Phillipi). *Copeia*, no. 2, pp. 82-84.

1944. Ocular anatomy and light sensitivity studies on the blind fish from Cueva de los Sabinos. *Zoologica*, New York, vol. 29, pp. 131-143.

- BREDER, C. M., JR., AND E. B. GRESSER
 1941a. Correlations between structural eye defects and behavior in the Mexican blind characin. *Zoologica*, New York, vol. 26, pp. 123-131.
 1941b. Further studies in the light sensitivity and behavior of the Mexican blind characins. *Ibid.*, vol. 26, pp. 289-296.
- BREDER, C. M., JR., AND R. F. NIGRELLI
 1938. The significance of differential locomotor activity as an index to the mass physiology of fishes. *Zoologica*, New York, vol. 23, pp. 1-29.
- BREDER, C. M., JR., AND P. RASQUIN
 1943. Chemical sensory reactions in the Mexican blind characins. *Zoologica*, New York, vol. 28, pp. 169-200.
- ESCOBAR, R. A., R. P. MINAHAN, AND R. J. SHAW
 1936. Motility factors in mass physiology: locomotor activity of fishes under conditions of isolation, homotypic grouping, and heterotypic grouping. *Physiol. Zool.*, vol. 9, pp. 66-78.
- ETKIN, W., R. W. ROOT, AND B. P. MOFSHIN
 1940. The effect of thyroid feeding on oxygen consumption of the goldfish. *Physiol. Zool.*, vol. 13, pp. 415-429.
- HUBBS, C. L., AND W. T. INNES
 1936. The first known blind fish from the family Characidae: a new genus from Mexico. *Occas. Papers Mus. Zool. Univ. Michigan*, no. 342, pp. 1-7.
- HYMAN, L. H.
 1940. The invertebrates: Protozoa through Ctenophora. New York, xi + 726 pp.
- KEYS, A. B.
 1930. The measurement of the respiratory exchange of aquatic animals. *Biol. Bull.*, vol. 59, pp. 187-198.
- SCHLAIFER, A.
 1938. Studies in mass physiology: effect of numbers upon the oxygen consumption and locomotor activity of *Carassius auratus*. *Physiol. Zool.*, vol. 11, pp. 408-424.
 1939. An analysis of the effect of numbers upon the oxygen consumption of *Carassius auratus*. *Ibid.*, vol. 12, pp. 381-392.
- SCHUETT, J. F.
 1933. Studies in mass physiology: the effect of numbers upon the oxygen consumption of fishes. *Ecology*, vol. 14, pp. 106-122.
 1934. Studies in mass physiology: the activity of goldfish under different conditions of aggregation. *Ibid.*, vol. 15, pp. 258-262.
- SHAW, R. J., R. A. ESCOBAR, AND F. M. BALDWIN
 1938. The influence of temperature and illumination on the locomotor activity of *Carassius auratus*. *Ecology*, vol. 19, pp. 343-346.
- WELLS, N. A.
 1935. The influence of temperature upon the respiratory metabolism of the Pacific killifish, *Fundulus parvipinnis*. *Physiol. Zool.*, vol. 8, pp. 196-227.

3.

Evidence for the Lack of a Growth Principle in the Optic Cyst of Mexican Cave Fish.

C. M. BREDER, JR.

AND

PRISCILLA RASQUIN.

The American Museum of Natural History.

(Text-figures 1 & 2).

INTRODUCTION.

Because studies in another group of animals yielded evidence of some physiological influence on growth and sexual development which was evidently based on retinal elements, it became necessary to determine the presence or absence of such an influence in the Mexican cave fish (*Anoptichthys*) before proceeding with other experiments in which such an influence would have to be considered.

Specifically Browman (1940) reported that rats enucleated on the day of birth had a slower growth rate regardless of what light conditions they were reared under, and postulated that some "principle" was elaborated by the retina which was essential to normal growth and sexual development. On the other hand Detwiler and Copenhaver (1940) found that such treatment did not interfere with the growth of *Amblystoma* larvae.

Since in the studies concerned with the Mexican cave characins we are dealing with a series of fishes grading from fully eyed specimens from without the caves to blind cave forms with a remnant capsule which is still light sensitive and finally to a form which has lost this sensitivity, it is necessary in any experimental work concerned with the growth and development of these fishes to determine if the presence or absence of retinal elements is in any way involved. On a basis of general observation it had been noted that the eyed river fish attained the largest size of any and the light insensitive the least and reproductive activity in aquaria was successful in decreasing order in the same series. For a discussion of the differences and similarities between these graded forms in regard to morphology and behavior see Breder (1942, 1943, 1944 and 1945), Breder and Gresser (1941a and b), Breder and Rasquin (1943) and Gresser and Breder (1940).

The experimental part of this work was carried on in the laboratories of the Department of Animal Behavior and assist-

ance was obtained from Mr. W. Sutcliffe and Mr. W. Tavalga who attended to feeding and similar matters.

MATERIALS AND METHODS.

Since the blind fish from La Cueva Chica, *Anoptichthys jordani* Hubbs and Innes, possess a blind but light sensitive cyst in the orbital cavity and since it may be removed with ease and impunity and results in, so far as is evident, only a loss of the light sensitivity, this form was used for the present studies. Another fact in determining this was that they are obtainable in quantity in a pure breed line. The fishes used actually represented the eleventh generation of tank reared fishes.

For any experiments involving the growth of fishes it is necessary to be particularly cautious that the ecological conditions established in one tank of standing water do not differ from another. As this is almost impossible to insure for any length of time, the problem was circumvented by connecting all the aquaria by glass tubing and slowly circulating the water through them. This guaranteed that the water in all would have the same temperature, chemical quantities and that the micro flora and fauna would be substantially similar. This arrangement was in fact essential because the experiment called for some of the aquaria being kept in the dark and others in the light which, without this provision, would have developed quite different ecological conditions.

In detail six aquaria measuring 2' × 1' × 1' were connected in a closed circuit as is indicated in Text-fig. 1. The three upper aquaria, A, B and C, were exposed to light and an overflow from C connected with the three lower aquaria D, E and F which were in darkness. A small motor-driven hard rubber pump lifted the water from a receiving reservoir and delivered it to A at about 200 cc. per minute. A program switch allowed the pump to operate on alternate hours. The glass tubing was covered with black tape

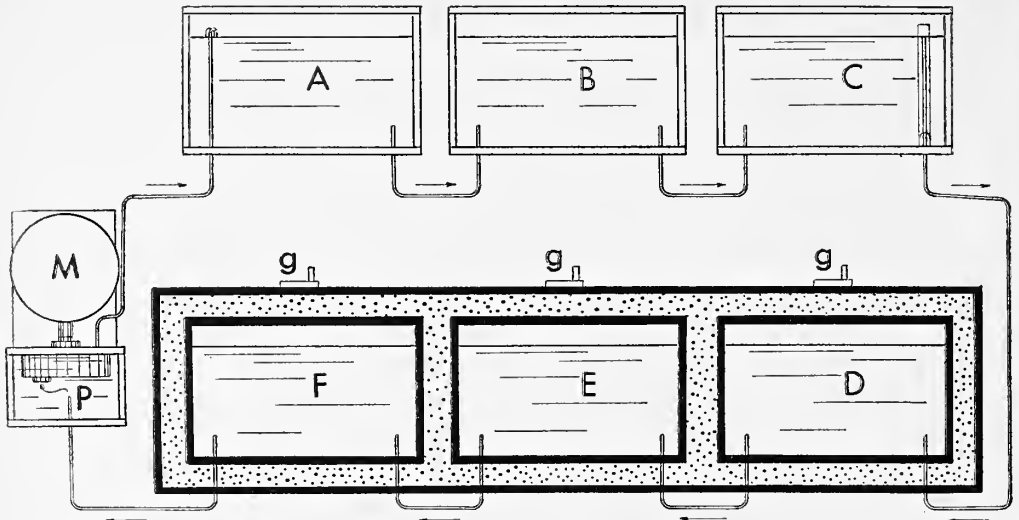

TEXT-FIG. 1. Diagram of closed circulation for the maintenance of identical water conditions in aquaria in light and darkness. *M*, motor. *P*, pump. *g*, gate for feeding.

and bent through several right angles in order to prevent light entering the dark aquaria.

Since, for the duration of the experiment, it was necessary not to expose the fishes in the dark aquaria to light at any time, it was necessary to provide some means of introducing food. To this end an arrangement was provided in the cover over each aquarium in the dark to permit such feeding, which is indicated by *g* in Text-fig. 1. A three-quarter inch hole was bored through the cover as shown in Text-fig. 2. This was protected by two small boards, one on top and one under the cover, which were rigidly connected by a bolt as is shown in detail in Text-fig. 2B. The upper board was provided with a simple handle as indicated. Thus the two small boards would move in unison with the bolt as a pivot when the handle was appropriately operated. A stop in the form of a small screw prevented complete rotation. Text-fig. 2A shows the apparatus in one position and the curved arrow shows the amount and direction of travel. It will be noted that at all times one board or the other blocks the passage of light through the hole in the cover.

In actual operation the device was set in the position shown in Text-fig. 2A and the required amount of food placed in the hole in the cover. Then the device was rotated as shown by the arrow. When it had been swung through the complete arc the upper board covered the hole in the cover but the lower one did not, which permitted the contents of the hole to fall to the water below. Since granular dried food was used throughout this operated satisfactorily.

Twenty-five fish were placed in each of the

six aquaria according to the following schedule.

Aquaria in light

- A. Fish with ocular cyst removed.
- B. Fish with optic nerve cut.
- C. Control.

Aquaria in darkness

- D. Fish with ocular cyst removed.
- E. Fish with optic nerve cut.
- F. Control.

All the 150 fish were individually anesthetized with a 1 per cent. solution of urethane made up with the water from the aquarium. They were immersed in this until immobilized. They were then measured, weighed and operated upon. The aquaria, D, E and F, were not covered for two days to be certain that any possible delayed mortality could be checked.

The fish were measured again at an intermediate time and at the termination of the experiment. Except for the second measurement the fish kept in dark tanks were at no time exposed to light.

When the experiment was well along to completion an accident happened to the circulating system which resulted in the death of some fishes in the dark aquaria. This could have vitiated the entire operation were it not for the fact that the results obtained, because of their nature, are demonstratively independent of this unplanned incident. The only other losses were due to a kidney disorder, which has been mentioned by Nigrelli (1943).

EXPERIMENTAL RESULTS.

Since the experimental results were all obtained as numerical quantities, they may

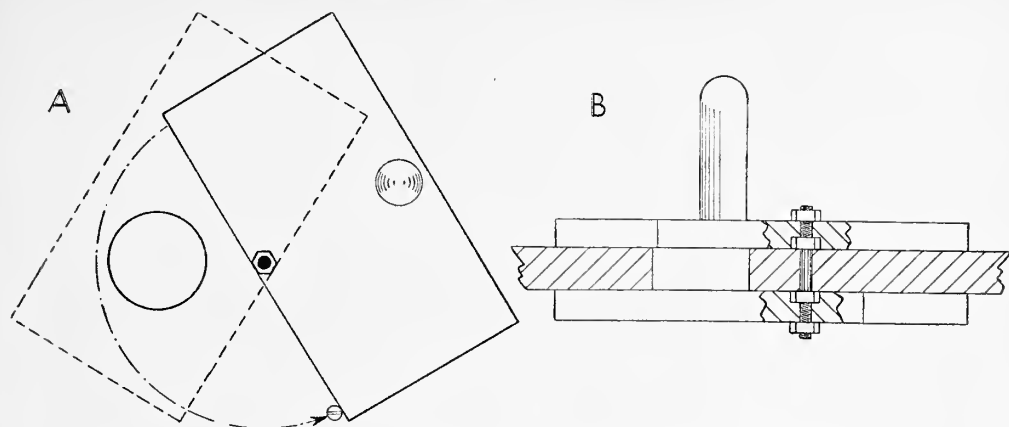
TEXT-FIG. 2. Feeding gate. **A**, plan view. **B**, elevation in cutaway section.

best be presented as a table of comparative values. These figures are given in Table I which includes dates, duration, standard lengths, mean weights, extent of mortality and measures of significance of the various comparative values.

The fish were operated on as soon as they were large enough to make it physically practicable, that is at about 20 mm. in standard length. The experiment was terminated when the fish had nearly doubled that length and increased in weight proportionally.

The aquaria in light, A, with cyst removed, B, with nerve cut and C, the control, on statistical analysis show that there has been no measurable difference in the growth of these fishes during this period of life where their growth is most active. Comparing these as samples they could have all been taken from a single population as in each case d/σ_d is much less than 3. Actually

the control tank showed slightly less growth in length than the other two while on the other hand it showed a greater growth in weight.

The tanks in darkness, D, with cyst removed, E, with nerve cut, and F, the control, were as previously noted damaged by an accident which killed all the fish in F and all but three in E. The tank D, which also was heavily involved in this trouble, nevertheless on statistical analysis shows no significant difference from those in light, yielding a value for d/σ_d very much less than 3.

Tank F in which only three fish remained cannot be compared in this manner because of the small numbers and if the χ^2 method is applied a P value of less than 0.01 is obtained which could, in a mathematical sense, be used to suppose that these fish in fact did have a different mean. However, other matters of a non-mathematical nature

TABLE I. CHANGES IN LENGTH AND WEIGHT UNDER VARIOUS CYST CONDITIONS.

MEAN GROWTH RATE

Numbers in parentheses indicate number of fishes.

AQUARIUM	MEAN MM. IN STANDARD LENGTH			INCREASE		$\Sigma (d^2)$	
	8/12/45	12/5/45	2/13/46	MM.	%	DAY 0	DAY 189
A	20.4 (25)	34.5 (16)	38.2 (14)	17.6	84	53.000	118.375
B	20.5 (25)	34.3 (18)	38.2 (16)	18.3	88	68.260	297.000
C	20.5 (25)	34.7 (20)	39.8 (19)	17.4	80	26.240	144.526
D	20.0 (25)	34.4 (14)	36.4 (13)	16.3	82	58.090	133.077
E	20.8 (25)	30.0 (3)	32.7 (3)	11.8	56	43.600	9.145
F	21.0 (25)	24.960	..
		MEAN WEIGHT IN GRAMS		GRAMS		%	
A	0.43	1.25	1.54	1.11	258		
B	0.36	1.28	1.67	1.31	364		
C	0.25	1.27	1.77	1.52	604		
D	0.26	1.29	1.79	1.53	588		
E	0.35	0.93	1.32	0.97	278		
F	0.29		

can be used to rule this out as is indicated in the discussion. The statistical notations and methods are those of Simpson and Roe (1939).

DISCUSSION.

It has been shown that there is no statistical difference to the growth means of blind fish from La Cueva Chica under several conditions; with cyst removed in either light or darkness and those with no operation and those with the nerve cut in light. The single case of those with the optic nerve cut which were kept in darkness, on a mathematical basis alone, might be so interpreted. However, it is unreasonable to suppose that they would actually show such a difference if there had been a sufficient number when it is recalled that those with the cyst completely removed show no such possibility and agree with three separate conditions in regard to the cyst of those kept in light. In fact the whole group shows remarkably uniform growth compared to the generality of aquarium reared fishes, which can only be credited to the circulating water arrangement.

Therefore it can be concluded that during the most actively growing period of these fishes, where they double their length in about six months, any possible effect of such retinal influence is either altogether absent or of such slight effect as to be impossible of detection by this method.

Consequently it seems likely, as might have been supposed on general considerations, that fishes behave more in a manner in accordance with amphibians than they do with mammals. Also it makes possible the disregarding of this factor in any ordinary problems of growth in these fishes.

After the experiment was terminated the fishes were retained for other purposes. Later, on examination in other connections, it was found that all types showed a perfectly normal gonadal development.

The purpose of these experiments was to determine if there was a growth or developmental function that could be ascribed to the remnant retinal elements in the optic cysts of the blind fish. Since, as has already been mentioned, the eyed river fish attain a somewhat larger size, a natural continuation would be to undertake experiments implanting or injecting retinal extracts into these blind fish in a manner analogous to the work of Browman and Browman (1944). If positive results were obtained one would then be in a position to indicate unequivocally that such an effect is present in fishes but the remnant left to the blind fish is too little to have its effects readily detected. The reverse experiment, that of blinding fish, is charged with so many practical difficulties that any retardation in growth, or the mere problem of keeping them in health for long

periods, introduces a considerable hazard to a satisfactory experiment.

SUMMARY.

1. There is no evidence for a role in growth and sexual development of the retinal elements in the blind optic capsule of the Mexican cave fish, *Anoptichthys jordani* Hubbs and Innes.
2. Fishes with optic cysts removed, with optic nerves cut and control fishes, in light and in darkness showed no statistical growth differences, nor other than normal development of the gonads.
3. In this respect these fishes evidently resemble conditions in amphibia rather than in mammals.
4. Further studies should be undertaken involving the injection or implantation of retinas from eyed fishes.
5. An arrangement for providing uniform ecological conditions in a series of aquaria in light and in darkness is described.

BIBLIOGRAPHY.

- BREDER, C. M., JR.
1942. Descriptive ecology of La Cueva Chica with especial reference to the blind fish, *Anoptichthys*. *Zoologica*, **27** (3): 7-15.
1943. Problems in the behavior and evolution of a species of blind cave fish. *Trans. N. Y. Acad. Sci.*, ser. 2, **5** (7): 168-176.
1944. Ocular anatomy and light sensitivity studies on the blind fish from Cueva de los Sabinos, Mexico. *Zoologica*, **29** (13): 131-144.
1945. Compensating reactions to the loss of the lower jaw in a cave fish. *Ibid.*, **30** (10): 95-100.
- BREDER, C. M., JR. AND GRESSER, E. G.
- 1941a. Correlations between structural eye defects and behavior in the Mexican blind characin. *Zoologica*, **26** (16): 123-131.
- 1941b. Further studies on the light sensitivity and behavior of the Mexican blind characins. *Ibid.*, **26** (28): 228-296.
- BREDER, C. M., JR. AND RASQUIN, P.
1943. Chemical sensory reactions of the Mexican blind characins. *Zoologica*, **28** (20): 169-200.
- BROWMAN, L. G.
1940. The effect of optic enucleation on the male albino rat. *Anat. Rec.*, **78** (1): 59-73.
- BROWMAN, L. G. AND BROWMAN, A. A.
1944. Effect of retinal extracts on growth of blinded male rats. *Proc. Soc. Exp. Biol. and Med.*, **57**: 171-173.

DETWILER, S. R. AND COPENHAVER, W. M.

1940. The growth and pigmentary responses of eyeless *Amblystoma* embryos reared in light and darkness. *Anat. Rec.*, **76** (2): 241-255.

GRESSER, E. B. AND BREDER, C. M., JR.

1940. The histology of the eye of the cave characin, *Anoptichthys*. *Zoologica*, **25** (10): 113-116.

NIGRELLI, R. F.

1943. Causes of diseases and death of fishes in captivity. *Zoologica*, **28** (22): 203-216.

SIMPSON, G. G. AND ROE, A.

1939. Quantitative zoology. McGraw-Hill Book Co., N. Y. pp. 1-414.

4.

Progressive Pigmentary Regression in Fishes Associated
With Cave Environments.

PRISCILLA RASQUIN.

The American Museum of Natural History.

(Plate I; Text-figure 1).

INTRODUCTION.¹

The Mexican blind characins which are derived from an eyed river form, *Astyanax mexicanus* (Filippi), are of several varieties. One of these, *Anoptichthys jordani* Hubbs and Innes, from La Cueva Chica, retains an optic capsule in various stages of degeneration and some degree of pigmentation, both of which evidently vary with the genetic constitution of the individual fish. The second variety, as yet undescribed, from Cueva de los Sabinos (see Alvarez, 1946) has a mere remnant of the optic capsule unconnected with the brain by any optic nerve and a pigmentary system which consists only of a few scattered melanophores (Breder, 1944). These chromatophores are so few in number that dispersion or concentration of their granules cannot bring about any noticeable difference in the coloration of the fish. The ancestral river form is characterized by large eyes and a considerable amount of black pigment. A dark stripe extends from behind the head to the tail, ending in a definite black spot just anterior to the caudal fin.

The pigmentation of these three forms showed a different quantitative reaction to conditions of light and darkness. The river fish conformed to the general pattern of chromatophore function, assuming a light phase when kept in darkness and an extremely dark phase when blinded and kept in light. The fish from La Cueva Chica kept in darkness were noticeably more pink in color and more translucent than those kept in light. On the other hand the Sabinos fish retained their translucent pinkish condition regardless of light conditions and in addition presented a yellowish appearance. This study was undertaken to determine what agents were responsible for these differences in coloration.

Most of the blind fishes studied in this report were brought from the Mexican caves by Mr. Benjamin J. Dontzin who was in charge of the expedition to Mexico sent out from the Department of Fishes and Aquatic Biology of the American Museum of Natural History in the spring of 1946.

The earlier part of the experimental work was carried out in the laboratories of the Department of Animal Behavior. The later portions were carried out in a laboratory of the Department of Birds which through the kindness of Dr. R. C. Murphy has been turned over to our use for blind fish studies.

MATERIALS AND METHODS.

Three kinds of fish were used. Of these, the *Astyanax mexicanus* were aquarium-raised descendants of fish collected from the Rio Tampoan, San Luis Potosi, Mexico, at Pujal, near La Cueva Chica in 1940. These will be referred to as "river fish." The second kind was *Anoptichthys jordani*, called "Chica fish." Some of these used were members of an eleventh generation raised in the light and some were brought directly from La Cueva Chica, at Pujal in the same Mexican state. Normal specimens were studied together with some in which the optic nerve remnants had been severed and some in which the blind capsule as a whole had been removed.² Not only were forms raised in the light observed, but animals kept in complete darkness, both operated and unoperated for a period of nine months, were used. The eleventh generation fish at the time of operation were no more than two months of age. The ages of the fish collected in Mexico are unknown. The third kind, as yet undescribed, were specimens brought from Cueva de los Sabinos, north of Valles, Mexico. Most of these were recent arrivals in the laboratory but specimens were available which had been kept under ordinary laboratory light conditions for more than two years. Those which were studied as having been in darkness, had traveled from Mexico in tightly closed tins painted on the inside with black asphaltum paint and were exposed to light for only five days before being placed in dark, light-tight tanks. Others were specimens killed and fixed in the cave without ever having been subjected to light other than the momentary hand lamps of the collectors. The river fish which were maintained in darkness had been put into the dark tank at the age of one month and maintained under such con-

¹ An abstract of this paper appeared under the same title (Rasquin, 1946).

² These fish are the same individuals which had been used by Breder and Rasquin (1947) for other studies.

ditions for more than two years. The only light to which they were exposed was that of a 10 watt ruby bulb used at feeding time.

One hundred Chica fish were operated on August 12, 1945. Fifty had both optic nerve remnants severed, and of these 25 were placed in a dark tank and 25 in a tank in which the ordinary conditions of daylight obtained. The second 50 had the entire blind capsule removed and were split 25 and 25 in the same manner. Fifty more fish which served as controls were subjected to the same process of anesthesia and distributed between similar dark and light tanks. Anesthesia was accomplished by immersing the fish in a 1 per cent. solution of urethane made with the water from the tanks in which the fish had been living. The river fish had the optic nerves severed in the same way and the fact that they were completely blinded was verified by their immediate assumption of a permanent dark phase, and a wandering continuous swimming activity characteristic of the cave varieties. The operations on the normally blind Chica fish were considered necessary for they had been previously proved to be light sensitive through the intermediation of the blind capsule (Breder and Gresser, 1941 a and b).

Denervation of melanophores in the caudal fin was accomplished by the technique used by Fries (1942), that is, a cut was made in the caudal fin at right angles to the fin rays, causing a degeneration of the nerve fibers distal to the cut. Four fish were used for this part of the experiment, one river fish, one Sabinos, one normal Chica and one Chica whose blind capsules had been removed. The experiments were repeated. One per cent. urethane was used in the first trial but anesthesia was found to be unnecessary and was abandoned in the second trial.

Serial sections were made of the heads of the experimentally blinded fish to check the severing of the optic nerves in those fish which were subjected to this method of blinding. Whole mounts of skin and peritoneum fixed in formalin as well as fresh preparations were studied for melanophores. For the demonstration of fat, formalin fixed tissue was treated with 2 per cent. osmic acid. A strip of skin, scales and underlying muscle tissue was removed extending from the dorsal to the ventral mid-line just anterior to the dorsal fin. These results were checked with frozen sections stained with Sudan IV.

Drawings of the distribution of the guanine were made free hand using the dissecting microscope at magnification of approximately 20 diameters. In each case the left side of the fish is pictured at a region just posterior to the body cavity and below the mid-line where the differences in guanine deposition are most marked and most easily recognizable.

The Chica fish subjected to light and darkness were kept in 6 tanks, 3 in light and 3

in darkness, so arranged that the water was kept circulating through all tanks by means of a pump. The same amounts of food were given to each tank. No plants were used in the light tanks. The water became green due to growth of natant algae but this plant material was circulated through all tanks by the action of the pump. See Breder and Rasquin (1947) for specific details of this apparatus.

EXPERIMENTAL RESULTS.

The river fish under normal light conditions exhibits a heavy pigmentation throughout the body. Sections show a deep layer of melanophores in the dermis and another less concentrated layer immediately beneath the surface epithelium. Layers of melanophores are seen in the fascia between the myomeres of the body musculature. Pigment cells are numerous along the pathway of the blood vessels, particularly along the aorta and its branches all the way down the body to the caudal fin. There is a heavy concentration in the meninges covering the brain and spinal cord. Internal pigmentation varies in individual fish but is always heavy. Large melanophores almost always in the dispersed condition are found in the peritoneum. These cells are characterized by broad blunt branches which resemble a syncytium forming an almost complete layer of pigment protecting the abdominal cavity. Examination of a river fish which had been kept in total darkness for a period of two years revealed a much different picture, agreeing in general with the observations of Ogneff (1908, 1911) on goldfish, Murisier (1920-21) on trout and Odierne (1937) on catfish. Much of the pigmentation was lost following the long sojourn in the dark. The superficial pattern was preserved, the lateral stripe was still distinct but the fish appeared to be in a very light phase due not only to concentration of the granules within the cells but to considerable reduction in the number of pigment cells. The internal pigmentation showed this reduction more clearly than the superficial pigmentation. The aorta and its branches were still marked by a few melanophores but the pigmentation surrounding the branches did not extend nearly as far distally as in the fishes raised in the light. Melanophores in the peritoneum were sparse and scattered and the syncytial appearance was not nearly so pronounced.

Examination of Chica fish killed and fixed in the cave, and never subjected to living conditions in the light, show varying conditions of pigmentation, in general those fish having better differentiated eyes having more pigment. However, this is not always the case. Occasionally heavily pigmented fish with completely blind capsules are seen and these are in a permanently dark phase corresponding to river fish which have been operatively blinded, but such specimens are

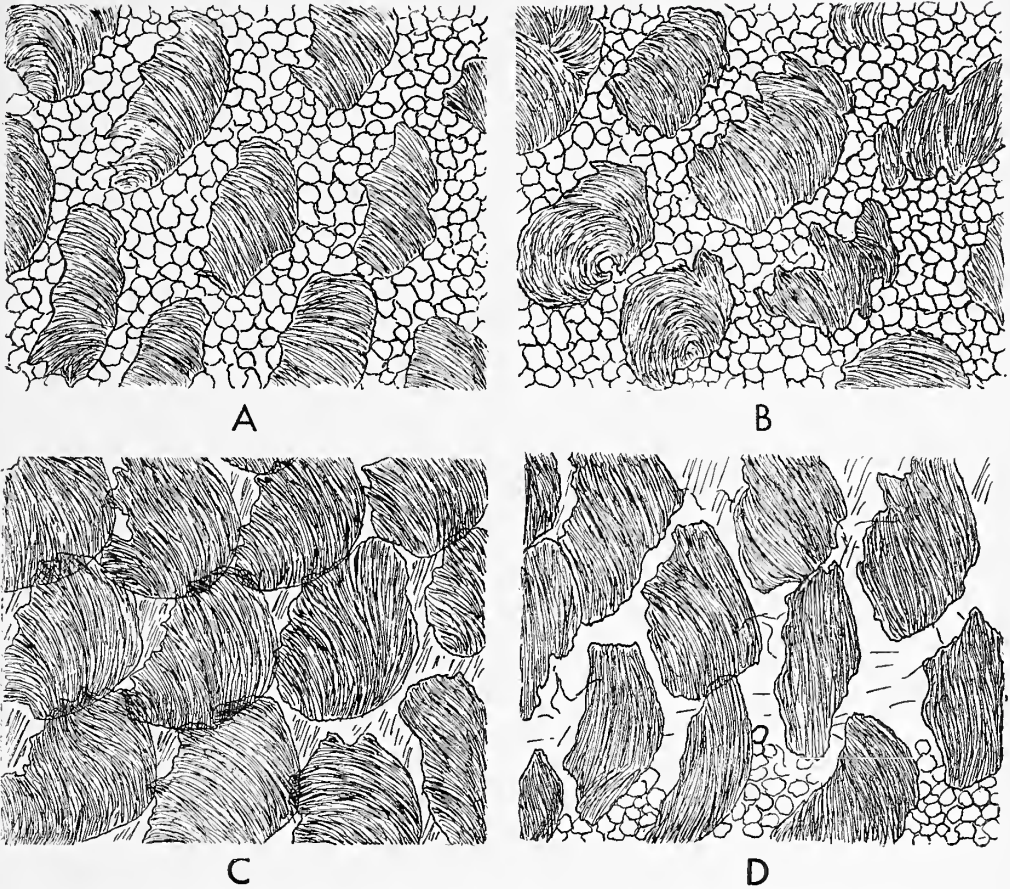

TEXT-FIG. 1. Semi-diagrammatic sketches of the fat and guanin deposits in the blind fishes. Sketches show the left side of the fishes at a region just posterior to the body cavity and below the mid-line at a magnification of approximately 20 diameters. **A.** Sabinos fish in the light. **B.** Sabinos fish in the dark. **C.** Chica fish in the light. **D.** Chica fish in the dark.

relatively rare (Breder, 1942). In general in those fish with eyes, melanophores are seen in the skin and the lateral stripe is usually evident. Melanophores can be seen along the blood vessels in the fascia between the myomeres of the dorsal region as well as in the meninges of brain and spinal cord. Those fish with a completely blind capsule showed much less pigment, little being seen along the blood vessels. All had melanophores in the skin and peritoneum and in fixed specimens conditions of both dispersal and concentration of granules in these cells were seen side by side. This would seem to indicate that the cells have not lost any power to react.

After removal of the blind capsules from these Chica fish or after severing of the remnants of the optic nerves rendering them insensitive to light, they did not enter upon a dark phase nor in the period of nine months that they were kept in the light did they produce a noticeable darkening in pig-

mentation such as did the blinded river fish. Between those fish raised in the dark and those raised in the light, whether operated upon or not, there was not a sufficient difference in the melanin content to account for the difference in translucence and coloration. The pinkish color of the dark raised fish is due to the color of the blood which shows through the skin. In those Chica fish with a considerable amount of pigment some of this color is undoubtedly blocked off by the position of melanophores about the blood vessels and in those raised in the dark the absence of the heavily pigmented layer of the peritoneum permits the viscera to be seen. Microscopic examination of live Chica fish brought into the light reveals concentrated melanophores, while those living in the light and subjected to the same amount of handling showed melanophores in a more dispersed condition.

In the Sabinos fish, which are insensitive to light, the superficial pigmentation con-

sists of a few scattered melanophores in the skin and there is no concentration of pigment cells forming a lateral stripe. In six fish examined which had been kept in the light for more than two years no melanophores were found between the myomeres. A few were seen scattered along the dorsal aorta and a few were present in the peritoneum and meningeal tissues. Microscopic examination of one of these fishes alive and in the light showed the melanophores to be in the punctate and stellate conditions; full expansion was not observed.

As a result of this observation it was thought best to determine whether the innervation of the melanophores in the Sabinos fish was also in a process of degeneration. Living in the light for two years produced no gross visible increase in pigmentation, nor was any such increase produced in the Chica fish through the rearing of eleven generations in the light. Accordingly four fish were subjected to cuts of two or three rays in the caudal fin, causing a degeneration of nerve fibers distal to the cut (Fries, 1942). One river fish was used, one Sabinos and two Chicas. Of the two Chicas one was an old fish and the other was a younger fish which had had the optic capsule removed several months previously. A darker streak was observed within five minutes on the tail of the river fish, indicating expansion of the melanophores when released from innervation by the cutting of the nerve. The others could not be seen to have such an immediate reaction, probably because of the fewer pigment cells present. Handling incident to inspection under the microscope caused a dropping off of the part of the fin distal to the cut. The cuts were therefore repeated on the other half of the fin and the fish returned to the aquaria to await microscopic examination after some healing had been accomplished. Care was taken to make the observations within the time limit before regeneration began (Abramowitz, 1935). Eleven days after the operations the fins were examined under the microscope. All melanophores in the denervated areas were in a dispersed condition in all three types of fishes, although the Sabinos showed more cells in the stellate condition than in a state of full expansion.

A freshly killed Sabinos fish which had been in the light only five days was examined. This fish was of unknown age, brought from the cave in Mexico. The melanophores were mainly contracted, but occasional ones were seen in the stellate condition and some in the head region were fully expanded, possibly incident to death. Death obviously did not cause immediate dispersion of all the melanophores for the majority were concentrated. No pigment cells were present in the peritoneum or mesentery.

Thirty Sabinos fish which had been killed

and fixed in the cave without ever being subjected to conditions of light were examined microscopically for pigment cells. In none of these specimens were any melanophores present in the peritoneum. The meninges showed a few scattered pigment cells. The melanophores of the skin were scattered and very few in number, and all were contracted. One fish examined after living in the light for six months still showed no melanophores in the peritoneum or mesenteries, but the skin and the meninges covering the brain showed a definite increase in the numbers of these cells. In the six fishes examined which had been living in the light for more than two years, the melanophores were found in all the places which are characteristic for fishes, including the peritoneum. The appearance of these peritoneal melanophores is particularly noticeable because there were none present before subsection to light but the actual increase in numbers is small.

Xanthophores contribute somewhat to the coloration of all these fishes, being numerous in the caudal and adipose fins. The anal fins contain scattered xanthophores which deepen in shade from a lemon yellow to almost a brick red in some cases, as they approach the anterior border of this fin. The deeply colored cells are more frequently noted in the river fish, both male and female, and are less frequently found in the Chica and Sabinos types. They are not always present in the river fish. Scattered xanthophores are seen in the dorsal fin and on the head and dorsal body regions. In the river fish the presence of many melanophores obscures the yellow color of the other chromatophores.

The Sabinos fish gives a distinctly yellow impression, particularly the male, but it cannot be said that this is due to any greater number of xanthophores as compared with the Chica fish or the river fish. A consideration of these three forms raised in the light shows a steady progression in the quantity of fat deposition. The river fish has very little, the Chica fish show a conspicuous amount and the Sabinos fish show great quantities of fat not only in the abdominal cavity but laid down in layers between the dermis and the musculature. It is this yellow fat showing through the skin which gives the Sabinos fish its yellowish appearance. The nature of and reason for this fat deposition is not within the province of this paper but will be made the subject of a later communication.

A variation in the amount of guanin crystals seems to be chief cause of the difference in coloration in the blind fishes. The river fish under the dissecting microscope presents a body covered with a sheath of guanin. The crystals are laid down on each scale, in the dermis underlying the scales and in the tissue between the peritoneum and the body wall so that a view

of the internal organs or of the color of the blood is completely blocked. The abundant pigmentation which overlies the guanine prevents much of the silvering from showing through. In the Chica fish raised in the light the same guanine deposition holds true. Scales are well marked and the guanine is deposited between scales so that the fish becomes an opaque silver, brilliantly flashing in the light. The lack of a dense overlying layer of melanin makes these fish much more conspicuous against any natural background than the river fish. In the dark-raised specimens, however, guanine is not nearly so abundant. Crystals are found laid down heavily on the scales and intervening tissue along the sides of the fish, particularly along the lateral pigmented stripe, but in the scales ventral and dorsal to this line guanine is seen on the scales alone, and is sparse and somewhat erratically laid down. This permits the color of the inner tissues to show through the skin. Some guanine crystals are seen between the peritoneum and body wall of these dark-raised fish but are not nearly as abundant as in the light-raised Chicas or in the river fish. This increased opacity due to guanine deposition takes place within three weeks after exposure to daylight conditions and occurs in the Chica fish whether or not they were made operatively insensitive to light. Therefore the optic remnants which have been shown to make these fish light sensitive cannot be involved in this reaction to light.

The Sabinos fish, whether kept in light or darkness, have less guanine deposits than the Chica fish raised in the dark. If there is an increase in guanine in these fishes when exposed to light it is not great enough to cause any change in coloration, nor to be detected by inspection under the dissecting microscope. Specimens newly brought from the cave showed no differences from those which had been kept in the light in the laboratory for more than two years. Guanine is seen on the scales alone and is not abundant. The colors of blood, viscera and fat are clearly visible through the relatively transparent skin.

DISCUSSION.

The blind cave derivatives of the Mexican characin *Astyanax mexicanus* offer interesting material for the study of pigmentation since they have lived for generations in an environment totally without light. They show a progressive loss of pigmentation which in general is correlated with the stages of eye degeneration. It seems probable that the stock from La Cueva Chica is contaminated by the occasional entry of eyed fish from the river since some of the fish, particularly from the pool near-

est the river, have functional eyes and normal distribution of melanin. The others from pools further removed from the river are mainly blind and lack much of the melanin which characterizes the eyed form. The fish from Cueva de los Sabinos on the contrary show no evidence of such contamination with river forms and are completely blind and indifferent to light. Pigmentation is still further reduced, melanin is present only in scattered melanophores in the skin and few are seen internally.

In the river fish the distribution of internal pigment agrees in general with that described by Gordon (1931) for *Platyplecillus* and with what seems to be normal for typical fishes. All the layers mentioned by Weidenreich (1912) are represented, that is epidermal and dermal melanin, together with perineural, perivascular and coelomic pigmentation. The peritoneum is particularly characterized by expanded chromatophores which seem to form a syncytium. Whether or not these cells are actually anastomosed cannot be determined by ordinary histological methods. It is not surprising to find these cells in a dispersed condition since Gilson (1926) observed that the melanophores of the peritoneum of *Fundulus* rarely showed a contracted form regardless of the condition of the superficial chromatophores. Ginsburg (1929) studied the living melanophores in embryos of *Lebistes reticulatus*, some of which would ultimately be drawn internally with the yolk sac and claimed that the melanophores could become anastomosed and the granules wander from one cell to another. Shanes and Nigrelli (1941), using a technique involving polarized light, seemed to find some evidence to support the hypothesis that these cells are interconnected. However, river fish which originally had this heavy pigmentation picture in the peritoneum lose it entirely when kept for some time in darkness and what melanophores are left are separated and show little evidence of anastomosed branches.

Sumner and Wells (1933) noted a loss of melanophores from the peritoneum of *Lebistes reticulatus* which had been adapted to a white background. Such optic stimuli as altered background conditions played no part in the reaction shown by the river fish kept in darkness. They were raised in light tight tanks from the age of one month to more than two years, receiving no retinal images in that time save that of the 10 watt carbon ruby dark room bulb used only at feeding time for checking the conditions of the tank. Coonfield's work (1940) on *Pomacentrus leucostictus* has more bearing on this problem for he found that the melanophores of eyed or blinded embryos kept in total darkness were contracted even

more than those kept over white backgrounds.

Melanophores in the cave fishes of both varieties are pale and seem to have few granules although the cells are clearly outlined and there is no difficulty in deciding whether or not the granules are in a dispersed condition. Goodrich (1927) in a study of *Oryzias latipes* found that the red and white varieties had as many melanophores as the brown, the only difference being in the amount of melanin within the cells. This is not the case here, for the blind cave fishes when compared with the ancestral river form are seen to have lost great quantities of melanophores. The loss of color is not due to fewer granules within existing cells but to the actual loss of great numbers of pigment cells.

The pigmentation of the phenotypic variants shown by the Chica fish differs so widely that it is impossible to tell what reaction has been effected by light or darkness on the numbers of melanophores. Rendering these fish insensitive to light by removal of the blind capsule causes no difference in their pigmentary reactions to light. In those with little pigmentation there are so few melanophores in the skin that mere dispersal of the granules would have no gross visible effect on the coloration and an increase in pigmentation could only be effected by a tremendous increase in the numbers of melanophores. The reaction of light probably does cause a slight increase in numbers since both the river fish and the less pigmented Sabinos fish show such an increase and the innervation of the pigmentary system has been proved to be functioning in all three types of fishes. Denervation experiments have shown that the power to react has not been lost in the cave fishes. Such an increase is more easily seen in the Sabinos fish because of the presence of even fewer pigment cells than in the Chica fish and because of the appearance of these cells in places where they were not observed before subjection to light. According to Osborn (1940, 1941) the melanophores must be in an expanded condition to produce an increase in melanin in existing cells and to produce an increase in the numbers of melanophores.

The Sabinos fish represent a stage of still further degeneration as regards pigmentation and eyes (Breder, 1944). The optic capsule as a structure is gone and there is no connection to the brain by an optic nerve. The increase in the numbers of melanophores which occurs when these fish are kept for long periods in the light is not sufficiently great to cause any visible difference in the coloration. The time required for this slight increase is in excess of six months. Fishes removed from dark-

ness or brought out from the cave show little internal pigmentation, none at all in the peritoneum and only a few scattered contracted cells over the dorsal region of the skin. Microscopic examination of fish kept more than two years in the light shows a definite increase in numbers in the meninges and perivascular tissues, melanophores have appeared in the peritoneum and the dorsal skin surface appears lightly peppered with pigment cells. These are not heavily laden with granules and the cells seem to be in the stellate condition rather than fully contracted or expanded.

No such magnitude of reaction takes place in the cave fish comparable to that which Odiorne (1937) demonstrated with blinded catfish. Osborn (1941) also demonstrated the appearance of large numbers of melanophores on the ventral surfaces of flounders by subjecting them to strong lighting from below through a glass bottomed tank. Both these forms are genetically provided with large numbers of melanophores and they may possess a potential for increase under proper conditions of stimulation which is evidently greater than that inherent in the blind fish. Melanophores in the Sabinos fish, which have appeared as a response to light, are not sufficiently great in number to be apparent macroscopically. Microscopic examination, however, shows them to be arranged in a differential pattern comparable to that of the river fish or to the general distribution which usually obtains in fishes which live in conditions where the lighting is from above. The increase in numbers is greatest over the dorsal region and gradually decreases ventrally. Before any response to light occurs, the few melanophores found in the Sabinos fish are seen over the same region, while none are seen below the midline. The Chica fish kept in darkness also show the same differential.

As far as could be determined, life in the cave environments has produced no such loss of xanthophores in the fishes as is the case with melanophores. These yellow chromatophores appear in about the same quantities in all three varieties of fishes, being obscured in the river fish by the greater numbers of melanophores. In the Sabinos fish kept either in light or darkness the xanthophores far outnumber the melanophores.

Several investigators have observed (Meyer, 1931; Kuntz, 1917; Murisier, 1920-21; Sumner and Wells, 1933) that conditions of light which favor a decrease in melanin content favor an increase in guanin and guanophores. This is at variance with observations on the cave fishes. Chica fish when raised in darkness and brought into ordinary daylight conditions

deposit enough guanin in three weeks' time to change them from a rather translucent, pinkish color to an opaque silver. This reaction takes place whether or not the fish are rendered operatively insensitive to light and therefore cannot be mediated through any optical nerve connection with the brain.

Craig-Bennett (1931) has observed that the blue color of the iris of the breeding male stickleback, *Gasterosteus aculeatus* Linnaeus, is due to the reduction in the amount of guanin in the guanophores, and a pinkish color of the operculum which precedes the development of erythrophores is due to the color of the blood in the gills which shows through after the guanin has been reduced. He found that the color changes would take place whether the male fish were kept in light or darkness. In the Chica fish the added accumulation of guanin takes place regardless of the sex of the fish. River fish which had lived in total darkness more than two years, including one specimen which had evidently been spawned in the tank, showed no less guanin than those which had been raised and kept in the light. The Sabinos fish showed no more guanin when kept in the light for more than two years than those which were kept in the dark or those which were received fresh from the cave environment.

Two conditions obtain in the Sabinos fish which make them distinctive in coloration from the Chica fish. One of these is the lack of a deposition of guanin in response to exposure to light and the other is the presence of an abundant deposition of subcutaneous fat which is independent of the action of light. The color of the blood and fat renders the Sabinos fish a distinct yellowish-pink as compared with the silvery Chica type. It is possible that there is some fundamental physiological difference between these two forms, but whether or not the lack of guanin and the presence of fat are interrelated in some physiological process is not clear.

SUMMARY.

1. A series of Mexican characins, ranging from a fully eyed form (*Astyanax mexicanus*, living in rivers) to a blind light-negative form (*Anoptichthys jordani* from La Cueva Chica) and a blind light-indifferent form (*Anoptichthys* sp. from Cueva de los Sabinos), exhibits gross color differences which are referable to reduction in melanin and guanin and increase in fat deposition in the sequence above listed.
2. The pinkish coloration of both blind forms kept in darkness, which is due to the blood showing through the skin, is

masked in the river form by abundant melanin found in skin and peritoneum and about the large blood vessels and nerves.

3. When kept in light the "Chica" form deposits an almost complete investment of guanin effectively masking the pink coloration but the "Sabinos" form remains pink since it shows no such reaction to light.
4. Melanin and guanin obscure the small amount of river fish fat, but a progressive increase in fat deposition is evidenced by the more yellowish color of the "Sabinos" fish as compared with the translucent "Chica" form kept in darkness.
5. Melanophores in all three varieties of fish have lost no power of dispersion and concentration of granules and exposure to light results in a definite increase in numbers of melanophores in the river fish and in the "Sabinos" form.
6. No change was found in numbers of xanthophores, the yellow color of the caudal fins of the cave forms being due to the relative absence of melanophores which obscure the xanthophores in the river fish.
7. Increase in guanin and melanin is a direct effect of light since it occurs whether or not the fish are rendered optically indifferent to light.

BIBLIOGRAPHY.

- ABRAMOWITZ, A. A.
1935. Regeneration of chromatophore nerves. *Proc. Nat. Acad. Sci.*, **21** (2): 137-141.
- ALVAREZ, J.
1946. Revision del género *Anoptichthys* con descripción de una especie nueva (Pisc., Characidae). *Anal. Escuela Nac. Cien. Biol.*, **4**: 263-282.
- BREDER, C. M., JR.
1942. Descriptive ecology of La Cueva Chica with especial reference to the blind fish, *Anoptichthys*. *Zoologica*, **27** (3): 7-15.
1944. Ocular anatomy and light sensitivity studies on the blind fish from Cueva de los Sabinos, Mexico. *Ibid.*, **29** (13): 131-144.
- BREDER, C. M., JR. AND GRESSER, E. B.
1941a. Correlations between structural eye defects and behavior in the Mexican blind characin. *Zoologica*, **26** (16): 123-131.
1941b. Further studies on the light sensitivity and behavior of the Mexican blind characins. *Ibid.*, **26** (28): 228-296.

- BREDER, C. M., JR. AND RASQUIN, P.
1947. Evidence for the lack of a growth principle in the optic cyst of Mexican cave fish. *Zoologica*, **32** (3) : 29-33.
- COONFIELD, B. R.
1940. Chromatophore reactions of embryos and larvae of *Pomacentrus leucostictus*. Carnegie Inst. Washington Publ., (517) : 169-178.
- CRAIG-BENNETT, A.
1931. The reproductive cycle of the three-spined stickleback, *Gasterosteus aculeatus*, Linn. *Phil. Trans. Roy. Soc. London*, ser. B, **219**: 197-279.
- FRIES, E. F. B.
1942. Some neurohumoral evidence for double innervation of xanthophores in killifish (*Fundulus*). *Biol. Bull.*, **82** (2) : 261-272.
- GILSON, A. S.
1926. Melanophores in developing and adult *Fundulus*. *Jour. Exp. Zool.*, **45** (2) : 415-456.
- GINSBURG, J.
1929. Beiträge zur Kenntnis der Guaninophoren und Melanophoren. *Zool. Jahrb. Abt. Anat. Ont.*, **51** (2) : 227-260.
- GOODRICH, H. B.
1927. A study of the development of Mendelian characters in *Oryzias latipes*. *Jour. Exp. Zool.*, **49** (2) : 261-288.
- GORDON, M.
1931. Morphology of the heritable color patterns in the Mexican killifish, *Platypoecilus*. *Amer. Jour. Cancer*, **15** (2) : 732-787.
- KUNTZ, A.
1917. The histological basis of adaptive shades and colors in the flounder *Paralichthys albiguttus*. *Bull. U. S. Bur. Fisheries*, **35**: 1-29.
- MEYER, E.
1931. Versuche über den Farbwechsel von *Gobius* und *Pleuronectes*. *Zool. Jahrb. Abt. Allg. Zool. Physiol.*, **49** (2) : 231-270.
- MURISIER, P.
1920-21. Le pigment melanique de la truite (*Salmo lacustris* L.). *Rev. Suisse Zool.*, **28**: 45-97; 149-195; 243-299.
- ODIORNE, J. M.
1937. Morphological color changes in fishes. *Jour. Exp. Zool.*, **76** (3) : 441-465.
- OGNEFF, J. F.
1908. Ueber die Veränderungen in den Chromatophoren bei Axolotlen und Goldfischen bei dauernder Lichtentbehrung und Hungern. *Anat. Anz.*, **32** (23-24) : 591-607.
1911. Ueber die Aenderungen in den Organen der Goldfische nach dreijährigem Verbleiben in Finsternis. *Ibid.*, **40** (2-3) : 81-87.
- OSBORN, C. M.
1940. The experimental production of melanin pigment on the lower surface of summer flounders (*Paralichthys dentatus*). *Proc. Nat. Acad. Sci.*, **25** (3) : 155-161.
1941. Studies on the growth of integumentary pigment in the lower vertebrates. I. The origin of artificially developed melanophores on the normally unpigmented ventral surface of the summer flounder (*Paralichthys dentatus*). *Biol. Bull.*, **81** (3) : 341-351.
- RASQUIN, P.
1946. Progressive pigmentary regression in fishes associated with cave environments. [abstr.] *Anat. Rec.*, **96** (4) : 82-83.
- SHANES, A. M. AND NIGRELLI, R. F.
1941. The chromatophores of *Fundulus heteroclitus* in polarized light. *Zoologica*, **26** (23) : 237-240.
- SUMNER, F. B. AND WELLS, N. A.
1933. The effects of optic stimuli upon the formation and destruction of melanin pigment in fishes. *Jour. Exp. Zool.*, **64** (3) : 377-394.
- WEIDENREICH, F.
1912. Die Lokalisation des Pigmentes und ihre Bedeutung in Ontogenie und Phylogenie der Wirbeltiere. *Zeitschr. Morph. Anthrop., Sonderheft 2*: 59-140.

EXPLANATION OF THE PLATE.

PLATE I.

Photomicrographs of whole mounts of the peritonea of the river fish and the Sabinos fish showing the condition of the melanophores after subjection to light and darkness. Magnification 110 X.

Fig. 1. River fish in the light.

Fig. 2. River fish in the dark.

Fig. 3. Sabinos fish in the light.

Fig. 4. Sabinos fish in the dark. American Museum of Natural History photographs.

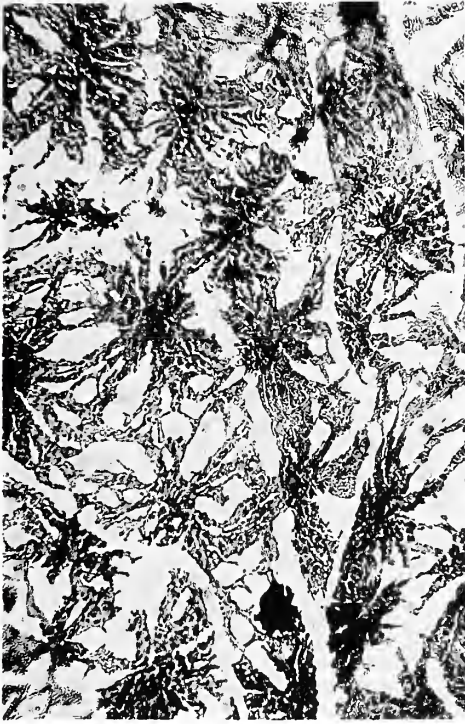

FIG. 1.



FIG. 2.

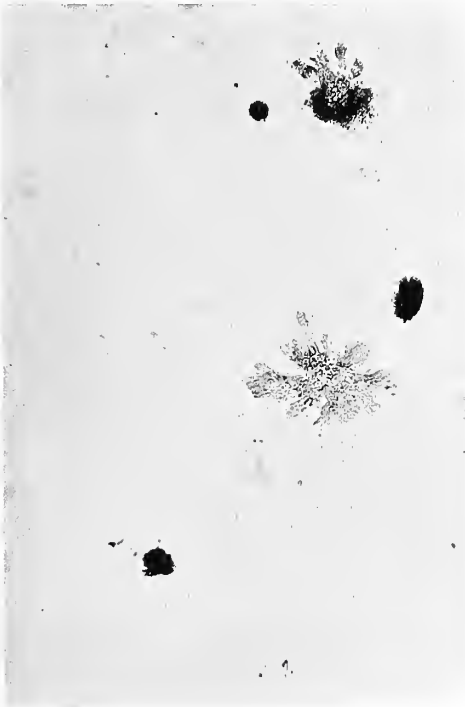

FIG. 3.



FIG. 4.

PROGRESSIVE PIGMENTARY REGRESSION IN FISHES
ASSOCIATED WITH CAVE ENVIRONMENTS.

5.

Ecology of Rancho Grande, a Subtropical Cloud Forest in Northern Venezuela.¹

WILLIAM BEEBE & JOCELYN CRANE.

Department of Tropical Research, New York Zoological Society.

(Plates I-V; Text-figures 1-10).

CONTENTS.

	PAGE
I. Introduction	43
II. The Fourteen Zones adjacent to Rancho Grande...	45
III. Physical and Biological Characteristics of the Rancho Grande Cloud Forest.....	48
A. Geography	48
B. Meteorology	49
C. Botany	56
D. Zoology	58
IV. Summary and Conclusions	58
V. Bibliography	59

I. INTRODUCTION.

Rancho Grande, the center of the research area described in this paper, is in the National Park of Aragua, in north central Venezuela, at 10° 21' North Latitude, 67° 41' West Longitude. It lies in a subtropical cloud forest on the coastal range of the Andes, at an altitude of 1,097 meters (3,600 feet). It is 80 kilometers west of Caracas, and midway between Lake Valencia and Ocumare de la Costa on the Caribbean Sea.

This area was headquarters for the forty-fifth and forty-sixth expeditions of the Department of Tropical Research of the New York Zoological Society. These were made possible by the kindness of the Venezuelan government, in putting the facilities of the National Park at our disposal, and through the generosity of the Creole Petroleum Corporation in financing and otherwise aiding the undertaking. A well-equipped laboratory and comfortable living quarters were established in the building known as Rancho Grande, and occupied for five months in 1945 and six and a half months in 1946. Here we carried on intensive observation and field study of the fauna and general ecological conditions, in an area of an approximate circle two kilometers in diameter.

The following pages deal briefly with the zones adjacent to Rancho Grande and with the various ecological aspects of the cloud forest itself, including the geography, meteorology, botany and zoology. The purpose of the paper is two-fold, first to give a bird's-eye view of the subtropical cloud forest from the viewpoint of the field zoologist, and, second, to lay a general foundation for the series of papers on the various faunal groups and

problems studied during the course of the two expeditions. These publications will succeed the present paper, and appear from time to time.

The expeditions were carried out under the direction of William Beebe, with Jocelyn Crane as Research Zoologist, Henry Fleming, Entomologist, and George Swanson, Artist. For part of 1946 Kenneth Gosner served as field artist and Mrs. Mary Fleming as field assistant. We were fortunate in our local helpers, Manuel Vegas, Pedro Infante and Eduardo Echenagueio performing their various duties thoroughly and efficiently, while Octavio Chellé, the general caretaker lent by the Creole Corporation, added much to the success of the expeditions.

We wish to express our appreciation to the innumerable individuals in Venezuela, not directly connected with our expeditions, who gave their constant friendly cooperation. Within the national government itself, we are grateful particularly to the officials of the *Ministerio de Agricultura y Cría*, within the jurisdiction of which now fall both the National Park and the building of Rancho Grande, and to those of the *Ministerio de Obras Publicas*; their endless help included everything from the maintenance of our water supply to the furnishing of maps and rainfall records, and to the prompt identification of ecologically significant plants.

Particular thanks go also to the officials of the State of Aragua, to all the officers of the Creole Petroleum Corporation and to many other friends, both North American and Venezuelan, in Caracas and Maracay. In addition, we want to mention the following individuals here, since the help they furnished, in the form of special data and loans of instruments and collections, was of a specifically scientific nature; in alphabetical order they are: Sr. Victor Badillo, Dr. Charles Ballou, Sr. Fulvio Benedette, Dr. Esteban Delgado, Sr. Walter Dupouy, Dr. Arnoldo Gabaldón, Rvdo. Hermano Ginés, Dr. Derald Langham, Dr. Tobias Lasser, Sr. René Lichy, Dr. Victor M. López, Sr. Rodolfo Luzardo, Sr. Roberto Perez, Mr. William H. Phelps, Mr. William H. Phelps, Jr., Dr. Henri Pittier, Dr. Eduardo Röhl, Dr. L. Schnee, Dr.

¹Contribution No. 752. Department of Tropical Research, New York Zoological Society.



TEXT-FIG. 1. Map showing location of three field laboratories of the New York Zoological Society in northern South America: Kartabo, British Guiana (1916-1924); Caripito, Venezuela (1942); and Rancho Grande, Venezuela (1945-1946).

Robert H. Tschudy, Dr. Luis Felipe Vegas and Dr. Guillermo Zuloaga.

The history of Rancho Grande and the National Park seem worth recording here. In this area near the pass called *Portachuelo* there existed for many years a little road-house or caravanserai which provided food and shelter for the burro trains carrying loads over the ancient trail from Maracay to Ocumare de la Costa. In 1915 good bridges were built across the gorges, and the road widened to accommodate carts. A final, complete change turned the winding track into an excellent cement automobile road, this transformation being brought about by the energetic dictator, Juan Vicente Gómez, during the years 1930 to 1933. In the latter year, the small road-house was torn down and in its place Gómez began the erection of a stately steel and concrete building of some 120 rooms which was to serve as an official hotel. In December, 1935, the dictator, who had reigned for three decades, died, and all work on the half-finished building ceased, leaving the new Rancho Grande in the general condition of a castle of the Middle Ages.

In February, 1937, 80,000 to 90,000 hectares (about 350 square miles) of the surrounding mountains and coastal lands were

set aside by government decree as the National Park of Aragua. Except for a few long-cultivated areas in the lowlands near Ocumare, some secondary savanna on the burned-over foothills of the Maracay slopes, and several cottages along the highway, the preserve is in its original state, the principal zones of vegetation including thorn woodland, seasonal forest and above all, a magnificent unbroken expanse of montane cloud forest.

The results of this ten-year protection of the forest and its wildlife are already apparent from the most cursory comparison with many recently similar areas in the tropics. Here in the Reserve, the usual tragic sequence of unplanned deforestation, erosion and desiccation has been halted, and with it the extinction of countless useful, attractive or scientifically interesting forms of animal life. The appreciation of all conservationists is due the officials of the Venezuelan government in general and Dr. Henri Pittier in particular for their foresight and energy in establishing this Park. Its present maintenance, when the urgent need for such reserves is scarcely realized by the public, will for years be an example and stimulus in other parts of the hemisphere.

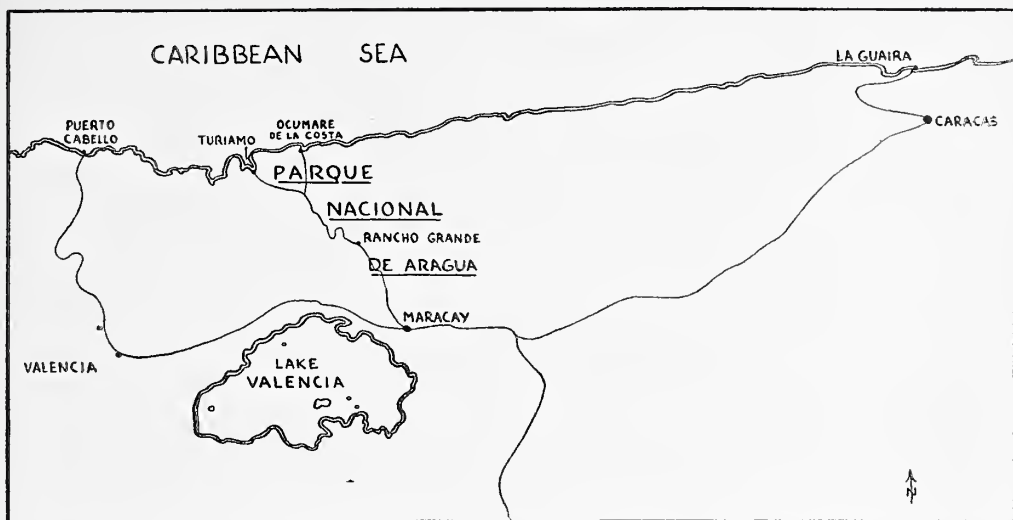

TEXT-FIG. 2. Location of Rancho Grande in north central Venezuela. Scale: 1 cm = 11 km.

II. THE FOURTEEN ZONES ADJACENT TO RANCHO GRANDE

[Note: The terminology of Dr. John Beard, as given in his definitive paper, "Climax Vegetation in Tropical America" (1944), is followed below in the discussion of the various terrestrial zones. The term "Montane Cloud Forest" is used, rather than his more general "Montane Rain Forest," because, as he himself suggests (p. 145), in agreement with Pittier's earlier usage, (e.g. 1939, p. 20), it is more applicable to this particular location.]

Our special area of study, as has been said, is a circle two kilometers in diameter with Rancho Grande at the center. In Nature, however, there are no hard and fast lines and every day there were found living creatures, causes and effects, which could not be accounted for or explained by one zone alone. With Rancho Grande as the hub, if the perimeter of our circle be enlarged to a radius of twenty-five kilometers, there will be found within its borders fourteen territories, to each of which, without impropriety, may be applied the term zone. (Text-figs. 5, 6).

Their influence on our central one is indirect, but it may be worth while briefly to visualize these zones. Ten kilometers off shore from Ocumare or Turiamo we float over a half mile of water, a depth sufficient to bring the Abyssal Zone of life within a comparatively short distance. This is probably the least known, yet at the same time the least varying of all the fourteen. Without use of net or bathysphere we could, with sufficient accuracy, from our previous experience elsewhere, enumerate the dominant forms of life—strange fish, crustacea, mollusks and coelenterata—which inhabit

and often illumine the deeper portions of this sunless, bitterly cold world with its terrible watery pressure.

On the surface of this off-shore area, is Zone Two, the Pelagic, intense blue over the deep water. As typical surface, aquatic and aerial forms of life, we may expect to find blackfish whales, petrels, tropicbirds, shearwaters, flyingfish and Portuguese-men-of-war.

Zone Three, the Shore Water and Reefs, is still marine, the water changing to turquoise over the shallows. Here are found shore fish, sharks and such birds as ospreys, gannets, frigatebirds, terns and pelicans. At Turiamo is a typical coral reef, the great flat fronds sheltering a host of beautiful creatures, brightly colored fish and equally colorful shelled and naked mollusks, crabs and anemones.

The Sandy and Rocky Littoral, Zone Four, exists wherever sea and land meet, alternately covered and exposed by the tide. Sand-burrowing, rock-clinging and crevice-loving creatures call this home. These are chiefly crustacea, snails and worms, having as dominant predators the many long-legged waders, such as sandpipers.

Zone Five comprises the Mangroves, a limited zone, bordering the bays, occupying a muddy, inter-tidal area, the home especially of herons and fiddler crabs.

The Fresh-water or Zone Six is almost synonymous with Lake Valencia. This is a large, slowly drying body of water, supporting many fish, especially characins and catfish, as well as crocodiles and reed-haunting birds. This zone enters our territory by way of rushing mountain streams which rise near Rancho Grande.

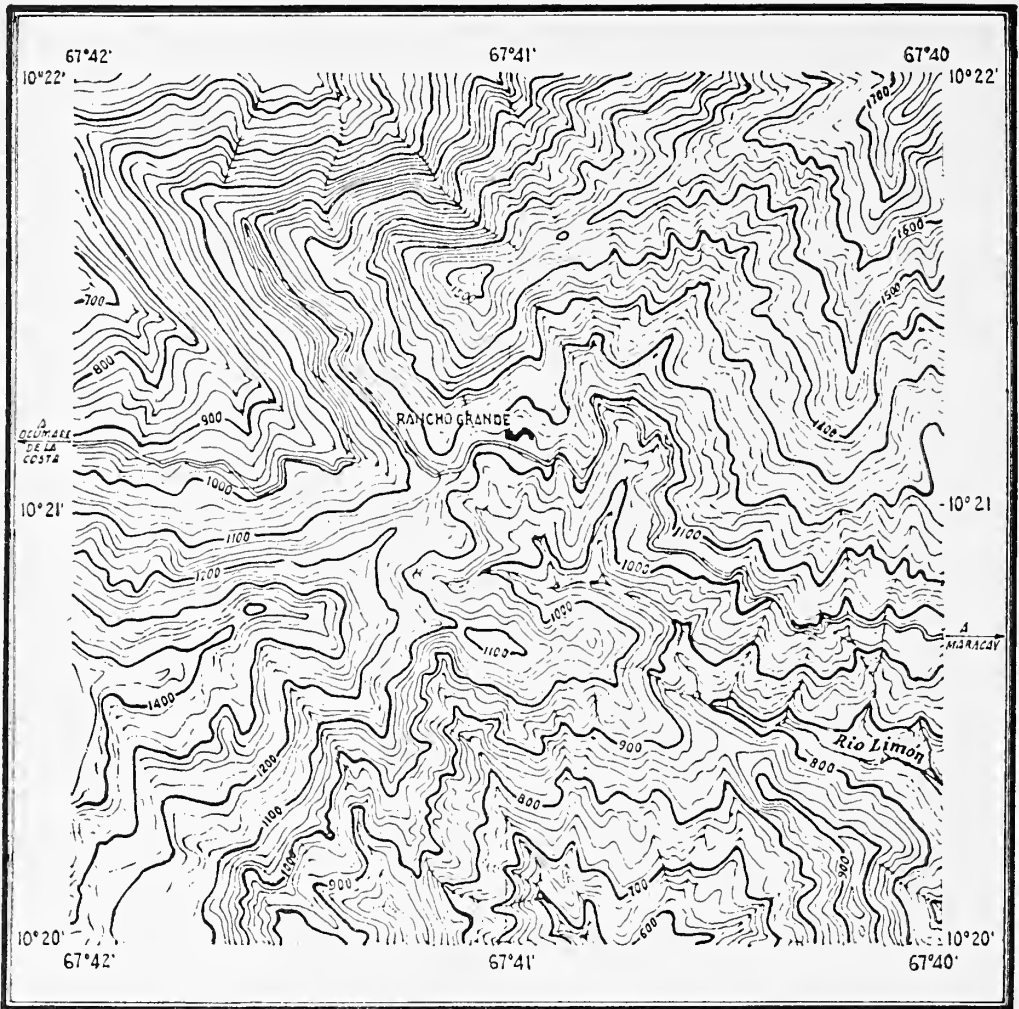

TEXT-FIG. 3. Contour map of the Rancho Grande area, from an official aeronautical survey. Courtesy of the *Ministerio de Obras Publicas de Venezuela*.

The Llanos or great, grassy rolling plains which comprise so large a part of Venezuela can barely be considered our Zone Seven, for typical llanos are found farther away than any of the other zones, well to the south of Lake Valencia. Their fauna is peculiar and controlled by the dominant grass vegetation and the extremes of wet and dry seasons.

Savanna, the Eighth Zone, bounds us to the south, over the lower slopes towards Maracay and Lake Valencia. It shows a monotonous expanse of grass, sparsely dotted with chaparral. Here are lizards, large and small, and covies of crested quail, while gray and white mockingbirds perch among the leathery leaves. This local savanna is not a climax formation but rather is a result of the early denudation of the seasonal forest combined

with almost annual burning during the dry season.

Cactus Scrub, our Ninth Zone, is found chiefly on the slopes immediately above the littoral and is typical of many Caribbean shores, including the one under discussion. It is a shock to the newcomer to the tropics to have as his first view, instead of lush jungle, great stretches of barren rock and gravelly slopes covered with sparse growths of agave, acacias and candelabra cactus, all bristling with an armor of thorns. Ground doves and equally dust-colored lizards scurry over the dry ground, and now and then a blazing vermilion flycatcher rises singing into the sky.

Merging almost imperceptibly with the coastal scrub on one side and the deciduous seasonal forest on the other, is found a sort

of Thorn Woodland, the Tenth Zone. It differs from Beard's general description in having a number of the dominant acacias deciduous, but otherwise agrees well with his diagnosis of "a scrubby type, varying from fairly open to more or less closed, with hard-leaved, microphyllous, evergreen spiny trees, 3 to 10 meters high . . . The soil is not grassed, ground vegetation being practically absent, save for rare bromeliads and succulents. Most of the thorn trees belong to the Mimosaceae and Caesalpiniaceae." (1944, p. 140). Examples are found chiefly on the Caribbean slope, and are distinguished from the cactus scrub by the almost total absence of cactus and by the higher, denser growth of the thorny thickets. Like the vegetation, the fauna is intermediate between that of the scrub and the seasonal forests.

Above the Savanna on the south, and in the foothills beyond the Cactus Scrub and Thorn Woodland on the Caribbean side, lies the Eleventh Zone, the Deciduous Seasonal Forest. This area contrasts in the most interesting manner with the Montane Cloud Forest so close above it. It agrees well with Beard's definition of the zone, the dominants being more than ten meters in height with two strata, the upper open, consisting of widely scattered trees of which more than two-thirds of the species are deciduous. In complete contrast to conditions in the Montane Cloud Forest, the tree trunks are almost always bare, except for a few common deciduous lianas, including a characteristic "monkey ladder" (*Bauhinia* sp.); arboreal epiphytes are practically absent; palms are rare, apparently confined to occasional examples of the *corozo* palm (*Acrocomia sclerocarpa*); heliconias, arums, ferns and mosses do not occur at all (except in stream bed intrusions, which, of course, do not properly belong in the zone).

Among the most conspicuous dominants of this zone on both sides of the mountains are the following, none of which occurs in the Cloud Forest: Various *Erythrina*, locally called *bucare* and famous here as throughout the Caribbean area for spectacular, flame-colored blossoms during the dry season; *Tecoma chrysantha*, the yellow-flowered *araguanay*; *Ceiba pentandra*, the giant silk cotton; *Burura simaruba*, the *pelo de indio* with the smooth reddish trunk; and *Hura crepitans*, the spiny-trunked *habillo*. The lower layer of the forest, though much more nearly closed than the upper, is ragged because of the steep slopes, and formed of mixed evergreen and deciduous species. The shrub layer, growing to a height of three or four meters, is composed of evergreens. During the dry season their thin leaves are drooping and paper dry. Vines, both leaved and leafless, some of them spiny, spring from isolated spots in the ground and creep toward the nearest saplings which they cover

in tangled mats; because of them, a machete is almost essential for progress. A trailing bamboo is locally abundant and even diagnostic on the Valencia side of the ranges. From February until the coming of the rains two or more months later, these deciduous forests appear utterly desiccated, the infrequent brooks are dry, the ground is slippery and crackling with dead leaves, and animal life is at its lowest ebb.

The fauna is of a wholly tropical character, rather than montane subtropical; for example, butterflies, including morphos, are abundant during the rains; termite nests are common; heat-loving *Cnemidophorus* and *Ameiva* lizards, both completely absent in the Cloud Forest, are plentiful; the birds are all lowland forms.

The Deciduous Seasonal Forest begins abruptly on the south at about the level of Guamitas, which lies at 737 meters, and extends to about 900 meters, where it merges imperceptibly with the next zone. On the Caribbean side, it extends, very roughly, from 100 to 500 meters.

Merging insensibly with the upper edges of the Deciduous Seasonal Forest and the lower margin of the Montane Cloud Forest is the narrow, rather anomalous Twelfth Zone, which in Beard's classification, corresponds more closely to his Semi-evergreen Deciduous Forest than to any of the others. This type of forest, in his analytical key, differs from the Deciduous Seasonal in having the upper story closed and only one-third to two-thirds of the individuals in the story deciduous. In the Rancho Grande area the upper story, even allowing for the steep slopes, is not noticeably closed, yet the zone fits this group much better than that of Lower Montane Rain Forest, which could more logically be expected here. Its character has doubtless been somewhat modified from the climax type by the deforestation of the adjacent lowlands, particularly on the Valencia side.

Its most diagnostic tree is *Bactris* sp., a spiny palm that occurs abundantly in this zone, but is absent from the Deciduous Forest, and uncommon in the cloud forest above. Both flora and fauna are decidedly transitional in character. Arboreal epiphytes are present in very limited numbers. The first *Monstera* appears in this zone, but the species is *pertusa* rather than any of the various forms appearing in the higher, more humid regions; also heliconias, several ferns and even a small tree-fern appear close to the stream beds. *Cnemidophorus* and *Ameiva* are absent, and typically subtropical birds begin to appear. On the southern, Valencia side, it extends from about 900 to 1,000 meters; on the Caribbean side from 500 to 800 meters. Part of the southern portion of this zone is included within the two-kilometer circle of concentrated work (Text-fig. 4).

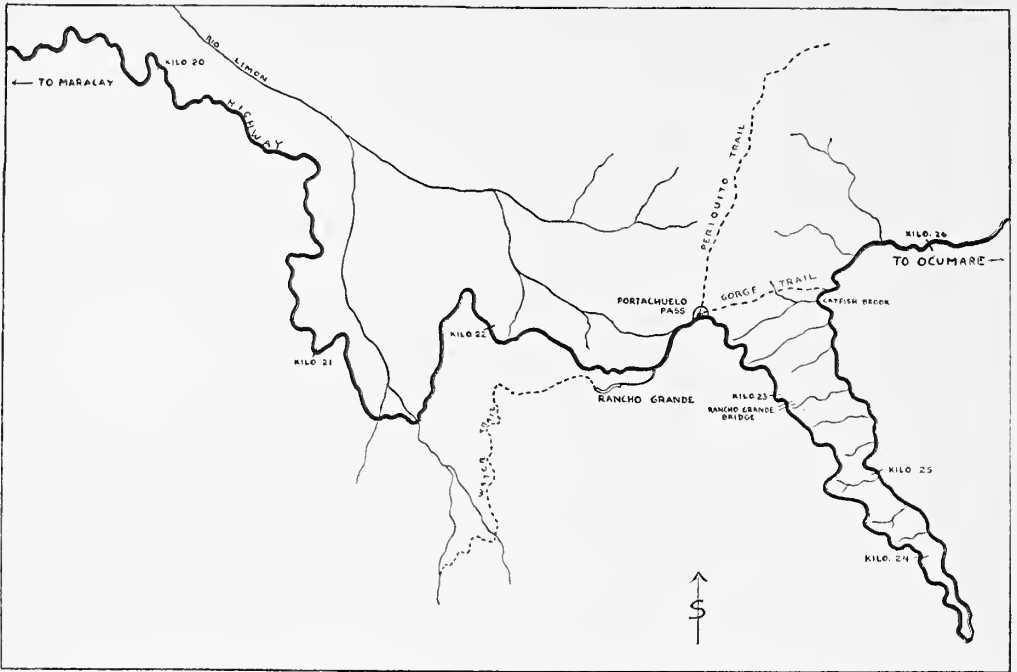

TEXT-FIG. 4. Area of concentrated work at Rancho Grande.

The Thirteenth Zone is the Montane Cloud Forest, on the lower edge of which is situated Rancho Grande. The succeeding section of this paper is devoted to its characteristics; here it will be said only that it is cooler and damper than any of the preceding zones; the forest is completely evergreen with mosses, ferns and epiphytes of many sorts at their optimum; tree-ferns are diagnostic; and in both botanical and zoological characteristics the zone is subtropical. It extends from about 1,000 meters upward on the Valencia side, and from around 700 or 800 meters upward on the Caribbean slopes.

It may be said here that each zone on a mountain side has intrusions in its valleys representing the next higher zone. For example, in the gorges of the Semi-evergreen Seasonal Forest are good examples of Cloud Forest flora, complete with hydrophilous arums and even tree-ferns, while near the riverbeds of the Savanna grow typical gallery forests of the seasonal type.

The fourteenth or Aerial Zone is the last of our subdivisions and was added to the list as an afterthought. Its authenticity was in considerable question in our minds, and we were fully resigned to elimination if in reality it proved too ethereal and indefinite. Surprisingly, it turned out to be one of the most distinct and sharply delimited of all the zones, and yielded an amazing amount of new and interesting facts and material. In brief, it was concerned chiefly with the migration of birds and insects wholly alien

to the Cloud Forest, through the narrow bottle-neck that formed the sharp divide of the Pass of Portachuelo, only a few hundred yards from Rancho Grande.

III. PHYSICAL AND BIOLOGICAL CHARACTERISTICS OF THE RANCHO GRANDE CLOUD FOREST.

A. GEOGRAPHY.

The outstanding geographical factors of the Rancho Grande area which influence its biology are the following: its location in the neotropics; its situation in the steep, narrow coastal range; its nearness to the ocean; the relatively low altitude, promoting subtropical rather than alpine conditions; the restricted size of the cloud forest, now extending in an unbroken strip for less than 100 kilometers along the ridges; the relative poverty of the soil; the presence of Portachuelo Pass; the nearness of Lake Valencia; and, finally, the nearness of deforested and settled areas.

Rancho Grande's exact geographical location is given in the first paragraph of this paper, p. 43. The following list of altitudes, in meters, will help orient the forest vertically: Rancho Grande, 1,097, Portachuelo Pass, 1,136, Maracay, 435, Mt. Guacamayo, to the east, 1,900, Mt. Periquito and Mt. Paraiso, both to the west, 1,525 and 1,814, respectively. The highest neighborhood peak, which lies to the south and east of Guacamayo, is La Mesa, reaching 2,240 meters.



TEXT-FIG. 5. General location of the principal ecological zones near Rancho Grande. Only the highest ridge of the coastal mountain range is indicated; actually the entire region, with the exception of the plain around Lake Valencia, is mountainous.

Scale:

1 cm. = 4.7 km.

B. METEOROLOGY.

[Note: In the following discussion, the phrase "enveloping cloud" is used to indicate the inside of the mountain cloudcap, called *neblina* in Venezuela; "overcast," on the other hand, indicates cloudiness in the sense of high clouds blotting out the sky and sun.]

1. GENERAL WEATHER CONDITIONS.

Because of its contrast to the better-known, desiccated lowlands, the weather at Rancho Grande is one of its most striking characteristics. Its uniform dampness and coolness are typical of tropical montane conditions. The rainfall is twice as high as in nearby Maracay, which lies seven direct miles to the south and less than 700 meters lower. This Rancho Grande average is, however, only 175.3 cm. (68.8 in.) annually over a five-year period, a figure not excessive for

the tropics. To the mountain cloud cap, therefore, must go most of the credit for the extreme lushness of the vegetation, since to its prevalence is due the high average humidity of 92.4% and the absence of great daily or seasonal extremes. From the plain below, or from the seacoast on the opposite side of the range, the local ridges appear buried in the clouds during most of the daylight hours, particularly in the afternoon, even when the lowlands are baking in full sunlight. The temperature during the period recorded, which includes the warmest months, is also distinctly subtropical, averaging 18.9° C. (66° F.) between March and August inclusive, 1946.

Although the mountain weather is very local in extent, it does reflect in general the seasonal characteristics of the lowlands. The temperature is lower around the winter solstice, and the rainfall and humidity are both

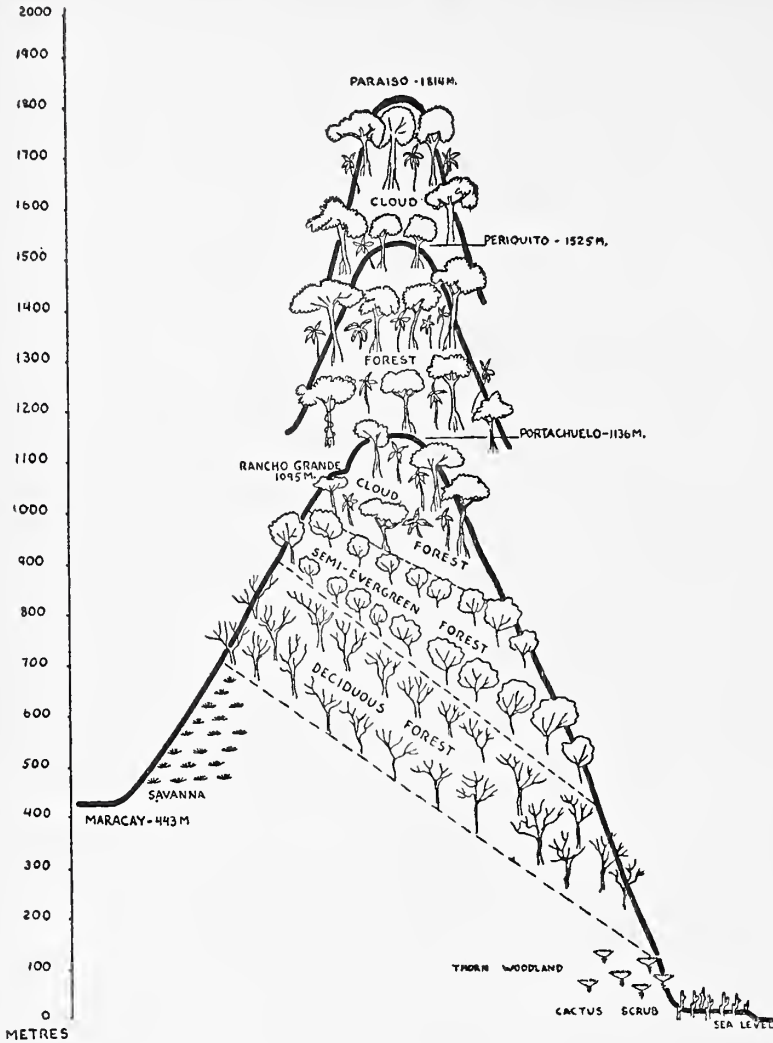

TEXT-FIG. 6. Diagram of altitudinal succession of ecological zones in Rancho Grande area.

less during the height of the country's dry season in February and March. The extreme of heat and drought, with the accompanying decrease in animal activity, are greatly reduced, however. Compared to the periodic desiccation found in the adjacent lowland seasonal forests, coastal scrub, savannas and llanos, the Rancho Grande dry season is not strongly marked; although there may be scarcely any precipitation during February and March, the cloud still keeps foliage and ground relatively damp.

The general meteorological character of a given year is also reflected faintly in the local weather of Rancho Grande. For example, prolonged, widespread spells of bad weather are experienced there in common with the lowlands. The rainy season of 1946 started somewhat early, in both the Maracay region and at Rancho Grande, with repeated downpours occurring in early April, while the months of June and July were abnormally

cool and dry, and August remarkably wet. Finally, in March, a three-day savanna fire on the lowest slopes of the range toward Maracay had a pronounced effect on both the humidity and temperature five hundred meters higher at Rancho Grande; the hottest, least humid days of the record occurred at this time.

An interesting observation was that the effect of the lunar phases on the weather was much more pronounced than in the adjacent lowlands. The least overcast periods of the month usually fell toward the middle and end of the second and fourth quarters, while the days of continuous enveloping cloud, drizzle and heavily overcast skies almost always occurred just after the new moon, and, to a lesser extent, following the full moon. This tendency is indicated in the following figures: In the second and fourth quarters combined, as opposed to the first and third, occurred 60% of the hours of sun-

TABLE I.
RANCHO GRANDE WEATHER: MARCH-AUGUST, 1946.

	Mar.	Apr.	May	June	July	Aug.
Average Temperature, C.	18.6	19.8	19.4	18.9	18.5	18.3
Average Humidity, %	88.3	94.8	94.0	92.6	92.7	92.3
Rainfall, mm.	16	363	330	132	179	511
Approx. no. of hrs. of enveloping cloud*	194	274	194	134	120	84
No. of days without enveloping cloud	6	1	3	11	14	12
No. of sunless days	2	12	5	3	4	4
Approx. no. of hrs. of sunshine	102	47	82	96	109	103

*Observed 6 a.m.—10 p.m. only.

light, 59% of the days (observed from 6 AM to 10 PM) totally without enveloping cloud, only 41% of the total number of hours of enveloping cloud, and only 26% of the completely sunless days. Short visits to Rancho Grande which involve general collecting or photography, should, therefore, be planned for the second or fourth quarter, unless the chief interest is in the collection of night-flying insects at the electric lights. These exceptions reached their maximum abundance in wet weather in the dark of the moon.

Although individual days vary radically, a typical daily weather pattern is apparent. This occurs frequently in both dry and wet seasons and includes a clear early morning; partial or complete overcast after eight o'clock; brief, partly sunny periods around noon; increasing overcast and enveloping cloud in the early afternoon; enveloping cloud, with or without showers, from around four to six or seven o'clock; and more or less complete clearing during the evening. Individual days, however, run the gamut from the very rare altogether clear exceptions to the much more frequent intervals consisting entirely of rain and enveloping cloud. Enveloping cloud after midnight is frequent.

The components of the weather are discussed below in more detail and summarized in Table I.

Although the actual rainfall was distinctly moderate, the figures give no idea of the

all-pervading dampness, since the mountain cloudcap rarely precipitated as drizzle strong enough to be recorded on the rainfall instrument. Comparison of the April and August data in Table I shows how little can be judged of actual weather by the amount of rainfall. April was not only very rainy but had sunshine reduced to a minimum while the hours of enveloping cloud reached their peak. August, on the other hand, though the rainfall was much greater, was notably a month of "good weather" from a human standpoint, the high rainfall being due largely to concentrated downpours.

It must be kept constantly in mind that the data given are for Rancho Grande itself, unless otherwise stated. Since the building is located on the lower southern edge of the cloud forest, that is, of the subtropical zone, the records of sunshine, humidity and temperature would have differed noticeably in opposite directions had the observations been made a mere hundred yards further up or down the mountain, or even at the same altitude in the lee of the range instead of close to Portachuelo Pass.

Dr. Röhl's monograph, *Climatologia de Venezuela* (1946), has arrived just as this paper is going to press. Thanks to his work, there are now available for comparison with the present Rancho Grande data extensive records of temperature, rainfall and extremes of humidity in many localities, including a few montane stations such as Colonia Tovar.

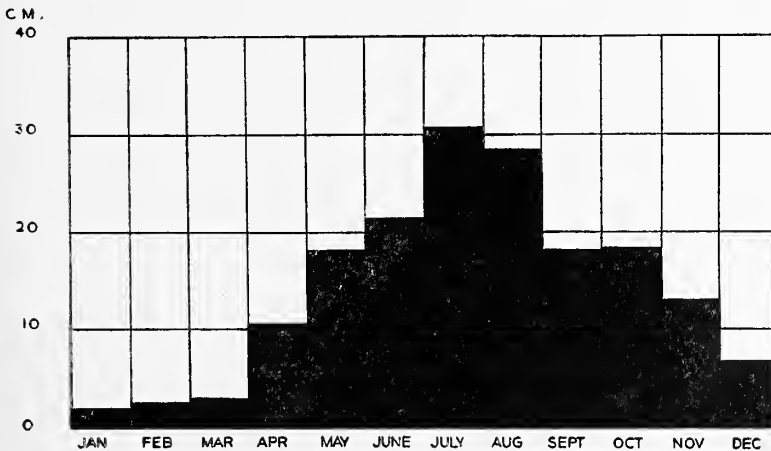

TEXT-FIG. 7. Average monthly rainfall at Rancho Grande, 1941-1945, inclusive. (The months of August and September are based only on 1941-1944 inclusive).

TABLE II.
RAINFALL.

(From Government records, Rancho Grande Station).

	1941		1942		1943		1944		1945		1946	
	mm.	(inches)	mm.	(inches)	mm.	(inches)	mm.	(inches)	mm.	(inches)	mm.	(inches)
January	12	(.5)	4	(.2)	67	(2.6)	7	(.3)	11	(.4)	11	(.4)
February	0	(0)	9	(.4)	81	(3.2)	15	(.6)	21	(.8)	21	(.8)
March	10	(.4)	35	(1.4)	69	(2.7)	4	(.2)	46	(1.8)	16	(.6)
April	48	(1.9)	118	(4.6)	149	(5.9)	36	(1.4)	150	(5.9)	363	(14.3)
May	165	(6.5)	143	(5.6)	164	(6.5)	287	(11.3)	180	(7.1)	330	(13.0)
June	201	(7.9)	198	(7.8)	217	(8.5)	244	(9.6)	218	(8.6)	132	(5.2)
July	257	(10.1)	333	(13.1)	220	(8.7)	241	(9.5)	452	(17.8)	179	(7.1)
August	361	(14.2)	158	(6.2)	300	(11.8)	326	(12.8)	612*	(24.1)*	511	(20.1)
September	141	(5.6)	248	(9.8)	116	(4.6)	234	(9.2)	193	(7.6)	182	(7.2)
October	155	(6.1)	227	(8.9)	194	(7.6)	171	(6.7)	90	(3.5)	170	(6.7)
November	136	(5.4)	133	(5.2)	92	(3.6)	224	(8.8)	18	(.7)	110	(4.3)
December	38	(1.5)	193	(7.6)	46	(1.8)	58	(2.3)	1991	(78.3)	66	(2.6)
TOTAL	1524	(60.05)	1799	(70.8)	1715	(67.5)	1847	(72.7)	2091	(82.3)	2091	(82.3)

*August and September together.

2. RAINFALL.

Complete rainfall records are available from the government gauge maintained in front of the Rancho Grande building for the years 1941-1945 inclusive, and it is from these that the averages given in Table III and Text-fig. 7 are derived. In addition, we include in Table II the totals for 1946, a year with abnormally high rainfall during April and August, while June and July were dry. The latter table shows the high degree of monthly variation in rainfall from year to year. Text-fig. 8 indicates the relative rainfall of four types of tropical areas: that of Kartabo, British Guiana, with an average of 254 cm. (100 in.), an example of climax rain forest; Caripito, Venezuela, average 203.2 cm. (80 in.), in a seasonal forest; Rancho Grande, average 175.3 cm. (69 in.), in montane cloud forest; and Maracay, adjacent to Rancho Grande in the Lake Valencia plain (altitude 1,400 ft.), average 91.9 cm. (36 in.), in a deforested area. The latter locality was probably originally seasonal forest and now comprises agricultural land and secondary savanna.

At Rancho Grande, as throughout the Caribbean area, there are two major seasons, dry and wet, the former extending roughly from January to April and including more or less of the latter month. In many parts of Venezuela, there is a "little dry season" in August and September, when the rainfall is somewhat diminished before rising again to a secondary, lower peak in the succeeding months. This secondary peak does not occur in the Rancho Grande curves, the rainfall usually dropping off gradually after the August heights.

Heavy showers at Rancho Grande almost always swept across the Maracay plain from the southeast, and occurred most often late in the afternoon.

3. HUMIDITY.

Of greater importance than the rainfall in maintaining the constant dampness of Rancho Grande is the high percentage of humidity even during the dry season. Table I shows the monthly averages from March through August of 1946; Table IV a comparison with 1945, and Text-fig. 9 a comparison of typical wet and dry season days with similar ones at Caripito in an area of seasonal forest. It will be remembered that the actual average precipitation at Caripito is more than 10 inches greater than at Rancho Grande (about 80 inches instead of less than 70). The average in the British Guiana rain forest is similarly high, but is due more to actual precipitation (average 100 inches), and has more low daytime extremes. The average at Rancho Grande for the six months is 92.4%, with an extreme low of 45% on

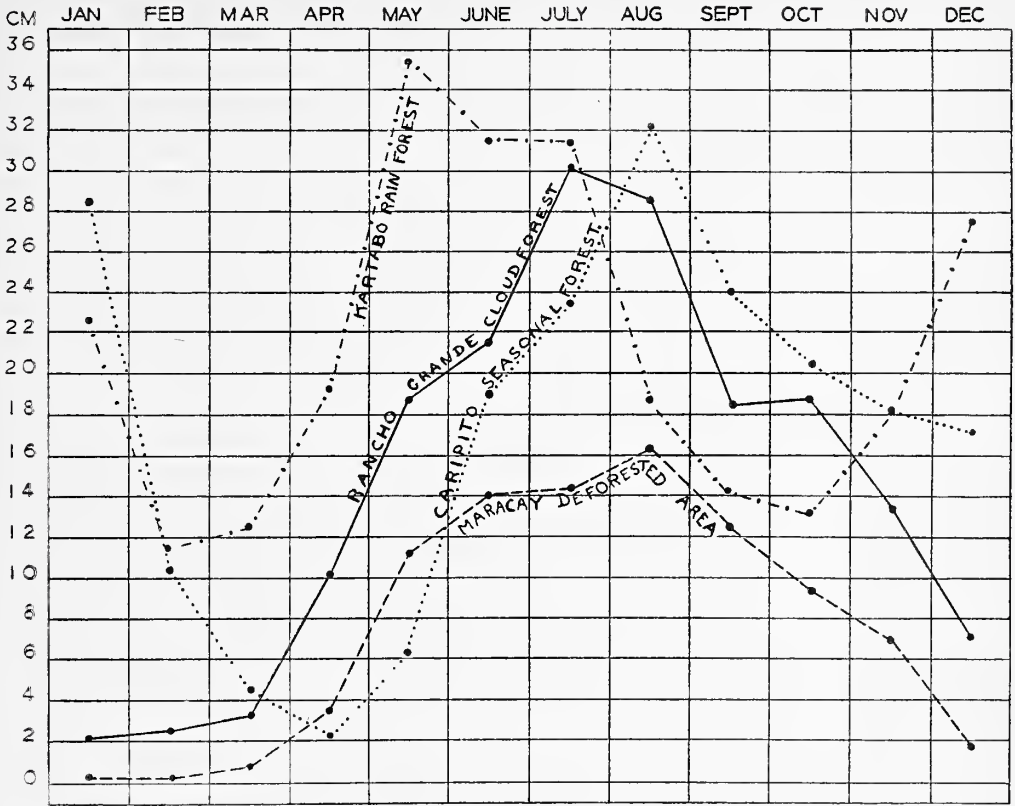

TEXT-FIG. 8. Average rainfall in four types of localities in northern South America. Dot-dash line: climax tropical rainforest, at Kartabo, Bartica District, British Guiana (9 year average, 1911-1920); dotted line: seasonal forest, Caripito, Venezuela (10 year average, 1932-1941); solid line: montane cloud forest, Rancho Grande, Venezuela (5 year average, 1941-1945); dashed line, deforested, cultivated land near Rancho Grande at Maracay, Venezuela (40 year average, 1900-1940).

June 20.² On only four days in the entire period did the reading drop, for a short midday period, into the fifties, and days with dips into the sixties and seventies were rare. Practically every afternoon and night the high nineties were reached. As will be seen from Table I, there was little difference in humidity between the drier and rainier months.

The basic causes of the formation of the mountain cloudcap are the same as in similar mountain ranges, since it results from the daily condensation of the rising, sunwarmed air of sea level against the cool flanks of the mountains. Complicating factors at Rancho Grande are Portachualo Pass, at Rancho Grande's gates, and Lake Valencia on the south. During the expedition, enveloping cloud occurred in the afternoon about two and a quarter times more often than during the morning; however, a common morning sight was the cloud forming in the adjacent range on the south and sweeping

northward through the pass, although it infrequently enveloped the Rancho itself at this hour. During the afternoon it poured through from the opposite direction, from the sea, and descended simultaneously upon the building from the higher ridges. Afternoons of enveloping cloud were often followed by clear nights.

From March through August of 1946, between 6 AM and 10 PM daily, there were at least 1,000 out of a possible total of 3,570 hours of cloud surrounding the building itself, or more than one-quarter. A five-minute walk up or down the mountain would have given respectively, much higher or lower percentages.

The apparatus used to record temperature and humidity was the Termoigrografo, manufactured by La Filotecnica Ing. A. Salmoiraghi S.A. of Milan, and was loaned to us through the kindness of Dr. Guillermo Zuñiga of Caracas. It was stationed on the Rancho Grande verandah about eight feet above ground level, in a position of excellent air circulation.

²Except during the days of forest fire on the lower slopes, around March 21.

TABLE III.

RAINFALL.

From Government records, Rancho Grande Station, 1941-1945 inclusive.

	Mean		Extreme	
	mm.	(inches)	mm.	(inches)
January	20.2	(.80)	4-67	(2-2.6)
February	25.2	(.99)	0-81	(0-3.2)
March	32.8	(1.29)	4-69	(2-2.7)
April	100.2	(3.98)	36-150	(1.4-5.9)
May	187.8	(7.39)	143-287	(5.6-11.3)
June	215.6	(8.49)	198-244	(7.8-9.6)
July	300.6	(11.83)	220-452	(8.7-17.8)
August*	286.25	(11.27)	158-361	(6.2-14.2)
September*	184.75	(7.28)	116-248	(4.6-9.8)
October	188.0	(7.40)	155-227	(6.1-8.9)
November	135.0	(5.32)	90-224	(3.5-8.7)
December	70.6	(2.78)	18-193	(3.1-7.6)
TOTAL, yearly	1747.1	(68.82)	1524-1991	(60-78.4)

*Based on 4-year average (1941-1944) only.

4. SUNSHINE.

The number of hours of sunshine given in Table I were estimated only by observation, and so give only a rough idea of the small amount. Sunny afternoons were exceedingly rare.

5. TEMPERATURE.

As with all observations except rainfall, no recordings have been made except for the time of our stay, during part of the 1945 expedition and throughout that of 1946; these periods included the months of June and July in 1945, and March through August of 1946. In temperature a most interesting discrepancy occurs in the 1945 and 1946 records during the two comparable months, the 1946 monthly average being from 2° to 3° C. (4° to 5½° F.) lower than during 1945 (Table IV). This period of 1946 was markedly cooler than usual in the hot country around Maracay also, as well as a period of drought in that locality, and of less than average rainfall at Rancho Grande. Probably the 1945 temperatures were nearer to the normal. The average 1946 temperature through the six months was 18.9° C. (66° F.); year-round temperatures would doubtless lower the average appreciably, judging by reports of visitors to Rancho Grande during the cold Venezuelan months of December and January. By contrast, the monthly averages at Caripito, on the edge of lowland seasonal forest, range from a December average

of 25.6° to a May average of 28.9° C. (78°-84° F.). At Kartabo, in the British Guiana tropical rain forest, the range is from a minimum average of 25.4° C. in January to 27.5° C. in October (77.8° to 81.5° F.). Depending on whether the 1945 or 1946 temperatures are nearer the true Rancho Grande average, and how low is the December-January minimum, the climate there is some 5.5° to 8° C. (10°-15° F.) cooler than at either Caripito or Kartabo.

At Rancho Grande, the extreme recorded highs were 24° C. (75.2° F.) reached half a dozen times around noon during late March and in April. This excludes the false highs of 25° and 26° C. (77° and 78.8° F.) attained during the forest fire on the lower slopes around March 21. The highest temperature for May was 22° C. (71.6° F.) while June, July and August each reached only 21° C. (69.8° F.).

The lowest recorded temperatures were 14° and 15° C. (57.2-59° F.), both reached frequently between midnight and dawn during the first ten days of March. From April through August, lows of 17° C. (62.6° F.) occurred occasionally every month.

6. WIND.

No wind records were made. As usual in the mountains, the breezes were variable. During the day the wind was often from the southeast, as in Caracas, changing during the late afternoon to northwest.

TABLE IV.

RANCHO GRANDE: HUMIDITY AND TEMPERATURE.
COMPARISONS BETWEEN 1945 AND 1946.

	Humidity		Temperature	
	1945	1946	1945	1946
June	93.9	92.6	20.9C. (69.6F.)	18.9C. (65.6F.)
July	93.0	92.7	21.6C. (70.9F.)	18.5C. (65.3F.)
August	92.5	92.3		

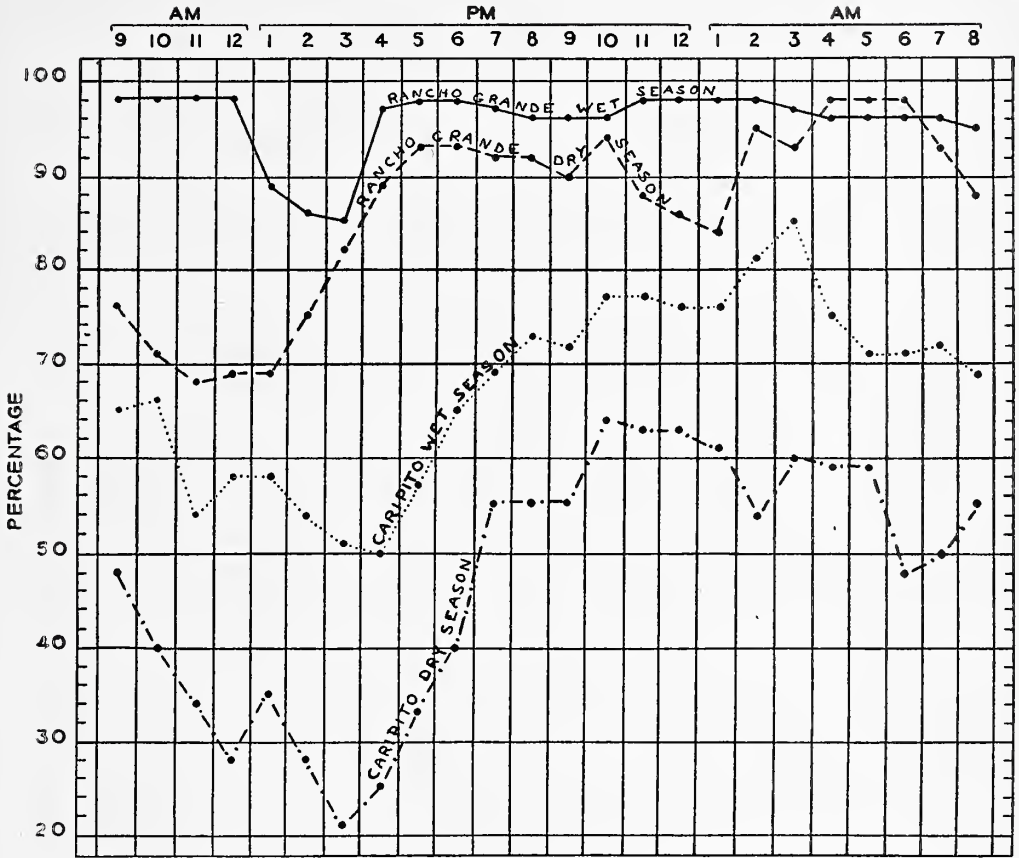

TEXT-FIG. 9. Humidity readings during typical rainy and dry season days in northern Venezuelan forests. *Solid line*: Rancho Grande montane cloud forest, rainy season day (June 26-27, 1946); *dashed line*: same, dry season day (Mar. 11-12, 1946); *dotted line*: Caripito seasonal forest, rainy season day (June 26-27, 1942); *dot-dashed line*: same, dry season day (Mar. 10-11, 1942).

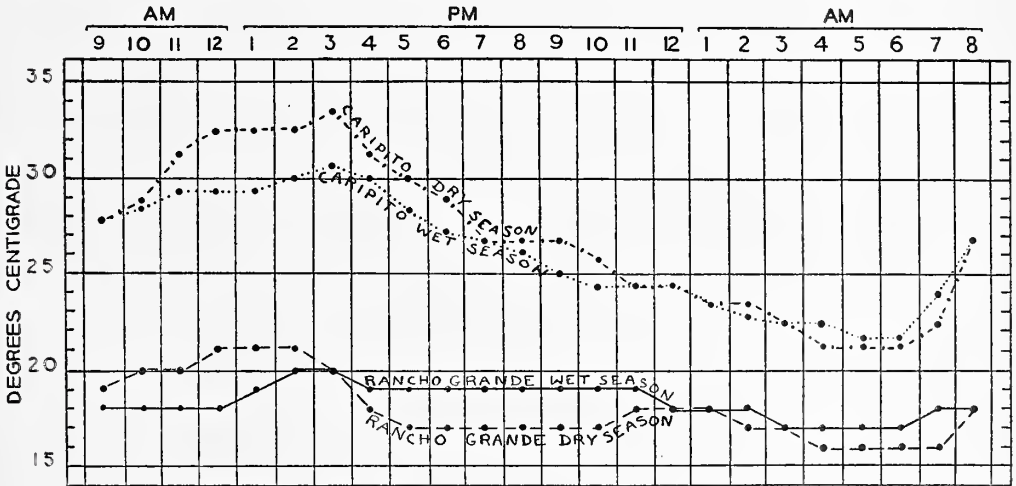

TEXT-FIG. 10. Temperature readings during typical rainy and dry season days in northern Venezuelan forests. *Solid line*: Rancho Grande montane cloud forest, rainy season day (June 26-27, 1946); *dashed line*: same, dry season day (Mar. 11-12, 1946); *dotted line*: Caripito seasonal forest, rainy season day (June 26-27, 1942); *dot-dashed line*: same, dry season day (Mar. 10-11, 1942).

C. BOTANY.

From a general ecological viewpoint, and in comparison with the neighboring zones, the principal botanical characteristics of the Rancho Grande Cloud Forest are the following: the presence of a climax evergreen forest; a moderate abundance of gigantic dominants; an abundance of epiphytes; an abundance of terrestrial hydrophilous groups, especially tree-ferns, small palms, large-leaved arums and families more or less closely related to the arums; and, finally, the presence of a few common, typical plants which, although immigrants from neighboring zones or ecologically widely spread, are important in the life histories of insects and other animals (e. g., a spiny *Bactris* on the lower fringes of the zone, *Cecropia* spp., and *Hedygium coronarium*, the wild ginger).

The zone agrees well with Beard's general description of a montane rain or cloud forest, his diagnosis being as follows (1944, p. 145): "The forest is in two closed stories, at 20 and 10 meters (60 and 30 feet) with a shrub layer formed mainly of simple-leaved dwarf palms and tree-ferns. The trees have heavy crowns, branch low, and are loaded with moss and epiphytes. Leaves are simple, mesophyllous, and covered with epiphylls." Here at Rancho Grande the zone extends on the south from about 1,000 meters to the crests of the local ridges of Guacamayo and Paraiso, which attain 1,814 and 1,525 meters respectively, without giving way to Elfin Woodland. On the northern, littoral side of the range it begins much lower, at about 700 to 800 meters, owing to the lower boundary of the cloudcap on that side.

The Venezuelan Cloud Forest, with special emphasis on this local example, has been so well described by Dr. Pittier, that it seems well to give a translation of his most detailed account (1939, p. 20-21): "When one looks toward the mountains of the Venezuelan coast from the sea, clouds are seen to form on the flanks after the early morning hours, and to increase in size from hour to hour until they cover the highest ridges. The lower edges are straight and uniform, but the mass rises and falls with the temperature. To these strata correspond the cloud forests, enveloped during part of the day in a dense cloud which keeps them perpetually humid. They are the temperate or subtropical rain forests, whose flora in extreme variety appears to possess the greatest number of endemic forms. The plants belonging to this formation have a number of characteristics in common with those of the tropical rain forest, and are not always inferior to them in size. They are distinguished, however, by the immense variety of epiphytes and the presence of a great number of dwarf palms in addition to larger species.

"The cloud forests appear on the flanks of the Andes and of the mountains of Guiana

as well as on the coast range. The most typical and best known are in the valley of Ocumare de la Costa [the Rancho Grande forest] and of Colonia Tovar. The first are of immense proportions and, because of their lower altitude (700-1,600 meters) are of a more tropical character. Here we note as dominant the *niño* or *cucharón* [or *candelo*] (*Gyranthera caribensis*), while the following also are frequent: *el vaco* or *palo de leche* (*Brosimum utile*), *el jobo* (*Spondias lutea*), *el guamo caraota* (*Inga marginata*), as well as *Fagar ocumarensis*, *Abarema trapezifolia*, *Coussapoa villosa*, *Hedyosmum bonplandianum* and many others no less conspicuous. Among the ferns, also numerous, *Hemitelia speciosa* is especially beautiful."

As with every ecological area with which one becomes closely acquainted, subzones early become distinguishable, due primarily to differences of soil, moisture and exposure. For example, in the immediate region of Portachuelo Pass, mosses, lichens, and tree-ferns, as well as epiphytic arums, bromeliads and orchids reach their optimum, because there the enveloping cloud is very prevalent while the temperature is still moderate compared with that of the higher ridges. Again, on the crests of the ridges, there is insufficient support for *Gyranthera*, the local tree giant, and the flora as a whole is poor; here alone is found a shrub-like species of bamboo. Finally, the saturated small gorges support a characteristic flora of their own, not particularly varied; *Dieffenbachia*, a terrestrial arum, reaches here its maximum development. As in all other mountain zones, the vegetation most typical of the Cloud Forest grows on the more moderate slopes, midway between ridge and gorge.

In spite of the constant moisture in the Cloud Forest even during the dry season, there is in many families a well-defined peak of flowering after the beginning of the rains. For example, the Melastomaceae, a family having many conspicuous representatives in this area, blooms principally in May and June; the majority of arums flower in May, June and July, each of the many species having a relatively short season; and the same is true of many bromeliads and orchids. Botanists could profitably spend years at Rancho Grande working out the life histories and ecological relationships of only the more common members of these few families.

D. ZOOLOGY.

To present even a casual view of the general fauna of Rancho Grande is difficult, yet a few paragraphs seem worth while if only to answer the numerous questions of many zoologists. A typical one is, "If I visited Rancho Grande, would I find an abundance of sphinx moths?" (Or fish or cotingas, as the case might be).

Our advice to a Protozoologist at Rancho

Grande would be to concentrate on the infinite number of tiny pools among the leaves and bracts of Bromeliads and Heliconias. These natural aquaria have a range of one to fifty meters above the ground, they are overflowing throughout most of the year, and afford an unending succession of Euglenas, Amoebae, Volvox and a host of other single-celled organisms. Hydras, too, inhabit these infusions and they are also found living more precarious lives on the legs of fresh-water crabs, both in and out of the mountain streams.

As at more tropical levels, Turbellaria or land planarians are common. One giant, six to twelve inches long, lives on leaves and damp moss. It is brilliantly colored and from its size should afford excellent material for experimentation in the field. Lumbricidae or earthworms are abundant, noticeable for their great size, serpent-like activity and frequent occurrence in decayed hollows of lofty trees.

Land mollusks are uncommon, varying from the great four-inch *Dryptus marmoratus* which breeds in the moss of the jungle floor, to small slugs and minute snails in their homes in the damp terrariums of the bromeliads. A few aquatic forms such as *Pachycheilus laevis*, manage a successful existence in the swift water of the small mountain brooks.

In these wooded heights and steep slopes high above the sea, crustacea are naturally a subordinate group. Nevertheless, the bromeliad pools teem with copepods and ostracods, while isopods thrive on the jungle floor. Two species of medium-sized brown land crabs (*Pseudothelphusa*) are found on almost every walk, wandering through the jungle or clinging, crouched, at the bottom of the swift brooks.

Six of the ten orders of Arachnoidea are present, but in relatively few numbers compared with lower, tropical rain forest areas. Among these are spiders, scorpions, whip scorpions, chelifers, harvestmen, ticks and mites. Ticks are rare but harvest mites, or bête rouge, are moderately troublesome.

Several species of *Peripatus* inhabit the Rancho Grande zone, but their discovery is accidental as they inhabit the detritus in the lower leaves of bromeliads and hollows high up in the trees. Millipedes and centipedes are common. The largest of the former, *Polyconoceras ruberculinus*, is six inches in length, brilliant scarlet with narrow black bands, lives on the ground, low brush and tree trunks and is visible from a considerable distance.

We found every order of insects except Protura, Mecoptera and Strepsiptera. Omitting mention of the rarer orders, Orthoptera increases from uncommon to abundant with the progression of the rains. Life histories of very many forms would be easy to work

out and offer a relatively untouched field to an entomologist. Grasshoppers and crickets range from the eight-inch spread of the scarlet-winged *Tropidacris deia* to the abundant, small quadrupedal *Tridactylides*. Giant tree crickets are abundant in bromeliads. Mantids and walking sticks, both small and large, thrive at this altitude and under these untropical temperatures. Earwigs are fewer than in more tropical areas, but much more common than in our eastern United States. They share with staphylinids the carcasses used as bait in the pits, as well as the spathes of terrestrial and epiphytic arums.

Isoptera or termites are very rare. Some element in the elevated and cool environment is against them. Arboreal nests are absent, and only at rare intervals is there a flight of the winged sexes from some hidden subterranean nest. Odonata are not common and their larvae find scant shelter in the upper reaches of the streams. We especially missed the spectacular *Mecistogaster* of the deep tropical jungle. Many families of Hemiptera and Neuroptera are present but in reduced numbers due to the absence of some important ecological necessities. Homoptera are more fortunate and almost up to their tropical numbers. Fulgorids are rare but a few striking forms come to our lights.

The great order of Coleoptera presents a very irregular sequence of family representation. Cicindelidae and Gyrinidae are almost absent from lack of suitable sand and water. Considering the abundance of dead trees both standing and fallen, it is not easy to account for the relative scarcity of Elateridae, Buprestidae, and to a less noticeable extent of Cerambycidae. It is perhaps the lack of dry dead wood which is the deterrent to successful breeding of the larvae. Flower weevils vie with Chrysomelids in abundance. Carabidae are rare for some unknown reason, whereas staphylinids are common, at least in individuals. As in groups of wholly unrelated organisms such as Myriopoda, Turbellaria and Mollusca, certain coleopteran families may have a single species which in size and conspicuousness stands out from any of its fellows. Examples are *Acrocinus* in Cerambycidae, and *Dynastes hercules* in Dynastidae. Sudden eruptions of enormous numbers may occur, as in several species of cockchafers or "Junebugs" among the Scarabaeidae, which occasionally come to the light in tens of thousands.

Diptera, owing to inadequate collecting, must be dismissed with the generalization of being present in far fewer numbers of species and individuals than in more typically tropic places. At Maracay, for example, houseflies are most unpleasant pests, while at Rancho Grande *Musca* is a rarity in the laboratory.

Drosophila melanogaster and *D. simulans*

were abundant from June through August, but were doubtless brought up from the low country on market fruit. When mangos or bananas were exposed in the forest, no *Drosophila* were attracted, nor were they taken on wild blossoms or fruit.

Hymenoptera, as far as wasps and bees are concerned, are far from common. Army and leaf-cutting ants are present in the same relative numbers as in the hot tropics. A few very large nests of the latter are near Rancho Grande, and bivouacs of army ants occur and reoccur here and there in the forest. Ants of other groups are decidedly rare, very few on the jungle floor, and almost wholly absent in the laboratory.

We have reserved the order Lepidoptera for the last of the insects. The use of electric light for the first time in a locality such as Rancho Grande results in an effect on moths which is indescribable, and which will be considered in detail in other papers. Throughout portions of two years, on all but moonlight nights, moths, in hundreds of species and thousands of individuals, came to the great windows of the laboratory and to three white-washed walls on the roof. As one example of this abundance, a preliminary survey reveals that we have taken at least 67 species of sphinx moths at the lights. The nocturnal hosts were all the more unexpected because in the course of our diurnal walks along the trails or through underbrush we almost never saw a moth, except now and then some very small species.

A phenomenon equally interesting concerned vast numbers of butterflies. These were migrants to the ultimate count of almost one hundred species, and numbers of individuals which attained astronomical proportions. For days and sometimes weeks, these poured through the pass of Portachuelo, only a few hundred meters from Rancho Grande.

Turning to the vertebrates, the fish afford a neat, concise bit of fauna, which can be considered in a single paragraph. Within the borders of our limited ecological boundaries there are only a few small mountain brooks and only three species of fish living in them. On the Caribbean side of the divide lives a small catfish (*Pygidium banneai*), while on the Lake Valencia slope to the south in the mountain torrents there are two species of characins (*Creagrutus beni* and *Hemibrycon dentatus metae*).

Final identification of the species of higher vertebrates of Rancho Grande is proceeding too slowly to draw upon for regional summaries in this present preliminary review. These will be included in subsequent reports.

Here it may be said only that frogs of a few species are common, particularly bromeliad tree frogs, as would be expected in this environment which combines high humidity with abundant epiphytes and absence of

standing water. Of ground living forms *Atelopus cruciger* is abundant, *Gastrotheca* common, while *Pipa* does not reach this altitude. No tortoises are found.

Snakes are moderately common, but of poisonous serpents bushmasters and rattlesnakes are absent, ferdelance moderately plentiful, and coral snakes rare. The most commonly seen of the latter group is *Micrurus mipartitus*. Lizards as a whole are uncommon. Especially noticeable for their absence at this altitude are the sun-loving *Cnemidophorus* and *Ameiva*. On the other hand, geckos and skinks are present and such unusual forms as *Argalia* and *Proctoporus* are not uncommon, although these two latter genera are absent from the seasonal forest lower down.

The avifauna while rich, thanks to the preservation of the cloud forest, does not compare with that of an undisturbed tropical rain forest. Most of the forms are distinctly subtropical. This does not refer to the migrants which at times pour through Portachuelo Pass. These include local, Argentinian and North American species. Because of the extremely steep slopes and the dense underbrush, continued ornithological observation is extremely difficult.

Mammals are not abundant in this zone, but most of the major groups are represented. A mammalogist, especially if interested in comparative physiology, would doubtless find ample problems and material in the bats and small rodents, especially the spiny rats. The most conspicuous mammal is a rufous-tailed squirrel, *Sciurus griseogana meridensis*. Anteaters are absent, jaguars are rare, ocelots and tayras fairly common. The commonest diurnal, terrestrial mammal is an aguti; the rarest a small deer.

SUMMARY AND CONCLUSIONS.

The following characteristics of Rancho Grande emerge as dominant:

1. Its location in north central Venezuela (10° 21' N. Lat., 67° 41' W. Long.), on the Caribbean coastal range of the Andes at an altitude of 1,100 meters, in the National Park of Aragua.
2. Its situation in an undisturbed montane cloud forest.
3. Its proximity to other ecological zones on both sides of the mountain range, including seasonal forests, savanna, thorn woodland, cactus scrub, Lake Valencia, mangroves, sandy and rocky littoral, coral reefs, and pelagic and abyssal zones of the Caribbean. All of these are accessible by car over excellent roads. Alpine zones do not occur in the neighborhood.
4. The steepness of the terrain.
5. The high humidity (average 92.4% during six months of 1946) and low temperature (18.9° C. during the same period), with a slight range of both, combined with moderate

average rainfall (175.3 cm. annually over a five-year period).

6. The weakly-marked seasons, because of the constant humidity, which promote moderate animal activity even during the dry season (January-April). There is, however, a decided peak in blooming and breeding during the first months of the rains.

7. The presence of a varied flora containing many endemic forms. It is especially remarkable for the profusion of epiphytes.

8. The presence of a subtropical rather than tropical fauna, which is rich in comparison with a temperate or alpine population, but poor compared with that of a tropical rain forest. It seems superior in number and variety of life forms to most types of tropical seasonal forests.

The accessibility of the National Park, near the center of the hemisphere and convenient to centers of transportation, should make it invaluable to scientists of both American continents. In addition to the more obvious problems of ecology, behavior and distribution, physiological studies of many vertebrates and invertebrates would certainly yield results in comparisons of cloud forest forms with their nearest lowland relatives. Except in the case of a few groups, such as moths, the assembling of large collections would be difficult and not very rewarding since the fauna itself, as has been said, is of only moderate richness, and the terrain is a decided physical handicap; in addition, the government quite rightly prohibits the killing of birds and game animals. The effects of this protection are even now beginning to be seen in the increased tameness of many birds and mammals which elsewhere are rare and unapproachably shy.

The present intention of the Venezuelan government is to maintain Rancho Grande as a biological field station, continuing the work inaugurated there by the New York Zoological Society through the generous cooperation of that government and of the

Creole Petroleum Corporation. The Park and the building of Rancho Grande are under the jurisdiction of the *Departamento de Bosques y Aguas, Ministerio de Agricultura y Cría*, Caracas. The congratulations of all conservationists and field biologists are due the Venezuelan government for its timely action in establishing the Park and in planning for the continuation of research.

V. BIBLIOGRAPHY.

BEARD, J. S.

1944. Climax vegetation in tropical America. *Ecology*, XXV: 2, pp. 127-158.

BEEBE, W.

1925. Studies of a tropical jungle; one quarter of a square mile of jungle at Kartabo, British Guiana. *Zoologica*, VI: 1, pp. 1-193.
1942. Physical factors in the ecology of Caripito, Venezuela. *Zoologica*, XXVIII: 9, pp. 53-59.

GONZALEZ, E.

1941. Climatología de Venezuela. *Estados Unidos de Venezuela: Ministerio de Agricultura y Cría: Dirección de Agricultura; Servicio de Meteorología Agrícola*. Caracas.

PITTIER, H.

1926. Manual de las plantas usuales de Venezuela. *Litografía del Comercio*. Caracas.
1939. Suplemento a las plantas usuales de Venezuela. *Editorial Elite*. Caracas.

VERDOORN, F. (Editor).

1945. Plants and plant science in Latin America. *Chronica Botanica Co.* Waltham, Mass.

RÖHL, E.

1946. Climatología de Venezuela. (*Impresión ordenada por el Ministerio de la Defensa Nacional*). *Tipografía Americana*. Caracas.

EXPLANATION OF THE PLATES.

PLATE I.

- Fig. 1. Looking east toward Rancho Grande from Mt. Cogollal, showing surrounding montane cloud forest. The cloud cap, which often covers the entire area, is seen in the upper edge of the picture, hanging over Mt. Guacamayo.
- Fig. 2. Looking toward Rancho Grande from the Valencia plain. In the foreground is pasture; beyond is the Limon River, marked by seasonal forest; the nearest foothills, completely deforested, are covered with savanna which is more or less burned over almost yearly; patches of deciduous seasonal forest remain only in their valleys; in the extreme distance on the right lies the montane cloud forest, capped with cloud and concealing Rancho Grande.

PLATE II.

- Fig. 3. The west wing of Rancho Grande from the road. The laboratory windows show in the left-hand end of the building.
- Fig. 4. Outlook from the roof of Rancho Grande toward Lake Valencia. The successive valleys and ridges are covered with montane cloud forest, semi-evergreen seasonal forest, deciduous seasonal forest, and on the deforested foothills near the lake, savanna.

PLATE III.

- Fig. 5. Laboratory of the expedition's headquarters at Rancho Grande.
- Fig. 6. Taking color motion pictures at the foot of a giant candelo tree (*Gyran-*

thera caribensis) beside the road in the cloud forest. The base of the tree extends in the background across the entire width of the picture. Among the distinguishable vegetation, terrestrial and epiphytic, are ferns, *Anthurium*, *Philodendron*, *Monstera*, *Heliconia*, *Calathea* and *Cecropia*.

PLATE IV.

- Fig. 7. Candelo tree (*Gyranthera caribensis*) in front of Rancho Grande, showing epiphytes. The tree loses its leaves briefly in July, during the rainy season, and its enormous load of bromeliads, orchids and arums can best be seen at that time. Here the epiphytes are set off by the cloud mass pouring through Portachuelo Pass and hiding the mountain slope immediately behind.
- Fig. 8. Tree-fern in Portachuelo Pass, with scandent ferns growing from its trunk. Method of collecting insects in inverted umbrella is shown.

PLATE V.

- Fig. 9. Canopy study at Rancho Grande. On the trunk the most conspicuous growth is *Carludovica*; orchids are distinguishable on the branches.
- Fig. 10. Aerial roots of arums and bromeliads silhouetted by a cloud rushing through Portachuelo Gorge. The adjacent mountain side is barely visible through the mist. Note vines climbing both up and down the roots.



FIG. 1.



FIG. 2.

ECOLOGY OF RANCHO GRANDE, A SUBTROPICAL CLOUD FOREST IN NORTHERN VENEZUELA.





FIG. 3.



FIG. 4.

ECOLOGY OF RANCHO GRANDE, A SUBTROPICAL CLOUD FOREST IN NORTHERN VENEZUELA.





FIG. 5.



FIG. 6.

ECOLOGY OF RANCHO GRANDE, A SUBTROPICAL CLOUD FOREST IN NORTHERN VENEZUELA.





FIG. 8.

ECOLOGY OF RANCHO GRANDE. A SUBTROPICAL CLOUD FOREST IN NORTHERN VENEZUELA.



FIG. 7.





FIG. 10.

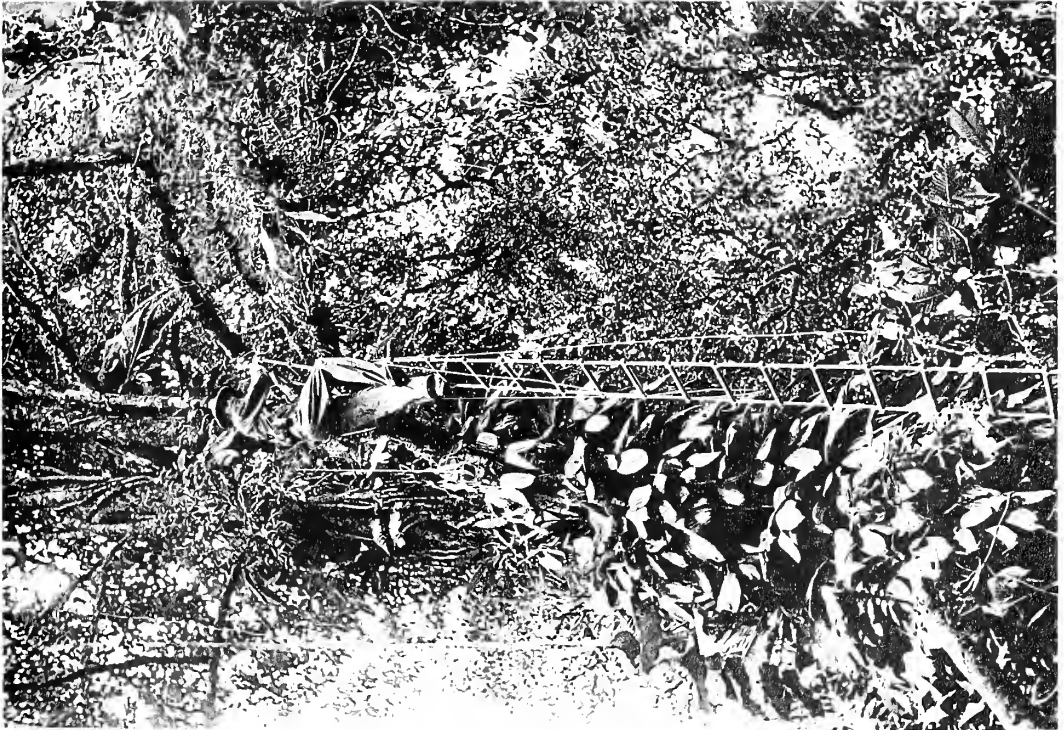
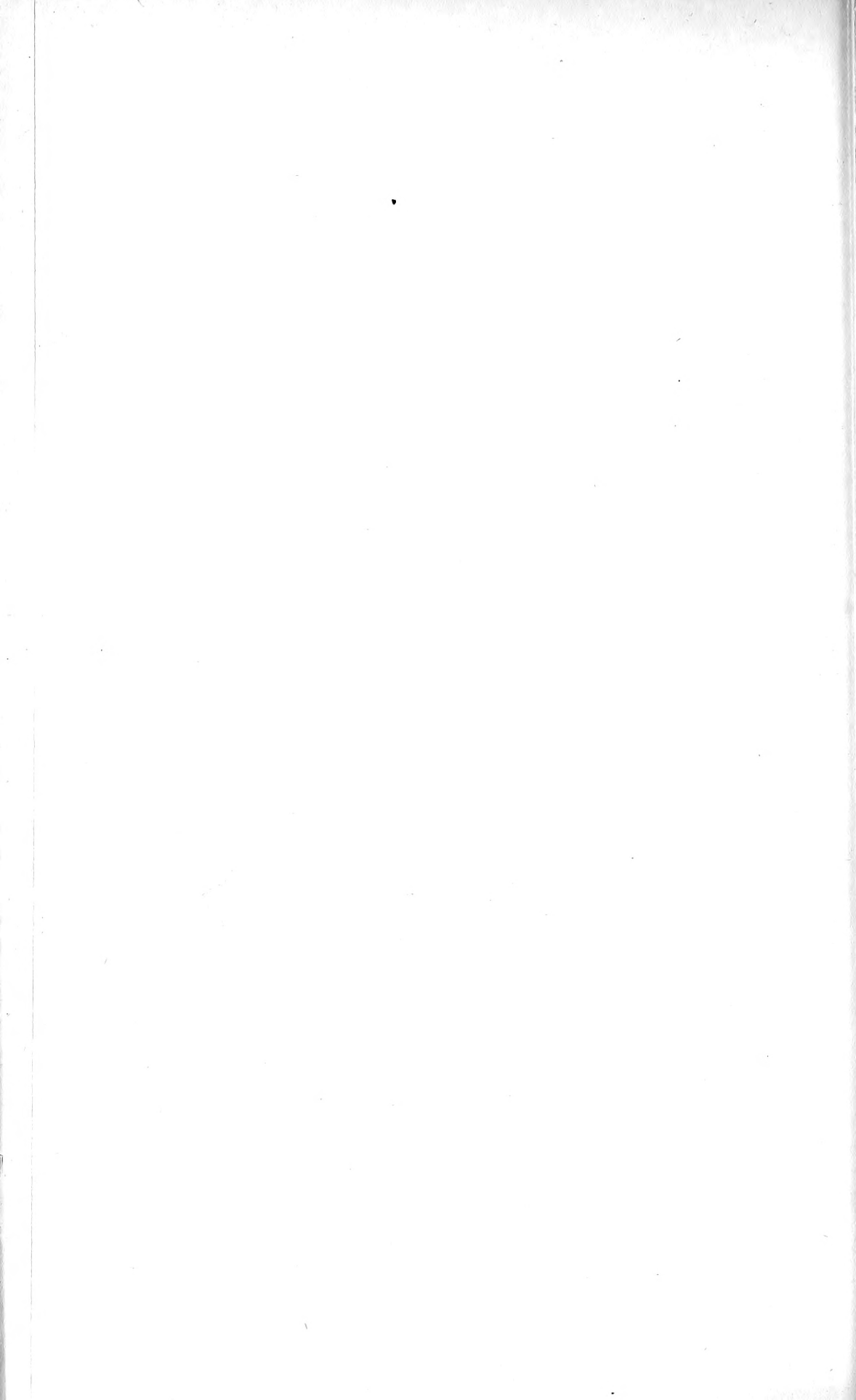

FIG. 9.

ECOLOGY OF RANCHO GRANDE, A SUBTROPICAL CLOUD FOREST IN NORTHERN VENEZUELA



6.

Two New Pseudoscorpions of the Subfamily
Lamprochernetinae from Venezuela.¹

C. CLAYTON HOFF.

Colorado Agricultural and Mechanical College, Fort Collins, Colorado.

(Text-figures 1-5).

[This is one of a series of papers resulting from the 45th and 46th Expeditions of the Department of Tropical Research of the New York Zoological Society, made during 1945 and 1946 under the direction of Dr. William Beebe, with headquarters at Rancho Grande in the National Park of Aragua, Venezuela. The expeditions were made possible through the generous cooperation of the National Government of Venezuela and of the Creole Petroleum Corporation.

[The characteristics of the region are in brief as follows: Rancho Grande is located in north central Venezuela (10° 21' N. Lat., 67° 41' W. Long.), 80 kilometers west of Caracas, at an elevation of 1,100 meters, in the undisturbed montane cloud forest which covers this part of the Caribbean range of the Andes. Adjacent zones include seasonal forest, savanna, thorn woodland, cactus scrub, the fresh water Lake of Valencia and various marine littoral zones.

[The Rancho Grande area is generally subtropical, being uniformly cool and damp throughout the year because of the prevalence of the mountain cloud cap. The average humidity during the expeditions, including parts of both wet and dry seasons, was 92.4%; the average temperature during the same period was 18° C.; the average annual rainfall over a five year period was 175 cm. The flora is marked by an abundance of mosses, ferns and epiphytes of many kinds as well as a few gigantic trees. For further details see Beebe and Crane, *Zoologica*, Vol. 32, No. 1, 1947. Unless otherwise stated, the specimens discussed in the present paper were taken in the montane cloud forest, within a radius of one kilometer of Rancho Grande.]

Three pseudoscorpions recently submitted to the writer for identification and study were collected at Rancho Grande, Venezuela, by the Expedition of the Department of Tropical Research, New York Zoological Society. Two of these individuals are described herein as belonging to new species. The third individual is a tritonymph and does not merit description at this time.

The specimens are deposited in the American Museum of Natural History.

¹Contribution No. 753, Department of Tropical Research, New York Zoological Society.

SUBORDER MONOPHYRONIDA
CHAMBERLIN.

FAMILY CHERNETIDAE CHAMBERLIN.

Subfamily Lamprochernetinae Beier.

Lustrochernes concinnus, new species.

Text-figures 1-3.

FEMALE: Body moderately stout; 3.45 mm. in length; appendages stout; body and legs light brown, carapace slightly deeper brown, palpi dark reddish-brown. Carapace virtually smooth; transverse furrows fairly well marked; lateral margins weakly convex, posterior margin nearly straight; setae acuminate, ten setae along the posterior margin; eye spots very weakly developed; length of carapace 1.05 mm., greatest width about 0.81 mm., width across the posterior margin little less. Abdomen fairly stout, length 2.4 mm., width about 1.4 mm. Tergites except the first and last divided, the anterior tergites not so strongly divided as the more posterior ones; first tergite with 15 setae; maximum number of setae on any tergal half is 10; setae acuminate; tergites virtually smooth. Sternites 5 through 10 divided; most sternal halves with 12 to 14 well-developed and acuminate setae; sternites virtually unsculptured. Anterior stigmatic plate with three setae, posterior plate with one.

Chelicera: Yellowish-brown in color; fairly stout; exterior surface of hand with a few netlike markings; interior and laminal setae very long, subbasal and basal setae much shorter and with one or two subdistal microspines; flagellum with the anterior blade unilaterally toothed; chelicera 0.3 mm. long, base 0.16 mm. wide. Fixed finger relatively slender and with a wide lamina exterior; inner margin of fixed finger with five somewhat retroconical teeth; three blunt denticles on the inner margin of the apical tooth; serrula interior with all but the distal four plates fused to form a velum. Movable finger little curved, 0.24 mm. long; subapical

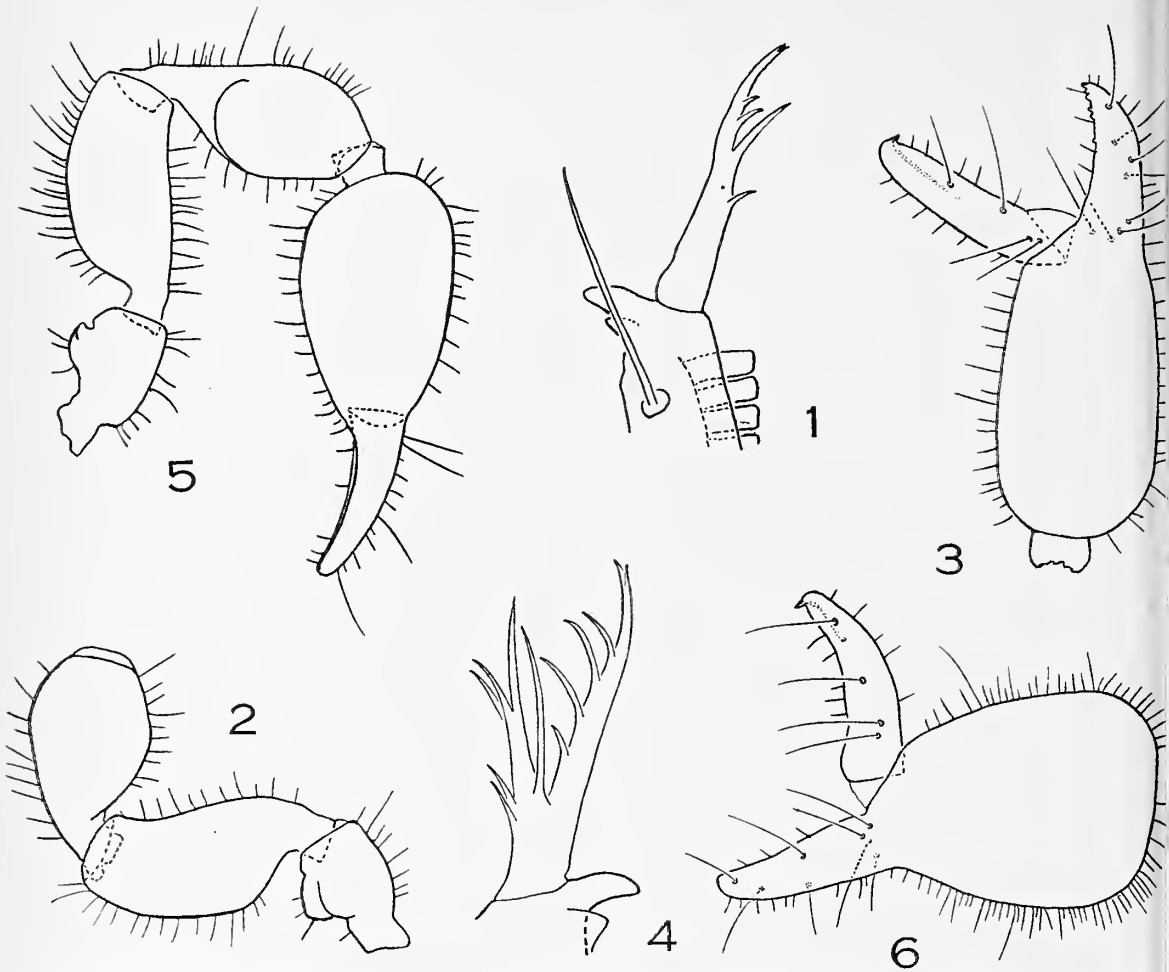

TEXT-FIGS. 1-5. 1. *Lustrochernes concinnus*, new species, female holotype, tip of movable finger of chelicera. 2. Idem, dorsal view of palpal trochanter, femur, and tibia. 3. Idem, lateral view of chela to show the position of the tactile setae; marginal and most accessory teeth omitted. 4. *Cordylochernes potens*, new species, male holotype, galea. 5. Idem, dorsal view of palp. 6. Idem, lateral view of chela to show the position of the tactile setae; teeth of fingers omitted.

lobe near the apical tooth and not especially well developed; galeal seta not reaching nearly to the tip of the galea; serrula exterior composed of 19 or 20 ligulate plates; galea fairly stout with six simple rami, variable in length and confined to the distal two-thirds of the galea.

Palpus: Maxilla yellowish-brown, rest of palp deep reddish-brown; maxilla with smooth surface; the extensor surface of the trochanter with a few granules on the protuberances, the femur with the flexor surface granulate; a few granules on the distal portion of the flexor surface of the tibia; chela virtually smooth; investing setae numerous, long, and usually acuminate, sometimes with one or two minute subterminal microspines. Maxilla 0.56 mm. long, 0.34 mm. wide. Trochanter with two protuberances, one somewhat conical in shape and lateral in position,

the other bluntly rounded and subdorsal in position; pedicle stout; length of trochanter 0.48 mm., width 0.31 mm. Femur subsigmoid in general shape; inner or flexor margin S-shaped with a weak sinuation near the distal end of the flexor margin of the pedicle; extensor margin flatly convex; pedicle well differentiated and not so long as wide; length of femur about 0.79 mm., greatest width 0.38 mm. and located at about the basal one-third of the podomere. Tibia with stout pedicle; flexor margin well rounded; length 0.79 mm., width 0.395 mm. View of chela from the dorsad not obtained since one chela is missing from the specimen. Chela without pedicle about 1.35 mm. long; movable finger 0.65 mm. long. From the side, chela moderately stout, basal margin evenly rounded and passing without interruption into the somewhat flatly convex dorsal and ventral mar-

gins of the hand; fixed finger somewhat curved, movable finger nearly straight;; length of hand without pedicle 0.81 mm., depth of hand 0.49 mm. Position of tactile setae as indicated in Text-fig. 3. Movable finger with 32 marginal teeth, those of the distal end of the row conical and cuspid, those of the proximal portion of the row rounded and acuspid; nine external accessory teeth evenly spaced along most of the finger margin; three internal accessory teeth clustered near the distal end of the finger; nodus ramosus located a little more than one areolar diameter proximal to tactile seta *t*. Fixed finger with marginal teeth similar to those of the opposing finger; five internal accessory teeth confined to the distal one-half of the finger; nine external accessory teeth confined to the distal two-thirds of the finger.

Legs: Light yellowish-brown in color; inner surfaces of podomeres unsculptured, outer surfaces with scalelike or netlike lines especially in the posterior legs; setae fairly numerous, acuminate, little more numerous on the distal than on the proximal podomeres. First leg with stout trochanter, 0.17 mm. long, 0.15 mm. deep; pars basalis 0.24 mm. long, 0.18 mm. deep; pars tibialis 0.48 mm. long, 0.20 mm. deep; entire femur 0.57 mm. in length; tibia stout, flexor margin a little convex, extensor margin proximally convex but distally very little concave, 0.44 mm. long, 0.13 mm. deep; tarsus subcylindrical, about 0.33 mm. long, 0.082 mm. deep. Fourth leg with trochanter 0.33 mm. long; pars basalis subtriangular, 0.34 mm. long, 0.245 mm. deep; pars tibialis stout, extensor margin evenly convex, flexor margin weakly convex, length 0.68 mm., depth 0.335 mm.; entire femur 0.83 mm. long; tibia shaped much as in the first leg except the distal portion of the extensor margin is very weakly convex, length 0.64 mm., depth 0.19 mm.; tarsus subcylindrical, a little deeper across the proximal end than elsewhere, length 0.44 mm., depth 0.12 mm.; a long tactile seta located 0.1 mm. from the proximal margin of the tarsus.

Genital complex: Anterior operculum with eight setae anterior to the genital pore and with a compact group of 14 smaller setae still more anterior; posterior operculum with 10 setae arranged in a single row along the margin.

TYPE LOCALITY: The female holotype from Rancho Grande, Venezuela. The specimen was taken from a Harlequin grasshopper.

Lustrochernes concinnus belongs to a subgroup of *Lustrochernes* in which identification is difficult. Our present species appears to be closely related to *L. subovatus* (With, 1908) from Argentina, *L. ovatus* (Balzan, 1891) reported from Venezuela to Paraguay, *L. communis* (Balzan, 1890) reported from Argentina to Dutch Guiana, and *L. dominicus* Hoff, 1944, from Dominica. From these

species, *L. concinnus* may be separated by the much more sigmoid shape of the palpal femur and the stouter condition of many of the pedal podomeres. In addition, the galea in *L. concinnus* is not bifurcated near the base. In general, our species may be separated from other members of the genus by the size and the length: width ratio of the palpal podomeres.

***Cordylchernes potens*, new species.**

Text-figures 4-6.

MALE: Body large, elongate; palpi stout, legs relatively slender; body and legs moderate to deep brown, carapace deep reddish-brown, palpi very dark reddish-brown; length of body 5.2 mm. Carapace with well-rounded anterior margin, lateral margins nearly straight and parallel behind the median furrow; furrows well impressed; eyes not distinguished in KOH treated specimen; surface finely but distinctly granulate anterior to the median furrow, smooth posterior to the furrow; setae fairly numerous, acuminate; setae of the posterior margin chiefly broken, but apparently about 16 in number; carapace nearly 1.6 mm. long, about 1.4 mm. in maximum width. Tergites 1 and 11 not divided, other tergites well divided; surface of tergites almost unsculptured but fine netlike lines observed in some areas; setae fairly numerous and acuminate; most tergal halves with about 10 setae. Sternites 4 through 10 divided; surface marked by weakly developed netlike lines; setae acuminate, sternite 4 with three setae on each half, some central sternal halves each with as many as 15 setae. Abdomen elongate in general shape, lateral margins weakly convex; length about 3.6 mm., width 1.8 mm. Pleural membranes marked by closely spaced parallel striations; each stigmatic plate apparently with six setae.

Chelicera: Brownish-yellow in color, fairly stout; external, basal, and subbasal setae with a minute subterminal microspine; interior and laminal setae very long and acuminate; the distal blade of the flagellum much flattened and with numerous acute denticles along the anterior border; length of chelicera about 0.47 mm., width of base 0.29 mm. Fixed finger a little curved; lamina exterior well developed; serrula interior with the distal five plates serrate and free, the last elongate, the other four platyform; inner margin of finger with six or seven denticles, inner margin of apical tooth with three weakly developed denticles. Movable finger fairly stout and little curved; serrula exterior of 26 ligulate plates; subapical tooth stout; three or four very small spinelike denticles on the inner finger margin near the level of the galeal seta and just proximal to the apical tooth; galeal seta not reaching the tip of the galea; galea with a very stout base, dividing near the basal one-fourth into two stout

branches and one very slender and shorter branch, each of the two stout branches with numerous simple rami along the margin; length of movable finger nearly 0.45 mm.

Palpus: Setae numerous, usually with one or two terminal and subterminal microspines; surface virtually smooth. Maxilla nearly as dark in color as the rest of the palp, 0.93 mm. long, 0.55 mm. wide. Trochanter with well-defined pedicle about as wide as long, a conspicuous subdorsal protuberance; length 0.97 mm., width about 0.59 mm. Femur with pedicle about as long as wide; flexor margin of femur with a very weakly developed concavity near the distal end; length 1.47 mm., width 0.64 mm. Tibia with flexor margin convex in the center; extensor margin straight to weakly concave in the basal half, convex beyond; a poorly developed but definite and distinct protuberance in the basal one-half, the protuberance placed subdorsal and not seen in profile in a strict dorsal view of the podomere; length 1.62 mm., width 0.71 mm. Hand with both flexor and extensor margins moderately convex; basal margin rounded and joining the other margins without interruption; fingers from dorsal gently curved; chela without pedicle 2.58 mm. in length, 0.96 mm. in width; hand without pedicle 1.46 mm. long, 1.21 mm. deep; movable finger 1.15 mm. in length. Hand from the side very heavy, ventral margin weakly convex, dorsal margin much more convex; hand deepest across the base; fixed finger stout and a little curved, movable finger a little less slender but much more curved. Tactile setae of chelal fingers as shown in Text-fig. 6. Fixed finger with about 55 marginal teeth, these contiguous and spaced along nearly the entire finger margin; marginal teeth of distal end of row conical and with a heavy cusp, those of proximal end of row rounded and with poorly developed cusps; external accessory teeth weakly developed, some apparently broken, probably about 16 arranged in the distal two-thirds of the finger; apparently 10 internal accessory teeth arranged in the distal one-half of the finger. Movable finger with marginal teeth similar in number and nature to those of the opposing finger; seven internal accessory teeth almost contiguous and lo-

cated in the distal one-third of the finger; numerous weakly developed external accessory teeth confined to the distal two-thirds of the finger; nodus ramosus located between tactile seta *t* and *st*, almost twice as far from the latter as from the former.

Legs: Relatively slender; setae numerous and long, often with one or two subterminal or terminal microspines; first leg reddish-brown in color, fourth leg lighter yellowish-brown; surface of some podomeres marked by weakly developed netlike lines. First leg with trochanter 0.34 mm. long, 0.27 mm. deep; pars basalis pedunculate, flexor margin very weakly convex, length measured along the flexor margin 0.42 mm., depth 0.33 mm.; pars tibialis with extensor margin weakly but evenly convex, flexor margin nearly straight, length measured along the extensor margin 0.81 mm., depth 0.29 mm.; length of entire femur 1.07 mm.; tibia with extensor margin weakly concave, flexor margin weakly convex, deepest near the distal end, 0.89 mm. long, 0.2 mm. deep; tarsus subcylindrical, length 0.61 mm., depth 0.13 mm. Fourth leg with relatively slender trochanter, 0.62 mm. long, 0.30 mm. deep; pars basalis subtriangular, with a long pseudotactile seta near the distal end of the flexor margin, 0.47 mm. long, 0.34 mm. deep; pars tibialis with extensor margin weakly and evenly convex, flexor margin nearly straight, length 1.10 mm., depth 0.39 mm.; entire femur 1.39 mm. long; tibia shaped much as the tibia of the first leg, with a pseudotactile seta near the center of the extensor margin, 1.22 mm. long, 0.23 mm. deep; tarsus subcylindrical, a tactile seta on the extensor margin 0.18 mm. from the proximal margin, length 0.76 mm., depth 0.155 mm.

Genital complex: Posterior operculum with 12 setae arranged chiefly in a single row; anterior operculum with 26 setae clustered anterior to and along the sides of the genital aperture.

TYPE LOCALITY: The single specimen, the male holotype, from Rancho Grande, Venezuela; 1945.

Cordylochernes potens may be separated from other members of the genus by the size, shape, and length : width ratios of the palpal podomeres.

7.

A List of the Mammals Collected at Rancho Grande,
in a Montane Cloud Forest of Northern Venezuela.¹

G. H. H. TATE.

American Museum of Natural History.

[This is one of a series of papers resulting from the 45th and 46th Expeditions of the Department of Tropical Research of the New York Zoological Society, made during 1945 and 1946 under the direction of Dr. William Beebe with headquarters at Rancho Grande in the National Park of Aragua, Venezuela. The expeditions were made possible through the generous cooperation of the National Government of Venezuela and of the Creole Petroleum Corporation.

[The characteristics of the research area are in brief as follows: Rancho Grande is located in north central Venezuela (10° 21' N. Lat., 67° 41' W. Long.), 80 kilometers west of Caracas, at an elevation of 1100 meters in the undisturbed montane cloud forest which covers this part of the Caribbean range of the Andes. Adjacent ecological zones include seasonal forest, savanna, thorn woodland, cactus scrub, the fresh water lake of Valencia, and various marine littoral zones. The Rancho Grande area is generally subtropical, being uniformly cool and damp throughout the year because of the prevalence of the mountain cloud cap. The average humidity, during the expeditions, including parts of

both wet and dry seasons was 92.4%; the average temperature during the same period was 18° C; the average annual rainfall over a 5-year period was 175 cm. The flora is marked by an abundance of mosses, ferns, and epiphytes of many kinds, as well as a few gigantic trees. For further details, see Beebe & Crane, *Zoologica*, Vol. 32, No. 5, 1947. Unless otherwise stated, the specimens discussed in the present paper were taken in the montane cloud forest zone, within a radius of 1 kilometer of Rancho Grande.]

The number of specimens of each species has no relationship to relative abundance in the local mammalian population, and abundance or scarcity of any species in the Rancho Grande collection indicates field technique (pit-traps extensively used). *Heteromys anomalus*, *Sigmodon hirsutus*, *Oryzomys meridensis*, and *Oligoryzomys delicatulus* are known from the work of other collectors to be quite abundant in the region. *Didelphis marsupialis*, *Sigmomys alstoni*, *Proechimys guairae*, and several bats are more plentiful than the present collection would lead one to believe. A few species — *Marmosa mitis*, *Akodon venezuelensis*, *Micromycteris megalotis*, *Glossophaga soricina*—absent from the Rancho Grande collection, are common but perhaps rather local.

¹ Contribution No. 754, Department of Tropical Research, New York Zoological Society.

Name	General Range	No. collected
<i>Didelphis marsupialis</i>	Northern South America and southern Central America: 0-5000 feet.	1
<i>Marmosa demararae meridae</i>	South America north of the Amazon and east of the Andes: 0-5000 feet.	2
<i>Marmosa fuscata</i>	Andes of Colombia and Venezuela: 1500-9000 ft.	2
<i>Monodelphis brevicaudata</i>	South America north of the Amazon and east of the Andes: 0-4000 feet.	4
<i>Myotis nigricans</i>	Tropical America: below 5000 feet.	1
<i>Eptesicus</i> , near <i>fuscus</i>	Holarctic with racial extensions through Central America to northern South America.	2
<i>Eumops bonariensis nanus</i>	A race of a widespread Neotropical species.	7
<i>Tadarida europs</i>	Northern South America and southern Central America: up to 4000 feet.	2
<i>Molossus obscurus</i>	Neotropics; chiefly near rivers.	4
<i>Promops occultus</i>	Neotropics.	1
<i>Chilonycteris rubiginosa</i>	Neotropics.	4
<i>Carollia perspicillatum</i>	Neotropics.	1

Name	General Range	No. collected
<i>Uroderma bilobatum</i>	Neotropics.	4
<i>Lonchoglossa caudifera</i>	Neotropics.	9
<i>Sturnira lilium</i>	Neotropics.	1
<i>Alouatta senicula</i>	Northern South America, north of the Amazon and east of the Colombian Andes.	1
<i>Cabassous lugubris</i>	Neotropics, north of the Amazon.	2
<i>Bradypus tridactylus</i>	Neotropics.	1
<i>Sciurus griseogenus meridensis</i>	Andes of Colombia and Venezuela.	2
<i>Oryzomys meridensis</i>	Venezuelan Andes: 3000-8000 feet.	9
<i>Oligoryzomys delicatulus</i>	Northern South America north of Amazonia: 2500-8000 feet.	3
<i>Oecomys bicolor</i>	Andes from Peru to Sucre.	1
<i>Neacomys</i> , near <i>spinosus</i>	Andes from Peru to Rancho Grande; also Guiana Highlands.	1
<i>Sigmodon hirsutus</i>	North coastal strip of Venezuela: 0-3000 feet. Semi-arid.	9
<i>Sigmomys alstoni venester</i>	Llanos of Venezuela, reaching into mountains: 0-3000 feet. Semi-arid.	2
<i>Heteromys anomalus</i>	Trinidad and north coastal strip of Venezuela: 0-3000 feet.	17
<i>Proechimys guairae</i>	Northern coastal strip of Venezuela (including Caracas).	1
<i>Cerdocyon thous</i>	Llanos.	1
<i>Conepatas</i> , near <i>gumillae</i>	Widespread llanos species reaching middle Orinoco and Sucre.	1
<i>Felis wiedii</i> near <i>pirrensis</i>	Neotropics.	1

8.

A New Species of Hesperiidæ (Lepidoptera, Rhopalocera) from Venezuela.¹

ERNEST L. BELL.

American Museum of Natural History.

(Text-figure 1).

[This is a contribution from the Forty-third Venezuelan Expedition of the Department of Tropical Research of the New York Zoological Society made under the direction of Dr. William Beebe. The expedition was sponsored by grants from the Committee for Inter-American Artistic and Intellectual Relations and from four trustees of the Zoological Society, George L. Clark, Childs Frick, Laurance S. Rockefeller and Herbert L. Satterlee, and by invaluable assistance from the Creole Petroleum Corporation. For maps and meteorological data, see *Zoologica*, Vol. XXVIII, No. 9, pp. 53-59, 1943.]

The writer had the opportunity of identifying the Hesperiidæ taken by Mr. Henry Fleming, Entomologist of the Department of Tropical Research of the New York Zoological Society, which he collected at Caripito, Venezuela, during the 1942 expedition.

Among the specimens collected by Mr. Fleming there is an apparently unnamed species of Pyrrhopyginae belonging to the genus *Yanguna*. This specimen emerged from a pupa found hanging about three feet from the ground on a woody plant in the dark jungle.

It is with pleasure that this handsome butterfly is named for Mr. Fleming.

Yanguna flemingi, new species.

MALE.

Both sides of the wings are black with a brilliant green sheen. The fringes of the primaries are black; those of the secondaries are black at the outer angle and then white to the anal angle.

The top of the head is blackish-brown, crossed by narrow white lines. There is a narrow white line on the collar. The shoulder

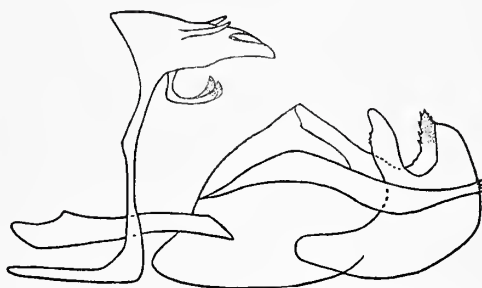

TEXT-FIG. 1. Male genitalia of *Yanguna flemingi*, new species, Type.

covers are red. The tegulae are black. The abdomen is black with each segment narrowly bordered with white. On the under side, the palpi are white, the pectus is white narrowly bordered internally with black, the thorax and the base of the abdomen are red, the rest of the abdomen is black and each segment is narrowly bordered with white. On the upper side the antennae are black, on the under side they are brownish.

Length of one primary wing: 24 mm.

Type Material: The holotype male is from Caripito, Venezuela, ex-pupa July 29, 1942, and is in the collection of the American Museum of Natural History, New York City.

The shed pupal case is approximately 37 mm. long and is light reddish-brown in color. The head bears long white hairs among which there are some black ones on the sides and the body is sparsely covered with shorter white hairs.

The male genitalia are very similar to those of *Yanguna rubricollis* Sepp and as in that species the right clasper and the left

¹ Contribution No. 755, Department of Tropical Research, New York Zoological Society.

one are not quite symmetrical. The figure shown in this paper illustrates the left clasper.

The lack of the discal band of three white hyaline spots on the primaries superficially distinguishes *flemingi* from *rubricollis*.

90.573

22

ZOOLOGICA

SCIENTIFIC CONTRIBUTIONS
of the
NEW YORK ZOOLOGICAL SOCIETY

VOLUME 32
Part 2
Numbers 9-12



Published by the Society
The Zoological Park, New York

██████████
July 31, 1947

CONTENTS

	PAGE
9. Eastern Pacific Expeditions of the New York Zoological Society. XXXVIII. Intertidal Brachygnathous Crabs from the West Coast of Tropical America with Special Reference to Ecology. By JOCELYN CRANE. Text-figures 1-3.....	69
10. The External Genitalia of the Gorilla, <i>Gorilla gorilla gorilla</i> (Savage & Wyman). By LEONARD J. GOSS. Plates I-IV.....	97
11. Spontaneous Neoplasms in Fishes. III. Lymphosarcoma in <i>Astyanax</i> and <i>Esox</i> . By ROSS F. NIGRELLI. Plates I-XI.....	101
12. Notes on the Hercules Beetle, <i>Dynastes hercules</i> (Linn.), at Rancho Grande, Venezuela, with Special Reference to Combat Behavior. By WILLIAM BEEBE. Plates I-IV.....	109

9.

Eastern Pacific Expeditions of the New York Zoological Society. XXXVIII.
Intertidal Brachygnathous Crabs from the West Coast of Tropical America
with Special Reference to Ecology.¹

JOCELYN CRANE.

Research Zoologist, Department of Tropical Research,
New York Zoological Society.

(Text-figures 1-3).

[This is the thirty-eighth of a series of papers dealing with the collections of the Eastern Pacific Expeditions of the New York Zoological Society made under the direction of Dr. William Beebe. The present paper is concerned principally with specimens taken on the Eastern Pacific Zaca Expedition (1937-1938); for general data, see *Zoologica*, Vol. XXIII, No. 14, pp. 278-298. A few were taken at Clarion I. on the Templeton Crocker Expedition (1936), and on subsequent trips to Panama and Ecuador made by the author in 1941 and 1944].

CONTENTS.

	Page
Introduction	69
Annotated List of Species	71
Family Majidae	71
<i>Eucinotops panamensis</i> Rathbun	71
<i>Acanthonyx petiverii</i> Milne Edwards	71
<i>Pelia pacifica</i> A. Milne Edwards	71
<i>Thoe sulcata sulcata</i> Stimpson	71
<i>Thoe sulcata panamensis</i> Nobili, subsp. nov.	71
<i>Herbstia tumida</i> (Stimpson)	72
<i>Pitho seddentata</i> Bell	72
<i>Anaptychus cornutus</i> Stimpson	72
<i>Mithrax denticulatus</i> Bell	73
<i>Mithrax orcutti</i> Rathbun	73
<i>Mithrax pygmaeus</i> Bell	73
<i>Teleophrys cristulipes</i> Stimpson	73
<i>Microphrys platysoma</i> (Stimpson)	74
Family Parthenopidae	74
<i>Daldorfia garthi</i> Glassell	74
Family Xanthidae	74
<i>Carpilodes cinctimanus</i> (White)	74
<i>Actaea dovii</i> Stimpson	74
<i>Actaea sulcata</i> Stimpson	74
<i>Daira americana</i> Stimpson	74
<i>Mcdaeus spinulifer</i> (Rathbun)	75
<i>Cyclozanthops vittatus</i> (Stimpson)	75
<i>Leptodius taboganus</i> Rathbun	75
<i>Xanthodius sternberghii</i> Stimpson	75
<i>Xanthodius stimpsoni</i> (A. Milne Edwards)	77
<i>Lophozanthus lamellipes</i> (Stimpson)	77
<i>Metapocarcinus concavatus</i> sp. nov.	77
<i>Panopeus purpuricus</i> Lockington	79
<i>Panopeus chilensis</i> Milne Edwards & Lucas	79
<i>Eurypanopeus planus</i> (Smith)	79
<i>Eurypanopeus transversus</i> (Stimpson)	80
<i>Eurytium tristani</i> Rathbun	80
<i>Micropanope zantusii</i> (Stimpson)	80
<i>Menippe frontalis</i> A. Milne Edwards	80
<i>Menippe obtusa</i> Stimpson	80
<i>Pilumnus gonzalensis</i> Rathbun	81
<i>Pilumnus pygmaeus</i> Boone	81
<i>Pilumnus zantusii</i> Stimpson	81
<i>Heteractaea lunata</i> (Milne Edwards & Lucas)	81
<i>Ozius verreauxii</i> Saussure	81

<i>Ozius perlatus</i> Stimpson	81
<i>Ozius tenuidactylus</i> (Lockington)	81
<i>Eriphia squamata</i> Stimpson	81
<i>Eriphides hispida</i> (Stimpson)	82
<i>Dumecia hispida</i> Eyraud & Souleyet	82
<i>Trapezia cymodoce ferruginea</i> Latreille	83
<i>Trapezia digitalis</i> Latreille	83
Family Grapsidae	83
<i>Grapsus grapsus</i> (Linn.)	83
<i>Geograpsus lividus</i> (Milne Edwards)	84
<i>Goniopsis pulchra</i> (Lockington)	85
<i>Pachygrapsus transversus</i> (Gibbes)	85
<i>Sesarma sulcatum</i> Smith	86
<i>Sesarma rhizophorae</i> Rathbun	86
<i>Aratus pisonii</i> (Milne Edwards)	86
Habitat Zones	86
Concluding Remarks on Field Observations	90
References Cited	93

INTRODUCTION.

This paper consists of three parts. The first is an annotated list of species of intertidal brachygnathous crabs taken between Cape San Lucas, Lower California, and Guayaquil, Ecuador, between 1937 and 1944, with special reference to color in life and other field observations. Fifty-one species, comprising more than 2,000 specimens are recorded. These figures exclude 29 species of Ocypodidae, the reports of which have already been published. Except as noted below, the synonymy of Rathbun's monographs is accepted (1918, 1925, 1930). In the report, one new species (*Metapocarcinus concavatus*) is proposed. One species is reduced to subspecific status (*Thoe sulcata panamensis*). *Mithrax areolatus* is considered a synonym of *M. denticulatus*, and *Xanthodius hebes* of *X. sternberghii*.

The second part discusses the habitats of these species and of the expeditions' ocypodids.

The paper concludes with some general remarks on the field observations.

In this report, the term "intertidal crabs" is used to embrace those species occurring typically in a habitat which is under tidal influence, so that the crabs are more or less amphibious. Rocky, sandy and muddy niches are included, as are those subject to moistening by waters of various degrees of salinity.

¹ Contribution No. 771, Department of Tropical Research, New York Zoological Society.



TEXT-FIG. 1. Shore collecting stations of the Eastern Pacific Expeditions of the New York Zoological Society.

In the delimitation, for ecological purposes, of such a group of species, various difficulties are naturally encountered, although in most cases there is no question as to the propriety of including a given zone or species. The only ecologically questionable zone treated is that of *Pocillopora* coral; it is included because most of the species inhabiting it occur also in definitely tidal zones, rather than in deeper waters. In regard to taxonomic groups, it was finally decided to exclude the following: all the Portunidae, Goneplacidae and Pinnotheridae, in spite of the fact that species of these families were occasionally taken in tidepools, coral, or in high-tide seines; the

Gecarcinidae, although they occur on the fringes of both beach and mangrove areas; several *Sesarma* which proved as typically fresh-water inhabitants as the Potamonidae, although they also occurred in the upper reaches of tidal streams; and all *Plagusia*, which, although rarely found in tidepools, are characteristically oceanic.

The following papers have already been published on the brachyuran crabs of the Eastern Pacific Expeditions of the New York Zoological Society: Glassell, 1936; Crane, 1937.1, 1937.2, 1940, 1941.1, 1941.2, 1943, 1944 (see "References Cited"). Those papers still to appear include reports on ocypodids

from Ecuador, on the non-tidal brachygnaths of the Eastern Pacific *Zaca* Expedition (1937-1938), and on the non-brachygnathous crabs collected on the same trip.

In the following "Annotated List of Species," references are given to the type description, to Rathbun's monograph, and to records which have appeared since the monograph. The zone numbers following the habitat description refer to the various types of habitat described in the section beginning on p. 86.

I wish to express my thanks to Dr. Waldo L. Schmitt of the United States National Museum and to Dr. John Garth and other members of the staff of the Hancock Research Foundation of the University of Southern California for their friendly cooperation in giving me access to comparison material in their respective collections.

ANNOTATED LIST OF SPECIES.

FAMILY MAJIDAE.

Eucinetops panamensis Rathbun, 1923, p. 73; 1925, p. 87. 19 specimens from Costa Rica (Port Parker, Piedra Blanca, Uvita) and Panama (Honda). Usually in tidepools, rarely under low-tide stones (Zones 4, 3). Eggs in Feb., Mar. (C.R.).

Color of 16 specimens from Piedra Blanca found in single small patch of fine green algae: Carapace and ambulatories forest green above; manus mottled forest green and greenish-yellow; dactyls white; underparts of body entirely bluish-white striped transversely with broken lines of purplish-blue; underside of ambulatories forest green; bits of weed and sand grains attached to carapace and chelipeds; eggs orange. Specimens from other localities also decorated with weed.

Range: Gulf of California to Panama.

Acanthonyx petiverii Milne Edwards, 1834, p. 343; Rathbun, 1925, p. 142; Boone, 1927, p. 137; Hult, 1938, p. 11; Garth, 1946, p. 376. 23 specimens from Nicaragua (Corinto), and Costa Rica (Piedra Blanca). Among elongate algae growing either in tidepools or, rarely, on exposed, surf-beaten rocks (Zones 4, 1). Also occasionally found below low-tide level. Eggs in Jan., Feb. (Nic., C. R.).

Color ranges from bright lettuce green through ochre and brown to deep maroon, depending entirely upon color of surrounding algae; in one pool, the crab was found on six or eight kinds of algae, all of different colors, so that extremes of variation were found on crabs living within 6 inches of one another; the greenest ones lived on a kind of smooth sea lettuce, and were smoother, with fewer tubercles, than the others. This variation in tubercles is well known, but the matching of smoothness and color to background has apparently not been recorded. In

relatively few examples, long flags of weed particles were attached to rostrum. One crab, ochre-colored, had several pale, central, bryozoan-like markings. Eggs orange.

Range: Southern Florida to Brazil; Mexico to Chile; Galápagos.

Pelia pacifica A. Milne Edwards, 1875, p. 73; Rathbun, 1925, p. 283. 26 specimens from Mexico (Acapulco), Nicaragua (Corinto), Costa Rica (Jasper I., Uvita) and Panama (Honda). Clinging to underside of low-tide stones, in tidepools, and in *Pocillopora* coral; once on orange seafan (Zones 3, 4, 5). Eggs in Jan., Feb., Mar. (Nic., C. R.).

Color at Uvita, on undersides of sponge- and algae-grown stones: Bluish-gray above, pile ochraceous yellow. Chelipeds: merus and manus translucent buff peppered with black; carpus and chelae flame scarlet. Underparts buffy green. Eggs orange. General color in tidepools at Corinto: dark red. Many specimens from various localities were well covered with hydroids (anteriorly only), sponges, algae and sand grains.

Range: Manzanillo, Mexico, to Panama.

Thoe sulcata sulcata Stimpson, 1860, p. 177; Rathbun, 1925, p. 349; Crane, 1937, p. 59. 23 specimens from Mexico (Clarion I., Chamela, Tenacatita, Sihuatenajo). In tidepools and *Pocillopora* coral (Zones 4, 5). Eggs in Nov., Dec. (mainland), May (Clarion). Text-fig. 2B.

Range: Gulf of California and west coast of Mexico to Oaxaca.

Thoe sulcata panamensis Nobili, subsp. nov.

(Text-fig. 2A).

Synonymy: *Thoe panamensis* Nobili, 1901, p. 30; Rathbun, 1925, p. 351 and syn.; Finnegan, 1931, p. 624.

67 specimens from Nicaragua (Cardon I., at Corinto), Costa Rica (Port Parker, Culebra, Piedra Blanca, Jasper I., Uvita) and Panama (Honda). Undersides of rocks and stones at extreme low-tide levels, in tidepools and in *Pocillopora* coral (Zones 3, 4, 5). Eggs in Jan., Feb., Mar. (C. R. and Pan.).

The two species, *sulcata*, ranging south to Oaxaca, and *panamensis*, known previously only from the Bay of Panama, have heretofore been distinguished by two characters: first, by the development of the outer row of excavations on the arm, which are well developed in *sulcata* and obsolete or obsolescent in *panamensis*, and second, by the spinulation of the upper margin of the ambulatory merus, which is strongly spinous in *sulcata* and only obscurely so in *panamensis*. Briefly, therefore, the northern form is more spinous and eroded.

Rathbun's suggestion that *panamensis* may perhaps not be specifically distinct is shown to be true by the present extensive series. Because of the variation in the development of both the excavations and spines

in northern and southern forms, there seems no valid specific distinction. Were it not for a sharp change in a detail of the abdominal appendage at about the latitude of Tehuantepec, the species should even be regarded as monotypic, although showing a tendency to form a geographical cline.

Even in the most northern, typical *sulcata*, the outer row of pits on the arm is completely developed only in the largest males, less so in the largest females; in other examples, only two or three outer excavations are present and these are confined to the distal part of the arm. In some examples from Nicaragua, on the other hand, the pits are so well developed that the specimens could almost be referred to *sulcata*, were it not that the spinulation on the ambulatory meri is very weak. In a series from Port Parker, Costa Rica, the pits are so variable that they are taxonomically useless, while there are traces of spinulation on the legs. In specimens from Jasper I., C. R., some examples have spines almost as strong as in typical northern *sulcata*; the rest of the Jasper series are typical *panamensis*.

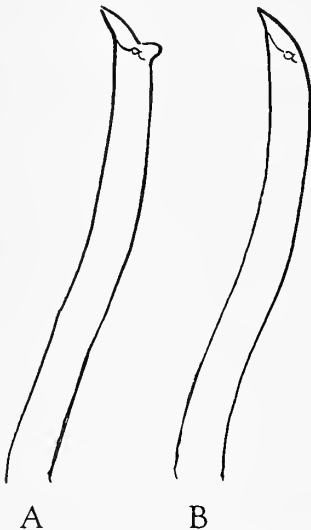

TEXT-FIG. 2. Right abdominal appendages in subspecies of *Thoe sulcata*, postero-lateral views of distal halves. A. *T. sulcata panamensis*. B. *T. sulcata s.*

The only sharp distinction in any is the form of the abdominal appendage. In all specimens taken north of the Gulf of Tehuantepec, there is no subterminal spur on the anterior inner surface; from Nicaragua south a very distinct spur invariably occurs. (We have no specimens from the intermediate region). The spur does not decrease gradually in size or prominence, from south northward, as would be the case in a cline;

the change is complete and abrupt. Additional specimens from the Cape San Lucas region, examined in the Hancock collections, show the same distinction in contrast to southern forms as do those from middle Mexico. It is on this basis that the relegation of *panamensis* to the status of subspecies is proposed.

Both subspecies are similar in color and habit. They are clingers, and are especially to be found among yellow sponges growing on stones and dead corals well covered with these and other animal and vegetable growths, at extreme low-tide levels, in tidepools and in *Pocillopora* coral. They are usually well decorated with the shells of *Spirorbis*-like polychaetes, bryozoans and other growths. Their basic color (Costa Rica) is dull yellowish-brown, except for manus of chelipeds which is pinkish, and the dactyls which range from deep rose to bright orange, shading distally to white. All underparts white. Females are usually more brown, less yellow, than males; young (around 4 mm.) paler yellow than adults, with manus violet, not pink; chelae even at this stage are bright orange.

Range: Corinto, Nicaragua, to Panama.

Herbstia tumida (Stimpson, 1871, p. 95); Rathbun, 1925, p. 299; Finnegan, 1931, p. 623; Crane, 1937, p. 59. 1 immature female from Panama (Honda). Previously known only from Mexico. On under side of stone at extreme low-tide level (Zone 3). Specimen compared with example in Hancock Foundation which was identified by Rathbun, and with other southern material in the same institution, which has not yet been recorded.

Pitho sexdentata Bell, 1835, p. 172; Rathbun, 1925, p. 367; Sivertsen, 1933, p. 11; Crane, 1937, p. 60; Garth, 1946, p. 387. 1 specimen from Costa Rica (Port Parker). Previously known from Cape San Lucas, the Gulf of California, Ecuador and the Galápagos. On underside of stone at extreme low-tide level (Zone 3).

Anaptychus cornutus Stimpson, 1860, p. 184 (56); Rathbun, 1925, p. 378. 40 specimens from Mexico (Chamela, Sihuatenejo), Costa Rica (Port Parker, Culebra, Piedra Blanca, Jasper I., Ballenas, Uvita) and Panama (Honda). Under side of stones at extreme low-tide level, in tidepools and in *Pocillopora* coral (Zones 3, 4, 5). Eggs in Nov. (Mex.), Jan., Feb., Mar. (C. R., Pan.).

Color at Chamela, in tidepool: Olive green overgrown with white bryozoans, green and purple sponges and algae. Eggs purplish-black (ready to hatch). Specimens from all localities typically covered with calcareous algae, sponges, hydroids, bryozoans, serpulids, barnacles and sand grains.

The number of tubercles or lobes on the central portion of the posterior crest varies from six to eight; often the lobes are so low

that the crests appear practically entire. Antero-lateral margins with lobes very variable, some almost as spinous as in *Mithrax*. Rostrum and pre-ocular spines are apt to be broken.

Range: Gulf of California to Panama.

Mithrax denticulatus Bell, 1835, p. 172; Rathbun, 1925, p. 428; Boone, 1927, p. 161; Garth, 1946, p. 395.

Synonymy: *Mithrax areolatus* Lockington, 1876, p. 71 (9); Rathbun, 1925, p. 433; Crane, 1937, p. 48.

86 specimens from Mexico (Chamela, Sihuatenejo, Guatulco, Tangola-Tangola), Costa Rica (Port Parker, Culebra, Piedra Blanca, Uvita) and Panama (Honda). On undersides of large stones at extreme low-tide levels, in tidepools among short weed and in *Pocillopora* coral (Zones 3, 4, 5). Eggs in Nov., Dec. (Mex.); Jan., Feb., Mar. (C. R., Pan.).

Color variable, but in general olive green to olive brown above, sometimes mottled, with hairs and underparts lighter. Notes from various localities indicate this variability: Chamela tidepools: Greenish with dark brown mottlings anteriorly. Port Parker coral: Carapace mottled chocolate brown and dull olive green; eyes chocolate brown; chelipeds and legs like carapace; hairs olive; distal half of chelae flesh pink; sternum and maxillipeds plain olive; abdomen white with joints brownish; underside of ambulatories greenish-white. Piedra Blanca, tidepools and undersides of rocks at extreme low-tide level: Entirely olive green to olive brown above, with hairs yellowish-brown; underparts buffy or greenish-white with joints of merus of cheliped bright orange; joints of ambulatories yellowish; chelae dark green tipped with cream. Uvita coral: Like above, but upper side plain dark olive with branchial sulcae white; young (ca. 4 mm. long) more light brown than olive. In other localities young were like adults. All eggs purple. When groups of living specimens were examined, in trays, all clung to one another in a ball, in lieu of weed.

M. areolatus Lockington should be synonymized with *M. denticulatus*. Our specimens vary in relative width, giving proportions intermediate between the diagnostic characters for the two species. Also, if Lockington and Kingsley omitted spines in their breadth measurements, the proportions of *areolatus* would approach those of *denticulatus*. Finally, the equal or unequal advance of the antennal articles is not a reliable character, since in the present series variation occurs on two sides of the same individual, and in different specimens from the same locality.

Range: San Diego, California, to Ecuador.

Mithrax orcutti Rathbun, 1925, p. 397. 1

immature male from Nicaragua (Corinto). Clinging to ochre weed in tidepool, and matching it perfectly in color (Zone 4).

Range: Mazatlan, Mexico, to Panama.

Mithrax pygmaeus Bell, 1835, p. 172; Rathbun, 1925, p. 406; Finnegan, 1931, p. 624; Hult, 1938, p. 12; Garth, 1946, p. 391. 4 specimens from Costa Rica (Port Parker, Culebra). First records north of Panama. In *Pocillopora* coral (Zone 5). A few other specimens, dredged in shallow water, will be recorded in a future report.

Some examples tend to have the front subtruncate instead of rounded. The spines, counting tubercles, may number 7 instead of 6.

Range: Costa Rica, Panama, Galápagos, Ecuador.

Teleophrys cristulipes Stimpson, 1860, p. 190 (62); Rathbun, 1925, p. 441; Finnegan, 1931, p. 625; Crane, 1937, p. 61; Glassell, 1934, p. 453; Schmitt, 1939, p. 25; Garth, 1946, p. 396.

Synonymy: *T. diana* Boone, 1927, p. 162; Sivertsen, 1934, p. 13; Hult, 1938, p. 12.

T. tumidus Rathbun, 1925, p. 442 (part.: the Galápagos specimen); Boone, 1927, p. 166.

99 specimens from Mexico (Chamela, Guatulco, Clarion I.), Costa Rica (Port Parker, Culebra, Jasper I., Uvita) and Colombia (Gorgona I.). Always in *Pocillopora* coral except for one specimen in a tidepool and another at low-tide level in dead pearl oyster (Zones 5, 4, 3).

Color in general olivaceous. Almost all the crabs were naked except, rarely, for two or three tiny *Spirorbis* encrustations. One specimen was decorated with a few algae.

Garth (1946, p. 399 ff.) has clarified the distinctions between *T. cristulipes* and the Peruvian *T. tumidus*, and commented on the variation in the two species. Our own series support his conclusions: In our two Gorgona examples, the crestiness and the anterior tooth are more strongly developed than in more northern specimens, and there is a crest similar to that of *tumidus* on the posterior part of the propodus. Comparison with specimens of both *tumidus* and *cristulipes* in the Hancock collections, however, leaves no doubt that the Gorgona specimens show only normal variation. Both Garth and Finnegan (1931, p. 625) noted that specimens of *cristulipes* cracked from coral had the legs more cristate and the spines of the anterolateral margins better developed than those from shore. In our examples great variation is shown even though almost all were taken from submerged corals. Even series of similar size from the same coral-head show considerable range. In the type series of *T. diana* Boone from the Galápagos, taken from corals in 15 feet of water, the specimens are all relatively smooth.

Range: Lower California to Colombia; Galápagos.

Microphrys platysoma (Simpson, 1860, p. 180); Rathbun, 1925, p. 497; Crane, 1937, p. 63; Garth, 1946, p. 405. 7 specimens from Mexico (Clarion I.), Costa Rica (Port Parker, Uvita) and Panama (Honda). Under stones at low-tide level, in tidepools and in *Pocillopora* coral (Zones 3, 4, 5). Specimens usually completely covered with vegetable and animal growth.

Range: Lower California to Ecuador; Galápagos.

FAMILY PARTHENOPIDAE.

Daldorfia garthi Glassell, 1940, p. 68 and syn.; Garth, 1946, p. 412. 1 specimen from Costa Rica (Port Parker), a large, worn male, taken under a rock at extreme low-tide level (Zone 3). When this specimen was compared with material in the Hancock collections from various localities, the following differences from the type description were found to be only normal variation: Postero-lateral and posterior margins are not straight; spines on antero-lateral margin are smaller and simpler; meri of ambulatories are practically smooth, lacking spines on dorsal (anterior) side; the abdomen is sculptured somewhat differently.

Range: Cape San Lucas, Lower California, to Colombia; Galápagos.

FAMILY XANTHIDAE.

Carpilodes cinctimanus (White, 1847, p. 336); Rathbun, 1930, p. 242; Crane, 1937, p. 69; Garth, 1946, p. 427. 15 specimens from Mexico (Clarion I., Guatulco), Costa Rica (Port Parker, Culebra, Jasper I.). In *Pocillopora* coral (Zone 5). One ovigerous female in Feb. from Jasper I.

Color as given by Rathbun, Garth and Crane, except that general color is often deep scarlet instead of light red, orange, or dragon's blood red. Black band of male manus never developed in specimens less than 9 mm. long; also lacking in one male of 12.5 mm. Smallest examples in our mainland series (around 5 mm.) are completely white above and below except for scarlet orange chelipeds and ambulatories. Cf. Garth's Galápagos growth series.

Range: Arena Bank in Gulf of California to Costa Rica; Galápagos; South Sea Islands; Japan and Australia to Gulf of Aden.

Actaea dovii Stimpson, 1871, p. 104; Boone, 1927, p. 203; Rathbun, 1930, p. 254; Finnegan, 1931, p. 632; Sivertsen, 1933, p. 15; Schmitt, 1939, p. 25; Garth, 1946, p. 431. 77 specimens from Costa Rica (Port Parker, Culebra, Piedra Blanca, Jasper I., Uvita), Panama (Honda, Pearl Ids.). In tidepools (among weed and under stones) and in *Pocillopora* coral (Zones 4, 5). Eggs in Jan. and Mar. (C. R., Pan.).

Varying considerably in color, but eyes always bright red. Adults: carapace and legs ranging from dull orange through brown to plum color; underparts white except pterygostomial region, merus of third maxilliped and manus and dactyl of ambulatories which are lavender; chelae dark brown tipped with buff; pile of carapace, legs and edges of abdomen ochre. Young (around 5 mm.) always with three dark red longitudinal bands alternating with two white bands, the latter being broadest in the very young. Sometimes the three red bands are broken irregularly, so that a checkerboard-like carapace results; legs all banded with dark red and white; nodules in dark stripes raspberry red, others white. One half-grown specimen was dull orange above with purplish legs. The color recorded by Rathbun of a Galápagos specimen ("eleven orange-red stripes extend backward from frontal and antero-lateral margins and converge posteriorly") and figured by Garth was not seen on any of the present specimens. Eggs dark purple.

The crabs always remain well concealed. Bits of shell and sand cling to the pile of the carapace and help make them inconspicuous. As they lie perfectly quiet in crevices in the coral and in tidepools, only their gleaming eyes, ranging in color from brilliant scarlet to vermilion, are visible.

Range: El Salvador to Ecuador; Galápagos.

Actaea sulcata Stimpson, 1860, p. 203; Rathbun, 1930, p. 259; Finnegan, 1931, p. 632; Crane, 1937, p. 69; Garth, 1946, p. 434. 8 specimens from Mexico (Clarion I., Tenacatita, Sihuatenejo, Guatulco) and Costa Rica (Port Parker, Jasper I.). In *Pocillopora* coral; once under tidepool rocks (Zones 5, 4). One ovigerous female at Sihuatenejo in Nov.

Color at Tenacatita, whitish with tubercles rose red except around eyes where they are white. Cf. color of Gulf of California specimens which were orange-red and orange-red mottled with white (Crane, 1937), and Galápagos specimens which were "neutral red with bluish tinge" with posterior median nodules "yellowish white" (Garth, 1946).

Range: Arena Bank, Gulf of California, to Colombia; Galápagos.

Daira americana Stimpson, 1860, p. 212 (84); Rathbun, 1930, p. 268; Crane, 1937, p. 70; Hult, 1938, p. 12; Garth, 1946, p. 439. 40 specimens taken from Mexico (Clarion I., Chamela), Costa Rica (Port Parker, Culebra, Uvita), Panama (Honda). In *Pocillopora* coral; sometimes under low-tide stones (Zones 5, 3). Eggs in Jan., Mar. (C. R.).

Color as in Crane, 1937, but abdomen often tinged with purple instead of carmine.

Food: 6 stomachs from Port Parker:

square bits of flat, brown algae, not macerated.

Range: Lower California to Ecuador; Galápagos.

Medaesus spinulifer (Rathbun, 1898, p. 585); 1930, p. 276; Finnegan, 1931, p. 643; Garth, 1946, p. 443. 2 specimens from Costa Rica (Jasper I.). In *Pocillopora* coral (Zone 5). Also occurs in deeper water.

Range: Cape San Lucas, Lower California, to Costa Rica; Galápagos.

Cycloxanthops vittatus (Stimpson, 1860, p. 206 (78)); Boone, 1927, p. 197; Rathbun, 1930, p. 291; Sivertsen, 1933, p. 15. Garth, 1946, p. 445. 8 specimens from Mexico (Guatulco, Tangola - Tangola) and Costa Rica (Port Parker). Under rocks at extreme low-tide levels and in *Pocillopora* coral (Zones 3, 5).

Color variable: Port Parker: one specimen uniformly pale tan; one white with a few black spots, a scarlet spot on cardiac region and one on each carpus of chelipeds. Fingers dark brown. Tangola-Tangola: Carapace and legs grayish-brown; chelae black; underside pale except abdomen, which is like carapace with a white line down middle. Eggs dark brown.

Range: Cape San Lucas, Lower California, Mexico to Panama; Galápagos.

Leptodius taboganus Rathbun, 1912, p. 3; 1930, p. 304. 62 specimens from Costa Rica (Port Parker, Piedra Blanca, Parida, Cedro I., Golfito), Panama (Honda) and Colombia (Gorgona I.). First records north of Panama. Under stones and rocks between tide levels (Zones 2, 3).

General color greenish with underparts lighter. Cedro I.: Carapace and chelipeds dark olive green; legs light olive, spotted with white; dactyls dark brown; underparts pale olive gray; eggs black. Golfito: Greenish-gray to greenish-brown above, speckled with dark blue; usually also a few white spots on carapace; chelae blue black to pale brown; lower half of manus buffy white to light brown. All underparts blue marbled with white except pterygostomian region, which is buffy white. Cf. Schmitt's notes in Rathbun, 1930, on Ecuador specimens ("sage greenish in general, mottled with some lighter traces of pea green.").

Range: Costa Rica to Ecuador.

Xanthodius sternbergii Stimpson, 1859, p. 52; Rathbun, 1930, p. 311 and synonymy.

Synonymy: *Xanthodius hebes* Stimpson, 1860, p. 208 (80); Rathbun, 1930, p. 313 and synonymy.

165 specimens from Mexico (Sihuatenejo, Puerto Angeles, Guatulco, Tangola), Nicaragua (Corinto, San Juan del Sur), Costa Rica (Port Parker, Piedra Blanca, Cedro, Ballenas, Uvita, Golfito), Panama (Honda) and Colombia (Gorgona). Hundreds more seen but not collected. Under stones between

tide levels on moderately protected shores; more rarely, in tidepools (Zones 2, 3, 4). Eggs in Dec. (southern Mexico, Nicaragua), Jan. (Nic., C. R.), Feb., Mar. (C. R.), Apr. (Pan., Col.).

The color varies irrespective of sex or size, from black through dark greens, grays and brown to buff and white, blending with the substratum, often speckled or blotched. A well-marked phase is dark with median pale stripe; this form occurs sporadically in varying numbers in different populations, and appears irrespective of substratum color. Ambulatories often banded distally with purple and yellow. The faithful matching of their environment, plus their habit of sheltering under stones, must give these crabs excellent protection, whether they are quiescent during low tide or actively feeding under water. When the background is homogeneous in color, the individuals of the population usually vary little, except for the usual scattering of often conspicuous individuals with a median white stripe. Where the background varies because of different colored pebbles, for instance, individuals within a radius of a few feet can be found to match every pebble in the habitat, from whitest to darkest.

The following field notes made in various localities indicate the range of variation within typical populations: *Guatulco*: majority ranging from pure white with a few brown spots through brown and gray speckled mixtures to black marked with gray; a few completely dark gray above, chelae black, and legs purple with joints and dactyls yellow. *Tangola-Tangola*: Carapace and chelipeds of large male olive green finely stippled with dark brown; ambulatories the same, with merus-carpal joint bright yellow, manus violet, dactyl straw; chelae grayish-brown; entire ventral surface except manus and dactyl of ambulatories white. Ovigerous female similar, but all of ambulatories violet except merus joint and dactyl as above, and abdomen speckled with olive on white. Carapaces of other females close by: (1) black, mottled in median region with pure white; (2) black with fine white mottlings; (3) white with black marblings; (4) white marbled with chocolate; ambulatories of all these phases more or less violet, with merus joints and dactyls yellow. *Isla Cardon, Corinto*: Population in relatively exposed position, mostly among dark rocks; majority dark brown, but when the stones are on sandy substratum, crabs often with one or two median streaks or lines of spots, pure white, down middle of carapace, especially on gastric region. Individuals also marbled greenish-buff with darker green, matching sand; this phase was especially common in the young of this population; chelae of young very pale brownish. Dark-

est crabs in general occurred among dark rocks of the more exposed tidepools. *Culebra* (seen, but not collected): great majority matching dark volcanic sand which forms substratum for stones; crabs of lighter shades occurring only in less protected regions, where they were rare, matching the tossed-up, water-worn coral. *Piedra Blanca*: 7 mm. male (none taken smaller than this); carapace bluish-violet except for white postero-lateral margin; legs dark. 10 mm. male: grayish-white except for ambulatories which have carpus lavender and dactyl straw. In both young and adults the eye-stalks always matched perfectly the circumorbital region of carapace. *Cedro I.*: Carapace of majority green-black, but those with median white stripe more than usually common. Eggs black.

In structure as well as in color these crabs proved to be exceedingly variable, as is to be expected with a widely distributed, successful species. Although they were the most abundant under-stone brachyurans on semi-protected shores the entire length of western Central America, the present report is the first to be published on a series gathered from many localities. Examination of these specimens and comparison with as yet unrecorded Hancock expedition examples from the same and more northern localities make it apparent that *Xanthodius hebes*, recorded from Lower California, and *X. sternberghii* from Cape San Lucas and from Panama to Peru, are not distinct species. *X. hebes* has been distinguished by: (1) the thicker, blunt, antero-lateral margin; (2) by the edge of the front being invisible, not visible in a dorsal view; (3) by the narrower carapace (in which the length is contained $1\frac{1}{2}$ instead of $1\frac{3}{4}$ times in the breadth) and in the broader abdomen. It is perfectly true that some individuals show these differences very distinctly, and in these, in addition, correlated with the shape of the abdomen, the abdominal appendage of the adult male is shorter, broader and more curved in *hebes* than in *sternberghii*. (A constant, corresponding difference in the female genital passage could not, however, be discerned). It is also true that the extreme *sternberghii* form appears less often in our collections made in Mexico than farther south. However, no basis whatever appears for recognizing even a geographical cline, much less a subspecies or species. In the more southern localities some populations were composed altogether of one form, others of the second, and still others, the majority, showed a preponderance of recognizable *hebes*, a few indecisive examples, and still fewer *sternberghii*. The width of the carapace was found to be the most variable character of all. Since the remaining characters cannot be accurately measured, but

depend on ocular comparison, they cannot be scientifically tabulated. However, in counts made with all the specimens spread out and visible at once, on three successive days, the following average totals were obtained: *hebes* form 80, dubious 44, *sternberghii* form 41. Clear-cut *hebes* and *sternberghii* forms were rare. Age and sex appear to have nothing to do with the appearance of the form and color variations do not link up with the morphological differences. Unfortunately, at the time the collections were made the difficulties of the taxonomy were not recognized, so that populations taken in slightly different niches in the same bay—for example, from portions of the shore differing in water salinity—were not kept separate. From the field notes, however, it appears possible that the *hebes* form, which owes its morphological characteristics basically to heavier deposits of mineral, represents merely a non-genetic response to environmental conditions. The population containing the largest individuals of the entire collection consisted almost wholly of pure *hebes*-type individuals, and was taken at Cardon Island, a relatively exposed locality close to the open sea near Corinto, Nicaragua; the large size of these specimens is another example of the frequently observed phenomenon that in invertebrates large size and high salinity are linked.

Behavior: Their observed behavior may be divided into two distinct parts: the quiescent period, when the tide is out, and the active period of feeding during high water. Their usual habitat at low tide is under stones, where they occur from the highest to the lowest tidemarks.

During low water, they are among the least mobile of the xanthids, and when first exposed or disturbed, remain motionless, with the betraying, non-pebble-like legs curled under them. The second defense reaction, among adult and sub-adult males, is the typical crab threat posture, with wide-spread chelicerae and gaping chelae. Females and young never threaten, but maintain the curled-up possum-playing position often for many minutes, even when turned on their backs.

When covered by water and undisturbed, they move about in the open, even in bright sunlight, feeding on algae. Always, however, they remain near the refuge of a stone or crevice.

When observed in tidepools, their feeding habits can be studied in detail. The algae is picked with the minor cheliped, the major being used for bracing and balancing. This balancing is doubtless necessary because most of the crab's weight is anteriorly placed, in the broad front and massive chelipeds; hence feeding with both

claws would be impossible, in contrast to *Pachygrapsus*, which has small chelipeds, and long legs holding up a moderate carapace and which feeds using both claws alternately. In *Xanthodius* the first and second ambulatories do most of the work in ordinary sidewise walking, the third helps, and the fourth, as well as both chelipeds, are suspended and do not touch the substratum except in climbing. The crabs feed at remarkable angles, often upsidedown, or standing on their hind legs and reaching far above with their minor chelae for especially rich patches of algae. Although they feed only a few seconds in one spot, then move on an inch or two, most individuals remain within a radius of about six inches. At Corinto, where observation conditions were especially favorable, they paid no attention to the little sand-colored blennies, which passed within an inch of them, but seemed to avoid the scarlet-legged hermit crabs, which fed on the same algae. On the other hand, the two forms occasionally fed within an inch of each other. Often, in several localities a single grown male was found under a damp rock or in a pool with two or three ovigerous females and one or more young. None was ever seen feeding out of water, or crawling on exposed rocks, yet they were found almost to extreme high tidemarks, as well as near low tide. At Cardon Island, Corinto, where night observations on tidepool animals were made, not a single *Xanthodius* was seen after dark; if they are exclusively diurnal, the feeding periods for the highest crabs must be very brief, unless migrations are made.

Range: Lower California to Peru.

Xanthodius stimpsoni (A. Milne-Edwards, 1879, p. 252); Rathbun, 1930, p. 315. 45 specimens from Mexico (Guatulco) and Costa Rica (Port Parker, Piedra Blanca, Uvita). Usually under encrusted stones exposed near low-tide level; rarely in tidepools and *Pocillopora* coral (Zones 3, 4, 5). Eggs in Dec. (Mex.), Jan., Mar. (C. R.).

Color very variable. Immediate environment usually consists of stones encrusted with varicolored animal life, with which crab in general blends. Adults, above, usually entirely black, greenish-black or dark gray mottled with gray, light green or cream, but may be dark brown with antero-lateral and frontal borders and all ambulatories pinkish-tan; chelipeds may be contrastingly pale or, occasionally, entire crab is buffy. Underparts usually pale, sometimes mottled. Very young crabs tend to be paler than adults. A single young was pinkish-tan with a median longitudinal white stripe like that often found in *sternberghii*; chelipeds chocolate brown; ambulatories pinkish-tan.

Although these crabs feign death when

disturbed, they rouse and attempt to escape more easily than do *sternberghii*. Usually they are never exposed more than one-half hour at each low tide.

Young crabs are rougher than old ones.

Range: Mouth of Gulf of California to Ecuador.

Lophoxanthus lamellipes (Stimpson, 1860, p. 205 (77)); Rathbun, 1930, p. 317. Garth, 1946, p. 451. 65 specimens from Mexico (Chamela, Tangola-Tangola), Costa Rica (Port Parker, Piedra Blanca, Uvita); Panama (Honda); Colombia (Gorgona). Under stones exposed near low-tide level, in tidepools, and, rarely, in *Pocillopora* coral (Zones 3, 4, 5). Eggs in Dec. (Mex.), Jan., Feb., Mar. (C. R.), Mar. (Pan.).

Color very variable. Some taken in various localities, which agreed with Rathbun's description, being slate-colored with reddish-white chelipeds and antero-lateral margins; more were entirely different. Locality examples: Chamela tidepool: Dark gray except front and antero-lateral margins which were cream. Port Parker: Some entirely chestnut; some gray with white or yellowish antero-lateral rim; some all gray; chelae entirely black. Piedra Blanca: Carapace brown changing posteriorly to purplish-brown; frontal and antero-lateral margins buff; chelipeds plain white with black dactyls, their extreme tips light; ambulatories dull lavender with greenish-yellow dactyls; entire underparts (except those of white chelipeds) dull ochre. Uvita (under tidepool stones): color range about the same as at Port Parker and Piedra Blanca. Eggs always dark purple; dark brown when about to hatch. (Cf. also Garth, 1946).

Range: West coast of Mexico to Ecuador; Galápagos.

Metapocarcinus concavatus sp. nov.

(Text-fig. 3).

Diagnosis: Front concave, single-edged; no tooth at base of major dactyl.

Description: Carapace moderately convex in the antero-posterior axis, naked, the regions scarcely marked, very finely granulate. In the female there are four, short, transverse lines of granules across the anterior portion of the carapace: one pair on the antero-lateral regions, at the level of the third antero-lateral teeth, the other pair, slightly further forward and inward, on the lateral medial areolations. These granules are scarcely or not at all discernible in the males. Antero-lateral margin with five teeth or lobes, all distinctly granulate; the first, at orbital angle, small, narrow, blunt, the second broad, low, almost obsolete; the third broad and blunt, but the most conspicuous of the five; the fourth at widest part of carapace, smaller; and the fifth almost obsolete, at the point where

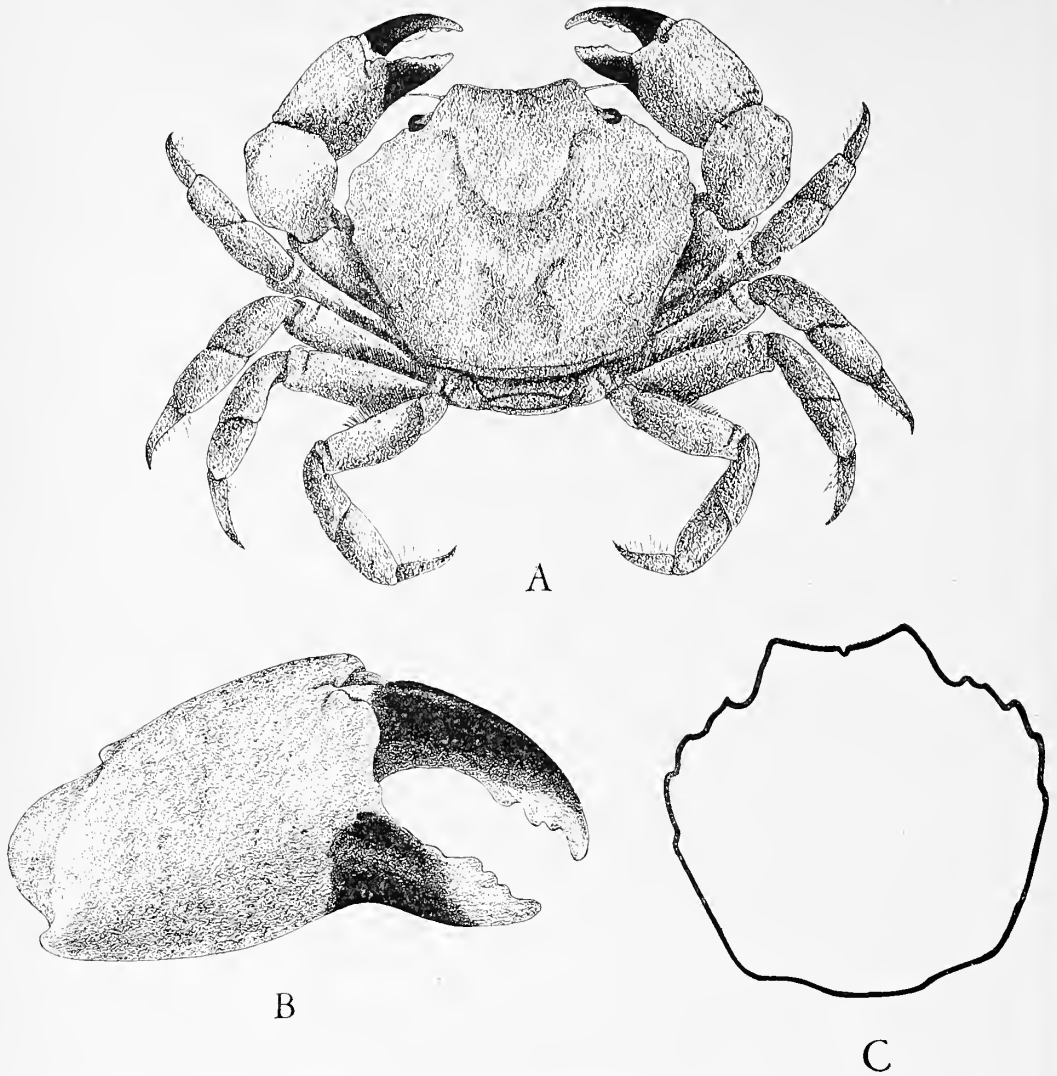

TEXT-FIG. 3. *Metapocarcinus concavatus*. **A.** holotype, dorsal view. **B.** major cheliped of holotype, external view. **C.** carapace outline of male paratype.

the marginal crest curves inward. The teeth tend to be noticeably asymmetrical on the two sides of each of the three crabs; in the juvenile male, the first and second lobes are better developed than in the others. Front very prominent, edge rather thick, but clearly only single-edged, granulate; it is concave, slightly sinuous, with a distinct median notch. Orbit with two closed fissures near outer upper edge; no noticeable lobe at middle of lower margin; inner lower angle a well-developed tooth which projects slightly beyond end of basal article of antenna; eyes filling orbit. Merus of outer maxillipeds about as broad as ischium, the distal edge transverse, slightly sinuous, the outer angle prominently pro-

duced, the inner distal edge broadly oblique and concave. Chelipeds and legs unarmed and naked, except for pile on dorsal (anterior) edges of ambulatory coxae, ischia and basal two-thirds of merus, and on ventral edges of feet. Chelipeds moderately unequal and massive, smooth except for microscopic granulations. Carpus with a blunt tooth at inner angle. Palms inflated; fingers gradually tapering, acuminate, with four blunt teeth in distal half of each chela; no tooth at base of prehensile edge of major dactyl; third to fifth segments of abdomen fused. Basal two-thirds of chelae dark, the dark color of pollex continued slightly on palm.

Color in Life: Male paratype from light

brown seaweed, in tidepool at Piedra Blanca: Carapace cream-colored; postero-lateral surfaces above bases of legs black, as recorded for *M. truncatus* by Stimpson (1860, p. 216 [88]). Chelipeds and ambulatories chocolate brown, except for pale dactyls; chelae brownish-black, except for tips which are pale. Underparts pale buffy brown. After nine years in alcohol, all of the color, except that of the chelae, has faded to creamy white.

Measurements in mm.: Male holotype length 5.6, breadth 6.1; female paratype, length 6, breadth 6.7, male paratype, length 4.8, breadth 5.2.

Range: The three known specimens were taken from Fumarole Shore, El Salvador (northern) side of Gulf of Fonseca and from Piedra Blanca, Costa Rica.

Habitat: The male paratype was in a brown, sargassum-like weed. Only this single specimen was taken in more than six carefully examined pailsful from the same tidepool (Zone 4).

Discussion: The proposed new species differs from *Metapocarcinus truncatus* Stimpson, 1860, as follows:—

1. The front is angularly concave and slightly sinuous, not truncate.
2. The lateral teeth are somewhat less obscure, particularly the third which is well developed.
3. The front is not double-edged.
4. There is no shallow lobe at the middle of the lower margin.
5. The basal antennal article does not reach quite as far forward as the inner suborbital tooth.
6. The merus of the outer maxillipeds is scarcely or not at all narrower than the ischium, its distal margin not oblique, its distal outer angle quite sharply produced, not arcuate, the distal inner margin decidedly excavate instead of slightly notched.
7. The dorsal edges of coxae, ischia, and basal two-thirds of meri of all ambulatories are pilous.
8. There is no trace of a tooth at base of prehensile edge of dactyl of major cheliped.
9. Sixth abdominal segment of immature female not widening distally.

Material: Male holotype, Department of Tropical Research, No. 37,675, Fumarole Shore, northern side of Gulf of Fonseca, El Salvador, December, 1937; female paratype, No. 37,675a, same locality, same date as holotype; male paratype, No. 38,178, Piedra Blanca, Costa Rica, February 4, 1938. The types are deposited in the collections of the Department of Tropical Research, New York Zoological Society.

Panopeus purpureus Lockington 1876 (1877), p. 101 (7); Rathbun, 1930, p. 344. 14 specimens from Costa Rica (Culebra,

Ballenas, Golfito) and Ecuador (Puerto Bolivar). Eggs in late April at Puerto Bolivar. In stony mud on edges of mangrove swamps and open mudflats (Zones 6, 7).

Range: Mexico to Peru.

Panopeus chilensis Milne Edwards & Lucas, 1843, p. 16; Rathbun, 1930, p. 346. 21 specimens from Nicaragua (Corinto: Castenones lagoon) and Costa Rica (Culebra). Eggs in Jan. at Culebra. In stony mud on edge of lagoon (Zone 7).

Range: Mexico to Chile.

Eurypanopeus planus (Smith 1869, p. 283); Boone, 1927, p. 212, 1929, p. 571; Rathbun, 1930, p. 420. 121 specimens from Nicaragua (near Potosi in G. of Fonseca, Cardon I. at Corinto, San Juan del Sur); Costa Rica (Port Parker, Piedra Blanca, Cedro I., Uvita, Golfito), Panama (Honda), Colombia (Gorgona). Eggs in Jan. (Nic.), Mar. (C.R., Col.). Under stones at junction of sandy beaches and stony shores, where fairly large, but movable stones are strewn on sand between mean high and mean low tide (Zone 2). This is exactly the habitat occupied by *Uca panamensis*, rather than that of *Xanthodius sternbergii*, which is under stones at similar tide levels, but on a rocky, not sandy, substratum.

Color range in Central America agrees well with that recorded by Schmitt (in Rathbun) for Ecuadorian specimens. In our series, the light dots on the carapace were not always present, and, when there, were almost white, no matter what the ground color; they were invariably confined to posterior part of carapace. Very young crabs, 7 mm. or less in length, were usually plain brown with dead white chelipeds except for purple or brown white-tipped fingers. The purple cast of the chelipeds develops at various ages, the smallest in which it occurs measuring 7.5 mm. In this specimen both chilipeds were entirely light blue. No sexual color dimorphism was noted. Eggs black.

A single large male was occasionally found with a single ovigerous female under the same rock, or with two ovigerous females. Have never seen more than one adult made under one stone, although young ones may be present. When disturbed, adult males threaten with chelipeds and chelae widespread, holding them motionless, with the white underparts very conspicuous. They do not move for at least 10 minutes, even when the disturbing human being promptly goes far down the beach behind rocks and out of their sight. The females and young show no threatening action whatsoever, and merely lie quietly, wherever put. Fourteen stomachs contained the following: algae of various kinds, worm spicules, remains of a bright red worm, amphipods, unrecognizable organic detritus, and sand grains. Those speci-

mens killed toward the end of a low tide period were always empty. This fact, combined with their complete quiescence during low tide, makes it probable that they feed under water. They are always found half buried in a form under, or in the shelter of, a rock; it seems likely that they do not dig this deliberately since there is never any trace of claw marks, but that they settle into positions before the tide recedes and allow the draining sand to harden around them.

Five specimens (Nos. 3834, 3860 and 38164, from San Juan del Sur, Port Parker and Piedra Blanca) are infested with *Sacculina*.

Range: Gulf of California to Ecuador.

Eurypanopeus transversus (Stimpson, 1860, p. 210 (82)); Rathbun, 1930, p. 407; Garth, 1946, p. 455. 111 specimens from Costa Rica (Port Parker, Culebra, Ballenas, Golfito) and Ecuador (Puerto Bolivar); many more seen than collected. Eggs in Jan., Mar., (C.R.); April (Ecuador). Under stones in the following localities: in gravelly mud, mud shores of bays and lagoons, among mangrove roots near high-tide mark, and on edges of open mud flats. (Zones 6, 7, 8).

Color: Ranging irrespective of locality from almost white to almost black, but most typical coloring as follows: Olive marbled with dark blue or black above; fingers black tipped with white; underparts olive buff.

Range: West coast of Mexico to Peru; Galápagos.

Eurytium tristani Rathbun, 1906, p. 100; 1930, p. 425. 43 specimens from Nicaragua (Castenones lagoon at Corinto), Costa Rica (Culebra, Ballenas, Golfito), Ecuador (Puerto Bolivar). First record north of Costa Rica. Among mangroves and on edges of mudflats (Zones 6, 7).

General color dark brown; upper surface of chelipeds violet; of finger deep red.

Range: Nicaragua to Peru.

Micropanope xantusii (Stimpson, 1871, p. 105 [15]); Rathbun, 1930, p. 438; Crane, 1937, p. 72; Garth, 1946, p. 457, and synonymy. 85 specimens from Mexico (Clarion I., Sihuatenejo, Acapulco) and Costa Rica (Port Parker, Culebra, Jasper I.). First records between Mexico and Galápagos. Eggs in Jan. at Port Parker. Always in *Pocillopora* coral (Zone 5), except for 3 young found at Port Parker in algae-covered stones among mangroves near low-tide level.

Color variable, but majority dark red mottled with lighter and darker. Sulci on major cheliped of adult males may be almost lacking.

Range: Clarion Island; Cape San Lucas, Lower California to Costa Rica; Galápagos.

Menippe frontalis A. Milne Edwards, 1879, p. 264; Rathbun, 1930, p. 477. Synonymy: *Eurypanopeus purpureus*, Boone,

1929, p. 570. 6 specimens from El Salvador, in Gulf of Fonseca (Fumarole Beach and Concharita I.). First record north of Nicaragua. 1 female ovigerous (Dec.). Under dark volcanic stones (Zone 2).

General color brownish or grayish-purple, or purplish-brown (nearest in Ridgway: dark heliotrope slate); no trace of the red present in Rathbun's preserved specimen. Underparts buffy yellow. Mouthparts patched with violet. Upper outer half of manus veined with buffy; lower half buff washed with violet; chelae black, except for buff bases of both fingers.

These large crabs look amazingly like lava stones. When disturbed they grip stones tenaciously with their ambulatories and box with their open chelae. They can maintain position remarkably well against constant tugging and, when possible seize the human intruder's fingers and hang on like bulldogs, shedding their chelipeds less readily than any other crab with which I am acquainted. They will not come out of their niches to attack and do not even run away except when greatly disturbed on open ground. When annoyed they stridulate with the ridges of the manus rubbed squeakily against the underside of the carapace, chiefly beneath the third lateral lobe; the tubercles of this region described by Rathbun, however, are not well developed in our examples. The sound produced is like the high cry of a distant bird and is heard only when a crab is almost caught. It appears likely that these methods of defense are quite effective against natural enemies such as shore-birds and crab-eating raccoons.

Range: Nicaragua to Peru.

Menippe obtusa Stimpson, 1859, p. 53 (7); Rathbun, 1930, p. 478, Sivertsen, 1934, p. 16. 5 specimens from Nicaragua (Cardon I. at Corinto). All in permanent tidepools (Zone 4). First record north of Costa Rica. All specimens taken were large females (35-43 mm.); many more, both sexes, seen but not captured.

Color in daylight, in air, brown to apricot orange. At night, under water, carapace and upper surface of chelipeds very dark green, almost greenish-black. Outer chelipeds, underside of carapace and ambulatories dull violet, the chelipeds speckled with blackish. Chelae brownish-black, teeth and tips white. Sternum and abdomen creamy blotched irregularly with violet; hair on distal segments of ambulatories dull green; posterior half of carapace sometimes also tinged with violet. Eyes red. Inner side of merus and carpal joints of chelipeds strawberry red.

Although doubtless common locally, these crabs are individually hermits, and are very retiring both night and day. Neither stridulation nor threat posture was observed. Unlike *M. frontalis*, *obtusa* spends its entire

life under water in the crevices between immovable rocks in tidepools. At night one large female went after a chiton in a fish trap she could not enter. When baited with a free chiton, she pulled it out of sight twice—once in daylight, once at night. This particular crab was finally caught by attracting her to the middle of a pool with a third chiton, at night, and by then jumping in and seizing her just as she was starting to pull away.

Range: Pacific coast of Nicaragua to Panama.

Pilumnus gonzalensis Rathbun, 1893, p. 240; 1930, p. 505. 3 specimens from Mexico (Tenacatita). First record south of Gulf of California. Among tidepool rocks (Zone 4). Grayish-brown.

Pilumnus pygmaeus Boone, 1927, p. 221; Rathbun, 1930, p. 515; Garth, 1946, p. 472. 3 specimens from Costa Rica (Port Parker, Culebra). Eggs in January. From weed in tidepools and on undersides of overgrown rocks, close to low tide (Zones 3, 4). Previously known only from the Galápagos.

Pilumnus xantusii Stimpson, 1860, p. 213; Rathbun, 1930, p. 486; Garth, 1946, p. 471. 2 specimens from Mexico (Sihuatenejo) and Costa Rica (Culebra). In *Pocillopora* coral (Zone 5). Dr. J. S. Garth kindly identified the Culebra specimen for me. The specimen from the Galápagos figured by Boone, 1927, p. 237, fig. 87B, as *Eriphides hispida* yg. should be referred to this species. Previously recorded only from Cape San Lucas and the Galápagos.

Heteractaea lunata (Milne Edwards & Lucas, 1843, p. 20); Rathbun, 1930, p. 532. Finnegan 1931, p. 644; Crane, 1937, p. 72. Not Boone, 1930, photo A, p. 127. 35 specimens from Mexico (Acapulco, Guatulco), Costa Rica (Port Parker, Culebra, Jasper), Colombia (Gorgona). Eggs in Jan. (Mexico), Jan., Feb. (Costa Rica), Mar. (Colombia). Our specimens were only found in *Pocillopora* coral (Zone 5); Rathbun reports specimens also from low tide rocks (Zone 3).

Range: San Diego, California (Faxon) to Chile.

Ozius verreauxii Saussure, 1853, p. 359; Boone, 1927, p. 223; 1929, p. 573; Rathbun, 1930, p. 540; Sivertsen, 1934, p. 17, Garth, 1946, p. 476. 35 specimens from Mexico (Puerto Angeles, Guatulco, Tangola-Tangola), Nicaragua (Cardon I. at Corinto, San Juan del Sur), Costa Rica (Port Parker, Golfito) and Colombia (Gorgona). 1 ovigerous female taken at Golfito in March. Under stones near low tide and in tidepools (Zones 3, 4).

Color pale olive buff to slate gray or chocolate brown except chelae, which are dark brown to black, three distal segments of ambulatories which are olive brown, and sternum and abdomen which are buff to

buffy-orange. A Guatulco specimen has the anterior third of carapace tinged with violet. Boone records bandings of coral at meral and carpal joints of ambulatories in the Galápagos; these were found on few Central American specimens, where they were represented by bright orange at joints of all legs and the entire length of the antennae. Young, plain light brown; very young almost white.

Range: Lower California to Ecuador; Galápagos.

Ozius perlatus Stimpson, 1860, p. 211 (83); Boone, 1927, p. 228; Rathbun, 1930, p. 543; Sivertsen, 1934, p. 17; Schmitt, 1939, p. 25; Garth, 1946, p. 477. 11 specimens from Mexico (Tangola-Tangola), Nicaragua (Cardon I. at Corinto, San Juan del Sur), and Costa Rica (Jasper I.). Under stones near low tide (Zone 3).

Carapace and chelipeds rose red; chelae ranging from very pale to dark brown. Posterior part of carapace sometimes apricot buff. Sternum buff. Abdomen apricot buff to rose red. Ambulatories rose red above, paler pinkish below. Dactyls straw colored. Ventral side of carapace in narrow rim just under antero-lateral margin, rose red like carapace. Cf. coloring in Galápagos (Garth, 1946).

These crabs, conspicuously colored to human eyes, are more active when their stones are overturned than are other sub-rock xanthids of the region. Often a number occur together under single stones.

Range: Cape San Lucas, Lower California, to Ecuador; Galápagos.

Ozius tenuidactylus (Lockington, 1877, p. 98); Glassell, 1935, p. 104; Garth, 1946, p. 479 and synonymy. *O. agassizii*, Rathbun, 1930, p. 544. 38 specimens from Mexico (Guatulco, Tangola-Tangola, Tenacatita), Nicaragua (Cardon I. at Corinto), Costa Rica (Port Parker, Piedra Blanca, Culebra, Cedro I., Ballenas, Golfito), Panama (Honda) and Colombia (Gorgona). Eggs in Feb. and Mar. (C.R. and Col.). Under stones near low-tide mark in tidepools (Zones 3, 4).

Reddish-brown or purplish to deep maroon, slightly paler beneath. Eyes bright red. Manus and dactyls of ambulatories covered with olive pile; chelae dark brown with white tips and teeth on major dactyl. Very young crabs (just under 5 mm.) pale brick red all over, lighter beneath; chelae lighter brown than in adult. Eggs purple to purplish-black.

Range: Gulf of California to Ecuador; Galápagos.

Eriphia squamata Stimpson, 1859, p. 56 (10); Boone, 1927, p. 231, 1929, p. 575, 1930, p. 143; Rathbun, 1930, p. 550; Hult, 1938, p. 13; Garth, 1946, p. 483. 35 specimens from Nicaragua (near Potosi R., Cardon I. at Corinto), Costa Rica (Port Parker,

Piedra Blanca, Ballenas, Uvita, Golfito), Panama (Honda) and Colombia (Gorgona). Under stones from mean low to high-tide marks, and, more rarely, in tidepools (Zones 2, 4). Once under mangrove root by mud flat (Zone 6). Eggs in Jan. and Feb. (Nic., C.R.), April (Col.).

General color dark but variable, ranging from slate gray through dark grayish-green to brown or black; often brownish or blackish mottled with greenish, or dark blue, blending admirably with algae in tidepool. Chelipeds like carapace, but fingers and ocular spines bright, ranging from burnt sienna to scarlet orange (Ridgway)—the latter shade the exact color of a red sponge that also grows in tidepool crannies, usually in small, longitudinal patches. Ambulatories banded with white or cream and purple, dark blue or brown. Underparts, and lower proximal part of manus and carpus cream. Often two narrow violet stripes extend down two-thirds of abdomen. Eyes olive green with brown centers. Eggs dark wine colored. Young (under 6 mm.) like adults, but lighter.

This crab is decidedly amphibious. I have seen it feeding both underwater on a mollusk in a tidepool, and at night, out of water, on tube worms. In day time I have only once seen it in the open out of water (though it frequently lies concealed under stones at low tide). This individual was scrambling on top of an exposed rock, but it had apparently been startled by a *Grapsus* out of its moist cranny or pool. All others were either well hidden or submerged. Saw one feeding in a submerged cranny holding what looked like a piece of mollusk in both claws and nibbling off it. Contents of 12 stomachs: Chiefly animal matter with some algae: (1) tiny, banded thread-algae, amphipods, 10 mm. hairy pink annelid with remains of hard tube, in only two pieces; (2) 1 megalops; (3) at least 3 megalopa and a few sand grains; (4) sand containing scum-like algae and a minute worm; (5) common red and black tidepool hermit crab (no shell); (6) tiny snails, mussels, worms, amphipods; (7) bits of algae and unrecognizable animal matter; (8-12) stomachs with thread or *Sargassum*-like algae in bits; 6 other stomachs were empty.

The first action of these crabs when attacked is to retreat. Their sight is relatively good: a moderate-sized male saw my fingers coming through the water 6 inches away, and backed repeatedly out of reach, reappearing each time in the opening of its cranny within one minute. Both males and females occasionally threaten with outspread chelipeds, but only when actively disturbed and retreat is impossible. The species is exceedingly common in tidepools and mid-tide stony zones, and ranks next to *Pachy-*

grapsus transversus and *Xanthodius sternberghii* in general abundance. The young do not threaten, but simply run away. The adults, too, are surprisingly fast out of water, when their stones are overturned, and are next to *Pachygrapsus* and *Grapsus* in speed, although none can compare with *Ocypode*.

Range: Gulf of California to Peru; Galápagos.

Eriphides hispida (Stimpson, 1860, p. 218 (90)); Boone, 1927, p. 236, not fig. 87B, p. 145; Rathbun, 1930, p. 552; Sivertsen, 1934, p. 18; Schmitt, 1939, p. 25; Garth, 1946, p. 487. 8 specimens from Nicaragua (Cardon I. at Corinto), Costa Rica (Port Parker, Jasper I.), Panama (Pearl Islands). Surf rocks, low down (Zone 1). Eggs in Feb. (C.R.).

Color purplish-brown above, rufous orange beneath; chaeae bright rufous orange; hairs black; eggs bright scarlet. Young, around 20 mm. long, like adults in color.

On the outer surf rocks this species takes the place of its cousin, *Eriphia squamata*. The burr-like bodies of the crabs stick tightly in rock depressions and crevices close to low-tide mark when the tide is out, but when the water covers them they swim freely in the outermost pools. They have tremendous clinging strength, most of the gripping being done with the middle two pairs of ambulatories, and they do not shed the chelipeds easily. They are rather solitary, although where one is found another usually occurs within a few feet. They appear to stay near low-water levels even when the tide is high; that is, unlike *Grapsus*, they do not progress with the rising water. Although most of the feeding is almost certainly done underwater, I have seen several feeding in the air on serpulid worms in tubes. Dr. Beebe (1924, p. 131) suggests that the Galápagos representatives of the species may dispossess the sea-urchin makers of hollows in the lava. Unmistakable remains of a sea-urchin's mouthparts were found in the stomach of a large female from Corinto, along with sand and several algae fragments. Four other stomachs held no recognizable material except sand. These crabs often let themselves be literally torn to pieces rather than lose their foothold. Our mainland experience corresponds to that of Dr. Garth, who speaks of the vise-like grip of their powerful nippers in the Galápagos.

Range: West coast of Nicaragua to Panama; Galápagos. This is the first record north of Costa Rica.

Domestia hispida Eydoux and Souleyet, 1842, p. 235; Rathbun, 1930, p. 554; Finnegan, 1931, p. 647; Crane, 1937, p. 73; Garth, 1946, p. 489. 107 specimens from Mexico (Clarion I., Guatulco, Sihuatenejo, Acapul-

co), Costa Rica (Jasper, Uvita), Panama (Honda), Colombia (Gorgona). Always, on this coast, taken in *Pocillopora* coral (Zone 5). Eggs in Nov., Dec., May (Mexico), Mar. (Colombia). Carapace mottled brown and white, spines blackish. (Cf. Verrill's account of Atlantic specimens: "Light yellowish red, front darker; spines blackish. Among sponges and branches of corals, and in holes of dead corals and stones").

Range: South Carolina Brazil, eastern Atlantic, Indian and Pacific Oceans to American Coast; Gulf of California to Colombia; Galápagos.

Trapezia cymodoce ferruginea Latreille, 1825, p. 695; Boone, 1928, p. 240; Rathbun, 1930, p. 557; Finnegan, 1931, p. 645; Crane, 1937, p. 73; Hult, 1938, p. 13; Garth, 1946, p. 491. 778 specimens preserved from Mexico (Clarion I., Acapulco, Guatulco, Sihuatenejo), Costa Rica (Culebra, Port Parker, Jasper I., Uvita), Panama (Honda). A majority of the females were ovigerous in every lot examined; from the data now at hand, therefore (incl. Crane, 1937), this species is breeding in the northern part of its eastern Pacific range, that is, in Mexico and Clarion I., at least from November to May, and in the southern part, between Costa Rica and Gorgona Island, at least from January through March. On this coast the species was never taken except in living *Pocillopora* coral (Zone 5) where it is the most typical and abundant single species, not only of crabs but of all macroscopic invertebrates. Even the smallest heads, measuring less than a foot in diameter, have at least one pair—usually an adult male and ovigerous female—clinging far inside.

Color scarlet to scarlet orange, as described by Rathbun and Crane. Chelae are never black, dark brown at most, paler in young. Very young crabs (around 5 mm. in length) are pale pumpkin orange, instead of scarlet or scarlet orange. Large males are decidedly the brightest of all.

This species seems almost without question to be the pattern for a case of crab-shrimp mimicry. The shrimp (*Crangon ventrosus*) is always less numerous, although as typical of the *Pocillopora* habitat as is *Trapezia*. Its scarlet and black color matches the crab's structures. The shrimp always has the carapace sideways in the coral, with the cheliped folded out of sight; the crab sits frontways, the dark-tipped chelae folded in front of it. The true eye of the shrimp and one of the paired black spots over the first abdominal segment represent the crab's eyes. The black median stripe of the carapace resembles the dark chelae of the crab folded in front of it. Except for the shrimp, and *Carpilodes cinctimanus*, *Trapezia* alone of the coral crustaceans is brilliantly, not protectively, colored. All the others either

mimic the dead coral at the base of the head, are inconspicuously translucent, or match the live corals' browns and ochres. Furthermore, the shrimps and *Trapezia* are the only ones in the living part which do not loosen their hold when bothered. Since the majority of the coral heads live in water so shallow that the red rays have not yet been much weakened, it is possible that *Trapezia* is warningly colored.

Experiments should be performed, feeding *Trapezia* and protectively colored crabs from the same environment, to such presumably natural enemies as scorpaenids and hermit crabs. Whether the red is actually a warning color, or whether it has developed unchecked merely because of *Trapezia's* adoption of a well-protected niche, the crab is certainly amazingly successful; it may be that its numbers are kept down only by destruction in the larval stages.

Range: From Clarion Island and Gulf of California to Colombia and the Galapagos; Red Sea to Indo-Pacific area.

Trapezia digitalis Latreille, 1825, p. 696; Rathbun, 1930, p. 559; Crane, 1937, p. 73; Garth, 1946, p. 493. 110 specimens from Mexico (Clarion I., Sihuatenejo), Costa Rica (Uvita), Panama (Honda). The remarks about breeding seasons in *Trapezia cymodoce ferruginea* apply equally to this species. Like it, too, it occurs only in *Pocillopora*, at least in the eastern Pacific (Zone 5).

Color on this coast always rich chocolate brown to chestnut brown above, except for the palms and dactyls of the ambulatories, which are usually bright chestnut red (cf. Rathbun's quotation of bright color descriptions). In the very young, the anterior part of the carapace darkens first.

Range: Southern part of Gulf of California to Panama; Red Sea to Indo-Pacific region.

FAMILY GRAPSIDAE.

Grapsus grapsus (Linn., 1758, p. 630); Rathbun, 1918, p. 227; Boone, 1929, p. 577, 1930, p. 203; Sivertsen, 1934, p. 18; Crane, 1937, p. 77; Garth, 1946, p. 504. 5 specimens preserved from Mexico (Banderas Bay), Nicaragua (San Juan del Sur) and Colombia (Gorgona I.). The species was recognized or collected and examined, but not saved, at the following localities: Mexico (San Benito I., Cape San Lucas, Chamela Bay, Tenacatita Bay, Manzanillo, Sihuatenejo, Tangola-Tangola, Acapulco, Dulce River, Port Angeles); El Salvador (La Libertad, Gulf of Fonseca), Nicaragua (Corinto), Costa Rica (Port Parker, Murcielago Bay, Potrero Grande, Culebra, Braxilito, Piedra Blanca, Uvita, Golfito, Parida I.); Panama (Coiba I., Bahía Honda, Balboa). Ovigerous females were common in all localities during the observation period (No-

ember to April). The species is usually found only on large rocks exposed to surf and spray (Zone 1), occurring very rarely in protected harbors. At night it sleeps out of range of the tide, but during the day, keeps always just above it.

Along the tropical coast of the eastern Pacific, this crab is midway in coloration between the dark phase of the Atlantic, and the stage found in the Galápagos where apparently all the adults, male and female, are bright scarlet. In the present range, where large colonies were observed all along the coast, only rare, fully adult males are reddish, and these are usually chestnut. Throughout the winter and spring, red males (always more than 60 mm. long) numbered not more than 1 in 50 to 100. The exact proportion of adult males to adult females was not obtained, but at a conservative estimate there were 10 grown females to one male noticeably red in color. Males which do show red never have the overall scarlet developed in the Galápagos. A 72 mm. specimen from San Benito I. had the carapace chestnut brown, and sternum striations paler; legs and chelipeds were bright scarlet, and the underside bluish-white. One from Chamela Bay was similar, except that there were also white spots on the chestnut carapace. In other localities, smaller males had a chestnut tinge on the edges of the sternum and posterior part of the carapace, or had the carapace completely dark but the chelae, legs and sternum brilliant red.

Only at Tangola-Tangola did the color adumbrate that of the Galápagos colony. Although the crabs showed the usual local coloring in general, having the carapaces black spotted with blue, and the legs black spotted with bluish-green, the carapace in both sexes was frequently washed posteriorly with chestnut. Of six females, 34 to 60 mm. long and all ovigerous, three had a reddish tinge on the sternum only, while the chelae were deep wine-color. The smallest males showing any red were about 30 mm. long and had a chestnut tinge on the borders of the carapace and sternum, but not on the legs.

The agility of these crabs and their gregarious custom of sunning themselves in groups on damp rocks are well known. When forced into the water they are good swimmers, but return to the rocks as soon as possible. They are distinctly diurnal; at night they lie quietly in cracks or on open rocks above the reach of the tide, and are so torpid that they often can be picked up without making any effort to escape, whether or not a flashlight is used. They feed by plucking the fur-like algae from the rocks, using the spooned chelipeds alternately. However, although predominantly algae-eaters, there is no doubt but

that these crabs are also scavengers. Several times I have seen individuals eating dead fish and insects, and once a *Grapsus* seizing and eating a live dytiscid beetle. For an account of Galápagos specimens catching ticks on iguanas and eating martins, see Beebe, 1924, pp. 93 and 121, or Boone, 1927, p. 246 ff.

Forty stomachs were examined with the following results: Practically all contained fine rock algae, usually more or less mixed with sand, such as is found washed up around the bases of the algae.

Ten stomachs contained one or more of the following: bryozoans, tiny mussels, barnacles, hydroids.

The chief enemies in many localities are doubtless nocturnal crab-eating raccoons; twice raccoon tracks were found beside *Grapsus* remains. Once a grackle was seen to seize a crab, having stalked it from around a projecting rock. Surf fishes must often catch unwary crabs that are washed into the sea.

Range: Tropical and subtropical shores of America and of the eastern Atlantic. The subspecies *G. grapsus tenuicrustatus* inhabits the Indo-Pacific region.

Geograpsus lividus (Milne Edwards, 1837, p. 85); Rathbun, 1918, p. 232; Boone, 1927, p. 253; Sivertsen, 1934, p. 19; Schmitt, 1939, p. 25; Garth, 1946, p. 506. 19 specimens preserved from Mexico (Tenacatita, Guatulco), Nicaragua (San Juan del Sur), Costa Rica (Port Parker, Culebra, Jasper I.), Colombia (Gorgona I.). Many others seen but not saved. Eggs seen from Nov. to April (Mexico to Colombia). Under large loose stones on rock shores, or with substratum of coral and sand; rarely in similar localities near mangroves; lives well above low tide marks (Zone 2).

Ground color of carapace varying from bright yellowish-green through pale emerald to black; reticulations or marblings contrasting, black or purple on light crabs, green on black ones. Chelipeds sometimes tinged with orange, or rusty orange above mottled with black; legs blue green to purplish; hairs yellow. Eggs purple. Young (7 mm. long), very pale green with black reticulations very narrow; chelipeds buff. Have not seen on the west coast the coloration recorded by Rathbun ("Yellowish red with reticulating lines or patches of a darker red or purplish; sometimes wholly red."). This may be typical of the east coast member of the species.

Of five stomachs containing food, one held remains of a minute sea urchin, two, insect remains (probably beetles), two amphipods, and two, a few bits of gravel.

Range: Florida keys to Brazil; Bermudas; Lower California to Chile; Galápagos; Hawaiian Islands.

Goniopsis pulchra (Lockington, 1877, p. 152); Rathbun, 1918, p. 239. 43 specimens preserved from Mexico (Chamela), Nicaragua (Corinto), Costa Rica (Culebra, Puntarenas, Golfito), Panama (Honda), Colombia (Gorgona I.) and Ecuador (Puerto Bolivar). Eggs in Dec. (Nic.), Feb. (C.R.). Among mangroves, especially along banks of estuaries and lagoons, close to water line (Zone 6). Rarely in almost fresh water, with no mangroves within several hundred yards.

General color dark above with light spots; chelipeds and legs reddish; females duller. In more detail the coloration is as follows: ground color of carapace usually jet black; the round to elongate spots and bars are pale olive brown to pale buff, fading to white on sides and posterior margins of carapace. These markings are very variable in size and number, but a few large ones are almost always present on postero-lateral sides of carapace. Chelipeds bright rufous to brilliant scarlet in males, except for black tubercles and creamy dactyls and distal part of manus; in females and young the merus and carpus are usually blackish-red to blackish-brown with other segments yellowish-cream washed with orange. Merus of ambulatories in males sometimes bright scarlet, sometimes only tinged with rose posteriorly; other segments pale olive brown to pumpkin orange, or light reddish, the manus spotted with black and white; all segments with black hairs and white spot at base of each hair. Underparts creamy except external maxillipeds which are pure white; legs of female without red, plain buff marked with black. Eggs dull purple. The red develops late; young crab (about 10 mm.) black with small cream spots all over except for manus and chelae which have black dorsal ridge, apricot buff central portion, and cream pollex and lower half of manus. A 12 mm. specimen was olive green all over except for typical white spots on postero-lateral sides of carapace; underparts, manus, dactyls and chelae all cream. A single male at Gorgona was much redder than any others seen, the color continuing even on the carapace, rather as in the Atlantic *cruentata*.

The steep banks of estuaries and mangrove swamps proper are often honeycombed with the burrows of this crab. Each burrow typically has two or more entrances, often close together; they tend to run parallel, close to the surface, for long distances, although holes more than three or four feet deep usually go down to water level, then back up and in; often they lead into each other or have common entrances. At Balleas the holes were everywhere on a low muddy flat that was always completely covered at high water; very few mangroves grew here; the ground was honeycombed,

with many tunnels parallel to the surface, although a few deep holes existed; some individuals lived under old mangrove logs.

When pursued, these crabs use any hole at all to escape; unlike *Uca* they apparently have little sense of property.

Range: From Magdalena Bay, Lower California, to Peru.

Pachygrapsus transversus (Gibbes, 1850, p. 181); Rathbun, 1918, p. 244; Boone, 1927, p. 255, 1929, p. 577; Pesta, 1931, p. 179; Finnegan, 1931, p. 649; Sivertsen, 1934, p. 19; Schmitt, 1939, p. 25; Garth, 1946, p. 507. 121 preserved from Mexico (Sihuatenajo, Tangola-Tangola), El Salvador (G. of Fonseca), Nicaragua (Cardon I. at Corinto, near Potosi R. in Gulf of Fonseca, San Juan del Sur), Costa Rica (Port Parker, Culebra, Uvita), Panama (Honda), Colombia (Gorgona I.). Eggs are plentiful everywhere from Nov. to March. This species is the most abundant and ubiquitous of shore crabs; it is found in all zones where there are stones or rocks, from moderately brackish water to open coasts, on muddy, sandy or stony substrata, in tidepools, and even among mangrove roots or logs with stones among them (Zones 1, 2, 3, 4, 6, 7, 8). It fails to occur only in coral, open mud or open sand, although it is rare on the most exposed surf-beaten rocks where *Grapsus* and *Eriphides* are typically found. The largest crabs are always found on the larger rocks, small ones stay near pools or under small stones. Length of largest male 13.5 mm.; largest ovigerous female 11.5; smallest ovigerous female 6.5 mm.

There is considerable color variation, the greenest crabs being among green weed, and the darker ones on dark stones. Typically, the crab is very dark green or black with bright green marblings or striations; longitudinal bar of bright green on intestinal region, and a transverse line of this color in both proximal and distal joints of carpus; chelae and lower three-quarters of manus creamy; upper and lower sides of ambulatories same as carapace and faintly banded with cream.

The following notes made at Cardon I., Corinto, concern behavior which is typical of these crabs everywhere along their Pacific coast range. "Dec. 31. Low tide. 13 small *Pachygrapsus* seen in an area near low-tide level measuring 1 x 3 feet, composed of large and small stones exposed in a pool between boulders. All of the crabs, in both sun and shade, were out of water feeding on algae as fast as they could, using their chelae alternately in perfect rhythm. Their bodies appeared very green and algae-like in the sun, yet in the shade the darker black markings gave the tone, so that, like the algae in shadow, they appeared almost black. Twenty-five minutes after low tide

the water had risen a good three inches in the pool, although it was still quiet. Nevertheless, most of the best algae was now under water, and not one of the 13 crabs was in sight. Evidently, they prefer to feed in the air, and since the richest algae beds are uncovered in these near-low-tide zones for such a very short time, the reason for their haste in feeding is evident. During the entire morning I saw only one *Pachygrapsus* feeding under water, and that was in a half-hearted fashion for a few moments only.

"The original 13 had no territorial precincts, individuals sometimes feeding alone on a rock, sometimes within three inches of a neighbor, and moving on to a new spot two or three inches away after a minute or so. Could see a movement of mine a good foot or more away, and would stop eating at once and run into a crevice. A half-grown *Grapsus* startled a *Pachygrapsus* away from its algae; it ran four inches and started feeding again under a ledge, while the *Grapsus* took up grazing in the *Pachygrapsus*' first site. Another *Pachygrapsus* backed into a grazing snail, the snail struck out viciously with its foot, and the *Pachygrapsus* ran away in this case too, although it was fully as large as the snail.

"The larger *Pachygrapsus* dare to get farther from the pools, grazing on top of the large boulders in damp hollows. They are startled by a human movement as much as two feet away.

"These crabs are active and feed at night, but not as much as during the day. They appear brown at night, like the weed and rocks, in the light of an electric torch."

Among their enemies are carnivorous tidepool fish; we took them from the stomach of a blenny, *Malacosteus xonifer*, and of the common tidepool goby, *Bathygobius soporator*.

Range: Cosmopolitan in the tropics.

Sesarma sulcatum Smith, 1870, p. 156; Rathbun, 1918, p. 289. 10 specimens from Costa Rica (Negritos, Ballenas, Golfito). In gravelly mud along a lagoon shore, on banks of drying streams (nearly or completely freshwater), and in slightly brackish mangrove mud (Zones 6, 7).

Large male from Golfito: Carapace and legs plain dark brownish-gray; cheliped merus, carpus, upper half of manus and upper basal part of movable finger chocolate brown; lower half of manus and rest of chelae bright creamy yellow; sternum, abdomen and all except manus and dactyls of undersides of ambulatories light buff; undersides of manus and dactyls grayish-brown. Ovigerous female: with yellow line across front, rest yellow brown all over mottled with black except chelipeds which are as follows: merus and carpus cream with striations and tubercles maroon. Manus

and chelae entirely cream except maroon striations on upper margin. Underparts all cream washed with gray. Eggs chocolate brown.

One specimen found in stomach of white ibis, Corinto.

The females and young, neither in our series nor in that at the United States National Museum, have the full number of spinules on the dactyl. Typical counts of our specimens are as follows: female, 4.8 mm., no side tooth, no dactyl spinules, legs slightly more slender than in adult (this specimen was taken at Ballenas in midst of a colony of this species, so there is no reasonable doubt of the identification); male, 5.1 mm., has side tooth, beginning of spinules, thicker legs; ovigerous female, 14 mm., 9 dactyl spinules; male, 17 mm., 9 dactyl spinules; male, 20 mm., 10 dactyl spinules. A conspicuous short longitudinal ridge, not mentioned in the descriptions, runs along middle of outer surface of palm in male; this ridge is present also in U.S.N.M. specimens.

Range: From La Paz, Lower California, to Panama.

Sesarma rhizophorae Rathbun, 1906, p. 99; 1918, p. 294. 2 specimens, male 8.3 mm., ovigerous female, 8.4 mm., from Costa Rica (Puntarenas and Ballenas). Among mangroves (Zone 6). Compared with holotype and other specimens in U. S. National Museum. Agrees perfectly except that the granules are more strongly developed in the holotype than in our specimen.

Range: Known only from Costa Rica.

Aratus pisonii (Milne Edwards; 1837, p. 185); Rathbun, 1918, p. 323. Boone, 1930, p. 207; Finnegan, 1931, p. 651. 16 specimens preserved from Nicaragua (Corinto, San Juan del Sur), Costa Rica (Port Parker, Ballenas, Golfito), Panama (Honda). On west coast of America, always on mangrove boughs, well above water (Zone 6).

Typical coloring: entire gastric portion of carapace nopal red (Ridgway); surrounding parts, including front and antero-lateral margins, off-white marbled with dark brown. Chelipeds nopal red. Inner parts and tips of dactyls flame scarlet. Hairs black with straw tips. Eyes olive gray. Eye stalks nopal red with black dots. Ambulatories dark gray marbled with black and, on merus, washed with orange-brown. Sternum and abdomen white. Underside of ambulatories pearl gray.

Range: Coasts of America, from Florida to Brazil and from Nicaragua to Peru.

HABITAT ZONES.

The habitats of the intertidal brachyuran crabs (as limited on p. 69) taken by the Eastern Pacific Expedition proved to divide themselves into nine quite distinct zones. These may be listed as follows:

1. *Surf Rocks*.
2. *Stones near Mid-tide Levels*: that is, tidal stones well above low tide levels.
3. *Stones near Low-tide Levels*: tidal stones only briefly uncovered by the tide.
4. *Tidepools*.
5. *Coral: Pocillopora*.
6. *Mangroves*: swamps and estuary banks.
7. *Mudflats*: open, unshaded.
8. *Sheltered Beaches*: sandy-mud or sandy.
9. *Exposed Beaches*: sandy.

It will be noted that in Zones 1-5, the substratum is hard, while in 6-9 it is more or less soft. In 1-5 and in 9, the salt concentration of the water is high, approaching that of open ocean; in 6, 7 and 8 it is low, ranging from almost fresh to around 75% of oceanic salinity. Unfortunately, no exact salinity analyses were made of these various habitats, except in the case of a few species of *Uca*. Obviously, the nine zones could be divided into a number of smaller niches, but this subdivision must await future, more exact investigation in the field.

These nine habitats will be described below in more detail, and a list of the crabs occurring in each will be given. It must be emphasized that these are only the records made by the present author. Some of the observations, such as the occurrence of *Grapsus* in the surf zone, have been repeatedly recorded by previous writers: others, such as the restriction of certain species to *Pocillopora* coral, although well known to even amateur field naturalists, appear never to have been published in the reports of this area. Although years of field work would be needed to make a complete report on this subject, still the usual habitats of the more common species are without question those given. The ecologic ranges of the rarer forms will, however, unquestionably be extended to other habitats. The following species included in the present report were also taken on the *Zaca* in deeper water: *Teleophrys cristulipes*, *Mithrax pygmaeus*, *M. areolatus*, *Anaptychus cornutus* and *Xanthodius stimpsoni*. A few other species, such as *Daldorfia garthi*, which were taken only on shore or in *Pocillopora* on the *Zaca*, have been reported by the Hancock and other expeditions from deeper water as well.

In spite of the above limitations, one of the clearest results of the present study is the restriction of the vast majority of species to only two or three niches having a number of characters in common—for example, tidepools, stones near the low-tide level, and *Pocillopora* coral, or mangroves and open mudflats. Finally, a considerable number appear to be confined to a single zone,

The following lists represent the summarized results of daily collections and notes made on 79 different species from more than 50 geographic localities. More than 3,500 specimens were collected and, of the more common forms easily identified at sight—for example, *Grapsus*, *Goniopsis* and *Ocyroide*—literally thousands of additional individuals were seen and their habitats noted, although no specimens were collected.

The zone references in parentheses following species names refer to the other zones in which that form was taken, and are given for purposes of easy cross-reference.

In the concluding section is given a summary of the relative richness of habitat zones.

Zone 1. Surf Rocks. This habitat consists of exposed rocks and cliffs to which algae are usually attached. Technically, it should be divided into two parts, an upper region dampened only by spray or exceptional tides, and a lower zone which is covered twice daily by normal tides. Since the scanty brachyuran fauna is little affected by these distinctions, they are not observed in this list. The four species found in the zone are the following:—

Majidae:

Acanthonyx petiverii. Also in tidepools (4).

Xanthidae:

Eriphides hispida.

Grapsidae:

Grapsus grapsus.

Pachygrapsus transversus. Rare here; also present in all other zones except coral (5) and exposed beaches (9).

Zone 2. Stones Near Mid-tide Levels. This zone is represented by tidal stones between mean and high-tide marks. It is distinguished from the next chiefly by the scarcity or absence of algae, serpulids, corals and other growths upon the under sides of the stones. This habitat occurs frequently between the ends of protected beaches and the boulders or cliffs which form the adjacent promontory.

Xanthidae:

Leptodius taboganus.

Xanthodius sternberghii. Also under stones near low tide (3) and in tidepools (4).

Eurypanopeus planus.

Menippe frontalis.

Eriphia squamata. Also in tidepools (4) and, rarely, among mangroves (6).

Grapsidae:

Geograpsus lividus.

Pachygrapsus transversus. Also present in all other zones except in coral (5) and on exposed beaches (9).

Ocyroideidae:

Uca panamensis.

Zone 3. Stones Near Low-tide Levels. This zone is represented by tidal stones near low-tide marks. They are uncovered at most only an hour or so during each tidal period, and during neap tides may be underwater for days at a time. Therefore, since the undersides of the stones never dry out, they are encrusted with a varied sessile fauna and flora, consisting chiefly of algae, sponges, corals, bryozoans, serpulid worms and tunicates. Here gather also many non-sessile animals, such as starfish, serpent stars, holothurians, worms, mollusks and snapping shrimps. As is to be expected, the crab fauna is rich, particularly in spiders. Most of the species cling upside down to the growth on the stones.

Majidae:

Eucinotops panamensis. Rare here; typically present in tidepools (4).

Pelia pacifica. Also in tidepools (4) and coral (5).

Herbstia tumida. Also in coral (5).

Thoe sulcata. Rare here; typically present in tidepools (4) and coral (5).

Pitho sexdentata.

Anaptychus cornutus. Also in tidepools (4) and coral (5).

Mithrax denticulatus. Rare here; typically present in tidepools (4) and coral (5).

Teleophrys cristulipes. Rare here; typically present in tidepools (4) and coral (5).

Parthenopidae:

Daldorfia garthi. Usually found in deeper water.

Xanthidae:

Daira americana. Rare here; typically present in coral (5).

Cyclothanoops vittatus. Also in coral (5).

Leptodius taboganus. Also under stones near mid-tide levels (2).

Xanthodius sternberghii. Also under stones near mid-tide levels (2) and in tidepools (4).

Xanthodius stimpsoni. Also in tidepools (4) and coral (5).

Lophoxanthus lamellipes. Also in tidepools (4) and coral (5).

Xanthidae:

Pilumnus pygmaeus. Also in tidepools (4).

Ozius verreauxii. Also in tidepools (4).

Ozius perlatus.

Ozius agassizii. Also in tidepools (4).

Grapsidae:

Pachygrapsus transversus. Also present in all other zones except in coral (5) and on exposed beaches (9).

Zone 4. Tidepools. This habitat is too well known to need discussion, except to point out that tidepools are usually in an exposed position, and that their rocky, uneven sides and bottoms give excellent support for many

kinds of algae. It is usually in the algae that most of the following crabs are found.

Majidae:

Eucinotops panamensis. Also under stones near low-tide levels (3).

Acanthonyx petiverii. Also on surf rocks (1).

Pelia pacifica. Also under stones near low-tide levels (3) and in coral (5).

Thoe sulcata. Also under stones near low-tide levels (3) and in coral (5).

Anaptychus cornutus. Also under stones near low-tide levels (3) and in coral (5).

Mithrax denticulatus. Also under stones near low-tide levels (3) and in coral (5).

Mithrax orcutti.

Teleophrys cristulipes. Rare here; typically present in coral (5).

Microphrys platysoma. Also under stones near low-tide levels (3) and in coral (5).

Xanthidae:

Actaea dovii. Also in coral (5).

Actaea sulcata. Rare here; typically present in coral (5).

Xanthodius sternberghii. Also under stones near mid-tide (2) and low-tide (3) levels.

Xanthodius stimpsoni. Also under stones near low-tide levels (3) and in coral (5).

Lophoxanthus lamellipes. Also under stones near low-tide levels (3) and in coral (5).

Metapocarcinus concavatus.

Menippe obtusa.

Pilumnus gonzalensis.

Pilumnus pygmaeus. Also under stones near low-tide levels (3).

Ozius agassizii. Also under stones near low-tide levels (3).

Ozius verreauxii. Rare here; typically present under stones near low-tide levels (3).

Eriphia squamata. Also under stones near low-tide levels (2) and, rarely, among mangroves (6).

Grapsidae:

Pachygrapsus transversus. Also present in all other zones except in coral (5) and on exposed beaches (9).

Zone 5. Coral (Pocillopora). This distinctive habitat zone is included in the present paper on intertidal crabs for two reasons. First, although the coral usually lies at least three feet and usually from six to eighteen or more feet under water, it is occasionally partially exposed during spring tides. Second, its fauna overlaps that of the tidal zones, rather than that of the deeper littoral. Associated with the very characteristic brachyuran fauna, are equally well-marked animals of other groups, particularly the snapping shrimp, *Crangon ventrosus*, as well as numerous other shrimps, serpent stars, worms, and occasional mollusks and fish. More than fifty heads of coral, ranging in diameter from six inches to more than two

feet, were carefully hammered open and their inhabitants collected. Of the 21 species of brachygnathous crabs found, nine were never taken by us in any other habitat.

Majidae:

Pelia pacifica. Also under stones near low-tide levels (3) and in tidepools (4).

Herbstia tumida. Also under stones near low-tide levels (3).

Thoe sulcata. Also under stones near low-tide levels (3) and in tidepools (4).

Anaptychus cornutus. Also under stones near low-tide levels (3) and in tidepools (4).

Mithrax denticulatus. Also in tidepools (4); rare under stones near low-tide levels (3).

Mithrax pygmaeus.

Teleophrys cristulipes. Also, rarely, under stones near low-tide levels (3) and in tidepools (4).

Microphrys platysoma. Also under stones near low-tide levels (3) and in tidepools (4).

Xanthidae:

Carpilodes cinctimanus.

Actaea dovii. Also in tidepools (4).

Actaea sulcata. Also, rarely, in tidepools (4).

Daira americana. Also, rarely, under stones near low-tide levels (3).

Medaeus spinulifer.

Cylothanoops vittatus. Also under stones near low-tide levels (3).

Xanthodius stimpsoni. Also under stones near low-tide levels (3) and in tidepools (4).

Lophozanthus lamellipes. Also under stones near low-tide levels (3) and in tidepools (4).

Micropanope xantusii.

Pilumnus xantusii.

Heteractaea lunata.

Domecia hispida.

Trapezia cymodoce ferruginea.

Trapezia digitalis.

Zone 6. Mangroves. This zone includes both swamps, estuaries, and the edges of lagoons — wherever mangroves are found. Fiddler crabs (*Uca*) are the most typical and abundant crabs of these brackish areas, the characteristics of which are too well known to require further comment. It should only be noted that small stones are often present near the edge of a swamp and that some species, particularly *Eurypanopeus transversus*, do not occur where stones are absent. Below are included only those species found among the mangrove roots or in their shade. Those living on nearby mudflats are in subsequent categories (7 and 8).

Xanthidae:

Panopeus purpureus. Also on mudflats (7).

Eurypanopeus transversus. Among stones only. Also among stones on mudflats (7) and sheltered stony-mud beaches (8).

Eurytium tristani. Also on mudflats (7).

Grapsidae:

Eriphia squamata. Rare here; present among stones near mid-tide levels (2) and in tidepools.

Goniopsis pulchra.

Pachygrapsus transversus. On roots and stones only. Also present in all other zones except in coral (5) and on exposed beaches (9).

Sesarma rhizophorae.

Sesarma sulcatum. Also on mudflats (7).

Aratus pisonii. Among mangrove branches only.

Ocypodidae:

Uca zaca.

Uca schmitti.

Uca brevivfrons.

Uca tomentosa.

Uca umbratila.

Uca inaequalis. Also on mudflats (7).

Uca tenuipedis.

Uca batuenta.

Uca crenulata.

Uca argillicola (in clayey mud); (type series only).

Uca limicola (type series only).

Uca latimanus. Rare here; typically on sheltered beaches (8).

Zone 7. Open Mudflats. In this and the following zone (8), there is a complete lack of shade, but mangroves are almost always at least within sight of the human eye. The richest areas are close to the vegetation; the center of the flats are usually lacking in crabs. As in the preceding zone, some of the species below are found only or chiefly where some stones are present in the mud.

Xanthidae:

Panopeus purpureus. Also among mangroves (6).

Panopeus chilensis.

Eurypanopeus transversus. Among stones only. Also among mangroves (6) and on sheltered beaches (8).

Eurytium tristani. Also among mangroves (6).

Grapsidae:

Pachygrapsus transversus. Among stones only. Also present in all other zones except in coral (5) and on exposed beaches (9).

Sesarma sulcatum. In gravelly mud only. Also among mangroves (6).

Ocypodidae:

Uca princeps. Also on sheltered beaches (8).

Uca heteropleura. Also on sheltered beaches (8).

Uca styliifera. Also on sheltered beaches (8).

Uca insignis. Also on sheltered beaches (8).

Uca macrodactyla.

Uca schmitti.

Uca galapagensis.

Uca oerstedii.

Uca inaequalis. Also among mangroves (6).

Uca saltitanta.

Uca beebei. Also on sheltered beaches (8).

Zone 8. *Sheltered Beaches*. These include stretches of sandy-mud or sandy shores, unshaded, covered at high tide by brackish water. Open water, whether estuary or narrow-mouthed bay, is usually closer than in Zone 7.

Xanthidae:

Eurypanopeus transversus. Only among occasional stones. Also among mangroves (6) and on mudflats (7).

Grapsidae:

Pachygrapsus transversus. Only among occasional stones. Also present in all other zones except in coral (5) and on exposed beaches (9).

Ocypodidae:

Ocypode gaudichaudii.

Ocypode occidentalis. Rare here; typically on exposed beaches (9).

Uca princeps. Also on mudflats (7).

Uca heteropleura. Also on mudflats (7).

Uca stylifera. Also on mudflats (7).

Uca insignis. Also on mudflats (7).

Uca festae.

Uca beebei. Also on mudflats (7).

Uca stenodactyla.

Uca deichmanni.

Uca latimanus.

Uca terpsichores.

Zone 9. *Exposed Beaches*. This zone is always sandy, and the concentration of the water approaches that of normal open ocean.

Ocypodidae:

Ocypode occidentalis. Also on sheltered beaches (8).

CONCLUDING REMARKS ON FIELD OBSERVATIONS.

A paper such as this one, which is composed largely of field notes, can never be prepared without a feeling of deep dissatisfaction. The individual observations are so fragmentary, the basic problems involved so little understood, that the only excuse for putting the notes on record lies in the scarcity of field observations of any kind. With these facts in mind, it seems worthwhile to conclude with a few remarks on the ecology, coloration and behavior of these crabs, which may suggest lines for worthwhile future study. Planned research in any of these directions would add not merely to knowledge of the Brachyura, but also to the clarification of vital problems of theoretical biology. All such studies on these north-tropical Eastern Pacific shores are facilitated by the characteristic warm waters, relatively well-watered shores, high tides and adequate bays and gulfs, which unite

to encourage an especially rich and varied littoral brachyuran fauna.

Thanks to the tireless work of Mary J. Rathbun, and, more recently, of Susan Finnegan, Steve Glassell and John S. Garth, the taxonomy and geographical distribution of the shore crabs of the tropical eastern Pacific are becoming very well organized and understood. These questions will not be considered here, except to remark on the convenience, for field workers, of the relatively wide ranges of most of the common shore species, which often extend from Cape San Lucas to Panama and beyond, as well as the occurrence of a number of species which are cosmopolitan in the tropics.

1. RICHEST COLLECTING STATIONS: Our experience on the *Zaca* showed a number of localities where crab collecting was especially fruitful, and a number of others where shore life in general and the crab fauna in particular were so poor that the results were scarcely worth the effort of landing. For the benefit of future workers, these richer bays are listed here. It should be kept in mind, however, that local shifts in population, the laying of pipe lines, or natural or artificial swamp drainage may swiftly ruin the best of collecting grounds. On the other hand, the richest colonies are often found near sewer outlets and garbage dumps, provided the water is not polluted by oil or chemicals. Examples of such richness, which are due at least partly to nearby habitation, are the entrance to Corinto harbor and certain localities around the mouth of the Panama Canal.

During the Eastern Pacific *Zaca* Expedition of 1937-1938, and my later (1941 and 1944) trips to Panama and Ecuador, the most fruitful localities, from the point of view of inter-tidal crab populations, were the following (see map, p. 70):

Mexico:

Acapulco. Moderately good; chiefly rocky short habitats and coral.

Tangola-Tangola. Of the three adjacent bays, Guatulco, Santa Cruz and Tangola-Tangola, the latter was by far the best. Stony, rocky and sandy beach and tidepool habitats; *Pocillopora*; the extensive lagoons, with mangroves, were not investigated for crabs.

Nicaragua:

Corinto. Excellent. Many habitats, from marine stones, rocks and tidepools at Cardon Island, to brackish water mudflats and mangroves.

Costa Rica:

Port Parker. Excellent. Many habitats accessible, from coral and marine rocks, stones and tidepools at Abajos Point to fresh-water streams. Limited mangrove and mud-flat areas.

Culebra. Mediocre stony shore populations, but good *Pocillopora* easily available; the latter were in individual heads rather than in reef form.

Piedra Blanca. Good rock, stone, beach and tidepool habitats.

Gulf of Nicoya. The upper portion, around Puntarenas, was excellent for brackish water, mangrove and mud-living species. Naturally, no coral was found here, but excellent *Pocillopora*, in extensive reef formation, occurred toward the mouth of the Gulf around Jasper Island. Ballenas Bay, beside the mouth, had a good lagoon fauna (mangrove and mudflat), but the stony shore and tidepool collecting was poor.

Uvita Bay. Moderately good exposed stony reef, rock and beach collecting; *Pocillopora* present; also a good fresh-water stream.

Golfito, in Gulf of Dulce. This practically uninhabited locality was wonderfully rich in all mud- and sandy-mud-living forms, having extensive protected mudflats and mangroves, and fresh-water rain-forest streams. We have heard, however, that it has been spoiled, zoologically speaking, by one of the fruit companies.

Panama and the Canal Zone:

Bahia Honda. Good, semi-exposed stony shore and beach collecting; also fair *Pocillopora*, mudflats and brackish streams.

Panama City and Balboa. The beach at Bellavista and the mangrove pocket known as La Boca still had adequate brackish-water crab populations as late as 1944. They had deteriorated, however, since 1941, because of wartime construction at La Boca and some apparently natural silting up of mudflats at Bellavista (cf. Crane, 1941).

Colombia:

Gorgona Island. (The only locality visited in Colombia). Moderately good shore-crab populations.

Ecuador:

Puerto Bolivar (at mouth of Guayas River). Excellent sheltered beach, mudflat and mangrove crab fauna here and on nearby Jambeli Island. The swamps were being drained in 1944, but the crab colonies, particularly of *Uca*, are so extensive that they should be safe for some years.

Guayaquil. The few, nearly fresh-water forms which can live here were all thriving in 1944. The apparently endemic *Uca festae* is abundant.

2. ABUNDANCE. The numbers of individuals of the various species in the expeditions' collection give no clue to their actual abundance in the field for three reasons: first, no effort was made to make collections from this point of view; second, some of the more common forms, such as *Eriphides* of the surf zone, were difficult to reach and collect

intact; third, extensive representations of some of the best known species, such as *Grapsus* and *Goniopsis*, were not considered necessary.

Field notes made on the *Zaca* from Acaulco to Panama, however, leave no doubt as to which were the most abundant species among these intertidal crabs. Naturally, it is impracticable to compare numbers of a large form such as *Grapsus* with a small one such as *Pachygrapsus*, or the dominant form in one habitat zone with that in another, but irrespective of zones, the following species are certainly among the most widely distributed and generally accessible, observable, abundant and successful of all the crabs within the area under discussion; they are arranged in taxonomic order:

Xanthodius sternberghii (Zones 2, 3, 4).

Eurypanopeus planus (Zone 2).

Eriphia squamata (Zones 2, 3, 4).

Trapezia cymodoce ferruginea (Zone 5).

Grapsus grapsus (Zone 1).

Geograpsus lividus (Zone 2).

Pachygrapsus transversus (Practically ubiquitous, except in coral and on open sandy beaches).

Ocypode occidentalis (Zone 9).

Ocypode gaudichaudii (Zone 8).

Of course, many other species, e.g. a number of *Uca*, are locally abundant.

A thorough study of any one of these readily available species would be certain to yield excellent results.

Spider crabs are notable for the absence of numerically abundant species.

3. HABITATS. Conditions naturally vary locally, but the following species are most universally present in their respective zones.

Zone 1. Surf Rocks. *Grapsus grapsus*.

Zone 2. Stones near mid-tide levels. *Xanthodius sternberghii*, *Eriphia squamata*. *Uca panamensis* and *Eurypanopeus planus* are practically always present in the mixed sand and stony area at ends of protected beaches.

Zone 3. Stones near low tide levels. No species outstanding, since local conditions vary greatly.

Zone 4. Tidepools. Same remarks as for Zone 3.

Zone 5. Coral (*Pocillopora*). *Trapezia cymodoce ferruginea*.

Zone 6. Mangroves. *Goniopsis pulchra*; *Aratus pisonii*.

Zone 7. Open mudflats. No species outstanding.

Zone 8. Sheltered beaches. *Ocypode gaudichaudii*.

Zone 9. Exposed beaches. *Ocypode occidentalis*.

In regard to the richness of habitat zones

in number of species in the collections, tide-pools and *Pocillopora* coral lead with 22 species each, followed by mangroves with 21, low-tide levels with 20, mudflats with 17 and protected beaches with 14. The poorest are exposed beaches with 1 species (*O. occidentalis*), surf rocks with 4 and stones at mid-tide levels with 8.

A field in which excellent detailed work could be done on this coast concerns the structural and physiological adaptations to niches. For example, the high proportion of hairy or decorated species which cling to the encrusted stones of low tide regions is always striking when contrasted with the predominantly naked or scarcely pilous forms of the mudflats. Subdivisions of this subject, concerning the variations in attachment, amount and kind of decoration in spider crabs are most interesting; a few examples have been given in the systematic part of this paper.

Again, the variations in foot structure, for clinging versus digging functions, for example, show beautiful adaptations. Finally, although work has been done on desiccation tolerance among east coast shore crabs (i.e. Pearse, 1936), west coast forms, which are subjected to exceptionally high and low tides, have not been investigated. Extreme adaptiveness to alternate and irregular submergence and aestivation must have been developed, furnishing challenging material for research. In *Uca* this tolerance is particularly striking.

4. COLOR. The wide prevalence of protective coloration was, as usual, the most striking crab color characteristic on the Pacific expeditions. During the exceptional opportunities presented by the *Zaca* trips, the adaptive variability in accordance with the terrain could be well appreciated. This was demonstrated both by different populations of the same species, and by individuals within populations. The variability was most notable in fairly active crabs on stony, sandy, or sandy-mud beaches, that is, in forms to which protectively colored carapaces are presumably of vital importance. Certain species, for example *Xanthodius sternberghii*, *X. stimpsoni* and *Ocypode gaudichaudii*, all showed remarkable individual and/or group adaptations to lighter or darker substrata, whether the general color of a beach was involved, or only that of a group of atypically colored pebbles. Whether these differences are genetic or somatic, individually fixed or adaptive, is unknown. Unfortunately, genetic study is not yet practicable, because of lack of successful rearing technique. However, even the simplest experiments concerning the extent of individual ability to change color would be very worthwhile.

Other forms of color variation are geo-

graphical and/or ecological, and further observations are greatly needed. One example is discussed under *Grapsus* (p. 84), and others in the discussions of *Uca princeps* and *U. beebei* (Crane, 1944, p. 166). Sometimes geographic variation in color is indicated in the rare observations of young stages from different localities. For example, the juvenile color patterns of *Carpilodes cinctimanus*, *Actaea dovii*, *Actaea sulcata*, *Cycloxanthops vittatus* and *Ozius perlatus* appear to differ on the mainland and in the Galápagos. (cf. color descriptions of these species in the present paper with those of Garth, 1946.1).

The field of epigamic colors is practically unexplored in crabs, except for some observations on *Uca*. Especially needed are ingenious, basic experiments on color vision, and on the tendency of certain crabs in breeding condition to develop white pigment (see Crane, 1944).

5. DAILY ACTIVITY CYCLE: This field was scarcely touched during the expeditions, since opportunities for night observation were few. The following divisions, however, were well established.

Diurnal: *Grapsus grapsus*; *Ocypode gaudichaudii*; most species of *Uca*².

Probably diurnal: *Xanthodius sternberghii*.

Diurnal and nocturnal: *Eriphia squamata* (more active at night); *Menippe obtusa*; *Pachygrapsus transversus* (more active during daylight).

Nocturnal: *Geograpsus lividus*; *Ocypode occidentalis*.

6. FOOD: The *Zaca* observations on feeding and stomach contents may be summarized as follows:

Vegetarians: *Daira americana*; *Xanthodius sternberghii*; *Pachygrapsus transversus*.

Predominantly vegetarians: *Grapsus grapsus*.

Carnivores and scavengers: *Menippe obtusa*; *Domecia hispida*; *Trapezia cymodoce ferruginea*; *Trapezia digitalis*; *Geograpsus lividus*; *Ocypode occidentalis*.

Omnivores: *Eriphia squamata*; *Eriphides hispida*; *Eurypanopeus planus*.

Feeders on microorganisms and organic detritus sifted from sand and mud: *Goniopsis pulchra*; *Ocypode gaudichaudii*; *Uca* spp. (the latter are sometimes also scavengers).

In regard to the general feeding habits of these intertidal species, the rather obvious statement may be made that all spider crabs and most xanthids, including naturally all *Pocillopora* inhabitants, feed when underwater, while the grapsids and ocypo-

² Martin D. Burkenroad in a forthcoming paper reports on the nocturnal, as well as diurnal, activity of an east coast *Uca*; all members of the genus must now be rechecked with his most interesting observations in mind.

dids are typically feeders in the air. However, observation will certainly draw finer distinctions. For example, although *Pachygrapsus transversus*, which frequently crawls around in tidepools, follows the grapsid custom and seems never to feed under water, *Sesarma* and other mud-livers in the family often eat when actually submerged in tidal puddles; this is also true occasionally of *Uca*. Again, *Eriphia squamata* feeds with apparently equal frequency both above and beneath the surface, being in this respect perfectly amphibious.

In the few observations that have been made, all species with spooned chelae are predominantly eaters either of close-growing rock algae, or of organic detritus in sand and mud. The species so far observed feeding in these fashions are *Xanthodius sternberghii*, *Pachygrapsus transversus*, *Grapsus grapsus*, *Ocypode gaudichaudii*, and the various species of *Uca*. The usefulness of the spoon adaptation is obvious. An exception is *Eriphides hispida*, which is probably chiefly carnivorous, although the minor chela is strongly spooned.

7. SOCIAL BEHAVIOR. The fields of gregariousness, territoriality, aggression and display are virtually untouched in these Pacific crabs, save for a beginning in *Uca* (Crane, 1941), and few observations have been made anywhere in the world. The following disconnected notes indicate the possibilities of crab-study as a focus for work on these general problems.

It was noted on the *Zaca* that, as in other animal groups, those crabs which are predominantly vegetarian or feeders on micro-organic food live in larger groups than predacious forms: for example, *Grapsus grapsus*, *Pachygrapsus transversus*, *Goniopsis pulchra*, both species of *Ocypode* and most *Uca* contrast with the solitary, carnivorous *Menippe obtusa* and, probably, *Eriphides hispida*.

Unlike *Uca*, *Goniopsis* shows little sense of territoriality, although both live comparable lives.

Sexual differences in aggression were noticed particularly in *Xanthodius sternberghii* and *Eurypanopeus planus*, as well as in *Uca*. In these forms, disturbed males are more aggressive than females, adopting the threat posture with chelipeds extended. In *Eriphia squamata*, on the other hand, both males and females threaten when actively disturbed, although the preferred reaction is to retreat, and their young never threaten.

There is evidence that in *Eurypanopeus planus* and *Trapezia cymodoce ferruginea* the sexes remain paired while the eggs are being carried, or, possibly, new pairs are being formed at that time.

8. BREEDING SEASONS. The breeding records included in this paper show only the months during which eggs were found on specimens collected in the various countries. The sole conclusion that can be drawn at present is that the series of most species yielded ovigerous females between December and May, the months during which our collections were made. The actual length and extent of the breeding seasons for different species in single localities, their variation with latitude, and their relation to the rainy season remain unknown.

REFERENCES CITED.

- BEEBE, W.
 1924. Galapagos: World's End. *G. P. Putnam's Sons*.
 1938. Eastern Pacific Expeditions of the New York Zoological Society, XIV. Introduction, itinerary, list of stations, nets and dredges of the Eastern Pacific *Zaca* Expedition, 1937-1938. *Zoologica*, vol. 23, no. 14.
 1942. Book of Bays. *Harcourt Brace & Co.*
- BELL, T.
 1835. Some Accounts of the Crustacea of the Coasts of South America, with Descriptions of new Genera and Species, founded principally on the collections obtained by Mr. Cuming and Mr. Miller. *Proc. Zool. Soc. London*, vol. 3, pp. 169-173.
- BOONE, L.
 1927. The Littoral Crustacean Fauna of the Galapagos Islands, Part I: Brachyura. *Zoologica*, vol. 8, no. 4, pp. 127-288.
 1929. A collection of Brachyuran Crustacea from the Bay of Panama and the fresh waters of the Canal Zone. *Bull. Amer. Mus. Nat. Hist.*, vol. 58, no. 11, pp. 561-583.
 1930. Scientific results of the cruises of the yachts "Eagle" and "Ara," 1921-1928, William K. Vanderbilt, Commanding. Crustacea: Stomatopoda and Brachyura. *Bull. Vanderbilt Marine Mus.*, vol. 2, pp. 5-228.
- CRANE, J.
 1937.1 The Templeton Crocker Expedition. III. Brachygnathous Crabs from the Gulf of California and the West Coast of Lower California. *Zoologica*, vol. 22, no. 3, pp. 47-78.
 1937.2 The Templeton Crocker Expedition. VI. Oxystomatous Crabs from the Gulf of California and the West Coast of Lower California. *Zoologica*, vol. 22, no. 7, pp. 97-107.
 1940. Eastern Pacific Expeditions of the New York Zoological Society, XVIII. On the Post-Embryonic Development of the Brachyuran Crabs of the Genus *Ocypode*. *Zoologica*, vol. 25, no. 6, pp. 65-82.

- 1941.1 Eastern Pacific Expeditions of the New York Zoological Society. XXVI. Crabs of the genus *Uca* from the West Coast of Central America. *Zoologica*, vol. 26, no. 3, pp. 145-208.
- 1941.2 Eastern Pacific Expeditions of the New York Zoological Society. XXIX. On the Growth and Ecology of Brachyuran Crabs of the Genus *Ocypode*. *Zoologica*, vol. 26, no. 29, pp. 297-310.
1943. Eastern Pacific Expeditions of the New York Zoological Society. XXXI. *Uca schmitti*, a new species of Brachyuran Crab from the West Coast of Central America. *Zoologica*, vol. 28, no. 6, pp. 31-32.
1944. On the color changes of fiddler crabs (Genus *Uca*) in the field. *Zoologica*, vol. 29, no. 3, pp. 161-168.
- EYDOUX, F. & L. F. A. SOULEYET.
1842. Voyage autour du monde exécuté pendant les années 1836 et 1837 sur la corvette "la Bonite" commandée par M. Vaillant. Tome 1, pt. 2.
- FINNEGAN, S.
1931. Report on the Brachyura Collected in Central America, the Gorgona and Galapagos Islands, by Dr. Crossland on the "St. George" Expedition to the Pacific, 1924-25. *Journ. Linn. Soc. London, Zool.*, vol. 37, no. 255, pp. 607-673.
- GARTH, J. S.
1940. Some New Species of Brachyuran Crabs from Mexico and the Central and South American Mainland. *Allan Hancock Pac. Exped.*, vol. 5, no. 3, pp. 53-95.
- 1946.1 Littoral Brachyuran Fauna of the Galapagos Archipelago. *Allan Hancock Pacific Exped.*, vol. 5, no. 10, pp. 341-522.
- 1946.2 Distribution Studies of Galapagos Brachyura. *Allan Hancock Pacific Exped.*, vol. 5, no. 11, pp. 603-638, charts 1-10.
- GIBBES, L. R.
1850. On the Carcinological Collections of the United States and an Enumeration of the Species contained in them, with Notes on the most remarkable, and Descriptions of new Species. *Proc. Amer. Assoc. Adv. Sci.*, vol. 3, pp. 167-201.
- GLASSELL, S. A.
1934. Some Corrections Needed in Recent Carcinological Literature. *Trans. San Diego Soc. Nat. Hist.*, vol. 7, no. 38, pp. 453-454.
1935. New or Little-Known Crabs from the Pacific Coast of Northern Mexico. *Trans. San Diego Soc. Nat. Hist.*, vol. 8, no. 14, pp. 91-106.
1936. The Templeton Crocker Expeditions. I. Six New Brachyuran Crabs from the Gulf of California. *Zoologica*, vol. 21, no. 17, pp. 213-218.
1940. In J. S. Garth, Some New Species of Brachyuran Crabs from Mexico and the Central and South American Mainland. *Allan Hancock Pac. Exped.*, vol. 5, no. 3, pp. 67-70.
- HULT, J.
1938. Crustacea Decapoda from the Galapagos Islands collected by Mr. Rolf Blomberg. *Arkiv för Zoologi, Stockholm*, Band 30A, no. 5, pp. 1-18.
- LATREILLE, P. A.
1825. Histoire Naturelle; Entomologie, ou histoire naturelle des Crustacés, des Arachnides, et des Insectes in; *Encyc. meth.*, vol. 10, pp. 1-832.
- LINNAEUS, C.
1758. *Systema Naturae*, ed. 10, vol. 1, pp. 1-823.
- LOCKINGTON, W. N.
1877. Remarks on the Crustacea of the West Coast of North America, with a Catalogue of the Species in the Museum of the California Academy of Sciences. *Proc. Calif. Acad. Sci.*, vol. 7, pt. 1, pp. 94-108, 145-156.
- MACCAGNO, T.
1928. Crostacei Decapodi. Le specie del genere *Uca* conservate nel Regio Mus. Zool. Torino. *Boll. Mus. Zool. ed Anat. Comp. R. Univ. Torino*, vol. 41, Ser. 3, no. 11, pp. 1-52.
- MILNE EDWARDS, A.
1873-1880. Etudes sur les Xiphosures et les Crustacés de la Région Mexicaine. *Mission Scientifique au Mexique et dans l'Amerique Centrale*, Pt. 5, pp. 1-368.
- MILNE EDWARDS, H.
1834. Histoire Naturelle des Crustacés, vol. 1, pp. 1-468.
1837. Histoire Naturelle des Crustacés, vol. 2, pp. 1-532.
- MILNE EDWARDS, H., & H. LUCAS
1843. In d'Orbigny, Voyage dans l'Amerique Méridionale, vol. 6, pt. 1, pp. 1-39; atlas, vol. 9, 1847, pls. 1-17.
- NOBILI, G.
1901. Viaggio del Dr. Enrico Festa nella Repubblica dell' Ecuador e regione vicine. Decapodi e Stomatopodi. *Boll. Mus. Zool. Anat. Comp. Torino*, vol. 16, no. 415, pp. 1-58.
- PEARSE, A. S.
1936. Estuarine Animals at Beaufort, North Carolina. *Jour. Elisha Mitchell Scientific Soc.*, vol. 52, no. 2, pp. 174-222.
- PESTA, M.
1931. Ergebnisse der Osterreichischen Biologischen Costa-Rica Expedition 1930. I. Teil. Crustacea Decapoda aus Costa-Rica. *Ann. Naturhist. Mus. Wien*, vol. 45, pp. 173-181.

RATHBUN, M. J.

1893. Scientific Results of Explorations by the U. S. Fish Commission Steamer "Albatross". XXIV. Descriptions of new Genera and Species of Crabs from the West Coast of North America and the Sandwich Islands. *Proc. U. S. Nat. Mus.*, vol. 16, pp. 223-260.
1898. The Brachyura collected by the U. S. Fish Commission Steamer "Albatross" on the Voyage from Norfolk, Virginia, to San Francisco, California, 1887-1888. *Proc. U. S. Nat. Mus.*, vol. 21, pp. 567-616.
1906. Descriptions of three new mangrove crabs from Costa Rica. *Washington, D. C. Proc. Biol. Soc.*, vol. 19, pp. 99-100.
1912. New decapod Crustaceans from Panama. *Washington, D. C. Smithsonian Inst. Misc. Collect.*, vol. 59, no. 13 (Pub. 2090), pp. 1-3.
1918. The Grapsoid Crabs of America. *Bull. U. S. Nat. Mus.*, No. 97, pp. 1-461.
1923. The Brachyuran Crabs collected by the U. S. Fisheries Steamer "Albatross" in 1911; chiefly on the west coast of Mexico. *Bull. Amer. Mus. Nat. Hist.* New York, vol. 48, pp. 619-637.
1925. The Spider Crabs of America. *Bull. U. S. Nat. Mus.*, No. 129, pp. 1-613.
1930. The Cancroid Crabs of America of the Families Euryalidae, Portunidae, Atelocyclidae, Cancridae, and Xanthidae. *Bull. U. S. Nat. Mus.*, No. 152, pp. 1-593.

SAUSSURE, H. DE

1853. Description de quelques Crustacés nouveaux de la côte occidentale du Mexique. *Rev. et Mag. de Zool.*, ser. 2, vol. 5, pp. 354-368.

SCHMITT, W. L.

1939. Decapod and other Crustacea collected

on the Presidential Cruise of 1938. *Smithsonian Misc. Col.*, vol. 98, no. 6, pp. 1-29.

SIVERTSEN, E.

1933. The Norwegian Zoological Expedition to the Galapagos Islands 1925, conducted by Alf Wollebaek. VII. Littoral Crustacea Decapoda from the Galapagos Islands. *Medd. Zool. Mus. Oslo*, no. 38, pp. 1-38.

SMITH, S. I.

1869. Notes on new or little-known Species of American Cancroid Crustacea. *Proc. Boston Soc. Nat. Hist.*, vol. 12, pp. 274-289.
1870. Notes on American Crustacea. No. 1. Ocyropodoidea. *Tr. Conn. Ac.*, vol. 2, pp. 1-24, 113-176.

STIMPSON, W.

1859. Notes on American Crustacea. No. 1. *Ann. Lyc. Nat. Hist. New York*, 1859 (1862), vol. 7, pp. 49-93.
1860. 22. Notes on North American Crustacea in the Museum of the Smithsonian Institution. No. 2. *Ann. Lyc. Nat. Hist. New York*, vol. 7, pp. 49-118 (177-246).
1871. 6. Notes on North American Crustacea in the Museum of the Smithsonian Institution. No. 3. *Ann. Lyc. Nat. Hist. New York*, vol. 10, pp. 2-46.

WHITE, A.

1847. Descriptions of a new genus and five new species of Crustacea. In Jukes, Narrative of the Surveying Voyage of H.M.S. "Fly", commanded by Captain F. P. Blackwood, R. N. in Torres Strait, New Guinea, and other Islands of the Eastern Archipelago during the years 1842-1846. Vol. 2, Append. no. 8, pp. 335-338.

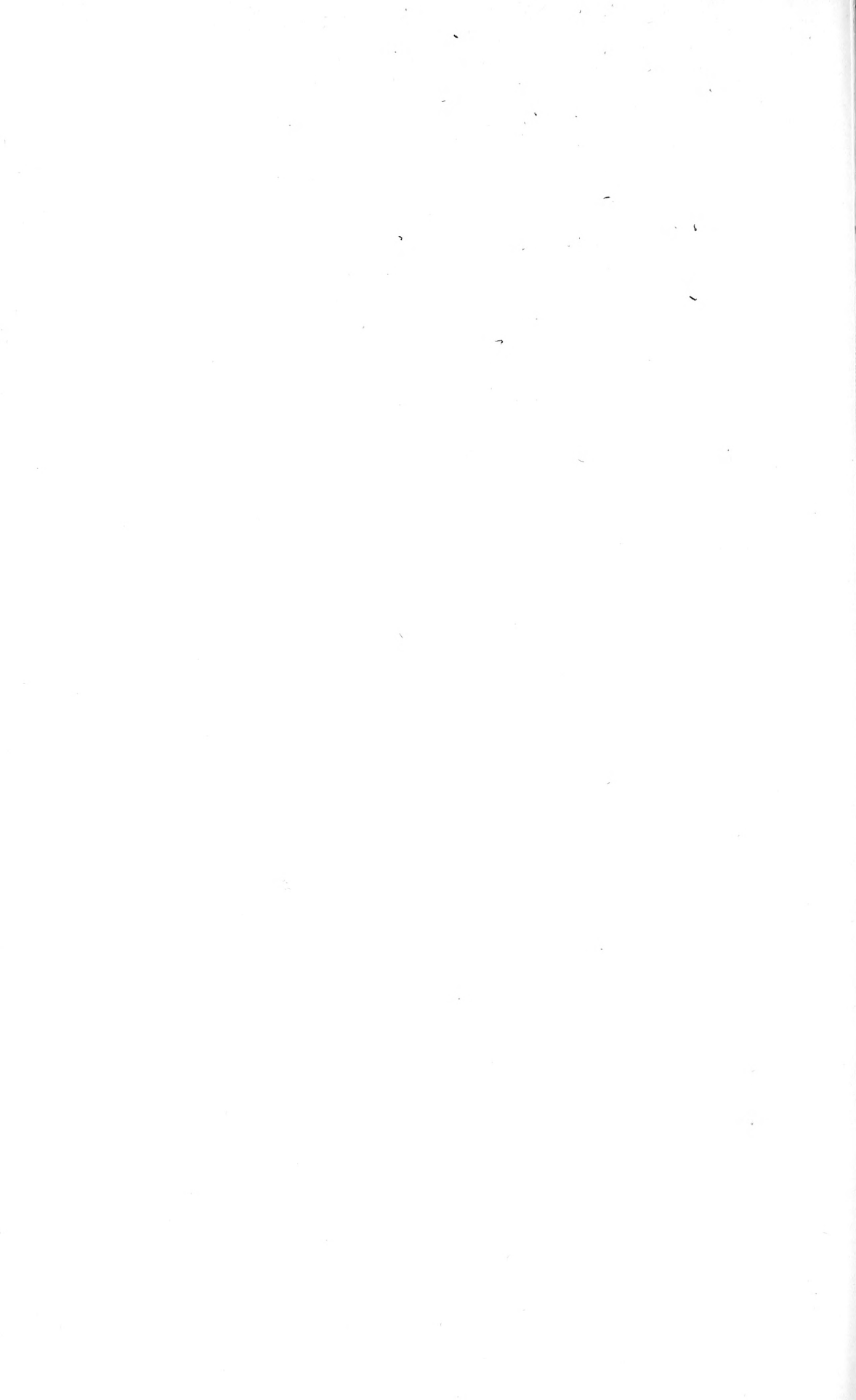

10.

The External Genitalia of the Gorilla, *Gorilla gorilla gorilla* (Savage & Wyman).

LEONARD J. GOSS.

Veterinarian, New York Zoological Park.

(Plates I-IV).

Determination of the sex of live gorillas is considered by many practical animal men to be difficult if not impossible. The reasons are not far to seek: the genital area is well covered with hair; the external genitalia are small for the size of the animal; live gorillas can seldom be confined so as to permit close observation and manipulation; comparatively few gorillas have been examined and reported upon by qualified anatomists.

Casual examination is always likely to be confusing, especially in the case of immature specimens, and this is especially true if both sexes are not available for comparison or if the observer is lacking in experience.

This paper describes briefly and illustrates the external genitalia of both male and female gorillas, variously at immature, sub-adult and adult stages. The series of photographs is not complete, chiefly because of the difficulties of handling mentioned in the first paragraph.

The animals upon which our observations were made and from which the illustrations were taken are:

1. Makoko, a male lowland gorilla, *Gorilla gorilla gorilla*, received at the New York Zoological Park in September, 1941, when its age was estimated at 2 to 3 years. It weighed 28 pounds on arrival, and is estimated to weigh 260 pounds now. See Figures 3, 4, 5 and 9.

2. Oka, a female lowland gorilla, received at the New York Zoological Park from the same source and at the same time as Makoko. Estimated age on arrival, 2 to 3 years; weight on arrival 20 pounds; weight at present (March, 1947) 192 pounds. See Figures 1, 2, 6, 7 and 8.

3. Janet Penserosa, a female lowland gorilla, from west central Africa. This animal was received at the New York

Zoological Park on October 31, 1928, and was estimated to be 18 to 20 months old. She weighed 17½ pounds on arrival. She was disposed of by the Zoological Park in 1940. Figure 10 (from Noback) was made after the gorilla had begun to menstruate, which was considered to be at the beginning of her ninth year.

4. Very large adult male shot by the late Harry Raven in 1930 in the French Cameroons, and now preserved in the American Museum of Natural History. See Figure 11.

Schultz (1927) states that the external genitalia of the female gorilla fetus and of the human fetus of the same stage of development are quite similar. In contrast to the human, he points out, however, that the slit on the lower side of the clitoris in the gorilla is very little developed and that the labia majora are relatively smaller than those of the human fetus but that they are high and clearly visible. Schultz asserts that in postnatal life the labia majora undergo a marked reduction in the three larger apes (gorilla, orang-utan and chimpanzee) and that many authors state that they are entirely missing. Bischoff (1879) studied three young specimens and Gerhardt (1906) a single adult and did not find labia majora. Deniker (1885) concluded from his material that the labia majora in gorillas and oranges do not completely disappear. Schultz finally takes a middle course by saying: "It is certain that these structures are laid down in fetal life, but, whereas, in man they persist throughout growth, in the anthropoids they undergo a process of atrophy which, in many cases, leads sooner or later to complete disappearance."

Wislocki (1932) thinks that the labia minora are relatively larger in man than in apes with the exception of chimpanzees and that the clitoris is larger in the great

apes than in man and it invariably has a median ventral furrow which is most prominent in the gibbon.

Pocock (1925) refers to sketches and a description of the penis of the gorilla (*Gorilla gorilla*) by Duvernoy in 1855. Duvernoy shows a peculiar expansion on the end of the penis which he compared to a fungus and claimed that in this respect the gorilla differed from all other anthropoid apes.

From the figures presented in this paper, it is immediately apparent why there has been confusion regarding the sexing of gorillas. We are unable to subscribe to all that is found in the literature regarding the external genitalia. Perhaps some of the conflicting information can be attributed to the difference in the ages of the specimens described or in the individual differences in the development of changes (maturing) of the specimens. Certainly we cannot agree with Duvernoy regarding the fungus-like enlargement on the end of the penis. We have seen no such structure in either immature or adult males.

Our observations are not totally in agreement with the aforementioned literature. According to Schultz (1925), the slit in the lower side of the clitoris of the gorilla fetus is very little developed in contrast to that of the human. Our Figures 1 and 2 show the slit extremely well developed in a two- to three-year-old specimen. In the same specimen, five and one-half years later (Figures 7 and 8), the entire clitoris is scarcely perceptible and the labia are well developed. Yet Noback's picture (Figure 10) of a nine-year-old female shows a very large clitoris with relatively undeveloped labia. In fact, this nine-year-old menstruating female's external genitalia closely resemble those of our two- to three-year-old male (Figure 3). The well developed labia in Figures 7 and 8 do not support the statements of Schultz, Bischoff, Gerhardt and others who claim that the labia are markedly reduced or entirely absent in the gorilla, orang and chimpanzee. If we use Noback's picture (Figure 10) and our Figures 1 and 2, we would agree with Wislocki that the labia minora are relatively smaller and the clitoris relatively larger than in man. Figures 7 and 8, however, would not support this idea.

McKenney et al (1944) make no mention of a fungus-like enlargement on the free end of the penis of the 580-pound male mountain gorilla from the San Diego Zoo. At autopsy, the penis "approximated 10. cm. in length and 1.5 cm. in diameter." Figure 11, likewise, shows no such formation on the Raven specimen at the American Museum of Natural History.

SUMMARY.

1. Eleven figures of the external genitalia of both male and female gorillas are presented.
2. Discrepancies encountered in the literature in descriptions of the external genitalia are pointed out.
3. It is suggested that some of the differences may be accounted for by age variations in the specimens described or by individual differences in development or rate of maturity of the specimens.

BIBLIOGRAPHY.

BISCHOFF, T. L. W.

1879. Vergleichend anatomische Untersuchungen über die äusseren weiblichen Geschlechts- und Begattungsorgane des Menschen und der Affen, insbesondere der Anthropoiden. Abh. der Math.-phys. Cl. k. Bay. Akad. d. Wissensch. München 13:2, pp. 207. (In Wislocki).

DENIKER, J.

1885. Sur un foetus de gibbon et son placenta. *Comp. Rend. Acad. Sci. Paris*, 100, pp. 654. (In Wislocki).

GERHARDT, U.

1906. Die Morphologie des Urogenitalsystems eines weiblichen Gorilla. *Jenaische Zeitschr. f. Naturwissensch.*, 41, pp. 632-654 (In Schultz).

MCKENNEY, F. D., TRAUM, J., BONESTELL, A. E.

1944. Acute Coccidiomycosis in a Mountain Gorilla (*Gorilla beringeri*) with Anatomical Notes. *Journ. Amer. Vet. Med. Assn.*, CV: 804, pp. 136-140.

NOBACK, C. R.

1939. The changes in the vaginal smears and associated cyclic phenomena in the lowland gorilla (*Gorilla gorilla*). *Anat. Rec.*, 73:2, and *Suppl.* No. 1 pp. 209-225).

POCOCK, R. I.

1925. The external characters of the catarrhine monkeys and apes. *Proc. Zool. Soc. London*, pp. 1479.

SCHULTZ, A. H.

1927. Studies on the growth of the gorilla and of other higher primates with special reference to a fetus of gorilla, preserved in the Carnegie Museum. *Memoirs Carnegie Museum*, XI: 1, pp. 1-87.

WISLOCKI, G. B.

1932. On the female reproductive tract of the gorilla, with a comparison of that of other primates. *Contrib. to Embryol.*, Carnegie Institution of Washington XXIII: 135, pp. 163-204.

EXPLANATION OF THE PLATES.

PLATE I.

- Fig. 1. Oka, ♀, 2-3 years old, weight 20 pounds. Lying on back with pelvic limbs spread apart. Digital pressure was applied on each side to part vulva and extrude large elliptical clitoris with ventral cleft. Note small labia, short perineum and absence of scrotum. **A**, Anus; **C**, Cleft in clitoris.
- Fig. 2. Oka, ♀, 2-3 years old, weight 20 pounds. Same position as in Figure 1. **A**, Anus; **CL**, Clitoris.

PLATE II.

- Fig. 3. Makoko, ♂, 2-3 years old, weight 28 pounds. Lying on back with pelvic limbs apart. Note longer perineum. **A**, Anus; **T**, Testes; **P**, Penis (note urethral opening).
- Fig. 4. Close-up of Figure 3, showing median raphe of scrotum, penis slightly elevated. **MR**, Median raphe.
- Fig. 5. Makoko, ♂, 2-3 years old, weight 28 pounds. Same position as in Figure 3. Penis extended full length. **A**, Anus; **T**, Testes; **MR**, Median raphe.

PLATE III.

- Fig. 6. Oka, ♀, 7½-8½ years old, weight 192 pounds. In standing position. **A**, Anus; **V**, Vulva.

Fig. 7. Close-up of Figure 6. **A**, Anus; **V**, Vulva.

Fig. 8. Same as Figure 6 and 7, but showing animal lying on right thigh with vulva parted. Note labia and clitoris. **A**, Anus.

Fig. 9. Makoko, ♂, 7½-8½ years old, weight estimated to be 260 pounds. Standing on all fours with head directed toward floor. Note well-developed scrotum, testes and long perineum. Penis cannot be seen, but is anterior to scrotum. **A**, Anus; **S**, Scrotum.

PLATE IV.

- Fig. 10. (From Noback). Janet Penserosa, ♀, about 9 years old, in copulative stage of menstrual cycle. (Anus is below the clitoris; not visible in this figure). **CL**, Clitoris.
- Fig. 11. From skin of large adult male (Raven specimen) in American Museum of Natural History preserved collection. Penis about 2 inches long; opening is probably larger than normal meatus because of skinning. **P**, Penis; **T**, Testes in scrotum.

Figures 1-9 and 11 by Staff Photographer Sam Dunton.





FIG. 1.

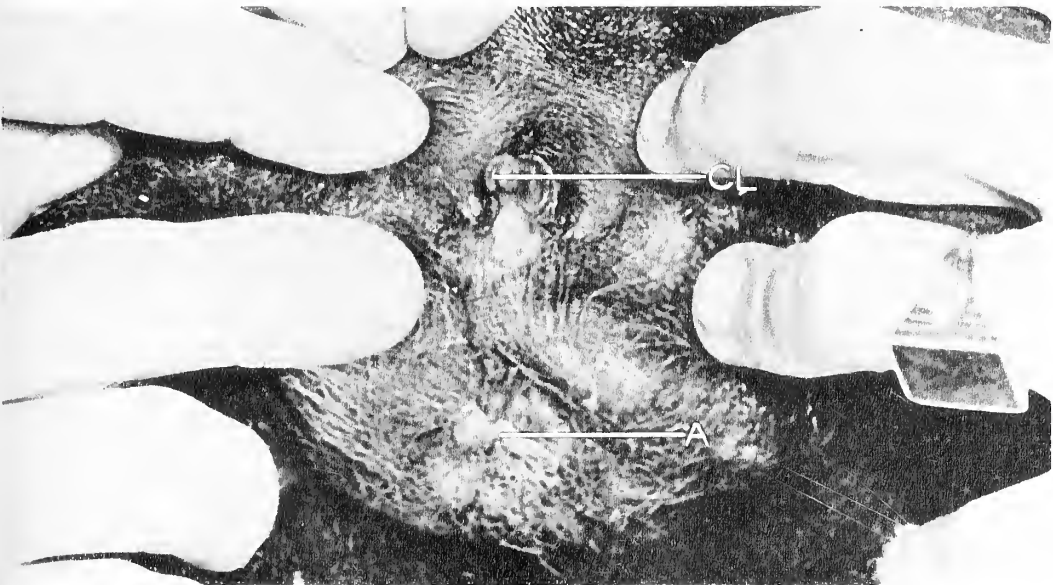

FIG. 2.

THE EXTERNAL GENITALIA OF THE GORILLA,
GORILLA GORILLA GORILLA (SAVAGE & WYMAN).

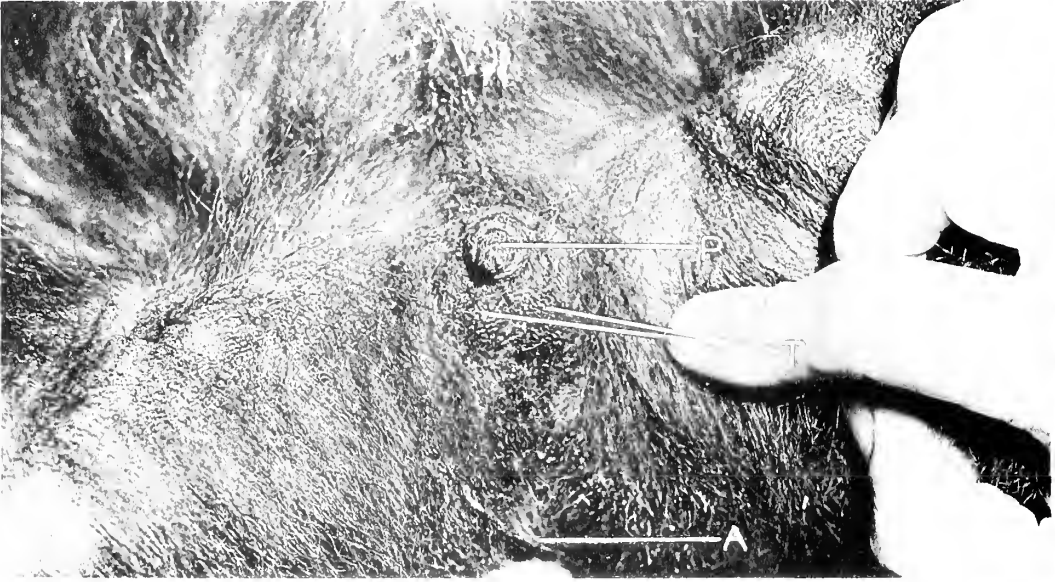

FIG. 3.



FIG. 4.

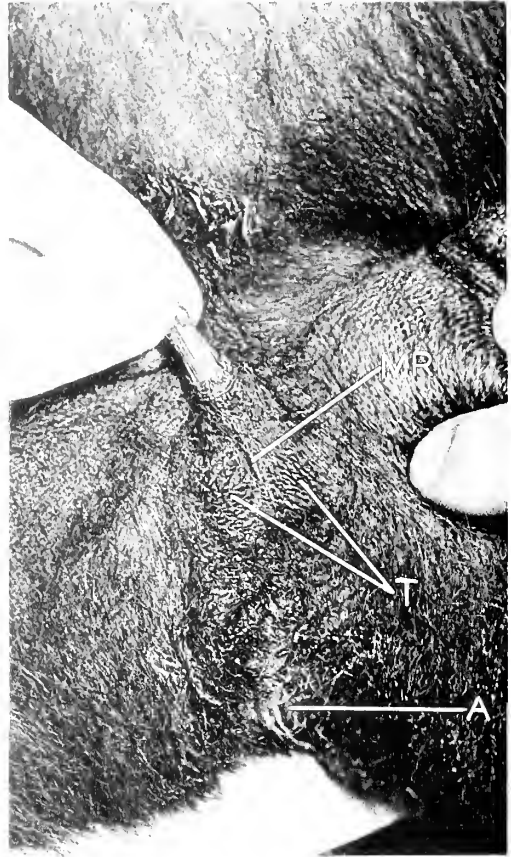

FIG. 5.

THE EXTERNAL GENITALIA OF THE GORILLA,
GORILLA GORILLA GORILLA (SAVAGE & WYMAN).

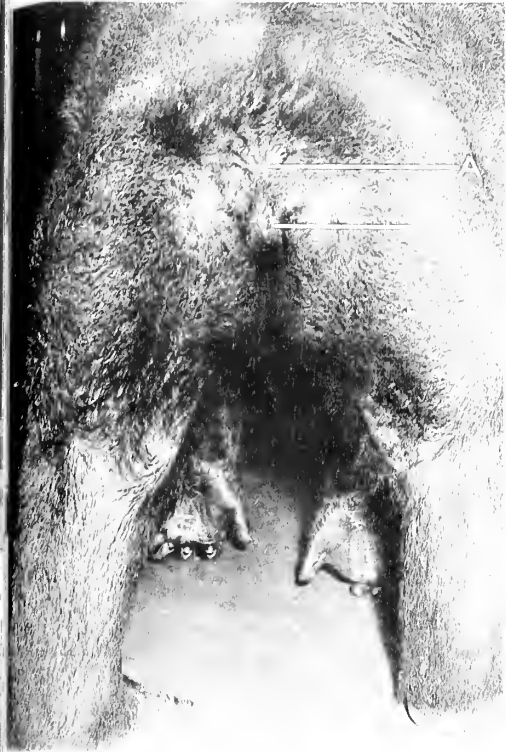

FIG. 6.



FIG. 7.

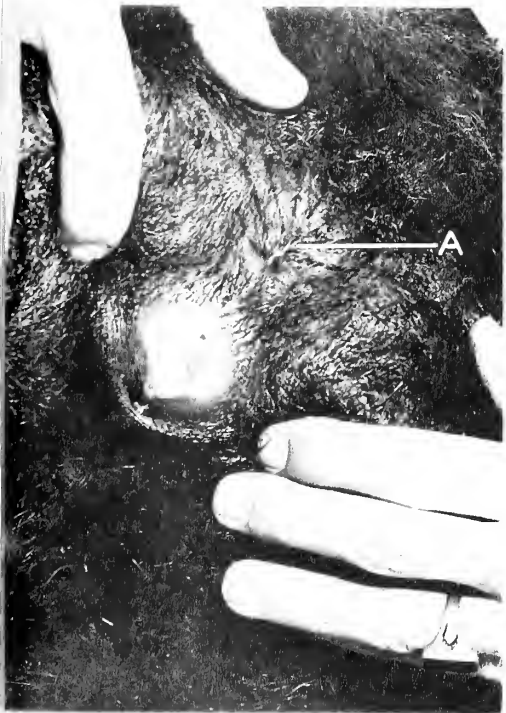

FIG. 8.

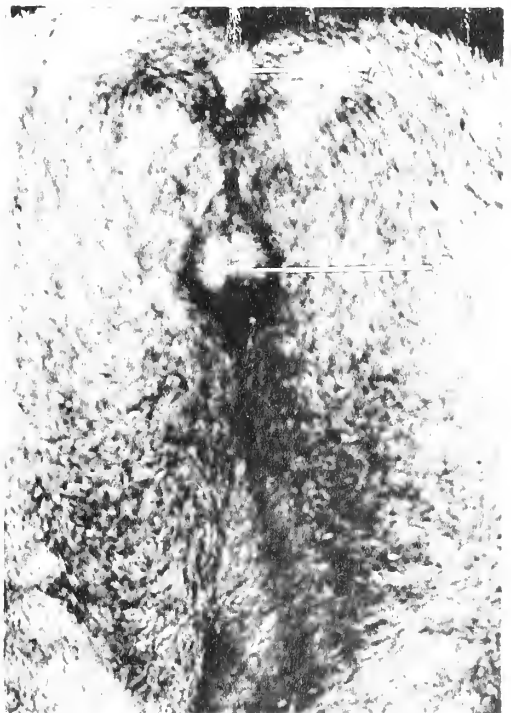

FIG. 9.

THE EXTERNAL GENITALIA OF THE GORILLA,
GORILLA GORILLA GORILLA (SAVAGE & WYMAN).



FIG. 10.

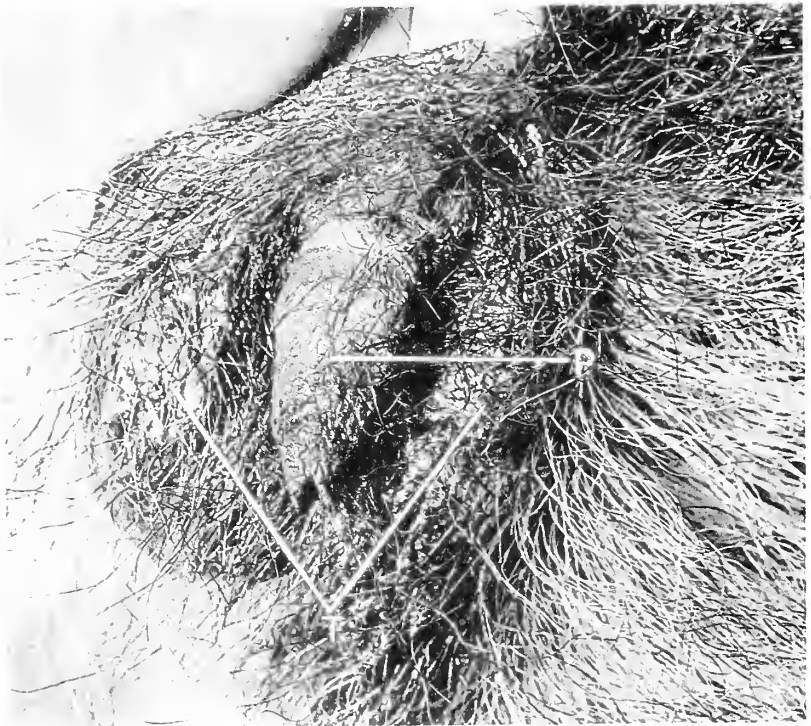

FIG. 11.

THE EXTERNAL GENITALIA OF THE GORILLA,
GORILLA GORILLA GORILLA (SAVAGE & WYMAN).

11.

Spontaneous Neoplasms in Fishes. III. Lymphosarcoma
in *Astyanax* and *Esox*.

ROSS F. NIGRELLI.

New York Aquarium, New York Zoological Society.

(Plates I-XI.)

INTRODUCTION.

Lymphosarcoma, or any disease involving lymphoid tissues, whether neoplastic or not, is rare in fishes. Several cases have been recorded in the literature but very few histological or cytological details have been given. Johnstone (1912) reported an intra-orbital lymphosarcoma which had its original locus in the chorioid layer. The growth on a female European flounder (*Pleuronectes flesus*) involved the left eye which was conspicuously protruded as a mass measuring 21×20 mm. The cornea was nearly opaque, anterior and posterior chambers were fused, iris was completely destroyed and the lens was lying detached in a mass of leucocytes and blood cells. Histologically, the growth consisted of a loose, delicate, fibrous connective or elastic tissue which gave rise to a still more delicate reticulum containing great numbers of lymphocytes. The latter were of two sizes; the smaller and more numerous had very little visible cytoplasm, the larger and less numerous a comparatively greater amount of cytoplasm. The growth was further characterized by the presence of large lymphatic spaces, very few blood vessels and a mild inflammatory reaction. The sclerotic coat was incomplete; there was no trace of the chorioid layer and very little of the pigmented layer of the retina remained. There was no evidence of metastases, and Johnstone believed that the growth was a primary one.

In 1926, Johnstone reported another case of lymphosarcoma in a herring measuring about 30 cm. in length. The growth consisted of two masses within the body cavity which were supported by thin folds of peritoneum. The larger mass measured about 50 mm. in length and 25 mm. in width. Histologically the major part of the growth presented the same picture as in the flounder. However, other areas in the mass showed spindle-shaped cells arranged concentrically and as whorls. The smaller growth, measuring about 15×5 mm., was reddish in

appearance. The color resulted from a plexus of blood vessels on its external surface, giving the growth the appearance of a hemolymph gland. Histologically this was similar to the large mass, but according to Johnstone, there was "a general tendency for the leucocytes to take on the sarcomatous, short spindle form," replacing the fibrous reticulum. No gonads were present although the fish was of a size that normally would have them. Johnstone believed that the reproductive glands had become involved in the lymphosarcomatous growth, "so that all traces of their original structure have become obliterated."

Plehn (1924) reported a lymphosarcoma in a goldfish. This case was the only one recorded by Thomas (1931) in his collected data on fish tumors, and probably the one referred to by Schäperclaus (1935) in his general discussion on fish neoplasia. According to Plehn, the fish showed an enormous ventral swelling, exophthalmia and raised scales. On autopsy it was found that the body cavity was filled with fluid and other conditions were present that are normally associated with renal dysfunction. Histologically the kidney showed a considerable proliferation of leucocytes which caused a great deal of destruction of the epithelial cells of the uriniferous tubules. In certain areas, the lymphocytes had invaded the lumen of the tubules, causing considerable dilation of various segments, including Bowman's capsule. Blood vessels were thrombosed. Metastases into the liver had occurred, infiltrating the parenchyma where compact lymphoid foci were set up, resulting in necrosis of the invaded areas. Neoplastic cells were also found in lymphatics and sinusoids.

A lymphosarcoma of the kidney of a fully grown female conger eel was reported by Williams (1931). Apart from a large ventral swelling, no other manifestations were noted. On dissection it was found that the swelling was due to a large oval, balloon-

like mass in the posterior part of the body cavity which measured 16.6 cm. in length, 7.8 cm. in width and 0.6 cm. in height. Numerous blood vessels were noted on the ventral surface of the growth. Histologically most of the growth was composed of great numbers of lymphocytes supported by a thin meshwork of reticular fibers. The uriniferous tubules were widely separated and greatly compressed. The growth was characterized further by a thickening of the fibrous covering with some indication of penetration by lymphocytes. Williams believed that the growth had developed fairly rapidly, and although it possessed infiltrative powers, its activities appeared to be purely local.

The present contribution deals with descriptions of lymphosarcomas in two species of fishes. They are considered separately because the origin and processes involved are distinct. In the pike, *Esox lucius* Linnaeus, the neoplastic cells were of the large lymphoblast type with the primary origin in the kidney. The growth in the characin, *Astyanax mexicanus* (Filippi), consisted mainly of typical lymphocytes with the primary origin probably in the thymus-like lymphoid tissue in the posterior branchial region.

The writer wishes to thank Dr. G. M. Smith for assistance in the preparation of the pike material, and Dr. C. M. Breder, Jr., and Miss Priscilla Rasquin of the American Museum of Natural History for the *Astyanax* and for histological material of related fishes.

1. LYMPHOSARCOMA IN THE PIKE.

A preliminary report of this disease in the northern pike, *Esox lucius* L. (= *Esox estor*), was given by Nigrelli (1943). Twelve fully grown fish succumbed at various intervals, particularly in the summer months, at the New York Aquarium during the years 1940 and 1941. Five females and one male were six years old, two females and one male were three years old, and three females were two years old. There were no external manifestations of the disease, but autopsies showed comparatively massive growths on the kidney (Plate I, Figure 1) and "abscesses" or nodules in the liver (Plate I, Figure 2). The kidney growths were in some instances grayish and granular in appearance with practically the entire posterior part of the organ involved. In other cases, the growths were nodular. Frequently both types were present on the same kidney and often continuous with one another. The granular stage may be a later manifestation of the disease (Plate I, Figure 4).

The material was fixed in 10% formalin and sectioned in paraffin from six to ten microns. Harris' and Delafield's hematoxy-

lin-eosin, Giemsa's and Mallory's triple stains were used.

Histologically the growths in the kidney were identified as lymphosarcomas. The neoplastic cells were mainly of the large lymphoblast type supported by irregular strands of fibrous stroma and a very delicate reticulum (Plates I-III). In some areas the amount of fibrous tissue was so extensive as to border on a fibrosis (Plate III, Figures 10 and 12; Plate IV, Figure 13). The cells varied in size and shape. Toward the center of the mass they were more or less flattened, but in other areas they were usually rounded or polyhedral in appearance (Plate II). The nuclei of these cells were vesicular, spherical or bean-shaped and usually eccentric in position. The chromatin was granular, varying as to number and size of granules. The cytoplasm was more or less homogeneous, but the staining reaction varied somewhat as demonstrated in those sections stained with Giemsa's. In the majority of cells with comparatively more cytoplasm, the staining reaction was slightly acidophilic. In other cells with lesser amounts of cytoplasm the reaction was decidedly basophilic. Granulocytes and transitional cells, commonly present in the normal teleost kidney, were not seen. Occasionally, small groups of typical lymphocytes with hyperchromatic nuclei together with few but widely scattered plasma cells were present. Giant cells typical of certain human lymphosarcomas were lacking. However, occasionally an uninucleate or binucleate "giant" cell with hyperchromatic nuclei was seen.

Cytoplasmic or intranuclear inclusions were not seen, nor was there any evidence of parasitic infection to which these fish are often susceptible.

There was much evidence of great activity of the neoplastic cells. Numerous mitotic figures in various stages were found throughout the growth (Plate II, Figure 7). The tubules were often constricted by the advancing lymphoblasts (Plate I, Figures 3 and 4; Plate II, Figure 8; Plate III, Figure 9) which in some instances gave the false impression that a hyperplasia of the renal elements was present (Plate I, Figure 3), as was interpreted by Nigrelli (1943). In many places the lumen was completely occluded or the tubules and glomeruli were invaded, destroyed and replaced by the lymphoid cells (Plate IV, Figure 14). This was especially evident in the granular type of tissue where only a relatively few tubules and glomeruli remained. Those that were present were widely scattered or crowded into limited areas of the kidney (Plate I, Figure 4). In certain regions hyperplastic growth of reticular cells had taken place, giving such areas the appearance of a reticulum type of lymphosarcoma. In

both the nodular and granular growths, the blood vessels were considerably thickened and thrombosed (Plate I, Figure 3). The fibrous elements were particularly noticeable toward the periphery of the growth, especially in the granular type of tissue (Plate III, Figures 10-12; Plate IV, Figure 13). The lymphoid cells from the outer edge of the kidney had proliferated out, giving rise to new loci. Such regions gave the appearance of follicular lymphoblastoma (Plate III, Figure 11). These areas were characterized by the paucity of blood vessels and other hemal elements. The lymphoid cells around the periphery of the follicles were more or less similar to those from the kidney, whereas those located in the center of the follicles were invariably necrotic.

Metastatic growth occurred in the spleen and liver. Although the spleen was not especially enlarged, invasion nevertheless had taken place. Sinusoids were invaded and distended by the neoplastic cells. The outstanding feature in the spleen, however, was the extensive development of "pulp cords" (Plate V, Figure 17). In some areas the neoplastic cells had broken through the capsule and infiltrated into the surrounding fat and into the retroperitoneal region (Plate V, Figure 18). Metastasis into the liver in all probability took place through the portal systems. There was considerable involvement of this organ. Grossly, the lesions appeared as "abscesses" or nodules (Plate I, Figure 2) on the surface of a more or less cream-colored liver. The gall bladder was distended (Plate I, Figure 2) and filled with bile of watery consistency. Histologically the nodules were composed of compact masses of lymphoid cells supported by a reticulum and fibrous material (Plate IV, Figures 15 and 16). The growth in the liver presented a more pleomorphic picture than that present in the kidney. Although a number of mitotic figures were encountered, karyorrhexis was much more common. The neoplastic cells in the surrounding parenchyma completely disarranged the orderly formation of liver tubules. The advancing growth compressed the tubules so that they appeared as "cords" composed of varying numbers of cells (Plate IV, Figure 16). Certain cytological changes occurred in the liver cells. The nucleus and cytoplasm stained more intensely, and many of the cells were highly vacuolated with the nucleus pushed to an eccentric position.

2. LYMPHOSARCOMA IN ASTYANAX.

The fish involved was a male characin, *Astyanax mexicanus* (Filippi), which measured about 50 mm. in total length. It was one of many bred and raised by Dr. C. M. Breder, Jr., at the American Museum of Natural History from stock originally tak-

en from the waters of Rio Tampaon, San Luis Potosi, Mexico. According to Dr. Breder's records the fish was hatched in 1942; it was approximately four years old when it was turned over to the writer in November, 1946. The external manifestations of the growth, such as enlargement of the area around the branchial region and exophthalmia (Plate V, Figure 19), had been first noticed about two months previously. When the fish was brought to the Aquarium's laboratory it was kept under observation for about three days. During this period it had acclimated itself to the new environment and all activities relative to handling, light, swimming, feeding, etc., were not unusual. The movements of the fish, either in the tank or when handled with a net, were vigorous and not those one would expect to find in a moribund fish. It was finally sacrificed, fixed in Bouin's and decalcified; paraffin sections were cut at thicknesses varying from 5 to 10 microns. The stains employed were Heidenhain's iron-hematoxylin and Delafield's hematoxylin with eosin, Masson's, Mallory's and Giemsa's.

The major part of the growth was a comparatively large mass of lymphoid cells supported by a delicate reticulum which extended into the left branchial cavity and was responsible for the swollen appearance of this region in the living fish (Plate VI, Figure 20). The origin of this growth was in all probability the thymus-like lymphoid "gland." A pair of such structures are normally present in the posterior region of the branchial cavity in juxtaposition to the last gill arch (Plate XI, Figure 38).

There was considerable local proliferation involving practically all the osseous, cartilaginous and muscular elements of the hyoid apparatus and related branchial structures (Plates VI and VII, Figures 22 and 23). There was also a direct invasion of the epithelium of the mucous membranes of the mouth and of the thyroid follicles (Plate VI, Figure 21). The pericardium was completely invaded and replaced by lymphoid cells (Plate VIII, Figure 26), the myocardium was invaded only slightly. Pressure from a large mass of lymphoid cells between the sclera and chorioid layers was primarily responsible for the exophthalmia (Plate V, Figure 19; Plate VI, Figure 20; Plate VII, Figure 27). The cells from this mass had proliferated into the surrounding regions through this pathway, invading the epichorioid lymph space and the anterior chamber. The cornea was slightly thickened but there was very little involvement of the retina and other structures of the eye. Extension of the growth took place not only by local proliferation but also by way of the blood stream (Plate IX, Figure 33; Plate X, Figure 36) and in particular through the

lymph system. Blood vessels were constricted and invaded directly by lymphoid cells (Plate IX, Figure 33). Metastatic growths were present in the corium of the skin (Plate VII, Figure 24; Plate VIII, Figure 29), the gills (Plate VI, Figure 20; Plate VIII, Figure 28), the submucosa of the intestine (Plate IX, Figure 30), the liver (Plate IX, Figure 31), pancreas (Plate IX, Figures 32 and 33; Plate X, Figure 34), kidney (Plate X, Figure 35) and in the retroperitoneum (Plate IX, Figures 30, 32, and 33; Plate X, Figures 34, 36 and 37).

Many of these metastatic growths were not unlike the clinical subvarieties often reported for human lymphosarcomas. As in human lymphosarcoma, the testes were also a site of metastatic growth. The seminiferous tubules were considerably dilated but not entirely filled with sperms. That the germinal epithelium was still functioning was indicated by the presence of numerous spermatocytes in phases of meiosis in their transformation to the mature sperm. The pathological effects on the kidney were not unlike those present in the lymphosarcoma of the pike. Renal tubules and glomeruli were constricted or destroyed and the parenchyma entirely replaced with lymphoid elements. The submucosa of the intestine was packed solidly as should be expected since this region is one of the main lymphopoietic areas in fish. The process extended laterally, invading and destroying the muscularis. In some regions the growth was so extensive that pressure on the mucosa was sufficient to cause the intestinal lumen to be partially or completely occluded. The stomach was not affected. In humans, retroperitoneal lymphosarcoma is a characteristic of the disease. In *Astyanax*, the growth in this region is likewise extensive. The majority of the lymphoid cells were typical of those present in other areas, but in certain regions groups of smaller round cells also were found (Plate X, Figure 37).

A structure characteristic of the spleen was not seen. However, an encapsulated mass near the intestine was found which showed darkly staining lymphoid cells around numerous lighter staining germinal centers. Freely scattered throughout the mass were many erythrocytes, but typical blood vessels were at a minimum. The neoplastic growth also involved the pancreas, which in this fish, as in most teleosts, is a diffuse gland embedded in a loose connective tissue containing fatty tissue and numerous blood vessels. Each normal acinus consists of a single row of typically staining epithelial cells, resting on a delicate basement membrane and converging towards a central lumen often with centro-acinar cells. The lymphoid growth had infiltrated throughout the gland (Plate IX,

Figures 32 and 33), breaking through the supporting membrane and disrupting the orderly arrangement of the acini and their ducts. The acini that remained intact invariably showed dilated lumens (Plate IX, Figure 32), but more frequently they were broken up into isolated cells (Plate IX, Figure 33). The typical cytological appearance of the pancreatic cells was lacking. The entire cell was basophilic and no zymogen granules were noted. Of interest is the fact that the Islet Gland, which is a distinct structure in these fishes, although surrounded by lymphoid cells, was not penetrated (Plate X, Figure 34). The liver was not involved extensively. In certain regions the liver sinuses were filled with lymphoid cells, but the parenchyma was invaded only slightly. There was some collateral effect due to pressure from the retroperitoneal masses and constriction of the bile duct by the surrounding neoplastic cells.

Histologically the cells involved in the lymphosarcoma in *Astyanax* were differentiated lymphocytes supported by a delicate reticulum. Most of the cells were round in appearance and more or less uniform in size, measuring about 3.5 microns in diameter. They had very little visible cytoplasm and the nuclei were hyperchromatic. In certain retroperitoneal masses (Plate X, Figure 37) nests of smaller lymphoid cells, measuring about 1.5 microns, with denser staining nuclei, were present together with the larger lymphocytes. Such masses showed the presence of the reticulum more clearly. In most regions the reticulum was very delicate; in a few areas it was thickened considerably. Frequent mitotic figures were found in all regions. There were no indications of inflammatory reaction, and regressive changes were rare. Intranuclear or cytoplasmic inclusion bodies were not seen.

DISCUSSION.

According to Feldman (1932), Boyd (1939), Ewing (1940) and others, there seems to be little doubt that lymphosarcoma is a true neoplasm. In the cases described above the cells involved in the growths have the power to infiltrate and destroy normal tissue. The presence of lymphoid cells lying in the meshes of a delicate reticulum, numerous mitoses, metastases and the absence of evidence of an inflammatory process or leukemic condition indicate that the diseases described for the pike and *Astyanax* fit into the category of lymphosarcoma.

Lymphosarcomas in human and other mammals usually begin in lymph nodes. However, such structures are not present in fishes, the lack of them being compensated by an abundance of lymphoid tissue in the submucosa, spleen, thymus, kidney and "head-kidney." In many teleosts, the kid-

ney (mesonephros) is the main hemopoietic organ, the intertubular tissue resembling the lymphomyeloid tissue of spleen (Jordan and Speidel, 1924). However, this does not seem to be the case in the pike. This fish has a well developed "head-kidney," an enlarged portion of the anterior part of the kidney, which is almost entirely composed of lymphoid tissue that has replaced the renal elements. The exact function of this organ is not entirely understood. Sections stained with Giemsa's and Mallory's show a well developed reticulum, numerous free erythrocytes, sinusoids and lymphoid cells of various sizes with staining reactions indicating that this part of the kidney functions mainly in hemopoiesis. Similar lymphoid tissue is found in certain regions (subcapsular) of the kidney proper, particularly in the vicinity of the larger blood vessels. It should be emphasized that the primary site of the lymphosarcomas in the pike was invariably found in the posterior part of the kidney. It is probable that the origin of the lymphosarcoma is centered in these masses of lymphoid tissue within the kidney.

A thymus is present in many fishes, if not in the adults at least in the embryos. In *Astyanax* and closely related fishes (e. g. *Anoptichthys jordani* Hubbs and Innes, a blind relative living in caves of Mexico) there is a paired lymphoid structure lying in juxtaposition to the last gill arches in the posterior part of the branchial cavity (Plate XI, Figure 38). These structures may represent the thymus in these fishes. Histologically it is composed of closely packed lymphoid cells of uniform size and staining reaction supported by a delicate reticulum. The lymphoid cells from these "glands" extend out to the gill filaments and under certain conditions are massed in large numbers. It has been suggested that the function of these lymphoid structures is to protect the gills, by phagocytosis, from harmful microorganisms and other foreign objects that may be strained through them. The striking similarity of the lymphoid cells in the lymphosarcoma of *Astyanax* to those present in these thymus-like bodies and the fact that the latter are not present in the diseased fish, the major part of the growth being a large mass protruding from this area into the branchial cavity, lead one to suspect that they are the primary loci of the growth in this fish. Circumstantial evidence that this may be the case is afforded by an instance of simple lymphoid hyperplasia found in another specimen of *Astyanax*. This fish was kept in complete darkness for a period of three years for experimental purposes. Stained sections show a marked proliferation of lymphoid cells from the thymus-like bodies into the gills, tissues of the hyoid regions, and the thyroid (Plate XI,

Figure 39). It may well be that here we have the beginning of the neoplastic process found in the *Astyanax* described above.¹

It is well known, as pointed out by Ewing (1940), that "lymphoid tissue responds to irritation with inflammatory hyperplasia far more actively than any other tissue," and further that "lymphoid tissues are relatively mobile rather than fixed, and lymphocytes are not only ameboid but are structurally placed in easy access to lymph- and blood-paths. Hence tumors and tumor-like processes in lymphoid tissue are frequent and, as a rule, tend to become widely diffuse." However, the etiology of many of the lymphoid growths in humans and other animals is still unknown. In certain types, an infective agent is indicated (e.g. lymphosarcoma in dogs); in others (e.g. lymphoblastoma in chickens) an hereditary predisposition is suggested (Feldman, 1932). The etiology of the lymphosarcomas in the pike and in *Astyanax* is still unknown. The appearance of the disease in pike of different ages and sex living in the same tank, and at different intervals, seems to point to an infective agent. However, it is quite possible that the disease in both species of fishes may be due to nutritional or hormonal imbalance, since there is no histological or cytological evidence to indicate that an infectious agent and/or an infectious process is involved.

SUMMARY.

1. Lymphosarcomas are described from the pike, *Esox lucius* Linnaeus, and the Mexican characin *Astyanax mexicanus* (Filippi).

2. The kidney is the primary locus of the disease in the pike, with metastatic growths occurring in the liver, spleen and retroperitoneal tissues. In the characin, the thymus-like lymphoid structure is apparently the primary locus, with extensive local proliferation and metastatic growth occurring in practically every tissue and organ of the body. The normal histology of these structures is described relative to the lymphosarcomas.

3. The lymphoid cells involved in the growths differ in the two species. In the pike, the cells are mainly of the lympho-

¹ Another instance of lymphoid hyperplasia, approaching more closely the lymphosarcomatous condition herein described, has been studied. The specimen, a female measuring 25 mm. in standard length, was a third generation *Astyanax* of the same general stock as the others. The fish was four months old and had been kept in total darkness for two months, together with nineteen others, when killed and sectioned. There were no external manifestations of the disease. Histologically, however, the thymus-like bodies were enormously enlarged and protruded into the branchial cavity. There was some local proliferation into the gills, skin and other surrounding structures with some indications of involvement of certain internal organs (intestine, kidney). The "head-kidney" was exceptionally enlarged. The condition described here appears to be intermediate to the two cases reported above.

blast type; those in the characin are typical lymphocytes. In both cases, however, there is an extensive development of the reticulum and fibrous stroma. Numerous mitotic figures in various stages are present.

4. There is no histological or cytological evidence of an infectious agent, even though, in the case of the pike, twelve fish varying in age and sex living together in same tank were affected with the disease during a year period (1940-1941). The lymphosarcoma in the characin is an isolated case.

REFERENCES.

- BOYD, WILLIAM.
1939. A Text-Book of Pathology. Third Edition. Lea and Febiger, Philadelphia. 1,064 pp.
- EWING, JAMES.
1940. Neoplastic Diseases. Fourth Edition. W. B. Saunders Co., Philadelphia and London. 1,160 pp.
- FELDMAN, WILLIAM H.
1932. Neoplasms of Domesticated Animals. *Mayo Clinic Monographs*. W. B. Saunders Co., Philadelphia and London. 410 pp.
- JOHNSTONE, JAS.
1912. Internal Parasites and Diseased Conditions of Fishes. *Report for 1911 on the Lancashire Sea-Fisheries Lab.*, No. XX: 33-74.
1926. Malignant and Other Tumours in Marine Fishes. *Proceedings and Transactions of the Liverpool Biological Society*, XL: 75-98.
- JORDAN, H. E., and C. C. SPEIDEL.
1924. Studies on lymphocytes. II. The Origin, Function, and Fate of the Lymphocytes in Fishes. *J. Morphology*, 38: 529-549.
- NIGRELLI, ROSS F.
1943. Causes of Diseases and Death of Fishes In Captivity. *Zoologica*, 28: 203-216.
- PLEHN, M.
1924. *Praktikum der Fischkrankheiten*. E. Schweizerbort'sche Verlagsbuchhandlung, Stuttgart. 479 pp.
- SCHÄPERCLAUS, WILHELM.
1935. *Fischkrankheiten*. Gustav Wenzel and Sohn, Braunschweig. 72 pp.
- THOMAS, L.
1931. Les tumeurs des poissons. *Bull. de L'association Française pour l'étude du Cancer*, 20: 703-760.
- WILLIAMS, G.
1931. On Various Fish Tumours. *Proceedings and Transactions of the Liverpool Biological Society*, XLV: 98-109.

EXPLANATION OF THE PLATES.

All photomicrographs, except Fig. 22, were taken of sections stained with hematoxylin-eosin.

LYMPHOSARCOMA IN THE PIKE, *Esox lucius*

PLATE I.

- Fig. 1. Lymphosarcoma nodule in the kidney of the pike. Slightly less than natural size. Photographed by S. C. Dunton, Staff photographer of the New York Zoological Society.
- Fig. 2. Metastatic nodules in the liver. $\frac{1}{2}$ natural size. Photographed by S. C. Dunton.
- Fig. 3. Section through the nodular growth of the kidney showing extensive proliferation of lymphoblasts, thickened and thrombosed blood-vessels. 75 X.
- Fig. 4. In some fish the nodular growth seen in Figure 1 is also associated with a granular type tissue. This figure is a section through such a growth. Many of the tubules are destroyed or replaced by the neoplastic cells. 150 X.

PLATE II.

- Fig. 5. Details of lymphoblast cells involved in the lymphosarcoma of the kidney. 675 X.
- Fig. 6. Another area of the kidney showing a nest of smaller lymphoid cells. 675 X.
- Fig. 7. Cells from the lymphosarcoma of the kidney. Note the mitotic figure. 675 X.
- Fig. 8. Neoplastic cells advancing on a renal tubule. 675 X.

PLATE III.

- Fig. 9. Renal tubule completely constricted and invaded by the neoplastic cells. 675 X.
- Fig. 10. Extension of the lymphosarcoma into the peripheral region of the kidney. Note the extensive development of reticulum. 75 X.
- Fig. 11. Same as Figure 10, except from another area. The appearance here is not unlike that of a follicular lymphoblastoma. 75 X.
- Fig. 12. Another region of the periphery of the kidney showing extensive development of fibrous tissue. 75 X.

PLATE IV.

- Fig. 13. Same as Figure 10 at higher magnification, showing cellular details. 675 X.
- Fig. 14. Epithelium of renal tubule invaded by lymphoid cells. 675 X.
- Fig. 15. Metastasized lymphoid elements in the liver. 350 X.

- Fig. 16. Details showing extensive development of fibrous tissue in liver, with liver cells arranged in cords resulting from pressure of the surrounding growth. 675 X.

PLATE V.

- Fig. 17. Spleen showing extensive development of "pulp cords." 75 X.
- Fig. 18. Infiltration of "pulp cord" material into surrounding fat. Note neoplastic cells in retroperitoneal area. 75 X.

LYMPHOSARCOMA IN *Astyanax mexicanus*.

- Fig. 19. Photograph of living fish showing external manifestations of the neoplastic disease. Note enlarged left opercular area and exophthalmia. About natural size. Photographed by S. C. Dunton.

PLATE VI.

- Fig. 20. Section of the region of the left branchial cavity showing the large lymphoid mass protruding into the cavity. Note the involvement of all tissues at this level, including the brain. 75 X.
- Fig. 21. Section through the hyoid region showing involvement of the thyroid, mucous membrane and other structures of this area. 75 X.

PLATE VII.

- Fig. 22. Lymphosarcoma involving the bony and cartilaginous structures of the branchial region. Note the hyperplasia of cartilage. Mallory's stain. 75 X.
- Fig. 23. Lymphoid growth infiltrating the bony and muscle structures of the head region. 75 X.
- Fig. 24. Groups of lymphoid masses in the corium. 75 X.
- Fig. 25. Invasion of the epithelium of the skin by lymphoid cells. 675 X.

PLATE VIII.

- Fig. 26. Lymphosarcoma involving the pericardium. 156 X.
- Fig. 27. Lymphosarcoma mass between the sclera and chorioid region of the eye. 156 X.
- Fig. 28. Section through the gills and at the edge of the main lymphoid mass shown in Plate VI, Figure 20. 156 X.
- Fig. 29. Lymphoid cells infiltrating the structures at the tip of the snout. Note also the involvement of melanophores. 156 X.

PLATE IX.

- Fig. 30. Retroperitoneal masses of the lymphosarcoma in the region of the intestine. The submucosa is solidly packed with lymphoid cells. 75 \times .
- Fig. 31. Nests of lymphoid cells in sinusoids of the liver. The hepatic cells and parenchyma are only slightly involved. 350 \times .
- Fig. 32. The exocrine part of the pancreas is a diffuse gland, but its basic architecture is not unlike that found in higher vertebrates. In some areas, as shown here, the acini are still intact, but their lumens are dilated considerably and are invaded. 156 \times .
- Fig. 33. In other regions the basement membrane supporting the epithelial cells of the acini is invaded, breaking up the structure into isolated cells. Note also the pinching-off effect on a blood vessel by the advancing growth. 350 \times .

PLATE X.

- Fig. 34. The endocrine part of the pancreas is a distinct structure. Note that although it is surrounded by lymphoid cells, no penetration has taken place. 350 \times .

- Fig. 35. Invasion of the kidney. Considerable destruction of the renal tubules and glomeruli can be seen. 75 \times .
- Fig. 36. Details of lymphoid cells from retroperitoneal mass. Note the lymphoid cells in the blood. 675 \times .
- Fig. 37. Details from retroperitoneal mass showing lymphocytes of two sizes. The relationship between these cells is not known. Note also the extensive development of the reticulum. 675 \times .

PLATE XI.

- Fig. 38. Section through one of the thymus-like lymphoid structures found in *Anoptichthys jordani*, a close relative of *Astyanax mexicanus* in which similar bodies occur. Note the relationships of this structure to the gills and surrounding tissue. 75 \times .
- Fig. 39. An *Astyanax mexicanus* kept in the dark three years, showing an extensive proliferation of the thymus-like lymphoid tissue. In this section the hyoid region is completely invaded, involving and destroying tissues of this region, including thyroid follicles. 75 \times .



FIG. 1.



FIG. 2.



FIG. 3.

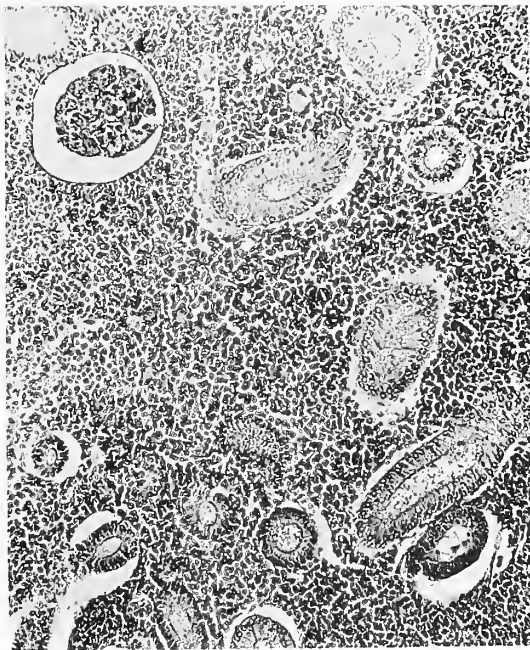

FIG. 4.

SPONTANEOUS NEOPLASMS IN FISHES. III. LYMPHOSARCOMA
IN ASTYANAX AND ESOX.

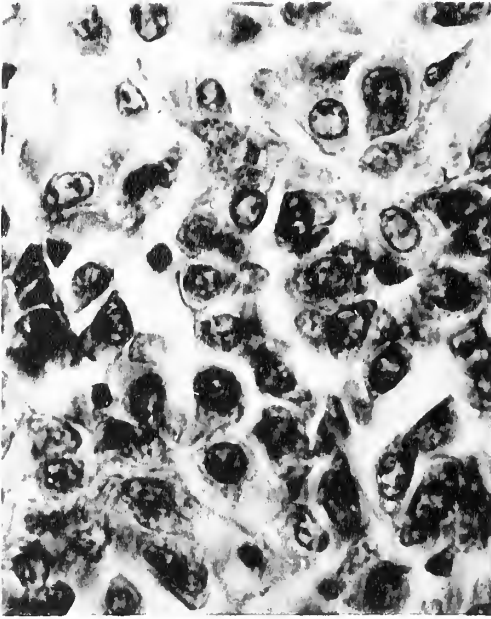

FIG. 5.

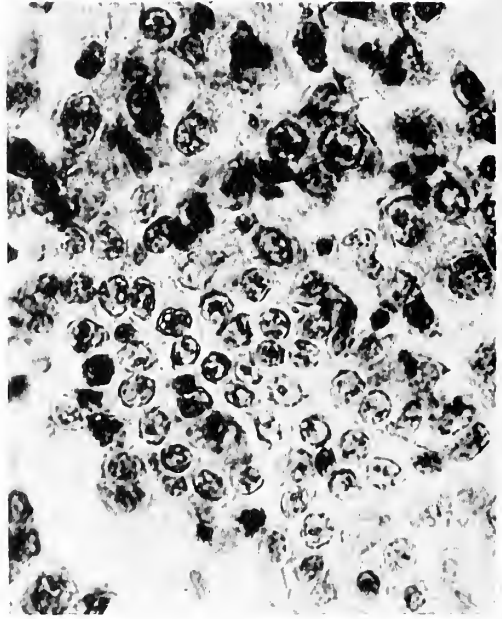

FIG. 6.

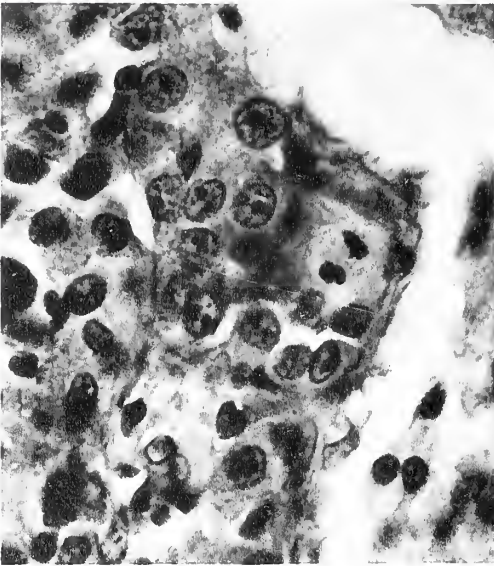

FIG. 7.



FIG. 8.

SPONTANEOUS NEOPLASMS IN FISHES. III. LYMPHOSARCOMA
IN ASTYANAX AND ESOX.

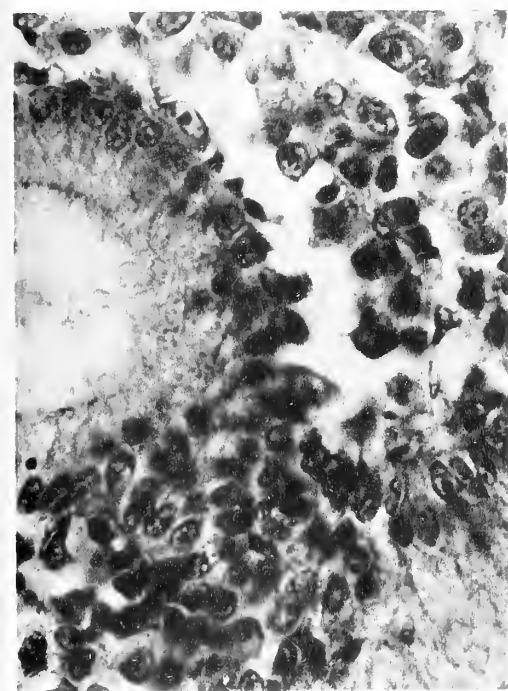

FIG. 9.

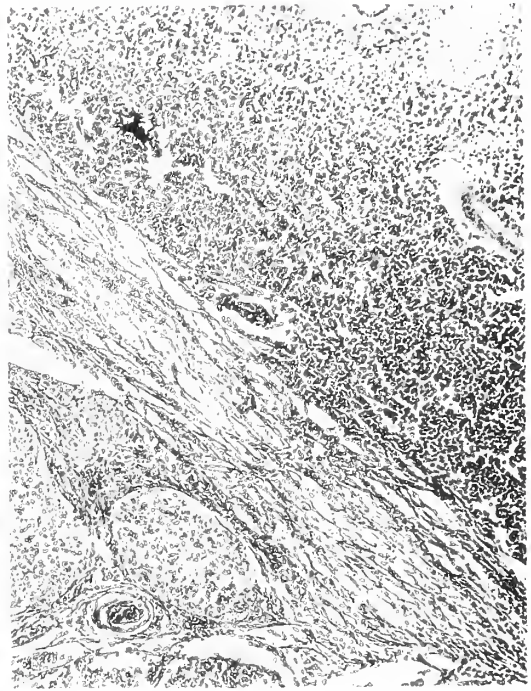

FIG. 10.

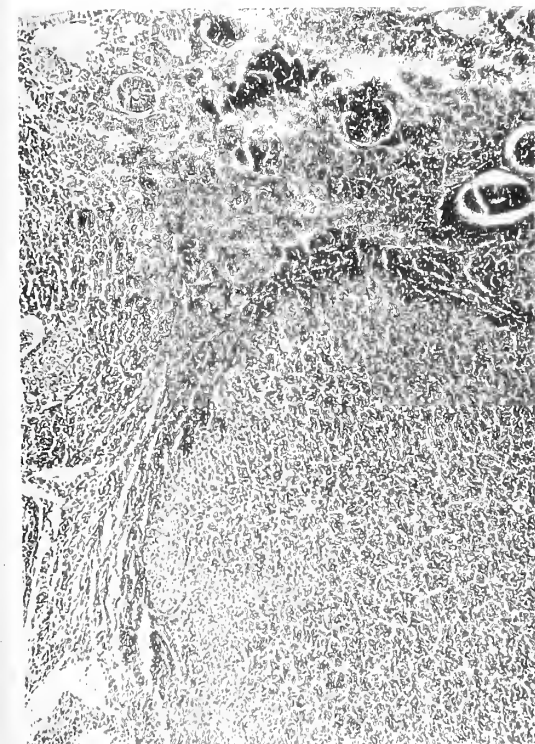

FIG. 11.

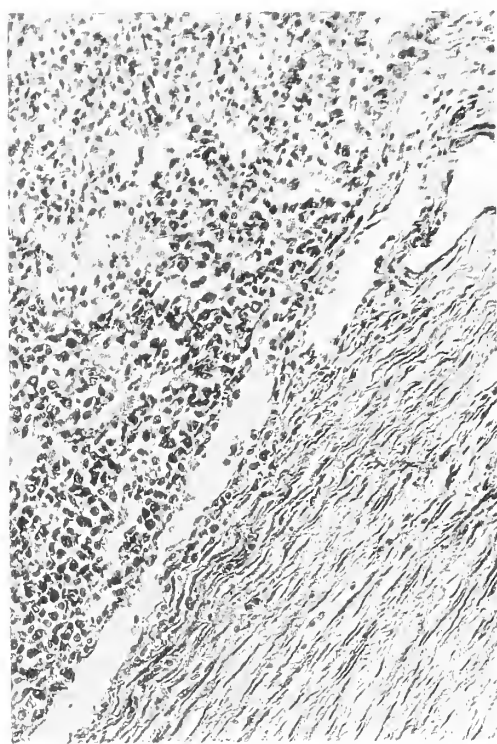

FIG. 12.

SPONTANEOUS NEOPLASMS IN FISHES. III. LYMPHOSARCOMA
IN ASTYANAX AND ESOX.

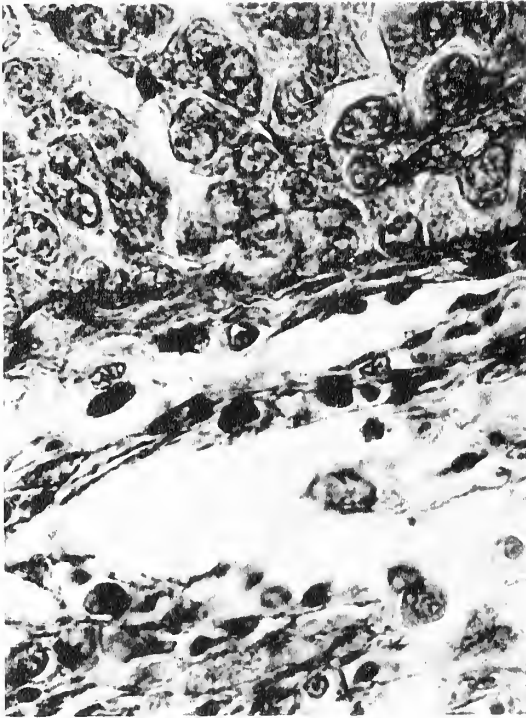

FIG. 13.

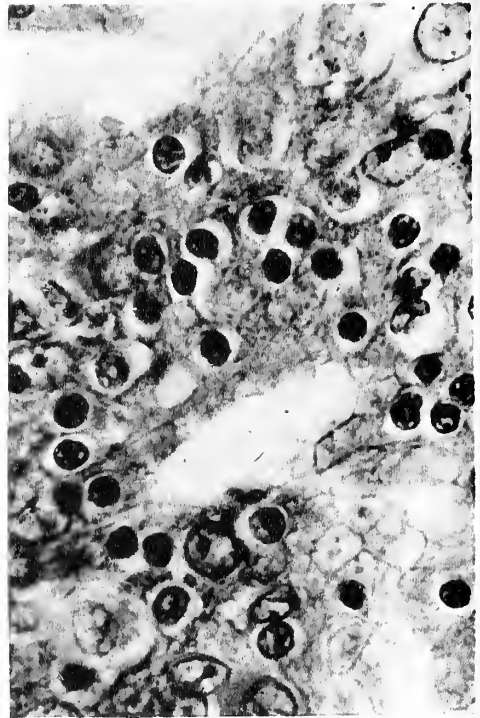

FIG. 14.

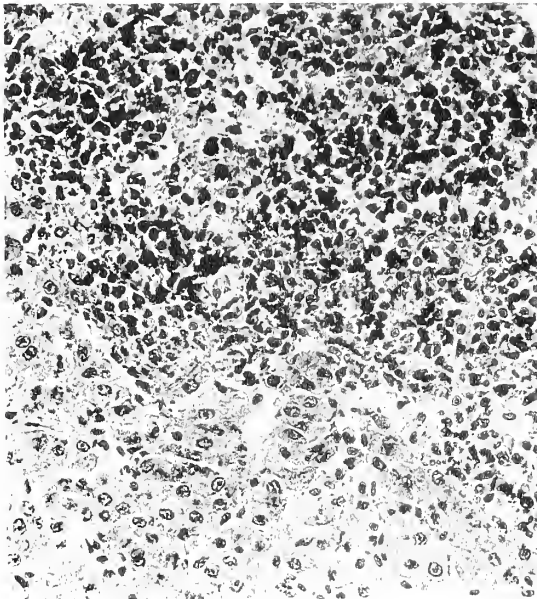

FIG. 15.

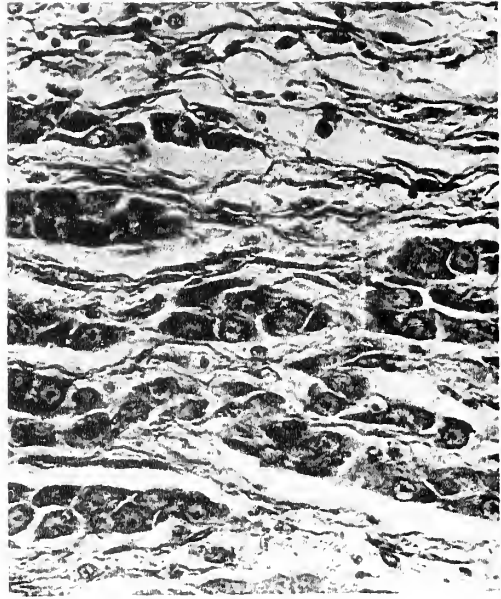

FIG. 16.

SPONTANEOUS NEOPLASMS IN FISHES. III. LYMPHOSARCOMA
IN ASTYANAX AND ESOX.

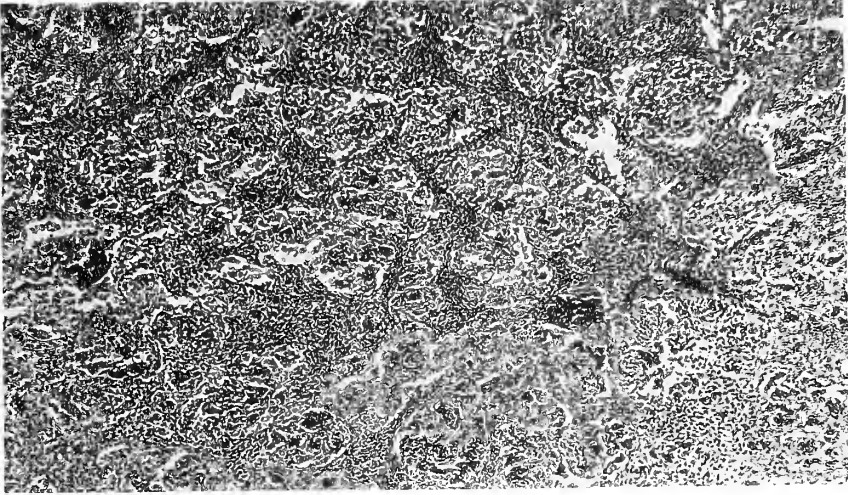

FIG. 17.

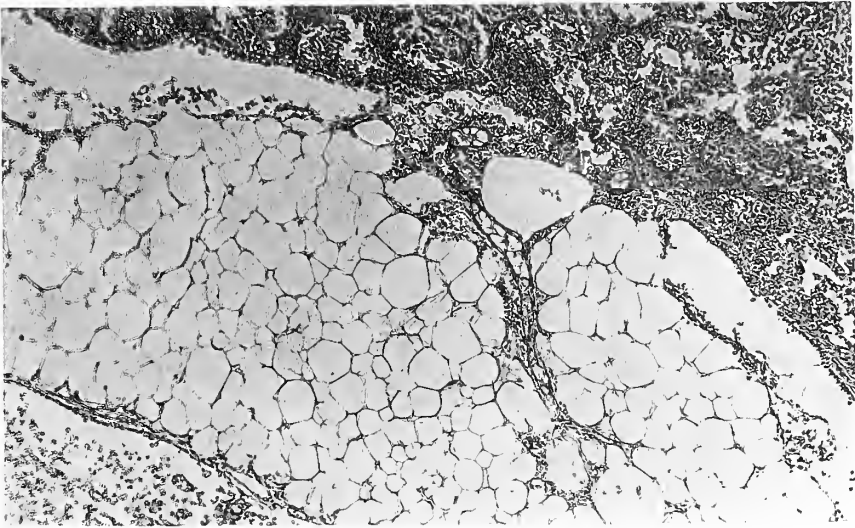

FIG. 18.



FIG. 19.

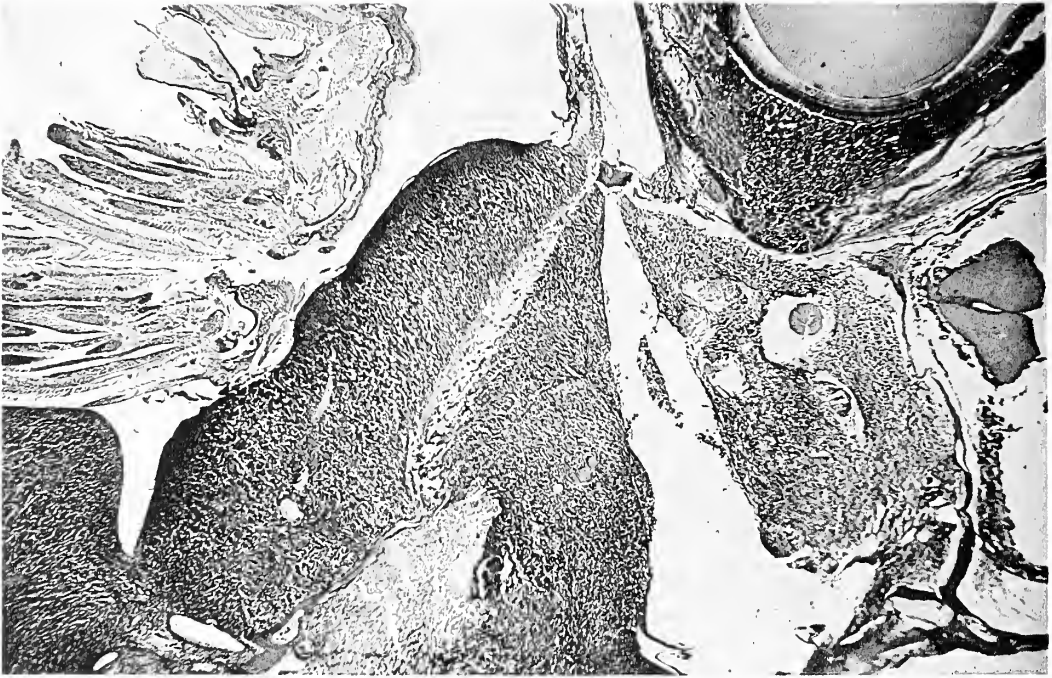

FIG. 20.

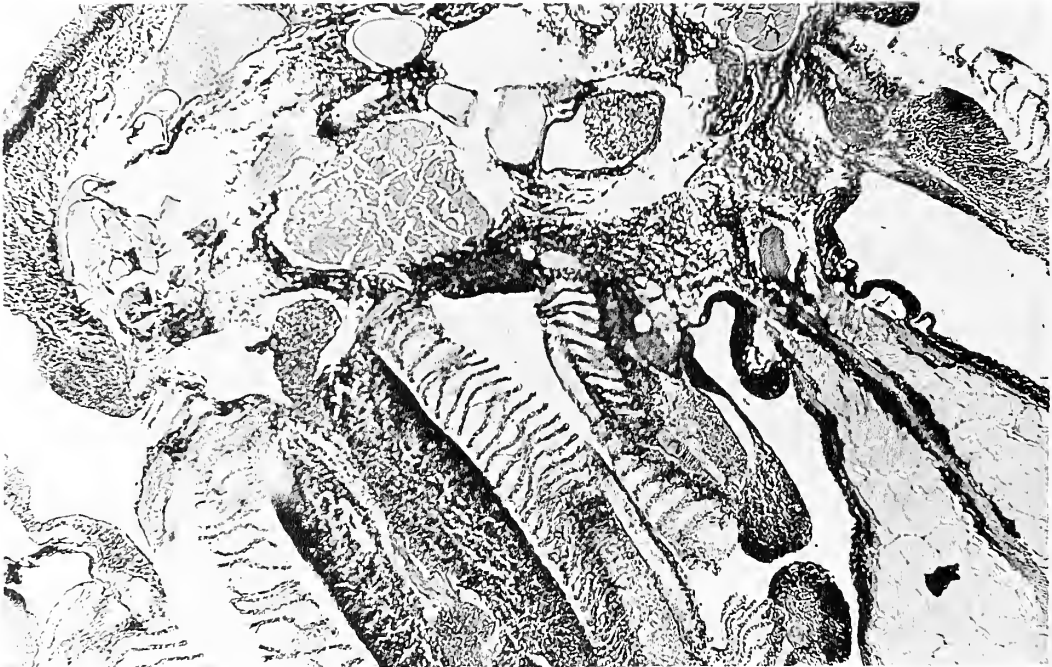

FIG. 21.

SPONTANEOUS NEOPLASMS IN FISHES. III. LYMPHOSARCOMA
IN ASTYANAX AND ESOX.

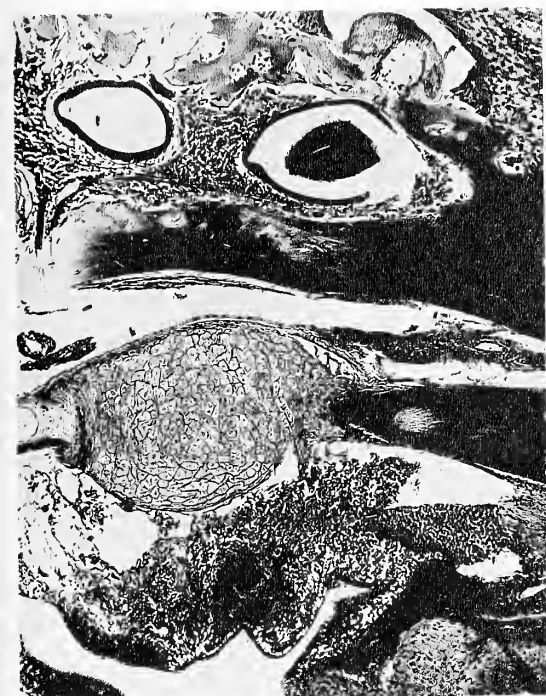

FIG. 22.



FIG. 23.

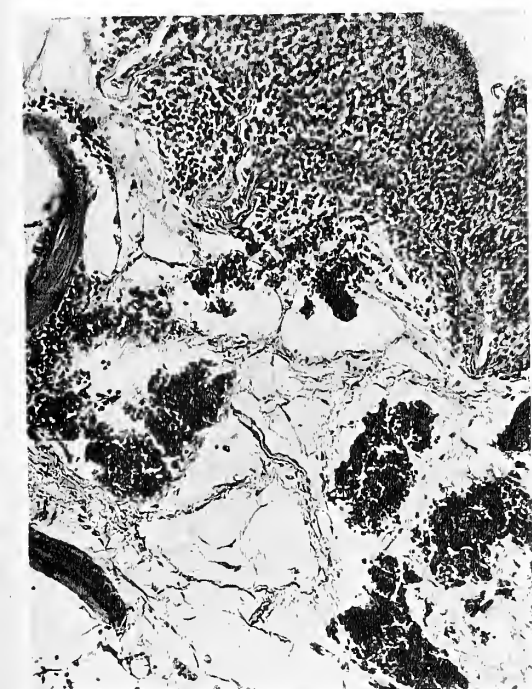

FIG. 24.



FIG. 25.

SPONTANEOUS NEOPLASMS IN FISHES. III. LYMPHOSARCOMA
IN ASTYANAX AND ESOX.



FIG. 26.



FIG. 27.



FIG. 28.

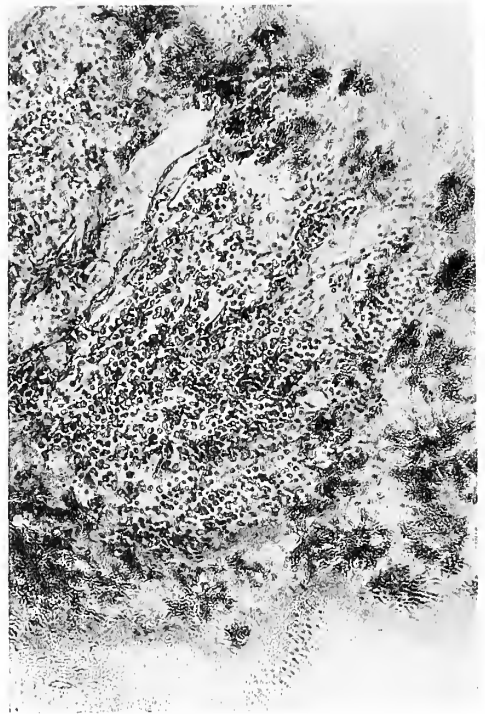

FIG. 29.

SPONTANEOUS NEOPLASMS IN FISHES. III. LYMPHOSARCOMA
IN ASTYANAX AND ESOX.

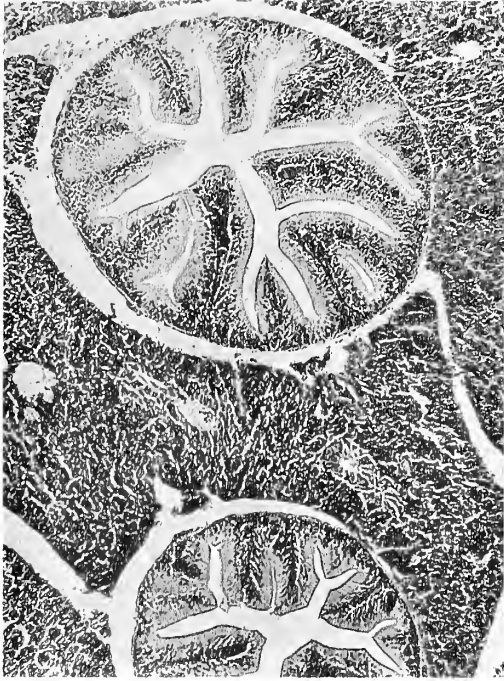

FIG. 30.

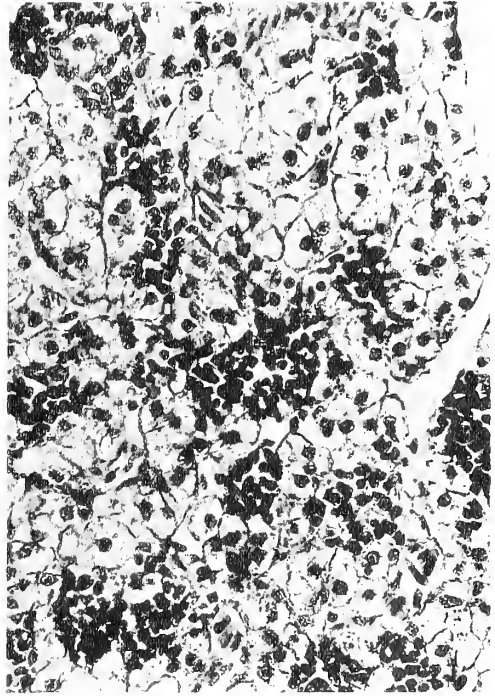

FIG. 31.



FIG. 32.

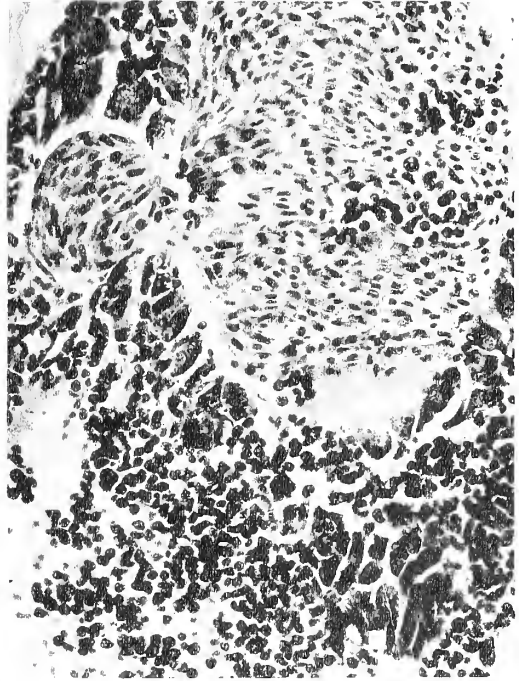

FIG. 33.

SPONTANEOUS NEOPLASMS IN FISHES. III. LYMPHOSARCOMA
IN ASTYANAX AND ESOX.

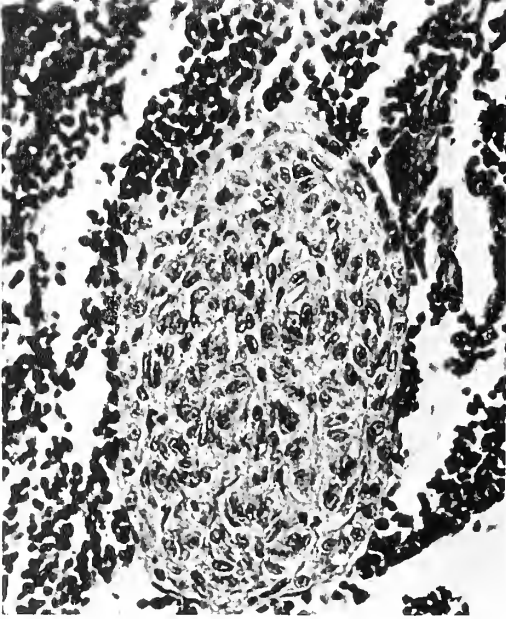

FIG. 34.

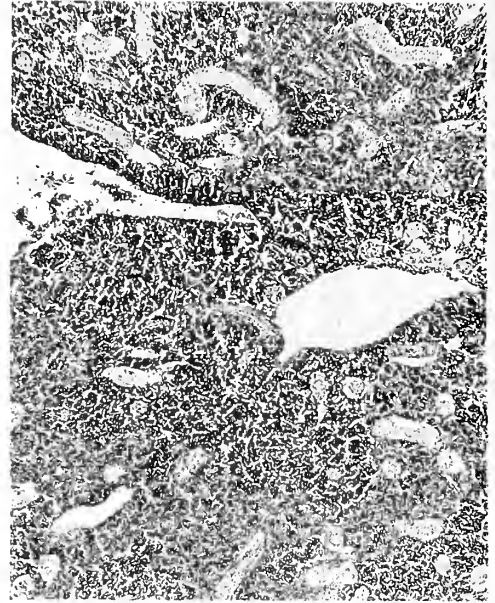

FIG. 35.

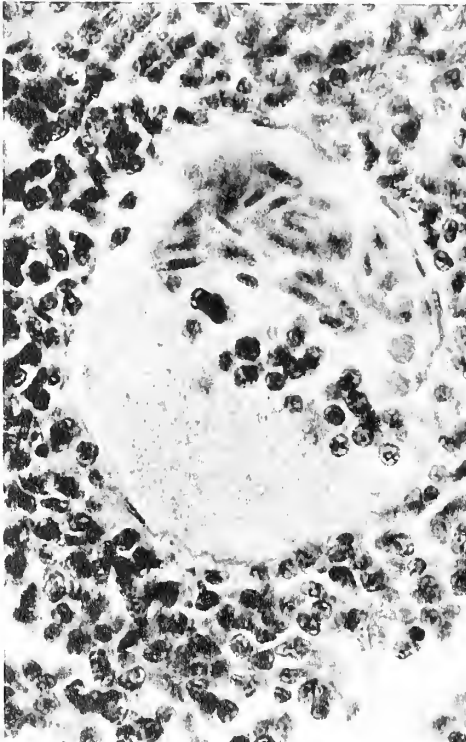

FIG. 36.

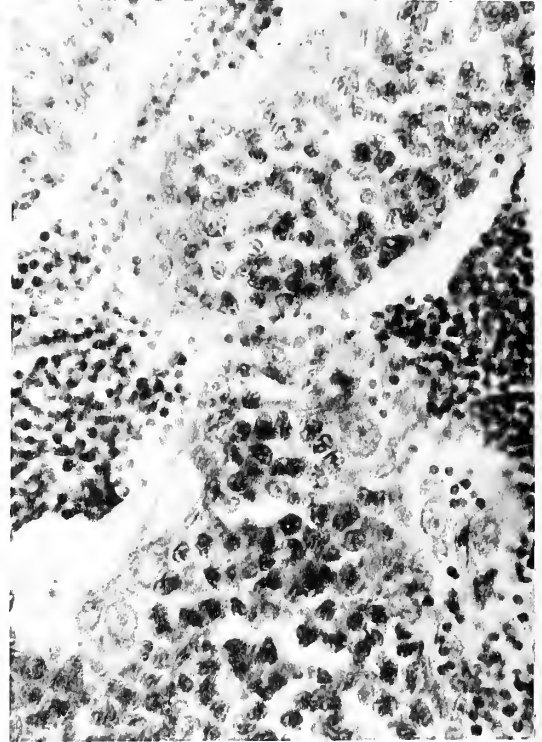

FIG. 37.

SPONTANEOUS NEOPLASMS IN FISHES. III. LYMPHOSARCOMA
IN ASTYANAX AND ESOX.



FIG. 38.

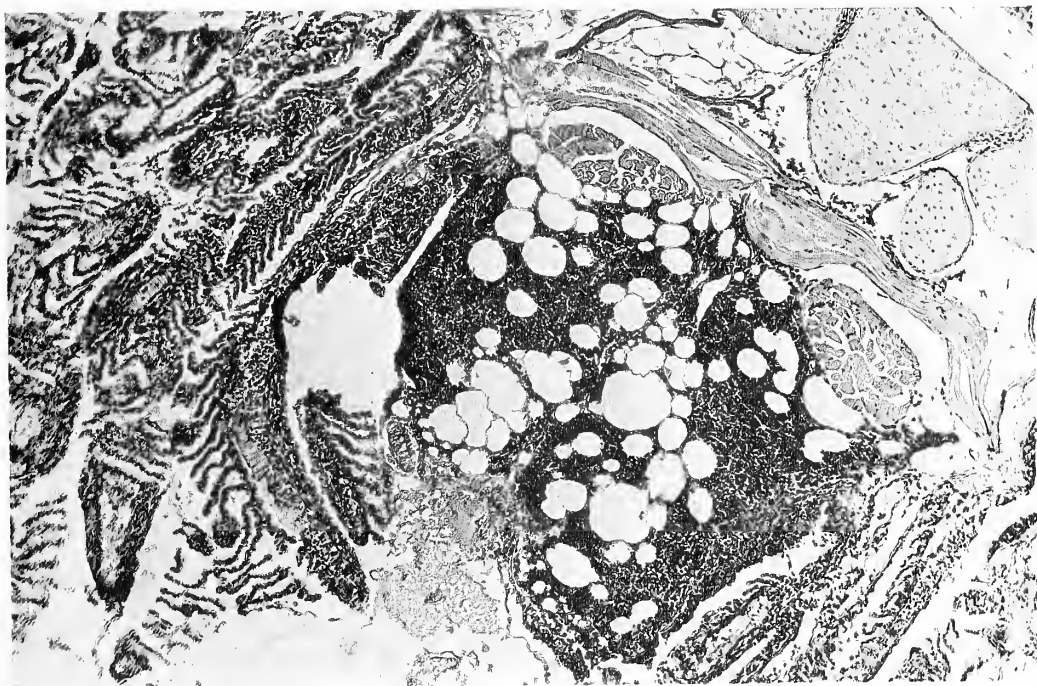

FIG. 39.

SPONTANEOUS NEOPLASMS IN FISHES. III. LYMPHOSARCOMA
IN ASTYANAX AND ESOX.



12.

Notes on the Hercules Beetle, *Dynastes hercules* (Linn.), at Rancho Grande, Venezuela, with Special Reference to Combat Behavior.¹

WILLIAM BEEBE.

Department of Tropical Research, New York Zoological Society.

(Plates I-IV).

[This is one of a series of papers resulting from the 45th and 46th Expeditions of the Department of Tropical Research of the New York Zoological Society, made during 1945 and 1946 under the direction of Dr. William Beebe with headquarters at Rancho Grande in the National Park of Aragua, Venezuela. The expeditions were made possible through the generous cooperation of the National Government of Venezuela and of the Creole Petroleum Corporation.

[The characteristics of the research area are in brief as follows: Rancho Grande is located in north central Venezuela (10° 21' N. Lat., 67° 41' W. Long.), 80 kilometers west of Caracas, at an elevation of 1,100 meters in the undisturbed montane cloud forest which covers this part of the Caribbean range of the Andes. Adjacent ecological zones include seasonal forest, savanna, thorn woodland, cactus scrub, the fresh water lake of Valencia, and various marine littoral zones. The Rancho Grande area is generally subtropical, being uniformly cool and damp throughout the year because of the prevalence of the mountain cloud cap. The dry season extends from January into April. The average humidity during the expeditions, including parts of both wet and dry seasons, was 92.4%; the average temperature during the same period was 18° C; the average annual rainfall over a 5-year period was 174 cm. The flora is marked by an abundance of mosses, ferns and epiphytes of many kinds, as well as a few gigantic trees. For further details, see Beebe & Crane, *Zoologica*, Vol. 32, No. 5, 1947. Unless otherwise stated, the specimens discussed in the present paper were taken in the montane cloud forest zone, within a radius of 1 kilometer of Rancho Grande.]

GENERAL ACCOUNT.

The first glimpse of *Dynastes hercules* at Rancho Grande is recorded in my journal under date of June 6th. I was sitting directly in Portochuelo Pass in full sunshine when an insect attracted my attention by the loud sound of its wings in flight. Usually in flight almost all of the details of an insect are lost, but this beetle hung suspended in midair. Every part of it except the flight wings was

in perfect focus — the pale olive elytra spotted with black, the lower upcurved cephalic horn and the down-curved thoracic horn extending far in advance of the head. I could even see the rich rufous pile, the chestnut fur lining the lower side of the upper horn. The insect flew with a slow steady motion, holding itself almost upright, with the great elytra lifted high out of the way of the flickering flight wings. The general effect was of a diminutive helicopter, the propeller a fuzzy maze, but the whole fusilage clear and distinct. The hercules beetle swung slowly up a few feet, cleared two bushes by only a little and then came roaring past my seat out over the gorge and again back at a higher altitude. I was too surprised, as well as immobilized by reason of a broken leg, to make any effective effort to capture it.

This detail is presented because, with one exception, this was the only time in our two seasons at Rancho Grande when we saw one of these beetles in the daytime. The diurnal discovery in the second instance was only the result of a nocturnal tragedy. On June 22, in Gorge Trail beyond the Pass, I found the head, thorax, fore legs and left elytrum of a female beetle. Within a few feet were bedraggled plumage feathers and much of the wing and a foot of a small screech owl, *Otus choliba crucigerus*, in the gray phase. The killer of the insect had in turn fallen a victim to a tayra whose tracks were about. With the feathers were three more legs of the insect.

On the day following the sight of the hercules beetle in flight, at nine in the evening, a male struck against the glass side of the laboratory, crashing head on. The impact did not even stun the insect and it fell to the sill and there kicked violently about, almost buried in the pile of fluttering moths. This was the first of many individuals which appeared at intervals, both at the laboratory windows and on the white-washed walls on the roof of Rancho Grande, all attracted by the glare of electric lights.

¹ Contribution No. 772, Department of Tropical Research, New York Zoological Society.

During the two seasons at Rancho Grande notes were made on sixty-odd beetles, and thirty or forty others were recorded but not collected or studied. Out of the three score insects only five came to the lights on clear nights. The same conditions controlled the attraction as obtained with moths and migratory birds. Heavy overcast, with dense nebula or fog, or nights of actual rain brought the beetles and the maximum of moths to the lights. As in the case of the other organisms, this was probably due to confusion resulting from poor visibility. Several times when I threw a beetle far out into the fog or rain it simply made a wide circle and returned at full speed.

The total count of the sexes amounted to 33 males and 27 females. Six of the former were male minors of extreme type, so that exclusive of these the normal males and females were equal in number. The relative proportions in the two years were quite unlike. In 1945 the males to females were 17 to 6, while in 1946, the proportion was 16 to 21. This may or may not have had something to do with the fact that the latter season was much colder than the former.

As to seasonal abundance, the beetles were rare or absent in the dry season and in April and May, increasing rapidly in June, with both sexes reaching the numerical peak in July, and dropping abruptly in August.

MEASUREMENTS AND WEIGHTS.

If we consider a general lot of males from the point of view of over-all length they resolve into three groups. Nine Majors grade gradually from the extreme of 142 mm., down by gentle intervals of millimeters of 3, 2, 0, 2, 2, 3, 0, 1 and 1. Then comes a group of Mediums with intervals of 10, 7, 10 and 2 mm. Finally extreme Minors show steps of 16, 5 and 6 mm. respectively, the smallest measuring 74 mm. over-all. In the course of two seasons at Rancho Grande six typical Minors were collected, three in June and three in July, and singly, on well separated dates.

When we consider characters in greater detail, the difference between Majors and Mediums on the one hand and Minors on the other becomes much more radical. In the two former the cephalic horn differs chiefly in size, whereas in the Minors it assumes a greatly simplified structure, totally lacking the series of teeth, or with the proximal one represented by a minute nubbin.

The weights of living or freshly killed male *hercules* present the following averages in grams in the three groups; Majors 34, Mediums 23 and Minors 15, the extremes being 37.5 and 15 grams.

Females show no radical distinctions in size. The average is 61.8 mm. in total length, with extremes of 50 and 76 mm., connected

by gradual steps. Their weights average 14 grams, with extremes of 11.5 and 16.3 grams.

The over-all lengths of Majors and Minors break down into a much more significant comparison of thorax-plus-horn versus body measurements. The average of body length in Majors is 48 mm., in Minors 40 mm. The thorax-plus-horn average 78 in Majors and 40 in Minors. Thus while in normal males the horn element is 137 per cent. of the body, in the Minors it is exactly equal.

Considered in terms of active life habits these measurements acquire considerable significance. At least in the limits of large laboratory cages, where several males and females are confined in a single enclosure, the proportional reductions in size in the Minors are a very slight handicap.

As we have seen, the body reduction is very slight, 40 as to 48 mm., whereas the thorax horn is as 40 to 78 mm. Thus the principal loss is in a secondary sexual character, as compared with the vital volant, digestive, respiratory and generative organs of the wings and abdomen. The concomitant functions result in complete failure in combative ability, but no loss in copulative efficiency. In the laboratory I have seen a Minor evade all conflict with other males, fleeing from them at full speed, yet mating successfully with one after another of three females. Whether this advantage would be attained under more natural conditions it is impossible to say. It would most certainly not be the case if jungle mating was preceded by physical contests between rival Major males. Nor can we be sure whether the dwarfing of a few individual males is due to different genetic conditions, or to adventitious deficiency in nutrition during the period of larval development.

The reduction of the thorax with its horn has taken place without radical dislocation of the relative position of the median double tooth. Both in the largest, 142 mm. Major, and the smallest 74 mm. Minor, the tooth remains about midway between the posterior thoracic edge and the horn tip. In the Majors this double tooth plays an important part in affording an opposing grip to the corresponding teeth on the cephalic horn. In the Minors it has resolved into two widely separated, wholly useless, blunt, dorsal spikes on the thorax itself.

But the cephalic horn shows distinct change and variation. The distal dorsal tooth ridge close to the tip is constant in all Majors and Mediums, but, as we have seen, is absent in Minors. The medial teeth vary from none to three, with much variation as to size and position, but with no relation to size of the insect. The following table shows the relative development of the dorsal teeth of the cephalic horn.

Total Lgth.	Cephalic Horn Dorsal Teeth	
	Proximal	Distal
141	Strong	0
139	Strong	Nubbin
139	Strong	Nubbin
137	Strong	Small
135	3 — joined together	
132	Strong	0
132	Strong	0
131	0	0 (deformed)
130	Strong	Strong
120	Strong	0
113	Strong	Strong
103	Strong	0
101	Nubbin	Nubbin
85	0	0
80	Minute	0
74	Minute	0

COLOR.

The ground color of the elytra appears very characteristic but when compared carefully with the plates in Ridgway it resolves into a variety of colors. Individuals may be light brownish-olive, isabella color, buffy olive, or dresden brown. Less common is a cold buff citrine. I shall lump these in the term brownish-olive for reference to notes in my journal. An unexpected phenomenon was the radical and often rapid change from an almost solid black or blackish-brown to the normal olive, spotted pattern, and back again. The following brief notes are of value only because they refer to the living, newly caught beetles. The numbers refer to those of the sixty specimens on which notes were made.

H2. Brownish-olive sparsely spotted with black.

H6. Minor; Isabella color sparsely spotted.

H7. Jet black. When given banana and feeding, the posterior half of the elytra lightened to buffy olive, black spotted.

H10. Minor; Brownish-black when caught at 11 P.M. At 11:30 began to mate with large female, and at once anterior, lateral area of elytra paled to buffy citrine, spotted with black. 12 midnight, mating. Brownish-olive over whole wing cases, except band down inner margin which is still black. 12:15 A.M., Mating finished. Dark margin has disappeared. This normal pattern remained for six days. Chloroformed and death resulted in a half and half design, the black being present in the form of several broad, irregular lines, extending longitudinally over the buffy citrine ground color. This pattern persisted in preservation.

H8, H9. Both males in buffy olive, black-spotted pattern, one with very small black spots, the other with spots twice as large. H8 changed to solid blackish-brown with two asymmetrical spots of brown on each outer elytrum edge. No change in H9.

H12. Very pale, buffy citrine, with sparse scattering of black spots. No change during

or after several violent battles, but when killed changed to black. The next morning the olive had returned, but with a wholly different pattern of black spots.

H14. Isabella color with five meandering lines of black.

H28. Pale brownish-olive with several, broken, black, longitudinal lines. Two of these reached posterior edge of elytra. One week later the wings turned black in the night, and remained so until four days later when normal pattern returned after death.

H31. Minor. Elytra olive with few black spots. Turned black in three days. After death, assumed a half and half pattern.

H35. Normal coloring with dark, inner, anterior area of wings. Many scattered, very small, black dots.

H38. Upper half, left elytrum black. The rest normal.

H45. Male with deformed cephalic horn. Brownish-olive, heavily lined and streaked, rather than dotted, with black.

H47. Basal fifth of elytra black, with the rest isabella color with a few large black spots.

H48. Pale buffy citrine, streaked with irregular, thin, black lines. A few large black spots at posterior end.

H56. Dresden brown with a few large black spots.

The spots may be solid black, or with a black central dot and an outer black ring, or with a black core and a gradually paling surrounding area. I know of only three males which have remained dark in preservation. One, H43, was sent north alive. In battle, or by accident the dorsal part of the thorax was badly crushed. The dominant color is black with considerable and widely distributed freckling and angular markings of the normal dresden brown.

The greater proportion of the females are blackish mahogany brown, but about forty per cent. show the brownish-olive, black-spotted male pattern to varying degrees. In extreme cases the posterior fourth of the elytra is thus characterized, and the olive extends forward along the outer margin in a wide band, becoming narrower as it approaches the thorax. The olive ground color may be immaculate, or finely or coarsely black-spotted. In one female the right elytrum is conspicuously bi-patterned while the left wing-cover is mahogany.

The color extremes in the male beetles have been known for almost two hundred years. Linnaeus puts *Scarabaeus Hercules* at the very head of the Class of insects, and among his references he includes two from the *Insecten Belustigung* of August Johann Rösel which appeared in 1749. We find two beautifully executed color figures of male *hercules* on different plates. The first is uniformly black, while the second illustra-

tion is brownish-olive with a sparse scattering of small black spots. Both are life-size, about 140 mm. The cephalic horn differs from our Rancho Grande specimens in possessing seven dorsal teeth in place of at most three. But the number and relative development of teeth in both figures show considerable differences.

SENSES.

On the evening of July 30 there were five captive male Majors on the Rancho Grande verandah, all eating banana, and, with their uncleaned cage, giving forth a strong aroma of overripe fruit. The females were all in vivariums in the laboratory. During the evening five additional males came to the dimly lighted cage instead of to the brightly lighted laboratory windows. In this case, it seemed to be the odor of fruit which was dominant over the drawing power of light.

Touching or brushing the thick, furry hair along the ventral surface of the thoracic horn produced no reaction, whereas the least touch of the hind tarsi made the insect jerk suddenly, or start quickly away.

I do not know exactly where, how, or to what extent audibility functions but I am certain that the perception of sounds, or vibrations which produce corresponding effects, does exist. I have mentioned elsewhere the thoracic-abdominal squeaking instrument in *hercules*, which comes into use before encounters and occasionally afterward. A splendid field of investigation awaits the ecological coleopterist who will wring from living tropical beetles auditory methods and reasons, productions and receptions. Examples will offer themselves, from the giant *Dynastes* and *Acrocisnus* to tiny coleopters whose frantic neck rubbings upon microscopic instruments indicate sounds, whose faintness or height of pitch prevents excitation of our aural receptors.

It would seem that scent must normally be a definite factor in sexual attraction, and in a small box or cage this is certainly the case. Aside from these limited, abnormal conditions I could find no verification of this theory. Four female *hercules* were placed together in a cage of medium size and exposed on the roof and again in the jungle at the edge of the road some distance from the laboratory. This was done on both clear, overcast and rainy nights. The insects were visited at midnight and in early morning long after the lights in Rancho Grande had been turned off. In no case was a single male found on the cage or in the vicinity.

FOOD.

No opportunity occurred of observing any feeding under natural conditions, but in laboratory terrariums the beetles of both

sexes would feed all day or all night if provided with a succession of bananas, mangos or other fruit. The insects push head on into the pulp, and slowly work their way, softening the fruit as they progress, until it acquires the consistency of mush. Given a hard, green banana, a beetle will eat a deep groove within a few minutes, all the adjacent pulp becoming soft and saturated.

EGGS.

In cleaning out the abdomens of females for preservation, ripe eggs were found first on May 6. The insect was 76 mm. in total length, the record for this sex, and the eggs were 31 in number, also a record. The eggs, which were about to be laid, were equal-ended, broad ovals, 3.5 by 4.3 mm. The shells were white and as hard as those of a bird or lizard. Under high power the surface was seen to be covered in rough lines by a multitude of short, thin ridges, each minutely toothed along the summit. The contents were a homogeneous, thick, white liquid.

This was the only occurrence of ripe eggs before mid-June. From this date the individuals rose gradually to a climax of breeding in mid-July with a single instance in mid-August. The ripe eggs were sharply set off from a multitude of very small, undeveloped ova. The occurrences were as follows, in order of number: 5, 8, 9, 14, 15, 16, 20, 21, 25 and 31 eggs. There was no relation between number of eggs and either size of the female or date of ripeness.

JOURNAL NOTES ON COMBAT BEHAVIOR.

(The present account possesses an especial interest in satisfactorily demonstrating the adaptive significance of male cephalic and thoracic horns in *Dynastes hercules*. Taken in connection with an earlier paper on *Megasoma elephas* and *Strategus aloeus*,² proof is presented that, at least in three cases of neotropical species, secondary sexual characters are of definite use in specialized combats between male beetles.

(It seems hardly necessary to mention the intentional use of anthropomorphic terms such as "accepting a challenge" or "combats with a rival." If we attempt to go purist in an account like this, we must invent a wholly new set of terms for a coleopteran glossary, which is manifestly silly. We have armed beetles fighting with one another over the possession of a desired female. The combatants make full use of specially adapted weapons. As long as we accept the mental activations of the whole performance as analogous, and only the visually apparent mental end results as homologous (as between vertebrate *vs.* invertebrate), I see no need for dictional apologia. Even "as ifs"

² Beebe, *Zoologica*, 1944, Vol. 29, No. 8, pp. 53-58.

may be understood, and therefore omitted).

July 9: Put a large Major (H2, 142 mm.) and a small Minor (H6, 80 mm.) together and they fought at once. After several casual feints the large beetle, suddenly aroused, seized the small one in a scissors grip of the two horns, and started away with him. After going about a yard, the Major tripped, fell and both rolled over. The Minor pushed himself up on his feet and rushed off, leaving his giant rival kicking helplessly on his back. This was the first exhibition of actual carrying or transportation. The Major had no difficulty in holding the small beetle well aloft, and in walking slowly off, carrying a weight one-half that of his own.

The next day the same Major and Minor were put in with three females. Both mated at once, but the Major soon left his female and attacked the other mating pair. In spite of his utmost efforts, he could not dislodge the Minor although both he and his female were rolled over and over. The unfortunate female bore much of the brunt of the attack. The Major could not open his forceps sufficiently to enclose and lift the mated pair. He soon gave up and returned to his female.

July 16: A new-caught Minor showed more vitality and activity than has any Major. Placed with five Majors and four females the small male mated with all the females in turn, and several times in succession with two of them, while the much larger beetles took time off from feeding to mate with only one or two. After careful observation, I believe that the copulations of the Minor were as complete and successful as those of the Majors.

In three combats with the two Majors the Minor showed no lack of courage and rushed his giant opponents, but always to no purpose. He was invariably seized and carried off the field high in air, in the massive, toothed horns. The Minor always attempted the conventional pincer grip of his species, in spite of the fact that the small size of his fighting weapons made them wholly inefficient and ineffective.

July 22: A very large Major came this evening to a cageful of four others eating bananas in the open verandah of Rancho Grande. I put the newcomer with the others, and he instantly crawled to a bit of fruit and attacked another male already deep in the pulp. The feeder was seized, carried about and ultimately banged down on the concrete floor. This stirred up another pair of beetles which clinched at once, and were in turn assaulted by the new-caught beetle. He secured a good grip on the preoccupied fighters and lifted both into the air, staggered about eighteen inches and dropped them heavily. This time he successfully lifted and transported twice his own weight. Immediately all three ceased fighting and

devoted themselves to the same half of a banana.

July 30: Day after day for a week I have matched two Majors against each other. One is dominantly Black and the other Olive. Black measures five inches over-all and weighs twenty-six grams; Olive is four and three-quarters inches and twenty-four grams. The equality is thus almost perfect, and I never saw that the slight discrepancy conferred or denied any advantage. Although the color distinction was a satisfactory method of telling them apart at a distance, yet even it was not permanent and Black might in time become Olive, and vice versa.

In the days intervening between combats I varied the situation, society and occupation of the two beetles. Black might be caged alone while Olive was given the association of several females; Olive might be furnished with an unending feast of banana, while Black fasted. Olive might be annoyed by the continual but futile attacks of a pair of bulldog-like Minors, while Black was kept in darkness and quiet for sleep or what corresponds to scarabaeal meditation. Yet in one conflict after another, day after day, neither surfeit of food, sex, annoying combats or restful quiet altered, in any way, the respective method of attack, or changed the very distinct personalities shown in contests between the two heavy-weight hercules beetles.

The general herculean battle routine proceeded as I have described it elsewhere, but the distinctive, individualistic sequence is as follows: The Black rushes the contest. Throughout what we might call Rounds, he seizes the other, raises him on high and stumbles about with him, and finally bangs him down. During all this Olive is perfectly quiescent, putting up just enough defence to show he is not actively trying to escape. His very relaxation seems to preserve him from injury, as is so often the case in human contests or other activities. When slammed down for the fourth or fifth time, the lethargic Olive is suddenly obsessed by what appears to be a most unbee-like rage, and from now on the melee is full of reciprocal action. The little bulging eyes must see more than they appear to, for again and again I have seen Olive avoid the scissors grip and snap of his dark opponent, and with what I can call nothing but skill, suddenly turn upon Black, grip him, shift his hold and rising so high that he seems on the point of overbalancing backwards, hurl the bigger beetle, with his handicap of two grams, once or as many as three times. Whereupon the erstwhile victor turns and scuttles off as fast as his six legs will carry him.

Seven times in the course of nine days this same performance took place with iden-

tical action and counter action. Only with respect to the last phase did variety enter in. Always Olive was at first the under dog; invariably at the end he was victor. But twice he fled as I have written above; once he lifted his great citrine shards and unlimbered the wide expanse of transparent, amber flight wings, and only a quick grasp on my part kept him from helicoptering off the field of battle, over the jungle, into the sky. Two other times Olive watched his vanquished rival vainly kick as he swivelled around on his back, and both of these times made his way to the nearest female and mated. The two remaining times his rage failed to cool and he continued the battle until Black was reduced to complete immobility, although ultimately he fully recovered. On these occasions Olive wandered away to a split banana, thereupon subordinating all other emotions.

GENERAL COMBAT BEHAVIOR.

Encounters between male hercules beetles are usually rather brief, and are dependent on the willingness of each to fight. One may be feeding or resting quietly when a second male approaches. Before any actual contact, when still several inches apart, the beetle which is eager for the engagement moves the thorax up and down, producing a rhythmic series of zizzing squeaks. There is not the slightest doubt that this is heard and understood. Even if mouth and head are buried deep in mushy banana plup, the eater gives a jerk on hearing the sound, and assumes for a moment what may well be an audient immobility. He may keep on guzzling or may back away practically into the waiting grip of the squeaker.

If the feeder chooses to accept the challenge this is evident in a complete change of demeanor. Ordinarily these hercules beetles move and feed and react in the same slow, bungling way common to most of their family. The deliberate awkwardness of June bugs and cockchafers is theirs. But at the sound of the hissing, or actual contact with another male who intends combat, there occurs a radical change. Movement shifts to quick, nervous jerking, evident whether the insect is standing still or walking. When combat is refused, the beetle turns and retreats rapidly, the gait soon shifting to the usual slow, aimless progress.

If the pacifist is picked up in the hand and brought close to the still squeaking male, the sudden revitalization can be distinctly felt in the held insect. The legs jerk spasmodically in mid-air and the beetle may, in turn, begin squeaking on its own behalf. If the two are brought into contact and irritated, a fight will usually ensue. The hissing squeak may now cease and another phase of the routine take its place. This is

a rapid jiggling up and down of the anterior part of the insect, an extension and flexion of the fore legs, recalling the corresponding exhibition of *Anolis* and other lizards. More frequently this diminutive war-dance is performed by the winner, after the termination of the fight.

The sequence of the actual encounter is unvarying. The two meet head on, but there is much less rearing and absolutely none of the attempts at tripping so characteristic of *Megasoma elephas*.³ The projecting horns touch and click, spread wide and close, the whole object of this opening phase being to get a grip outside the opponent's horns. When the four horns are closed together, there is a dead-lock. All force is now given over to pinching, with the apparent desire to crush and injure some part of head or thorax. When the beetles are quiet in this attitude for a few seconds, nice details in adaptive arrangements for protection become evident. One such is the oblique chitinous bar stretching part way across each eye, exactly like a skeleton visor, or the nose-guard on the helmet of an eleventh century medieval knight.

Again and again, both opponents back away, freeing their weapons, and then rush in for a fresh grip. When a favorable hold is secured outside the other's horns, a new effort, exercised with all possible force, is initiated. This is a series of lateral jerks, either to right or left, with intent to shift the pincer grip farther along the thorax as far as the abdomen and if possible on to mid-elytra. In addition, if the hold is at first confined to the incurving horn tips, the shift must be ahead, so that the final grasp brings into play the two opposing sets of teeth on the horns. Once this hold is attained and a firm grip secured the beetle rears up and up to an unbelievably vertical stance. At the zenith of this pose it rests upon the tip of the abdomen and the tarsi of the hind legs, the remaining four legs outstretched in mid-air, and the opponent held sideways, kicking impotently. This posture is sustained for from two to as many as eight seconds, when the victim is either slammed down, or is carried away in some indefinite direction to some indeterminate distance, at the end of which the banging to earth will take place. After this climax, if the fallen beetle is neither injured nor helpless on its back, it may either renew the battle, or more usually make its escape.

The general sequence of combat is almost unvarying, but the certainty of outcome is another matter. For example, the successful impersonator of the part of his namesake Hercules, may by chance happen to trip over a twig or his own feet, while carrying the Antaeus actor high in air. Both then may

³ Beebe, 1944, *Zoologica*, Vol. 29, No. 8, pp. 53-58.

roll over and over, whereupon, if the erstwhile Antaeus is the first to rise, he may reverse his mythological part, assume in turn the herculean role and start off with his struggling burden on the path to victory. His course may take him over the identical ground which he had just traversed in the jaws of the other male.

Or again, after such an accident, both beetles may scramble to their feet, rush off in opposite directions, and if their path should cross a banana, all subsequent concern with combat may be lost in gustatorial delights.

There is no doubt of the crushing power of the two opposed horns, but I have never been able to feel it exerted on my fingers. The toothed elements of the Majors and the sharp tips of the horns of the Minors can press hard enough on flesh to be painful, but the insects seem to recognize a tissue foreign to that of their own kind, and never exert full force. I have caused a quick shift to a severe crunch by suddenly substituting the elytra of a beetle for my fingers, when the hard, resistant shards bend beneath the increased pressure.

With our ear held close to the fighters we can distinctly hear the clash of chitin on chitin, changing to a scraping as the grip shifts sideways. When the teeth come into play, a third sound, a real crunch, is audible, as the wing covers bend or even break.

The combats between a full-sized Major and a Minor were always a foregone conclusion. The small one never refused a tilt and would rush pellmell into the encounter, squeaking as loudly as the giant. But it was no use. His instincts remained unchanged and his undersized dwarfed weapons which could not encompass a beetle of his own size, were useless against the girth and weight of the Major. His opponent simply clinched his long horns around the smaller beetle and carted him away high in air. His very lightness seemed to be an advantage in the end, for only once did I see a Minor injured or stunned by the slamming to the ground.

TRANSPORTATION OF THE FEMALE.

Observations on female beetles being carried about between the horns of the males are few, scattered and lack details. None, so far as I know, have been checked or reconfirmed. Bateson and Brindley (*P.Z.S.*, 1892, p. 590) quote Baron von Hugel indirectly: When these Javan beetles, *Xylotrupes gideon*, were untied, "the males immediately sought out the females, and seizing them transversely, carried them about, held between the two horns, with evident satisfaction. He tells us that this was observed again and again, and was clearly a definite habit. The males with small horns, though unable to lift the females, nevertheless made ludicrous

efforts to do so." The same habit was observed in a pair of *Chalcosoma atlas*.

In *Country Life* for August 28, 1942, M. Forster Knight, writing of stag beetles, presumably *Lucanus cervus*, says that the male occasionally lifted his mate and carried her for some distance. The battles of the males are described as "lift, carry and toss."

Until our experience with hercules beetles at Rancho Grande I had never believed the story of the male carrying off the female, held firmly between its horns. One day after a Major had speedily defeated and transported a small Minor, and flung it down according to schedule, the Major came upon a female and with no hesitation picked her up and walked off. She was held rather awkwardly and soon one of her dangling legs tripped him and she was dropped. I considered this a blind, instinctive continuation of the transportation of the Minor.

On subsequent occasions, however, this performance was repeated and with such deliberateness that I was compelled to admit it as an accepted fact. The cause remained insoluble, and the certainty of occurrence could not be foretold. Time after time a male would approach a female, whether she was feeding or moving about, and mate at once. On other occasions he would touch her, playing over her back with his antennae, and soon pick her up and walk away. Twice females were carried as far as I dared let them go into the underbrush. At other times the female was dropped gently (not slammed down as would be the case with another male) and left while the Major went to a banana and fed. Other carryings were indeterminate because of the confined space in a laboratory cage. Once only did I see a mating follow a short transportation. What significance this has in the sexual economy of hercules when the event takes place normally at night in the jungle, I cannot even guess. Miss Crane obtained good color movies both of all phases of combat and of the female being picked up, raised high and carried out of the picture.

DISCUSSION.

In *hercules* there seems to be a complete absence of any courtship or display by the male in respect to the female. The relationship of the sexes is confined to direct mating in which the female is receptively passive. There is also an occasional, inexplicable, aimless transportation of the female a short distance.

The males use their horns in combat, utilizing the specialized shape and position of these characters in a specific routine. This instinct and method persists in Minors whose horns are too small and abortive to be effective. Squeaking and repeated bowing are also indulged in before and after the encounters.

SUMMARY.

Dynastes hercules is a very large scarabid, the males armed with specialized horns of great size. This species is not rare at Rancho Grande, coming to lights on overcast or rainy nights. Notes are presented on abundance, proportion of sexes, size and weight, Major and Minor males, change of pattern and color, food and eggs.

Especial attention is given to combat behavior, the handicap of the Minor males, the individuality of combat routine, the unexplained transportation of the female, and comparison with the very different method of combat of *Megasoma elephas*.

EXPLANATION OF THE PLATES.

PLATE I.

- Fig. 1. Male Minor, female and male Major (preserved specimens).
 Fig. 2. Living hercules beetle, showing size.
 Fig. 3. Beginning of combat of two Major males, showing extremes of pattern and color.

PLATE II.

- Fig. 4. Major male with a Minor male held between its horns.
 Fig. 5. In combat between two Major males, one is lifted partly off the ground.

PLATE III.

- Fig. 6. The beetle is lifted clear off its legs.
 Fig. 7. The beetle is raised twice its own height into the air.

PLATE IV.

- Fig. 8. The victor is supported by only four legs.
 Fig. 9. The victor is now almost vertical, supported by only the two hind legs and the tip of the abdomen, preparatory for the downward smash.
 Fig. 10. Victorious male approaching female.
 Fig. 11. Male obtains a grip on the thorax of the female.
 Fig. 12. Male carrying off the female.

Figures 8 to 12 inclusive are enlarged from 16 mm. kodachrome motion picture film. All illustrations of living beetles by Jocelyn Crane.



FIG. 1.

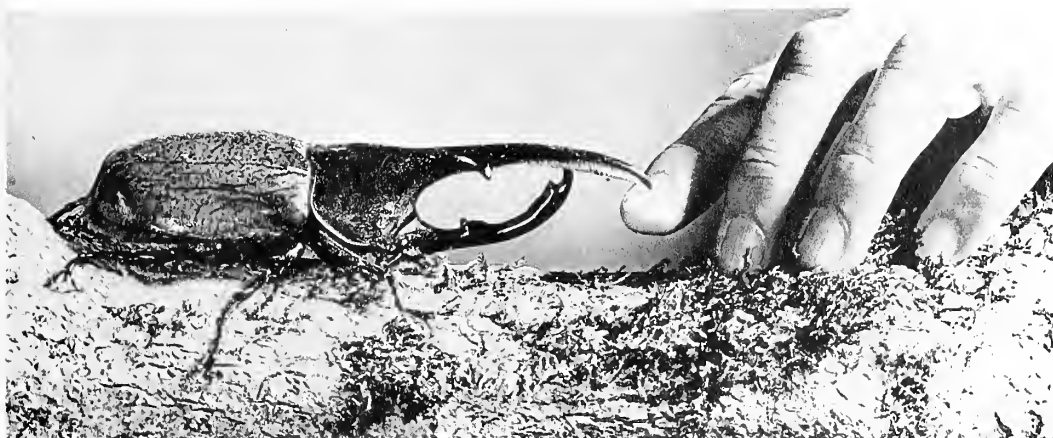

FIG. 2.

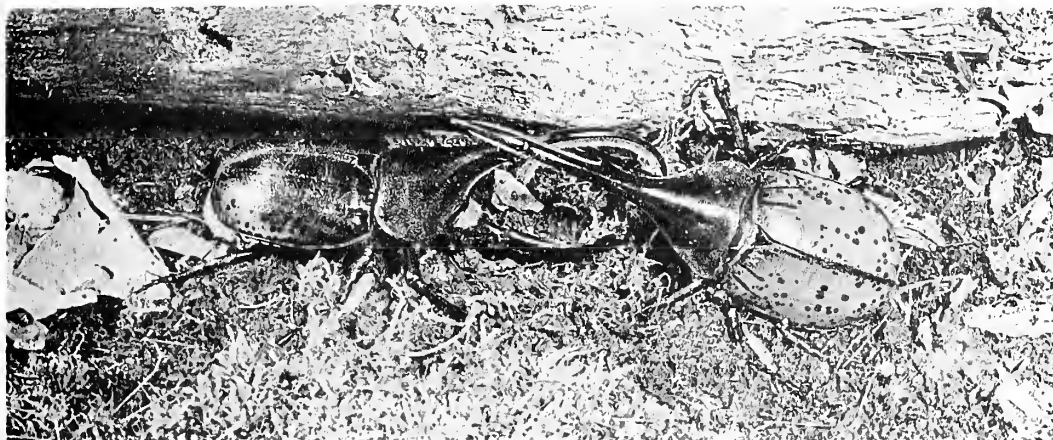

FIG. 3.

NOTES ON THE HERCULES BEETLE, *DYNASTES HERCULES* (LINN.), AT RANCHO GRANDE, VENEZUELA, WITH SPECIAL REFERENCE TO COMBAT BEHAVIOR.



FIG. 4.



FIG. 5.

NOTES ON THE HERCULES BEETLE, *DYNASTES HERCULES* (LINN.), AT RANCHO GRANDE, VENEZUELA, WITH SPECIAL REFERENCE TO COMBAT BEHAVIOR.



FIG. 6.



FIG. 7.

NOTES ON THE HERCULES BEETLE, *DYNASTES HERCULES* (LINN.), AT RANCHO GRANDE, VENEZUELA, WITH SPECIAL REFERENCE TO COMBAT BEHAVIOR.



FIG. 8.



FIG. 9.



FIG. 10.



FIG. 11.



FIG. 12.

NOTES ON THE HERCULES BEETLE. *DYNASTES HERCULES* (LINN.), AT RANCHO GRANDE, VENEZUELA, WITH SPECIAL REFERENCE TO COMBAT BEHAVIOR.

NEW YORK ZOOLOGICAL SOCIETY

General Office: 630 Fifth Avenue, New York 20, N. Y.
Publication Office: The Zoological Park, New York 60, N. Y.

OFFICERS

FAIRFIELD OSBORN, *President*
ALFRED ELY, *First Vice-president*
LAURANCE S. ROCKEFELLER, *Second Vice-president*
HAROLD J. O'CONNELL, *Secretary*
CORNELIUS R. AGNEW, *Treasurer*

SCIENTIFIC STAFF

General

JOHN TEE-VAN, *Executive Secretary*
WILLIAM BRIDGES, *Editor and Curator of Publications*

Zoological Park

LEE S. CRANDALL, *General Curator*
LEONARD J. GOSS, *Veterinarian*
BRAYTON EDDY, *Curator of Reptiles and Insects*
GRACE DAVALL, *Assistant to General Curator*

Aquarium

CHRISTOPHER W. COATES, *Curator and Aquarist*
JAMES W. ATZ, *Assistant Curator*
ROSS F. NIGRELLI, *Pathologist*
MYRON GORDON, *Geneticist*
C. M. BREDER, JR., *Research Associate in Ichthyology*
G. M. SMITH, *Research Associate in Pathology*
HOMER W. SMITH, *Research Associate in Physiology*

Department of Tropical Research

WILLIAM BEEBE, *Director*
JOCELYN CRANE, *Research Zoologist*
HENRY FLEMING, *Entomologist*
WILLIAM K. GREGORY, *Associate*
JOHN TEE-VAN, *Associate*
GLORIA HOLLISTER, *Associate*
MARY VANDERPYL, *Associate*

Scientific Advisory Council

A. RAYMOND DOCHEZ
ALFRED E. EMERSON
ALAN GREGG
K. S. LASHLEY
JOHN S. NICHOLAS
GEORGE M. SMITH

Editorial Committee

FAIRFIELD OSBORN, *Chairman*
WILLIAM BEEBE
WILLIAM BRIDGES
CHRISTOPHER W. COATES
LEE S. CRANDALL
BRAYTON EDDY
LEONARD J. GOSS

JOHN TEE-VAN

590.573

ZOOLOGICA

SCIENTIFIC CONTRIBUTIONS
of the
NEW YORK ZOOLOGICAL SOCIETY

VOLUME 32

Part 3

Numbers 13-17



Published by the Society
The Zoological Park, New York
November 12, 1947

CONTENTS

	PAGE
13. Notes on Ectoparasites from Venezuela (Siphonaptera and Acarina). By IRVING FOX. Text-figures 1 & 2.....	117
14. Preliminary Studies of the Effects of Sulfonamides on Fish and <i>Bacterium salmonicida</i> . By WALTER L. SMITH & ROSS F. NIGRELLI.....	121
15. <i>Nocomis</i> Nests Used by Other Breeding Cyprinid Fishes in Virginia. By EDWARD C. RANEY. Plate I.....	125
16. Sphingidae (Moths) of Rancho Grande, North Central Venezuela. By HENRY FLEMING.....	133
17. Scale Adaptation and Utilization in <i>Aesiocopa patulana</i> Walker (Lepidoptera, Heterocera, Tortricidae). By WILLIAM BEEBE. Plates I & II; Text-figures 1 & 2.....	147

13.

Notes on Ectoparasites from Venezuela (Siphonaptera and Acarina).¹

IRVING FOX.

Department of Medical Zoology, School of Tropical Medicine, San Juan, Puerto Rico.

(Text-figures 1 & 2).

[This is one of a series of papers resulting from the 45th and 46th Expeditions of the Department of Tropical Research of the New York Zoological Society, made during 1945 and 1946 under the direction of Dr. William Beebe with headquarters at Rancho Grande in the National Park of Aragua, Venezuela. The expeditions were made possible through the generous cooperation of the National Government of Venezuela and of the Creole Petroleum Corporation.]

[The characteristics of the research area are in brief as follows: Rancho Grande is located in north central Venezuela (10° 21' N. Lat., 67° 41' W. Long.), 80 kilometers west of Caracas, at an elevation of 1,100 meters in the undisturbed montane cloud forest which covers this part of the Caribbean range of the Andes. Adjacent ecological zones include seasonal forest, savanna, thorn woodland, cactus scrub, the fresh water lake of Valencia and various marine littoral zones. The Rancho Grande area is generally subtropical, being uniformly cool and damp throughout the year because of the prevalence of the mountain cloud gap. The dry season extends from January into April. The average humidity during the expeditions, including parts of both wet and dry seasons, was 92.4%; the average temperature during the same period was 18° C.; the average annual rainfall over a 5 year period was 174 cm. The flora is marked by an abundance of mosses, ferns, and epiphytes of many kinds, as well as a few gigantic trees. For further details, see Beebe & Crane, *Zoologica*, Vol. 32, No. 5, 1947. Unless otherwise stated, the specimens discussed in the present paper were taken in the montane cloud forest zone, within a radius of 1 kilometer of Rancho Grande.]

A small collection of ectoparasites made by Dr. William Beebe at Rancho Grande, 3,600 ft., Venezuela, in addition to providing several noteworthy host and locality records, includes a new species of flea and a new mite. Of the five species of fleas here reported upon, three belong to *Rhopalopsyllus*, a genus of particular medical interest because its members have been implicated on epidemiological grounds in the transmission of plague in Venezuela and other countries of South America (Hecht,

1942 and 1943; Fuller, 1942). All this material has been generously presented by its collector to the School of Tropical Medicine and is in the Entomological Collections of the Department of Medical Zoology.

FAMILY DOLICHOPSYLLIDAE.

Rhopalopsyllus steganus Jordan and Rothschild.

Rhopalopsyllus steganus Jordan and Rothschild, 1923, *Ectoparasites*, 1:338, Fig. 356.

Host. Squirrel (Cat. No. 30590), *Sciurus griseogena meridensis*, collected March 25, 1946.

Remarks. This species was originally described from one male taken at San Esteban, Venezuela, of *Sturnira lilium*. The present collection consists of one male and two females. (Cat. No. 46286).

Rhopalopsyllus peronis Jordan and Rothschild.

Rhopalopsyllus peronis Jordan and Rothschild, 1923, *Ectoparasites*, 1:340-342, Figs. 353, 359.

Host. Spiny mouse (Cat. No. 30944), *Heteromys anomalus*, collected August 14, 1946.

Remarks. The original description states, "Probably Venezuela or Columbia off *Heteromys melanoleucus*." The present collection consisting of four males and seven females (Cat. No. 46943) proves the occurrence of the species in Venezuela.

Rhopalopsyllus beebei, new species.

Male. Frontal tubercle prominent. Pre-antennal region of head with two rows of bristles, the upper row consisting of four bristles of which the one nearest the antennal groove is the largest; the lower row consists of three bristles of which the middle is the smallest. Two bristles present posterior to the eye, one on a level with its middle, the other considerably below it. Postantennal region with three rows of bristles. Labial palpus extending beyond the basal half of fore coxa. Hind tibia

¹ Contribution No. 778, Department of Tropical Research, New York Zoological Society.

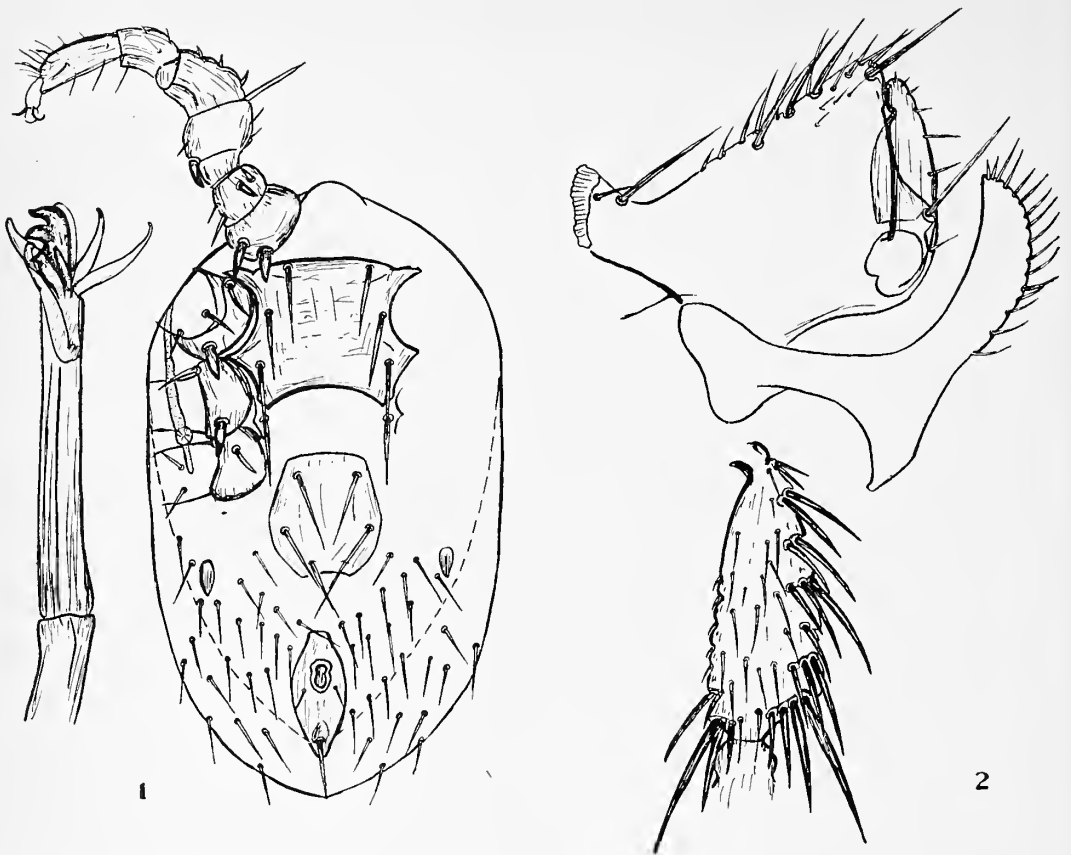

TEXT-FIG. 1. *Neolaelaps heteromyx*, new species. Female, ventral view, and chelicera.

TEXT-FIG. 2. *Rhopalopsyllus beebei*, new species. Male, modified segments and hind tibia.

(Text-fig. 2) differing from other species in that apically it bears a group of four stout bristles, and subapically a group of three such bristles. Longest bristle of hindtarsal segment I not reaching apex of segment II; longest bristle of hindtarsal segment II not reaching apex of segment III. Modified segments as in Text-fig. 2. Clasper triangular, bearing one large posteriorly directed bristle subapically, its tubercle not very near the apex; acetabular bristle well above the acetabulum. Movable finger wider basally than distally, its posterior margin with several faint bristles. Sternite IX without bristles basally, its posterior margin with 16 faint bristles distally, most of which are of about the same size. Below the stigma of tergite VIII are two bristles, a large one and a small one. Total length, about 2.5 mm.

Type material. Male holotype (Cat. No. 46731) from *Didelphis marsupialis* (Cat. No.

30830) at Rancho Grande, Venezuela, 3,600 ft. collected August 3, 1946, by Dr. William Beebe.

Remarks. This species seems to be near *R. roberti* (Rothschild) from which it is distinguished by details of the chaetotaxy of the legs and sternite IX.

FAMILY HYSTRICHOPSYLLIDAE.

Adoratopsylla bisetosa Ewing.

Adoratopsylla bisetosa Ewing, 1925, *Jour. Parasitol.*, 12:44-45.

Host. Opossum (Lot No. 30829), *Monodelphis brevicaudata*, collected July 30, 1946 (Cat. No. 46724 including three females of the above species); same host (Cat. No. 30955) collected August 16, 1946 (Cat. No. 46969 consisting of one female specimen of this flea).

Remarks. The original description was based upon males and females from the same host taken at Río Branco, Santa

Maria, Brazil. As far as can be ascertained, the species has not heretofore been reported from Venezuela.

***Tritopsylla intermedia* (Wagner).**

Typhlopsylla intermedia Wagner, 1902, *Soc. Ent. Rossica Horae*, 35:8, Pl. I, Fig. 9.

Host. Mouse opossum (Cat. No. 30564), *Marmosa demararae meridae*, collected March 8, 1946 (Cat. No. 46240 consisting of one male and one female specimen of the above flea); opossum (Cat. No. 30830), *Didelphis marsupialis*, collected August 3, 1946 (Cat. No. 46731 including one female specimen of this flea).

Remarks. This species is generally distributed in Central America and northern South America. Ewing and Fox (1943) erroneously synonymized *Tritopsylla* with *Doratopsylla*, but it is a perfectly good genus near *Leptopsylla*.

FAMILY LAELAPTIDAE.

***Neolaelaps heteromys*, new species.**

Female. Body oval in shape, longer than broad, well provided with prominent setae. Total length, not including capitulum, 1.2 mm.; width, .72 mm. Chelicera (Text-fig. 1) prominent with three large teeth, the middle the largest; basally with radiating transparent processes. Sternal plate (Text-fig. 1) lightly sculptured, broader than long. First pair of sternal setae on the anterior border of the sternal plate, second pair more or less level with the middle of coxa II; third pair on a level with the anterior border of coxa III; sternal pores placed as usual. Metasternal plates faint but their setae conspicuous. Genito-ventral plate of the shape shown in the figure, with three large setae. Metapodal plates moderate in size. Anal plate more or less lemon shaped with three setae, of which the most posterior is the largest and has its base in a defined sclerotized area. Anal pore situated closer to the anterior margin than to the posterior. Flanking the anal plate on each side are several irregular rows of large

setae. Peritreme not broad or prominent and not reaching beyond coxa I. Stigmal pore level with the posterior border of coxa III, distant from the lateral border of the body. Legs well provided with normal setae. Leg I bears on its coxa two large spine-like setae, on its trochanter one smaller spine-like seta, on its femur a single posteriorly directed spine-like seta. Coxae II and III each with a spine-like seta on the posterior border. Dorsal plate shield shaped, not covering the whole dorsal surface, provided with many long, stout and for the most part straight setae.

Type material. Female holotype and female paratype (Cat. No. 46943) selected from a series of eight females from *Heteromys anomalus* (Cat. No. 30944) collected at Rancho Grande, Venezuela, 3,600 ft., August 14, 1946, by Dr. William Beebe.

Remarks. This new species is similar to *N. magnistigmatus* (Vitzth) from which it differs in the shapes of the ventral plates as in other respects. The presence of three setae on the genito-ventral plate relates this new species to others in *Neolaelaps*, but the differences are so great that the former species will probably be regarded as of generic rank some day.

REFERENCES.

- EWING, H. E. and FOX, I.
1943. The fleas of North America. *U. S. Dept. Agric. Misch. Pub.*, No. 500: 1-142.
- FULLER, H. S.
1942. Notes on Neotropical Siphonaptera. *Rev. de Entomol. (Brasil)*, 13:39-44.
- HECHT, O.
1942. Las pulgas de las ratas en Venezuela. *Rev. Sanid. Asist. Social Venezuela*, 7:811-820.
1943. Consideraciones entomologicas a la epidemiologia de la peste bubonica de los roedores en Venezuela. *Ibid.*, 8: 1159-1162.



14.

Preliminary Studies of the Effects of Sulfonamides on Fish and *Bacterium salmonicida*.WALTER L. SMITH¹ & ROSS F. NIGRELLI.*Department of Biology, Washington Square College, New York University, and New York Aquarium, New York Zoological Society.*

INTRODUCTION.

Very little is known about the effects of sulfonamides on fish and their use in the prevention and treatment of bacterial and other parasitic diseases of fishes kept in captivity. Gutsell (1946, 1947) and Wolf (1947) have reported on the effectiveness of certain of these drugs on furunculosis, a fatal hemorrhagic disease of salmonoid fishes in aquaria and hatcheries, caused by *Bacterium salmonicida*. Both of these investigators found that best results were obtained with sulfamerazine. Weighed amounts of the drug per body weight or weight of food per day were given to fishes kept in hatcheries. By these methods the mortality due to furunculosis was rapidly and substantially decreased.

None of these experiments indicated whether the drugs used were prophylactic or curative in action. The present contribution deals with the toxic effects of sulfonamides on an aquarium fish, *Tilapia macrocephala* (Bleeker), and the action of these drugs on cultures of *Bacterium salmonicida* Lehmann and Newmann.

The writers wish to thank Dr. Mark Welsh, Lederle Laboratories Inc., for the sulfonamides and other chemicals used in these experiments and Professor William B. Sarles of the College of Agriculture, University of Wisconsin, for the culture of *Bacterium salmonicida*.

MATERIALS AND METHODS.

A. Bacteriological.

The drugs used were the sodium salts of sulfathiazole, sulfadiazine, sulfamerazine and sulfamethazine (Sulmet). Sterile tubes containing 0.8, 0.4, 0.2, 0.1 and 0.05% of the drugs in 5 cc. of nutrient broth were inoculated with *Bacterium salmonicida* (strain M-39) from an 18-hour-old broth culture. The degree of turbidity of each tube after 48 hours of incubation at room temperature was used as an indication of

¹ Based on material submitted in partial fulfillment of the requirements for the Master of Science degree at New York University.

the amount of growth that had taken place. Tubes which showed slight or no apparent growth were subcultured on nutrient agar slants and kept at room temperature for 24 hours.

B. Toxicological.

The toxic levels were obtained by placing the fish in various concentrations of the sulfonamides and observing their reactions over a period of time. The experimental fish, *Tilapia macrocephala*, was chosen because of its hardiness and availability. The specimens varied from 2½ to 3 inches in total length. For this initial test two-gallon tanks containing 5 liters of conditioned water were used. One fish was placed in each tank and a specific amount of sulfonamide was added. The temperature was maintained at about 75° F. and the pH was checked frequently.

To test the toxicity of the various drugs with more than one fish per tank, a second series was started in which five fish were placed in twenty-gallon tanks containing 62 liters of conditioned water and to each of which sulfonamide was added to make up a concentration of 0.80 mg. per cc. Bratton and Marshall's (1939) method, employing a photoelectric colorimeter, was used to determine the amount of sulfonamide present per cc. Because of the high concentration of drug the tests were made on a ¼ cc. of the water. The pH was checked with each reading.

A third series was used to check the changes, if any, in the level of the non-toxic concentrations of sulfathiazole in a tank containing a single *Tilapia*. The experiment was extended for 120 hours.

A control tank was maintained under the same conditions for each of the experimental series. The pH remained at 7.8 for the duration of the experiment (30 days) and only one death was recorded.

RESULTS.

A. Bacteriological.

The tubes of broth containing 0.1% or greater concentrations of sulfathiazole and

sulfadiazine showed no apparent growth. Sulfamerazine showed growth in tubes containing less than 0.2%. Growth occurred in tubes containing Sulmet at all concentrations. The results are tabulated in Table I.

TABLE I.

Action of various concentrations of sulfonamides on *Bacterium salmonicida*.

DRUG	% OF DRUG					Control
	0.8	0.4	0.2	0.1	0.05	
Sulfathiazole	O	O	O	O	XX	XXX
Sulfadiazine	O	O	O	O	X	XXX
Sulfamerazine	O	O	O	XX	XX	XXX
Sulmet	X	XX	XX	XX	XX	XXX

O, no growth; X, weak growth; XX, moderate growth; XXX, maximum growth.

Inoculation from the tubes which showed slight or no apparent growth were made on agar slants. These sub-cultures showed growth in all cases after a period of incubation of 24 hours at room temperature, indicating that the action of the drugs at these concentrations was bacteriostatic. The results are summarized in Table II. The symbols used to indicate the intensity of growth are the same.

TABLE II.

Results of subcultures from bacteriostatic growth of *Bacterium salmonicida*.

DRUG	% OF DRUG					Control*
	0.8	0.4	0.2	0.1	Control*	
Sulfathiazole	X	X	X	XXX	XXX	XXX
Sulfadiazine	X	X	X	XXX	XXX	XXX
Sulfamerazine	XX	XX	XXX	XXX	XXX	XXX

* The control nutrient agar slants were inoculated from the control nutrient broth tube.

B. Toxicological.

The results of the first series of tests on a single fish in two gallon tanks are summarized in Table III.

As shown in the Table, the non-toxic concentration for sulfathiazole was 0.1%, for sulfadiazine and sulfamerazine it was 0.5%, and for Sulmet it was 0.14%.

In a second series, five fish were placed in twenty-gallon tanks containing 62 liters of conditioned water. The drug concentration was 0.8 mg. per cc. This concentration remained more or less constant throughout the experiment. For Sulmet, a toxic reaction was obtained in 16 days, all of the fish dying. The drug concentration was 0.76 mg. per cc.; the pH shifted from 8.4 to 7.7. A toxic reaction resulted in 11 days for sulfamerazine. However, the drug concentration and pH remained constant. A toxic reaction was obtained in 20 days for sulfadiazine. There was a slight drop

in pH (7.8 to 7.4) but the drug concentration remained the same. No toxic effects were obtained with sulfathiazole. The fish were kept in the solution, which remained constant in its drug concentration, for more than 30 days. The pH shifted slightly downward from 8.2 to 7.9.

TABLE III.

Reaction of *Tilapia macrocephala* to sulfonamides.

DRUG	% SOL.	pH OF WATER	pH OF WATER PLUS DRUG	TIME OF DEATH
	1	7.4	9.0	24 hrs.
	0.5	8.0	8.5	3 hrs.
	0.25	7.4	8.0	24 hrs.
	0.1	7.3	8.0	non-toxic
Sulfadiazine	2.5	7.4	8.3	1½ hrs.
	2	—	—	48 hrs.
	1	7.4	8.4	48 hrs.
	0.5	—	—	non-toxic
Sulfamerazine	2	—	—	4½ hrs.
	1	7.4	8.5	4 hrs.
	0.5	8.0	8.1	non-toxic
Sulmet	2	—	—	5/6 hrs.
	1	7.4	9.1	1-1/6 hrs.
	0.5	—	—	1½ hrs.
	0.25	7.4	8.4	1½ hrs.
	0.14	8.0	8.9	non-toxic

Except for sulfathiazole, therefore, all of the other sulfonamides are toxic at this concentration.

A third series was studied to check the constancy of the drug concentration indicated above. A single fish in a two-gallon tank containing 5 liters of conditioned water was used. To these tanks sulfathiazole was added to make up a concentration of 0.8 mg. per cc. The results are tabulated in Table IV.

TABLE IV.

Concentration of sulfathiazole and pH at the start and termination of experiment (120 hrs.). One fish per tank.

Time in Hours	pH	TANKS				
		1*	2	3	4	5†
Start	8.3	8.3	8.4	8.5	8.0	8.5
	mg/cc	.69	.82	.82	.80	.80
24	8.3	.68	.82	.81	.80	.80
	8.3	.68	.82	.81	.80	.80
48	8.2	.69	.80	.80	.80	.80
	8.2	.70	.80	.82	.80	.80
96	7.8	.70	.80	.82	.80	.80
	7.8	.70	.80	.82	.80	.80
120	7.8	.70	.80	.80	.80	.80
	7.8	.70	.80	.80	.80	.80

* The lower concentration used in tank 1 was picked arbitrarily and has no significance except to indicate, as do the others, that the amount of drug present was the same throughout the experiment.

† Control tank, containing drug but no fish.

The common cause of fatality in all these experiments was hemorrhage apparent in the gills. Fishes kept in water with lethal concentrations of the drug appeared restless and attempted to jump out of the tank. As shown in Table III death occurred at various intervals. That pH was not a factor in these deaths can be seen from the fact that mortality also occurred in those tanks in which there was very little shift in the reaction. In addition, there were no deaths at the non-toxic levels even though there was a change in pH. Further studies on *Tilapia macrocephala* are being made on the effects of these drugs on the kidneys and other organs.

CONCLUSIONS.

Tests *in vitro* indicate that sodium sulfathiazole was most effective in producing a bacteriostasis of *Bacterium salmonicida*. The concentration which inhibited growth was also non-toxic for the test fish, *Tilapia macrocephala*. Since the drug concentration in the water remained approximately the same throughout the experiments, indicating that no absorption was taking place, it is believed that the sulfonamides were not acetylated. The liver of *Tilapia*, therefore, is like the liver of the dog in this respect (see Shay and co-workers, 1944). This may also be true for other teleosts. It seems that sodium sulfathiazole would be best used as a preventative rather than a curative drug for *Bacterium salmonicida*.

SUMMARY.

A study was made of the effects of the sodium salts of sulfamerazine, sulfathiazole,

sulfadiazine and sulfamethazine (Sulmet) on *Bacterium salmonicida*, the causative agent of furunculosis in salmonoid fishes. All four were found to be bacteriostatic in effect. Toxic reactions in the fish, *Tilapia macrocephala* (Bleeker), resulted from the use of three of the drugs in concentrations effective against *B. salmonicida*. Only sodium sulfathiazole proved non-toxic at a concentration that inhibited growth of this organism. There was no evidence that the fish absorbed the drug, since the concentration of the drugs in the water remained constant. It therefore appears that fish livers are unable to acetylate these compounds.

REFERENCES.

- BRATTON, A. CALVIN and MARSHALL, E. K.
1939. A New Coupling Component for Sulfanilamide determination. *J. Biol. Chem.*, 128: 537-550.
- GUTSELL, JAMES S.
1946. Sulfa Drugs and the Treatment of Furunculosis in Trout. *Science*, 104 (2691): 85-86.
1947. Furunculosis and Its Treatment. *The Progressive Fish-Culturist*, 9: 13-20.
- SHAY H., HORNAROV, S. A., SIPLET, H. and FELS, S.
1944. The role of the Liver and Gallbladder in the Excretion in the Dog of Some of the Newer Sulfonamides. *Gastroenterology*, 2: 432-436.
- WOLF, LOUIS E.
1947. Sulfamerazine in the Treatment of Trout for Furunculosis and Ulcer Disease. *The Progressive Fish-Culturist*, 9: 115-124.

15.

Nocomis Nests Used by Other Breeding Cyprinid Fishes in Virginia.

EDWARD C. RANEY.

Department of Zoology, Cornell University, Ithaca, New York.

(PLATE I).

INTRODUCTION.

The observations reported below were made during the period June 18-28, 1946, while the author was engaged in ichthyological studies of streams of the Piedmont and Coastal Plain in Virginia and North Carolina. A grant from the Trustee-Faculty Committee on Research, Cornell University, financed a large part of the field work and all specimens mentioned herein are deposited in the fish collection of that institution. Assistance was given by Dr. Ernest A. Lachner and Robert D. Ross.

Little has been recorded on the habits of many of the minnows, Cyprinidae, of the regions visited. Of interest is the discovery that the Carolina chub, *Nocomis leptcephalus* (Girard)¹, like other members of the genus, builds circular nests of small stones which are carried in the mouth of the male. Furthermore these nests are used as a spawning site by many of the other common minnows found in the same region. Similar nests built by the river chub, *Nocomis microgogon* (Cope), and the hornyhead chub, *Nocomis biguttatus* (Kirtland), in the late spring are a prominent feature of many streams of more northern and western drainages. Their common use as breeding places by several other minnows has been noted by Hankinson (1920, p. 8, and 1932, p. 317), Hubbs and Cooper (1936, p. 65), Greeley (1929, p. 172), Raney (1940a, p. 6; 1940b, p. 128; 1940c, p. 363), and Reighard (1943, p. 417). The species that most commonly use *Nocomis* nests are the common shiner, *Notropis cornutus* (Mitchill); rosy-face shiner, *Notropis rubellus* (Agassiz); stoneroller minnow, *Campostoma anomalum* (Rafinesque); and redbelly dace, *Chrosomus erythrogaster* (Rafinesque). Several other cyprinids, such as the fall fish, *Leucosomus corporalis* (Mitchill); the cutlips, *Eryoglossum maxillingua* (LeSueur); and the tongue-

tyed minnows, *Parexoglossum lauræ* Hubbs and *Parexoglossum hubbsi* Trautman, build similar structures which may also be used by some of the above mentioned fishes.

NESTS.

Nocomis leptcephalus ranges from the James River system of Virginia south through Georgia. It is one of the most common fishes found in Piedmont streams and also occurs less commonly in mountain creeks. Most observations of activity over *Nocomis* nests were made on June 21-22 in the Roanoke River system, Virginia, but the nests themselves were commonly observed in other more southern drainage systems. The problem of obtaining materials for nest building is solved in sandy Piedmont streams by searching the bottom over a large area to obtain hundreds of minute stones. These pebbles were deposited in a circular pile which varied roughly from 1 to 2 feet in diameter and 6 to 12 inches in height. The nests were usually located just above the break of the riffle. Less often they were found in slow riffles or in quiet water often under a low overhanging branch which offered some shelter. These nests were one of the most important spawning sites for other common cyprinids. Compared with more northern streams a striking parallelism was noted both in the type of fishes present and their precise location over the nests. For example, *Notropis cerasinus* (Cope) which in part replaces *Notropis cornutus* in the Roanoke River system, occupies the same territory an inch or so above the pebbles. *Chrosomus oreas* Cope swarms low over the nest and almost touches the stones just like *Chrosomus erythrogaster* and *Campostoma anomalum* in the north. *Notropis ardens* (Cope), like the more northern *N. rubellus*, holds the area high over the other fishes which may be present at the nest. Although not closely related these two minnows are elongate fishes that assume a reddish nuptial coloration and occupy a similar ecological niche at breeding time.

Cope (1869, p. 209) also observed these nests of *Nocomis* in July, 1867, in the head-

¹ This name is used only provisionally for the chub found in the Roanoke River system. It appears to be a much different fish than the blue chub, the true *Nocomis leptcephalus* (Girard), described from the Yadkin River system at Salem, North Carolina. The systematics of *Nocomis* are now being thoroughly studied by Dr. Ernest A. Lachner, Pennsylvania State College.

waters of the Roanoke River. However, he erroneously guessed that they had been built by suckers and also failed to correctly interpret the activities of the associated species. Local suckers do not build pebble nests but usually breed over gravel in moderate riffles. Cope noted that eggs were deposited beneath piles of stones and that various minnows gathered to eat them, and also observed territorial behavior in some species. Although he gave few details his brief remarks are significant and are here quoted except that the nomenclature is changed to bring it up to date: "Refulgent shoals of *Clinostomus vandoisulus* and *Notropis ardens ardens* would lie close to the heaps down the stream, and when startled by the approach of a stranger, would disappear like the passage of a stream of blood in the current; or the inquisitive *Chrosomus oreas*, in his harlequin hues, and the graceful *Rhinichthys atratulus*, would try to force away the pebbles and reach the coveted store, while pairs of a scarlet *Notropis cerasinus* would chase each other in and out, and by their superior size and activity keep up a perpetual commotion among the industrious party. The *Campostoma*, too, of pale tints, and painted fins, swimming in pairs on the bottom, would gather with ease whatever the stream carried from the burrowing *Chrosomus*."

TERRITORIAL BEHAVIOR.

On June 21, 1946, in Otter River, Roanoke River system, 4 miles northeast of Bedford, Bedford County, Virginia, three minnows, *Notropis cerasinus*, *Notropis ardens ardens* and *Chrosomus oreas*, were observed over a *Nocomis leptocephalus* nest. The stream was a rather fast falling, clear mountain brook about 75 feet wide on the average with long moderately fast riffles and short shallow pools. The temperature of the water was 70° F., and air 75° F., at 12:30 p. m. The nest was located near the head of a riffle in moderately swift water about 18 inches deep. The lower edge was lodged against a jutting slab of bed rock which projected about 10 inches above the stream bed and was obliquely located about 20 feet from the nearer bank. The small, flat pebbles were mostly from three-fourths to one and a half inch in diameter, were piled in a semi-circle, and reached to a height of about 8 inches against the downstream rock.

As the nest was approached about 10 male *Notropis ardens ardens* were seen facing upstream and jockeying for positions over the nest. This species was distinguished easily by the slender shape, a suffusion of reddish-purple over the back and sides of the body, and by a prominent patch of light colored nuptial tubercles on the top of the head. They were located 4 or 5 inches

above the stones of the nest. The largest males held the upstream positions while the smaller ones were forced to the apparently less desirable spots on the downstream and lateral boundaries of the nest. There was intense and constant competition for the entire nest area. The smaller males constantly attempted to better their positions by moving forward into the territory of another. Any aggressive move was immediately met by a short savage rush by an adjacent male. The smaller male usually gave ground and actual contact seldom resulted, although the sharp, forward pointing nuptial tubercles on the snout and rest of the head are ideally placed for offensive action. A male appeared to regard the area within 3 or 4 inches of his body as his territory to be guarded against intrusion by any other male of the same species. However, no attempt was made to drive away any of the swarm of male *Chrosomus oreas* which covered the nest immediately below them. Female *ardens* surrounded but were largely concentrated below and at the sides of the nest. When ready to spawn a female moved into the center of the nest. She appeared to collide momentarily with a male but the precise details of the breeding act were not clear. An outstanding characteristic of *ardens* was a notable lack of fear of observers standing only a few feet distant. Even after a seine was pulled over the nest the individuals that escaped immediately returned to carry on their nuptial activities. Despite their great nervous activity they were quite alert to floating objects. They quickly rose and engulfed any insect carried downstream by the current but rapidly returned to guard the same territory.

About 10 minutes after the nest was first observed a large male *Notropis cerasinus* assumed a position at the head of the nest. He was distinguished from *ardens* by his larger size, deeper body, greenish rather than red back, and by the less well developed tubercle patch on the head. Other male *cerasinus* soon moved in over the nest and established territories. They darted nervously about attempting to drive away the smaller male *Chrosomus* which were well established over the nest. However, they met with little success since the *Chrosomus* gave ground only temporarily. On the other hand, *cerasinus* males did not often clash with male *ardens* which were conspicuous just over them. They were easily frightened by sudden movements of an observer and on such occasions moved rapidly away from the nesting area. Female *cerasinus* occasionally appeared about the periphery of the nest but actual spawning was not seen. The behavior over the nest was in general much like that of a related species, *Notropis cornutus*, as reported by Raney (1940a, p. 8).

BREEDING OF *Chrosomus*.

About 20 brilliantly colored male *Chrosomus oreas* swarmed immediately above the pebbles of the same nest. They attempted to hold a small territory which consisted of an area about two inches to either side. The duller colored females were mostly concentrated downstream but a few constantly entered or passed through the nesting area. Upon sighting a female the male usually left his holding and followed her. If she remained quiet, 2 or sometimes 3 males would crowd close about her and spawn. Several males followed females for distances up to 10 feet from the nest only to return within a short time. Males dashed at each other in case of the intrusion of one upon the territory of another but much of the activity was of the ceremonial type described by Reighard (1910, p. 1128) for the creek chub, *Semotilus atromaculatus* (Mitchill). They were somewhat disturbed by the presence of observers but soon returned to the area.

Further observations were made on June 22, 1946, in another stream in the same drainage system, South Fork of Chestnut Creek, just north of Sydnorsville, Franklin County, Virginia. Here about 30 male *Chrosomus oreas* were crowded over a *Nocomis leptocephalus* nest that was located in quiet water about 10 feet above a riffle. A camera was set up on shore about four feet away from the nest and although the water was slightly turbid some photographs were obtained which show certain phases of their behavior. The brilliantly colored males were holding territories over the entire nest but were more crowded over the more desirable upstream slope where often a distance of only one or two inches separated them. Part of such a concentration over a section of the nest is shown in Pl. I, Fig. 1. The males fought to hold territories against infringement by other smaller males. Many females were seen usually on the downstream edge of the nest. Occasionally one moved up over the nest and was immediately joined by two males that took a position close to and on either side of the female. The spawning act occurred as they vibrated together, and its successful completion within a second was heralded by a rush of *Chrosomus* to the spot of spawning in search of eggs as shown in Pl. I, Fig. 2. The egg predators included the erstwhile parents and up to a dozen *Chrosomus* were seen standing on their heads eating the eggs which fell between the pebbles of the nest. Rarely spawning occurs with only one male taking part. He threw his caudal peduncle over that of the female and forced her against the bottom. Within a few minutes the flurry of egg eating ceased and the males returned to their ter-

ritories. At times a male followed a female or another male out of the nest. Occasionally a male appeared to tire of the activity of territory holding and went off downstream for several minutes. He was not observed to return to the same spot but forced his way into a position commensurate with his size and pugnacity.

During all this activity several other egg predators were searching over the surface of the nest. Small *Nocomis leptocephalus* and fantail darters, *Catnotus flabellaris* (Rafinesque), were seen moving slowly about and were not challenged by the male *Chrosomus*. After a considerable period several adult male *Notropis cerasinus* took up positions at the head of the nest and began their persistent but rather futile attempts to drive away the male *Chrosomus*.

Cope (1869, p. 234) reported that *Chrosomus oreas* deposits its eggs toward the end of July in the mountain streams forming the headwaters of the Roanoke River, in Montgomery County, Virginia. Nothing else has been published on the spawning habits of this species. However, Smith (1908, p. 13) made a thorough study of the breeding habits of the southern redbelly dace, *Chrosomus erythrogaster*, in Illinois during the last half of May and the first two weeks in June. He found them breeding in shallow riffles in very large schools that consisted of a far greater number of males. The actual pairing is usually like that of *oreas* described briefly above.

No adult *Nocomis* were observed working on or spawning over any nest, but it probably was a little late in the season for most of them. They also are more easily frightened by observers and it takes a long time to condition them so that they will return to a nest.

SEXUAL DIMORPHISM.

All three species, like other territory holding Cyprinidae, show marked sexual dimorphism. Male *Notropis cerasinus* are larger, more brilliantly colored, and have much better developed nuptial tubercles than females. The largest males are 3.5 to 4 inches in total length while the females rarely are longer than 3 inches. Nuptial males are brilliantly colored with reddish-purple on the sides except for the occasional scattered black scales that characterize this species. The cheeks and opercle are purple and the lips are red. The dorsum is dark with the mid-dorsal streak an iridescent green. All fins are reddish-purple with a milky white anterior border and a narrow clear edge on the posterior border of each fin. The base of the anal fin is milky white. Female *cerasinus* are silvery with some red about the snout and lips in an occasional individual. Large breeding tubercles are

scattered over the head and snout of male *cerasinus*. They are sharp-pointed and with a slight hook which is directed forward. A row of large tubercles line the lower jaw. Only slightly smaller ones are scattered over the back in front of the dorsal fin. Still smaller pearl organs are present on most of the scales. On the fins they are most pronounced on the dorsal surface of the pectorals. A scattering also occur on the upper surface of the pelvic fins, on the upper third of the caudal fin, and a few line the anterior and lateral aspect of the first dorsal fin ray. In female *cerasinus* all ripe or nearly ripe specimens also had nuptial tubercles developed but to a lesser extent in size and number. Fairly large, forward pointing ones are scattered over the top of the head and snout. Relatively few small ones line the scales on the back in front of the dorsal fin and the upper surface of the pectoral fins. The character of the tubercles constitutes one of the best differences between *Notropis cerasinus* and *Notropis cornutus cornutus* which is distributed from the James River system northward in the Atlantic coastal drainage. Female *cornutus* are almost always devoid of tubercles, and the male has fewer on the head and back. Those on the head of *cornutus* are erect in contrast to the forward hooked ones of *cerasinus*.

Male *cerasinus* also differ at least at the breeding time in possessing a smaller anal papilla which is non-protruding, while that of the female is quite swollen and protrudes posteriorly. The pelvic fins of the male are longer and when depressed extend well beyond the origin of the anal fin while the shorter pelvic fins of the female do not reach the anal fin origin. The pectoral fins are also longer in the male and reach well beyond the origin of the pelvic fins when depressed. In the female they are smaller and do not reach the pelvic fin origin.

Sexual differences in the stream-lined *Notropis ardens ardens* are of the same type. The male averages only slightly longer and reaches its maximum total length between 2.5 and 3 inches. Only a few females reach a length greater than 2.5 inches, and some were spawning at a length of 2 inches. The male at breeding time is very brilliantly colored a deep, reddish-purple on the body and fins. The dorsum and iris are also reddish in contrast to *N. cerasinus*. Female *ardens* are silvery colored. On the top of the head and snout the large breeding tubercles are closely placed and appear as a large light patch against the darker background of the rest of the head. These tubercles are sharp and pointed forward. They gradually diminish in size posteriorly on the body but extend to the origin of the dorsal fin. A few large ones line the chin. Smaller tubercles occur on the scales

on the anterior half of the body. Sharp pointed tubercles that are directed posteriorly line the rays on the upper surface of the pectoral fins. A single row is found on the first ray while a double row is present on the other rays except the last 3 or 4 rays which are naked. A few line the anterior and lateral edges of the first dorsal fin ray, and some are found on the first anal fin ray. In female *ardens* a few poorly developed ones are seen on the top of the head but do not break the surface. None were observed on the body or fins. In breeding males the anal papilla is small and does not reach beyond the anal fin origin. That of the female is large and swollen, and reaches posteriorly beyond the origin of the anal fin. The anal fin is inserted more anteriorly in the male. The distance from the hypural to origin of the anal fin goes 1.6 to 1.8 times in distance forward from the anal fin origin to the tip of snout while, in the female this distance goes 1.9 to 2.0 times.

Female *Chrosomus oreas* average slightly longer than males. The larger females and males range from 2 to 2.7 inches total length although some of each sex are mature at 1.5 inches. In this connection it is pertinent to note that the territory-holding instinct is less well developed in this and other cyprinids where the sexes are nearly equal in size than in those where the males are notably larger. A male *oreas* in high breeding color is one of the most brilliant vertebrate animals known. The lower sides and belly are blood red. The fins are yellow. The yellowish-brown dorsum is covered with large dark blotches (Figs. 1 and 2). The male has 4 very light spots which perhaps serve as recognition marks. They are located anterior to and just above the base of the pectoral fin; just below and behind the eye, above the opercle, and on the back at the origin of the dorsal fin. These are absent or very dull in the female and are not seen at a distance. The black underside of the head and the breast as well as the black lateral band on the body are much more intense in the male. Normally breeding females are rather dull colored and with little, if any, red and with small black spots on the back. However, one exceptional female with very large eggs was colored as brightly as any male, and also had well developed breeding tubercles. This assumption of the male nuptial color by the female apparently occurs occasionally in practically all cyprinids. The males have the head and body covered with small light colored pearl organs with the former being slightly larger. A double row of rather sharp tubercles line the upper edge of the second to fourth or fifth pectoral fin rays. A few scattered ones are found on the dorsal side of

the pelvic fins and along the lateral edge of the first dorsal fin ray. From 6 to 8 rows of comb-like tubercles line the breast on either side immediately posterior to the gill clefts. They are also present in the female but are smaller and not apparent except on close examination. Females also have small tubercles scattered over the head, dorsum and sides of body but none were observed on the fins. In the male the pectoral and pelvic fins are longer, reaching beyond the origin of the pelvic fins and anal fin respectively, while in the female neither of these points is attained. However, the female has a longer anal fin that is situated slightly more posteriorly on the body. In the male the anal papilla has a projecting tube on the median aspect of the posterior edge. The female lacks this posterior projection but the papilla is larger and has a median flap on the ventral side.

Nocomis × *Campostoma* HYBRIDS.

Six large specimens of an intergeneric hybrid, *Nocomis leptocephalus* × *Campostoma anomalum*, were collected on June 21, 1946, in the Roanoke River, 2 miles north of Allegheny Springs, Montgomery County, Virginia. At the same time numerous specimens of the parent species were taken. These hybrids were no doubt a result of a fortuitous combination of the sexual products as each of the parent species carried on normal spawning behavior over a nest of *Nocomis*. Cope (1869, p. 210), as quoted above, observed *Campostoma* over *Nocomis* nests in this region. In Michigan, Reighard (1943, p. 416) observed *Campostoma* carrying on spawning activities at the same time that *Nocomis micropogon* and two species of *Notropis* were breeding. Interspecific and intergeneric hybrids are known in several families of fishes² and some have been reported for the Cyprinidae. Other intergeneric hybrids involving either *Nocomis* or *Campostoma* have been recorded by Greeley (1938, p. 51) and Raney (1940d, p. 270).

A careful comparison of the hybrid with the parent species reveals they are intermediate in most structures. These results are in line with the findings of Hubbs (1940, p. 205) and have been confirmed in some other families of fishes by the results of laboratory matings. *Campostoma anomalum* is unique among minnows in having the long intestine coiled spirally about the air-bladder. In *Nocomis* the intestine is much shorter and the several loops lie entirely below the air-bladder. In the hybrid the intestine is intermediate in length. However, it is not coiled about the air-bladder,

but the ventrally placed loops come far up on either side of the air-bladder. The actual diameter of the intestine is also intermediate between the thin one of *Campostoma* and the relatively thicker intestine of *Nocomis*. The length of the air-bladder is also midway between the short one of *Campostoma* and the longer one of *Nocomis*. A well developed maxillary barbel is characteristic of *Nocomis* but is absent in *Campostoma*. The barbel came through in only one out of the six hybrids and is present on both sides and only slightly smaller than in normal *Nocomis*. It is generally true that the barbel does not appear in cyprinid hybrids when one of the parents does not possess it. A comparison of some other structural characters is presented in Table I.

Those characters that are common to the parent species are also possessed by the hybrid. For example, the peritoneum is black; anal fin rays 7; dorsal fin rays 8; pelvic fin rays 8-8; pectoral fin rays 16 or 17.

An examination of the gonads and nuptial tubercles yield some interesting points. The largest hybrid, 109 mm. in standard length, is a male with prominently developed tubercles. Indeed, it has the large, sharp-pointed ones on the top of the head of the type found both in *Nocomis* and *Campostoma*. On the back in front of the dorsal fin are a scattering of the smaller, rather blunt, tubercles that are found in breeding male *Campostoma* but which are absent in *Nocomis*. Numerous quite small tubercles are also present on the head and on the outer and upper surface of the pectoral fins. Slightly larger tubercles border the posterior edge of many of the scales along the sides. The testes are enlarged and were probably functional. Neither the dark bars to be found on the dorsal and anal fins nor the black spot on the caudal fin in breeding male *Campostoma* were seen on the male hybrid.

A small male, 83 mm. in standard length, shows the basal element of 17 large tubercles that never broke through the skin. They extend from the inner nasal region to the area midway between eye and occiput. Some very small tubercles are seen on the dorsal surface of the pectoral fins but are lacking elsewhere. The testes are little developed and this specimen had probably not matured and spawned.

The other 4 hybrids are females. The largest, 103 mm. in standard length, had well developed ovaries with a number of large normal-appearing eggs scattered through them. The bases of 12 large tubercles appear on the top of the head in the position described in the smaller male above. These are either scars or more prob-

² For a summary of investigations and further references on the subject of hybridization in fishes see Hubbs and Kuronuma (1942), Hubbs, Hubbs and Johnson (1943), and Hubbs, Walker and Johnson (1943).

TABLE I. COMPARISON OF THE CHARACTERS OF 6 SPECIMENS OF THE HYBRID *Campostoma anomatum* × *Nocomis leptocephalus* WITH THOSE OF THE PARENT SPECIES TAKEN IN ROANOKE RIVER, 2 MILES NORTH OF ALLEGHENY SPRINGS, MONTGOMERY COUNTY, VIRGINIA, ON JUNE 21, 1946.

Character	<i>Campostoma anomatum</i>	Hybrid	<i>Nocomis leptocephalus</i>
Cartilaginous pad on lower jaw	Well developed and separated from the lower lip by a groove. Pad protrudes well in front of lower lip	Somewhat developed and separated by a shallow groove from lower lip. Protrudes anteriorly only about half as far as in <i>Campostoma</i>	Not developed
Mouth, position of	Inferior	Intermediate	Subinferior
Ventral fin, location	Inserted farther forward; the distance from the posterior tip of hypural plate to origin of ventral fin, when measured forward, falls in front of tip of snout	Intermediate; the same distance, when measured forward, reaches a point well in front of nostril to a point beyond the tip of snout	Inserted more posteriorly; the same distance, when measured forward, reaches a point well behind nostril
Dorsal fin, location	Inserted farther forward; distance from posterior tip of hypural to origin of dorsal, when measured forward, reaches a point between the anterior nostril and tip of snout	Intermediate in five specimens; the same distance, when measured forward, reaches from a point in front of eye to the anterior nostril. In the sixth specimen, the distance reaches midway between the snout and anterior nostril and thus resembles <i>Campostoma</i>	Inserted more posteriorly; the same distance, when measured forward, reaches the eye
Scale rows Around body just anterior to dorsal fin In lateral line	44 to 48 47 to 51	33 to 35 42 to 45	28 to 31 39 to 41
Length of head in standard length	3.8-4.3 (mean 4.1)	3.8-4.0 (mean 3.9)	3.4-3.8 (mean 3.6)
Intestine Length	Greater. Length of stomach plus intestine, divided by total length, equals 5.4 to 6.7	Intermediate—equals 4.0 to 4.1	Smaller—equals 1.5 to 1.9

ably incipient tubercles which did not break through the outer skin. Some female *Nocomis* have been observed to have similar pearl organs but they have not been seen on female *Campostoma*. Two other females, 86 mm. and 83 mm. standard length, also had the same type of breeding tubercles on the top of the head. The former had medium sized eggs in rather large ovaries while the latter had only small eggs in poorly developed ovaries. The 4th female, 60 mm. long, had no tubercles and only very small eggs in undeveloped ovaries.

Additional ecological studies of *Nocomis* nests covering a period of at least one season's activity would yield further information of great interest.

SUMMARY.

1. The Carolina chub, *Nocomis leptocephalus*, a common minnow of the Piedmont streams of Virginia and North Carolina, builds a circular nest of pebbles in late June. They are similar to those constructed somewhat earlier in the year by other more northern and western species of *Nocomis*.

2. These nests are used as breeding sites by many other common minnows. In the Roanoke River system, Virginia, three cyprinids, *Notropis cerasinus*, *Notropis ardens ardens* and *Chrosomus oreas*, were holding breeding territories over one nest. Breeding behavior of *Chrosomus* was observed.

3. The three species show marked sexual dimorphism in such characters as size, coloration, development of nuptial tubercles, length of fins and the development of the anal papilla.

4. Six large specimens of an intergeneric hybrid, *Nocomis leptocephalus* × *Campostoma anomalum* were taken with many specimens of the parent species in the Roanoke River. They are intermediate in most structural characters. Some of the hybrids had well developed nuptial tubercles and judging from the appearance of the gonads were functionally mature earlier in the season.

BIBLIOGRAPHY.

- COPE, E. D.
1869. On the distribution of fresh-water fishes in the Allegheny region of southwestern Virginia. *Jour. Acad. Nat. Sci. Phila.*, (2) 6: 207-247.
- GREELEY, J. R.
1929. Fishes of the Erie-Niagara watershed. In: A biological survey of the Erie-Niagara system. Suppl. 18th Ann. Rept. N. Y. Conservation Dept., 1928: 150-179.
1938. Fishes of the area with annotated list. In: A biological survey of the Allegheny and Chemung watersheds. Suppl. 27th Ann. Rept. N. Y. Cons. Dept., 1937: 48-74.
- HANKINSON, T. L.
1920. Report on investigations of the fish of the Galien River, Berrien County, Michigan. *Occ. Pap. Mus. Zool. Univ. Mich.*, (89): 1-14.
1932. Observations on the breeding behavior and habitats of fishes in southern Michigan. *Pap. Mich. Acad. Sci., Arts, and Letters*, 15 (1931): 411-425.
- HUBBS, C. L.
1940. Speciation of fishes. *Amer. Nat.*, 74: 198-211.
- HUBBS, C. L. and G. P. COOPER
1936. Minnows of Michigan. *Bull. Cranbrook Inst. Sci.*, (8): 1-95.
- HUBBS, C. L. and K. KURONUMA
1942. An analysis of hybridization in nature between two species of Japanese flounders. *Pap. Mich. Acad. Sci., Arts, and Letters*, 27 (1941): 267-306.
- HUBBS, C. L., L. C. HUBBS, and R. E. JOHNSON
1943. Hybridization in nature between species of catostomid fishes. *Cont. Lab. Vert. Biol., Univ. Mich.*, 22: 1-76.
- HUBBS, C. L., B. W. WALKER, AND R. E. JOHNSON
1943. Hybridization in nature between species of American cyprinodont fishes. *Ibid.*, 23: 1-21.
- RANEY, E. C.
1940a. The breeding behavior of the common shiner, *Notropis cornutus* (Mitchill). *Zoologica*, 25 (1): 1-14.
1940b. Nests under the water. *Bull. N. Y. Zool. Soc.*, 43 (4): 127-135.
1940c. Reproductive activities of a hybrid minnow, *Notropis cornutus* × *Notropis rubellus*. *Zoologica*, 25 (3): 361-367.
1940d. *Rhinichthys bowersi* from West Virginia a hybrid, *Rhinichthys cataractae* × *Nocomis micropogon*. *Copeia*, 1940 (4): 270-271.
- REIGHARD, J.
1910. Methods of studying the habits of fishes, with an account of the breeding habits of the horned dace. *Bull. U. S. Bur. Fish.*, 28 (1908): 1113-1136.
1943. The breeding habits of the river chub, *Nocomis micropogon* (Cope). *Pap. Mich. Acad. Sci., Arts, and Letters*, 28 (1942): 397-423.
- SMITH, B. G.
1908. The spawning habits of *Chrosomus erythrogaster* Rafinesque. *Biol. Bull.*, 15:9-18.

EXPLANATION OF THE PLATES.

PLATE I.

Fig. 1. Part of a nest of *Nocomis leptocephalus* showing a group of male *Chrosomus oreas* scattered about. Each male may be easily identified by the prominent light spots on the back at the anterior base of the dorsal fin, just above the gill cover, and at the base of the pectoral fin. The large dark spots on the back are also characteristic of the male. Adjacent males aver-

age about 2 to 2.5 inches in total length and are two or three inches apart. Several dull colored females may be seen in the foreground.

Fig. 2. Same group of *Chrosomus* as above. In lower front are a group of males and females digging for eggs at a spot where spawning had just occurred. Other more distant males continue to guard territories.



FIG. 1.



FIG. 2.

NOCOMIS NESTS USED BY OTHER BREEDING CYPRINID FISHES IN VIRGINIA.



16.

Sphingidae (Moths) of Rancho Grande, North Central Venezuela.¹

HENRY FLEMING.

Department of Tropical Research, New York Zoological Society.

[This is one of a series of papers resulting from the 45th and 46th Expeditions of the Department of Tropical Research of the New York Zoological Society, made during 1945 and 1946 under the direction of Dr. William Beebe with headquarters at Rancho Grande in the National Park of Aragua, Venezuela. The expeditions were made possible through the generous cooperation of the National Government of Venezuela and of the Creole Petroleum Corporation.]

[The characteristics of the research area are in brief as follows: Rancho Grande is located in north central Venezuela (10° 21' N. Lat., 67° 41' W. Long.), 80 kilometers west of Caracas, at an elevation of 1,100 meters in the undisturbed montane cloud forest which covers this part of the Caribbean range of the Andes. Adjacent ecological zones include seasonal forest, savanna, thorn woodland, cactus scrub, the fresh water lake of Valencia and various marine littoral zones. The Rancho Grande area is generally subtropical, being uniformly damp throughout the year because of the mountain cloud cap. The dry season extends from January until April. The average humidity during the expeditions, including parts of both wet and dry seasons, was 92.4%; the average temperature during the same period was 18°C.; the average annual rainfall over a 5-year period was 175 cm. The flora is marked by an abundance of mosses, ferns and epiphytes of many kinds, as well as a few gigantic trees. For further details, see Beebe & Crane, *Zoologica*, Vol. 32, No. 5, 1947. Unless otherwise stated, the specimens discussed in the present paper were taken in the montane cloud forest zone, within a radius of 1 kilometer of Rancho Grande.]

CONTENTS.

	Page
I. Introduction	133
II. Comparison of Rancho Grande with other Faunas	135
A. Kartabo	135
B. Caripito	135
C. Hacienda La Trinidad	135
III. Relationship of Sphingidae to Season	136
IV. The Relative Abundance of Species in Various Faunas	136
V. Annotated List of Species	137
VI. References Cited	145

I. INTRODUCTION.

The spinx moths discussed in this paper were collected at Rancho Grande, Venezuela, during 1945 and 1946. Sixty-seven species came to the lights installed on the roof of the Department of Tropical Research laboratory—a result undoubtedly favored by the

fact that the lights were placed high and threw their beams far over the forest. The roof of the laboratory is about 50 feet from the ground.

Three 100-watt electric bulbs were used to attract the moths, one facing south, one west, and one north. White cement walls aided in reflecting the light and also served as a resting place for the moths. Since these walls were only seven or eight feet high, it was possible to reach any desired specimen.

The south and west bulbs which cast their light over a deep valley attracted many more specimens than the north bulb which faced the side of a mountain. Lights placed low, as on the forest floor, attracted comparatively few. On the other hand, a lamp resting on a 10-foot bank attracted three times as many moths, as well as more varied forms, than a light on the forest floor. On one occasion a gasoline lantern was placed on a partly cleared peninsula of land that jutted out over a deep, extensive chasm. The light in this instance was able to penetrate the near-by vegetation and reach over above the trees in the chasm. Collecting at this lantern was excellent compared with results from another lantern of the same strength placed at the base of the peninsula. The latter shed most of its light on a region at about the same level as itself.

In 1942 at Caripito, Venezuela, the same factor of height was important. Most collecting was done at a refinery which consisted of several levels or floors of open steelwork. The upper two levels, which were well above the surrounding forests, were always superior to the lower levels as a collecting site. The near-by forests were made up of seasonal forest and palm marsh, broken by patches of savanna one-quarter to one-half mile in diameter. Lanterns placed either in the center or on the edges of these grasslands were discouragingly unproductive, nor was collecting improved when the lights were placed among the trees but on the ground.

At Rancho Grande, when one stood on

¹ Contribution No. 779. Department of Tropical Research, New York Zoological Society.

the floor below the lights, it was possible to see the moths coming from the surrounding territory to the lights. These moths, making a steady stream on good nights, almost invariably rose to the lights. Occasionally one appeared to approach the lights horizontally. I do not recall ever seeing a moth drop down to the lights except when very near or when, having been disturbed near the light, it circled about before returning. Occasionally I have seen moths on the outer fringes of the lights, travelling at right angles to the beam, pass by without being attracted.

Two separate factors seem involved in this attraction to highly-placed lights: first, the majority of moths circulate about the tree-tops, and, second, they simply appear to prefer highly-placed lights.

Moths appear to vary in their selection of the amount of light desirable for their resting place. In particular, many sphinx will select a locality almost in darkness and away from the direct rays of the light. Thus, it is necessary to go searching with a flash-light in the darker regions and shadows in order to be sure of garnering all the sphinx.

It has always been a puzzle to me why moths are more numerous on damp nights or shortly after a rain. The usual explanation that the rain instigated the emergence of the moths has always seemed unsatisfactory. Rain in the morning, afternoon, or even in the early evening, might well stimulate many moths to emerge and consequently increase the total number available for that evening's collecting. It is not reasonable, however, to suppose that the length of time that a short, hard rain lasts is sufficient to allow the moths to emerge, unfold their wings and fly to the lights before the last drops of the shower have fallen.

Rancho Grande offered ideal conditions in which to observe the operation of this rain-and-moth coincidence. The most singular ecological fact was the frequent presence of a cloud cap along the top of the mountain ridges (Beebe and Crane, 1947). On nights when the collecting lights were enshrouded in this fog, the collecting, relative to the season of the year, was invariably good. It was good even if the moon were visible on the periphery of the fog area only half a kilometer away, provided it was dense and deep enough to obliterate the moon. On nights when the fog was so dense as to precipitate, provided the rain was not too driving and windswept, the lights seemed even more attractive. It was a marvel to watch the parade of moths, the sphinx, saturnids and larger moths being most noticeable, come to the lights through a rain that would drench a man in thirty seconds. Nevertheless, the moths would ar-

rive at the light-walls in excellent condition. It can not be that these moths had emerged during the short time the storm had lasted, nor that the high humidity had caused the greater activity. The humidity on other nights, when rain or fog were absent, frequently differed so little as to be negligible. Often, too, a near-by area would be covered by fog, presumably causing this theoretical greater activity, but the unfogged collecting lights would be barren.

Apparently there is some connection between the lights and the particles of water in the atmosphere. The lights on a clear night are clear-cut and sharply illuminate the surrounding area. Our lights could be seen for at least ten kilometers on a clear night. On a foggy night they could barely be perceived from a distance of three kilometers, but the illumination was diffused all about the source as if by a huge reflector. The bulbs or actual source of the light could only be inferred by the more intense radiance in the center.

In general, wind is a hindrance to collecting, though moths are able to reach the light in a surprisingly high wind. They show even greater ability to resist the wind at their resting places. The larger number of moths at Rancho Grande generally selected a wall which was at right angles to the wind.

A cool night, other conditions being favorable, brought out fewer specimens than a warm night.

The best collecting, from the point of view of number of specimens, is between the hours of 7 to 11 in the evening and from approximately 4 in the morning to just before the first flush of dawn. Other conditions may alter this to a limited extent. If it is clear until 9 p. m. and then the weather takes a turn for the better, entomologically, and becomes rainy and foggy, moths will continue to come in until midnight or 1 o'clock. During the two expeditions to Rancho Grande, I have never seen any significant improvement in numbers of moths after 1 p. m., regardless of how favorable climatic conditions might be. This does not mean that excellent and valuable specimens may not be captured out of hours, but that due to the diminished numbers coming to the lights, the possibilities are less. The hours that various species appear vary somewhat. *Amplipterus tigrina* among the sphinx seemed to be among the first arrivals, while some of the Sesiinae were invariably quite late. The few *Sysphinx* captured were taken in the morning hours at Rancho Grande—a fact that was not true at Caripito—while *Copiopteryx* came quite early in the evening. In general, the number of moths taken in the morning hours was not as great as in the evening,

though the effort of collecting in the morning was always amply repaid.

My thanks go to Dr. William Beebe for his valuable assistance and criticism during the writing of this paper.

II. COMPARISON OF RANCHO GRANDE WITH OTHER FAUNAS.

The sphinx moths from three other regions may be compared with the collection from Rancho Grande. At the first locality, Kartabo, British Guiana, the Department of Tropical Research operated a station for portions of eight years, and at the second locality, Caripito, Venezuela, for seven months. Ecologically, Kartabo and Caripito represent different but tropical areas, whereas Rancho Grande is a humid subtropical island within the tropics. The ecology of the first two regions has been published (Beebe, 1925 and 1943) and for a list of the sphinx moths taken, see Beebe and Fleming, 1945. The third region, Hacienda La Trinidad, is only nine kilometers from Rancho Grande but is ecologically very different. This collection was made by P. Cornelius Vogl over a period of 10 years from 1926 to 1936 (Vogl, 1944).

A. KARTABO.

With the exception of the Sesiinae, all the subfamilies of the Sphingidae were captured in greater numbers at Rancho Grande than at Kartabo. The difference between the number of species and specimens of Choerocampinae taken at Kartabo and those taken at Rancho Grande is most significant. Only 8 species and 14 specimens of Choerocampinae were taken at Kartabo, whereas 16 species and 901 specimens were captured at Rancho Grande. The Sesiinae from Kartabo are represented by 12 species not taken at Rancho Grande. Nine taken at Rancho Grande were not found at Kartabo. A significant difference also exists in the Acherontiinae. Only 10 species were captured at Kartabo, compared with 15 species at Rancho Grande.

B. CARIPITO.

This station was in northeastern Venezuela, at the southern foot of the mountains that lie along the northern coast of Venezuela. Rancho Grande is situated on this same range of mountains in central Venezuela, approximately three hundred and fifty miles to the west of Caripito.

The lights at Caripito attracted moths principally from a palm marsh interrupted by patches of savanna and a deciduous seasonal forest. At the outer edges, four to five kilometers away, evergreen and semi-evergreen seasonal forest prevails, with mangrove woodland along the San Juan River.

As I have said, the most significant difference between the Caripito-Kartabo and the Rancho Grande sphinx faunas is the large number of both species and specimens of Choerocampinae taken at Rancho Grande and their comparative rarity at Caripito. Sixteen species of Choerocampinae with over 901 specimens were taken at Rancho Grande while only 9 species and 17 specimens were captured at Caripito. Only the Acherontiinae and Ambulicinae were more numerous in species at Caripito. Of the Acherontiinae, one specimen of *Phlegethontius dilucida*, a most unusual record, and *Phlegethontius franciscae*, which was common at Caripito, were the only two species taken at Caripito and not at Rancho Grande. *P. franciscae* is closely related to *P. florestan* which was abundant at both localities, making the absence of *franciscae* at Rancho Grande even more significant.

Only 4 species of Ambulicinae were taken at Rancho Grande and all were common; 6 were taken at Caripito but only 2 were common. *Protambulyx strigilis* and *Amphypterus gannascus* are able to exist equally well in the cool, foggy climate of Rancho Grande and in the hot, relatively dry, climate of Caripito. *Amphypterus tigrina* is restricted to the upper cloud cap zone in the Rancho Grande region (Lichy, 1943). *Protambulyx eurycles* was more numerous at Rancho Grande than at Caripito.

The Sesiinae were more numerous at Rancho Grande than at Caripito. *Erinnyis ello* was the commonest species at both places, as it seems to be everywhere in the tropics. Every fifth specimen of Sphingidae taken at Rancho Grande was a member of this species. Neither *Hemeroplanes* nor *Perigonia*, both represented by 3 species at Rancho Grande, were found at Caripito.

The Philampelinae fauna is richer at Rancho Grande than at Caripito. However, one species, *Pholus capronnieri*, taken at Caripito was not found at Rancho Grande. Three species were taken at Rancho Grande and not at Caripito. *Pholus satellitia licaon* was abundant at both localities.

The abundance of the Choerocampinae at Rancho Grande and the scarcity at Caripito has already been commented upon. *Xylophanes chiron nechus* was the commonest choerocampid at both localities. Seven common or abundant species at Rancho Grande were not taken at Caripito. Two species from Caripito, *Xylophanes turbata* and *Xylophanes pistacina*, were not taken at Rancho Grande.

C. HACIENDA LA TRINIDAD.

In the years from 1926 to 1936, P. Cornelius Vogl (1944) made a collection at Hacienda La Trinidad approximately 9 kilometers from Rancho Grande. This region is 455 meters high and lies at the foot of the coastal range in the valley of

Lake Valencia. The lake area is largely given up to agriculture and dairying. While La Trinidad is actually in the rich, flat, alluvial lands, it abuts on the low, eroded, grass and chaparral covered mountain savanna (see Beebe and Crane, 1947). This region is very different from Rancho Grande. It is lower, warmer, drier, and the agriculture and dairying have greatly altered the original flora and moisture-retaining properties of the soil.

A total of 46 species was captured at Hacienda La Trinidad over an eleven-year period in comparison with 67 species taken at Rancho Grande in one six-months period. However, the following 12 species were taken at the Hacienda, but not at Rancho Grande: *Phlegethontius hannibal*, *Isognathus caricae*, *Pachylia syces*, *Leucorhampa triptolemus*, *Madoryx oiclus*, *Madoryx bubastus*, *Hemeroplanes pan*, *Eupyrrhoglossum sagra*, *Sesia tantalus*, *Sesia titan*, *Pholus adamsi* and *Xylophanes turbata*. *Pholus adamsi* and *Xylophanes turbata* are listed as rare and *Leucorhampa triptolemus* and *Madoryx bubastus* as uncommon. *Madoryx oiclus* has been reported from various localities in Venezuela by Rene Lichy (1944) but not above 700 meters altitude. *Isognathus rimosa papayae* was uncommon at the Hacienda but common at Rancho Grande.

III. RELATIONSHIP OF SPHINGIDAE TO SEASON.

The following tables are self explanatory. Table II shows plainly that there are two main flights of Sphingidae, one in April and May and the other in July. The first flight is the larger, as all subfamilies except one, the Ambulicinae, are more numerous in April and May than in any other month. The Ambulicinae, on the other hand, were more numerous in July. The Sesiinae and Choerocampinae were the dominant subfamilies.

Table I tabulates the species and corroborates the comments concerning Table II. April shows a sharp increase over March in the number of species and the number of moths reaches its zenith in May with 48 species of sphinx caught at the lights. As shown in Table II, another increase after a slack period occurs in July. In August, interestingly enough, a large number of species was captured although the number of specimens was moderate. The two dominant subfamilies in number of species are the Sesiinae and Choerocampinae.

As regards rainfall, the number of specimens does not increase proportionally to the amount of rain. The rain may go on increasing in amount, but after the first few weeks, the moths reach their maximum numbers. The change in average temperature between March and April amounted to only 1.2° C., which, of course, is not of sufficient

magnitude to account even in part for their mass emergence. As a matter of fact, the average temperature was lower during the second season, July and August, than in March.

TABLE I.
Number of Species Taken Each Month
in 1946.

	Acherontinae	Ambulicinae	Sesiinae	Philampelinae	Choerocampinae	Total for Month
March	5	3	5	3	9	25
April	8	4	12	5	12	41
May	9	4	16	5	14	48
June	8	4	10	7	11	40
July	9	4	14	6	13	46
August	10	4	12	7	14	47
Total for Six Months	15	4	24	8	16	67

TABLE II.
Number of Specimens Taken Each Month
in 1946.

	Acherontinae	Ambulicinae	Sesiinae	Philampelinae	Choerocampinae	Total for Month
March	42	14	16	12	27	111
April	219	25	311	148	214	917
May	78	26	305	61	176	646
June	105	23	134	23	145	430
July	102	68	113	31	223	537
August	65	43	78	40	116	342
Total for Six Months	611	199	957	315	901	2,983

IV. THE RELATIVE ABUNDANCE OF SPECIES IN VARIOUS FAUNAS.

The generalization is often made that in the tropics a large number of species and but few individuals of each species are present, but this is not true of the sphinx taken at the lights of Rancho Grande.

Certainly it is true that a greater number of species are present in the tropics than in the temperate zone. The records from New York City and vicinity list only 46 species of sphingids and some of these are vagrants which have wandered or have been blown from the south, but in a six-months period at Rancho Grande 67 species were collected, not one of which would appear to be other than indigenous to the region. Thus, while we could separate the tropical and temperate faunas from one an-

other on the basis of the number of species, a different picture is revealed when the relative abundance of each species is determined.

If we consider as common these species of which more than 10 specimens were taken during the six months of collecting at Rancho Grande in 1946, we discover that 37 (55%) of the 67 species are common. These 37 species account for 2,866 (96%) of the 2,983 specimens captured. Thirty (45%) species are distributed variously among the remaining 117 specimens. Eight (12%) species may be termed abundant, as more than 100 specimens of each were captured and account for 64% of the specimens obtained. The average number of specimens per species is 44—and if we exclude the abundant species, 18.

It is difficult to compare other regions with Rancho Grande in the same terms, as I have not been able to find other lists in which a definite effort was made to record every specimen of sphinx that came to the lights. However, percentages based on the collection made at Caripito in 1942 are reasonably close, for while many specimens of the common species were disregarded by the collector, the rarer and less common species were collected assiduously. Eleven (22%) of the 51 species taken at Caripito were common, and 78% were rare.

Moss (1920, p. 335) at Pará classified relative abundance under four heads and considered approximately 22 (24%) species to be common or abundant. However, since he does not state how many specimens are the basis of each division, it is difficult to align his categories with mine. It seems probable that part of his "hidden but not rare" group would fit in the lower part of my "common" series.

I have been unable to discover any comparable list for the temperate zone, but 20% to 25% of the species of sphinx found in the northeastern part of the United States may be considered common and the remainder rare or occasional.

A list of Noctuidae was assembled by Walden (1937) in Kansas, and while he used bait rather than light, it is possible to compare the relative abundance of the species within each system. His trap, which was in operation for 2,615 nights, captured 14,741 specimens of 72 species. He excluded the small noctuids and catocalas in his counts. Fifty-four specimens would bear the same relation to his total catch as 11 specimens to the Rancho Grande total. By such a comparison, 21 (20%) species in the temperate zone were common and represented 14,403 (98%) of the specimens, and 80% were rare or occasional.

The collecting at Kansas and Rancho Grande was total and not selective, and

therefore it is possible to present the comparisons in another way. Since 72 species were captured at Kansas and 67 species at Rancho Grande, 7 species in each locality represent approximately 10%. The commonest 7 species in Kansas compose 75% of the total catch there, and at Rancho Grande the 7 commonest represent 60%. Thus, in these two localities only 10% of the species make up well over half of the population.

It is not possible to separate the sphinx faunas of the tropics from those of the temperate zone on a basis of the percentage of rare and common species. At Rancho Grande, as a matter of fact, the number of common species of sphinx was greater than the uncommon species. The faunas of Pará, Caripito (and to this the collection the Department made at Kartabo can be added), the northeastern United States and the noctuid collection at Kansas, have the proportion of approximately one common species to three which are rare or occasional. The sphinx fauna at Rancho Grande is unusual in that the proportions are about equal.

The above statements are dependent upon the truth of the assumption that the sphinx attracted to the lights reflect to a reasonable extent the actual number of species and specimens living in a natural state.

V. ANNOTATED LIST OF SPECIES.

SPHINGIDAE.

The most abundant species is *Erinnyis ello*; the number of specimens captured is more than double that of any other species. The four species next most abundant are, in order, *Xylophanes chiron nechus*, *Phlegthontius florestan*, *Pholus satellitia licaon* and *Herse cingulata*.

In the following section, the percentages given after the designations "Abundant," "Common," etc., express the proportion of specimens of the respective species to the total number of specimens (3,983) of Sphingidae captured in 1946 *only*. While the Department of Tropical Research was based at Rancho Grande for parts of two years, 1945 and 1946, the collecting done in 1946 was spread over a greater number of months and an effort was made to record all of the Sphingidae arriving at the lights during collecting hours.

My terms for designating comparative abundance of specimens are:

Abundant	101 or more specimens
Common	11 to 100 specimens
Occasional	5 to 10 specimens
Rare	2 to 4 specimens
Unique	One specimen

These terms similarly refer only to specimens taken in 1946.

In the section which follows, when figures

are placed in parentheses after the dates, they refer to the number of specimens taken on that date. A date not followed by a parenthetical figure means that only one specimen was captured.

ACHERONTIINAE.

One out of every five specimens of Sphingidae captured was an acherontiid. The total was 611. *Herse cingulata* and *Phegethontius florestan*, 2 out of the 15 species taken, totalled 443 specimens or 72% of the subfamily.

Herse cingulata (Fabricius).

Abundant (7.04%).

In 1945, 125 specimens:

May 12, 15 (2), 16, 22, 28.

June 11 (5), 12 (2), 13 (3), 14 (2), 16, 27 (11).

July 1 (5), 3 (42), 4 (3), 5 (3), 6, 11 (19), 12 (5), 14, 16 (16).

In 1946, 210 specimens:

April 17, 18 (4), 21 (3), 22 (3), 30 (3).

May 6, 14, 15, 22 (8), 26 (6).

June 16 (7), 21, 22 (14), 24, 25 (3), 26, 27 (20), 30 (8).

July 1 (21), 4 (2), 5, 16 (3), 18 (2), 19 (19), 20 (12), 21, 22 (4), 24 (2).

August 14 (31).

One of the commonest species of Sphingidae at Rancho Grande. Distributed throughout tropical and subtropical America and occurs as a straggler as far north as Canada.

Cocytius cluentius (Cramer).

Common (.6%).

In 1945, 12 specimens:

May 5.

July 3 (3), 14, 16 (4).

In 1946, 18 specimens:

April 21, 22 (3).

June 22, 26 (2).

July 19 (2), 21, 26.

August 4, 9, 14 (4), 18.

Generally distributed from Mexico to southern Brazil.

Cocytius beelzebuth (Boisduval).

Unique (.03%).

In 1946, 1 specimen:

May 7.

Distributed from Central America to South Brazil.

Cocytius duponchel (Poey).

Common (.6%).

In 1945, 11 specimens:

June 27.

July 5, 11 (2), 12 (2), 16 (4).

In 1946, 18 specimens:

May 22 (2).

June 20, 26, 27 (2).

July 2 (2), 16, 18, 19, 22.

August 8, 13 (2), 14 (3).

Widely distributed in the neotropics.

Cocytius anteus medor (Cramer).

Occasional (.16%).

In 1945, 7 specimens:

June 4.

July 11, 14, 16 (4).

In 1946, 5 specimens:

May 25.

June 22.

July 16.

August 13, 14.

Occurs during the wet season but only in very moderate numbers. Tropics and subtropics.

Cocytius lucifer Rothschild & Jordan.

Unique (.03%).

In 1946, 1 specimen:

June 29.

Generally distributed in the neotropics.

Amphimoea walkeri (Boisduval).

Rare (.13%).

In 1946, 4 specimens:

April 22.

June 17.

August 18, 19.

Since this species occurs throughout a number of months, it is curious that no specimens were captured in 1945. This species often makes a vociferous squeak similar to some of the Cerambycidae when captured. Widely distributed in the neotropics.

Phegethontius sexta paphus (Cramer).

Rare (.13%).

In 1946, 4 specimens:

May 25, 27.

June 18.

July 26.

Distributed from Central America to Argentina.

Phegethontius diffissa tropicalis (Rothschild & Jordan).

Common (.8%).

In 1945, 2 specimens:

May 20.

July 5.

In 1946, 24 specimens:

March 28, 30, 31.

April 17, 19, 21, 24 (2), 26 (2).

May 6, 7 (2), 10, 13 (2).

June 18, 21, 22, 26.

July 1 (2).

August 18 (2).

Generally distributed throughout our whole stay in 1946, but only one or two individuals on any one night. Appears to be restricted to tropical South America.

Phegethontius scutata (Rothschild & Jordan).

Common (1.47%).

In 1945, 12 specimens:

May 9, 15, 22.

June 14.

July 3, 5, 11, 12, 14 (3), 16.

In 1946, 44 specimens:

March 7.

April 17 (2), 18 (2), 19, 20, 21 (3), 23, 30 (3).
 May 4, 5, 8 (2), 14, 17, 18, 21, 22, 23, 30.
 June 16, 20, 26 (2), 27 (2), 29 (5).
 July 1 (3), 16, 19, 21, 25.

Specimens were captured every month except August. Distributed in northern and western South America.

Phlegethontius ochus (Klug).

Unique (.03%).

In 1946, 1 specimen:
 August 18.

Distributed from Mexico to northern South America.

Phlegethontius rustica rustica (Fabricius).

Rare (.13%).

In 1945, 1 specimen:
 July 12.

In 1946, 4 specimens:
 July 16, 20, 22.
 August 14.

All specimens were taken long after the rainy season had started. A larva was obtained on May 10 on garbancillo (*Lithospermum mediale* Johnston). This is a species of Boraginaceae native to the Andes but horticulturally used as a hedge plant in many parts of Venezuela. The larva pupated on May 26 and emerged as an adult on June 16. Moss (1920) figures two larvae of this species which occurred on different plants. Our larva resembles his drawing on pl. 2, fig. 1a, except in being darker and in lacking the grayish-white speckling in the ground color.

Generally distributed in tropical and sub-tropical America.

Phlegethontius albiplaga (Walker).

Common (.97%).

In 1945, 2 specimens:
 May 22.
 July 11.

In 1946, 29 specimens:
 March 22 (2), 31.
 April 15, 16, 21 (3), 22 (3), 24 (2), 26.
 May 5, 6, 7, 21.
 July 19 (2), 21.
 August 3, 14, 18 (4), 19.
 September 3.

Conspicuously absent during the month of June. Distributed from Mexico to southern Brazil.

Phlegethontius lichenea (Burmeister).

Common (.5%).

In 1945, 7 specimens:
 June 4.
 July 5, 9 (2), 11 (2), 16.

In 1946, 15 specimens:
 March 27, 30 (3).
 April 18 (4), 19 (2), 20 (2), 24.
 July 16.

Widely distributed from Mexico to Argentina.

Phlegethontius florestan (Cramer).

Abundant (7.8%).

In 1945, 40 specimens:

April 5, 6 (2), 7, 9 (4), 12 (2), 18 (3).
 May 2 (2), 3, 10 (2), 11, 13, 14 (5), 15 (5), 19, 20 (2), 22 (3).
 July 12.

In 1946, 233 specimens:

March 17, 22, 25 (2), 26 (2), 27 (2), 28 (3), 29, 30 (11), 31 (6).
 April 4, 16 (7), 17 (15), 18 (34), 19 (12), 20 (17), 21 (14), 22 (17), 23 (12), 24 (18), 26 (6), 30 (10).
 May 4 (2), 5 (8), 6 (10), 7, 10 (3), 13 (3), 14 (2), 21 (3), 22, 23.
 June 30.
 July 17.
 August 14, 16, 18, 19, 26.

Larvae were found on garbancillo in June. Adults emerged in early August. A very abundant species at Rancho Grande. Widely distributed throughout tropical America.

AMBULICINAE.

Only 4 species of this subfamily were found at Rancho Grande, but each was common. A total of 199 (.07%) out of 2,983 sphinx specimens were captured.

Protambulyx eurycles (Herrich-Schäffer).

Common (.87%).

In 1945, 12 specimens:

June 2, 4, 11, 16.
 July 1 (2), 5, 9, 11 (3), 16.

In 1946, 26 specimens:

March 22, 30.
 April 20.
 May 10, 18 (2), 25.
 June 16 (2), 21, 26, 27.
 July 1 (4), 16 (2), 19, 26 (2).
 August 11, 12, 13, 18 (2).

Taken during every month of our stay. Distributed throughout tropical South America.

Protambulyx strigilis (Linnaeus).

Common (2.24%).

In 1945, 29 specimens:

June 4, 24.
 July 1, 5, 11 (7), 12 (12), 14 (6).

In 1946, 67 specimens:

April 18.
 May 10, 18, 21, 25, 28, 29.
 June 18, 22, 26 (3), 29 (2).
 July 1 (2), 2 (7), 13, 14 (2), 16 (2), 19 (6), 20 (6), 21 (8).
 August 5 (2), 13 (6), 14 (6), 18 (2), 19 (3).

While this species occurred each month of our collecting, the major emergence was in the latter part of July and August. Widely distributed in the American tropics.

Amphypterus gannascus (Stoll).

Common (1.5%).

In 1945, 59 specimens:

April 5, 6, 8, 9.
 May 12, 22 (2), 28 (2).
 June 2, 12 (3), 13, 16 (2), 27, 28, 29.

July 1 (7), 2, 3 (2), 5 (2), 8 (3), 9 (2), 10, 11 (6), 12 (7), 14 (2), 16 (7).

In 1946, 45 specimens:

March 8, 22, 25 (2), 29.

April 9, 14, 21, 22, 24 (4).

May 7, 14, 21 (3), 25.

June 21, 22 (3), 26 (2), 27.

July 1, 19 (3), 20, 21 (2), 22, 24, 26.

August 5, 7, 8, 13, 18 (3), 19 (2).

This species was more plentiful in 1945 when many of the specimens were disregarded, than in 1946 when all were recorded. Widely distributed throughout the American neotropics.

Amplipterus tigrina (Felder).

Common (2.03%).

In 1945, 30 specimens:

Dry season form *A. t. tigrina* (Felder):

April 5, 13.

May 11, 15.

Wet season form *A. t. simaea* Lichy:

June 1, 28 (2), 29 (3), 30.

July 1 (4), 4 (3), 5, 6 (2), 8, 10, 11 (3), 14, 16 (2).

August 1.

In 1946, 61 specimens:

Dry season form:

March 7, 22, 30 (4).

April 7, 15, 16 (2), 17 (3), 18, 19, 21 (4), 24.

May 4, 7 (2), 18, 25.

Wet season form:

March 30.

May 7 (2), 8, 16, 22, 24.

June 16 (2), 18, 20.

July 16, 17, 18, 20, 21 (4), 22 (2), 24 (3), 26 (2).

August 16 (4), 17, 18 (4), 19.

Distributed in tropical South America.

SESIIINAE.

This is the largest subfamily in the western hemisphere with approximately 100 species described. At Rancho Grande we took 24 species. One species, *Erinnyis ello*, was the most abundant sphinx representing 63% of the specimens of this subfamily captured.

Pseudosphinx tetrio (Linnaeus).

Common (1.87%).

In 1945, 16 specimens:

June 1, 11, 12, 27 (2), 28 (2).

July 1 (2), 4, 12 (5), 14.

In 1946, 56 specimens:

March 26.

April 20, 21 (2), 22 (2), 30 (2).

May 6, 18 (2), 21 (4), 25 (9), 28 (6).

June 1, 16, 22 (8), 26 (5), 27 (2).

July 1 (2), 2, 19, 20.

August 14 (3), 18.

Occurred every month of our stay. Distributed from Mexico to Argentina.

Isognathus swainsoni Felder.

Unique (.03%).

In 1946, 1 specimen:

July 21.

This is the most northwestern record for the species. It is listed in the literature as

occurring from Surinam to south Brazil though we captured the species at Kartabo and it was common at Caripito.

Isognathus scyron (Cramer).

Unique (.03%).

In 1945, 1 specimen:

July 5.

In 1946, 1 specimen:

August 18.

Distributed from Venezuela to Pará.

Isognathus rimosa papayae (Boisduval).

Common (.46%).

In 1945, 2 specimens:

July 3, 11.

In 1946, 14 specimens:

May 21, 25.

July 16 (5), 19 (2), 20 (2).

August 14, 18, 19.

Distributed in Venezuela and Guiana.

Erinnyis alope (Drury).

Common (2.51%).

In 1945, 69 specimens:

June 4 (3), 13, 27 (5), 28 (2).

July 1 (2), 2, 3 (25), 4, 5 (2), 8, 11 (16), 12 (4), 16 (6).

In 1946, 75 specimens:

April 21 (5), 22 (2), 23, 30 (4).

May 5, 7, 18, 21 (3), 25 (3), 28, 29.

June 1, 16, 18, 21 (6), 22 (3), 26 (3), 27 (4), 29.

July 1 (2), 2, 6, 14, 16, 19 (10), 20 (2), 24.

August 13, 14 (10), 18 (2).

Distributed throughout the American tropics and subtropics.

Erinnyis lassauxi (Boisduval).

Common (.6%).

In 1945, 2 specimens:

form *lassauxi*:

July 14.

form *omphaleae*:

July 10.

In 1946, 18 specimens:

form *lassauxi*:

March 9.

form *omphaleae*:

May 25.

August 14.

form *impunctata*:

May 25.

June 22, 29.

July 1(2), 2, 16, 20, 21 (2), 22, 25 (2).

August 14 (2).

Distributed in tropical and subtropical America.

Erinnyis ello (Linnaeus).

Abundant (20.34%).

In 1945, 49 specimens:

March 27.

April 26.

May 9, 10, 20, 22 (2), 28 (6).

June 4 (8), 10 (2), 11 (3), 13, 27 (2).

July 1 (12), 3 (7), 11.

In 1946, 607 specimens:

March 7, 25 (5), 27, 28 (2), 30, 31.

April 17, 18 (12), 19 (6), 20 (7), 21 (77), 22 (139), 23 (4), 24 (7), 30 (19).

May 5, 6 (10), 7 (12), 8, 13 (20), 14 (14), 18 (44), 21 (15), 22 (8), 24 (24), 25 (6), 26 (34), 28 (8), 29 (2), 30.

June 16 (6), 18 (2), 21, 22 (10), 24, 25 (5), 26 (15), 27 (8), 28 (4), 30 (3).

July 16, 18 (2), 19 (11), 20 (9), 21 (5), 22 (4).

August 13, 18, 26 (26).

The most abundant species at Rancho Grande. One out of every five specimens of sphinx was this species. While indigenous in the American tropics and subtropics, it wanders as far north as Canada.

Erinnyis oenotrus (Cramer).

Common (1.2%).

In 1945, 10 specimens:

May 20.

June 4 (2), 11 (4), 27.

July 1, 4.

In 1946, 36 specimens:

February 25.

March 6, 7.

April 18 (2), 21 (2), 24.

May 6, 14, 18, 19, 25 (5).

June 16, 21 (2), 22 (4), 26 (3).

July 2 (3), 21 (2).

August 13 (2), 14 (2).

Distributed throughout the American tropics and subtropics.

Erinnyis crameri (Schaus).

Common (1.91%).

In 1945, 36 specimens:

May 28 (3).

June 4, 11 (3), 17.

July 1 (2), 3 (3), 4 (2), 5 (3), 8, 11 (9), 12 (2), 16 (6).

In 1946, 57 specimens:

April 3, 24 (2).

May 14, 18 (4), 21 (3), 25 (19), 28.

June 16, 22 (3), 25, 26 (8), 27.

July 1 (2), 2 (2), 19 (5), 22, 26.

August 14.

Found throughout tropical and subtropical America.

Erinnyis obscura obscura (Fabricius).

Occasional (.26%).

In 1945, 3 specimens:

July 3, 4, 5.

In 1946, 8 specimens:

April 23, 24 (2).

May 21, 29.

June 29.

July 2, 16.

Distributed in tropical and subtropical America.

Pachylia ficus (Linnaeus).

Common (.36%).

In 1945, 9 specimens:

July 9, 12, 14 (2), 16 (5).

In 1946, 11 specimens:

May 6.

June 27, 28, 30.

July 1 (2), 25.

August 5, 13 (2), 14.

Ranges from Florida to Argentina.

Pachylia resumens Walker.

Unique (.03%).

In 1945, 1 specimen:

May 31.

In 1946, 1 specimen:

June 18.

Distributed in the American tropics and subtropics.

Oryba kadani (Schaufuss).

Unique (.03%).

In 1946, 1 specimen:

April 18.

Distributed from Panama to southern Brazil.

Hemeroplanes nomius (Walker).

Rare (.1%).

In 1945, 1 specimen:

July 4.

In 1946, 3 specimens:

April 20, 24 (2).

Distributed from Guatemala to southern Brazil.

Hemeroplanes calliomenae (Schaufuss).

Common (.8%).

In 1945, 9 specimens:

May 22.

July 2, 3 (2), 5, 11, 16.

August 5 (2).

In 1946, 24 specimens:

May 5 (2), 6, 10, 28.

June 7, 24, 26, 27 (3), 28, 29.

July 1 (5), 2 (3), 10, 19, 22.

Recorded from Haiti, Colombia and Venezuela.

Hemeroplanes parce (Fabricius).

Occasional (.33%).

In 1945, 6 specimens:

June 11.

July 4, 6, 16.

August 5, 11.

In 1946, 9 specimens:

May 5, 23.

June 16, 27.

July 1, 19.

August 6, 13, 14.

Widely distributed in the American tropics and subtropics.

Stolidoptera tachasara (Druce).

Unique (.03%).

In 1946, 1 specimen:

April 16.

Ranges from Mexico south to Venezuela.

Epistor lugubris lugubris (Linnaeus).

Occasional (.16%).

In 1945, 5 specimens:

July 16.

August 1, 5 (3).

In 1946, 5 specimens:

May 2, 6.
July 1.
August 13 (2).

A tropical and subtropical species that occasionally wanders as far north as New England.

Epistor ocypte (Linnaeus).

Rare (.06%).

In 1945, 2 specimens:

August 5 (2).

In 1946, 2 specimens:

July 13, 14.

Distributed from Mexico to Paraguay.

Nyceryx tacita (Druce).

Unique (.03%).

In 1946, 1 specimen:

March 25.

Mexico to Bolivia.

Perigonia pallida Rothschild and Jordan.

Common (.46%).

In 1945, 1 specimen:

May 22.

In 1946, 14 specimens:

May 5 (3), 6 (7), 7 (3), 15.

This species emerges very early in the rainy season and does not appear at the lights later in the season. Distributed from Venezuela to Argentina.

Perigonia stulta Herrick-Schäffer.

Rare (.13%).

In 1945, 1 specimen:

May 20.

In 1946, 4 specimens:

April 18.

May 8, 25.

June 25.

Central America to southern Brazil.

Perigonia lusca (Fabricius).

Occasional (.23%).

In 1945, 4 specimens:

form *restituta* (Walker):

June 4.

form *interrupta* Walker:

July 10.

August 5 (2).

In 1946, 7 specimens:

form *restituta*:

April 18.

May 18.

August 13.

form *interrupta*:

April 20.

May 7 (2).

August 13.

Widely distributed in the neotropical region.

Sesia fadus (Cramer).

Unique (.03%).

In 1946, 1 specimen:

April 19.

This specimen was taken from a spider's

web where it had been sucked dry by the spider. Found throughout the neotropical region and occasionally in the nearctic region.

PHILAMPELINAE.

Of the 8 species captured, one species, *Pholus satellitia licaon*, accounts for 217 (68%) out of 315 specimens.

Pholus anchemolus (Cramer).

Occasional (.33%).

In 1945, 3 specimens:

July 11 (2), 14.

In 1946, 10 specimens:

April 17, 19, 20, 21.

May 25.

June 22.

July 20.

August 13, 14, 19.

Distributed in the neotropical region.

Pholus triangulum Rothschild and Jordan.

Occasional (.26%).

In 1945, 2 specimens:

July 1, 16.

In 1946, 8 specimens:

May 7, 18.

June 29.

July 1, 21.

August 16, 18.

Distributed from Mexico to Bolivia.

Pholus satellitia licaon (Cramer).

Abundant (7.27%).

In 1945, 38 specimens:

May 5 (2), 7, 9, 11, 13, 14 (3), 15 (12), 18, 19 (2), 22 (2), 27, 28.

June 11 (2), 12, 17.

July 5, 7, 12 (2), 14, 16.

In 1946, 217 specimens:

March 25, 29, 30.

April 16, 17 (11), 18 (13), 19 (10), 20 (6), 21 (18), 22 (20), 23, 24 (9), 26 (5), 30 (37).

May 4 (5), 5 (7), 6 (11), 7 (4), 8, 13 (4), 14 (2), 21 (3), 25, 28, 29.

June 18, 21, 22 (3), 24, 26, 30.

July 2, 16, 18 (4), 19 (2), 20 (3), 21 (3), 22 (2), 26.

August 13 (4), 14 (8), 16, 18 (2), 19 (3).

Distributed from Mexico to Bolivia and northern Brazil.

Pholus obliquus Rothschild and Jordan.

Common (.87%).

In 1945, 2 specimens:

May 5, 12.

In 1946, 26 specimens:

March 18 (2), 22 (3), 27, 29, 30.

April 18 (2), 20 (2), 23, 24.

June 27.

August 13, 14, 16, 18 (7), 20.

Distributed in tropical South America.

Pholus vitis vitis (Linnaeus).

Common (1.13%).

In 1945, 23 specimens:

May 15, 28 (2).

June 5, 11 (2), 27.
July 1 (4), 3 (3), 6, 11 (2), 12, 14 (3), 16, 18.

In 1946, 34 specimens:

April 18, 22 (2), 24, 26.

May 21 (6), 23, 25 (8).

June 22, 26, 27.

July 16, 18, 19 (2), 20 (2), 21, 29.

August 13 (2), 14.

Distributed throughout the neotropical region and occasionally as far north as New England.

Pholus fasciatus (Sulzer).

Unique (.03%).

In 1946, 1 specimen:

June 27.

Distributed in the neotropics and southern nearctic regions and occurs as straggler in New England.

Pholus phorbos (Cramer).

Occasional (.23%).

In 1946, 7 specimens:

April 22, 24.

June 16, 18.

July 19.

August 16, 19.

Distributed from Venezuela to northern Brazil.

Pholus lobruscoe (Linnaeus).

Common (.40%).

In 1945, 32 specimens:

June 11 (3).

July 3, 4, 5 (2), 6, 11 (6), 12 (2), 14 (2), 16 (8), 23.

In 1946, 12 specimens:

May 14, 28, 30.

June 26, 27 (3), 30 (2).

July 2, 22.

August 14.

Much more common in 1945 than in 1946. A tropical American species that straggles into the temperate regions.

CHOEROCAMPINAE.

Of the 901 specimens captured, the 4 abundant species comprise 637 (71%) specimens, or somewhat more than 21% of the whole family. One other fact of interest is that only one species was unique, *X. t. thyelia*, and one rare, *C. lineata*. This subfamily, therefore, is the most successful subfamily, as a whole, of the Sphingidae at Rancho Grande.

Xylophanes pluto (Fabricius).

Common (1.27%).

In 1945, 5 specimens:

June 13.

July 1, 5, 8, 11.

In 1946, 38 specimens:

April 21, 23, 24, 30.

May 28, 30.

June 22, 26, 28.

July 2 (2), 16 (2), 19 (5), 20 (5), 21, 22, 26 (4).

August 14 (2), 18 (5), 19 (2).

Distributed from Florida to south Brazil.

Xylophanes tyndorus (Boisduval).

Common (1.27%).

In 1945, 10 specimens:

May 2, 22 (3), 28 (2).

June 27.

July 3, 4, 5.

In 1946, 37 specimens:

March 27, 28, 29, 30 (2), 31.

April 17 (2), 18 (5), 19, 20, 21 (2), 22 (4), 23 (2), 24 (4).

May 4, 5, 6 (2), 7, 18, 22.

June 26.

July 2.

August 1, 13.

Distributed from Mexico to southern Brazil.

Xylophanes porcus continentalis Rothschild and Jordan.

Common (.36%).

In 1945, 1 specimen:

July 8.

In 1946, 11 specimens:

March 30.

May 5 (2), 18.

June 25.

July 16, 20.

August 5, 13, 14, 19.

Distributed from Mexico to southern Brazil.

Xylophanes germen yurakano Lichy.

Abundant (3.41%).

In 1945, 10 specimens:

May 1 (2), 15, 22.

June 6, 11 (3).

July 2, 4.

In 1946, 102 specimens:

March 7, 28, 31.

April 18 (9), 19 (4), 20 (3), 21 (2), 22, 23 (3), 24 (5), 26, 30 (2).

May 5 (8), 6 (3), 7 (4), 8, 10 (2), 13, 16 (2), 17 (2), 18, 21 (6), 22, 23, 25 (3), 26, 30.

June 22 (2), 26 (2).

July 16 (2), 17, 18, 19, 21, 22, 26 (2).

August 5, 14 (4), 16 (2), 18 (3), 23.

September 2.

This subspecies has been reported only from Venezuela.

Xylophanes ceratomioides (Grote and Robinson).

Common (.73%).

In 1945, 7 specimens:

April 15.

May 20.

June 11, 12.

July 1, 11, 14.

In 1946, 22 specimens:

March 9.

April 16, 18 (2), 20 (2), 21, 24, 30.

May 5 (2), 16.

June 26.

July 1, 16, 17, 20, 25, 29.

August 5, 9, 12.

Distributed from Mexico to south Brazil.

Xylophanes anubus (Cramer).

Occasional (.2%).

In 1945, 1 specimen:
July 12.In 1946, 6 specimens:
May 18.
June 28, 30.
July 22 (2), 26.

Distributed from Mexico to Argentina.

Xylophanes amadis meridanus Rothschild
and Jordan.

Common (1.2%).

In 1945, 3 specimens:
May 12.
July 5, 10.In 1946, 36 specimens:
March 9.
April 18, 19, 21, 22, 24 (5), 26.
May 6, 28.
June 18, 22, 25 (2), 26.
July 18, 21, 22 (4), 24, 26 (5).
August 5, 14, 16 (2), 18 (2).

This subspecies was described from western Venezuela.

Xylophanes chiron nechus (Cramer).

Abundant (8.07%).

In 1945, 71 specimens:
June 4 (2), 11 (5), 16, 27 (7).
July 1 (4), 3 (27), 4 (2), 5 (5), 6 (3), 12 (14), 16.In 1946, 242 specimens:
March 31.
April 18 (7), 21 (8), 22 (4), 24, 30 (6).
May 3 (2), 5 (4), 7 (2), 10 (12), 14 (10), 21 (4), 22 (13), 24, 25 (12), 26 (20), 28 (3), 29, 30.
June 16, 22 (30), 26 (28), 27 (15), 28 (5), 29 (3), 30 (4).
July 1 (8), 16, 19 (12), 20 (14), 22 (5).
August 14 (5).

Distributed from Mexico to Argentina.

Xylophanes crotonis (Walker).

Abundant (4.02%).

In 1945, 26 specimens:
March 31.
April 2, 5 (4), 6 (6), 7, 8, 9, 12.
May 14 (4), 15, 20 (2).
July 14, 16 (2).In 1946, 120 specimens:
March 25 (3), 27, 28, 29, 30, 31.
April 16 (2), 17 (5), 18 (24), 19 (8), 20 (3), 21 (14), 22 (13), 23 (6), 24 (5), 26 (2), 30 (2).
May 5 (3), 6 (2), 7, 10 (3), 17, 21, 25 (2).
July 21, 26.
August 13 (4), 14 (7), 16, 19.All of the above species I consider as belonging to the form *crotonis*. Yet in some respects they are between form *crotonis* and form *aristor*. In the majority of the specimens a definite mesial stripe is present, but it is not gray. Distributed in Central America and northern South America.**Xylophanes titana** (Druce)

Abundant (5.79%).

In 1945, 16 specimens:
June 4, 12, 27.
July 1, 3 (2), 4, 5, 8, 10, 11 (3), 12, 13, 16.In 1946, 173 specimens:
March 22 25, 30 (3).
April 18 (2), 19 (5), 20, 21 (7), 22 (5), 26.
May 5, 18 (2), 20, 21, 22 (2).
June 18, 22 (16), 26 (7), 27 (2).
July 1 (3), 2 (11), 16 (9), 19 (20), 20 (20), 21 (3), 22, 24, 26 (5).
August 5 (5), 13 (20), 14 (7), 18 (3), 19 (6).
Distributed from Mexico to southern Brazil.**Xylophanes resta** Rothschild and Jordan.

Occasional (.23%).

In 1945, 3 specimens:
June 2, 4 (2).In 1946, 7 specimens:
April 18.
May 6, 8, 14, 22.
July 16.
August 16.

Distributed in northern South America.

Xylophanes tersa (Linnaeus).

Common (2.71%).

In 1945, 3 specimens:
July 1, 4, 11.In 1946, 81 specimens:
May 6, 22 (2), 23 (2), 28 (2), 30.
June 1, 13, 18, 20 (3), 26 (2), 27, 29 (3).
July 1 (2), 2 (7), 16, 19 (12), 20 (4), 21 (12), 22 (3), 24, 26 (3).
August 6, 12, 13 (4), 14 (3), 18 (2), 19 (4), 20.

Found from Canada to Argentina.

Xylophanes neoptolemus (Cramer).

Common (.43%).

In 1945, 13 specimens:
April 20.
May 14.
June 6 (3), 17.
July 1, 3, 5, 7 (2), 8, 9.In 1946, 13 specimens:
March 22.
April 18.
May 7, 18.
June 26.
July 16 (2).
August 13, 18 (2).
September 2.

Distributed from Mexico to Surinam.

Xylophanes thyelia thyelia (Linnaeus).

Unique (.03%).

In 1945, 2 specimens:
June 13 (2).In 1946, 1 specimen:
April 14.
Distributed in South America.

Xylophanes pyrrhus Rothschild and Jordan.

Occasional (.33%).

In 1945, 2 specimens:

April 5.

June 11.

In 1946, 9 specimens:

April 18, 20.

May 8, 10.

June 18 (2), 22.

July 7.

August 18.

Distributed in northern South America.

Celerio lineata lineata (Fabricius).

Rare (.1%).

In 1945, 1 specimen:

August 5.

In 1946, 3 specimens:

July 19.

August 18 (2).

Distributed in North and South America.

VI. REFERENCES CITED.

BEEBE, W.

1925. Studies of a tropical jungle; one quarter of a square mile of jungle at Kartabo, British Guiana. *Zoologica*, VI: 1, pp. 1-193.1942. Physical factors in the ecology of Caripito, Venezuela. *Zoologica*, XXVIII: 9, pp. 53-59.

BEEBE, W. and J. CRANE

1947. Ecology of Rancho Grande, a subtropical cloud forest in northern Venezuela. *Zoologica*, 32: 1, pp. 43-60.

BEEBE, W. and H. FLEMING

1945. Sphingidae of Kartabo, British Guiana, and Caripito, Venezuela. *Zoologica*, 30: 1, pp. 1-6.

LICHY, R.

1943. Documents pour servir a l'étude des Sphingidae du Venezuela; une forme nouvelle de l'*Amplipterus tigrina* Fld. *Boletín de Entomología Venezolana*, II: 1, pp. 1-15.1944. Documents servir a l'étude des Sphingidae du Venezuela; sur un cas d'adaptation à un nouveau regime alimentaire chez *Madoryx oclus* Cr. *Boletín de Entomología Venezolana*, III: 4, pp. 195-202.

MOSS, A.

1920. Sphingidae of Pará, Brazil. *Novitates Zoologicae*, XXVII: 2, pp. 333-424.

VOGL, P. C.

1944. Esfingidos y Dipteros de la Hacienda La Trinidad de Maracay, coleccionados por P. Cornelius Vogl. *Boletín de la Sociedad Venezolana de Ciencias Naturales*, IX: 60, pp. 321-323.

WALKDEN, H. H.

1937. Noctuidae taken at a bait trap in Kansas. *Annals of the Entomological Society of America*, XXX: 2, pp. 296-303.



17.

Scale Adaptation and Utilization in
Aesiocopa patulana Walker (Lepidoptera, Heterocera, Tortricidae).¹

WILLIAM BEEBE.

Department of Tropical Research, New York Zoological Society.

(Plates I & II; Text-figures 1 & 2).

[This is one of a series of papers resulting from the 45th and 46th Expeditions of the Department of Tropical Research of the New York Zoological Society, made during 1945 and 1946 under the direction of Dr. William Beebe with headquarters at Rancho Grande in the National Park of Aragua, Venezuela. The expeditions were made possible through the generous cooperation of the National Government of Venezuela and of the Creole Petroleum Corporation.

[The characteristics of the research area are in brief as follows: Rancho Grande is located in north central Venezuela (10° 21' N. Lat., 67° 41' W. Long.), 80 kilometers west of Caracas, at an elevation of 1,100 meters in the undisturbed montane cloud forest which covers this part of the Caribbean range of the Andes. Adjacent ecological zones include seasonal forest, savanna, thorn woodland, cactus scrub, the fresh water lake of Valencia and various marine littoral zones. The Rancho Grande area is generally subtropical, being uniformly cool and damp throughout the year because of the prevalence of the mountain cloud cap. The dry season extends from January into April. The average humidity, during the expeditions, including parts of both wet and dry seasons, was 92.4%; the average temperature during the same period was 18° C.; the average annual rainfall over a 5-year period was 174 cm. The flora is marked by an abundance of mosses, ferns and epiphytes of many kinds, as well as a few gigantic trees. For further details, see Beebe & Crane, *Zoologica*, Vol. 32, No. 5, 1947. Unless otherwise stated, the specimens discussed in the present paper were taken in the montane cloud forest zone, within a radius of 1 kilometer of Rancho Grande.]

About 9 o'clock on the evening of June 11 I was on the roof of Rancho Grande watching the onrush of hosts of moths as they siphoned in from the dark jungle and came to rest on the whitewashed wall, attracted by the brilliance of the electric light overhead. Close to my face there alighted a small brown, bell-shaped tortricid. After recording its alighting position, I collected

it alive and later carried it to the laboratory with the intention of noting the resting position next morning. There intervened a phenomenon of egg-laying and defense adaptation which gave greatly increased interest to the moth.

She was enclosed in a small, round, glass-topped, glass laboratory dish, measuring 50 mm. in diameter by 25 mm. deep. When I left her at midnight she was resting quietly on the bottom. In the morning about 6 a.m. she was quiescent in the same position, while directly overhead, on the inside of the glass cover, were the eggs and their defensive barrier which she had deposited in the intervening six hours.

Subsequently the egg-laying tortricid (Cat. No. 46564) was identified by the kindness of Dr. J. F. Gates Clarke. On June 23 a second female was hatched from a naked pupa at Rancho Grande (No. 461190), and this was named by Dr. T. N. Freeman. Both proved to belong to the same species, *Aesiocopa* (or *Cacoecia*) *patulana* Walker. The locality of Walker's type was Oajaca (*sic*) in southern Mexico, and to this Dr. Clarke added localities in Central Mexico, Guatemala and Costa Rica. The present Rancho Grande specimens represent a considerable southward extension of the range, to north-central Venezuela.

EGGS: During the night of June 11 a mass of more than three hundred eggs was deposited in an almost circular form, singly around the periphery, doubling and trebling in depth toward the center. The mass measured 8.6 mm. across and .7 mm. deep. The collection was opaque, pale viridine green in color (Ridgway), with the individual eggs apparent by slightly curved outlines on the surface, and a series of scallops around the outer edge. There were sixteen to eighteen eggs across the widest part and about fifty around the outside. The general deposition arrangement was in concentric lines.

The whole flat mass was covered with a fairly thick but irregularly scattered nap

¹ Contribution No. 780, Department of Tropical Research, New York Zoological Society.

of very fine, short, colorless, transparent, needle-like scale-hairs, very difficult to see. Outside of the eggs, on the glass, there was a very narrow, irregular, ring of these scales as if they had fallen here by accident instead of on the eggs. They lay flat, facing in every direction, and the outer scattered fringe was about .75 mm. wide. The area bordering a single egg scallop contained fifty to seventy of these hairs. They were .20 to .25 mm. long.

Outside of these, beyond a perfectly clear space of 1.5 to 2 mm., there extended a second ring of wholly different scales. Viewed obliquely the egg mass looked like a flat, pale-green island in clear water, surrounded at a little distance by a dense palisade of stakes standing upright in the water.

the expanded bases. The encircling palisade was from ten to fifteen scales in width, and the entire ring about 43 mm. in circumference. A conservative estimate, after several counts, gave a total of three thousand.

A vertical view showed the green egg mass surrounded by a brown ring of small kidney-shaped dots. An oblique sight brought the ring scales slowly into upright elevation, as unexpectedly as a stereoscopic photograph.

There is no doubt that this achievement on the part of a small moth is an adaptation of the most complex character. The method of denudation of her body of three thousand scales (in addition to the egg mat of thousands of hair scales), of the placing of the palisade scales in erect, orderly arrangement, separated by almost arithmeti-

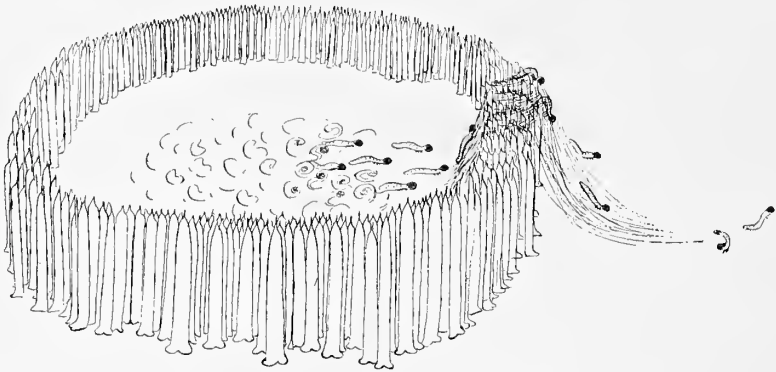

TEXT-FIG. 1. Sketch of palisade scale ring with escaping caterpillars. (Drawing by Pamela Marmont).

This outer ring was a circle of scales. The ring was slightly broken at the bottom, an imperfection due unquestionably to the exigencies of the abnormal conditions of the glass container. Proof of this is provided by the actual presence of the missing scales, misplaced, flattened and scattered over a very small asymmetrical section of the eggs themselves. The ring was somewhat irregular as to width, 1.5 to 2 mm., and every scale was vertically on end and separate from its fellows. Each scale had a pale-brown, kidney-shaped basal expansion, forming a flat foot which must have been sticky enough to allow it to become fast and continue to support the scale absolutely vertically. A very few scales, having lost their bases, were lying flat. Each one was extremely thin, flat or slightly curved and wide, equally calibered throughout, except at the tip which changed abruptly into a fine, needle-like, sharp spine. The erect scales were so thin and straight that from above, almost nothing was visible but

cally exact spaces, and fastening into place, forms a complicated sequence, the evolution of which is beyond our comprehension.

Eight days after deposition, on June 19, each egg was seen to be filled with the body of the embryo. The head showed as a large black spot, while close behind it was a dark, rectangular area, the prothoracic dorsal scute of the hatched caterpillar. The jaws were extended in advance of the head, and each embryo faced outward toward the periphery of the egg circle. Two days later, on June 21, the whole egg mass had changed in color to dark olive. The width of the eggs was about .8 mm. I was worried about the dried aspect of the upper side of the eggs, so dissected out one larva, but it and all others in the vicinity wriggled healthfully.

LARVAE: The following day, June 22, eleven days after the eggs had been laid, I found that a third of the larvae had emerged and disappeared. The central part of the upper layer of the mass had emptied

first. Even this hinted at a delicate but appreciable adaptation, for this upper layer of eggs must have been deposited last, *after* the lower layers, even if the interval had been only a few minutes, and now a much longer, as well as a reversed, period of time intervened between the hatching of the relative layers. Not a single first floor occupant had emerged, while most of the upper floor tenants had already left their glassy cells.

As I watched, two more newly hatched caterpillars appeared, walking back and forth. Soon both reached the outer rim of the eggs at the exact point nearest the source of light from the laboratory window. They crossed the clear space and began to investigate the edge of the palisades. One reared high and after feeling about a few times, strained upward and crept over the first two spikes. Then the second attempted it and both crossed with amazing speed. It was very evidently uncomfortable but over they went and swiftly humped themselves down the outer side, across the glass, and on lightwards.

I now watched a black pair of jaws which had just appeared, chewing upwards into view in the egg expanse. I started the stopwatch. In two minutes the caterpillar had gnawed a hole of his own caliber, pushed up and out, and began crawling. He completed a small circle, then turned toward the light, crossed the open take-off, mounted, crept across and reached the far side of the palisade in exactly two more minutes. In four minutes he had gnawed his way out of his egg, found and surmounted his first ontogenetic hurdle.

The palisade traverse bothered me. It was too easy, for the stakes were as erect, the points as sharp as ever. I made a slight shift in focus of the microscope lens and the mystery was no longer a mystery. A wide pathway over the lighted segment of the palisade was covered with the thinnest of thin silk webbing. The apparently casual weaving back and forth of the larval heads became significant. The speed and ease of crossing was explained by the soft approach ramp and the silk carpet over the top.

I now revolved the glass cover holding the egg mass, half a circle away from the light side. Closest examination of this former darkened section showed only a few stray strands of web. After a minute a second tier larva began to shred and tear his cell wall. When he had eaten through the wall of his particular egg he walked a short distance and then made quick work of a trapdoor in the roof, for the emerging of the earlier caterpillars had cleared a large space beneath the transparent, communal ceiling. The larva emerged in par and at once set out lightwards. As soon as he

touched the first palisade he began weaving, but proved to be a pioneer, not merely adding a ratline here and there to the suspension bridge of preceding brethren. His was the hard way, he made slow progress, it was difficult going. On his posterior pair of prolegs he raised himself half way up a vertical scale, and with bent head wove the first warp of a silken path. The palisades were as strong and efficient as when they were first mysteriously planted by the parent moth and the larva would touch and flinch at each sharp point. Then he would pull back, reach down and draw out a strand of silk. This was wound muffler-like, forming a soft wad around the needle tip. Another step was taken, with much irritated jerking and twisting, and finally the hindmost pair of prolegs of the caterpillar gripped the very summit of the wadded spikehead. This provided a new periphery, enabling him to reach two further palisades.

An unailing instinct held him straight on—the inevitable pull of the light. He never stopped or wavered. Close on the left the stakes thinned out, leaving a free little alley for some distance of the traverse, but he did not see or else ignored this easy but oblique path. He held straight on, travelling the shortest line which led directly toward the light.

I now revolved the whole affair so that at this stage he was suddenly headed toward the dark side. But the formative positiveness of his phototropic instinct had done its part, and was now past history. He kept on and when free of the obstacle he humped full speed toward the darker direction.

I watched another larva emerge and do his palisade crossing and when he had reached the outermost rim of the glass, I touched and lifted him with the entangling hairs of a camel's-hair brush. He payed out several inches of web, dangling in midair, and I dropped him again on the egg mass. He righted himself, cut his rip-cord and began walking rapidly about. Now and then he met and crawled over another larva, or stopped for a moment at the touch of a black head arising from its cell. All the larvae hatching while he walked about—six altogether—went through their post-natal routine: all emerged, crossed the clear space, hopped the fence and started out full of directed energy. My returned caterpillar still roamed about. He would start off full tilt over eggs and bodies until he reached the palisade, feel about for a moment, then turn and step out in another diagonal, and again turn back. The last I saw of the confused caterpillar he was resting quietly close to the egg opening

from which he had emerged. Five hours later he was still there and quite unresponsive to any effort to arouse him to activity. I had interfered with his set routine, his sequence of instincts; I had set back the time clock of his life and he refused to repeat and catch up again. Quite uninjured, he was again in the identical situation, with the same means to scale the obstacle, but he had yielded to the next item on the program, to walk, walk, walk until, under normal conditions, he probably would have arrived at the leaf which the equally blind instinct of his parent should have placed within his reach. Foiled in this he became obsessed with a meaningless quiescence. My ignorance meant his death, for even if I had not interfered with his routine I had no possible means of knowing which of the thousands of jungle plants growing about Rancho Grande was the one suited for his nourishment.

My final experiment was to reorient the egg mass so that the accidental opening in the outer palisade ring faced the source of

light from the laboratory window. Four caterpillars hatched during the next few minutes and crept straight for the opening. One kept on with scarcely a second's hesitation. The other three interrupted their progress with six to twenty seconds of indefinite turning, twisting and reaching up and about. Two of the larvae halted close to the broken periphery. The other experienced his momentary confusion 20 millimeters beyond where the palisade would have been if the ring was perfect. It appeared "as if" seventy-five per cent. of the larvae experienced an instinctive expectancy of a barrier.

SOURCE OF THE PALISADE SCALES: On the terminal portion of the abdomen of this tortricid moth is an extensive mass of specialized structures which I shall call palisade *sheaves* because each unit consists of varying numbers of palisade *scales*.

Their appearance is most difficult to describe. The most apt simile is the mass of basalt crystals which forms the so-called Giant's Causeway in Ireland. The palisade

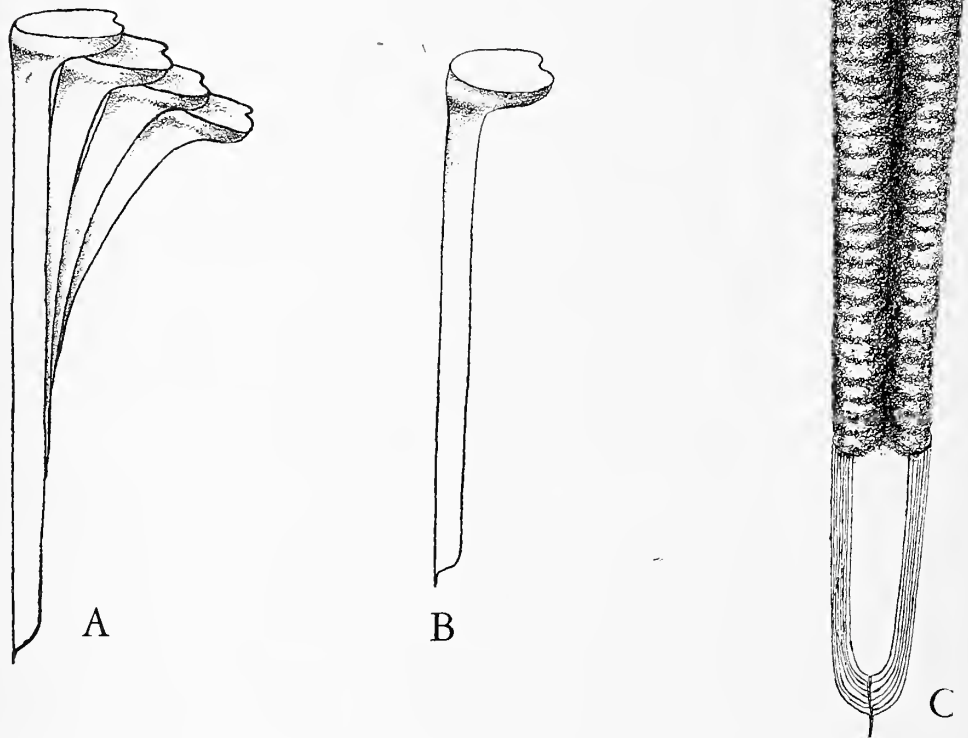

TEXT-FIG. 2. **A.** Four of the forty palisade scales telescoped in one sheaf. **B.** Lateral view of outer single scale of sheaf. **C.** Posterior view of a single sheaf, showing successive layers of scales.

sheaves form three-fifths of a steeply sloping cone, covering the whole of the ventral and lateral areas of the terminal abdominal segment. The remaining two-fifths occupy the flattened, dorsal portion. The diameter of the base of the cone is 2.2 mm. and the height 1.4 mm. These scales enclose the paired ovipositors ventrally and laterally, leaving the antero-dorsal aspect in direct contact with the more normally shaped lepidopteran scales of the rest of the abdomen.

Anterior to the ventral limits of the palisade sheaves is a dense, rough triangle of a solid mass of very small, hair-like scales, extending over a transverse area of 1.2 mm. These are the scales which form the fine nap overlying the egg mass.

Ventrally, the palisade sheaves on the undisturbed abdomen of the virgin tortricid, number about three hundred and the lateral extensions add some two hundred more, the total count being around five hundred. The hair-scale area slightly overhangs the bases of the anterior sheaves, which here lie almost flat, their heads directed posteriorly, with about half their length exposed. Posteriorly, in the direction of the ovipositors, the scales become more erect, bringing the expanded summits closer and closer together. At the time of utilization, there must be some muscular or other mechanism for erecting and leveling off the entire expanse of palisade sheaf tops.

The palisade sheaf count on the abdomen of the *parent* tortricid is about three hundred, considerably less than the total on the body of the reared, virgin moth. In the parent insect, however, the contraction of the shrunken, eggless abdomen has drawn down the tip of the body, so that many of the peripheral rows of sheaves are concealed, especially those that have been telescoped beneath the overhanging fringes of the matted hair-scales.

Even if we endow the parent moth originally with the full five hundred sheaves of the virgin female they do nothing to explain the three thousand extracted, individual palisade scales mounting guard about the eggs, each with a kidney-shaped base, indistinguishable from the tops of the abdominal sheaves here *in situ*. For days this remained a mystery, apparently solvable only by a refutation of the law that two bodies may not occupy the same space.

Finally, a single sheaf was freed from its bed and placed on a microscope slide. Pressure from a needle point solved the problem, for one by one, like the successive enveloping leaves of an endive stalk, palisade scales split off, until, instead of one, there were three and twenty, each, except in size, practically identical with the first, outermost shell which I had lifted from

its place. A second sheaf revealed the fact that by means of the moistened tip of a needle it was possible to lift first the uppermost legume-shaped cap, together with its slender spine-tipped body, and then in turn all those beneath. A typical, first, uppermost scale measured .7 mm. in length. Scale number twenty-three was one half as long. We later found that extremes were as much as 3 to 1. In general shape all were similar, except that the terminal spine was relatively short on the first scale, gaining in length and slenderness on each succeeding one. It was difficult to remove from its bed a complete palisade sheaf. At the slightest pressure the successive scale layers bent slightly outward or sprang free. When one was finally isolated and examined, still partly *in situ*, it was found that the entire protruding length was bean-shaped in section. This shape was contributed by the vertical series of bean-shaped caps resting one upon another, externally visible only as a succession of rounded layers, with the concavity pattern continuing down one side.

The particular sheaf under consideration, when completely freed, showed the lower third of the anterior aspect quite open, marking the lower end of the pile of caps together with the exposed inner aspect of the lowermost scale. In this particular individual sheaf there were forty-one scales. This number of palisade scales in single sheaves varied from fifteen to forty-one, a reasonable average providing a total of twelve thousand five hundred scales for the use of the parent moth.

Allowing our egg-laying parent tortricid a full five hundred sheaves of scales, she must have utilized the six uppermost layers to build her circle of three thousand palisades.

METHOD OF DEPOSITION: Darkness, and especially the lack of any warning, combined to prevent any actual observation of the process, but a few facts give us meagre indications of a possible mode of deposition. The sheaves on the abdomen of the moth are so oriented that the incised or concave sides of the bean-shaped extremities are all directed posteriorly. A second fact is the presence of a series of shallow scallops around the periphery of the palisade ring, which are about abdomen width. In the third place, the direction of the concave sides of what are now the bases of the palisades are uniformly directed outwardly.

From these facts we can guess that after the deposition of the eggs, the moth stationed herself with head over the center of the egg mass and abdomen pointed outward. In this position the abdomen tip would reach a little way beyond the circular patch

of eggs. A mucilaginous application of the ovipositors (or other source of viscosity) followed by a touch of the sheaves would result in the abstraction of the uppermost layer of scale heads and retention of the entire scales in an upright position on the adhesive surface.

A slight swivelling of the moth to left or right would make possible a repetition of the process, forming another scallop or segment in the growing ring of palisades. This is all sheer conjecture, but it seems within the realm of explanatory probability until we have an opportunity of observing the process at first hand.

ENEMIES: Against what particular enemies the palisade ring functions successfully we do not know. In the case of at least one mite and one ant, however, it justified its existence. When I was studying the structure under low power, a small pink mite appeared by accident on the glass and walked to the ring of scales. It made several attempts to climb but none to penetrate the stockade, then turned and kept on its slow way until it came to the broken section, felt about for a minute and walked away.

I deposited a small ant outside the ring and it ran at once to the outermost series, tried to push between, and then twice made a definite attempt to climb, failing in both.

I dropped it in the center of the scales. It fell through them to the glass, squeezed between four pairs and then became completely trapped, wedged tightly. I did not want to leave it there, but in the rescuing process I upset three scales. All this is artificial yet significant evidence as to the possible value of the palisades.

SUMMARY: A female tortricid moth, identified as *Aesiocopa patulana* Walker, was taken at light on the roof of Rancho Grande in north-central Venezuela on June 11, 1946.

The same night, in a small glass laboratory dish, the moth deposited three hundred eggs, arranged in a flat, rounded mass. At a little distance from the eggs, the moth had erected a circular stockade of about three thousand pointed, elongate scales, standing upright upon enlarged bases firmly attached to the glass.

The caterpillars hatched on the eleventh day after the laying, and made their escape over the stockade of pointed scales by spinning a ramp and mat of silk. The direction of escape was always toward the strongest illumination.

The source of the scales was a group of four to five hundred sheaves near the tip of the abdomen, each containing from fifteen to forty of the pointed, palisade scales.

EXPLANATION OF THE PLATES.

PLATE I.

- Fig. 1. *Aesiocopa patulana*, female, wings closed.
 Fig. 2. *Aesiocopa patulana*, female, wings spread, showing shrivelled abdomen.
 Fig. 3. End of abdomen of female moth showing 300 palisade sheaves in place.

PLATE II.

- Fig. 4. Egg mass and circle of palisade scales, showing laboratory dish and the glass cover on which they were deposited.
 Fig. 5. Vertical view of egg mass and protecting ring of palisade scales.
 Fig. 6. Oblique view of eggs and scales, showing erect position of the three thousand palisade scales.



FIG. 1.



FIG. 3.



FIG. 2.

SCALE ADAPTATION AND UTILIZATION IN *AESIOCOPA PATULANA* WALKER
(LEPIDOPTERA, HETEROCERA, TORTRICIDAE).



FIG. 4.



FIG. 5.



FIG. 6.

SCALE ADAPTATION AND UTILIZATION IN *AESIOCOPA PATULANA* WALKER
(LEPIDOPTERA, HETEROCERA, TORTRICIDAE).

NEW YORK ZOOLOGICAL SOCIETY

General Office: 630 Fifth Avenue, New York 20, N. Y.
Publication Office: The Zoological Park, New York 60, N. Y.

OFFICERS

FAIRFIELD OSBORN, *President*
ALFRED ELY, *Vice-president*
LAURANCE S. ROCKEFELLER, *Vice-president*
DONALD T. CARLISLE, *Vice-president*
HAROLD J. O'CONNELL, *Secretary*
CORNELIUS R. AGNEW, *Treasurer*

SCIENTIFIC STAFF

General

JOHN TEE-VAN, *Executive Secretary*
WILLIAM BRIDGES, *Editor and Curator of Publications*
SAM DUNTON, *Photographer*

Zoological Park

LEE S. CRANDALL, *General Curator*
LEONARD J. GOSS, *Veterinarian*
BRAYTON EDDY, *Curator of Reptiles and Insects*
GRACE DAVALL, *Assistant to General Curator*

Aquarium

CHRISTOPHER W. COATES, *Curator and Aquarist*
JAMES W. ATZ, *Assistant Curator*
ROSS F. NIGRELLI, *Pathologist*
MYRON GORDON, *Geneticist*
C. M. BREDER, JR., *Research Associate in Ichthyology*
G. M. SMITH, *Research Associate in Pathology*
HOMER W. SMITH, *Research Associate in Physiology*

Department of Tropical Research

WILLIAM BEEBE, *Director*
JOCELYN CRANE, *Research Zoologist*
HENRY FLEMING, *Entomologist*
WILLIAM K. GREGORY, *Associate*
JOHN TEE-VAN, *Associate*
GLORIA HOLLISTER, *Associate*
MARY VANDERPYL, *Associate*

Scientific Advisory Council

A. RAYMOND DOCHEZ
ALFRED E. EMERSON
ALAN GREGG
W. A. HAGAN
CARYL P. HASKINS
K. S. LASHLEY
JOHN S. NICHOLAS
GEORGE M. SMITH

Editorial Committee

FAIRFIELD OSBORN, *Chairman*
WILLIAM BEEBE
WILLIAM BRIDGES
CHRISTOPHER W. COATES
LEE S. CRANDALL
BRAYTON EDDY
LEONARD J. GOSS
JOHN TEE-VAN

90.573

(11-11-1947)

91

ZOOLOGICA

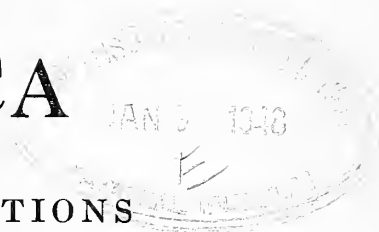

SCIENTIFIC CONTRIBUTIONS
of the
NEW YORK ZOOLOGICAL SOCIETY

VOLUME 32

Part 4

Numbers 18-20

Published by the Society
The Zoological Park, New York
December 29, 1947

CONTENTS

	PAGE
18. Avian Migration at Rancho Grande in North-central Venezuela. By WILLIAM BEEBE. Plate I; Text-figure 1.....	153
19. <i>Endosphaera engelmanni</i> Endoparasitic in <i>Trichodina spheroidesi</i> Infecting the Puffer, <i>Sphaeroides maculatus</i> . By MORTON PADNOS & ROSS F. NIGRELLI. Plates I & II; Text-figures 1 & 2.....	169
20. Ithomiinae (Lepidoptera) of Rancho Grande, Venezuela, Including Two New Species. By RICHARD M. FOX & JEAN W. FOX. Plate I	173
Index to Volume 32.....	179

18.

Avian Migration at Rancho Grande in North-central Venezuela.¹

WILLIAM BEEBE.

Department of Tropical Research, New York Zoological Society.

(Plate I; Text-figure 1).

[This is one of a series of papers resulting from the 45th and 46th Expeditions of the Department of Tropical Research of the New York Zoological Society, made during 1945 and 1946 under the direction of Dr. William Beebe, with headquarters at Rancho Grande in the National Park of Aragua, Venezuela. The expeditions were made possible through the generous co-operation of the National Government of Venezuela and of the Creole Petroleum Corporation.

[The characteristics of the research area are in brief as follows: Rancho Grande is located in north-central Venezuela (10° 21' N. Lat., 67° 41' W. Long.), 80 kilometers west of Caracas, at an elevation of 1,100 meters in the undisturbed montane cloud forest which covers this part of the Caribbean range of the Andes. Adjacent ecological zones include seasonal forest, savanna, thorn woodland, cactus scrub, the fresh water lake of Valencia, and various marine littoral zones. The Rancho Grande area is generally subtropical, being uniformly cool and damp throughout the year because of the prevalence of the mountain cloud cap. The dry season extends from January into April. The average humidity during the expeditions, including parts of both wet and dry seasons, was 92.4%; the average temperature during the same period was 18° C; the average annual rainfall over a 5-year period was 174 cm. The flora is marked by an abundance of mosses, ferns and epiphytes of many kinds, as well as a few gigantic trees. For further details, see Beebe & Crane, *Zoologica*, Vol. 32, No. 5, 1947. Unless otherwise stated, the specimens discussed in the present paper were observed or taken in or over the montane cloud forest zone, within a radius of 1 kilometer of Rancho Grande.]

GENERAL ACCOUNT.

When we first occupied the station at Rancho Grande in north-central Venezuela, we had no idea of the importance of Portachuelo Pass as a migration flyway for birds and insects. Even later on, when we came to compile a list of thirteen apparent life zones within our purlieu, I added a fourteenth, the Aerial Zone, with hesitation, having in mind the inclusion of organisms such as hummingbirds and mayflies which spend the major part of their life in midair. Almost immediately, however, the value of and need for such a niche in our phenological program became apparent.

If for no other reason, an Aerial Zone was needed to accommodate the volant organisms which passed and repassed, or occasionally were detected soaring high in air, and which were never to be found resting or flying in the jungle of our immediate area of research. Many of these organisms were essentially tropical, occupying our subtropical elevation only as a temporary route of passage.

About two hundred yards north of Rancho Grande is a Pass in the coast range of these eastern Andes. This is Portachuelo Pass, with an elevation of 1,136 meters, about 100 feet higher than Rancho Grande. The shoulders on either side of the Pass rise in sharp ridges to Pico Paraiso on the west, with a height of 1,814 meters, and on the east to Pico Guacamayo with an elevation of 1,900 meters (Text-figure 1). To the south the Valley of Limon leads to the lowlands of Lake Valencia and Maracay, and to the north the deep gorge Valley reaches the Caribbean Sea six miles away at the little village of Ocumare de la Costa, while further west is Turiamo. Other passes exist at a distance in both directions, but this, for some reason, is the dominant flyway for both birds and Lepidoptera. A later paper will deal with the great number of species of butterflies and moths which in season pour through this gap. Hawk Mountain in Pennsylvania would seem to be a similar and equally inexplicable flyway.

During my period of observation I was able to identify with certainty more than

CONTENTS.

	Page
GENERAL ACCOUNT	153
I. SEASONAL MIGRATION	
1. Intercontinental Migration	156
2. Continental Migration	159
3. Migration of Breeding Residents	160
4. Local Flocking of Permanent Residents	161
5. Lowland to Lowland Non-resident Migration	161
II. DAILY MIGRATION	
6. Lowland to Lowland Non-resident Migration	163
7. Irregular Daily Shuttling	163
8. Temporary Daily Local Migration	165
III. IRREGULAR MIGRATION	
9. Irregular Migration of Non-residents	165
10. Wandering	167

¹ Contribution No. 781, Department of Tropical Research, New York Zoological Society.

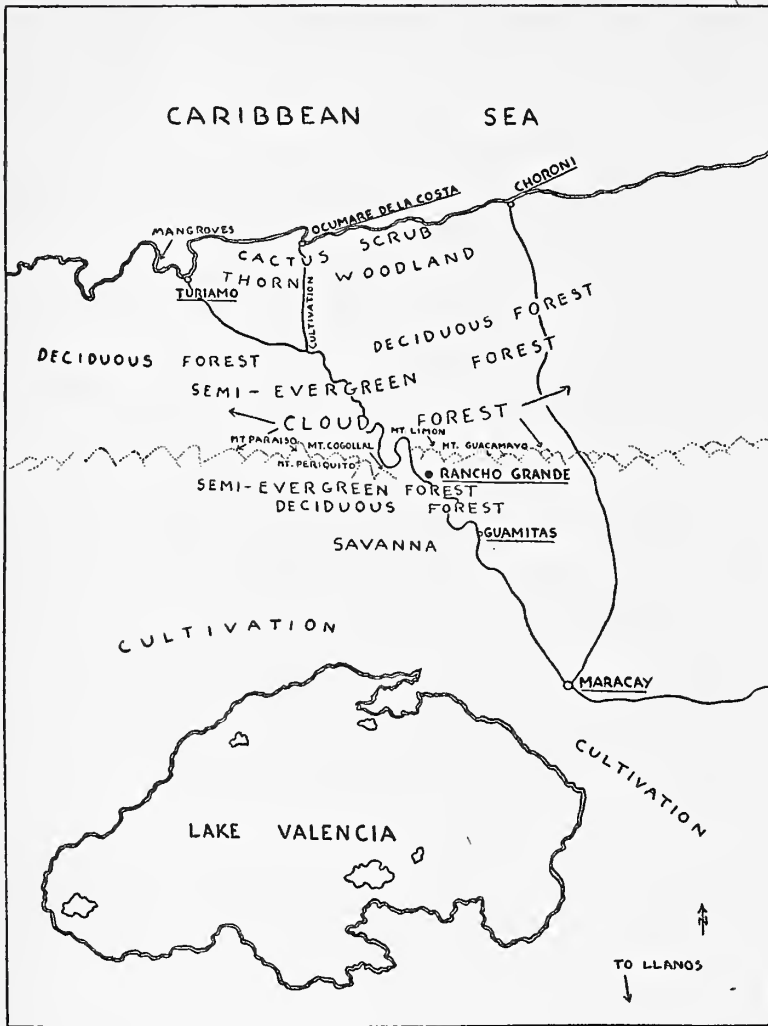

TEXT-FIG. 1. Map showing Rancho Grande in its relation to the Caribbean Sea and Lake Valencia. Portachuelo Pass is just across the road from the black dot marking Rancho Grande.

sixty species of birds which used the Pass, seasonally, daily or irregularly. For purposes of differentiation it was found possible to divide these migrants into ten categories, which seem sufficiently distinct to serve this present purpose. More concentrated observation over longer periods of time would certainly bring about many shifts. Several other factors entered in to make this preliminary list of migrant birds only partly complete, while in addition the numbers must be considered as minimum counts. Among the controlling phenomena were the frequent presence of fog, neblina, wind and rain, combined with the resultant impossibility of nocturnal observation in the Pass. On the other hand, the combination of these factors worked to our advantage at the laboratory itself, by insuring the attracting of many birds to the lights. The birds would frequently strike the glass windows, recover and fly away into the fog and rain. Or they might be injured or

killed, or at least so confused as to allow themselves to be picked up and examined.

One of the agreements made with the Venezuelan Government upon our occupation of Rancho Grande, was that we should respect the law forbidding indiscriminate shooting in this preserved National Park. Fortunately most migrants were perfectly satisfactory subjects for sight identification, and many were collected after injury at the laboratory windows. Occasionally I was forced to shoot on the wing, as in the case of the hosts of *Phaeoprogne tapera fusca*, which passed close overhead, day after day, through the thin neblina with the speed of bullets, completely defying even family identification.

Again and again sight identification with the naked eye or seven-power stereos was supplemented by the miraculous lenses of the twelve- and twenty-powered giant binoculars, mounted on a tripod. This instrument would bring down a bird soaring high in air, or one

perched in the highest candela tree, to within arm's reach, portraying clearly and distinctly the color of the iris, as well as every individual variation of feather pigment or pattern.

Other rare, almost unknown species, such as *Cypseloides cryptus* and *Neocrex erythrops olivascens* (?) would have wholly escaped record without skins.

If only for the number of individuals and species of North American wood warblers the flyway of Portachuelo Pass would be notable. I recorded thirteen species and Dr. Alexander Wetmore added another not far away. Night after night we heard the chirps of these birds flying over, and on nights of wind and fog the numbers which struck against our laboratory windows gave a hint of the immense flocks which passed unseen and unrecorded by us.

Still another interesting factor is the abundance of migrants through this Pass in connection with its situation at the extreme eastern edge of migration distribution at present recognized in north-central Venezuela. Examples of this are *Mniotilta varia*, *Protonotaria citrea*, *Oporornis agilis* and *Dendroica caerulescens caerulescens*.

In preparation for the long aerial trail of most of the northern migrants, their bodies were bundles of fat with not a particle of super-cargo food in their stomachs. To a less yet decidedly appreciable extent, this was true of certain Venezuelan species of birds which are considered as wholly resident. I believe that when we can band them in sufficient numbers we will find that many tropical Venezuelan birds (corresponding to our northern common crow), which are to be found locally every month in the year, will show considerable individual shifting, north or south, or at least away from their breeding places.

Extremes in non-migratory, permanent residential species are exemplified at Rancho Grande by *Sayornis nigricans angustirostris* and *Thryothorus mysticalis ruficaudatus*, whose territories, at least throughout eight months of two successive years, were bounded by an area of about fifty and about three hundred square meters of jungle respectively.

Dr. Alexander Wetmore, ten years ago (1937), in the course of a short stay in October and November, both at Rancho Grande and Ocumare, made a number of observations on migrants.² The following ten species were not seen by us, and are recorded by Wetmore at Ocumare, between the dates of October 22 to 31, 1937. They are all migrants from the north:

Eastern green heron, *Butorides virescens*

virescens (Linnaeus); blue-winged teal, *Anas discors* (Linnaeus); lesser yellow-legs, *Tringa flavipes* (Gmelin); greater yellow-legs, *Tringa melanoleuca* (Gmelin); western sandpiper, *Ereunetes mauri* Cabanis; Baird's sandpiper, *Erolia bairdii* (Coues); pectoral sandpiper, *Erolia melanotos* (Vieillot); white-rumped sandpiper, *Erolia fuscicollis* (Vieillot); stilt sandpiper, *Micropalama himantopus* (Bonaparte); bobolink, *Dolichonyx oryzivorus* (Linnaeus).

Wetmore's observations on other Ocumare migrants are included in the body of the present paper.

Two additional northern migrants which we did not see are recorded by Wetmore from Rancho Grande:

Dendroica cerulea (Wilson).

Cerulean Warbler.

Wetmore's record reads as follows: "At Rancho Grande in the early morning of November 4, 1937, a dozen or more were feeding actively through the treetops at the house where I was living."

Piranga rubra rubra (Linnaeus).

Summer Tanager.

Wetmore writes: "At Rancho Grande on November 4 one was calling from trees on an open slope at an elevation of 3,400 feet."

The present paper is intended only as a preliminary presentation of the species of birds observed, and their tentative division into a number of types of migration. The bottle-neck of Portachuelo Pass and the constricted area in which northern migrants arrive at and leave the shore at Ocumare, offer a unique opportunity to learn more of many phases of migration in general.

First, the tropical distribution, habits and instincts of the northern migrants concentrated in this area; second, the causes of this particular choice of locality; third, the physical factors of the migration as a whole. A wide and little-known field is the relation of the selection of this particular place to the various theories of migration and migrational navigation; the initiation and development of the boreal pull in these tropics, including the possible effects of neotropical seasons, temperature and light; the visual factors of land, sea, stars, sun, lunar phases, winds and clouds; influence of the vast numbers of birds travelling in close association; possible effects of some radar-like influence and results of recent researches on geographical lines of equal magnetic intensity.

There is also the problem of the relation of the Portachuelo flyway to others in Venezuela, and the concomitant data on other types of migration existing among the resident Venezuelan avifauna. An unexpected phase, correlated with this subject is the contempo-

² Wetmore, Alexander, Observations on the Birds of Northern Venezuela. *Proc. U. S. Nat. Mus.*, 1939, Vol. 87, No. 3073, pp. 173-260.

rary use of the Pass as one of the most remarkable butterfly flyways ever recorded.

A second season of observation with our present appreciation of known and unknown factors should yield valuable data.

In this investigation, as in all phases of my ornithological work in Venezuela, I owe a debt of gratitude to Mr. William H. Phelps and his son, Mr. William H. Phelps Jr., of Caracas, for their constant help and kindness. From his extensive collections Mr. Phelps selected a series of species of birds likely to be found in north-central Venezuela and hence at Rancho Grande. These skins were kept at the laboratory throughout our stay and were of constant use in sight identifications. In the case of skins of uncertain status taken by me, Mr. Phelps made all identifications.

I. SEASONAL MIGRATION.

1. INTERCONTINENTAL MIGRATION.

Under this heading is included all the North American species of birds which spend the winter or dry season in South America, and which we have recorded as using Portachuelo Pass as a flyway on their migration north. After leaving the coast in the vicinity of Ocumare they may turn west and fly up through Central America, or they may choose the more dangerous but direct route across the Caribbean, Cuba and Jamaica, to Florida or the Gulf Coast of the United States. Some may end their long trek in the States or continue to Canada and even Alaska.

In August and September the vanguard of the returning hosts began to appear. Wetmore observed this autumn migration at Ocumare.

Buteo platypterus platypterus (Vieillot).

Broad-winged Hawk.

March 11. A loose flock of sixteen of these well-known birds circled slowly northward through the gap, not very high up, against a fair wind. Three of the birds made passes at one another as they flew. I watched them as long as possible through glasses, and as they continued toward the sea, they spread out into small groups or individuals. The apparent flocking of this rather solitary species may have been due only to the accident of all flying at one time through the bottleneck of the Pass.

Other Records: Wetmore shot three of these birds at Rancho Grande on November 5, 6 and 9.

Pandion haliaetus carolinensis (Gmelin).

Osprey.

June 4. An osprey in full plumage soared northward through the Pass in early morning. Ten days later, on the 14th, a pair of

these birds appeared lower down, but in almost the same part of the heavens, and also headed north. All Venezuelan ospreys are considered to be migrants from the north, but these dates seem very late in the year.

Tringa solitaria solitaria (Wilson).

Solitary Sandpiper.

April 24. Four of these sandpipers were seen running about in the road, at 23rd kilometer, beyond the Pass. I watched them through the glasses as they pursued low-flying insects. They were frightened as a squirrel ran across, they took to wing, and flew straight down the valley toward the Caribbean. The road was still wet from a cloud-burst the night before.

September 9. In early morning after a heavy storm, a solitary sandpiper was found in the road near Portachuelo Pass. It was weak but staggered to its feet, took a few steps and sank down. On my approach the bird evaded me and fluttered down into the dense jungle of the gorge.

Sandpipers are occasionally heard going over at night.

Other Records: Wetmore took a male at Ocumare on October 29.

Actitis macularia (Linnaeus).

Spotted Sandpiper.

March 7. A bird in full spring plumage alighted in the laboratory window at my table for some time, in a light rain among the fluttering moths. When I approached outside, the bird disappeared at once, going up and out into the mist.

Other Records: We have seen this species at Lake Valencia, and Wetmore records several at Ocumare between October 23 and 31.

Coccyzus americanus americanus (Linnaeus).

Yellow-billed Cuckoo.

April 1. I watched one of these cuckoos hopping about a small tree in the Pass in early morning. April 11. A yellow-billed cuckoo and a squirrel cuckoo (*Piaya cayana circe*) were feeding in the same melanostomid bush on the north side of the Pass.

Other Records: Wetmore collected two and observed a third at Ocumare on October 26 and 29, and on November 4 saw one at Rancho Grande.

Nuttallornis borealis (Swainson).

Olive-sided Flycatcher.

From March 23 to April 12 these birds were not uncommon, perched singly, in tall trees along the ridge near Rancho Grande. On April 14, in early morning, a loose flock of birds flew through the Pass. They were frightened by something and two darted down and alighted near me. One was a red-

start, *Septophaga ruticilla*, and the other an olive-sided flycatcher.

Other Records: Wetmore, ten years before, found these birds in exactly the same position along the same trail at Rancho Grande from November 3 to 10.

Hirundo rustica erythrogaster (Boddaert).

Barn Swallow.

On four separate occasions between March 24 and April 7 I saw barn swallows, two, four, one and six in number respectively, flying up the valley or across the road in front of Rancho Grande. Two of these observations were made in early morning from the windows of my bedroom over the laboratory. All the birds were headed or working their way slowly as they fed, northward, toward the Pass a few hundred yards beyond.

Other Records: Wetmore found this species common at Ocumare from October 23 to 31.

Hylocichla minima minima (Lafresnaye).

Gray-cheeked Thrush.

April 22. A male flew against the laboratory windows in late evening in a drizzling fog. It left and returned twice, each time to a different window. I then caught it. No. 30,646, male, excessively fat, weight 36.7 grams, stomach empty. Two others came to the window within the hour but were not caught.

On first comparison with the birds in his collections in Caracas, Mr. Phelps found this specimen confusing, its cold, bright, dark spring plumage was so unlike the dull, more worn plumage of the series in the collection, all of which had been taken in late autumn.

The nearest northern breeding ground of this species would be Newfoundland, twenty-four hundred miles away, while it might continue to north-west Alaska, a full five thousand miles beyond Rancho Grande.

Hylocichla fuscescens fuscescens (Stephens).

Veery Thrush.

April 19. A female flew against the laboratory windows and was captured. No. 30,632. It was exceedingly fat and in the stomach was only a single, large, amber berry. No other veery was recorded.

Vireo olivaceus olivaceus (Vieillot).

Northern Red-eyed Vireo.

Four individuals recorded; No. 30,377, female, April 8, 1945, taken at electric light in rain at Bodega near Rancho Grande by Pedro. Very fat, no food. April 9, 1945, a live bird handled and compared with above specimen and two in Phelps's collection. Identical in lack of yellow on under tail-coverts and along rectrice edges.

April 6, 1946. Two caught against win-

dows. Typical northern red-eyes with whitish under tail-coverts and rectrice edges.

Vireo altiloquus altiloquus (Vieillot).

Caribbean Vireo.

On April 19 a Caribbean vireo flew against the window of the laboratory and was caught. No. 30,633, female, not breeding, very fat, weight 21.6 grams, a small chrysomelid beetle in stomach. Later in the evening two more vireos flew against the window in my bedroom and escaped. I examined them closely through the glass with my face only six inches away and the facial buffy color was very apparent.

If they were headed north their probable goal would be Haiti or Porto Rico.

Mniotilta varia (Linnaeus).

Black-and-White Warbler.

On March 10 I watched a pair of these warblers for some time on Water Trail. They were high up, creeping over the bark of a candela tree. Two days later, March 12, another creeping warbler was busily feeding in a low melanostomid bush near the road beyond the Pass. It flew at once and disappeared down the valley.

Other Records: Wetmore collected this species at Rancho Grande on November 3 and 8.

These records would seem to be near the easternmost limit of the bird's winter quarters in northwestern South America.

Protonotaria citrea (Boddaert).

Prothonotary Warbler.

On March 7, at 9:15 in the evening, a full-plumaged male flew about and alighted on the orchids and monstera near the entrance of the porch at Rancho Grande. An hour later the same or another individual perched for several minutes in a laboratory window in company with a male redstart.

On September 6 two were plainly seen in a small flock containing at least four redstarts. These were near the road beyond the Pass.

Remarks: Not until I reached Caracas and talked with Mr. Phelps did I realize that this species is considered rare in Venezuela, and about at its eastern limits. In the Santa Marta region to the west Todd-Carriker³ records it as "One of the most abundant of the winter resident warblers within its local habitat, which is never far from the sea-beach, or water of some kind."

Vermivora chrysoptera (Linnaeus).

Golden-winged Warbler.

Near the road on March 11, insect hunting in a small tree, a beautiful golden-winged

³ Todd, W. E. Clyde and M. A. Carriker, Jr. The Birds of the Santa Marta Region of Colombia, *Annals Carnegie Museum*, XIV, 1922, pp. 3-582.

warbler came within six feet of where we stood, too close even for binocular focus. It turned upside-down, sideways and around, doing everything it could to impress every character. The throat and upper breast were washed faintly with pearly gray.

(I never gave up hope of seeing a Tennessee Warbler (*V. peregrina*) but none came, at least within identifiable distance.)

Dendroica petechia aestiva (Gmelin).

Northern Yellow Warbler.

These birds are not uncommon in the lowlands, and I observed them several times both at Maracay and Ocumare.

Only once, on April 8, did I see this species at the altitude of Rancho Grande. Five were feeding in a small tree across the road from the laboratory, in early morning, in thin neblina. The night had been windy and with a strong drizzle.

Other Records: Wetmore took a male at Maracay on October 21.

Dendroica caerulescens caerulescens (Gmelin).

Black-throated Blue Warbler.

About 11:30 on the night of April 21 an unmistakable male in full plumage struck against and clung to one of my bedroom windows. I went over and watched it in the brilliant electric light. It held its precarious position for about two minutes in spite of being buffeted by a cloud of moths. It then disappeared into the wind and pouring rain. Within five minutes a female redstart had taken its place. I went down and turned on the laboratory lights but it did not reappear, and the following morning an hour's search of the vicinity of the Rancho revealed no other individual.

Other Records: Wetmore observed one at close range at Ocumare on October 27.

Dendroica fusca (P.L.S. Muller).

Blackburnian Warbler.

On the evening of April 21, two male blackburnians flew at the same time against the glass of two separate windows of the laboratory, one near my table, the other at the far end of the room. Both males remained for a short time but disappeared into the fog before we could reach them from the outside.

The next evening April 22, a third male flew and fluttered for a few seconds against a window of my bedroom.

Dendroica castanea (Wilson).

Bay-breasted Warbler.

A male of this familiar species flew against the window of my bedroom in the evening of April 22, about an hour after the visit of the blackburnian. This bird struck twice, flew off into the darkness and fog, and re-

turned twice, once clinging to the frame, fluttering there for some time, then hanging back exhausted. Every marking was perfectly distinct. These windows are twenty feet from the ground and the laboratory lights below were still on.

Dendroica striata (Forster).

Blackpoll Warbler.

This was by far the commonest of the migrant North American warblers at Rancho Grande. Between fifty and sixty individuals were observed between April 21 and May 5, the peak being on the 22nd, when forty-two were seen or caught and liberated in the single evening. The dates in April when birds struck against the windows were 21, 22, 25, 28, 29 and 30, and these were exactly these evenings which we marked in our weather records as characterized by "fog, wind and rain."

The ratio of sexes on one night was 25 males to 9 females. Only four birds out of the entire total were injured or killed, two of which I skinned, No. 30,641, male, weight 17.5 grams, April 21; No. 30,642, female, weight 18 grams, April 21. All birds examined were excessively fat, all the body organs being encased, and the stomachs were empty.

I have a record of 14 grams for a blackpoll taken in mid-winter in British Guiana. So if we accept this as normal weight, the 18-gram Rancho Grande individual has added more than one-quarter to its weight in fuel for its trans-Caribbean flight.

Unlike most of the other warblers these sat quietly in the windows among the masses of fluttering moths of all sizes. One male remained for a full hour and allowed Miss Crane to set up an elaborate apparatus and take a flood-light photograph. (Plate I).

Only once, on April 29, did I observe a blackpoll in daytime. This bird was hopping slowly about a bush across the road.

Other Records: Wetmore recorded blackpolls at Rancho Grande on November 5, 6 and 7, and at Ocumare on October 25, 26 and 27.

Seiurus aurocapillus aurocapillus (Linnaeus).

Ovenbird.

April 19. An ovenbird was observed walking about on the ground, apparently searching for food, under a guava tree in front of Rancho Grande. It was very tame, allowing Miss Crane, Mr. Fleming and myself to approach closely.

April 22. A second and a third ovenbird flew against the laboratory windows about 9 p.m., three days after we had watched the first individual. They remained among the moths for some time, the light orange head patches showing up clearly. Later, on the same evening, a northern water-thrush struck with such force that it was killed.

At the time of observation we had no idea that the ovenbird was a rare visitor to Venezuela.

Other Records: The ovenbird has been recorded once from Santa Marta to the west, and once from the Paraguana Peninsula in Venezuela.

Selurus noveboracensis noveboracensis
(Vieillot).

Northern Water-thrush.

April 21. A quick glimpse of a small bird walking about the porch of Rancho Grande in the electric light left me convinced that it was this species, but it may have been an ovenbird.

April 22. A male water-thrush flew against a laboratory window with such force that it was killed and later picked up from the ground below. It was excessively fat with a completely empty stomach. No. 30,647, weight 22 grams.

Oporornis agillis (Wilson).

Connecticut Warbler.

April 29. The only certain identification of this species was a male captured and skinned after it flew against a window of the Rancho Grande laboratory. As usual with migrants, its body was encased in fat, and the stomach contained no food. No. 30,668, weight 19.8 grams.

On the same and several succeeding days there were flocks of small, dull-colored warblers which may well have been of this species but which were too high up in the dark shade of jungle trees for identification.

May 2. A full-plumaged male fed within a few feet of us in a low tree near the Pass for as long as we wished to watch.

Other Records: Wetmore collected a migrating male at Ocumare on October 23.

Oporornis philadelphia (Wilson).

Mourning Warbler.

April 9. Three birds, all males, fed in the undergrowth near the road beyond the Pass. They seemed tired, perhaps after battling through the neblina and high wind of the past night. They paid no attention to us even when we approached within six feet. To our amazement one of them uttered its song, faint but almost complete, reminiscent of, yet quite different from the song of the ovenbird. One bird had a faint, imperfect eye ring but the jet black breast of the present species was unmistakable.

Setophaga ruticilla (Linnaeus).

American Redstart.

Next to blackpolls, this warbler was the most abundant of Rancho Grande migrants.

February 27 was the earliest date it was observed, and until May 5 at irregular in-

tervals they could be seen feeding with other small birds during the day. On nights of fog, rain or wind they struck against the laboratory windows. The females outnumbered the males about two to one. All these skinned were coated with fat. For example, No. 30,626, female, weight 10.3 grams; No. 30,630, male, weight 11 grams.

Fall migrants returning from the north were recorded as follows: August 31, male in tree; September 6, 7 and 8, respectively four males, two males, two females, all feeding along the Pass trail with other warblers and tanagers.

Other Records: Wetmore saw redstarts at Maracay on October 21 and November 11; at Ocumare on October 23, 29 and 30.

2. CONTINENTAL MIGRATION, SOUTH.

This division includes only a single species, whose appearance was so unexpected and extensive that full details are recorded. It is well known that these southern brown-breasted martins mingle in the dry season with those from northern regions, but I do not know of any consistent or regular migration of great numbers having been recorded before. I can offer no reason for the time or direction of the flight.

Phaeoprogne tapera fusca (Vieillot).

Southern Brown-breasted Martin.

These birds from southern and central parts of South America were first seen migrating north through Portachuelo Pass on July 28. For several days their speed and the presence of heavy fog prevented identification. Both Mr. Tee-Van and I at first thought they were plovers. On August 2 I shot three birds. Their impetus carried two of these far over the Pass and into the heart of the valley jungle. The third fell almost at my feet and proved to be a male *Phaeoprogne tapera fusca*. The identification was made by William H. Phelps after comparison with his large series of *t. tapera* and *t. fusca*. A few days later, by sheer accident, at one side of the Gorge Trail, I came across one of the shot martins which had over-passed me. It was badly decomposed and almost buried by scarab beetles, but the characteristic line of mid-breast, dark-brown spots was still unmistakable.

The migration was unified and continuous, extending at least from July 28 to August 31. In the daytime it was sharply limited from four or five in the afternoon until it was too dark for us to see. Without exception every bird was headed north through the Pass.

The following is a brief résumé of my notes:

July 28. Together with swifts, a number of brown plover-like birds were seen passing north through the Pass.

July 29. For an hour, from 4 to 5 P.M. John Tee-Van and I watched more than one thousand of these birds (1,071 were actually counted) fly past. At terrific speed the birds appeared and disappeared out of and into the dense fog, giving us only a momentary glimpse. They came singly or in groups. There was no diminution in numbers when we left at 5 P.M.

July 30. The birds began passing in heavy fog at 4 o'clock. Counted 341 and missed a great many before it began to rain.

August 1. From 5 o'clock to 5:45 two of us counted considerably more than 5,000 birds all going north. The weather was clear and many of the martins were passing very high up, flying straight and strongly. With them were numbers of *Chaeturella rutila brunnicorques* and *Streptoprocne zonaris albicincta* whose speed was somewhat less than that of the martins.

August 2. Shot three birds in dense neblina. The martins passed with no let-up from 4:30 until dark. One of us counted 4,860. The shot bird was a male, No. 30,912, not very fat, weight 36 grams. Its food consisted of a dragonfly (Aeschnidae), several small beetles, besides a neuropteran and a homopteran. Almost no signs of molt, except the half-grown first primary of each wing.

August 7. The martins began passing at 4:55 P.M. Within the next twenty minutes counted 985, missing as many more. They were flying low through the Pass, below tree-top level. Circumstances precluded observations during succeeding eight days.

August 16. Martins appeared at 5:10 P.M. and in constantly increasing numbers until 5:45. My total was 3,910. There was dense neblina in the valley on the north side, and at first the birds came over in mid-Pass and plunged headlong into the solid fog, vanishing at once. Later, as the fog drifted up toward the Pass, the migrants swerved out over the road, curving low over and through bushes and trees.

August 31. For two weeks I was away from Rancho Grande, lecturing in other parts of the country, and for the intervening time had to depend on the scanty notes of a native assistant. He reported that on at least eight of the fourteen days martins were seen going over. On August 22 a very large number passed through.

Today (August 31) on my return, the martins appeared as usual at 4:45 P.M. and in a half hour 776 were counted as they went easily with the wind, always northward. This completes my observations, as no more birds were seen on succeeding days.

The presence of this southern form at Rancho Grande is not without precedent, for Hellmayr gives as its range: "Breeding in northern Argentina, Uruguay, Paraguay, eastern Bolivia and southern Brazil, north to

Matto Grosso, Goyaz and Minas Geraes; spreading in winter north to British Guiana, Venezuela, Amazonia and Colombia."⁴

Mr. Phelps has birds in his collection from Lake Valencia, Ocumare, Puerto Cabello and Carenero, Miranda. Dr. Niceforo lists several Colombian records, including one near Bogota at an altitude of 2,600 meters.

What awaits explanation is: Why should a minimum of seventeen thousand southern martins be flying north, at this season, in a definite temporal and spatial migration, headed for the Caribbean Sea only a few kilometers away?

Did they swerve east or west after they vanished from sight into the fog?

Why do they not fly, like *Progne chalybea chalybea*, during the day, and how far into the night does the flight continue?

When and by what route do these birds return to the Argentine and other breeding haunts to nest in November and December?

3. MIGRATION OF BREEDING RESIDENTS.

With more extended, concentrated observation, this section could, of course, be very greatly increased. It would account for the lessening in numbers or disappearance after the breeding season, of resident birds. I have included only three species, all of which we observed utilizing the Pass as a flyway.

Pygocheildon cyanoleuca cyanoleuca (Vieillot).

Blue-and-white Swallow.

Together with house wrens, these swallows were our constant familiars at Rancho Grande, breeding in numbers in the drain openings and crevices of the unfinished walls. On February 22 there were only twelve birds present, all roosting together in the most distant, upper doorless rooms. By the time breeding had begun the flock became three times as large. After the second brood was reared the number of the swallows gradually decreased. As to their return, Wetmore records this same colony as present in small numbers in early November.

My inclusion of the species in Pass migration rests upon two flocks, seen on July 16 and August 4, of sixty and thirty-four birds respectively, which flew slowly, well up, southward through the Pass. The second flock was accompanied by a few rough-wings and short-tailed swifts. They were not feeding, and very definitely were not from our colony, which was still present in strength.

Stelgidopteryx ruficollis aequalis (Bangs).

Caribbean Rough-winged Swallow.

Only three pairs bred at Rancho Grande, in complete amity with *Pygocheildon*. They

⁴ Hellmayr, Charles E., Catalogue of Birds of the Americas, *Field Museum of Natural History, Zoological Series*, XIII, Part VIII, 1935, p. 29.

have but one brood and disappear as soon as the young are well-grown. My more definite inclusion of the species as migrants is the certain identification of five rough-wings in company with a southward-headed flock of *Pygochelidon* on August 4.

Other Records: Wetmore secured two females near Rancho Grande on November 3 and 9. One of the birds was in full wing molt. At lower elevations, from October 22 to November 10 he observed these birds near holes in banks, but no definite proof of their breeding at this season was obtained.

Platycichla flavipes venezuelensis (Sharpe).
Venezuela Gray-backed Robin.

Platycichla leucops (Taczanowski).
Black Robin.

So far as migration data are concerned, our notes on both of these birds are identical. In 1945 both gray-backed and black robins were not uncommon, and from the actions of pairs of birds they seemed to be nesting in several places in Gorge Valley on the north side of the Pass and bordering the trail leading up to Pico Paraiso to the west. On August 16 we saw a flock of twenty-four birds, about one-third of which were black. They flew up from the Limon Valley toward us, and on through the Pass in a long drawn out, narrow line several birds in width, on and into thin neblina on the Caribbean side. Two days later on August 18 a pair of birds, both black, flew through the Pass in the same direction.

Learning of the uncertain specific status of these two color-patterned robins, I kept close watch in 1946, but throughout five months I neither saw nor heard a single bird. The song is very characteristic and cannot be confused with that of any other species.

4. LOCAL FLOCKING OF PERMANENT RESIDENTS.

The gathering together of a few or of many species of birds into definite flocks, occurring after the breeding season, is one of the commonest avian phenomena in tropical jungles. The wanderings of these flocks are irregular, and seem to follow no definite routes, but, at least near Rancho Grande, are usually restricted to territory embodied within a few square kilometers. A traverse of the east and west ridges forming Portachuelo Pass was a path occasionally followed by these flocks, and their passage was so leisurely and the birds so tame that a reasonably complete census was often possible. Now and then it seemed certain that the same flock reoccurred several times with about two weeks intervening. Identity seemed certain, for example, as in one case in which the members included exactly twenty-nine *Tangara arthrus arthrus*

Some flocks were composed solely of two or three species of larger birds, such as caciques, toucanets and green jays, but most of them embraced a heterogeneous assembly of perhaps a dozen species of small birds, a mingling of woodhewers, tanagers, honey creepers and antbirds.

Members of these groups seem bound together by something more than casual association, for more than once I have seen two flocks progressing in different directions, meet, cross, and emerge with identity unbroken, and respective components unaffected by the temporary warp and woof of crossing.

The cause of this flocking is uncertain. The birds are always busy searching for food or feeding, yet there is no stirring up of insect life as with the followers of army ants. As to mutual protection, the resultant increase of sight and sound would seem disadvantageously to advertise their presence to predators. I have omitted any detailed list of species included in this section as being too casual in their use of the Pass.

5. LOWLAND TO LOWLAND MIGRATION OF NON-RESIDENTS.

In this division I have placed the few species of birds which at least once have definitely used Portachuelo Pass as a migration flyway after their breeding season. Their numbers, as well as their direction, together with the fact that all are non-residents, mark them definitely as migrants.

That there is no bond between them except this tenuous habit may be perceived from the fact that four are raptorial birds, one a goatsucker, one a martin and one an oriole.

Elanoides forficatus yetapa (Bonn. and Vieillot).

Swallow-tailed Kite.

Twice, in June, we saw individual kites hovering over the distant jungle of Limon Valley in front of Rancho Grande, searching for lizards or grasshoppers. In both cases the birds moved away without finding food. On August 15 at 2 P.M., in full sunshine, nine of these lovely birds circled slowly, well up, over the valley and then moved northward through the Pass. Two of us and two visitors watched them until they were out of sight. Two hours after they disappeared fog and rain settled down.

At the height at which they were circling they could easily have passed over Pico Paraiso, but like so many other creatures, both birds and butterflies, the exact center of the Pass drew them like a magnet. A very enlightening simile would appear to be Hawk Mountain in Pennsylvania, with its amazing numbers of species and individual raptors, where the reason for the concentration of

spatial migration seems as nebulous as that of Portachuelo Pass.

These essentially tropical swallow-tailed kites were never seen to return, so I can classify their passage only as a seasonal, post-breeding shift to new areas.

Harpia harpyja (Linnaeus).

Harpy Eagle.

We had no expectation of seeing harpy eagles near Rancho Grande. The last I had observed were at sea-level in British Guiana, and as far as I know, they have never been associated with migration in any form. Although their general distribution is given as "Mexico from the Isthmus of Tehuantepec south to Bolivia, southern Brazil, Paraguay and northeastern Argentina," few people within these boundaries have ever caught a glimpse of one of these eagles. They are essentially tropical, solitary, and their usual haunts are the jungles whence they obtain their favorite prey of sloths and monkeys. These birds have not, I believe, been recorded from northern Colombia or northwestern Venezuela, and there are only a few, scattered records for all of Venezuela.

During our stay at Rancho Grande, on two separate occasions, harpy eagles presented perfect opportunities for deliberate observation and identification. The first bird was seen early in the morning of August 2, 1945, after a night of rain and wind. This fully adult eagle was perched in a dead tree part way up Limon Valley. When it flew, it flapped heavily up the valley and on through the Pass to the north. A half-mile away one of my staff saw and described what was apparently the same bird as it flew on down the valley on the north side.

In the following year on August 7 in the afternoon at the Pass, a hint of something unusual was evident by the sudden terror of several passing flocks of giant swifts and conures, which in their alarm, dashed past, very low, close to where I sat. Soon after this excitement four harpy eagles soared fairly high over the Pass. One was in white immature plumage, three were adults. After these had disappeared from view, another pair of eagles came into sight. All were moving swiftly, but in narrow circles or spirals, which kept them in full view for a considerable time. With number seven binoculars, elbows steadied on knees, I could make out every detail of pattern and color, from the occasionally raised crest to the great yellow feet. This August day was one of the most memorable at the Pass.

The birds worked northward until they were out of sight. They were not graceful birds, but, in what must have been an upsurge of air, they soared as effortlessly as the frigatebird which later appeared high above

them. Day by day, month after month, watching of the Pass yielded no more harpy eagles, and two excited reports by staff members were without binocular confirmation.

Beyond the fact that on the seventh of August six harpies went north through the Pass, we are completely ignorant. It seems almost impossible that they could remain unnoticed on their further travels, but whence they came and whither they were bound, we cannot even guess.

Falco albogularis albogularis (Daudin).

Bat Falcon.

We recorded this species on two occasions, once as real migrants. On July 6, I discovered one perched in the top of a candela tree at the gate of Rancho Grande and watched it for a whole hour, using 12 and 20 powers of the giant binoculars. It took flight twice, circled and returned. Then, unexpectedly, six more bat falcons appeared from somewhere to the south and circled overhead, working toward the Pass. As they went, my bird, with a loud chattering, joined them and all disappeared northward through the gap. I saw no other bird of this species until August 4, when a single falcon drifted slowly high up, disappearing into thin clouds before I could be sure of its general direction.

In spite of the lone perching bird, the species seems to be essentially tropical and only a casual visitor and migrant at Rancho Grande altitudes.

Milvaga chimachima cardatus (Bangs and Penard).

Chimachima Hawk.

The chimachima was occasionally seen in the vicinity of Rancho Grande, but it is predominantly a resident of the lowlands. Several were killed by passing cars near the upper level and close to Portachuelo Pass, and I saw one with a large and very lively coral snake in its claws directly over the laboratory.

My inclusion of the species here is due to eight of these hawks circling slowly, low down, headed northward through the Pass, which classifies them as non-residents, lowland to lowland transient migrants.

Other Records: Wetmore records this species as found in small numbers at Ocumare and fairly common at Maracay.

Nyctidromus albicollis albicollis (Gmelin).

Parauque.

I was surprised to flush two of these old friends on the road in front of Rancho Grande on an evening in early May. Later, on May 10, we saw another nighthawk and a week later a pair close to the Pass. In Limon where the rise to Rancho Grande begins,

these birds could often be flushed in the evening.

Their inclusion here is because of sixteen paraques circling slowly over and through Portachuelo Pass, headed southward, on April 16. I watched them as long as possible through glasses and not a bird caught an insect. They were moving leisurely, in a single flock, from somewhere along the coast to somewhere in the interior.

Other Records: Wetmore saw these birds at Ocumare on October 30.

Progne chalybea chalybea (Gmelin).

White-breasted Martin.

This widely distributed swallow was common and nesting at Turiamo, Ocumare and Maracay. In early morning from the porch of the Hotel Jardin in Maracay, hundreds of these martins could be seen quartering the sky, feeding on clouds of gnats. I never saw a single bird at Rancho Grande until, on July 18, a mass migration began from the north. From 8:15 to 9:15 in the morning, small and large flocks of martins poured through Portachuelo Pass, coming from the northern valleys and concentrating into the narrow gap. We counted 1,246 in all and must have missed at least as many more. One flock contained more than 300, and at other times small groups of seven to ten would straggle past. A fairly stiff wind kept the birds twisting and bucking, and now and then they would be held stationary for a few seconds before they could again regain impetus. None were feeding.

On July 23, two large and one small flock came through, a total of at least 643. On two preceding days and for three succeeding ones, more of this species were reported, but I did not see them. On our next visit to Turiamo, only a few individuals were visible. Until August 10 the martins at Maracay seemed undiminished, but after that date fewer were noted, although our observations were confined to early morning and late afternoon.

The fact that Wetmore in November did not record this species from either Ocumare or Maracay would indicate that the migration must be continued farther to the south, and that it lasts at least from mid-July to November.

Cacicus cela cela (Linnaeus).

Yellow-rumped Cacique.

This tropical species was recorded at Rancho Grande only as a migrant. On July 20 a compact flock of 37 caciques came south through Portachuelo Pass, and again on the 24th fourteen more birds followed the same route, with two additional stragglers striving to catch up.

On our next visit to Turiamo the two low-

land colonies near the road were still occupied, so the migrating flocks must have originated further east or west. No return was noticed during our stay.

II. DAILY MIGRATION.

6. REGULAR LOWLAND TO LOWLAND MIGRATION OF NON-RESIDENTS.

We include only black vulture under this heading, but in spite of our watching, there may be a few others which use the Pass as a daily or at least a regular highway to and fro, from sleeping to feeding grounds and return.

Coragyps atratus (Beckstein).

Black Vulture.

Early on the morning of our second day of arrival at Rancho Grande I recorded eleven of these vultures flying low against a light wind, headed north through the Pass. After a few days I gave up continuing such records. Except on days of heavy storm or solid fog, from 11 to 36 vultures flapped up the valley from Maracay through the Pass and on out of sight. In the afternoon, in the van of the incoming fog or neblina, they returned singly or en masse.

I never saw one turn aside, circle, soar or slacken its directed speed. It was a most regular, daily migration from lowland to lowland. Again and again, while intent on some observation, the sudden *whoof! whoof!* beat of wings would attract my attention up to the passing vultures. This bird was the most perfect justification of Rancho Grande Number 14, Aerial Zone.

7. IRREGULAR, DAILY SHUTTLING.

This section includes most of the parrots and swifts. The majority of the species of these groups are present near Rancho Grande as rare to fairly common residents, but our memory of them is chiefly as flocks passing back and forth through Portachuelo Pass. Excluding *Cypseloides cryptus*, four species of swifts come under this heading. The irregularity of these movements prevents any classification of objectives, such as feeding, roosting or breeding. From the beginning to the end of our stay these birds were observable in flocks.

Aratinga wagleri transilis (Peters).

Red-crowned Green Conure.

This was the most abundant of its family at Rancho Grande, its raucous screeching audible several times a day. Its presence in this list is due to its eternal flying back and forth, north and south through the Pass, in smaller or larger flocks, the members always in multiples of two. In both clear sun and fairly dense fog these irregular local move-

meters kept up. The beginning and end of the shifts were usually beyond our view.

Pyrrhura haematotis haematotis (Souance).
Red-eared Conure.

This conure was not uncommon and was often seen passing through the gap. The tail was the best identification character when seen against green foliage. A bird secured from a flock of twelve on May 21 was a female, not breeding, No. 30,711, weight 66 grams. The stomach was full of reddish fruit. A half-eaten individual found on a trail had put up such a stout fight with its assailant that sufficient feathers were scattered around to identify the attacker as *Otus choliba crucigerus*.

Forpus passerinus viridissimus (Lafresnaye).
Green Dwarf Parakeet.

This is essentially a lowland bird but I have five records for Rancho Grande. Three of these were of flocks going through the Pass, north, south and north respectively, of 6, 16 and 3 birds. The dates were February 28, March 3 and 7. On two days these parakeets were seen feeding in a berry tree directly opposite the laboratory, the last time in company with *Pionus sordidus*. The twenty-power giant binoculars showed every feather.

We saw dwarf parakeets both at Turiamo and Maracay and Wetmore recorded them at Ocumare.

Amazona ochrocephala ochrocephala (Gmelin).
Yellow-fronted Amazon.

A single feather picked up in the road indicated this species. On April 6 two flocks of 6 and 8 birds went north through the Pass. After this, from time to time, small flocks in pairs vibrated back and forth, irregularly. On two occasions single birds perched within easy range of the giant binoculars.

Pionus sordidus sordidus (Linnaeus).
Black-headed Amazon.

In pairs and small flocks these parrots occasionally fed near by and seemed to be real residents of the subtropical area around Rancho Grande. But more frequently they were seen going through the Pass. Several flocks would appear from the south and fly directly through and on into the north valley. Then at noon, or later, these or others would return, or they might come into view, wheel and turn back on their tracks. Their *peevunt* often called attention to the 4 to 10 birds which usually composed the groups, even before they came in sight. They were recorded every month of our stay.

The one exceptional migratory flight, on March 11, was a compact flock of at least 96 individual parrots. We were several kilo-

meters down the road toward Maracay when we sighted the birds, flying low, silhouetted against the jungle, and headed straight up the valley toward the Pass.

Touit batavica (Boddaert).
Seven-colored Parakeet.

On June 25 in the road near Rancho Grande I found several small green feathers, together with a single lateral tail feather. The latter instantly brought to mind the name *Touit batavica* and a memory of the exquisite little parrot to which it belonged, and which I had last seen many years ago in British Guiana. Mr. Phelps later confirmed the identification. No other bird's feather has the wonderful changing purplish-pink with the black tip of this rectrice.

This parakeet would seem to be an inhabitant of lowland tropics. The only other record for Rancho Grande is a flock of four which came down the valley from the north, and at the Pass alighted in a cecropia. I had already focussed the 12-power of the giant glasses on a tanager in the same tree, so it required only a slight lateral shift of the two-foot binocular tubes to bring into perfect focus three of the quartet of seven-colored birds with all their beauty of yellow, black, green, blue, rose and purple. Before long they took to wing and swung swiftly on their way toward the lowlands of Maracay.

Streptoprocne zonaris albicincta (Cabanis).
Giant White-collared Swift.

Soon after our arrival I ceased keeping an exact count of these splendid birds, for there seemed no regularity in their movements. During clear days they might occasionally be seen hawking with our swallows or other swifts high in air. Aside from this they were recorded chiefly as dashing back and forth through Portachuelo Pass. For example on June 24, four, and then sixteen birds, drove southward in separate flocks toward Maracay. At 3 P.M., just before the fog rolled up, a loose flock of 64 rushed past, low, northward.

At nine o'clock on the night of July 3, 1945, two giant swifts, in dense neblina, killed themselves against the laboratory windows. No. 30,447 weighed 105.8 grams; and No. 30,452, 96 grams. Both were adult males, but the white pectoral band in the latter bird was so narrow and faint as to be almost absent. Their crops and stomachs were crammed with flying ants.

The first swift (No. 30,447) had eaten hundreds of a pure culture of winged female *Azteca* ants. The second bird (No. 30,452) had dined on equally large numbers but a greater variety, including ants of the genera *Dolichoderus*, *Solenopsis* and *Crematogaster*. The absence of all mutual species of ants in

the two birds might indicate that, although they arrived at the laboratory simultaneously, they may have been quite dissociated in feeding locale.

Other Records: Wetmore observed these birds at Rancho Grande on November 3, 6 and 10.

***Chaeturella rufila brunnitorques* (Lafresnaye).**

Chestnut-collared Swift.

In abundance this swift ranks as third. In irregular Pass migration versus feeding within sight of Rancho Grande, the proportion is about ten times to one. It lives in small flocks, never more than twelve, and often single birds are seen hawking about with the swallows. Except with the giant binoculars, these birds are more easily identified when silhouetted against the green foliage than when high in air.

In 1945 seven birds struck against the laboratory windows, all on nights of rain and fog. Two of these chestnut-collared swifts were caught. No. 30,382, May 14, male. This bird struck among a fluttering mass of hundreds of moths and was instantly killed. The collar was very wide and bright rufous. The bird weighed 25 grams. The food consisted of several hundred flying female *Camponotus* and *Solenopsis* ants. This was the very first evening when the electric lights were operating. No. 30,448, July 3, male, weight 22.9 grams. Collar was one-half normal width on nape, and almost absent on breast. Food, many *Crematogaster* ants.

***Chaetura brachyura brachyura* (Jardine).**

Short-tailed Swift.

This was the commonest swift to be seen at Rancho Grande. On clear days, numbers often fed with the swallows, whereas on partly cloudy days or when fog threatened to drive up one or the other valley, these birds shot through the Pass in numbers. They were equally in large, loose flocks, or small compact groups. We saw this swift every month of our stay, and often daily.

Other Records: Wetmore recorded this species at Rancho Grande November 4.

8. TEMPORARY, DAILY, LOCAL MIGRATION.

Only one species was observed which fitted into this category. When we know more about the ecology and life habits of tropical jungle birds we will be able to write more intelligently of these incipient migrations.

***Psarocollis angustifrons oleagineus* (Sclater).**

Green Caciue.

In the course of watching the inception of one unit of a five-tree colony of green caciues within sight of Rancho Grande, it became evident that a temporary daily migra-

tion was going on. From the time of the first woven attachment of the great nests until final completion, the polygamous male and his whole harem of females would leave simultaneously, late every afternoon, and fly in the direction of Portachuelo Pass. Several times, when we were returning, this flock passed up, flying low through the Pass. The birds evidently stopped somewhere in the heart of Gorge Valley for we could continue to hear their noisy chatter. Early next morning all would be back at work, the females laboring to complete their nests and the male encouraging them with song and courtship acrobatics.

This routine migration ceased with the laying of the eggs, and when most of the nests were finished and occupied, the male would start on the five o'clock trek accompanied by only two or three females. Local and transient as this movement was, it presented a regular sequence, extending from the tree of unfinished nests of the colony to some relatively distant and definite feeding or sleeping place, and back again.

Migratorially this cacique offered another interesting phase, for when the young were fledged and able to care for themselves, the whole colony joined with green jays or toucanets, to form one of the many wandering flocks (Section 4).

III. IRREGULAR MIGRATION (AS OPPOSED TO SEASONAL AND DAILY).

9. IRREGULAR MIGRATION OF NON-RESIDENTS.

This section includes a number of species whose migration must be called sporadic. The association is in part a confession of ignorance, but for the present, logical.

The several lowland wading birds included, drift irregularly back and forth from Ocumare and Turiamo through the Pass to Maracay, in family groups or singly, with little reference to the breeding season. The remainder represent mostly a single nocturnal visit to laboratory windows and must be sequestered here until we know more about the reason for their unseasonable and nocturnal appearances.

***Leucophoyx thula thula* (Molina).**

Snowy Egret.

This is a familiar bird of the lowlands and I saw it again and again at Turiamo, Ocumare and Lake Valencia. On March 3 seven birds flew northward through the Pass, and three more on March 6. On July 29 four egrets appeared suddenly in early morning, beating their way south, low, through the light neblina.

These seemed rather casual small flocks, shifting from one bit of water to another; more week-end visitors than migrants.

***Neocrex erythrops olivascens* Chubb (?).**

Red-faced Rail.

Six of these rails flew against the laboratory windows at Rancho Grande, and two were caught, skinned, and presented to Mr. Phelps when it was evident that they were of exceptional interest. Seventeen more were seen early one morning flying south through Portachuelo Pass.

Mr. Phelps has personally compared these two specimens with the 31 known specimens of the species in the American museums. He sent a specimen of *olivascens* from Caracas to Dr. Kinnear of the British Museum, who compared it with the 8 specimens of the species there. The result of these comparisons is that the Rancho Grande specimens are much brighter than all the others: the forehead is purer, brighter bluish-gray; the chin and throat are pure white instead of dirty white; breast and abdomen brighter bluish. Phelps believes that there is a possibility that the Rancho Grande specimens are *olivascens* in perfectly fresh plumage while all the other known specimens happen to be in worn plumage.

Whatever the ultimate decision, my present concern is with the birds only as migrants in north-central Venezuela.

On the night of June 14, 1945, a rail flew against the lighted windows of the laboratory and I picked it up from the grass outside quite dead. There was considerable fog and on the windows at the time were about two thousand moths.

Collection No. 30,422, Color Plate 1772, male, not breeding. Length 165 mm., wing 102, tail 34, culmen 23, tarsus 33 mm. Bill chartreuse green with scarlet base, feet dark peach red, iris scarlet orange. Body exceedingly fat. Food, small seeds of various kinds.

On the night of May 23 of the following year, 1946, a second rail of the same species came to the electric lights on the roof of Rancho Grande and was caught alive, killed and prepared. The night was fairly clear, except for thin clouds. Collection No. 30,722, male, near breeding, testes 7.5 mm. in length. Length 202 mm., wing 103, tail 38, culmen 22, tarsus 31 mm. Body exceedingly fat, weight 55.4 grams. Colors as in other bird except that the basal red on the maxilla extends dorsally to the anterior end of nostrils. Food, remains of weevils and flies.

The same evening four more rails, distinctly seen, struck the windows but even after an extended search in the darkness outside, no trace was found. Two days later, on May 25, at Portachuelo Pass in early morning, two of us saw a flock of several *Streptoprocne zonalis albicincta* and three *Progne chalybea chalybea* passing low going south. Immediately afterward a group of seventeen small, red-faced rails, appearing identical with the

one taken two days before, flew low overhead in the same direction headed toward Lake Valencia. They flew rather slowly as rails do, and were perfectly distinct.

***Jacana jacana intermedia* (Sclater).**

Venezuelan Jacana.

Two of these birds were found on the Rancho Grande porch outside the laboratory about 9 o'clock on the evening of June 22. I caught one with a butterfly net and the other flew off into the rather thick fog. No. 30,783, female, largest ova 2.5 mm., gizzard full of small pieces of white quartz and remains of two small fish. Migrant-like, the bird was exceedingly fat, both in the body cavity and under the skin and along the oesophagus. Weight 111.5 grams. The lapets and maxilla as far as nostrils rich deep scarlet, rest of bill bright straw yellow, legs and feet pale green. A few white feathers on chin and upper throat.

***Charadrius collaris* (Vieillot).**

South American Collared Plover.

On June 25 we saw three of these birds, one apparently immature, feeding in the long grass at the roadside close to the Pass. They gave us several minutes of uninterrupted observation with glasses, and then rose together and flew straight down the gorge toward the sea. I have never before seen this species away from the coastal lowlands.

***Himantopus himantopus mexicanus* (Müller).**

Black-necked Stilt.

Four black-necked stilts flew through the Pass in bright sunshine, headed south, on May 21. They are frequently seen in pairs in the lowlands, both at Maracay and on the Turiamo and Ocumare sides.

***Leptotila verreauxi verreauxi* (Bonaparte).**

White-fronted Dove.

My only record of this bird in the daytime, at rest, near Rancho Grande is a pair in a tree at the roadside in late afternoon of July 10. Yet a few kilometers down the road toward Maracay, at 700 and 800 meters elevation, they are often flushed from the road or seen in pairs perching in trees, at all times of the day.

We have five separate records of these doves dashing against the windows late in the evening on rainy or foggy nights. Three were caught and liberated after identification. The fifth was injured, so was killed and preserved. April 23, No. 30,650, female, not breeding, very fat, weight 132 grams. Three others were seen in the porch the same evening, and next morning a flock of about a dozen was counted going through the Pass northward. Circumstantial evidence, there-

fore, would indicate that this was a local migration on the part of a bird which is widely resident in Venezuela.

***Oreopeleia montana montana* (Linnaeus).**

Ruddy Quail Dove.

This widely distributed species is rare at Rancho Grande. On only two occasions did I flush them. A pair the first time, and four doves the second, rose from the jungle floor along the water trail.

Four quail doves struck, late in the evening, against the windows of the laboratory. Two of these were caught. April 22, No. 30,649, female, not breeding, moderately fat, weight 99.5 grams. April 30, No. 30,671, male, breeding, testes 17 mm., fairly fat, weight 108.5 grams. Three days later, a trio of very red-backed doves flew through the Pass, which very likely were of this species.

***Cypseloides cryptus* (Zimmer).**

White-chinned Swift.

In 1945 a new species of swift was described.⁵ The type came from Rio Tavera, Peru. Only four other specimens were known, taken at the following localities: British Guiana (Kaieteur Falls), Venezuela (Mt. Auyan-tepui, and Sororopán-tepui), and Costa Rica (San Pedro).

On April 20, 1946, a female of this swift crashed against the laboratory windows at Rancho Grande, at 8:30 in the evening, and was stunned. No. 30,634, female, not breeding, fairly fat, weight 40.2 grams. Length 120 mm., wing 137, tail 48, culmen 5.5, tarsus 16 and wing-spread 355 mm. The stomach was full of winged female *Azteca* ants.

On the following evening at the same time, April 21, a second bird killed itself against the identical window. No. 30,640, female, not breeding, considerable fat, weight 35.8 grams. Length 138 mm., wing 130, tail 50, culmen 5, and tarsus 15 mm. A great quantity of *Crematogaster* and *Azteca* flying ants in stomach. First primary in each wing half-grown. Mr. Phelps made the identification.

This wholly unexpected visitation only multiplies the mystery of the definite distribution of these birds. I do not know whether the Rancho Grande swifts were headed north or south, but it was in dense fog and rain. A migration of less or greater scope would be indicated by the nocturnal flight, fairly fat condition and absence of any other record during our stay.

***Pachyramphus polychopterus tristis* (Kaup).**

Glossy-crowned Becard.

My only records of this tropical species at

⁵ Zimmer, John T., A New Swift from Central and South America. *The Auk*, 62: 1945, No. 4, pp. 586-592.

Rancho Grande are two males which struck against the laboratory windows during heavy rain and fog. April 18, 10 P. M., No. 30,631, male, near breeding, testes 7 mm., rather fat, weight 19.4 grams, in stomach a large berry and a small beetle. April 23, 9 o'clock, No. 30,651, male, near breeding, testes 6 mm., rather fat, weight 18.7 grams. This bird had the entire under plumage faintly freckled and lined with white. It can only be assumed that they were migrating at night from lowlands through the Pass to some other unknown lowland. They certainly were not resident at this altitude.

Other Records: Wetmore's nearest record for this cotinga is El Sombrero.

***Vireo olivaceus vividior* (Hellmayr and Seilern).**

Venezuelan Red-eyed Vireo.

On March 25 in heavy fog a male struck against the laboratory windows at 9:30 in the evening. No. 30,593, male, very fat, weight 14.5 grams, stomach empty. Iris pale reddish.

The next morning early, from my seat in Portachuelo Pass I watched near at hand seven red-eyed vireos feeding in the melanostomid bushes. They may have been the northern migrating form, *v. olivaceus*, but the earliest certain identification of these was on April 6. Or very likely they may have been in the same flight as the *vividior* of the previous night.

The resident red-eye in Venezuela is almost wholly tropical. The sudden presence in such numbers at this altitude, the nocturnal flight, extremely fat condition and empty stomach all suggest at least a local, transpass migration from lowland to lowland of the resident subspecies.

10. WANDERING.

Wandering may be thought a very indefinite term to be used in the present connection, but it might also prove a stage in the initiation of movements which in time would be more worthy of classification as migration.

***Fregata magnificens rothschildi* (Mathews).**

Caribbean Frigatebird.

These birds are always to be seen at Ocumare and it is likely that they nest on a small, offshore islet.

On August 7 and September 4 I sighted one and two frigatebirds respectively, high over Portachuelo Pass. Both days were free of cloud so these visitations were voluntary, and inspired by reasons clear only to the birds themselves.

EXPLANATION OF THE PLATE.

PLATE I.

- Fig. 1. Portachuelo Pass, half hidden by mist, as seen from the courtyard of Rancho Grande.
- Fig. 2. Migrating male Blackpoll Warbler, *Dendroica striata* (Forster), in a window of the laboratory at Rancho Grande, on the evening of April 22. This was just before the bird took off in the fog and rain, on a trans-Caribbean flight, with objectives of Vermont, Labrador or northern Alaska.

Photographs by Miss Jocelyn Crane.

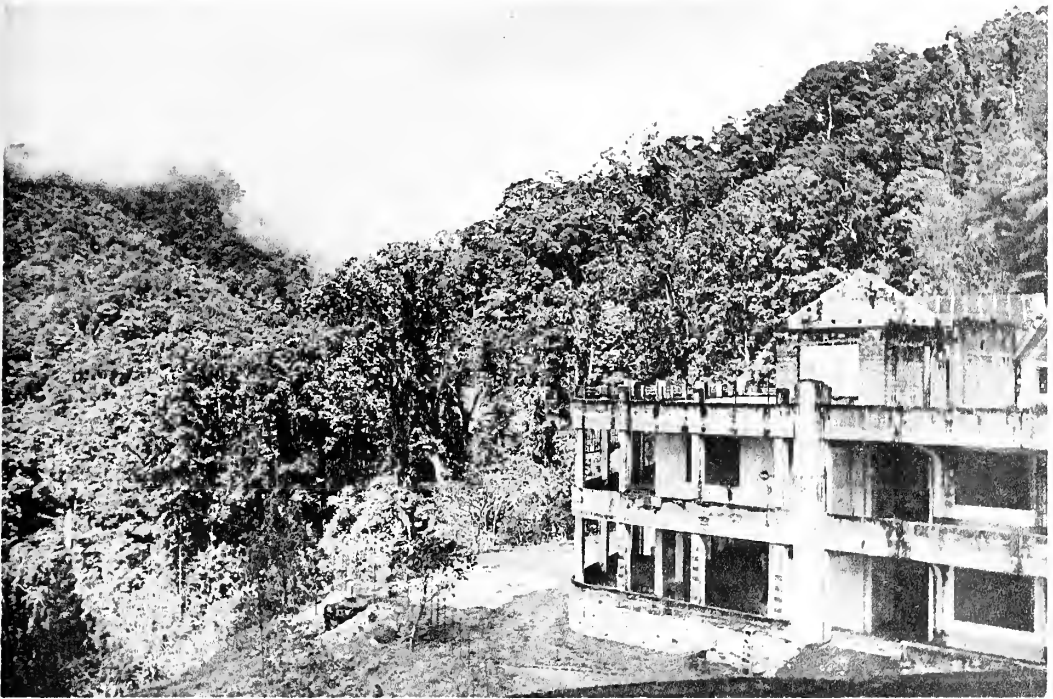

FIG. 1.

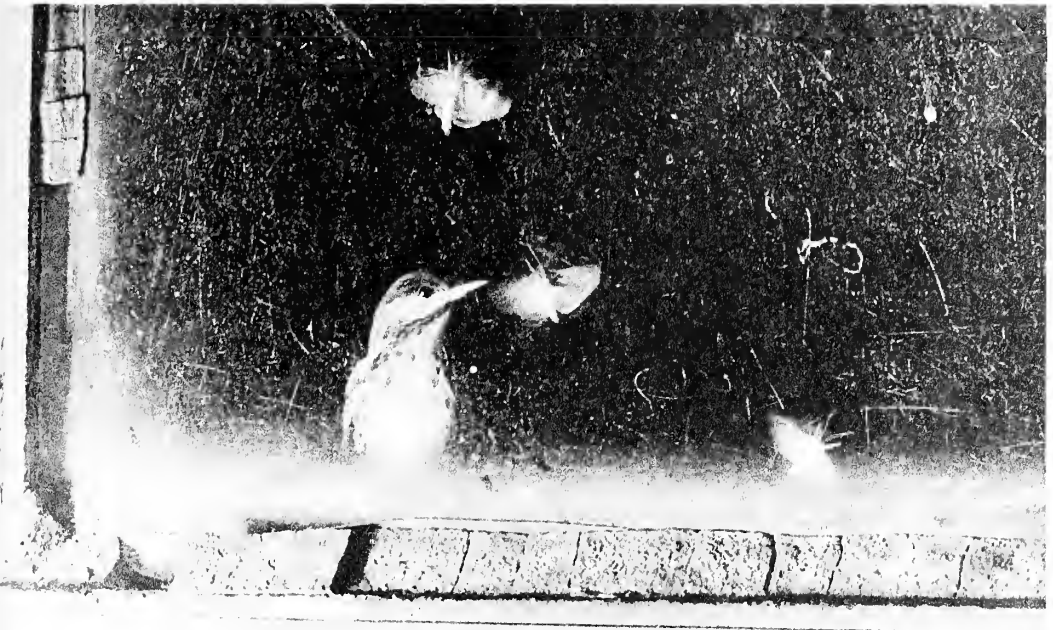

FIG. 2.

AVIAN MIGRATION AT RANCHO GRANDE IN NORTH-CENTRAL VENEZUELA.

19.

Endosphaera engelmanni Endoparasitic in *Trichodina spheroidesi*
Infecting the Puffer, *Sphaeroides maculatus*.

MORTON PADNOS

&

ROSS F. NIGRELLI.

*Department of Biology, Washington Square College, New York University;
and New York Aquarium, New York Zoological Society.*

(Plates I & II; Text-figures 1 & 2).

INTRODUCTION.

Endosphaera engelmanni Entz is a suctionian parasite of both marine and fresh-water protozoans, especially those belonging to the Order Peritricha. However, many investigators usually associate this interesting parasite with a fresh-water protozoan host, giving only passing reference to its marine occurrence (see Doflein, 1928; Kudo, 1946).

Among the *Trichodina*, *T. pediculus* commonly found on *Hydra* was reported as being infected with *E. engelmanni* by Sand (1899). There is some evidence indicating that the "larval" stage described and figured by Chatton (1910) for *Amoeba mucicola* endoparasitic in *Trichodina labrorum* (from the gills of European marine fishes) may be a stage in the development of *Endosphaera engelmanni*.

Lynch and Noble (1931) have given the best description of *Endosphaera engelmanni*, which they found parasitic in the fresh-water peritrich, *Opisthonecta henneguyi*. The present studies deal with the presence of this parasite in a marine species of *Trichodina* and will compare the morphology, cytology and life history of this marine endoparasite with its fresh-water relatives.

MATERIAL AND METHODS.

During the 1938 epizootic trichodiniasis among puffers, *Sphaeroides maculatus* (Bloch & Schneider), in littoral waters of New York and New Jersey, the two gill parasites responsible, *Trichodina spheroidesi* Padnos & Nigrelli and *T. halli* Padnos and Nigrelli, were found to be infected with *Endosphaera engelmanni*. The incidence of infection was 20% among the former and 2% among the latter species of *Trichodina*. This study was made only on preserved material which was fixed in Schaudinn's fluid and 10% formalin. The Schaudinn-treated material was stained with iron hematoxylin; the formalin material was impregnated with 5% silver nitrate solution.

THE PARASITE.

The young form of the parasite, including the free living stage (swarmer) as well as the bud within the parent cell, measures from 9 to 16 microns in diameter (average diameter 11 microns), is round or slightly ovoid in shape and contains a rounded macronucleus 3-8 microns in diameter (average, 6 microns) and a micronucleus, 0.5-1.5 microns in diameter (average, 1 micron). A contractile (?) vacuole is present which is most clearly defined in specimens identified as recently emerged forms and in fully developed buds within the parent cell (Text-fig. 2, E & F). These measurements are in close agreement with those given by Lynch and Noble (1931) for corresponding stages of their fresh-water form. These investigators also reported three rows of equatorial cilia on the newly formed bud and the free-swimming swarmer. Only 0.1% of the parasites observed in our preparations were swarmer. In the hematoxylin-stained individuals the ciliary pattern could not be determined. In the silver nitrate-treated material, however, equatorially arranged granules were seen in the fully developed buds still within their parent cells (Text-fig. 2, E). These were placed so closely that their number and arrangement could not be determined. Since the measurements and cytological characters of the parasite in the present study closely correspond to those described by Lynch and Noble (1931), we do not hesitate to assign it to the same species, *Endosphaera engelmanni* Entz.

Endosphaera engelmanni enters the host by penetrating its pellicle, to which it remains attached by a short stalk through which passes a canal terminating in a birth pore (Text-fig. 1). The macronucleus is central in position in the free end of the organism, while the micronucleus is situated some distance away towards the narrower attached end.

Through study of a number of parasitic stages, it appears that reproductive activity (endogenous budding) is initiated by a swelling process. Measurements made on parasites in varying growth stages prior to the formation of the bud, indicate that the cell diameter increases to twice its original size (12-30 microns, average 21 microns). The diameter of the ovoid-shaped macronucleus is also doubled (4-11 microns, average 9 microns). (See Plate I, Figs. A-D.) These measurements correspond closely to those given by Lynch and Noble (1931) for parasites showing no traces of buds.

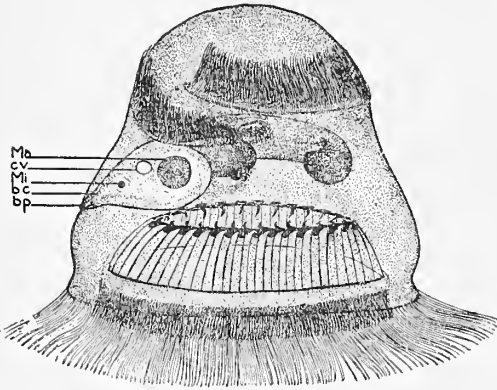

TEXT-FIG. 1. *Trichodina spheroidesi* parasitized by *Endosphaera engelmanni*. Side view. $\times 950$. Semi-diagrammatic reconstruction from iron hematoxylin and silver nitrate preparations. Ma, macronucleus; cv, contractile (?) vacuole; Mi, micronucleus; bc, birth canal; bp, birth pore.

The preliminary swelling of the macronucleus is followed by a further expansion during which it becomes irregular in shape (Plates I & II, Figs. E-G). During this period of macronuclear swelling, the micronucleus starts mitotic activity and develops its metaphase. At this stage, the cytoplasmic area around the micronucleus is denser and stains more deeply with hematoxylin than the rest of the cell cytoplasm. This area is the anlage of the cytoplasmic substance of the bud (Plate I, Fig. D).

With continued growth the macronucleus extends part of its mass into the denser cytoplasm (Plate I, Figs. E, F) where it is pinched off to become the macronucleus of the bud (Plate II, Figs. G-J). During this period the micronucleus passes into telophase and divides into two. One micronucleus remains within the newly formed cytoplasmic region while the other migrates out of this field and becomes associated with the parent macronucleus (Plates I & II, Figs. F-I). Such newly formed buds average 10 microns in diameter; their macronuclei average 5 microns and micronuclei 1 micron. The

cytoplasmic area, now at its greatest density, develops a membrane around its periphery, becomes distinct and separates from the parent cytoplasm and lies in a space at the base of the birth canal (Plate II, Figs. H-K). The mature bud or swarmer probably passes into the birth canal and out through the birth pore to become a free-swimming organism. Myonemes in the vicinity of the birth pore, as described by Lynch and Noble (1931), were not present in our preparations.

Although as many as three parasites were observed in one *Trichodina*, in no case was more than one bud found in the reproducing individuals. However, we agree with Lynch and Noble (1931) that the parent cell continues to produce more buds, since in no case have we observed evidence of disintegration of the parasite associated with this phase of development.

EFFECTS OF THE PARASITE ON THE HOST.

Endosphaera engelmanni in *Trichodina* apparently interferes with the normal development of the host by exerting pressure on the host's cytoplasm and macronucleus. In many of the single infections and in all of the double and triple ones, the host macronucleus is displaced and distorted. An extreme malfunctioning of the host's macronucleus under such a pressure was noted in parasitized *Trichodina* undergoing binary fission. Under such conditions, the macronucleus of the host was forced into the upper third of the cell and therefore was prevented from participating in the fission process, resulting in its failure to pull apart (Text-fig. 2, C). The normal position of the macronucleus in non-parasitized *Trichodina* at this stage of fission is in the lower two-thirds of the organism (Text-fig. 2, D). The normal trophic macronucleus of *Trichodina* is horse-shoe shaped. Many examples of distortion of the macronucleus were observed, especially in double and triple infections (Text-fig. 2, A & B).

Another sign of disturbance of the host's macronucleus, probably resulting from the presence of the growing parasite, is seen in the internal changes of that structure. In the normal macronucleus, chromatin granules are homogeneously distributed throughout the matrix, whereas the macronucleus of the parasitized protozoan contains large chromatin clumps within vacuolated areas (Text-fig. 2, A & B). These macronuclear changes apparently occur when the parasite occupies about half of the volume of the host. This is indicative of macronuclear disintegration, ending in death of the host. Similar results were described by Sassuchin (1934) for the ciliate, *Nyctotherus ovalis*, infected with a fungus, particularly when the sporangium of the parasite occupied a large volume of the host.

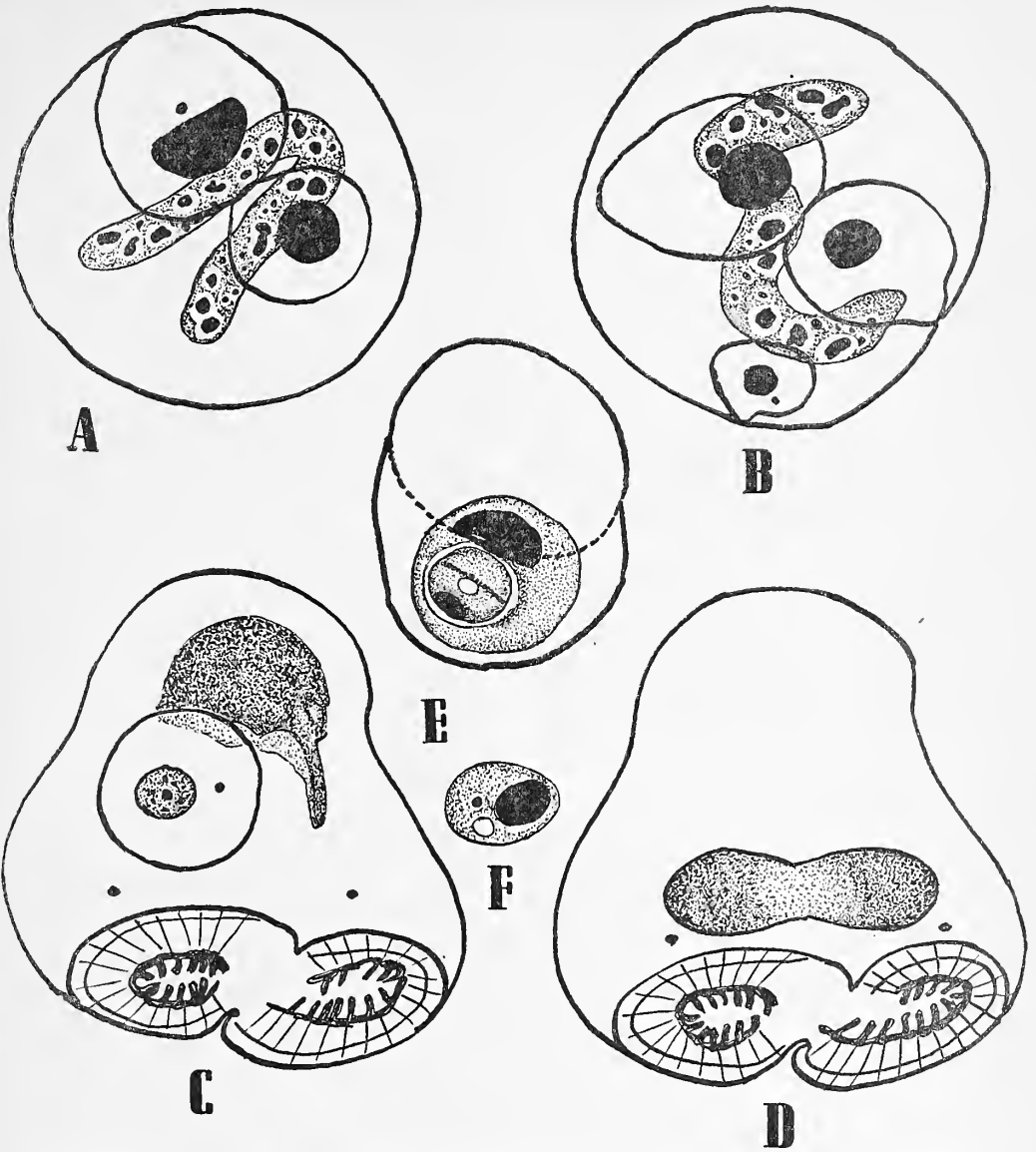

TEXT-FIG. 2. Effects of *Endosphaera engelmanni* on *Trichodina*. $\times 950$. From iron-hematoxylin preparations. **A**, double infection. Note the distortion of the host macronucleus, vacuolated areas in the macronuclear substance. **B**, triple infection. **C**, single infection with displacement of host macronucleus during fission. **D**, normal position of macronucleus during fission in non-parasitized *Trichodina*. **E**, Stage showing completely formed bud. Silver nitrate preparation. $\times 950$. Note equatorial band of basal granules and contractile (?) vacuole. **F**, free-living form (swarmer) of the parasite. Hematoxylin preparation. $\times 950$. Cilia are not evident with this preparation.

SUMMARY AND CONCLUSIONS.

1. *Trichodina spheroidesi* and *T. halli*, parasites on the gills of the puffer, *Sphaeroides maculatus*, were found infected with a suctionian parasite belonging to the genus *Endosphaera*.

2. The nuclear behavior and the formation of the bud is described. The anlage of the bud is recognized as early as the metaphase

stage of the micronucleus of the parent cell. This is manifest as a concentration of denser cytoplasm around the dividing micronucleus.

3. The development of cilia could not be followed in detail, but bands of basal granules around the equatorial region of the bud were recognized. No evidence of myoneme structures in the vicinity of the birth pore were observed.

4. Mechanical and physiological disturbances to the host's cytoplasm and macronucleus are apparent with the growth of the parasite. Distortion and displacement of the macronucleus as well as disintegration of the macronuclear substances was observed.

5. The suctorian is in all probability *Endosphaera engelmanni* Entz, previously described from fresh-water protozoa, since morphological and cytological studies reveal no recognizable differences.

REFERENCES.

CHATTON, E.

1910. Protozoaires parasites des branches des Labres; *Amoeba mucicola* Chatton, *Trichodina labrorum* n. sp., Appendice: Parasite des Trichodines. *Arch. Zool. Exper.*, 5: 239.

DOFLEIN, F.

1928. Lehrbuch der Protozoenkunde. Spezielle Naturgeschichte der Protozoen. II: 439-1262. Verlag von Gustav Fischer, Jena.

KUDO, RICHARD R.

1946. Protozoology. 778 pp. Charles C. Thomas, Publisher, Springfield, Ill.

LYNCH, JAMES E. and NOBLE, ALDEN E.

1931. Notes on the genus *Endosphaera* Engelmann and on its occasional Host *Opisthnecta henneguyi* Fauré-Fremiet. *Univ. Calif. Publ. Zool.*, 36: 97.

PADNOS, MORTON and NIGRELLI, ROSS F.

1942. *Trichodina spheroidesi* and *Trichodina halli* spp. nov. Parasitic on the Gills and Skin of Marine Fishes, with Special Reference to the Life-history of *T. spheroidesi*. *Zoologica*, 27: 65.

SAND, R.

1899. Étude monographique sur le groupe des infusoires tentaculifères. *Ann. Soc. Belge Micr.*, 24: 57.

SASSUCHIN, D. N.

1934. Hyperparasitism in Protozoa. *Quart. Rev. Biol.*, 9: 215.

EXPLANATION OF THE PLATES.

Endosphaera engelmanni parasitic in *Trichodina spheroidesi*. Camera lucida drawings of hematoxylin-stained specimens. $\times 950$.

PLATE I.

- Fig. A. Initial penetration by *Endosphaera*.
 Fig. B. Double infection. Early growth stage of the parasite. Note swelling of the macronucleus.
 Fig. C. Double infection. Continued swelling of the macronucleus.
 Fig. D. Micronucleus in metaphase surrounded by densely staining cytoplasmic area.
 Fig. E. Irregularly shaped macronucleus with cytoplasmic area more concentrated. Micronucleus in telephase.
 Fig. F. Micronucleus in late telophase.

PLATE II.

- Fig. G. Start of the process of endogenous budding. Part of the macronucleus extends into the newly formed cytoplasmic area. Micronucleus divided. One micronucleus remains within cytoplasmic area; the other becomes associated with the parent macronucleus.
 Fig. H. A later stage of the process shown in G. The macronucleus resembles a mushroom. The cytoplasm of the bud is separated and distinct from the surrounding cytoplasm.
 Figs. I & J. Macronuclear material pinched off into cytoplasmic area.
 Figs. K & L. Fully formed bud in parent cell.

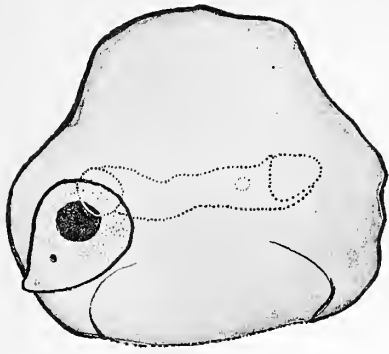

A

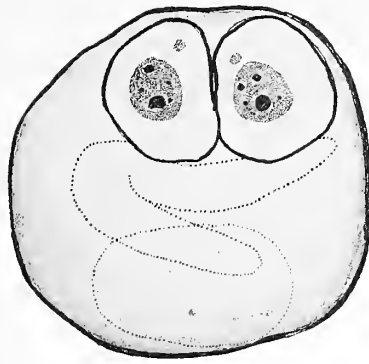

B

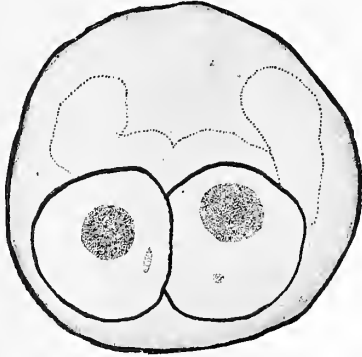

C

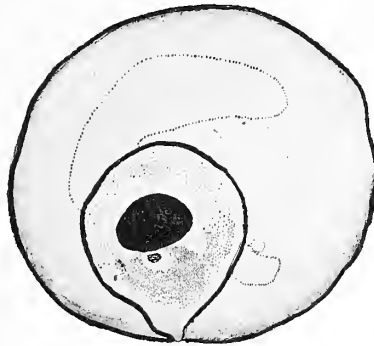

D

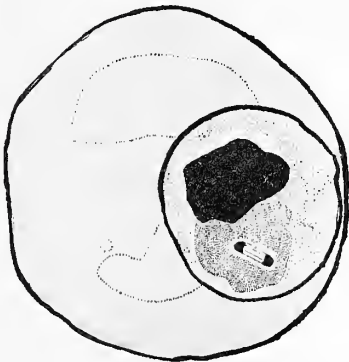

E

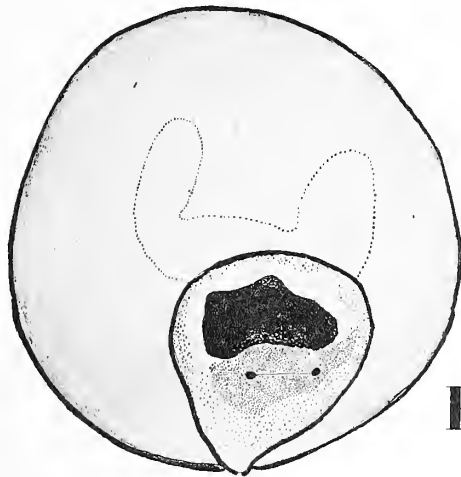

F

ENDOSPHAERA ENGELMANNI ENDOPARASITIC IN TRICHODINA SPHEROIDESI
INFECTING THE PUFFER, SPHCEROIDES MACULATUS.

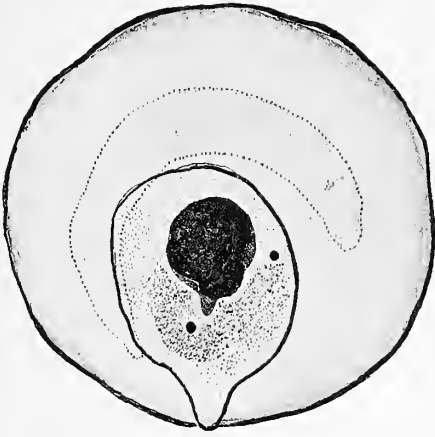

G

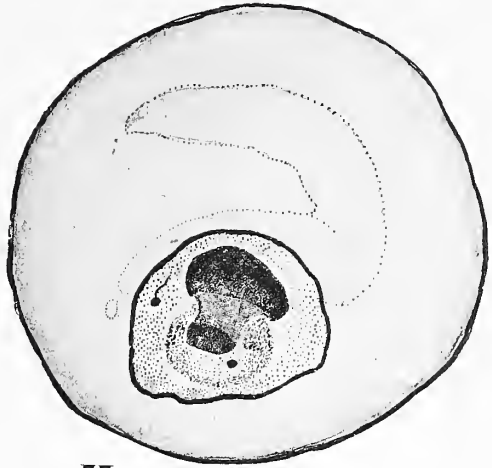

H

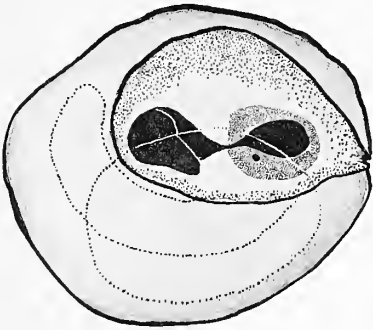

I

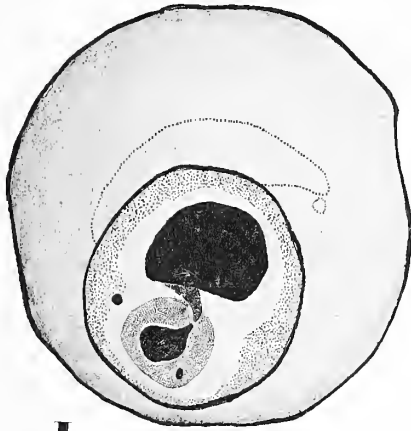

J

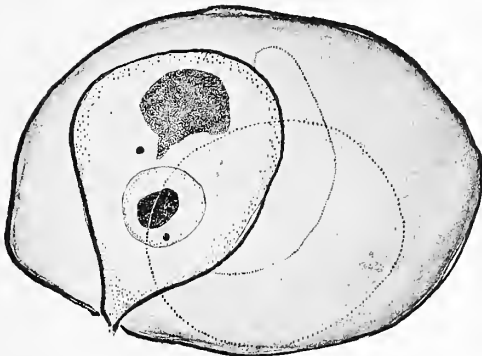

K

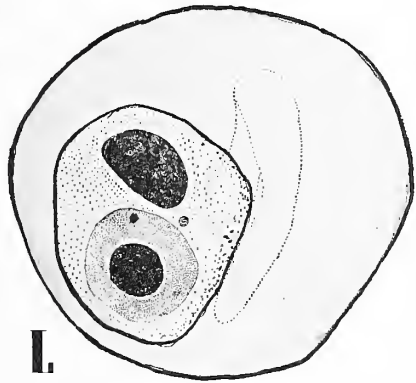

L

ENDOSPHAERA ENGELMANNI ENDOPARASITIC IN TRICHODINA SPHEROIDESI
INFECTING THE PUFFER, SPHCEROIDES MACULATUS.

20.

Ithomiinae (Lepidoptera) of Rancho Grande, Venezuela,
Including Two New Species.¹

RICHARD M. FOX & JEAN W. FOX.

Carnegie Museum and the University of Pittsburgh.

(Plate I).

[This is one of a series of papers resulting from the 45th and 46th Expeditions of the Department of Tropical Research of the New York Zoological Society, made during 1945 and 1946 under the direction of Dr. William Beebe with headquarters at Rancho Grande in the National Park of Aragua, Venezuela. The expeditions were made possible through the generous cooperation of the National Government of Venezuela and of the Creole Petroleum Corporation.

[The characteristics of the research area are in brief as follows: Rancho Grande is located in north-central Venezuela (10° 21' N. Lat., 67° 41' W. Long.), 80 kilometers west of Caracas, at an elevation of 1,100 meters in the undisturbed montane rain forest which covers this part of the Caribbean range of the Andes. Adjacent ecological zones include seasonal forest, savanna, thorn woodland, cactus scrub, the fresh-water lake of Valencia and various marine littoral zones. The Rancho Grande area is generally subtropical, being uniformly cool and damp throughout the year because of the prevalence of the mountain cloud cap. The dry season extends from January into April. The average humidity during the expeditions, including parts of both wet and dry seasons, was 92.4%; the average temperature during the same period was 18° C; the average rainfall over a five-year period was 174 cm. The flora is marked by an abundance of mosses, ferns and epiphytes of many kinds, as well as a few gigantic trees. For further details, see Beebe and Crane, *Zoologica*, Vol. 32, No. 5, 1947. Unless otherwise stated, the specimens discussed in the present paper were taken in the montane cloud forest zone, within a radius of one kilometer of Rancho Grande.]

The New York Zoological Society's Department of Tropical Research, during the 1945 and 1946 field work at Rancho Grande, Venezuela, collected 800 Ithomiinae which we identify as 30 species representing 19 genera; two of these species are described as new. This collection was made in the area discussed by Beebe and Crane (1947), a subtropical cloud forest.

So much tropical collecting has been poorly documented, unfortunately, that many species cannot yet be assigned with certainty

to vertical ecologies. In general, the Ithomiinae with strong color and pattern are scarcer at higher altitudes.

P. J. Anduze collected assiduously in that area, and his Ithomiinae have been itemized by Dr. Forbes (1940) and commented upon by Lichy (1943). The Carnegie Museum contains a large collection made in northern Venezuela by S. M. Klages, and a smaller one made by M. Graham Netting. None of these collections emphasized the cloud forest ecology. It is interesting to note that they included some species not taken at Rancho Grande; the inference is that such species probably are not cloud forest forms, but belong to some lower vertical ecology. On the other hand, several species are in the present collection which have not been taken at all, or only sparsely, at lower altitudes; such species are suggestively cloud forest inhabitants. In the list following we have attempted to note our opinion on those species which appear to belong in the cloud forest, or other ecology. Where no opinion is noted, we regard evidence at hand as inconclusive.

The fauna of northern Venezuela differs to a surprising extent from that of the great highlands south of the Orinoco. The affinities, of Ithomiinae particularly, of northern Venezuela are with northern Colombia and sometimes even reach into Central America; the fauna extends into Trinidad with only minor changes. Venezuelan Guiana, the southern highland region, on the other hand, has a fauna closer to that of British Guiana. These differences have been discussed by Dr. Forbes (1942) in his report on Anduze's collecting south of the Orinoco.

Of particular interest is Lichy's discussion (1944) of the structure and habits of *Hyalyris coeno* and *H. cana*, since it is one of the very few studies of its kind published on Ithomiinae and offers ecologic information which is sorely needed.

Generic assignments in the list following are according to Fox (1940), differing from those found in Haensch (1909).

¹ Contribution No. 782, Department of Tropical Research, New York Zoological Society.

Athesis clearista clearista Doubleday & Hewitson.

A. clearista Dbld. & Hew., 1847. Gen. Diurn. Lep., 1: 110; pl. 16, fig. 3. (Venezuela).

This subspecies is endemic to Venezuela, being replaced in Colombia by the darker *A. c. bassleri* Fox. The lone male taken at Rancho Grande probably was a stray, the subspecies belonging closer to sea level. (2 ♂).

Eutresis hyperia hyperia Doubleday & Hewitson.

E. hyperia Dbld. & Hew., 1847. Gen. Diurn. Lep., 1: 111; supplemental plate (1852), fig. 2. (Venezuela).

This is a widespread subspecies found in Colombia and Venezuela south into north-eastern Peru, but not characteristic of the high Andean valleys. (4 ♂, 1 ♀).

Tithorea harmonia furia Staudinger.

T. furia Staudinger, 1884. Exot. Schmet., 1: pl. 30. id., 1885, ibid.: p. 73 (Venezuela & Colombia).

This is not a typical cloud forest form. *T. h. furia* is found throughout northern Venezuela and northern Colombia. In south-western Venezuela and in the Colombian Amazons, *T. h. furina* Godman & Salvin, a darker subspecies, intergrades with it, the latter in characteristic coloring and pattern being found in central and southern Colombia in the mountains. (1 ♀).

Melinaea lilis lilis (Doubleday & Hewitson).

Mechanitis lilis Dbld. & Hew., 1847. Gen. Diurn. Lep. 1: 130; pl. 17, fig. 4. (Venezuela).

This subspecies likewise is found throughout northern Venezuela and west into Colombia, from whence a recently collected series from the Department of Cauca is at hand. Dr. Forbes (1940) found *M. l. sola* Kaye, the Trinidad subspecies, in Paria. (5 ♀).

Xanthocleis aedesia aedesia (Doubleday & Hewitson).

Thyridia aedesia Dbld. & Hew., 1847. Gen. Diurn. Lep. 1: 118; pl. 16, fig. 4. (Venezuela).

A subspecies widely distributed throughout the northwestern quarter of South America, often common; probably these specimens were strays in the cloud forest. Reliable altitude records at hand place the normal vertical distribution between 500 and 1,200 meters. In a recent revision of the genus, d'Almeida (1945) includes Nicaragua, Costa Rica, Honduras and Panama in the range; this subspecies does not occur at all in Central America, but is replaced by *X. a. melantho*. (4 ♂, 8 ♀).

Mechanitis doryssus veritabilis Butler.

M. veritabilis Butler, 1873. Cist. Ent., 1: 155. (Venezuela).

The Venezuelan subspecies, which is probably not a typical cloud forest form. (4 ♂, 10 ♀).

Hyaliris coeno coeno (Doubleday & Hewitson).

Ithomia (Ceratinia) coeno Dbld. & Hew., 1847. Gen. Diurn. Lep., 1: 127; pl. 18, fig. 2. (Venezuela).

Authentic records of this subspecies are confined to higher altitudes and in Venezuela only; probably it is an endemic cloud forest form. We suspect that this is the insect which Dr. Forbes (1940) called *Ceratinia frater*. The latter is found only in the Andean valleys of eastern Ecuador and northern Peru, never in Venezuela. *H. frater* is amazingly similar, superficially, to several other Venezuelan members of the genus *Hyaliris*. (2 ♂, 1 ♀).

Hyaliris cana cana (Haensch).

Ceratinia cana Haensch, 1905. Berl. Ent. Zeit., 50: 157; pl. 5, fig. 16. (Colombia).

This is a species sibling to *coeno*. However, not only is it not a variation of *coeno*, as several authors have suggested, but it belongs to an entirely different section of the genus, as a study of the genitalia shows. Records at hand indicate a cloud forest distribution in northern Venezuela, west into the Santa Martas of Colombia. René Lichy has an interesting and accurate account (1944) of *H. coeno* and *H. cana*. (4 ♂, 1 ♀).

Hypothyris euclea fenestella (Hewitson).

Ithomia fenestella Hew., 1854. Exot. Butt., 1: 27; pl. 14, fig. 25. (Venezuela).

This is a common form in Venezuela and Trinidad. In Colombia it is replaced by *H. e. intermedia* Butler, and in Central America by *H. e. valora* Haensch. Long series at hand from Trinidad and a wide assortment of Venezuelan localities suggest that *fenestella* is not sharply differentiated from *H. e. euclea* Godart. (35 ♂, 56 ♀).

Ithomia agnosia agnosia Hewitson.

I. agnosia Hew., 1854. Exot. Butt., 1: 34; pl. 17, fig. 45. (Venezuela).

The distribution is throughout the mountains of Venezuela, Colombia and south into northern Peru. (6 ♂, 12 ♀).

Ithomia iphianassa iphianassa Doubleday & Hewitson.

I. (Ceratinia) iphianassa Dbld. & Hew., 1847. Gen. Diurn. Lep., 1: 127; pl. 18, fig. 3. (Venezuela).

This subspecies has often been recorded

as a subspecies of "*Ithomia*" *lycaste*, but one of us has shown (Fox, 1939) that *Papilio lycaste* Fabricius belongs in the genus *Hypothyris*, not in *Ithomia*; *iphianassa*, therefore, has no connection with *lycaste*.

The present subspecies is common in Venezuela, is replaced in Colombia by *I. i. anaphissa* Herrich-Schaeffer. Along the common boundary area between their ranges they intergrade. (109 ♂, 37 ♀).

***Oleria victorine graziella* (Oberthür).**

Ithomia graziella Obert., 1878. *Ann. Soc. Ent. France*, (5) 8: 161. (San Estevan, Venezuela).

I. victorina, Hew. (not Guerin), 1855. *Exot. Butt.*, 1: 43; pl. 22, fig. 75. (Venezuela).

O. v. victorine (Guerin) (altering the original ending to "a" is false scholarship), is Bolivian, *O. v. graziella* is Venezuelan. Confusion exists in the literature as to the application of these names, a condition made more acute by erroneous statements in Seitz by Haensch (1909). Dr. Forbes (1940) applied the names correctly. *O. v. graziella* ranges west into Colombia and is replaced by *O. v. paula* Weymar in Central America. (2 ♂, 7 ♀).

***Oleria makrena makrena* (Hewitson).**

Ithomia makrena Hew., 1854. *Exot. Butt.*, 1: 28; pl. 14, fig. 29. (Venezuela).

This is distributed in northern Venezuela west into Colombia. (51 ♂, 21 ♀).

***Oleria phemonoë phemonoë* (Doubleday & Hewitson).**

Ithomia phemonoë Dbld. & Hew., 1847. *Gen. Diurn. Lep.*, 1: 126; pl. 18, fig. 5. (Venezuela).

This and *O. makrena* are sibling species. *O. p. phemonoë* is much the scarcer, and appears to be limited to Venezuela. (2 ♂, 3 ♀).

***Aeria eurimedla agna* Godman & Salvin.**

[*Ithomia (Aeria) agna* Dbld. & Hew., 1847. *Gen. Diurn. Lep.*, 1: 127. (Venezuela). (Without description or figure).]

A. agna Gdm. & Slv., 1879. *Biol. C. A., Rhop.* 1: 15-16; pl. 3, fig. 12. (Panama).

Widespread, this is found in Trinidad, Venezuela, Colombia, Panama, Costa Rica and Nicaragua. (11 ♂, 5 ♀).

***Callithomia agrippina alphi* (C. & R. Felder).**

Ithomia alphi Feld., 1865. *Reise Novara, Lep.* 2: 359-360. (Venezuela).

This is found in northern Venezuela west into the Santa Martas. It usually is associated with altitudes lower than the cloud forest. (1 ♀).

***Dircenna jemina jemina* (Geyer).**

Ceratinia jemina Geyer, 1837. In Hübner, *Zutr. Exot. Schm. Erde*: figs. 807, 808.

This is distributed in Venezuela and northern Colombia. (4 ♂, 2 ♀).

***Ceratinia tutia tutia* (Hewitson).**

Ithomia tutia Hew., 1852. *Exot. Butt.*, 1: 22; pl. 11, fig. 6. (River Amazon).

Hewitson's type locality must have been wrong, as all specimens seen have come from northern Venezuela west into Colombia. (14 ♂, 8 ♀).

***Episcada hymenaea* (Prittwitz).**

Ithomia hymenaea Prtw., 1865. *Ent. Zeit. Stettin*, 26: 136. (No type locality).

Widespread throughout all of South America. There is so little pattern that subspeciation would be hard to detect. (3 ♂).

***Episcada sylpha* Haensch.**

E. sylpha Haensch, 1905. *Berl. Ent. Zeit.*, 50: 171-172; pl. 5, fig. 7. (Venezuela).

A species sibling with *E. hymenaea*. The yellow-white scaling at the end of the cell of the fore wing forms a much shorter bar in *hymenaea*, extending down only to M₁, and there is a submarginal light spot only at the anal angle. In *sylpha* there is a complete row of submarginal pale spots above, within the border and in the distal edge of the transparent area, while the light costal bar at the end of the fore wing cell is a little wider and extends down nearly to M₂. Known only from Venezuela; many records are from fairly high altitudes. (1 ♂).

***Pteronymia adina* (Hewitson).**

Ithomia adina Hew., 1854. *Exot. Butt.*, 1: 34; pl. 17, fig. 47. (No type locality).

Records at hand are from Venezuela at about 1,000 meters altitude. (2 ♂, 11 ♀).

***Pteronymia aletta* (Hewitson).**

Ithomia aletta Hew., 1854. *Exot. Butt.*, 1: 29; pl. 15, fig. 31. (Venezuela).

Records at hand are from moderate elevations in Venezuela. (1 ♂).

***Pteronymia asopo* (C. & R. Felder).**

Ithomia asopo C. & R. Felder, 1865. *Reise Novara, Lep.* 2: 363-364. (Venezuela).

This is found in northern Venezuela and northern Colombia. (3 ♂, 2 ♀).

***Pteronymia beebei* n. sp.**

P. artena, Haensch, 1909 (part). In Seitz, *Gross. Erde*, 5: 156.

P. tigranes, Forbes, 1940. *Bol. Soc. Ven. Cien. Nat.*, 6: 316.

Godman and Salvin themselves sank *P. tigranes* as a synonym for *P. artena* (Hewitson) (see Biol. C. A., Rhop. Suppl.: 646), and evidently were correct in doing so. In resurrecting the name, Haensch (1909) figured the female as *P. tigranes* and the male as *P. artena*. Bryk (1937), not knowing anything about Ithomines, merely followed suit.

A series of genitalic dissections indicates that *P. artena* is limited to Central America, and that this superficially similar species in Venezuela is clearly distinct.

Pattern and coloration (fig. 1) like *P. artena* with the following differences noted: On the fore wing at the outer edge of the transparent area next to the black opaque border there is a series of vague whitish spots; in *artena* this series consists of a larger spot Cu_1-Cu_2 , three smaller dots from Cu_1 to M_1 , and another larger one R_5-M_1 ; in *beebei* there is only the larger one in Cu_1-Cu_2 and one dot in M_3-Cu_1 , the rest of the series being missing. On the underside of *artena* in the apex of the fore wing there are two tiny white dots, black ringed, well separated, in R_5-M_1 and R_4-R_5 , sometimes with a third smaller one in R_3-R_4 ; in *beebei* these apical dots are larger, not separated, and all three of them are present. The black crossbar at the end of the fore wing in *artena* is oblong, its inner and outer margins nearly parallel, and with a small point on the inner edge of the recurrent vein; in *beebei* the crossbar is triangular, wider toward the costa, very rarely with a black point over the recurrent vein. There is also a difference in size between the two species, as indicated by the length of the fore wing measured from base to apex at the tip of R_5 ; *P. artena*, ♂ 28.8 mm. (28-30 mm.), ♀ 27.5 mm. (27-28 mm.); *P. beebei*, ♂ 25.3 mm. (25-26 mm.), ♀ 24.7 mm. (24-25 mm.).

Both species have, in the males, M_1 of the hind wing branching from R_3 about half way to the margin from the end of the cell; in the females R_3 and M_1 are complete with 1d minute or wanting. Both sexes have a short distad spur on the humeral.

The male genitalia of the two species are very different. In *P. artena* (fig. 3) the apex of the valve is armed with a single, erect and prominent spine-like tooth; in *P. beebei* (fig. 5), the apex of the valve has a pair of small recurring finger-like projections. The penis of each species is provided on its anterior end with a pair of slender perpendicular lateral members, evidently for muscular attachment; in *artena* these are strongly developed, while in *beebei* they are smaller and differently placed. In *artena* the saccus is the same length as the tegumen plus uncus, in *beebei* it is half again as long. The penis of *artena* is up-angled at its mid-point, that of *beebei* is straight; both are terminally sinuate.

Holotype ♂. Rancho Grande, Venezuela; July 7, 1946; N. Y. Z. S. expedition; American Museum of Natural History.

Allotype ♀. Topotypic; June 4, 1946; N. Y. Z. S. expedition; American Museum of Natural History.

Paratypes, 44 ♂, 11 ♀. 30 ♂, 6 ♀, topotypic; N. Y. Z. S. expedition; 26 ♂, 4 ♀, American Museum of Natural History, and 4 ♂, 2 ♀, Carnegie Museum. 3 ♂, 3 ♀, San Esteban, North Venezuela; S. M. Klages; Carnegie Museum. 7 ♂, Las Quiguas, North Venezuela; S. M. Klages; Carnegie Museum. 2 ♀, Venezuela; S. M. Klages; Carnegie Museum. 2 ♂, Rio Magdalena, Colombia [locality doubtful]; Holland collection, Carnegie Museum. 1 ♂, Choroni, Aragua, Venezuela; 1,450 m.; Anduze, 1937; Cornell University Collection. 1 ♂, Mucuchachi, Venezuela; Cornell University Collection.

Pteronymia nubivaga n. sp.

This species (fig. 2) has not been noted in collections previously made in Venezuela; probably it is exclusively a cloud forest inhabitant. It is much like *P. asopo* (Felder) in pattern and coloring, but the white bar just beyond the end of the fore wing cell is less opaque, with the veins crossing it entirely black except for a short part of M_1 , while in *P. asopo* all veins crossing the white bar are also white. In *P. nubivaga* R_3 is narrowly black where it traverses the white bar, cutting off an oblong white spot above it in the costal margin. Both fore and hind wings are more acute in this than in *P. asopo*. The vague whitish bar mentioned runs down as far as M_3 and, except for the oblong in the costal margin, nowhere is strong enough to be seen except against a dark background. There is a series of five vague whitish spots in the transparent area against the black border, from Cu_2 to R_3 , and a whitish cast in the cell.

On the underside, the margins are tawny-brown, the same shade as in *P. asopo*, lined proximad and distad with narrow black lines. The fore wing has three white, black-encircled dots in the apex. There is a series of elongate submarginal dots in the hind wing border, complete from the apex to the anal veins; however, only the uppermost three or four may be white centered, black-encircled, the others represented merely by thickening of the black marginal line; the dot below Cu_1 , when white, is divided into a double spot by a thin black median line. The costal margin and particularly the humeral angle is a little yellower than the rest of the margins; there is a black streak in the costal border along the top of the transparent area in the cell.

The humeral vein of the hind wing bears a short distad spur; M_1 is present as a short branch of R at the margin and is 3 mm. long.

On the fore wing the cubital segment between M_3 and Cu_1 is longer than the same vein in *P. asopo*, widening the base of cell M_3-Cu_1 .

The male genitalia are figured (fig. 4).

Holotype ♂. Rancho Grande, Venezuela; N. Y. Z. S. expedition; July 2, 1946; genitalia slide No. 574; American Museum of Natural History.

Paratypes: 11 ♂, topotypic; N. Y. Z. S. expedition; 8 ♂, American Museum of Natural History, 3 ♂, Carnegie Museum.

***Pteronymia vela* (Hewitson).**

Ithomia vela Hew., 1852. Exot. Butt., 1: 23; pl. 12, fig. 14. (No type locality).

This was found in considerable numbers at Rancho Grande, but is quite rare in collections made at lower altitudes in Venezuela. (41 ♂, 11 ♀).

***Godryls kedema kedema* (Hewitson).**

Ithomia kedema Hew., 1854. Exot. Butt., 1: 30; pl. 15, fig. 33. (Venezuela).

A Venezuelan subspecies, replaced in Colombia by *G. k. albinotata* (Butler). (17 ♂, 14 ♀).

***Pseudoscada timna* (Hewitson).**

Ithomia timna Hew., 1854. Exot. Butt., 1: 33; pl. 17, fig. 44. (Venezuela).

Pseudoscada arzalia, Forbes (not Hew.), 1940. *Bol. Soc. Ven. Cien. Nat.*, 6: 316.

P. arzalia is Bolivian, but is quite similar to *P. timna*. The white band across the fore wing of *timna* extends to the marginal color in M_3-Cu_1 , but in *arzalia* does not quite reach the margin. (16 ♂, 2 ♀).

***Hymenitis andromica andromica* (Hewitson).**

Ithomia andromica Hew., 1854. Exot. Butt., 1: 31; pl. 16, fig. 38. (Venezuela).

This ranges in Colombia and Venezuela; probably a cloud forest form. (66 ♂, 43 ♀).

***Hymenitis dercetis* (Doubleday & Hewitson).**

Ithomia dercetis Dbld. & Hew., 1847. Gen. Diurn. Lep., 1: 125; pl. 18, fig. 6. (Venezuela).

This is found both in Venezuela and Colombia at higher altitudes. (72 ♂, 12 ♀).

LITERATURE CITED.

D'ALMEIDA, R. F.

1945. Revisão do Gênero *Xanthocleis* Boisdu. 1870. *Arg. Zool. Est. São Paulo*, 4: 97-112.

BEEBE, W. & J. CRANE.

1947. Ecology of Rancho Grande, a Subtropical Cloud Forest in Northern Venezuela. *Zoologica*, 32: 43-59; pls. 1-5; text figs. 1-10.

BRYK, F.

1937. *Lepidopterorum Catalogus*, pars 80.

HAENSCH, R.

1909. In Seitz, *Grossschmetterlinge der Erde*, 5:116-171; pls. 31-41.

FORBES, W. T. M.

1940. Las Danaides del Norte Venezuela. *Bol. Soc. Venez. Cien. Nat.*, 6: 308-317.

1942. Note on the Butterflies of Venezuelan Guiana. *Bol. Ent. Venez.*, 1: 24-36.

FOX, R. M.

1939. A Note on the Fabrician Species *lycaste* (Lepidoptera: Ithomiinae). *Ent. News*, 50: 141-144.

1940. A Generic Review of the Ithomiinae (Lepidoptera: Nymphalidae). *Trans. Am. Ent. Soc.*, 66: 161-207; pls. 5-8.

LICHY, R.

1943. Observaciones y Rectificaciones sobre Lepidópteros recolectados por P. J. Anduze en los Estados orientales de Sucre y Monagas, cuya enumeración se publicó en el Boletín de la Sociedad Venezolana de Ciencias Naturales, No. 32, 1938. *Bol. Soc. Venez. Cien. Nat.*, 8: 205-232.

1944. Documents pour servir à l'étude des lépidoptères du Vénézuéla. *Bol. Acad. Cien. Fis. Matem. Nat.*, 24: (13-27).

GODMAN, F. DUC. & O. SALVIN.

1879-1901. *Biol. Cent. Am.*, Rhop., vol. 1 & Supplement.

EXPLANATION OF THE PLATE.

PLATE I.

- Fig. 1. *Pteronymia beebei* n. sp. Holotype ♂. Natural size.
- Fig. 2. *Pteronymia nubivaga* n. sp. Holotype ♂. Natural size.
- Fig. 3. *Pteronymia artena* (Hew.), Carillo, C. R. Male genitalia, slide No. 572.
- Fig. 4. *Pteronymia nubivaga* n. spec. Holotype ♂. Male genitalia, slide No. 574.
- Fig. 5. *Pteronymia beebei* n. sp. Paratype ♂. Male genitalia, slide No. 573.

In the photographs, the detached wings to the left illustrate the under sides of the wings. The drawings of genitalia all are to the same scale, as indicated; the left valves have been dissected and are shown separately.



FIG. 1.



FIG. 2.

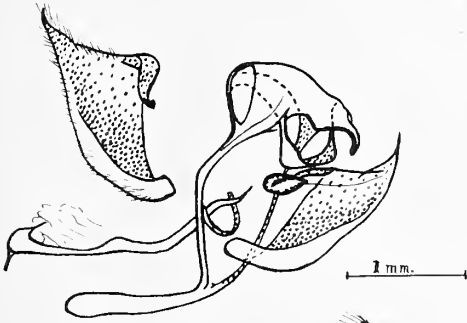

FIG. 3.

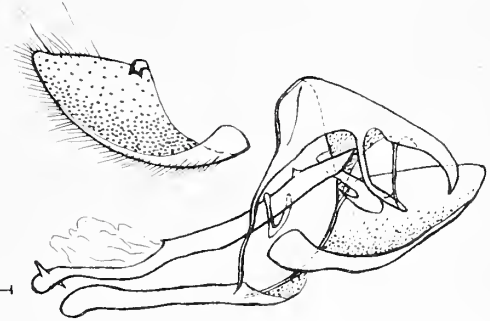

FIG. 4.

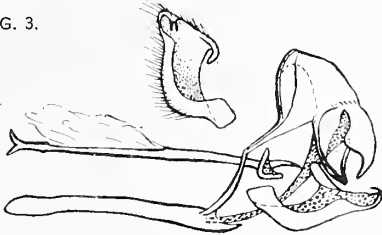

FIG. 5.

ITHOMIINAE (LEPIDOPTERA) OF RANCHO GRANDE, VENEZUELA,
INCLUDING TWO NEW SPECIES.

INDEX

Names in **bold face** indiceta naw genera, specias or varieties, numbars in **bold face** indicate illustrations, numbers in parentheses ara tha serial numbers of papers containing the platos listad immadietely following.

A

Acanthonyx petivarii, 71
Actaea dovii, 74
sulcata, 74
Actitis macularia, 156
Adorotopsylla bisatosa, 118
Aaria eurimedia agna, 175
Aasiocope patulana, 147, 148, 150,
(17) **Pls. I & II**
Alouatta senicula, 66
Amazona ochrocephala
ochrocephala, 164
Amphimoea walkari, 138
Amplipterus gannascus, 139
nigrine, 140
Anaptychus cornutus, 72
Anoptichthys sp., 41
jordani, 17, 29, 35
Aratinga wagleri transilis, 163
Aretus pisonii, 86
Asryanax maxicanus, 17, 35, 102,
(11) **Pls. V-XI**
Athisis clariste cleerista, 174

B

Bacterium salmonicide, 121
Bradypus tridactylus, 66
Buteo platypterus platypterus, 156

C

Cabassov lugubris, 66
Cacicus cala cela, 163
Cellithomia agrippina elpho, 175
Campostoma anomalum, 129
Carollia perspicillatum, 65
Carpilodas cincimanus, 74
Celario lineata lineata, 145
Ceratinia tutie tutie, 175
Cerdocyon thous, 66
Cheetura brachyura brachyura, 165
Chaeturalia rutila brunnitorquas, 165
Cheredrius collaris, 166
Chilonyctaris rubiginose, 65
Chrosomus oreas, 127, (15) **Pl. I**
Coccyzus americanus americanus,
156
Coccytus anteus medor, 138
baelzebuth, 138
cluentius, 138
duponchel, 138
lucifar, 138
Conepatas, naar gumillae, 66
Coragyps atratus, 163
Cordylochernas potens, 62, 63
Cycloxentrops vittatus, 75
Cypseloides cryptus, 167

D

Daire americana, 74
Daldorfia gerthi, 74
Dandroica castanea, 158
caerulascens caerulescens, 158
carulea, 155
fusca, 158
petachia aestive, 158
striata, 158, 168, (18) **Pl. I**
Didalphis marsupialis, 65
Dircenna jemina jamine, 175
Dromacia hispida, 82
Dylnestes hercules, 109, (12)
Pls. I-IV

E

Elanoidas forficatus yatepa, 161
Endosphaera engelmanni, 169, (19)
Pls. I & II
Episcoda hymeneee, 175
sylphe, 175
Epistor lugubris lugubris, 141
ocypate, 142
Eptasicus, naar fuscus, 65
Erinnyis elope, 140
cramari, 141
allo, 140
lassauxi, 140
obscura obscure, 141
cenotrus, 141
Eriphia squemete, 81
Eriphidas hispide, 82
Esox lucius, 102, (11) **Pls. I-V**
Eucinetops panamensis, 71
Eumops bonariensis nenus, 65
Eurypanopeus planus, 79
transversus, 80
Eurytium tristani, 80
Eutresis hyperia hyperia, 174

F

Felco alboguleris elbogularis, 162
Felis wiedii, naar pirrensis, 66
Forpus pesserinus viridissimus, 164
Fregate magnificens rothschildi, 167

G

Gaograpsus lividus, 84
Godyris kedame kedeme, 177
Goniopsis pulchre, 85
Gorilla gorilla gorille, 97, (10)
Pls. I-V
Grepus grapsus, 83

H

Harpia harpyja, 162
Hameroplanas celliomanae, 141
nomius, 141
parce, 141
Herbstia tumide, 72
Hersa cingulate, 138
Hateractaa lunata, 81

Hataromys anomalus, 66
Himantopus himantopus maxicanus,
166
Hirundo rustica arythrogastar, 157
Hyaliris cana cana, 174
coeno coeno, 174
Hylocichla fuscescans fuscescens,
157
minima minima, 157
Hymanitis endromica andromice, 177
darctetis, 177
Hypothyris auclaa fanastella, 174

I

Isognathus rimosa papayaa, 140
scyron, 140
swainsoni, 140
Ithomia agnosia agnosie, 174
iphianassa iphianassa, 174

J

Jacana jacana intermedia, 166

L

Leptodius teboganus, 75
Laptotila verreauxi verreauxi, 166
Laucophoyx thula thula, 165
Lonchoglosse caudifara, 66
Lophoxenthus lemallipes, 77
Lustrochernas concinnus, 61, 62

M

Marmose demarerae maridee, 65
fuscate, 65
Machenitis doryssus varitabilis, 174
Medaeus spinulifer, 75
Malinaea lilis lilis, 174
Menippe frontalis, 80
obuse, 80
Matapocarcinus concavatus, 77, 78
Micropanope xantusii, 80
Microphrys platysome, 74
Milvago chimachima cordatus, 162
Mithrax danticulatus, 73
orcutti, 73
pygmaeus, 73
Mnotilta veria, 157
Molossus obscurus, 65
Monodalphis brevicaudata, 65
Myotis nigricans, 65

N

Neecomys, naar spinosus, 66
Naocrex erythroops olivascens, 166
Naolaalaps heteromys, 118, 119
Nocomis leptocephalus, 125, (15)
Pl. I
Notropis ardans ardans, 131
ceresinus, 131
Nuttellornis borealis, 156
Nyceryx tacita, 142
Nyctidromus albicollis elbicollis, 152

O

- Oecomys bicolor*, 66
Oleria makrena makrena, 175
 phemonoë phemonoë, 175
 victorine graziella, 175
Oligoryzomys delicatulus, 66
Oporornis agilis, 159
 philadelphia, 159
Oreopeleia montana montana, 167
Oryza kadani, 141
Oryzomys meridensis, 66
Ozius perlatus, 81
 tenuidactylus, 81
 verreauxii, 81

P

- Pachygrapsus transversus*, 85
Pachylia ficus, 141
 resumens, 141
Pachyramphus polychopterus tristis, 167
Pandion haliaetus carolinensis, 156
Panopeus chilensis, 79
 purpureus, 79
Pelia pacifica, 71
Perigonia lusca, 142
 pallida, 142
 stulta, 142
Phaeoprogne tapera fusca, 159
Phlegethontius albiplaga, 139
 diffissa tropicalis, 138
 florestan, 139
 lichenea, 139
 ochus, 139
 rustica rustica, 139
 scutata, 138
 sexta paphus, 138
Pholus anchemolus, 142
 fasciatus, 143
 labruscae, 143
 obliquus, 142
 phorbas, 143
 satellita licaon, 142
 triangulum, 142
 vitis vitis, 142
Pilumnus gonzalensis, 81
 pygmaeus, 81
 xantusii, 81
Pionus sordidus sordidus, 164

- Piranga rubra rubra*, 155
Pitho sexdentata, 72
Platycichla flavipes venezuelensis, 161
 leucops, 161
Platypoecilus maculatus, 1, 3, 5-7, 12
Proechimys guairae, 66
Progne chalybea chalybea, 163
Promops occultus, 65
Protambulyx eurycles, 139
 strigilis, 139
Protonotaria citrea, 157
Psarocolius angustifrons oleagineus, 165
Pseudoscada timna, 177
Pseudosphinx tetrio, 140
Pteronymia adina, 175
 aletta, 175
 artena, 178, (20) Pl. I
 asopo, 175
 beebel, 175, (20) Pl. I
 nubivaga, 176, (20) Pl. I
 veia, 177
Pygochelidon cyanoleuca cyanoleuca, 160
Pyrrhura haematosus haematosus, 164

R

- Rhopalopsyllus beebel*, 117, 118
 peronis, 117
 steganus, 117

S

- Sciurus griseogena meridensis*, 66
Seiurus aurocapillus aurocapillus, 158
 noveboracensis noveboracensis, 159
Sesarma rhizophorae, 86
 sulcatum, 86
Sesia fadus, 142
Steophaga ruticilla, 159
Sigmodon hirsutus, 66
Sigmomys alstoni venester, 66
Sphoeroidesi maculatus, 169
Stelgidopteryx ruficollis aequalis, 160
Stolidoptera tachysara, 141

- Streptoprocne zonaris albicincta*, 164
Sturnira lilium, 66

T

- Tadarida europis*, 65
Teleophrys cristulipes, 73
Thoe sulcata panamensis, 71, 72
 sulcata sulcata, 71, 72
Tilapia macrocephala, 121
Tithorea harmonia furia, 174
Touit batavioa, 164
Trapezia cymodoce ferruginea, 83
 digitalis, 83
Trichodina spheroidesi, 169, 170, 171, (19) Pls. I & II
Tringa solitaria solitaria, 156
Tritopsylla intermedia, 119

U

- Uroderma bilobatum*, 66

V

- Vermivora chrysoptera*, 157
Vireo altiloquus altiloquus, 157
 olivaceus olivaceus, 157
 vividior, 167

X

- Xanthocleis aedesia aedesia*, 174
Xanthodius sternberghii, 75
 stimpsoni, 77
Xylophanes amadis meridanus, 144
 anubus, 144
 ceratomioides, 143
 chiron nechus, 144
 crotonis, 144
 germen yurakano, 143
 neoptolemus, 144
 pluto, 143
 porcus continentalis, 143
 pyrrhus, 145
 resta, 144
 tersa, 144
 thyelia thyelia, 144
 titana, 144
 tyndarus, 143

Y

- Yanguna Flemingi*, 67

NEW YORK ZOOLOGICAL SOCIETY

General Office: 630 Fifth Avenue, New York 20, N. Y.
Publication Office: The Zoological Park, New York 60, N. Y.

OFFICERS

FAIRFIELD OSBORN, *President*
ALFRED ELY, *Vice-president*
LAURANCE S. ROCKEFELLER, *Vice-president*
DONALD T. CARLISLE, *Vice-president*
HAROLD J. O'CONNELL, *Secretary*
CORNELIUS R. AGNEW, *Treasurer*

SCIENTIFIC STAFF

General

JOHN TEE-VAN, *Executive Secretary*
WILLIAM BRIDGES, *Editor and Curator of Publications*
SAM DUNTON, *Photographer*

Zoological Park

LEE S. CRANDALL, *General Curator*
LEONARD J. GOSS, *Veterinarian*
BRAYTON EDDY, *Curator of Reptiles and Insects*
GRACE DAVALL, *Assistant to General Curator*

Aquarium

CHRISTOPHER W. COATES, *Curator and Aquarist*
JAMES W. ATZ, *Assistant Curator*
ROSS F. NIGRELLI, *Pathologist*
MYRON GORDON, *Geneticist*
C. M. BREDER, JR., *Research Associate in Ichthyology*
G. M. SMITH, *Research Associate in Pathology*
HOMER W. SMITH, *Research Associate in Physiology*

Department of Tropical Research

WILLIAM BEEBE, *Director*
JOCELYN CRANE, *Research Zoologist*
HENRY FLEMING, *Entomologist*
WILLIAM K. GREGORY, *Associate*
JOHN TEE-VAN, *Associate*
GLORIA HOLLISTER, *Associate*
MARY VANDERPYL, *Associate*

Scientific Advisory Council

A. RAYMOND DOCHEZ
ALFRED E. EMERSON
ALAN GREGG
W. A. HAGAN
CARYL P. HASKINS
K. S. LASHLEY
JOHN S. NICHOLAS
GEORGE M. SMITH

Editorial Committee

FAIRFIELD OSBORN, *Chairman*
WILLIAM BEEBE
WILLIAM BRIDGES
CHRISTOPHER W. COATES
LEE S. CRANDALL
BRAYTON EDDY
LEONARD J. GOSS
JOHN TEE-VAN





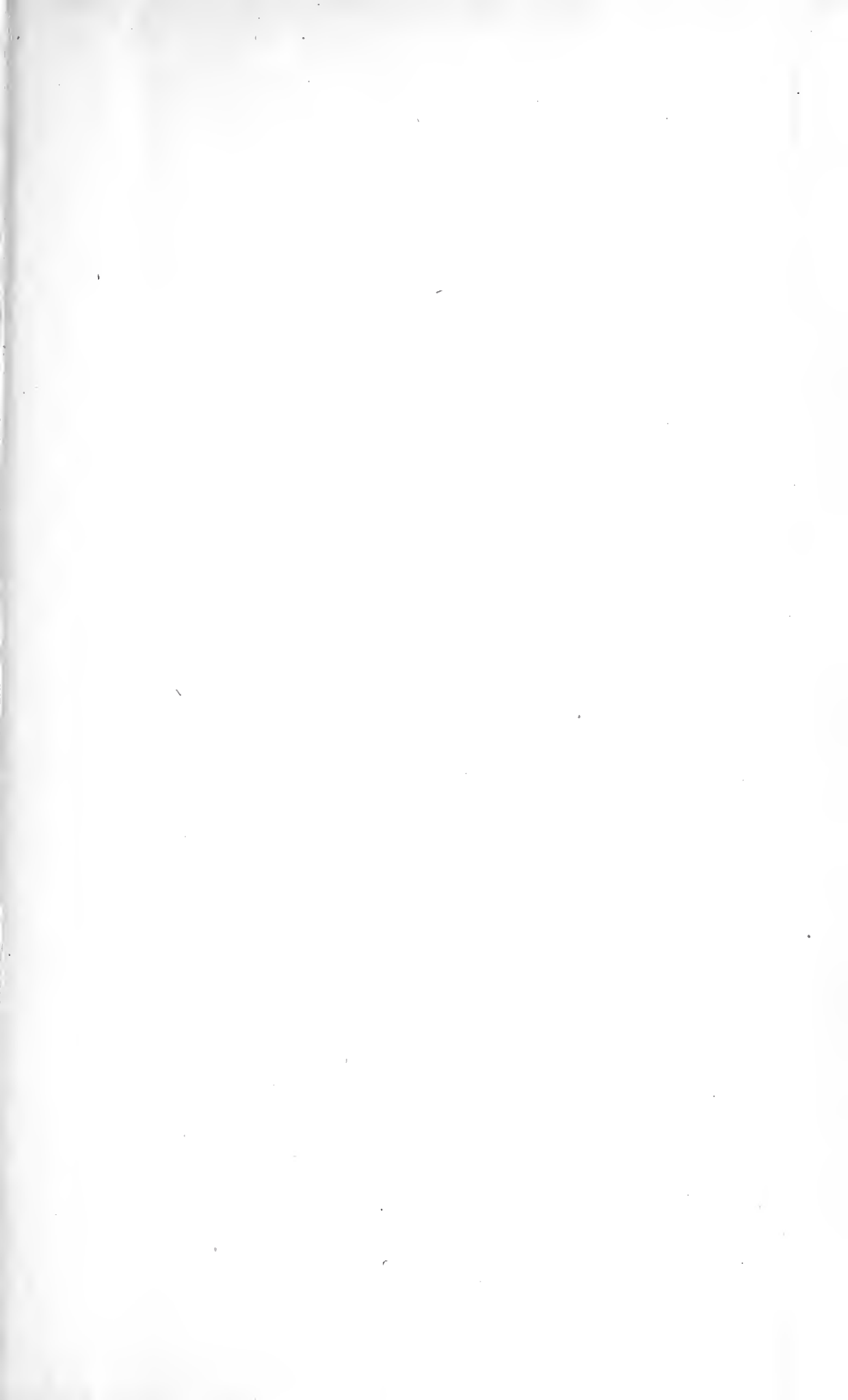

SMITHSONIAN INSTITUTION LIBRARIES



3 9088 01405 9026