

To the

Library of the
Marine Biological Laboratory,
Woods Hole, Mass.

With the compliments of
the author, January 25, 1932.

MBL/WHOI



0 0301 0014748 4



THE GRAY SQUIRREL.

(Courtesy of F. H. Tucker, Boston.)

Zoology

*A Textbook for College and
University Students*

By

F. E. CHIDESTER, A.M., PH.D.

Professor of Zoology, West Virginia University

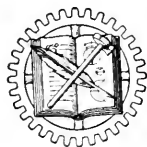

NEW YORK
D. VAN NOSTRAND COMPANY, INC.
250 FOURTH AVENUE

1932

Copyright, 1932,
by
D. Van Nostrand Company, Inc.

All Rights Reserved.

*This book or any parts thereof may not
be reproduced in any form without
written permission from the publishers.*

PRINTED IN U. S. A.

LANCASTER PRESS, INC.
LANCASTER, PA.

To the Student who uses this Textbook:

This textbook represents many years of learning and experience on the part of the author. It does not treat of an ephemeral subject, but one which, since you are studying it in college, you must feel will have a use to you in your future life.

Unquestionably you will many times in later life wish to refer to specific details and facts about the subject which this book covers and which you may forget. How better could you find this information than in the textbook which you have studied from cover to cover?

Retain it for your reference library. You will use it many times in the future.

The Publishers.

DEDICATED TO
DR. AND MRS. C. W. CHIDESTER
A RARE COMBINATION IN
MEDICAL PRACTICE AND A CONSTANT SOURCE OF
STIMULATION TO SCIENTIFIC EFFORT

PREFACE

This text was written as a general survey of modern zoology for use by college students and to serve as a reference book for biologists. In the author's attempt to include in the introductory course not only the basic principles so obviously essential to a general culture course in animal biology, but also to satisfy the needs of students entering medicine and agriculture, he has found it desirable to emphasize physiology, ecology and applied zoölogy. Many of the most interesting portions of this text have been introduced as a result of inquiries by keen students.

After using much of the subject matter as a mimeographed text, the author prepared the manuscript in its final form, and during three summers has availed himself of the aid of many specialists at the Marine Biological Laboratory, Woods Hole, Mass. Through the interest of various authorities who gave advance information about their work, certain chapters include material prior to the actual publication of the research discussed.

Some of the most important features of the book are the logical arrangement of facts about the animals within a group, a statement of the chief characteristics at the beginning of the discussion, and a summary on the economic importance at the end of each section. The newer physiology has been introduced and a bibliography checked by experts in each field is given at the end of each chapter. Sources readily available have been selected and resumés chosen instead of the pioneer researches. Extensive discussions of Embryology and Animal Behavior have been found undesirable since such studies cannot be comprehensively treated in an introductory course without excluding other fundamental subjects.

The writer takes pleasure in thanking the following colleagues at West Virginia University: Dr. A. M. Reese, Dr. L. H. Taylor, Mr. A. G. Eaton, Dr. L. H. Peairs, Dr. A. J. Dadisman, Mr. Chandler Brooks, Dr. J. A. Eiesland, Dr. P. D. Strausbaugh, Dr. A. J. Hare, Dr. F. B. Trotter and Dr. C. G. Brouzas.

Certain chapters have, furthermore, received the benefit of criticism by the following specialists: Dr. G. N. Calkins and Dr. C. A. Kofoid, Protozoa; Dr. M. M. Metcalf, Evolution; Dr. C. E. Mc-

Clung and Dr. E. Carothers, Cytology; Dr. A. B. Dawson, Blood; Dr. A. C. Redfield, Respiratory Pigments; Dr. A. M. Lucas, Ciliary Action; Dr. Edwin Linton, Dr. C. A. Kofoid, and Dr. H. W. Stunkard, Platyhelminthes; Dr. Frank Smith and Dr. Earl Martin, Annelida; Dr. N. A. Cobb, Dr. M. C. Hall, Dr. C. A. Kofoid, Nematoda; Dr. R. S. Lynch, Dr. H. M. Miller and Dr. H. B. Smith, Trochelminthes; Dr. B. H. Grave and Dr. E. D. Crabb, Mollusca. Dr. C. M. Child, Dr. Austin Clark and Dr. William Patten have kindly furnished concise summaries of their important theories.

With the aid of their staffs the following Librarians, Mr. George Osborn, Rutgers University, Dr. L. D. Arnett, West Virginia University, and Mrs. T. H. Montgomery, Marine Biological Laboratory, have so contributed to the accuracy of the text by their tireless efforts in furnishing reprints, references and books that they deserve much of the credit for such corrections of errors made by senior scholars as the author may have been able to make.

Dr. W. H. S. Demarest, Dr. F. B. Trotter, and Dr. J. R. Turner, the University Presidents under whom the writer enjoyed every opportunity for effective teaching that these able executives could possibly furnish, should be heartily thanked for their aid.

The writer also wishes to acknowledge his indebtedness to: the late Dr. C. W. Hargitt, Dr. W. M. Smallwood, Dr. C. F. Hodge, Dr. A. M. Reese, Dr. F. R. Lillie, Dr. E. G. Conklin, Dr. C. B. Davenport, Dr. T. J. Headlee, Dr. Gary Calkins and Dr. C. E. McClung. By their encouragement, these men have been largely responsible for the vigor and enthusiasm with which the writer has been able to study zoological problems and to teach his subject for more than twenty years.

General criticism has been offered by Dr. J. A. Dawson, Dr. Mary MacDougall, Dr. W. C. Curtis, Dr. D. H. Tennent, Dr. Charles Packard, Dr. R. A. Budington, Dr. W. L. Dolley, Dr. Oscar Richards, Dr. J. H. McGregor, Dr. J. W. Mavor, Dr. Leigh Hoadley, and many others.

In the preparation of the glossary, Professor A. J. Hare of the West Virginia University has assumed the responsibility for the Greek and Latin derivations of the words used.

The drawings were made by Mr. W. J. Moore, Mrs. Helene Lammers and Mr. Norris Jones.

F. E. C.

CONTENTS

PREFACE

CHAPTER	PAGE
I—INTRODUCTION	1
The Function of Zoology—The Divisions of Zoology—Living Things Compared with Non-Living Matter—Protoplasm—Structure of the Cell—Structure of Protoplasm—Physiological Properties—Chemical Composition—Proteins—Carbohydrates—Fats—Water—Chemical Elements—Carbon—Hydrogen—Oxygen—Nitrogen—Sulphur—Mineral Salts, Enzymes, Hormones and Vitamins—Animal Relationships—Fitness to Survive—Plants and Animals—Table—Classification—Metazoa—Vertebrates—Phylum Chordata—Sub-phylum Vertebrata—Sub-phylum Adelephora—Sub-phylum Urochorda—Invertebrates—Phylum Arthropoda—Phylum Mollusca—Phylum Molluscoidea—Phylum Trochelminthes—Phylum Annelida—Phylum Echinodermata—Phylum Nemathelminthes—Phylum Platyhelminthes—Phylum Coelenterata—Phylum Porifera—Phylum Protozoa.	
II—PROTOZOA	21
Classification—Characteristics—Natural History—Class 1. Sarcodina—Type of Group—Ameba proteus—Orders of Sarcodina—Parasitic Sarcodina—Class 2. Mastigophora (Flagellates)—Type of Group—Euglena—Economic Importance of Flagellates—Class 3. Infusoria (Ciliates)—Type of Group—Paramecium—Parasitic Ciliates—Class 4. Sporozoa—Type Plasmodium vivax, the Malarial Sporozoon—Orders of Sporozoa—General Considerations—External Anatomy and Internal Differentiation—Locomotion—Ingestion and Digestion—Respiration—Circulation—Excretion—Irritability—Reproduction and Regeneration—Sarcodina—Mastigophora (Flagellata)—Infusoria (Ciliata)—Sporozoa—Endomixis—Distribution—Economic Importance—Fossil Relatives and Relationship to Other Phyla—Metazoa.	
III—PORIFERA	47
Classification—Characteristics—Distribution—Pigment in Sponges—Type of Group—Grantia—External Anatomy—Ingestion and Digestion—Circulation—Respiration—Excretion—Reproduction—Nervous System—Habits—Enemies—Associations—Economic Importance of the Porifera—Positive—Negative—Fossil Relatives—Ancestry and Relationship to Other Phyla.	
IV—COELENTERATA	54
Classification—Characteristics—Natural History—Class 1. Hydrozoa—Hydra—Obelia—Alternation of Generations in the Hydrozoa—Siphonophora—Class 2. Scyphozoa—Type of Group—Aurelia—Class 3. Actinozoa—Anemones and Corals—Class (or Phylum) Ctenophora—	

CHAPTER	PAGE
General Consideration of the Coelenterates—Distribution—Anatomy—Physiology—Habitat—Regeneration—Fossil Relatives—Ancestry and Relationship to Other Phyla—Economic Importance of Coelenterates.	
V—PLATYHELMINTHES	71
Classification—Characteristics—Natural History—Class 1. Turbellaria—Type of Group—Planaria—Class 2. Trematoda—Anatomy and Life History of the Liver Fluke—Trematode Parasites—Class 3. Cestoda—Type of Group—Taenia solium—Cestode Parasites—General Consideration of the Platyhelminthes—Distribution—Anatomy and Physiology—Behavior—Regeneration—Fossil Relatives—Ancestry and Relationship to Other Phyla—Axial Gradient Theory of Child—Nemertinea, Possibly Allied to Platyhelminthes.	
VI—NEMATHELMINTHES	87
Classification—Characteristics—Natural History—Class Nematoda—Family 1. Ascaridae—Type of Group—Ascaris lumbricoides—Family 2. Anguillidae—Life History of Caconema (Heterodera) radicola—Family 3. Strongylidae—Life History of Necator americana—Family 4. Trichotrachelidae—Family 5. Filaridae—Life History of Filaria bancrofti—Family 6. Trichinellidae—Life History of Trichinella spiralis—Uncertain Classes formerly placed under Nematelminthes—Acanthocephala—Gordiaceae—Mermithidae—General Consideration of the Nematelminthes—Distribution—Physiology—Fossil Relatives—Ancestry and Relationship to Other Phyla.	
VII—ANNELIDA	100
Classification—Characteristics—Natural History—Class 1. Archiannelida—Polygordius—Class 2. Chaetopoda—Type of Group—Lumbricus terrestris—Conjugation in the Earthworm. Class 3. Hirudinea—Type of Group—Hirudo medicinalis—Adaptation of the Leech to its Mode of Life—General Consideration of the Annelida—Distribution and Habits—Parasites of the Annelida—Physiology, Anatomy, and Locomotion—Regeneration—Fossil Relatives—Ancestry and Relationship to Other Phyla—Economic Importance of Annelida.	
VIII—TROCHELMINTHES	121
IX—MOLLUSCOIDEA	127
Natural History—Class 1. Brachiopoda—Class 2. Bryozoa (Polyzoa)—Class 3. Phoronidea.	
X—ECHINODERMATA	129
Classification—Characteristics—Natural History—Class 1. Asterozoa—Type of Group—Asterias—Artificial Parthenogenesis—Class 2. Ophiurozoa—Class 3. Echinozoa—Class 4. Holothurozoa—General Considerations—Anatomy and Locomotion—Physiology—Behavior—Embryonic Development—Parental Care—Regeneration	

CONTENTS

ix

CHAPTER	PAGE
and Autotomy—Fossil Relatives—Ancestry and Relationship to Other Phyla—Economic Importance.	
XI—MOLLUSCA	142
Classification—Class 1. Pelecypoda or Lamellibranchiata—Class 2. Amphineura—Class 3. Gastropoda—Class 4. Scaphopoda—Class 5. Cephalopoda—Characteristics—Natural History—Class 1. Lamellibranchiata—Types of Group—Clams and Mussels—Natural History of Lamellibranchiata—Class 2. Gastropoda—Natural History of Gastropoda—Class 3. Scaphopoda—Value of Dentalium—Class 4. Cephalopoda—Natural History—Pearls—Composition—Source and Value—Culture Pearls—Coated Glass Substitutes for Pearls—References—General Consideration of the Mollusca—Distribution—Physiology—Nervous System—Regeneration—Growth Studies of the Mollusca—Embryology—Care of the Young—Fossil Relatives—Ancestry and Relationship to Other Phyla—Economic Importance of Mollusca—Positive—Negative.	
XII—ARTHROPODA	163
Classification—Characteristics—Natural History—Class 1. Crustacea—Types—Crayfish and Lobster—Class 2. Onychophora—Class 3. Myriapoda—Class 4. Insecta (Hexapoda)—Type of Group—Lubber Grasshopper—Characteristics of More Important Races of Honey Bees—Methods of Insect Control—Class 5. Arachnida—Bibliography on Venomous Spiders—Other Classes—Xiphosura—Pycnogonida—Tardigrada—General Consideration of the Arthropoda—Characteristics and Distribution—Integument and Musculature—Digestive System—Respiration—Circulatory System—Excretion—Nervous System and Sense Organs—Fossil Relatives.	
XIII—CHORDATA	209
Classification—Sub-phylum Hemichorda (Enteropneusta)—Sub-phylum Urochorda (Tunicata)—Sub-phylum Cephalochorda (Adelochorda or Acrania)—Sub-phylum Vertebrata or Craniata—Class 1. Cyclostomata—Class 2. Pisces—Class 3. Amphibia—Class 4. Reptilia—Class 5. Aves—Class 6. Mammalia—Invertebrates versus Vertebrates—Sub-phylum Hemichorda (Enteropneusta)—Type of Group—Balanoglossus—Sub-phylum Urochorda (Tunicata)—Sub-phylum Cephalochorda (Adelochorda or Acrania)—Type of Group—Amphioxus—Theories of the Origin of Vertebrates—Amphioxus—Arthropod—Annelid—Nemertean—Bibliography.	
XIV—CYCLOSTOMATA	221
Craniata—Classification—Characteristics—Cyclostomata—Characteristics—Myxinoids—Petromyzontia.	
XV—PISCES	224
Classification—Characteristics—Natural History—Sub-class Elasmobranchii—Type of Group—The Skate—Sub-class Teleostomi—Order 1.	

CHAPTER	PAGE
Crossopterygii—Order 2. Chondrostei—Order 3. Holostei—Order 4. Teleostei—Sub-class Dipnoi—General Consideration of the Fishes—Locomotion—Coloration—Sound Producing Organs—Respiration—Poison Glands—Skin—Blood—Lymph—Endocrine Glands—Lymphoid Tissue—Senses—Messmates and Associates—Parental Care—Habitat—Temperature—Electric Organs—Phosphorescent Organs—Adaptation of Fishes to their Environment—Economic Importance—Positive—Negative—Migration in Fishes—Homing Instinct—Fossil Relatives.	
XVI—AMPHIBIA	265
Classification—Apoda or Coecilians—Urodela or Caudata—Anura, Salientia or Ecaudata—Characteristics—Natural History—Order 1. Apoda—Order 2. Urodela—Family 1. Amphiumidae—Family 2. Salamandridae—Family 3. Oroteidae—Family 4. Sirenidae—Order 3. Anura—Family 1. Pipidae, etc.—Family 2. Bufonidae—Family 3. Ranidae, etc.—Type of Group, <i>Rana pipiens</i> , the Leopard Frog—External Characters of the Frog—Skin—Muscle, Tendon, Fascia—Digestive System—Circulatory System—Action of the Heart—Respiratory System—Urinogenital System—Nervous System, Sense Organs—General Consideration of the Amphibia—Distribution—External Anatomy—Skeleton—Muscles—Physiology—Digestive System—Respiratory System—Circulatory System—Urinogenital System—Embryology—Parental Care—Parthenogenesis—Experimental Embryology—Regeneration—Habitat—Fossil Relatives—Economic Importance—Positive—Poisonous Amphibians—Resistance of Amphibia to Poisons.	
XVII—REPTILIA	302
Amnion and Allantois—Classification—Characteristics—Natural History—Super-order 2. Chelonia—Type of the Group—The Slider Terrapin—Super-order 6. Archosauria—Order Rhyncocephalia—Order Crocodilia—Order Squamata—Sub-order Lacertilia—Sub-order Ophidia—General Consideration of the Reptilia—Distribution—Anatomy and Locomotion—Digestive System—Respiratory System—Superficial Differences between the Crocodilia—Voice—Circulatory System—Excretory System—Reproductive System—Care of the Young—Nervous System and Sense Organs—Rattle of the Rattlesnake—Poisonous Reptiles—Action of Snake Venom on the Digestive Tract—Toxicity—Treatment of Snake Bite—Susceptibility of Snakes to Poison—Do Mother Snakes Swallow their Young?—Some Superstitions that Exist Regarding Snakes (Casselberry)—Fossil Relatives—Adaptations of Reptilia—References on Reptilia.	
XVIII—AVES	334
Division A. The Ratitae—Characteristics—Tinamous—Division B. The Carinatae—Characteristics—Classification—Order 1. Pygopodes—Order 2. Longipennes—Order 3. Tubinares—Order 4. Steganopodes—Order 5. Anseres—Order 6. Odontoglossae—Order 7. Herodiones—	

CONTENTS

xi

CHAPTER	PAGE
Order 8. Paludicolae—Order 9. Limicolae—Order 10. Gallinae— Order 11. Columbae—Order 12. Raptores—Order 13. Psittaci—Or- der 14. Cocyges—Order 15. Pici—Order 16. Machrochires—Order 17. Passeres—Natural History—The Anatomy and Physiology of Birds—Characteristics—Temperature—Feathers—Color—Skeleton— Digestive System—Tongue—Buccal Glands—Esophagus—Crop— Proventriculus—Gizzard—Small Intestine—Rectal Cecae—Rectum— Liver—Pancreas—Circulatory System—Respiratory System—Voice— Excretory System—Reproductive System—Nervous System—Sense Organs—Susceptibility of Birds to Poison—Types of Nests—Bird Mi- gration—Why Do Birds Migrate?—Speed of Flight—Economic Im- portance of Birds—Positive—Negative—Fossil Relatives—Arche- opteryx—Archeornis—Ichthyornis—Hesperornis—A Living Connect- ing Type.	
XIX—NATURAL HISTORY OF MAMMALS.....	373
Characteristics—Order 1. Monotremata—Order 2. Marsupialia— Order 3. Insectivora—Order 4. Chiroptera—Order 5. Carnivora— Sub-order Fissipedia—Sub-order Pinnipedia—Order 6. Rodentia— Sub-order Simplicidentia—Sub-order Duplicidentia—Order 7. Ede- tata—Order 8. Ungulata—Sub-order Hyracoidea—Sub-order Peris- sodactyla—Sub-order Artiodactyla—Order 9. Sirenia—Order 10. Ce- tacea—Order 11. Primates—Races of Man—Fossil Man—Mam- mals as Migrants.	
XX—MAMMALIA—PHYSIOLOGY.....	420
Man versus the Higher Apes—Physiology of the Vertebrate Animal— Mammalian Physiology—External Anatomy and Locomotion—His- tology—The Skin—Claws or Nails—Hair—Perspiration—Digestive System—Mouth—Teeth—Salivary Glands—Tongue—Esophagus— Stomach—Small Intestine—Liver—Pancreas—Digestion in the Small Intestine—Cecum—Appendix—Large Intestine—Digestion in the Ruminant—Chemical Characteristics of Protoplasm—Proteins—Col- loids—Precipitin Reaction—Carbohydrates—Monosaccharids—Disac- charids—Fats—Lipins—Chemical Elements of Protoplasm—Carbon— Hydrogen—Oxygen—Nitrogen—Mineral Salts—Sulphur—Phosphorus —Calcium—Silicon—Fluorine—Sodium—Chlorine—Potassium— Magnesium—Copper—Iodine—Arsenic—Iron—Manganese—Bro- mine—Boron—Zinc—Aluminium—Enzymes—Autocatalysts—Nutri- tion and Vitamins—The Organs of Internal Secretion—Endosecretory Glands with a Duct—Testis—Ovary—Liver—Pancreas—Ductless Glands—Thyroid—Parathyroid—Thymus—Suprarenal—Pineal— Pituitary—Interrelations of the Organs of Internal Secretion—Effects of Emotions on the Internal Secretions—References on the Endocrines —Circulatory System—Action of the Heart—Pulse—Comparative Anatomy of the Portal Systems—Blood—Blood Groups—Lymph— Lymphatics—Flow of Lymph—Spleen—Respiratory System—How Long Can Aquatic Mammals Submerge?—Voices of Mammals—Excre-	

tory System—Reproductive System—Female—Male—Propagation Rate in Mammals—Periods of Gestation—Nervous System and Sense Organs—A Triumph of Coordination—Fatigue in the Nerve Cell—Regeneration in the Nervous System—Hibernation and Aestivation Organs that Man Can Lose—Statistics of Vitality—Susceptibility of Mammals to Poison.

XXI—SOCIAL LIFE OF ANIMALS..... 482

Association of Different Species—Living Free—Commensalism—Symbiosis—Parasitism—Effects of Parasitism—On Parasite—On Host—Association of the Same Species—Colonies—Communities—Gregariousness—Polygyny and Polyandry—Cases in which the Sexes Live Apart—Societies Composed of Different Species—Monogamy—Seasonal Mateships—Types of Families—Parent Families—Father Families—Mother Families—Child Families—References on Animal Relationships—Protection—Masking—Color Resemblance—Mimicry—Geographical Distribution—Barriers—Salinity of Water—Water Supply—Depth of Water—Temperature—Mountain Ranges—Domestication of Animals—Dog—Cat—Horse—Donkey—Pig—Cattle—Goat—Sheep—Rabbits—Pigeons—Fowls—Ducks—Geese—Peacocks—Turkeys—Tissue Survival Outside of the Body—Longevity of Animals—Mammals—Birds—Reptiles—Amphibia—Fishes—Arthropoda—Mollusca—Annelida—Coelenterata—Pulse Frequency.

XXII—EVOLUTION, HEREDITY, EUGENICS..... 499

Cell Division—Amitosis—Mitosis—Oogenesis—Spermatogenesis—Fertilization—Theories of Heredity and Evolution—History of the Evolutionary Idea—What we owe to Charles Darwin—Examples of Mendelian Inheritance in Man—The Origin of Species according to Lamarck, Darwin, Weismann, Mendel and DeVries—Evidences for the Theory of Evolution—1. Morphology—2. Classification—3. Blood Tests—4. Embryology—5. Palontology—6. Geographic Distribution—Sex Determination—Sex Linked Characters—Crossing Over—Genes—Lethal Factors—Physiological Basis—Parthenogenesis—Identical versus Fraternal Twins—Hermaphroditism and the Free Martin—Hen Feathering in the Sebright Bantam—Evidence for and against the Inheritance of Acquired Characters—Inheritance of Disease—1. Prenatal Infection—2. Prenatal Injury to the Germ Cells or Embryo—3. Inheritance of Weakness Predisposing to Disease—4. Inheritance through the Germinal Substance—Maternal Impressions—Eugenics.



CHAPTER I

INTRODUCTION

LIVING as they did near the Mediterranean and Aegean seas where tides receded and left animals upon the shore, and where insects developed in decayed flesh, it was natural that the early Greeks and Romans should believe in the *spontaneous generation of life*. This belief persisted until the experiments of an Italian naturalist, Redi, performed in 1688, showed that maggots originated in meat from eggs laid by flies. In the middle of the nineteenth century, Pasteur proved conclusively that not only larger organisms, but even minute *bacteria* would not develop in sterilized media unless they were introduced.

We believe that all life came from pre-existing life—*omne vivum ex vivo*—but it is not our purpose to discuss in this text the various theories of how life came into being. We are interested in the science of all *living things*, *Biology* (Gr. *bios*, life; *logos*, discourse), once termed *Natural History*, which includes the study of the structure and activities of both plants and animals. While we must consider the plants in their relationship to animals, we cannot include the study of *Botany*, but must confine ourselves to the study of animals, called *Zoölogy*.

The Function of Zoölogy.—The science of *Zoölogy* (Gr. *zoön*, animal; *logos*, discourse) indicates to us the relationship of animals from the unicellular to the most highly developed multicellular organism, man. In order to understand an animal thoroughly, we must know its anatomy, physiology, reaction to environmental conditions, and its economic importance.

Medicine in all its aspects owes a great debt to *Zoölogy*, not only because of the opportunity to observe lower forms under favorable circumstances, but also because of the important relationship of parasitic animals to each other and to man. Some of the most important discoveries in sanitation and preventive medicine, as well as in surgery, have been made as a direct result of zoölogical studies.

Agriculture owes much of its advancement to experimental work

done by medical men and veterinarians, but within the past ten years physiologists and biochemists in agricultural and medical colleges have united in nutrition studies, undreamed in previous decades.

The Divisions of Zoölogy.—*Systematic Zoölogy*, or *Taxonomy* (Gr. *taxis*, arrangement; *nomos*, law), has since the earliest days engaged the attention of naturalists. In fact, for many years they contented themselves with merely naming hundreds of animals. Fierce battles were waged over the question of priority and much time was wasted in futile arguments over species differences. In 1735 a Swedish naturalist, who took the Latin name of Linnaeus, conceived the idea of a system of binomial nomenclature such that the generic and specific names written in Latin or Greek could be understood by scientists of all nations. Animals distinguished only slightly from each other were placed as different species of the same genus. For example, the domestic cat, the wild cat, and the lion belong to the same *genus*, which we call *Felis*; the domestic cat belongs to the *species domestica* and the lion is *Felis leo*. Over 450,000 species of insects alone have been described. The branches of Systematic Zoölogy include, among others, *Cônology*, the classification of Molluscs; *Entomology*, the classification of Insects; *Herpetology*, the classification of Reptiles; *Ornithology*, the classification of Birds; and *Mammalogy*, the classification of Mammals.

From comparison of external characters, science progressed to a study of internal arrangement and functions. Thus we have two great divisions arising, one which deals with the form and structure, being called *Morphology* (Gr. *morphe*, form; *logos*, discourse), and the other treating of the functions of organs and parts, called *Physiology* (Gr. *phusis*, nature; *logos*, discourse).

Morphology includes *Gross Anatomy* (Gr. *anatemno*, to cut up), which deals with dissection; *Histology* (Gr. *histos*, a web; *logos*, discourse), which is the study of the structure of cells and tissues usually stained by dyes; *Embryology* (Gr. *en*, in; *bruo*, bud), which traces the development of the egg; and *Pathology* (Gr. *pathos*, suffering; *logos*, discourse), which deals with the structure of diseased tissues. The study of Pathology is linked with Histology, Embryology and Physiology.

But Zoölogy is by no means confined to the study of stained or preserved specimens. It is not the type of subject that it was termed by the Professor of Latin quoted by Conklin: "Biology

deals with things as dead as the dead languages and not nearly as well preserved."

Biology rests ultimately upon the foundation of the two fundamental sciences, *Physics* and *Chemistry*. Recent advancement in the utilization of ultra-violet light and radium on animal growth gives us an inkling of the future possibilities in *Physics*. The comparatively new science of *Biochemistry* is continually presenting us with explanations of extremely important physiological processes hitherto unknown.

'In another age, all the branches of knowledge, whether relating to God, or man or nature, will become the knowledge of "the revelation of a single science," and all things, like the stars in heaven, will shed their light upon one another.' Jowett: *Plato*, Introduction to *Meno*.

Physiology (Gr. *phusis*, nature; *logos*, discourse), the study of functions, includes the study of Animal Behavior and Psychology. Lovatt Evans, in an address before the British Association for the Advancement of Science, said: "Physiology is something more than bio-chemistry and bio-physics; it is and always will remain a biological subject."

Ecology (Gr. *oikos*, house; *logos*, discourse), the study of the relationship of animals to their environment, has developed far beyond the old Natural History of which Miall said: "Natural History is encumbered by multitudes of facts which are recorded only because they are easy to record." The study of Physiology is now so linked with that of Ecology that it is difficult to separate them.

Zöogeography treats of the spatial distribution of animals while Paleozoölogy, which deals with their fossil remains, links Geology with Zoölogy.

Evolution (Lat. *e*, out; *volvere*, roll), the study of the origin and descent (or ascent) of species, must draw upon all fields of Morphology and Physiology as well as on Taxonomy and Paleontology. *Heredity* treats of the transmission of characteristics from parents to offspring. *Genetics* deals with Heredity and Variation.

Living Things Compared With Non-Living Matter.—The late Professor W. K. Brooks of Johns Hopkins University once said: "A living thing is a being which responds to the stimulus of any event in such a way as to adapt its actions to other events of which the stimulus is the sign."

There are certain fundamental distinctions between living and non-living matter, as will be seen in the following table.

INTRODUCTION

LIVING AND NON-LIVING MATTER

Each plant and animal has a definite size limit and form characteristic of the species.

Living organisms grow by *intussusception*, the addition of particles of protoplasm prepared from their food by metabolic processes.

Living organisms contain certain elements characteristic of protoplasm, and including complex proteins, built up from Carbon, Hydrogen, Oxygen and Nitrogen, and undergo constant tearing down (katabolism) and upbuilding (anabolism).

Living organisms are able to reproduce complete individuals like themselves, and to regenerate mutilated portions.

Besides growth and reproduction, living matter has other powers: contractility, irritability, nutrition, respiration and excretion.

There is no limit to the size¹ or form reached by non-living matter (e.g. water).

Non-living bodies grow by adding to themselves on the outside by accretion,² accumulations of material chemically the same.

Non-living matter may contain the same elements but be lacking in the spark of LIFE.

Non-living matter is utterly unable to reproduce.

Non-living matter is devoid of these characteristics.

PROTOPLASM

Protoplasm is the term used to indicate that complex substance from which all living things are built up. Protoplasm is somewhat jelly-like in appearance, and nearly colorless, but may be opaque when it contains food particles. It is considered to be an emulsoid, existing either as an apparently liquid *sol*, with minute invisible molecules; or as a *gel*, firm in consistence, with larger visible particles. Protoplasm is made up of "unit masses," which we term *cells*. Each cell has a nucleus and cytoplasm. Plant cells may have a cellulose wall, but in animal cells a cell wall is frequently absent.

Structure of the Cell.—A *cell* is a complex living system or physiological unit of protoplasm which contains a *nucleus*. The protoplasm outside of the nucleus is usually called "cytoplasm." All the contents of the cell have been shown to be the seat of vital activity, but the *nucleus* contains certain elements, colored readily by dyes, hence called *chromatin granules*, which a vast amount of

¹ Since radiation pressure will in the end overcome gravity, even the mass of a star beginning as a nebula cannot exceed a certain limit. Nature abhors infinity of size. (J. A. Eiesland.)

² Huxley cited crystals as an example of accretion. We now believe that crystals are assembled by electrical forces less complicated than in organic combinations.

scientific study has shown to be the carriers of hereditary characteristics, but which may yet share the honors with unknown units. Chemical or physical agents may combine to determine the activity of these granules.

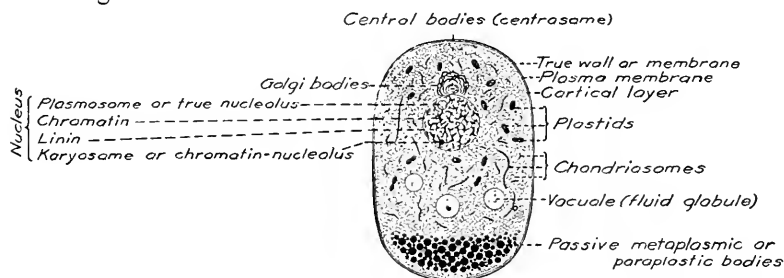

FIG. 1. Diagram of a generalized cell. (After Wilson, *The Cell in Development and Heredity*. Courtesy of The Macmillan Co.)

Cell Membrane and Cell Wall.—The *cell membrane* protects the cytoplasm from many physical and some chemical injuries. It is, however, only semi-permeable, and admits some solvents, but retains the colloids of its own protoplasm, and excludes foreign ones.

On account of the tendency for water to pass or *diffuse* from a liquid with *low* concentration of soluble substance, through a permeable membrane to a liquid with *higher* concentration, we find that the energy or *osmotic pressure* varies with the degree of similarity of the concentrations. In discussing two solutions, we refer to their *tonicity*. For example, a solution *losing* water through a membrane would be *hypotonic*, while the one that gained the water would be called *hypertonic*. Two solutions in osmotic equilibrium are called *isotonic*.

The cell membrane may have a covering of some resistant material like chitin or hardened gelatin in the animals, or of woody cellulose in the plants. This covering is called the *cell wall*.

Cytoplasm.—The most conspicuous structure in the cytoplasm, aside from the nucleus and certain large vesicles and plastids, is the *centrosome*, or central body (consult Figure 1), which we find acting as the division center for the aster in mitotic division. (See page 500.) No centrosome is present in the cells of flowering plants.

Cytoplasmic Granules.—Granules of various kinds are scattered throughout the cytoplasm, suspended in the clear, viscid "hyaloplasm." The relatively large *yolk granules* occur as solids, semi-solids or as liquid drops. *Fat* and *glycogen* appear as cell inclusions.

Plastids, found chiefly in plant cells, aid in the formation of starch and various pigments. Chlorophyll bodies, the centers of formation of starch by photosynthesis, are considered the most important of the chloroplastic type.

Secretory granules of various chemical composition and physical consistency, more or less transitory in nature, are found in secretory cells. They dissolve to produce *fat*, mucin, or an *enzyme*. (See page 10.) *Storage granules* are also quite generally distributed.

Fibrillae, almost as characteristic as granules, appear in many types of cells, including gland cells, nerve cells and muscle cells. Fibrillae may be produced by the fusion of small granules, but like certain other cytoplasmic inclusions, some fibrillae are regarded as artifacts.

The *chondriosomes* or mitochondria vary in form from granules of 0.2 μ . to rods and filaments of much greater length. They are found in most living cells and resemble albumins somewhat, both in solubility and in staining reactions. The earlier technique of fixation by acids such as acetic destroyed the mitochondria, but they are shown successfully in living cells by Janus Green B. Regaud suggested, as a possible explanation of their function, that they are the centers of chemical action, and that they extract substances from the protoplasm, transforming them into specific intra-cellular structures. Cowdry has suggested that they supply a surface-film, perhaps with a significance comparable to the nuclear and cytoplasmic membranes.³

The *Golgi apparatus* is the term given to a group of cell-components found widely distributed in both plant and animal cells. They, like chondriosomes, require fixation by reagents lacking acetic acid. Osmic acid fixers seem to show them best. The apparatus appears in *diffuse* form as separate bodies, or in *localized* form as a "Golgi net" consisting of concentrated fibrils. It has been suggested by Nassanov, Bowen and others that the Golgi-bodies have a secretory function. Bowen suggested that the Golgi apparatus may be a center for the formation of enzymes.

H. Hibbard (Arch. d'Biologie, Tom. 38, p. 1, 1927) and M. Parat (Arch. d'Anat. mic., Tom. 24, p. 73, 1928) have shown that Golgi-bodies may be depositions of the stain used. We are still in considerable doubt regarding the function of Golgi-bodies, mitochon-

³ Consult Osterhout, W. J. V. 1929. Some aspects of permeability and bioelectrical phenomena. Bull. Nat. Res. Council, pp. 170-288, Washington, D. C.

dria and other cell components, but it is hoped that improved technique in fixation and staining, together with the development of tissue culture studies and the micro-manipulation of living cells, will reveal the functions of real structures and indicate which granules are only artifacts.

There are other scattered bodies in the cytoplasm, not readily seen but "haloed" under strong illumination, which may be the ultimate units from which chondriosomes and Golgi-bodies are aggregated.

Nucleus.—The *nucleus* is visible in living cells. Some cells contain several nuclei, as in the giant cells of bone marrow, and many others are found to contain two types of nuclei, certain protozoa, in fact, having both a nutritive and a reproductive nucleus. The nucleus is essential to the life of the cell, and is related to metabolism and the secretory phenomena.

The *nuclear membrane*, tough and elastic, is found in the majority of animal cells, but is absent in certain protozoa. It disappears during mitosis (indirect cell division, page 500).

The nucleo-reticulum consists of *chromatin*, which is stained by *basic* dyes. Chromatin may appear in the form of fine granules, larger granules, or in a network, with *net-knots* of massed granules. (See Fig. 1.)

Chromatin granules (*chromomeres*, *chromioles*) are suspended on a reticulum of *linin*, which is delicate in structure and stained by *acid* dyes. The granules aggregate to form chromosomes,⁴ which are constant in number for the cells of the same species. Apparently the granules are not dissociated, but usually prepared to reassemble. The *chromosomes* are carriers of hereditary *factors* or "*genes*," although we are not certain that they are the sole means of transmission from one generation to the next. (See p. 538.)

Nucleolus.—The *nucleolus* or plasmosome is a dense body, spherical in shape, and chemically different from chromatin since it is stained with acid dyes. During cell division, the nucleolus usually disappears. Sometimes there are several nucleoli, which may play a part in the metabolism of the cell.

Structure of Protoplasm.—The fact that protoplasm differs under various physiological conditions has given rise to several

⁴"Chromosomes are individual chromatic elements which appear definitely in the nucleus at the end of the prophase stage and which act as unit structures during mitosis." E. Carothers. See page 500 for a discussion of mitosis.

theories of its structure. The *granular theory* suggests that a protoplasmic mass is made up of minute granules which mass into solids or arrange themselves in a linear series to form fibrils. The *fibrillar theory* notes the fibrous structure of certain organs and stresses the idea of a feltwork of fibrils. According to the *reticular theory*, protoplasm is to be compared to a fish net or a hammock. The *alveolar theory* indicates that protoplasm is comparable to an emulsion such as milk, or a mixture of oil and water. The *colloidal theory* recently championed by E. B. Wilson suggests that the alveoli are of secondary origin and that the ultimate particles, "minute scattered bodies, finally produce an emulsion-like structure."

Physiological Properties.—Protoplasm has the power to utilize foods, to grow and repair wastes and develop energy. It secretes usable material and excretes wastes. Repair of broken-down tissues and construction of new is termed *anabolism*. The destruction of waste materials is called *katabolism*. Both processes combined, which result in life activity, are called *metabolism*. Protoplasm responds to all sorts of external *stimuli*, adjusting itself to the environment whenever possible. Finally it has the power of reproduction and a limited power of regeneration.

Chemical Composition.—When we attempt an analysis of the chemical constituents of living protoplasm, we induce important changes. By weighing the material before treating it, and then comparing the weights of all substances determined, we find that it is possible to learn most of the constituents, except that all important one—LIFE. Protoplasm consists of proteins, carbohydrates, fats, inorganic salts, enzymes, water and the "vitamins."

Proteins, which constitute about 40 per cent of dry protoplasm, are compounds with high molecular weights, containing about 53 per cent carbon, 22 per cent oxygen, 17 per cent nitrogen, 7 per cent hydrogen. They also contain small quantities of sulphur and phosphorus. Proteins include the albumen of eggs, fibrin of the blood and casein of milk. They are *colloids*, and as such do not readily diffuse through membranes nor go into solution.

Carbohydrates, which constitute about 12 per cent of dry protoplasm, consist of carbon, hydrogen and oxygen, the last two elements being always present in the same ratio as in water, dextrose for example being $C_6H_{12}O_6$. Glycogen, the only example of animal starch, is found chiefly in the liver and muscles. Carbohydrates can be converted into fats.

Fats, constituting about 12 per cent of dry protoplasm, contain carbon, hydrogen, and oxygen in such proportions that there is much less oxygen than in the carbohydrates. Fats of the body are derived from fatty substances consumed and are also formed from carbohydrates and proteins. Fats are essential in maintaining the proper body temperature.

Water is most essential to life and constitutes over 50 per cent of the weight of most animals. Even the most ardent anti-prohibitionist is made up of about 60 per cent water. It is necessary to bathe tissues and to furnish the adequate liquid for blood, lymph and cerebro-spinal fluid.

Chemical Elements of Protoplasm.—**Carbon** compounds are the primary materials of protoplasm. About 18 per cent of protoplasm consists of carbon. Carbon unites with oxygen to form carbon dioxide and to liberate energy.

Hydrogen (about 11 per cent of protoplasm) is taken into the bodies of plants and animals in combination with oxygen as water, and is also excreted in this form.

Oxygen is found in the free state and unites with various compounds of protoplasm, the process of oxidation releasing energy. In combination with living tissues we find that oxygen makes up about 65 per cent of protoplasm.

Nitrogen is essential to protoplasm of which it comprises about 2 per cent. It forms 79 per cent of the atmosphere. Taken into plant bodies usually in the form of nitrates, the plants utilize it in the manufacture of proteins. *Ammonia*, a nitrogen compound, formed in the katabolism of plants and animals, is changed by certain bacteria into nitrates which are then absorbed by plants.

Sulphur, usually found in the soil as calcium sulphate, is absorbed by plants and used in the manufacture of some amino-acids.

Mineral Salts, Enzymes, Hormones and Vitamins.—The above elements are said to comprise about 99 per cent of the weight of an animal, but there are a number of other elements present in various chemical combinations in extremely minute quantities. Some of these are absolutely necessary to life, while others influence the glands of internal secretion and thus affect growth. Among the most important of these elements are iodine, iron, calcium, phosphorus, chlorine, magnesium, potassium, and sodium. Other elements assuming greater importance every day are arsenic, manganese, copper and zinc. Suffice it to say here that *mineral*

salts are so essential to life that if they are withheld from the animal body, death ensues much more quickly than from the lack of proteins, carbohydrates, and fats. In solution the salts of the body provide the proper medium for living tissues, and aid in maintaining the optimum condition of physiological equilibrium. (For a further discussion of the significance of the salts of these elements see page 437.)

Enzymes are complex organic substances produced in living cells by glands some of which are modified to produce other important secretions. Enzymes are able as *catalysts* to hasten chemical reactions, but do not enter into the end product of the reaction, and are not themselves consumed.

Endocrine glands are glands of internal secretion that produce catalyzing hormones which act as "messengers of stimulation," influence growth, and regulate the animal throughout its whole life. (See page 444.)

Vitamins are certain accessory food factors that have been studied extensively since 1911. Just what their chemical composition may be has not yet been fully decided. The reader will find further discussion of the subject in the section on Nutrition and the Endocrines (page 441).

ANIMAL RELATIONSHIPS

Fitness to Survive.—If we study simply the structure and the activities of organisms and neglect the relation of the living being to its environment, our study is not Biology, or the science of life. Biology introduces a new problem, that of fitness. Biology asks "When, how, why?" Aristotle said: "The essence of a living thing is not what it is made of, nor what it does, but why it does it."

It is the *adjustment* of the *individual* to his *environment* which makes life possible. Life is one long continuous fight, a "struggle for existence." T. R. Malthus in his "Principles of Population" showed that human population tends to increase in a geometrical ratio (1, 2, 4, 8) while the food supply tends to increase in an arithmetical ratio (1, 2, 3, 4, 5, 6, 7, 8). Famines are still occurring in India and China.

Today man is dependent on his fellow man for his subsistence and directly or indirectly dependent on the plants and animals about him. Each animal or plant represents a force in Nature and is beneficial or injurious. If we study the habits of animals we will

be able to evaluate them and to determine whether they should be treated as friends and encouraged to increase, or even artificially propagated, or whether they should be attacked by chemical and mechanical agencies or by protecting their natural enemies.

The most practical way within our reach of studying that adjustment between the organism and the external world—the fitness—which constitutes life is to learn all we can about the physical basis, and all we can about its fitness.

To study life, we must consider three things: (1) the orderly sequence of external nature; (2) the living organism and the changes that take place in it; and (3) that continuous adjustment between the two sets of phenomena which constitutes life.

Plants and Animals.—It might appear that, since man is an animal, Zoölogy is the more important of the two studies. But we must remember our thesis—the proper relation of the individual to his environment—and we will see that plants and animals alike make up the environment. The study of the relation of animals and plants to disease is at present demanding the attention of some of the world's greatest scientists.

To Linnaeus (1707-78) we owe the classification of plants and animals. He stated that "plants grow and live, while animals grow, live, and feed." Owen (1803-93) declared that a definition of plants excluding all animals, or of animals excluding all plants, is impossible. As we go down to the simplest forms we find difficulty in distinguishing between plant and animal. No one can tell. We call these lowest types Zoöphytes (Protista) and Phytozoa.

Origin.—Every organism known in nature arises as a simple cell. In the plant we call it the ovule; in the animal the ovum.

Composition.—So far as their chemical nature is concerned, the plant and animal cell are the same. This has been repeatedly proved. All contain carbon, hydrogen, oxygen, and nitrogen. The skeletons, however, differ widely. The skeleton is largely a cell wall modified in many ways. In general, plants exhibit a *linear aggregation* of cells, while animals show a *mass aggregation*.

Morphology.—No outline can be drawn which will be common to all plants and animals.

Physiology.—Plants and animals stand widest apart in the mode of nutrition, and here we have the chief distinctions:

INTRODUCTION

Characteristics of Animals

Animals usually have a definite shape and are possessed of automatic motion.

Animals depend chiefly on solid food which is liquified by internal digestion.

Animals derive carbon from starch, sugars, fats, from plants and from other animals.

Animals derive their Nitrogen from complex nitrogenous compounds formed by other organisms. They secrete Nitrogenous wastes.

Animals are chiefly devoid of chlorophyll.

Animals are composed of cells with or without cell walls and chiefly without cellulose.

Animals have more marked division of labor among the organs and tissues of the body.

Animals use the potential energy of food, changing it into kinetic energy. We may say they are generally oxidizers.

Animals are destructive or *katabolic*.

Exceptions

Some plants move and some animals are stationary.

Certain parasites, animal and plant, absorb food from that to which they are attached.

Symbiotes in hydra make food for hydra and hydra makes CO₂ for symbiotes. Fungi are also exceptions.

Some Protozoa live like plants and some plants are carnivorous.

Some protozoa, sponges and cocenterates have chlorophyll while some parasitic plants have no chlorophyll.

Cellulose is found in Flagellates and the tunic of Tunicates.

Characteristics of Plants

Plants have a more variable shape and are devoid of automatic motion.

Plants absorb food in the form of liquid or gases.

Plants derive their Carbon chiefly from CO₂ of the air and water.

Plants derive their Nitrogen from simple Nitrogen compounds especially in the soil. They do not give off Nitrogenous wastes.

Plants are chiefly chlorophyll bearing and use the kinetic energy of sunlight in building up complex compounds.

Plants are composed of cells with definite cellulose walls

Plant cells show little division of labor.

Plants build up simple food into complex substances. They convert kinetic energy of sunlight into potential chemical energy. They are reducers of carbon dioxide, liberating oxygen.

Plants are predominantly constructive or *anabolic*. They make more energy than they can use.

CLASSIFICATION

Natural Classification is an attempt to group animals on the basis of similarity in structure and probable relationship.

Let us trace the cat from Kingdom to Species.

KINGDOM—*Animalia*

PHYLUM—*Chordata*

SUB-PHYLUM—*Vertebrata*

CLASS—*Mammalia*

ORDER—*Carnivora*

FAMILY—*Felidae*

GENUS—*Felis*

SPECIES—*Felis domestica*.

Metazoa.—Animals belonging to the Phyla above the Protozoa have many cells and are called *Metazoa* (Gr. *meta*, beyond; *zoön*, animal). Beginning as single cells, the Metazoa pass through stages in which the cells are arranged in at least two layers, the ectoderm and the endoderm. As adults Metazoa are made up of cells arranged in unlike groups. Definitely specialized for particular functions, we find the cells dependent on one another, and manifesting a pronounced "division of labor."

It is customary to begin the study of zoölogy with types of the *Protozoa*, the lowest of the great divisions of animals. But before we take up these forms, it may be well to survey briefly the animal kingdom, beginning with the highest group of *Vertebrates*, the *Mammalia*, to which class we belong.

VERTEBRATES

Vertebrates belong to the most highly developed *Phylum* of the animal kingdom, called *Chordata*. Members of this group include five well known classes, Fishes, Amphibians, Reptiles, Birds, and Mammals. All of them possess a bony axis called the backbone or vertebral column. In general we find that the vertebrates are of much larger size than the invertebrates, and their greater activity is accompanied by special adaptations of structure.

Phylum—Chordata.—

Sub-Phylum—*Vertebrata*

Class I. Cyclostomata

Class II. Pisces

Class III. Amphibia

Class IV. Reptilia

Class V. Aves

Class VI. Mammalia

To the vertebrates belong all the most familiar animals such as fishes, frogs, snakes and dogs. Vertebrates have certain structures in common:

1. Remarkable similarity in the three divisions of the body, head, trunk, and tail.
2. All vertebrates are bilaterally symmetrical, i.e. a plane passed through an axis of the body will divide it into two equal halves.
3. A supporting axis, the notochord, is found at some stage of development in all forms, but is replaced in all higher vertebrates by an axial skeleton. Both appendicular and axial skeleton are internal.
4. All vertebrates have two body cavities, the coelom and the digestive tube.
5. The nerve cord is hollow and dorsal to the alimentary canal.

Class Mammalia (13,000 species).—Mammals are warm-blooded animals with hair or wool covering the body, having a muscular diaphragm which separates the chest from the abdomen. They never have gills, but breathe by lungs. They have a well developed and usually convoluted brain with many important association tracts. While some mammals are adapted to aquatic and others to aerial life, the majority are suited to life on land. Except in a few of the lower forms we find that before birth young mammals are closely attached to their mothers by a structure called the placenta. In general, mammals are further advanced at birth than in the lower classes of vertebrates. Mammary glands furnish nourishment to the young until they are able to shift for themselves. Mammals range from the most highly developed form, man, to the primitive duckbill platypus, which lays eggs and has diffuse mammary glands.

Class Aves (23,000 species).—Birds are unlike mammals, having specialized in a quite different direction. They have a body temperature ten degrees higher than that of the mammals, and are distinguished from all other animals by the presence of feathers. Their highly developed wings and pectoral muscles, hollow bones, large lungs, and air sacs adapt the majority of them to an aerial life, although some forms like the ostrich are flightless. Birds are of great economic importance in the extermination of insects, but they are of aesthetic value since many of them are beautifully colored, while others are sweet singers.

Class Reptilia (5,000 species).—Reptiles differ more widely

among themselves than other classes of vertebrates. In some respects they appear to be related to both birds and mammals. They have scaly or armored skins, never have gills, but breathe by lungs and are cold blooded. They have three chambers to the heart, the ventricular septum being perforate in all except the crocodilia. Living forms are terrestrial or aquatic but extinct forms were aerial. With the exception of a few lizards and snakes, they are oviparous. (Lizards, snakes, turtles, alligators.)

Class Amphibia (4,000 species).—With slimy skins, the modern species lacking armor, but externally resembling the reptiles so much that Cuvier once termed them “naked reptiles,” the amphibia mark a transition from the aquatic life of fishes to the terrestrial life of reptiles. In the larval condition practically all amphibia have gills, while as adults they breathe by lungs, although in some forms gills still persist. Amphibia are cold blooded, and their unpaired fins are never supported by fin rays. They are, with a few exceptions, oviparous. (Salamanders, frogs, toads.)

Class Pisces (20,000 species).—As strikingly adapted to life in the water as birds are to life in the air, the fishes are all aquatic, moving chiefly by a muscular tail. They have paired appendages in the form of fins, and unpaired median fins always supported by fin rays. All have permanent gills supported by cartilaginous or bony gill arches. Fishes are cold blooded, the body temperature remaining the same as that of the medium in which they swim. The heart is two chambered, only the lung fishes exhibiting a primitive auricular septum. In the skin of most fishes, one finds scales. Some fishes are oviparous, others are viviparous. (Shark, sturgeon, mackerel, trout.)

Class Cyclostomata.—While they somewhat resemble the bony true eels, the hags and lampreys have no jaws, no lateral appendages and no scales. A rasping tongue and a circular sucking mouth are present. The gills are pocket-like and the vertebrae are separate from the notochord. Lampreys are true vertebrate parasites.

Sub-phylum Adelochorda (Cephalochorda).—Fish-like forms once classed with the mollusca. Branchiostoma (Amphioxus) has a dorsal fin, lateral metapleural folds, well developed myotomes, and a persistent notochord. The nerve cord has a neurocele. A pharynx, with many gill slits, leads into a ventral atrium and currents pass out the atriopore. A cranium is absent.

Sub-phylum Urochorda (1,500 species).—Once called worms, the

tunicates or "sea squirts" were later called mollusca. They are characterized by a cellulose tunic, retrogressive metamorphosis and reversible heart beat.

INVERTEBRATES

Having described briefly the Urochorda and Adelochorda, which we may consider types intermediate between the Vertebrates and the Invertebrates, let us consider the characteristics that differentiate the Invertebrate Phyla. We have seen that all the Vertebrates belong to the same Phylum, and are to a great extent related, but the Invertebrate Phyla are widely different in characteristics.

1. Invertebrates have neither internal skeleton nor notochord.
2. For the most part their nervous system is ventral to the digestive tract.
3. They lack gill slits or visceral clefts.
4. When present, the heart is dorsal.

Phylum Arthropoda (450,000 species).—Segmented animals, some with jointed appendages. Body covered by a chitinous exoskeleton secreted by cells beneath it; bilaterally symmetrical, with anus but poorly developed coelom. (Examples—crab, spider, mosquito.)

Phylum Mollusca (60,000 species).—Unsegmented with no true appendages. Fundamental bilateral symmetry is lost in Gastropoda; while the ventral muscular foot characteristic of the group is subject to modification. Frequently a bilobed shell is present with the mantle, a dorsal fold of the body wall covering the animal. Sometimes both shell and mantle are absent; but a coelom and anus are present. (Examples—oyster, clam, snail and octopus.)

Phylum Molluscoidea (2,000 species).—*a.* Bryozoa or Polyzoa—Colonial, like some Coelenterates. Complete alimentary canal. Large body cavity. (Pectinatella is the commonest fresh water form.) *b.* Brachiopoda—once gigantic bivalves, rulers of the ocean.

Phylum Trochelminthes (500 species).—Somewhat resembling the infusorian protozoa, the Rotifers are often called "wheel animals." Well developed digestive system with mouth, mastax (chewing stomach), glandular stomach, intestine and anus. Females large, males few in number and small; resemble larvae of annelids and molluscs.

Phylum Annelida (4,000 species).—Visibly segmented worms with three cellular layers. (Triploblastic.) No jointed appen-

dages; setae in the skin. Coelom opens to exterior by dorsal pores and ventral nephridiopores. Alimentary canal well developed and usually specialized. Nervous system consists of two dorsal ganglia and a ventral chain of ganglia. (Examples—earthworm, leech.)

Phylum Echinodermata (3,000 species).—Triploblastic (three layered) with a calcareous exoskeleton in plates or as spicules; larvae bilaterally symmetrical but adults radially symmetrical. The coelom is well developed; slow locomotion facilitated by water vascular system; all marine; never bud to form a colony. (Examples—starfish, sea urchin, and brittle star.)

Phylum Nemathelminthes (1,500 species).—Unsegmented with an elongate cylindrical body covered with tough cuticle; tubular digestive tract with mouth and anus; coelom present; paired excretory organs and tubular gonads; nerve ring and associated ganglia; many parasitic. (Examples—hookworm, eel-worm, trichina.)

Phylum Platyhelminthes (4,600 species).—Unsegmented flattened worms, bilaterally symmetrical and with three distinct layers (triploblastic). Free living forms have a gastro-vascular cavity with no anus, while the degenerate parasitic forms lack a digestive cavity. (Examples—liver fluke, tape worm, and planaria.)

Phylum Coelenterata (4,500 species).—Radially symmetrical with two cellular layers, and a non-cellular mesoglea; single gastro-vascular cavity or Coelenteron; formerly called Zoöphytes. Stinging cells or nematocysts in the body wall. (Examples—corals, sea anemones, jelly fishes and hydroids.)

Phylum Porifera (2,500 species).—Bodies of sponges consist of a mass of connective tissue with two-layered (diploblastic) body wall penetrated by canals or pores. All are aquatic, mostly marine. Radially symmetrical; skeleton of spicules usually supports the body wall. (The common bath sponge is an example.)

Phylum Protozoa (10,000 species).—Although it would seem that in some respects sponges might be considered colonial Protozoa, we must distinguish the latter from all Metazoa by their characteristic of being complete single celled animals, without true tissues. They are mostly so small as to be visible only with the aid of a microscope; many species are colonial; many are parasitic.

PHYLUM PROTOZOA.

Class I. Sarcodina.

Class II. Mastigophora

Class III. Infusoria.

Class IV. Sporozoa.

PHYLUM PORIFERA.

PHYLUM COELENTERATA.

- Class I. Hydrozoa.
- Class II. Scyphozoa.
- Class III. Actinozoa or Anthozoa.

PHYLUM OR CLASS CTENOPHORA.

PHYLUM PLATYHELMINTHES.

- Class I. Turbellaria.
- Class II. Trematoda.
- Class III. Cestoda.
- Uncertain Class, Nemertinea.

PHYLUM NEMATHELMINTHES.

- Class I. Nematoda.
- Uncertain Classes.
- Acanthocephala.
- Gordiaceae.

PHYLUM ANNULATA, OR ANNELIDA.

- Class I. Archi-Annelida.
- Class II. Chaetopoda.
- Class III. Hirudinea.

PHYLUM TROCHELMINTHES.

PHYLUM MOLLUSCOIDEA.

- Class I. Brachiopoda.
- Class II. Bryozoa.
- Class III. Phoronidea.

PHYLUM ECHINODERMATA.

- Class I. Asteroidea.
- Class II. Ophiuroidea.
- Class III. Echinoidea.
- Class IV. Holothuroidea.

PHYLUM MOLLUSCA.

- Class I. Pelecypoda.
- Class II. Amphineura.
- Class III. Gastropoda.
- Class IV. Scaphopoda.
- Class V. Cephalopoda.

PHYLUM ARTHROPODA.

- Class I. Crustacea.
- Class II. Onychophora.
- Class III. Myriapoda.
- Class IV. Insecta (Hexapoda).
 - Order 1. Thysanura (Aptera).
 - Order 2. Ephemera.
 - Order 3. Odonata.
 - Order 4. Plecoptera.
 - Order 5. Isoptera.
 - Order 6. Corrodentia.

- Order 7. Mallophaga.
- Order 8. Thysanoptera.
- Order 9. Euplexoptera.
- Order 10. Orthoptera.
- Order 11. Hemiptera.
- Order 12. Neuroptera.
- Order 13. Mecoptera.
- Order 14. Trichoptera.
- Order 15. Lepidoptera.
- Order 16. Diptera.
- Order 17. Siphonaptera.
- Order 18. Coleoptera.
- Order 19. Hymenoptera.

Class V. Arachnida.

Other Classes.

- Pycnogonida.
- Tardigrada.

PHYLUM CHORDATA.

- Sub-phylum Hemichorda (Enteropneusta).
- Sub-phylum Urochorda (Tunicata).
- Sub-phylum Cephalochorda (Adelochorda or Acrania).
- Sub-phylum Vertebrata or Craniata.

Class I. Cyclostomata.

Class II. Pisces.

- Sub-class Elasmobranchii.
- Sub-class Teleostomi.
 - Order 1. Crossopterygii.
 - Order 2. Chondrostei.
 - Order 3. Holostei.
 - Order 4. Teleostei.
- Sub-class Dipnoi.

Class III. Amphibia.

- Order 1. Apoda or Coecilians.
- Order 2. Urodela or Caudata.
- Order 3. Anura (Salientia or Ecaudata).

Class IV. Reptilia.

- Super-order 1. Cotylosauria.
- Super-order 2. Chelonia.
- Super-order 3. Therapsida (Theromorpha).
- Super-order 4. Sauropterygia.
- Super-order 5. Ichthyopterygia.
- Super-order 6. Archosauria.

Class V. Aves.

- Division A. Ratitae.
- Division B. Carinatae.
 - Order 1. Pygopodes.
 - Order 2. Longipennes.
 - Order 3. Tubinares.

INTRODUCTION

- Order 4. Steganopodes.
- Order 5. Anseres.
- Order 6. Odontoglossae.
- Order 7. Herodiones.
- Order 8. Paludicolae.
- Order 9. Limicolae.
- Order 10. Gallinae.
- Order 11. Columbae.
- Order 12. Raptores.
- Order 13. Psittaci.
- Order 14. Coccyges.
- Order 15. Pici.
- Order 16. Machrochires.
- Order 17. Passeres.

Class VI. Mammalia.

- Order 1. Monotremata.
- Order 2. Marsupialia.
- Order 3. Insectivora.
- Order 4. Chiroptera.
- Order 5. Carnivora.
 - Sub-order Fissipedia.
 - Sub-order Pinnipedia.
- Order 6. Rodentia.
 - Sub-order Simplicidentia.
 - Sub-order Duplicidentia.
- Order 7. Edentata.
- Order 8. Ungulata.
 - Sub-order Hyracoidea.
 - Sub-order Perissodactyla.
 - Sub order Artiodactyla.
- Order 9. Sirenia.
- Order 10. Cetacea.
- Order 11. Primates.

CHAPTER II

PROTOZOA

THE PROTOZOA (Gr. *protos*, first; *zoön*, animal) are the simplest living animals and some of them resemble plants. Primitive and mostly microscopic though they are, the Protozoa are complete organisms in a single cell, carrying on the physiological processes of higher forms. A protozoan may be ameboid, flagellated, or ciliated, depending on its organs of locomotion.

CLASSIFICATION

Class 1. Sarcodina (Gr. *sarx*, flesh) move by false feet or pseudopodia.

Class 2. Mastigophora (Gr. *mastix*, whip; and *phero*, bear) move by flagella.

Class 3. Infusoria (Lat. *infusus*, crowd in) move by cilia, and are also called Ciliata.

Class 4. Sporozoa (Gr. *spora*, seed; and *zoön*, animal). No locomotor organs in adult stage.

CHARACTERISTICS

1. Morphologically the simplest ones are equal to isolated epithelium.
2. Physiologically they are equal to the whole group of cells making up the human body. Protozoa are complete unicellular organisms and many have a brief multicellular phase.
3. Functionally they epitomize life processes.
4. Theoretically they are generalized cells.
5. Of practical economic importance, they cause many diseases.
6. As soil organisms protozoa are of doubtful importance.

Protozoa were first discovered by Leeuwenhoek in rain water. Misconceptions arose because of the insufficient magnification possible. O. F. Mueller (1786) made the first classification. He classified 350 species, 150 of which are still regarded as valid. He

believed them to be the simplest form of animal. Von Siebold and Kölliker (1849) proved that Protozoa are single cells and complete organisms as well. Max Schultze (1865) gave the present idea.

NATURAL HISTORY

Class I. Sarcodina. Type of Group—*Ameba proteus*. External Anatomy.—Amebae resemble minute grayish animated particles of jelly. Some species of amebae, large enough to be seen

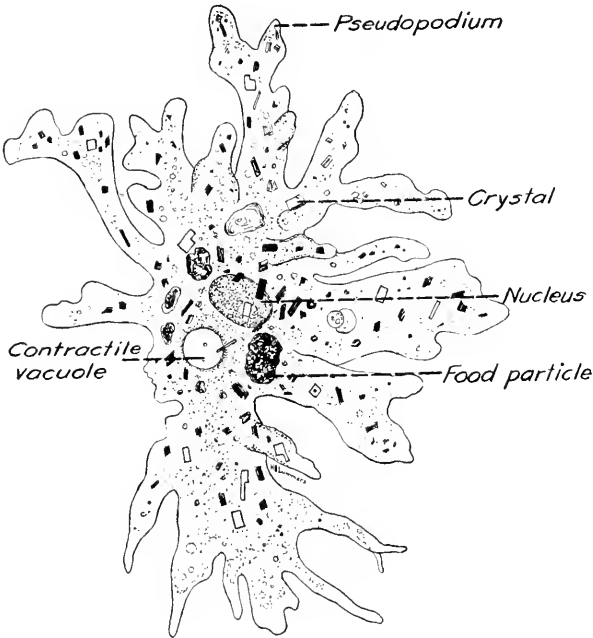

FIG. 2A. *Ameba proteus-dubia* Schaeffer. (Drawn by H. N. Lammers, after F. F. Botsford, *Jour. Exp. Zool.*, vols. 45-46, 1927.)

with the naked eye, have been selected and cultivated for laboratory use. The diameter of the smaller ones is as little as five microns. They constantly change their shape, sending out little projections called pseudopodia, or "false feet" (Fig. 2, A and B).

The outer covering of the amoeba is called the *ectosarc* (ectoplasm) and is lacking in color. The inner portion of the animal called the *endosarc* (endoplasm) contains the nucleus, the synthetic and hereditary center of life, and vacuoles of different types. The

presence of numerous granules and particles of food gives the animal a grayish appearance.

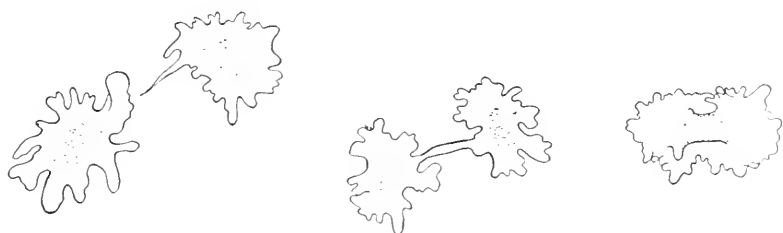

FIG. 2B. *Ameba* dividing. (Drawn by H. N. Lammers, after E. F. Botsford, *Jour. Exp. Zool.*, vols. 45-46, 1927.)

Locomotion.—There are a number of theories attempting to explain the movement of amoeba, but none of them seems quite adequate.

According to the *contractile theory* of Dellinger (1906) and others, contractile fibrillae were postulated. He showed that when viewed with the microscope in a horizontal position the amoeba “walks” on stiff pseudopodia¹ (Fig. 3A).



FIG. 3A. Locomotion of *Ameba*. (After Dellinger.)

The *surface tension theory* indicates that ectoplasm is most rapidly formed at the point where surface tension is increased. Schaeffer (1920) has also emphasized the fact that amoeba has a wavy path or a flattened spiral.²

The *adherence theory* states that a pseudopodium adheres more strongly to one side and that the endoplasm of that region, and ultimately the whole animal, moves in that direction.

In the theory advanced by Mast (1923)³ it is suggested that

¹ Dellinger, O. P. 1906. Locomotion of Amoeba and allied forms. *Jour. Exp. Zool.*, vol. 13, pp. 337-358.

² Schaeffer, A. A. 1920. *Amoeboid Movement*. Princeton University Press.

³ Mast, S. O. 1923. Mechanics of locomotion in Amoeba. *Proc. Nat. Acad. Sci.*, vol. 9, pp. 258-261.

the movement of ameba is dependent on changes of the protoplasm from *sol* to *gel* and back to a *sol* state again. (See page 4.) It has also been suggested by Mast that form in ameba is dependent on water content.

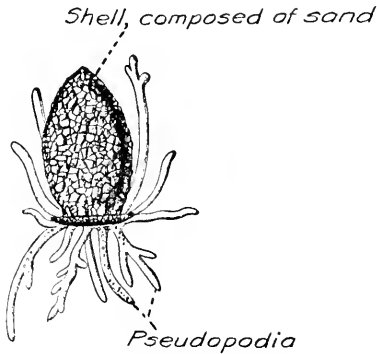

FIG. 3B. *Diffugia*. (After Leidy.)

Digestion.—Food is ingested directly through the *ectoplasm*, and having entered the *endoplasm*, minute quantities of HCl secreted around the food mass form a gastric vacuole. Carbohydrates are not acted upon to any extent, digestion being chiefly limited to protein and fat. Solid wastes are extruded at any point, the ameba moving away and allowing the weighty excrement to pass through the *ectoplasm*. Ameba

can nip a paramecium in two, engulfing one-half, and leaving the other half outside.

Circulation.—There is no definite distribution of food materials but the movements of the animal thoroughly distribute the food granules.

Respiration.—Oxygen is taken in through the whole surface of the body, and CO₂ is extruded. The *contractile vacuole* is also important in the interchange of gases.

Excretion.—Besides the ejection of solid feces by merely leaving them behind as the animal moves forward, the *contractile vacuole* definitely functions in the excretion of liquid and gaseous wastes.

Reproduction.—The ameba is able to *divide* its nuclear and cytoplasmic constituents equally, the process being called *binary fission* or division. Under adverse conditions or sometimes solely for reproductive purposes the ameba *encysts*. It then forms daughter cells which mature in about three weeks. The number produced varies in different species.

Nervous System and Reactions.—Without nerve cells or fibers, the ameba is still a complete *neuromuscular* organism. It reacts to all sorts of stimuli, including light, heat, touch, gravity, currents of water, chemicals, and electricity.

Tropisms.—The term “tropism” has long been used to indicate the reaction of an animal to some sort of stimulus. A few of the

tropisms are indicated: (1) Phototropism, or heliotropism—reaction to light. (2) Geotropism—reaction to gravity. (3) Rheotropism—reaction to currents (stream pressure). (4) Thermotropism—reaction to heat. (5) Thigmotropism—reaction to touch or contact. (6) Chemotropism—reaction to a chemical. (7) Galvanotropism—reaction to electrical currents.

In general we find that for any animal there exists an *optimum* attracting stimulus, which we may term *positive tropism* (or *taxis*), and a negative stimulus, usually the more powerful one. For example, the ameba will be *positively phototropic* to a certain light, but *negatively phototropic* to one of greater intensity.

Orders of Sarcodina. *Order 1.—Lobosa*—(Ameba) soft jelly-like—5–200 μ in diameter. They are found in pools of stagnant water. Each species assumes its characteristic shape (Fig. 3 *A*). They are full of granules and have one or more nuclei and a contractile vacuole. They reproduce by simple fission, by sporulation, and rarely by conjugation.

Order 2.—Foraminifera. They have a test or shell full of openings, through which project filose pseudopodia. They are chiefly marine, varying in size from microscopic to two inches in diameter. Their shells are calcareous, siliceous and chitinous (horny). There are 120 species of Foraminifera in English chalk cliffs. The Norfolk chalk measures are 1,450 feet thick. Globigerina ooze forms gray chalk which is deposited on the bottom of the ocean to depths of 2,500 fathoms. They reproduce by motile swarm spores and by binary fission. Sometimes young with shells are formed in the terminal chamber of the adult. The *nummulites*, the largest of the foraminifera, are as large as a silver dollar. The limestone pyramids of Egypt are full of nummulites.

Order 3.—Heliozoa are mostly found in fresh water. They have fine stiff radiating pseudopodia. Some have skeletons of delicate siliceous spicules. Some species are colonial. Reproduction is by *fission*, *spore-formation* and by *conjugation* (Fig. 4).

Order 4.—Radiolaria are all marine. They differ from Heliozoa in having a much more elaborate skeleton of siliceous or other mineral substance. They have a central capsule surrounding the nucleus. They are united to form colonies of various shapes in some groups. Fossil radiolaria are found in slate, flint, chalk and deep sea deposits.

Reproduction.—(a) Binary fission. The nucleus divides first, then the central capsule, then the extra-capsular tissue. (b) Spore-formation. The intra-capsular protoplasm divides into small

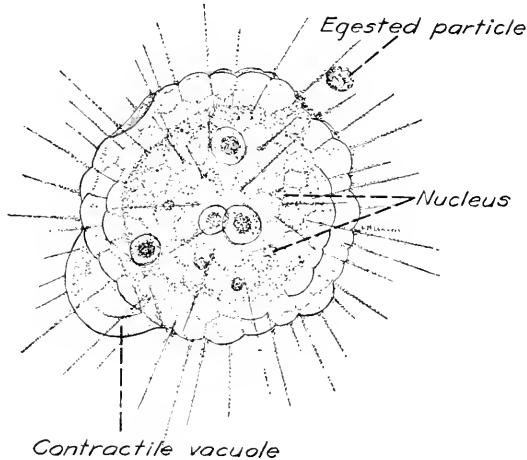

FIG. 4. *Actinosphaerium*, a Heliozoan. (Drawn by H. N. Lammers. After Leidy.)

masses, each of which becomes a *flagellula* with a single *flagellum*. Sometimes the spores produced are alike, in others they are dimorphic some being microspores and others megaspores.

Symbiosis of Radiolaria.—Radiolaria and algae (yellow cells) live in symbiotic relation. (See page 482.) The radiolarian supplies CO_2 and N waste. The alga gives off O and makes sugar.

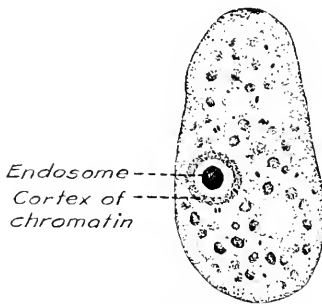

FIG. 5. *Endamoeba intestinalis*. (After Calkins, *Biology of the Protozoa*. Courtesy of Lea and Febiger.)

Parasitic Sarcodina.—Lamb1 (1860) discovered an organism in feces of a child and decided that it was connected with diarrhea, but later rejected this opinion. Later Lewis and Cunningham (1870) found amebae in the feces of nearly 20 per cent of *cholera* patients examined in India. They were not the cause of

cholera, however. Other investigators found two species of ameba in the intestine of man, one harmless, *Entamoeba coli*, one causing *dysentery*, *Entamoeba histolytica* (Fig. 5).

Entameba buccalis (gingivalis), found in the mouth around carious teeth, is considered one of the causes of *Pyorrhoea alveolaris*.⁴

Class 2. Mastigophora (Flagellates). *Type of Group—Euglena.*—Certain intermediate forms called *Mastigamebae* (Fig. 7)

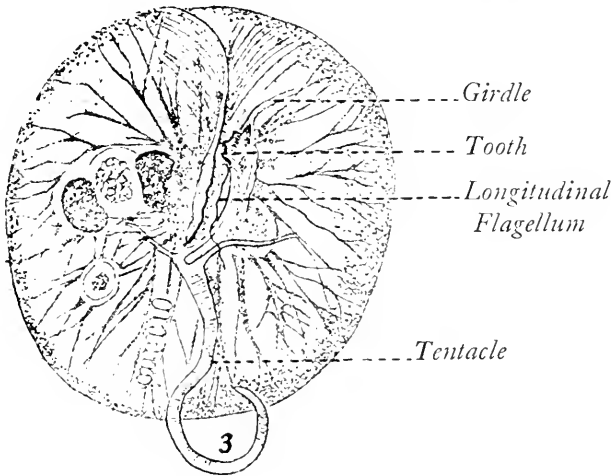

FIG. 6. *Noctiluca scintillans*, postero-ventral view. (Courtesy of C. A. Kofoid.)

have not only the changeable shape and *pseudopodia* of the ameba, but are provided with a flagellum in addition. There is apparently a direct *evolution* from the pseudopodium to the flagellum.

The true flagellates may have one or more flagella. Sometimes one flagellum is used for locomotion and another as an anchor. Some forms have cellulose tests and some are without any shell or case. One group of *marine* flagellates have siliceous skeletons similar to those of the Radiolaria. Reproduction is by simple longitudinal division. Sometimes *encystment* occurs.

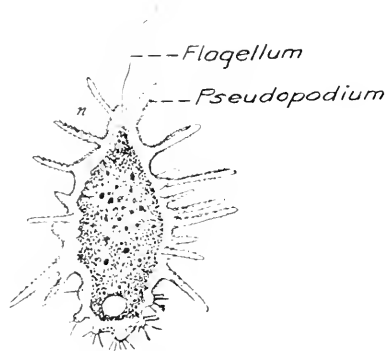

FIG. 7. *Mastigameba aspera*. (Calkins. After F. E. Schultze.)

Euglena is a green flagellate found in fresh water associated with

⁴ Kofoid, C. A. 1929. The protozoa of the human mouth. Jour. of Paras., vol. 15, pp. 151-174.

other protozoa and with many of the algae. At times used in elementary courses by botanists, since it furnishes the movement so necessary to intrigue the student, it is unquestionably a plant-animal. Its shape is roughly that of a cigar and it moves through the water by means of a flagellum (Fig. 8).

The body is covered by a *cuticle*, the external portion of the *ectosarc*. The *endosarc* contains the gullet, a *reservoir*, *contractile vacuoles*, *chromoplasts* and a *nucleus*.

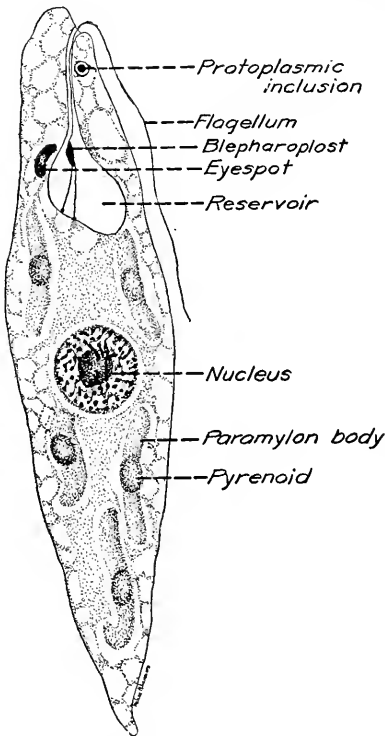

FIG. 8. *Euglena gracilis*. (Drawn by H. N. Lammers. After W. B. Baker.)

Some authors have claimed (apparently without observation) that *Euglena* does not ingest solid particles. The writer has observed with a class of thirty students a whole culture of *Euglena* in the act of ingesting food granules. The animal thrives best, however, when given abundant sunlight. It is quite evidently one of those *Phytozoa* which is able to utilize *chlorophyll* as well as to ingest solids.

The red "eye-spot" is apparently composed of material with the power of absorbing light. Reaction to shadows occurs in *Euglena* just before the pigment spot reaches the shaded region. In *Volvox*, a colonial flagellate, each cell has a true "eye-spot." Strong light produces negative phototropism.

Economic Importance of Flagellates.—*Uroglena* not only colors drinking water yellow, but produces a fishy oily odor similar to that of cod liver oil. *Peridiniums* (*Gonyaulax*) sometimes turn the sea red as blood off the coasts of California, Australia and India. They remove the free oxygen from the water and cause suffocation of the fish. *Synura uvella* produces in drinking water a bitter spicy taste resembling that of ripe cucumbers. *Dinobryon*, also a colonial form,

has a fishy odor similar to seaweed. *Cristispira* is the large flagellate found in the crystalline style of clams and oysters.

Trypanosoma gambiense, found in Southern Africa, causes *sleeping sickness* in man. It is known to be transmitted by the bite of *Glossina palpalis*, the tse-tse fly. Other species of tse-tse flies transmit different species of trypanosomes to mammals. *Trypanosoma brucei* causes the tse-tse fly disease of cattle in tropical Africa. The Germans claim that a drug called Bayer 205 is a specific for sleeping sickness. A remedy for paresis, *tryparsamide*, developed at the Rockefeller Institute, has been substituted for the German patented preparation, and reported successful.

Leishmania transmitted by insects cause *Leishmaniasis* or infantile ulcer, and tropical ulcer. *Surra* and *dourine* are trypanosome diseases of cattle and horses.

Giardia (Lamblia) intestinalis, parasitic in the duodenum of man and the rodents, causes diarrhoea. The parasite is specific for each mammal.

Histomonas meleagridis causes *black-head* (entero-hepatitis) of turkeys. It is a small degenerate flagellate of the trichomonad type, which in tissues, loses its flagella.

Symbiosis.—Symbiosis between termites and protozoa has been discussed by Cleveland (*Science*, vol. 61, no. 1585, p. 520) who has shown that the intestine of wood-feeding termites contain small flagellate protozoa, which may be removed by incubation, starvation, or oxygenation without killing the termites. Neither organism can live very long without the other, the termites dying three or four days after the protozoa are taken from them. Cleveland emphasizes the fact that oxygenation will destroy ciliates and flagellates found in cockroaches as well.

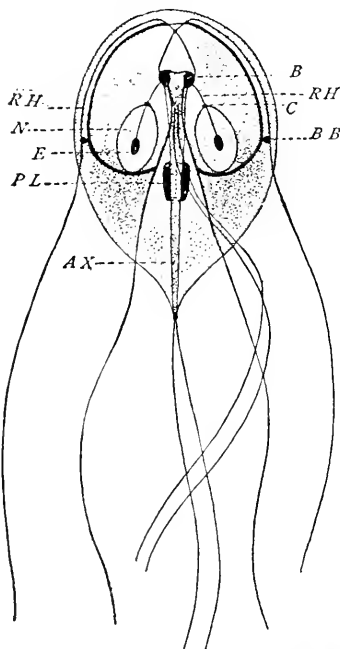

FIG. 9. *Giardia muris*. AX, axostyle; B, blepharoplast; BB, basal body; C, centriole; E, endosome; N, nucleus; PL, parabasal body; RH, rhizoplast. (Calkins. After Kofoid and Swezy.)

Class 3. Infusoria.—In the Infusoria we find that the body is provided with *cilia* useful in locomotion and the ingestion of food. All Infusoria possess cilia in at least the immature condition, but in a few forms they are replaced in the adult by tentacles.

Subclass 1. Ciliata.—Infusoria having cilia throughout life. They have a mouth, often with an undulating membrane. They include five orders.

Order 1. Holotricha.—Primitive Infusoria with small uniform cilia arranged in more or less spiral rows. (Examples: *Paramecium*, *Colpoda*.)

Order 2. Heterotricha.—Infusoria in which small cilia are found covering the body while the peristome is bordered with a spiral of large *adoral* cilia. Fusion of the cilia into membranelles produces a direct pathway to the mouth. (Example: *Stentor*.)

Order 3. Oligotrichida.—In this order the adoral zone forms a ring around the margin of the peristome. Cilia are greatly reduced or absent, and membranelles are the only motile organs. There are three families, two of which are free living (*Halteridae* and *Tintinnidae*), and the third consists of parasitic forms (*Ophryoscolecidae*) in the stomach of ruminant mammals. (See page 482.)

Order 4. Hypotricha.—Ciliata with a dorso-ventrally flattened body. The dorsal surface has longitudinal rows of vestigial cilia in the form of spines, while the ventral surface has hooks, fans, and fringed plates. The hooked cirri act as legs. (Examples: *Stylonychia*, *Oxytricha*.)

Order 5. Peritricha.—Ciliata for the most part bare of cilia, except in the oral region, and in some species with an aboral circlet of cilia. The peristome bears a spiral band of large cilia, which continues around the lid-like disc marking the distal end. Many of the Peritricha are attached by a stalk which contains a contractile fiber. (Examples: *Vorticella*, *Epistylis*.)

Subclass 2. Suctorina (*Acinetaria*, *Tentaculifera*).—Infusoria which have cilia in the young condition, but tubelike tentacles in the adult. They have no locomotor organs except in the free-swimming young, and are attached by a stalk. Other Infusoria are caught by the tentacles and after the cuticle has been dissolved, the fluid protoplasm is sucked down into the body of the suctorian. (Examples: *Podophyra*; *Dendrosoma*, a colonial form.)

Subclass 1. Ciliata. Infusoria. Order 1. Holotricha. Type—*Paramecium caudatum*.—*Paramecium* is a slipper-shaped, ciliated

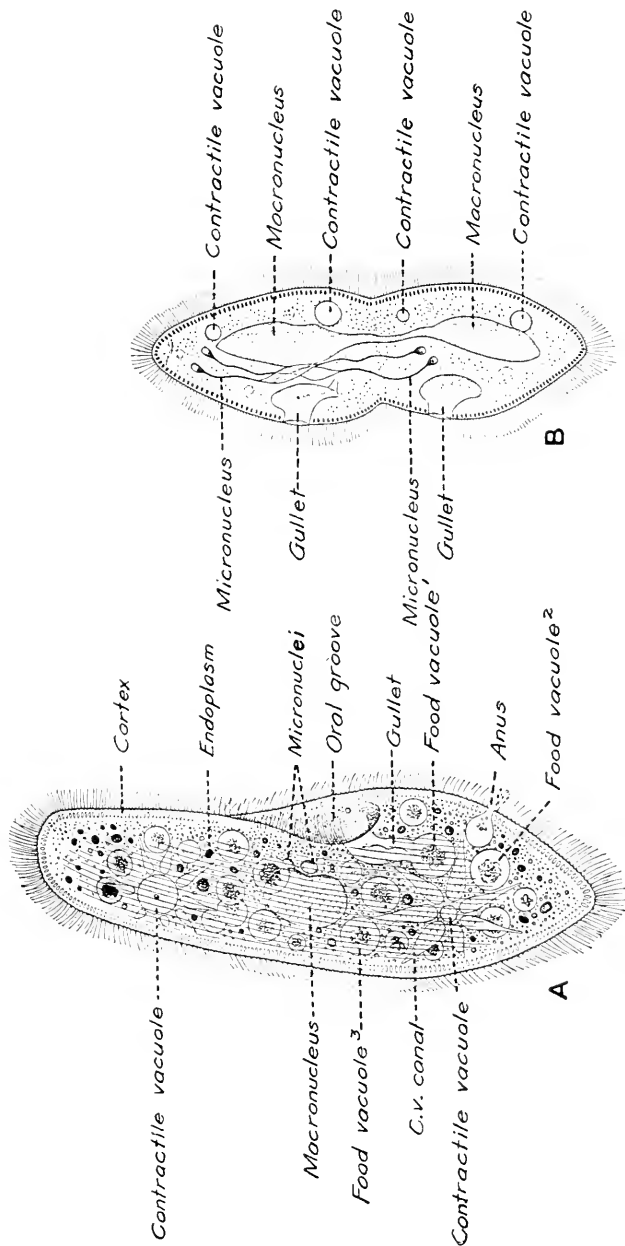

FIG. 10.1. *Paramecium aurelia*. B. *Paramecium aurelia* dividing. (From Newman, *Outlines of Zoology*. Courtesy of The Macmillan Co.)

animal found active in infusions of decaying vegetation. It is readily obtained from hay immersed in water (Fig. 10, *A* and *B*).

The outer covering or ectosarc has at its outer edge a thin *cuticle* which tends to keep the animal of the same shape although it is able to bend laterally. An *oral groove* running obliquely from the anterior end to about the middle of the body aids in producing a *spiral* movement as the cilia beat. The *cilia* are found all over the body in spiral lines, and are especially prominent along the *oral* groove and along the *anterior* and *posterior* ends. Under the cuticle the ectoplasm contains a layer of protective organs called *trichocysts*. The trichocysts in *Epistylis umbellaria*, a peritrichous ciliate, are found in minute capsules arranged in pairs, each containing a coiled thread. They are similar to the *nematocysts*, which are characteristic of Coelenterates. The *endoplasm* contains vacuoles, nuclei and food balls of ingested bacteria which traverse the endoplasm along a definite path.

Locomotion.—The cilia beating violently in unison direct the animal forward, or reverse it, and the spiral lines give the spiral rotation which keeps the course of the animal in a straight line.

Digestion.—The cilia lining the oral groove direct particles of food towards the mouth, and an *undulating membrane* (formed by fused cilia) forces them down the gullet and into the interior of the animal. The same type of *gastric vacuole* characterizing the Ameba is found in Paramecium. Microchemical determinations have shown that dilute HCl is formed around the food particles and that protein digestion takes place. Excretion of indigestible material is through a definite excretory aperture, the *anus*.

Circulation.—As in Ameba we find no circulatory canals. The action of the two contractile vacuoles removes fluid. Water is taken in by the mouth with the food which is distributed in the movement called *cyclosis*.

Respiration.—Oxygen is taken in, and CO₂ is extruded, through the whole surface of the animal. The contractile vacuoles aid in gaseous interchange.

Excretion.—Indigestible material not attacked by the HCl in the food vacuoles is extruded at once along the oral groove by the reversal of direction of the ciliary beat and the *contractile vacuoles* are supposed to aid in excretion of liquids and possibly of nitrogenous wastes, as well as gases. The anal aperture extrudes wastes subsequent to digestion.

Reproduction.—Paramecium reproduces by simple binary fission and frequently conjugates. Isolated daily, the offspring of a single Paramecium have been kept running since 1907 by Woodruff of Yale University. Over 13,500 generations have been produced by

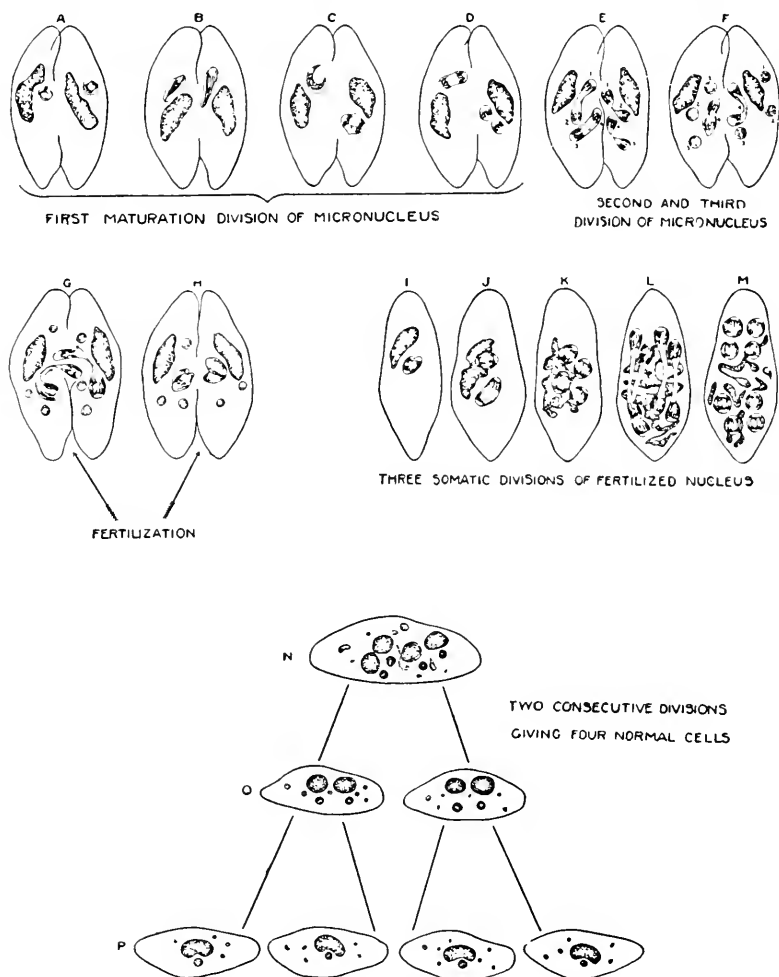

FIG. 11. Conjugation in *Paramecium caudatum*. (After Calkins.)

division without an opportunity for conjugation with a different line⁵ (Fig. 10, *A* and *B*).

⁵ Woodruff, L. L. 1929. Thirteen thousand generations of *Paramecium*. Proc. Soc. Exp. Biol. and Med., vol. 26, pp. 707-708, May.

Conjugation.—The nuclear elements of *Paramecium* are of two kinds. The *nutritive* or somatic *nucleus* (macronucleus), considerably larger than the *reproductive* or sexual *nucleus* (micronucleus),



FIG. 12A. *Lacrymaria* sp.

is responsible for the metabolic activities of the animal. If a *Paramecium* is cut in two, the part containing the two nuclei will survive, but the other half will die. The reproductive nucleus assumes importance in conjugation and sexual reproduction and the nutritive nucleus then temporarily disappears (Fig. 11). *Paramecium aurelia* has two reproductive nuclei.

Preliminary to conjugation the *oral* surfaces of two animals are united by a protoplasmic bridge. The reproductive nucleus goes through the maturation process, divides twice forming four gametes, three of these degenerate, the survivor divides, forming a resident *female pronucleus* and a *small migrant male pronucleus*. Each male pronucleus passes across the protoplasmic bridge into the endoplasm of the other animal and fuses with the female pronucleus, thus fertilizing it, forming the *zygote nucleus*. After mutual fertilization, the fusion nucleus of each animal divides by indirect division (see p. 500 for *mitosis*) into two and finally into eight nuclei equal in size. Four of these develop into *nutritive* or *somatic nuclei*, and four into *reproductive* or *sexual nuclei*. Transverse divisions (simple fissions) result in four animals, each with a nutritive and a reproductive nucleus.

Conjugation has been supposed to be necessary to prevent degeneration of Protozoa, but experiments previously mentioned

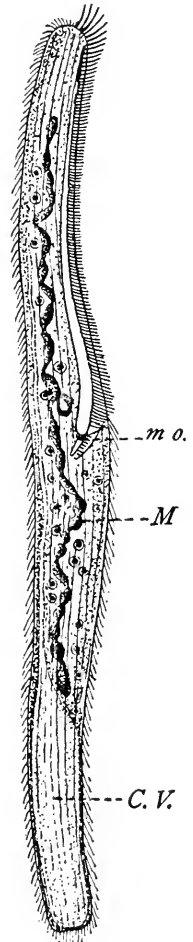

FIG. 12B. *Spirostomum ambiguum*. (After Stein. From Calkins, *Biology of the Protozoa*. Courtesy of Lea and Febiger.)

have proved that *Paramecium* is potentially immortal.

Nervous System and Reactions.—On account of its rapid locomotion, *Paramecium* has been used a great deal in studies of be-

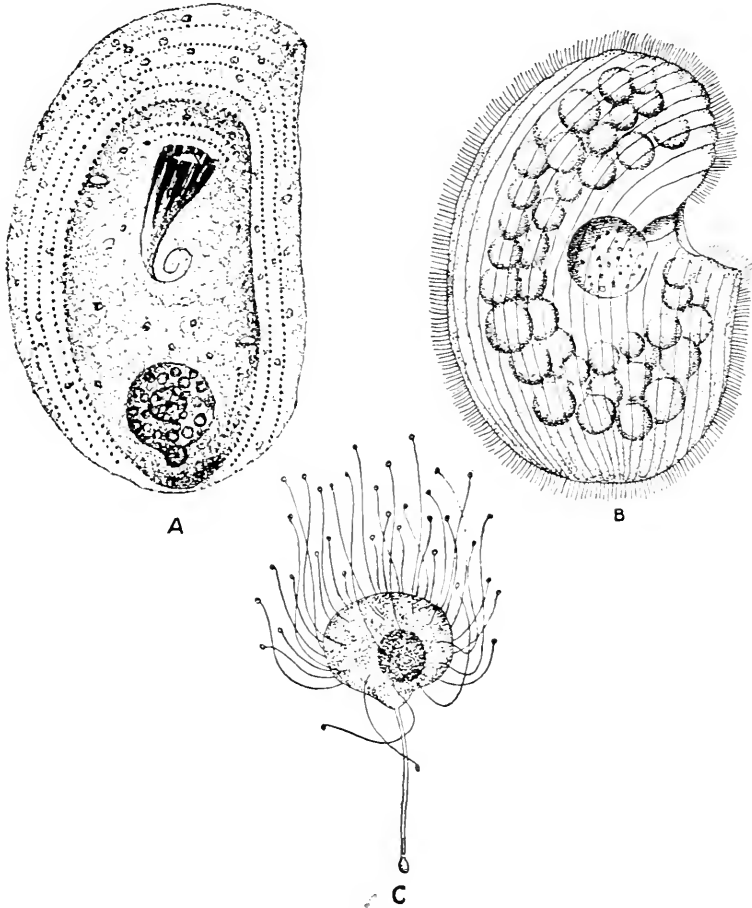

FIG. 13. *A. Chilodon.* (After M. M. MacDougall.) *B. Colpoda cucullulus.* (After Bütschli.) *C. Podophyra* sp., a Suctorian. (After Calkins, *Biology of the Protozoa.* Courtesy of Lea and Febiger.)

havior. Jennings has shown that *Paramecium* responds positively to contact, gravity and to running water, and that its behavior with reference to stimuli of light, chemicals, electricity and heat depends

upon the force of the stimulus, in some cases the reaction being positive and in others negative.

Economic Importance of Ciliates.⁶—*Bursaria* is said to produce an odor in water supplies similar to that of a salt marsh. *Vorticella* and *Stentor* (Fig. 14, A) are frequently found in "pipe moss" and along edges of reservoirs and dams, but are not injurious. Ciliates clean up bacteria in sewage disposal plants.

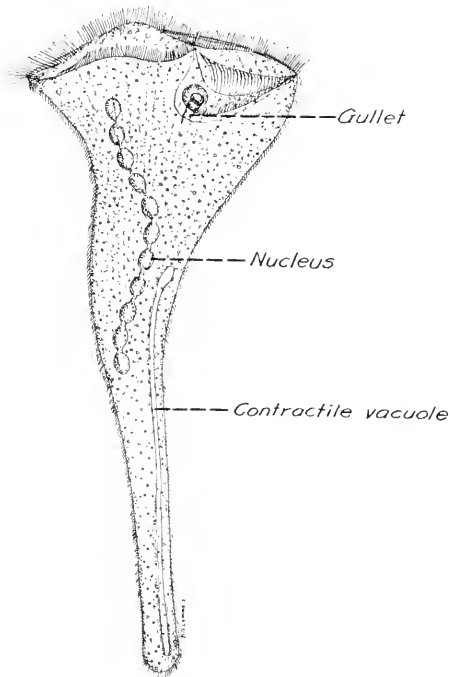

FIG. 14A. *Stentor* sp. (After Stein. Drawn by H. N. Lammers.)

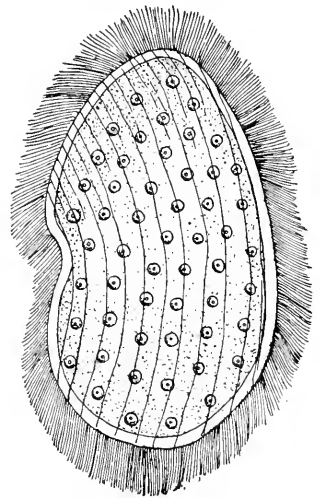

FIG. 14B. *Opalina*. (After Bütschli. Drawn by H. N. Lammers.)

Parasitic Ciliates.—*Balantidium coli* and *Balantidium minutum* have been found in the intestines of human beings infected with

⁶ In considering the value of Protozoa, we must remember that they are marvelously adapted to laboratory experimentation. Calkins, Woodruff, Jennings, and others have demonstrated this by a variety of fundamental studies on life processes. Packard has studied the influence of salts on the division rate of *Paramecium*, adding to our information facts which may have significance in efforts at the control of cancer. (Packard, C. 1926. Effect of sodium on the rate of cell division. *Jour. of Cancer Research*, vol. 10, pages 1-14.)

dysentery and are thought to be concerned with certain ulcers of the large intestines.

Opalina (see Figure 14B) is parasitic in the intestine of the frog (Metcalf). Several species of *ectoparasitic* infusoria are known to attack fishes, causing inflammation and death. *Ichthyophthirius* attacks steel-head-trout fingerlings, catfish, bass and perch. The common stickleback is one of the carriers for the parasite.

Cyclochaeta and *Chilodon* are parasites of goldfish, brook trout and small mouth black bass but apparently do not infest salmon, steel-head trout or perch. *Cyclochaeta* thrives best when the temperature of the water is low, below 50° F., but *Chilodon cyprini* requires a higher temperature (Guberlet).

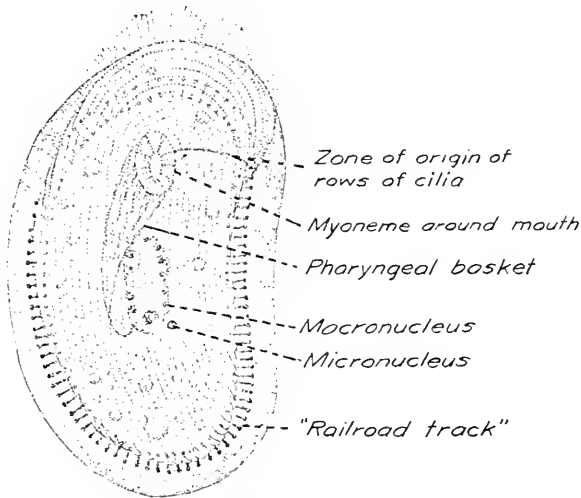

FIG. 15. Neuromotor apparatus of *Chlamydon*. (After M. S. MacDougall. *Biol. Bull.*, vol. 54, p. 473, 1928.)

Class 4. Sporozoa. *Type—Plasmodium vivax.*—The Sporozoa lack organs of locomotion and are characterized by their method of reproduction by *spore formation*. They are all parasitic forms at the active stages of their life cycle.

The *malarial Plasmodia* include three species. One, *P. vivax*, produces chill every 48 hours; another, *P. malariae*, causes chill every 72 hours; while the third, *P. falciparum*, produces attacks daily or at irregular intervals (Fig. 16).

Infected *female* mosquitoes of the *Anopheline* group are able to

transmit the organisms. The blood of a malarial patient containing gametocytes is sucked up into the alimentary canal of the mosquito where the gametocytes produce matured macrogametocytes (egg)

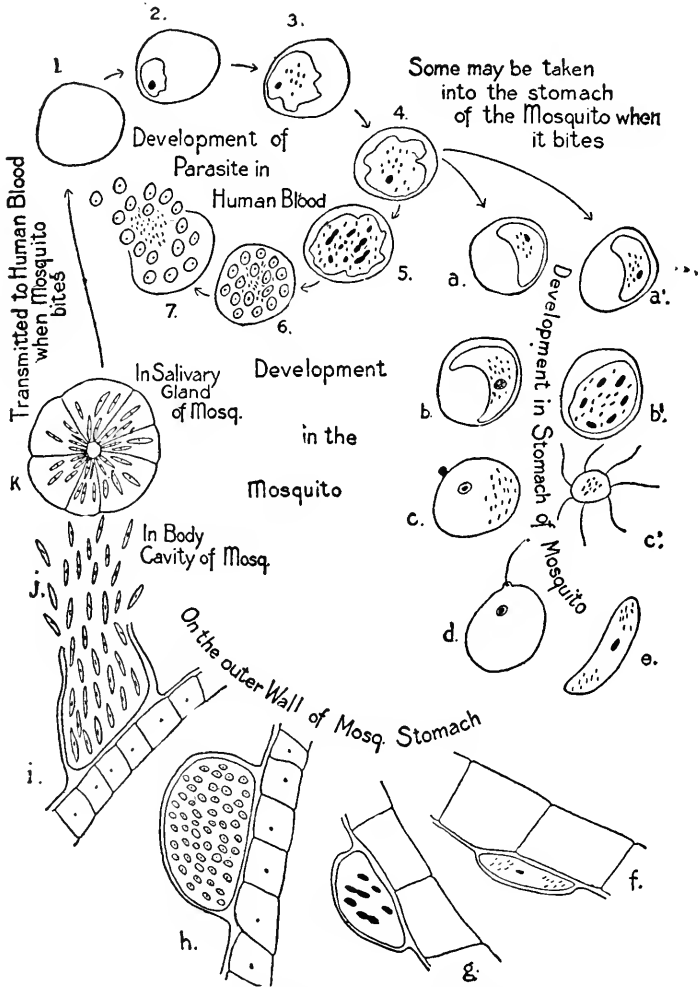

FIG. 16. Life history of the malarial organism. (After Kellogg and Doane. Courtesy of Henry Holt & Co.)

and flagellated microgametocytes (sperm) which conjugate and form a zygote or oökinete which grows into a multicellular somatella or sporoblast in a cyst in the wall of the stomach. This cyst liberates

thousands of tiny sporozoites which collect in the mosquito's salivary glands. If the mosquito afterwards bites a human being some of the sporozoites from the wound may be introduced and will enter the red blood corpuscles, and when sufficiently numerous will produce a chill. Such chills occur at the end of every 48 hours with each recurring cycle of sporulation, in the case of *Plasmodium vivax*. Quinine, the specific against malaria, may be resisted by certain of the malarial parasites in the spleen or bone marrow.

Orders of Sporozoa. *Order 1. Gregarinida.*—*Monocystis* is an abundant parasite of the seminal vesicles of the earthworm. *Porospora gigantea* (two-thirds of an inch long) is parasitic in the alimentary tube of the lobster.

Order 2. Coccidia.—Coccidia cause red dysentery in calves and infest the liver and intestine of man and other vertebrates, besides oysters, insects and crustacea. At least five species of *Eimeria* occur in chickens. One of these is very destructive to young chickens.

Order 3.—Haemosporidia live in the blood. The two important families are the Plasmodiidae and the Babesidae.

The *Plasmodiidae* include the malaria organisms. They induce malaria in birds and mammals. *Plasmodium vivax* causes tertian fever, *P. malariae* causes quartan fever and *P. falciparum* causes tropical fever. Paresis has recently been treated successfully by infecting the patients with malaria. The organisms are transmitted by Anopheline mosquitoes. (See Fig.

89.) O'Roke (1930) has found a fatal malarial disease in quails transmitted by a degenerate fly, *Lynchia*, living in the feathers.

The *Babesidae* include several important blood parasites, all of which are transmitted by ticks. *Babesia bigemina*, the organism producing Texas cattle fever, is transmitted by the bite of the tick *Boophilus annulatus*. Death occurs in acute cases in two days. Trypan-blue has been used in the treatment of babesiasis. *Babesia canis*, the organism attacking dogs, has been the most studied. *East Coast fever* is caused by *Babesia parva* which is found in the red blood corpuscles of cattle, producing anemia. *Oroya fever* is a human disease occurring in mountain valleys of Peru. It is a



FIG. 17. A Polycystid gregarine. Wasielewsky. (From Calkins, *Biology of the Protozoa*. Courtesy of Lea and Febiger.)

severe anemia associated with irregular fever, caused by *Bartonella bacilliformis*.

Order 4.—*Myxosporidia* cause epidemics in fishes and silk worms.

Order 5. *Sarcosporidia*.—*Sarcocystis* is found in the muscles of pig, mouse and man. It has been suggested that the larvae of flies may transmit *Sarcosporidia*.

GENERAL CONSIDERATIONS

Protozoa are generalized single cells. They are differentiated into ectoplasm and endoplasm. All organs of *locomotion* and *defense* are from the ectoplasm. The seat of *digestion* and other functions is the *endoplasm*. All Protozoa have a *nucleus*. There is generally one but very often Protozoa are multinuclear. Other forms, Infusorians, have two nuclei, one macronucleus and one micronucleus. The former may be chain or dumb-bell shaped.

Locomotion.—The organs of locomotion in Protozoa are pseudopodia, flagella or cilia. The ciliates are extremely speedy in movement, while many of the flagellates scull rapidly. Shipley found that in the case of four amebae given ten trials, the fastest moved 0.2 of a mm. in 60 seconds, while the slowest moved that distance in 80 seconds.

Nutrition.—Nutrition consists of capture and ingestion, digestion and defecation. It may occur also by osmosis.

(1) Many organisms can build up complex proteins from simpler chemical materials. There are *holophytic* plant-like types in which sunlight energy is used in synthesis and *saprozoic* forms in which the protoplasm is built up from organic substances in solution.

(2) Other organisms are entirely dependent on a supply of protein ready made, obtained either by the *holozoic* method—by engulfing and digesting other living organisms; or as parasites—by feeding on digested foods. Parasites generally absorb their food in an *osmotic* manner rather than by engulfing it. Some species of *Euglena* are holophytic and others saprozoic. Some species in the life of one individual are holophytic in the sunlight and saprozoic in the dark.

Ingestion.—The ameba type is *enclosing*; but *vortex* currents are set up by the cilia in *Ciliates* while the Suctorians pour their *endoplasm* into an animal, *digest* it and then suck it through their tentacles. Wenyon states that enzymes probably aid in liquefying the protein.

Digestion is always *intracellular* and in the endoplasm. *Gastric vacuoles* contain fluids taken in with the food. Water is modified by *osmosis* to become a digestive fluid weak in HCl. At the beginning of the digestive process, when food matters are first ingested, there is a remarkable secretion of acid. This secretion ceases with the beginning of the breakdown of food materials. Usually there is a distinct alkaline reaction in the food vacuoles. *Proteins* are the main sources of nutrition; starch is affected but slightly, but it is claimed that the Rhizopoda dissolve starch grains and even cellulose.

Few protozoa are known to digest fats, but oil droplets and fat bodies are found in practically all of the protozoan groups. Dawson and Belkin have shown⁷ that *Ameba dubia* and *A. proteus* are able to digest several of the oils, including peanut oil and olive oil.

Some of the injurious bacteria may serve as excellent food for an ameba. *Endameba coli* ingests *intestinal* bacteria and *Endameba histolytica* engulfs red blood corpuscles. Kofoid finds that a flagellate (*Pentatrichomonas*) ingests red blood corpuscles. The majority of protozoan parasites absorb food by osmosis. Some Ophryoscolecidae eat chlorophyll grains.

Excretion is by osmosis and also in the majority of Protozoa by one or more contractile vacuoles. Contractile vacuoles are formed in the endoplasm by accumulation of liquid. The cause of their contraction is unknown. Probably the *contractile vacuole* is also a respiratory organ. In one-half hour a protozoan throws out a quantity of water equal to the size of its body.

Irritability.—The Protozoa are sensitive to nearly all stimuli. There is not satisfactory evidence of *color vision*, although many forms react to changes in light intensity. With regard to reaction to the pull of gravity it is argued that this is not a true positive *geotropism* (p. 25) in Paramecium. The Protozoa react to temperature changes, chemical and electrical stimuli. Ameba is a complete *neuromuscular organism* capable of responding to stimuli without correlation. ~~Reproduction in Ameba consists of: (1) simple division or fission; (2) budding; (3) spore-formation.~~

Reproduction and Regeneration. *Reproduction in the Sarcodina.*—(1) Fusion of two amebae is said to occur, resulting in a new organism. The significance and results of such a procedure are unknown. Such a process has been compared to the fusion of the

⁷ Proc. Soc. Exp. Biol. and Med., 1928, vol. 25, pp. 790-793; and Biol. Bull., 1929, vol. 56, p. 80.

sperm with the egg but no cytological proof of zygote formation has been achieved. (2) *Sporulation* or encystment occurs in *Ameba*. The animal becomes spherical, secretes three-layered cysts and produces, by successive divisions of the nucleus, a multicellular somatella containing 2, 4, 8 or more nuclei. The *Ameba* divides at encystment into as many individuals as there are nuclei in the somatella. These emerge through a pore from the cyst as *amebulae* and in a few hours develop into full grown amebae. (3) *Fission*. In some forms, division (binary fission) takes place during activity; in others it takes place in a cyst. (4) *Budding*. In *Euglypha*, the animal *buds* and new particles go out from the shell. Simple division in Protozoa may lead to *colony formation*. (5) *Conjugation* in the Sarcodina is general, except in *Lobosa* and an investigator thought that he had seen it in *Ameba proteus*. This may have been only agglutination. (6) There is no evidence of reorganization, or *endomixis* (see page 44) in the Sarcodina.

Regeneration in the Sarcodina.—The excision of one-fourth of the cytoplasm of the *Ameba* has no effect on its division. Regeneration may take place in twenty-four hours and division follows normally. Eucleated amebae can move, but are not able to carry on other body processes and soon die.

Reproduction in the Flagellata. (1) *Fission*.—With but few exceptions the flagellates have longitudinal fission. (2) *Encystment* and *sporulation* also occur at times.

Reproduction in the Ciliata.⁸ (1) *Fission*.—All ciliates have transverse division. The reproduction of the *macronucleus* is usually by *direct* division with little evidence of *spindle formation* or definite chromosomes. In less complicated types of *division*, the division of the *macronucleus* is relatively simple. In some forms the *macronucleus* elongates, then constricts to form two equal portions, one passing to each of the daughter cells (*Paramecium*, *Colpoda*). When two macronuclei are present, each divides independently of the other (*Oxytricha*, *Stylonychia*). In some types multiple macronuclei may contain nuclear clefts with large granules which reproduce by division. *Micronuclei*, if multiple in the cell, do not fuse. The chromatin contents may be in part distributed and then unite into a long banded nucleus. No *elimination* of micro-nuclear material occurs. Each one divides by *mitosis*, with a

⁸ Consult Robertson, M. 1929. Life cycles in the Protozoa. Biol. Rev., vol. 4, no. 2, April.

definite number of chromosomes. (2) *Conjugation* is typical of the Ciliata (see p. 33). (3) *Encystment* and *sporulation* are characteristic of many forms like Colpoda. In spore-formation there are many simultaneous divisions.

Encystment, while characteristic of the Sporozoa, is found in all classes of the Protozoa. Motor organs are withdrawn and the animal forms a test or shell excluding the water, and becoming encysted or fixed.

"In the majority of cases (Minchin, p. 165) an individual in the process of encystment becomes perfectly spherical; occasionally ovoid or pear shaped. Any food particles or foreign bodies are usually ejected or absorbed, contractile vacuoles disappear, all locomotor organs absorbed or cast off. The protoplasm of the organism becomes less fluid and more opaque. Lastly the cyst membrane itself appears around the body. It stands off distinctly from the rest of the body and may vary from a soft slimy or gelatinous coat to a firm membrane, often tough and impervious."

Protozoa in the encysted state are able to withstand drying, freezing or sun baking. They may be transmitted by winds or birds to a great distance. In parasitic forms, encystment is an adaptation connected with a change from one host to another.

In the *sporozoan parasites*, two forms of cysts are distinguishable: 1. Full grown forms may produce large resistant cysts, spherical or oval in form. 2. Smallest forms in developmental cycle, the products of multiple fission or sporulation, may secrete around themselves tough resistant envelopes, within which they may multiply further. In this case, the envelope is the sporocyst and the entire body a spore. "The spores of bacteria are for the most part simply cysts, but are called spores on account of their small size" (Minchin, p. 166).

The functions of encystment are: 1. To protect during adverse conditions. 2. For purpose of digestion after a heavy meal. 3. Reproduction. 4. Reinfection.

It should perhaps be emphasized at this point that some ciliates (*Colpoda*) divide *only* after forming a *division cyst*.

Regeneration in the Ciliata is a phase of growth. Ciliata with the macronucleus (nutritive nucleus) will live since this nucleus supervises constructive metabolism. Yet Dawson showed that *Oxytricha*, lacking a micronucleus, would live for 289 generations, from July 10, 1917, to Nov. 17, 1919, without conjugation, reorganization (endomixis), or encystment.

If *Stentor* is cut into two pieces, any part containing a portion of the nucleus will regenerate readily.

Endomixis.—There is some controversy over the significance of the complete nuclear reorganization without cell fusion first described by Woodruff as occurring periodically in pedigreed races of *Paramecium*. At regular intervals of about 30 days, in *Paramecium aurelia* (sixty in *P. caudatum*) the old *macronucleus* gives rise to buds or fragments which are absorbed in the cytoplasm. Each of the *micronuclei* divides twice, which forms new products of both micro- and macronuclei.

It is the belief of Calkins, from his investigations on *Uroleptus*, that "endomixis" is a satisfactory substitute for the fusion of different nuclei at conjugation. He holds that continued vitality is possible when either process furnishes the necessary reorganization of nuclear elements. Endomixis does not seem to be essential to all ciliates. It has been interpreted as parthenogenesis.

Distribution of the Protozoa.—Even the most barren *soils* contain Protozoa, the same species being found in tropical, temperate, and arctic soils. The maximum numbers of soil Protozoa are found at a depth of 4 to 5 inches, but some species seem able to live under anaerobic conditions. Certain Protozoa thrive as internal parasites, and live in the blood or internal organs of other animals.

The majority of the Protozoa, however, are aquatic. They are found from the deepest seas (5,000 fathoms) to a point 10,000 feet above sea level. Juday reported a fresh water *anaerobic* ciliate found in the centrifuged plankton of Lake Mendota. It appeared in water containing a minimum amount of oxygen. The maximum number (95,250) appeared in a litre of water from a stratum having no oxygen.

Pack reported 2 ciliata, 9 algae, 5 bacteria, 1 crustacean and 2 fly larvae in the water of Great Salt Lake which has 23 per cent salinity. Dilution of the medium caused a shortening of the cirri of the ciliates with increased size and activity.

Fossil Relatives and Relationship to Other Phyla.—The *Foraminifera* are of great geological importance, and are common as fossils from the Silurian rocks down to the present time. Today they are found in calcareous ooze, and are building beds of chalk and nummulithic limestone.

The siliceous skeletons of the *Radiolaria* are found in slate and deep sea ooze. They aid in the formation of flint. (See p. 52.)

ECONOMIC IMPORTANCE OF PROTOZOA ¹

<i>Classes</i>	<i>Positive</i>	<i>Disease</i>	<i>Negative</i>	<i>Organism</i>
Sarcodina	Limestone Chalk Flint	Amebic dysentery		End. histolytica
Flagellata		Bad taste in drinking water Sleeping sickness Dysentery	Synura, Uvella, Dinobryon Tryp. gambiense Giardia (Lamblia) intestinalis	
		Tropical ulcer Pyorrhoea	Leishmania Endameba buccalis	
Ciliata	Experimentation	Odor in drinking water Dysentery	Bursaria (salt marsh smell) Balantidium Opalina	
Sporozoa		Malaria Coccidiosis Red dysentery Silk worm disease Encysted in muscle, degenerate it	Plasmodium vivax Eimeria Eimeria Nosema bombycis Sarcocystis	

From the Tertiary deposits of the Barbadoes, Ehrenberg described 278 species of Foraminifera, known today.

We consider the Protozoa as the most primitive forms of animal life. Certain forms are so closely allied to the plants that they can scarcely be claimed exclusively by zoölogists.

The *Sarcodina* form an ascending series from the Lobosa, with no skeleton, up to the Radiolaria, which have well-developed skeletons. The *Mastigameba* is a Flagellate with pseudopodia, and we might consider it a connecting type between the two classes of Protozoa. The fact that Porifera have collar cells, somewhat resembling the flagellated protozoa, has led some zoölogists to suggest the evolution of *Choanoflagellata* into Sponges. Kofoid finds in the colonial *Dinoflagellata*, with nettling organs and eye spots, relationships to the Coelenterata.

¹ Negri bodies were at one time classed as Sporozoa, and later as Sarcodina, but they are now grouped with various other inclusions of diseased cells, such as in trachoma, and spruce, as *Chlamydozoa*, or "mantle-covered" animals. Cowdry has even questioned whether the granules are microorganisms. Hurst suggests (Lancet, Sept. 19, 1931, p. 622) that *rabies* may have been transmitted in certain Trinidad cases from humans to cattle, by vampire bats. See also Knutti, R. E., 1929, Jour. Amer. Med. Assoc., vol. 93, p. 754.

REFERENCES ON PROTOZOA

- BÜTSCHLI, O. 1889. Protozoa, in Bronn's Tierreich.
- CALKINS, G. N. 1901. The Protozoa. Lemcke and Buechner, New York.
- CALKINS, G. N. 1909. Protozoölogy. Lea and Febiger.
- CALKINS, G. N. 1926. The Biology of the Protozoa. Lea and Febiger.
- CLARKE, J. J. Protozoa and Disease. Pt. 1, London, 1903; Pt. 2, London, 1908.
- CONN, H. W. 1905. Protozoa of Fresh Water of Connecticut. Bulletin Geological and Natural History Survey of Connecticut.
- CRAIG, C. F. 1926. A Manual of the Parasitic Protozoa of Man. J. B. Lippincott Co., Philadelphia, Pa.
- DOFLEIN. 1927. Lehrbuch der Protozoenkunde. Jena.
- LEIDY, J. 1879. Fresh-water Rhizopods of North America. Government Printing Office.
- MINCHIN, E. A. 1912. Introduction to the Study of the Protozoa with Special Reference to the Parasitic Forms. E. Arnold, London.
- SANDON, H. 1927. The Composition and Distribution of the Protozoan Fauna of the Soil. Oliver & Boyd, Edinburgh.
- STITT, E. R. 1918. Practical Bacteriology, Blood Work and Animal Parasitology, 5th edition. Philadelphia and London.
- WAKSMAN, S. A. 1927. Principles of Soil Microbiology. Bailliere, Tindall and Cox.
- WARD, H. B., AND WHIPPLE, G. C. 1918. Fresh-water Biology. John Wiley and Sons.
- WENYON, C. M. 1926. Protozoölogy, 2 vols. Wm. Wood & Co., N. Y.

Metazoa. (Gr. *meta*, beyond; *zoon*, animal.)—As we have already shown (page 13), the Metazoa include all the Phyla above the Protozoa. The *Metazoa* begin as single cells, the fertilized eggs or ova, but early in their embryonic life they form two or three *cell layers*, from which develop the organs and structures of the adult animal. The *germ cells* are functional in reproduction, while the *body* (somatic) *cells* carry on all other functions. To what extent the germ cells (germplasm) may be affected by the somatic cells (somatoplasm) and by environmental influences, is the basis of considerable controversy. (See page 514, Inheritance of Acquired Characters.) The somatic cells form *tissues*, the discussion of which is deferred to a later chapter. (Page 426.)

CHAPTER III

PORIFERA

PORIFERA (Lat. *porus*, a pore; *ferre*, to bear) were originally classed as colonial Protozoa. Found attached to rocks and other submerged objects, they resemble sea weed and were at one time considered as plants. With the exception of one family they are found in salt water.

While sponges may reproduce by eggs and sperm, they commonly reproduce by budding, colonies sometimes reaching a diameter of three feet. It is possible to cultivate them artificially since a complete sponge will develop from a single isolated cell.

There are three kinds of sponges, the *horny* sponge used in commerce, the *siliceous* sponges and the *calcareous* sponges, the last named having no commercial value.

CLASSIFICATION

Class I. *Calcarea* (Lat. *calcarius*, lime) with spicules of carbonate of lime.

Class II. *Hexactinellida* (Gr. *hex*, six; *aktin*, a ray) with siliceous spicules, in six rays.

Class III. *Demospongiae* (Gr. *demos*, people; *sponges*, sponge) having spicules of silicon, or spongin.

CHARACTERISTICS

1. Sponges are the simplest Metazoa, with two distinct layers, *ectoderm* and *endoderm*, and an undifferentiated middle layer, the *mesoglea*—which is filled with spicules of siliceous, horny or calcareous material. They are a community of cells with relatively little division of labor.
2. There is no true coelom or body cavity, but the internal gastral cavity or *cloaca* ranges from a single tube to many branched chambers.
 - a. Ascon—incurrent apertures pass directly into inner space.
 - b. Sycon—cell layers folded—ectoderm and endoderm, central space.

- c. Leucon—external opening to canals, through orifices leading through ectoderm to endoderm. The water comes in the incurrent canal, then into the radial, then to the paragastric cavity. The *radial* canals are lined with *flagella*; all whip down and suck the water in.

3. The general symmetry of the embryonic gastrula stage is retained in the adult.



FIG. 18. Top, commercial sponge. Center, the finger sponge. Bottom, red sponge. (From A. G. Mayer, Seashore Life. Courtesy of N. Y. Zool. Soc.)

Distribution.—The majority of the sponges are marine, but there are a few fresh water forms (Spongillidae). They are found attached to rocks, sea weed and submerged objects. The *true horny* sponges are found in *shallow* water, not deeper than 450 fathoms. Other forms are found at great depths.

Pigment in Sponges.—Many sponges contain *pigment*. The lipochrome pigment *zoönerythrin* (seen in lobsters) is common. The green pigment of the fresh water sponge, analogous to chlorophyll, probably aids in *holophytic* nutrition.

Sponges vary in color from red brown to bright colors with pronounced

iridescence. The majority are gray in color. They vary in size from microscopic to several feet in diameter. Their shape, while frequently cylindrical, is quite variable. They may branch to form a network, or assume the shape of a fan, or even that of a hat-crown. (Figure 18.)

Type of Group—*Grantia*.—*Grantia* is a cylindrical, vase-shaped marine sponge, somewhat less than an inch in length. It is readily obtained from submerged piles and rocks alongshore, and since it is convenient in size for external gross study, and can readily be sectioned, it is ordinarily studied in college courses.

External Anatomy.—*Grantia* has an outer or *dermal* layer, consisting of epithelial cells, contractile cells, gland cells and porocytes. Lime spicules and spongin fibers are formed by the scleroblasts, which belong to the inner portion of the dermal layer. The body wall consists of a skeleton of calcareous spicules of which there are four varieties, a long and a short scimitar shape, a trident shape, and a T shape. At times other four- and five-rayed spicules are noted.

The middle layer is a jelly-like *mesoglea*, with wandering ameboid cells, which ingest, store and transport food materials. From time to time, germinal cells are here developed from some of the wandering cells, and form ova or spermatozoa. Gemmules (statoblasts) are formed in certain species. (See p. 50.)

The inner or gastral layer lining the radial canals is made up of "collared" flagellate cells, or choanocytes, which create currents of water and bring inward particles of food.

Ingestion and Digestion. (Figure 19.)—Food is ingested by specialized cells and digested as in protozoa. Some cells are for *ingestion*; the flagellated collar cells are extremely important in absorbing and taking up food. They form rather dense masses near the nuclei. Certain cells in the mesoglea are for *storage*, and still others are for *nutrition*. The sponges make use of detritus coming from dead plant and animal tissues found in sea water along the coast. Food vacuoles are formed as in the Protozoa.

Circulation.—Circulation is by means of the ameboid wandering cells of the middle layer. *Respiration* is carried on by the cells of the body wall. *Excretion* is osmotic by cells, and also by the expulsion of solids through the osculum.

Reproduction. (1) *Asexual.*—*Buds* may arise near the base of the sponge and become detached as a separate individual, or in

some sponges colonies may be formed. Budding or branching is a common method of reproduction in sponges.

In the fresh water *Spongilla* and in some of the marine sponges, the autumnal death of the adult sponge is preceded by the formation of statoblasts, or *gemmules*. The mesogleal cells aggregate in a clump, are surrounded by a firm membrane, and protected by blunt spicules, called *amphidiscs*. These gemmules survive the winter,

and develop into males or females. From the fertilized eggs come the summer generation of sponges which produce gemmules and die in the fall. The gemmules serve to preserve the race, and to disperse it as well. They may be desiccated for years and then grow new *Spongillae* when the water returns.

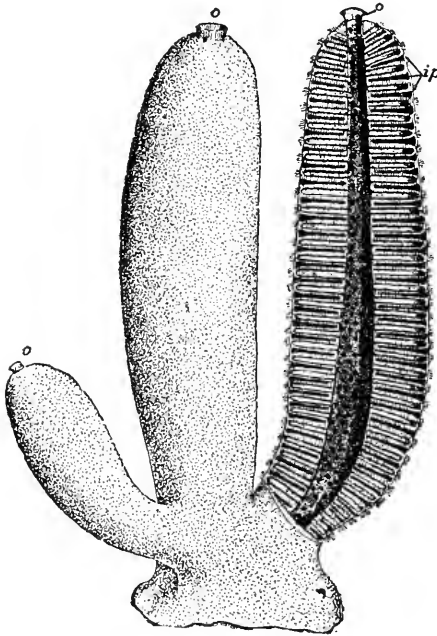

FIG. 19. Longitudinal section of a simple sponge. *o*, osculum; *ip*, incurrent pores. (Parker and Haswell, *Textbook of Zoology*. Courtesy of Macmillan and Co., Ltd.)

(2) *Sexual*.—Ameboid wandering cells from the mesoglea form eggs or spermatozoa. The fertilized eggs become flagellated free swimming larvae, then become fixed, pass through a primitive gastrula stage, and finally develop the inhalant ostia and the exhalant osculum of an adult. The flagellated cells of the larva develop

into the gastral choanocytes of the adult, and the larval inner cells develop into the dermal layer.

Nervous System.—The first clearly marked *neuromuscular* cells in the Invertebrates are found in the sponges where certain “porocytes” are found surrounding the pores leading to the incurrent canals. There is no nervous receptor present, but the *porocytes* contract as do the Protozoa when stimulated. This may be called the *independent-effector* stage. Although the nervous system is thus

but little developed, the sponge reacts to stimuli. G. H. Parker has shown that the oscula (of *Stylotella*) were closed in quiet sea water and on exposure to the air and to ether. The *ostia* (pores) opened in sea water currents and in fresh water and atropine, and closed in weak ether and cocaine.

Habits.—Sponges furnish shelter for small organisms. They are inactive (sessile) and only open and close their openings. They are not eaten by fishes or even Arthropoda. Their strong odor and

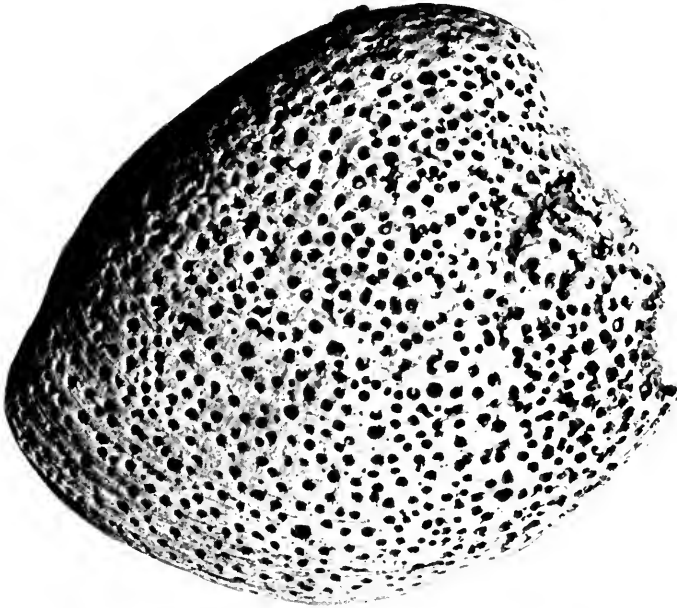

FIG. 20. Clam shell infested with boring sponge. (From A. G. Mayer, *Seashore Life*. Courtesy of New York Zool. Soc.)

taste are important aids to the spicules in keeping enemies away. Micro-organisms that find their way through the pores are taken in as *food* by the phagocytic cells of the cloaca and radial canals. Sponges are *not* true *parasites*, but the boring sponge, *Cliona*, perforates the shell of oysters and other similar forms, seeking *protection* instead of food. (Figure 20.)

Enemies of the sponges are bacteria, plant parasites and a few fish, which attack them when they are young.

Associations.—Certain species of crabs (*Dromia*) are *masked* by sponges living as *commensals*, which profit by securing more oxygen.

A compact orange-colored sponge (*Suberites domuncula*), of peculiar odor, grows around the shell inhabited by a hermit crab and dissolves the shell substance. Algae live in *symbiosis* with some sponges. A cuttlefish (*Rossia glaucopis*) (see Mollusca, p. 154) puts its eggs in pockets in the substance of a siliceous sponge.

Economic Importance. Positive.—1. The uses of the sponge are too well known to more than mention that they are of great importance in hospitals, homes, factories and garages.

2. As an industry, sponge fisheries are of great value, probably being worth nearly two million dollars annually. In 1926 they brought in (Florida fisheries alone) \$666,093.00.

3. The siliceous sponges form flint deposits.

Negative.—1. Sponges may kill oysters by boring into them. (Boring sponges.)

2. They may attach to the oysters and starve them by taking the food first.

3. They may actually reduce the oxygen of the water in their immediate vicinity by using currents first.

4. Sometimes *fresh water sponges* are of serious injury in that they attach to the walls of reservoirs and water pipes, and offer lodgment for fresh water mussels and Bryozoa. Various algae accumulate and the debris lodging against the miscellaneous organisms produces a felt-like mass called "pipe-moss."

5. The United States Department of Agriculture has published a bulletin on the reclamation of soil in Florida marshes showing that the sponge spicules wear away the hoofs of the mules used in plowing, while the shoes of the plowmen are worn through and their feet rendered raw in one day.

Fossil Relatives.—Fossil sponges similar to existing groups have been found in formations from the Cambrian period down. They are chiefly found in chalk and flint.

It has been estimated that a mass of sponge skeletons may give rise to beds of flint nodules in the space of fifty years. Siliceous sponges derive their spicules from small quantities of silicate in the sea water, originating from the decomposition of igneous rocks such as granite. The sponges and the Radiolaria (see page 44) furnish siliceous skeletons to aid in flint formation. The siliceous chalks are the first stage in the formation of flint. There is evidence from the casts of spicules found that the silica of sponge skeletons actually dissolved and was then redeposited.

Ancestry and Relationship to Other Phyla.—Porifera are nearer the Protozoa than are any of the other types of Metazoa. The collar cells resemble certain colonial *choano-flagellates*.

While the sponges somewhat resemble the Coelenterata, in having a fixed mode of life, in budding, and in having a large gastro-vascular cavity, the mode of formation of *embryonic layers* in the two groups shows radical dissimilarity. They are probably derived separately from the Protozoa.

REFERENCES ON SPONGES

- COBB, J. N. 1902. The Sponge Fishery of Florida in 1900. Report of U. S. Fish Com.
- DAVIS, R. O. E. 1912. Sponge Spicules in Swamp Soils. Circ. No. 67, Bureau of Soils, U. S. D. A.
- FLEGEL, CH. 1908. The Abuse of the Scaphander in the Sponge Fisheries. Bull. U. S. Bureau Fish., Vol. 28.
- MOORE, H. F. 1908. The Commercial Sponges and the Sponge Fisheries. Bull. U. S. Bureau of Fisheries, Vol. 28, part 1, pp. 403, 407-11, 426.
- TRESSLER, D. K. 1923. Marine Products of Commerce. Chem. Cat. Co., N. Y.
- WILSON, H. V. 1910. Development of Sponges from Tissue Cells Outside the Body of the Parent. Bull. of the Bur. of Fish., Vol. 28, pp. 1265-1271.
- WILSON, H. V. 1911. Development of Sponges from Dissociated Tissue Cells. Bull. of the Bur. of Fish., Vol. 30.
- Consult, also, papers by Galtsoff, P., U. S. Bur. Fish.



CHAPTER IV

COELENTERATA

THE COELENTERATA (Gr. *koilos*, hollow; *enteron*, intestine) are aquatic, and are for the most part marine, some developing into enormous colonies. Their bodies, especially the tentacles, bear *nematocysts* or "thread cells," structures not found in other Phyla, which are used for offense and defense. The corals, which secrete hard exoskeletons, are the most significant economically.

CLASSIFICATION

Class I. Hydrozoa (Gr. *hudra*, water serpent; *zoon*, animal). They include fresh water hydra, marine hydroids, small jelly fishes (Gonionemus), and some stony corals.

Class II. Scyphozoa (Gr. *skuphos*, cup; *zoon*, animal). They include most of the large jelly fishes (Aurelia).

Class III. Anthozoa or Actinozoa (Gr. *anthos*, a flower; *zoon*, animal). Include sea anemones, most stony corals, sea fans, sea pens.

CHARACTERISTICS

1. Radially symmetrical.
2. They have two cellular layers, ectoderm and endoderm, with a non-cellular mesoglea, a jelly-like substance, between.
3. They have a hollow body, the central space being called the gastrovascular cavity or coelenteron. This may be very small (Aurelia).
4. They have stinging cells or nematocysts.

NATURAL HISTORY

Class I. Hydrozoa. Hydra. (Figure 21.)—Because it is so easy to collect and keep in the laboratory, many zoölogists include Hydra in the first course in zoölogy. It is from 1/16 of an inch to 3/4 of an inch long, and lives in fresh water attached by one end, but is able to move about. The body is a tube cylindrical in shape, with

a *basal disk* for attachment, and a *mouth* surrounded by *five to ten* tentacles at the other.

Reproduction.—Buds appear laterally, and during the reproductive season in October the *spermaries* (testes) may be seen on the anterior third of the body, while the *ovaries* are seen on the posterior or basal end. Hydra eggs resemble an ameba in appearance. Buds are formed by the outgrowth of the endoderm and the ectoderm, and at first include an enteron connection with that of the parent.

The outside of the Hydra, except the basal disc, is covered by a thin cuticle. Hydra has two distinct cellular layers, an outer *ectoderm*, which is thin and colorless, and an inner layer, the *endoderm*, which is more than twice as thick as the outer layer and has in it brown or green coloring matter depending on the species. Between the ectoderm and endoderm there is a jelly-like substance called the *mesoglea*. The body and the tentacles are hollow, the space being called the *gastrovascular cavity* or *cloaca*. (Figure 22, A, B, C.)

The *ectoderm*, protective and sensory, consists of (a) epitheliomuscular cells, inverted cones with contractile fibrils; (b) interstitial cells, which produce three kinds of nematocysts, (1) barbed with hypotoxin; (2) cylindrical, with a coiled thread and no barbs, and (3) spherical, with a barbless thread in coils; (c) glandular cells at the basal disk, which aid in attachment. The sex cells of both ovaries and spermaries are derived from ectodermal interstitial cells. The *mesoglea* is thin, jelly-like and non-cellular. The *endoderm* has large digestive cells with muscle fibrils at the base, and with flagellae or pseudopodia projecting into the cloaca;

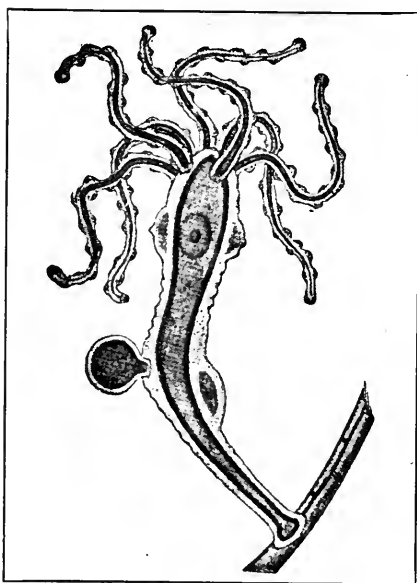

FIG. 21. *Hydra viridis*, showing testes above and ovaries below. (After Hertwig-Kingsley, *Manual of Zoology*. Courtesy of Henry Holt & Co.)

absorptive cells in the gastrovascular endoderm, and secretory cells which are small gland cells.

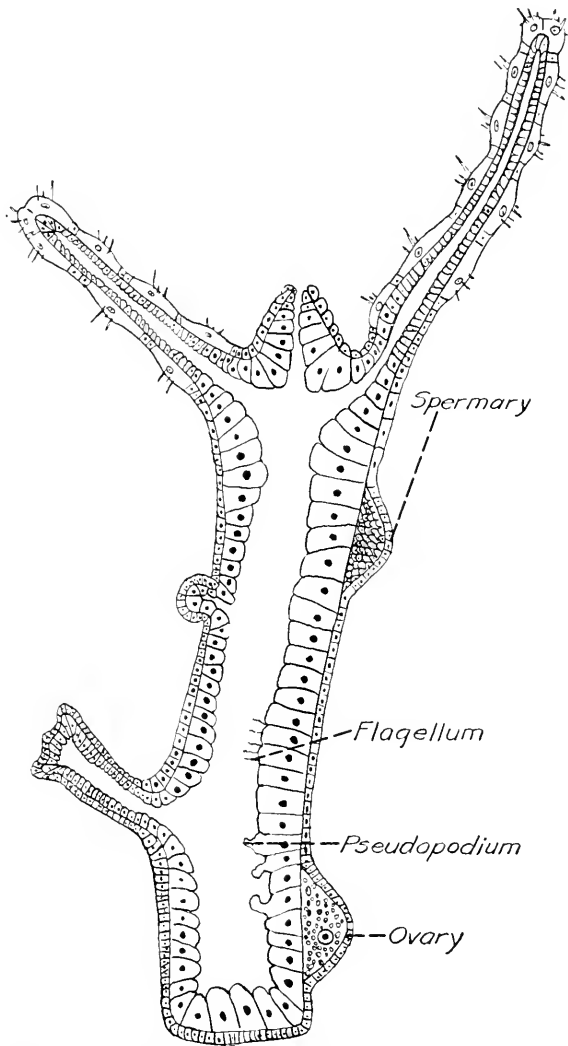

FIG. 22A. *Hydra*, longitudinal section. (Modified from Parker. Courtesy of The Macmillan Co.)

Nerve cells are present in hydra in the ectoderm, a few in the endoderm. Some nerve cells are connected by processes with the muscle fibers of the epitheliomuscular cells.

Ingestion and Digestion.—Hydra feeds on those minute animals that it can seize with its tentacles. It attacks them with nematocysts and propels them to its mouth by tentacles. Muscular contraction of the body walls forces the food into the lower part of the coelenteric chamber. Some of the endoderm cells have projecting *pseudopodia* or *flagella*, while others are glandular.

Digestion.—1. The secretory cells of the endoderm furnish the digestive fluid which acts on the contents of the gastrovascular cavity. 2. The digestive cells with pseudopodia engulf some of the food. 3. The absorptive cells take it in.

Nervous System.—Ectodermal nerve fibers and cells form a plexus. There are superficial sensory cells. Some nerve cells connected with epitheliomuscular cells are motor. There are a few endodermal nerve cells also.

Behavior.—Hydra attach, swing and feed, and sometimes loop or somersault.

In response to mechanical stimulation, hydra contracts at first but, becoming habituated, gives no further reaction, except as it may at times move away from the occupied region. The righting position is not determined in hydra by gravity. It reacts to light, temperature and chemical stimuli. In other coelenterates, particularly the sea anemones, one finds remarkable response to tactile and photic stimuli.

Food.—The food of hydra consists of aquatic forms, including an occasional mosquito larva and rarely the eggs and fry of fishes.

Enemies.—The chief enemies of hydra are bacteria, saprolegnia, aquatic insects and of course fishes and crayfish.

Economic Importance.—Hydra is to some extent beneficial in that it captures an occasional mosquito larva. Since it also devours

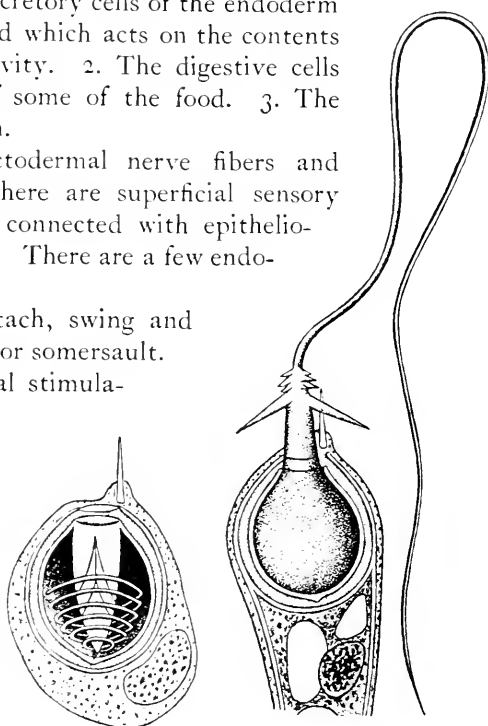

FIG. 22B. *Hydra* stinging cells. (After Dahlgren and Kepner. Courtesy of The Macmillan Co.)

annelids and crustacea that are food for fishes it may be considered injurious. Gudger has called attention to early studies of Trembley and the more recent ones of Beardsley which indicate the surprising ability of hydra to capture young fishes. Beardsley found that in one of the hatcheries of the U. S. B. F., hydras averaged 131 per square inch in certain troughs used for black-spotted trout fry and that they were responsible for a considerable mortality among the young trout.

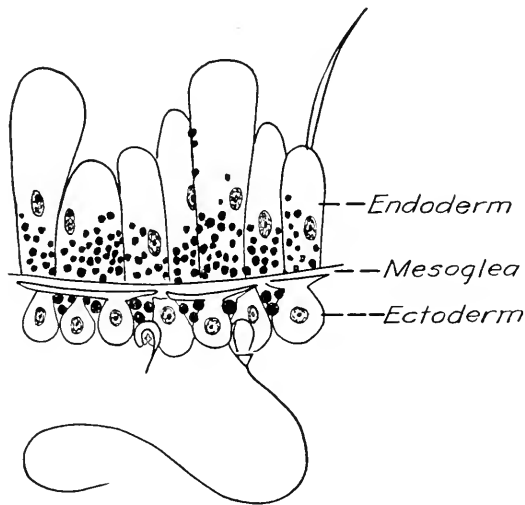

FIG. 22C. *Hydra*, cross section. (After Marshall and Hurst.)

The Hydrozoa are especially interesting to us on account of their two forms of zoöids, the nutritive hydranths and the reproductive zoöids, called medusae. In many of the Hydrozoa we find alternation of generations, the asexual generation being a fixed, plant-like colony, while the sexual generation is a free swimming medusa.

Obelia, a Hydroid.—Since alternation of generations is especially well shown in *Obelia*, it is frequently used in elementary zoölogy courses.

Obelia is a colonial animal that looks like a plant. It has a basal root, the *hydrorhiza*, attached to rocks, wharves and to alga, which gives off stems, the *hydrocauli*. The side branches from the hydrocauli develop *hydranths*, or independent zoöids, like a hydra in structure. The tentacles of the hydroid are not hollow but solid.

Occasionally one finds a modified hydranth which is for the purpose of reproduction, and is called the *gonangium*.

The *perisarc* is the thick outside covering, which is hard and chitinous. It is expanded to form the cup of the *hydranth* and is then called the *hydrotheca*, or in the case of the *gonangium*, the *gonotheca*. A shelf across the base of the hydrotheca is the support

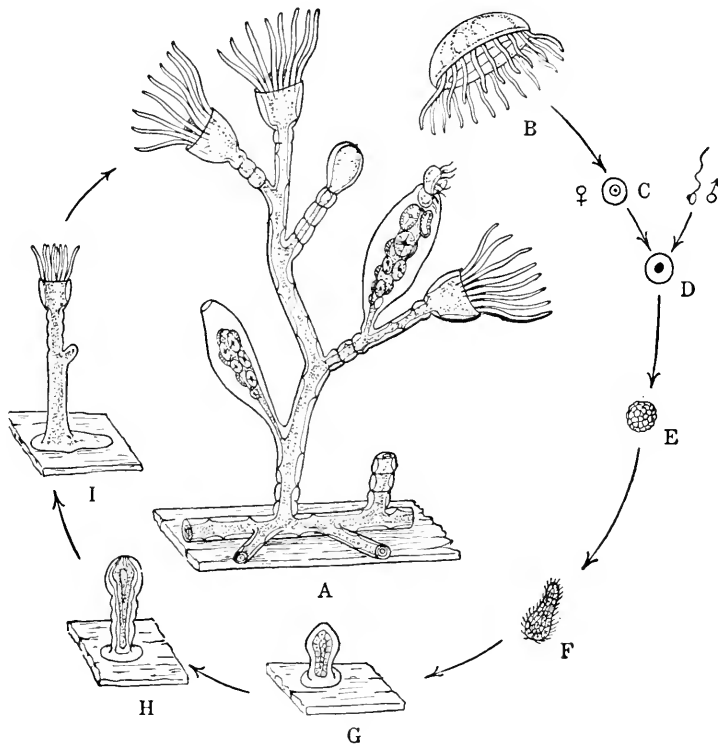

FIG. 23. Alternation of generations in the Hydroid *Obelia*. (From Shumway, *General Biology*. Courtesy of John Wiley & Sons.)

for the hydranth. The soft parts of the stem are called the *coenosarc*, and the cavities of the coenosarc open into the hydranth forming the typical *gastrovascular* cavity.

The *ectoderm* contains nerve cells, epitheliomuscular cells and interstitial cells with nematocysts of two or more types. The *mesoglea* is an undifferentiated, jelly-like layer between the ectoderm

and endoderm. The *endoderm* contains large feeding cells with pseudopodia and flagella, digestive cells (gland cells), and muscle fibers. (Figure 23.)

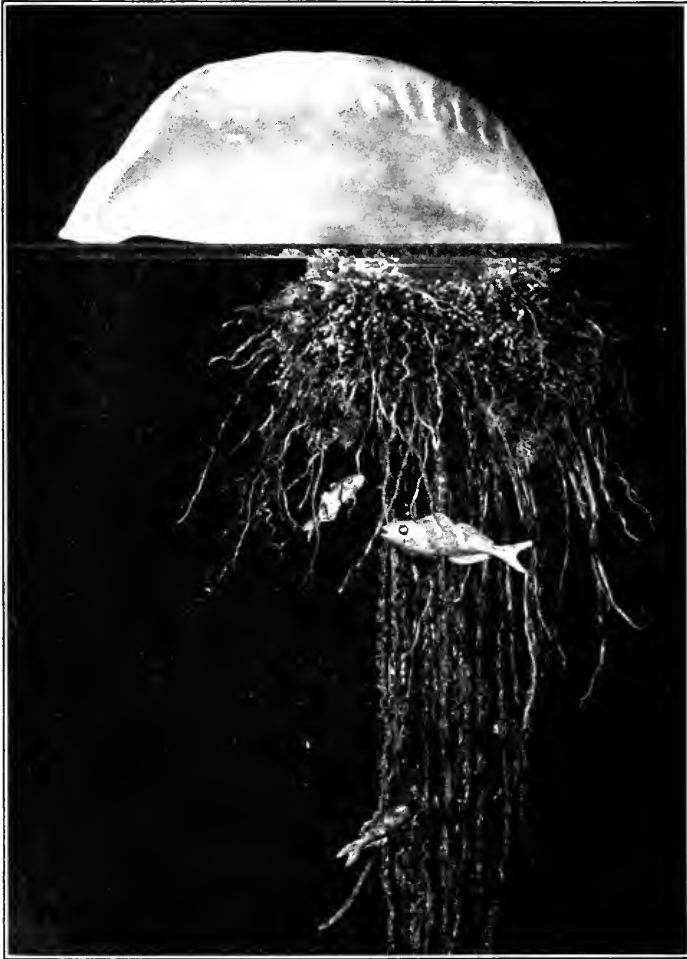

FIG. 24. Portuguese man-of-war, *Physalia*, sheltering several shepherd fish, *Nomeus*, amid its tentacles. (Courtesy of American Museum of Natural History.)

Alternation of Generations (Metagenesis) in the Hydrozoa.— In *Obelia*, there are two types of zoöid. The *reproductive one*, called the *gonangium*, produces ectodermal *medusa-buds* along the *blasto-*

style, which is a continuation of the living central portion, the *coenosarc*. The medusa buds, when mature, pass out at the top of the gonangium and develop into medusae. Some medusae produce eggs and some produce sperms. The fertilized eggs develop into a motile stage which, after swimming around for a time, settles down and grows into a colony similar to the parent. The *colonial* form reproduces *asexually*, by budding, and the medusae reproduce *sexually*, by eggs and sperms. The zoöphyte stage begins in the autumn, and the medusa stage in the spring, so the life history takes one year.

Siphonophora.—While we cannot discuss all the Orders of Hydrozoa, we will consider briefly one of the most beautiful of the pelagic forms, belonging to the Order Siphonophora. The familiar "Portuguese Man of War" (Figure 24) consists of a colony of individuals illustrating the condition of polymorphism. The ectoderm invaginates and produces a large pneumatophore or float. From the coenosarc arise individuals functioning as sensory polyps or feelers, and numerous retractile tentacles supplied with nettle cells. Feeding tubes digest and distribute the food. Reproductive zoöids are also present.

Class 2. Scyphozoa.—All Scyphozoa are marine, the majority being pelagic, i.e., swimming at the surface of the ocean. Some of them are beautifully colored, and certain species are *phosphorescent*. All jellyfishes are carnivorous, and the larger forms are able to capture and consume fishes. In their life history alternation of generations is found, but the asexual stage is not highly developed and in some cases a simple metamorphosis occurs.

Type of the Group—Aurelia. (Figure 25.) *External Characteristics.*—Aurelia is a saucer-shaped jelly fish about 4 inches in diameter, with four distinctive *gastric pouches*, conspicuous because of the orange *gonads* found inside them arranged along the outer wall towards the margin. The concavo-convex *umbrella* has an *exumbrella* only slightly elevated in comparison with *Gonionemus*, and the velum is absent. Each *gastric pouch* has a *subgenital pit*. These have no connection with the extrusion of embryos and probably are respiratory and excretory.

Digestive System.—The *mouth*, rectangular when distended, is usually collapsed in the preserved specimen. *Four oral arms*, folded like a leaf, and although they are devoid of tentacles, plentifully supplied with *nematocysts*, are used to transport food to the mouth,

and with the aid of the nematocysts on the *marginal tentacles*, to kill it preparatory to digestion. From the mouth leads a short *gullet*, situated on the *manubrium*. The *stomach* is extended at four points into the horseshoe-shaped *gastric pouches*. These have relatively thick jelly walls. The gastric pouches have many *gastric filaments*,

covered with nematocysts, so that even if prey remains alive up to that point, it can be killed.

The *radial canals* carrying food to the *circular canal* are of two types, the unbranched *adradial*, which proceed directly from the sides of the gastric pouches to the circular canal, and which have no *sense organs* at their ends; and the branched canals, called *per-radial* and *inter-radial*. The per-radial canals originate at the *corners* of the

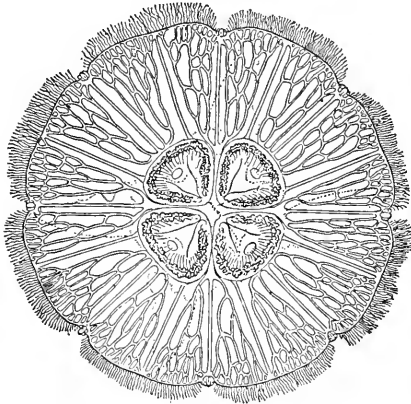

FIG. 25. *Aurelia*, a Scyphozon. (From Verrill.)

mouth, between the pouches, and have a *sense organ* at the end of their central trunk; the *inter-radial* canals branch so close to the gastric pouches that one cannot in some cases actually see the beginning of the lateral branching. They arise at the middle of the outer margin of the gastric pouches, and they also have sense organs at the end of the main trunk.

Respiration is osmotic through the entire animal; and *possibly* facilitated by means of the subgenital pit. *Circulation* is not vascular, merely by water currents with food in suspension. *Excretion* is by the extrusion of solids through the mouth, and by osmosis. Again the subgenital pits *may* function. The circular canal of some medusae communicates with the exterior by small *excretory pores* at the tips of papillae. These apparently function in the excretion of nitrogenous wastes.

Reproduction.—The gonads are situated in the gastric pouches and the *eggs* or *sperms* are discharged, *not* through the subgenital pits, but into the stomach and out through the mouth. Fertilized eggs are frequently seen developing attached to the *oral arms*. (Figure 26.)

Nervous System and Sense Organs.—The nervous system consists of a plexus of nerve fibers extending over the subumbrellar surface between the epithelial layer of ectoderm and the muscular layer. The plexus is thickened in a ring extending around the animal near the circular canal and connecting with the sense organs, or *tentaculocysts*. The marginal *tentaculocysts* are equilibratory and olfactogustatory. Adjacent to the *ocellus* or *statocyst* are found the so-called “*olfactory pits*.”

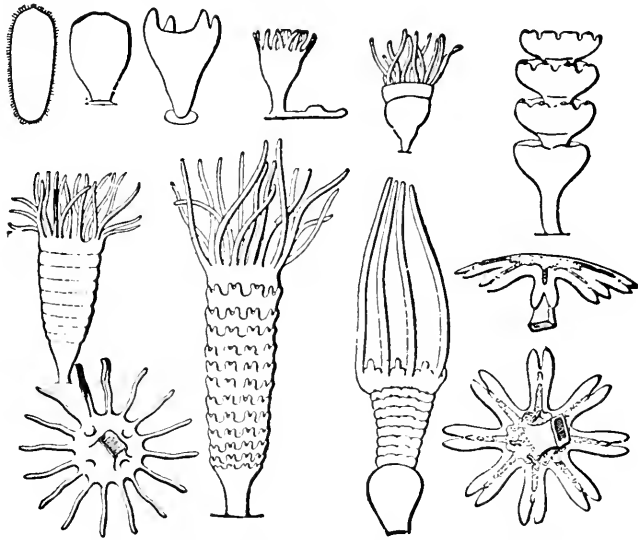

FIG. 26. Development of *Aurelia*. First row, growth of planula to scyphostoma; below, strobilation (separation of ephyrae): left, oral view of scyphostoma; right, two ephyrae. (After Hertwig-Kingsley, *Manual of Zoology*, after Hatschek. Courtesy of Henry Holt & Co.)

Class 3. Actinozoa (Anthozoa). Sea Anemone.—The Actinozoa include numerous species of sea anemones and corals. Sea anemones are solitary animals, forming no permanent colony. They are fleshy, with no skeleton.

Anatomy of the Sea Anemone.—The sea anemone is cylindrical, with its *peristome* covered with hollow, horn-shaped tentacles, bearing *nematocysts*. The mouth is provided with a muscular ciliated groove, the *siphonoglyph*, which aids in holding and propelling the food. George Meredith said, “Sea anemones are flowering stomachs which open to anything and speedily cast out what they cannot con-

sume." The gastrovascular cavity is divided by thin double *mesenteries* into six radial chambers. Other shorter mesenteries, not attached to the digestive tube, incompletely divide the cavities still further. Near the base of the *coelenteric* chamber (gastrovascular cavity) there are two types of *mesenterial* filaments. The first are secretory in function, while the second, the *acontia*, are provided with gland cells and nematocysts. The *acontia* may be shot out through the body wall of an irritated anemone until the mass of white threads conceals the bottom of an aquarium jar. Italians eat certain sea anemones, terming them "ogliole."

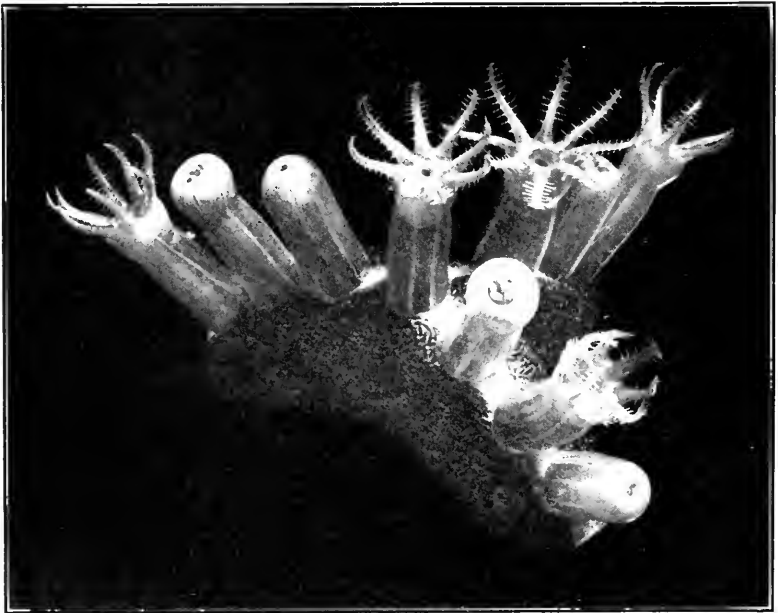

FIG. 27. Corals. (Courtesy of American Museum of Natural History.)

Corals.—The *coral polyps* resemble the sea anemones in their internal structure, having an esophageal tube, mesenteries, and internal gonads. Unlike the anemones, they form *colonies*, and have leathery, calcareous, stony, or horny skeletons of ectodermal origin. In the *red coral*, originally separate spicules become embedded in a cement-like deposit of calcium carbonate, forming a hard branched rod which serves as an axis for the colony. Members of a coral colony are connected, each individual securing its own food,

however. In one group of stony corals, the zoöids are differentiated, certain smaller individuals, the siphonozoöids, lacking longitudinal muscles, tentacles and gonads. Red coral is fashioned into jewelry for children, while the white and rose pink Japanese corals bring high prices. (See page 70.)

The living polyps are significant since they may become the foundation of islands, or protective barrier reefs (Figure 28), but frequently menace shipping when they grow to a point just below

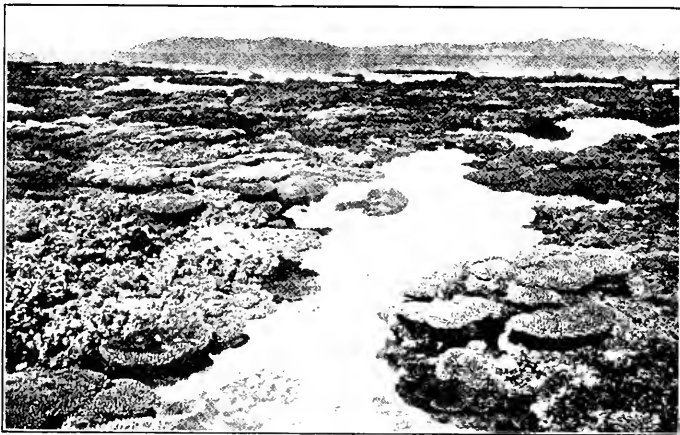

FIG. 28. Great Barrier Reef of Australia. (Courtesy of Amer. Mus. of Nat. Hist.)

the surface. In general, the corals that build reefs are found in a zone extending about 30° on each side of the equator. For the most part, since they cannot live in water below a temperature of about 60° , corals are found in tropical waters, near the coast, ranging no lower than 20 fathoms, and never found in brackish or fresh water.

Formation of Coral Islands.—Charles Darwin suggested that an island surrounded by a coral reef might subside,² thus accounting for an *atoll* and its enclosed *lagoon*. (See Figure 29.) Sir John Murray and A. Agassiz have staunchly supported the *erosion* theory. According to this theory coral reefs form around an oceanic island. The reef grows but the soil and rock of the island are washed away until an *atoll* with its *lagoon* are left. The few *lagoons* that serve

² Davis, W. M., 1928, in his book *The Coral Reef Problem*, Am. Geog. Soc., agrees with Darwin. The glacial control theory of Daly is the only serious rival to the subsidence theory.

as safe harbors for ships do not offset the many dangerous coral reefs that threaten ocean shipping.

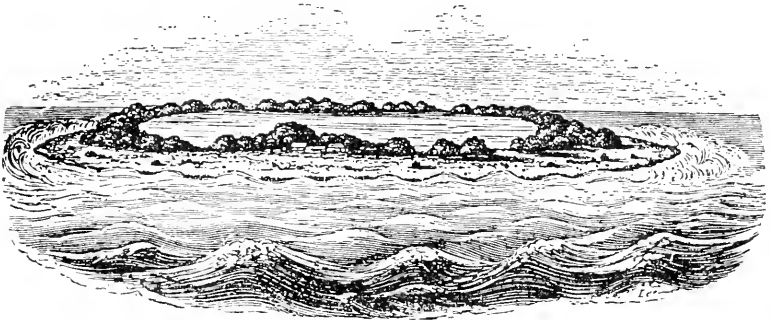

FIG. 29. Whitsunday Island in the South Pacific, an atoll built by corals. (After Darwin.)

Ctenophora.—The **Ctenophora** (Gr. *ktenos*, of a comb; *phoreo*, I bear) are free-swimming marine animals, extremely transparent, and for the most part found in tropical seas, although quite generally distributed. They are called sea walnuts or comb jellies. (Figure 30.)

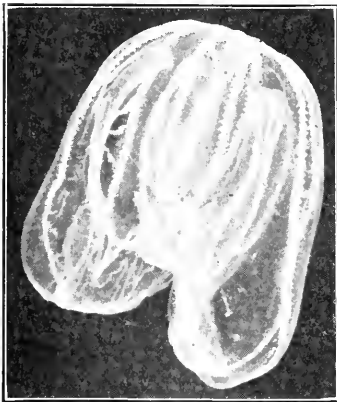

FIG. 30. *Mnemiopsis*, a Ctenophore. (Courtesy of T. C. Nelson.)

They are of little importance except as food for other marine animals. The U. S. Bureau of Fisheries has, however, reported the appearance of great numbers of Ctenophores coincident with the disappearance of oyster larvae in Great South Bay. Formerly known as destructive to molluscan larvae, there have been a number of years, 1917, 1921, 1927, when heavy "sets" of young oysters were lost during the month of June. Probably certain temperature conditions were responsible for the appearance of the Ctenophores at a date earlier than usual, and at a time when they could do damage to young oysters. It is of course also barely possible that the temperature changes were injurious to the oysters, and that the injury done by Ctenophores was correspondingly less.

GENERAL CONSIDERATION OF THE COELENTERATA

Distribution.—The majority of the Coelenterates are found in salt water, where they are extremely numerous. The common fresh water hydra and a species of fresh water medusa are the only inland types.

Anatomy.—All Coelenterates have a body wall consisting of two layers of cells (ectoderm and entoderm) and an undifferentiated mesoglea. Digestion and circulation take place in a single coelenteron. Muscle fibers aid in the process of locomotion. Locomotion is active in the jelly fishes like *Gonionemus*, which ejects jets of water, but less rapid in the larger jelly fishes, which execute undulatory movements. Hydra loops and somersaults.

Physiology.—*Digestion* is largely extracellular in some coelenterates, the enzymes being discharged into the gastrovascular cavity. In others it is an intracellular process. The endoderm cells responsible for digestion and absorption are ameboid in character, in some cases apparently fusing to form a *syncytium*. In many Coelenterates, cilia or flagella bring about a slow circulation of the liquid, which may be termed gastrovascular circulation. *Tryptic* ferments found in some Coelenterates probably furnish an acid secretion as in protozoa. Digestion of animals with a *chitinous* covering is effected in the anemones by *mesenterial filaments* which penetrate to all parts of the body and there digest and absorb food matters. There is little or no evidence of free existence of proteolytic enzymes in the gastral cavity. Glandular cells empty their secretion into the gastric cavity, where it becomes liquid and evidently has a part in what may be termed predigestion of food. Products of this early digestion may be, and doubtless are, carried to the most distant parts of the body by a sort of circulation, sometimes termed gastrovascular. This group appears to present a sort of transition between purely intracellular digestion as it appears among the protozoa and purely extracellular digestion found in higher animals.

Respiration and *excretion* are performed through the body wall and solid wastes are extruded through the mouth.

Nervous System.—In the Coelenterates we find that specialized ectodermal cells receive and transmit stimuli to internally situated contractile cells. The *nerve net* consists of a diffuse network between the receptor and effector cells. Parker¹ calls the units of

¹ Parker, G. H. 1919. Elementary Nervous System. J. B. Lippincott Co., N. Y.

this nerve net *protoneurons*. There are sense organs for equilibration, touch, visual sense and gustation.

Reproduction is asexual, by fission and budding; and sexual, by ova and spermatozoa. Hermaphroditism and separate sexes are both found. Many species of Coelenterates give off medusae when not a month old. Their life cycles may be completed in three months. *Sagartia* completes its life cycle in about 15 months. The sea anemones may undergo pedal "laceration," which is asexual reproduction.

Size.—Hydrozoa are mostly of small size. The Scyphozoan jelly fishes are larger, *Cyanea arctica* reaching a diameter of 12 feet with tentacles nearly 100 feet long. The largest reef anemone, *Discosoma*, an Actinozoan found in the Mediterranean Sea, reaches a diameter of 2 feet.

Habitat.—A little hydroid lives in the mouth of the tube of the worm *Sabella*. *Stylactis*, another hydroid, lives on the skin of the rock perch, *Minous minoi*. *Stylactis vermicola* attaches to the worm Aphrodite at 2,900 fathoms. Scyphozoa have been found at a depth of 2,000 fathoms.

Regeneration.—The remarkable ability of *Hydra* to regenerate has been known since the experimental work of Trembley in 1744. The hypostome with the tentacles will produce an entire new individual, and as many as seven heads have been produced by splitting the animal anteriorly. *Hydra* may be turned inside out and become normal in a short time. It was at first thought that the ectoderm cells were transformed into endoderm. This is not so, however. The animal either turns itself back or else the inturned ectoderm disappears and new ectoderm forms from the lips downward, covering the endoderm.

Interesting experimental work has been done by several investigators with various Scyphozoa including *Aurelia*. They regenerate remarkably when segments are cut out.

Fossil Relatives.—Hydrozoa are found as fossils from the Cambrian to the present. Scyphozoa are 99 per cent water and so few traces remain in the rocks. Lithographic slates, found in the Jurassic strata of Bavaria, show the impressions of the thin soft bodies or tentacles of jelly fishes. Sometimes the digestive cavity was filled with sand and covered by other mud or sand before the body of the jelly fish disintegrated and so the outline of the containing cavity was preserved. Actinozoa or Anthozoa are found from the

Cambrian to the present. Corals are composed of CaCO_3 and so are well preserved. Sea anemones and Ctenophores are not preserved as fossils.

Ancestry and Relationship to Other Phyla.—The lowest Coelenterate form known is the simple hydrozoan polyp, represented by *Hydra* and by the *hydrula* stage of many Hydrozoa. Scyphozoan polyps are represented by the *scyphula* of *Aurelia*, which is more complex because of the stomodaeum, gastric ridges and filaments. The Actinozoan polyp or *actinula* is more complex still.

The *hydroids* have adopted asexual multiplication by *budding* during the larval stage. Certain of the zoöids become *medusae*, the rest retaining the polyp form and furnishing nourishment for the asexual colony.

The relationships of the **Ctenophora** to other Coelenterata are doubtful. While the *absence of stinging capsules* and the *presence of collared endoderm cells* in the **Porifera** places them in a separate Phylum, it is assumed that they were derived from the Protozoan ancestors of the Coelenterates.

ECONOMIC IMPORTANCE OF COELENTERATES

Hydrozoa.—*Hydra* is an enemy of mosquito and other insect larvae, but of relatively small importance in such a rôle. It also attacks trout fry. *Hydra* is an enemy of annelids (*Tubifex*) and small crustacea such as *Daphnia*, which are important food for fishes. The *hydroids* are food for fishes. *Polypodium* is in early life parasitic on the eggs of the sturgeon. *Scyphozoa* are eaten in Japan and the Philippines, preserved in salt or between oak leaves. *Sertularia* are sometimes sold as "air-plants."

Actinozoa.—*Sea anemones* have been used as food by the Italians for many years. They are sold under the name of "ogliole." When fried in oil they are said to be very palatable. In the West Indies, a coral-like form called the "sea-ginger" is esteemed as a condiment.

Corals are the only Coelenterates of great importance economically. Coral reefs are formed by the limestone secretions of innumerable animals resembling anemones somewhat in structure. Sometimes *reefs* of coral surround islands which submerge (Darwin's theory, page 65) and leave a "lagoon" that proves a safe haven for ships. But, in many cases, reefs are dangerous liabilities in

ocean travel. Many Pacific Islands are formed entirely of coral rock, while the East Coast of Northern Queensland is bounded for 1,250 miles by the Great Barrier Reef, which extends parallel to the coast at a distance from shore ranging from 10 to 90 miles. (See page 65.)

The *precious corals* have been known for centuries. In India, coral is used as a gift to the dead to keep evil spirits away from the bodies. Pure white Japanese coral necklaces are extremely valuable, those with pale pink tints bringing as much as \$5,000. The finest rose-pink coral brings from \$400 to \$600 an ounce, but the ordinary red pieces bring only about \$10. The small fragments used in children's necklaces bring about 40¢ a string.

REFERENCES ON COELENTERATES

- HARGITT, C. W. 1901. Synopsis of the Hydromedusae of North America. *American Naturalist*, vol. XXXV.
- TREMBLEY, A. 1744. Mémoires pour servir à l'histoire d'un genre de polypes d'eau douce à bras en forme de cornes. Leyden. (Remarkable first study of Hydra.)

CHAPTER V

PLATYHELMINTHES

THE PLATYHELMINTHES (Gr. *platus*, broad; *helminthus*, an intestinal worm) are soft bodied, bilaterally symmetrical and dorsiventrally flattened worms lacking the true segmentation characteristic of the earthworm. The majority of the Turbellaria are free living, the Trematodes are all ectoparasites or endoparasites, and the Cestodes are all endoparasitic. Some parasitic flatworms require several hosts in order to complete their life history.

Platyhelminthes have two embryonic layers, the ectoderm and endoderm. They differ from higher worms in that they have no coelom. A packing tissue, the mesenchyme, forms a compact mass of *parenchyma* (connective tissue) occupying the space between the organs and the body wall. The majority are hermaphroditic, i.e., with the gonads of both sexes in one individual. The digestive tract, when present, is a coelenteron with no anal opening.

CLASSIFICATION

Class 1. Turbellaria (Lat. *turbo*, I disturb), Planaria.

Class 2. Trematoda (Gr. *trema*, a pore; *eidōs*, resemblance), Distomes, liver flukes.

Class 3. Cestoda (Gr. *kestos*, girdle; *eidōs*, resemblance), tape worms.

CHARACTERISTICS

1. Flattened dorsiventrally.
2. Bilaterally symmetrical.
3. Do not bud to form a colony, but do form linear chains (tape worm).
4. Lack a coelom, the spaces between the organs and body wall being occupied by connective tissue called parenchyma.
5. Excretory system of paired branched proto-nephridia or flame cells, connected in a water vascular system.
6. Nervous system consists of a supra-esophageal ganglion with main ventral nerve trunks.
7. Have two embryonic layers.

NATURAL HISTORY

Class 1. Turbellaria.—Turbellaria are unsegmented worms, living in fresh, brackish or salt water or moist earth. They are elongated and flat, and antero-posteriorly differentiated, with two prominent eyes. They vary in color from transparent to red, gray, brown and almost black. Some (*Planaria maculata*) are spotted. Locomotion is by undulation and by means of cilia. (Figure 31.)

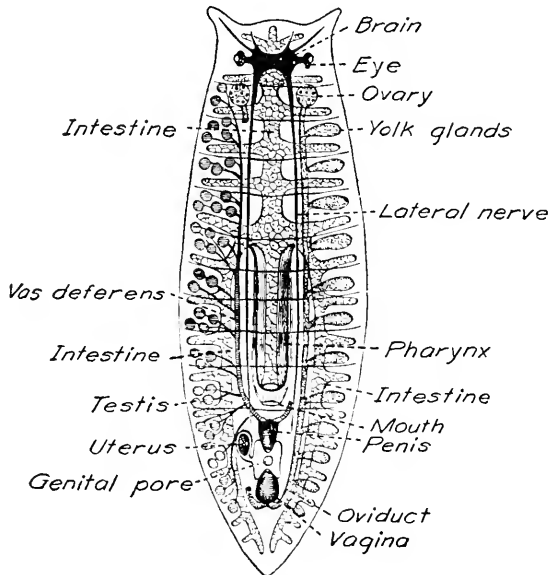

FIG. 31. A Planarian worm. (From Lankester, after von Graff.)

Planarians vary in size, but do not usually exceed one-half inch in length. Some greenhouse and tropical tree planarians are over a meter in length. They are widely distributed in fresh or salt water, but only a few are pelagic. They usually live free but are sometimes found in a state of *commensalism*, as for example *Bdelloura*, which lives in the gill books of the horseshoe crab, *Limulus*. Planaria are dorsoventrally differentiated and have eye-spots and ganglia. The lappets, antero-laterally situated, are olfacto-gustatory organs. The ectoderm is ciliated, often glandular, and equipped with *rhabdites*, rod-like bodies capable of being discharged on irritation. Turbellaria with a branched digestive tract are called *Dendrocoela*, and those with a straight digestive tract are called *Rhabdocoela*.

Type of Group—Planaria. *Anatomy of P. maculata.*—The body wall consists of the ciliated epidermis basement membrane, circular muscles, external longitudinal muscles, internal longitudinal muscles, outside of the connective or packing tissue, called parenchyma.

Digestive System.—The mouth is situated at the end of a protrusible *proboscis* or *pharynx*, which is midventral. The mouth leads into a central tube which may be axial as in the Rhabdocoela, or branch, one running towards the head, and two, postero-laterally, towards the tail. Digestion is both *intercellular* and *intracellular*. Irregular columnar cells and goblet cells line the digestive cavity. The goblet cells secrete an enzyme, probably used entirely in the digestion of *fat*. Intracellular digestion begins when the columnar cells push out *pseudopodia* which seize and ingest food particles, which later appear in *vacuoles*. There is no anal opening and any undigested food must be discharged from the mouth.

There are no well-developed *circulatory* or *respiratory* systems, as the branched digestive tract distributes the food in the form of *lymph*.

Excretory System.—The water vessels of the *excretory system* run through all parts of the body. They consist of two main longitudinal trunks running on the *right* and *left* sides of the body and *opening externally* on the dorsal surface by means of several minute pores; connected in front by a transverse vessel. From each main trunk come numerous branches which give off in turn a system of fine vessels which terminate in flame cells, which are cells with cilia directed down the tube. Some zoölogists think that they may also be *respiratory* in function.

Reproductive System.—The reproductive system is *hermaphroditic* (monoecious). The *male* part of the apparatus consists of the *testes*, *vasa deferentia* and *cirrus* or *penis*. The testes are numerous, rounded structures situated near the right and left borders. Two ducts, the vasa deferentia, run backwards from the neighborhood of the testes and unite in the middle line posteriorly. The median duct thus formed passes into the protrusible *cirrus* which opens in the genital cloaca. At the base of the penis the seminal vesicles empty, while the ducts of the prostate glands also empty into the canal. The female reproductive organs consist of the *ovaries*, *oviducts*, vitelline glands (*yolk glands*) and the *uterus*, a muscular sac. Fertilization takes place in the *uterus* and the *eggs* develop in *cocoons* that are passed along the oviducts from the animal's body, producing

tremendous lacerations sometimes, but the tissue destroyed is easily regenerated.

The cocoons contain about a score of *eggs* with several hundred *yolk cells* containing food. The *larva* at a certain stage develops a temporary larval mouth and gullet, and swallows the food yolk, by which it is able to grow rapidly. The larval mouth disappears and a new permanent mouth replaces it. The *embryo* is like its parents when it leaves the shell. Adult over-nourished Planaria undergo fission, the posterior portion quickly regenerating a head.

The *nervous system* consists of the brain, a bilobed affair with two longitudinal nerve cords or ventral *nerve chains* running backwards, and giving off, internally and externally, transverse branches which also subdivide. The inner ones frequently anastomose to form commissures. The brain is rather diffuse and made up of groups of ganglion cells, nerves, and has transverse fibers connecting the nerve cords. The animals are responsive to all sorts of stimuli, and the eye-spots, the lateral olfacto-gustatory organs, and the anterior end are all well supplied with nerve endings.

Food.—Planaria live upon small Crustacea, larvae of Crustacea, water mites, and Rotifera, as well as on plant food such as diatoms and algae. They are also said to attack earthworms.

Class 2. Trematoda.—The Trematoda are leaf-like parasites with no cilia in the adult, a thick cuticle, ventral suckers, sometimes with posterior hooks, and with a forked or branched alimentary canal ending in blind branches, the cecae.

Type of Group.—*The liver fluke, Fasciola (Distomum) hepatica.* The adult liver fluke lives in the bile ducts of sheep, cattle, horses and pigs, and sometimes occurs in man. It is soft-bodied, flattened and leaf-like with a triangular lobe at the broader end, and with two well-developed suckers, the anterior one being perforated by the mouth, and the posterior one ventrally situated. The disease "liver rot," which is especially prevalent among sheep pastured on snail-inhabited marshy ground, has killed many millions of sheep.

Life History.—The eggs of the liver fluke are $1/180$ of an inch long, with brownish shells, having a greenish sheen. They can develop only in water where they hatch in from four to five weeks.

The larva or *miracidium* is $1/125$ of an inch long, ciliated, and with a single eye, but has no gut. If the larva does not find a snail of the right species in from eight to ten hours, it dies. Having entered the lungs of the snail, it loses its cilia, becomes broader and,

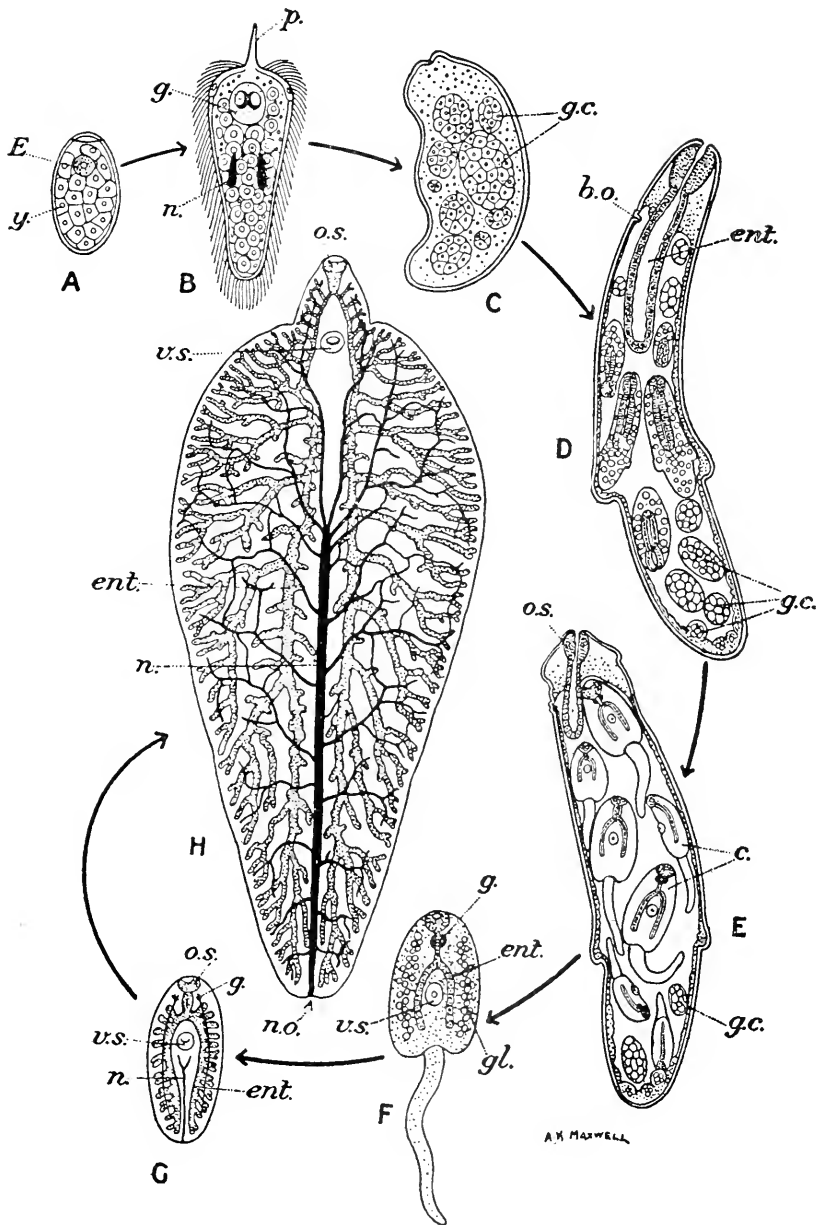

FIG. 32. Life-history of *Fasciola hepatica*. A, "egg"; B, miracidium; C, sporocyst; D, E, rediae; F, cercaria; G, tail-less encysted stage; H, adult (neither reproductive organs nor nervous system is shown). *b.o.*, Reproductive opening of redia; *c.*, cercaria; *E*, egg; *ent.*, intestine; *g.*, nerve-ganglion; *g.c.*, germ-cells; *g.l.*, cyst-producing gland-cells; *n.*, nephridium (only a few of the main branches of the excretory network are shown); *n.o.*, nephridial opening; *o.s.*, oral sucker; *p.*, proboscis (extruded); *v.s.*, ventral sucker; *y.*, yolk-cells. (After Kerr. Courtesy of Macmillan and Co., Ltd.)

as a *sporocyst*, develops germ cells which produce embryos. These embryos grow into *rediae* which have germ cells and a primitive digestive tube including a mouth, a pharynx and an intestine but no anus. If the weather is warm, the *rediae* continue to multiply in the lungs of the snail. If it is cold they multiply for a short time and then pass into the liver of the snail where they give rise to tailed forms called *cercariae* which have an oral and a ventral sucker, and a forked intestine with no anus. The *cercariae* escape from the

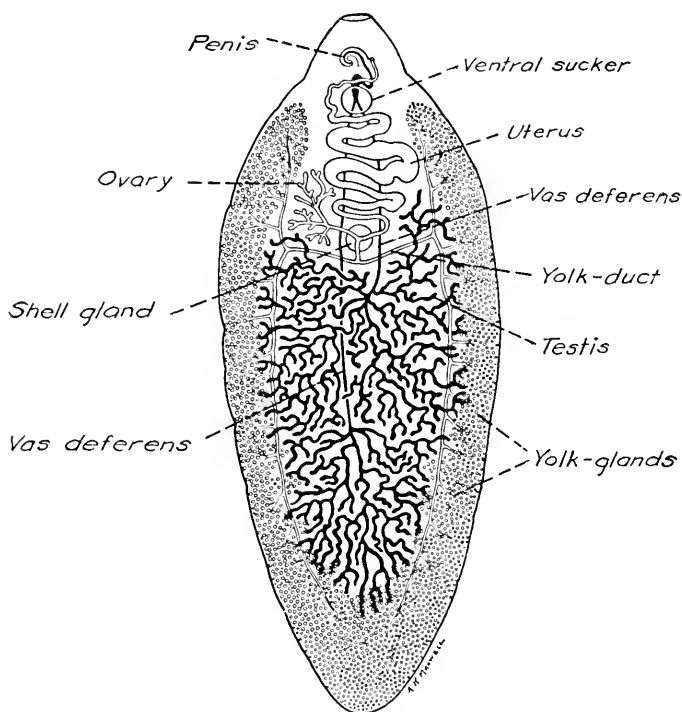

FIG. 33. An adult liver fluke. (After Kerr. Courtesy of Macmillan and Co., Ltd.)

body of the snail and, after swimming about, settle down on grass, later becoming encysted. When their plant substrate is eaten the *cercariae* develop in about six weeks into adult *liver flukes* and travel from the intestine of the sheep to its bile ducts. Thus from one single egg come the larval stages, *miracidia*, *sporocysts*, *rediae*, *cercariae* and finally many *adult flukes*.

The *adult liver fluke* is a tailless *cercaria* with well-developed

hermaphroditic gonads. Its *digestive system* consists of a mouth, pharynx, oesophagus, intestine and non-anastomosing caecal tubes. The intestine is usually darkened by the blood and bile used as food. The *excretory system* consists of a main duct with four anterior ducts, a dorsal and a ventral one on either side. The *nervous system* consists of a *collar* around the pharynx; two lateral *ganglia* and one ventral median ganglion. The *male reproductive system* consists of a pair of testes, vasa deferentia near the seminal vesicle, the ejaculatory duct and the penis or cirrus with its sac. The *female reproductive system* consists of the ovary, oviduct, yolk glands, shell gland, vitellarian ducts and the vagina or uterus, opening at the genital pore.

Trematode Parasites.—Some of the trematodes infesting other mammalian hosts are likely to infest man occasionally. For example, *Fasciola hepatica* has been found in the human liver. Some are normally parasites of man.

The blood fluke *Schistosoma* (*Bilharzia*) *haematobium* is a human parasite found in Egypt involving large numbers of troops during the recent war. The *cercaria* enter the blood stream through the skin, finding their way to the small veins of the bladder and colon and becoming mature in the submucous tissue. They require as an intermediate host the non-operculate fresh water snail *Bulinus* or *Planorbis*. Developing in the liver of the snail into *tubular sporocysts*, germ cells develop within the sporocysts into cercariae with forked tails. These later escape from the snail and in the free state these cercaria must find a mammalian host in forty hours or die. When they come in contact with mammalian skin they cast off their tails, dissolve the cells of the skin, and work their way into a lymphatic or the blood stream and thence to the liver where they mature and eventually lodge in the mesenteric veins. There was very good scientific basis for the blind worship of the Nile ibis, an important enemy of snails. (See p. 154.)

Schistosoma japonicum, found in the Orient, is somewhat smaller than *Bilharzia*. It requires as its intermediate host the snail *Katayama nosophora* in Japan and *Oncomelania hupensis* in the Yangtze Valley. It is quite possible that several snails found in the United States might act as carriers for *Schistosoma japonicum* but none as yet have been found. *Schistosoma* cause inflammation of the rectum and bladder. Other species of *Schistosoma*³ are found in tropical America, the West Indies and the Philippines.

³ Cort, W. W. 1928. Schistosome dermatitis in the United States (Michigan). Jour. Amer. Med. Assoc., vol. 90, p. 1027.

Clonorchis sinensis, found in China and Japan and recently introduced into the U. S., infests the liver of man, cats, dogs and pigs. It is generally leaf-like in shape and has two suckers. The eggs hatch in the operculate snail *Bithynia* and the cercariae leave the snail and encyst in thirty-four reported species of fresh water fish. Man and the other mammalian hosts acquire the infection by eating uncooked infected fish.

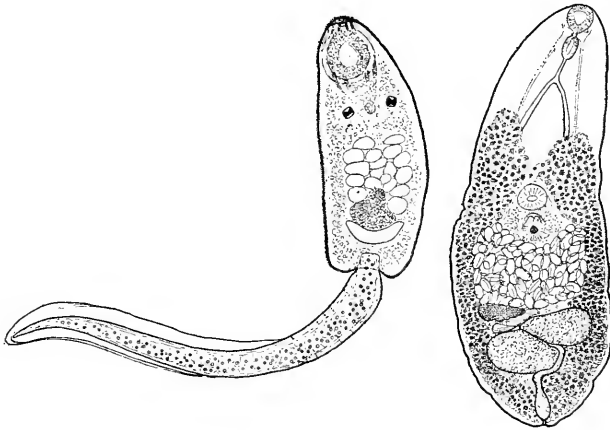

FIG. 34. Cercaria and adult of *Cryptocotyle lingua*. (Courtesy of H. W. Stunkard.)

In *Cryptocotyle lingua*, studied by Stunkard,⁴ we have an interesting illustration of what may occur with introduced species. The snail, *Littorina littorea*, brought with ballast to New Brunswick, Canada, in 1855, is supposed to have carried with it the cercariae of *Cryptocotyle lingua*. The metacercariae of *C. lingua* occur in marine fishes, chiefly the cunner, and adults are found in the intestines of fish-eating birds and mammals. Four related species have been shown experimentally to be infective for man. (Figure 34.) It is possible that this form, readily collected at the Marine Biological Laboratory, Woods Hole, Mass., may be used inland just as the nematode *Metoncholaimus pristiurus* is now being shipped to distant points. (See page 98.)

Class 3. Cestoda. Type—*Taenia solium*.—The common pork tape worm lives in the alimentary canal of man as an adult. Its secondary host is the pig. The *adult* tape worm has a well-developed

⁴ Stunkard, H. W. 1930. The life history of *Cryptocotyle lingua*. Jour. Morph. and Physiol., vol. 50, pp. 143-183.

"head" or *scolex* armed with both *hooks* and *suckers*. The proglottids are budded from the neck, the oldest being at the posterior end. The worm may reach a length of over twelve feet and have 1,000 proglottids.

An *alimentary canal* is *not* necessary on account of the parasitic habit of *absorbing* food predigested. Excretory tubes end in *flame cells*.

The complete *reproductive system* develops in each of the proglottids and attains sexual maturity beginning with the 200th. The animal is *male* nearer the *anterior* end and *hermaphroditic posteriorly*. The male structures consist of *testes*, *effluent ducts*, *vasa deferentia*, a *cirrus* and a *cirrus sac*.

The *female* reproductive system consists of the paired *ovary*, the *oviduct*, *yolk gland* and *duct*, *shell gland* and *duct* and the *uterus* and *vagina*. The uterus is simple until the 600th segment; then it branches.

The egg rises in the *ovary*, passes into the *oviduct*, and is included with the yolk cells and spermatozoa in a *chitinous shell*, and finally passes into the *uterus* and is released by rupture of the uterus when the matured segment is discharged. Fertilization takes place before the shell is formed, and *may be* by sperms from the same proglottid. The eggs develop into *hexacanth* (6 hooked) *embryos* while still in the uterus. They pass out in the feces and if eaten by a pig escape from their covering and bore into the muscles. A *proscölex*, which is a cyst with the cavity filled with water, develops a head and forms a *bladder worm* or *cysticercus* with the scolex invaginated into the bladder. When infested pork which is not fully cooked is eaten, man receives *cysticerci*, which evert and attach, by the scolex, to the wall of the *alimentary canal* and develop a chain of *proglottids*.

Cestode Parasites.—*Echinococcus granulosus* (*Taenia echinococcus*) is found in the intestine of the dog. It is the most injurious to man of the parasites belonging to the Cestode group and is taken into the body upon unwashed salads or in drinking water contaminated by ova from infected dogs. The adult worm in the dog has usually not more than four or five proglottids. When the eggs reach the *alimentary canal* of man, cattle, sheep, and hogs, the egg shells are dissolved and the hooked embryos bore into the liver where they develop into cysts. The *bladder-worm* stage is extremely large, sometimes reaching a diameter of seven inches. It produces a large number of *scolices* which in turn produce other crops of scolices.

The tissues of the host wall up the bladder worm and the enlarging bladder worm is known as a *hydatid cyst*.

Taenia saginata is a human tape worm which grows to a length of forty feet, its terminal segments reaching a width of $\frac{3}{16}$ of an inch. The *scolex* has four large strong suckers without hooks. The cysticercus stage is found in the muscles of cattle and occasionally in dogs. It is more common in the United States than the pork tape worm.

Taenia solium is one of the commonest tape worms of man in Europe. It reaches a length of twelve feet. Its scolex has both suckers and hooks. The "*bladder worm stage*," *Cysticercus cellulosae*, is found normally in the muscles of the pig but also occurs in the dog, cat, rat and man.

Dipylidium caninum is found in the dog and cat and occasionally occurs in man. Each proglottid contains a double set of reproductive organs. The cysticercus is extremely small, a fact correlated with its existence in secondary hosts as small as dog lice and fleas.

Taenia serrata, the common tape worm of the dog, has the rabbit as its secondary host. If the rabbit swallows the eggs of the tape worm, larvae develop in the alimentary canal and bore their way through its wall into blood vessels which carry them to the liver. From the liver the larvae migrate to the peritoneal cavity where they grow into *bladder worms* or cysticerci. When a bladder worm is swallowed by a dog the *scolex* attaches to the mucous lining of the alimentary canal by means of *hooks* and *suckers* and buds off a chain of proglottids.

Taenia coenurus, the dog tape worm, produces larvae (*Coenurus cerebralis*) which infest the brain of cattle, sheep and deer and cause the disease known as "staggers" or "gid." It has many segments as an adult in the intestine of the dog, and the cystic form may reach a size of $\frac{3}{4}$ of an inch in the brain of the intermediate host.

Diphyllobothrium latum, the broad tape worm, causes anemia in man. Its ciliated hexacanth embryo gets into the gut of a fresh water copepod, *Cyclops strenuus* or *Diaptomus gracilis*, then is eaten by fish in whose muscles it encysts in the form of an immature worm known as a plerocercoid. If eaten uncooked it becomes the adult tape worm in man. Recently immigrants from Finland and Baltic regions of Europe have introduced this parasite in the Great Lakes region where fish have become infected. It is believed that

the severe anemia produced by this parasite is due to a toxin given off by the tape worm and absorbed into the blood of the host.⁵

Although there are many parasitic flatworms to be found in fishes, birds and mammals, there is little danger of contracting disease if the meats are well cooked.⁶

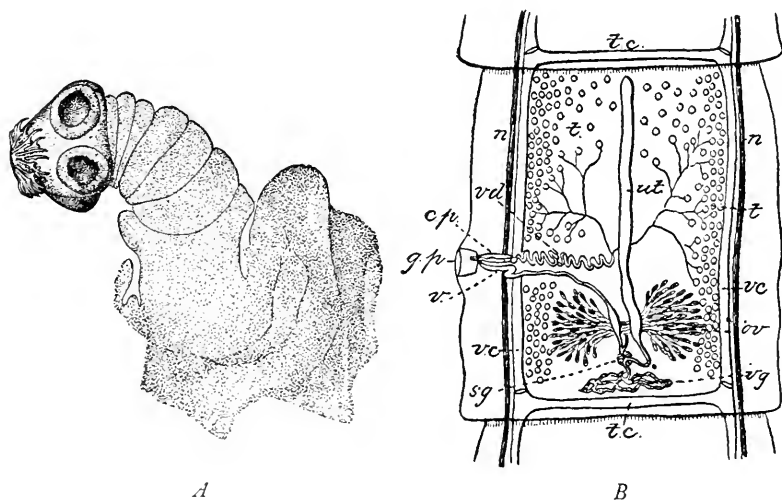

FIG. 35. *A.* Tapeworm head. *cp*, cirrus pouch; *gp*, genital pore; *n*, nerve; *ov*, ovary; *sg*, shell gland; *t*, testicles; *tc*, transverse canal; *ut*, uterus; *v*, vagina; *vc*, ventral canal; *vd*, vas deferens; *yg*, yolk gland. $\times 20$. (After Deffke, 1891, pl. 1, fig. 3.) (*Coenurus cerebralis*.) *B.* A segment. (Ranson. U. S. Dept. Ag., Bull. 66.)

Remedies for Platyhelminth Infections.—While it has been demonstrated that santonin and nicotin, in doses fatal to ascarids, have little effect on the cestodes, we know that the tape worm, *Taenia*, is more sensitive to Beta-naphthol than *Ascaris*. The oil of “male fern” (*Aspidium*) and *Chenopodium* are specifics for tape worm. They stupefy the animal, it releases its *scolex*, and then a mild cathartic will remove the whole worm.

⁵ Vergeer, T. 1928. *Diphyllobothrium latum* (Linn. 1758) the broad tapeworm of man. Jour. Am. Med. Assoc., vol. 90, pp. 673-678. Also consult: Lyon, M. W., Jr. 1926. Native case of infestation by the fish tapeworm *Diphyllobothrium latum*. Jour. Am. Med. Assoc., vol. 86, pp. 264-265.

⁶ Linton, Ed. 1912. Cestode cysts in the flesh of marine fish and their bearing on food values. Trans. Am. Fish. Soc. (References.)

GENERAL CONSIDERATIONS

Distribution.—Free living flatworms occur from the deep sea to the surface of fresh water lakes, while parasitic forms infest animals of all the higher Phyla.

The *Turbellaria* are usually free-living, consuming insect larvae and aquatic worms and eking out their diet by means of diatoms and algae. Some forms like the flatworm, *Bdelloura*, which lives in the gill books of the king crab, are commensals, while still others are found parasitic in the intestines of Echinoderms and worms.

The *Trematoda* are all parasitic, some of them attaching to the gills of fishes by hooks and suckers as ectoparasites. Others are true internal parasites, found in the pericardial cavity of the mussels, the urinary bladder of Amphibia and the alimentary canals, liver and lungs of vertebrates. Many Trematodes find molluscs necessary as their secondary hosts, the commonest instance being that of the liver-fluke and the snail.

The *Cestoda* are internal parasites usually found in the alimentary canal and requiring another vertebrate or invertebrate as a secondary host. Passage from one host to another is not an active migration as in the Trematodes. On account of their extreme parasitism we find that the Cestodes are the most degenerate of the flat worms.

Physiology.—The *Turbellaria* are covered with fine vibratile cilia which aid in respiration as well as locomotion. They have a well-developed, branched digestive tract, and a complicated excretory system consisting of water vessels which give off fine capillaries, which terminate in flame cells. It is assumed that the excretory system may also function in respiration. The reproductive system is "monoecious," or *hermaphroditic*.⁷ The nervous system is highly developed, consisting of central cerebral ganglia or brain, from which proceed posteriorly two longitudinal ventral nerve cords, with connecting nerve strands or commissures. The *Trematoda* lack cilia but have minute cuticular papillae. They have an anterior mouth surrounded by a muscular oral sucker, while posteriorly is a larger ventral sucker. Other openings are the median genital openings and the posteriorly situated excretory pore. The mouth leads into a muscular pharynx, a short esophagus and a rather

⁷ Consult Curtis, W. C. 1902. Life history, normal fission, and reproductive organs of *Planaria maculata*. Bost. Soc. Nat. Hist., vol. 30.

large intestine which divides into two lobes, each branched into ceca. The only external opening of the alimentary canal is through the mouth. Excretory system and nervous system are well developed, while the reproductive organs are hermaphroditic. In the *Cestoda* we find that an alimentary canal is absent, but that reproductive, nervous, and excretory systems are well developed.

Behavior.—The Turbellaria have well-developed tactile, olfactory-gustatory and light percipient organs, but in the Trematodes and Cestodes little development of these functions is found. In the green marine worm, *Convoluta roscoffensis*, geotropism has been found to fluctuate with the rise and fall of the tides, even when the animal was moved to an aquarium. Geotropism is dependent on the statocyst. In *Convoluta* and in another Turbellarian, *Vortex*, it is found that the parenchyma contains symbiotic unicellular green algae (see page 26) similar in relations to that with the yellow cells of Radiolaria.

Regeneration.—Planaria are notable in their ability to regenerate new parts, a single individual having been cut into one hundred twenty transverse pieces, behind the eyes, and each piece regenerating a perfect worm. The tape worms are able to produce new proglottids as long as the scolex remains.

Fossil Relatives.—Fossil flatworms are rare. They occur from the Pennsylvanian down to the present.

Ancestry and Relationship to Other Phyla.—The Turbellaria and the Ctenophora have possibly been derived from a common ancestor, the bands of cilia in larval Turbellaria resembling somewhat the ciliary swimming plates found in Ctenophora. The simplest Platyhelminthes are Turbellaria; then we come to the Trematoda, in which the larval cercaria corresponds to the cysticerci of the Cestoda. The form Ligula has been considered a connecting link between the Trematoda and the Cestoda, since it has the elongated body and multiple gonads of the tape worm, but represents only a single proglottid.

Axial Gradient Theory of Child.—Dr. C. M. Child of the University of Chicago, after experimenting with Planaria for many years,⁸ elaborated an important theory of axiate organization, according to which there is a gradient of metabolic activity in every

⁸ Consult also Child, C. M. 1915. Individuality in Organisms; and Senescence and Rejuvenescence. Published by Univ. of Chicago Press.

organism. Dr. Child kindly consented to prepare for this text a brief summary, which we are privileged to print without alteration.

“Many different lines of evidence, observational and experimental, indicate that physiological polarity of axiation in general is in its simplest terms a gradation or gradient in physiological condition along the axis in question involving both quantitative differences in metabolism and protoplasmic constitution. During development the primary gradient or gradients may be altered, may disappear and new gradients may arise so that the original gradients do not necessarily persist in the adult organism. Localization and differentiation at different levels of an axis result from the differences in physiological condition at different levels of a gradient and are often factors in altering or obliterating the original gradient.

“The evidence also indicates that such gradients arise or originate in the reaction of a cell or a cell mass to some environmental differential, but after its establishment a gradient may persist through cell division or other reproductive process and so be inherited by the offspring of such reproduction. A gradient may be determined by the localization, experimentally or otherwise, of a region of increased physiological activity in a cell or cell mass. The gradient in its beginning may be nothing more than the gradation in activity from the center to the periphery of such a region. In consequence of growth the center of such a region may become an apical or anterior end of an axis. The environmental differentials which determine gradients may be of various sorts, light, electric current, local stimulation, differential exposure to oxygen, etc., and in the case of organ axes, buds, etc., the environmental factors determining the gradient may consist in the relations of the part concerned to other parts of the organism.

“The high or most active end of a gradient may exercise a physiological dominance over other regions. This dominance in its more primitive form apparently decreases in effectiveness with increasing distance from the dominant region and if a part of the organism comes, either through increase in size of the organism or through decrease in dominance or certain other conditions, to lie beyond the range of dominance, physiological isolation of the part results and in many of the simpler organisms such physiological isolation may result in agamic reproduction.

“The gradient theory has no quarrel with heredity. The gradient merely provides the plan, the pattern, the framework, so to speak, while the material and its possibilities are given in the hereditary constitution of the protoplasm in which the gradient exists.”

Class (or Phylum) Nemertinea. (Gr. *nemertes*, true).—The *Nemerteans* are soft, contractile, chiefly marine flatworms sometimes classed with the Turbellarian Platyhelminthes. They range in length from 5 mm. to 90 feet.

The mouth is anterior and ventral and the anus is posterior. They have an eversible proboscis armed with stylets, indicating that it is functional both as a tactile and an offensive or food-taking organ. The *digestive tract* consists of an esophagus, stomach, intestine with paired diverticula or a long cecum, and a rectum. The *circulatory system*, not found in Platyhelminthes, consists of two or three longitudinal trunks with connecting branches. The blood sometimes contains hemoglobin. *Excretion* is effected through paired and many-branched longitudinal canals which open to the outside through pores. Most nemerteans are *unisexual*, and a few are hermaphroditic. The paired gonads discharge their products through the body wall, having no permanent genital ducts. A few are viviparous. Development is direct or in some forms by the metamorphosis of a free swimming larva, the *pilidium* (Desor's larva). (See p. 220.) The *nervous system* consists of a four-lobed brain with a pair of large lateral nerves uniting at the posterior end of the body, a dorsal median nerve, and, in some, a ventral median nerve. There are lateral ciliated cerebral canals related to the dorsal cerebral lobes. Certain species have as many as two hundred *ocelli* equipped with a lens and nerve, while others have two otolithic vesicles.

Nemerteans are carnivorous, and feed on soft-bodied invertebrates, certain large species capturing tubiculous worms. A few are *parasitic*, infesting crustacea and mollusca, while others are *commensals* in the pharynx and atrial cavities of tunicates.

REFERENCES ON PLATYHELMINTHES

- FANTHAM, STEVENS AND THEOBALD'S (1920) Translation of Braun's Thierischen Parasiten des Menschen.
- LINTON, E. Many papers published by the U. S. Bureau of Fisheries.
- STILES, C. W. Cestode Parasites of Man. Bulletins 25 and 28, U. S. Hygienic Laboratory.
- STILES AND HASSALL. The Inspection of Meats for Animal Parasites. Bulletin 19, U. S. Dept. of Agriculture.
- STUNKARD, H. W. Many papers listed in his bibliography, New York University.

Consult also papers listed in standard books on Parasitology, such as Castellani & Chalmers, Chandler, Rivas, Stitt, and Underhill.

REFERENCES ON NEMERTINEA

- COE, W. R. Synopsis of the Nemerteans, pt. I. *Am. Nat.*, vol. 39, p. 425.
- VERRILL, A. E. 1892. Marine Nemerteans of New England and adjacent waters. *Trans. Conn. Acad. of Sc.*, vol. 8, p. 332.

CHAPTER VI

NEMATHELMINTHES. NEMAS

THE NEMATHELMINTHES (Gr. *nema*, thread; *helmins*, an intestinal worm) or *Nemas* live in fresh and salt water, damp earth and moss, and among decaying substances; many are parasitic. They are often minute in size and some may remain viable when dried. They vary in size from 0.01 to 1 meter or more in length.

CLASSIFICATION. (Modified)

Class Nematoda

- Fam. 1. Ascaridae.
2. Anguillulidae
3. Strongylidae.
4. Trichuridae.
5. Filaridae.
6. Trichinellidae.

CHARACTERISTICS

1. Elongate worms, many parasitic.
2. Body usually cylindroid and unsegmented.
3. A nerve ring with associated ganglia.
4. Single and paired excretory organs, and tubular gonads.

NATURAL HISTORY

Dr. N. A. Cobb states (Nematodes and their Relationships):

“The number of species of nematodes must be enormously greater than is commonly supposed. It may be estimated that more than 80,000 nematode species infest the 40,000 species of vertebrates. Insects, much infested, will add many thousands of other species. The mollusks, crustaceans and various groups of worms are also infested and investigations continue from these species also to augment the number of known species of parasitic nematodes.

“Numerous as the parasitic species are, it is certain that the nematodes living free in soil and in water far out-number them; they probably con-

stitute one of the important mechanical as well as biological factors in soil and in the bottom of lakes and oceans. Estimates based on (Dr. Cobb's) investigations show that in the upper foot of an arable soil the numbers of nematodes run to thousands of millions per acre."

Longevity.—When in encysted condition in grains or in the soil, *nemas* may live for years. Needham found in 1743 that nematodes in wheat ears would live for several months in a dried condition. Baker found that nematodes dried for twenty-eight years became active again when moistened. (Becquerel. Latent Life. Scientific Am. Supp., vol. 82.)

Family 1. Ascaridae.—In the *nemas* of this family the body is thick, and the mouth has three lips always bearing papillae and amphids. The males are smaller than the females and have a curved caudal end. Numerous species attack the vertebrates and many of the invertebrates, living as parasites in their intestines, but found in other organs or in the body cavity. In general they require no intermediate host.

Type of the Group—*Ascaris lumbricoides*.—*Ascaris lumbricoides*, the human "eelworm," is found in the human small intestine where resultant lesions may induce the symptoms of anemia.¹ Profound respiratory affections such as pneumonia may be caused by ascarids lodged in the lungs. It has been estimated that from 10 per cent to 40 per cent of Europeans are infested with *A. lumbricoides*.

The females contain as many as sixty million eggs. After fertilization the eggs pass out of the body of the host with the feces. The eggs become embryonated in the soil. Such ova remain viable for five or six years. They enter the digestive tract through water or contaminated food. Dirt eaters sometimes take them in and it is possible that they may also enter with unwashed vegetables.

Ascaris lumbricoides has been found in the dog, sheep and hog. It possibly occurs in the cat and the rat. The host relationship of pig and human ascarids has been tested by feeding eggs of the human ascaris to pigs. They induced respiratory disturbances but did not become established in the digestive tract of any of the pigs.

¹ Wells, Jour. Paras., vol. 17, pp. 167-182, June, 1931, found that a single dog-hookworm, a strongyle, see p. 92, may withdraw .8 cc. of blood from the host in 24 hours. The Ascaridae may be extremely injurious also. The number of *nemas* as yet known and studied is relatively so small that their classification is still provisional.

Eggs of the pig ascaris did not produce mature ascarids in the monkey and the two human subjects. No intermediate host is required for the development of *Ascaris lumbricoides*.

Anatomy.—The female *Ascaris lumbricoides* is about six inches long. It has a slender body tapering at both ends. The body is grayish pink in color with lateral stripes.

Digestive System.—The *mouth* has one dorsal and two sub-ventral lips. The dorsal lip bears two large papillae, each sub-ventral lip bears a small lateral papilla and a large sub-ventral papilla. The amphids are small pores slightly dorsal to the lateral papilla. Amphids are supposed to be gustatory. The long muscular *esophagus* leads into the intestine which runs throughout the body, ending with a slightly smaller rectum that opens at the *anus*. Absorption takes place through the walls of the intestine.

Excretory System.—The excretory system consists of two longitudinal canals, one in each lateral chord; they open to the exterior through a single ventral pore near the post-pharyngeal region. (Figure 36.)

Reproductive System.—The female reproductive system consists of two slender coiled, thread-like ovaries, continuing into the dilated uteri which join to form a short tube, the vagina. The sperm from the male fertilizes the eggs in the uteri and the eggs pass out through the genital pore, situated about one-third the distance from the head. The eggs are covered with a shell resisting digestive juices. The *male* (about 4 inches long) has a single thread-like testis from which the vas deferens leads to the seminal vesicle and thence to the ejaculatory duct which opens at the rectum.

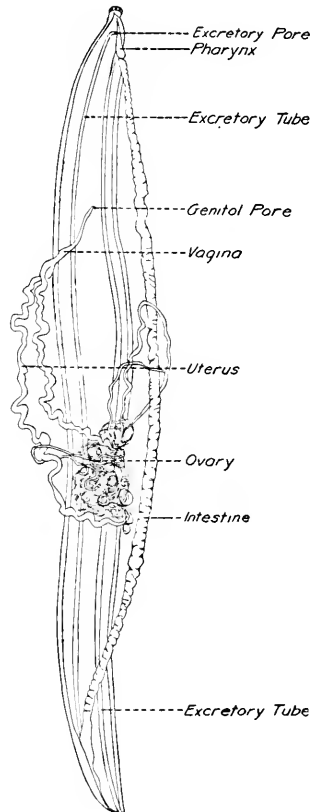

FIG. 36. Anatomy of a female round worm *Ascaris*. (After Shipley and McBride. Courtesy of Macmillan and Co., Ltd.)

Nervous System.—A nerve ring encircles the esophagus connected to two large nerve cords, one ventral and one dorsal; with several other lesser cords and numerous nerve strands and connectives.¹

Other Ascarids.—*Parascaris equorum*, the largest species of *Ascaridae*, is found in the horse family where it infests the small intestine. Males are eight to ten inches and females ten to twelve inches long. This species was used by Van Beneden in his classical study of chromosomes. It is said that one-third of the dry substance of *A. megalocephala* consists of glycogen.

Ascaris vitulorum infests calves, attacking the small intestine and sometimes ascending to the abomasum. It produces diarrhea, colic and intestinal inflammation. *Ascaris ovis* infests the small intestine of sheep. *Ascaris suilla* (*lumbricoides*) infests the hog's small intestine. If it enters the stomach it causes nausea; if it infests the pancreas it may occlude the bile ducts and cause jaundice. Infesting the lungs, it causes "thumps." *Toxocara canis* and *Toxoscaris leonina* infest dogs; *Toxocara mystax* infests cats. *Ascaridia lineata* occurs in poultry, infesting the intestine. *Ascaridia maculosa* (syn. *Heterakis maculosa*) attacks pigeons.

Enterobius (*Oxyuris*) *vermicularis* (*Oxyuroidea*), a white worm called the pinworm of man, is less than $\frac{1}{2}$ inch long. The male is 2 mm. to 3 mm., the female 9 mm. to 10 mm. in length. The color is white, the body is expanded anteriorly. Metchnikoff believed the pinworm an important cause of appendicitis. Several conflicting reports have since appeared, but there is good evidence that the eggs and larvae of the pinworm are found in diseased appendices. *Oxyuris equi*, the horse pinworm, is found in the rectum and large intestine of the horse, ass and mule.

Rhabditis nigrovenosa (*Rhabdiasoidea*).—In this form we find well marked the *alternation of generations*—*hermaphroditic* with *sexual*. It is found in the lungs of the frog and toad in a hermaphroditic condition. The eggs are laid and pass into the alimentary canal from the lung. They develop in water or soil into a *nematode* in which the *sexes* are *separate*. Fertilized eggs develop internally and eat all but the cuticle of the mother. From a free life in the mud they pass into the frog's lung, by way of its cuticle and mouth.

¹ For nervous system of *Ascaris* see Handbuch der Zoologie, v. 2, Achte Lieferung Teil (4) Bogen 23-32, ss. 280-283.

Family 2. Anguillulidae.—This immense group consists of small, thread-like nematodes which live in water, mud and soil, and also parasitically in plants and animals.

Anguillula aceti, the vinegar eel,¹ a frequent subject for laboratory experimentation, lives in vinegar and stale paste. *Tylenchus dipsaci* (*devastatrix*) attacks oats, rye, clover, hyacinths, the ear cockle of wheat and about a hundred other plants. *Tylenchus tritici* attacks oats. *Caconema* (*Heterodera*) *radicicola* attacks over seven hundred plant species, including tomatoes, cucumbers, potatoes, turnips, peach trees, lettuce, and most other crops and weeds. In crop rotation it is most important to keep down the weeds.

Life History of *Caconema radicicola*.—The female is pear shaped, and about 1/25 of an inch or about one-half the diameter of the head of an ordinary pin. More than 500 eggs may be produced by one female. Some of these pass out to the exterior, but many remain in the body of the mother to develop, nourished by her remains and by egg yolk. Upon hatching, the larvae seek out roots of many species of hosts and drill into them by means of a protrusible oral spine. The irritation causes a swelling or tubercle, the root-gall or *root-knot*. The males pass through a larval stage and shed their skins, then travel through the root tissue, as long eelworms, pair with the females and die. Males are 1/12 to 1/10 of an inch long.

Experiments showed that *Heterodera schachtii*, the beet-root nema, will travel thirty feet to a bed of germinating beet seeds.

In warm climates, such as the southern states and parts of California, soil nematodes may pass through ten generations a year. In colder latitudes, freezing may destroy them. Their ability to encyst themselves preserves many in cases where the soil is porous enough to enable them to burrow deep and then encyst. Warm, moist sandy soils favor these *nemas*; heavy wet soils are less affected.

Control.—The best method of removing plant parasitic nemas from the soil seems to be by *rotation of crops*. A few plants, like some varieties of wheat, millet, peanuts, rye, red-top, *corn*, cow-peas and soy beans, prove to be only slightly susceptible to *Caconema* (*Heterodera*) *radicicola*. In greenhouse soils, either steam sterilization or the use of hot water is effective. In the absence of weeds, *lure-crops* are used in greenhouses to advantage.

¹ Consult G. Zebrowski, 1931, "Anguillula Aceti—A Desirable Nema For Type Study." *Science*, vol. 74, pp. 390-391, Oct. 16, 1931.

Family 3. Strongylidae.—This family is of especial interest to us since it includes the hookworm of man, the gapeworm of fowls, and many other internal parasites infesting domestic animals. While these parasites are ordinarily found in the digestive tract, *strongylosis* may be bronchial or pulmonic, intestinal, vascular or renal. Young animals suffer more than adults. Larvae of the hookworm cause profound irritation as they bore through the skin of the feet into lymph spaces.



FIG. 37. *Syngamus trachealis*, the gape-worm. (After Jordan and Kellogg, *Animal Life*. Courtesy of D. Appleton & Co.)

Dictyophyme renale (*Eustrongylus visceralis*) (*S. gigas*, Rud) is the largest of the Nematelminths. The females may reach a length of 39 inches. It infests the kidneys of Carnivora (dog), Ungulata (horses, cattle) and even man.

Strongyloidea (*Dictyocaulus viviparus*) (*Strongylus micrurus*) infests the bronchi and air cells of cattle and causes *verminous bronchitis*. *Dictyocaulus filaria* infests sheep, goats and camels, attacking the bronchi and lungs. *Metastrongylus elongatus* attacks the bronchi and lungs of hogs. *Strongylus elongatus paradoxus* infests the fourth stomach (abomasum) of sheep, goats and cattle. *Strongylus equinus* bores through the gut into the blood vessels and causes aneurisms in the mesenteric vessels of the horse. Numerous other forms infest the domestic animals. A very common parasite of the fowls is *Syngamus trachealis* (Figure 37), the "gape-worm." In the tropics several cases of human infestation by gapeworms have been

reported this year (1931).

Oesophagostoma radiatum forms cysts in the mucous membrane of the intestines of cattle. *O. columbianum*, the nodular worm of sheep and cattle, produces nodules in the large intestine which have been mistaken for intestinal tuberculosis.

Necator americanus, the hookworm of man (Figure 50, A, B, C and D), causes tibial ulcer and dirt eating, besides weakness from loss of blood. The symptoms of hookworm include paleness, thinness, dull skin and eyes, dry hair, weakness, a depraved appetite for

ashes, tobacco, paper, plaster. Hookworm disease may be mistaken for anemia as the red corpuscles are deficient in number. The eggs pass out in the feces and if allowed to get into the soil will develop into tiny worms. Larvae of the hookworm enter the feet, boring through the skin into lymph spaces, thence via the lymph vessels to the veins and into the heart. The heart pumps them through the pulmonary arteries to the lungs. From the lungs (where they form lesions) they travel up the bronchi and trachea to the pharynx and are swallowed down the esophagus and into the stomach and intestine. They may come *directly* into the intestine from the mouth and esophagus, if taken in with dirty water or food. In the intestine they do not multiply, but the females continuously produce ova remaining there sometimes for three years. Nicoli showed (1917) that hookworm larvae will live in water for eighteen months, but Ackert found (1924) that at the end of that time, they were no longer infective.² Ackert also discovered that larvae will live in water ranging from 45° to 98° F. The similar *European hookworm* (*Ancylostoma duodenale*), found first in English Egypt, is about 2/5 of an inch long, living in the small intestine of man.

Ancylostoma braziliense, a worm infesting the small and rarely the large intestines of the cat, dog and fox, is the cause of "ground itch" in Southern United States. Reference has been made (page 88) to the important study of Wells (1931) on anemia produced by the dog-hookworm.

Through the activity of Dr. C. W. Stiles, U. S. P. H. S., and his co-workers in the Rockefeller Sanitary Commission,³ the hookworm is now being controlled in the United States and approaching control elsewhere. Dr. Stiles has pointed out (*Scientific Monthly*, October, 1931, vol. 33, pp. 362-364) that hookworm disease is even now one of the most important causes of backwardness in southern school-children.

Family 4. Trichuridae.—These nematodes, placed under the family Trichinellidae by some writers, are called the "hair necks," as they have a long slender anterior portion which contains the esophagus. The head is nude and the mouth rounded. They are oviparous.

² Ackert, J. E. 1924. Studies on the longevity and infectivity of hookworm larvae. *Am. Jour. of Hyg.*, vol. 4, no. 3, pp. 222-225.

³ Cort and his associates, in the International Health Board, have published more than thirty papers on hookworm disease, chiefly in the *Am. Jour. of Hygiene*.

Trichuris trichiura (*Trichocephalus trichiuris*) lives in the large intestine near the cecum of man. It does not move and is supposed to be of little injury. The posterior part of the body is threadlike, while the anterior part is much narrower and hairlike. Related species infest the colon and cecum of sheep, cattle, dogs and hogs.

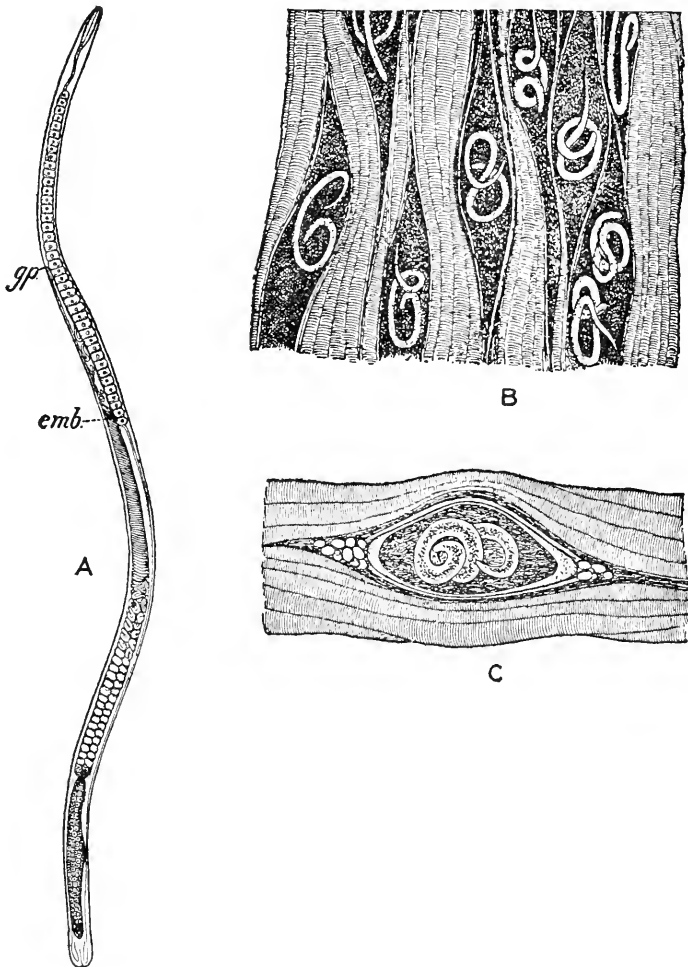

FIG. 38. A, *Trichinella spiralis*, female. B, larvae in muscle, not yet encysted. C, encysted larva. (From Daugherty after Leuckart. Courtesy of W. B. Saunders Co.)

Family 5. Trichinellidae. (Figure 38, *A*, *B* and *C*.)—In the minute *Trichinella spiralis*, the body is thicker posteriorly and not so slender and filamentous anteriorly, as in the *Trichuridae*. The embryos develop in the uterus and are hatched there, so that the young are brought forth alive (viviparous).

The Trichinellidae are found in the muscles of pigs, rats, mice, man, rabbits, guinea pigs, and dogs. They are not found in birds. Each larval worm is encysted in an oval capsule 0.4 to 0.6 mm. long. Cysts may number 100,000 to 125,000 per cubic inch of meat.

Life History of *Trichinella spiralis*.—If the cysts are eaten, the digestive juices free the worms from the meat in which they are encysted. They then enter the small intestine and become mature in a few days. The female, 3 to 4 mm. long (male 1.5 mm.), penetrates the intestinal mucous membrane and in a month gives birth to 1,500–10,000 living young and then dies. Young are carried from the lymph vessels through the thoracic duct to the veins, and finally from the blood vessels they wander into the most actively used muscles of the body, such as the diaphragm, eye-muscles, and muscles of the neck. They destroy the sarcolemma and become encapsulated in cysts about 1.5 mm. long. High fever is a symptom of trichinosis. In Emmerslaben, Saxony, in 1884, there was an historic instance of one infected pig producing serious illness in 364 people, 57 of whom died in the space of one month.

Within the past five years, a number of fatalities have been recorded, due to *Trichinella* infections, in these United States.

Family 6. Filaridae.—These extremely minute elongated worms live in blood and lymph vessels, serous cavities of the body, and in subcutaneous connective tissue. The males usually have a spirally rolled tail, and the females have two ovaries. The majority of them are viviparous. None of the family are blood suckers.

Filaria bancrofti, formerly called *Filaria sanguinis hominis*, is a slender, threadlike worm, the male about 40 mm. in length and the female about 100 mm. (4 inches). They live in the *lymphatic glands* of man, and pass from the eggs into the blood and sometimes into the kidneys. They are supposed to cause elephantiasis by obstructing the flow of lymph. They are transmitted by *night-flying* mosquitoes. *Loa loa*, a smaller form, is transmitted by a biting fly (*Chrysops*), which is *day-flying*. *Filaria perstans* is transmitted by a midge (Culicoides). It is essentially a parasite of the dark skinned races, rarely attacking the whites of West Africa.

Filaria equina infests the serous cavities and has been found in the aqueous humor and causes opaque cornea in the horse.

The female *Guinea worm* (*Dracunculus medinesis*) is about thirty-six inches long and as large as packing twine. It produces abscesses under the skin in which the worm is coiled. Embryos must enter water and penetrate the microscopic crustacean *Cyclops*. The larva reaches man through drinking water containing *Cyclops*. Guinea worms occur in Asia, Africa, and tropical America.

Mermithidae.—The hairworm, *Mermis subnigrescens*, is a parasite of the common grasshopper. The grasshoppers swallow the eggs with their plant food. The hairworm *Agamermis decaudata* also infests grasshoppers. Cobb and his associates have suggested that control of grasshoppers as pests may be aided by parasitizing them, thus causing sterility and death. They found that a *high* degree of parasitism caused all developing hairworms to become *males* and a *low* degree of parasitism resulted in the parasites all being *females*, with a gradient (see page 84) between the extremes, corresponding to the degree of parasitism. The *Mermithidae* constitute a very large group, *others* of which infest injurious insects, such as mosquitoes, ants, cutworms, and the like.

Forms Uncertain in Position Formerly Classed with the Nematelminthes—Acanthocephala.—In this group of “thorn-headed” worms, we find a protrusible rostrum or proboscis with five or more rows of recurved hooks. An alimentary canal is absent. An unpaired cerebral ganglion is present.

The larva of *Echinorhynchus gigas* lives in the larva of the June bug (*Melolontha*). The adult worm is found in the pig, attached when full grown to the wall of the small intestine. It is dioecious, i.e., the sexes are separate. The *ovaries* of the female break up into free floating egg groups. The *uterus* picks up immature and fertilized eggs indiscriminately, but only the elongate, *shelled* ones may pass the canals; immature eggs are led by a ventral opening back to the coelom. In *E. gigas*, protonephridia open beside the genital opening. The oviducts of the female and the penis of the male are at the posterior end.

Gordiaceae.—These minute, slender animals are commonly known as “horse-hair worms.” They have an esophageal nerve ring, a ventral nerve cord and the female genital opening is at the cloaca. The larvae infest insects and the adults live in water, twining around plants and depositing their eggs.

Treatment of Nematosis.—A diet rich in carbohydrates is said to lessen the damage to the liver, kidneys and adrenals that frequently ensues from the use of *carbon tetrachloride* in hookworm disease. Hexylresorcinol is also effective. (Science, Aug. 18, 1931.)

In certain pioneer studies, T. B. Johnson and W. W. Hodge, in May and June, 1913, determined the phenol coefficients of resorcinol,

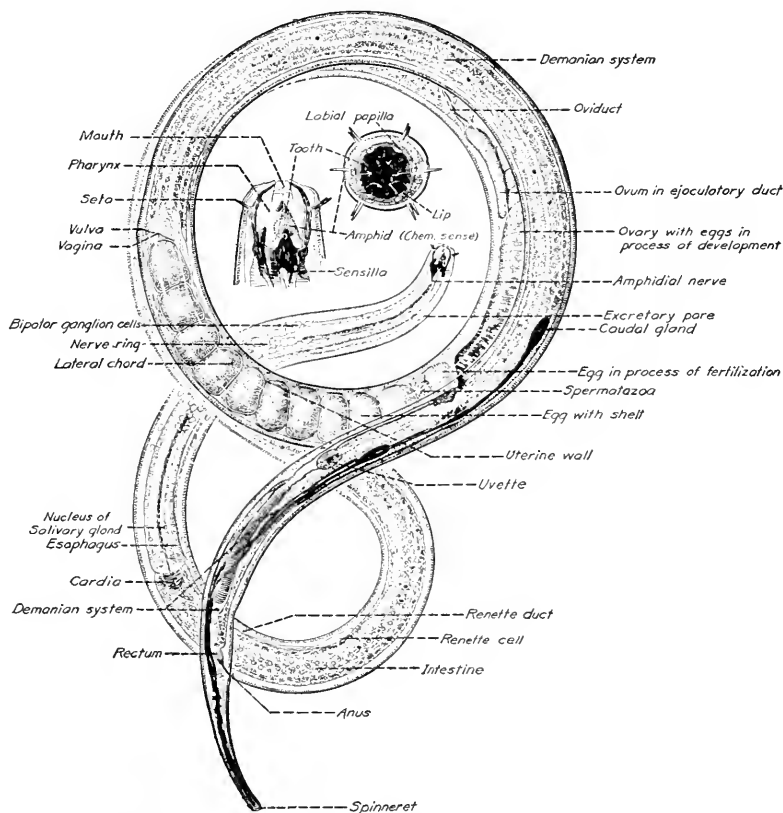

FIG. 39. Marine free living *Nematode*, *Metoncholaimus pristiurus*, female. Courtesy of N. A. Cobb. (Drawn by J. Danforth.)

ethyl resorcinol and propyl resorcinol, three of the four points on the curve. A brief account of the work of Professor Hodge was published in 1913, *Jour. Amer. Chem. Soc.*, vol. 35, p. 1014, but it was not until 1921, *Jour. Amer. Chem. Soc.*, vol. 43, pp. 348-360, that Hodge's curve with one more point added was published.

As an outgrowth of this pioneer work on alkyl-resorcinol derivatives, Doctor Leonard of Johns Hopkins University has developed the internal antiseptic "hexyl resorcinol."

Thymol in 60-grain doses is effective in the treatment of human helminthiasis. The active principle of *oil of chenopodium*, called *ascaridole*, is used in doses of 0.5 c.c. Calomel, *santonin*, and oil of male fern (*Aspidium*) are beneficial in trichinosis, but not effective after the parasites have become encysted.

Nematodes as Laboratory Material.—Certain free-living aquatic nemas are so resistant to external conditions that they can be shipped alive long distances, and are thus favorable laboratory material for zoölogical courses in schools and colleges. Prominent among these are species inhabiting foul mud, such as *Metoncholaimus pristiurus* (marine) and its close relatives, and certain species of *Dorylaimus* (fresh water). *M. pristiurus* have been shipped thousands of miles both summer and winter, and used successfully.⁴

GENERAL CONSIDERATION OF THE NEMATHELMINTHES

Distribution.—Nematodes are found from the depths of the sea to the tops of mountains and in hot springs and Antarctic ice. While it was formerly supposed that they were almost all parasitic, it is now known that besides infesting animals and plants of all species, there are very many, small, free-living species.

Physiology.—Nematodes usually have a simple digestive tract, well-developed excretory organs, tubular gonads and a nerve ring with sensory papillae and both dorsal and ventral nerves.

Fossil Relatives.—The Nematodes range from the upper Paleozoic to the present. They are found in the Coal measures and parasitic in insects in the Tertiary amber.

Ancestry and Relationships to Other Phyla.—The various classes of Nematelminthes differ and it is still very doubtful whether they should be grouped into a single Phylum. Some of the families formerly classed under the Nematelminthes are now separated, apparently resembling the Annelida.

REFERENCES ON NEMATODES

CHANDLER, A. C. 1922. *Animal Parasites and Human Diseases*. J. Wiley and Sons, N. Y.

⁴ Cobb, N. A. 1931. *Science*, vol. 74, pages 489-490.

- COBB, N. A. 1914. Nematodes and their Relationships. Year Book of U. S. D. A., 1914, and many papers.
- CORT, W. W., AND ASSOCIATES. (Many papers in Am. Jour. of Hygiene.)
- HARRIS AND BROWN. 1925. *Oxyuris vermicularis* as a causative factor in appendicitis. Jour. Am. Med. Assoc., vol. 84, no. 9, pp. 650-654.
- STILES, C. W. 1903. Hookworm Disease. Bulletin 10, Hygienic Lab., Washington.
- STILES, C. W. 1910. Hookworm Disease. Pub. Health Bulletin 32, Washington.
- STILES, C. W. 1910. Soil pollution as cause of ground itch, hookworm disease and dirt eating. Circ., Rockefeller Sanitary Commission for the Eradication of Hookworm Disease.
- UNDERHILL, B. M. 1924. Parasites and Parasitosis of the Domestic Animals. Macmillan Co., N. Y.
- WARD, H. B., AND STUDENTS. (See bibliography from Univ. of Illinois.)

CHAPTER VII

ANNELIDA OR ANNULATA

THE OLDER terminology included the Molluscoidea, the Platyhelminthes, the Trochelminthes, and the Nemathelminthes with the Annelida under the general term Vermes. For several decades, however, the Phyla have been separated.

The Annelida (Lat. *annellus*, a little ring) are the most highly developed of the worms, with regularly segmented bodies, which in most cases indicate by external annulations the metameric arrangement within, which is such that the internal organs are repeated in each segment. The head usually has a "prostomium" in front of the mouth. (See Figure 45.)

There is usually a well-developed coelom, and an extensive series of blood vessels. Hair-like or comb-like gills function in respiration in some forms, while in others minute capillaries in the skin aërate the blood. The excretory organs, called nephridia, are segmentally arranged and the nervous system consists of dorsal cerebral ganglia, and a ventral nerve cord with segmentally arranged ganglia.

CLASSIFICATION

1. **Class *Archi-Annelida*** (Gr. *arche*, beginning; Lat. *annellus*, a little ring) without setae or *parapodia*.
2. **Class *Chaetopoda*** (Gr. *chaite*, bristles; *pous*, foot) with setae.
3. **Class *Hirudinea*** (Lat. *hirude*, a leech) without setae or *parapodia*, but with suckers.

CHARACTERISTICS

1. Segmented worms in which the segmentation is in most cases visible externally.
2. Appendages paired, not jointed.
3. Setae are present in the body wall.
4. The coelom usually communicates with the exterior by paired nephridia, and pores.

5. The nervous system consists of two dorsal ganglia, connecting commissures passing around the pharynx, and a ventral chain of ganglia with lateral nerves.
6. The alimentary canal is well developed and usually specialized.
7. Trochophore larva found in many forms.

NATURAL HISTORY

Class 1. Archi-Annelida.—The most primitive of the Annelida are the Archi-Annelida, represented by two families, both marine and exceedingly small. The family *Polygordiidae* includes the sand-living form *Polygordius*. It is slightly over an inch long, with indistinct external annulations, but a septate coelom, and metameric development of nephridia, gonads, digestive tube and ventral nerve cord. The larva has a trochophore stage.

The family *Histriodrilidae* are minute parasitic worms infesting the lobster. They have three horny jaws, a well-developed digestive system consisting of esophagus, intestine and rectum; and have primitive united cerebral ganglia. The sexes are separate.

Class 2. Chaetopoda.—In the Chaetopoda, segmentation is distinct both internally and externally, and the setae are segmentally arranged on the parapodia or sunk in pits.

Order 1. Polychaeta.—The polychaetes are chiefly marine animals, with setae arranged in groups on the fleshy parapodia. They have a distinct head, usually provided with sense organs. The *prostomium* bears from one to ten dorsal *tentacles* and two ventral *palps*, which in certain forms are broken up into long respiratory filaments. The sexes are usually separate. Eyes are present on the prostomium of some forms, and *lithocysts* in a few forms (*Arenicola*). Polychaetes are of different colors, including red, blue, green, or yellow. They usually pass through a *trochophore stage*. (See p. 125.)

Heterogony is present in *Nereis*, a small pelagic form alternating with a large bottom living one. The *palolo worms* of Samoa (*Leodice viridis*) come to the surface during the October full moon to breed and are caught by the natives who use them for food.

A few polychaetes are found in fresh water; the rest are marine, and chiefly bottom living animals, which burrow in the sand or live in tubes. The free-living forms are *predaceous*; the sedentary ones live on all kinds of organic matter. There are many commensals and a few parasites. (See p. 483.)

Syllidae are brightly colored forms less than an inch long, which are frequently found associated with sponges; some have an alternation of generations, in *Autolytus* for example (Fig. 40) an asexual individual sending off from its posterior end buds which become male or female.

Aphroditidae are scale bearers, the scales, called *elytra*, acting as breathing organs. *Lepidonotus squamatus* has twelve pairs of *elytra*. *Polynoë*, a small form about an inch long, has a large proboscis, with four strong jaws and a circle of papillae. It has twelve pairs of scales. *Aphrodite*, sometimes called the "sea mouse," is about five inches long and of a brilliant iridescent color.

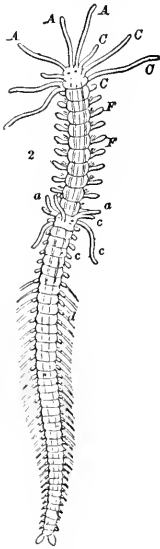

FIG. 40. A sexual individual of *Autolytus* with male about to detach. (From Verrill, *Invertebrate Animals of Vineyard Sound*.)

Phyllodocidae are green and usually iridescent, with a long head which bears four pairs of short and four pairs of long tentacles. They secrete slime which binds mud together.

Nereidae include the common *Nereis*, which may reach a length of eighteen inches. The "clam worm," as it is called by fishermen, is bluish green in color, and lives during the day in burrows in the sand, but comes out during the night, and is preyed upon by fishes.

Nephtydidæ are dorsi-ventrally flattened, elongate worms, whitish in color with a distinct red dorsal blood vessel. They are found in sand and mud along the shore.

Leodicidae (*Eunicidae*) include the Pacific (Samoan) palolo worm, and the Atlantic palolo worm (*Leodice fucata*) of the West Indies and the Gulf of Mexico, which swarm within three days of the full of the July moon. (See the Samoan palolo, page 118.) *Diopatra* is a large reddish brown worm, found from Massachusetts to South Carolina, in long tubes which project above the surface. *Diopatra* reaches a length of twelve inches, but is difficult to capture on account of the speed with which it hides in its tube. (Fig. 41.)

Glyceridae include forms which are smooth, about eight inches long, and have many segments. The small conical head has many tentacles. The long proboscis has four hooked jaws. The *Seden-*

taria lack both jaws and a protrusible pharynx. They have small *uncini*, or hooked setae, and a few hair setae. Some species form calcareous tubes (Serpula), while others use the material available, furnishing a cement by which they bind together sand, shells, or sea weed into protective coverings. The *Spionidae* include a number of small burrowing worms with long peristomial cirri curving over the back, and with the dorsal cirri serving as gills. The proboscis lacks jaws. The *Chaetopteridae* include fifteen species of short, stout worms, which live in parchment-like tubes.

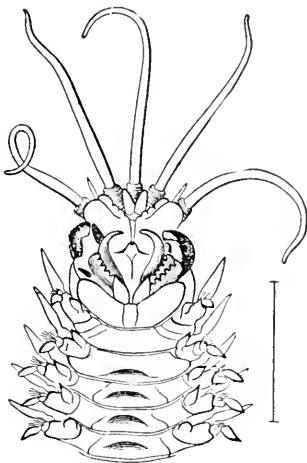

FIG. 41. *Diopatra cuprea*.
(From Verrill.)

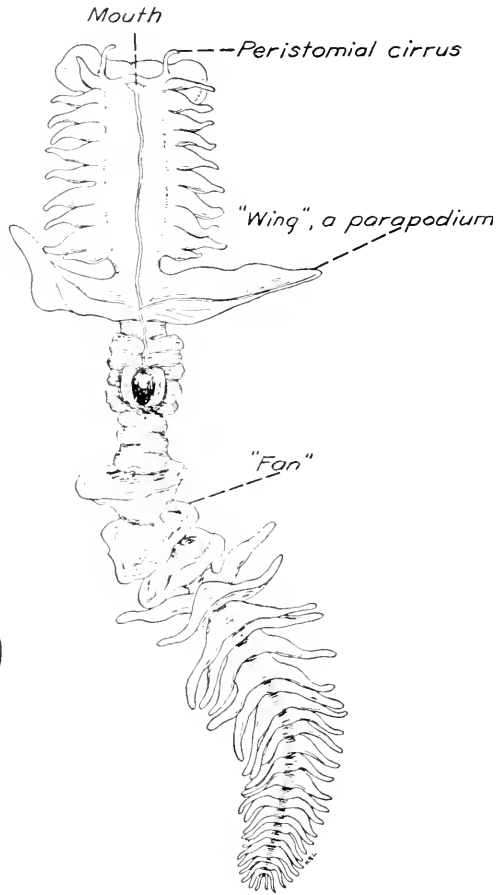

FIG. 42. *Chaetopterus pergamentaceus*. (Original drawing by H. Lammers.)

Certain species are highly phosphorescent. Important studies in Experimental Embryology have been made with the Woods Hole species, *C. pergamentaceus*. (Fig. 42.) In the *Terebellidae* we find a cylindrical body, having many similar lobes, and with well-de-

veloped mucus-forming glands. *Amphitrite* (Fig. 43) reaches a length of fifteen inches, and is reddish brown in color. It is found in sand and mud at low water mark. *Polycirrus* (the blood worm) is a long, slender, blood-red worm which does not form a tube, and has no branching gills. The *Amphictenidae* are small worms which form portable tubes of sand open at both ends. *Cistenides* (*Pectinaria*) *gouldii* is a flesh-colored form found in shallow water from North Carolina northward.

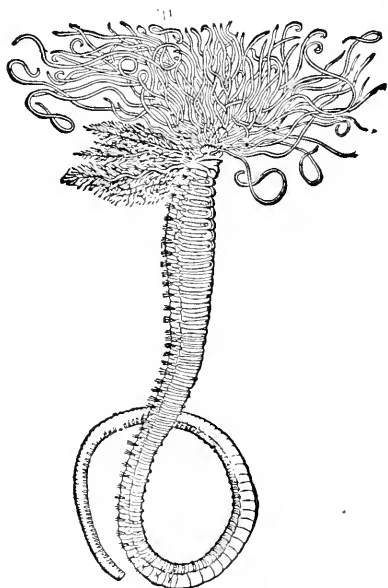

FIG. 43. Tufted worm (*Amphitrite ornata*).
(Drawn by Verrill.)

The *Cirratulidae* are worms with a cylindrical body, having many similar segments with long filamentous cirri. They live in burrows.

Maldanidae form sand tubes. They lack gills. *Clymenella* is one of the commonest types. The *Arenicolidae* are represented by but two common species. *Arenicola marina*, called the "lug-worm," reaches a length of ten inches. It has twelve pairs of branched red gills on the central segments. It burrows as much as two feet into the sand, but can be located by castings at the entrance. The *Sabellidae* include a number of genera.

The tentacles are rudimentary, the palps very large. A proboscis is present. They form membranous tubes in mud and sand. Example—*Sabella microphthalmia*. *Serpulidae* form long contorted calcareous tubes which are found incrusting shells. (*Serpula* or *Hydroides*.)

Order 2. Oligochaeta.—These hermaphroditic annelids lack tentacles and parapodia, and have only a few setae, projecting from pits in the body wall. Certain oligochaetes have external gills (*Nais*). The head is not distinct, but has a small projection, the *prostomium*, and a *peristomium*, which contains the mouth, but lacks setae. Paired ovaries and testes are present in each animal, and seminal receptacles store the sperm prior to the extrusion of eggs

and sperm into a cocoon, which is secreted by the modified clitellum. There is no metamorphosis. The oligochaetes are singularly lacking in sense organs, pigment eyes being found in the Naids. We shall mention only five of the eleven families. (Figure 44.)

Aelosomatidae are microscopic fresh water worms, whose red, yellow and brown oil globules make them appear spotted. They reproduce by fission, and are considered the most primitive oligochaetes.

Enchytraeidae are slender small worms found in plants and in fresh water, near the sea shore. Their blood may be colorless, red or yellow. The small white form, *Enchytraeus albidus*, is recommended by Gamble as exceedingly useful for observation under a binocular microscope. It requires a temperature not higher than 60° F.

Naidae are small, transparent, aquatic forms with a distinct head, and from two to four groups of setae on each segment. In *Nais*, a common fresh water species, the blood is yellow or red. Eyes are usually present. Budding is a common form of reproduction. The *Tubificidae* are slender reddish worms living in tubes, from which they protrude the posterior end into the water. Many species of *Tubifex* are found in brackish water; a few occupy fresh.

Lumbricidae include the common earthworms. Among them are the familiar *Lumbricus terrestris* of Europe and America; *Eisenia (Allolobophora) foetida*, commonly found in manure; and *Helodrilus*, represented in America by ten species. Aristotle called the earthworms the "intestines of the earth."

Order 2. Oligochaeta. Fam. Lumbricidae. Type—*Lumbricus terrestris*.—The earthworm is from 5 to 18 inches long, with 100 to 160 segments, strongly marked by external rings. A tropical species, *Megascolex australis*, reaches a length of eleven feet.

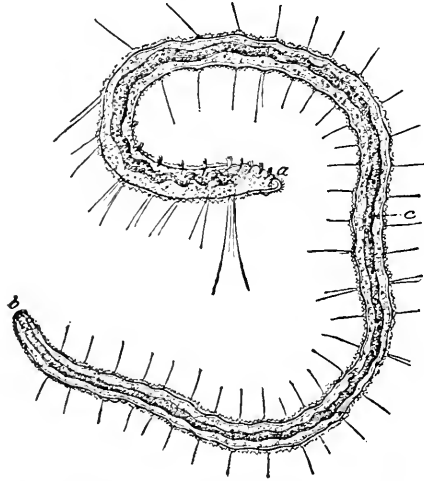

FIG. 44. *Nais*. (From Leunis. Davenport's Zoology. Courtesy of The Macmillan Co.)

Anatomy.—At its anterior end, *Lumbricus terrestris* has a proboscis-like fleshy lobe called the *prostomium*, with a mouth immediately behind it on the ventral side. The skin is covered by a transparent *cuticle* which is slightly iridescent, and is externally marked by annulations representing true segments. All segments except the first and the last have four pairs of *setae*, two pairs being ventral and two pairs ventro-lateral. (Fig. 45, *A* and *B*.)

From the 31st to the 37th somite, the *clitellum* is situated. This aids the worms in adhering at mating and furnishes a slimy sub-

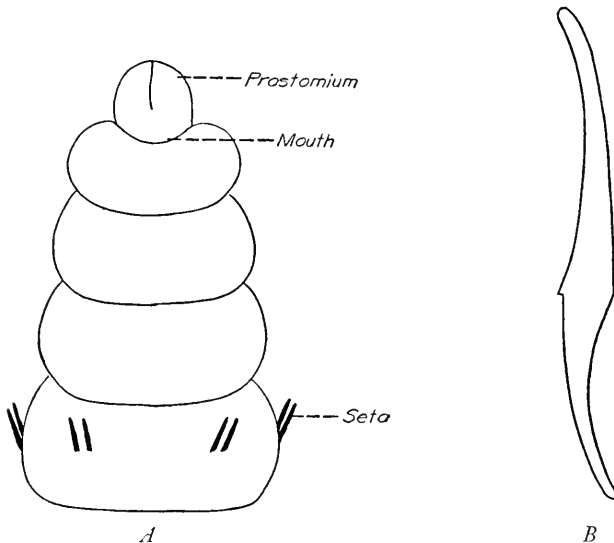

FIG. 45. *A*, ventral view of the first four segments of *Lumbricus terrestris*, showing rows of setae. *B*, enlarged seta. (Drawn by W. J. Moore.)

stance that hardens into the cocoons in which the eggs are fertilized and develop. The setae of the 26th somite are modified for reproduction.

The external openings include the *mouth* and *anus* at opposite ends. There are two *nephridiopores* for each somite except the first three and the last. The two pairs of *seminal receptacle* openings are found between the ninth and tenth and the tenth and eleventh somites. The two *oviducal openings* are at the 14th somite. The two *vasa deferentia* at the 15th somite are readily seen. There are also *dorsal pores* on the middle line of the back between the rings,

from the 8th somite to the last one, which permit the passage of fluids from the coelom to the skin. The *anus* is at the posterior end.

Skin.—The thin protecting *cuticle* is formed from the living cells of the hypodermis beneath. The *hypodermis* consists of a single layer of cells most of which are covering and supporting, but some of which are modified into glandular (mucus) cells, and others into nervous cells. The nerve cells are connected with sensory fibers passing into the nerve cord, and the animal is very sensitive to light, touch and chemically different substances. The setae which are chitinous are worn away and replaced by reserve setae that grow from the main seta-sac.

Muscular System.—The circular muscles lie immediately beneath the hypodermis and, contracting, elongate the segments. The longitudinal muscles, contracting, draw the ends of the segments towards each other, and the direction of the *setae* determines whether the movement is forwards or backwards.

Body Cavity.—The body cavity, lined by peritoneum, contains the digestive tract, gonads, nephridia, circulatory system and nervous system beside the coelomic fluid with *yellow cells*, derived from the walls of the intestine, and the phagocytic *amebocytes* which, like the phagocytic white corpuscles of man, engulf poisonous particles.

Digestive System.—The mouth or buccal cavity (1–3 somites) leads into the pharynx (4–5 somites), with *glands* which moisten, and with powerful muscles which force food on. External muscles attached to the body wall *expand* the pharynx. The esophagus (6–14th somite) has three pairs of saccular *calciferous glands*, at the 10th, 11th, and 12th somites, secreting *calcium carbonate*, which neutralizes the free acid of the soil. The secretions from the posterior pairs of calciferous glands open into the anterior pair, and thence into the esophagus. (Figure 46.)

The three pairs of glands are really parts of one glandular structure, which extends from somites 10 to 14. In many specimens of *Lumbricus terrestris*, the only distinct enlargements are in somite 10. The *crop* (15th and 16th somites) is for storage, and mixture with the secretions of the calciferous glands. The *gizzard* (17th and 18th somites) grinds the food with sand and gravel. The stomach-intestine (19th somite to anus) has a median dorsal infolding, the *typhlosole*, that increases the surface for absorption and retards the passage of food.

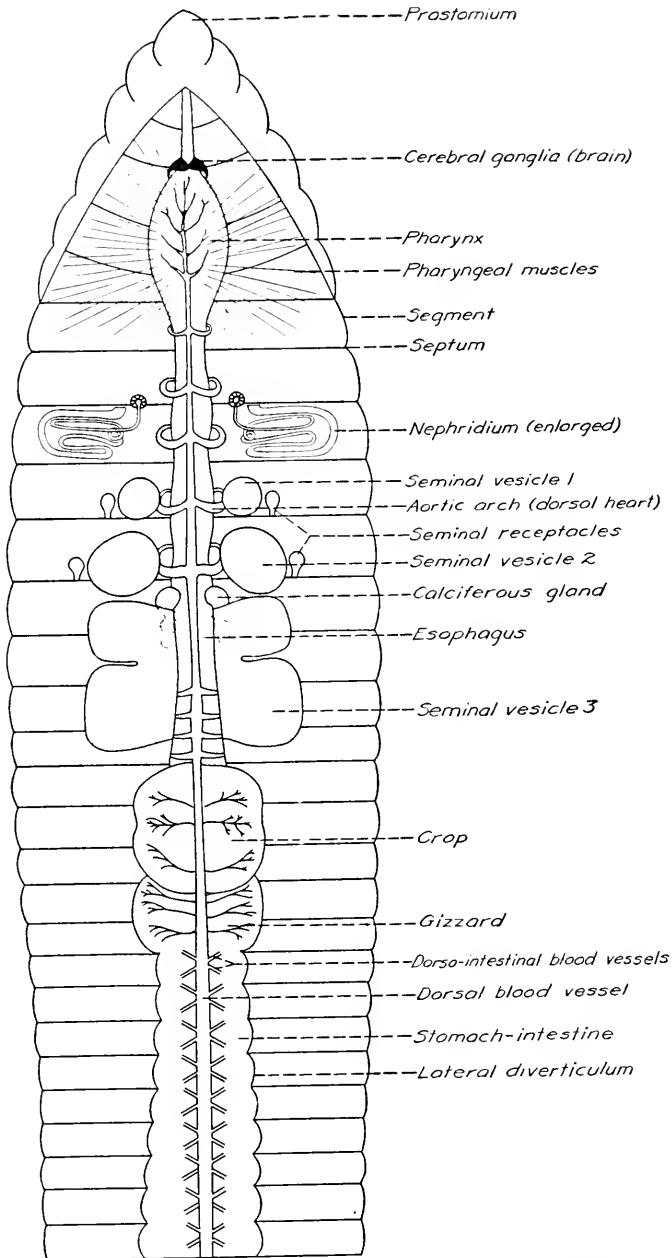

FIG. 46. Internal anatomy of the earthworm. (Drawn by W. J. Moore and Norris Jones.)

The *stomach-intestine* has secretory cells that furnish a digestive fluid corresponding essentially to the *pancreatic juice* of the mammals, as it digests proteins, carbohydrates and fats. Albumin is broken down in $3\frac{1}{2}$ hours at 37° C. in an alkaline medium, or $28\frac{1}{2}$ hours in an acid medium. It is believed that a peptolytic ferment is present that accounts for *slow* digestion in an *acid* medium. An *amylotic* ferment diastase changes *starch* into *sugar* (maltose). An *emulsifying* ferment acts on the fats. *Absorption* is by osmosis and the *blood* transports the nutriment. The *rectum* is the posterior part of the intestine and has *no* typhlosole. It opens to the outside through the posterior *anus*.

Circulatory System.—There are 5 longitudinal blood vessels; 1 dorsal, 1 ventral, 1 subneural and 2 lateral neural vessels; 5 pairs of *dorsal hearts* or *aortic arches* (7–11 somites). Parietal vessels connect the dorsal longitudinal vessel to the subneural.

In the first 12 somites the dorsal vessel is *not* a collecting vessel, but behind the last pair of hearts in the 11th somite, it receives blood from the body wall and the alimentary tract. Two longitudinal trunks lateral to the alimentary canal *collect* blood from the anterior somites and passing posteriorly, join the dorsal vessel in the 12th somite.

From the posterior part of the body the blood is carried forward in the *dorsal vessel* as far as the “hearts” which force it into the ventral vessel. *Valves* in the *aortic arches* and dorsal blood vessel prevent the blood from returning. The *ventral vessel* distributes the blood, which flows anteriorly in front of the aortic arches and posteriorly through the remainder of the body wall, nephridia, and alimentary system. Aërated blood returns to the dorsal trunk through the subneural and intestinal vessels.

There are two distinct fluids which remain separated. The *coelomic fluid* is found between the gut and the body wall. The *haemolymph* is found in a series of closed tubes. The *coelomic* fluid corresponds to the lymph of higher animals which bathes the individual cells of the body. *Haemolymph* is apparently a solution of haemoglobin. The *red fluid* corresponds to red blood corpuscles of the blood of the higher animals and serves as a carrier of oxygen to various cells and tissues of the body.

In marine worms the respiratory pigment is called *chlorocruorine*. It is *porphyrin* combined with iron. Some marine forms like *Arenicola* and *Nereis* have brilliant red blood; *Aphrodite* and

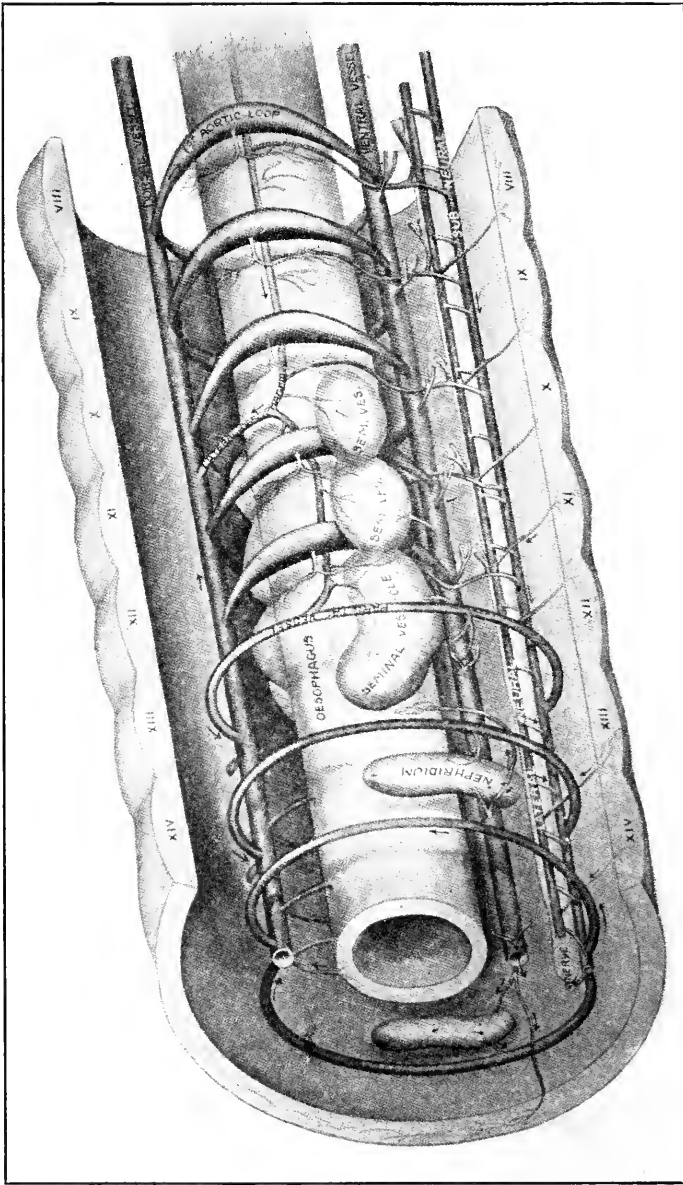

FIG. 47. Stereogram showing the relation of the circulatory and other organs in the anterior part of the earthworm. (Worked out by Professors McGregor and Calkins, and drawn by Miss Hedge. After Calkins. Courtesy of Henry Holt and Co.)

Polynoë have pale yellow blood; but in *Sabella* it is an olive green.

The nervous system is well supplied with blood, having two *lateral neural* and one *subneural* vessel for the *nerve cord*. At room temperature (12°–18° C.) in *Lumbricus terrestris*, the dorsal vessel pulsates about fifteen to twenty times per minute, and in *Nereis* (marine sand-worm) it is about eight times per minute. *Respiration* is osmotic. There are many capillaries under the cuticle.

Excretion.—Paired *nephridia* are found in each segment except the first three and the last. The receiving opening, the ciliated *nephrostome*, is situated one segment anterior to the one containing its own *nephridium* and *nephridiopore*. From the nephrostome or funnel, currents flow into the *ciliated neck* which passes through the anterior wall of the segment behind, then into a *narrow tube* which *coils* three times and then opens into a *wide glandular tube*, which expels the waste at the external opening, the *nephridiopore*. About half of the nephridiopores are situated on the ventral surface in front and slightly laterad to the outer seta of the inner double row; while the remainder of the excretory apertures are high up on the side of the animal, dorsad to the row of dorsal seta bundles, at irregular distances.¹

Solid wastes pass out the *anus* and *gaseous* wastes through the *dorsal* pores of the body wall, which are mid-dorsal, in the groove between the segments. The first one is between segments ten and eleven and opens into segment eleven.

Reproductive System. (Figure 46.)—The earthworm is hermaphroditic (monoecious) with the gonads of both sexes, but does not fertilize its own eggs.

FEMALE

Internal Structures

Ovaries, 13th somite.

Two pairs of *seminal receptacles*.

External Structures

Oviducts opening at 14th somite.

Openings to the *seminal receptacles* between the 9th and 10th; and the 10th and 11th somites.

¹ In our description of the earthworm it will be noted that certain errors of most textbooks have been corrected, particularly in treating of the calciferous glands, the position of the nephridiopores, and the collecting vessels in the anterior somites. Such corrections were inspired by the paper by Frank Smith, Certain differences between text book earthworms and real earthworms. Trans. Ill. Acad. Sc., vol. 17, pp. 78–83. For systematic study of the Annelida, see Verrill, A. E., 1880, New England Annelida. Trans. Conn. Acad. Sci., vol. 4.

MALE

Paired *testes* in the 10th and 11th somites.

Three pairs of *seminal vesicles* attached from the 9th to the 12th somite. The last pair, bi-lobed, extend down over the 13th and sometimes the 14th somite.

Paired *vasa deferentia* opening at the 15th somite.

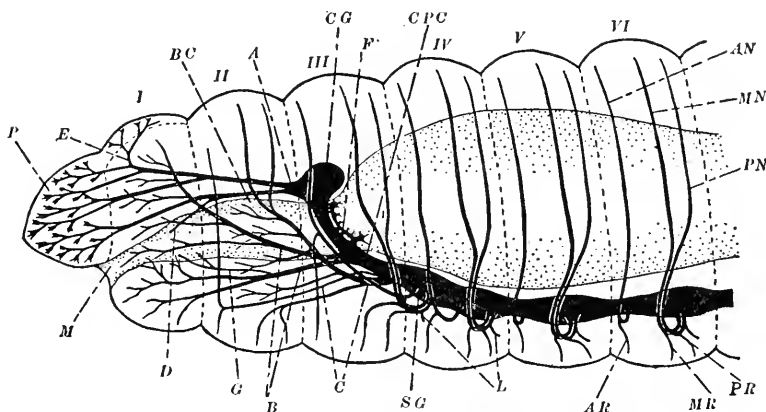

FIG. 48. Nervous system of the earthworm. Drawing showing a lateral view of the arrangement of the larger nerve trunks in the left half of the anterior segments of the earthworm, *Lumbricus terrestris*. *A*, nerve from lateral region of cerebral ganglion which passes to prostomium; *AN*, dorsal ramus of anterior segmental nerve; *AR*, ventral ramus of anterior segmental nerve; *B*, nerve from near middle region of circumpharyngeal connective which passes to segment 1; *BC*, buccal cavity; *C*, nerves from ventral region of circumpharyngeal connective which pass to segment 2; *CG*, cerebral ganglion; *CPC*, circumpharyngeal connective; *D*, branch of nerve to prostomium that supplies tissues of dorsal region of buccal cavity; *E*, nerve that supplies the portion of the prostomium in the dorsomedian region of segment 1; *F*, gangliated thickening of enteric nerve plexus; *G*, branch of nerve to segment 1 that supplies tissues of ventral region of buccal cavity; *L*, septal nerve; *M*, mouth opening; *MN*, dorsal ramus of median segmental nerve; *MR*, ventral ramus of median segmental nerve; *P*, prostomium; *PN*, dorsal ramus of posterior segmental nerve; *PR*, ventral ramus of posterior segmental nerve; *SG*, subpharyngeal ganglion; *I-VI*, segments 1 to 6. (Courtesy of W. N. Hess, *Journal of Experimental Zoology*, vol. 40, p. 235.)

Conjugation.—Two earthworms pair so that segments 9, 10 and 11 of each animal are opposite the *clitellum* at segments 31–37, and the *vasa deferentia* of each animal are nearly opposite the 26th segment of the other where the *setigerous glands* are modified. *Mucus* secreted by the *clitellar* and other *glands* of each worm becomes hardened into a *single "slime-tube"* encasing both animals from the

8th to the 37th somite. Two parallel lines extend posteriorly from the *vasa deferentia* to the clitellum, forming primitive *channels* for the *passage* of seminal fluid. Within the *slime-tube* the seminal fluid flows, containing free *spermatozoa* and spermatophores. The spermatophores are deposited in the *seminal receptacles* of the other worm and the slime-tube is soon left.

Fertilization.—Later on at the appearance of the capsule or *cocoon*, formed by *capsulogenous glands* in the clitellar region, the 4-6 mature eggs are picked up at the egg-sacs opening at the oviducal apertures in the 14th somite; and the sperms that were stored in the *receptacles* are secured at their openings between the 9th and 10th and the 10th and 11th somites. Fertilization is effected in the cocoon at the time it slips off over the head, and since the *sperms* are from another animal, self-fertilization is prevented. In *Lumbricus communis*, two embryos are produced as a rule, in many cases arising as twins from a single ovum. Foot found (1898) that the total number of eggs in 100 cocoons was 399, about 4 to a cocoon. Isolated worms deposit cocoons for weeks.

The observations of Foot and Wilson have been to some extent contradicted by Grove and Cowley (1926), who found in *Eisenia foetida* that cocoon formation does not take place while the worms are still united by the conjugation slime tube.²

² Grove, A. J., and Cowley, L. F. 1926. On the reproductive processes of the branding worm, *Eisenia foetida* (Sav.). Quart. Jour. Microsc. Sci., 70 (4), 559-581.

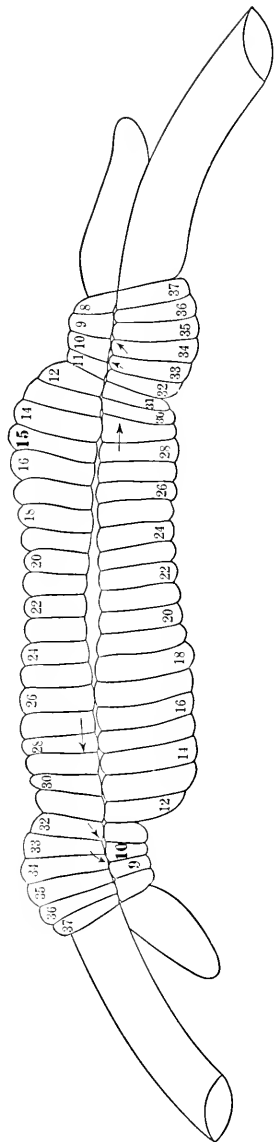

FIG. 49. Sperm transfer in *Lumbricus terrestris*. (Drawn by W. J. Moore.)

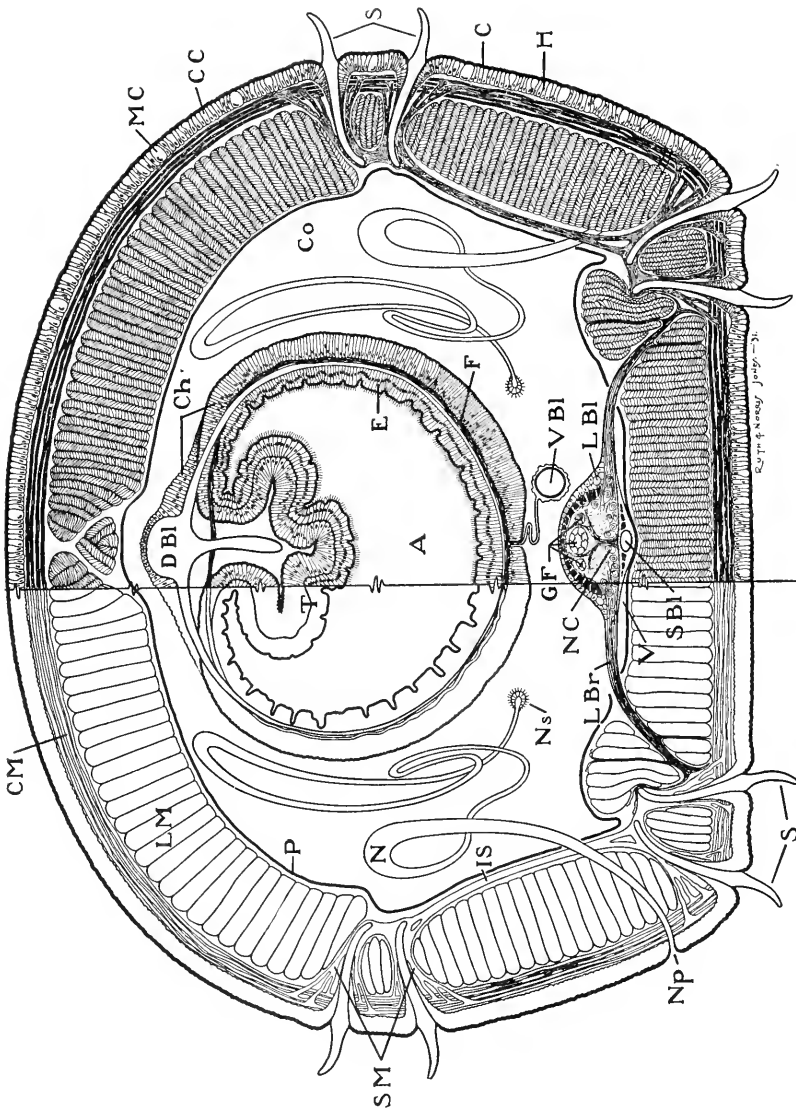

FIG. 50. Cross section of the earthworm. By Ruth and Norris Jones. *CM*, circular muscle; *LM*, longitudinal muscle; *P*, peritoneal layer; *SM*, setigerous muscles; *N*, nephridium; *IS*, inter-setal muscle; *NP*, nephridiopore; *S*, setae; *LBr*, lateral nerve branch; *V*, ventral nerve cord; *SBI*, subneural blood vessel; *NC*, nerve cell; *GF*, giant fibers; *LBI*, lateral neural blood vessel; *DBI*, dorsal blood vessel; *F*, fibromuscular layer; *MC*, columnar cell; *CC*, coelom; *H*, hypodermis; *Co*, coelom; *C*, cuticle; *DBI*, dorsal blood vessel; *CH*, chloragogue cells; *T*, typhlosole; *E*, lining epithelium; *F*, fibromuscular layer; *A*, alimentary canal.

They noted that after conjugation, a new slime tube is formed extending from the 7th to the 34th segment and that the eggs pass back into the cocoon, before it leaves the region of formation at the clitellum. Whether the sperms are squeezed out as the capsule reaches the apertures of the seminal receptacles, or they are also passed back to the capsule, the authors are not certain.

Nervous System.—In the worms we have well-developed cerebral and ventral ganglia, constituting the *centralization stage* in the evolution of the nervous system of invertebrates. A bilobed *brain* (paired cerebral ganglia) sends off two *circumpharyngeal connectives*, which unite at the *subpharyngeal ganglion*. A *ventral nerve cord* has a *ganglion* in each segment, with three pairs of *lateral nerves*. Two pairs come off at the ganglia and one pair *between* the ganglia. Afferent nerve fibers are sensory; efferent nerves are motor. Stough (Jour. Comp. Neurol., vol. 40, no. 3, June, 1926) has shown that the giant fibers, seen in cross sections of the earthworm nerve-cord, are strictly segmental structures, and consist of a large number of closely applied parallel axones. *Epidermal* sense organs, chiefly located anteriorly and posteriorly, were discovered by Fanny Langdon when a college Junior. (Figure 50.)

Behavior.—Earthworms react to the ordinary stimuli of light, temperature, chemicals and electricity. They are very susceptible to the contact stimuli produced by vibrations. It is reputed that one way to drive earthworms from their burrows is to bore with a sharp stake into adjacent soil.

Several articles have appeared recently regarding the so-called "singing" of earthworms. Apparently reliable reports have been made of the peculiar noises, possibly due to the rasping of the setae over stones or pebbles. Clark (Animals of Land and Sea) states that the singing girls of Java sometimes swallow earthworms in the hope that the tinkling sound will be "imparted to their voices."

Class 3. Hirudinea—Leeches.—*Hirudo medicinalis*, the medicinal leech, has a deep olive hue, is velvety, two to three inches in length, hermaphroditic and is found in Europe, America, Turkey and Africa. Medicinal leeches live 15–20 years, and are adult at 5 years. They inhabit water; the female deposits 15–20 eggs in a cocoon. These hatch in 3–4 weeks.

External Anatomy.—Their external segmentation does not correspond to the internal. There are usually 5 external grooves to each segment. The medicinal leech has 2 suckers.

Digestive System.—The digestive tract consists of the mouth, with three jaws, armed with chitinous teeth, a pharynx, esophagus, crop with eleven lateral diverticula, stomach and an anus. A secretion called *deutero-albumose* (hirudin) prevents the blood from clotting. It is formed by the glands located near the jaws. The muscular *pharynx* dilates to receive the blood and passes it on through the short *esophagus* to the *crop* which has 11 pairs of *lateral diverticula* and which stores the blood until it is digested in the globular *stomach*. No digestion takes place in the lateral "pockets." The *rectum*, situated between the last two *diverticula*, is separated by a *sphincter* muscle from the true *stomach*. It ends as the dorsal *anus* near the *posterior sucker*.

Circulatory System.—There are two main lateral vessels running longitudinally. These are connected with each other by looped vessels which give off many branches. There are two *sinuses*, one dorsal and one ventral, with numerous primitive lymphatic vessels. The blood is red with many white blood corpuscles. The leech has a body temperature of about 57° F., except when it has just gorged with mammalian blood.

Respiration is carried on by the highly vascular skin. Experiments have shown that leeches will live in pure Nitrogen for from 2 to 6 days.

Excretory System.—Seventeen pairs of nephridia, from the second to the eighteenth segment, open laterally on the ventral surface. There are about five external annulations to each true segment.

Reproductive System.—Leeches are hermaphroditic. There are nine pairs of diffuse *testes*, which are situated on each side of the nerve cord. The *spermatozoa* pass by a short canal into the long wavy *vasa deferentia*. From these they travel in the *epididymis* where they are bundled into *spermatophores* and pass out by the *penis*. They leave the body in the mid-ventral line between rings 30 and 31.

Two small tubular *ovaries* are enclosed in *vesicles*, continuing into *oviducts* which unite as a *uterus*. *Glandular cells* secrete into the uterus a mucus fluid which later hardens into a *cocoon*.

The *genital pore* is situated in the mid-ventral line at rings 35 and 36 (segment 11). Conjugation consists in the actual simultaneous insemination of each worm by the other. *Spermatophores* may remain for a long time in the uterus or may travel almost immediately in the female ducts and fertilize the eggs at the ovaries. *Cocoon* formation results.

The *Nervous System* consists of a pair of *dorsal ganglia* situated above the pharynx and of a *double commissural nerve cord* with 23 ganglia. The dorsal, *supra-esophageal* ganglia are connected with the *sub-esophageal* pair by a rather narrow nerve ring surrounding the esophagus. The sub-esophageal ganglia represent five pairs of *fused ganglia*. From the dorsal ganglia, nerves supply the "eyes" and *tactile* and *gustatory* organs. The *last ganglion* gives rise to seven pairs of nerves. The *brain* gives rise to five pairs of optic nerves. There are ten "eyes" and many olfacto-gustatory and tactile sense organs.

Allied Injurious Leeches.—*Hirudo sanguisuga* is found in the nasal passages of man. *Haemopsis vorax*, the horse leech, is taken into the mouth when young by horses and cattle. It lives in ponds, ditches and springs and attacks man, the horse, ox, camel, and dog. It may become attached to the mouth, pharynx or even descend to the trachea. It is also found attached to the conjunctiva. It produces anemia, emaciation and even death. The treatment is strong salt solution, alum, and tar. The tar causes coughing and expulsion of the parasites loosened by the action of the salt and alum. If the water is stocked with fish or filtered through sand, the parasites are destroyed.

The *land leeches*, *Haemadipsa Zeylanica*, are wiry, active forms, thin as a knitting needle, 1 inch long and not more than $\frac{1}{2}$ inch in diameter. They attach to the legs of man and animals. They are found in Ceylon, India, the East Indies, Japan, Australia and South America.

Adaptation of the Leech to Its Mode of Life.—The leech is remarkably adapted to its habitat. It can swim with great rapidity; it is protected by a rather tough hide. It has a mouth with 3 jaws armed with chitinous teeth, a crop with 11 lateral diverticula capable of storing enough blood to last 9 months. It takes in 3 times its own weight at one time. Not only does it have anterior and posterior suckers, but it secretes a substance "hirudin" said to be deuterio-albumose, which prevents blood from clotting.

GENERAL CONSIDERATIONS

Distribution.—The *Chaetopoda*, which include earthworms and aquatic worms found in both salt and fresh water, are distributed widely. Very few are parasitic but a number are commensals. It

is estimated that the average field soil has 150,000 earthworms to the acre.

Some fresh water *Oligochaeta* form tubes of mud held together by a mucus secretion. Others like the marine *Chaetopterus* form a yellow, parchment-like tube. Some species like *Hydroides* (*Serpula*) form lime tubes on shells. *Sabellaria*, an aberrant form, builds reefs on porous rocks from sandy tubes. Some species excavate galleries in rock or corals.

Behavior.—The *palolo-worm*, *Eunice*, found in the Pacific coral reefs, swarms during the last quarter of the moon in October and November. The sexual posterior part of the worm (called the *epitoke*) separates from the sexless anterior portion (*atoke*) and floats on the sea, giving off spermatozoa and eggs. Fishermen prepare their nets and boats and capture these worms in great numbers, sometimes cooking them in leaves, but at other times eating them alive. (See p. 102.)

The Annelids are said to give little response to light and shadow after they have become accustomed to them. But Copeland, 1930 (Jour. Comp. Psychol., vol. 10, p. 339), showed that in *Nereis virens*, an apparent "conditioned response" was induced by either increased or decreased illumination, which indicated to the worm the presence of food. The *earthworm* draws leaves into the burrow to line it. There is no exploration of the form of the leaf; it is seized at any point, but only those seized at or near the apex get into the burrow.

Hirudinea.—The leeches (*Hirudinea*) are parasitic forms infesting invertebrates as well as vertebrates. The majority of the leeches live in fresh water and parasitize molluscs and the vertebrates. Certain of them are permanent ectoparasites, *Branchellion* attaching to various elasmobranchs. The *giant leech* (*Macrobodella valdiviana*) may reach a length of 1½ feet and is subterranean and carnivorous. *Clepsine* carries its young on the ventral surface. The *skate sucker* (*Pontobdella muricata*) has a leathery knobbed skin. It lays its soft eggs in empty mollusc shells and guards them for over 100 days. *Lophobdella* lives on the lips and jaws of the Crocodilia. Certain intermediate types, the *Myzostomata*, parasitize the feather stars, forming galls on them.

Parasites of the Annelida.—Certain parasitic *Nematodes*, the minute threadworms (*Pelodera pellio*), are found in the body cavity and nephridia as well as the ventral blood vessels of the earthworm. Various protozoa also infect the Annelida.

Physiology, Anatomy, and Locomotion.—The Chaetopoda are made up of similar segments or metameres. At the sides are borne chaetae or *setae*, which are in some forms attached to muscular processes called *parapodia*. The well-developed body cavity or *coelom* contains the alimentary canal, the vascular system and respiratory branchiae. The excretory organs, *nephridia*, are arranged in pairs in each segment except the first three and the last. Sexes are separate in some forms while others are hermaphroditic. The nervous system consists of paired dorsal cerebral ganglia and a ventral chain of ganglia with lateral nerves. The larval form is called a *trochophore*. The *Naidae* are fresh water forms which bud *asexually*. The *Hirudinea* have about *five* external *annulations* to each internal segment and have an extremely distensible crop for the storage of blood. They are hermaphroditic. They swim with great rapidity. The aquatic forms have an undulatory movement, while the land forms, like the ordinary earthworm, contract the circular muscles of the body, thus elongating the segments, and then having fixed the setae in the ground, by contraction of the longitudinal muscles, direct the movement of the worm either anteriorly or posteriorly.

Regeneration.—Earthworms will regenerate a head or a tail, sometimes forming a tail in place of the head, and starving to death. Grafting and fusion to form two-headed or two-tailed individuals have been successful.

Fossil Relatives.—The *Chaetopoda* are found as fossils from the Cambrian to the present, while the *Hirudinea* are unknown as fossils.

Ancestry and Relationship to Other Phyla.—There seems to be a well-defined connecting link between the leeches and the allies of the earthworm, since we find that the leech *Acanthobdella* has setae and a well-developed coelom.

There seems to be a wide gap between the Platyhelminthes and the Annulata, since both metamerism and a different nervous system characterize the latter. Some would hold that the hair worm, *Gordius*, is a close relative of the Annulata. On account of the common Trochophore larva, some have linked the Trochelminthes with the Annulata. (See page 125.)

ECONOMIC IMPORTANCE OF THE EARTHWORM

Positive.—(a) Charles Darwin estimated that there were 50,000 worms in one acre of ground and cited a stony hill covered with earth

three inches deep in twenty years. Eighteen tons of earth were brought to the surface in one acre.

(b) Earthworms have been and probably are still used by some savages as food.

(c) Earthworms and marine annelids are used as fish bait.

Negative.—(a) Earthworms may be of slight injury in greenhouse soils.

(b) Earthworms are *accidentally* intermediate hosts in the transmission of the gape-worm, *Syngamus trachealis*. It is not *necessary* to the life of the parasite that it be taken in by the earthworm.

(c) Certain medical men have from time to time suggested that the earthworm may be important in transmitting cancer through the deposition of the organism in feces transferred to vegetables by the earthworm. This is purely conjectural.

ECONOMIC IMPORTANCE OF THE LEECH

Positive.—(a) In cases of hemophilia (persistent bleeding) and after contusions, physicians and veterinarians still use leeches to extract blood. Some drug stores keep a supply of leeches on hand in the *spring* to serve the needs of those foreigners who get black eyes at weddings and other celebrations. The doctor of the Middle Ages was called the "leech."

(b) Leeches are said to have been used for food by some savages.

Negative.—Leeches parasitize some aquatic and amphibious forms.

CHAPTER VIII

PHYLUM TROCHELMINTHES

THE ROTIFERA, sometimes called "wheel animalcules," belong to a group, the exact relationship of which is unknown. They have sometimes been classed with the worms. The majority of them are free swimming and move by means of a trochal disc (Fig. 51). In other forms a telescopic tail aids the animal in performing looping movements similar to those of a leech. Przibram states that, in the Rotifer, growth is not followed by the formation of new cells, but the size of single cells increases.

Rotifera are for the most part found in fresh water, although a few are marine. When the water dries up, the thick-shelled *winter eggs* of certain rotifers may be dispersed by the wind or by animals. They are able to survive freezing temperature.

Eichhorn (1781) describing *Floscularia* says: "Now I come to a very wonderful animal, which has often rejoiced me in my observations: I call it the Catcher: extraordinarily artistic in its structure, wonderful in its actions, rapid in capturing its prey." (From H. S. Jennings, in Ward and Whipple's "Fresh Water Biology," published by John Wiley and Sons, Inc., 1918.)

Rotifera have an elongated *body*, with a tail-like appendage, the *foot*, which commonly ends in two pointed *toes*. Pedal cement glands aid in attachment. The *digestive system* is well developed with an anteriorly situated *mouth* which is between the ciliated trochal discs and leads into a muscular *pharynx*. At the lower end of the pharynx is the gizzard or *mastax* which has chitinous teeth. (See Gosse, "Structure, Functions and Homologies of the Manducatory Organs in the Class Rotifera." Phil. Trans., 1856.)

The *excretory system* is relatively simple, with paired convoluted tubes, the kidneys, which open directly or indirectly into the cloaca. The *nervous system* consists of the dorsally situated brain, with nerves given off to the corona, the muscles, integument, and sense organs. Two large nerves are given off laterally from the brain and each divides into a ventral and a lateral longitudinal trunk. The sense organs consist of the tactile and olfacto-gustatory an-

tennae, and the single or paired eyes, which are not present in all forms.

The *male* reproductive system consists of a large testis, two or

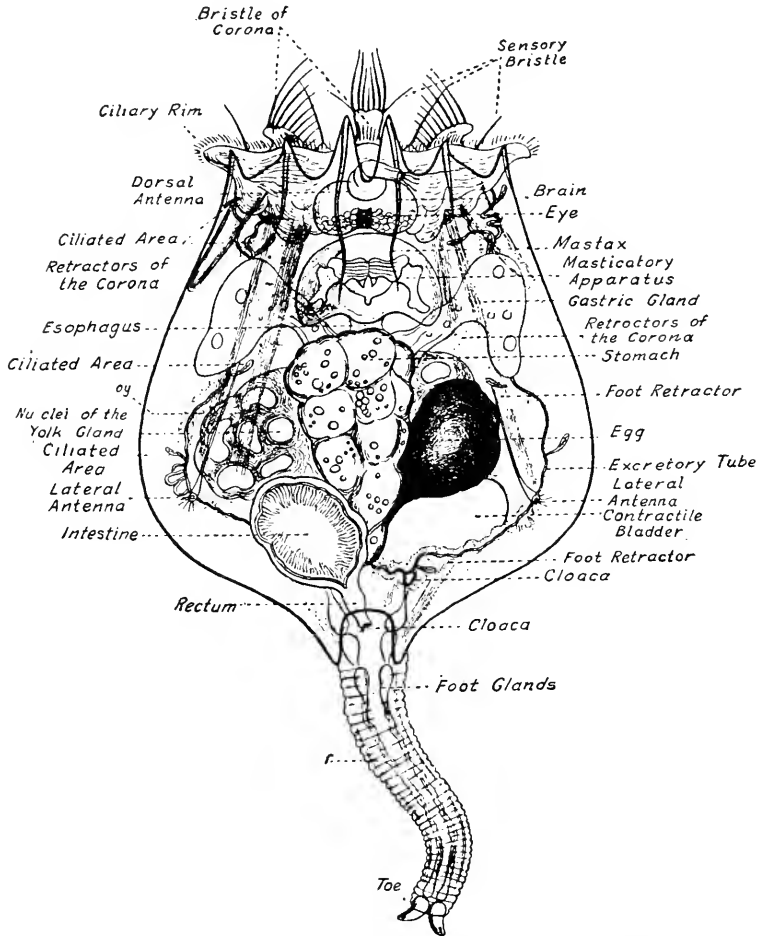

FIG. 51. Diagram of a Rotifer. *Brachionus rubens* Gosse. (After Wesenberg-Lund.)

four so-called prostate glands, a well-developed vas deferens, a large seminal vesicle, and a protrusible penis.

Males of most Rotifera are relatively short-lived and quite degenerate. In some species no traces of the digestive glands and mastax, prominent in the female, are found. The rudimentary

anterior portion of the digestive tube serves as a suspensory ligament for the testis. (Miller, 1931.)

Cloacal fertilization is not apparently the rule, since in many cases the male apparently bores into the body wall and the sperms evidently pass through the wall of the oviduct in order to fertilize the eggs. (Gamble, Camb. Nat. Hist.) Males hatch from the small eggs of the *mictic* females.

In the female the large yolk-gland or *vitellarium*, which usually consists of eight cells, is found on the ventral side of the stomach. The true *ovary* consists of many small, rounded cells, the posterior one enlarged and receiving a shell just before it is extruded.

Rotifers are especially interesting to us on account of their use in experiments on the alternation of parthenogenetic and bi-sexual development. Whitney, Shull, Luntz and others have studied the influence of food and other factors on the control of the reproductive cycle in rotifers (Figure 52).¹

Recalling Loeb's discovery that in the Echinodermata the extraction of water from the eggs by hypertonic solutions would start developmental processes, Jacobs (1909) suggested that in certain rotifers desiccation is able to bring on reproduction. Hickernell (1917), studying *Philodina roseola*, found that the dried rotifer had an integument thinner than that of the undried specimen, and that an increase in the number of ovarian nuclei occurred at the very beginning of the drying process, while the animal was recovering. But Whitney (1930), reporting on the hatchability of eggs of *Hydatina senta* stored for twenty-two years, found that the fecundity of individuals hatching from fertilized eggs after this long period of desiccation was lowered, the mothers from *old* eggs producing an average of thirty less daughters than the controls.

It was shown by dal Bianco (Jour. Exp. Zoöl., vol. 39, no. 1, 1924) that HCl and FeSO₄ brought about a notable acceleration of the life cycle of *Proales felis*, even with concentrations that induced a marked mortality.

Jennings and Lynch (1928) studied the origin of individual differences during parthenogenetic reproduction under constant environmental conditions. Their studies seem to indicate that differences in the length of life of rotifers result from the interaction of rhythmic processes of digestion and reproduction. They found,

¹ Consult Shull, A. F., Determination of types of individuals in aphids, rotifers and cladocera. Biol. Rev., 1929, vol. 4, no. 3, pp. 218-248.

in addition to difference in length of life, differences in *fecundity* of individuals, correlated with differences in the size of the parthenogenetic eggs from which they were derived. Lynch and Smith (1931) showed that in rotifers it is possible to produce and maintain depression for a long period of time and that the depression becomes

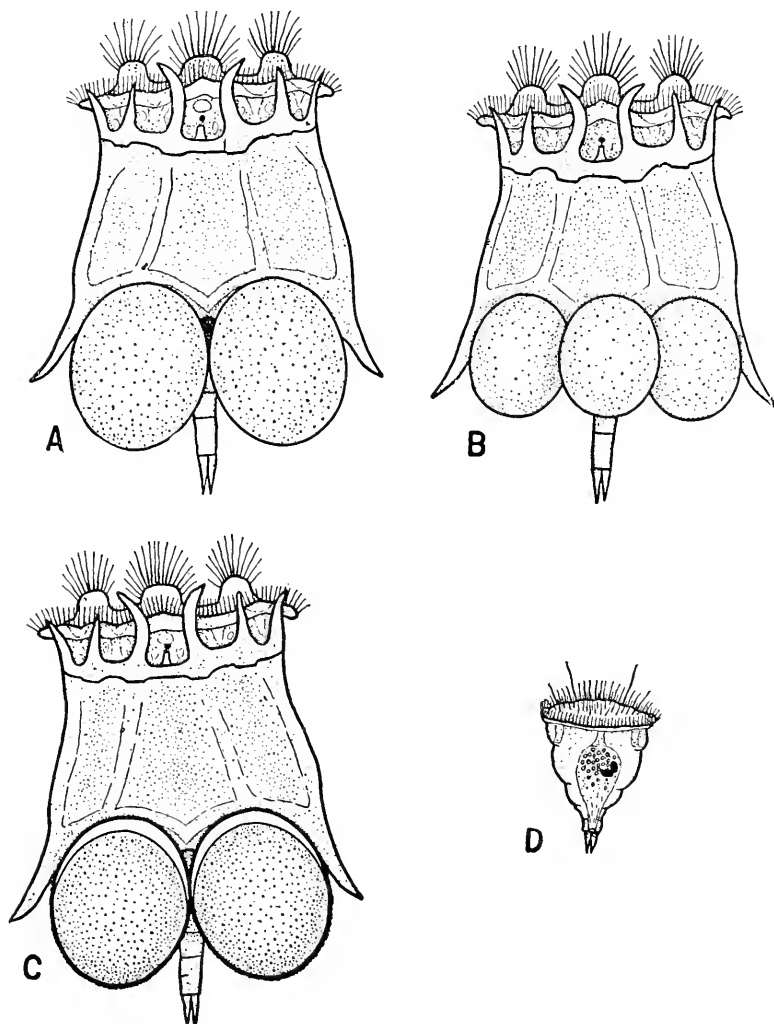

FIG. 52. *Brachionus militaris*. Dorsal views. A, female with attached parthenogenetic female eggs; B, female with attached parthenogenetic male eggs; C, female with attached fertilized eggs; D, male. (After Whitney, *Jour. Exp. Zool.*, vol. 24, Oct. 1917.)

greater in later generations. With restoration to normal conditions, however, it disappears within one or two generations.

Miller (1931) has described the life history of the rotifer *Lecane*, which is admirably suited to a study of the alternation of parthenogenetic and bisexual generations. The *mictic* female rotifer, capable of sexual reproduction, produces small eggs which if unfertilized develop into males. The fertilized eggs are larger and produce females. The common type of rotifer female, the *amictic*, cannot reproduce by amphimixis (see page 518). Eggs of the amictic females develop by diploid parthenogenesis (see pages 503 and 505) and produce diploid females, which may be either *amictic* or *mictic*. In Miller's studies, the length of life of females of *Lecane inermis* depends to some extent on the severity of the process of egg production. The mictic females produce about two-thirds as many eggs as the amictic and have a longer life.

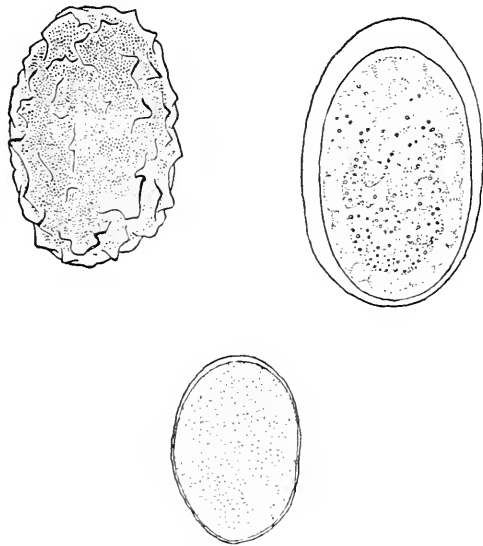

FIG. 53. Female producing and male producing eggs of *Lecane inermis*. Left, the fertilized (female producing) egg of the mictic female. Right, the (female producing) egg of the amictic female. Bottom, the (male producing) egg of the mictic female, before the initiation of cleavage. (Courtesy of H. M. Miller and the Biol. Bull.)

Parasitism in Rotifers.—Some rotifers (Drilophaga) parasitize worms and some (Seison) parasitize crustacea. Others are internal parasites found infesting the coelom or the intestine of worms.

The *trochosphere*, or *trochophore* larvae of the Rotifera, resemble the free swimming larvae of certain annelids. (See page 119.)

REFERENCES ON TROCHELMINTHES

- HICKERNELL, L. M. 1917. A study of desiccation in the rotifer *Philodina roseola*, with special reference to cytological changes accompanying desiccation. Biol. Bull., vol. 32, no. 5, pp. 343-407.

- JACOBS, M. H. 1909. The effects of desiccation on the rotifer *Philodina roseola*. Jour. Exp. Zoöl., vol. 6, no. 2, pp. 207-263.
- LUNTZ, A. 1926. Untersuchungen über den Generationswechsel der Rotatorien. I. Die Bedingungen des Generationswechsels. Biol. Zentralbl., 46: 233.
- LUNTZ, A. 1929. Untersuchungen über den Generationswechsel der Rädertiere. II. Der zyklische Generationswechsel von *Brachionus bakeri*. Biol. Zentralbl., 49: 193.
- LYNCH, R. S., AND SMITH, H. B. 1931. A study of the effects of modifications of the culture medium upon length of life and fecundity in a rotifer, *Proales sordida*, with special relation to their heritability. Biol. Bull., vol. 60, no. 1, pp. 30-63.
- MILLER, H. M. 1931. Alternation of generations in the rotifer *Lecane inermis* Bryce. I. Life histories of the sexual and non-sexual generations. Biol. Bull., vol. 60, no. 3, pp. 345-381.
- SHULL, A. F. 1911. Jour. Exp. Zoöl., vol. 10, 1911, and later papers.
- WESENBURG-LUND. 1929. Handbuch der Zoölogie, Bd. 2, L. 50, W. de Gruyter & Co., Berlin u. Leipzig.
- WHITNEY, D. D. 1907. Determination of sex in *Hydatina senta*. Jour. Exp. Zoöl., vol. 5, pp. 1-26.
- WHITNEY, D. D. 1916. The control of sex by food in five species of rotifers. Jour. Exp. Zoöl., vol. 20, pp. 263-296.
- WHITNEY, D. D. 1930. Hatching twenty year old eggs and the reduction of vigor in the rotifer *Hydatina senta*. Anat. Rec., vol. 47, p. 354.

CHAPTER IX

MOLLUSCOIDEA

CERTAIN forms known as Brachiopoda and Bryozoa ("Polyzoa" of England), on account of their resemblance to Mollusca, have been grouped under the Phylum Molluscoidea.

In 1830, J. V. Thompson separated the Bryozoa from the polyps, and called them Polyzoa from their habit of gemmation, and their digestive tube. One year later, Ehrenberg changed the term to Bryozoa. In 1841, Milne-Edwards created the Phylum Molluscoidea, including it in Bryozoa and Tunicata. Subsequently the Tunicata were removed, and in 1853, Huxley added the Brachiopoda.

Class 1.—The *Brachiopoda* (Gr. *brachion*, the arm; and *pous*, a foot) are strictly marine, being found in all oceans, and occupy a calcareous bivalved shell, the valves of which are dorsal and ventral instead of lateral as in the Lamellibranchs. Once rulers of the sea, it is supposed that the Brachiopoda or "lamp-shells" were notably reduced in numbers by *boring molluscs*. They are geologically very ancient, *Lingula*, the oldest known genus of animals, having changed but slightly since the earliest Silurian times.

Class 2.—The *Bryozoa* (Gr. *bruron*, moss; and *zoon*, animal) are for the most part colonial, somewhat resembling hydroids. They are sometimes stained and

sold as "air-plants" but Hydrozoa (page 69) are the common "air plants." They are found in both salt and fresh water. The *false coral* (*Discosoma nidita*) is a marine colonial form that encrusts shells and stones until it somewhat resembles coral. It is found in water at least thirty feet deep. (Mayer.)

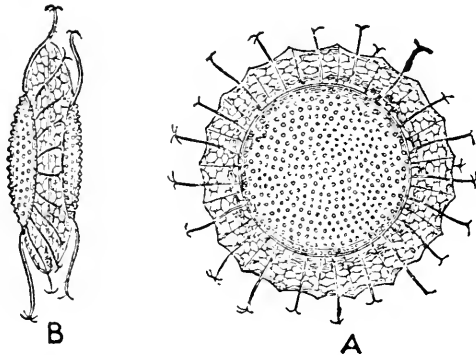

FIG. 54. Statoblast of *Cristatella*. (After Allman. Courtesy of Macmillan and Co., Ltd.)

Occasionally one finds the fresh-water Bryozoa *Fredericella* and *Plumatella* encrusting masses of vegetation and plant life in "pipe moss." They die speedily when water is filtered, or when ground water is used. The compound bryozoan *Pectinatella* alarms some pond owners as it increases rapidly, forming a jelly-like mass, sometimes six feet in diameter. (Figure 54.) Bryozoa are eaten by sharks, the cunner (a teleost), and an aquatic mammal, the "black-fish."

REFERENCES ON BRYOZOA

- ALLMAN, G. J. 1856. Monograph of freshwater Polyzoa. Proc. Roy. Soc.
 BOSSLER, R. S. The Bryozoa or Moss Animals. Smiths. Inst. Rep. no. 2633.
 O'DONOGHUE, C. H. AND E. 1926. Second List of Bryozoa from Vancouver Island Region. Cont. to Can. Biol., N.S., 111, pp. 47-132.
 OSBURN, R. C. 1912. The Bryozoa of the Woods Hole Region. Bull. of the Bur. of Fish., vol. 30, doc. no. 760, pp. 205-266.

Class 3. Phoronidea.—The Phoronidea resemble the Bryozoa in some respects and are usually placed under the Molluscoidea. Phoronidea are sessile marine worms bearing tentacles and living in chitinous sand-covered tubes. The body of Phoronis is cylindrical, and unsegmented, containing a large body cavity, with mesenteries dividing it into three chambers. There are two circulatory fluids, a colorless one in the body cavity, and the red *hemoglobin*-containing blood of the closed circulatory system. Phoronis is hermaphroditic, the larvae in their metamorphosis passing through a stage called the *Actinotrocha*. A horseshoe-shaped nerve ring is located at the base of the tentacles, with two ciliated sensory grooves anterior to it.

CHAPTER X

ECHINODERMATA

ECHINODERMATA (Gr. *echinos*, a sea hedgehog; *derma*, skin) is a group of marine animals representing the most highly specialized of the radially symmetrical forms, and is further distinguished by the presence of a calcareous skeleton, which is sometimes in the form of scattered particles or spines, in other cases developed into plates. A well-developed coelom points to a high degree of organization.

CLASSIFICATION

- Class 1. Asteroidea** (Gr. *aster*, a star; *eidōs*, resemblance) pentamerous; arms not sharply marked off from disc; ambulacral groove present. (Starfishes.)
- Class 2. Ophiuroidea** (Gr. *ophis*, a snake; *oura*, a tail; *eidōs*, form) pentamerous; arms sharply marked off from disc; no ambulacral groove. (Brittlestars.)
- Class 3. Echinoidea** (Gr. *echinos*, hedge-hog; *eidōs*, form) pentamerous; without arms or free rays; test of calcareous plates having movable spines. (Sea urchin, sand dollar, heart urchin.)
- Class 4. Holothuroidea** (Gr. *helos*, whole; *thurois*, rushing) long ovoid; muscular body wall; tentacles around mouth. (Sea cucumbers.)
- Class 5. Crinoidea** (Gr. *krinon*, a lily; *eidōs*, form). Arms generally branched and with pinnules; aboral pole usually with cirri or sometimes with stalk for temporary or permanent attachment. (Feather star, sea lily.)
- Class 6. Cystoidea** (Gr. *cystis*, bladder; *eidōs*, form)—extinct. Confined to Paleozoic; extend from Cambrian to Permian inclusive with maximum development in Ordovician and Silurian.

Calyx usually stemmed; mouth nearly or quite central upon the upper (ventral) surface. From the mouth radiates two to five or more simple or branching ambulacra along which food particles pass to the mouth probably driven

by numerous cilia. These food grooves may be on outer surface and are rarely extended into free branches, the arms. Anal opening excentric, often closed by a valvular pyramid.

Cystoids are the oldest and least specialized group of Pelmatozoa (which include cystoids, blastoids and crinoids).

Class 7. *Blastoidea* (Gr. *blastos*, a bud; *eidos*, form)—extinct. Confined to the Paleozoic, ranging from the Ordovician to the Permian. Calyx ovate, short stemmed or stemless; distinct arms absent, existing only as pinnules. Ten spiracles around mouth, connected internally with hydrospires. Some have a distinct anal opening; in others this is fused with one of the spiracles. From the mouth radiate five ambulacral areas.

CHARACTERISTICS

1. Radially symmetrical; larvae bilaterally symmetrical.
2. Calcareous skeleton, sometimes in plates which fit into each other to form a shell; sometimes in the form of scattered particles or spicules.
3. In many the surface is beset with spines or tubercles.
4. Never move rapidly in an adult condition; some are fixed by a stalk.
5. Never bud to form a colony.
6. All marine.
7. Water vascular system (coelomic in origin) used for locomotion and to open bivalve molluscs.
8. Body cavity well developed in the disc and usually in the arms, and separate from the digestive cavity.

NATURAL HISTORY

Class 1. *Astroidea*. *Type of Group*—*Asterias forbesii*. *Starfish*. (Figure 55).—The starfishes have a star-shaped body, with a central disc and five radiating arms, each of which contains a prolongation of the body cavity and the organs belonging to the digestive, reproductive and water-vascular systems. On the dorsal side one finds the anus and the madreporic plate, while on the ventral surface the tube feet protrude from five narrow grooves.

External Anatomy.—The upper (aboral) surface is distinguished by the presence of many *spines* of various sizes; *pedicellariae* at the bases of the spines; a *madreporite* which is the entrance to a *water-vascular* system; and *anus*.

The lower surface, usually attached, has a *mouth*, five grooves (ambulacral) with two to four rows of *tube feet* extending from them.

The skeleton is made up of *calcareous plates* (*ossicles*) united by connective tissue. Ossicles are regularly arranged around the mouth and in the *ambulacral grooves* and often along the sides of the



FIG. 55. Common starfish. (From Mayer. Courtesy of N. Y. Zool. Soc.)

arms. The *ambulacral ossicles* are movably articulated so that they can open or close the *groove*. At the end of the ray the *ambulacral ossicles* end in a median terminal *ossicle*. There are thus two or three rows of movable *ambulacral spines*. The *spines* are *short* and *blunt*, covered with *ectoderm* and arranged in irregular rows parallel with the long axes of the rays. They are supported on irregularly shaped ossicles.

In the spaces between the ossicles are a number of *minute pores*, the *dermal pores*, bearing *retractile dermal branchiae* or *papulae* which are soft filiform processes and *concerned in respiration*. The body wall is covered with a layer of *ciliated epithelium*, the *epidermis*, continued over tubercles, spines, pedicellariae, dermal branchiae and tube feet. (Figure 56.)

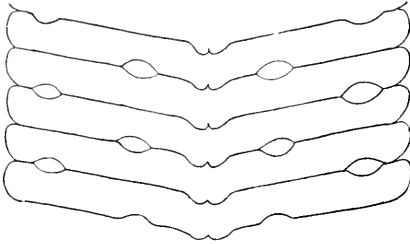

FIG. 56. Ambulacral plates and pores.
(W. J. Moore.)

Musculature.—The arms are movable, being supplied with muscle fibers in the body wall.

Digestive System.—The *mouth* opens through a short passage, the *esophagus*, into a wide sac, the *cardiac* division of the stomach. This is *five-lobed* (pentagonal), with

each lobe opposite one of the five arms. The *cardiac* stomach is everted through the mouth. Its retraction is effected by special retractor muscles attached at the sides of the ambulacral ridges.

The *cardiac stomach* communicates with the smaller pentagonal pyloric stomach, which in turn opens into a short conical *intestine*, leading upward to open at the *anal aperture* on the aboral side of the disc of the starfish. The *pyloric stomach* is extended at its five corners to form a pair of pyloric ceca in each ray. Each pair of pyloric ceca begins as a cylindrical duct, leading into the pyloric chamber. This bifurcates to form two smaller ducts, which give off laterally short branches, each connected with many small glandular pouches. The glandular pouches secrete juices containing enzymes and pass them through the series of ducts into the pyloric stomach.

The *pyloric* (hepatic) *ceca* are productive of a digestive juice similar to the pancreatic juice of vertebrates, which converts starch into sugar, proteins to peptones and emulsifies fats. Intestinal ceca, attached to the intestine, secrete a brownish material, probably excretory.

Water Vascular System.—This remarkable system (Figure 57) is used in the starfish for locomotion and in securing its food. It is a specialized portion of the coelom. From the *madreporic plate*, the *stone canal* leads downwards to the ring canal or *circular canal*. (The circular canal bears four pairs of Tiedemann's vesicles and one extra opposite the stone canal); from this canal five *radial* canals pass out,

one into each arm; the radial canals give off side branches from which come connecting canals to the tube feet and *ampullae*. The *tube feet* furnish a means of adhering to smooth surfaces when a vacuum has been created by the withdrawing of water into the ampullae. Squeezing the ampullae causes the water to distend the tube feet and they protrude through the pores.

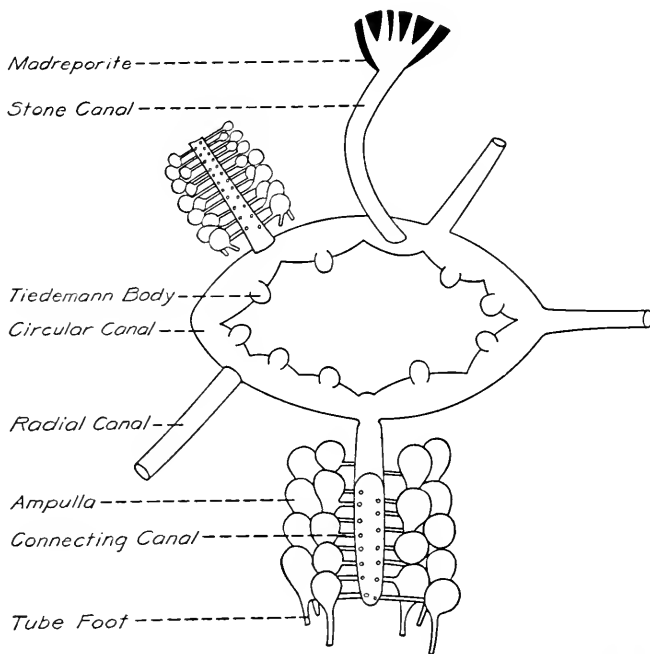

FIG. 57. Water-vascular system of the starfish. (Drawn by W. J. Moore.)

Respiration.—The *dermal branchiae* are thin-walled finger-like sacs that protrude through little holes in the wall of the animal, called dermal pores. Dermal branchiae, as the name indicates, are for respiration.

Circulation.—The presence of a well-developed digestive system and of a quantity of coelomic fluid renders the blood vascular system of less importance. The coelomic fluid contains a number of ameboid corpuscles that collect wastes and pass them to the exterior by passing along the walls of the dermal branchiae. It is also worthy of note that the minute Tiedemann's vesicles on the circular

canal of the water vascular system produce *ameboid lymphocytes* that may be quite important.

The *perihæmal system*, compared by some to a true blood vascular system, consists of the axial organ (genital stolon), adjoining the stone canal; the oral ring vessel, surrounding the mouth and divided by a septum; the perihæmal vessel, divided by a septum, and the five radial blood vessels that are found in the rays. The perihæmal septum is found to contain gelatinous connective tissue and many white blood corpuscles (leucocytes), and is perforated by many irregular channels.

Excretion.—Besides osmotic excretion, the starfish has the ability to excrete shells and other wastes from the mouth. Indigestible foods also pass through the intestine and out at the anal aperture. The ameboid corpuscles of the coelomic fluid aid in excretion.

Reproduction.—Starfishes are not hermaphroditic, although some other Echinoderms are. Each animal produces from paired gonads either eggs or sperms. The gonads are situated in the rays with their ducts opening on the aboral surface through minute pores on a pair of sieve-like plates situated close to the bases of the arms, between the rays. During the spawning season the gonads may have so many eggs that the starfish will have enormously distended rays, and the hepatic ceca may be crowded until they are much reduced in size. The eggs are fertilized outside the body, although many perish without fertilization having been effected. In one year a starfish may have arms two and one-half inches long and be ready to spawn.

Artificial Parthenogenesis.—Norman, Greene, Matthews, Morgan and Loeb, developed a method of inducing the development of unfertilized eggs of echinoderms. Loeb continued the work for many years and proved that *in the absence of sperms*, variation in the temperature, the addition of sodium chloride, potassium bromide and cane sugar solutions would cause normal larvae to develop. For years students in the embryology course at the Marine Biological Laboratory at Woods Hole, Massachusetts, have repeated the experiments with complete success. Subsequent to his echinoderm work, Loeb succeeded in producing fatherless frogs. (See page 299.) In nature, echinoderms and some annelids as well as plant lice and rotifers normally develop parthenogenetically, that is, without the stimulus of sperm.

Nervous System.—The nervous system consists of the *nerve ring*,

found in the disk, and a *radial nerve* with branches, found in each ray, in the integument covering the ambulacral groove. There are also two radial nerve bands forming the deep nervous system, and a third set of nerve elements, the aboral or coelomic nervous system, extending along the roof of the arm superficial to the muscles.

Sense Organs.—The tube feet and the spines have *tactile* nerves associated with them and the whole animal is undoubtedly sensitive to temperature. At the end of a ray one finds a red spot, the “*eye*,” which is sensitive to light. Above it is a process, called the tentacle, similar in appearance to the tube feet but without a terminal sucker. The tentacles are *olfacto-gustatory* organs and more important to the starfish than the so-called “eyes.”

Behavior.—The starfish senses food and is able to open oysters readily. MacBride states that small bivalves are taken completely into the stomach of the starfish, the empty shell being later expelled through the mouth.

MacBride quotes Schiemenz as follows: “A bivalve able to resist a sudden pull of 4,000 grams will yield to a pull of 900 grams long continued. A starfish can exert a pull of 1,350 grams but must raise itself into a hump in order to open an oyster.” Turned upon its back the starfish ordinarily uses certain rays to right itself.

Economic Importance. *Positive.*—Starfish are used to a limited extent as fertilizer, and have been extremely valuable in the study of embryology, particularly in connection with the problems of fertilization. *Negative.* The starfish injures oysters and other molluscs by direct action, opening and devouring them or ingesting small ones and expelling the shells from the mouth. One little starfish ate over 50 young clams in 6 days (Mead).

Class 2. Ophiuroidea.—The *brittle stars* or “*serpent stars*” resemble the true starfishes considerably, having a star-shaped body with a central disc and five radiating arms. They have distinct *oral* and *aboral* surfaces with the mouth in the center of the disc.

The arms are slender and tapering, covered with plate-like *ossicles* and *lateral spines*. The muscular system of the arms is highly developed so that rapid movement is effected by their lateral sweep. *Pyloric ceca* and *anus* are lacking, the *madreporic plate* is on the ventral surface instead of the dorsal, the *tube feet* are *tactile* instead of locomotor and the *ampullae* have disappeared. Serpent stars secure their food by means of specialized, oral tube feet, two

pairs to each arm. “Brittle stars” have highly developed *autotomy* and the ability to *regenerate* new arms. (Figure 58, *A* and *B*.)

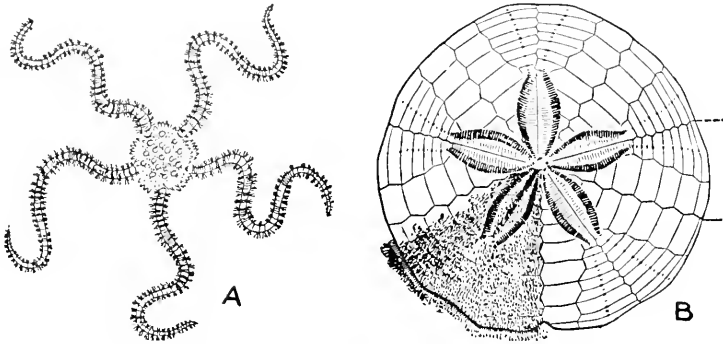

FIG. 58. *A*, serpent star. *B*, sand dollar. (From Verrill.)

Class 3. Echinoidea.—The *sea urchins* are not star-shaped, but globular. The *shell* or *test* is made up of firmly united *ossicles* ranged in rows which run from the oral to the aboral poles. Many of the plates bear movable *spines* which aid in locomotion. Five

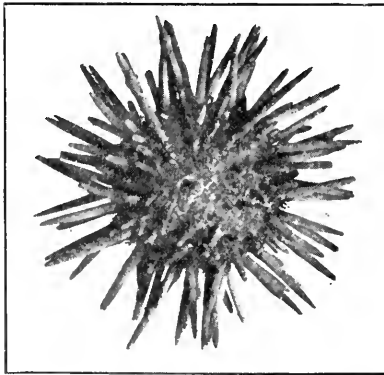

FIG. 59. Purple sea urchin. (From Mayer, *Seashore Life*. Courtesy of N. Y. Zool. Soc.)

ambulacral plates have openings into the egg sacs. There are five bands of distensible locomotor *tube feet* beginning near the oral opening and running towards the aboral pole. The distinctive feature of the *sea urchin* known as *Aristotle's lantern* consists of five jaw-like structures, each bearing a rather large sharp white tooth. The intestine is quite long and has no radiating *ceca*. Sea urchins are able to chisel out solid rock by turning round and round. The spines of large sea urchins have been

used as slate pencils by missionaries in the Pacific Islands.

The *sand dollars* or “*cake urchins*” are flattened and disc-like, living near the surface of the sand. The *heart urchins* or “*sea bears*” bury themselves in the muddy sands for several inches. Under the

name of “*sea eggs*,” the urchins are sold during the spawning season in the Orient.

Class 4. Holothuroidea.—The *sea cucumbers* include rather small forms which are found in the colder waters, and large tropical species. Some of the *Holothurians* are called *sea slugs* because of their resemblance to a mollusc. Other forms are called *cotton spinners* because they excrete *cottony filaments* when irritated.

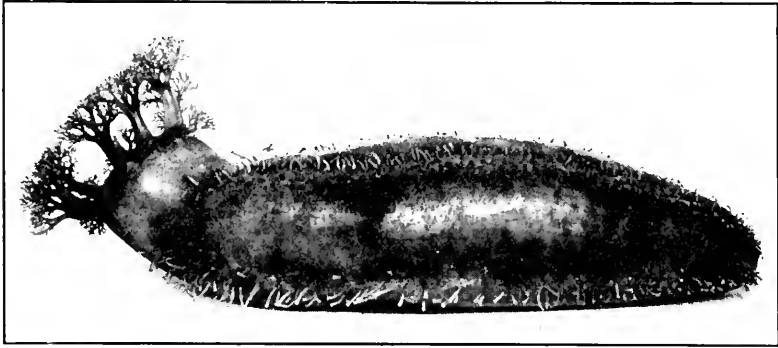

FIG. 60. Sea cucumber. (Courtesy of Amer. Mus. of Nat. Hist.)

The *sea cucumber* has a muscular body wall with a few calcareous spicules, a circling of tentacles around the mouth and five zones of tube feet running from mouth to anus. (*Synapta* lacks tube feet.)

The alimentary canal consists of a long coiled *intestine* with a muscular enlargement, the *cloaca*, at the posterior end. Respiration is carried on by the cloaca, tentacles, respiratory trees and body wall.

GENERAL CONSIDERATIONS

In the adult condition, Echinoderms usually creep along the sea bottom, for they are all marine. The larvae, however, are surface swimmers, or “pelagic.” They are gregarious in habits and found in all depths.

Anatomy and Location.—The Echinodermata are radially symmetrical, with an exo-skeleton of calcareous plates or ossicles bearing in most cases spines. They have a well-developed alimentary, nervous and water vascular system, with a poorly developed vascular system. Reproduction is sexual.

Locomotion in the starfishes is a slow, creeping movement by

means of the tube feet. The Holothuroidea utilize their tentacles in movement. The brittle stars move by lateral contractions of their arms. The Echinoidea move by means of spines and a few tube feet.

Physiology.—In the sea urchin we have the *first instance of masticatory structures* in the invertebrates. The five teeth of the "Aristotle's lantern" are extremely powerful. The *digestive system* is extremely efficient as seen in the starfish. (See p. 132.) *Respiration* is carried on by the dermal branchiae. *Circulation* is not well developed and perhaps is not needed with the complicated water vascular system. The body fluid, *hydrolymph* or blood, is similar to the fluid in the water vascular system, but is richer in albumen. In the sea cucumber, Thyone, the hemoglobin occurs in small, very numerous corpuscles. *Excretion* is carried on by the mouth, the dermal branchiae and the intestine.

Reproduction.—Well-developed gonads are present and sexes are separate in many of the Echinoderms. Parthenogenesis occurs frequently. (See p. 134.)

Behavior.—The Echinoderms have well-developed reactions to stimuli of touch, light and temperature. They also have primitive olfacto-gustatory sense.

Embryonic Development of the Echinodermata.—The eggs of Echinoderms divide into 2, 4, 8, 16, 32, 64 cells, each finally becoming a *blastula*, then a *gastrula*, and finally a *larval* stage. The larvae are bilaterally symmetrical, with an alimentary canal from which later bud two coelomic sacs. These form the body cavity and the water-vascular system. The larvae of the different classes vary somewhat in structure. Bilateral symmetry is lost in the adults except as it is retained slightly in the Holothuroidea.

Importance of Echinodermata in Biological Research.—During the past thirty years, we have seen increased utilization of invertebrate forms in research at our marine laboratories. The starfish and the sea urchin have been the types used in numerous chemical and physiological studies, far-reaching in their significance. Mathews, Child, J. Loeb, Tennant, F. Lillie, R. Lillie, Just, Heilbrunn, Glaser, Sampson, Woodward, and their associates, have been especially active in these studies.¹

¹ See the Wistar Institute Bibliographic Service, and the Journal, Biological Abstracts, for references. Also refer to paper by D. H. Tennant, 1929, Studies in experimental embryology based on sea urchin eggs. Sc. Mon., vol. 29, no. 2 (1927), pp. 117-124.

Echinoderm eggs are especially convenient for studies on the physiological changes occurring during development. Warburg found for example that fertilized starfish eggs *utilized oxygen* eight times as fast as the unfertilized ones. Important studies on the changes in *permeability* of eggs immediately following fertilization have been made by R. Lillie and more recently by Dorothy Stewart.

F. Lillie and E. Just believe that the secretions of *Arbacia* (a sea urchin) eggs contain an amboceptor with an ovo-phile side chain which combines with the egg and a spermo-phile side chain which combines with the sperm. The egg secretion enables the sperm to fertilize the egg. (Consult Lillie, F. R. 1919. Problems of Fertilization. Univ. of Chicago Press.)

But A. E. Woodward finds that it is possible to precipitate from the egg secretion by one method a substance which activates the sperm, and by another method a second substance which brings about parthenogenetic development of the sea urchin egg. Dr. Woodward has also utilized iodine (see page 439) as an agent in parthenogenesis. (Consult Woodward, A. E., and Hague, F. S. 1917. Iodine as a parthenogenetic agent. Biol. Bull., vol. 38, pp. 355-360.)

The writer of this text believes that iodine saturates the unsaturated fats of the egg, and that increased oxidation causes cell division to occur.² (See papers by Chidester and associates.)

Parental Care.—In the Asteroidea, the young are sheltered in the arms of the adults. One form, *Pteraster*, has a tent-like brood pouch.

Regeneration.—The Echinoderms have a well-developed characteristic known as self-mutilation or *autotomy*. This is most marked in many Ophiuroids, some Asteroids and some Holothurians, but does not occur at all among the Echinoids. Brittle-stars and starfishes, when removed from water or molested, will sometimes break off portions of their arms, piece by piece, to the very base. The central disc is entirely capable of regenerating new arms. The *sea cucumbers* frequently eviscerate themselves, escape from their

² Iodine has a well-known corrosive action on fats, and it is undoubtedly effective in dissolving the fatty pellicle around tubercle bacilli as well as other pathogenic organisms treated successfully by cod liver oil. The West Virginia University group are treating certain diseases with super-iodized cod liver oil. Possibly iodine is responsible for the protective and curative actions ascribed to other chemicals administered in combination with it.

enemies and later regenerate the entire alimentary canal. Mayer (Seashore Life) reports that the brittle sea cucumber *Synapta* lives in a ringed sand tube agglutinated with slime. Bands of sand are formed and forced down to finally form the tube. *Leptosynapta* breaks itself up into short lengths and then regenerates.

Fossil Relatives.—Cystoidea are extinct. Their fossils are confined to the Paleozoic, extending from the Cambrian to the Permian with maximum development in the Ordovician and Silurian. The Blastoidea, also extinct, are confined to the Paleozoic, ranging from the Ordovician to the Permian. The Crinoidea range from the Ordovician to the present time, being most abundant as fossils in the Upper Paleozoic. The Asteroidea, Ophiuroidea, Holothuroidea and Echinoidea have descended to the present, from the upper Paleozoic.

Ancestry and Relationships to Other Phyla.—It has been found so difficult to connect the Echinodermata with other Phyla that they have been for some time considered relatively isolated. Early attempts to link them with the Coelenterata on account of their radial symmetry have encountered the objection that the Echinodermata have an extensive coelom or body cavity. They have highly developed alimentary and nervous systems not present in the lower Phyla. It is now believed that the embryonic history of the Echinoderms indicates that they developed from a group with *bilateral symmetry*. The oldest classes of Echinodermata are those with the radial symmetry least developed. Thus the stalked Crinoids are considered the ancestors of the free living forms. Crinoidea, Cystoidea and Blastoidea represent the primitive type, while radially symmetrical Asteroidea, Ophiuroidea and Echinoidea are probably descended from the primitive Holothuroidea. The Echinodermata are an isolated group, with no living or fossil links. The echinoderm larva, somewhat comparable to that of *Balanoglossus*, called *Tornaria* (see page 217), has led evolutionists to place the Phylum in the series of Invertebrates that are supposed to be progenitors of Vertebrates.

ECONOMIC IMPORTANCE OF THE ECHINODERMATA

<i>Class</i>	<i>Positive</i>	<i>Negative</i>
Asteroidea.	Fertilizer. Eggs used as food. Experimental embryology.	Attack oysters and clams, opening shells and devouring the soft parts.
Echinoidea.	Roe of sea urchins are eaten. Spines are used as slate pencils.	
Holothuroidea.	Several species of sea cucumbers are utilized as food by the Chinese under the names of <i>trepang</i> or <i>beché-de-mer</i> .	

REFERENCES ON ECHINODERMATA

- COLE, L. J. 1913. Direction of locomotion in the starfish, *Asterias forbesii*. J. Exp. Zoöl., vol. 14.
- GEMMILL, J. F. 1912. The locomotor functions of the lantern in Echinus, with observations on other allied activities. Proc. Roy. Soc. Lond., Ser. B, vol. 85.
- KINDRED, J. E. 1924. The cellular elements in the perivisceral fluid of echinoderms. Biol. Bull., vol. 46, pp. 228-251.
- PAINE, V. L. 1926. Adhesion of the tube feet in starfish. J. Exp. Zoöl., vol. 46, pp. 361-366.

CHAPTER XI

MOLLUSCA

THE MOLLUSCA (Lat. *mollis*, soft) are bilaterally symmetrical. This symmetry is modified by dextral, sinistral, or frontal torsion in the adult Gastropoda. While for the most part the *Mollusca* differ from the Annelida and the Arthropoda in being unsegmented, the Cephalopoda have certain segmented ducts, and the Amphineura are segmented. The majority have an exoskeleton of calcium carbonate, the shell. In general we find that Mollusca are sluggish. Many Mollusca are of economic importance (see page 161).

CLASSIFICATION

- Class 1. *Pelecypoda*** (hatchet foot) or Lamellibranchiata (leafy gills). Clams, oysters, mussels, scallops. Usually bilaterally symmetrical, with two-valved shells, and a two-lobed mantle. Abundant in Cretaceous of America. Marine and fresh water.
- Class 2. *Amphineura*** (on both sides—a nerve). Chitons, with bilateral symmetry, shell of eight transverse calcareous plates and many pairs of gill filaments. Ordovician to present. Marine.
- Class 3. *Gastropoda*** (belly foot). Snails, slugs, whelks, with a spirally coiled shell. Some dextral and others sinistral. Cambrian to the present. Abundant since Ordovician. Marine and fresh water.
- Class 4. *Scaphopoda*** (boot foot). Tooth shells with tubular shell and mantle. Cambrian to the present. Dentalium from the Tertiary to the present. Marine.
- Class 5. *Cephalopoda*** (head foot). Cuttle fishes, squids, octopi and nautili. Bilaterally symmetrical foot divided into arms with suckers. Nervous system is located in the head. Nautiloids are first known from the Cambrian rocks; they reach their maximum development in the Silurian and decline to the Triassic. Marine.

CHARACTERISTICS

1. Mollusca are mostly unsegmented and without jointed appendages.
2. Symmetry is fundamentally bilateral, but in the Gastropoda there is superposed dextral or sinistral asymmetry.
3. The foot is usually for locomotion.
4. The mantle is a dorsal fold of the body wall which covers the animal.
5. Frequently a shell is secreted by the mantle, but *sometimes* the mantle and shell are absent.

NATURAL HISTORY

Class 1. Lamellibranchiata. Clams and Mussels.—As a *type* for study either the fresh water mussel (*Anodonta*) or the clam (*Venus*) proves excellent. Both are bilaterally symmetrical and have a well-developed foot.

The Structure of the Shell.—“The mussel shell consists of three layers. The outside horny layer is called the periostracum; the middle prismatic layer is formed from tiny prisms of calcium carbonate separated by thin layers of the horny conchiolin found in the periostracum; the inner layer is the nacre or ‘mother of pearl’ which consists of alternate layers of calcium carbonate and conchiolin arranged parallel to the surface. The periostracum and the prismatic layers are secreted from the edge of the mantle, while the nacre is secreted from the whole of the epidermal surface of the mantle.”¹

Externally marking the shell, we find rather prominent depressions, three or four in number, called lines of growth, indicating the number of seasons of growth. Less prominent depressions, the lines being close together, indicate the number of new edges of the shell laid down by the mantle during the course of a single season. There are also annual layers of nacre.

Internal Anatomy.—In both forms we find well-developed anterior and posterior *adductor* muscles. These must be cut in order to separate the shells. When cut, the dorsal *hinge ligament* forces the valves to gape open. Lining both valves we find the *mantle*. This is adherent to the shell ventrally just inside the edge, the point of

¹Parker, T. J., and Haswell, W. A. 1928. Text-book of Zoölogy. The Macmillan Co., London.

attachment, the *pallial line*, being readily seen in the cleaned shell.

In the hard-shelled *clam*, *Venus*, which has two well-developed siphons, we find a posterior invagination under the adductor muscle called the pallial sinus. It marks the point of attachment of the siphonal muscles. The siphons of fresh water *mussels* are very poorly developed.

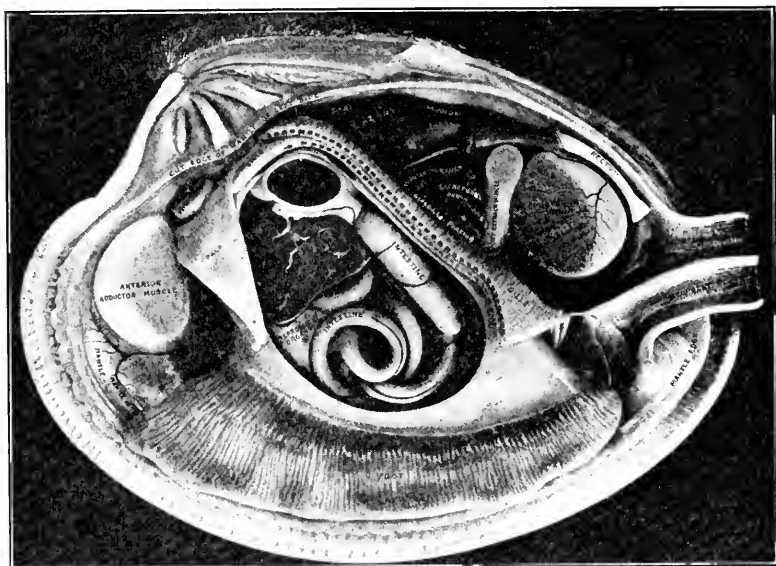

FIG. 61. Model of clam. (Courtesy of Amer. Mus. of Nat. Hist.)

Digestion.—The *mouth* has two pairs of *labial palps*, ciliated externally; the gullet or *esophagus* is short. A pair of irregular dark brown glands, the *liver*, surround the large stomach which has in it a slender gelatinous rod, the crystalline style. T. C. Nelson (Biol. Bull., 1925, vol. 49, no. 2, pp. 86-99) gives three views of the functions of the *crystalline style*. (1) It contains amylolytic ferments which digest starch. (2) Its mucous or viscid secretion holds the food long enough for proper digestion. (3) It separates the food from foreign particles, acting as a “stirring rod.”

The *intestine* passes from the posterior end of the stomach to the visceral mass, coils parallel to the first portion, then turns backwards and proceeds as the rectum through the *pericardium* and above the posterior adductor muscles, finally discharging into the

dorsal *exhalant siphon* or cloaca. The wall of the *rectum* has a longitudinal ridge or *typhlosole* (as in the earthworm). Two similar ridges begin in the stomach and are continued into the first part of the intestine. An oyster is said to strain 135 liters of water daily to obtain its oxygen and food. Galtsoff, P. (1928, Bull. Bur. of Fish., vol. 44), has shown that for the North Atlantic oyster the maximum flow of water is 3.9 liters per hour at 25° C.; for the Gulf of Mexico oysters, it is nearly twice as much, 7.5 liters per hour at 25° C.

Circulation.—The heart consists of a *ventricle*, surrounding part of the rectum, and *two auricles*. The ventricle contracts and drives the blood through the anterior and posterior aortae. Some of the blood goes to the mantle where it is oxygenated and then returns to the heart but not to the kidneys. The rest circulates through the body and is finally collected by the vena cava just beneath the pericardium. From the vena cava, the blood passes into the kidneys and gills to the auricles and into the ventricle. Oxygen and dissolved food are carried to all parts of the body, CO₂ to the gills, and other wastes to the kidneys.

Respiration takes place through the surface of the mantle, and by means of a pair of branchiae or *gills* made up of two lamellae on each side, united at the edges except dorsally. A lamella is composed of gill folds supported by chitinous rods and covered with cilia. The cilia of the gills produce a current which sets in through the inhalant siphon into the mantle cavity and through the ostia and the water tubes into the suprabranchial (epibranchial) chamber and out at the exhalant siphon. The ingoing current carries oxygen for the aëration of blood, and also brings food such as diatoms and Protozoa, which pass into the mouth between the ciliated labial palps. The outgoing current carries excreta from the blood and feces from the cloaca.

Excretion.—The *nephridia* (organs of Bojanus) are a single pair, one on each side of the body just below the pericardium. They are U-shaped tubes bent on themselves and opening at one end into the pericardium and at the other on the external surface of the body. There are two parts—a brown, spongy, glandular *kidney*, and a thin-walled non-glandular *bladder* with ciliated epithelium which communicates with its mate anteriorly by a large oval aperture. The kidney receives excreta from the pericardium by cilia. Waste is carried out through the exhalant siphon. The bladder receives

excreta from the blood. Another excretory organ is the *pericardial gland* or "Keber's organ." It lies just in front of the pericardium and discharges into it. It may collect from the kidney; it secretes uric acid.

Reproduction.—The sexes are usually separate. A few forms are hermaphroditic and protandrous. The *gonads*, situated above the foot, are paired masses of tubes which open just in front of the renal aperture on each side. *Spermatozoa* pass out of the dorsal siphon of the male and into the ventral siphon of the female. The *eggs* pass out of the genital aperture and lie in the gills. They are fertilized there and develop in a modified pouch or *marsupium*. The eggs develop by cell division until in the fresh water mussel a

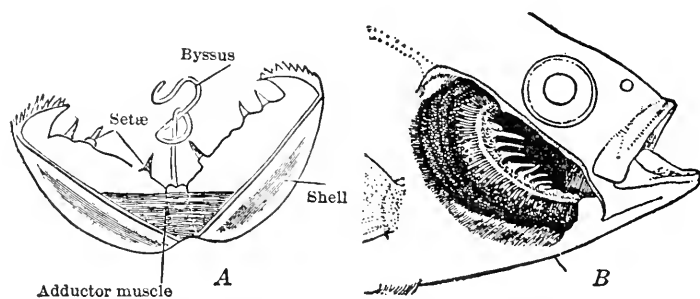

FIG. 62. Glochidium of Anodonta.—*A*, a young mussel or glochidium. (After Balfour.) *B*, the gills of a fish in which are embedded many young mussels forming "blackheads." (After Lefevre and Curtis.) (From Hegner, *College Zoology*. Courtesy of Macmillan Co.)

glochidium is produced. This has a shell with two valves, hooked in some species, and closed by muscles. The glochidia attach to the gills or fins of a fish, become surrounded by the stimulated epithelium of the host, and develop there until able to carry on independent existence. They are thus dispersed by the fishes to considerable distance. (Figures 62 and 63.)

In *Venus* and many other molluscs, we find that the embryo develops as a free swimming *larva* of the *trochophore* type called a *veliger*.

Eggs.—Lamellibranchs have a large number of eggs. The oyster has 300,000 to 60,000,000 per annum. The fresh water mussel has 200,000.

Nervous System.—There are *two cerebral ganglia* (one on each

side of the esophagus) with cerebral commissures forming a nerve ring. Each cerebropleural ganglion sends a nerve cord ventrally, ending in a single *pedal ganglion* in the foot. Each cerebropleural ganglion gives off a cerebrovisceral connective (sometimes enclosed by the kidneys) leading to a single *visceral ganglion*.

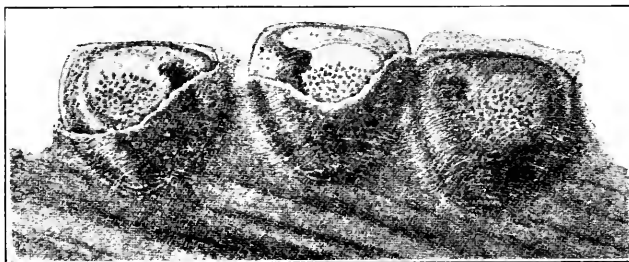

FIG. 63. Different stages of cyst. Proliferation in glochidia, fin margin of carp. (After Lefevre and Curtis. *Jour. Exp. Zool.*, 1910.)

Sense Organs.—A patch of yellow epithelial cells, the “osphradium,” covers each visceral ganglion. They are supposed to be *olfacto-gustatory* organs. Paired *otocysts* (statocysts) with calcareous statoliths behind the pedal ganglia are organs of equilibrium. Yves Delage removed the otocysts and caused lack of balance. The edges of the mantle have sensory cells—especially on the inhalant siphon—which are sensitive to *light* and *touch*. *Pecten*, the scallop, has from 80 to 120 ocelli at the edge of the mantle. They are connected with the branchial ganglion and each has cornea, lens, and optic nerve. Apparently *visual organs* are *absent* in the *fresh water* bivalves, but they are better *developed* in the *marine* forms along shore. There is no satisfactory evidence for color vision in Mollusca. Certain eyeless species react to sudden darkening very quickly, but soon get used to stimuli and cease to respond. The sense of *geotropism*² is determined by obscure conditions. Reactions are influenced by size of illuminated or darkened surface, as well as by intensity of light.

Class 1. Lamellibranchiata.—*Fresh water mussels* or clams (*Unionidae*, *Anodontidae*, *Lampsilidae*) have assumed considerable importance in America. The United States Bureau of Fisheries has established a Biological Station at Fairport, Iowa, for the artificial

² See page 25 for definition of tropisms.

propagation of mussels in the Mississippi basin. Valuable pearls are secured from the adult mussels, and pearl buttons are manufactured from certain mussel shells. Their larvae (glochidia), parasitic on the gills and fins of fishes, become dispersed widely. (Figure 64, *A* and *B*.)

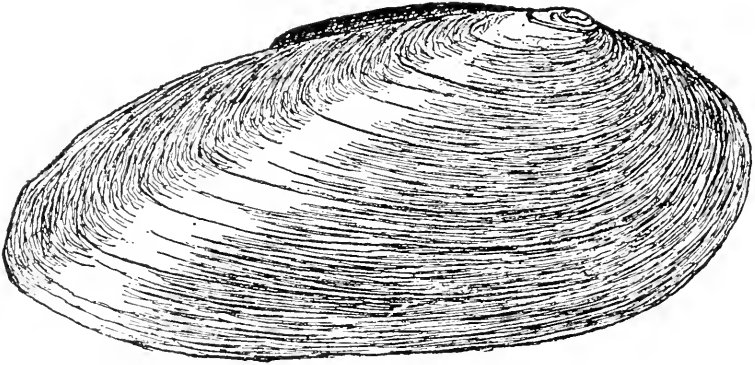

FIG. 64*A*. *Unio gibbosus* Barnes. (After Simpson, *U. S. B. F. Bull.*, 1898.)

The salt water or edible mussel (*Mytilus edulis*), cultivated for many years in France and England, has only recently come into general use in the United States. Through the activities of the late Dr. I. A. Field,³ the many mussel beds on the Atlantic coast are now being utilized. In mid-summer, mussels may sometimes become poisonous.

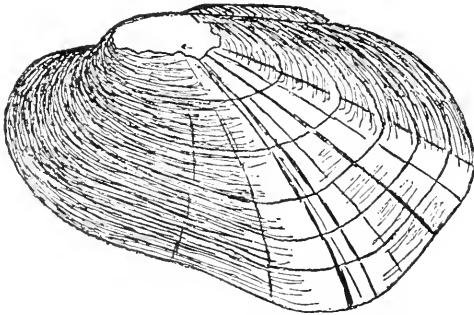

FIG. 64*B*. *Lampsilis luteolus* La. Female. (After Simpson, *U. S. B. F. Bull.*, 1898.)

The "pearl-oyster" (*Meleagrina*), which is not a true oyster but a mussel, is found in the South Sea Islands, Japan, Ceylon, the East Indies and the West

Indies. Pearls are an accumulation of layers of "nacre" laid down around foreign substances. (See page 157, Culture Pearls.)

The soft-shelled clam (*Mya arenaria*), sometimes called the long-

³ Field, I. A. 1911. The food value of sea mussels. *Bull. Bur. Fish.*, vol. 29.

necked clam, is preferred by New Englanders for clam bakes and chowders. It has extremely long siphons. The *quahog* (*Venus mercenaria*), or *hard-shell clam*, is found along the entire Atlantic coast. Used little at the coast, it is preferred inland as it can be shipped long distances and kept alive for a considerable time. Blue-lined ones were used as money "wampum" by the American Indians (Figure 65, *A* and *B*). The *giant clam* (*Tridacna gigas*) is

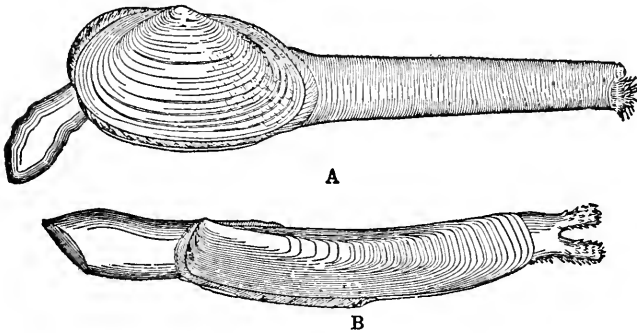

FIG. 65. *A*, soft shell clam, *Mya*. *B*, razor shell clam, *Ensis*. (From Arnold. Courtesy of The Century Co.)

found in tropical waters where it sometimes proves a menace to divers. Its shell may weigh five hundred pounds and reach a length of four feet. A single valve may be found in use as a church font. The *razor-shell clam* (*Solen maximus*) is eaten by the poorer people of the British Isles, but not known in fashionable restaurants. The giant "geoduck" clam of the Pacific coast (*Glycimeris generosa*) reaches a weight of six pounds and has a siphon sometimes extended twenty-four inches. The *West Coast "little neck" clam* (*Tapes staminea*) is an important food. The *cockle* (*Cardium edule*) is eaten considerably in Europe. It is easily digested.

The *scallop* (*Pecten irradians*) found off-shore on the Atlantic coast does not reach a diameter greater than three inches. Its single adductor muscle is used for food. The *giant scallop* (*Pecten maximus*) is found in deeper water and reaches a diameter of seven inches. Both the scallops are extremely rich in iodine and should be utilized more inland since they keep on ice in a much better condition than do oysters. The crusaders brought with them from the Holy Land a Mediterranean scallop (*Pecten jacobaeus*) which they wore as a badge, indicating their foreign service.

The *oyster* (*Ostrea*)⁴ is sessile and lacks a foot. It is used in America more than any other shell fish and has been popular in spite of the occasional occurrence of typhoid carried by freshened oysters. The practice of transporting oysters from relatively clean salt water to the mouths of *polluted* rivers and there keeping them "floating" until they have become bloated and swollen and have lost their true ocean flavor is one that has brought oyster dealers additional money when they sold oysters by the quart, but has lost many lives from the typhoid germs collected.

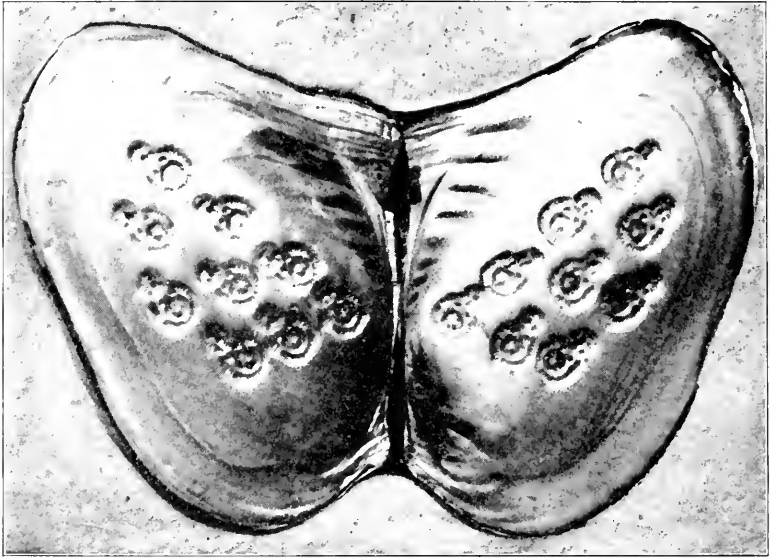

FIG. 66. Mussel with Buddha images. Chidester. (*Sci. Am. Suppl.*, 1915.)

The *window-glass shell* (*Placuna placenta*) is used in the tropics for windows in churches and other buildings. Reese reports that the demand for "window pane" shell in the Philippine Islands has recently exceeded the supply, so that the Philippine Bureau of Science planted new beds.

The *wood-boring ship-worms* (*Teredo* and *Bankia*) were in early days a formidable enemy of wooden ships. Recently it was discovered that the wood-boring ship-worm, *Teredo navalis*, was doing

⁴ Brooks, W. K. 1905. The Oyster. Balt.

great damage to the piles in Pacific and Eastern harbors.⁵ Attempts by the United States Navy to protect *wharves* and piles

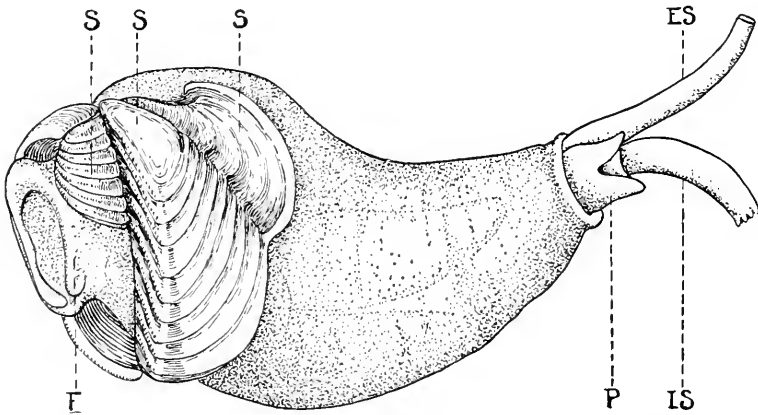

FIG. 67. *Teredo navalis*. Age five weeks from metamorphosis. S, shell; F, foot; is, incurrent siphon; es, excurrent siphon; p, pallet. (B. H. Grave, *Biol. Bull.*, Oct. 1928.)

have resulted in the sheathing of some docks with concrete. Impregnation of the piles with creosote has also given a large measure of protection (Figure 67). The *borer* (*Pholas*) is able to penetrate rocks and cement. It has extremely long united siphons and a shell with a file-like surface.

Class 2. Amphineura. (Figure 68.)—The *chitons* are bilaterally symmetrical molluscs with eight calcareous plates or shields which protect the dorsal surface of their boat-shaped body. Like the wood louse and armadillo they are able to roll themselves into a ball for protection. In some species the shell plates have between eleven thousand and twelve thousand primitive visual organs. Chitons

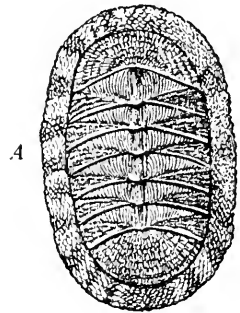

FIG. 68. Chiton. (From Hertwig-Kingsley, *Manual of Zoology*. Courtesy of Henry Holt & Co.)

⁵ Grave, B. H. 1928. Natural history of shipworm, *Teredo navalis*, at Woods Hole, Mass. *Biol. Bull.*, vol. 55, no. 4, pp. 260-282.

Hill, C. L., and Kofoid, C. A. Marine Borers and Their Relation to Marine Construction on the Pacific Coast. Final Report of the San Francisco Bay Marine Piling Committee. 1924.

Sigerfoos, C. P. 1908. Natural History, Organization and Late Development of the Teridinidae or Shipworms. *Bull. U. S. Bur. Fish.*, vol. 27, p. 191.

are found in shallow water, and are used as bait and for food. One Pacific coast species reaches a length of eighteen inches.

Class 3. Gastropoda.—The Gastropoda differ from the Lamellibranchiata considerably, in that they usually have a spirally coiled shell consisting of a single piece, a head region with eyes and sensory tentacles, and in the alimentary canal have a buccal organ, the *odontophore*, bearing rows of chitinous teeth and functional in rasping food and in cutting through other shells. Gastropoda creep slowly on a ventral foot, which in the marine snails carries a horny *operculum* used in closing the orifice when the foot is retracted.

The *chank-shell* (*Turbinella pyrum*), found in the Indian Ocean, is used in the East Indies for bangles. When cut into armlets and anklets, chanks are worn by the women of Hindustan. Chank-shells were also used for beating cloth. The *whelk* (*Buccinum*) is eaten by some Europeans. Another *whelk* (*Purpura*) was used by the ancients in the production of "Tyrian Purple." The Romans secured their dyes from shells found off the coast of Tyre in Asia, and at Meninge on the shore of Africa. Pliny speaks of the mixture of dyes of different shades to produce the finest purple for royal robes. The *slipper limpets* (*Crepidula fornicata*) are degenerate scale-like animals that in many cases become attached permanently to a stone or dead shell by a stony cement secreted by the foot. The embryology of *Crepidula* was the subject of an authoritative study by Conklin (*Jour. of Morphology*, vol. 13, 1897). The common *limpet* (*Patella vulgata*) is used as food in England and on the Continent much more than in the United States. The **ear-shells** (*Haliotis*) found on the Western coast of America appear like the *single* valve of a Lamellibranch, but they are true gastropods. The shells are used for the manufacture of ornaments, in *inlays* and also for making *buttons*. They also yield blister pearls of brilliant colors. The fleshy foot of the animal is an excellent food, which has been eaten in Europe and the Orient for centuries, and furnishes *abalone* steak in California. It is also dried and shipped to the Orient. The *cowries* (*Cypræidae*) are used for ornaments, to sink fishnets, and as money. A small species (*Cypræa moneta*) is used in Siam and Western Africa as money. Lankester mentions the fact that in the Friendly Islands the orange cowrie, a symbol of rank, is worn only by the chief of the tribe.

The *helmet shells* (*Cassidae*) are used in the manufacture of *cameos*, since either white or black may be carved with the other as

a background. The *tritons* or *sea conchs* (*Tritonidae*) reach a length of twelve inches. The South Sea Islanders use one species as a trumpet.

The common *periwinkle* (*Littorina*), used as food in Europe, particularly the British Isles, is not so popular in America, although it occurs along the Atlantic coast.

The *oyster drill* (*Urosalpinx cinereus*) is an important enemy of the Lamellibranchs. Using its "radula" it quickly bores holes into the hardest shell. (Figure 69, *A* and *B*.) The *drilling sea snail* (*Natica heros*) deposits its eggs in a "collar" composed of sand, agglutinated by mucus. The *land snail* (*Helix pomatia*), imported from Europe, is sold in large cities and considered a delicacy. The American *Helicidae* are smaller in size and are considered by some vegetable gardeners to be quite injurious to plants. The escaped European garden snail is very destructive to certain vegetables and flowers. Pliny speaks of snails, cultivated by the Romans, with shells that would hold a quart of wine! The modern snails are not more than three or four inches long.

The common *poud snails* include the genus *Limnaea* with its shell a right-handed spiral, which lays its eggs in the spring in capsules covered with jelly; and the genus *Physa* (in which the

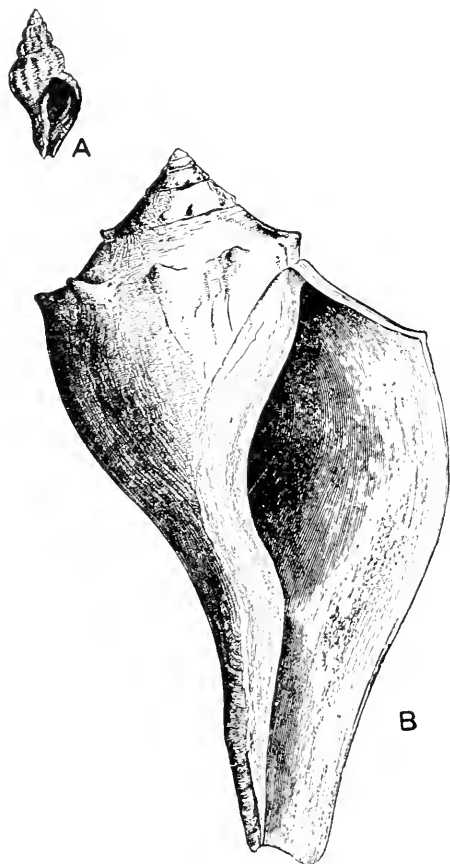

FIG. 69. Enemies of the oyster. *A*, *Urosalpinx*, the drill; *B*, *Fulgur*, the whelk. (From U. S. B. F. Report, 1897.)

spiral is a left-handed one), which attaches its egg capsules to sticks and leaves in the water. Either form is excellent for the study of embryonic development, since the eggs are deposited in laboratory aquaria and develop rapidly. (Figure 70, *A* and *B*.)

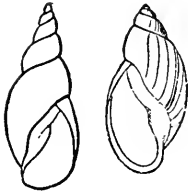

FIG. 70. Left, *Lymnaea* with dextral shell. Right, *Physa* with sinistral shell.

The *land slugs* (*Limacidae*) have a vestigial shell. A species found in California reaches the length of twelve inches. The *giant slug* (*Ariolimax sp.*) is used by the South American Indians in the manufacture of "bird lime" to capture humming birds.

Snails are of great sanitary and medical significance as hosts of larval trematodes, parasitic in vertebrates, including man. (See p. 77.)

Class 4. Scaphopoda.—The **tooth shells** or **tusk shells** have a tubular calcareous *shell* open at both ends. The *foot* is at the larger end. A *lingual ribbon* (radula) is present, and the animal has a rudimentary head. Tentacles, eyes, a heart and gills are absent. The captacula are ciliated contractile filaments perhaps for breathing and securing food. The animal has the univalve shell and radula of the Gastropoda and the symmetry and pointed foot, without tentacles or head, that characterize the Lamellibranchiata.

The *Dentalium* or *tusk shell* was used in California among the Indians and the early whites as currency. The shells used were valued at \$5.00 each if about two and one-half inches long; smaller ones were about one inch long and were worth about 50¢. An eleven-shell string was worth about \$50.00. Dentaliums were traded for wives, clothing, furs, and woodpecker scalps, whose red topknots were of considerable value also.

Class 5. Cephalopoda.—The Cephalopoda, which include the squids, sepias and octopuses, are highly developed marine Mollusca. They have a true head, with well-developed eyes and olfactory organs, and the anterior portion of the foot is modified into tentacles or arms. The body is bilaterally symmetrical. Locomotion is accomplished by movements of the tentacles and by expulsion of water from a funnel or siphon leading out from the mantle cavity. The shell is usually internal, that of the cuttlefish being sold as "cuttle-bone," but in the Nautilus, the shell is highly developed as a chambered external coiled structure.

The *cuttlefishes*,⁶ or *Sepias*, have ten arms and a pair of highly developed eyes. The body is covered by the mantle. Cuttlebone comes from the inner shell, which is very porous and light in weight and largely lime. Cuttlefishes furnish sepia ink which is used in art. Ground cuttlebone called "pounce" is used somewhat in medicine as an anti-acid and when powdered fine is used by draftsmen to prevent blotting. Italians esteem the "sepias" a delicacy. India ink is made from the ink bags of fossil cuttlefishes.

The *octopus* (*Octopus vulgaris*) bears eight arms. It may reach a length of fifteen feet and weigh seventy-five pounds. Terrible stories are related (at a few dollars a column) regarding the battles of divers with these horrible "devil fishes." They are used for food by the Chinese and Italians.

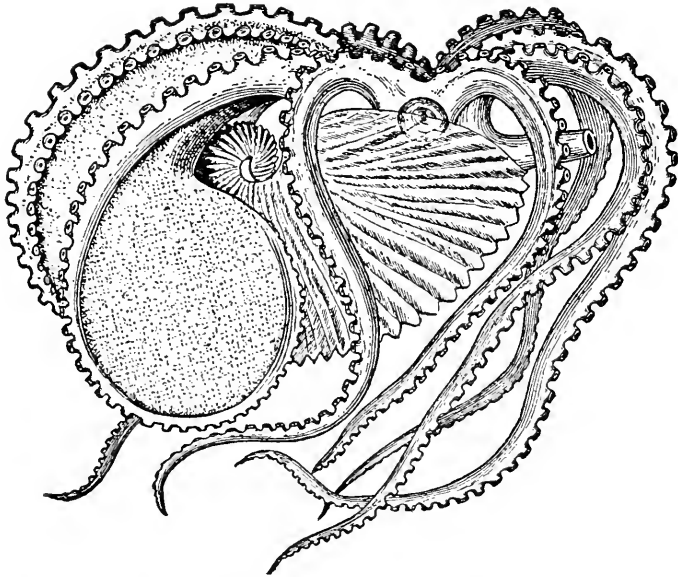

FIG. 71A. Female *Argonauta argo*. (Lull, *Organic Evolution*, after Claus-Sedgwick. Courtesy of Macmillan and Co., Ltd.)

The *squid* (*Loligo*) reaches a length of about one foot. The internal shell, called the "pen" on account of its resemblance to a feather, is relatively thin and chitinous (horny), not calcareous.

⁶ The Arctic cuttlefish is said to reach a length of eighteen feet, its size being apparently correlated with the greater abundance of diatoms and other food in the plankton of northern waters.

Giant squids may reach a total length of thirty feet, the body being not more than ten feet long. They form the food of the sperm whales. Squids are used for bait and are eaten by French, Italians, and the Orientals. Squid oil has been used for lubricating, and by the Chinese as a medicine.

The *chambered nautilus* (*Nautilus pompilius*) is a cephalopod with a many-chambered, spiral shell, lined with beautiful pearly *nacre*. Unlike the squids and octopi, the nautilus lacks an ink sac and cannot change its color. Oliver Wendell Holmes' celebrated poem has immortalized "The Chambered Nautilus."

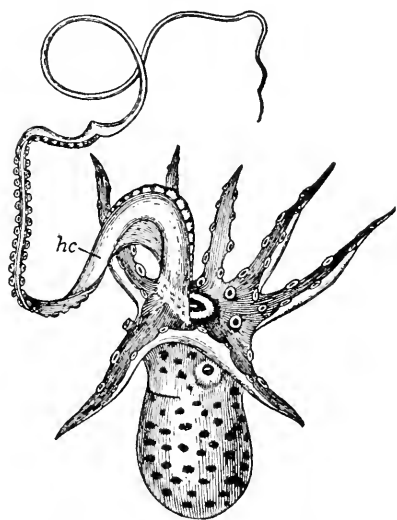

FIG. 71B. Male *Argonauta* showing hectocotylized arm. (Lull, *Organic Evolution*, after Claus-Sedgwick. Courtesy of Macmillan and Co., Ltd.)

The *paper nautilus* (*Argonauta argo*) with a thin shell is more active than the chambered variety and is frequently seen near the surface of the ocean. The females are pelagic during breeding season, but are found in the depths the rest of the time. The male Argonaut, one inch long, only 1/10 of the size of the female, has no shell, and is able to detach the third arm on the left side laden with spermatophores and spermatozoa. The entire "hectocotylized arm" passes into the mantle cavity of the female and, attaching, permits the spermatozoa to fertilize her eggs. (Figure 71, A and B.)

Pearls.—Since so much of the reputation for economic importance of the Mollusca depends on the value of pearls, let us consider the source of pearls and the methods used in producing "culture pearls."

Composition.—The composition of pearls is 91.72 per cent carbonate of lime, 5.94 per cent organic matter and 2.34 per cent water.

Source and Value.—The pearl "oyster," one of the *Aviculidae*, *Margaritifera*, is not an oyster but a mussel. It is found in the Persian Gulf and off the coasts of Ceylon and Japan. Similar forms

have been found in the Philippine Islands and on the coasts of Venezuela and Pacific Mexico. Black pearls from the "pearl oyster" of the Gulf of Mexico are extremely valuable. The fresh water mussels, besides furnishing pearl buttons, also produce a fine quality of pinkish pearls. The *abalones* (*Haliotis*) found in the Pacific Ocean produce very few good blister pearls but the shells are valuable for mother of pearl. Pink pearls are sometimes secured from the large West Indian conch shell, *Strombus gigas*, one of them having sold for five thousand dollars.

True pearls increase in value notably according to the size. If a one-grain pearl is worth \$10.00, a two-grain pearl is worth \$40.00, while a ten-grain pearl is valued at \$1,000.00.

Culture Pearls.—The nucleus of a pearl may be a parasite, an ovum, a fragment of tissue, or a bit of shell or other hard material. Investigators have found Cestode larvae, Trematode worms, and even small Crustacea and Hydrachnids as the nuclei of pearls. Centuries ago the Chinese discovered that if foreign substances were placed between the mantle and shell of a mussel, in many cases a coating of "mother-of-pearl" was laid down over the insert.

The Japanese developed the earlier work of the Chinese to a great enterprise under the guidance of the late Prof. Mitsukuri, opening the oysters slightly and inserting bits of sand, images, and bits of mother of pearl, with the result that *blister* or culture pearls were produced. In 1892, Kokichi Mikimoto, the "Pearl King," following the suggestions made to him by Professor Mitsukuri, began the cultivation of pearls on a large scale. Mikimoto's oyster beds extend over 40,000 acres. According to Jordan (1927) he employs one thousand people. The divers are all young women who, it is reported, can remain two minutes under water.

Culture pearls with a spherical mother-of-pearl nucleus are just as aesthetic as a natural pearl, which may be the "sarcophagus" of a tape-worm. In spite of attempts to bar them from the market as genuine, they are now sold for as much as \$200 each. Chemically and biologically they *are* true pearls.

Coated Glass Substitutes for Pearls.—Alabaster or glass beads are now coated with pearl essence secured by the extraction of *guanin* crystals from herring and other fishes (see page 254) and are sold as artificial pearls.



REFERENCES ON PEARLS

- CHIDESTER, F. E. 1915. Artificial production of pearls. Sc. Am., Supp. No. 2043, Feb. 1915, p. 140.
- JORDAN, D. S. 1927. Mikimoto and the culture pearls. Sc. Am., Oct. 1927, pp. 300-302.
- TRESSLER, D. K. 1923. Marine Products of Commerce. N. Y.

GENERAL CONSIDERATION OF THE MOLLUSCA

Distribution.—Mollusca are found in both fresh and salt water, and on land. While they are usually free-living, they serve as obligatory intermediate hosts in the development and transmission of certain parasitic worms, such as the lung and blood flukes of man, and are also found in association with some of the aquatic crustacea.

Physiology.—The soft bodies of the molluscs are protected by a slimy covering frequently supported by a shell. Certain of the gastropods and cephalopods lack such a shell.

In the Lamellibranch, *Pecten*, the two valves are rapidly opened and closed and the animal flaps along at considerable speed. Other forms like the *long-necked clam* (*Mya*) utilize their siphons in burrowing while the majority move slowly by means of the foot. The oyster is sessile in the adult condition. In certain Gastropoda there is a slow wave-like muscular motion of the foot; whereas in other species locomotion is accomplished by ciliary activity (Copeland⁷). The Cephalopoda when undisturbed move slowly by means of the tail fin and sometimes by "walking" on the arms, but they are capable of very rapid backward movement by jets of water ejected from the "funnel" or siphon.

The Mollusca have a well-developed body cavity usually divided into two chambers, the pericardial and the visceral. Digestion is facilitated by the secretions from the *hepato-pancreas* or "liver." The Gastropoda have a highly developed lingual ribbon, the "radula," which is instrumental in the penetration of hard shells. *Snails* are able to digest cellulose without the aid of bacteria. In Cephalopoda a salivary secretion is poisonous enough to paralyze small crabs. The devil-fish or *octopus* has acid-secreting glands which soften the shells of oysters at the point of drilling. *Teredo* feeds in part on the wood from its burrows filed off by its shell.

⁷ Copeland, M. 1919. Locomotion in two species of the gastropod, *Alectrion*. Biol. Bull., vol. 37, no. 2, pp. 126-138.

Many of the snails *respire* by means of air taken into the mantle cavity which functions as a lung. Other aquatic forms breathe by means of gills. Pinna-globulin is a pigment in the blood of the Lamellibranchs. *Pinna squamosa* has manganese instead of the copper common to invertebrates, including oysters, but it does not appear to function in transporting oxygen.

Many gastropods and cephalopods have haemocyanin, and in the Gastropod *Planorbis*, haemoglobin occurs. (Redfield, personal communication.)

Nervous System.—The nervous system of the Mollusca consists of cerebral, visceral and pedal ganglia, with connectives. In the Gastropoda, the coiled shell causes the nervous system to be in a spiral.

It is said that the smallest snail can withstand more strychnine than an adult man. Richards has shown ⁸ that *Mytilus* is poisoned readily by atropine and camphor and less so by caffeine.

Regeneration.—Autotomy is not characteristic of mollusca in general, but a few Lamellibranchs and Gastropods are able to part with and regenerate a new bit of their foot.

Growth Studies on the Mollusca.—Molluscs are especially suited for studies of the growth of animals because the shell is added to and extended by the mantle as the organism grows. The amount added in a given time, or the rate of growth, depends on the amount of food that the animal receives. During the winter the animals get little food and the edge of the shell thickens leaving a growth ring or check mark when the growth begins again early the next spring.

On Cape Cod, Massachusetts, the growth of the edible mussel (*Mytilus*) begins in March following the great increase of its food (plankton) in January and February.⁹ The growth rings of the Pacific Coast *razor clam* (*Siliqua*) appear very clearly so that Weymouth¹⁰ and his associates have been able to extend our views

⁸ Richards, O. W. 1929. Conduction of the nervous impulse through the pedal ganglion of *Mytilus*. Biol. Bull., vol. 56, pp. 32-40. Richards has shown that the rate of conduction of the nervous impulse was 92.9 ± 3.3 cm. per second in *Mytilus edulis* at 24° C.

⁹ Richards, O. W. Studies on the growth of *M. edulis* and *californianus* in progress communicated personally to the author.

¹⁰ Weymouth, F. W., and McMillin, H. C. 1930. Relative Growth and Mortality of the Pacific Coast Razor Clam and Their Bearing on the Commercial Fisheries. Bull. U. S. B. F., vol. 46, pp. 543-567.

of the nature of the growth process from the analysis of measurements of the growth of this clam. Other forms do not show these rings clearly so that Richards has used x-ray pictures to show the internal structure of the shell not visible to the unaided eye. The growth of many shells takes place in an orderly manner and in some cases in precise mathematical form such as the logarithmic spiral formed by the chambered nautilus.¹¹

Embryology.—The eggs of the Mollusca are extremely numerous. In the oyster, it is estimated that there are 60,000,000; in the squid as many as 40,000. The sexes are usually separate except in the Gastropoda. (Figure 72.)

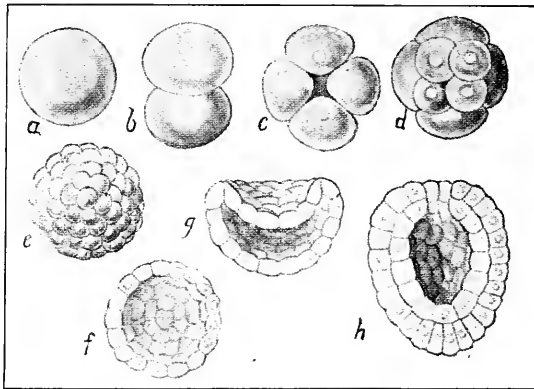

FIG. 72. First stages in embryonic development of the pond snail (*Lymnaeus*): *a*, egg cell; *b*, first cleavage; *c*, second cleavage; *d*, third cleavage; *e*, after numerous cleavages (Morula); *f*, blastula (in section); *g*, gastrula just forming (in section); *h*, gastrula completed (in section). (After Rabl.) This may be taken as a type of the earliest development of all many-celled animals (*Metazoa*). (From Jordan and Kellogg, *Animal Life*. Courtesy of D. Appleton and Co., Publishers.)

Most larval molluscs include a *trochophore* stage, which becomes a *veliger* larva. The *velum* is situated anteriorly to the mouth and proves extremely important in the locomotion and dispersal of the animal. In the fresh water mussels, a parasitic stage, the *glochidium* (see page 148) attaches to the gills or fins of fishes.

Care of the Young.—In certain of the Gastropoda, the eggs hatch within the body of the parent. In one form the female (*Galerus chinensis*) hatches her eggs by keeping them between her foot and

¹¹ Thompson, D. A. W. 1917. Growth and Form. Camb. Univ. Press.

the stone to which she adheres. The octopus broods her eggs, renewing the water around them by siphonal jets.

Fossil Relatives.—As indicated on page 142, under Classification of Mollusca, they are found from the Cambrian to the present, the Lamellibranchs being especially abundant in the Cretaceous of America.

Ancestry and Relationship to Other Phyla.—On account of the occurrence of the *trochophore* larva the Mollusca are linked with the worms. The Cephalopoda are separated from the other Mollusca, having no free larvae and being provided with highly developed eyes and nervous system.

ECONOMIC IMPORTANCE OF MOLLUSCA

<i>Class</i>	<i>Positive</i>	<i>Negative</i>
Lamellibranchiata.	1. As money. Quahaugs and cowries. 2. Pearls. Pearl oysters, clams and mussels. 3. Buttons from mussel shells. 4. As ornaments. 5. Food—oyster, clam, mussel, scallop (adductor muscle), shells as chicken grits. 6. For roads (New England uses oyster shells). 7. As church fonts— <i>Tridacna</i> (500 lb. shells). 8. Window pane (<i>Placuna</i>).	1. <i>a.</i> Pholas—"borer." <i>b.</i> "Ship-worms." <i>Teredo navalis</i> and <i>Bankia fimbriata</i> attack wooden ships and piles. 2. Giant clam. <i>Tridacna gigas</i> (enemy of divers).
Gastropoda.	1. For food or bait. Whelks, periwinkles, top shells, limpets, the abalone (<i>Haliotis</i>). 2. For buttons and as ornaments. Ear shells, sea snails, cameo shells (<i>Cassis</i>), top shells. Queen conch shells (<i>Strombus gigas</i>) were formerly used in Liverpool for the manufacture of porcelain. 3. For dye stuffs the "sea hare" furnishes purple dye. "Tyrian purple" (<i>Purpura</i> , the whelk). 4. For bird lime. The giant slug is used by South American Indians to lime humming birds. 5. The calcareous front doors (opercula) of some S. American gastropods are sold for use in the U. S. as "eye-stones."	1. Boring gastropods attack lamellibranchs. 2. Destroy vegetables and plants—garden snail (slug) <i>Limax</i> . 3. Sometimes snails attack the eggs of fish in nests. 4. Intermediate hosts of larval stages of flukes of man.

Amphineura.	1. Chiton used as food and for bait.
Scaphopoda.	1. Tusk shells (<i>Dentalium</i>) were used as currency in California by the Indians.
Cephalopoda.	<ol style="list-style-type: none"> 1. <i>Sepia</i> "bone" and "cuttle bone" used to feed birds requiring lime. 2. Dr. J. A. Eiesland cites the use of cuttlebone for erasers in Norway about 1870. 3. "Pounce" as anti-acid (medicine); in art work to prevent blotting. 4. <i>Sepia</i>—for ink. 5. Squid oil—medicine and as lubricant. 6. Food and fish bait. Squids, octopi and <i>sepia</i>.

REFERENCES ON MOLLUSCA

- COOKE, A. H. 1895. Mollusca, in Cambridge Natural History, Macmillan Co.
- GOULD, A. H. 1870. Report on Invertebrata of Massachusetts. 2d ed. Binney (Mollusca and Tunicata).
- JOHNSON, M. E., AND SNOOK, H. J. 1927. Shore Animals of the Pacific Coast. The Macmillan Co., N. Y.
- SIMPSON, G. B. 1901. Anatomy and Physiology of *Polygyra albolabris* and *Limax maximus*, etc. New York State Educational Department.
- TRESSLER, D. K. 1923. Marine Products of Commerce, N. Y.
- VERRILL, A. E. 1882. Report on the Cephalopods of the Northeastern Coast of America. Report of U. S. Fish Commission for 1879. Government Printing Office.

CHAPTER XII

ARTHROPODA

THE ARTHROPODA (Gr. *arthron*, a joint; *pous*, a foot) include more than one-half the number of species in the animal kingdom and comprise a wide variety of forms, with great significance economically.

The body, segmented and bilaterally symmetrical as in the Annelida, is covered by a chitinous exoskeleton. The heart is usually elongated and the nerve cord is ventrally situated, while the cerebral ganglia are dorsal and anterior as in the earthworm.

This Phylum includes insects, barnacles, crabs, crayfishes, spiders, ticks, and scorpions. The bee is an example of a beneficial form; the housefly, of an injurious type.

CLASSIFICATION

- Class 1. Crustacea.*
- Class 2. Onychophora.*
- Class 3. Myriapoda.*
- Class 4. Insecta.*
- Class 5. Arachnida.*

CHARACTERISTICS

1. Marked metamerism.
2. Appendages jointed.
3. Body covered by chitinous exoskeleton, secreted by cells beneath it.
4. Bilateral symmetry.
5. Mouth and anus at opposite ends.
6. Seldom ciliated.
7. Muscles usually striped.
8. Dorsal heart, with incomplete circulatory system, the blood sinuses extremely important.
9. Nervous system includes a ventral nerve chain with ganglia and paired dorsal cerebral ganglia.

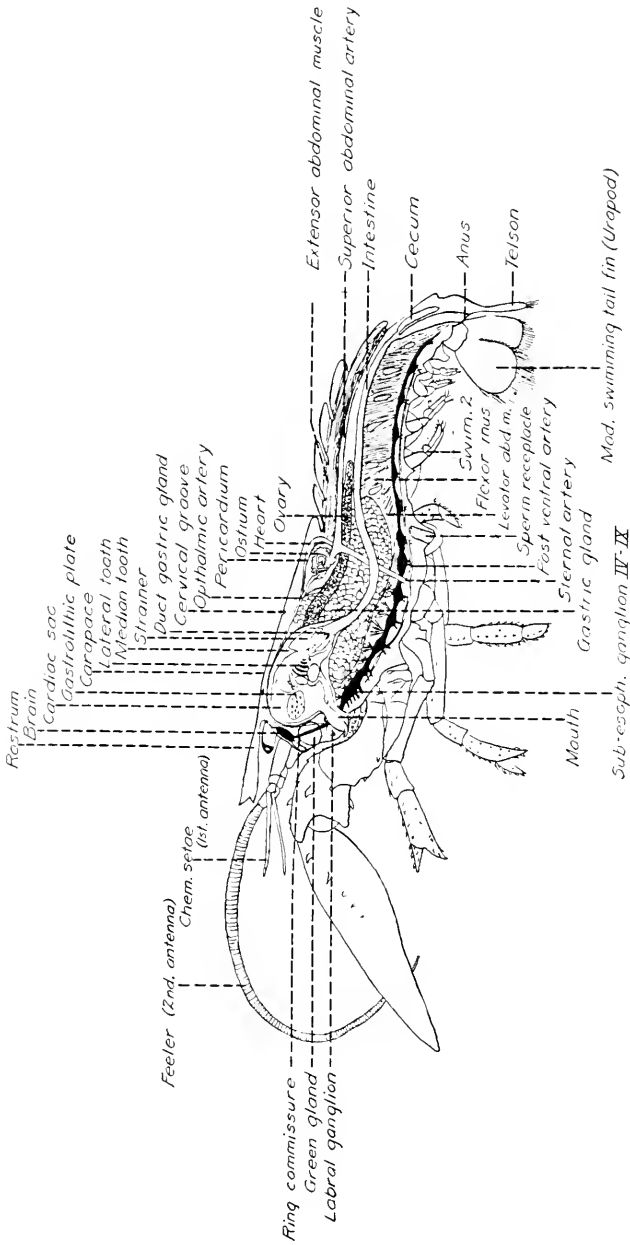

FIG. 73. Anatomy of female lobster (After Herrick, U. S. B. F.)

NATURAL HISTORY

Class I. Crustacea.—*Crustacea* vary in size from microscopic to the 34-pound lobster. Nearly all have a hard exoskeleton. They shed this and grow for a time. Young crayfishes and lobsters moult 8 times the first year, 5 times the second year, 3 times the third year and from one to three times annually, thereafter. They are divided into the head, thorax and abdomen. The head and thorax are frequently fused to form a *cephalothorax*. There are usually 21 segments in higher crustacea. Seven is the typical number of abdominal segments. There are eight in the cephalothorax (5 legs and 3 appendages) and six in the head.

Subclass Malacostraca. Order Decapoda. Type—Lobster or Crayfish. (Figure 73.) *Digestive System.*—This consists of the esophagus, cardiac stomach, pyloric stomach, intestine, and liver. The *esophagus* is lined by chitinous cuticle and supplied with small "salivary" glands. The *cardiac stomach* contains the *gastric mill*, which is equipped with powerful chitinous teeth, the most important being the two laterals and the single dorsal. The posterior *pyloric stomach* has a sieve-like strainer of coarse hairs. The short mid-gut receives the secretions from the lateral *liver* or hepato-pancreas. This gland absorbs peptones and sugar, manufactures glycogen and furnishes enzymes corresponding to the gastric and pancreatic juices of mammals. The *intestine* is long and straight, except for a slight dilatation in the sixth abdominal segment, the *rectum*. An *intestinal cecum* is dorsally situated. Chitin-lined, the intestine has but few glands. Both *mouth* and *anal* opening are ventrally situated.

Circulatory System.—The *blood* is a colorless liquid with amebocytes. In *Crustacea*, hemoglobin is replaced by a fluid containing *copper* instead of iron, which is called *haemocyanin*. It is colorless when flowing, but turns plumbago colored when exposed to the air. The *heart* is shield shaped with three pairs of *ostia*. There are seven *arteries* and many *sinuses*. The *ophthalmic artery* supplies the esophagus, stomach and head. Two *antennary arteries* supply the stomach, antennae and excretory organs. Two *hepatic arteries* supply the *digestive glands*. There are also *dorsal abdominal* arteries, the *sternal* artery which passes through the spinal cord, the *ventral thoracic*, and the *ventral abdominal*.

Circulation of the Blood.—The heart sends the blood to the arteries, capillaries, sternal sinus, and to the *gills* where it is purified.

It returns from the gills to the *cardiac sinuses*, *pericardial sinus* and back through the *ostia* to the heart. There are valves in the arteries and sinuses.

Respiration is by means of gills. *Astacus*, the crayfish found west of the Rockies, has 18 pairs; the lobsters have 20 pairs and *Cambarus*, east of the Rockies, has only 17 pairs.

Excretion.—Paired, flattened “*green-glands*” are found in the ventral region of the head near the esophagus.

Reproductive System.—Ordinarily the sexes of the lobster and the crayfish are separate, although Turner has recorded many interesting cases of hermaphroditism in the crayfish. The essential organs of reproduction in the male are the bilobed *testis*, the paired vasa deferentia transporting the sperms to the outside, and the modified abdominal appendages, called stylets, which are used to transfer the spermatozoa to the ventral pouch (seminal receptacle) of the female.

In the female, the bilobed *ovary* sends off eggs which pass from the paired oviducts and are fertilized by spermatozoa stored in the ventral pouch at the time of conjugation, sometimes months previously. A lobster from 8 to 10 inches long produces from 3,000 to 100,000 eggs in a season. The crayfish may produce 2,000 eggs in a season. Each egg is attached to one of the swimmerets and hatches in about two months, the larvae undergoing two or three moults before they leave the mother, and moulting 8 times the first summer.

The Nervous System consists of a *brain* (two cerebral ganglia) and a ventral nerve cord with *esophageal connectives* uniting the *cerebral ganglia* and the nerve cord in the sub-esophageal region.

The ventral cord shows by the great number of concentrated lateral nerves as well as by the marked enlargement in the anterior thoracic region that the right and left halves of the ventral cord have fused. To a *limited* extent this fusion is evident in the abdomen.

The *ganglia* of the *last three cephalic* and the *first three thoracic* segments have united forming a large compound *sub-esophageal* ganglion. Between the fifth and sixth thoracic ganglia the ventral nerve cord is separated widely to permit the passage of the *sternal artery* which runs dorsi-ventrally. There are 12 ganglia belonging to the nervous system. The *brain* supplies the *eyes*, *antennae* and *antennules*. (Figure 74.)

Senses of the Crayfish.—*Touch* is the most valuable sense. Crayfish are sensitive to touch over the whole body, especially on the *chelae* and *chelipeds*, mouth parts, the ventral surface of the abdomen and the edge of the telson.

Vision.—The compound eyes are almost worthless for detecting the forms of stationary objects, but good for moving objects. The response is not due to any change in the *intensity* of light such as that caused by a shadow falling on the animals, for they react to a movement made on the opposite side of them from a window. Crayfish are *sensitive* to a strong light and hide during the day under stones, among the roots of plants near the bank, or burrow into the bank. They *retreat* from a strong light, but *approach* a dim one.

Smell and Taste.—Bell applied *meat juice* to various parts of the body of the crayfish and found that the *antennae*, *antennules*, mouth parts and *chelipeds* were especially sensitive.

Holmes and Homuth found that the outer rami of the *antennules* bearing the *olfactory setae* were especially sensitive to *olfactory stimuli*, that the inner rami of the *antennules* and the *antennae*, the *mouth parts*, and the tips of the *chelipeds* were all sensitive to some extent to *olfactory stimuli*. Crayfish have a highly developed *topochemical* or *contact-odor* sense. The crayfish is sensitive to food when *not* in contact with it. Experiments with freshly cut meat and with meat on which the cut surfaces had *dried* showed that the crayfish prefers fresh meat, probably because it locates it sooner.

Hearing.—Bell learned that the crayfish has *no sound* reactions, but is sensitive to *vibrations*

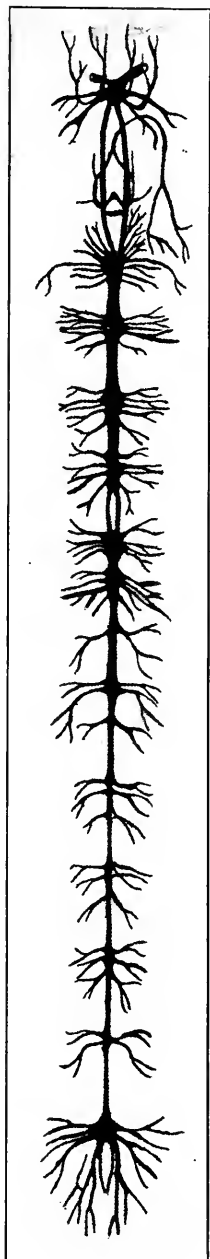

FIG. 74. The central nervous system of the lobster. (After Calkins, *Biology*. Courtesy of Henry Holt & Co.)

in the water. Huxley said, "the crayfish has nothing to say to himself or anyone else."

Equilibrium.—Bunting found that *young crayfish* with the *statocysts* removed would swim upside down as readily as right side up. It is also pretty certain that older crayfish have a sense of equilibrium, although the response to rotation in their case is not definite, but purely individual.

In an experiment by Kreidl, shrimps recently moulted and lacking statoliths were placed in filtered water and furnished iron filings which they at once popped into their statocysts. By means of an electromagnet he directed their movements, the animals orienting according to the combined forces of the magnet and of gravity.

Eyes.—The compound eyes have about 2,500 visual rods, called *ommatidia*.

Food of the Lobster and Crayfish.—Lobsters eat conchs, *Acyotypus* (oyster drill), dead and live fish, eelgrass and *Mya arenaria* (the long-neck clam). In order to secure *hard-shell clams* (*Venus*) they must dig holes 2 feet in diameter and 6 inches deep. Crayfish are omnivorous. Some crayfish eat a great deal of vegetable matter; one species, the chimney builder, *Cambarus diogenes*, seeming to prefer it. The vegetable matter eaten consists of dead leaves, potato, onion, young corn and buckwheat. The animal food consumed by the crayfish consists of worms, insects, insect larvae, a few fish, frog, toad and salamander eggs, and occasionally a dead fish or frog. Both lobsters and crayfish are *cannibalistic*. Sometimes females eat eggs from their own abdomens and devour their own freed offspring.

Enemies.—The chief enemies of the lobster, besides man, are the codfish, trematodes, and gregarines. The gregarine protozoan *Porospora gigantea* is a parasite on the lobster's intestine reaching a length of two-thirds of an inch. The *crayfish* suffers from internal and external enemies. Among the plants which live with the crayfish are diatoms, bacteria and saprolegnia. Internally, *Distoma cerrigerum* and *Branchiobdella* have been noted. Besides man, many small animals find crayfish palatable.

Many fish, including the black bass, *Micropterus*, which fishermen find very partial to crayfish, eat them. Surface reports that the salamanders *Cryptobranchus allegheniensis* and *Necturus maculosus* are among the chief enemies of the crayfish. Ortmann mentions seeing the water snakes, *Natrix sipedon* and *N. lebens*,

when captured, disgorge crayfish and has found garter snakes, *Eutaenia sirtalis*, in the holes of *Cambarus monongalensis*. The common *box turtle* catches many crayfish. Many birds, including the eagle, king-fisher, wild ibis and turkey, have been observed with crayfish in their claws; or the remains have been seen at the nests.

Economic Loss from Crayfish.—The *river species* do not especially injure human interests except in occasionally capturing a few toads, fish and frogs, but the *burrowing species* are cited by Ortmann as being very injurious, especially in the lowlands of Pennsylvania, Maryland and West Virginia. They make mud piles which clog harvesting machines, and are considered by the farmers of Maryland as such pests that it is common to throw unslacked lime over the fields in order to kill the unwelcome tenants. West Virginia farmers claim that the crayfish destroys crops of buckwheat, corn and beans by eating the young sprouts. Great damage is done by the burrowing species, *Cambarus diogenes*, in burrowing into dams on ponds and reservoirs, a notable instance being the *levees* of the Mississippi.

To destroy crayfish it is customary to throw unslacked *lime* over the field, or to pour *carbon bisulphide* into the holes, or to *drain* the infested area. None of these measures is efficacious, the first two methods being impracticable on account of the difficulty in reaching the bottom of the burrow and the last, simply lowering the water level, only delays matters a little.

Economic Gain from Crayfish.—With the lobster fishery in a state of decline, it seems as if the crayfish could be profitably substituted for its larger cousin. Crayfish mature in one season and grow to a length of from four to five inches in three years, so that, considering the large number of eggs (100–600) laid by one female, there should be but little difficulty in supplying a large demand for these animals. When we consider that the large *Astacus* readily adapts itself to the slight difference in environment in the east, we see that the crayfish is a very practicable substitute for the lobster. There should be no difficulty in disposing of the smaller *Cambarus*, either as fresh food or canned, as we get the abdomens of shrimps.

In school and college laboratories, the anatomy of the crayfish has been studied ever since Huxley wrote "The Crayfish." The habits and activities of the young and adult crayfish are of great interest and profit for study. The animal is suited for many kinds of experiments, and the large *ganglia* and nerve cells are readily removed and are excellent for *neurological* work. Psychologists

should study the relations of mother and offspring for the few days just after the young are detached from the mother's swimmerets.

REFERENCES ON THE CRAYFISH AND THE LOBSTER

- CHIDESTER, F. E. 1912. The biology of the crayfish. Amer. Nat., vol. 46, pp. 279-293.
 HERRICK, F. H. 1911 (1909). Natural History of the American Lobster. Bull. Bur. of Fish., vol. 29, pp. 149-408.
 HUXLEY, T. H. 1880. The Crayfish. D. Appleton Co.

Crustacea. (Entomostraca and Malacostraca.)—The Branchiopoda, Ostracoda, Copepoda, and Cirripedia are certain Subclasses of primitively developed Crustacea which are grouped under the heading of *Entomostraca* as distinguished from the *Malacostraca*. They are small in size and while not themselves especially significant to man, they are of tremendous importance as the food of fishes.

Subclass Branchiopoda.—These crustacea generally have a shell, and many pairs of leaflike swimming appendages. The **Order Phyllopoda** includes the fairy shrimp and the brine shrimp. The *fairy shrimp*, *Branchipus*, a most beautiful form, is found in fresh water just after the ice has left certain ponds. The *brine shrimp*, *Artemia salina*, has been the subject of experimental work on the influence of reduced and increased salinity on its characteristics. One species, *Artemia fertilis*, is found in the Great Salt Lake.

To the **Order Cladocera**¹ belong certain species of *Daphnia*. This form has a bivalved carapace enclosing the trunk. The eyes are *sessile* and fused. The interesting study of phagocytosis made by Metchnikoff showed that when the spores of a fungus, *Monospora*, were swallowed by *Daphnia*, they perforated the wall of its alimentary canal, but were attacked and destroyed by the blood corpuscles. (Figure 75, *A* and *B*.) Elton reports a huge multiplication of water fleas in the Antwerp reservoirs in 1896 such that six men worked night and day removing them by straining the water through wire gauze. It was estimated that ten tons of water fleas were taken out.

Subclass Ostracoda.—The common bivalved form **Cypris** uses its antennae in swimming. It has no special economic significance, except as food for other animals.

¹ Banta, A. M., and associates, have made numerous important studies on sex intergrades and the determination of sex in Cladocera. See his recent paper, Control of sex in Cladocera, Phys. Zoöl., vol. 2, Jan. 1929.

Subclass Copepoda.—These Entomostraca have no shell and lack abdominal appendages. They are among the most important fish foods. Forms like *Cyclops* are the best known. The parasitic guinea worm (page 96) is transmitted by *Cyclops*. The Copepoda

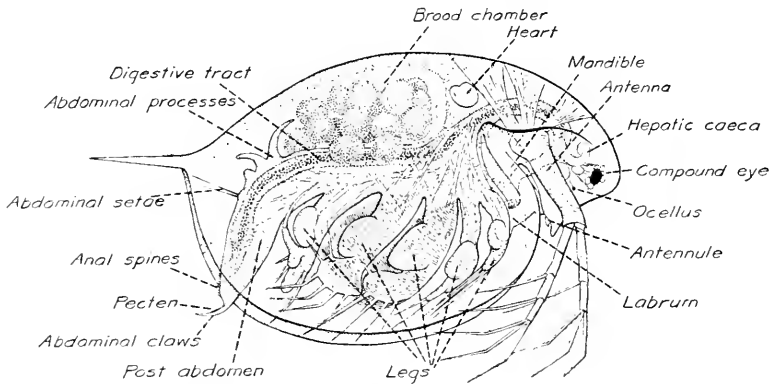

FIG. 75A. Female *Daphnia pulex*, bearing summer eggs. (Dodds, *Univ. of Colorado Studies*, vol. 11, 1915.)

include many important fish parasites, the form *Argulus* being parasitic on the carp. Dr. C. B. Wilson of the U. S. Bureau of Fisheries is our international authority on parasitic Copepoda. (Figure 76.) Lake Plankton is rich in the Copepod *Diaptomus*.

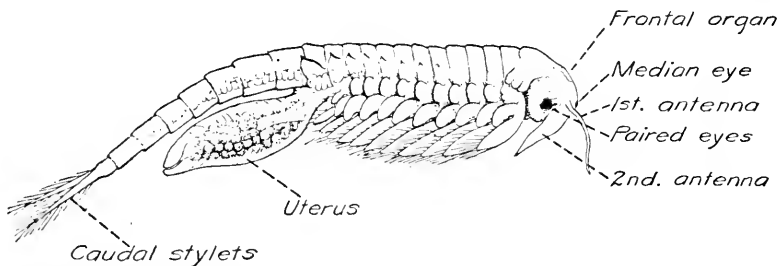

FIG. 75B. *Branchinecta packardii* female showing uterus and eggs. (Dodds, *Univ. of Colorado Studies*, vol. 11, 1915.)

A number of species of *Cyclops*, colorless and blind, have been found in wells.

Subclass Cirripedia.—The *Cirripedia* (Figure 77) include the common *gooseneck barnacle*, *Lepas*, and the *acorn barnacle*, *Balanus*. The latter are found along the coast attached to rocks and wharves where

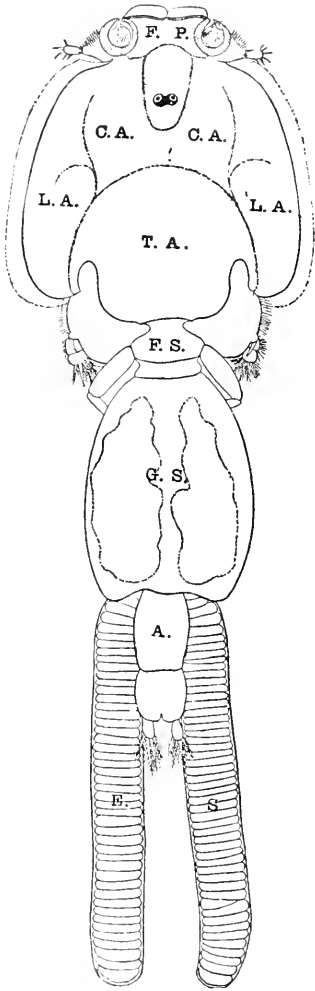

FIG. 76. *Caligus mutabilis*, dorsal view. *F.P.*, frontal plates; *C.A.*, cephalic area; *L.A.*, lateral areas; *T.A.*, thoracic area; *F.S.*, free thoracic segment; *G.S.*, genital segment; *A.*, abdomen; *E.S.*, egg strings. (Courtesy of C. B. Wilson.)

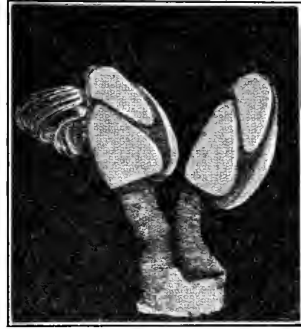

FIG. 77. Stalked barnacles (*Lepas anatifera*). (From Kellogg & Doane. Courtesy of Henry Holt & Co.)

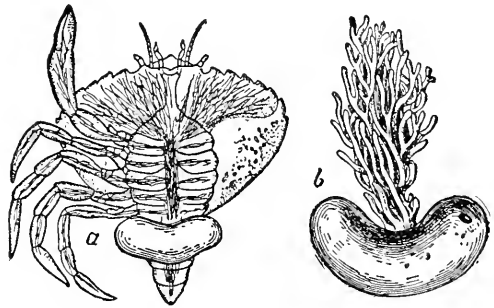

FIG. 78. *Sacculina*, a crustacean parasite of crabs. (a) Attached to a crab, with root-like processes penetrating the crab's body; (b) removed from the crab. (From Jordan and Kellogg, *Animal Life*. Courtesy of D. Appleton & Co.)

their sharp shells are sources of much annoyance to bathers. Barnacles encrust the bottoms of ships.² Huxley described the barnacle as a "crustacean fixed by its head and kicking food into its mouth with its legs." One of the *Cirripedia*, a parasitic form known as *Sacculina*, is considered to be the most *degenerate of parasites*. (Figure 78.) It attacks the abdomen of crabs and causes degeneration of the gonads. Barnacles are degenerate crustaceans.³ The animals have lost their independence by attachment of the head or back, and the readjustment of segmental plates to suit the new needs. Embryology of the barnacles shows that they probably arose from free swimming phyllopods. Ruedemann discovered a primitive *Balanus* attached to the shell of a Cephalopod in the Ordovician shale, which also bears out this hypothesis. The goose-barnacles (*Lepas*) became fixed by the head, and developed several valves.

Subclass Malacostraca.—The *Malacostraca* are usually large crustacea, with five cephalic, eight thoracic and six abdominal segments, and with a grinding "gastric mill" in the stomach. The Malacostraca include lobsters, crabs, prawns, shrimps and pill bugs. The orders which we shall consider are the Amphipoda, the Isopoda and the Decapoda. The Amphipoda lack a carapace and have an elongated abdomen with three pairs of posteriorly directed feet, and three pairs of anteriorly directed swimming feet.

The *beach fleas*, *Amphipoda*, found on sea beaches, are important food for other marine animals. A boring amphipod, *Chelura*, attacks piles and wooden ships. The *Isopoda* have no carapace, a broad flat body, leaflike legs, and seven free thoracic segments. The *wood-lice* or sow bugs are *Isopoda* which live a wholly terrestrial life. They feed on decaying vegetable matter but sometimes damage plants in gardens and greenhouses. As they breathe by abdominal gills, they seek moist places. Some of their relatives live in fresh and salt water.⁴

² Visscher, J. P. 1927. Nature and Extent of Fouling of Ships' Bottoms. Bull. U. S. Bur. Fish., vol. 43, 1927, Doc. 1031. Visscher found that paint of lighter colors should be used to prevent fouling of ships' bottoms while they are in port. Barnacles are stimulated most by light in the field of green and blue.

³ Clarke, J. M. 1921. Organic Dependence and Disease. N. Y. State Museum.

⁴ Allee, W. C., who for over fifteen years has been studying animal aggregations in Isopoda and other forms, has recently given an excellent summary, Animal aggregations, Qu. Rev. of Biol., 1927, vol. 2, no. 3, pp. 367-398. Consult also his book, Animal Aggregations, U. of Chi. Press, 1931.

An important genus, *Limnoria*, is found attacking submerged wood, sometimes honeycombing piles more than half an inch. Piles are accordingly creosoted or infiltrated with paraffin. (Figure 79.)

The order *Decapoda* includes our common crabs, shrimps and lobsters. The first three pairs of thoracic appendages are modified as maxillipeds, the thoracic segments are covered by a carapace and there are five pairs of thoracic walking legs. The compound eyes are stalked.

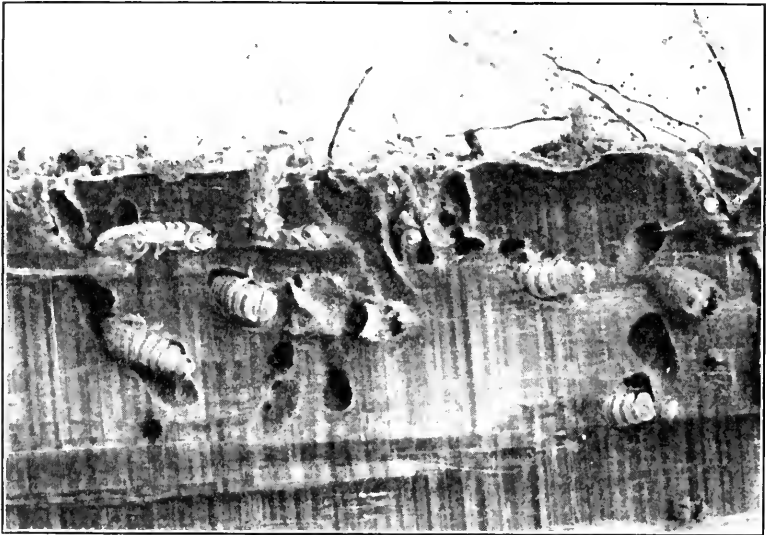

FIG. 79. *Limnoria*. (Courtesy of C. A. Kofoid.)

There are two distinct genera of *crayfishes* in America, *Cambarus*, found east of the Rocky Mountains, and *Astacus* extending to the Pacific coast. The latter genus includes individuals that grow to a length of 9 inches. The largest crayfish in the world, *Astacopsis franklinii*, found on the northwest coast of Tasmania, may weigh as much as 9 lbs.

The American *lobster*, *Homarus americanus*, the European lobster, *H. grammurus*, and the Norwegian lobster, *Nephrops norvegicus*, are extremely important as food of fishermen and when served as delicacies inland. The *lobster* is found along the Atlantic coast, ranging from North Carolina to Labrador. The largest lobster ever taken weighed 34 lbs. and was 23.75 inches in length (Herrick).

The *sea crayfishes*, *Palinurus vulgaris*, sometimes called the spiny or "rock lobsters," have *no chelae* and a much reduced *rostrum*. They are valued by Europeans for food and are said to be similar to the true lobster in flavor. The *common prawn*, *Palaemonetes vulgaris*, reaches a length of about 2 inches. It is transparent. The body is compressed and the exoskeleton lacks lime. The rostrum, eye stalks and antennae are very conspicuous. The *common shrimp*, *Crangon (Crago) vulgaris*, is exceedingly abundant on the Pacific coast, along the shore of the Gulf of Mexico. The *edible shrimp*, *Penaeus setiferus* is found in shallow bays and estuaries from Virginia to Texas. It reaches a length of 6 inches. Its value as food is estimated to be over \$200,000 annually. While speaking of shrimps, we might mention the order *Stomatopoda* which includes Malacostraca with five pairs of anterior thoracic maxillipeds, three pairs of thoracic legs and an extremely short carapace. The *mantis shrimp*, *Squilla (Chloridella) empusa*, belonging to this order, reaches a length of 10 inches. Several species of *Squilla* are eaten in the Mediterranean and tropical Pacific. They are esteemed as a delicacy in Tahiti and Samoa. Perhaps the American form may yet come into use.

The *hermit crabs*, *Eupagurus*, related to the shrimps and prawns, live in the shells of gastropods which they seek out very early in their life history and in which they are protected. Sea-anemones and hydroids are commonly found attached to the shells occupied by hermit crabs. (See Commensalism, p. 482.) *Robber crabs* (*Birgus latro*) are related land forms found on coral islands in the Indian Ocean. They ascend cocoanut trees, and feed on the pulp of the cocoanut. The *blue crab* (*Callinectes hastatus*) is the commercial soft-shell crab. *Rock crabs* and *painted crabs* are also used for food when soft. *Oyster crabs* bring a high price in the market. The *ghost crab*, a scavenger, destroys the eggs of sea birds. (Figure 80.) A little *marine crab*, *Melia*, inhabiting coral reefs, uses small sea-anemones for defense and for feeding. It captures an anemone in each claw and when attacked it thrusts the anemone towards the enemy for defense. When the anemones capture food, the crab seizes the tidbit.

Class 2. Onychophora.—The *Onychophora* (Gr. *onux*, a claw; *phoreo*, bear) include approximately fifty species of the genus *Peripatus*, found in Australia, New Zealand, Africa, South America, and the West Indies. All the species of *Peripatus* are terrestrial,

living in damp places. About thirty species live in the tropics, eight appearing in Africa. *Peripatus* lives in crevices in rocks and other dark sheltered places, and moves slowly, avoiding strong light. It ejects slime from a pair of oral glands, capturing insects and crustacea. Much as it resembles the hypothetical "ancestral Arthropod" of some zoölogists, *Peripatus* is *not ancestral*, but merely

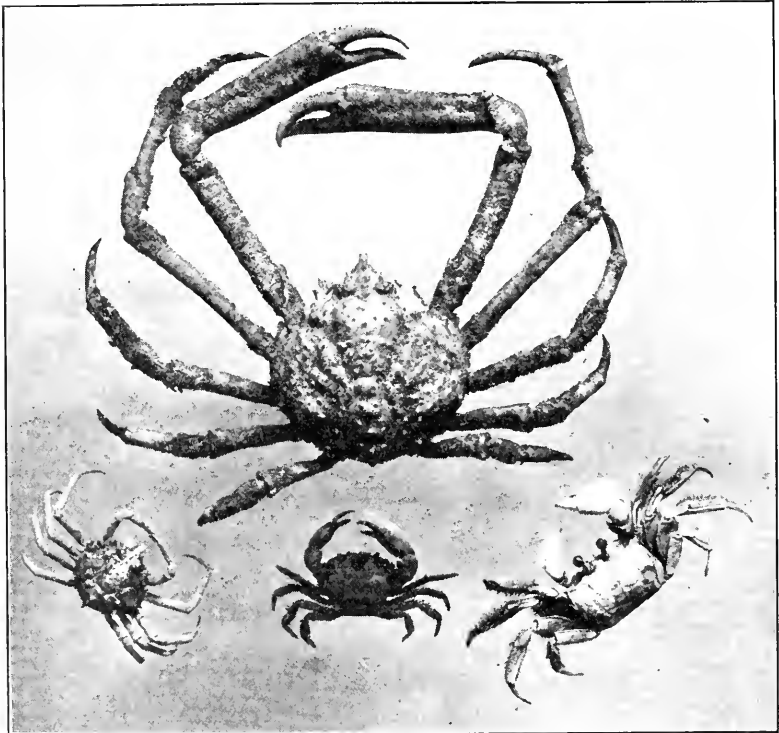

FIG. 80. Above, male spider crab. Left, female spider crab. Right, ghost crab. Center, mud crab. (From Mayer, *Seashore Life*. Courtesy of N. Y. Zool. Soc.)

a primitive type, modified from an old stock. When first discovered, it was termed a slug. Although it is an *Arthropod*, we find that *Peripatus* has a number of characteristics of the *Annelida*, such as paired segmental nephridia, and ciliated cells in the lining of the reproductive tubes. Like the *Arthropoda*, its appendages are modified as jaws, and it has well-developed tracheae, but lacks a coelom around the alimentary canal. (Figure 81.)

Class 3. Myriapoda.—The *Myriapoda* (Gr. *myrics*, ten thousand; *podes*, feet) have a head with paired antennae and mandibles, many similar body segments bearing leglike appendages, tracheae, and excretory (Malpighian) tubules which open into the intestine. The *Millipeds* are wormlike in appearance with about three hundred segments, to each of which is attached *two pairs* of appendages.

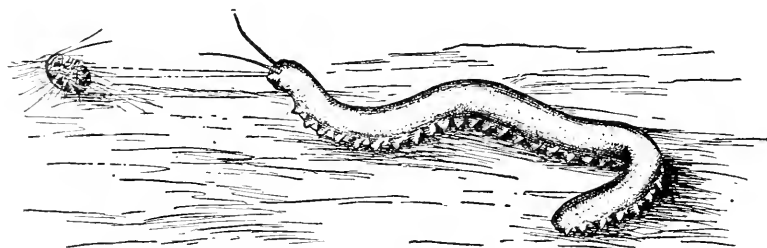

FIG. 81. *Peripatus*. (From Pearse, *General Zoology*. Courtesy of Henry Holt & Co.)

Very few of them are injurious to agriculture. *Julus* is a crop destroyer. *Centipedes* have but *one pair* of appendages for each segment. The large *tropical centipedes* (*Scolopendra*) are reported to be extremely venomous and their bite may even be fatal to man. They reach a length of eighteen inches, are carnivorous and able to kill insects almost instantly. South American Indians use them as food. The *house centipede* (*Scutigera forceps*) feeds on flies, cockroaches, and bed-bugs and since it is not very poisonous to man, is of considerable economic importance.

Class 4. Hexapoda. (Insecta.) (Gr. *hex*, six; and *pous*, foot.) —We live in the Age of Insects, and struggle with them for the possession of the earth. Not only physical and chemical agencies, but all available natural enemies must be utilized in order to keep the insects under control. They devour our foodstuffs, destroy our animal friends and still prevent us from claiming important new territory. The number of species of insects outnumbers those of all other animals taken together, and the number of individuals is incalculable. Little is known about the histology, embryology or physiology of insects, but all that we do know has shown that they are of tremendous importance economically. Interesting studies of their habits have shown that insects are highly developed and specialized in their behavior.

The *Insecta* have three well-defined regions, the head, thorax and

abdomen. All insects have three pairs of thoracic legs and the majority have one or two pairs of thoracic wings. Respiration is accomplished by means of a complicated tracheal system. Insect classification is based on the structure of the mouth parts and the character of the development. Aldrich reported (1907) that there were 640,000 named insect species.

CLASSIFICATION⁵

<i>Metamorphosis very slight</i> ; biting mouth parts; wingless.....	Thysanura.
<i>Metamorphosis incomplete.</i>	
With biting mouth parts.	
Wings membranous.....	{ Ephemeraida. Plecoptera. Odonata. Isoptera. Corrodentia. Orthoptera. Euplexoptera.
Fore wings parchment-like.....	{
Wingless.....	{ Mallophaga.
With sucking mouth parts.....	{ Hemiptera. Thysanoptera.
<i>Metamorphosis complete.</i>	
With biting mouth parts.	
With wings membranous.....	{ Neuroptera. Mecoptera. Trichoptera.
With fore wings thickened.....	{ Coleoptera.
With sucking mouth parts.....	{ Lepidoptera. Diptera.
With lapping or piercing and sucking mouth parts.....	{ Siphonaptera. Hymenoptera.

Folsom (1922) gives a most elaborate classification of insects according to food habits: Microphaga, feeders on sugars and salts, with yeasts and bacteria; sarcophaga, flesh eaters; coprophaga, eaters of molds and bacteria; mycetophaga, consumers of fungi; necrophaga, eaters of dead animals, etc. (A flesh-eating insect larva may eat 200 times its own weight in 24 hours.) In America it is customary to classify the insects into 19 orders. We will consider them thus, treating briefly of each order.

Insects. Order 1. *Thysanura*. (*Aptera*).—The *Thysanura* include wingless insects with retracted mouth parts and no meta-

⁵ Classification after Kellogg and Doane.

morphosis. The common “*fish moth*” or *silver fish* attacks starched clothing, book bindings and wall paper paste, and the “*snow flea*” sometimes gets into maple sap.

Order 2. Ephemera.—The *May-flies* have delicate wings, poorly developed mouth parts and an incomplete metamorphosis. The young *May-fly* lives in the water. Adult *May-flies* are said to take no food, but to mate, deposit their eggs and die, all within the short span of twenty-four hours. (Figure 82.)

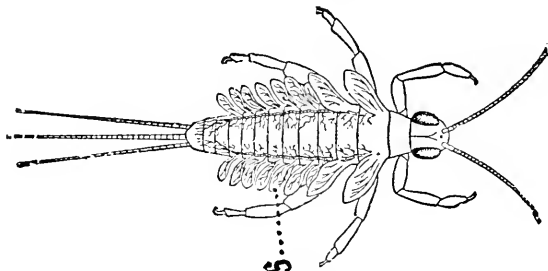

FIG. 82. Young nymph of *May-fly*, showing tracheal gills. (After Jenkins and Kellogg, from Kellogg and Doane, *Zoology and Entomology*. Courtesy of Henry Holt & Co.)

Order 3. Odonata.—The *dragon flies*, as larvae and as adults, are important enemies of mosquitoes. They have large compound eyes, four membranous wings and strong, biting mouth parts.

Order 4. Plecoptera.—The *stone flies* are less important as fish food. The nymphs live in running water where they cling under stones.

Order 5. Isoptera.—The *termites* or “*white ants*” are found in the tropics in great abundance, where they destroy houses and other structures made of wood. Some species attack soft plants and living trees. In Africa, they sometimes build pyramidal nests twenty feet high. The termites are social insects. (See p. 484.)

Order 6. Corrodentia.—The *book-lice* are wingless insects frequently found defacing the paper and bindings of old books. *Bark lice* are winged forms feeding on lichens, oak leaves and other foliage.

Order 7. Mallophaga.—There are about fifteen hundred species of *biting lice* which live among the feathers of birds or the hair of mammals. While they are not sucking forms, they cause bleeding and the results are almost as bad. They irritate the animals which resort to dust baths.

Order 8. Thysanoptera.—The *thrips* are minor pests of wheat, onions, citrus fruits and grasses. Their feet are clawless with bladders adapted for clinging to leaves. They have four narrow membranous wings, fringed with long hairs.

Order 9. Euplexoptera.—The *earwigs* feed on fruit and flowers, but are of no economic significance in America, where they are rare. The mother remains to guard her eggs for a time.

Order 10. Orthoptera.—The *cockroaches*, *Blattidae*, are nocturnal insects frequenting water pipes and attacking food stuffs. There are four species in the U. S., the common "croton bug" being the form most frequently found. They eat the "silver-fish," bed-bugs and each other.

The *praying mantis*, *Mantidae*, has its front legs peculiarly adapted for seizing and holding its prey. Its peculiar attitude when lying in wait for its food gives it the name "praying."

The *walking sticks*, *Phasmidae*, resemble their background so perfectly that it is exceedingly difficult to locate them at times. They feed on the leaves of trees, usually the oak.

Locusts or short-horned grasshoppers, *Acrididae*, have extremely short antennae and well-developed leaping legs. They are important enemies of plant life and, when they migrate in hordes, seem to devour almost everything. Locusts were eaten in the Orient and are still prized by some savages. (Figure 83.)

The *Tettigoniidae* (*Locustidae*) include the meadow grasshoppers and the katydids. The *katydids* are large green insects feeding on leaves and tender shoots, but occasionally devouring other insects. The *females* are *silent*. Certain yellowish brown, wingless forms, living in cellars and caves, are called "cave crickets."

The *Gryllidae* have their wings flat on the body and are usually stout-bodied. Many are wingless. The *true crickets* (house crickets) are black forms, feeding on plants for the most part. The eggs are laid in the ground in the fall and hatch in the summer. The *tree crickets* are slender and light in color. The "*snowy tree cricket*" injures grape vines and berry plants. The female guards her eggs. The *mole cricket* has its front tibiae broadened for burrowing. It is an important enemy of growing plants, particularly the potato.

Type of the Order—Lubber Grasshopper—*Rhomaleum Micropterum*. *Anatomy.*—The *grasshopper* is divided into three distinct regions: The head, the thorax with three segments, and the abdo-

men consisting of eleven segments. The *head* is rather elongated dorsiventrally and bears two rather large laterally situated compound eyes with many facets. There are three simple eyes, the ocelli, one near the middle of the forehead and the others situated near the bases of the antennae. The antennae are long and segmented to give flexibility. They bear many spines which furnish increased points of contact. The *mouth parts* consist of a dorsally situated labrum; two crushing mandibles with serrated edges; a pair of maxillae, each provided with a maxillary palp; and a ventral labium with a pair of labial palps.

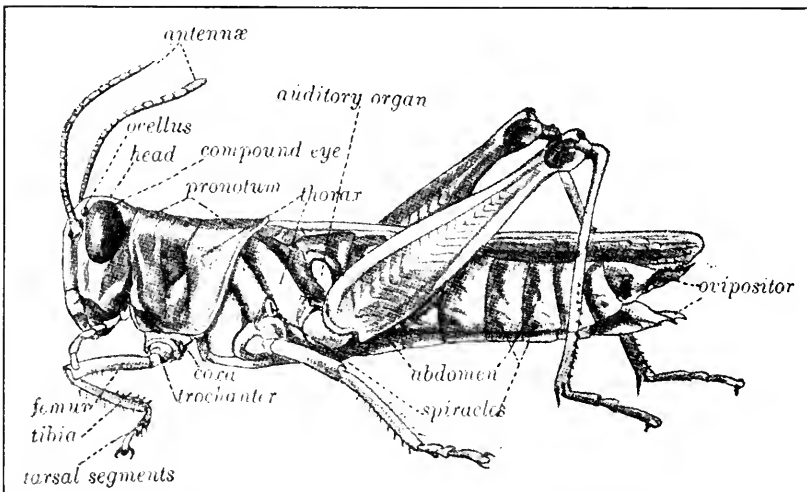

FIG. 83. Locust, with external parts named. (From Kellogg, *The Animals and Man*. Courtesy of Henry Holt & Co.)

The *thorax* consists of three segments, prothorax, mesothorax and metathorax, with a pair of legs attached to each of the segments. The third and second thoracic segments bear wings in the grasshoppers. The anterior pair of wings are wing covers and used for gliding, while the posterior pair, folded like a fan when at rest, are the true flying wings.

The *abdomen* consists of eleven segments. In the male there are nine distinct movable sterna. The posterior end in the female is modified by hardened ovipositors, the tips of which are protruded beyond the eleventh tergum. During oviposition, the tips are

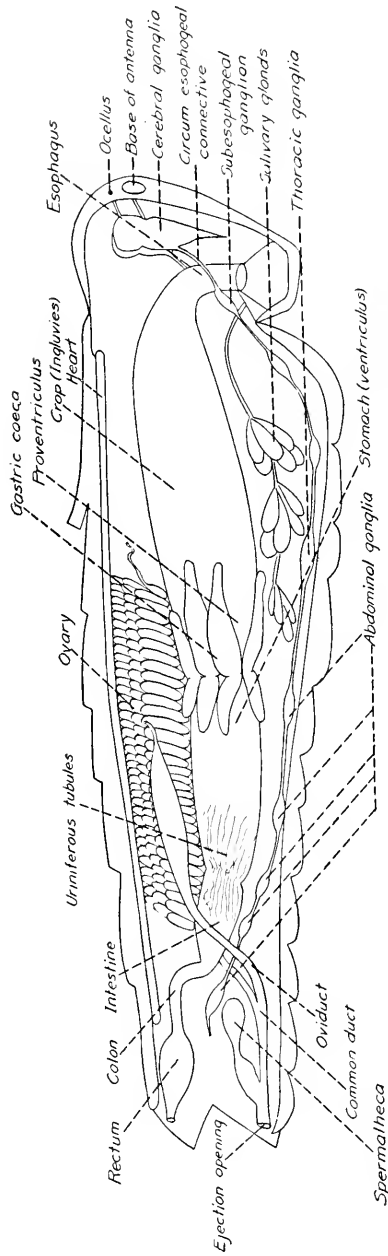

FIG. 84. Lateral view of the dissected grasshopper. (Drawn by W. J. Moore.)

forced into the ground, then separated, forming a pit for the reception of the eggs.

The Digestive System.—From the anterior *mouth* a short rather broad *esophagus* (Fig. 84) extends dorsally and posteriorly into the thorax, where it enlarges to form a thick-walled *crop* or *ingluvies*, which extends through the mesothoracic and metathoracic segments.

On each side of the anterior end of the crop are delicate branched *salivary glands* which communicate by means of salivary ducts with the mouth cavity. The *proventriculus* is not constricted from the crop, but extends a short distance to the stomach. The *stomach* or *ventriculus* extends to the seventh abdominal segment. At the point where the ventriculus originates, there are eight cylindrical pouches, the *gastric ceca*, extending *anteriorly* on the sides of the proventriculus and continuing as eight *diverticula* or *ceca* *posteriorly* along the sides of the ventriculus. No liver is present. The *ileum*, or intestine which has noticeably hardened walls, is found in the seventh, eighth and ninth abdominal segments, constricting posteriorly as it enters the *colon* or hind intestine, which runs dorsally down the ninth and tenth segments. The *rectum* is a small white enlargement situated in the dorsal portions of the ninth and tenth segments and emptying at the *anus* on the lower surface of the eleventh tergum.

Respiratory System.—In the grasshopper there are two pairs of *thoracic stigmata* or spiracles. Eight pairs of abdominal *spiracles* are situated laterally just above the pleurons, the most conspicuous being the pair found on the anterior margins of the *tympani*. Extending throughout the body, we find a well-developed system of *tracheal tubes*, which take the place of the complicated circulatory system found in some other invertebrates, but lacking in the Arthropoda.

Circulatory System.—The heart is a long, narrow vessel, extending in the dorsal portion of the abdomen. It is divided by valves into chambers, the anterior one being called the aorta. There are no arteries or veins, but the blood passes through *sinuses* and finally enters the heart through lateral *ostia*. (Many of the strongest cardiac poisons have no action whatever on the insects.)

Urinary System.—The Malpighian tubules are masses of fine tubes, anterior to the rectum, and open into the intestine. They are primitive kidneys.

Reproductive System.—The *ovaries* consist of a long white struc-

ture above the ventriculus and intestine made up of two sets of tubes bound together into a compact mass. Two delicate *oviducts* pass posteriorly around the ileum and colon to the ventral portion of the body where they unite to form the single median *vagina* which opens on the upper surface of the subgenital plate at the *ovipositor*. The *spermatheca* is a small white pouch situated above the posterior end of the *vagina* and communicating with it at the *bursa copulatrix* by means of a minute orifice. The *testes* consist of two sets of coiled tubules bound together in one mass and situated above the intestine. Each testis sends off a *vas deferens*, the two uniting to form a median *ejaculatory duct*. To each *vas deferens* is attached a *seminal vesicle*, while *cement glands* empty into the ejaculatory duct.

The *Nervous System* consists of dorsally situated *cerebral ganglia*, two *circum-esophageal connectives*, a pair of *fused sub-esophageal*, three pairs of *fused thoracic*, and five pairs of *fused abdominal ganglia*. The thoracic ganglia are much *larger* than those of the abdomen. Such highly developed *concentration* of ganglia in *cephalic* and *thoracic* regions indicates a very high development of reactions. In the ants and bees we find even greater concentration.

Order 11. Hemiptera.—The *Hemiptera* have sucking mouth parts and when wings are present, they have four. Most of the *Hemiptera* are winged. Some generations of aphids are wingless.

The *Heteroptera*, true bugs, include aquatic and land forms. The *giant water bugs* (Belostomatidae) are important enemies of insects, tadpoles and small fishes. The *harlequin cabbage bug* is an important pest in the South, while the *green soldier bug* and the *spined soldier bug* are predaceous, destroying the larvae of injurious *Hexapoda*. The *squash bugs* (*Coreidae*) and allied forms attack squashes, pumpkins and other garden vegetables. The *assassin bugs* (*Reduviidae*) are predaceous forms attacking other insects such as the bed-bug. They may even attack man. The *Indian bed-bug* (*Cimex hemipterus*) and the *common bed-bug* (*Cimex lectularius*) transmit *dum-dum fever*, a flagellate disease. (See p. 29.) The *chinch-bug* is one of the worst pests of corn known and also attacks wheat. The *leaf bugs* attack foliage.

The most important of the *Homoptera* are the scale insects and the plant lice. The *cicadas* (*Cicadidae*) include a form known as the seventeen-year "locust," which lives underground as a *nymph* from thirteen to seventeen years. The eggs are laid in living twigs. They hatch in about six weeks, burrow into the ground and feed on

the juices of roots until the seventeenth year, when they emerge, moult and become adults.

The *plant lice* or aphids (*Aphididae*) include our most destructive greenhouse and orchard pests. The *grape phylloxera* (*Phylloxera vastatrix*) causes decay of the roots of grapevines. Aphids undergo parthenogenetic development. (See p. 123.)

The *scale insects*, especially the *San Jose scale*, are extremely injurious to fruits. The *cottony-cushion-scale*, which attacks the orange groves of California, was successfully controlled by the lady beetle (*Novius cardinalis*) imported from Australia.

Several families of plant hoppers occur. These include the spittle insects, the lantern flies, some of which are *luminescent*, the leaf hoppers and the tree hoppers. The leaf hoppers are injurious and difficult to control.

Certain *Hemiptera*, known as the *Parasitica* (*Anoplura*), are wingless and constitute formidable enemies of man and other mammals. The species that infest man (Genus—*Pediculus*) include the *head louse*, the *body louse* and the *crab louse*. Domestic animals are infested by the genus *Haematopinus*.

Order 12. Neuroptera.—A number of orders were formerly grouped under the Neuroptera, but are now separated. The order Neuroptera includes some very large insects. They have four long narrow and finely netted wings. Their metamorphosis is complete and they have biting mouth parts. Their antennae are conspicuous.

Larvae of the *dobson fly*, known as “helgrammites,” are used for fish bait. The *ant lions*, or “doodle-bugs,” make pits in sand, dust or decayed wood, capturing thus many small insects. The adult ant lion resembles a *damsel fly*.

The *lace-winged flies* or “aphis lions” have thin lacy wings and are green in color. Their larvae resemble those of the *ant lions* but have yellow or red markings. They feed on colonies of plant lice. The adults have brilliant golden eyes.

Order 13. Mecoptera.—The *scorpion flies* have four membranous wings, thickly veined but with few cross-veins. The head is beaked and the mouth parts are adapted for biting. Metamorphosis is complete. Scorpion flies feed on small insects. Both the larvae and the adults are carnivorous.

Order 14. Trichoptera.—The *caddice flies* have rudimentary mouth parts, four membranous wings thinly clothed with hairs, and have complete metamorphosis. The aquatic larvae lack pro-legs

and form cocoons of sand, pebbles and silk, which are easily recognized as those of the "caddice-worm."

Order 15. Lepidoptera.—*Lepidoptera* have four wings covered with fine, powdery scales. The larvae of moths and butterflies, called caterpillars, are worm-like, having three pairs of true thoracic legs and from one to five pairs of pro-legs.

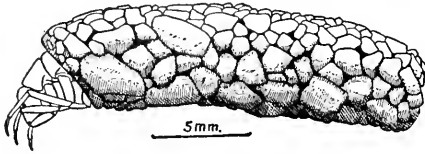

FIG. 85. Case of *Discosmoecus gilvipes*. (Dodds, G. S., and Hisaw, F. L., *Ecology*, vol. 6, no. 2.)

The *Pyralidina* or "leaf-rollers" feed on stored grain. The *European corn borer* (*Pyrausta nubilalis*), an important pest in this country, appears to accumulate in destructive numbers in areas of naturally high soil and atmospheric moisture. *Meal moth* (*Pyralis farinalis*) larvae feed on meal and flour, making tubes of silk in the meal. The *Mediterranean flour moth* (*Ephestia kushniella*) is one of the most injurious forms, infesting flour mills. Other injurious forms are the meal-moth, the clover-hay worm, the melon-worm and the pickle-worm. The *Tineina*, smallest of the *Lepidoptera*, include the grain moths and the clothes moths. *Grain moths* attack grains both in the field and stored. The *common clothes moths* are yellowish moths whose larvae do a great deal of damage to woolen clothing and furs. (Figure 86, A and B.)

The family *Tortricina* includes the *bud moth* which attacks young shoots of apple trees, the *strawberry leaf roller* and the extremely injurious codling moth. The *codling moth* causes an annual loss of over \$12,000,000. The larvae burrow through the blossom end of an apple and eat their way to the core, devouring the seeds. The larvae of the second generation usually feed on the surface of the apple. In the fall the larvae burrow into crevices of the bark, spin white silk cocoons and hibernate. The *Oriental fruit worm* was introduced on the ornamental cherry trees sent from Japan to decorate the city of Washington. It attacks twigs and young peaches. The *Noctuidae* are the largest family in the order, with more destructive forms than any other. The *army worms* migrate from field to field in large bodies. The *corn ear worm* or *cotton-boll worm*, the *cotton worm*, and the *cabbage looper* are a few of the more

important pests. The cotton-boll worm and the cotton worm cause millions of dollars loss annually to the cotton growers. The *Bombycidae* include the *common silk-worm moth*. The silk worm has been artificially bred in China for over five thousand years.

Some of the largest and most showy of the moths belong to the giant silk worm family, the Saturniidae. These include the Polyphemus, the Cecropia, and the Luna moths. The Cecropias are a trifle injurious to shade trees, but in general these species are interesting only on account of their size. The *carpenter moths* (Cossidae) are wood-borers attacking trees.

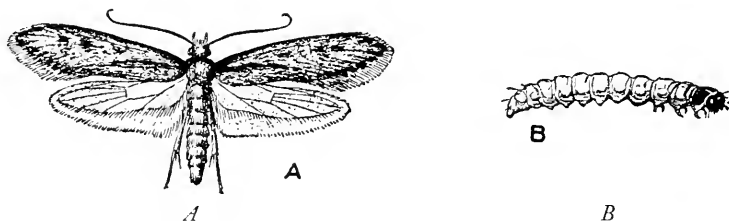

FIG. 86. *A*, clothes moth. *B*, larva of clothes moth. (After Riley. U. S. Dept. Agr.)

The *Geometridae* are called “*measuring worms*” when in the larval state. An extremely important species is the spring *canker worm* (*Paleacrita vernata*) whose larvae feed on the leaves of fruit trees. The *Liparidae* or *tussock moths* injure shade trees. The *white marked tussock moth* is a native form injurious to fruit and shade trees, while the *antique* or *rusty tussock moth* is a European species found in Nova Scotia, New England and the West. The *brown tail moth* attacks shade and forest trees, but avoids the conifers. The *gypsy moth* has spread from the New England states into some of the Middle Atlantic states. The *Sphingidae* include the *hawk moths* or *humming bird moths*. They have long tongues adapted for sucking nectar from flowers like honeysuckles. The *butterflies* have their antennae enlarged at the tips, and fly exclusively in the *daytime*, while moths fly at night and have threadlike or feathery antennae. There are two great super-families, the *Papilionina* or *true butterflies* and the *Hesperina* or *skippers*.

The *Nymphalidae* include forms with poorly developed front legs, not adapted to walking. Some of the more common forms are the *thistle butterfly*, the *Admiral*, the *wood nymph* and the *viceroy*. The viceroy is interesting because it closely resembles the bad tasting

monarch butterfly and is supposed to be thus protected. (Natural Selection, p. 515.) The *swallow-tailed butterflies* (Papilionidae) include the *black swallow tail* whose larvae feed on celery and parsley; and the *tiger swallow tail*, yellow in color, which is the largest common species. Caterpillars of the *cabbage butterflies* devour the outer leaves, then bore to the heart of the cabbage.

The *alfalfa caterpillar* (*Eurymus*) attacks alfalfa in the West. The *gossamer winged butterflies* (*Lycaenidae*) are the smallest and most delicate butterflies. The larvae are small and slug-like and feed on plants. One carnivorous form, the "harvester," is valuable to the fruit-grower since its larva feeds on the wooly aphids.

Pigment in Butterfly Wings.—One of the present day fads is that of enclosing butterfly wings in glass brooches. The natural color should remain for some time since colors in the wings of fossil butterflies were found persistent when exhumed by Dr. R. J. Tillyard millions of years after they were sealed with mud. Exposure to the air caused rapid fading, however.

Order 16. Diptera. (*Flies, Mosquitos, etc.*)—The Diptera, as the name indicates, have two wings. They have sucking mouth parts, and the metamorphosis is complete. There are over 7,000 species of Diptera in North America.

The *common housefly* (*Musca domestica*) carries typhoid, tuberculosis and other bacterial diseases. It is also important in the transmission of the eggs of several species of *Nematode* and *Cestode worms*. A fly wing is said to vibrate 330 times per second. Houseflies lap up liquid food with their folding proboscis.

The *blow fly* and the *flesh fly* (*Sarcophagidae*) deposit their eggs on meat and cheese on which the maggots feed. The *horse fly* (*Tabanidae*) attacks cattle and horses and even man. The female feeds on blood, but the male lives on nectar. The *tachina fly* (*Tachinidae*) is an important enemy of caterpillars (particularly the *army worm*), and kills many locusts and leaf-eating beetles.

The *bot-flies* (*Oestridae*) attack cattle and horses. The eggs of the horse bot-fly, licked off their legs by infested animals, develop in the lining of the stomach until the time of pupation when they are extruded.

The *ox-warble larvae* (*Hypoderma lineata*) pass to the esophagus of the host in the same manner as those of the horse bot-fly, but then burrow into the subcutaneous tissue and lodge just under the

skin where they cause lumps. Ultimately they develop and pass out through the hide, riddling it with holes. Herms cites a case of the ox warble in a child in which the grub, *Hypoderma lineata*, travelled from below the knee to a point behind the ear, taking about two months' time.

The *sheep-bot flies*, living in the nostrils of sheep and antelopes, travel up the frontal sinus and cause the disease known as "staggers." Other bot-flies attack rodents and even man. One form, *Dermatobia hominis*, found in Mexico, Central, and South America, attacks Birds, Mammals and Man. It is transported by certain mosquitoes, particularly *Psorophora lutzii*. The larval period requires about three months.

*Mosquitoes (Culicidae)*¹ have slender sharp-pointed mandibles, enabling them to puncture the skin of animals. Mosquitoes are extremely important in the transmission of parasites causing disease. They include three important groups: Anopheles, Aedes, and Culex. (Figure 87.)

In the *Anophelines*, the head has upright forked scales and the palpi in both sexes are almost as long as the proboscis. *Anopheles larvae* lack a siphon tube and breathe through a stigmatic opening on the eighth abdominal segment. They rest at the surface of the water. In resting, as in the position of biting, the *Anopheles adult* elevates its body in a characteristic manner (Figure 88). *Anopheles quadrimaculatus* and several allied species transmit malaria. Bird malaria is transmitted by the Culicine mosquitoes (*Culex pipiens*).

In *Aedes (Stegomyia)* (Figure 89), the head has a few forked scales and a mass of flat scales covering the head while the palpi are less than one-half as long as the proboscis. *Aedes larvae* have a short, conical siphon tube, and hang down from the surface of the water. The successful completion of the Panama Canal was accomplished only after measures were taken to kill the yellow fever transmitting mosquito, *Aedes aegyptii (Stegomyia calopus)*.

In the *Culicines*, the head has a few flat scales, but many narrow curved and upright forked scales. The palpi of the male are nearly

¹ Varro, the Roman author, cautions the builder against placing his farm-house on swampy ground "because certain minute animals, invisible to the eye, breed there, and, borne by the air, reach the inside of the body by way of the mouth and nose and cause diseases which are difficult to get rid of." Centuries later mosquitoes were proved to be the carriers of malaria and yellow fever.

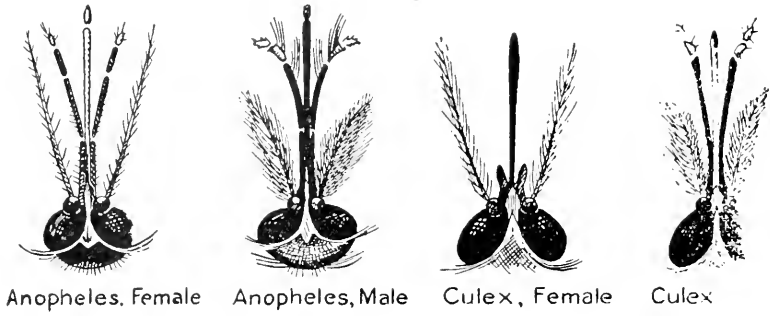

A

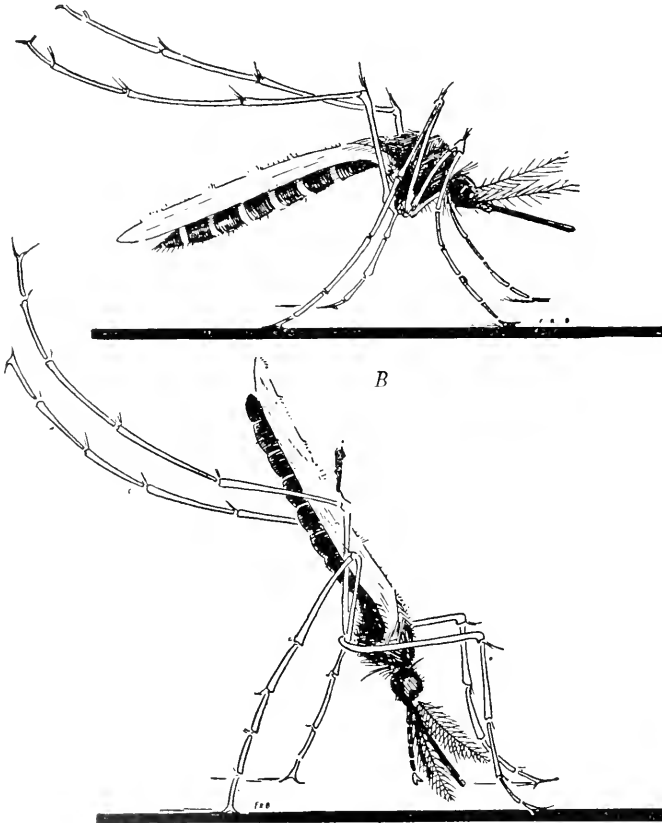

FIG. 87. A, structural characteristics of antennae of *Culex* and *Anopheles*. B, resting position of *Culex* mosquito (above), and *Anopheles* mosquito. (Courtesy of Major George C. Dunham, and U. S. Army Medical Field Service School.)

as long as the proboscis, while those of the female are less than one-half as long. *Culex* larvae have a slender, long siphon, and hang down from the surface of the water. The *adults* in resting position do not elevate the abdomen as in the Anophelines. Filariasis, the disease known as *elephantiasis*, which is caused by a small nematode,

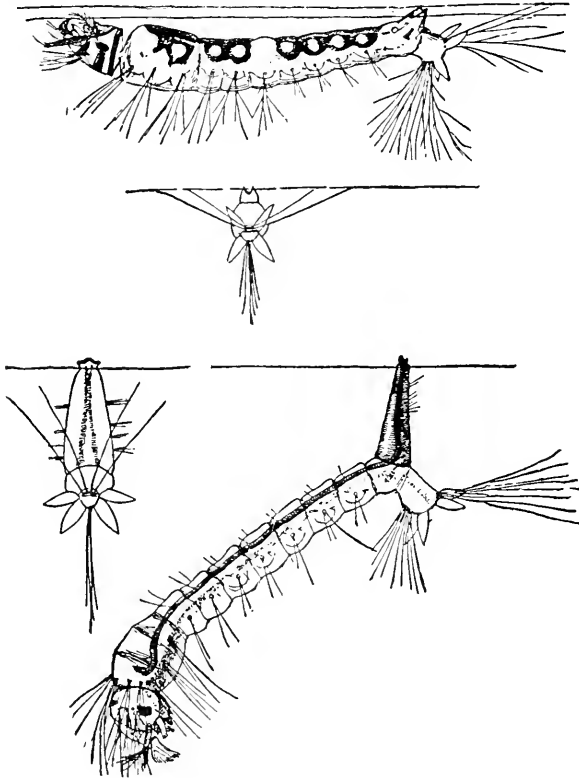

FIG. 88. Larvae of *Anopheles*, above, and *Culex*, below, in feeding and breathing position. (From Howard, *Mosquitoes of the U. S.*)

Microfilaria bancrofti, is transmitted through the agency of a Culicine mosquito, *Culex (fatigans) quinquefasciatus*. Dengue, or breakbone fever, is a tropical disease, found in Mexico, which is transmitted by both *Culex fatigans* and *Stegomyia calopus*.

Poison.—The poison of female mosquitoes has not been thoroughly studied, but Noguchi reports that there are three sets of glands, two of which are ordinary salivary glands, and the third set,

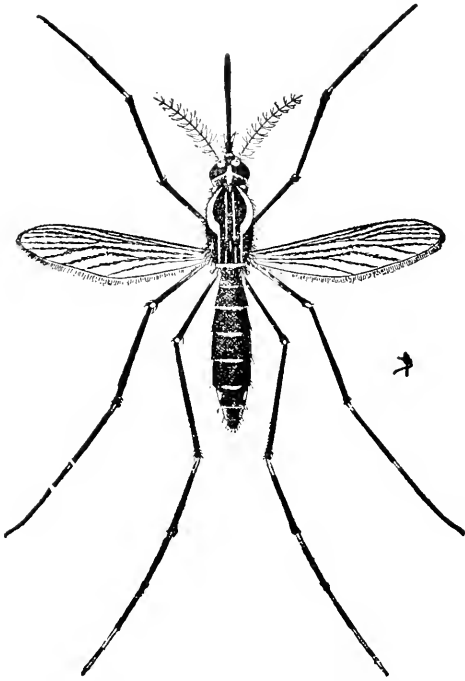

FIG. 89. Yellow-fever mosquito, *Stegomyia fasciata*. (Howard, F. B., 1934, U. S. D. A.)

situated between the other two, secretes the poison. If a mosquito punctures the skin, but does not reach blood, the poison is not injected. An anticoagulant is produced by the mosquito.

The *gall gnats* (*Cecidomyiidae*) are terrestrial forms attacking many plants and producing "galls." The *Hessian fly*, a small black form, is estimated to damage wheat and rye to the extent of many millions of dollars annually. The *crane flies* (*Tipulidae*) somewhat resemble mosquitoes. They are often quite large, with long, loosely attached legs.

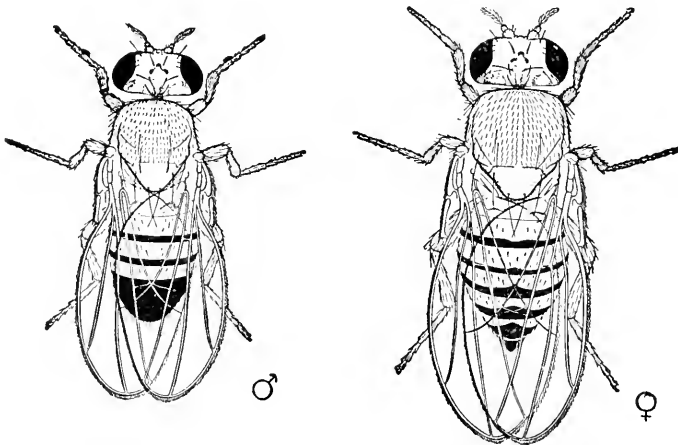

FIG. 90. Male and female fruit flies (*Drosophila melanogaster*). (Morgan, *Physical Basis of Heredity*. Courtesy of J. B. Lippincott Co.)

Their larvae live in the soil and injure the roots of plants. The *midges* (*Chironomidae*) are small flies somewhat resembling *mosquitoes*. In the larval state they are red, wormlike, aquatic forms. The *black flies* (*Simuliidae*) are aquatic in the larval state, and the adults are great pests in some localities since they are blood suckers and attack fishermen.

The *fruit flies*, particularly the *Drosophilidae* (Fig. 90), are used in investigations on heredity. (See p. 538.) There are about 1,000 species of *Trypaneidae* attacking various fruits. The *Mediterranean fruit fly*⁶ (*Ceratitis capitata*), known for over 100 years, and of considerable importance in the Mediterranean countries and more recently in Hawaii, was discovered in Florida on April 6, 1929. Its life cycle takes from 30 to 40 days, pupation occurring in the ground. In Hawaii and in South Africa, *Ceratitis capitata* has proven a serious pest of the citrus fruits, but also attacks deciduous fruits such as peaches and apricots. Lemons are practically immune to this pest, but sour oranges are more susceptible than the sweet varieties. In Hawaii, poison sprays have not been used with any degree of success, but they appear to be more effective in the U. S.

The *Syrphus flies* (*Syrphidae*) are important enemies of the aphids and feed on nectar and pollen. Some are scavengers, the "rat-tailed" larvae feeding on *foul organic matter*. (Figure 91.)

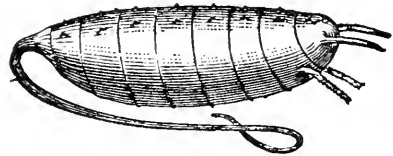

FIG. 91. A "rat-tailed" larva (*Syrphidae*). (Smith, *Insects of New Jersey*, N. J. Board of Agr.)

Some of the species "mimic" the bees and wasps. According to the ancient Bugonia myth, bees develop in the carcasses of dead animals, but the drone-flies (*Eristalis tenax*) are the forms thus found. The reactions of the drone-fly to light have been extensively studied by Dolley.⁷

⁶ In climates where the mean temperature falls below 50° F. over periods covering 3 months, there is little development of *Ceratitis capitata* and accordingly it is hoped that we can limit its ravages to the Southern states. (Herrick, G. W. The procession of foreign insect pests. Sc. Mon., vol. 29, pp. 269-274.)

⁷ W. L. Dolley, Jr., and J. L. Wierda. 1929. Relative sensitivity to light in different parts of the compound eye in *Eristalis tenax*. Jour. Exp. Zool., vol. 43, pp. 129-139, May.

The *sheep tick*, the *horse tick* and various *bird ticks* belong to the sub-order *Pupipara*.

Order 17. Siphonaptera. (Fleas.)—The Siphonaptera, or *fleas*, are wingless, with sucking mouth parts and complete metamorphosis. There are about 50 species in the United States. The common cat and dog flea, *Ctenocephalus canis*, attacks man. The *human flea* (*Pulex irritans*) and the *chigoe* or “chigger” (*Sarcopsylla penetrans*) are important enemies of man, the latter burrowing into the skin. This is *not* the common *chigger*, which is a *mite*. (See page 201.)

The *rat flea* (*Laemopsylla cheopus*) transmits *bubonic plague* from rats and ground squirrels to man. Fleas may start out with one animal as a host and transfer to its enemy.

Order 18. Coleoptera. (Beetles.)—The beetles have four wings, well-developed biting mouth parts, and a complete metamorphosis. There are over 12,000 species found in America, exclusive of Mexico.

The *tiger beetles* (*Cicindelidae*), both in the larval and adult states, are important enemies of insects and crustaceans. The larvae live in holes in the ground. The *ground beetles* (*Carabidae*) are extremely important predaceous insects. They destroy the larvae and adults of many injurious leaf-eating insects. The *caterpillar hunter* (*Calosoma scrutator*) is an important enemy of the hairy “tent-caterpillar.” Other forms attack cut-worms and canker worms. A few species feed on young grains, but the majority of the Carabidae are beneficial. The *carnivorous water beetles* (*Dytiscidae*), are important enemies of mosquitoes and other injurious insects. The larva, the ferocious “water-tiger” traps air under the hairs of its tergum and is able to remain under water for some time. Large “tigers” reach a length of three inches. The *water scavengers* (*Hydrophilidae*) are large forms living under the surface of water during the day, but flying to lights at night. They are black and over an inch in length. The *whirligig beetles* (*Gyrinidae*) are small aquatic forms not more than $\frac{3}{8}$ of an inch long. Children sometimes call them “money-bugs.” The *lady bugs* (*Coccinellidae*) or “lady-bird beetles” are predaceous in the larval as well as the adult condition. They are important agents in the control of plant lice and scale insects. The genus *Epilachne* is herbivorous.

The *carpet beetle* (*Anthrenus scrophulariae*) attacks rugs and clothing, including feathers. The *club-horned beetles* (*Clavicornia*)

may be found on land and in the water. Some are herbivorous and exceedingly injurious. The *Dermestidae* destroy stored grains. The *saw-toothed grain beetle* (*Cucujidae*) is an extremely injurious species.

The *buffalo-moth* attacks wool, feathers and furs, while the larder beetle destroys and spoils animal food products. The *Elateridae*, or *click-beetles*, are interesting as adults, but their larvae, called *wire-worms*, attack plants and seeds. Certain of the *wood borers* (*Buprestidae*) are distinguished as the flat-headed borers.

The *fireflies* or *Lampyridae* are luminous insects flying at night. Many non-luminous forms belong to the same family. The *blade horned beetles* or *Lamellicornia* have antennae with their terminal joints developed into leaflike plates forming a club. There are two families, the *Lucanidae* or *stag-beetles*, and the *Scarabaeidae*. One of the most familiar forms is the stag-beetle, with its long mandibles or "antlers." Some males have well-developed mandibles and are called "pinching bugs." The *Scarabaeidae* include the most of the Lamellicorns. The *leaf chafers* feed on flowers and leaves. The scavenger beetles bury or eat decaying matter. The *sacred beetle* or *Scarab*, found in Egyptian tombs, is a species of dung-feeding tumble bug. Egyptians worshipped the scarab because it killed worms. Other forms notably injurious are the *June bug* and the *rose chafer*. The larval June bug called the white grub or "molly grub" is of considerable injury to underground roots, while the adult form, injurious to foliage in a less degree, is a household annoyance in the early summer. The *Japanese beetle* (*Popillia japonica*), a serious pest, was imported into New Jersey and Pennsylvania and has spread into adjoining states at the rate of about twenty miles per year. The *rhinoceros beetle* is the largest American species. In the West Indies related forms reach a length of six inches.

The *plant eating beetles* (*Phytophaga*) include the pea and bean weevils (*Bruchidae*), the leaf beetles (*Chrysomelidae*), and the long-horned beetles (*Cerambycidae*).

The *Bruchidae* larvae feed on the seeds of peas and beans and are called *bean-weevils*. The most injurious *Chrysomelids* include the *elm-leaf beetle*, and the *Colorado potato beetle*, which is one of the largest of the Chrysomelids and an important enemy of the potato. The *Cerambycidae* are long-horned beetles including many wood-boring forms, such as the *apple tree borers* and the *maple borers*.

The larvae are called the "round-headed borers" to distinguish them from the *Buprestid* larvae which are flat-headed. The *Tenebrionidae* include the ordinary *meal worm* which is a minor pest in spoiled grain, but is useful in feeding pet birds and "horned toads." The *Meloidae*, or *blister beetles*, feed on plants. They are used to supply the *cantharides* or Spanish fly used for blistering. The *snout beetles* (*Rhynchophora*) include the bark beetles, most destructive to trees, and the *Curculios* or weevils. The *Mexican cotton-boll-weevil* has cost the South many thousands of dollars by destroying its cotton, while the *alfalfa weevil* is a serious pest on the West Coast.

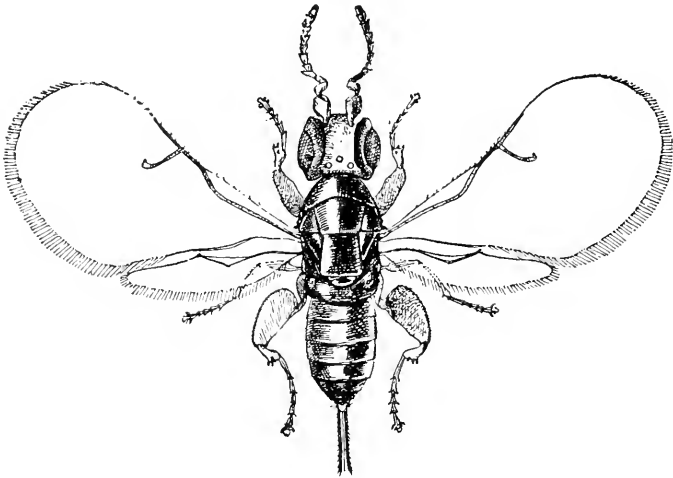

FIG. 92. *Blastophaga*, the insect which pollinates figs. (U. S. D. A.)

Order 19. Hymenoptera. (*Gall-flies, Ants, Wasps and Bees.*)—The sawflies, horntails and gall flies are boring Hymenoptera whose larvae feed on the leaves of shrubs and in some cases induce development of *galls*.

The *chalcid flies* (*Chalcidoidea*), minute parasites attacking the eggs and larvae of injurious insects, are for the most part extremely beneficial to man. One species is responsible for the fertilization of the fig. The *fig-wasp* has recently been introduced from Asia Minor into California. The *gall-flies* (*Cynipoidea*) utilize a sharp ovipositor to thrust their eggs into green stems of oaks, roses and a few other plants where the hatching larvae stimulate the plant to

form a gall. The *giant oak-gall* grows to the size of the human fist.

The *Ichneumonoidae* are parasitic hymenoptera attacking many injurious insects such as the cabbage butterfly, tent-caterpillars, cotton-worms, brown-tail and tussock moths.

The *braconid flies* (*Braconidae*) are also valuable in that they parasitize plant lice, tomato worms, sphinx caterpillars and fall web-worms. The *Serphoidea* are a group of mostly small insects parasitic on other insects.

In the stinging *hymenoptera*, which include the ants, bees and wasps, the females and workers sometimes have the ovipositor developed into a "sting."

Ants. (*Formicoidea*).—Found in nearly all parts of the world, and comprising some twenty-five hundred species, ants have developed to a marked degree a differentiation in body structure and in habits. The first two segments of the abdomen are expanded dorsally, serving as a peduncle to the rest of the abdomen. The nest or home, usually underground, is divided into many channels and passages.

The *carpenter ant* (*Camponotus penn*) builds its nest in the dead wood of living trees and of buildings. The *mound building ant* builds ant hills ten feet in diameter. The *slave making ants* (*Formica difficilis*) depend on their servants (other ants) for shelter and food. (See Communities, p. 484.)

The *corn louse ant* (*Lasius brunneus*) tenderly cares for one of the extremely injurious aphids attacking the roots of corn. The *tiny red ant* (*Myrmicidae*), while something of a pest in this country, becomes an actual menace in the Orient.

Stingless ants, the *Campanothinae*, are provided with a cushion-like **poison apparatus** and secrete **formic acid**. Males do not possess a poison.

Wasps.—The *digger wasps* (*Sphecoidea*) are distinguished from the true wasps by their non-folded wings. They are solitary and place paralyzed insects and spiders in their nests, where the larvae feed on living helpless prey.

The *true wasps* (*Vespoidea*) include the solitary wasps and the social wasps. The *solitary wasps* (*Eumenidae*) resemble the digger wasps in that they form burrows. They deposit their eggs and then abandon them. (Consult Taylor, L. H., 1922, Psyche, vol. 29, no. 2.) The *social wasps* (*Vespidae*) include the *yellow jackets* and hornets. The queens have stings but the males are harmless. Social

wasps feed the young continually through the larval stage of about two weeks. The *white-faced hornet* makes a large paper nest.

The *Chrysoidea* are parasitic Hymenoptera, about one-half inch long, feeding on larvae of other Hymenoptera, or on the stored food in their nests.

Bees.—The *Apoidea* include the bees. Bees are stouter bodied than wasps and usually hairy. Their tarsal segments are flattened and enlarged for carrying pollen.

The *short-tongued bees* are either solitary or gregarious, but *never social*. Most of them are mining bees, sinking perpendicular shafts a foot into the ground of grassy fields. The *long-tongued bees* (*Apidae*) have the lower lip greatly developed for securing nectar. The *leaf cutter* is a solitary species depositing her eggs in a hole in some trees, with a supply of pollen and nectar for the young, and then abandoning them. The *guest bees* (*Psithyrus*), regarded as degenerate bumble-bees, have no worker forms but infest the nests of solitary bees.

The *social bees* or “bumble-bees” (*Bombus*) live in communities like the ants. They are important in the pollination of clovers. (See page 484.) The queen usually starts her nest in a deserted mouse’s nest. The *honey bee* (*Apis mellifera*),⁸ a native of Europe, has been domesticated the world over for centuries. There are two genera, one stingless, the other including our common hive bee. The colony consists of queens, drones and neuter workers. The queen is fed on “royal jelly,” which is a nutritious fluid excreted by the nurses. The bee is able to lift and carry about twenty-five times its own weight (Figure 93).

Honey.—For centuries honey has been used for food and at the present time the United States produces about 250,000,000 pounds of honey annually. Although it is reported to be lacking in vitamins and minerals, honey is esteemed as a delicacy and is used in the preparation of medicines and candies.

“The honeys of Hymettus and of Hybla were especially famous in ancient times; and both retain to the present day their characteristic flavor of wild thyme.” (Consult L. Whibley, “A Companion to Greek Studies.” Cambridge University Press, 1905.)

⁸ Alpatov, W. W., 1929, furnishes a new classification of bees in “Biometrical studies on variation and races of the honey bee (*Apis mellifera*)”. *Quart. Rev. of Biol.*, vol. 4, no. 1, pp. 1-58, March. Vergil, in one of the finest passages of ancient poetry (*Georgics*, Book IV), treats of the culture of bees. He discusses the placing of hives, the managing of swarms, and describes a battle between two discordant “kings.”

In Northern Asia Minor *poisonous* honey has recently been reported. This phenomenon was described earlier by Xenophon and Aristotle. The bees are supposed to secure toxic nectar from two species of rhododendron. The toxic honey causes giddiness and sometimes a brief loss of consciousness, followed by a short period of general malaise "as though one had been on a spree."

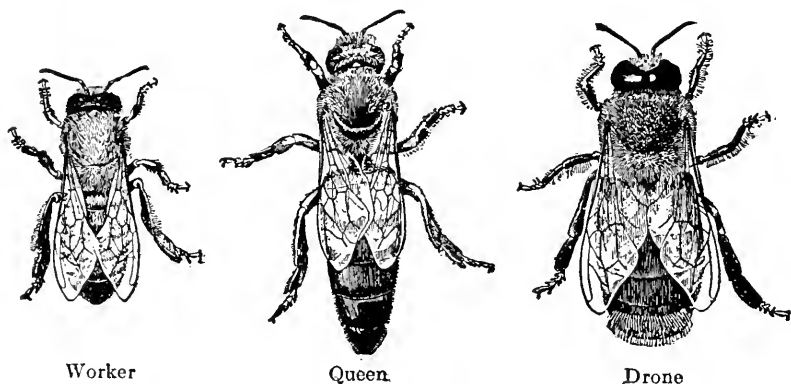

FIG. 93. Worker, queen, drone. (From Phillips, U. S. D. A. Farmers Bull. 447.)

Methods of Insect Control.—Insects are controlled by poisons acting through the alimentary canal or by contact. Sucking insects are controlled by contact poisons while biting and chewing insects are controlled by internal poisons.

Contact Insecticides.—In the adult condition, the chief substances used as contact insecticides against sucking insects, such as flies and bugs, are lime sulphur wash, whale-oil soap, kerosene emulsion, tobacco decoction, miscible oils, pyrethrum, lime dust, commercial sodium fluoride, carbolic acid emulsion, and white arsenic. In the case of aquatic larvae like those of the mosquito, a thin film of oil or a thin coating of some substance like Paris green or pyrethrum proves effective.

Stomach Poisons for Biting Insects.—In the case of the biting insects attacking trees and vines, it is customary to spray or dust with active poisons such as Paris green, arsenite or arsenate of lime, arsenate of lead, hellebore, or sodium fluoride. Arsenate of lead is used in preference to Paris green.

The Use of Gases.—Repellants such as naphthalene are used to drive insects away. Lime repels the striped cucumber beetle, while

whitewash containing a repellent chemical is used on tree trunks to drive away the egg-laying adults of borers. The poisonous gases most commonly used as fumigants in insect control are carbon bisulphide, naphthalene, hydrocyanic acid gas, sulphur dioxide, tobacco, formalin and carbon tetrachloride. Young trees are usually fumigated when imported into a state or received from a foreign country. In the orchard, trees are covered with tents and fumigated.

Temperature Control.—Fall cultivation with reference to the susceptibility of the animal to low temperatures proves beneficial in killing wire worms, potato beetles, tomato worms and grasshoppers. Superheating will kill most of the flour mill insects. The Mediterranean fruit fly is limited to a temperature above 50° F., so will probably never get a foothold in any but our Southern States.

Burning.—As weeds are likely to harbor injurious insects, they should be destroyed. Larvae and adults of garden and orchard pests are burned with the infested brush and vines.

Natural Enemies.—Sometimes pests are imported into a new territory without the simultaneous introduction of their natural enemies. It is then necessary to find the most important forms that prey upon them. Such has been the province of explorers working for the United States Department of Agriculture.

Next to the insects themselves, the birds are our most effective insect enemies.⁹ Some of the most important are the quail, the robin, the cuckoo and the sparrows. Even the despised crow more than pays for the small amount of corn that he eats. Measures that prevent the multiplication of wild races of *cats* will prove effective in the protection of the birds.

Other Protective Measures.—Valuable lumber is sometimes stored under water in order to prevent the action of wood borers. The use of fertilizers to stimulate plant growth may hasten development so that the plant will be able to resist an insect attack. To protect from the tent caterpillar, trees are frequently banded with tar and wrapped in burlap. Crop rotation and early lure crops often rid a plot of potato beetles. Ballou of the U. S. Department of Agriculture discovered (1928) that after a meal of geranium leaves or petals, the Japanese beetle becomes paralyzed. Post-mortems on the 35 per cent of paralyzed beetles which died inside

⁹ Strickland, E. H. 1928. Can birds hold injurious insects in check? *Sc. Mon.*, vol. 26, pp. 48-56.

of twenty-four hours showed that the digestive tract is destroyed in that time, and that all soft parts of the body cavity are disintegrated in forty-eight hours. The geranium is particularly attractive to the Japanese beetle.

Class 5. Arachnida.—These air-breathing Arthropoda have no antennae, or true jaws; have the head and thorax fused into a cephalothorax; and at the posterior part the abdomen; and have four pairs of walking legs, with their first pair of appendages developed into nippers, or chelicerae. They include spiders, mites, ticks, scorpions, and the king crab.

Scorpionidae.—The scorpions are found in warm regions hiding away during the day and coming forth at night to prey on insects and spiders, which they sting with their poison fang at the tip of the abdomen. The sting of an ordinary scorpion of three or four inches has been compared with that of a hornet. Patten believes that scorpions are descended from the fossil *Merostomata* (*Eurypterida*). (See pages 207, 218.)

Phalangidea.—The *harvest men* or “daddy-long-legs” have extremely long legs and a segmented abdomen. They feed on living insects.

Acarina.—The *common red mite* and the “*red spider*” of greenhouses attack plants. The *chiggers* or harvest mites attack mammals, including man, burrowing into the skin and causing much irritation. The *follicle mite*, *Demodex folliculorum*, invades the hair follicles of mammals and man, producing *black heads*. The *itch mite* is a parasite of the epidermis. The *scab parasite*, *Psoroptes communis*, produces sores on cattle and horses.

Ticks are responsible for the transmission of a number of diseases. The *cattle tick*, *Boophilus (Margaropus) annulatus*, is the medium of transfer of a *sporozoan*, *Piroplasma bigeminum*, which causes Texas fever. In Africa, a common tick, *Ornithodoros moubata*, has habits like a *bed-bug* and causes *relapsing fever*.

Order Araneida. (*Spiders.*)—Spiders (Figure 94) are among the most interesting of the Arthropoda. They construct webs, using two kinds of silk, one dry and inelastic, the other viscid and elastic. Spiders use silk to construct webs, to build tents or nests, and also in locomotion. Man uses spider threads for cross-hairs in his telescopes. Spiders are Arachnids, with the abdomen separated distinctly from the cephalo-thorax, but the segments of each region closely fused. They have four pairs of legs and two pairs of mouth

parts. The mandibles or chelae are large and end in a slender, sharp-pointed hollow fang, through which poison flows. The palpi (*pedipalpi*) are sometimes half as long as the legs.

The *trap door spiders*, *Cteniza*, dig tunnels, line them with silk,

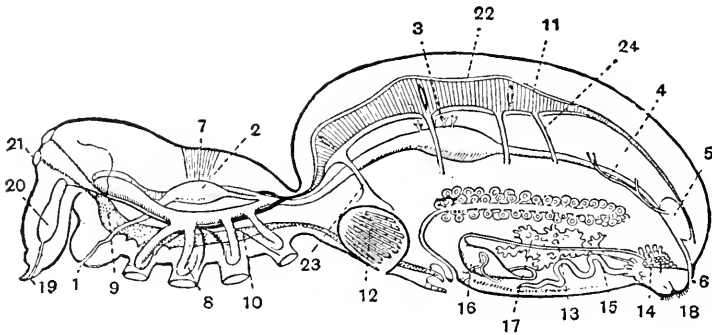

FIG. 94. Internal anatomy of a spider. 1, mouth; 2, sucking stomach; 3, ducts of liver; 4, so-called malpighian tubules; 5, stercoral pocket; 6, anus; 7, dorsal muscle of sucking stomach; 8, caecal prolongation of stomach; 9, cerebral ganglion giving off nerves to eyes; 10, subesophageal ganglionic mass; 11, heart with three lateral openings or ostia; 12, lung sac; 13, ovary; 14, 15, 16, 17, silk glands; 18, spinnerets; 19, distal joint of chelicera; 20, poison gland; 21, eye; 22, pericardium; 23, vessel bringing blood from lung sac to pericardium; 24, artery. (From Sedgwick, *Textbook of Zoology*. Courtesy of Macmillan and Co., Ltd.)



FIG. 95. *Epeira*, a garden weaver. (Photo by A. M. Reese.)

and equip them with a hinged lid. The *ground spiders*, *Drassidae*, deposit their eggs in silken tubes and do not spin a web. The *funnel web weavers*, *Agalenidae*, weave concave sheets of silk with a funnel on one side, attaching the web to blades of grass by threads. After a heavy dew, the webs are conspicuous on the lawn or in the field. The *cobweb weavers* (*Theridiidae*) are small, light-colored forms, hanging downward from shape-

less mazes of threads, frequently spun in corners of rooms. The *orb weavers*, *Epeiridae* (Figure 95), construct webs that are marvels of efficiency, and sometimes span streams twelve feet wide.

Poisonous Spiders.—The *black widow spider* has caused a number of deaths. Kellogg states (1915) that a *diadem spider* of 1.4 gr. contains sufficient poison to destroy completely all the blood corpuscles in 2.5 litres of rabbit blood. Comstock says that the *tarantula*, frequently found in bunches of bananas, is incapable of seriously injuring man.

BIBLIOGRAPHY ON VENOMOUS SPIDERS

- BAERG, W. J. 1923. The effects of the bite of *Lactrodectes mactans*. Jour. Parasit., vol. 9, pp. 161-169, March.
- BOGEN, E. 1926. Arachnidism, spider poisoning. Arch. of Int. Med., vol. 38, no. 5, pp. 622-632, Nov. 15.
- COMSTOCK. The Spider Book.
- KELLOGG, V. L. 1915. Spider poison. Jour. Parasit., vol. 1.
- LLOYD, J. S. 1921. Spiders used in medicine. Sc. Amer. Mon., vol. 60, July.
- REESE, A. M. 1921. Venomous spiders. Sc., vol. 54, no. 1399, Oct. 21.
- REESE, A. M. 1929. Economic Zoölogy. 3d Edition.

Other Classes. *Xiphosura*.—The king crab or horseshoe crab (Figure 96), is the only living representative of an ancient group. Related fossil forms from the Carboniferous indicate that it originated in fresh water. The *horseshoe crab*, *Limulus*, is a large marine form (2 feet long), commonly found on our Atlantic coast. It lives in shallow water and feeds on worms. It has a large cephalo-thorax and a relatively large abdomen with a long caudal spine. It is used for fertilizer and to feed hogs. It is particularly interesting to us because of the theory of the origin of vertebrates, developed by William Patten. (See p. 218.)

Pycnogonida.—Sometimes classed as relatives of the Arachnids, these marine forms have four somewhat primitive eyes resembling those of spiders. They have a slender cephalo-thorax and abdomen and four pairs of jointed legs with seven or eight segments each. The alimentary canal extends as ceca into the legs. Organs of respiration are absent. The *males* have four to seven cement glands on certain of their appendages, usually the third. The secretion

cements the legs together in masses which are carried on the "ovigerous" legs of the male, and in one species on the female. The nervous system consists of cerebral, subesophageal and three other thoracic ganglia with two pairs of abdominal ganglia. Metamorphosis usually occurs. The larvae of one genus are parasitic on the Coelenterata. They have no economic significance.

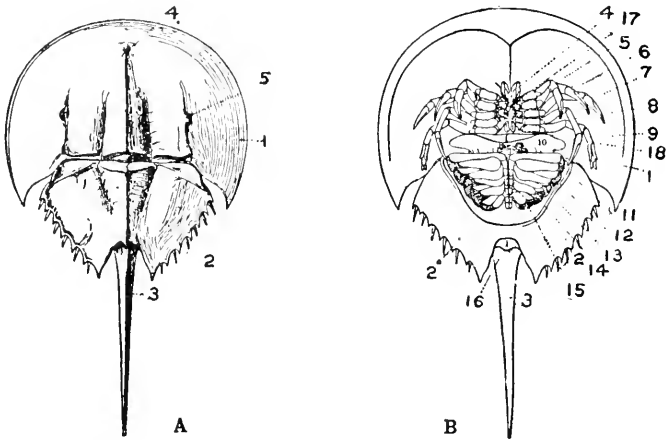

FIG. 96. *Limulus polyphemus*, the king-crab. *A*, dorsal view. 1, carapace; 2, meso- and meta-soma; 3, telson; 4, median eye; 5, lateral eye. *B*, ventral view. 1, carapace; 2, meso- and meta-soma; 3, telson; 4, chelicera; 5, pedipalp; 6, 7, 8, 9, 3d to 6th appendages, walking legs; 10, genital operculum turned forward to show genital aperture; 11, 12, 13, 14, 15, appendages bearing gill books; 16, anus; 17, mouth; 18, chilaria. (From Shipley and McBride. Courtesy of Macmillan and Co., Ltd.)

Tardigrada.—The Tardigrada, slow-moving forms called "water bears" are small soft-skinned animals living in fresh and salt water or damp moss. They have four pairs of short-hooked, unjointed legs. The digestive tract is well developed, the buccal cavity containing teeth sometimes calcified. Their muscles are non-striated. No respiratory or circulatory organs are developed. The gonads are saccular and empty into the rectum. The nervous system consists of cerebral ganglia, and a nerve cord with four ventral ganglia.

GENERAL CONSIDERATION OF THE ARTHROPODA

Characteristics and Distribution.—Deep sea crustacea are huge in size and have a brilliant red coloring. Some are phosphorescent.

Many aquatic forms are microscopic in size. Except in certain fixed forms, like the barnacles and parasitic forms like *Sacculina*, we find bilateral symmetry.

The Arthropoda walk, leap, burrow, swim, and fly, with locomotor organs and accessory structures correspondingly developed.

Geographically they are most cosmopolitan. In the Island of Cyprus, certain centipedes are found on the burning plains and in the snows of the mountains. A fresh water crustacean, *Lepidurus glacialis*, is found only in the Arctic regions. The brine shrimp *Artemia salina* is found in brackish water and in pans of exceedingly salty water evaporating in the sun. In certain hot springs, crustaceans and insect larvae live at a temperature of 60° C.

Integument and Musculature.—The *skin* of the Arthropoda contains *epidermal cells* (pigmented membrane of the lobster) which secrete a chitinous exo-skeleton frequently containing lime salts, but found to be extremely thin at the joints. Chitin is *anhydride of dextrosamine*, a sugar derivative. Growth is in most cases effected by a process of *ecdysis* or *moulting*, in which the old shell cracks off and the new skin rapidly hardens. The period just after moulting is a most dangerous one for most Arthropoda, for their brethren are cannibalistic. Under the epidermis we find *connective tissues* and the *dermis* with nerves and blood vessels.

Circular muscles found in the Annelida are absent in the Arthropoda, the longitudinal muscles causing movement of the segments. The appendages are well supplied with muscles.

Digestive System.—In parasitic forms the mouth may be extremely rudimentary. The wide difference in mouth parts of insects gives a basis for their classification. The digestive tube varies much with the type of food consumed. Crustacea like the lobster have a short gullet leading to a large cavity, the stomach, which has a *gastric mill* for gizzard-like grinding.

In *insects* with mandibles (grasshoppers, crickets, and locusts) we find a well-developed gizzard. In the insects there is great variation in the form and length of the digestive tube. In carnivorous species the crop, gizzard and large intestine are sometimes absent. In bees the crop is the "honey-bag." There is no true liver in the insects, but the functions of a hepato-pancreas are performed by glands in the stomach.

In *spiders* the pharynx and gullet are extremely small and the

alimentary canal is short and straight. The stomach and intestine send out lateral tubular or bladder-like expansions.

There are many species of *parasitic Arthropoda*. Fish lice (crustacea) are external parasites and suck in nourishment. *Rhizocephala*, such as *Sacculina*, send ramifying absorptive roots through the body of the host. But in insects and arachnids we find parasitism most highly developed.

Respiration.¹⁰—In water-breathing Arthropoda we find modified appendages (gill-books of the king crab) or well-developed gills such as in the lobster. The air breathers have a highly developed tracheal system opening to the exterior by paired *spiracles* or *stigmata*.

Circulatory System.—The system of circulation of Arthropoda is not closed but an open one with *sinuses* playing an important part in the collection of impure blood. The *heart* is usually elongated and dorsally situated in Arthropoda. The Crustacea (lobster) have a shield-shaped heart just posterior to the stomach. The blood enters the *pericardial sinus* and passes into the heart by several pairs of *ostia* which have valves. Arteries leave the heart and pass to the intercellular spaces.

The orange color of the blood of the prawn, and the yellow color of the insects' blood are perhaps due to carotene, according to A. C. Redfield. The green blue color of the blood of a lobster is due to hemocyanin.

The rôle of carotene, a highly unsaturated hydrocarbon ($C_{10}H_{16}$) as an important agent in holding and slowly emanating absorbed radiant energy, is a subject that interests the author of this text. (P. 442.)

Excretion.—In Insects and Arachnids there are excretory tubules (Malpighian tubules) which communicate with the intestine. In the lobster and allied crustacea, the paired green glands send their secretion out from pores at the bases of the antennae.

Nervous System.—In Arthropoda the cerebral and subesophageal ganglia have developed highly. We also find that the *thoracic ganglia* are large and show the effects of a lateral fusion. The nerves in the thoracic region are especially well developed. On the whole the nerve cord reminds one of that of the Annelid but is more highly developed.

¹⁰ Lee, M. O. 1929. Respiration in the insects. Qu. Rev. of Biol., vol. 4, no. 2, pp. 213-232.

Sense Organs.—Tactile and olfacto-gustatory senses are extremely well developed in the group.¹¹ Equilibratory organs (otocysts) are found at the base of the antennules in the Crustacea. In the mosquito we find auditory vibratile hairs, while the grasshopper has specialized *tympani*, with nerve cells for the reception of sound waves.

Vision is accomplished by two kinds of eyes, simple ones called *ocelli*, and compound ones. The compound eye consists of ommatidia arranged radially around the end of the optic nerve. Each *ommatidium* consists of an external cornea (facet), a cellular cone-like lens, sensory retinal cells which receive the light, and pigment cells which separate the retinal elements of the ommatidia from each other.

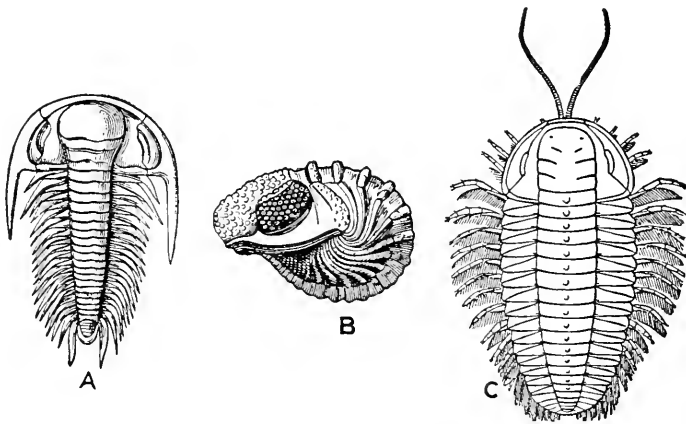

FIG. 97. Three trilobites. *A*, a Cambrian species; *B*, a Devonian species, showing a compound eye; *C*, an Ordovician species. (From Norton, *Elements of Geology*.)

Fossil Relatives. *Eurypterida* (*Merostomata*).—This order is linked with *Limulus* by many Paleozoölogists. Specimens six feet long are found in strata from the Cambrian to the Carboniferous. The head is small and unsegmented, bearing two lateral compound eyes, two median ocelli, and six pairs of gills, covered by plates.

¹¹ In insects the chemical sense is much more highly developed than in man. The mouth parts and tarsal segments of the red admiral butterfly (*Pyrameis atalanta*) are 256 times as sensitive to saccharose as the human tongue. Olfaction in the bee is keen; but the bitter substances such as quinine are readily accepted when mixed with saccharose. (D. E. Minnich. 1929. The chemical senses of insects. *Qu. Rev. of Biol.*, vol. 4, no. 1, pp. 100-112, Mar.)

Patten considers that Paleozoic Eurypterids have *scorpions* as their survivors and that the *Ostracoderms* represent their fossil descendants, which led towards the true Vertebrates. (See page 219.)

Trilobita.—The extinct trilobites (Figure 97) were dominant species in the Cambrian period, but disappeared in the Carboniferous. The limbs resembled those of Crustaceans and antennae were present. It has been suggested that trilobites descended from a stock common to Arachnoidea and Crustacea.

Arachnoidea.—The scorpions are represented in the Silurian rock by fossil forms similar to those now living. All living Arachnoidea are represented in Tertiary deposits. *Crustacea* are abundant as fossils, from the early Paleozoic. *Myriapoda* are found from the Devonian. *Insecta* appeared in the Pennsylvanian.

CHAPTER XIII

CHORDATA

CLASSIFICATION

Subphylum Hemichorda (Enteropneusta).

Subphylum Urochorda (Tunicata or Ascidia).

Subphylum Adelochochorda (Acrania).

Subphylum Vertebrata (Craniata).

Class Cyclostomata.

Class Pisces.

Class Amphibia.

Class Reptilia.

Class Aves.

Class Mammalia.

THE PHYLUM CHORDATA includes not only common Vertebrate animals such as Fishes, Amphibia, Reptilia, Birds and Mammals, but also includes certain marine forms that are extremely significant in discussions of the probable origin of Vertebrates from Invertebrates.

The name Chordata is derived from the *notochord*, which is found at some stage of the existence of all Vertebrates, but is persistent in the *adults* of those intermediate types that we will shortly proceed to describe. The notochord is a long, cylindrical, double-pointed rod, which is located ventral to the nerve cord. Notochordal tissue consists of large vacuolated cells (somewhat resembling the pith of plants) with their nuclei confined to the dorsal and ventral regions. The vacuoles of these cells are filled with liquid which renders them turgid. The notochordal sheath is extended dorsally to enclose the nerve cord.

COMPARISON OF VERTEBRATES AND INVERTEBRATES

Up to the present time we have been dealing entirely with the Invertebrates. It is therefore desirable, before we go further with the animal phyla, to compare briefly the Invertebrates with the

Vertebrates, pointing out the distinguishing features which mark an advance in the Vertebrate type.

INVERTEBRATES VERSUS VERTEBRATES

Dorsal heart.
Solid nervous system.
No endoskeletal structures.

Ventral heart.
Tubular dorsal nervous system.
Either a notochord or a vertebral column.

There is no Class of the Invertebrate Metazoa whose characters have not been repeatedly suggested to reveal affinities with the Vertebrates.

Before discussing the different theories of Origin of the Vertebrates, it will be best to take up the anatomy of examples of the *Hemichorda*, *Urochorda* and *Cephalochorda*, since these are considered by some to be connecting types.

Subphylum Hemichorda. (Enteropneusta.) Characteristics. (*Balanoglossus*.)—1. Hollow, tubular notochord, opening into a straight alimentary canal.

2. Gill slits.

3. Dorsal blood vessel and anterior (dorsal) heart.

4. Dorsal and ventral nerve strands, with many nerve fibers and scattered giant nerve cells.

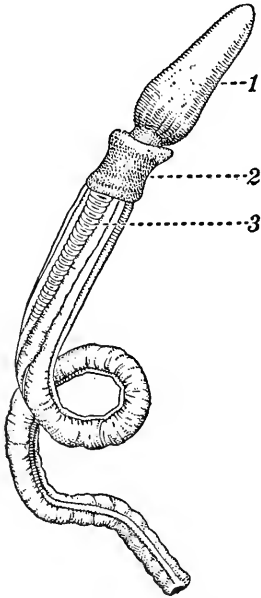

FIG. 98. *Balanoglossus*. Linville and Kelly. 1, proboscis; 2, collar; 3, gill-slits. (After A. Agassiz. Courtesy of Henry Holt & Co.)

The genus *Balanoglossida* includes *Balanoglossus (Dolichoglossus) kowalevskii*. This form is divided into three regions, the *proboscis*, the *collar*, and the *trunk*. The *proboscis*, when distended with water, serves as an organ for burrowing in the mud. *Gill slits* open into the anterior end of the straight alimentary canal. The paired *hepatic caecae* are located near the posterior end of the digestive tube. The dorsal and ventral *blood vessels* receive blood from the anterior *heart*. Excretions are extracted by the *kidney*, which sends its wastes out through the proboscis-pore, with other expelled fluids. The *sexes* are separate and the *germ cells*, formed in a

double row of *ovaries* or *testes*, are extruded through pores in the body wall. (Figure 98.)

Some species of *Balanoglossidae* have a ciliated larva called the *Tornaria*, which was once considered a larval *Echinoderm*. (See p. 217.) *Cephalodiscus* and *Rhadopleura* are colonial Hemichorda, which reproduce by buds. Both these forms were at one time regarded as *Polyzoa*. They have small probosces, and their alimentary canals are bent. Both are deep-sea forms.

Subphylum Urochorda. (Tunicates, Sea Squirts, Ascidians.)

Characteristics.—1. Retrogressive metamorphosis.

2. Multiplication by budding, as well as by gonads.

3. Reversal of the heart beat.

4. A tunic or mantle composed of cellulose ($C_6H_{10}O_5$).

Adult *sea squirts* (Figure 99, *A*, *B*, *C*, *D*, *E*, *F*) resemble the siphonate molluscs in the possession of incurrent and excurrent orifices and a mantle. The Tunicates hence were long associated with

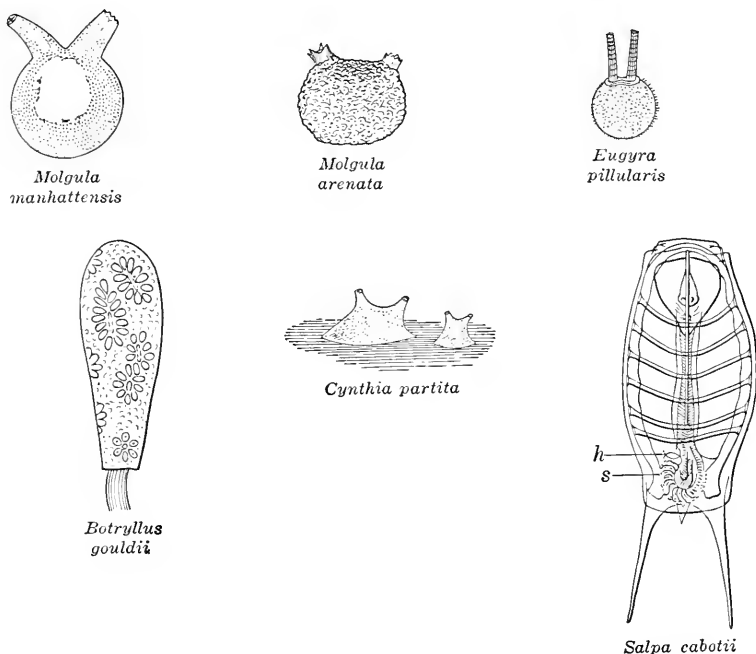

FIG. 99. A group of Urochorda. *A*, *Molgula manhattensis*. *B*, *Molgula arenata*. *C*, *Eugyra pillularis*. *D*, *Cynthia partita*. *E*, *Botryllus gouldii*. *F*, *Salpa Cabotii*. (From Verrill.)

the molluscs. Later, they were associated with the worms. Their development, however, shows them to be related to the Vertebrates. The larval ascidian is more highly developed than the adult.

Anatomy and Physiology.—The tunic or mantle has the same chemical constituents as cellulose ($C_6H_{10}O_5$). Nowhere among animals is there such a rich formation of cellulose. The anterior part of the digestive tract is modified into a pharynx or branchial chamber, the walls of which are perforated by a number of gill slits leading to the exterior, or to a peri-branchial chamber, and from this to a cloaca. While respiratory water passes through the gill slits, the food particles which it contains are received by a ring-shaped ciliated band and, enveloped by mucus, are led to the esophagus. The mucus is formed by a ciliated glandular groove, the *endostyle* on the ventral surface of the pharynx. The *ventral tubular heart* lies in the pericardium between the gill region and the stomach. It changes the direction of its contractions frequently, first driving the blood to the gills, then resting; then pumping it from the gills and sending it to the stomach. The ductless excretory organs are in the second loop of the intestine; the dorsal ganglion and the subneural gland are the only remains of the comparatively well-developed brain of the larva. The subneural gland which is associated with the dorsal ganglion is homologous to the hypophysis¹ of the higher vertebrates. The gonad is hermaphroditic, the testis surrounding the ovary, and the animal is first a female, then after pregnancy becomes a male. The larva of the ascidians is active, swims by a long tail, looks like a tadpole, and has a notochord. (Figure 100.)

Description of the Larval Ascidian.—The tail is fringed with a caudal fin which is an outgrowth of the thin test covering the whole surface. The notochord is in the axis of the tail. The nerve cord is dorsal and forms the trunk ganglion and sense vesicle with otocyst and eye. The digestive system consists of pharynx, esophagus, stomach and intestine. The larva remains only a few hours in the tailed free swimming stage. Then it becomes fixed by adhesive papillae and begins to undergo retrogressive metamorphosis. *Molgula manhattensis* (which has no tailed form) reaches its full size

¹ Butcher (1930), Jour. Exp. Zoöl., vol. 57, no. 1, pp. 1-11, has shown that in *Molgula manhattensis* the pituitary gland has the oxytocic principle of posterior pituitary. (See page 448.)

of one inch in about six weeks. *Botryllus* (the star-spangled jelly) is a compound ascidian ranging from New Jersey to Maine.

Economic Importance.—The sea squirt or “sea-peach” is eaten in South America and the Mediterranean countries, but is said to taste rather bitter.

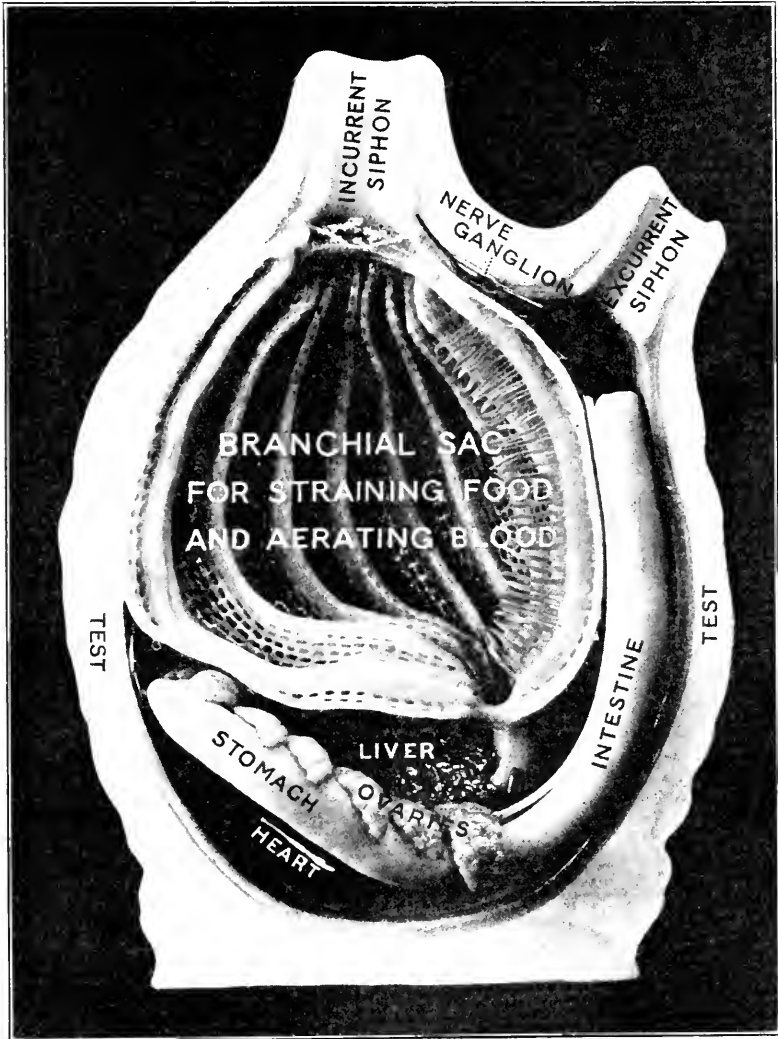

FIG. 100. Internal anatomy of the adult sea squirt. (Courtesy of Amer. Mus. of Nat. Hist.)

Subphylum (Cephalochorda, Adelochorda, or Acrania). Type—Branchiostoma² or Amphioxus.—Amphioxus, the lancelet, is transparent, less than three inches long, lives in shallow sea water, partly buried in sand, burrows head foremost, swims at night. Beebe reports them in the Sargasso Sea. (Figure 101.)

It has a median dorsal fin, extending posteriorly to form the caudal fin and then ventrally to the post-atrial region to form the ventral fin. The laterally situated meta-pleural folds occupy the position of lateral fins in fishes.

Body Wall.—The outer covering is a single layer of columnar epithelium cells, the *epidermis*, with sensory cells, goblet cells (unicellular glands) and ciliated cells. The *dermis* consists of soft connective tissue.

Muscular Layer.—The muscular layer has strikingly definite metameric segmentation. The myomeres, myotomes or muscle plates are alternately arranged on the right and the left sides permitting flexible lateral movements and with connective tissue septa

² Balanoglossus, the Tunicates, and Branchiostoma have the following characteristics in common at some stage in their existence: (1) notochord; (2) pharyngeal gill slits; (3) dorsal nervous system.

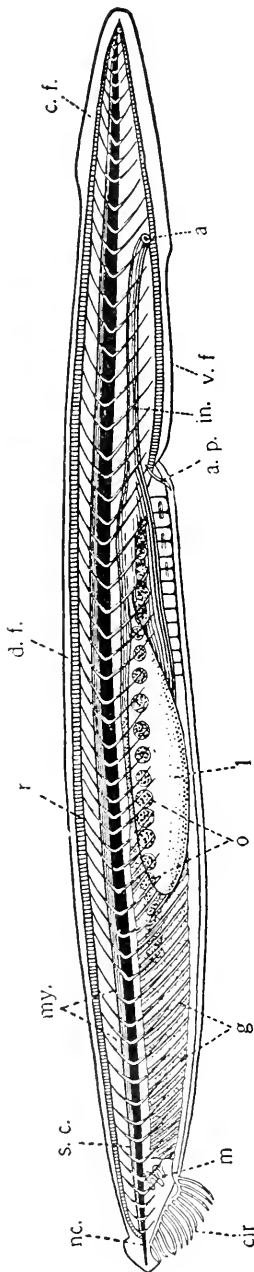

FIG. 101. A lateral view of *Amphioxus* (transparency). *a*, anus; *a.p.*, atrial pore; *c.f.*, caudal fin; *cir.*, cirri, on the edge of the vestibule leading to the mouth; *d.f.*, dorsal fin; *r*, fin rays; *g*, gill of branchial structures consisting of alternate *slits*, through which the water passes, and supporting *plates*, in the walls of which are the blood vessels; *in.*, intestine, from which as a diverticulum springs *l*, the liver; *m*, the mouth surrounded by a fringed *velum*; *my.*, myotomes or muscle segments; *n.c.*, notochord; *o*, ovaries; *s.c.*, spinal cord; *v.f.*, ventral fin. (From Galloway. Courtesy of P. Blakiston's Sons Co.)

called myocommas. The dorsal body wall is greatly thickened as it is in all Chordates and contains the hollow nervous system and the notochord. The notochordal sheath of connective tissue is produced dorsally into a covering for the canal containing the nervous system. The cells are turgid with fluid.

Digestive System.—The mouth has ciliated oral cirri, with tactile sensory cells. The twelve velar tentacles extend as strainers from the velum across the mouth. The pharynx with its one hundred pairs of gill slits functions in respiration as well as digestion. The epibranchial groove is ciliated, dorsally indenting the pharynx, and the ventrally situated *endostyle* (Figure 102) (hypobranchial groove) furnishes mucus which entangles food particles. The food is carried by the cilia of the epibranchial groove to the intestine. The liver, attached to the anterior end of the intestine, protrudes into the pharyngeal cavity. The hepatic secretion is a digestive juice probably analogous to the secretion of the pancreas of the vertebrates.

Respiratory System.—The atrium is a wide chamber between the body wall and the pharynx into which the gill clefts lead. As in the tunicates the cilia lining the gill clefts produce a current setting in at the mouth, entering the pharynx and passing thence by gill slits into the atrium and out the atriopore. The current is for respiration as well as food. The *coelom* consists of paired cavities in the pharyngeal region connected by narrow canals in the gill folds with the endostyle.

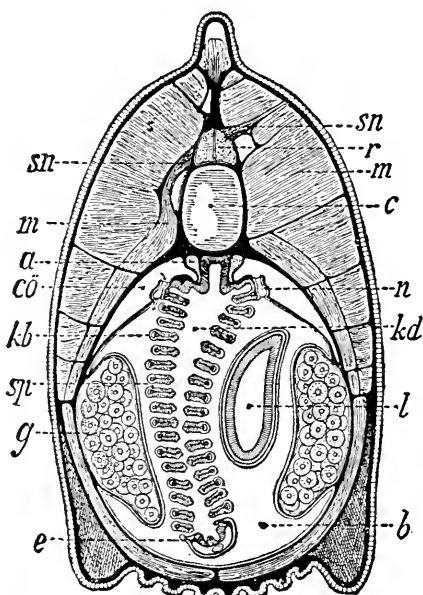

FIG. 102. Cross-section *Amphioxus*. Hertwig-Kingsley. *a*, aorta descendens; *b*, peribranchial space; *c*, notochord; *cō*, coelom (branchial body cavity); *e*, hypobranchial groove, beneath it the aorta ascendens; *g*, gonad; *kb*, gill arches; *kd*, pharynx; *l*, liver; *m*, muscles; *n*, nephridia, on the left with an arrow; *r*, spinal cord; *sn*, spinal nerve; *sp*, gill slit. (After Lankester and Boveri. Courtesy of Henry Holt & Co.)

Circulatory system consists of a dorsal vessel (paired and unpaired dorsal aortae); a ventral vessel (subintestinal vein and ventral aorta); and commissural, connecting, afferent and efferent branchial arteries with intestinal capillaries. The circulation differs from that in the Annulata, since the blood in the ventral vessel travels forwards and the blood in the dorsal vessel travels backwards which is the opposite from the condition in the Annelida. All the intestinal blood passes through the liver before reaching the ventral aorta. The hepatic portal system is characteristic of all vertebrates. The blood is almost colorless with no leucocytes and but few erythrocytes.

Excretory System.—There are 90 pairs of *nephridia* situated above the pharynx. Columnar and excretory cells are situated on the floor of the *atrium*.

Reproductive System.—The sexes are separate, 26 pairs of *gonadial pouches* opening into the atrium. The ripe *germ cells* burst from the inner walls of the gonadial pouches and escape by way of the atrium and atriopore to the external water where fertilization takes place.

Nervous System.—The dorsal nerve tube has an axial cavity, the *neurocele*, which is dilated anteriorly to form the *cerebral ventricle*. The dorsal portion of this ventricle is dilated into a pointed pouch, the *median olfactory lobe*, while in the ventral posterior portion there is a depression probably corresponding to the *infundibulum* of higher forms. A large number of spinal nerves come from the spinal cord. They arise alternately, in each segment, two dorsal nerves, sensory and motor, supplying the skin and transverse muscles; and two ventral nerves, purely motor, supplying the myotomes.

Sense Organs.—The olfactory pit (*hypophysis*) is a ciliated depression opening externally on the left side of the snout. The median cerebral "eye" has no lens and may not be sensitive to light. The so-called gustatory groove on the roof of the buccal cavity may not be an organ of taste. There are no equilibratory or auditory organs known.

Economic Importance.—Vast quantities of the *Amphioxus* are used as food by the Orientals, particularly the Chinese.

THEORIES OF THE ORIGIN OF VERTEBRATES

Theories of the origin of vertebrates include the *Amphioxus* theory, the Annelid theory, the Nemertean theory and the Arthropod

theory. The higher phyla of Invertebrates have practically all been studied by investigators with the idea that affinities with the vertebrates could be determined.

Amphioxus Theory.—The Amphioxus theory as developed by various workers and set forth by Willey is as follows. The ancestor of the vertebrates was a free swimming animal intermediate between the tadpole of the Tunicate and Amphioxus. It had the ventral mouth, pituitary and notochord (limited) of the Tunicate; and the myotomes, coelomic epithelium, and straight alimentary canal of the Amphioxus. The chief factor in the evolution of the vertebrates has been the concentration of the central nervous system along the dorsal side of the body and its conversion to a hollow tube. The hypophysis may have become evolved in connection with a functional neuropore. Adam Sedgewick and Van Wijhe suggested that the neural canal had as its original function the promotion of oxygenation of the tissue of the Central Nervous System, the water entering by the neuropore and leaving through the posterior neurenteric canal. Harmer and Brooks suggested independently that the gill slits arose at first to carry away the bulk of water constantly entering the mouth with the food, obviating the necessity of the flow of water through the alimentary canal. Later they aided in performing the function of respiration. (Cephalodiscus has luxuriant branchial plumes, sufficient for respiration, and the pair of gill slits allow the water to pass from the pharynx.) The *notochord* occurs in *Balanoglossus* (*Enteropneusta*) in the proboscis; and in the tail of larval Tunicates. In *Balanoglossus* it may be a divergent structure. The notochord may have arisen as a solidification of the endoderm, continued into the caudal portion of the body to afford axial support for a locomotor tail. Endoderm as a stiffening substance has been developed in some medusae and hydroid polyps as there is skeletal tissue in their tentacles in the form of a solid endodermal axis.

The Amphioxus theory supposes that Amphioxus was derived from a Tunicate (Ascidian) and that the Tunicate arose from a form possibly like *Balanoglossus*. *Balanoglossus* may or may not have arisen from the Echinodermata. The ciliated *Tornaria* larva of *Balanoglossus* is similar to the larvae of the Echinoderms in that it possesses bilaterality, ciliated bands, pelagic life and is small and quite transparent.

That the earlier fishes were similar to Amphioxus and that the

higher fishes developed from the primitive type through the influence of a rapid stream environment is the belief of T. C. Chamberlain.

Arthropod Theories.—The theory of Gaskell (1908) is based on the assumption that the whole alimentary canal of a crustacean-like **Arthropod** united with the nerve cord to form the hollow brain and spinal cord of the vertebrates. Gaskell's theory reflects his knowledge of physiology, but indicates his lack of training in comparative anatomy, embryology and paleontology.

Patten's **Arachnid theory** was first published in 1889 in the *Quarterly Journal of Microscopical Science*, and was followed by a number of important papers preceding the publication of his book in 1912. Dr. Patten has pointed out (personal communication, 1931) that the Arachnid theory gives a satisfactory explanation of the other theories of evolution of vertebrates while none of these theories explains the detailed resemblance between Vertebrates and Arachnids.

The following summary was furnished by Dr. Patten (consult his article in the *Quarterly Journal of Microscopical Science*, vol. 31, pp. 317-378, 1890):

"The Arachnid theory—1890—is based on the following evidence: (1) In the Arachnids, the first sixteen, or more, metameres form a characteristic pattern, consisting of five groups of highly specialized functions and organs, all of them different and all arranged in a definite sequence. (2) This basic pattern is essentially the same as that in the "head" of vertebrates, and all the corresponding organs in each group have essentially the same structure, and develop embryologically in essentially the same ways. Some of the corresponding parts are the notochord and the endocranium, the main divisions of the brain, special groups of sense organs, nerves, ganglia, somites, gill sacs, and oral arches. (3) The marine Arachnids were the highest animals in existence during the long and very early geologic eras. In the Cambrian, or some pre-Cambrian era, they apparently gave rise to the great class of Ostracoderms, which are mainly Silurian; and they in turn gave rise to the true fishes, with united oral arches, which first appeared in the Devonian. Many peculiarities of the Ostracoderms, especially the structure of the exoskeleton and the oral arches, support this conclusion. (4) The Tunicates, Amphioxus, and other chordate

types, are regarded as defective, aberrant offshoots of the main vertebrate arachnid phylum."

The recent discovery by Prof. J. Kiaer of well-preserved fossil Ostracoderms in the Silurian rocks of Norway, and the collection by Professor Stensö of perfectly preserved fossils of one of them, *Cephalaspis*, from the Devonian rocks of Spitzbergen, have given new evidence to support Professor Patten, and gratified the friends of this "grand strategist of evolution." Serial sections of the Spitzbergen specimens studied by Patten indicate that the "radiating bony channels for the cranial nerves, and many other architectural features of the anatomy of the head conform to the general plan seen in the heads of fossil *Eurypterids* and other arthropods."³

Professor Patten has made three expeditions to the Island of Oesel excavating fossils and in 1931 found six new species of ostracoderms.⁴

Annelid Theory.—The Annelid theory advanced by Dohrn, Semper, Beard and Delsman postulates that an annelid is turned over on its back and develops a mouth and anus. The notochord is represented in the annelids by a bundle of fibers running along the nerve chain, occupying a similar position to the notochord of the chordata and apparently serving the same function of support. Connective tissue encloses both nerve cord and fiber bundles (Faserstrang.) just as the notochord and the spinal cord are enclosed in the higher type.

The segmentally arranged nephridia correspond to the primitive kidney tubes of the vertebrate kidney. The segmentally arranged ganglia around the appendages of some worms (*Nereis*) may correspond to the branchial and lateral sense organs of the Ichthyopsida and the ganglia of some of the cerebral nerves.

The fundamental relationship of the nervous system and the vascular system to the digestive tract as found in the annelids is quite comparable to the condition in the primitive vertebrates.

Wilder has indicated the present trend away from the Annelid theory and points out that a worm-like ancestor does not necessarily mean that we must accept an annelid. (See trochophore, p. 125.)

³ Gregory, W. K., 1928, in *Creation by Evolution*, edited by F. Mason. Macmillan Co., New York.

⁴ Consult Patten, W., 1931, *New Ostracoderms from Oesel*. *Science*, vol. 73, no. 1903, pp. 671-673. *Tremataspis* has, as predicted, paired jaws or oral arches, like those in embryonic vertebrates (frog) and which work *sidewise*, not forward and backward as in the united oral arches of adult vertebrates.

Nemertean Theory.—The Nemerteans, probably related to the Platyhelminths, were suggested as having affinities with vertebrates, by Hubrecht. His theory attempts to homologize the proboscis sheath of the Nemertean with the notochord of the chordate. He suggests that the vertebrate nervous system developed from the three nerve cords of a Nemertean. The dorsal nerve cord of the Nemertean became the central nerve system and the lateral nerve cords persist in the rami lateralis X. of the lower vertebrates. As the other organs of the animals are not similar in arrangement the theory seems of little importance.

REFERENCES ON THE ORIGIN OF VERTEBRATES

- DELSMAN, H. C. 1922. *The Ancestry of Vertebrates as a Means of Understanding the Principal Features of Their Structure and Development.* Weltevreden (Java).
- GASKELL, W. H. 1908. *The Origin of the Vertebrates.* London, Longmans-Green.
- HUBRECHT, A. A. W. 1883. On the ancestral form of the Chordata. *Quart. Jour. Micr. Sci., N.S.*, 23: 349-368.
- LULL, R. S. 1917. *Organic Evolution.* New York, Macmillan.
- MACBRIDE, E. W. 1914. *Text-book of Embryology.* Vol. 1, Invertebrate. London, Macmillan.
- NEWMAN, H. H. *Vertebrate Zoölogy.* New York, Macmillan.
- OSBORN, H. F. 1917. *The Origin and Evolution of Life.* New York, Scribners.
- PATTEN, W. 1912. *The Evolution of the Vertebrates and their Kin.* Phila., Blakiston.
- PATTEN, W. 1920. *The Grand Strategy of Evolution.* Boston, R. G. Badger.
- WILDER, H. H. 1909. *History of the Human Body.* New York, Holt.

CHAPTER XIV

CYCLOSTOMATA

Craniata.—The *Craniata* include the vertebrates, from the eel-like lamprey, up to man himself. In all we find that in the embryo an axial notochord appears. This is persistent inside the centrum of the vertebra of an elasmobranch, but is replaced in higher forms by the true vertebral column.

Classification.—

- I. Cyclostomata.
- II. Pisces.
- III. Amphibia.
- IV. Reptilia.
- V. Aves.
- VI. Mammalia.

Characteristics of Craniata.—1. Segmented animals without external ringing of the body but with metameric arrangement of the internal parts.

2. A cuticular skeleton absent, but there may be a horny epithelium or dermal ossifications. (Scales, etc.)

3. An axial skeleton is present; either a notochord or skull and vertebral column. Two kinds of appendages are supported by the axial skeleton, the unpaired fins of the fishes and amphibia and the paired fins, or limbs of the higher vertebrates.

4. The central nervous system is dorsal and hollow and consists of cerebrum, midbrain, optic lobes, cerebellum, and medulla oblongata, with the spinal cord attached. The eyes and ears are the most highly developed of the sense organs.

5. The respiratory organs arise from the endoderm; gill slits are present in the embryo. In land forms, these are replaced by lungs, developed from the hinder part of the pharynx.

6. The heart is ventral and consists of one or two auricles; and one or two ventricles. In gill breathers the blood in the heart is venous. Pulmonary respiration brings blood to the heart pure

from the left side. The sinus venosus brings the impure blood to the right side of the heart. Circulation is a thoroughly closed system.

Cyclostomata. (Gr., a circle; a mouth.)—The Cyclostomes, forms just below the fishes, include hag-fish and lampreys, both of which somewhat resemble eels but differ in a number of essential characteristics. (Figure 103.)

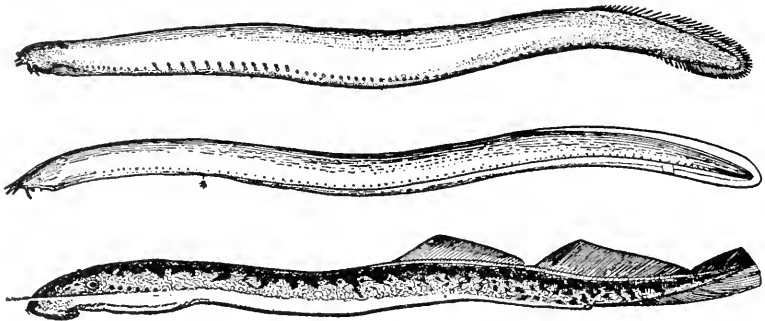

FIG. 103. *Cyclostomes*. Upper figure, Pacific hagfish, *Bdellostoma dombeyi*. $\times \frac{1}{3}$. The light apertures along the sides are mucous canals, the dark ones are branchial openings. Middle figure, Atlantic hagfish, *Myxine glutinosa*. $\times \frac{1}{2}$. The dots along the side are mucous pits; the left common branchial aperture is at *. Lower figure, sea lamprey, *Petromyzon marinus*. $\times \frac{1}{6}$. (After Dean.)

Characteristics.—1. No jaws.

2. No lateral appendages.

3. No scales.

4. No masticatory apparatus; rasping tongue present.

5. No atrial cavity.

6. Have a median unpaired nostril and the first distinct appearance of a head.

7. Have round mouth closed by the tongue.

8. Pocket-like gills.

9. Persistent notochord.

10. Vertebrae present, separated from notochord.

11. The gonads discharge into the coelom.

Myxinoids.—The *hag-fishes* produce slime and, when captured, “turn water into glue.” They are all marine. They attack disabled fish and enter the gills or mouth. Their digestive apparatus is so large that one meal takes a long time to digest. Blind, they

hunt at night. They are hermaphroditic, with an ovotestis, but one sex always predominates.

Petromyzontia. (Stone; suck in.)—The lampreys are found in both fresh and salt water, the marine species being larger. They are predaceous, true vertebrate parasites. (Brook lampreys are not parasitic.) The lamprey breathes through the mouth except when feeding, then through the gill clefts.¹ Gage and Day of Cornell University showed that the lake lampreys have in their buccal glands an anticoagulating substance similar to "hirudin." (See page 116.)

The larvae, once called *Ammocoetes*, resemble *Amphioxus*. They have a hood, median eye, endostyle, epibranchial groove (which becomes the esophagus). The endostyle becomes the thyroid gland, and the median fin specializes.

¹ Consult Gage, S. H. 1927. The Lampreys of New York State. Supp. to 17th. Ann. Report, N. Y. State Conservation Commission.

Gage, S. H. 1929. Lampreys and their ways. Sc. Mon., vol. 28, pp. 401-416, May.

Surface, H. A. 1897. Lampreys of Central New York. Bull. U. S. Fish. Comm., vol. 18, pp. 210-215.

Wheeler, W. M. 1900. Development of Urinogenital Organs of the Lamprey. Zool. Jahrb., vol. 13, pp. 1-88.

CHAPTER XV

PISCES

CLASSIFICATION

Subclass **Elasmobranchii.**

Subclass **Teleostomi.**

Order 1. Crossopterygii.

Order 2. Chondrostei.

Order 3. Holostei.

Order 4. Teleostei.

Subclass **Dipnoi.**

CHARACTERISTICS

1. Aquatic vertebrates.
2. Breathe by gills (vascular outgrowths of the pharynx). In the Dipnoi a single or double swim bladder functions as a lung, and the air is received at the surface of the water.
3. The swim bladder of the Teleostomi is used as a hydrostatic organ.
4. There are two pairs of fins, pectoral and pelvic, and also unpaired median fins.
5. The skin usually has numerous scales, formed from the dermis, but covered with epidermis which may produce enamel. Scales are suppressed in electric fishes, and rudimentary in some other forms. Glandular cells are also found in the skin. There are sensory mucus canals, for touch and chemical sense. Some fishes have well-developed poison glands near the fins.
6. The lateral line organs along the trunk are for vibrations of low frequency.
7. The muscle segments persist throughout life. There is no muscle in the dermis however.
8. The gut ends in a cloaca in many; in others a distinct anus is situated in front of the genital and urinary apertures.

9. The nostrils are paired; there are no posterior nares, so the organs are *exclusively olfactory*.
10. There are no tympanic cavities or ear drums.
11. The heart is two chambered with venous blood except in the Dipnoi where it begins to be three chambered and receives pure blood from the lung as well as impure blood from the body.

Apart from the Dipnoi, the heart has one auricle, receiving impure blood from the body; one ventricle which drives it through the ventral aorta to the gills, whence the purified blood flows to the head and by the dorsal aorta to the body. There is a sinus venosus receiving the impure blood and sending it into the auricle and thence to the ventricle. The conus or bulbus arteriosus, located at the exit of the arterial trunk from the heart, becomes more bulbous in the Dipnoi, presaging the development of the distinct bulb of the Amphibian heart. There are no vena cavae, but there are two posterior cardinal vessels.

12. The kidney is the persistent mesonephros. There is no distinct urinary bladder. (Small paired ones in some fishes.)

NATURAL HISTORY

Subclass Elasmobranchii. (Gr., a metal plate; Lat., a gill.)

Characteristics.—The Selachii have a cartilaginous skeleton, placoid scales, gills covered (separate covers), heart with arterial cone, a spiral valve in the large intestine and no swim bladder. *Sharks* have triangular teeth with notched edges; *dogfish* have flat, diamond-shaped teeth. They are *marine* except one fresh water Nicauragan shark. (Figure 104.)

The *great white shark* or “man-eater” (*Carcharodon carcharius*) grows to thirty feet in length. Usually found in tropical waters, it sometimes strays to the North Atlantic. It will follow ships and seize refuse and so occasionally gets a “man overboard.” Until the summer of 1916 all reports of attacks on man by sharks in American waters were branded as false. *Whale sharks* reach a length of fifty to sixty feet. They eat small fish, squids and shrimps, straining them out of the water by means of the gill rakers. The *thresher shark* has a much elongated upper lobe on its “super-heterocercal tail,” which furnishes a powerful weapon and also drives the small

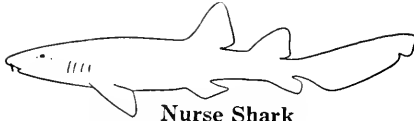

Nurse Shark
Ginglymostoma cirratum (Gmelin)

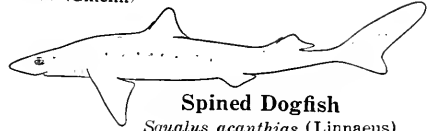

Spined Dogfish
Squalus acanthias (Linnaeus)



Smooth Dogfish
Mustelus canis (Mitchill)

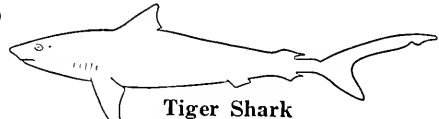

Tiger Shark
Galeocerdo tigrinus
(Müller and Henle)



Hammer-head Shark
Sphyrna zygaena (Linnaeus)



Thresher Shark
Alopias vulpes (Gmelin)

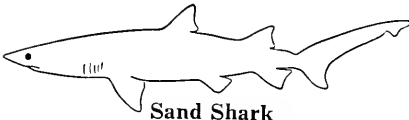

Sand Shark
Carcharias littoralis
(Mitchill)



Man-eater Shark
Carcharodon carcharias
(Linnaeus)



Mackerel Shark
Isurus tigris (Atwood)

FIG. 104. Sharks of various types. (After Nichols and Breder. Courtesy of N. Y. Zoological Society.)

fish together. *Angel sharks* are transition types between sharks and the skates and rays. They have large pelvic and pectoral fins, extending laterally. (Figure 105.) *Rays* and *skates* are much flattened dorsiventrally. They vary in size from the small "rugs" of the New Jersey coast to large skates eight feet in diameter. (Figure 106.)

In the *electric ray* (*torpedo-ray*) modified muscle plates called electropaxes are developed from the muscles of the pectoral region. They are under control of the ray and connected with nerve centers in the medulla. The *whip-tailed* or *sting-rays* have tails armed with barbed spines, eight to nine inches long. At the base of the spines poison is secreted which entering the wounds made by the tail causes severe inflammation. *Eagle rays* may reach a width of twenty feet. The animal envelops prey with its "wings." Pearl divers have been drowned by these "sea vampires." *Sawfish* may be twenty feet long with a five-foot snout equipped with saw-like teeth. (Figure 107, A, B, C, D.)

Holocephali. (*Chimeras*.)—The sea cat has an operculum or gill cover and five claspers developed from its fins. It reaches a length of three feet and rarely attacks bathers. (Figure 108).

Subclass *Elasmobranchii*. *Type of the Group*—*The Skate*.¹
General External Characteristics.—1. Body flattened dorsiventrally. (The flounder is flattened laterally.)

2. Pectoral fins broad, fused perfectly with head and trunk. Pelvic fins well developed and bilobed, bearing claspers in the male.

3. Ventral mouth with teeth.

4. Paired nostrils located ventrally.

5. Dorsally situated spiracles, originally the first pair of gill clefts, communicating with the pharynx.

6. Five pairs of gill clefts located ventrally. (Laterally in the dogfish.)

7. Ventral anus leading into cloaca.

8. Two small pouches, one on each side of anus with two abdominal pores opening into coelome.

Integument.—The epidermis has several layers of cells and is richly supplied with glandular *goblet cells*. The dermis is studded with bony dermal placoid scales or "skin teeth," which are based in

¹ Since it is possible to secure rather small mature skates, many instructors prefer to use them instead of the shark. We will therefore describe the skate, but present figures to illustrate the nervous system of the dogfish.

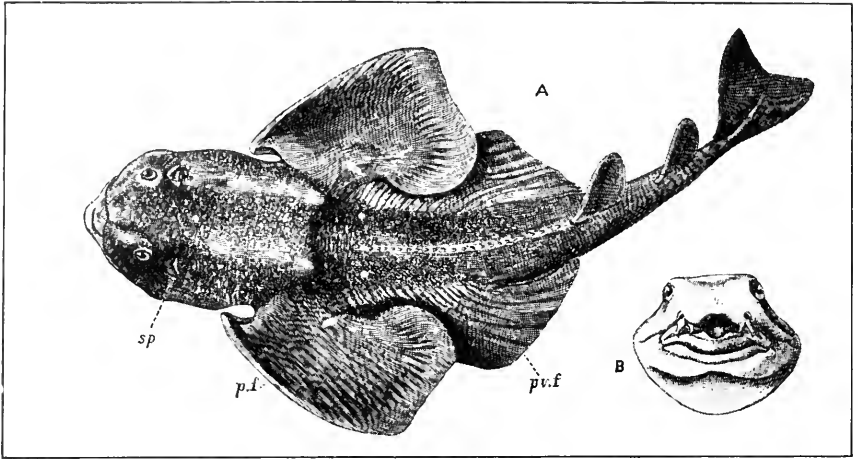

FIG. 105. The angel-shark (*Rhina Squatina*). *A*, dorsal view; *B*, view of the mouth and nasal barbels. *p.f.*, pectoral fin; *pv.f.*, pelvic fin; *sp*, spiracle. (Courtesy of Am. Mus. of Nat. Hist.)

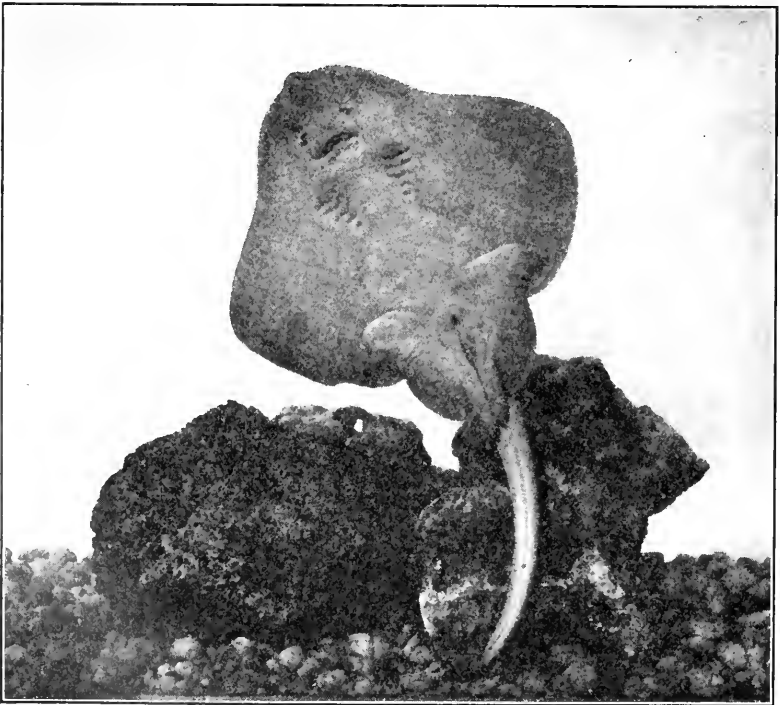
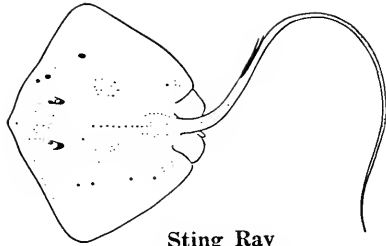
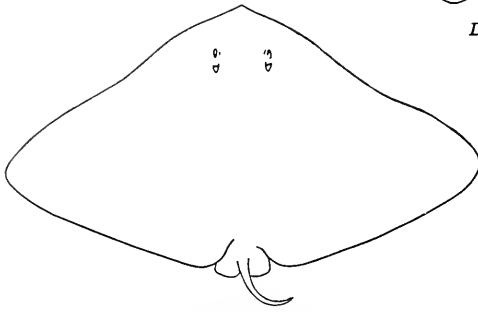

FIG. 106. Common skate. (Courtesy of N. Y. Zool. Soc.)



Sting Ray
Dasyatis centrura (Mitchill)



Butterfly Ray
Pteroplatea maclura (Le Sueur)

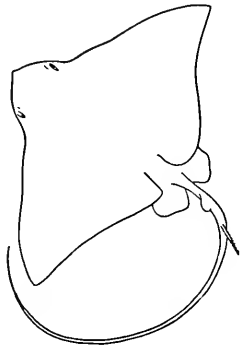

Eagle Ray
Myliobatis freminvillei (Le Sueur)

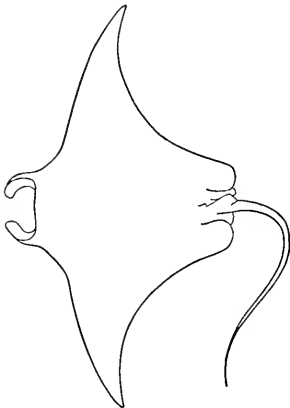

Great Manta
Manta birostris (Walbaum)

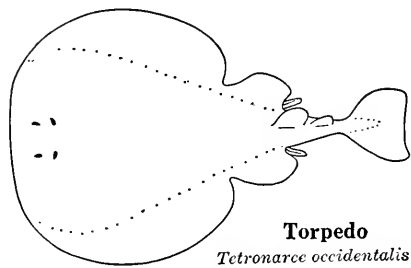

Torpedo
Tetronarce occidentalis
(Storer)

FIG. 107. Rays. (Courtesy of Nichols and Breder and the N. Y. Zoological Society.)

bone, cored with dentin or ivory and tipped with enamel from the epidermis. The enamel is inorganic, the cells being replaced by lime salts. The dentin contains 34 per cent organic matter and the bone is cellular tissue.

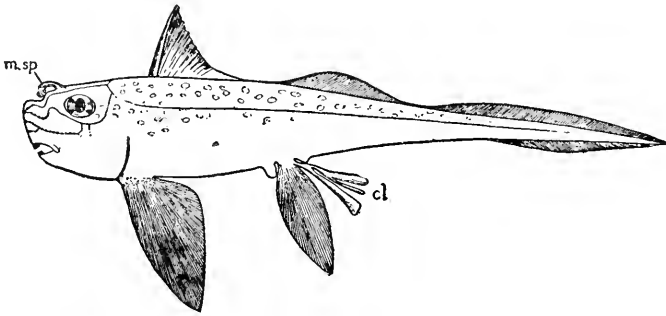

FIG. 108. Chimaeroid fish. After R. Lull. (Courtesy of The Macmillan Co.)

There are *sensory tubes* or mucus canals on the ventral surface just under the skin. They function for touch and chemical sense, having ampullae with sensory cells at the inner ends and pores opening to the outside. There are no spines on the ventral surface except a few bristly ones in the region of the cloaca.

Muscular System.—The muscles are segmentally arranged, the jaw muscles being well developed. Organs not present in the *skate* are the *electric organs*, best developed in the teleosts, a South American eel (*Gymnotus*) and an African Siluroid (*Malapterurus*), but also found in the Elasmobranch *torpedo ray*. In the torpedo they lie on each side of the head between the gills and the anterior part of the pectoral fin. They are vertical prisms, divided by transverse partitions of connective tissue into large number of cells formed from metamorphosed muscle fibers. These electropaxes or electric plates consist of muscle substances and many nerve endings. Four nerves connect them with the electric lobe in the medulla oblongata.

Skeleton.—The skeleton is cartilaginous with a deposition of bone in the jaws and vertebral column. The *skull* of the skate is not ossified: It consists of a large cartilaginous case with brain cavity; 2 condyles, 2 large ear capsules, 2 large nasal capsules, a long rostrum in front and two fontanelles on the roof. The *pectoral girdle* is a hoop of cartilage attached dorsally to the crest of the vertebral plate. The ventral region, the coracoid is separated from

the dorsal, scapular region, by three facets serving as attachments for the three basal portions of the pectoral fin, while the suprascapula connects the scapula with the crest of the vertebral plate. The *pelvic girdle* is not attached to the vertebral column. In the male the claspers are connected closely with the posterior part of the *hind limb* and have a complex cartilaginous skeleton and an associated gland.

Cavities.—The *coelom* in the trunk is divided into a pericardial cavity, lined with *pericardium* consisting of coelomic epithelium and connective tissue, while the abdominal cavity is lined with *peritoneum*. In the dorsal neural cavity is found the central nervous system.

Digestive System.—The *mouth* has teeth (special development of dermal teeth) which are worn away at the outside and renewed on the inside. A naso-buccal groove connects the nostrils with the buccal cavity, while the spiracles which communicate with the buccal cavity ventrally, open dorsally behind the eyes. The *tongue* is reduced or almost entirely absent, in skates but is present in sharks. *Salivary glands* are lacking, but the short broad esophagus has mucus glands which lubricate it somewhat. The U-shaped *stomach* (see Figure 109) is divided into cardiac and pyloric regions. The *small intestine* is extremely short and receives the secretions from liver and pancreas. The three lobed *liver* has a large gall bladder, leading by the bile duct to the small intestine. The *pancreas* at the end of the duodenum, has its duct opening opposite the bile duct. The *colon* is rather large and has a well developed *spiral valve*, in which the mucous layer of the large intestine is so coiled that it increases surface for absorption and retards the passage of the food.

The *rectal gland*, possibly with an excretory function,² is at the posterior part of the intestine. The *spleen*, a ductless gland, dark red in color, is attached to the stomach by mesentery but has no digestive significance. It is functional in blood formation.

Respiratory System.—The spiracles open dorsally, each containing a rudimentary gill on the anterior wall supported by a spiracular cartilage. Water may enter or leave the mouth. The spiracles serve as intakes for the respiratory stream and also as spout holes to clear away debris and to keep the eyes clean.³

² Crawford, J. 1899. On the rectal gland of the Elasmobranchs. Proc. Roy. Soc. Edinburgh, vol. 23, pp. 55-61.

³ Rand, H. W. 1907. Amer. Nat., vol. 41, p. 285.

In higher vertebrates the spiracle is used in connection with audition and while other gill clefts disappear entirely, it gives rise to the tympanic cavity and the Eustachian tube. There are five pairs of gill pouches, opening *internally* to the pharynx and *externally* by gill slits.

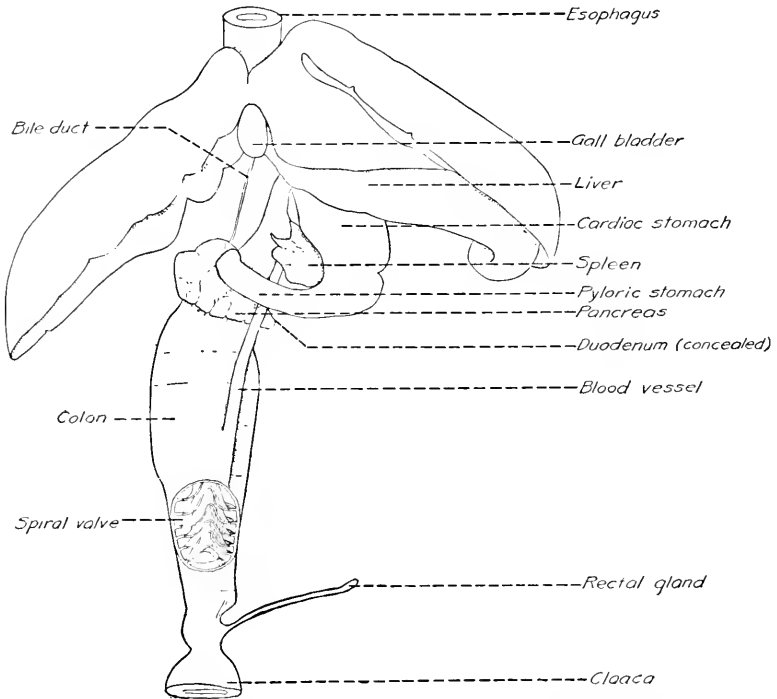

FIG. 109. Digestive system of skate. (Drawn by W. J. Moore.)

Water enters the mouth and passes the interior clefts into the branchial pouches, then outward by the exterior clefts. Gill pouches are developed from the pharynx and so the respiratory epithelium is endodermal. Cartilaginous visceral arches alternate with the gill clefts. A gill consists of two hemibranchs or half gills. The Dipnoi utilize the gills and the modified swim bladder which functions as a lung.

Circulatory System.—The *heart* is four-chambered consisting of one auricle, one ventricle, with an auriculo-ventricular valve with two lips, the sinus venosus, situated dorsally and posteriorly and

with numerous valves, which lead into the auricle, and the conus arteriosus with six valves, which carries the blood anteriorly from

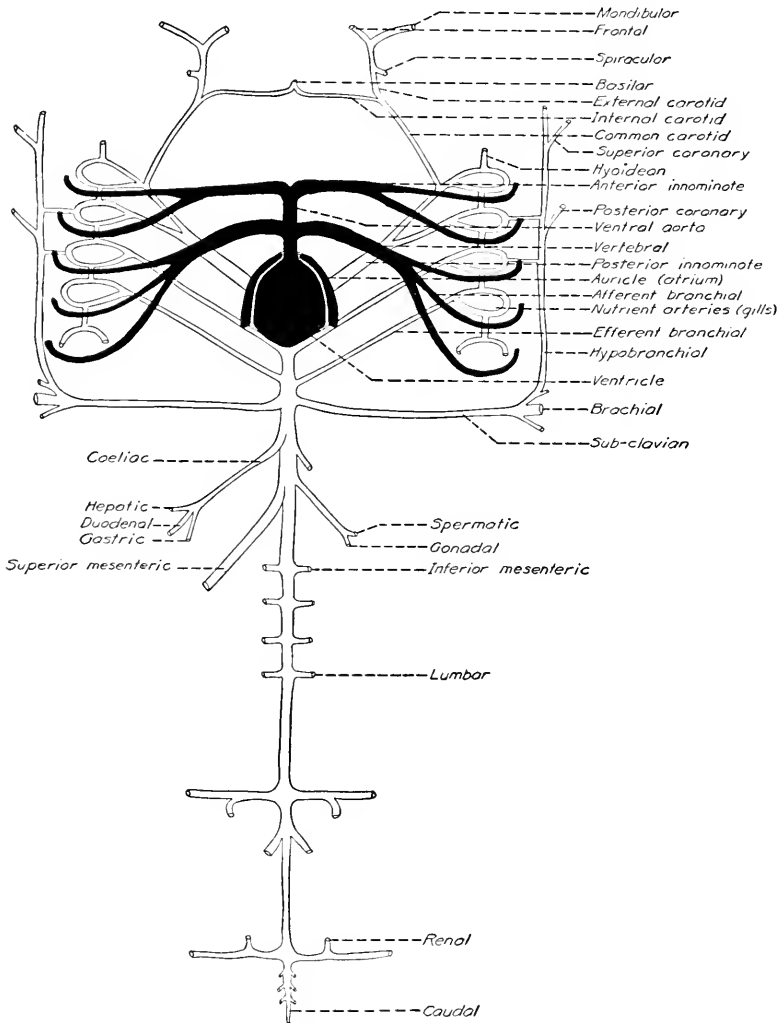

FIG. 110. Arterial circulation of skate. (Drawn by W. J. Moore.)

the heart to the ventral aorta. (Figure 110.) In fishes the heart is at the anterior end of the coelome. (Figure 111.) The walls of the ventricle are thick and the walls of the auricle are thin. The

hearts of all fishes except the Dipnoans contain *venous blood* only. The ventricle forces the blood through the ventral aorta to the afferent branchial arteries to the capillaries of the gills, where it is oxygenated and thence passes into the efferent branchial arteries and into the dorsal aorta, thence throughout the body.

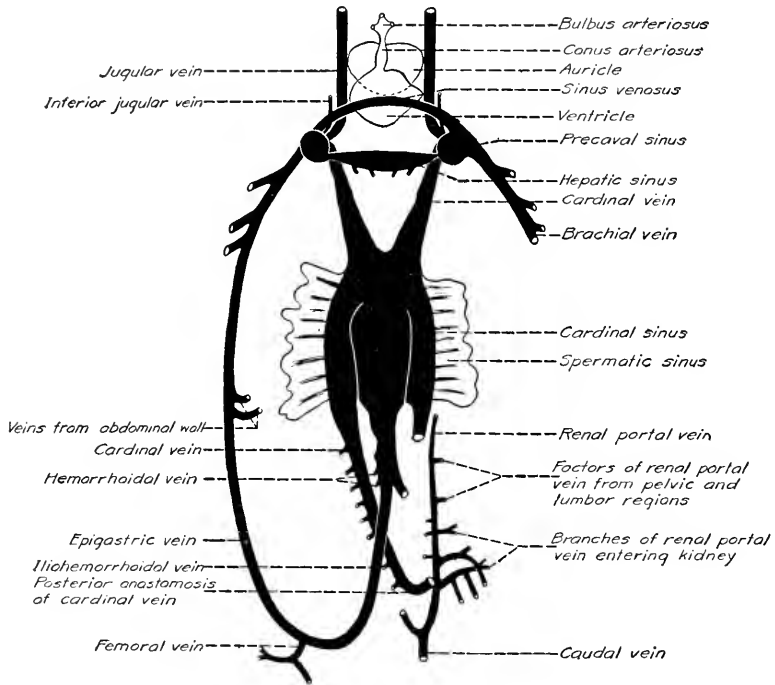

FIG. 111. Venous circulation of skate. (After Parker's *Zootomy*. Courtesy of Macmillan and Co., Ltd.)

The *renal portal system* is well developed in the Elasmobranchs but disappears in birds and mammals. In the *skate* the caudal vein brings blood from the tail, dividing in the abdominal cavity to form the right and left renal portal veins, which end in afferent renal veins supplying the kidneys. The blood leaves the kidneys by the posterior cardinal veins which enter the cardinal sinus.

The *hepatic portal vein* is formed by the union of veins that bring blood from the stomach, intestine, spleen and pancreas. The large vessel thus formed passes forwards and enters the liver. Leav-

ing the liver the blood enters the sinus venosus by two hepatic sinuses, closely apposed.

Urinogenital System.—The dark red *kidneys* lie dorsal to the vertebral column. Several tubes from each kidney combine to form a *ureter*. The two ureters open into the urogenital sinus,

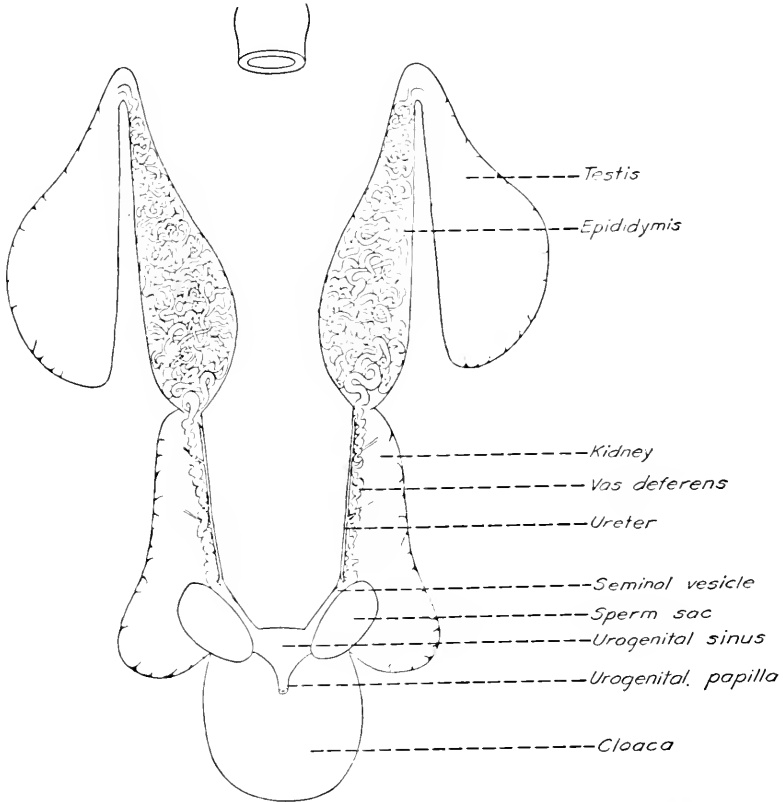

FIG. 112. Urinogenital system of male skate. (Drawn by W. J. Moore.)

whence the watery products pass out by the cloaca; in the female they open into little bladders—the dilated ends of the Wolffian ducts—and thence by a common aperture into the cloaca.

Segmental ducts divide into Wolffian and Müllerian ducts. The Wolffian duct becomes in the *male* the *vas deferens*; in the *female* it is an unimportant *Wolffian* duct; the *Müllerian* duct becomes in

the *female* the *oviduct*, in the male it is a mere rudiment. The body cavity rids itself of waste through the *abdominal pores*.⁴

In the *male*, the anterior portion of the kidney persists as the epididymis, and its duct becomes the spermiduct. The posterior portion, the functional kidney, has its own duct, the ureter. In the female no direct connection exists between the reproductive and renal organs in the anterior portion. The ureters open in males into a median chamber—the *urino-genital sinus*—which also re-

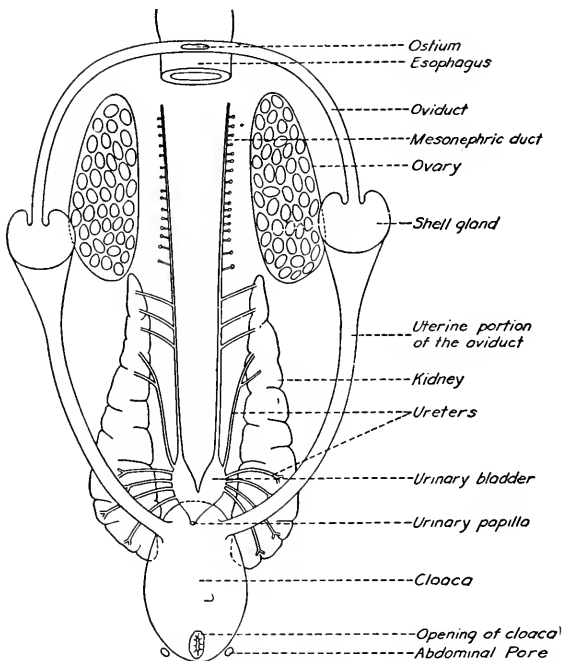

FIG. 113. Urinogenital system of female skate. (Drawn by W. J. Moore.)

ceives the spermiducts. This communicates with the *cloaca* by a median opening on a papilla—the urino-genital papilla. There is a median urinary sinus in females. The ureters open into the sinus or directly into the cloaca. The *testes* are fastened by a fold of peritoneum on each side of the cardinal sinus. (Figure 112.) Spermatozoa pass from the testes by the *vasa efferentia* into a tube

⁴ Smith et al. have shown that the perivisceral fluid escapes through the abdominal pores. They also emphasize the secretory capacity of the pericardium and peritoneum in Elasmobranchii. (Smith, H., 1929, J. Biol. Chem., vol. 81, no. 2.)

surrounded anteriorly by the epididymis. The tube of the epididymis is continued into the *vas deferens* which is dilated posteriorly into the seminal vesicle and adjacent sperm sac. The vasa deferentia open into the urogenital sinus. Sperms pass along the groove between the *claspers* of the male.

The *ovaries* are anchored by peritoneum on each side of the cardinal sinus. The eggs escape into the body cavity, and enter the single anterior aperture of the two oviducts. (Figure 113.) The lower portions of the oviducts open into the cloaca. Many of the dog fishes and sharks are *viviparous*, while the skate is *oviparous*, with a horny purse (Figure 114) secreted by its oviducal or "shell" glands.

Nervous System.—The brain consists of the fused cerebral hemispheres with a nervous roof, the optic thalamus or thalamencephalon, with dorsal pineal body, and ventral pituitary body and thinly roofed third ventricle within; the mid-brain with paired optic lobes above, the crura-cerebri below, the Aqueduct of Sylvius or *iter* passing below; the cerebellum with its anterior and posterior lobes both marked by ridges and grooves; and the medulla oblongata which has a thin vascular roof, and lateral restiform bodies. There are ten pairs of cerebral nerves, and many paired spinal nerves.⁵ (Figure 115, Figure 116.)

Sense Organs.—In the Elasmobranch eye, there is *no focusing device*. The shape of the eye and the density of the vitreous humor aid in keeping the spherical lens close to the pupillary opening of the iris. The *ears* are sacs with three pairs of semicircular canals. Within the vestibule are calcareous



FIG. 114. Egg case of a skate. (Drawn by Norris Jones.)

⁵ Norris, H. W., and Hughes, S. P. The cranial, occipital and anterior spinal nerves of the dogfish, *Squalus acanthias*. Jour. Comp. Neurol., vol. 31, no. 5, pp. 293-395.

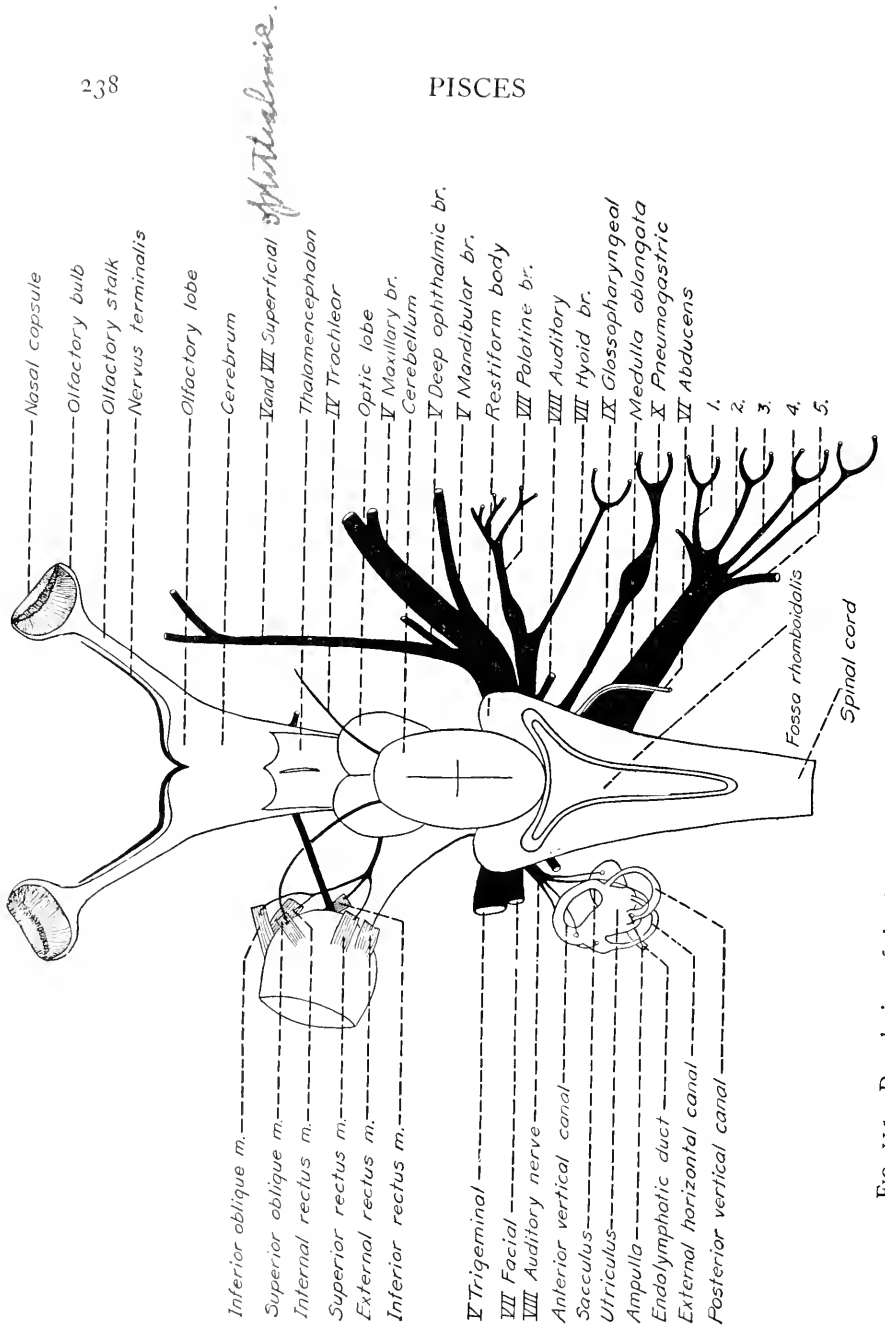

FIG. 115. Dorsal view of the dogfish brain. (Drawn by W. J. Moore and Norris Jones.)

otolithic particles surrounded by a jelly. The *nasal sacs* are cup-like cavities with plaited cells. They serve for *smell only*. The *sensory tubes* are best seen on the ventral surface, where they lie just under the skin. At their internal ends lie ampullae, containing sensory cells. At their outer ends there are pores. It is

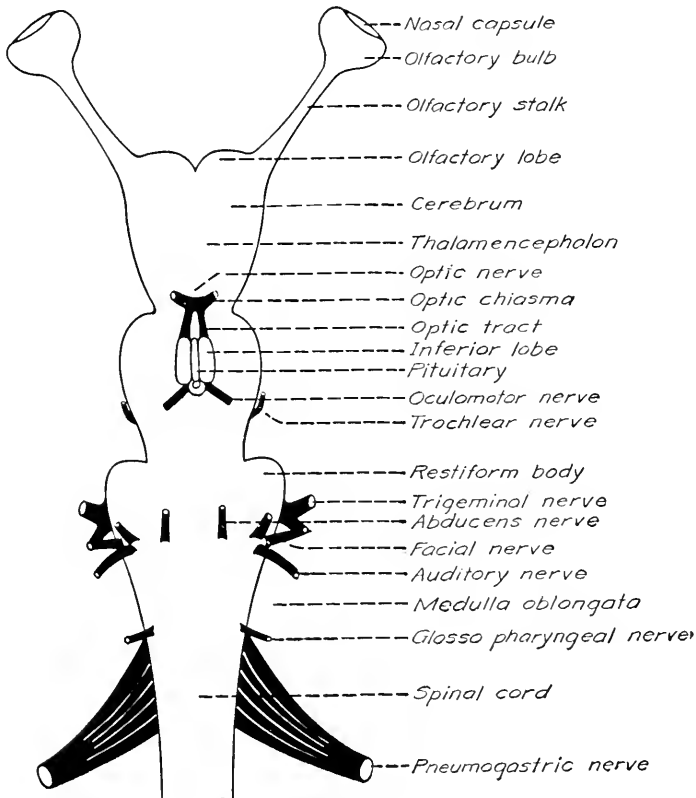

FIG. 116. Ventral view of dogfish brain, showing cerebral nerves. (Drawn by W. J. Moore.)

probable that they are organs partly of touch and partly of "chemical sense." The *lateral line organs* detect vibrations of low frequency. The ear, the lateral line, and a pre-auditory sensory patch are developed from a thickening of the ectoderm. The ectodermal rudiments of the otocyst and the lateral line are in some cases continuous at first. Sensory cells in the canals closely resemble the sensory cells of the ear. (See p. 259.)

Subclass Teleostomi. **Order 1. Crossopterygii.** (*Long-finned Ganoids*).—*Polypterus bichir* (*Senegalus*) (Figure 117) lives in the deeper waters of the Nile (Harrington), but does not bury itself in the mud like true mudfishes. The air bladder is an accessory respiratory organ. It is connected by a primitive trachea with the pharynx and used as a lung. The larva of *Polypterus* resembles amphibian larvae. It has external gills, and utilizes its pectoral

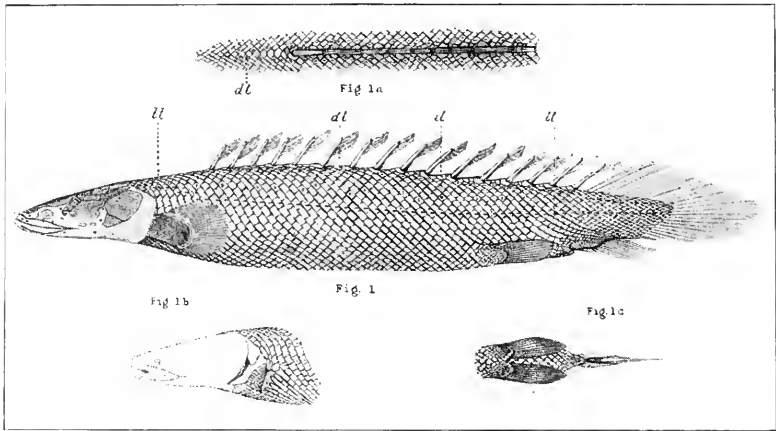

FIG. 117. *Polypterus bichir*. Ganoid. 1, full length lateral view of 44 cm. *Polypterus bichir*. $\times 1$. 1a, dorsal view of mid-dorsal line of same. $\times 1$. 1b, lateral view of anterior portion of trunk of same, with pectoral fin removed. $\times 1$. 1c, ventral view of anal fins of same. $\times 1$. (Courtesy of Amer. Mus. of Nat. Hist.)

appendages as supports. The median fin is primitive like that of the tadpole, but differs in that it has cartilaginous supports or rays.

Calamichthys, the other genus of Crossopterygii, has an eel-like shape, and lives in small muddy streams in middle western Africa, feeding mainly on crustacea. The Paleozoic *Crossopterygii* are regarded as probable ancestors of the terrestrial vertebrates and the present day fishes.

Order 2. Chondrostei.—This order has a skeleton largely cartilaginous, with ganoid scales and a heterocercal tail.

The *paddlefish* or spoon-bill (*Polydon*) lives in the Mississippi River and its tributaries. It may reach a length of six feet and weight of one hundred fifty pounds. It is sluggish, feeding on mud, shoveled up with its spoon-bill snout, which is equipped with

many tactile and gustatory end organs. A relative of the American spoon-bill lives in the waters of China.

The *sturgeon* (*Acipenser*) (Figure 118) has its rostrum prolonged into a snout with a transverse row of barbels hanging from the ventral surface. The scales are large and arranged in five longitudinal rows, and have keels. The sturgeons are found in the Great Lakes, and in the Black and Caspian

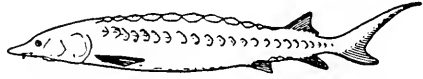

FIG. 118. Short-nosed sturgeon. (Nichols and Breder. N. Y. Zool. Soc.)

seas. Caviar, is made from the eggs of sturgeons, and their flesh is also eaten. They reach a size of thirty-two hundred pounds.

Order 3. Holostei.—Holostei are between the Elasmobranchs and the Teleosts, and include *Amia* and *Lepidosteus*. They have the cartilaginous and bony skeleton, *ganoid* scales, swim bladder and pyloric appendages of the teleosts; and the conus arteriosus and spiral valve of the elasmobranchs. The tail is diphycercal. (See p. 255.)

The *gar pikes* (*Lepidosteus*) are fresh water fishes, ranging from five to ten feet (Alligator gar), and found in North and Central America. They have long slender bony snouts with sharp teeth, and kill many other fishes. The air bladder serves as a lung when the animal comes to the surface to gulp in a fresh supply of air. (Figure 119.)

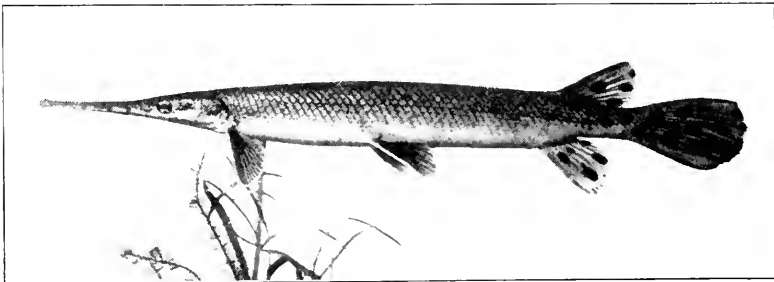

FIG. 119. Long-nosed gar. (Courtesy of N. Y. Zool. Soc.)

The *bow fin*, *Amia calva*, called the "mudfish" or "fresh water dog fish," resembles the true bony fishes. It has, however, a continuous dorsal fin, heavy ganoin covered scales and a tail modified from the heterocercal to a shape almost homocercal. The air

bladder is used as a lung. The male guards the nest and later takes care of the young for a short time. The embryonic development is less like that of a teleost than of an amphibian. (Figure 120.)

Order 4. Teleostei. (Gr.—complete,—a bone.)—The teleosts include most of our common food fishes. The skeleton is ossified. Except for one genus, the spiral valve is absent. The stomach has

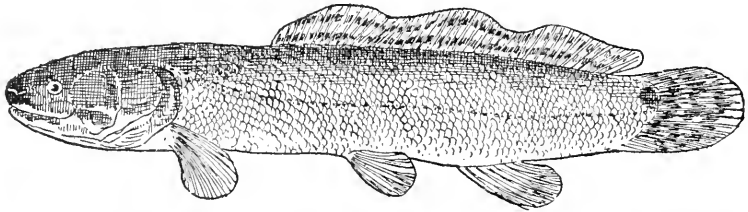

FIG. 120. Bowfin, *Amia calva*. (From L. A. Fuertes. Courtesy of Slingerland-Comstock Publishing Co.)

pyloric appendages (120 in the cod). The scales are cycloid or ctenoid. The gills are comblike and an operculum is always present. The swim bladder is usually present though its duct is not always open. The eyes are large and lidless. The optic nerves of Teleostei cross each other, without interlacing.

The marine tarpon (*Elopidae*), (Figure 121) called the “silver king” is much sought by fishermen as it is a gamey fighter. Its

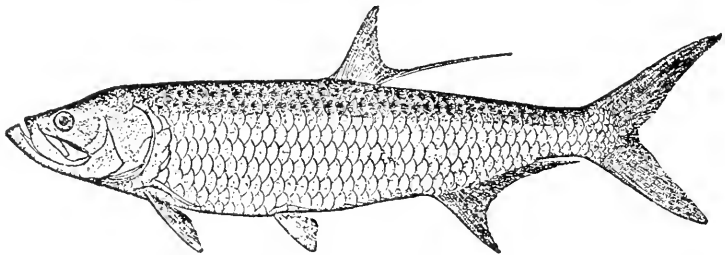

FIG. 121. Tarpon. (From Goode. U. S. B. F.)

large silvery scales furnish *ganoin* for the manufacture of ornaments.

The *salmon* (*Salmonidae*) is a marine fish spawning in fresh water at the age of four or five years. Its long migration to ancestral spawning grounds has puzzled and thrilled scientists for many years. (See page 263.)

The *white fish* lives in deep water in the winter and migrates to

the shallows to feed and to spawn. It ranges in weight from three to twenty pounds. The *lake trout* ranges from a few pounds to over one hundred pounds in weight. The *red spotted brook trout* (speckled trout) is a shy fish inhabiting clear cold streams and is much sought after by fishermen. (Figure 122.)

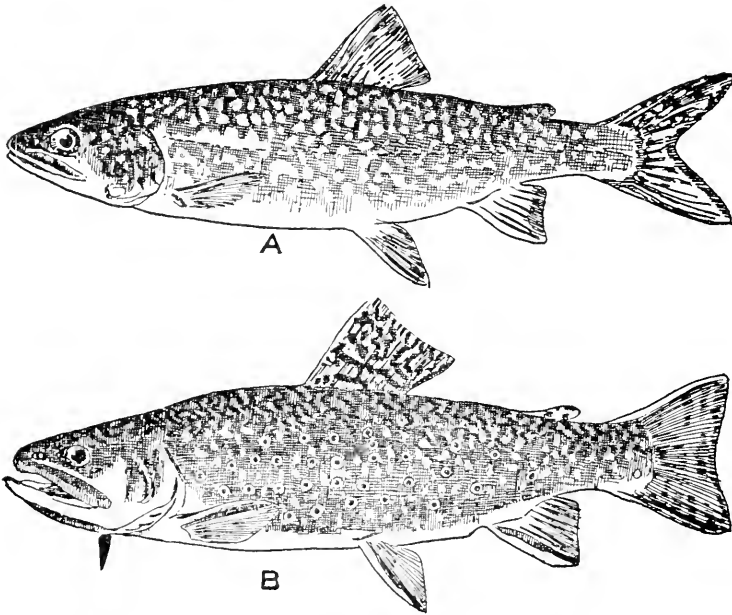

FIG. 122. *A*, lake trout. *B*, brook trout. (From L. A. Fuertes. Courtesy of Slingerland-Comstock Publishing Co.)

The *bullheads* and *catfishes* (*Siluridae*) are for the most part fresh water fishes. The Mississippi catfish grows to a length of six feet and may weigh one hundred pounds. (Figure 123.)

The *saw-toothed piranha* is one of the most savage of fishes and although it seldom reaches a length of one foot is feared by man and attacks fishes and even alligators. Travellers find that the *piranha* will seize one's fingers, trailing over the side of a boat. In catching piranhas, copper wire, three strands thick, is used to attach the hook.

The *barracuda* of the Eastern coast which sometimes reaches a length of six feet, is an important enemy of crustaceans, fish and aquatic mammals. It is reputed to attack man, but most of the cases reported proved to be the bites of tropical *sharks*.

The *chubs*, *horned dace* and *carp* belong to the family Cyprinidae. The German carp is a fish introduced to America in 1872, and now plentiful. It is not well flavored and is probably injurious to other fishes, as well as active in keeping down vegetation ordinarily fed upon by ducks. *Gold-fish*, *Cyprinida*, bred for centuries by the Japanese, have been developed into beautiful forms.

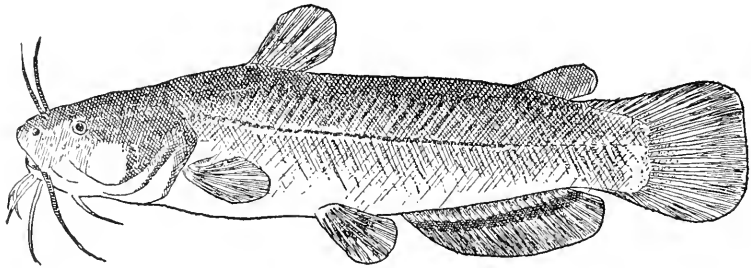

FIG. 123. Bull head. (From L. A. Fuertes. Courtesy of Slingerland-Comstock Publishing Co.)

The *suckers* (*Castostomidae*) are fresh-water fishes with long protractile mouths. *Mullets* are relatives.

The common *herring* (*Clupeidae*) is said to be one of the most important food fishes. Slight differences in temperature have a great influence on the appearance of the shoals of these fish along our coast.

There are six species of *cave-fishes* (*Amblyopsidae*) in the subterranean streams of Missouri, Kentucky and Indiana. They have been studied most by Dr. Eigenmann of Indiana University. The eyes are reduced. Loeb has found that some fish eggs develop without eyes if kept in the dark (Neo-Lamarckism, page 514).

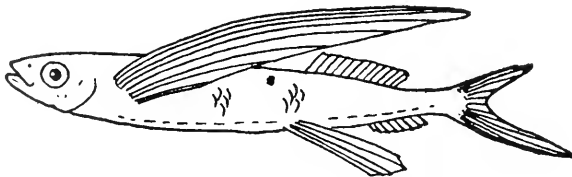

FIG. 124. Atlantic flying fish. (From Nichols and Breder.)

The *flying fishes* (*Exocoetidae*) (Figure 124) have the power to plane along above the surface of the water. As in other fishes the tail gives a great initial impetus. It is said that they can "fly" two hundred yards.

The true *eels* (*Anguillidae*) are found in fresh and salt water. They migrate upstream to the headwaters of fresh water rivers and live there until at maturity they pass down to the sea to spawn. It is only recently that their habits became fully known. (See page 264.)

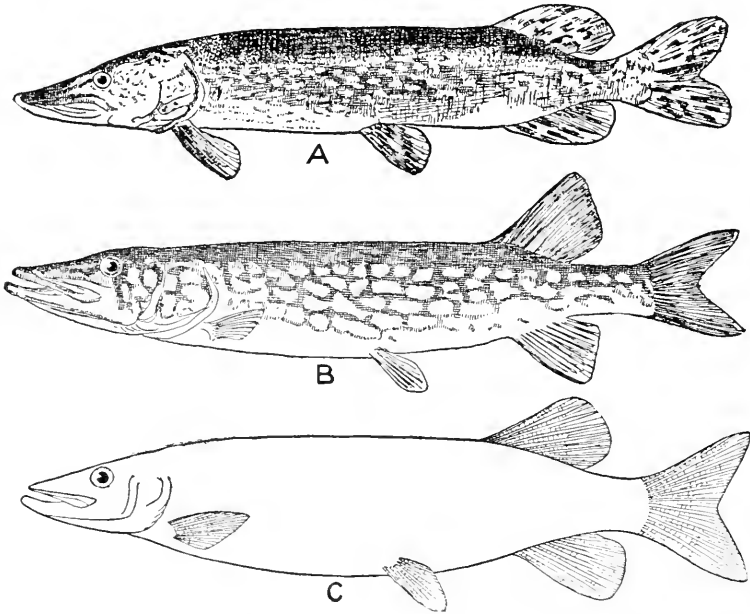

FIG. 125. A, pike. B, pickerel. C, muskellunge. (Courtesy of Slingerland-Comstock Publishing Co.)

The *piques* (*Esoxidae*) (Figure 125, A, B, C) include the pickerel, *Esox lucius*, which is a serious enemy of other more important food fishes, and also captures frogs and small birds. The *muskellunge* (*Esox masquinongy*) is a hard fighting food fish reaching a weight of one hundred pounds and a length of six feet.

The *mummichogs* (*Poeciliidae*) include the salt water minnow, *Fundulus heteroclitus*, which is not only extremely valuable in mosquito extermination on the northern salt marshes of the U. S., but is of great use in experimental embryology. (Figure 126, A and B.)

The *top minnow* (*Gambusia affinis*) is of great importance in the extermination of the larvae of Anopheline mosquitoes. They

have been utilized in the southern part of the U. S. and, shipped to other countries, have successfully attacked the mosquito larvae there. Top-minnows must be renewed in many places where winter floods carry them away.

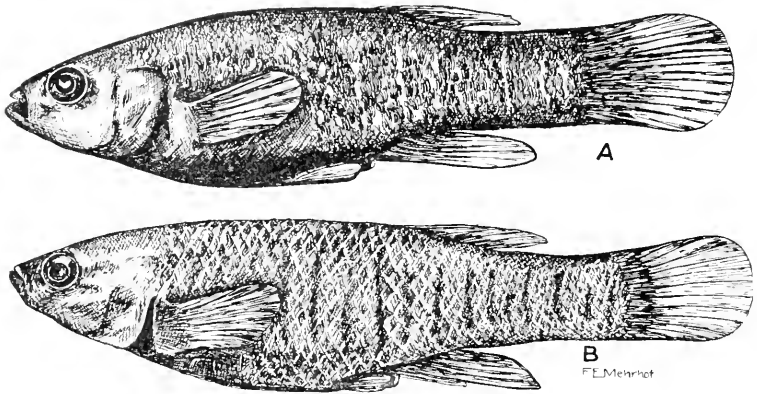

FIG. 126. A, *Fundulus heteroclitus*, male. B, *Fundulus heteroclitus*, female. (F. E. Chidester, Bull. 300, N. J. Exp. Sta., 1916.)

The *sticklebacks* (*Gasterosteidae*) are interesting because of the nest building of the male. He entices the female to the nest and after she has spawned, he fertilizes the eggs and guards the nest. (Figure 127.)

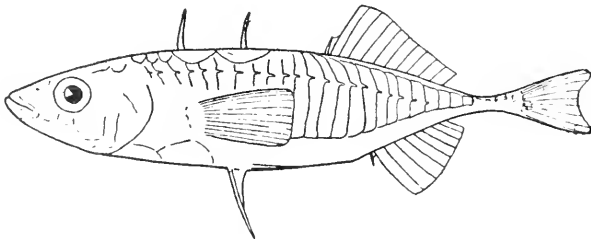

FIG. 127. Two-spined stickleback. (From Nichols and Breder.)

Both the *pipe fish* and the *sea horse* (*Syngnathidae*) are peculiar in that the male carries the eggs in a ventral brood pouch. (Figure 128.) Jordan states that the female deposits the eggs on the bottom of the sea and that the male transfers them to his brood pouch. The *sea horse* is the only fish with a prehensile tail.

The *sea basses* (*Serranidae*) are mostly marine. The striped bass and the black sea-bass are the most prized by fishermen. The latter is said to reach a weight of 300 lbs.

A small fish (*Rhodeus amarus*) lives in the embryonic state in the gill cavities of the mussel (*Unio*). Thus a fresh-water mussel may send out glochidia that attach to an adult fish, which at the same time sends its embryos to be sheltered by the mussel.

The smallest fish in the world is the Philippine goby (*Pandaka pygmaea*), which is but five-sixteenths of an inch long when full grown. A slightly larger goby (*Mistichthys luzonensis*) is also found in Luzon, P. I.

The *perches* (*Percidae*) include the little used yellow perch and the pike perch. The latter is considered a valuable species and propagated by the U. S. Bureau of Fisheries.

The *small-mouthed black bass* (*Centrarchidae*) is extremely gamy. The common **sunfish** or "*pumpkin seed*" is not to be confused with the Hawaiian "sun fish." (Figure 129, *A* and *B*.)

The *porcupine fishes* (*Diodontidae*) are armed with movable spines and when alarmed puff their bodies full of air, and float belly upward. (Figure 130.)

The *head fish*, or "*sunfish*" of Hawaii, is an odd appearing fish (Figure 131), with a skeleton largely cartilaginous and with heavy armor. The smooth skin is extremely thick. The body looks as though it extended but a short distance beyond the head and lacked a tail entirely. Some specimens are said to have reached a weight of 2,000 lbs. (Zane Grey's record fish) and a diameter of 8 feet.

The *shark-suckers*, or *remoras* (*Echeneididae*) (Figure 132), are equipped with a modified anterior dorsal fin resembling a rubber boot sole. It acts as a sucking disk, enabling the animals to attach

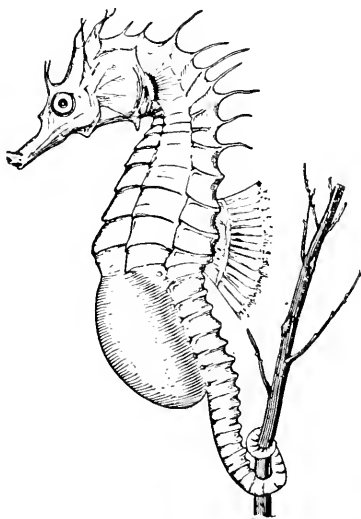

FIG. 128. Seahorse, male, with abdominal pouch. From Lull, *Organic Evolution*, after Döflein. (Courtesy of The Macmillan Co.)

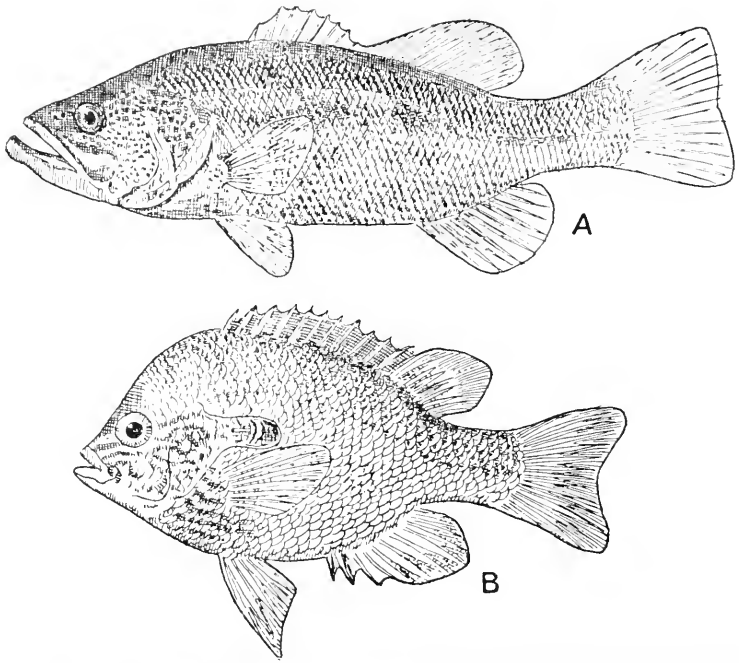

FIG. 129. *A*, large mouth black bass. *B*, long-eared sunfish. (Courtesy of Slingerland-Comstock Publishing Co.)

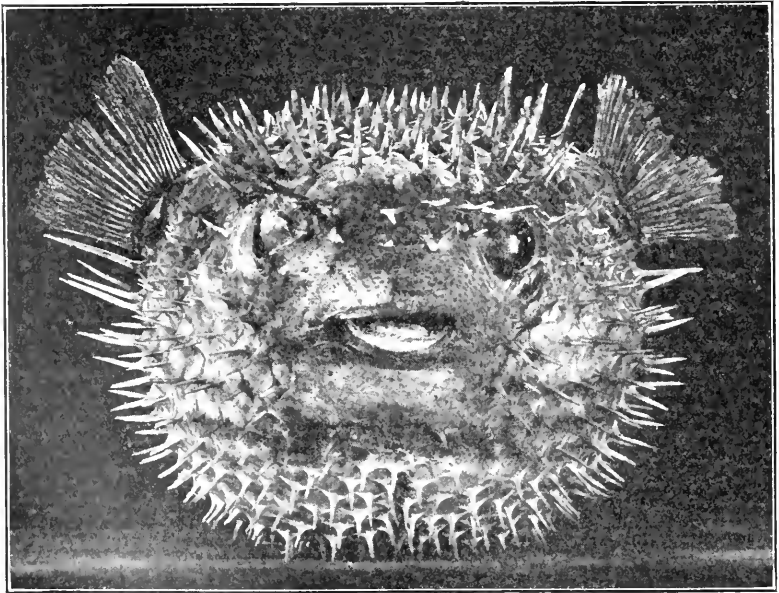

FIG. 130. Puffer fish. (Courtesy of Amer. Mus. of Nat. Hist.)

themselves to sharks and other marine forms. The *remoras* have been used by natives in capturing other fish (Gudger). The *goose fish*, or angler (*Lophiidae*), is a fish with an enormous mouth and a modified first dorsal ray which it uses as a lure. The *common mackerel*, the Spanish mackerel, and the tuna (called "horse-mackerel") are examples of the family *Scombridae*. The *tuna* is large, sometimes weighing 150 lbs.

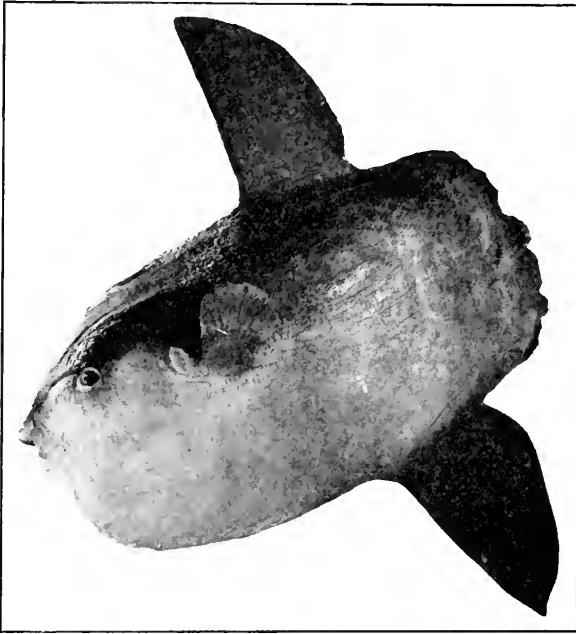

FIG. 131. Head fish, *Mola mola*. (Courtesy of Amer. Mus. of Nat. Hist.)

The *flatfishes* (*Pleuronectidae*) include the smaller species and the large halibut (*holibut*). The lateral eye of one side moves over to the other and the fish lies on its side. *Flounders* are well pigmented and have been utilized in experiments by Sumner and Mast who showed that color change will assume the character of the background-checkerboard, etc., if the eyes are intact. Blinded, the fish cannot change color, to match its environment. (Figure 133.)

The upper jaw of the *swordfish* (*Xiphiidae*) (Figure 134) is extended into a formidable weapon. Instances are recorded in which a large swordfish (500 lbs.) has penetrated the bottom of a

heavy whaleboat. The swordfish is one of the finest of the food-fishes, but utilized in New England chiefly. The *sailfish* is another odd type.

The *cod*, the *haddock*, and the *hake* are all important members of the family *Gadidae*. The cod is now especially valuable as a source of cod liver oil. This oil has been used as a remedy for growth deficiencies for many years, but recently its importance has been much emphasized by the "vitamin" enthusiasts. (Figure 135.)

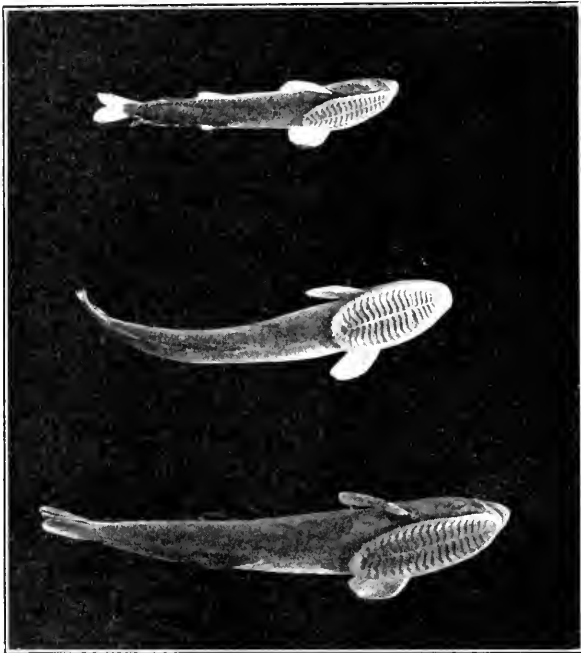

FIG. 132. Shark suckers. (Courtesy of Amer. Mus. of Nat. Hist.)

Subclass Dipnoi. (Gr., "two breathing apertures.")—The *lung fishes* have a heart with the beginnings of a division into two auricles. Gill respiration is combined with the use of a modified swim bladder which acts as a lung. A posterior naris opens into the mouth cavity. They have paired fins and persistent notochord. The *Australian lung-fish* (*Neoceratodus fosteri*) feeds on worms, crustaceans and mollusks secured from the bottom vegetation. Its single lung is utilized when it comes to the surface. It can survive in stagnant and polluted water where other fishes perish. (Figure 137.)

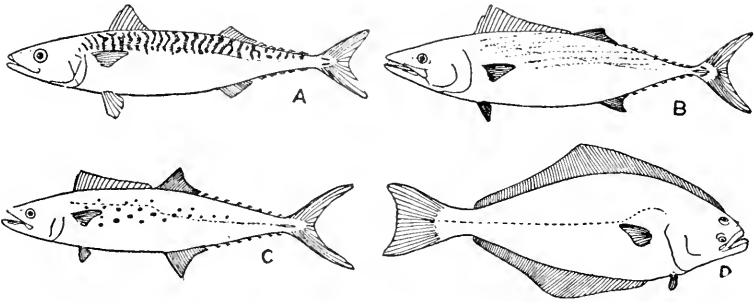

FIG. 133. *A*, common mackerel. *B*, bonito. *C*, Spanish mackerel. *D*, halibut. (From Nichols and Breder. Courtesy of N. Y. Zool. Soc.)

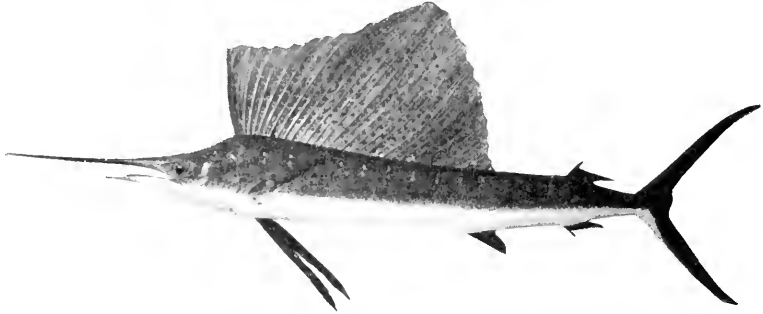

FIG. 134. Sailfish. *Istiophorus gladius*. (Courtesy of American Museum of Natural History.)

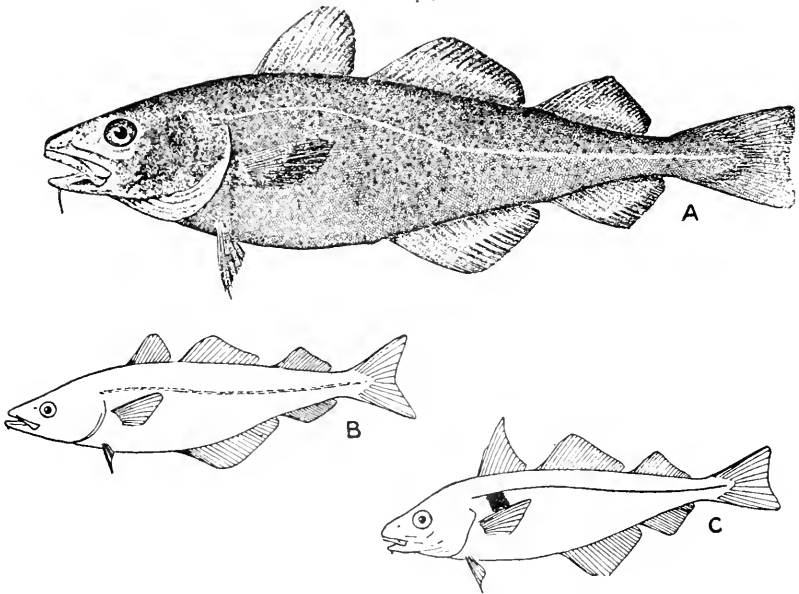

FIG. 135. *A*, cod. (From U. S. B. F. Manual.) *B*, pollock. *C*, haddock. Nichols and Breder. (Courtesy of N. Y. Zool. Soc.)

The *African lung-fishes* (*Protopterus*) feed on worms, crustaceans, frogs and insects. They burrow into the mud, secreting a cocoon of

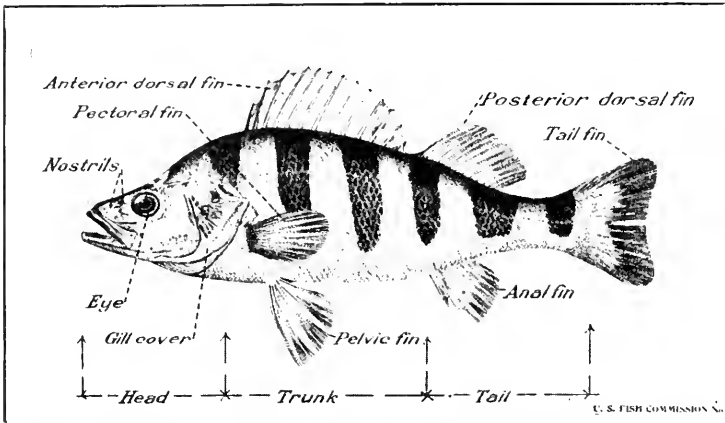

FIG. 136. Yellow perch indexed. (Courtesy of Amer. Mus. of Nat. Hist.)

slime, and aestivate during the dry season. A slimy covering encloses the animal except for a small aperture through which lung breathing is carried on.

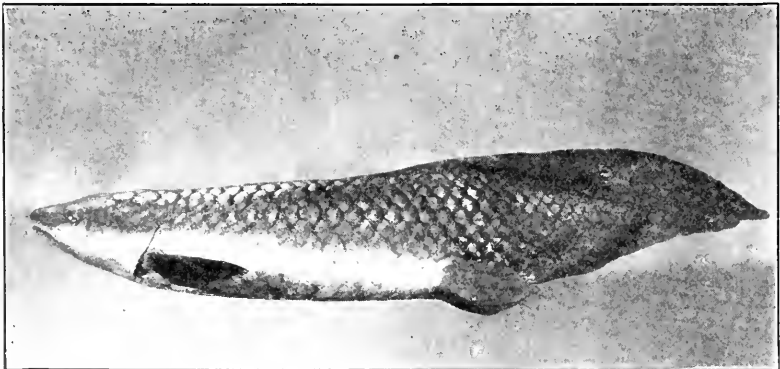

FIG. 137. Australian lung fish, *Ceratodus*. (Courtesy of Amer. Mus. of Nat. Hist.)

The *South American lung-fish* (*Lepidosiren*) is a trifle more terrestrial than *Protopterus* and lives in a deep burrow in the swamp, laying eggs in the soil. It takes several gulps of air at a time when it comes to the surface of the water.

GENERAL CONSIDERATION OF THE FISHES

Locomotion in fishes may be by: Swimming, leaping from the water, crawling or hopping about with the pectoral fins (Angler fish and E. Indian Goby); planing on extended pectoral fins (flying fishes); or wriggling after rains from one stream or pond to another (eel).

Coloration.—The coloration of fishes is due to the presence in the dermic portion of the skin of (a) special pigment containing cells (chromatophores), (b) a peculiar reflecting tissue composed of iridocytes. Coloration varies with the species of fishes and may vary in the same fish according to background, age, ill-health, and emotions.

Sound Producing Organs.—(a) *Stridulation.*—The bull head uses its preoperculum for stridulation while the gurnard uses its hyomandibular bone. In the drumming fish, the postclavicles stridulate with a grooved area on each cleithrum and the air bladder takes up the vibrations. Friction of the upper and lower teeth causes a grinding noise in the mackerel. The sunfish makes sounds like those of pigs grinding their teeth.

(b) *Expulsion of the air* from the swim bladder and mouth produces quite noticeable sounds in the eel, the carp and the loach. The eel is said to produce a single note, more musical than any uttered by other fishes. The air-bladder and its muscles in the drum-fish (*Pogonias chromis*) constitute the most powerful sound producing apparatus in fishes.

Respiration.—The rate of breathing varies with the species, the minnow and the stickleback breathing 150 times per minute, while the blue wrass and the rockling have a respiratory rate of fifteen per minute. Skin respiration, vascular caudal fins and larval external gills are important, while some fishes use the air bladder or develop special accessory organs for aquatic or aerial respiration. Many fishes rise to the surface and swallow the air. The air bladder is used for respiration in the ganoids and many teleosts, and in the “lung fishes.”

Skin.—*Placoid* scales are found in the Elasmobranchs, and while they are usually closely set, we find that in the skate they are scattered. In sharks one can trace the evolution of placoid scales into *teeth*.

Ganoid scales are hard plates forming an armor in such forms as

the gar-pike. The outer surface "ganoin" is extremely hard and smooth and readily polished. (Figure 138.)

Teleostean fishes have two types of scales, *cycloid* and *ctenoid*. *Cycloid* scales are circular in shape and overlap. *Ctenoid* scales are rounded but have a serrated comb-like edge that makes them firmer in position. *Flounders* have ctenoid scales on the upper side and cycloid scales on the under side. The pipe-fish and the sea horse

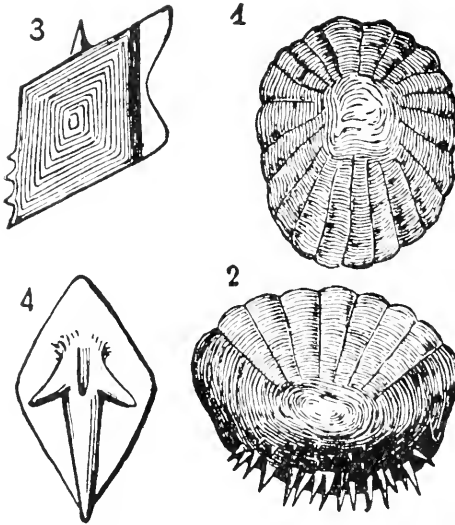

FIG. 138A. Scales of fishes. 1, cycloid; 2, ctenoid; 3, ganoid; 4, placoid. (From Hertwig-Kingsley. Courtesy of Henry Holt & Co.)

have scales fused into a bony armor. Embryonic eels have scales, but in adults it is impossible to see even traces of them with the naked eye.

In some elasmobranchs and teleosts from the depths of the ocean we find epidermal organs modified from glands into *luminous organs* or "photophores." Some fishes like shad, herring, and menhaden have in the *tela subcutanea*, crystals of *guanin*, which form the base of pearl essence. (See page 157.)

Fish have *chromatophores* (melanophores) and change color to match their background, but when blinded the color changing stops.

Poison Glands.—When the poisonous secretion produced by glands at the bases of *dogfish* spines is injected into the lateral line of a fish, respiration is accelerated and the animal soon becomes lethargic. *Eagle rays* and *sting rays*, have barbed serrated spines at the base of the tail and the glandular secretion accompanying a blow from the tail, undoubtedly adds to the effects produced by the irritation. Several teleostean fish including the catfish, have *poison glands* associated with spines on the dorsal fins or in the axillary region.

Blood.—In fishes the blood consists of a nutritive fluid, *plasma*,

in which float red corpuscles and white corpuscles. In the Cyclostomata (*Petromyzon*) the red corpuscles are circular, but in the true fishes they are usually biconvex, flat, oval, nucleated and with hemoglobin, and rich in iron. In the Dipnoi (lung fishes) the red

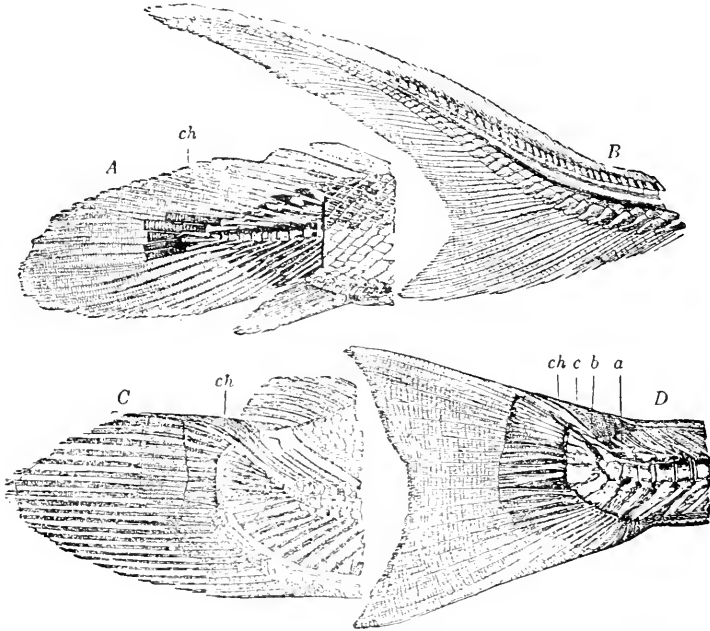

FIG. 138B. Types of tails of fishes. *A*, diphycercal fin of *Polypterus bichir*. (Vertebral column and notochord divide the tail into symmetrical dorsal and ventral portions.) *B*, heterocercal tail of the sturgeon. (As a result of an upward bending of the notochord and vertebral column the fin has become asymmetrical, the ventral portion much larger than the dorsal.) *C*, *D*, homocercal fins, *C*, of *Amia calva*; *D*, of *Trutta salar*. (By a still greater upward bending of the notochord and vertebral column the dorsal portion has almost entirely disappeared and the ventral portion almost alone forms the fin, externally apparently symmetrical, but in its internal structure very asymmetrical.) *ch*, chorda; *a*, *b*, *c*, cover-plates. (From Hertwig-Kingsley. Courtesy of Henry Holt & Co.)

corpuscles are larger than in most animals (40 μ - μ in diameter) being exceeded in size only by the Urodele Amphibians. Leucocytes are not plentiful in most fishes, but are more numerous in the Dipnoi than in other vertebrates.

Digestive System.—In the large intestine of the *Elasmobranchii* there is a spiral valve, lacking in the *Teleostei*. The small intestine

is very short, but receives the secretions from well-developed liver and pancreas.

In the Teleostei, the teeth are premaxillary, vomerine, superior pharyngeal, inferior pharyngeal, and mandibular. There are no salivary glands, no spiracles and no posterior nares. The pharynx is equipped with a fringe of gill rakers (strainers). The small non-muscular *tongue* is supported by the ventral part of the hyoid arch.

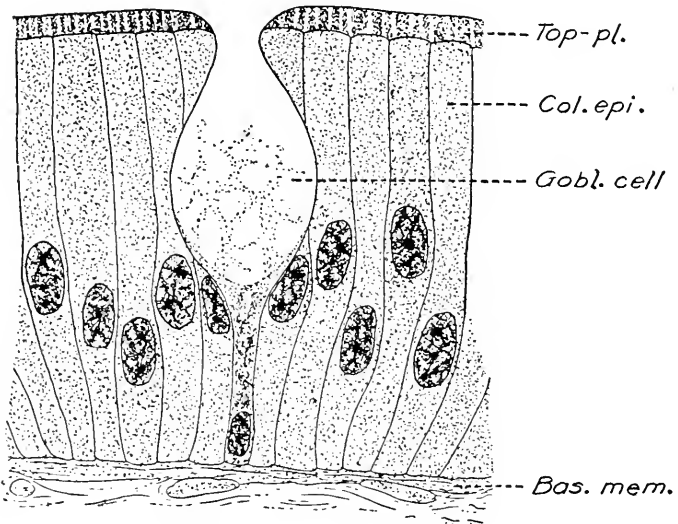

FIG. 139. A highly magnified view of a portion of the intestinal epithelium of the sea bass, showing several columnar cells and a large goblet cell. The striated 'top-plate' is evident, interrupted at the mouth of the goblet cell. *Bas.mem.*, basement membrane; *Col.epi.*, columnar epithelium; *Gobl.cell*, goblet cell; *Top-pl.*, top-plate. (Courtesy of I. H. Blake, *J. Morph.*, vol. 50, Sept. 1930.)

The gullet is broad and short, and the *stomach*, curved, is divided into cardiac and pyloric regions with *pyloric caeca* ranging from six in the perch to one hundred and twenty in the cod, and secreting pancreatic enzymes. The *pancreas* is absent, but in a few teleosts, pancreatic tissue is combined with the liver. In the goosefish, and many other teleosts there are isolated *Islands of Langerhans* in the mesentery that furnish the requisite "insulin." The Toronto investigators have extracted it from fishes, and treated diabetes successfully.

All the Cyprinidae lack peptic glands. Babkin and Bowie⁶ have shown that *Fundulus heteroclitus* has no stomach, that pepsin and HCl are absent and that every phase of digestion takes place in an alkaline medium.

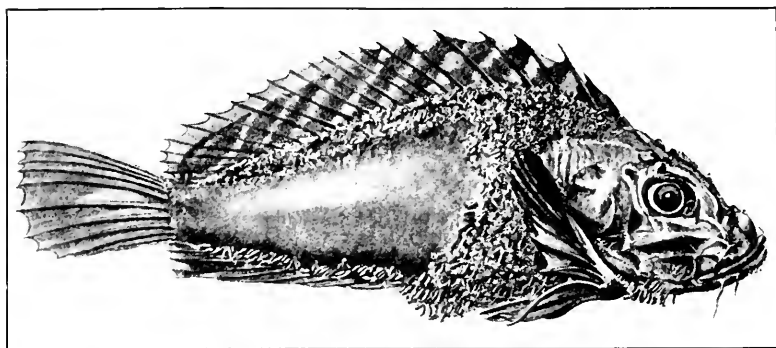

FIG. 140. Scorpaenoid fish. (Courtesy of Amer. Mus. of Nat. Hist.)

Lymph.—Fishes have small vessels (the lymph capillaries), lymph spaces, and lymph sinuses. In the eel a *lymph heart* in the tail communicates with the smaller of the two caudal veins and rhythmically pumps lymph into the vein. Lymph consists of plasma minus red corpuscles, but normally rich in the white corpuscles with large nuclei called lymphocytes.

Endocrine Glands.—The **thyroid** gland in the Elasmobranchs is a large compact organ near the anterior end of the ventral aorta. In the Teleostomi it is sometimes paired or as in the perch consists of diffuse masses of reddish lobules scattered along the afferent branchial artery. The **thymus** gland of the embryo Elasmobranchs and Teleosts has a multiple origin, arising from a series of epithelial thickenings, one of which is developed at the dorsal extremity of each of the gill clefts except the spiracle. The rudiments invaginate and fuse. The thymus of the adult Elasmobranchs is paired, the organ lying just above the branchial arches. In the Teleostomi, the thymus is found at the dorsal extremity of the last branchial arch near the mucous membrane of the branchial cavity. The **pancreas** is represented in teleosts by the pyloric appendages, while isolated

⁶ Babkin, B. P., and Bowie, D. J. 1908. The digestive system and its function in *Fundulus heteroclitus*. Biol. Bull., vol. 54, no. 3, pp. 254-277.

Islands of Langerhans in the mesentery furnish **insulin**. (See p. 256.)

Elasmobranchs have two structures, the paired **suprarenals** and **interrenals**. The *suprarenals* are segmentally arranged bodies situated in pairs on the segmented arteries given off from the dorsal aorta. The first pair are called axillary hearts. The *interrenal* is a thin, elongated, yellow body with one or two anterior lobes. It extends in the median line between the two kidneys or occupies the internal portion of the ventral surface of each kidney. In Teleosts the suprarenals, varying from two to five in number, are frequently found embedded in the kidneys.

Lymphoid Tissue.—Ordinary lymphatic glands are absent in fishes and it is probable that functional lymphoid tissue abounds to compensate. The large anterior portion of the *mesonephros* in the Teleostomi, called the *head kidney*, is almost entirely replaced by *lymphoid tissue*, practically no renal structure remaining. It is concluded, from the presence of free red corpuscles and oxyhemoglobin, that the head kidney performs a blood destroying function. The *spleen*, of course, forms leucocytes and also destroys blood corpuscles, devouring worn out reds. Possibly the head kidney performs a similar double service.

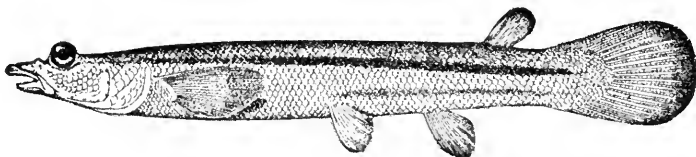

FIG. 141. Four-eyed fish, *Anableps doyii*. (Courtesy of Amer. Mus. of Nat. Hist.)

Senses.—Fishes vary greatly in their use of the senses. Some are predominantly olfactory or gustatory while others depend largely upon vision to direct their movements. In all, the temperature sense⁷ and lateral line sense are of paramount importance.

Olfaction, Gustation. (*Chemical Sense.*)⁸—Fish have a chemical sense dependent on free nerve endings; smell, dependent on a highly developed distance receptor, the olfactory nerve; and taste, which

⁷Chidester, F. E. 1924. A critical examination of the evidence for physical and chemical influences on fish migration. Brit. Jour. Exp. Biol., vol. 2, pp. 79-118.

⁸Parker, G. H. 1922. Smell, Taste and Allied Senses in the Vertebrates. J. B. Lippincott, Philadelphia, Pa.

is dependent on the taste buds. Fish are extremely sensitive to variations in acidity and alkalinity in the water.

Vision.—Fish are able to change color, adapting themselves to the background. When blinded, they are unable to thus adapt themselves. Experiments of Lyon showed that fish see the banks of streams, and will react to currents of water even if not directly in contact with them.

Tactile and Kinesthetic Senses.—Currents and surface waves are apprehended by fish through the general cutaneous nerves for touch. In general, fish react to stream pressure, aligning their bodies to face the current.

Lateral Line.—Parker holds that the *lateral line* nerves serve in an auxiliary capacity aiding the general cutaneous nerves in *rheotropic* responses. Lateral line organs are stimulated by vibrations of *low* frequency, about *six per second*. Parker concludes that lateral line organs are intermediate in function between the organs of touch and the *ear*, the latter being sensitive to vibrations of *high* frequency.

Hearing.—The surface between the air and the water is a screen through which little sound passes. Vibrations of the water induced by foot-falls on the bank are not to be confused with stimuli affecting the *sacculus*, which Parker believes to be the chief organ of hearing. During the recent war Parker, experimenting with cannon fired near the surface of the water, found that fish were driven away by the concussion. As vibrations of the air were transmitted to the water it is difficult to believe that true hearing was evidenced.

Messmates and Associates.—The small *horse mackerels* (*Carangidae*) swim in the shelter of large jelly fishes. A small fish (*Amphiprion*) lives inside the large sea anemone (*Crambactis*). *Fierasfer*, a small fish, lives in the hind-gut of the sea cucumber. Another form lives in the mantle cavity of the large sea snail, *Strombus gigas*.

Parental Care.—One of the most remarkable instances of parental care by the male is that seen in the *sea horse* and the *pipe fish*, where the eggs are carried in a ventral brood pouch by the male. The males of *sticklebacks* and *lump-suckers* guard their nests for weeks. The *butterfish* (*Pholis gunnellus*) coils around its eggs and guards them.

Habitat.—The trout lives in water ranging from 20° C. to 2° C. and spawns in October. The common eel of Europe ranges from

Iceland to the Nile. In studying the fishes of the New Jersey salt marshes during the winter the author found that small *minnows* dug from their burrows and brought into the laboratory in stiff, immobile condition would revive in a short time.

Britton⁹ studied the freezing, overwarming and resuscitation of the eel, skate, flounder and cod. When the temperature exceeded 30° C., or went below -2° C. the fish became immobile and finally the heart stopped beating. Resuscitation was readily effected in many cases by transferring the fish to water of the normal temperature, about 16° C. In one case a skate, *Raia laevis*, was exposed for "sixteen hours in a refrigerator to a temperature as low as -20° C., the whole of the fish being solidly frozen," and on gradual thawing the heart beat returned to a slow regular thym, but the animal did not fully recover. At the lower temperatures, 6° C. to 10° C., the respiratory action was almost coincident with heart beat.

Reaction to Temperature Change.—One of the greatest factors in the behavior of fishes is their response to temperature change. We find that, by means of *heat* and *cold corpuscles* in the *skin*, fish proceed towards warmer or cooler water, and that it is the *relative* temperature that determines their activity. Herring are sensitive to very slight temperature changes, according to Shelford and Powers (1915), reacting to differences as small as 0.2° C. It has been shown that temperature changes influence the reactions of fishes to *light*, *salinity*, Ph and to *internal factors* such as the developing gonads. Unquestionably this sense is the greatest single factor that we find influencing the metabolism and behavior of fishes. It must even be considered in connection with the instincts of the species.

Electric Organs.—In the Elasmobranchs we find electric organs present in the *torpedo ray*. The *electric eel* is a Teleost with the power to shock the unwary. With but one exception, electric organs are composed of *metamorphosed muscles* and retain their original nerve endings.

Phosphorescent Organs.—The highest development of piscine *phosphorescent* organs is in fishes inhabiting the depths of the sea. A luminous organ in the fish is a collection of gland cells usually forming the lining of a series of radially arranged tubules in the deeper portion of the organ. The luminous organ contains ganglion

⁹ Britton, S. W. 1924. The effects of extreme temperatures on fishes. Am. Jour. of Physiol., vol. 67, no. 2, pp. 411-421.

cells and nerves joining either a spinal or cerebral nerve. Phosphorescent organs are used to see prey, to dazzle and frighten enemies and as recognition lights.

Harvey¹⁰ has studied *luminescence* in two species of fish (*Photoblepharon* and *Anomalops*). In these forms the luminescent organs consist of a large number of sets of parallel gland tubes. The lumina of the tubes are filled with an emulsion containing granular and rodshaped *bacteria* living in *symbiotic* relation.

Adaptation of Fishes to Their Environment.—Fishes have their head, body and tail compressed into a curved *spindle form* which offers little resistance to the water. They have a well-developed caudal fin used for propulsion; paired pectoral and pelvic *fins* are important in executing lateral movements, while their dorsal and ventral fins aid in preserving an even keel. Fishes swim, leap, flop and plane. The climbing perch moves up tree trunks by small hooks on its pectoral fins. The sea robin uses its pectoral fins in progressing over the sandy bottom. The *mucus* secreted by the glands of the skin and the fact that the *scales* overlap, tend to reduce friction in swimming. In many forms the *swim bladder* furnishes a means of varying the specific gravity so that the animal can rise or sink in the water. Some fishes are provided with sharp spines and *poison glands* for offense and defense. Well-developed organs of vision, olfaction and the lateral line sense enable fishes to locate food or warn them of danger.

ECONOMIC IMPORTANCE OF FISHES AND THEIR RELATIVES

Positive.—*Cyclostomes* were formerly used as food.

Elasmobranchs.—Dogfish, sharks and skates are eaten fresh and canned. Shark leather, formerly used for "shagreen" spectacle cases, and also for polishing wood and other materials, has recently been advertised widely by the United States Bureau of Fisheries for use in making shoes, handbags and pocketbooks. Attempts have also been made to utilize other elasmobranch skins. Shark fins have been used as gelatin in China and India. Sharks are also used as fertilizer. Shark liver oil has been used as a substitute for cod liver oil. A basking shark may produce over a ton of oil. Dogfish oil is now purified and used as an insect repellent. The odor is not obnoxious to man.

¹⁰ Harvey, E. N. 1920. The Nature of Animal Light. J. B. Lippincott Co., Philadelphia.

Teleosts.—Many species of the bony fishes are valued as food. Some of the common food fishes are herring, shad, codfish and salmon. Fish are eaten fresh, smoked, dried, salted, canned whole, or flaked, and pickled. Cod, halibut and salmon skins have been suggested as a source of leather, but are not in use by civilized man. The Alaskan Indians have for many years used salmon skins to make shirts and boots. Eel leather has been utilized for pig-tails and flail thongs. Some Southern negroes value eel skins as a cure for rheumatism. The swim-bladder of the sturgeon and some other fish is used to make isinglass and fish-glue. Menhaden are caught by the ton and made into oil and fertilizer.

Pearl essence is secured from herring, alewives, shad and menhaden. The California sardine is also a source. Pearl essence is secured by the extraction of the blade-like crystals of *guanin* found in the epidermis of the fish. The crystals are separated into uniform sizes and when mixed with gelatin are used to coat glass beads, making imitation pearls. A solution of guanin is also prepared for use as nail-gloss.

Fish meal is secured from fish and fish waste by cooking without scorching, and pressing the oil out while the fish is hot. Fish meal is used in poultry and stock feed.

While it will probably never replace cod liver oil, in furnishing Vitamins A and D for human consumption, there is no question that the vast quantities of salmon liver oil will reduce prices for the cheaper grades of fish oil used in cattle feeding.

Negative. Cyclostomes.—Lampreys attach themselves to the bodies of other fish, cut through the body wall and suck out the blood and soft parts until the victim dies. Hags parasitize marine fishes, entering the body cavity of the host through the hole that they cut.

Elasmobranchs.—The great white shark called the “maneater” sometimes reaches a length of forty feet and can cut the body of a man in two at one bite. Small dogfish destroy lobsters, crabs, and food fishes, and injure nets and other fishing gear to the extent of \$500,000 per year in Massachusetts. Sting-rays or “stingarees” occasionally injure man. Rays and some sharks have poison glands at the base of their dorsal fins. The torpedo or electric ray is able to give a shock of fifteen volts and temporarily disable a man.

Teleosts.—Certain of the bony fishes are enemies of man. The barracuda, sometimes reaching a length of six feet, is reputed to

attack man. Its flesh, while said to be poisonous, is probably never injurious unless ptomaines have been allowed to develop. (See page 243.) The saw-toothed piranha has powerful teeth and occasionally attacks bathers. It is said not to fear the alligator. Some of the catfishes have poison glands at the bases of their spines.

Migration in Fishes.—Fishes apparently seek waters of a certain temperature or acidity or salinity which are the optimum for their developing eggs and furnish food for themselves and fry. Certain races frequent the same streams year after year unless driven away.

The fresh water fishes in many cases (trout) travel from the larger rivers to brooks, where the temperature is cooler, to spawn. Suckers have an annual migration very early in the spring.

Salmon, shad, and sturgeons leave the salt water for fresh water to spawn, but spend their life to maturity in feeding in the salt water and migrating only from the deep to the shallow, more brackish water inshore. When they ascend rivers salmon sometimes travel over 2,000 miles to spawn. Apparently the young salmon return to their ancestral spawning grounds whenever possible. Extensive scale studies and tagging experiments of American and European investigators have proved that many individuals return after two or three years to the very region whence they came as newly hatched fish. King salmon have averaged forty-two miles a day for a journey of 1,500 miles. In the case of the *anadromous* (up running) fishes such as the salmon, it is the belief of many observers that their remarkable ability to find their way back to the "parent-stream" is inexplicable except as a mysterious instinct. Some would hold that the ancient habit of migration to a region once inundated by salt water has persisted through the centuries in spite of the fact that the land has risen and that the animals must now travel long distances in fresh water. Other investigators have concluded that the olfactory and chemical senses, oxygen supply, tactile and kinesthetic senses, temperature sense and the hormonal stimulation of the developing gonads play an important part.¹¹

¹¹ Consult Chidester, F. E. 1924. A critical examination of the evidence for physical and chemical influences on fish migration. Brit. Jour. Exp. Biol., vol. 2, pp. 79-118. The author has recently conceived the idea that the iodine-fat balance may be concerned in the migrations of fishes. For example, the eel, living in fresh water, may migrate down to the salt water in order to secure the optimum iodine necessary for it to mature its eggs or sperms. On the other hand, the salmon, and other anadromous fishes, may find it necessary to migrate from the salt water to the fresh to reduce the iodine content sufficiently so that eggs or sperms may develop under physiological conditions determined for the race ages before.

In the case of the *eel*, a catadramous (down running) form in which adults from Europe and America seek the same spawning grounds, we have the most remarkable case of "homing instinct" known in animals. The larvae of two different species find their way back to fresh water streams of the proper continent without guidance by older fishes. The eel migrates from fresh waters for over 2,000 miles into the ocean and the American and the European eels have been discovered by Dr. Johannes Schmidt of Copenhagen to have a common spawning ground in the West Atlantic Ocean off Florida, about equidistant between the Leeward Islands (West Indies) and Bermuda.

The time for maturity is different in the two species of eels and the American eel terminates its larval stage in about one year and so is not far enough away from the American coast to go to Europe. The European eel takes three years to pass through its larval development and thus is near the coast of Europe when it is time for it to move up into fresh water. It is believed that when adult eels migrate down from fresh water streams where they have lived perhaps 20 years, seeking a spawning ground in salt water, they are all maturing sexually and have that stimulus in common. Their metabolic condition may determine the optimum salinity and temperature. Eels take from 5 to 20 years to mature their eggs and sperms and then they pass down the brooks and rivers to the ocean for their last voyage, for they die after spawning.

Fossil Relatives of Fishes.—The *Elasmobranchii* arose in the Upper Silurian, and were extremely abundant in the Carboniferous. The development of a bony skeleton can be traced in the fossil forms. Some of the ancient *Selachii* had dorsal and anterior spines. The fossil *Holocephali* show in their skulls certain similarities to the *Dipnoi*. Rocks of the Devonian Age (Age of Fishes) show spines and teeth of the *Holocephali*. *Physostomous Teleosts* (those with the duct of the swim-bladder open) are said to be the most ancient. Herring-like forms appeared in the Jurassic period. *Dipnoi*, or lung fishes of the type now found in Australia (*Ceratodus*), are very ancient, appearing in the Triassic period. The *Dipnoi* are intermediate types between Fishes and Amphibians, but not necessarily to be considered the "connecting links."

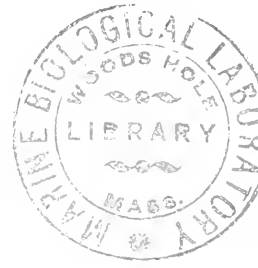

CHAPTER XVI

AMPHIBIA

THE FAMILIAR amphibia are the toads, frogs, and salamanders. As the name indicates, they live two lives, one in the water and the other on land. The majority of the amphibia lay their eggs in water and the larvae breathe by gills, while the adults breathe by lungs. Some adult amphibia have persistent gills, however. Amphibia are of considerable economic importance, toads being particularly beneficial in capturing insects.

CLASSIFICATION

Amphibia. (Gr., "leading a double life.")

Apoda or *Coecilians.* (Legless amphibians found in the tropics.)

Urodela or *Caudata.* (Salamanders.)

Anura or *Salientia.* (Tailless toads and frogs.)

CHARACTERISTICS

1. Skin smooth, moist and devoid of scales.
2. Limbs penta-dactylic or with five toes.
3. Skull articulates with the first vertebra by two occipital condyles, and is composed of very few bones.
4. Lungs are present except in a few cases.
5. Heart has three chambers, a ventricle and two auricles.
6. Most of the species undergo a metamorphosis, the young living in the water and breathing by means of gills. As the lungs become functional these gills disappear, except in a few of the lower amphibia.
7. As a rule, the Amphibia are aquatic or semi-aquatic in habits, and even when they live far away from the water during most of the year, they nearly always go to the water in the spring to deposit their eggs.
8. Amphibians are confined to the torrid and the temperate zones. In the temperate zone they hibernate when cold weather sets in.

Order 1. Apoda (Gymnophiona or Coecilians).—In this family there are about forty species, placed in seventeen genera, on slight grounds, the characters probably having been developed independently in various countries. (Figure 142.) The Apoda have no limbs or girdles. The eyes are subcutaneous and probably only serve as a means of distinguishing light from dark. They burrow in the ground feeding on small invertebrates. They have a protrusible sensory tentacle between the eyes and nose. Fossil Apoda are unknown, as their subterranean life does not favor preservation. Some are oviparous and some are viviparous.

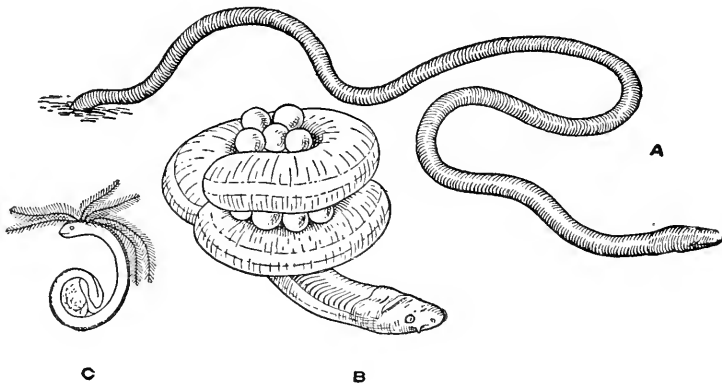

FIG. 142. Group of Apoda. *A*, *Caecilia*, emerging from burrow; *B*, *Ichthyophis glutinosus* (nat. size), female guarding her eggs, coiled up in hole in the ground; *C*, a nearly ripe embryo, with cutaneous gills, tail-fin, and still a considerable amount of yolk. (Redrawn after P. and F. Sarasin.) (From Newman, *Vert. Zool.* Courtesy of The Macmillan Company.)

After hatching, when the gills have disappeared, the young of *Ichthyophis glutinosus* (Ceylon, Malay Islands) take to water and move about like an eel, coming to the surface occasionally to breathe. This form has from 200 to 300 vertebrae. Apoda have apparently *degenerated* from the ancestral amphibians.

Order 2. Urodela (Gr., visible tail) or Caudata.—The tailed amphibia have many vertebrae and are not so pronounced in their metamorphosis as the Anura.

	<i>Trunk Vertebrae</i>	<i>Tail Vertebrae</i>
Amphiuma.....	63	35
Cryptobranchus.....	20	24
Necturus.....	19	29

The Urodela may retain their gills permanently, lose them permanently, or may have a persistent gill slit.

Family 1. Amphiumidae.—The *hell bender* (*Cryptobranchus allegheniensis*) is possessed of two vestigial gill clefts, with no gills. *C. allegheniensis* inhabits rivers and streams of North America and reaches a length of over two feet. The eggs are fertilized internally, as many as four hundred being produced in strings by the female. The larvae have gills. *Cryptobranchus* has four fingers and five toes. The skin is excessively slimy, being rich in goblet cells.

The *giant salamander* of Japan (*Cryptobranchus japonicus maximus*), between five feet and six feet in length, is found in the mountainous regions of Japan and China where it is still feared and even worshipped by natives. It has no gill openings and has but three branchial vessels (thus resembling *Necturus*). It is situated from 600 to 4,500 feet above sea level, and feeds on fishes, amphibia, worms, and insects that it secures from the small streams of mountain meadows. It is caught on the hook and eaten by the Japanese.

The “*Congo snake*” or “*Congo eel*” (*Amphiuma means*) is an eel-like salamander growing to a length of three feet. It is found in the Mississippi rice fields and in swamps and muddy water. It lays hard-shelled eggs and the female coils around them to protect. The larvae have external gills with legs larger than those of the adult.

Family 2. Salamandrinae (Salamandridae).—The *crested newt* (*Triton cristatus*) is significant on account of its sexual dimorphism. The male has a high crest on the head and trunk. The upper surface of the head is black and white, while the under parts are orange yellow with black spots. The female has no crest and generally has a median yellow line on the back. The crested newt is found in Central Europe and the British Isles. It is not found in Spain nor in Southern France.

The *vermilion spotted newt*, *Triturus (Diemictylus) viridescens*, is interesting on account of its changes in color. It lives in the water for the first three years, becoming green with external gills. Leaving the water it becomes *yellow* with *vermilion* spots. Returning to the water for the breeding season it again becomes green, establishes pharyngeal respiration and lives in perfect aquatic adjustment, only to return to the land again, re-establish oral cilia and take on the vermilion and yellow of terrestrial life.

The *Alpine salamander* (*Salamandra atra*) is a form that produces

but two young at a birth, and these feed on the other eggs in the uterus and metamorphose before birth. It was claimed by Paul Kammerer that this type transformed to another species on bringing *S. atra* to the lowlands.

The *spotted* or *fire salamander* (*Salamandra maculosa*) is the European species that Kammerer claimed to have duplicated by placing *S. atra* in water. *S. maculosa* is found in moist places, except when it spawns. Then it seeks the water and deposits fifteen or more eggs which have been fertilized by a spermatophore discharged into the water by the male. The young take nine or ten months to develop, and live as gilled forms for about four months before they metamorphose into the land type. The cutaneous poison of the fire salamander is a milky white fluid fatal to small mammals and to the cold-blooded animals as well. It is extremely painful when applied to mucous surfaces.

The *tiger salamander* (*Ambystoma tigrinum*) is black with yellow spots which may extend from blotches to broad stripes and bands. It lives on land, but its larval form, once called *Axolotl*, may remain aquatic or transform according to circumstances and individuals. The capacity to *retain* the *larval body* and become sexually mature is called *Neoteny* and is a most interesting attribute of certain Amphibia.

Family 3. Oroteidae. (The Mud-Puppies.)—The *common mud-puppy* (*Necturus maculatus*) of North America is possessed of large fringed external gills. It has small limbs, lidless eyes, and lacks maxillary bones. It is of a brownish color, with black spots. (Figure 143.)

The *blind cave mud puppy* (*Proteus anguineus*) is found in caves of Central Europe. It has a white body, with three pairs of bright red gills. When taken from darkness and exposed for a time to the light the skin becomes patched with gray and finally a jet-black. *Typhlomolge rathbuni* is a similar form found in the caves of Texas.

Family 4. Sirenidae. (The Sirens.)—The *mud-eel* (*Siren lacertina*) is interesting because of its retrograde metamorphosis. Cope found that its young lose their external gills and then redevelop them. However, old Sirens can live without gills.

REFERENCES ON THE URODELA

- BISHOP, S. C. 1926. Notes on the Habits and Development of the Mud Puppy. N. Y. St. Mus. Bull., no. 268.

- REESE, A. M. 1906. Anatomy of *Cryptobranchus allegheniensis*. Am. Nat., vol. 40, no. 472, pp. 287-326.
- SMITH, B. G. 1912. The embryology of *Cryptobranchus allegheniensis*, including comparison with some other vertebrates. Jour. Morph., vol. 23, pp. 61-157.



FIG. 143. *Necturus maculosus*. (Courtesy of S. C. Bishop.)

Order 3. Anura (Salientia. Ecaudata).—The Anura (Gr., *not, a tail*) are highly specialized types, with marked metamorphosis. There are over nine hundred species of frogs and toads in this order. They have nine to ten vertebrae with the coccyx (urostyle). No tail or gills are found in the adult.

The *Surinam toad* (*Pipa*) lacks a tongue and has a common opening for the Eustachian tubes. It is a South American form with peculiar breeding habits. Its mating is such that the long oviducts

of the female protrude from her body and the eggs pass out to be fertilized by the sperms and then are guided forwards so that they are spread over the back of the female, where they sink into pockets in the skin. Each pocket has a hinged lid which the larva lifts.

The *fire toad* (*Bombinator igneus*) has a purplish ventral surface with orange yellow patches. When alarmed it throws itself back to display the brilliant abdomen, elevating the head and turning the legs over the back. *B. pachyphus*, a poisonous variety, has lemon-colored patches.

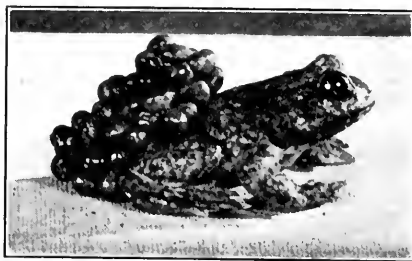

FIG. 144. Mid-wife toad, *Alytes obstetricans*. (Courtesy of the Amer. Mus. of Nat. Hist.)

The *mid-wife toad* (*Alytes obstetricans*) lives in France and Switzerland. The eggs are externally fertilized and the male carries them away with him into the water at intervals. When they are nearly ready to hatch, he remains in the water to facilitate such development. (Figure 144.)

The *spade-foot toad* (*Pelobates cultripes*) is a toad which digs deep holes in the sand by means of a spur on the hind foot.

The *Bufo*idae, the *true toads*, comprise a large family which is found on all continents of the globe. Toads possess a rough skin, whose irregularities are caused by the large number of poison glands contained in it. Their secretion is abundant and the toad is on this account not attacked by many animals (see page 300). *Bufo lentiginosus americanus*, the common toad of North America, is considered to be of great economic importance. Estimates of its value as a destroyer of injurious insects vary from \$5.00 to \$15.00 per individual annually. Toads are said to devour plant-eating millipeds which secrete *hydrocyanic acid*. (Figure 145.)

The *tree frogs* (*Hylidae*) are an extensive and widely distributed family, there being over one hundred and fifty species. They have the power of changing color from the ordinary green to either grey or dark brown. By means of small discs on the tips of their toes they are able to climb trees. They are extremely noisy at night when they spend most of their time catching insects. One form (*Notothrema*) has in the female a fold of skin on the back serving as an egg

pouch. In another type (*Hyla goeldii*) the female carries the eggs in a depression on the back.

The *true frogs*, *Ranidae*, are represented by only one genus (*Rana*) in North America. The *bull frog* (*Rana catesbiana*—Figure 146) is the largest North American species and one of the largest of the genus. It reaches a length of from five to eight inches. The color of the upper surface is green or olive brown, marked with dark spots. Bullfrogs seldom go far from the water. They feed on other species of *Rana*, and even eat ducks and chickens if small. The

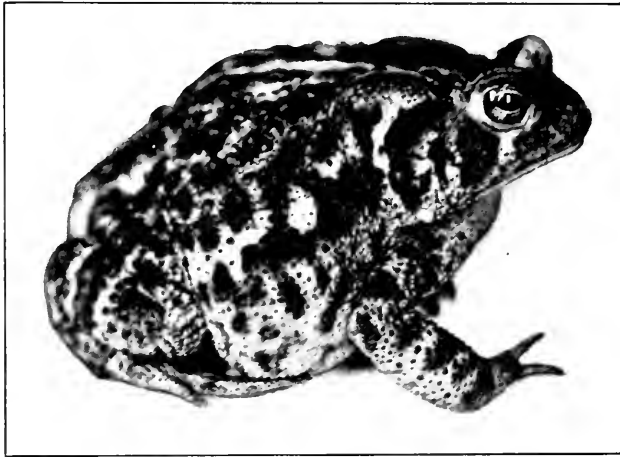

FIG. 145. Toad. (Photo by Newton Miller.)

writer has found in the stomach of a single large specimen two full-grown leopard frogs, packed as neatly as one places shoes in a box. The *green frog* (*Rana clamitans*) (Figure 147) has a greenish color and is marked by small irregular black spots. Its length is three inches. It lives in or near the water. The *wood frog* (*Rana sylvatica*) is found in damp beech woods often far from water.

The *leopard frog* (*Rana pipiens*), formerly called *Rana virescens*, is the most common of all the North American species of *Rana*. Its greenish ground color is marked by large black blotches, edged with whitish. The legs are crossed above with black bars. There are two irregular rows of black spots down the back and the lower side of the pale body. The legs are very long.

The *pickerel frog* (*Rana palustris*) resembles the preceding species.

It is brownish in color, with two rows of large brown spots between the dermal plicae which are ridges or folds of skin behind the eyes. This species is found in the eastern part of the United States.

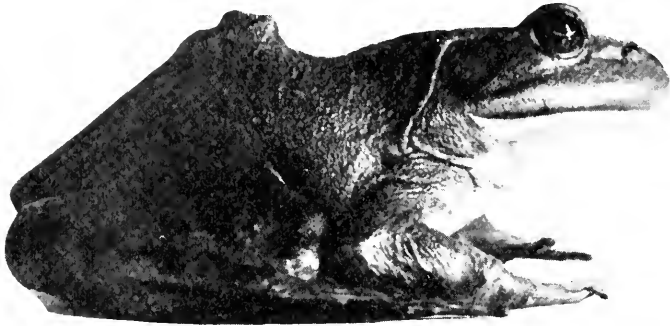

FIG. 146. *Rana catesbeiana*, the bullfrog. (Courtesy of A. A. and A. H. Wright.)

The *Javan flying frogs* (*Rhacophorus pardalis*) have extremely large webbed feet by which they plane from branch to branch.

Studies made at the Biological Station in Dominica (Caribbean Sea) show that a frog (*Eleutherodactylus martinicensis*), but one

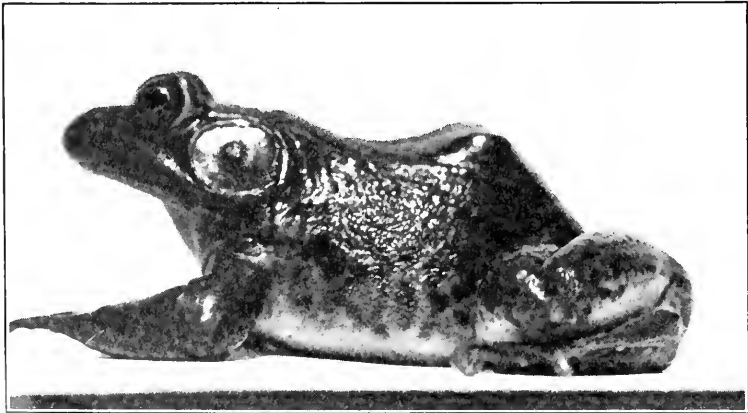

FIG. 147. *Rana clamitans*, the green frog, male. (Photo by A. A. and A. H. Wright.)

inch long at maturity, deposits its eggs in small groups on wet forest mould. The eggs are large enough to be mistaken for those of a salamander (one-fourth of an inch in diameter). Tadpoles pass through the ordinary gilled stage and develop in a short time, with-

out living in any liquid except that of the egg. (P. G. Howes, Nature Magazine, July, 1926, vol. 8, pp. 13-15.)

A Cuban toad (*Bufo empusus*), called the shell-headed toad or, in Spanish, *sapo de concha*, lives in a burrow, and closes itself in, using its hard horny head as an operculum.

A gigantic frog (*Rana goliath*), weighing ten pounds and said to be "as large as a good sized terrier," is the largest frog known. It comes from French West Africa where it is eaten by negroes who "consider its thigh bones priceless for purposes of divination" (Barbour).

The smallest known frog (*Phyllobates limbatus*), one centimeter long, was discovered in Cuba in 1910 by Thomas Barbour after sixty years had elapsed from the time when the species was originally described.

Anura. Type—Leopard Frog (*Rana pipiens*).¹ External Characters.—The frog has no neck, its head being united to the trunk. The eyes protrude considerably but can be withdrawn into the orbits as the eye socket is not separated from the mouth by any of the bones of the skull. In the center of the eye is a dark oval opening, the *pupil*, which is surrounded by a brightly colored ring, the *iris*. The eye is covered at times by the eyelids. The upper eyelid is capable of but little movement, but the lower lid can be drawn up so as to cover nearly the whole eye. The lower eyelid corresponds to the lower eyelid of the mammal plus the *nictitating membrane*, which appears to form a dorsal continuation of the lid. Behind the eye is a nearly circular area, the *tympanic membrane*, the covering of the drum of the ear.

Above and behind the snout lie the paired nostrils or *external nares*, guarded by valves which open and close in connection with the respiratory movements. The tip of the upper jaw is movable and when it is pushed upward the valves of the nostrils become closed and prevent the passage of air. Inside the mouth are a pair of openings, the *internal nares*. On the upper side of the head in front of the eyes there occurs a small light-colored mark, the *brow spot*, which is the outer portion of a glandular outgrowth of the brain, the *pineal gland*. (See Hatteria, N. Z. Lizard, page 308.)

The forelegs are short and consist of three divisions, the upper arm, forearm and the hand. The hand has four fingers and an

¹The material herewith presented is largely compiled from Holmes, S. J., 1927, Biology of the Frog, The Macmillan Co.

additional rudimentary *finger* which is easily felt under the skin. The two inner fingers contain three joints each and the two outer four joints each. The "thumbs" of the male are thickened noticeably. The hind legs are long and well suited for jumping and swimming but of little service in walking. They are also divided into three parts, the thigh, shank, and foot. The foot is well developed and has the ankle remarkably elongated. There are five toes and the rudiment of a sixth toe called the *prehallux*, situated on the inner side of the foot.

The toes increase in length from the first to the fourth. The fifth is a little shorter than the third. The first two toes contain three joints each, the third and fourth contain four each, and the elongated fourth toe has five joints. The webbed hind feet are used in swimming.

The Skin and Its Appendages.—The loose skin consists of the cuticle or epidermis and the cutis vera, corium or dermis, and contains numerous glands. The *epidermis* has several layers of epithelial cells, the outer ones horny and flat, the middle polygonal, and the inner columnar. Each cell has a distinct nucleus. In the deeper cells the nucleus is broad, oval and rounded; in the other cells it is flattened and thin. The *horny layer* is usually very thin, consisting of one or two layers of flattened cells, but on the back and on the under side of the toes it is very thick and rough. Contractile *pigment cells* are also found in the epidermis. Just beneath the horny layers are found the *goblet cells* or mucous cells. These are supposed to contain a substance important in connection with the process of casting off the skin. Toads and frogs are known to eat their shed skins.

Cutis Vera.—The epidermis is attached to the *cutis* by means of a continuous layer of branched cells deeply stained when the animals are fed certain foods. Many of these cells are pigmented. This layer is seldom flat, but raised into papillae or folds which are repeated by the superimposed epidermis. In addition to this layer the corium (dermis) has, except in webs and supplemental toes, three distinct layers of connective tissue, with much unstriped muscle fiber.

The skin is loose in structure and serves for an important lymph space; accordingly the frog is much used in medical studies of *edema*. The muscle *fiber* of the *cutis* is unevenly distributed. It is found in the back of the dorsal surface of the head and neck and less freely

on the dorsal surfaces of the extremities, but not to any extent on the abdomen, breast and ventral surface of the extremities, and is absent in the feet.

Pigment of the Skin.—The greater quantity of the pigment cells of the skin is found in the cutis. These cells are called *Chromatophores*. They play an important part in bringing about the well-known changes in the coloring of the skin. These cells have been found to be supplied by nerve fibers. When the nerve fibers were stimulated, the cells were influenced. Blinded, the frog cannot change color.

Webs and Folds.—On the under side of the *toes* are little cushions or *pads*. The toes are connected together by a *web* which makes the foot an excellent paddle. Behind the eyes there extend two ridges formed by a thickening of the skin. These are the dorso-lateral *dermal plicae* or folds.

Muscle.—The muscles of the frog retain their vitality for a long time after they have been removed from the body, and accordingly they are well adapted for physiological experiments, the large *gastrocnemius* or calf muscle of the frog being used a great deal in the study of physiological activity. Contraction may be brought about by the application of nervous, thermal, chemical, mechanical or electrical stimuli. The response to stimulus is very rapid in voluntary muscle and is much slower in involuntary muscle.

Tendon.—Most of the *muscles* are attached by one or both ends to bones. In some cases the attachment is direct, in others by means of a *tendon* which is a band of very tough inelastic connective tissue. The outer surface of the muscle is covered by *connective tissue* or *fascia* which is more or less elastic. The tendons of many muscles are formed by a continuation of the *fascia*, which becomes thicker toward the end of the muscle where it becomes a dense fibrous band.

Digestive System. (Figure 149.)—The function of food is to afford energy necessary to carry on the various activities of the organism, and to rebuild wastes. In order that food material may be built up into the tissues of the body, it must be rendered soluble, so that it can pass through the inner lining of the alimentary canal into the blood and lymph, and from these fluids through the walls of the cells in the different parts of the body. The frog does not *chew* the food taken into the mouth but *swallows* it down the

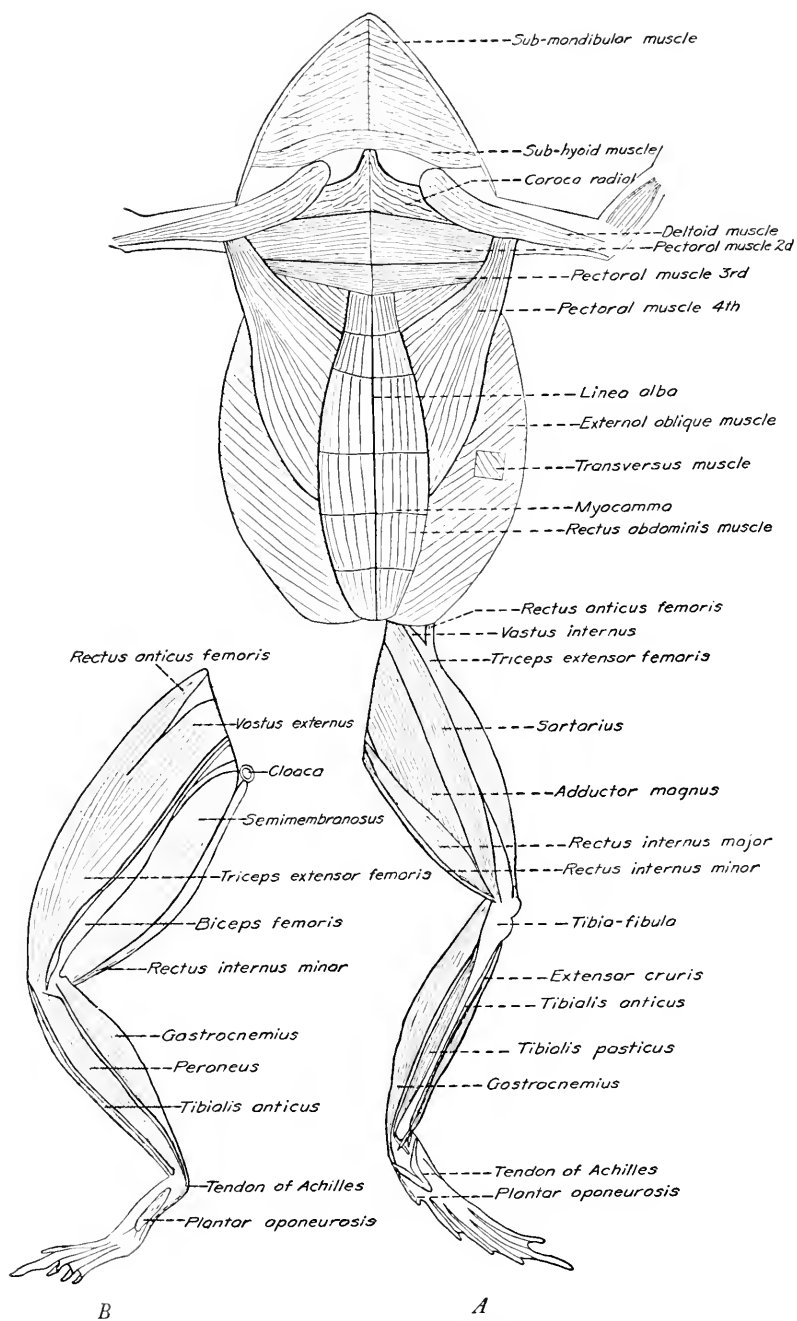

FIG. 148. *A*, amphibian muscular system. Ventral view. *B*, outside view of the leg.
(Drawn by G. C. Weber.)

esophagus into the stomach where it is acted upon by the *gastric* juice.

The *alimentary canal* consists of: (a) the esophagus, a short, wide tube leading from the buccal cavity to the mouth; (b) the *stomach*, a wide tubular sac, one and one-half inches long, narrowed behind and separated from the duodenum by the pyloric constriction, a valve; (c) the *small intestine*, with the *duodenum*, one inch

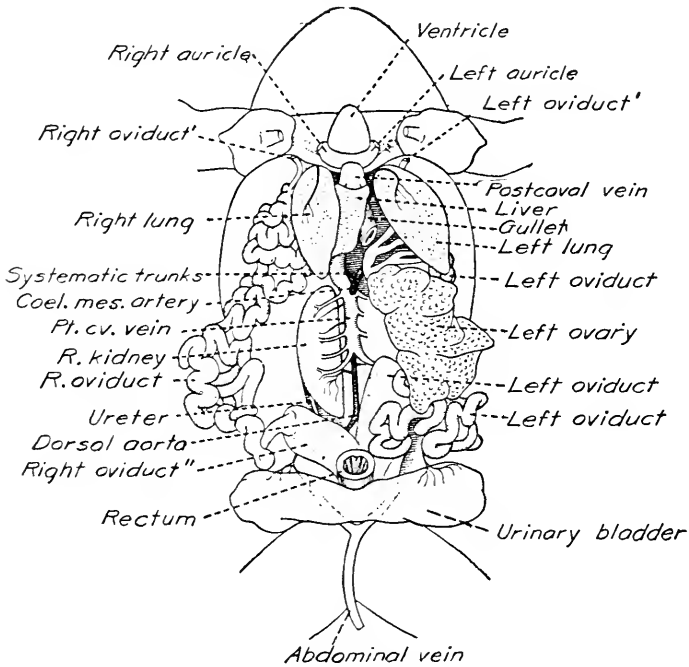

FIG. 149. Organs of a female frog. (From Newman, after Parker and Haswell. Courtesy of The Macmillan Co.)

long, bent back parallel with the stomach, and the coiled *ileum*, a slender tube about four and one-half inches long; (d) the *large intestine* or *rectum*, a straight tube about one and one-fourth inches long and three-fourths of an inch wide; (e) the *cloaca*, continuous with the large intestine. It receives the *large intestine*, *bladder*, *ureters* and *genital ducts*.

Accessory Organs.—The *liver* is a reddish brown organ with two lobes connected by a narrow bridge. The left lobe is large and subdivided into two. The *gall bladder* is a small spherical greenish

sac between the lobes of the liver. The *bile duct* leads to the *duodenum*, one-half inch below the pylorus. The distal end reaches the pancreas. The *pancreas* is a whitish irregularly lobed mass lying in loop between stomach and duodenum. Pancreatic ducts are numerous and open into the bile-duct which passes through the pancreas to reach the duodenum.

Layers of Stomach.—(a) *Serous*, flattened and derived from peritoneum; sub-serous, consisting of a few longitudinal muscles and connective tissue. (b) Circular muscle layer. (c) *Submucous*, composed of connective tissue and blood vessels with a muscularis mucosae made up of inner circular and outer longitudinal muscles. (d) *Mucous*, consisting of glands embedded in a matrix of connective tissue.

At the cardiac end of the stomach, the glands are long and their mouths deep. The *pyloric glands* are less deep with the mouths of the glands deeper in proportion.

Gastric Digestion.—As in higher vertebrates, the gastric juice contains HCl and the ferment *pepsin* and acts on *proteins*, converting them into soluble peptones. There is no action on carbohydrates and fats. The secretion of the esophagus is *alkaline* and lubricates the esophagus. It must be made *acid* by the gastric juice before it can digest a substance. Holmes states that the pepsin content of the esophageal glands of the frog is greater than an equal area of the stomach. The frog digests a piece of worm in about twenty-four hours.

The small intestine has folds but no true villi or glands in the mucous layer. Goblet cells and absorptive cells are found. The small intestine receives the bile and pancreatic juice and is important in absorption. The intestinal juice is primarily *amylotic*.

Pancreatic secretion is alkaline from Na_2CO_3 and contains three ferments: (1) Trypsin, which changes proteins to amino-acids to peptones, completing the action of the digestive juices. Unlike pepsin it acts in an *alkaline* or *neutral* medium. (2) *Amylopsin*, which converts starch to sugar. (3) *Steapsin* or *lipase*, which splits fats into fatty acids and glycerin and then emulsifies and saponifies them.

The *liver* secretes bile, an alkaline fluid of complex composition. The fatty substance, cholesterol, and the bile pigments are waste products. In higher vertebrates it has been proved that bile has a weak ferment that acts on fats, aiding in their emulsification.

It also has slight *amylotic* and *proteolytic* ferments. Desaturation of fats is one of the most important functions of the liver.

The principal function of the liver is the formation of glycogen, sometimes called "animal starch." The glycogen is given out into the blood in the form of dextrose, into which it changed by an enzyme in the hepatic cells. The liver thus acts as a reservoir for food, storing it up when it is in excess, expending it gradually to tide over periods of fasting, such as hibernation. *Glycogen* is also found in muscles, ovaries, the central nervous system and the skeleton. The pancreas regulates the liberation of sugar (page 455).

As an organ of excretion the liver collects *urea* from the muscles and so changes it that the kidneys can extract the injurious substances more readily.

When food passes from the stomach into the duodenum of the intestine it has an acid reaction due to gastric juice. In the duodenum it is mixed with bile and pancreatic juices which are alkaline and so is neutralized. Proteins not acted on by pepsin are acted upon by the trypsin of the pancreatic juice and converted into peptones. The pancreatic juice changes starch into sugar. The soluble food is absorbed through the walls of the intestines into the blood and lymph.

Spleen.—Since the spleen is found attached to the digestive tube by mesentery it is usually identified and drawn with the digestive system. It is, however, ductless and important in connection with the *circulatory* system, but without digestive function. During embryonic life the spleen produces red corpuscles. Even in the adult amphibian spleen *leucocytes* (white blood corpuscles) and occasional spindle cells are formed. The destruction of old, worn-out, red corpuscles and the ingestion of wastes with pigment granules seem to be important splenic functions.

Circulatory System.—The functions of the circulatory system are to carry food material and oxygen to all parts of the body, and to remove the CO_2 and other waste products of tissue metabolism to the organs where they are eliminated. Two fluids, blood and lymph, perform these functions.

The vascular system of the vertebrate is a *closed system* of tubes of vessels filled with blood, and ramifying through all parts of the body. Its main parts are: The heart, which contracts and continually drives the blood around the system of vessels, the arteries, which take the blood from the heart to all parts of the body, the

AMPHIBIA

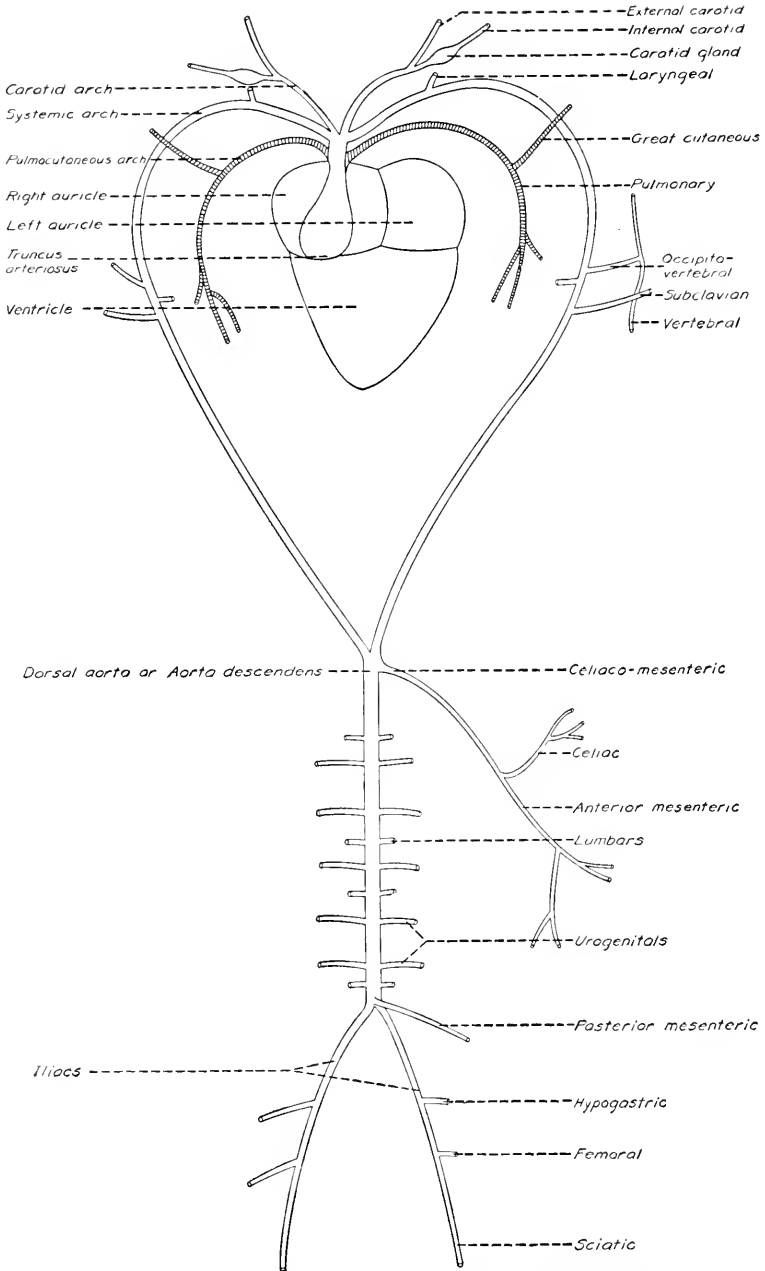

FIG. 150. Arterial system of frog. (Drawn by W. J. Moore.)

veins, which carry the blood from these parts back to the heart, the capillaries, which are very small vessels connecting the arteries and veins. (Figure 151.)

Structure of the Heart.—The *heart* of the frog, situated in the anterior part of the body cavity ventral to the liver, lies within a sac, the *pericardium*, whose cavity is completely cut off from the coelom,

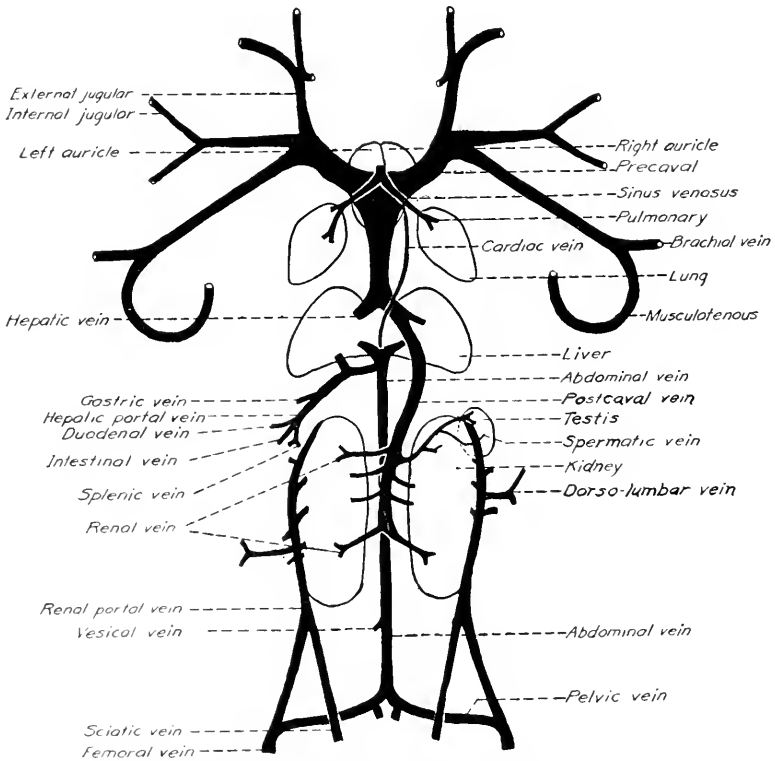

FIG. 151. Venous system of the frog. Dorsal view. (After Parker and Haswell. Courtesy of Macmillan and Co., Ltd.)

although originally continuous with it in early development. In Amphibians and in Reptiles, the heart has three cavities, two auricles and one ventricle.

The *venous* blood from the body is received into the *right auricle* and the *purified* blood from the lungs into the *left*. Both throw their contents into the ventricle which pumps the mixed blood in two directions, partly to the lungs and partly around the system.

Circulation is incomplete, since three kinds of blood are found, *arterial*, *venous*, and *mixed*. In many animals arrangements exist which nearly separate venous from arterial blood.

When the pericardium is opened on the ventral side, the following parts come into view: (1) The conical *ventricle* with its apex pointing backward. The ventricle has very thick muscular walls and ap-

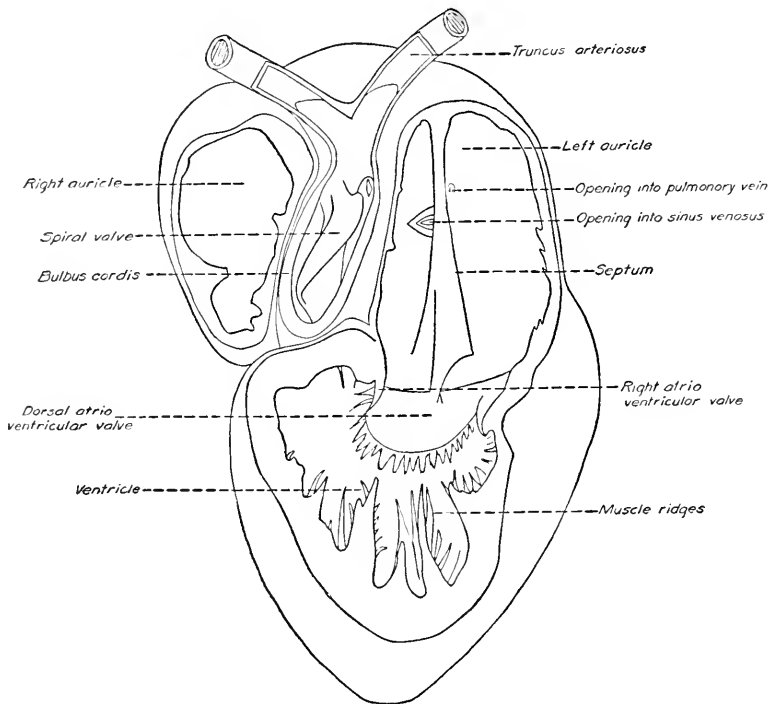

FIG. 152. Internal view of the heart of the frog. (Modified from Kerr. Courtesy of Macmillan and Co., Ltd.)

pears paler than the rest. (2) The thin-walled *auricles* lie immediately in front of the *ventricle*; they are separated internally by a *septum*. (3) The *truncus arteriosus*, a cylindrical body arising from the right anterior border of the ventricle, and running obliquely across the auricles. It divides into two trunks which soon give rise to arteries—common carotid, systemic and pulmocutaneous. (4) The *sinus venosus*, a thin-walled sac, dorsal to the ventricle and behind the auricle; it receives two precavae and the large postcava.

The four divisions of the heart contract in order, first the sinus venosus, then the two auricles, next the ventricle, and lastly the truncus arteriosus. (Figure 152.)

Internal Structure.—The heart propels the blood always in one direction and keeps the *pure* and *impure* blood separated. The *sino-auricular* aperture leads from the *sinus venosus* into the *right auricle*. It is a transversely oval opening, guarded by imperfect *anterior* and *posterior* valves, in the *ventral* wall of the *sinus venosus* near the median plane of the anterior end. The *right auricle* is the larger of the two. It has thin walls, thickened by muscular strands which form interlacing ridges on its inner surface. In its dorsal wall is the opening from the sinus venosus (*sino-auricular aperture*). The *left auricle* is smaller, sometimes much smaller, than the right auricle, which it resembles in the structure of its walls. In its *dorsal* wall, very close to the *sino-auricular aperture*, is the opening of the *pulmonary vein*. The *inter-auricular septum*, the partition between the right and left auricles, is much thinner than the walls of the auricles, and is placed obliquely, the left auricle lying more dorsal than the right. The *septum* ends with a free posterior edge, opposite the auriculo-ventricular aperture.

The *auriculo-ventricular aperture* lies at the base of the ventricle, and rather to the left side. It is guarded by valves which hang into the ventricle and it is divided by the lower edge of the septum into right and left divisions, admitting blood from the right and left auricles respectively.

The *ventricle* is conical in shape with the apex backwards, and has a small central cavity, with thick spongy walls. The spongy character is due to great development of a network of interlacing muscle strands similar to those of the auricles. The pockets formed by muscle ridges serve to keep the pure and impure blood separated.

Arteries.—The *truncus arteriosus*, a cylindrical body, arises from the right anterior border of the ventricle and runs forward across the auricles. (See Figure 150.) It divides in front into a right and left branch, each of which again divides into three aortic arches, the carotid arch, the systemic arch and the pulmocutaneous arch.

(1) The *carotid arch* is the most anterior of the three arches. It runs around the side of the esophagus and is connected dorsally with the second or systemic arch.

(2) The *systemic arch* runs obliquely around the esophagus to the dorsal surface and unites with the systemic arch of the other side at about the level of the anterior end of the kidneys to form the dorsal aorta.

(3) The *pulmocutaneous arch* is the most posterior of the three aortic arches. It divides into the great cutaneous and the pulmonary arteries.

Veins.—Except the blood coming from the lungs, all of the blood is returned to the heart through the three large venous trunks which enter the *sinus venosus*. The two *anterior vena cavae* are each formed through the junction of three branches, the external jugular, the innominate and the subclavian. The *posterior vena cava* is a median vein which returns to the heart the blood from the liver and kidneys and indirectly the blood from the other viscera and the hind limbs. The three vena cavae open into the sinus venosus. The left auricle receives the pulmonary veins.

Portal Systems.—The blood from the hind limbs does not empty directly into the posterior vena cava as in the higher vertebrates, but it is forced to pass through a second system of capillaries before reaching that vessel. A portal vein, returning blood from the capillaries of some organ, breaks up before reaching the heart into a second set of capillaries within some other organ. These again unite to form a vein which carries the blood to the heart. In the frog there are two portal systems, the *renal portal* system leading to the kidneys, while the hepatic portal system brings to the liver blood from the hind limbs and from the alimentary canal.

Action of the Heart.—The auricles contract and the oxygenated blood from the left auricle, which has come in from the pulmonary vein, is forced into the left side of the ventricle; and the impure blood from the right auricle, received from the sinus venosus, passes into the right side and middle of the ventricle.

The blood is prevented from being mixed by being received into the before-mentioned pockets or chambers in the ventricle. The *impure blood*, nearer the opening of the truncus arteriosus, passes out first and into the *pulmocutaneous arches*, while the *pure* pulmonary blood from the left side is forced out at the close of the ventricular contraction and passes into the *carotid* and *systemic arches*. Thus the impure blood from the heart goes mainly to the lungs and skin where it is purified, while the purer blood passing out towards the close of the contraction is sent throughout the body.

The heart of the frog beats for hours after being removed from the body. Electrical, thermal and chemical stimuli will cause the heart to beat again after it has ceased normal contractions.

Vocal Organs.—In vertebrates the vocal and the respiratory organs are intimately associated since the production of sound is caused by the expulsion of air from the lungs. The sound-producing organs of the frog are situated in the larynx below the pharyngeal cavity. The larynx opens into the pharynx through the *glottis* above and posteriorly by a pair of openings into the lungs. The skeleton of the larynx is composed of cartilages affording places for attachment to muscles which open and close the glottis.

Sound is produced by the expulsion of air from the lungs which set in vibration the paired vocal cords. In the *males* of many species of *Rana* we find a pair of *vocal sacs* at the side of the pharynx.

Respiratory System.—The *lungs* are thin-walled sacs covered with peritoneum. The inner surface of the lungs is divided by septa into small chambers or *alveoli* which increase the amount of surface exposed to the air. The walls of the alveoli are richly supplied with capillaries. The alveoli are lined with a single layer of thin flattened epithelial cells. On the edges of the septa they are columnar and ciliated. Outside the epithelium is a layer of connective tissue containing blood and lymph vessels and highly contractile smooth muscle cells.

The respiratory movements of the frog consist of throat movements and lung breathing. Throat movements may take place without movements of the body or nares, with the glottis closed and no air passing into or out of the lungs. Air is drawn through the open nares into the mouth cavity. Its floor is lowered, and forced out through them when the floor is again raised. Lung breathing causes distinct lateral expansions of the body wall.

The process of respiration consists of: *External respiration* with exchange of gas between the blood and the surrounding medium, carbon dioxide being given off and oxygen taken in; and *internal respiration*, gaseous exchange between the blood and the tissues. Most of the oxygen in the blood is carried by red corpuscles in weak chemical combination with hemoglobin. Oxygenated blood is bright red, impure blood is dark blue in color.

The *skin* is a respiratory organ in air and water, and during hibernation it is the only respiratory organ. More CO_2 is given off through the skin than through the lungs.

Urinogenital Organs.—Every cell excretes as well as secretes, part of the waste passing off as CO_2 , while solids are discharged by special organs. The *skin* is an organ of excretion in the frog. In higher vertebrates the sweat glands excrete. The *liver* is an im-

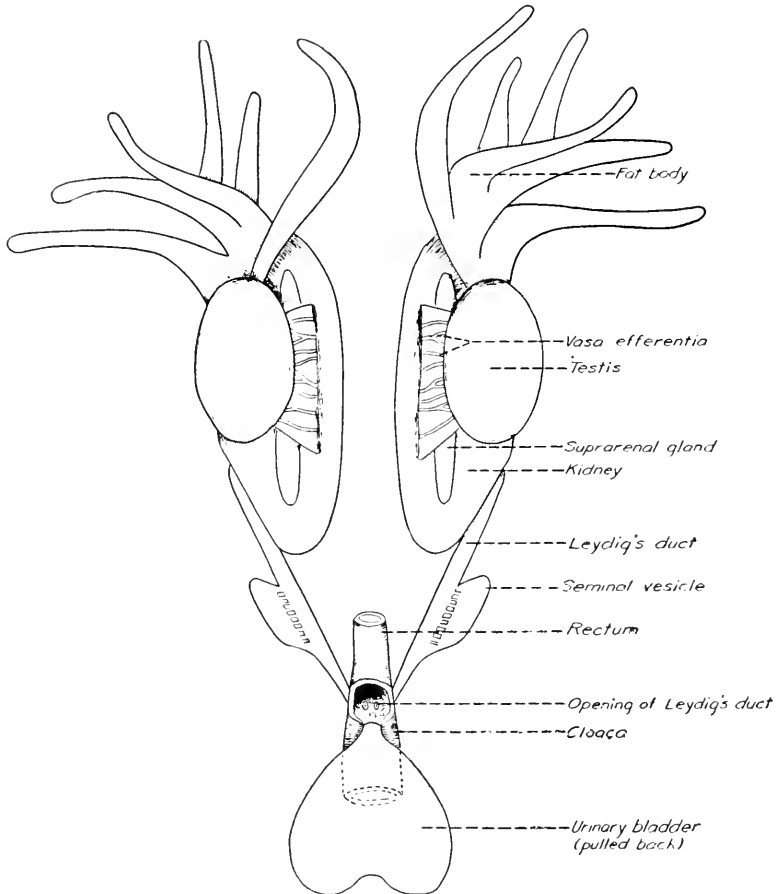

FIG. 153. Urinogenital system of male bull-frog. (Drawn by W. J. Moore.)

portant excretory organ, through *bile* and the formation of *urea*. The walls of the *intestines* are important in excretion. The *kidneys* are the most important. The *kidneys* of the frog are oval, flattened, dark red bodies in the posterior part of the body cavity. The duct of the *kidneys* (*ureter*) is at the outer margin of the *kidneys*. The

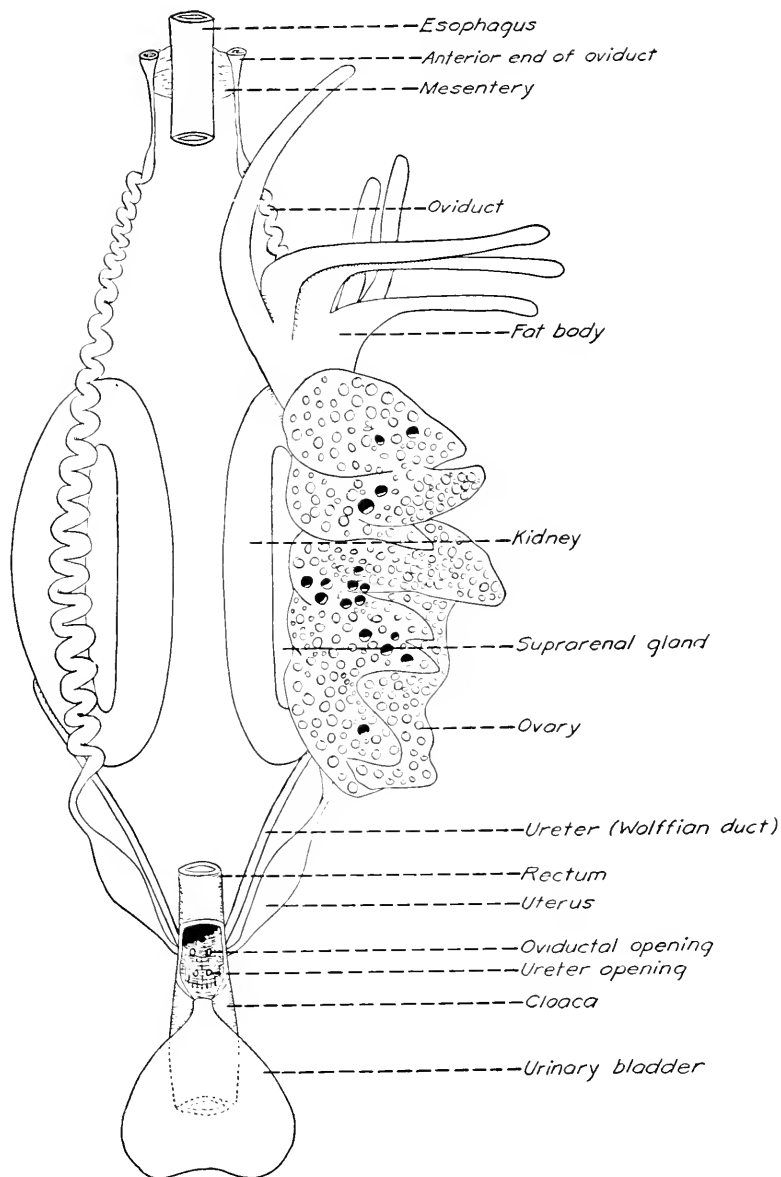

FIG. 154. Urinogenital system of female frog. (Drawn by W. J. Moore.)

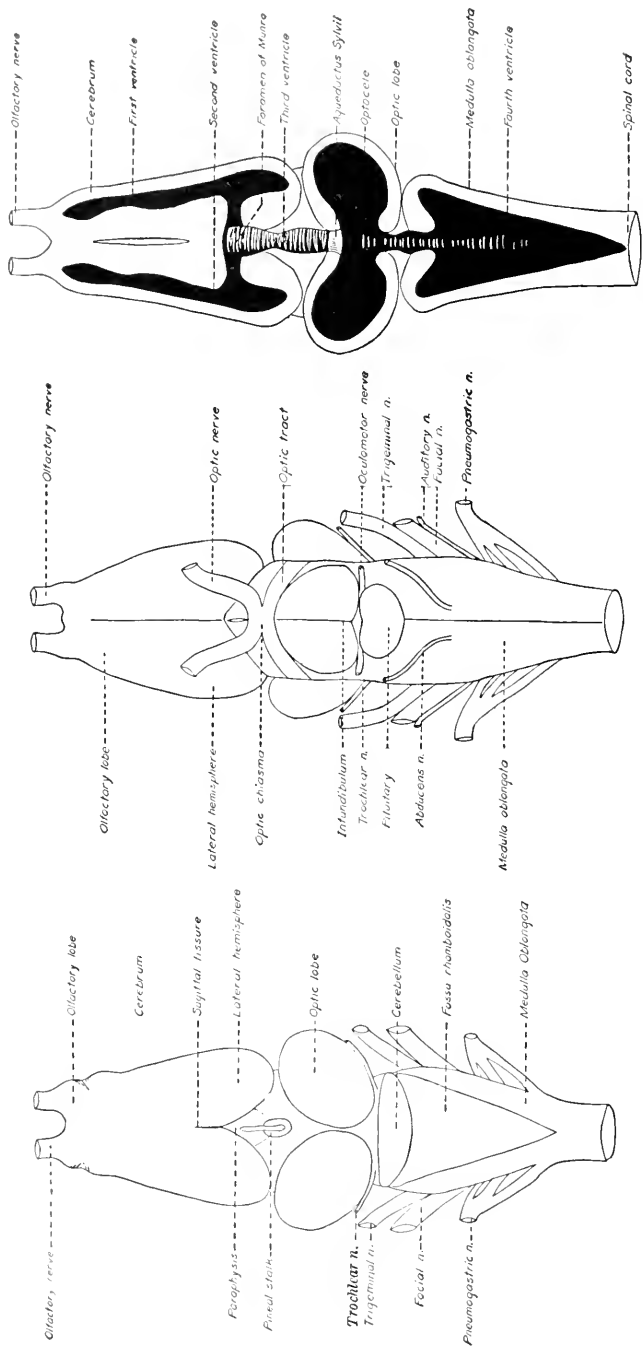

FIG. 155. A, dorsal view of frog brain. B, ventral view of frog brain. C, horizontal section of the frog brain showing ventricles. (Drawn by W. J. Moore.)

ventral surface is flatter than the dorsal. The orange-colored *adrenal* body, on the ventral surface, is a gland of internal secretion. (See page 286.) The kidneys are made up of coiled *uriniferous tubules* with a knot of blood vessels, the *glomerulus*, at one end.

The Wolffian duct is the *spermiduct* in the male and the *ureter* in the female. The Müllerian duct is the *oviduct* in the female and rudimentary in the male of *Rana pipiens*. It is absent in the bull frog. The *kidneys* of the male frog are closely related to the sexual organs. (Figures 153 and 154.)

The *vasa efferentia* are ducts carrying spermatozoa from the testes, passing into the substance of kidneys and through the kidney to the ureter which acts as a *vas deferens* also and is called *Leydig's duct*.

The kidney receives blood from two sources, the renal arteries from the aorta and the renal portal veins which bring venous blood to be purified. The kidney secretes urea (NH_2CO_2) and Na, K, Ca, and Mg phosphates and chlorides.

The *urinary bladder* is a *bilobed sac* attached to the ventral side of the cloaca below the openings of the *ureters*. The bladder collects urine when the cloaca is closed.

*Nervous System.*²—The *brain* (Figure 155, A, B, and C) consists of small *olfactory lobes* at the anterior end of the two elongated *cerebral hemispheres*; two large *optic lobes*, a *diencephalon* with the vestigial *pineal stalk* attached, a narrow *cerebellum* situated just

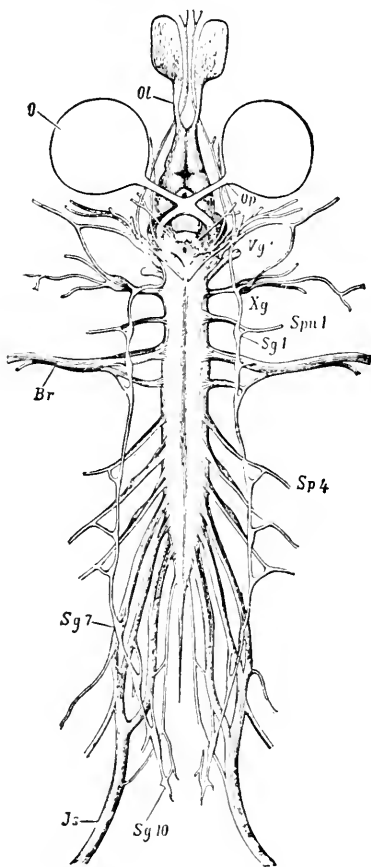

FIG. 156. Ventral view of the nervous system of frog. (After Woodruff, *Foundations of Biology*, from Ecker. Courtesy of The Macmillan Co.)

² Strong, O. S. 1895. Cranial nerves of amphibia. *Jour. Morphol.*, vol. 10.

anterior to the rather wide *medulla oblongata*. Ventrally one sees the paired *optic nerves*, which cross (optic chiasma), the *infundibulum* to which is attached the *pituitary gland* or *hypophysis*. There are ten pairs of cerebral nerves. (See table, below.)

Sense Organs.—Olfactory sense is served by small nasal cavities with folded walls of *nasal membrane*. The *anterior nares* lead to the cavities from the outside and the *posterior nares* open into the mouth. In the fish, as already noted, the olfactory openings were used only for smell, but in the amphibia and higher vertebrates, the *nares* are important in *respiration*. The *eyes* are well developed, but the

ORIGIN, COMPONENTS, FUNCTION AND DISTRIBUTION OF THE TEN CEREBRAL NERVES OF FISHES AND AMPHIBIA

<i>Number</i>	<i>Name</i>	<i>Functional Components</i>	<i>Cells of Origin</i>	<i>Distribution</i>
I.	Olfactory	Sensory	Nasal mucous membrane	Mitral cells of olfactory bulb.
II.	Optic	Sensory	Gang. cells of retina	Diencephalon (Thalamencephalon).
III.	Oculomotor	Motor	III. Nucleus in midbrain	Sup., Inf. and Int. Recti; and Inf. oblique muscles of the eye.
IV.	Patheticus or Trochlearis	Motor	IV. Nuc. dorsal midbrain	Sup. oblique muscle.
V.	Trigeminal	Sensory and Motor	(Motor) V. nuc., medulla Gass. gang.	Mandibular nerve to jaws; Ophthalmic, Maxillary and Mandibular nerves.
VI.	Abducens	Motor	VI. Nuc., medulla	Ext. rectus muscle. Sensory fibers associated.
VII.	Facial	Largely Motor	VII. Side of medulla	Muscles of face, muscles of hyoid arch, roof of mouth, palatine, hyomandibular and lateral line (in larval amphibia).
VIII.	Auditory	Sensory	Side of medulla	Utriculus, sacculus and semi-circular canals of internal ear.
IX.	Glosso-pharyngeal	Motor and Sensory	Side of medulla	Muscles and sensory corpuscles of pharynx and tongue.
X.	Pneumo-gastric or Vagus	Motor and Sensory	X. Nuc., medulla	Sensory and motor fibers to visceral arches, pharynx, heart, and alimentary canal.

animal, like many others, is *sensitive* primarily to *moving* objects. The tongue is supplied with *papillae*, bearing taste organs. In order to detect a substance it must be liquefied.

Hearing is quite well developed. Near the center of the tympanic membrane is a little protuberance, the tip of the *columella*, the small *bone* at its inner end connected with an opening in the skull which communicates with the inner ear. When the *tympanic membrane* vibrates in response to sound waves, the *vibrations* communicated to the internal ear produce the sensation of hearing.

Amphibian tadpoles have functional *lateral line* organs sensitive to vibrations of low frequency, one step below the sensation of hearing. In adult amphibia they disappear. In the skin there are *thermal* and *tactile* organs.

GENERAL CONSIDERATION OF THE AMPHIBIA

Distribution.—Amphibia live in or near swamps, ponds and streams and are never found in salt water. They are on this account absent from most oceanic islands. Although many of them have lost their gills and taken up terrestrial life, they return to water to spawn. The salamanders are for the most part limited to the temperate zone, while the Anura are found widely distributed and hibernate or aestivate as temperature demands.

External Anatomy.—There is a great variation in the matter of retention of gills in the salamander, some having persistent gills and lungs while others lose the gills entirely.

In the toads and most tree frogs, *webs* are lacking from the hind toes, while certain species of frogs have their toes ending in rounded *sucking discs*.

Amphibia respire largely by the skin, which is full of capillaries. The *stratum corneum* of the skin is shed periodically. Warts and granules are cornifications of the epidermis. In the males of the African "hairy frog" (*Astylosternus*), the granules of the skin are developed at the breeding season into hairlike structures, which, according to Kingsley, are supplied with nerves and are probably sensory in function, although certain writers have described them as accessory breathing organs.

The skin of amphibia is rich in mucus glands, *Cryptobranchus* being especially slimy. Some species of amphibia have well-developed poison glands. (See page 300.)

Skeleton of the Amphibia.—The *skull* of the amphibian has less cartilage in the adult than is found in the bony fishes. It has two occipital condyles for articulation of the first vertebra. The cartilaginous nasal capsules are connected with the auditory capsules

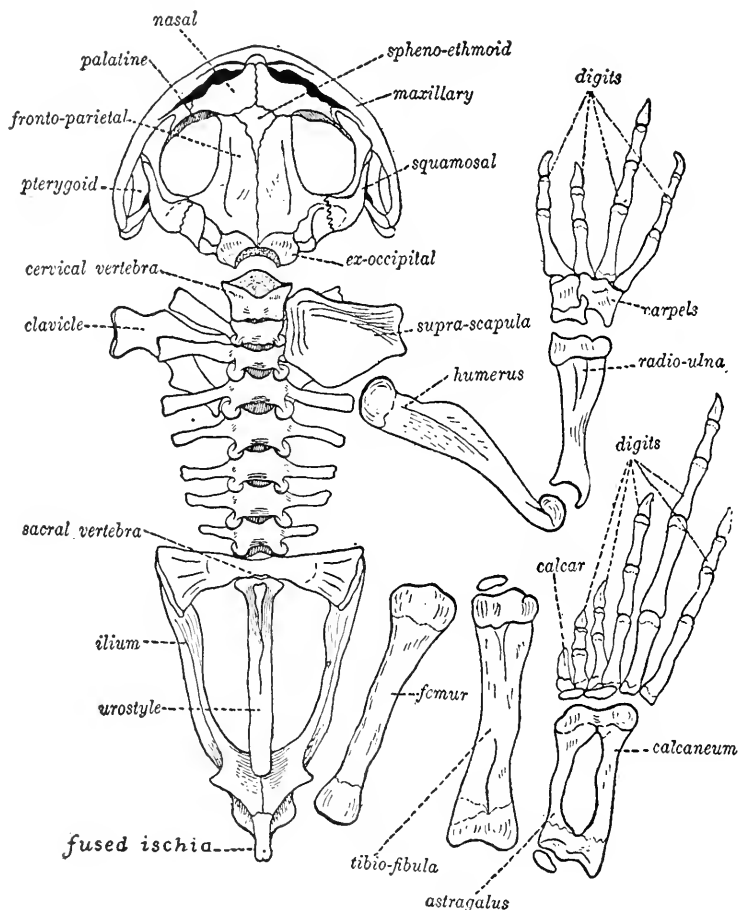

FIG. 157. Skeleton of garden toad. (After Kellogg, *Animals and Man*. Courtesy of Henry Holt & Co.)

by trabeculae. In the tailless amphibians (*Anura*) there is a well-developed tympanic cavity opening internally by the *Eustachian* opening.

In the frog, cartilage develops into the bones of the *upper jaw*

and the *hyoid apparatus*, which remains partly cartilaginous and supports the tongue. The cartilaginous *cranium* has a number of cartilage bones and some membrane bones.

The scapula is ossified and connected with the dorsal supra-scapula, which is partly cartilaginous. The ossified coracoid has a bar of cartilage, the pro-coracoid, while the clavicle is a membrane bone attached to it. The coracoid and pro-coracoid are joined ventrally by the epi-coracoid cartilage.

The episternum, tipped by the cartilage plate, the omosternum, projects anteriorly from the united epi-coracoids. The sternum extends posteriorly and is tipped by the cartilaginous xiphisternum.

The *pectoral* limb consists of the humerus, the fused radio-ulna, six carpals and four complete digits with a vestigial pollex on the radial side.

The *vertebral* column has nine vertebrae and an elongated posterior urostyle. The vertebral column furnishes a firm dorsal supporting structure, and protects the delicate nerve cord.

The *pelvic arch* consists of two long curved ilia, the fused ischia with the ventral fused pubes. Into the acetabulum or socket fits the femur. The tibia and fibula are united (tibio-fibula), while the two proximal tarsal bones, the calcaneum and the astragalus, are extremely elongated, making an additional segment in the hind limb. Next to the three distal tarsal bones there are five well-developed digits with a spur, the prehallux on the tibial side of the first.

Muscles.—In the lower Urodela the muscles are segmented in both trunk and tail. In the Anura, the myotomic structure is for the most part lost except in the divisions of the rectus abdominis muscles. Muscles are attached to bones by means of bands of modified connective tissue known as tendons.

Physiology. Digestive System.—In the common toad, teeth are absent. The retractor bulbi muscles pull the eye balls down in both toads and frogs for protection, so that they are able to clamp down on worms and insects that otherwise might escape from their mouth.

When present in the Amphibia, teeth occur on the premaxillae, maxillae and vomers, but they are also found on the palatines and the dentaries. The tongue is fixed in many salamanders, while in the frogs and toads it is usually free posteriorly and can be flipped out. In a few forms, called the Aglossa, it is absent.

Respiratory System.—The most striking example of metamorphosis occurs in those amphibia in which the larval external and internal gills are replaced in the adult by lungs (see Figures 158 and 159). In many salamanders, respiration is pharyngeal and cuta-

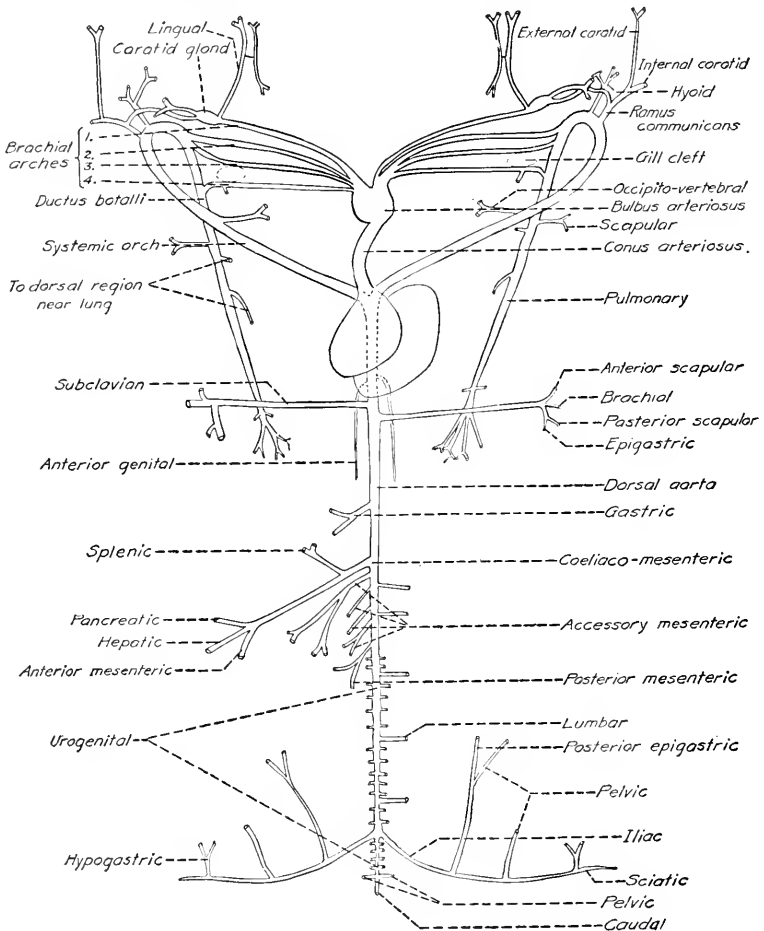

FIG. 158. Arterial system, ventral view, of *Cryptobranchus*. (After Reese, *Amer. Nat.*, 1906, vol. 40.)

neous. Even in the frog, during hibernation, respiration is cutaneous. The body temperature of the frog varies from 58° to 63° Fahrenheit. Salamanders are mute, but frogs and toads are noisy creatures, especially at spawning time.

Circulatory System.—It is very easy to see in the embryonic Anura and even in the adult Urodela a transition from the fish type of vascular system. The red blood corpuscles of the Amphibia are oval, nucleated and extremely large. In the salamander *Amphiuma*, the red corpuscles are eight times as large as those of a man.

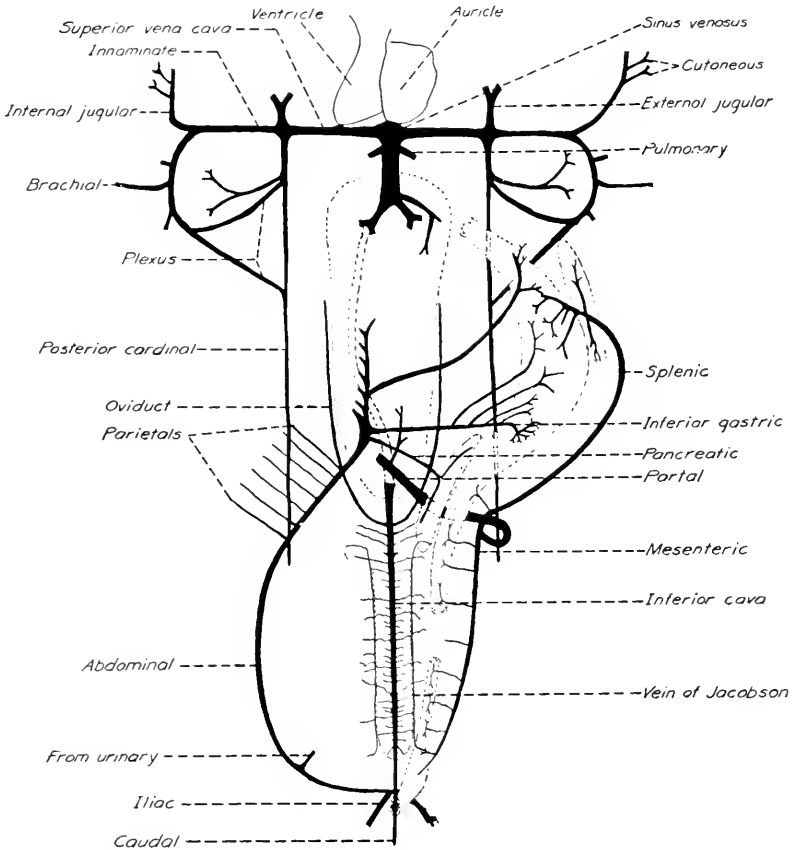

FIG. 159. Venous system. Ventral view. (After Reese, *Amer. Nat.*, 1906, vol. 40.)

Urinogenital Organs.—In the male amphibian, we find an interesting condition in that the “Leydig’s duct” transports both urine and sperm to the cloaca.

Embryology.—The ripe *ova* of frogs have distinct *polar* differentiation. The upper “animal pole” is deeply pigmented, while

the lower "vegetal pole" has no pigment but is rich in *yolk* and much heavier. Frog eggs are deposited in a mass of jelly which encloses green algae aiding in aëration, and which unquestionably aids in the absorption and radiation of heat. The *jelly* also preserves the eggs from friction and the attacks of enemies. (Figure 160.)

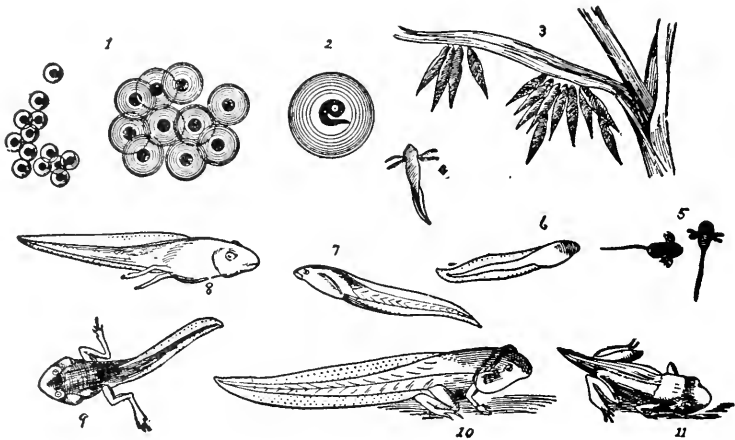

FIG. 160. The metamorphosis of the frog. (After Brehm, from Galloway-Welch, *Textbook of Zoology*. Courtesy of P. Blakiston's Son & Co.)

Cleavage.—The first vertical cleavage occurs about 3 hours after fertilization, and divides the ovum into a right and a left half. The second vertical cleavage about three-fourths of an hour after the first is at right angles to the first while the third cleavage, an equatorial one, divides the dorsal pole from the ventral. *Segmentation* which is *total* but *unequal* results in the development of a ball of cells of which the dorsal ones are smaller and more numerous than the yolk cells beneath. At this stage the egg is called the *blastula*.

At the close of segmentation the egg has developed into a hollow sphere with the cavity or *blastocoel* nearer the dark upper pole. The upper hemisphere has two quite distinct layers. A crescentic groove appears at one side of the egg between the layer of white and dark cells. The horns of the crescent extend until they form a circle, the *blastopore*, which is filled with a mass of white cells called the *yolk plug*. Rapid division of the marginal black cells in the dorsal region reduces the diameter of the blastopore. At this stage the

egg is called the *gastrula*. The upper germ layer or *ectoblast* develops from this layer of black cells.

From the development of the band of cells and the fusion of its right and left halves, a *meridional* band extends into the dorsal lip of the *blastopore*. On the dorsal side, the *groove* becomes a long narrow slit which is the primitive *digestive tract* of the frog. The roof of the *mesenteron*, as it is called, is the beginning of the lower germ layer, the *entoblast*.



FIG. 161A. Vinal Edwards and Robert Goffin at the nets, Woods Hole, Mass.

The middle germ layer, the *mesoblast*, arises as two plates split off from the outer surface of the *entoblast* and yolk cells. The *mesoblast* separates into two layers with a space between which becomes the *coelom*.

Germ Layers.—From the *ectoblast* are derived epidermis, nervous system and the lining of the mouth and anus. An anterior invagination called the *stomodaeum* develops into the mouth and a posterior one into the *proctodaeum*.

From the *entoblast* are derived the lining epithelium of the digestive tract and its associated glands.

From the *mesoblast* come muscles, bones, blood vessels and urino-genital organs.

Superficial Changes.—At first the egg is spherical, then in four or five days it becomes ovoid, finally elongating at about the 10th

day into a fish-like *tadpole* with distinct head, body and tail. Three pairs of *external gills*, which are later to be replaced by internal gills,



FIG. 161B. George M. Gray, Curator,
Marine Biological Laboratory.
(Photo by Chidester, 1931.)

function in respiration. In front of the two gill-arches two depressions unite to form a ventral horseshoe-shaped *sucker*. Shortly after hatching the *mouth* and *anus* are developed and the alimentary canal becomes tubular and folded while its *diverticula*, the liver and pancreas, are formed.

Internal gills covered by *operculi* replace the external gills. Rapid increase in size occurs, the *tail* which has been developed to a remarkable extent soon begins to degenerate, and the limbs appear. At about the 8th week the gills are replaced by lungs. At about the 10th week the tadpole ceases to feed on algae, the skin is moulted, the gills are absorbed, the digestive system assumes its adult condition and the animal becomes carnivorous. Then the tail is completely resorbed, the hind limbs elongate and the animal comes to shore as a young *frog*.

REFERENCES

- HODGE, C. F., AND DAWSON, J. Civic Biology. Ginn and Co.
 WRIGHT, A. H. 1910. The Anura of Ithaca, N. Y. A key to their eggs.
 Biol. Bull., vol. 18, no. 2, pp. 69-71.
 WRIGHT, A. H. 1914. Life Histories of the Anura of Ithaca, N. Y.
 Carnegie Inst. Washington, D. C., Pub. 197.

Parental Care.—A number of species of frogs and toads build nests in which eggs are deposited. Some frogs attach these nests to leaves over the water and the tadpoles hatch and drop in. Still others deposit their eggs in masses of froth some distance from the water. The male sometimes proves to be the caretaker of the young. In the obstetric toad he carries strings of eggs until the tadpoles are ready to hatch. In another species, the South American *Rhino-derma*, the male transfers the eggs to his huge vocal sacs until they are hatched. The viviparous salamanders have already been mentioned.

Parthenogenesis.—Bataillon, Loeb and others have induced the parthenogenetic development of frogs. Parmenter's studies of the chromosomes of these fatherless creatures show that they may be either male or female.

Experimental Embryology and Regeneration.—On account of the convenience with which amphibian eggs may be secured inland, they have been used a great deal in experimental embryology. Grafting of two different species and divisions of the egg at the two-cell stage have been successfully accomplished.

W. Roux, Hertwig, Morgan, W. H. Lewis, Spemann, and many other investigators have performed experiments on the developing eggs of amphibia. Roux injured the first formed blastomeres, and Hertwig (1893) and later Morgan (1902) studied the development of half embryos and whole embryos from one of the first two blastomeres of the frog's egg. W. H. Lewis first showed (1904, *Amer. Jour. of Anatomy*, vol. 3) that the optic vesicle determines location of the lens. Spemann and his students have made many significant studies on the development of the eggs of Triton, the salamander. (Consult Morgan, T. H., 1927, *Experimental Embryology*, Columbia University Press.)

Harrison, who was the pioneer (see page 495) in tissue culture (*J. Exp. Zoöl.*, 1907, vol. 4, p. 239; 1910, vol. 9, p. 787), has trained a number of anatomists, who have carried on extremely important experiments on transplantation and extirpation of limbs and eyes in Amphibians. An interesting account of some of the work was brought out in the discussion following a lecture by Detweiler given at the November, 1930, meeting of the N. Y. Neurological Society, and reported in *Archives of Neurology and Psychiatry*, vol. 25, no. 4, pp. 914-919, April 1931. (Consult also papers by Harrison, Detweiler, D. Hooker, F. Swett, and R. Burns.)

Habitat.—As stated before, amphibia hibernate and aestivate. That they are able to live in cavities in solid rock has often been reported. But Buckland, after experiments with frogs and toads enclosed in cavities of stone and excluded from air and food, found that none lived over two years and most succumbed inside of a year.

Fossil Relatives.—The *Stegocephalia* are extinct, tailed forms which lived in fresh water. Their teeth were complexly infolding (Labryinthodonts). One form known as *Mastodonsaurus* had a skull over four feet long and nearly as wide. They were abundant in the lower Permian and Upper Pennsylvanian. Traces of gills in certain fossil forms indicate that the *Stegocephalian* larvae were aquatic. They were armored, some of them having overlapping scales like fishes.

The *Urodela* have very few fossil remains. One, found in Germany, in Miocene rocks, was called “homo diluvii testis,” or “the man who witnessed the flood.” *Anuran* fossils are rare, and found only from the Comanchian to the present, while *Apodan* (*Gymnophionan*) fossils are unknown.

The connecting links between the lobe-finned fishes (*Crossopterygii*) and the amphibians have not yet been discovered, but comparison of the skulls, labyrinthine teeth and fishlike shoulder girdles of land-living amphibia with these fishes indicates their close relationship.

The *Stegocephalia* are apparently related to certain of the extinct *Reptiles*, the *Theromorpha* (Therapsida), which appear to have affinities with the *Mammals*. Huxley, comparing amphibians with mammals, brought out the fact that both have two occipital condyles, and that the carpal bones resemble each other. But *Theromorpha* (see page 331) also have two occipital condyles.

Economic Importance of Amphibia. Positive.—1. As food, we find that frogs (legs) are in considerable demand.

2. Frogs and toads are important enemies of injurious insects.

3. As experimental animals for use in Physiology and Embryology the Amphibia are unexcelled.

4. Savages secure arrow poison from the skins of some Anura.

Poisonous Amphibians.—The poisons from the skin glands of toads, salamanders and newts, when injected can kill mammals, birds, reptiles, and even fishes, provided the dose is proportionate to the size of the animal. Small birds and lizards succumb in a few minutes while guinea-pigs, rabbits and dogs succumb in an hour.

A young dog will suffer discomfort for twenty-four hours after taking a toad in its mouth. Snakes, however, eat toads without any discomfort.

The Indians of Columbia obtain poison from *Dendrobates tinctorium* by exposing the frog to fire, and use it for shooting monkeys, as it acts on the central nervous system. Toads do not cause warts, although their skin is poisonous. The Chinese have for thousands of years used a toad-skin preparation called "Senso" as a heart stimulant. It is said to be fifty to one hundred times as powerful as digitalis, to which it is chemically allied.

Resistance of Amphibia to Poisons.—The toad is *not* poisoned by dosages of *digitalis* that prove fatal to the frog. This resistance depends upon a difference in the tissues, as the isolated hearts behave the same. The frog is tolerant of *morphine* in quantities fatal to man.

REFERENCES ON THE AMPHIBIA

- BARBOUR, T. 1926. Reptiles and Amphibians.
- CHAMBERLAIN, F. M. 1927. Notes on the Edible Frogs of the U. S. Report of the Commissioner, U. S. Fish. Com.
- DICKERSON, MARY C. 1906. The Frog Book. New York.
- KIRKLAND, H. A. 1897. The Habits of the American Toad. Hatch Expt. Sta. Bull. 46.
- MILLER, N. 1909. The American toad. Am. Nat., vol. 43, pp. 641-668 and 730-745.
- SURFACE, H. A. 1913. First Report on the Economic Features of the Amphibians of Penna. Zoöl. Bull., Penna. Dept. Agr., Harrisburg, May-July.
- WRIGHT, A. H. 1914. Life Histories of the Anura of Ithaca, N. Y. Carnegie Inst. Washington, D. C., Pub. No. 197.
- WRIGHT, A. H. 1920. Frogs, Their Natural History and Utilization. Bur. Fish. Doc. No. 888.

CHAPTER XVII

REPTILIA

Amnion and Allantois.—Comparison of Reptilia with Aves and Mammalia shows that the first two Classes, sometimes grouped as

Sauropsida, are much more closely related to each other than either one is to the Mammalia. The three classes are alike in possessing a structure called the *amnion*.

In the course of development in the *reptiles*, *birds* and *mammals*, called Amniota, the embryo is enclosed in a membranous dome-like sac, the *amnion*, which contains a fluid, the *amniotic liquor*. A network of blood vessels is developed over the yolk-sac which is an organ of respiration as well as of nutrition. (Figure 162.)

In *higher mammals*, however, the *allantois* effects respiration. The *allantois* is a vascular sac-like outgrowth from the hinder part of the embryonic intestine. It is present in Amphibia but is very small. The *fishes* and *amphibia*, lacking both allantois and amnion, are sometimes called *Anamniota*.

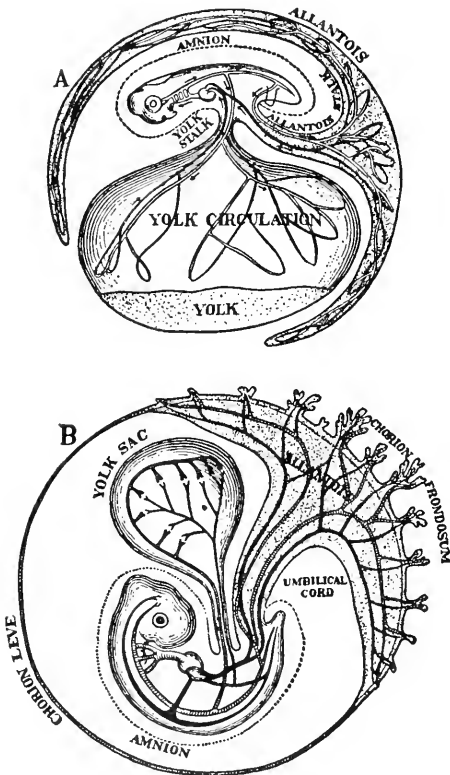

FIG. 162. Vertebrate embryos with their membranes. *A*, reptile or bird; *B*, placental mammal. In *A* the yolk sac is functional and the allantois respiratory; in *B* the yolk sac is functionless and the allantois becomes the nutritive placenta and umbilical cord. (After Wilder, *History of the Human Body*. Courtesy of Henry Holt & Co.)

In Amniota, the allantois grows around the embryo as a *stalked vesicle*, which in reptiles, birds and monotremes lies close beneath the egg shell and acts as a *respiratory organ* during the rest of the embryonic period. It also receives *excretory* matters from the kidneys. In the mammals *above* the monotremes, an important vascular connection takes place between mother and fetus by means of the allantois. This is called the *placenta*. The allantois becomes attached to a definite region of the uterine wall and from it vascular processes or villi arise so that the fetal and maternal blood vessels come into close relationship with each other. Gills are no longer necessary since the *allantoic placenta* functions in the respiration and nutrition of the fetus.

CLASSIFICATION

- Super-order 1. Cotylosauria.** Primitive fossil forms.
Super-order 2. Chelonia. Living forms, including turtles and tortoises.
Super-order 3. Therapsida (Theromorpha). Fossils linked with mammals.
Super-order 4. Sauropterygia. Fossil forms with a long neck.
Super-order 5. Ichthyopterygia. Fossil aquatic forms.
Super-order 6. Archosauria. Besides the primitive fossil Thecodontia, Pterodactyla and Dinosauria, the super-order includes one living connecting type, the Rhynchocephalian Hatteria, and the living orders of Crocodilia and Squamata.

Since only four orders of the Reptilia have living representatives, we shall discuss these first, and defer the description of fossils to the section on Fossil Relatives (page 330).

LIVING ORDERS OF REPTILIA

- Chelonia.
- Rhynchocephalia.
- Crocodilia.
- Squamata.

CHARACTERISTICS

The reptiles have an amnion, an allantois, a horny skin, ossified skeleton, two auricles, two ventricles with incomplete septum (except in the Crocodilia), a single occipital condyle, are cold blooded, breathe by lungs and have twelve cerebral nerves.

NATURAL HISTORY

Super-Order 2. Chelonia.—Skull without temporal vacuities. Compact body enclosed in a case, consisting of bone and horny plates, which form a dorsal carapace and a ventral plastron. The vertebrates and ribs of the thoracic region fuse into the carapace, and the pectoral and pelvic girdles are internal to the ribs. The limbs terminate in claws, or are flipperlike. There are no teeth and the quadrate bones are immovable. The cloaca is elongated.

This order includes *tortoises*, which are strictly terrestrial; *turtles*, semi-aquatic and marine; and *terrapins*, which are hard-shelled fresh water species.

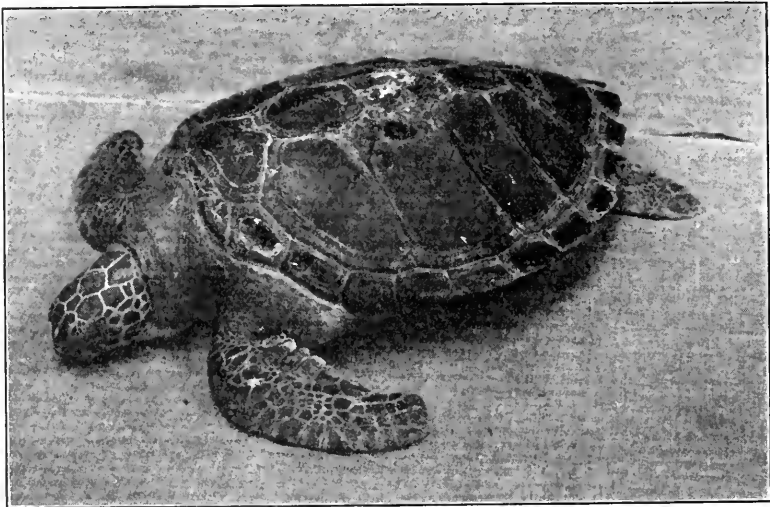

FIG. 163. Atlantic green turtle. (Courtesy of N. Y. Zool. Soc.)

The *green turtle* (*Chelone mydas*) is a marine form, reaching a weight of 400 pounds, whose flesh, oil and eggs are all consumed by South Americans. In this country, soup and flesh are esteemed delicacies. The *hawks-bill turtle* (*Chelonia imbricata*) is a smaller marine form once used as a source of tortoise-shell, but now little sought. The *leathery turtle* (*Sphargis coriacea*) is the largest living turtle, reaching a weight of 1,000 pounds and a length of six feet. It is marine, but spawns on land. It is inedible. The *giant tortoise* (*Testudo*) of the Galapagos Islands is a gentle form, frequently photographed at zoos carrying children on its back. It may reach a weight of 300 pounds. The *common snapping turtle* (*Chelydra*

serpentina) of Eastern America and the *alligator snapping turtle* (*Macrochelys lacertina*) of Southern United States are vicious forms, feeding on fishes. The common snapper attacks young water fowl.

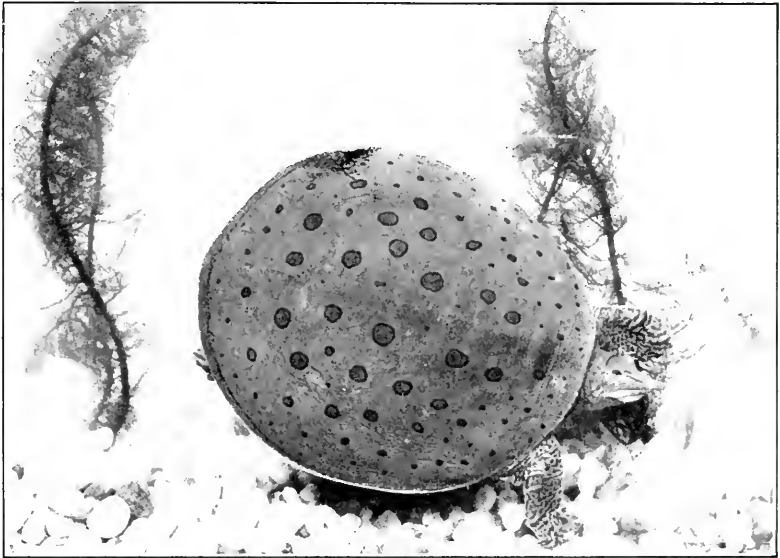

FIG. 164. Soft-shelled turtle. (Courtesy of N. Y. Zool. Soc.)

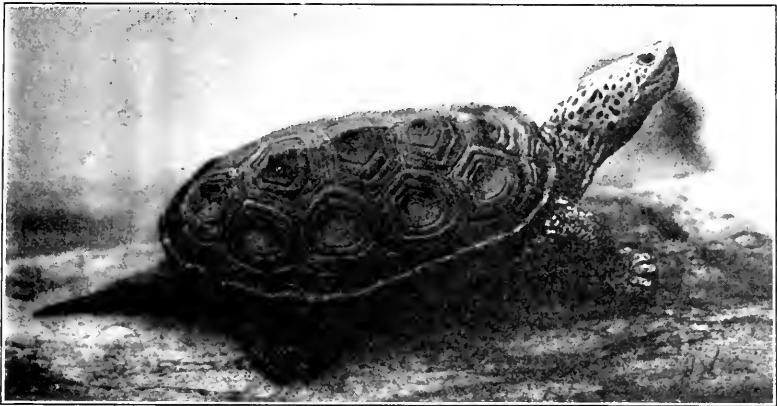

FIG. 165. Diamond back terrapin. (Courtesy of N. Y. Zool. Soc.)

The *painted terrapin*, *Troosts terrapin*, and the *yellow-bellied terrapin* are little used for food, but the *red-bellied* or "*slider*" *terrapin* and the *diamond-backed terrapin* are much served in fashionable

restaurants. Overfishing has reduced the importance of the terrapin fisheries over one half in 30 years. The *wood terrapin* is edible and protected from extermination in New York State. The *common spotted turtle* is said to be unable to eat when out of the water.

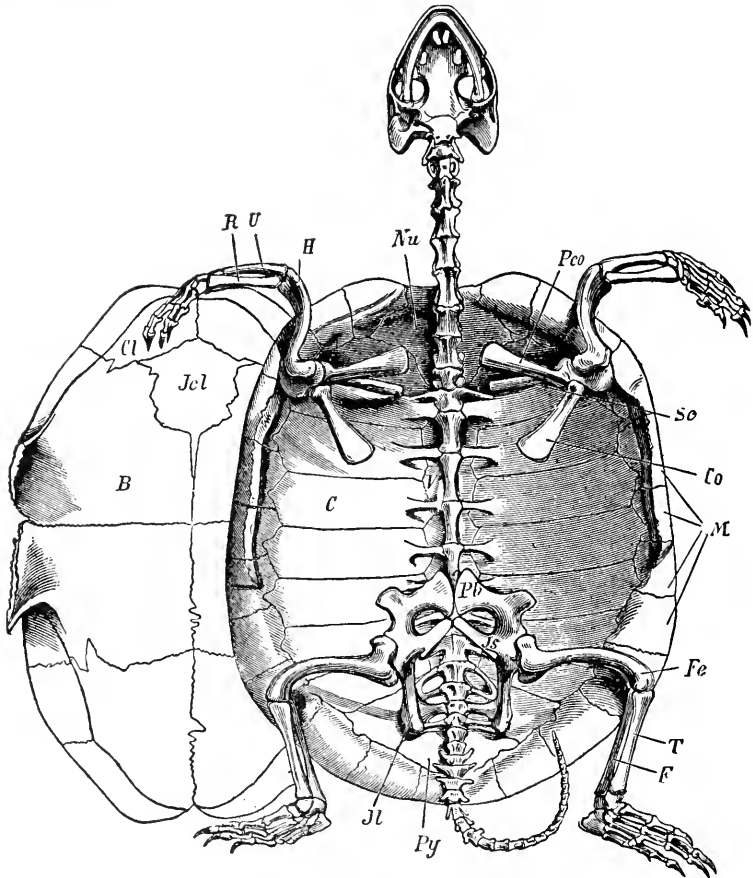

FIG. 166. Skeleton of *Cistudo* (*Emys europaea*). *V*, vertebral (neural) plates; *C*, costal plates; *M*, marginal plates; *Nu*, nuchal plate; *Py*, pygal plate; *B*, plastron (ventral shield); *Cl*, clavicle; *Jcl*, inter-clavicle; *Sc*, scapula; *Co*, coracoid; *Pco*, acromial process (pro-coracoid); *Pb*, pubis; *Js*, ischium; *Jl*, ilium; *H*, humerus; *R*, radius; *U*, ulna; *Fe*, femur; *T*, tibia; *F*, fibula. (After Claus-Sedgwick. Sonnenschein, London.)

The *musk*, *map* and *speckled* turtles are all important enemies of insects. The *common box turtle* feeds on insects, but also consumes some vegetable matter. It has a lobed plastron which it can close tightly. (Figs. 163, 164, 165, 166.)

The *soft-shelled turtles* (*Aspionectes feros*) are edible forms found from South Carolina to Texas and up the Mississippi to the Great Lakes. They weigh as much as 30 pounds. They are omnivorous, feeding on crustacea and insects, but also destroying *fish* and *water fowl*, since they are extremely fast swimmers.

Type—The “Slider” *Terrapin* (*Pseudemys rubriventris*).—The turtle has no *teeth*, but *horny jaws*. Its tongue is broad and soft, and the pharynx is thin walled and distensible. The thick-walled *esophagus* bears *papillae*. The *stomach* has a pyloric valve. The *small intestine* consists of the *duodenum*, *ileum*, with an ileocecal valve, *large intestine* and *rectum*. There are paired cloacal sacs and the *respiratory system* consists of the *glottis*, *larynx*, *trachea* and two *bronchi*. The *lungs* are large and many branched. The *hyoid apparatus* supports the larynx. Movements of the hyoid, neck and anterior limbs aid in respiration.

Aquatic tortoises and marine turtles have two large *sacs* attached to the *cloaca*. These are filled with water and richly vascular. At times, when water is replaced by CO₂, they may buoy up the shell and supplement the lungs. Females are said to utilize the liquid in these sacs in wetting down the eggs deposited in sand on the shore.

The *heart* has two *auricles* and incompletely divided *ventricles*, the *septum* being *perforated*. The venous blood passes from the *postcaval* and two *precaval* veins into the *sinus venosus* and thence to the *right auricle*. From the right auricle it flows to the right side of the ventricle.

From the right ventricle it goes to the *pulmonary artery* which divides on the right and left; and also through the *left aorta* which sends blood to the viscera and into the dorsal aorta. The *left arch* is therefore *venous* to the alimentary canal by way of the *coeliac*. Purified blood from the lungs passes to the auricle and left side of the *left ventricle*. The blood then goes through the *right aortic arch* to the dorsal aorta. It is *impure*, because mixed in the ventricle. The turtle has no *renal portal*, but the usual *hepatic portal system*.

Urinogenital Organs.—The urinary system consists of paired, reddish, oval *kidneys*, paired *ureters*, a urinary *bladder* shaped like a dirigible balloon, the *cloaca*, oval in shape, and the *anus*.

The *testes* are oval, yellow bodies with *vasa deferentia* leading to the grooved *penis* which is attached to the anterior wall of the *cloaca*. The paired *ovaries* are rather diffuse, somewhat resembling the single *left ovary* of the bird. The *oviducts* open into the cloaca.

Turtles lay white oval or rounded eggs in the sand, tamping the earth down with the posterior portion of their shell.

Nervous System.—The *cerebral hemispheres* and *cerebellum* are large and the *olfactory* apparatus is well developed. The *eyes* are small and *hearing* is acute. *Tactile sense* is well developed, the animal being sensitive to raps on its *shell*. The *skin* of the *appendages* is especially sensitive.

Super-Order 6. Archosauria. Rhynchocephalia.—Rhynchocephalia (Gr. *rhynchos*, snout; and *cephale*, the head) are generalized types, linking the Squamata, Crocodilia and Dinosauria. They resemble the Lacertilia in form, but differ in having a fixed quadrate bone. They are represented by one living relative, *Sphenodon* (*Hatteria*). (See page 331.)

The *New Zealand lizard*, *Sphenodon* or *Hatteria*, has a well-developed *pineal eye*, sensitive to light. It lives in a burrow. There are several fossil relatives from the Permian to the present, with maximum development in the Triassic.

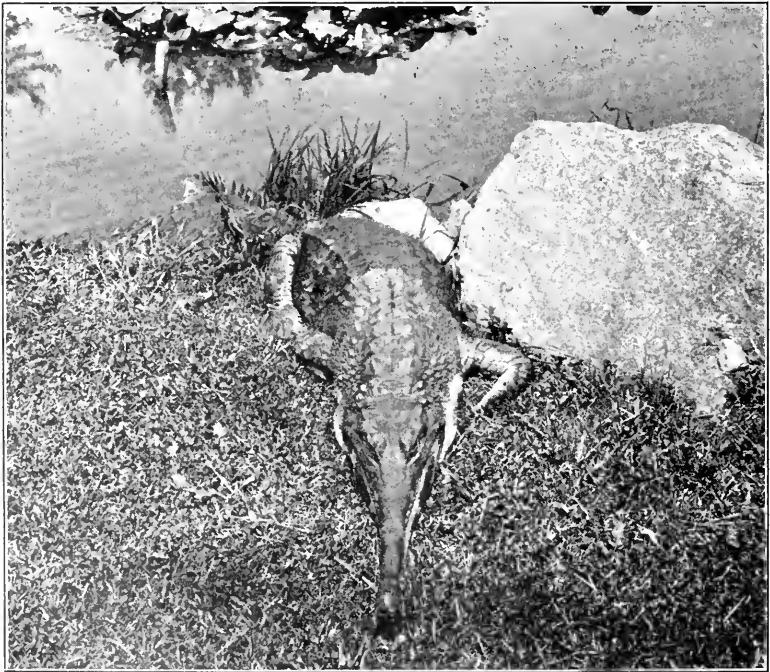

FIG. 167. Gavia. (Courtesy of N. Y. Zool. Soc.)

Order Crocodylia.—Alligators, crocodiles, and caimans, like the turtles, have an oval cloacal opening, immovable quadrate bones, and bony plates in the skin. They differ in structure from all other reptiles although their shape is lizard-like. They have abdominal ribs and abdominal sternum. Their teeth are placed in sockets. The heart is completely four-chambered.

The *Chinese alligator* (*Alligator sinensis*) lives in the Yang-tse Kiang in China. It is a small species, greenish black, with yellow spots. It is the *nearest living relative* of the American *alligator*.

The *American alligator* (*Alligator mississippiensis*) is found as far north as North Carolina. It may reach a length of 16 feet 3 inches. It is the only crocodylian that *bellows*. It is much less vicious than the crocodiles. Alligators are sold to tourists, and there is a constant demand for their hides, used for bags and pocket-books. Alligator farms supply animals to the cinema producers.

The *caimans* of South America are quite vicious. *Gavials*, found in India, may reach a length of thirty feet, and are quite ferocious, but rarely attack man. (Figure 167.)

The *salt water crocodile* and the *mugger* of India and the sacred *African crocodile*¹ are extremely dangerous animals and cause many deaths annually. An American crocodile, resembling the African form, was found in Florida in 1875, by Dr. W. T. Hornaday. It is extremely vicious.

Order Squamata. (*Super-Order VI.*)—This order includes two sub-orders, *Lacertilia*, or lizards, and *Ophidia*, or snakes. The Squamata (Lat. *squamatus*, a scale) have horny scales, renewed periodically, movable quadrate bones, a transverse cloacal opening and paired penes.

Sub-Order Lacertilia. (Lat. *lacertus*, a lizard.)—The lizards, chameleons and iguanas have certain characteristics distinguishing them from the snakes and the crocodylia. Lacertilia have paired appendages or rudiments, scaled ventral surface, tympanic membranes, a sternum (usually) and movable eyelids.

The *blind-worm*, or slow-worm, a limbless lizard (*Anguis fragilis*) found in Europe and Asia, is a most snaky animal. Its body is covered with smooth round scales and its locomotion resembles that

¹ "The crocodile is esteemed sacred by some of the Egyptians, by others he is treated as an enemy, and the people of Elephantine even eat their flesh. The Ionians called the Egyptian 'Champsae' crocodiles, after the wall-lizards of Ionia." (Herodotus II, 69.) The name Champsae remains today in the Coptic language.

of a snake. It is not blind and certainly not at all worm-like. It is viviparous. Ditmars cites a case of a *fourteen-inch* female giving birth to sixteen young, each three inches long. Young slow-worms feed on termites. Adults feed on earth-worms, insect larvae and slugs. The teeth are re-curved and fang-like with traces of a *groove*, showing that the animal is related to the poisonous lizards.

The "*glass snakes*" (*Ophisaurus apus* of Europe, and *O. ventralis* of America) are limbless lizards. (Figure 168.) Their movable eyelids, and ear openings distinguish them from the true snakes. When attacked, they quite easily drop their brittle tail and move away to regenerate a new one.

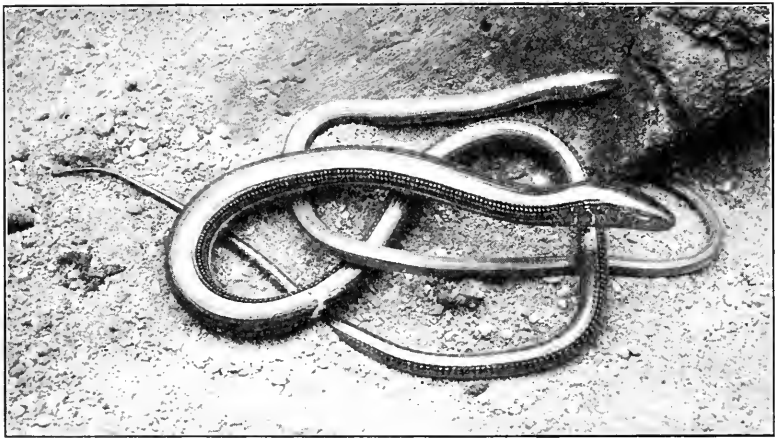

FIG. 168. Glass snake, *Ophisaurus ventralis*. (Courtesy of N. Y. Zool. Soc.)

The *beaded lizards* (*Helodermatidae*) include two poisonous forms found in deserts in the United States, Mexico and Central America. The Gila monster (*H. suspectum*), a beaded lizard with grooved fangs, has been reported to be quite poisonous to man, but the evidence is rather inconclusive. (See p. 328.) Its large tail is a reservoir for fat storage. It may reach a length of two feet.

The *geckos* of the Mediterranean region (*Geckonidae*) can run on smooth surfaces, climbing walls and ceilings by means of *adhesive pads* on their toes. The suctorial disks are arranged like the slates on a roof. The gecko is non-venomous, feeding on insects. It drops its tail when attacked. (Figure 169.)

The European "*green lizard*," or *wall lizard* (*Lacerta viridis*),

is a generalized type. It eats insect larvae but is not able to digest those with hard chitinous coverings. Its tail is very brittle and quickly dropped off when the animal is irritated. The *common swift* (*Sceleporus spinosus undulatus*) is an arboreal lizard living chiefly on tree-inhabiting insects. It deposits its eggs, which resemble tortoise eggs, in a rather deep tunnel.

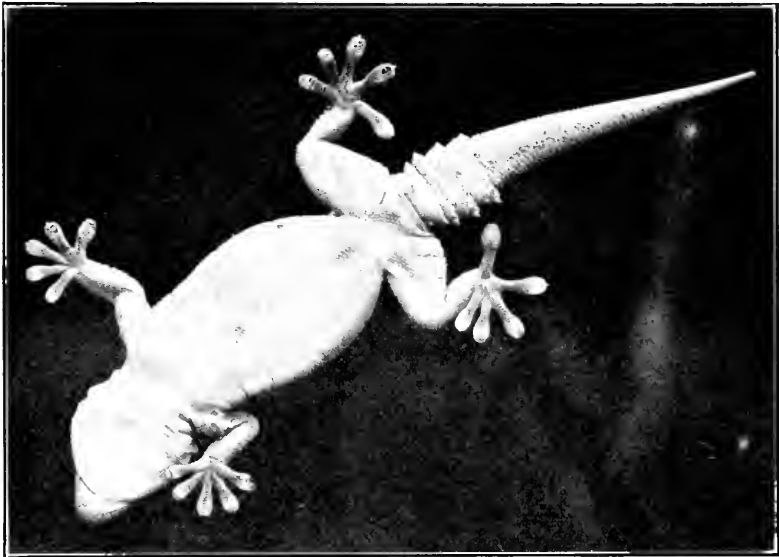

FIG. 169. Ringed gecko, ventral view. *Tarentola annularis*. Northern Africa. (Courtesy of N. Y. Zool. Soc.)

The *flying dragon* (*Draco volans*) (Figure 170) lives in the Indo-Malay region. It has *membranes* stretched between the fore and hind limbs and extends these to plane from tree to tree or limb to limb. It is brightly colored like the flowers among which it lives.

The *horned-toad* (*Phrynosoma cornutum*) (Figure 171) is a true lizard armed with long neck spines and peculiarly adapted for desert life, having a dull grey concealing color and being equipped with *valves* in its nostrils which prevent the inhalation of fine sand. It drinks dewdrops and eats insect larvae and ants. Captive specimens have been observed by Ditmars and others to shoot *jets* of *blood* from the eyes a distance of five feet. The animal is not poisonous, is easily tamed, and can be "hypnotized" by gently stroking its ventral surface.

The *skinks* include a species (*Eumeces quinquelineatus*) which lives from Massachusetts to Florida and westward to Texas. It may reach a length of ten inches. It changes in color in a striking manner as age increases.

The *monitor* (*Varanus salvator*) was for many years considered the largest lizard. It is found in Ceylon and the Malay Archipelago. It reaches the length of eight feet and is able to swallow a hen's egg at one gulp. It is used as food.

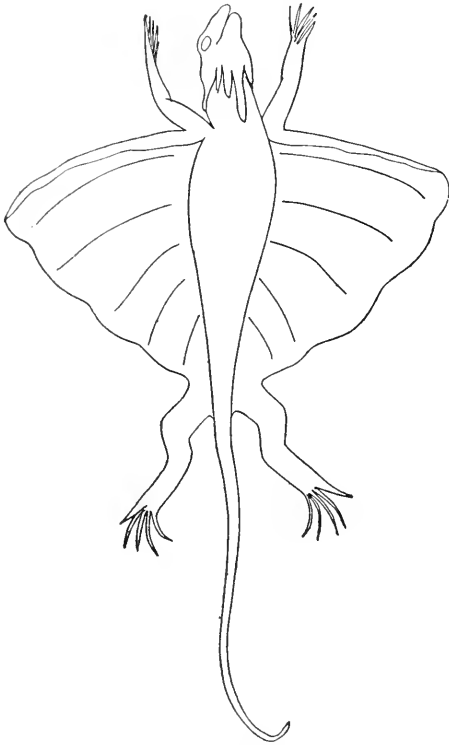

FIG. 170. *Draco volans* (flying lizard). (After Hilzheimer.)

The *Nile monitor* (*Varanus niloticus*) digs through the rain-softened walls of the clay nests of a South African termite, and deposits its eggs, ten to thirty in number, in the center of the nest. The termites repair the nest, but after about ten months the young escape from their leathery egg shells and, aided by the rainy season, tunnel out and seek the nearest stream.

The *largest living lizard* (*Varanus komodoensis*) was only recently discovered in the hills of Kommodo in the Lesser Sunda Islands. It is said to reach a length of ten feet.

The *smallest lizard* (*Lepidoblepharis sanctaemariae*) found in eastern

Panama is about two inches long, weighing less than five grams.

The *sea lizard*, an iguana (*Amblyrhynchus cristatus*), inhabits the shores of the Galapagos Islands. It feeds on sea weeds and when attacked swims away into the sea. The animals are gregarious, living in flocks of several hundred.

The *common iguana* (*Iguana tuberculata*) found in tropical

America is largely *herbivorous*, but the *young* individuals feed upon insect larvae. Adults will also capture small *rodents* and *young birds*. The *iguana* is arboreal and grows to a length of six feet. The flesh, tasting much like chicken, is considered a delicacy in tropical America.

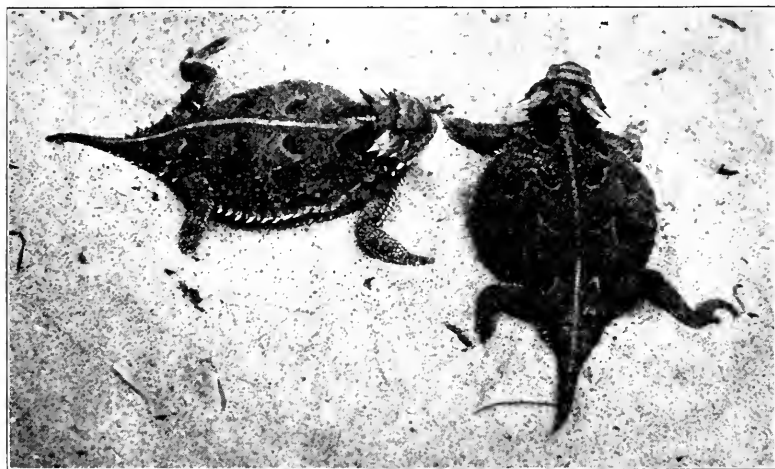

FIG. 171. *Phrynosoma*. (Courtesy of N. Y. Zool. Soc.)

The *chameleons* (*Chamaeleon vulgaris*) are arboreal forms found in the Old World, some in Africa and Arabia, others in India and in Spain. The club-shaped tongue, half the length of the body, is covered with glutinous material and is used in capturing insects. The colors include green, blue, grey, brown, black and yellow. Chameleons are able to change their color with extreme rapidity, but do not, according to Ditmars, assume the colors of their background, as do fishes and amphibia.

The *American "chameleon"* (*Anolis carolinensis*) is found in Southeastern United States. It is not a true chameleon, but changes color under changed conditions of light and temperature. From ashy grey it will turn to a dull yellow or a vivid green. Its food is meal-worms and flies and it drinks dew from leaves. It reaches a length of six inches.

Sub-Order Ophidia.¹ (Gr. *ophis*, a snake.)—Snakes have a

¹ Much of the material on snakes in this text has been compiled from R. L. Ditmars' *Reptiles of the World and Reptile Book*. Doctor Ditmars has inspected a part of the MS.

bifid protrusible tongue, frequently fanged, movable, displaceable maxillary and palatine bones, numerous vertebrae, movable ribs and ventral scutes. They lack tympani, Eustachian tubes, sternum, and appendages. Their eyelids are fused. The lungs are asymmetrical, some species having a degenerate right and others a degenerate left lung. The urinary bladder is absent and the urine, chiefly uric acid, as in birds, solidifies in the air. The temperature of snakes varies from 68° to 84° Fahrenheit.

“The limbless serpent can outclimb the monkey,
 Outswim the fish,
 Outleap the zebra,
 Outwrestle the athlete,
 And crush the tiger.”

(Owen.)

The *yellow-headed worm snake* (*Glauconia albifrons*) reaches a length of eight inches. It lives in ant hills and is a formidable enemy of termites.

The *Boidae* (*pythons* and *boas*) have vestigial hind legs, a pair of strong movable spurs attached to vestiges of the pelvic bones. Among the common pythons are the *regal python*, which may reach

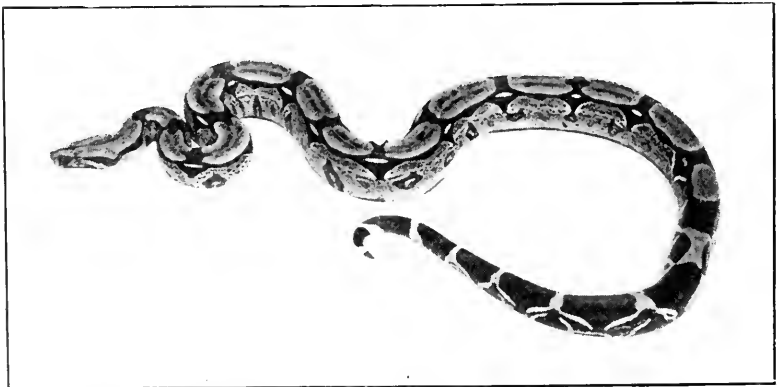

FIG. 172. West Indian boa. (Courtesy of N. Y. Zool. Soc.)

a length of thirty feet, and can swallow a small antelope; and the smaller *Indian python*, which is much used in side-shows, as it is easily tamed. The *Anaconda* or *water boa* is extremely vicious. It is viviparous, Ditmars recording one specimen that gave birth

to thirty-four young, each one twenty-seven inches in length and an inch in diameter. (Figure 172.)

The *common boa* (*Boa constrictor*) reaches a length not greater than 11 feet. It is a native of tropical South America. Easily tamed it is used by "snake-charmers," although its smaller size renders it less thrilling to audiences, fearful lest they miss the sight of a snake tightening its coils on its tamer. Ditmars relates a case of a brood of 64 young. Other boas include the vicious Cuban boa, the common American rubber boa, and the Indian sand boas. The

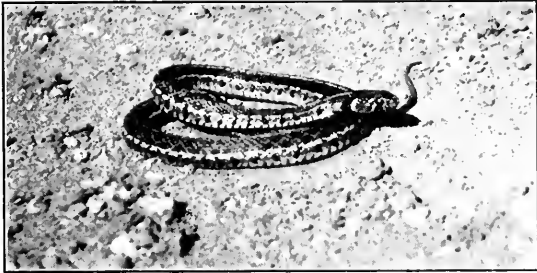

FIG. 173. *Thamnophis marciana*. (Courtesy of A. G. Ruthven.)

brown sand boa or two-headed snake (*Eryx johnii*) has a round stumpy tail, sometimes painted with "eyes" by the Hindoos, who claim that one end of the animal watches while the other sleeps.

The sub-family *Colubrinae* includes the majority of snakes. All of this family lack poison glands and hollow fangs. (Figure 173.) The *Eastern ribbon snake* is a beautiful reptile, reaching a length of 3 feet. It feeds on fishes and amphibians. The garter snakes (*Eutania*) are all prolific viviparous forms, and are beneficial for the most part. The *water snakes* (*Tropidonotus*) are sometimes quite vicious but are non-venomous. The *brown water snake* is the largest, reaching a length of 5 feet. An *Indian water snake* (*T. macrophthalmus*) spreads its neck and was mistakenly brought in by the natives when the British first offered a bounty for the hooded cobra. The *Indian rat snake* of the Malay peninsula is protected by a fine, as a rat exterminator. It reaches a length of 8 feet. The *American black snake* (*Zamenis constrictor*) is not a constrictor, but holds its prey to the ground under a coil. It destroys small rodents, but occasionally eats amphibians and young birds.

The family *Colubridae* include a number of large snakes killing

by constriction and feeding entirely on mammals and birds. They are of tremendous importance in destroying injurious rodents. The *pilot black snake* (*Coluber obsoletus*) is found from New England to Florida and ranges west of the Mississippi. It hibernates with the timber rattler. The *chicken snakes* (*Coluber o. quadrivittatus*) are feared by poultrymen as enemies of young fowls and as egg eaters, but destroy more than enough rodents to pay their way.

The *hog-nosed snake*, blowing viper or *puff-adder* (*Heterodon platyrrhinus*) is a most sinister reptile. When alarmed it flattens the anterior portion of its body, hisses, shakes the tail and darts its head here and there. It feigns death on some occasions, rolling on its back and becoming limp. It will not bite.

The *common king snake* or *chain snake* (*Ophibolus getulus*) ranges from Southern New Jersey to Florida and westward to the Pacific coast. Although a deadly enemy of the poisonous snakes of America and apparently immune to their venom, Ditmars found that when injected with the poison of the Cobra, they died within the hour. The king snake is cannibalistic but is extremely fond of rodents. A large king snake may be 6 feet long. The animal, although such an enemy of other reptiles, is easily tamed by man. The *milk snake* (*Ophibolus doliiatus*) is found in the Northeastern states. It frequents barns, hunting for mice, and has been mistakenly thought to rob the dairy, although it has never been caught "milking the cows." The *ring-necked snake* (*Diadophis regalis*) found west of Illinois is the largest of the genus. It lays eggs which are so thin skinned that they hatch in half the time required by other snake eggs. It lives under flat stones and in dead trees and feeds upon earthworms, salamanders, young lizards and snakes. The *scarlet king snake* (*Cemophora coccinea*) is found in the southeastern part of the United States. Its chief interest is that it is confused with the deadly coral snake. The scarlet snake feeds on mice and reptiles. It is oviparous and coils around its eggs until they are hatched.

The *Opisthoglypha* are not as poisonous as the *Elapine* and *Viperine* snakes, since they have furrowed or grooved fangs, located at the extreme rear of the upper jaw. Ditmars, however, emphasizes the fact that their venom acts on the nerves and that it will kill a lizard more quickly than the bite of a viper.

The *annulated snake* (*Sibon septentrionalis*) of Africa and the tropical Americas, and the *pike-headed snake* (*Oxybelis acuminatus*)

of Mexico and South America, are opisthoglyphs that feed on lizards.

The *Proteroglypha* include two sub-families, the *Hydrophinae* which are marine forms, and the *Elapinae* which include Old World Cobras and the New World coral snakes. Their fangs are hollow and connected with venom glands secreting powerful poison. The fangs are rigidly attached on the anterior portion of the upper jaw instead of folding back against the roof of the mouth as in the *viperine* snakes.

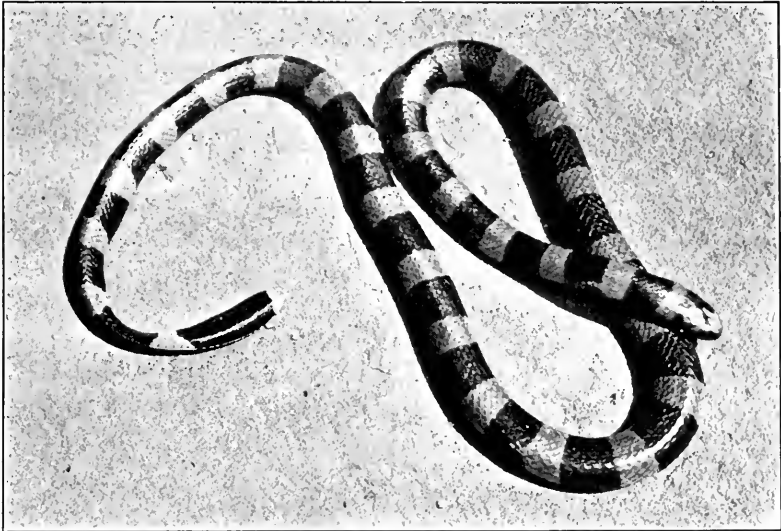

FIG. 174. Sea snake. (Courtesy of N. Y. Zool. Soc.)

One of the *Hydrophinae*, the *yellow-bellied sea snake* (*Hydrus platurus*), is found in salt water off the coast of Central and tropical South America. The sea snakes swim in schools of 20 or more. They are preyed upon by fish and sea birds. Their venom is extremely powerful and produces a numbing of the nerve centers. (Figure 174.)

The *Elapine* snakes have a slender body and a narrow head. Their fangs are short, always erect and situated on the anterior portion of the jaw. But one genus of these reptiles is found in America.

The *Spectacled Cobra* or "Cobra-de-Capello" (*Naja tripudians*) is found in India and the Malay Archipelago. Although the fangs

are extremely small, their wounds are more quickly fatal than those of the vipers with large teeth. Spectacled cobras are said to be most vicious when in captivity, apparently proving untamable. Ditmars states that cobra venom ejected and entering the eyes will produce blindness or death. Cobras feed on small rodents, birds and amphibians and can swallow eggs entire. They reach a length of over 6 feet. (Figure 175.)



FIG. 175. Asp. (Courtesy of N. Y. Zool. Soc.)

The *Egyptian cobra* or Asp (*Naja haje*) is a smaller snake than the spectacled cobra, reaching a length of not more than five feet. It is extremely intelligent and startlingly quick in its movements.

The *king cobra* or Hamadryas (*Naja bungarus*) reaches the length of 12 feet. It is said to be the most deadly of the Old World

snakes. Apparently tamable, it is most treacherous. Cobras are oviparous. In 1927, there were 19,069 deaths from snake-bite in India. Cobras and kraits were chiefly responsible.

The *Ringhals* (*Sepedon haemachates*), a South African cobra, reaches a length of five feet. It feeds on amphibians, birds and their eggs, and small rodents. It ejects jets of poison six feet. The *krait* (*Bungarus coeruleus*) is an extremely dangerous snake found in Asia and the Malay Archipelago. It has no hood. It reaches a length of 4 feet.

The *Australian black snake* (*Pseudechis porphyriacus*), an extremely venomous snake, is sometimes called the purple death adder. (See p. 328, Snake Venoms.)

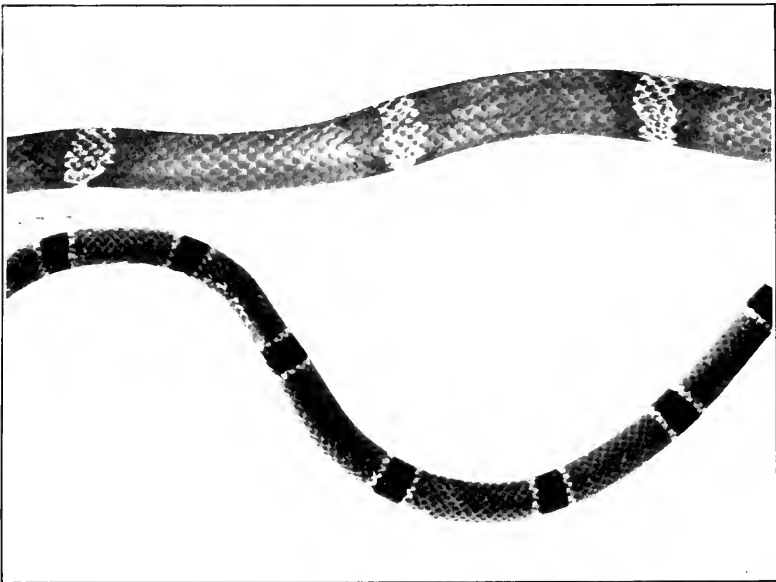

FIG. 176. Body rings of false coral snake and true coral snake. (Courtesy of Antivenin Institute of America.)

Several species of *Doliophis* are found in Southeastern Asia. The venom-secreting glands are not confined to the head but extend through the anterior one-third of the body. Due to this strange variation, the heart is located more posteriorly than in other snakes.

About 26 species of the New World *Elapine* snakes are known, two of them being found in Southern United States. The two

species of Elaps found in the United States resemble harmless forms including the Western milk snake and the scarlet king snake.

The poisonous snake (Figure 176) has single black rings bordered with a pair of yellow rings while in the harmless species the yellow rings are single bordered with a pair of black rings. The *harlequin snake* or *coral snake* (*Elaps fulvius*) is found in our Southern States and ranges into Mexico. It is cannibalistic but very fond of lizards, which seem quite susceptible to its poison. Coral snakes seem quite gentle and do not "strike" but certainly do bite and chew vigorously. They are oviparous and according to Ditmars the eggs require as much as *thirteen weeks* for development.

Family Viperidae.—The viperine snakes are *long fanged* with small vertical movable maxillaries each bearing an extremely long hollow fang. Each maxillary has a lever bone aiding in the elevation of the fang. When the jaws are closed, the fangs of the vipers fold against the roof of the mouth. The majority of the viperine snakes have thick bodies and flattened heads, the pupils resembling those of a cat eye.

Certain of the true vipers (*Sub-family Viperinae*) are horrific in appearance while others found in South Africa are according to Ditmars "Moderately slender with an ordinary head while the eye has a round pupil and there is a loreal plate (between the eye and the nostril) as seen in the typical harmless snakes."

The *Cape viper* (*Causus rhombeatus*) has relatively small fangs which are lifted at will. Cape vipers are found in Southern Africa, reaching a length of about 3 feet. Unlike vipers in general, this form is *oviparous*. It feeds on frogs, apparently without using its poison fangs. The *common viper* (*Vipera berus*) is found all over Europe and is the only poisonous snake found in the British Isles. It feeds on rodents and young birds. The *sand natter* (*Vipera ammodytes*) is found in Southeastern Europe. A soft horn about one-eighth of an inch in length protrudes from its snout. It reaches a length of two feet and is extremely dangerous. It feeds on small rodents.

The *Daboia* or *Russell's viper* (*Vipera russellii*) is one of the most deadly snakes of India. The *Puff adder* (*Bitis arietans*), found in Africa, hisses loudly at each breath. The *gaboon viper* (*Bitis gabonica*) of tropical Africa will stand its ground when surprised, hissing viciously. Ditmars calls it "the most sinister of all the venomous snakes, in its aspect." The *horned viper* or *asp*

(*Cerastes cornutus*) is a small African desert species with a sharp spine above each eye.

The *pit vipers* (Sub-family *Crotalinae*) have a deep pit between the eye and the nostril. (Figure 177, A and B.)

The *water moccasin* or *cotton-mouth snake* (*Agkistrodon piscivorus*) is a semi-aquatic form found in the Southeastern United States.

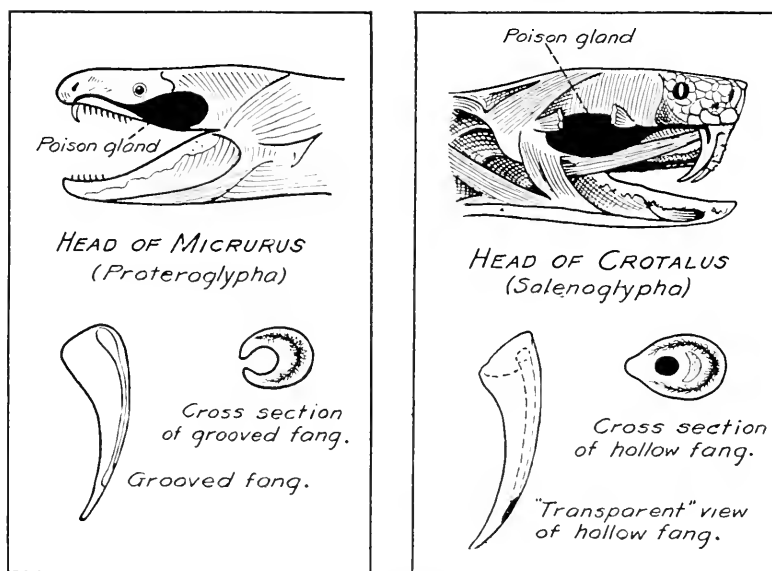

FIG. 177. Fangs and head of coral snake (*Micrurus*) and rattler (*Crotalus*). (Courtesy of Antivenin Institute of America.)

It reaches a length of six feet. It is omnivorous, devouring fishes, amphibians, other reptiles and small birds and mammals. Death may ensue in one-half hour after the bite of an adult specimen. (Figure 178.)

The *copperhead snake* (*Agkistrodon contortrix*) is found east of the Mississippi River, ranging South from Massachusetts. It occurs as far west as Texas. It is not extremely vicious although one of the most venomous of forms. Its food includes amphibians, small birds, and rodents. It is viviparous and produces as many as a dozen young at a birth. (Figure 179.)

The *bushmaster* (*Lachesis mutus*) is found in Central and tropical South America. Reaching a length of ten feet, it is said to be the

only Crotaline snake that lays eggs. Ditmars cites a case of death in less than ten minutes after an eight-foot bushmaster had bitten a man.

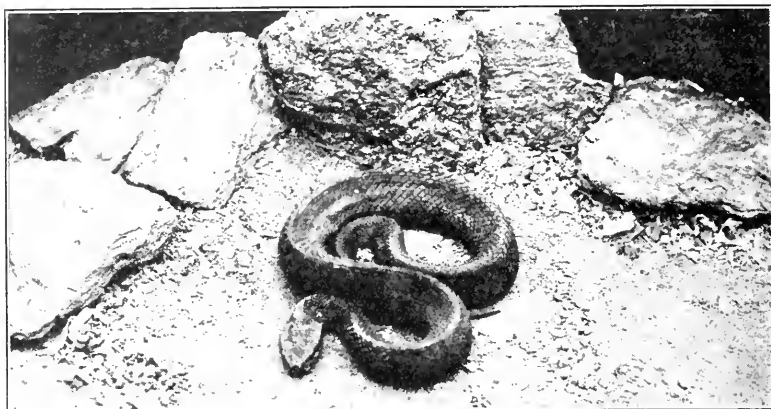

FIG. 178. Cotton mouth (water) moccasin, *Agkistrodon piscivorus*. (Courtesy of Antivenin Institute of America.)

The *fer-de-Lance* (*Lachesis lanceolatus*) is found ranging from Southern Mexico into South America. On the Islands of Martinique and Guadeloupe it is much feared by workers on sugar plantations.

In Honduras, the "*barba amarilla*" or *yellow beard*, an ally of

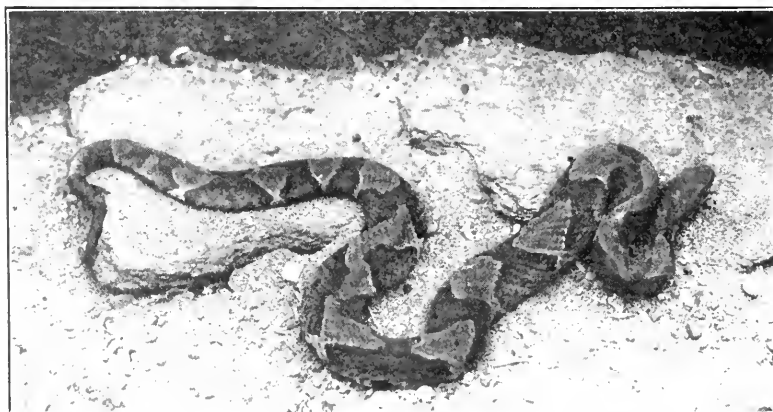

FIG. 179. Copperhead snake, *Agkistrodon mokasen*. (Courtesy of Antivenin Institute of America.)

the fer-de-lance of Martinique and the *jararaca* of tropical South America, is feared on account of its size (8½ feet) and the fact that it injects a teaspoonful of poison. (Figure 180.)

The *diamond back rattlesnake* (*Crotalus adamanteus*), found in the Southeastern part of the United States, grows to a length of eight feet and weighs more than any other poisonous form. Death ensues in less than an hour after its bite.

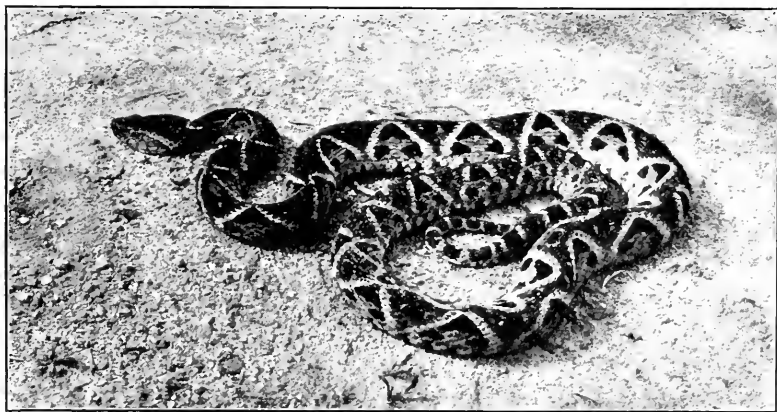

FIG. 180. *Barba amarilla*. (Courtesy of N. Y. Zool. Soc.)

Other rattlesnakes of the United States include the *pigmy* or *ground rattlesnake* of Southeastern United States, the *Massasagua* of the Central and Western states, the *Texas rattler* (6 feet long) (Figure 181), the *timber rattler* of the eastern mountains, and the *horned rattler* or *sidewinder* of the Western states. (Figure 182.)

Ditmars has recently described a ten-foot Honduran rattlesnake that produces paralysis of the neck muscles in a few minutes.

The *smallest* adult snake, a Syrian *Leptotyphlops*, is blind, lives in the sand and resembles in size and shape a steel knitting needle.

GENERAL CONSIDERATION OF REPTILIA

Distribution.—The Lacertilia are of wide distribution. The wall lizard (*Lacerta muralis*) is found from Belgium to North Africa. The Chelonia are found in the temperate and tropical regions for the most part. The sea-turtles are confined chiefly to the tropical seas. The Caimans are found in Central and South America, while

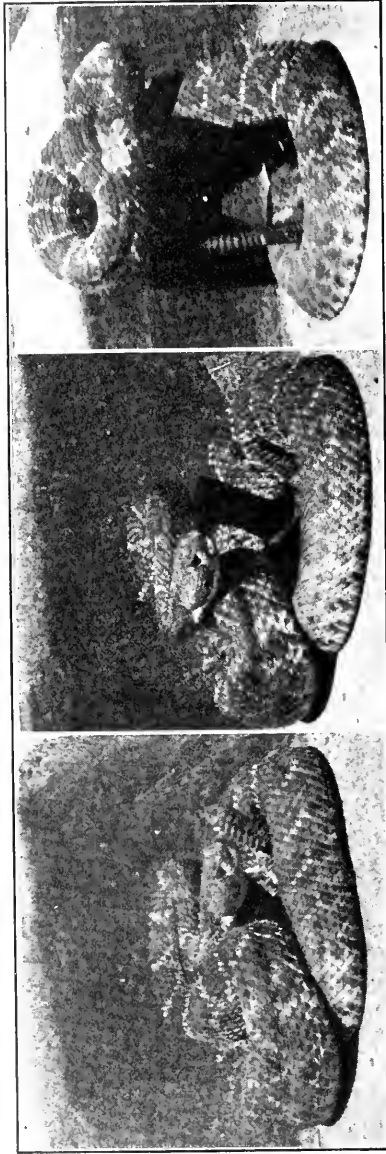

FIG. 181. The Texas rattler in three positions preparatory to striking. (Courtesy of Antivenin Institute of America.)

the alligators are found in North America and in China. The true Crocodiles of Africa and Asia have an American relative. The Snakes are widely distributed, the common grass snake (*Tropidonotus natrix*) ranging from Sweden to Algeria.

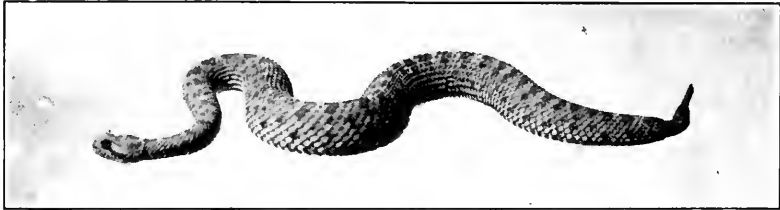

FIG. 182. The sidewinder or horned rattler (*Crotalus cerastes*). (Courtesy of Chas. Bogert.)

Anatomy and Locomotion.—The Reptiles vary from the limbless Snake to the Lizards and Crocodiles which have well-developed limbs and a powerful tail.

The oddest appearing forms are of course the Turtles. In the Chelonia both dorsal and ventral surfaces are covered by large horny plates. The scales are confined to the head, neck, limbs and tail. The Lizards and Snakes have horny plates covering their entire surface. In the skin of the geckos there are minute hard bodies intermediate between cartilage and bone. In the Crocodilia the whole surface is covered with horny plates underlaid with a pad of dermal connective tissue. In all Reptiles, except the Crocodilia, a periodical moult or ecdysis occurs. This casting of the old skin is done completely in Snakes and some Lizards, while in other Reptiles it is by degrees.

Lizards move by means of their limbs and tail. Snakes have an undulatory movement on land and are able to swim very well. The aquatic Chelonia utilize their legs very effectively in swimming. Crocodilia depend upon limbs and tail and are able to swim with rapidity. On land their activity is much reduced but they are surprisingly quick in seizing prey and in the use of their powerful tail.

Digestive System.—For the most part Lizards are non-poisonous. The Mexican beaded Lizards have grooved teeth and are supplied with poison glands. Snakes rarely have premaxillary teeth. The *vipers* have a single large curved hollow poison fang

with small reserve fangs at its base. This is moved to a vertical position when a snake opens its mouth to strike its prey. In the Chelonia there are no teeth but the horny jaws resemble a bird's beak. The Crocodilia have many conical hollow teeth on the premaxillae, maxillae and dentary.

The tongues of certain Lizards are forked and retractile as in Snakes. The *chameleon* has an extremely long club-shaped tongue. In Snakes the tongue is extremely slender and is utilized as a tactile organ. Some hold that it is sensitive to *sound vibrations*.

In the esophagus of *turtles* there are large horny recurved *papillae*. Crocodilia and Chelonia have a gizzard-like stomach. In Lizards and Snakes a rudimentary *cecum* is found at the anterior end of the *large intestine*.

Respiratory System.—In the Snakes and some snake-like Lizards there is a great reduction in the size of the *left lung*. Chameleons have inflatable air-sacs which enable them to puff up and startle their enemies. The Crocodilia and Chelonia have large and well-developed lungs.

In the Crocodilia the nostrils are at the upper end of the snout and can be closed by two valves. In front of the *choanae*, two soft "palatal folds" shut off the mouth from the pharynx. When a crocodilian is drowning its prey, it can push the glottis anteriorly to meet the posterior nares, and then respire comfortably.

Old male gavials have a cartilaginous hump containing air which, situated at the tip of the snout, enables them to remain under water longer than younger animals.

SUPERFICIAL DIFFERENCES BETWEEN THE CROCODILIA

Alligator.	Crocodile.
Exposes four points above water when floating—the eyes and the nostrils.	Exposes snout and neck crest when floating.
Fourth tooth from front bites into socket in upper jaw; in older animals it may pierce jaw and show from above.	Fourth lower tooth from front projects slightly outward and fits into grooved notch in outer edge of upper jaw.
Makes nest of sticks and grass.	Makes nest in sand.
Less active and vicious.	More active and vicious.

The *caimans* may have a blunt snout like the alligator or a pointed one like the crocodile. They also have the fourth tooth of

the lower jaw fitting into a socket. The *gavial* has a decidedly long and pointed snout and the first and fourth lower teeth bite into grooves in the upper jaw.

Voice.—Snakes and lizards have no vocal cords, but hiss through the nose. Crocodilia roar and the tortoise of the Galapagos Islands bellows.

Circulatory System.—All Reptilia have a four-chambered heart, but with the exception of the Crocodilia the ventricular septum is perforated. The red corpuscles of snake blood are 22 microns long, approximately the same as in frog blood, but those of the lizard are about 16 microns in length.

Excretory System.—The kidneys are not always symmetrical in Reptiles, in the Snakes for example being elongated and band-like. The kidneys of Lizards are fused in the mid-line. A urinary bladder (usually bi-lobed) is found in Lizards and Chelonians, but is lacking in Snakes and Crocodiles. The urine is rich in salts and solidifies quickly on reaching the air as in the case of birds.

Reproductive System.—Fertilization is internal in the Reptilia, which have either a bifid or a median solid penis. Many Lizards and the majority of Snakes are viviparous but the Crocodilia and Chelonia are oviparous.

Care of the Young.—Crocodilia and Chelonia deposit their eggs in nests of sand or twigs and grass, and return to them periodically. The female python protects her eggs by coiling around them, her *temperature rising* several degrees during the process to promote hatching.

Nervous System and Sense Organs.—In the Reptilia the brain has distinctly advanced from the amphibian type. The cerebral hemispheres have developed greatly but the cerebellum remains small. The eyes are large and the ears well developed, except in the Snakes where a middle-ear is absent. Tactile, olfactory and gustatory senses are well developed. The Turtle is surprisingly sensitive to taps on its shell.

Rattle of the Rattlesnake.—Several species of snakes, including the bushmaster and the copperhead, have a large horny spine at the base of the tail. In the rattlesnake after the first year, three moults occur annually and at each moult a new rattle is formed. Considering the first ring to represent the first year, the age of a rattlesnake may be determined by allowing three rings for each year. The possibility of accidental loss of a segment or two must of course be considered.

Poisonous Reptiles.—With the exception of the beaded Lizards, the Lacertilia are not poisonous. A Bornean Lizard, *Lanthanotus*, is suspected of being poisonous. *Heloderma* produces painful swellings in man, but its venom has no hemolytic action.

The salivary glands of Snakes are differentiated into organs for the formation of powerful poisons. In the Australian black snake they *act on the blood*, causing intravascular clotting; some of this class also contain hemolytic substances. The arterial and venous walls are broken down and the blood oozes out. Gangrene may set in. Cytolysins act on red cells, white cells and the endothelium of the blood vessels.

The other class, typified by the cobra, *cause a paralysis of respiration*. According to Cushney and Yagi, the action of cobra venom is like that of curare in that it paralyzes nerve endings. Noguchi states that in the case of cobra venom toxic action must be ascribed to neurotoxin. Poisoned animals suffer from motor paralysis.

The chief local effect produced by rattlesnake and water moccasin venom is, according to Noguchi, the escape of red blood corpuscles from the vessels. Hemorrhages are not restricted to the site of the injection of the venom. Animals killed with snake venom decompose rapidly because of the decrease in bactericidal power of the blood, caused by the venom.

Toxicity.—According to Barbour the common laboratory standard of toxicity² is the minimal lethal dose per pigeon. The poison of sea-snakes which is dangerous to man instantly kills fish. Turtles are almost as susceptible to all venoms as fish. Worms, Insects and Echinoderms are only slightly susceptible to snake venoms. While snakes and frogs quickly succumb to cobra venom, they are relatively insusceptible to the bites of rattlers and moccasins. The digestive juices destroy most snake venoms, but poisons of the cobra, the Old World Vipers, and the Australian black snake are resistant.

² Philpott (Proc. Soc. for Exp. Biol. and Med., vol. 26, pp. 522-523, 1929) has shown that the venom of the Texas rattlesnake (*Crotalus atrox*) in dilutions of 0.00025 gm. per cc. had an immediate lethal effect on *Paramecium caudatum*, *Stentor coeruleus* and *Bursaria truncatella*. Action was slow in effect on *Volvox spermatosphera* and *Oxytricha fallax*, and was only temporary and slight in *Chilomonas paramecium*. *Coleps hirtus*, *Podophyra fixa* and *Dileptus gigas* were unaffected. The minimum lethal dose of *Agkistrodon piscivorus* (moccasin) for *Paramecium caudatum* was 0.0000014 gm., and for the venom of the fer-de-lance (*Bothrops atrox*) was 0.0000125 gm.

Treatment of Snake Bite.—If administered very soon after the person is bitten, *anti-venin serum* is effective. A tight ligature, preferably of rubber, should be placed above the wound, but must not be left on more than half an hour at a time or gangrene will set in. The wound should be cut open with a knife or razor blade and may be sucked although this is unsafe if a person has sores in his mouth. A strong potassium permanganate solution is injected or poured upon the wound and serum is administered if available. After the first few moments potassium permanganate is not effective.¹ Subsequent treatment should include the draining of a wound for two weeks at least.

Most engineers and explorers now carry into territory where rattlers and moccasins abound, *antivenins*, a little vial of *potassium permanganate crystals*, a scalpel or razor-blade to cut open the wound, bandages, and a *tourniquet*. However, if one wears boots or puttees, he is usually quite well protected. Hypodermic injections of strychnine are useful as a stimulant. It is held by some that small doses of alcohol are beneficial. This is a pernicious belief, as the administration of alcohol is likely to hasten death by distributing the venom more rapidly in the blood vessels. Caffeine (strong coffee) and strychnine are beneficial in relieving from giddiness and stupor.

Susceptibility of Snakes to Poison.—The snake is not poisoned by amounts of digitalis fatal to the frog. Its tissues are not susceptible, as isolated hearts behave the same. Cayenne pepper, fresh slaked lime and powdered sulphur are worthless as snake repellents. Snakes are immune to tear-gases and to poison gases including phosgene and chlorin. They are, however, susceptible very quickly to *chloroform* and also to *mustard-gas*.

Do Mother Snakes Swallow their Young?—This question is one that has often been propounded. There is absolutely no doubt that snakes do swallow other snakes and that they may even, when alarmed, swallow their own young. Many people have testified to seeing the old snake swallow little ones, but no one has ever reported the interesting phenomenon of the little snakes returning to the light of day. Perhaps they do!

¹ Dr. A. M. Reese is studying the effects of potassium permanganate on mammals receiving injections of snake venom that would ordinarily be toxic.

Some Superstitions That Exist Regarding Snakes.³—

- “1. Snakes do not suck or milk cows. This is next to a physical impossibility and science has no authentic record to prove it true.
- “2. Hoop snakes do not exist. Substantial rewards have been offered for specimens and a demonstration of ‘rolling’ but no one has tried to claim the reward.
- “3. Snakes do not charm birds but cause them to become so excited or nervous that they lose reason or instinct of protection. This is especially true of nesting birds.
- “4. When a snake is killed some vital organ or organs stop functioning, but all cells are not killed. These living cells function by reflex action for a varying period of time dependent on the kind of cells, and not dependent on the action of the sunlight.
- “5. Snakes do chase people, especially the blue racer. It is, however, a coward and will run equally fast in the opposite direction if the pursued become the pursuer.
- “6. Snakes do not sting or bite with any part of the body except the teeth. The tongue is sensory in function, being the seat of the senses of touch, taste and perhaps smell.
- “7. No snake or part thereof has any medicinal property which cannot be found in some other material. For instance sweet oil is just as good as rattler oil, and not as repulsive to most people. This belief has been imposed upon the people by ‘fakes’ or ‘quack doctors.’ They are not even considered by reputable physicians.
- “8. Green is not a warning color against poisonous snakes.
- “9. Snakes are blind only during the process of molting or when the old skin is loose and is being shed because a new skin has developed underneath.
- “10. A horse-hair rope will not act as a barrier to a rattlesnake. This has been demonstrated many times by actual test.”

Fossil Relatives. Super-Order I. Cotylosauria.—Geologically the oldest known reptiles, appearing in the Carboniferous and disappearing in the Triassic. Skulls completely roofed, with no lateral temporal vacuities. Pelvis, flattened. Resembled Stegocephalia in presence of pectoral cleithrum. Heavy neural arches. Example: Seymouria.

³ By permission of R. D. Casselberry from the Pennsylvania State College, Correspondence Study Department, Zoölogy 35 C, Lesson 7.

Super-Order II. Chelonia. (Gr. *chelone*, a tortoise.)—Fossil relatives of the turtles include a Permian species *Eubotosaurus*, found in S. Africa, which had teeth and widened ribs.

Super-Order III. Therapsida. (*Anomodontia*, *Theromorpha*.) (Gr. *ther*, a wild beast; *morphe*, form.)—Single lateral temporal vacuity below post-orbital and squamosal. Brain case high, ear low, columella articulates with quadrate. Lower jaw flattened, with loosely articulated bones. Fossils found in Permian and to the Triassic age, chiefly from Africa and North America.

The Mammalia are supposed to have arisen from this order, possibly by way of the Theriodontia, which were carnivorous, with teeth resembling the incisors, canines and molars of mammals. The Monotremata (see p. 373) have been compared with the Theriodontia, in support of such a theory. Examples: (*Dicynodon*, *Cynognathus*, *Galepus*, *Ophiacodon*).

Super-Order IV. Sauropterygia. (Gr. *sauros*, a lizard; *pterygia*, fins.)—Aquatic reptiles with a single temporal vacuity, bounded by the post-orbital squamosal arch. Single coracoids, meeting in a ventral symphysis. The cervical region is extremely long, and the caudal portion of the spinal column is very short. Sauropterygia range from the Triassic to the Cretaceous.

Super-Order V. Ichthyopterygia. (Gr. *ichthys*, a fish; *pterygia*, fins.) (*Ichthyosauria*.)—Marine reptiles with a single lateral temporal vacuity, a large head, elongated jaws, teeth in grooves, no neck, and a long tail resembling a fish. They had two pairs of paddle-like limbs, no sacrum, primitive pelvis, no sternum, but well-developed abdominal ribs. They are of the Mesozoic age, ranging from the Triassic to the Upper Cretaceous.

Super-Order VI. Archosauria.—Several Orders belong to this super-order, which includes the reptiles that have two lateral temporal vacuities in the skull.

Order 1.—*Thecodontia* are the earliest Reptiles to show a diapsid skull with two lateral temporal vacuities.

Order 2.—*Rhynchocephalia* appeared in the Permian, with maximum development in the Triassic.

Order 3. *Dinosauria.* (Gr. *deinos*, terrible; *sauros*, a lizard.)—These Mesozoic land reptiles were among the largest, reaching a length of one hundred feet and a height of twenty feet. The earliest species, in the Triassic, were carnivorous. Another branch, the *Sauropoda*, include gigantic herbivores. A herbivorous branch, the

Ornithopoda, had a bird-like beak, and the *Orthopoda* had pneumatic bones and a bird-like pubis.

Order 4. Crocodilia.—Fossil *Crocodilia* are found in the Triassic strata. Huxley traced an “almost unbroken series” of *Crocodilia* from the Triassic down.

Order 5. Pterodactyla or Pterosauria. (Gr. *pteron*, a wing; and *sauros*, a lizard.)—The *Pterosauria* were adapted for flight, having a long neck and a pair of bat-like leathery wings. The bones were light and hollow, the breast bone was keeled. The earlier forms had sharp teeth. They varied in size from that of a sparrow to the *Pterodactyl* with a twenty-four foot wing stretch. The largest forms lacked teeth and had a short tail.

Order 6. Squamata.—The *Squamata* are geologically the most recent of the *Reptilia* now persistent.

Sub-Order (a). Lacertilia.—There are a few fossil lizards in the Jurassic, but the majority began with the Tertiary.

Sub-Order (b). Ophidia.—Fossil snakes appeared in the Tertiary strata.

Sub-Order (c). Pythonomorpha.—These extinct forms had a snake-like body with paddle-like limbs used in swimming. They reached a length of over fifty feet (*Mososaurus*). The skull resembled that of the *Lacertilia*.

Adaptations of Reptilia.—The **Crocodilia** have protective bony plates in the skin, sharp teeth, strong jaws and a muscular tail. A valve in the throat shutting off the mouth from the pharynx (see p. 326) enables them to submerge their prey and still breathe with ease. The **Chelonia** have a strong compact box-like shell and powerful cutting jaws. Large lungs enable them to remain under water for some time. **Lacertilia** have rapid locomotion. In some protective coloration is evident. The long tail is a storehouse for food and in many species is broken off and left when enemies are pressing. **Ophidia** have displaceable jaw bones and loose ribs, permitting the animal to swallow prey larger than itself. The *glottis* is anterior to the mouth, enabling the snakes to breathe while swallowing. The teeth are recurved so that the prey cannot escape. Snakes kill by crushing or utilizing *poison glands*.

Economic Importance of Reptilia.—**Crocodilia** furnish skins that are used in the manufacture of shoes, bags, pocket books and belts. They feed on fish and in the case of the Asiatic and African crocodiles, destroy many human lives. The flesh of crocodiles is said to be

unpalatable on account of its strong musky flavor. (Clark.) Alligators are occasionally eaten by the Southern negroes. **Lacertilia** are important in the extermination of injurious insects and some species (iguana) are utilized as food. **Ophidia** are in general beneficial in exterminating harmful rodents and insects. The poisonous snakes are relatively few, but cause twenty-five thousand or more deaths annually, most of them in India.

REFERENCES ON REPTILIA

- BARBOUR, T. 1926. Reptiles and Amphibians. Houghton Mifflin Co.
DITMARS, R. L. 1907. The Reptile Book. New York.
DITMARS, R. L. 1910. Reptiles of the World. New York.
REESE, A. M. 1915. The Alligator and its Allies. New York.
SURFACE, H. A. First Report on the Economic Features of the Turtles of Penna. Zool. Bull. of the Dept. of Agr. of Penna., Harrisburg, Aug.-Sept.
SURFACE, H. A. 1907. The Lizards of Pennsylvania. Bull. of the Dept. of Agr. of Penna., Harrisburg.

CHAPTER XVIII

AVES

BIRDS are more highly specialized in structure and habits than even the mammals. They, like the insects, are perfectly adapted to flight. Geological records and some vestigial structures (scales) indicate the close relationship of birds to reptiles.

So widely distributed are birds and so familiar to our sight and hearing, that it is difficult to conceive of a civilization without them, or what would happen to that civilization, did they not exist. Economically, birds are of the greatest significance, since they not only serve as food, but are the most important agencies in keeping insects from utterly destroying the food of men. More than 23,000 species of birds have been described. They have been classified according to types of bills and claws and in some cases from their colors and habits. The classification is variable and unreliable.

Subclass I. Archeornithes.—Fossil birds.

The fossil, reptile-like birds belonging to the genus *Archeopteryx* are quite evidently connecting types between the reptiles and the birds. (See *Fossil Relatives of Birds*, page 370.)

Subclass II. Neornithes.—Recent birds.

Among the more recent birds, there are two Orders that exist as fossils, and will be described later, under the heading of *Hesperornithiformes*, and *Ichthyornithiformes*. (See page 371.)

The remainder of the Subclass *Neornithes* will be arbitrarily divided into two divisions, the running birds, called *Ratitae*, and the flying birds, or *Carinatae*.

NATURAL HISTORY

DIVISION A. THE RATITAE

The *Ratitae* are the *running* birds with reduced wings. Examples: ostrich, emu, cassowary, rhea.

Characteristics.—1. Raft-like or keelless breast bone.

2. Wings rudimentary or not large enough for flight.

3. Foot two-toed, large leg fitted for running.

The *ostrich* reaches a height of 6 to 8 feet and may weigh 450 pounds. Its single stride when running is 25 feet and it runs 60 miles per hour, but in circles, and is easily caught. It uses its two-toed feet in defense and can kick a horse to the ground. Ostriches do not hide their heads in the sand, but they do thrust them into the sand in search of water which they frequently find. The eggs are said to contain as much food as 24 hens' eggs. African savages utilize the egg shells as containers. Ostrich plumes are extremely valuable or less so according to the fashion dictated by milady. High tariff, overproduction, and post-war depression, caused the price of feathers to drop from \$14 to less than \$4 a pound. There are now about 250,000 birds on African ostrich farms. In the United States, ostriches have been bred since 1882. The plumes are plucked or clipped twice a year. (Figure 183.)

The *emu* is an Australian form next to the ostrich in size. It lacks the ornamental wings and tail plumage of the ostrich. The *cassowaries* inhabit Australia and the Malay Archipelago. They have long silky plumage and live in thickly wooded regions. Sometimes they take to the water for bathing. The female cassowary is larger than the male. Both sexes are black. The plumage is made into rugs, mats and head ornaments. The *rheas*, the New World ostriches, live on the pampas of the Argentine Republic, Southern Brazil, Bolivia and Paraguay. Their wings are better developed than those of the ostrich. They flap them as they run.

The *elephant birds*, now extinct, were existent in Madagascar 400 years ago. They were flightless and about 7 feet tall. Their eggs, found in Madagascar, are 13 x 9 inches with a capacity of two gallons. A single *Aepyornis* egg was equal to 12 ostrich eggs, 288 hens' eggs, or 500,000 humming-bird eggs. The natives of Madagascar claim that elephant birds are still left in the interior, but this is doubted. The *moa* (*Dinorthiformes*), now extinct, lived in New Zealand 500 years ago. It was like the ostrich, but with heavier bones and rudimentary wings. The *kiwis* of New Zealand belong to the genus *Apteryx*, and are not completely wingless. They are probably related to the cassowaries. Their voice is a shrill sound—**KI-WI**. The nostrils are at the tip of the bill. The male incubates the eggs which are about one-fifth the body weight of the bird.

Tinamous, which are found from South America to Mexico, are classed by some authorities near the ostriches and considered *Ratitae*; while others class them as an aberrant family of the order

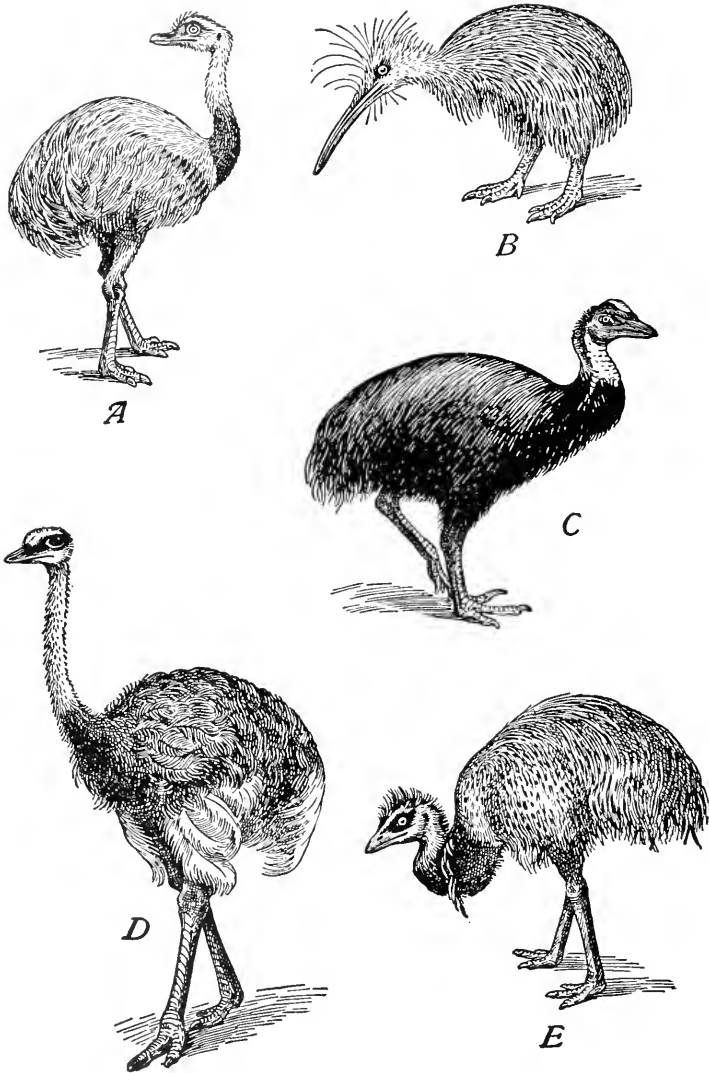

FIG. 183. Group of Ratite birds. *A*, Rhea, *Rhea americana*; *B*, the Kiwi, *Apteryx australis*; *C*, Cassowary, *Casuarus uniappendiculatus*; *D*, Ostrich, *Struthio camelus*; *E*, Emeu, *Dromaeus novaehollandiae*. (Newman, *Vertebrate Zoology*. Redrawn after Evans. Courtesy of The Macmillan Co.)

Galliformes, among the Carinatae. The wings are short and rounded; the keel of the sternum is well developed and the pectoral muscles large. The tail feathers are reduced. Strong, swift runners, they can rise, after considerable effort, to 150 feet and fly or plane a thousand yards. Probably the tinamous represents an intermediate condition between the flying birds and the running or flightless birds.

DIVISION B. THE CARINATAE

The Carinatae include most of our common flying birds.

Characteristics.—They have a keeled sternum and are for the most part fliers.

Classification (Modified from the A. O. U. Check List).—

- Order 1. Pygopodes—auks, grebes and loons, penguins.
- Order 2. Longipennes—gulls and terns.
- Order 3. Tubinares—petrels and albatross.
- Order 4. Steganopodes—frigates, cormorants and pelicans.
- Order 5. Anseres—wild geese and swans.
- Order 6. Odontoglossae—flamingo.
- Order 7. Herodiones—storks, herons, ibises, and spoon-bills.
- Order 8. Paludicolae—cranes, rails and coots.
- Order 9. Limicolae—plovers and snipes.
- Order 10. Gallinae—pheasants, pea-fowls, chickens, turkeys.
- Order 11. Columbæ—pigeons and doves.
- Order 12. Raptores—hawks and owls.
- Order 13. Psittaci—parrots and paroquets.
- Order 14. Cocyges—kingfishers and cuckoos.
- Order 15. Pici—woodpeckers.
- Order 16. Machrochires—humming birds, swifts, nighthawks, and whip-poor-wills.
- Order 17. Passeres—flycatchers, larks, jays, orioles, and grackles.

Order 1. Pygopodes.—*Loons* are large, often 24–28 inches long, and the most expert diving birds. Their cry is weird, laughing, loud and melancholy, resembling the dying wail of a person. The small European *grebe* is called the “dabchick” because it tucks its young under its wings when it dives to escape enemies. Grebes resemble penguins more than loons.

The “*Great Auk*,” once abundant on the islands north of Scotland and near Newfoundland, has been killed off, feathers being the

chief attraction. The eggs have been collected, resulting in no evidence of their presence, other than bones. The last living specimen was seen in 1844.

The *penguins* (Figure 184), marine birds found in the Antarctic seas, have paddlelike wings which work from the shoulder in a rotary fashion. The legs are set far back, and the feet are used for steering, not propulsion. Penguins have almost waterproof feathers. Their plentiful subcutaneous fat produces a marketable oil. The male aids in incubating the eggs which require 6 weeks to hatch, and the young are blind.

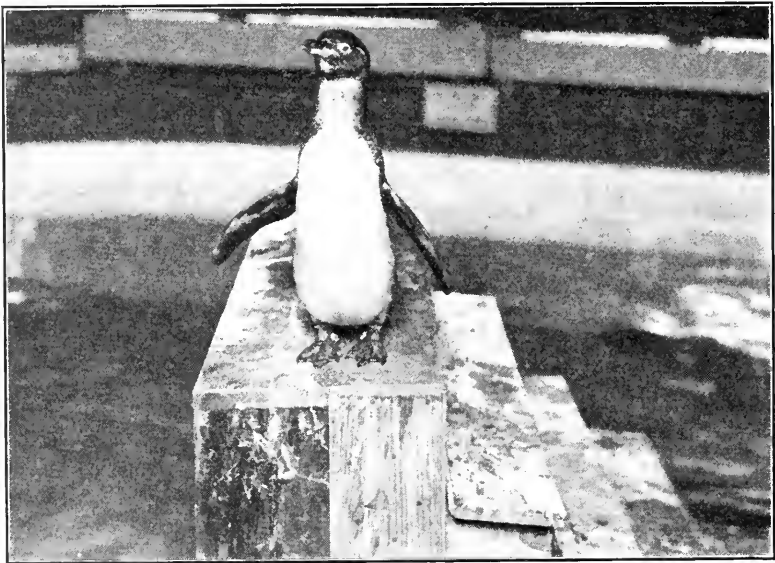

FIG. 184. Galapagos penguin. (Courtesy of N. Y. Zool. Soc.)

Order 2. Longipennes.—*Gulls* (Figure 185, *A* and *B*) are aquatic, mainly oceanic, of medium size, with long pointed wings and webbed feet. They are scavengers of the ocean, feeding from the surface. **Terns** are more active than gulls. Their bodies are slender and they have long-forked tails and pointed bills. They nest on islands in colonies.

Order 3. Tubinares.—The *petrels*, “Mother Carey’s Chickens,” are widely ranging sea birds of moderate size with long narrow wings and a hooked bill. The “stormy petrel,” the smallest of

web-footed birds, is deemed a prophet of rough weather. The *albatross*, immortalized by Coleridge in his "Rime of the Ancient Mariner," is one of the largest of the flying birds with a wing stretch of from twelve to fifteen feet and may weigh twenty pounds. It is able to fly and soar for hours. The *gannets* are sea birds frequenting the colder regions, coming ashore during stormy weather.

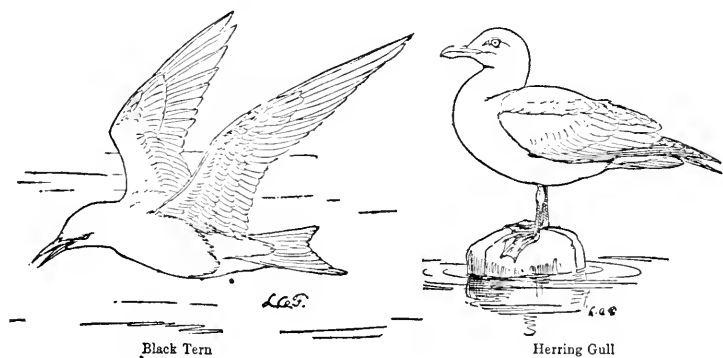

FIG. 185. A, black tern. B, herring gull. (From L. A. Fuertes. Courtesy of Slingerland-Comstock Publishing Co.)

Order 4. *Steganopodes.*—The *cormorants* are large sea-coast birds. They are voracious fish eaters, coming to inland lakes during the breeding season. The Chinese tame them and use them in catching fish. The *darters* or "snake birds" are not marine, but frequent inlets of the sea and fresh water lakes. They excel as divers, but are poor flyers. The *frigate birds* or "man-of-war birds" are true sea birds, only coming to shore to nest. They have long wings, and an extremely long tail. Their legs are weak, but they are remarkable flyers. The *pelicans* are large tropical birds. The large bill and lower jaw are provided with large *pouches* in which are stored fish. They are known to many by their stubby tail and short legs. (Figure 186.)

Order 5. *Anseriformes.*—The *swans* are large birds, graceful in form and movement. They are pugnacious and quarrelsome. Their voice is "like a blast from a French horn," but musical when given by a large flock in chorus. The *trumpeter-swan* is white. The *geese* are intermediate between swans and *ducks* in some characteristics, especially in the length of the neck. (Figure 187.) Some *ducks* are feathered brilliantly. One of the most handsome

is the male *mandarin duck*. Diving birds can remain under water about one minute. *Eider ducks* are natives of the north and are the best known and most valuable of the duck family. Many eider ducks are slaughtered to secure the much prized breast feathers,



FIG. 186. Pelican. (Courtesy of E. R. Sanborn and N. Y. Zool. Soc.)

“eider-down.” The *mergansers*, or fish ducks, differ from true ducks in having more slender bodies, grebe-like necks, and long compressed bills with serrated edges. They are fish eaters and hence not as edible as other ducks, but are much sought by hunters on account of their “quick-get-away.” (Figure 187, *A, B, C, D.*)

Order 6. *Odontoglossae.*—*Flamingoes* are large, long-legged, long-necked birds with pink plumage. They are good flyers, but are better known as waders. They scoop up fish and shell-fish, straining them out as the water and mud pass through holes in the lower part of their beak.

Order 7. *Herodiones.*—*Hérons, ibises,* and *storks* bear a strong resemblance to one another. The *ibis* fed on snails in the Nile, and was worshipped. (See *Schistosoma*, page 77.) The long legs, collapsible necks, and flapping wings of storks are well known to all children. The stork migrates long distances. (See p. 366.)

The *spoonbill* is stork-like with a spoon-shaped bill that easily captures insect prey, larvae, fish, frogs, etc. It is found in the tropics. The *tropic birds* are found in the tropic oceans, flying hundreds of miles from land and taking refuge on ships or floating debris. (Figure 188.)

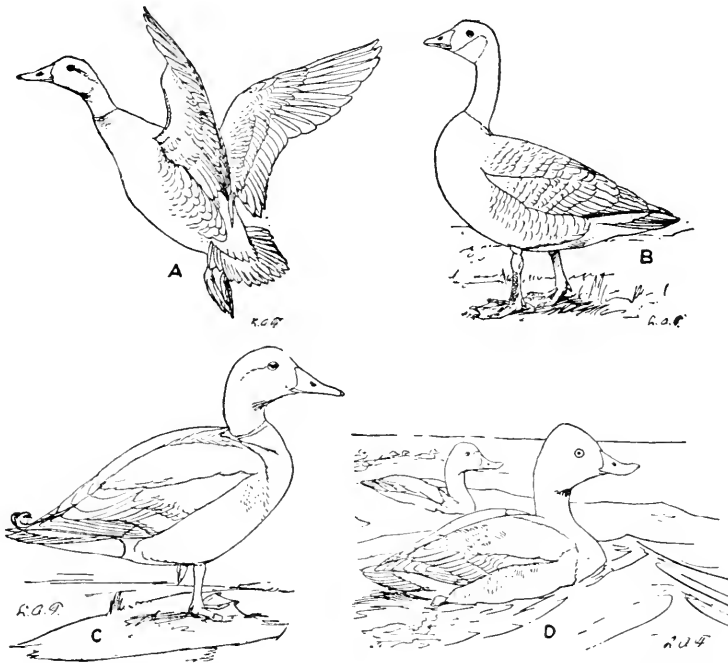

FIG. 187. A, black duck. B, Canada goose. C, greater scaup. D, mallard ducks. (From L. A. Fuertes. Courtesy of Slingerland-Comstock Publishing Co.)

Order 8. Paludicolae.—The *sandhill crane* is the most abundant and largest of this species found in America. The *great bustard* is the largest of European birds, being about 45 inches long and weighing about 30 pounds. It looks like a goose, but has a head and bill resembling the crane. The *sun bitterns* are small, like the rails, with short legs, thin neck, a large head and a long, pointed bill. The head is sunk on the body, when at rest, giving the bird a neckless appearance. The *rails* resemble the quail and the plover. (Figure 188, A, B, C, D.)

Order 9. Limicolae.—The *Limicolae* are marsh and shore birds, with long necks, long slender bills, rather long slender legs, short tails

and wings. They are usually brown or gray, with blotches of white. The hind toe is, with one exception, lacking or extremely short. There are about 75 species of these mud-dwellers in the United States.

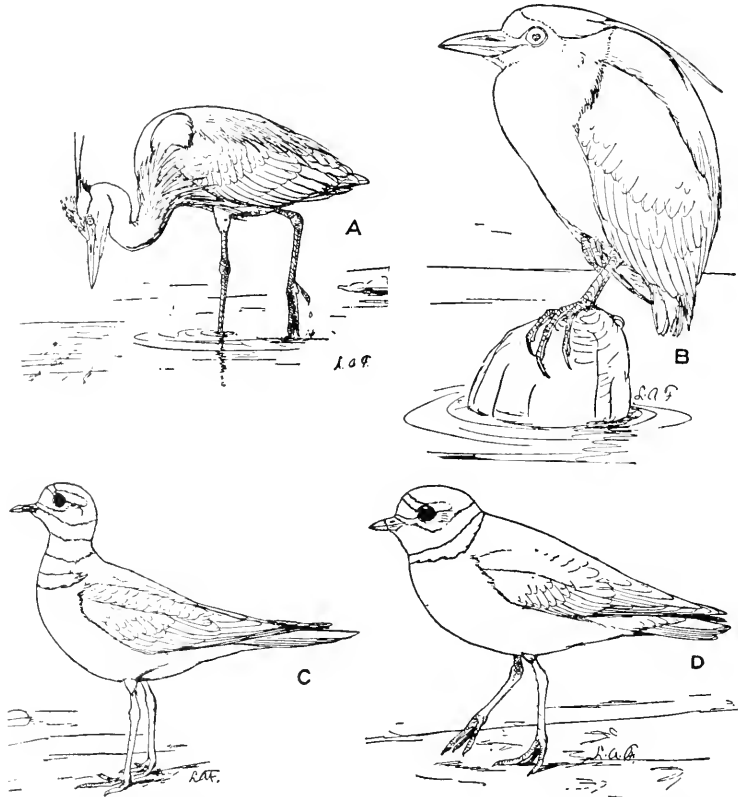

FIG. 188. A, great blue heron. B, night heron. C, killdeer. D, ring-necked plover (From L. A. Fuertes. Courtesy of Slingerland-Comstock Publishing Co.)

The *phalaropes* are small in size with lobed toes. The female is more brilliantly colored than the male (which is uncommon in birds) and does the courting. The male incubates the eggs. The *plover*, or *killdeer*, is one of the most beautiful of the shore birds, being found along inland pools and ponds. The *American golden plover* is found along the seashore and frequenting the banks of tide pools. It migrates tremendous distances. (See p. 366.)

Other members of this order are the *American woodcock*, with its long sensitive, probe-like beak, used in procuring earthworms; the *Wilson's snipe*, the *sandpipers*, and the *curlews*.

Order 10. Gallinae.—This order includes two families of unfamiliar birds, the *brush turkeys* (*Megapodes*) of Australia and New Guinea and the *curassows* and *guans* (*Cracidae*) of tropical America.

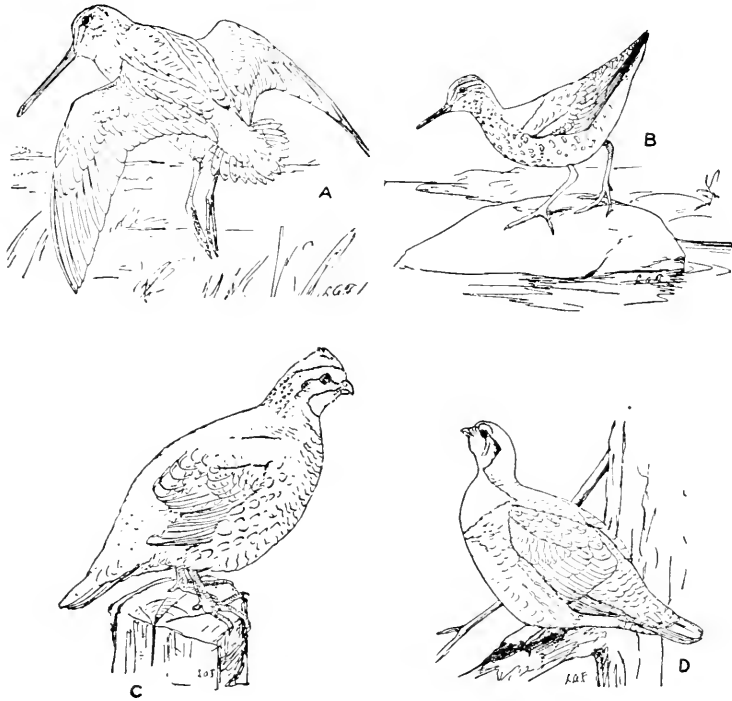

FIG. 189. A, snipe. B, spotted sandpiper. C, bob white. D, spruce grouse. (From L. A. Fuertes. Courtesy of Slingerland-Comstock Publishing Co.)

The *Gallinaceous* birds include the common fowl and game birds such as wild turkeys, grouse, partridges, bob-whites, and ptarmigans. The most highly specialized types are characterized by brilliant plumage, being the males of the *golden* and *Lady Amherst pheasants*, native to South China and Eastern Thibet.

The *common bob-white* or *quail* is an extremely important weed-seed and insect destroying bird. The *ruffed grouse* are strong flyers and their flesh is extremely palatable. Ruffed grouse are susceptible to the disease *tularemia*. *Wild turkeys* are still found in the East,

in Pennsylvania and West Virginia. *Ptarmigans* turn snow white in winter. *Pea fowls* are oriental birds, domesticated all over the world.

There are four distinct species of the *jungle fowls*, all native to the jungles of the Indo-Malayan regions. The *domestic fowl* has come from the red jungle fowl of this species. The *black breasted game fowl* has retained more than the others the original characteristics of its ancestors. The most different from the primitive is the *Japanese tosa fowl*, in which the tail feathers have been known to reach a length of fifteen feet, and also the Cochins, with their short, plump appearance and feathered shanks. (See p. 494, Domesticated Animals.) The Greeks were addicted to the sport of cock- and quail-fights. The Chinese and Malays still have quail-fights. (Consult D'A. W. Thompson, "A Glossary of Greek Birds." Oxford, 1895.)

Order II. Columbæ. (*Pigeons, doves.*)—The **dodos**, recently extinct, were large, peculiar looking pigeons. Pictures of them, and their bones, prove them to be odd looking, short, plump with an eagle-like beak and very little plumage. The *true pigeons* are a large family widely distributed. The best known are the carrier pigeons, rock pigeons and the great crowned pigeon. The *rock pigeon* or rock dove is the species from which most fancy breeds of domestic pigeons have come. When they are allowed to interbreed freely the offspring revert to the characters of their wild ancestors.

Homing pigeons were used by the Greeks who probably learned the art of training pigeons from the Persians. The Sultan established a message system using pigeons, which lasted in Bagdad from 1150 to 1258. Homing pigeons were used in transmitting messages by the Roman general Decimus Julius Brutus who was then besieged by Mark Antony. During the World War the combatants used over five hundred thousand homing pigeons, the American Army utilizing twenty thousand. Our homers are equipped by the Signal Corps with "pigeon whistles" to frighten away hawks.

The *passenger pigeons* (Figure 190) once lived in flocks of enormous numbers. Wilson, an early American ornithologist, estimated one flock to include *two billion* individuals.⁴ The last passenger pigeon, hatched in the Cincinnati Zoo, died there on

⁴ A town in Michigan marketed (1869-1870) in two years 15,840,000 pigeons. Hornaday. (Our Vanishing Wild Life.)

September 1, 1914, at the age of twenty-six years. The passenger pigeon had a pointed tail and nested several feet from the ground.

The *mourning dove* is a beautiful bird, and although it has a square tail is sometimes confused with the passenger pigeon. It is an important enemy of weed seeds. It nests on or near the ground.

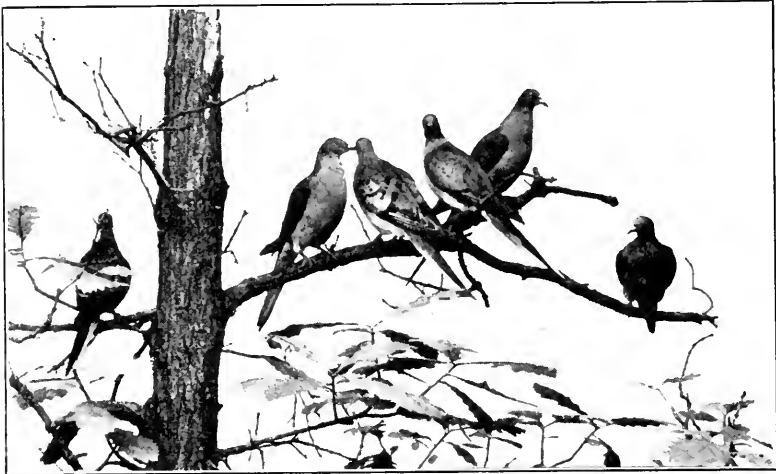

FIG. 190. Passenger pigeons. (Courtesy of Field Museum of Natural History.)

Order 12. Raptores.—Eagles, hawks, falcons, owls and condors are characterized by hooked sharp beaks, strong talons, large crop and markedly predaceous habits.

The *golden eagle* has dark brown plumage. It is nearly one yard long, with a wing spread of nearly seven feet. It destroys poultry, young deer, and small mammals. It is still found in the Rockies. The *American*, or "*bald*" eagle, our national bird, has a white head and tail in its fourth season. It lives along rivers and feeds on fish, although it is not above the occasional capture of a lamb. (Figure 191.)

The *sharp-shinned hawk* and *Cooper's hawk* (Figure 192) are the common hawks most responsible for the loss of game and poultry, while the *duck hawk* is extremely destructive to water fowl. *Sparrow hawks* and *pigeon hawks* are important enemies of the English sparrow, and beneficial rodent exterminators, but attack some valuable birds.

The *American goshawk*, a native of Canada, coming to the United States only in the winter, is a bold destroyer of game birds, especially the ptarmigan. It has been known to escape with a freshly killed chicken or even to follow the owner into the house and



FIG. 191. Eagle family. The female is ripping up a fish to feed to her three eaglets, whose white heads are ranged before her. The inbending of the left foot of the male, seen taking off in the air, was due to an old wound. He was wantonly killed in the following November. Vermilion, April 27, 1924, at about six in the evening. By F. H. Herrick. American Eagle Series of Western Reserve University.

snatch it from the table (Fisher). It reaches a length of twenty-five inches. The ancient sport of *falconry* is being revived somewhat abroad and in the United States, and goshawks are the favorite "falcons." In Turkestan, sparrow-hawks, goshawks, buzzards,

kites and eagles have been used in falconry for centuries. Golden eagles are used to hunt foxes for their pelts.



FIG. 192. Young Cooper's hawk. (Courtesy of W. E. Rumsey and A. J. Dadisman.)

REFERENCES ON FALCONRY

- BLANC, M. E. 1895. Hunting with birds of prey. *Pop. Sc. Mon.*, vol. 47, no. 6, pp. 818-823, Oct.
- FUERTES, L. A. 1920. Falconry, the sport of kings. *Nat. Geog.*, Dec.
- GOODMAN, G. G. 1920. Falconing. *Nat. Hist.*, July-Aug.
- LATTIMORE, O. 1929. The desert road to Turkestan. *Nat. Geog.*, June.

The *Turkey buzzard* (see Figure 193 C), seen in most of the Southern States, is valued by man on account of its importance as a scavenger. Laws once existed in some Southern States protecting the buzzard. It is suspected of carrying the germs of *hog cholera*.

The *Andean condor*, the *Californian condor* and the *king vulture*, all members of the group *Falconiformes*, are notable in their ability

to soar for hours. This capability has baffled physicists interested in the problems of aviation.

The *secretary birds* are the strangest of the birds of prey. They

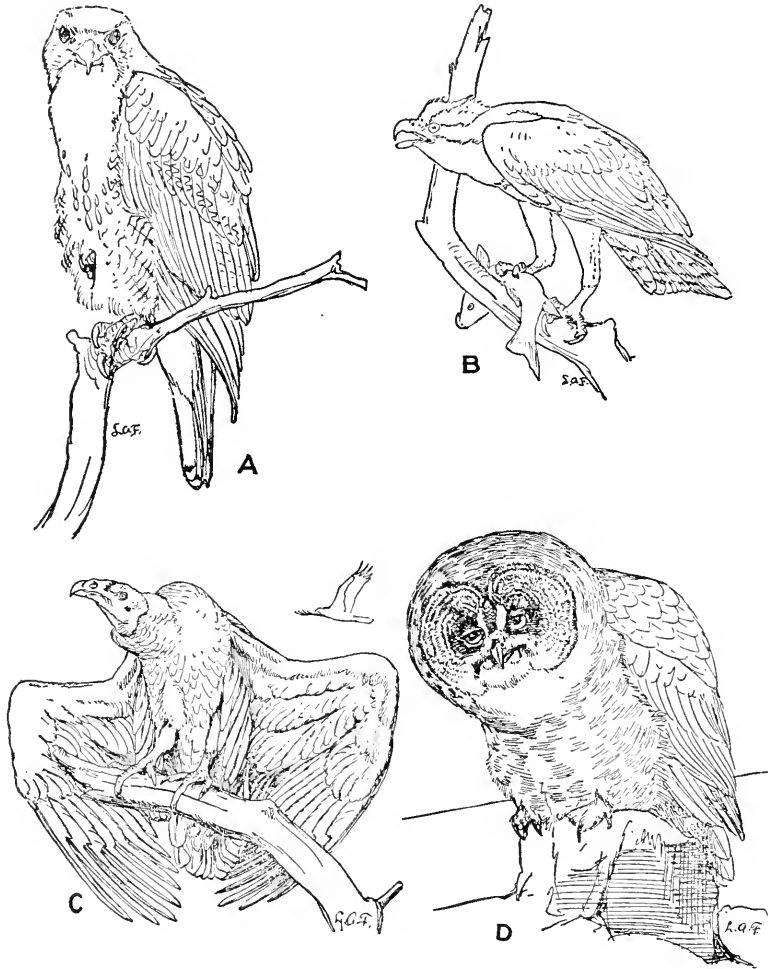

FIG. 193. *A*, red-tailed hawk. *B*, osprey or fish hawk. *C*, turkey buzzard. *D*, great gray owl. (From L. A. Fuertes. Courtesy of Slingerland-Comstock Publishing Co.)

are long-legged, standing about four feet high and with great speeding ability. They are fond of snakes, but will eat lizards, frogs,

and insects. Distending a stiff wing, they receive the bite of a snake, stun the reptile and kill it.

There are eighteen species of *owls* in the United States. Among the commonest forms are the *barn owl*, the *long-eared owl*, the *barred owl*, the *great gray owl*—an Arctic bird never found south of the Ohio River, and the *screech owl*. The *great horned owl*, sometimes called the “tiger of the air,” is a bloodthirsty game killer. Besides killing poultry, it is of great importance as a destroyer of rodents. It is the *only owl* that can be considered an *enemy* of man. The *snowy owl* comes from the Arctic zone to the Northern part of the United States in the winter. It feeds upon wild game and rodents, but avoids poultry yards. The *burrowing owl* is found in prairie dog holes in the Southwestern states. It does not prey upon the “dogs” but avoids them and their companions (?) the rattlesnakes. Burrowing owls are able to dig their own holes, and certainly do not go down into homes already occupied.

Order 13. Psittaci. (*Parrots and paroquets.*)—The *parrots* are brilliantly colored with great ability to mimic. They live to a great age (seventy-five years) and learn to talk quite readily. At times they display remarkable memory for certain expletives uttered by their owners in moments of stress. The *African Gray parrot* with a red tail is the best talker. The *brush-tongued parrots*, found in Australasia, have an odd “brush” at the end of the tongue, adapted to feeding on honey. The *paroquets* are extremely small parrots found in the United States, in Florida. They feed on fruit and seeds. The *macaws* are large scarlet and blue birds with long pointed tails and horrible voices. The *hyacinthine macaw* of Brazil feeds on nuts of the palm, macuja, crushing them by means of its powerful beak. The *cockatoos* are usually snow-white, with long triangular erectile crests. They are frequently trained for vaudeville exhibition. A giant black species from New Guinea with a slender cylindrical tongue, and an enormous beak, is able to open the excessively hard “canary nut.”

Order 14. Cocyges.—The *cuckoos* are best known from their peculiar habit of placing eggs in other birds’ nests. Instead of building a nest of her own, the female lays the egg on the ground, then carries it in her bill to some other nest. This parasitic habit belongs to the *Old World Cuckoo*, for the American cuckoo builds its own nest.

The **Coraciae** are sub-orders having affinities with the cuckoos

and the sparrows. They include the *kingfishers* and the *horn-bills*.

The *horn-bills* are large birds using their enormous bills in walling up nests. The male seals up the female in a hollow tree, feeding her through a small aperture. The *kingfisher* family includes three species in the United States. It nests in a hole dug horizontally into a bank of earth. Its food consists almost entirely of small fishes. The *belted kingfisher* is an enemy of trout and other fry at fish hatcheries.

Order 15. Pici.—The *woodpeckers* and *sapsuckers* are the most familiar of our native birds. There are about twenty-five species of American woodpeckers. The *flicker*, or *golden-winged woodpecker*, is a large bird which perches crosswise on limbs like the true perchers. It is also called the “yellow hammer” or “high-hole.” Its stomach contents show over fifty per cent *insect food*, about forty per cent vegetable food, chiefly berries and *seeds*. The *red-headed woodpecker*, immortalized in Longfellow’s “Hiawatha,” is a showy creature with a brilliant crimson head and neck, white breast and black back and tail. Its food consists of ants, beetles, *weed-seeds* and fruits. It is particularly fond of beech-nuts. The *downy woodpecker* and the *hairy woodpecker* consume about seventy-five per cent insect food and about twenty-five per cent vegetable food, mostly weed-seeds and wild fruits. The *yellow-bellied sapsucker* injures trees by girdling them. It drinks the sap exuding from its neatly formed squarish holes. In New England some orchard owners protect their trees with fine wire netting. This form is the most migratory of our woodpeckers. *Toucans* have enormous bills which, however, are extremely thin and light in weight.

Order 16. Machrochires.—The Machrochires include the whip-poor-will, night hawk and chimney swift which are exceedingly valuable as enemies of both day and night flying insects. (Figures 194 and 195.)

The *humming-birds* feed on insects and spiders and on the sap of trees in holes prepared by the sapsucker, as well as upon the nectar of flowers. Humming birds, although small, are exceedingly brave and pugnacious, and one pair of them will attack and drive to flight hawks and large snakes. The *swifts* are less attractive than humming birds and are often mistaken for swallows. They have a broad bill and wide mouth like the goat-suckers.



FIG. 194. Rufous hummingbird on nest. (Photo by W. L. and Irene Finley. Courtesy of National Park Service.)

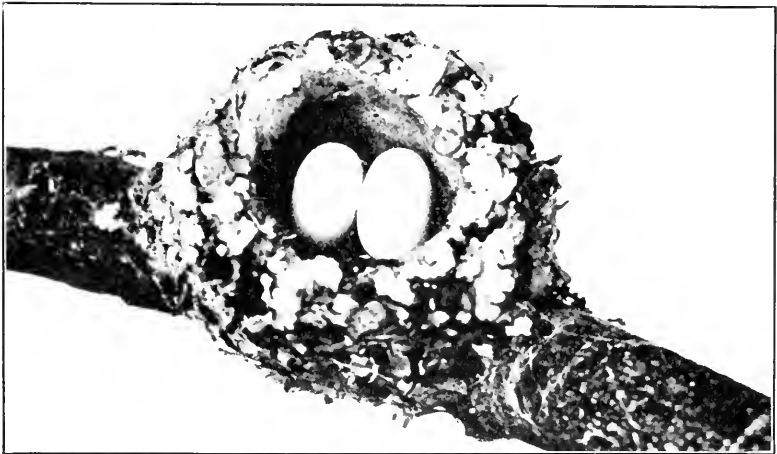

FIG. 195. Nest and eggs of ruby-throated humming bird. (Courtesy of Fred E. Brooks.)

Order 17. Passeres.—This is the largest order of birds, containing over half the species. As the name indicates the forms are perching birds. The birds of paradise are the most brilliantly colored of the order. The *great bird of paradise* is the most beautiful of the species. The *lyre-birds* rival the birds of paradise in plumage construction, but are not so brilliant.

The *blue-birds*, *robins* and the *thrushes* (*Fam. Turdidae*) are important enemies of insects and worms. Robins are a bit injurious to cherries, since the dietary change offered by these (acid) fruits is so welcome to them. The *chickadee* (*Fam. Paridae*) is an extremely important enemy of insects, including aphids (plant-lice) and canker worms.

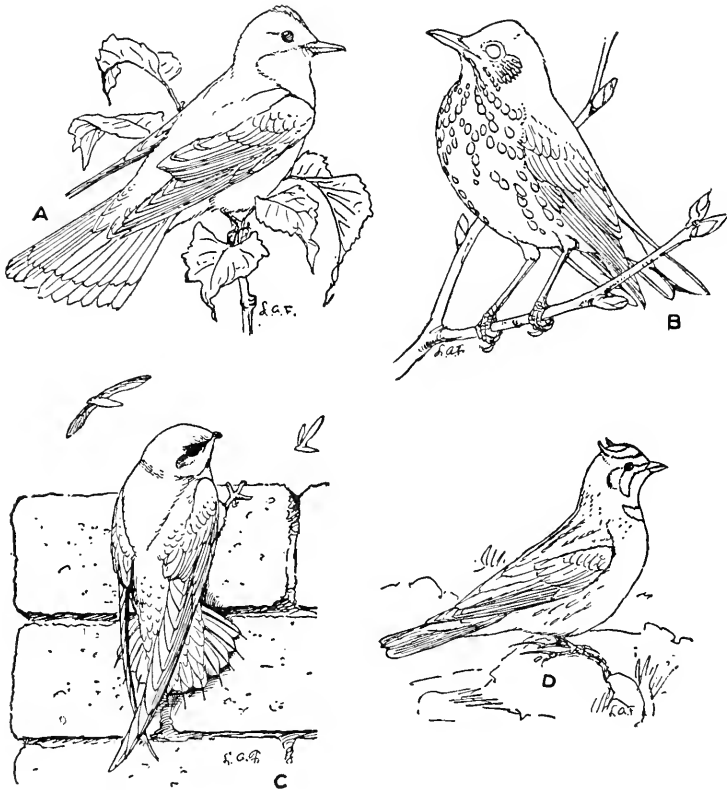

FIG. 196. A, kingbird. B, woodthrush. C, chimney swift. D, horned lark. (Courtesy of Slingerland-Comstock Publishing Co.)

The *crows* and *jays* (*Fam. Corvidae*) number over two hundred species. They eat fruits, insects, seeds and the eggs and young of other birds.

The *king-bird*, the *phoebe* and the *fly-catchers*, *crested* and *least* (*Fam. Tyrannidae*), are all extremely important insect destroyers.

The *king-bird*, however, is said to be an important enemy of honey bees.

Black-birds and *orioles* (*Fam. Icteridae*) are among the most beautiful of birds. The *bobolink* of the south is an enemy of rice fields. In the north it is considered one of our sweetest singers. The *orioles* are extremely beautiful birds with peculiar nests hanging down considerable distances from boughs. The *cow-bird* has the habit of laying its eggs in the nests of other birds, particularly sparrows and warblers.



FIG. 197. Young brown thrashers. (Courtesy of G. H. Roush.)

The *sparrows* and *funches* (*Fam. Fringillidae*) are all important destroyers of weed-seeds. The *English sparrow*, however, which was introduced into America in 1851 has proved a menace to the eggs and young of our beneficial tree swallows.

The *shrikes* or *butcher birds* (*Fam. Laniidae*) are important enemies of English sparrows and rodents, but on account of their habit of killing the small forms like the chickadee and the wren, must be considered injurious. They impale the bodies of their victims on twigs.

The *swallows* (*Fam. Hirundinidae*) are extremely efficient insect destroyers. Their relatives, the *purple martins*, will readily take up their abode in bird houses. The *mocking-birds*, *thrashers* and *wrens* are beautiful singers and important enemies of insects. The *warblers* (*Fam. Mniotiltidae*) include over one hundred species, about seventy-five of which are found in the United States. They are important enemies of insects.



FIG. 198. Whitebreasted nuthatch. (Courtesy of F. E. Brooks.)

THE ANATOMY AND PHYSIOLOGY OF BIRDS

No animal has feathers except the bird. "A bird is known by its feathers." Every part of the organization is modified for aërial life.

Characteristics.—1. Feathers.

2. Sternum and shoulder girdle enlarged to support wing muscles.

3. Forelimbs modified as wings.

4. Pelvic girdle and hind limbs adapted to support the body on the ground.
5. Respiratory system developed to produce a higher temperature than in any other animal.
6. Absence of teeth.
7. Loss of the left aortic arch.
8. Right ovary and oviduct lost.
9. Poorly developed olfactory organs.
10. Extraordinary development of the eyes.

Temperature⁵ is lower in most lowly organized birds. There is a progressive gradation to the higher birds. The apteryx or *kiwi*, a wingless bird of New Zealand, has a temperature of 37.9° C. (100.2° F.). The emu, cassowary and penguin have a temperature of 39° C., the sparrows and warblers from 42° C. to 44° C. (107.6° F.), the common fowl, 40.6° C. The average of sparrows is 109.9° F., which is 10° above the temperature of man. (Figure 199.)

Feathers have a hollow, transparent barrel, or quill, continuous with the shaft or rachis. The shaft is opaque, quadrangular in cross section and filled with a pithy substance. From the shaft above the quill arise lateral branches, known as barbs or rami. Barbs give off barbules and these in turn give off the barbicels which are hooked processes. The hooked processes produce the web and furnish it strength to resist or act upon the air. From the underside of some feathers at the juncture of the quill with the web-bearing portion is a secondary feather, the after shaft. There are three kinds of feathers: (1) Contour feathers (complete). (2) Down feathers, soft shaft, no barbs, serve to retain heat. Some have no shaft. (3) Filoplumes, degenerate, hairlike with few or no barbs.

Feathers are derived from cornification of the inner layer of the epidermis. The papillae consist of external epidermis and internal dermis, the latter furnishing nutriment to the growing feathers. Epidermal scales of the birds arise similarly from papillae.

Birds shed their old feathers. They molt in the fall and have a partial molt in the spring *breeding-season*. They acquire a new set of feathers from the follicles. Some also shed parts of their claws, bill and bill membranes. (Figure 200.)

⁵ For further data on temperature and color, see Knowlton's *Birds of the World*.

Color.—(1) The *chemical absorption* colors have coloring matter as a pigment or *coloring* solution. Colors thus produced are black, red, brown, orange and yellow, *rarely* green, and *never* blue. Certain red birds (plantain eaters, *Musophagidae*) lose their red color in the rain but regain it when dry. The pigment (turacin, a copper salt) stains the water into which the animal goes for a bath.

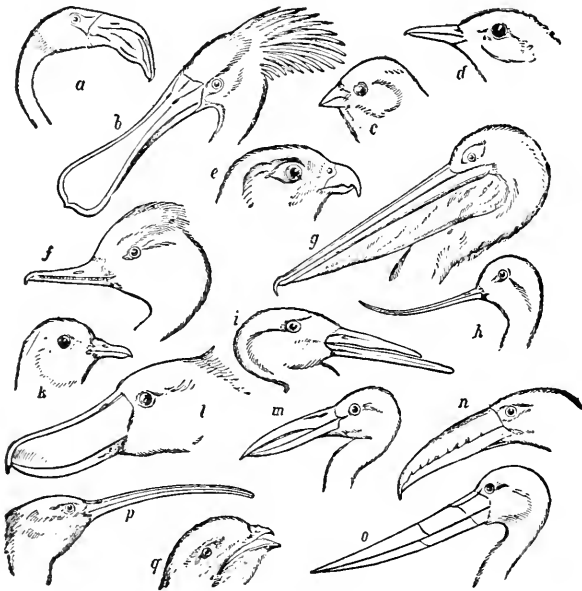

FIG. 199. Forms of beaks. After Claus. Forms of beaks (a, b, c, d, k, after Naumann; g, i, m, o, règne animal; l, from Brehm): a, *Phoenicopterus antiquorum*; b, *Platalea leucorodia*; c, *Emberiza citrinella*; d, *Turdus cyanus*; e, *Falco caudicans*; f, *Mergus merganser*; g, *Pelecanus perspicillatus*; h, *Recurvirostra avocetta*; i, *Rhynchops nigra*; k, *Columba livia*; l, *Balaeniceps rex*; m, *Anastomos coromandelianus*; n, *Pteroglossus discolor*; o, *Mycteria senegalensis*; p, *Falcinellus igneus*; q, *Cypselus apus*. (From Daugherty. Courtesy of W. B. Saunders & Co.)

(2) Another type of color production is by means of pigment combined with structural peculiarities, such as ridges and furrows in the surface of the feather itself. Thus we find produced blue, green usually, sometimes yellow. In transmitted light, feathers with *these* colors show the color of the pigment.

(3) *Metallic* colors are found in the humming birds, dove, grackle, starling, and peacock. The commonly accepted hypothesis is that

metallic colors are due to the structure of the surface of certain parts of the feathers such as *striae*, *ridges*, *knobs* or *pits*, in combination often with an extremely *colorless* layer, these elements acting as *prisms*. Dr. R. M. Strong believes that in the pigeon the *metallic* colors of the *neck* feathers are due to spherical granules of the transparent wall and terms them "plate interference colors" or Newtonian rings. Feathers are found only on certain feather tracts which differ in different species of birds.

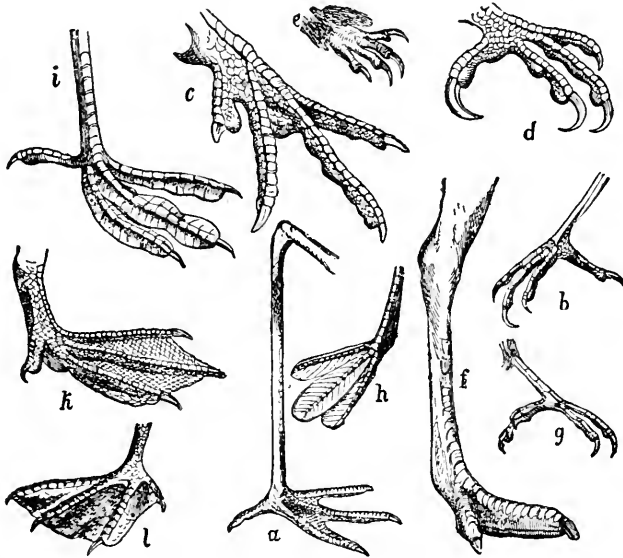

FIG. 200. Foot forms. *a*, semi-palmate, wading of *Ciconia*; *b*, perching of *Turdus*; *c*, rasorial of *Phasianus*; *d*, raptorial of *Falco*; *e*, adherent of *Cypselus*; *f*, cursorial of *Struthio*; *g*, zygodactyl (scansorial) of *Picus*; *h*, lobate of *Podiceps*; *i*, lobate and scalloped of *Fulica*; *k*, palmate of *Anas*; *l*, totipalmate of *Phaethon*. (From Schmarda. Hertwig-Kingsley. Courtesy of Henry Holt & Co.)

Skeleton.—The forelimbs and pectoral girdle (Figure 201) are modified for flight. The skeleton of the limb is rigid. The hind limbs and pelvic girdle are used for bipedal locomotion. The skeleton is permeated by air usually in ratio to the mode of life.

(1) Condors and cranes, soaring birds, have lightly built skeletons. (The snipe and the curlew have airless bones, but fly long distances.)

(2) Ducks and other water fowls have cavities of the long bones filled with marrow.

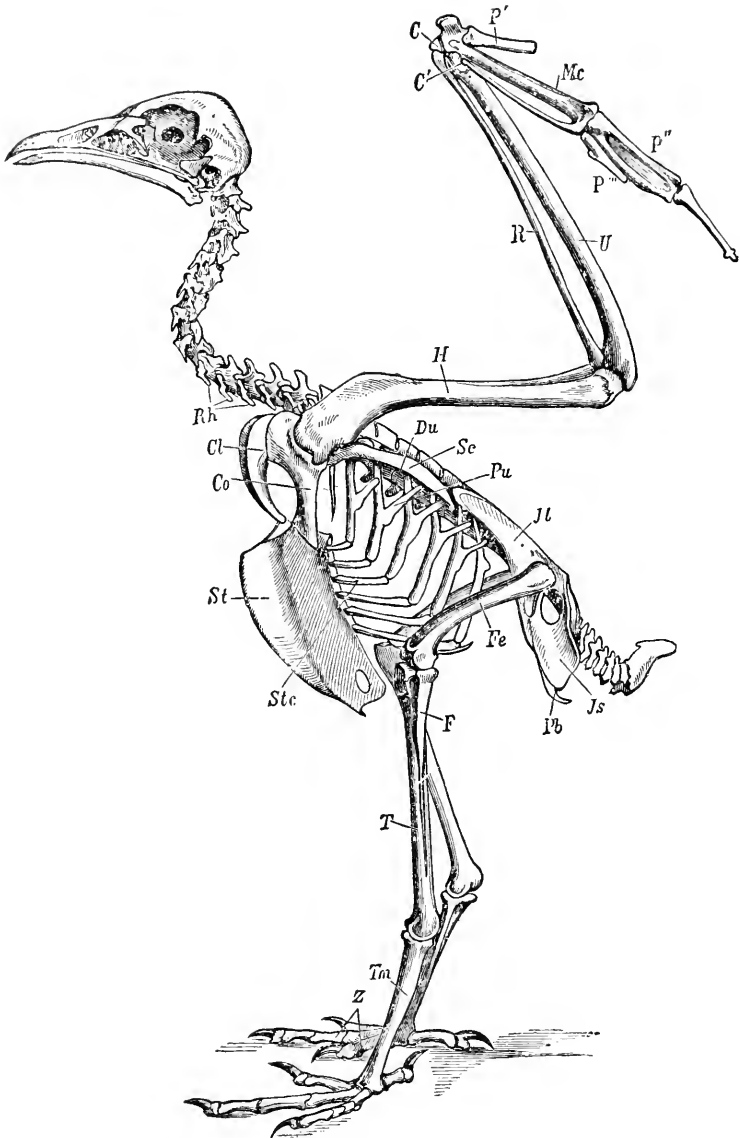

FIG. 201. Skeleton of an Egyptian vulture. *Rh*, cervical ribs; *Du*, inferior spinous process of the thoracic vertebrae; *Cl*, clavicle; *Co*, coracoid; *Sc*, scapula; *St*, sternum; *Stc*, sternocostal bones (sternal ribs); *Pu*, uncinat process of the thoracic ribs; *Il*, ilium; *Is*, ischium; *Pb*, pubis; *H*, humerus; *R*, radius; *U*, ulna; *C C'*, carpus; *Mc*, metacarpus; *P' P'' P'''*, phalanges of the three fingers; *Fe*, femur; *T*, tibia; *F*, fibula; *Tm*, tarso-metatarsus; *Z*, toes. (Claus-Sedgwick. Courtesy of Macmillan and Co., Ltd.)

(3) Bones of strictly aquatic birds are solid, being filled with bony tissue. The presence of air in the bones is believed to aid in oxygenizing the blood and in adjusting the air pressure when a bird descends rapidly from a great height.

A fossilized wing of a *pterosaur* recently sent to the U. S. National Museum from Oregon was so perfectly preserved that it was possible to determine the character of the bones. Instead of being hollow as in our modern fliers, the cavities of the bones were filled with light spongy tissue which served to strengthen them.

Digestive System.—The *mouth* is without teeth. (Vestigial teeth are present in some parrots.) The *tongue* is of various types: (1) Pointed, in the pigeon; (2) Long and protrusible, in the woodpecker; (3) Short, in parrots; (4) Sucking tubes, in the humming birds.

In birds we find that swallowing consists of violently jerking the head with an accompanying tongue pressure. There is no soft palate, and no epiglottis is present, but the larynx is protected by retroverted *papillae* at the base of the *tongue*. Insectivorous birds have a *pouch* at the base of the throat. In the nutcrackers there is a goitrous swelling in the throat, where the animal stuffs itself with nuts. The pelican's enormous bill holds 10 quarts of water.

The upper part of the *esophagus* has *buccal* glands, sometimes called *salivary glands*, used to moisten the food. The *crop* is a non-glandular sac in which the food is softened and macerated. Animal food may remain in the crop for 8 hours, and vegetable food may be retained for from 16 to 20 hours. Fruit and insect eating birds have no *crop*. The pigeon has a *double crop*. "Pigeon's milk" is formed in the *crop* and consists of proteins and oil, with no casein and no sugar of milk. It is a milky appearing fluid which mixes with macerating grains and is regurgitated for the young. The toucan regurgitates and chews over its food. The indigestible parts of the prey of the owl are regularly "cast" or regurgitated from the stomach. The lower part of the *esophagus* is a continuation from the *crop* to the *stomach*. The *proventriculus* has glandular walls, its gastric follicles secreting gastric juice. (Figure 202.)

The *gizzard* is thick and muscular, and is used to grind food. It corresponds to the pyloric end of the mammalian stomach.

The triturating agents are hard foreign bodies such as sand and gravel. Pigeons and other gallinaceous birds carry gravel to their young. It is necessary to have such in order to bruise the grains

and allow the gastric juice to act. Fowls can pulverize glass and some metals by grinding them in the gizzard.

The *small intestine* consists of the duodenum and the ileum.

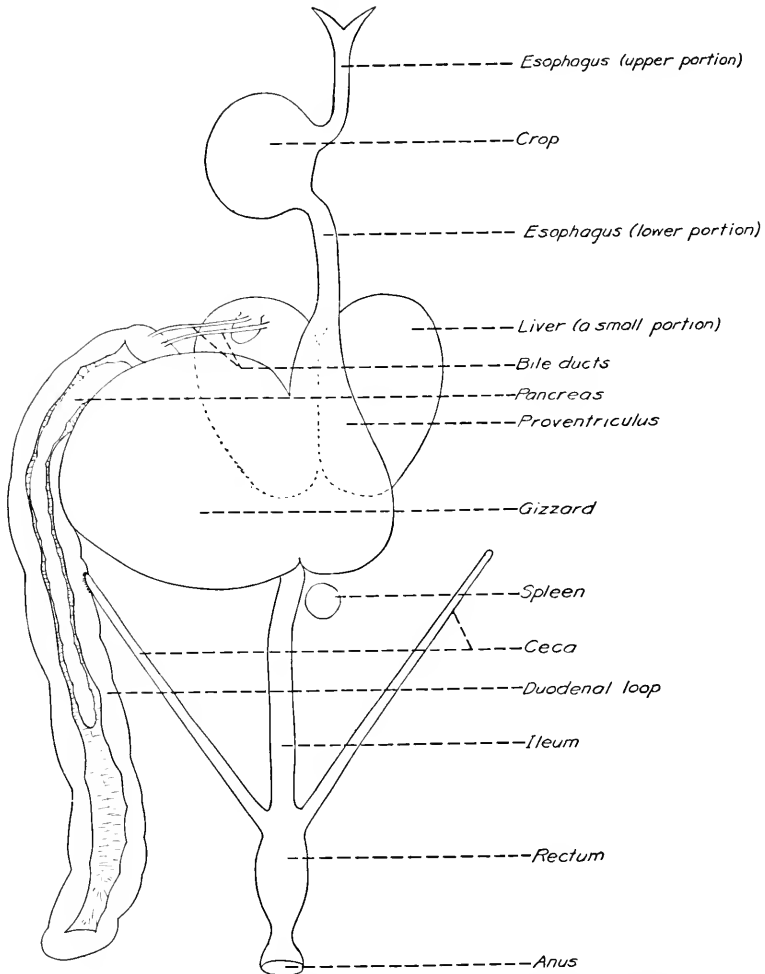

FIG. 202. Digestive tract of common fowl. (Drawn by W. J. Moore.)

The *duodenum* has a U-shaped loop. This varies in different birds but is ordinarily quite long and equal to twice the length of the body, except in the fish eaters, where it may be but one-eighth the length

of the body. The *ileum* is not ordinarily long, but in the owls it is nearly as long as the duodenum.

The *rectal ceca* are diverticula at the point where the ileum enters the rectum. In the grebe, a single cecum is present. In most birds there are two ceca, variable in length according to their habits. In the pigeon the ceca are not more than 2 inches long (shorter than in any other vegetable feeder) while in the common domestic fowl, they may reach a length of 3 feet.

Rectum.—The large intestine (called the rectum rather than the colon) is wider than the small intestine, and has coarse, short villi. It terminates by a valvular opening in a dilated cavity, the remains of the *allantois* (see page 302), now a rudimentary urinary bladder. The ureters and generative ducts open into a transverse groove at the lower part of the urinary dilation. The anal follicles are in a conical glandular cavity communicating with the posterior part of the cloaca and named the "Bursa Fabricii."

Liver and Gall Bladder.—There is usually a gall bladder, with two bile ducts leading from the large liver to the duodenum. The pigeon has no gall bladder but the fowl has an extremely large one.

Pancreas.—The pancreas is a compact elongated reddish gland lying in the loop of the duodenum, into which it discharges its ferments through three ducts. The three enzymes digest proteins, carbohydrates and fats as in mammals (p. 432).

Circulatory System.—The heart is comparatively large. (Figure 203.) Two auricles are present and the two ventricles are completely separated. The right auricles receive impure blood from the right and left precavals, and the postcaval veins. The blood passes from the right auricle through the auriculo-ventricular valve to the right ventricle. From the right ventricle it goes past the semilunar valves to the pulmonary artery and thence to the lungs. Four pulmonary veins from the lungs bring the blood to the left auricle. From the left auricle through the mitral valve it passes to the left ventricle. From the left ventricle it passes the semilunar valves to the right aortic arch⁶ which gives off the innominate arteries, then continues as a dorsal aorta. Venous and arterial blood do not mix in the bird. The jugular veins are united by a

⁶ In the reptiles, the right aorta transmits pure blood, while the left aortic arch contains mixed blood.

The pigeon (*Columba*) has about 2,000,000 red corpuscles in a cu. mm. of blood. Erythrocytes vary in size from 12.1 microns in the fowl to 14.7 in the pigeon.

transverse vein so that if the head is turned around the blood can still flow back into the heart through one of the jugular veins.

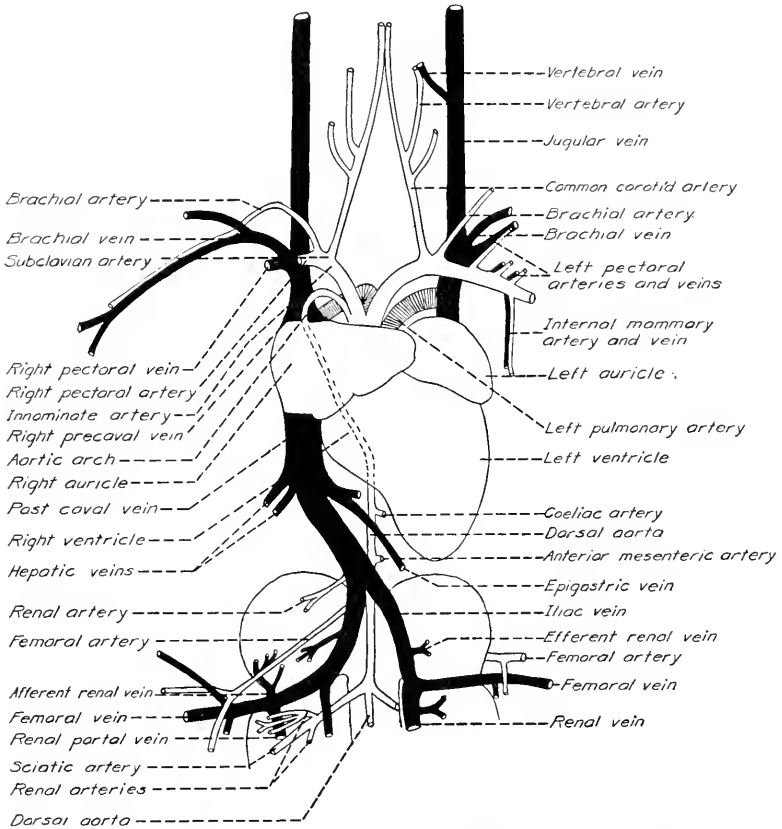

FIG. 203. Heart of pigeon. (After Parker's *Zootomy*. Courtesy of Macmillan and Co., Ltd.)

Respiratory System.—Air passes from the anterior nares or nostrils through the posterior nares, pharynx, trachea, and bronchi into the lungs and thence into from six to nine large air sacs. The air is forced into the air sacs by passage through the air in flight and out of them by wing compression. Hollow bones which render them lighter in the air are found in the soaring birds.

Voice Box.—The syrinx is a structure found at the point where the trachea divides into the bronchi. A flexible valve extends

forward at the point where the trachea divides. Muscles control the tension of this valve and the number of vibrations and pitch resultant are thereby regulated.

Bird Songs.—Call notes are heard throughout the year, but songs, which Darwin believed to be associated with sexual selection, are limited in most birds to the breeding season. (See page 515, Sexual Selection.) The rhea and the ostrich are said to be mute.

REFERENCES ON BIRD SONGS

- ALLAN, F. H. Some little known songs of common birds. *Nat. Hist.*, vol. 22, p. 235.
- OLDYS, HENRY. 1917. The meaning of bird music. *American Museum Journal*, vol. 17, February, pp. 123-126.
- SAUNDERS, ARETAS A. Flight songs and mating songs. *Auk*, vol. 39, p. 172.
- TYLER, W. M. 1923. Courting orioles and blackbirds from the female bird's eyeview. *Auk*, vol. 40, Oct., pp. 696-697.

Excretory System.—The kidneys are *paired* and ordinarily three lobed. The first lobe is usually larger although in the pelican the third lobe is larger. The tern has 7 or 8 lobes in its kidneys and the eagle has four. *No urinary bladder* is present. A rudimentary urinary bladder is found most highly developed in the ostrich, while the owl, pelican, grebe and swan have small ones. The urine *solidifies* on reaching the air.⁷ The adrenals (suprarenals), endo-secretory glands regulating blood pressure, are rounded and yellowish and found on the inner edge of the first lobe of the kidney.

Reproductive System. *Male.*—In the male, there are two *testes* which vary greatly in size according to season. Two seminal vesicles store the sperms. There are two vasa deferentia with eversible papillae at the cloacal end. The Anatidae have a penis, coiled when flaccid. The Cursores have a penis consisting of two fibrous bodies with a fissure between. (Figures 204 and 205.)

Female.—In the female the *right ovary* is *degenerated*, with a vestigial oviduct. The left ovary persists and has a long convoluted oviduct with a papilla at the end. The oviduct secretes albumen in the upper part, farther down the *shell gland* secretes the shell membrane and finally the posterior part secretes the shell. The

⁷ Great deposits of the feces and urine of certain birds are found in Peru. This substance, rich in salts, is sold as the fertilizer, "guano." See page 368.

uterus is considerably enlarged. **Antiperistalsis** of the oviduct sometimes results in the formation of a new shell on an egg already provided with one.

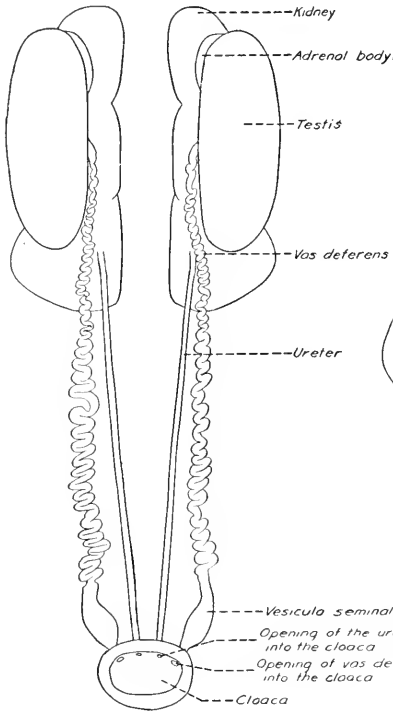

FIG. 204. Reproductive system of the fowl, male. (Drawn by W. J. Moore.)

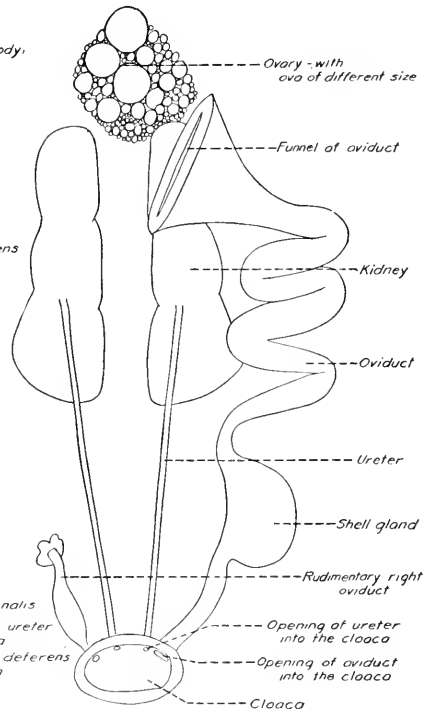

FIG. 205. Reproductive system of the fowl, female. (Drawn by W. J. Moore.)

Nervous System.—The brain is short and very broad. The *cerebral hemispheres* are large and the optic lobes immense. The *cerebellum* is extremely large, indicating well-developed equilibration. The *olfactory lobes* are very small.

Sense Organs.—The bill and tongue are *tactile* organs; tactile nerves are also present at the base of the feathers, especially the wings and tail. The sense of *smell* is very poorly developed while the sense of taste is poor but serviceable. *Hearing* is extremely acute and *vision* is phenomenal. The eyes are very large and of a biconvex shape. Birds have a tremendously developed power of accommodation. They can swoop down to the water with great

rapidity and seize a fish which is unseen by a man standing on a cliff above the water. Buzzards see a sleeping man and gather quickly. Many a traveler has when ill been quite disconcerted by the sight of buzzards gathered in his vicinity. Keen eyes enabled one of them to note his quietude and others quickly gathered as the scout circled downward. Whether the buzzard smells decaying flesh of dead animals is a debated question. Experiments seem to indicate that it sometimes does. Many zoölogists are of the opinion that sight is the chief means of locating the buzzards' food.

Susceptibility of Birds to Poison.—Small doses of morphine produce in birds disturbances of the digestive tract and a light sleep.

Types of Nests.—Birds' nests vary greatly in structure and in location. Birds may deposit their eggs on the sand, unprotected, or they may build a nest in an excavation in the ground or in a hollow tree. Some forms seek out lofty *eyries*, others build *colonies* on the sides of cliffs, while still others build *mounds*. The mound-building birds of Australia open the mounds to admit the sun and remove or add debris as the humidity varies. The nests of others float on stagnant pools or are built in the grasses of swamps and meadows.

There is a great specialization in the *material* used in constructing the nest. Some *warblers* line their nests with the *seed capsules* of a certain species of moss. The tailor bird sews leaves together with plant fibers. The tropical *bower-bird* includes bits of shell and bone in its nest. The *crow* and the *starling* are particularly fond of bright bits of *metal*. Stories are told of tame crows that successfully stole table silver.

The *chipping sparrow* lines its nest with *horsehair*, while the *crested flycatcher* usually includes a portion of the cast skin of a snake. As mentioned before, the South American hornbill male seals his spouse into her nest in a hollow tree and brings food to her during the nesting period. The *chimney swift* builds its nest (in a chimney) of twigs stuck together by *saliva*.

The *edible birds' nests* of the Orient are built by swift-like birds (*Collocalia*), in rocky caverns along the sea. The first nests built are made up almost entirely of *glutinous* salivary secretion and are sold for as much as \$15.00 per pound. The first quality nests are almost entirely destroyed by native collectors. Later nests containing twigs and other foreign matter are not destroyed, or the birds would soon be extinct.

One of the most beautiful of the birds' nests is that of the *Baltimore oriole*. It is easily recognized by the long strand suspending it a foot from its supporting branch. It is tightly woven and when the bird is on its nest its weight closes the opening so that no rain can enter. The South American *cacique* builds a nest similar to that of the oriole and with a much longer anchor. It may hang seven feet from a branch.

Bird Migration.—Coward classifies birds with respect to their migrations as:

(1) Permanent residents; (2) Summer residents. (Leaving in autumn and returning in spring); (3) Winter residents. (Leaving in the spring for their breeding area); (4) Birds of passage—or spring and autumn migrants; (5) Irregular migrants—occasional invaders; (6) Stragglers or wanderers.

The *American Golden plover* nests along the Arctic coast from Alaska to Hudson Bay; winters in Argentina, after a roundabout oceanic flight of 2,500 miles, passing through Labrador and Nova Scotia with rests and feeding at each of these places, then flies directly across the sea to Guiana and thence after a further rest to Brazil where it feeds until March. The return route is a more direct one. The distance covered in the elliptical indirect route is said to be nearly 20,000 miles. Birds usually migrate in company with other experienced travellers, but they make successful pilgrimages when it is evident that older birds are not there to guide the flock.

Storks marked in Prussia have been taken in the African Transvaal. The *Arctic tern* nests along the coast of Maine and Northward to the limit of land, but winters along the borders of the Antarctic continent. Thus it migrates about 11,000 miles, probably at sea. Cooke states that the Arctic tern has more hours of daylight than any other animal. "The midnight sun has already appeared before the birds' arrival at the Northern nesting site, and does not set during their entire stay at the breeding grounds. During two months of their sojourn in the *Antarctic*, the birds do not see a sunset." They have 24 hours of daylight for at least 8 months of the year.

Some species fly by day and some by night, others fly both day and night. Some day-migrants follow coast lines or river valleys, guiding themselves by sight. But in the case of the *noddy* and *sooty terns*, studied by Watson and Lashley, birds liberated at sea, 600

miles from their nests and 450 miles from shore, and others liberated on the mainland 850 miles away flew directly to the proper island and nests.

Why Birds Migrate.—One of the commonly accepted theories as to migration is that ages ago the United States and Canada were occupied by *non-migratory* birds. When the Arctic ice fields moved South during the glacial period, rendering the Northern half of the continent uninhabitable, because of lack of food supply and a low temperature, the birds migrated farther and farther each decade until finally the racial habit of long migrations was established. Another theory is that the birds' *original home* was in the South and that as the ice retreated northward they sought a less crowded breeding ground, only to return to their winter quarters in the South.

In some recent work done by W. Rowan of Alberta, Canada, the factor of the *physiological* impelling force of the developing *gonads* is emphasized along with the environmental factor provided by varying day lengths.⁸ Rowan says: "Migration cannot be looked upon as an act of volition, but as the automatic response to a certain physiological state probably induced by a gonadial hormone. The birds must migrate if physically able to do so." Unquestionably Rowan's point regarding the influence of the gonads is well taken. (See Fish Migration, page 263.)

We know that birds have a time sense, and that the northerly movement of the robin is correlated with the attainment of a certain mean daily temperature. The average of weather conditions influences the average time of arrival, and the flight of night migrants is known to be correlated closely with meteorological conditions. Adams found that bird migrants arrive in waves following peculiar types of weather.

In spite of the evidence collected by many observers, there are those who seem content, like many of the adherents of the "parent-stream" theory in fishes, to dismiss the whole problem by stating that it is probably due to a mysterious sense of direction.

Others have suggested that a peculiar physical property of the feathers causes the magnetic pole to exert a powerful attractive influence.

⁸ In his studies on the sexual cycle of the European starling, Bissonnette has shown that increased daily light periods will increase spermatogenic activity. Consult Bissonnette, T. H., 1931 (Jour. Exp. Zool., vol. 58, pp. 281-319), and earlier papers.

Speed of Flight.—Migrating birds are able to reach a speed of 100 miles an hour and travel from 1,000 to 5,000 feet above the earth. A carrier pigeon is recorded as having averaged fifty-five miles an hour for four hours, probably exceeding the speed of most migrants.

Mr. Thomas Ross, who is in charge of the army lofts at Fort Monmouth, N. J., is quoted (*American Magazine*, June 1928) as stating that an American carrier pigeon flew 300 miles at a little over seventy-one miles an hour. He also quotes the unsubstantiated statement that a pin-tail duck has made 125 miles an hour. Herons, hawks and flickers fly about twenty-five miles per hour. According to Chapman, the great wandering albatross of the Southern Seas has been known to fly 3,400 miles in eight days.

Economic Importance of Birds. Positive.—1. The eggs and flesh of the common fowl, ducks, geese, and even the ostrich, are eaten.

2. Feathers of the ostrich, the egret and the bird of paradise have been in times past great favorites for ornamentation.

3. The Chinese are extremely fond of the edible birds' nests secured along the coast, north of Borneo.

4. From the Islands of the South Pacific comes the important fertilizer known as guano.⁹ This has been deposited for centuries.

5. As scavengers, the buzzards and vultures are especially valuable.

6. Birds are preëminently our best friends in that they destroy insects, rodents and the seeds of our most pestiferous weeds. The English starling, until recently considered as great a pest as the English sparrow, is, according to S. S. Pennock of Philadelphia, an extremely successful hunter of the larvae of the *Japanese beetle*.

Negative.—1. Destroyers of poultry. Very few birds attack domestic fowls. Several species of the hawks may be classed as injurious, while the only owl that is injurious is the great horned owl.

2. Enemies of beneficial birds. The English sparrow, the starling and the jay drive away other birds and the jay eats eggs and young. The shrike or butcher bird is an important enemy of our bird friends.

3. Destroyers of crops and fruits. The crow, the English sparrow, the robin, and the grackle consume some of our food products.

⁹ For further information regarding guano, consult: Murphy, R. C. 1924. The most valuable bird in the world. *Nat. Geog. Mag.*, vol. 46, p. 279, and Coker, R. E. 1920. Peru's wealth producing birds. *Nat. Geog. Mag.*, vol. 37, pp. 537-566.

4. Disseminators of injurious seeds and parasitic animals. Even our valuable game birds may be the means of dispersing parasitic worms and protozoa, and it is a well-known fact that the starling, introduced into New Zealand, spread the seeds of the English blackberry, with the result that the thorny bushes form a snare for lambs and interfere with cultivation.

REFERENCES ON BIRDS

- BEAL, F. E. L. AND OTHERS. 1916. Common Birds of S. E. United States in Relation to Agriculture. Farmers' Bull. no. 755, U. S. Dept. Agr.
- BRADLEY, O. C. 1915. The Structure of the Fowl. A. and C. Black, Ltd., London.
- CHAPMAN, F. M. 1910. Birds of Eastern North America. New York.
- CHAPMAN, F. M. 1903. Color Key to North American Birds. New York.
- FISHER, A. K. 1908. Economic Value of Predaceous Birds and Mammals. Yearbook of the U. S. Dept. Agr.
- FORBUSH, E. H. Game Birds, Wild-Fowl and Shore Birds. Mass. State Board of Agriculture.
- FORBUSH, E. H. Useful Birds and their Protection. Published by the Massachusetts State Board of Agriculture.
- FRIEDMANN, H. 1929. The Cow Birds. C. C. Thomas Co., Springfield, Ill.
- HEILMANN, G. 1927. The Origin of Birds. D. Appleton and Co., New York.
- HENSHAW, H. W. Fifty Common Birds of Farm and Orchard. Farmers' Bull. no. 513.
- KAUPP, B. F. 1918. The Anatomy of the Domestic Fowl. W. B. Saunders Co.
- MCATEE, W. L., AND BEAL, F. E. L. Some Common Game, Aquatic, and Rapacious Birds in Relation to Man. Farmers' Bull. no. 497.
- MENTOR. 1913. Game Birds of America. Vol. 1, Oct. 6, no. 34.
- MENTOR. 1916. American Birds of Beauty. Vol. 1, June 2, no. 16.
- NATIONAL GEOG. MAG. 1914. 64 Pictures in Colors of Common Birds of Town and Country. Vol. 25, May.
- THOMSON, J. A. 1923. The Biology of Birds. The Macmillan Co., N. Y.
- WEED, C. M., AND DEARBORN, N. Birds in their Relation to Man. J. B. Lippincott Co., Philadelphia, Pa.

Fossil Relatives of the Birds. Saururæ.—These reptile-like forms had a long, slender, lizard-like tail, sharp teeth, a short neck, a small keel to the breast bone and claws on the fingers and toes. Two specimens were found in the Jurassic of Bavaria. The *Archeopteryx* (Gr. ancient wing) was discovered in 1861 at Solen-

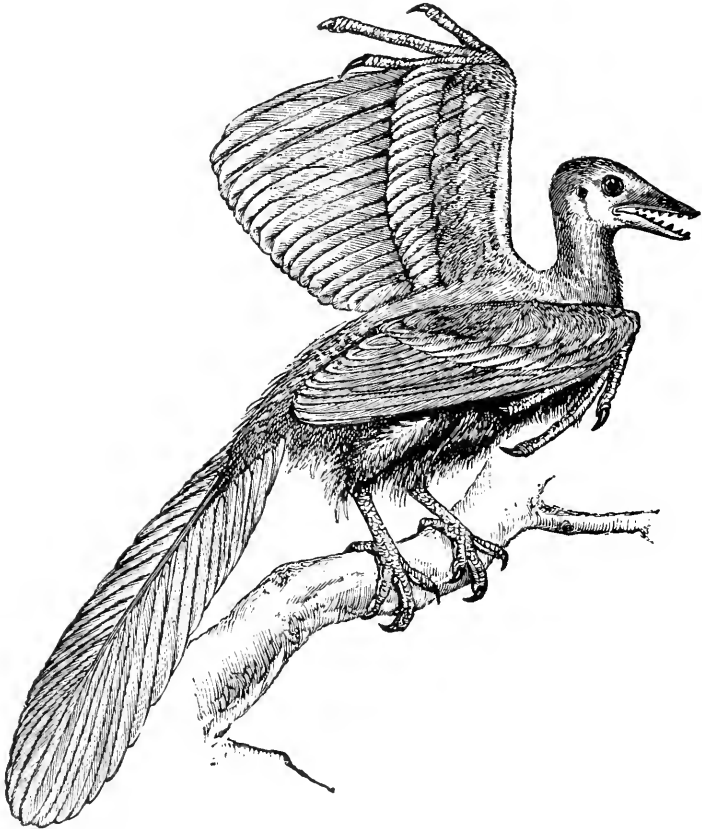

FIG. 206. *Archeopteryx* as it would appear with feathers restored. (From Romanes, *Darwin and After Darwin*. Courtesy of Open Court Publishing Co.)

hofen, Bavaria: (Figure 206.) It had been so well preserved between the layers of lithographic slate that the details of feathers of the wing and tail were plainly seen. It had a bird-like head and brain. Its jaws were, however, equipped with sharp reptilian teeth. The head and neck were devoid of feathers while the legs had quill feathers. The wings had three fingers with reptile-like claws, with

the metacarpal bones separated. The fingers had the same number of joints as in the lizards. The keel was only lightly developed. *Archeopteryx* used its wings chiefly for *planing* rather than *flying*. The *Archeornis* (Gr. ancient bird), slightly different from the *Archeopteryx*, was discovered in an almost perfect state of preservation in 1877, near Eichstatt, Bavaria. It had an extremely long reptilian tail with twenty-one joints, which was "like a telescope pulled out, while the tails of the modern birds are like a closed telescope."

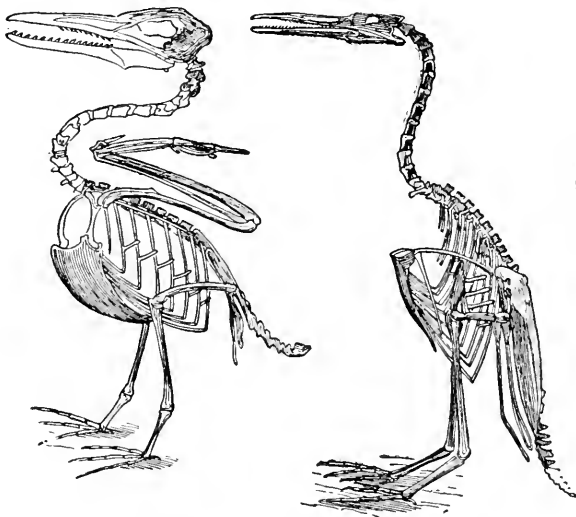

FIG. 207. Left, *Ichthyornis victor*. Right, *Hesperornis regalis*. (From Daugherty. Courtesy of W. B. Saunders & Co.)

Ichthyornithiformes.—*Ichthyornis* (Figure 207 *A*) had socketed teeth, a keeled sternum and was a strong flyer and apparently a fish eater. It was found in the Cretaceous of Kansas. It was small, about the size of a pigeon.

Hesperornithiformes.—*Hesperornis* (Figure 207 *B*) was a three-foot, flightless diving bird, with grooved teeth, a keelless sternum and strong paddle-like hind limbs. It was also found in the Cretaceous of Kansas.

A Living, Connecting Type.—In the South American Hoactzin, the adults are like certain pheasants, but differ in anatomical characteristics. The breast bone is wider behind than in front; the keel of the sternum is confined to the posterior part; the *crop* is

large and muscular, taking the space usually filled with pectoral muscles and the anterior part of the sternum. The young birds when first hatched have a *clawed thumb* and *index finger* on the wing,

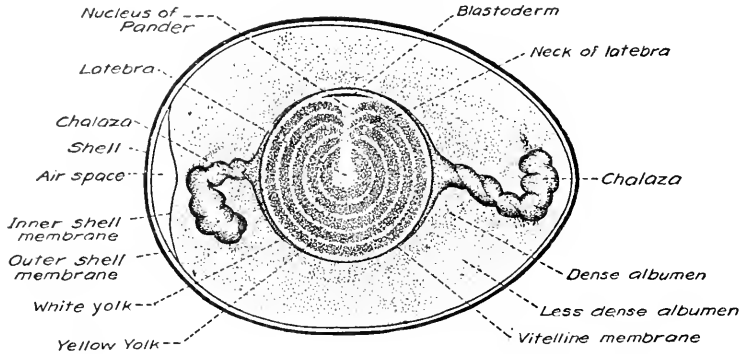

FIG. 208. Diagram of the hen's egg in longitudinal section. (After Lillie. Courtesy of Henry Holt & Co.)

resembling the condition in *Archeopteryx*. They are able to climb about the branches and find their own food, using their feet and wing digits.

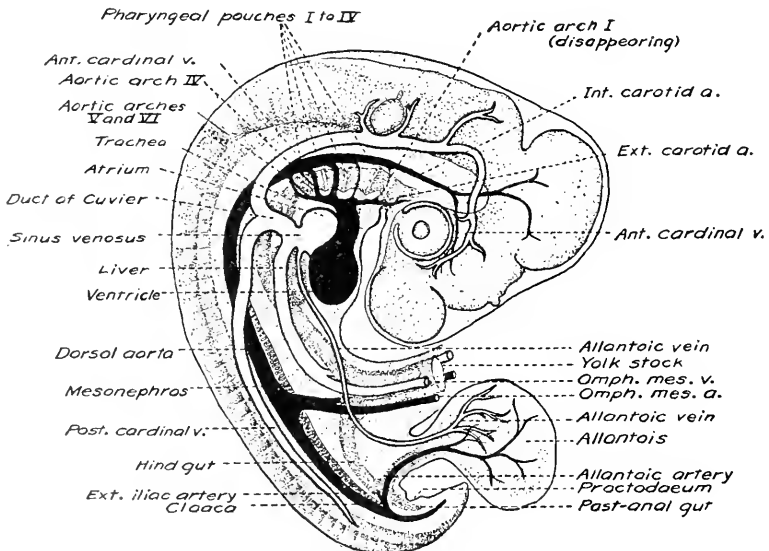

FIG. 209. Internal organs of a four-day chick. (From Lillie, *Development of the Chick*. Courtesy of Henry Holt & Co.)

CHAPTER XIX

MAMMALIA

PERHAPS our chief interest in the Mammals is derived from the fact that we ourselves belong to this great class of vertebrates. In the early days man found his most formidable enemies among the mammals, and even now he suffers from the activities of the rodents. On the other hand, mammals have furnished milk, meat, and furs, and certain forms have been used for centuries as servants and beasts of burden. Like the Birds, they are a tremendous economic factor in our civilization.

CHARACTERISTICS

Mammals have a double occipital condyle, a hairy skin, and well-developed milk glands. They are warm blooded, with the heart divided into four chambers and the single (left) aortic arch curving over the left bronchus and continuing as a dorsal aorta, the visceral arches modified into the earbones, with the cerebral hemispheres usually connected by a heavy commissure called a corpus callosum. The thoracic and abdominal cavities are separated by a muscular diaphragm.

Order 1. Monotremata.—This order includes egg-laying mammals with mammary glands devoid of teats. Eggs about half an inch long, rich in yolk with soft, but tough shells. Episternum and coracoid well developed. Oviducts distinct throughout; cloaca in both sexes, into which the ureters and urinary bladder open separately. In the center of the vertebrae the epiphyses are absent or imperfectly developed. The bones of the skull coalesce early. The corpus callosum is absent. (Figure 210.)

The *spiny ant eater* (*Echidna aculeata*), found in Australia, Tasmania and New Guinea, reaches a length of about 18 inches. As the name would indicate, it is covered with spines and hairs. It curls up like a hedgehog when alarmed. It has no teeth but is provided with a long extensible *tongue* which it utilizes in securing insects and worms. It places its egg in a primitive *mammary pouch* consisting of a fold of the abdominal skin. The young when hatched

are fed by milk exuding upon the hairs of the mother's abdomen. The young are later protected by being concealed in a burrow. The *long-snouted Echidna (Praechidna)* is found in New Guinea; here under the name of the "Nodiak" it is eaten by the natives.

The *duck-bill (Ornithorynchus (paradoxus) anatinus)* (Figure 211) is found in Australia, New Guinea, and Tasmania. It has a small rounded head, and a black horny bill. It crushes its food between



FIG. 210. Echidna. (Courtesy of N. Y. Zool. Soc.)

the ridged plates of its lower jaw and the roof of its mouth. Highly developed glandular cheek pouches aid in digesting the food before it reaches the small stomach.¹ The body temperature of the duck-mole, like that of Echidna, is but two to five degrees higher than the surrounding medium. Its oviducts open separately into the cloaca, but as in the birds the left ovary and oviduct alone are functional. Aquatic, it digs burrows thirty feet into the banks of deep pools. It builds a nest and deposits two eggs. When hatched, the young are blind, hairless, with short beaks, but possessing teeth. The *duck-bill* has no *mammæ* and the milk oozes out through many fine

¹ Consult H. Burrell. 1927. The Platypus. Angus and Robertson Ltd., Sydney, Australia.

apertures upon two mammary areas each about one half inch in diameter. The young scrape and suck the milk from these areas.

Young duck-bills feed upon crustacea, insects and worms. On each hind foot, male duck-bills, or duck-moles, have a sharp horny spur with a *poison gland* connected.



FIG. 211. Platypus. (Courtesy of N. Y. Zool. Soc.)

Fossil Relatives of the Monotremata.—Monotremata are found in the Pleistocene, and it is possible that the doubtfully mammalian types of *Protodonta*, *Dromatherium* and *Micronodon*, of the Upper Triassic, are also related.

Order 2. Marsupialia.—Viviparous, usually carrying their young (born in a rudimentary condition) in a *marsupium* or pouch; allantoic placenta usually absent. Small eggs undergo a total segmentation in most species, and develop in the maternal uterus, nourished by a secretion from its walls. The ventral surface is supported by the *marsupial* bones, slender rods articulated right and left, at the pubic symphysis. Corpus callosum absent.

The *opossum* family (*Didelphidae*), found in America, is distinguished by the presence of a *marsupial pouch*. This may be absent or relatively shallow as in the case of some species or it may approach the highly developed condition existent in the kangaroo. The young of the Virginia Opossum (*Didelphys virginiana*) remain for two months with their mother, at first residing in the pouch, then ride around on her back. The opossum feeds on wild fruit, berries, corn, insect larvae, eggs and young birds and mammals.

Tasmanian marsupials (Family *Dasyuridae*) have fewer incisor teeth than the American opossum; they lack a cecum and their tail is not prehensile.

The *Murine opossum*, a mouse-like form, is found in South America. It is about the size of a chipmunk and lacks an abdominal pouch.

The *Australian ant-eater* lacks a pouch and resembles a red squirrel in appearance. The *wombats* are unwieldy creatures resembling the badger. They have rudimentary cheek-pouches and tail.

The *Kangaroos* (*Macropodidae*) are found in Australia where nearly all land mammals are marsupials. Unlike the opossum and the *Tasmanian devil*, the kangaroo family are all *herbivorous*. The newly born young are taken by the mother and placed in her pouch where they remain until their eyes open and they have developed hair. For some time after this they return to the pouch from little excursions into the world. When first born, a kangaroo may be not more than an inch long.

The "*Old man*" or *gray kangaroo* reaches a height of over five feet, weighs two hundred pounds and can leap over twenty feet, using its long legs and powerful tail. The *red kangaroo* with a brick red coat of a very fine, silky texture is the one most frequently seen in captivity. It reaches a height of almost four feet. The *rock wallabies* (genus *Petrogale*) do not utilize their tails a great deal in locomotion but use them as balancers. The black-tailed wallaby and the opossum are said to have starved out the other animals on Kawau Island.

Fossil Relatives of the Marsupialia.—For the most part the marsupials are found as fossils from the Upper Triassic to the present.

Order 3. Insectivora.—Small, usually terrestrial (but sometimes aquatic or arboreal) clawed mammals; feet plantigrade,

generally pentadactyle; molars enamelled, tuberculated, and rooted. They have a primitive brain. There are frequently *scales* on the tail among the hairs; the clavicle is present; the animals have soft hair, and usually a proboscis-like, tactile snout.

Feeding almost wholly on insects and worms they are chiefly nocturnal. They are found almost everywhere except in Australia and South America. Evidence from fossils indicates that they are *survivors* of extremely primitive *placental* mammals. The eyes are extremely small and in some cases hidden by fur.

The *colugo* (*kaguan*) is a peculiar form, sometimes called the "flying lemur." It is found in trees from Siam to Java with a smaller relative inhabiting the Philippines. It belongs to a sub-order, *Dermoptera*. Extensions of its furry skin stretched between the fore and hind legs enable it to plane through the air like a flying squirrel. It is about the size of a small cat.

The *shrews* (*Soricidae*) are small, mouse-like animals with pointed heads, external ears and eyes, rat-like feet, slender bodies and a short tail. The common *shrew* is found on the Atlantic coast, ranging from New England, Southward to North Carolina and Northwestward to Alaska. It is quick of hearing, utterly untameable, and from glands in the axillary region, emits a musky odor, which repels hawks, cats and foxes, but apparently attracts weasels and owls. The *water shrew* is the largest of the American forms, measuring 6 inches in length, with a tail over 2 inches long. The *great musk shrew* of India, called the "muskrat" in the Old World, is important as a destroyer of insect vermin. Some of the *long-nosed shrews* are aquatic, living in bank burrows and swimming and diving with ease. (Figure 212.)

The *short-tailed* or "*little*" *shrew* (*Cryptotis parva*) has a total length of but 3.1 inches and is the smallest American mammal. It is found from the middle West to the Atlantic coast.² Shrews eat worms, insects, young birds, but also feed on roots and nuts. European superstitions regarding the shrews include such statements as that of Rev. Edward Topsell, who in his rare "Historie of Four-footed Beastes," printed in London in 1607, says of the shrew that "It is a ravening beaste, feigning itself gentle and tame, but, being touched, it biteth deeply and poysoneth deadly. It beareth a cruel minde, desiring to hurt anything, neither is there any creature that

²H. E. Anthony. 1928. Field Book of North American Mammals. G. P. Putnam's Sons, N. Y.

it loveth, or it loveth him, because it is feared of all." (Ingersoll, 1906 p. 71.)

Physicians report the characteristics of the shrew as occurring in certain women and men as well. Perhaps dementia praecox and paranoiac tendencies may be fostered by a policy of letting children have their own sweet will, and only defending oneself from their actual blows.



FIG. 212. Smoky shrew. (Courtesy of W. Va. Exp. Sta.)

The *moles* (*Talpidae*) have vestigial eyes, broad, spade-like front teeth and no neck. Unlike the shrew, the animals have no external ears or external eyes. There are twelve species. On the body the mole has fine, thick velvety fur, but the tail is hairless.

The *common mole* is gray in color, with webbed hind feet, and reaches a length of about six inches. It burrows in loose earth and in ten seconds will leave upheaved tunnels. Hornaday timed a mole in a clover field and found that it had tunnelled twenty-three feet in seven hours.

The *star-nosed mole* has, on the tip of its nose, eighteen ray-like points, with four smaller ones between them. It burrows into swamps along the banks of ponds and brooks and apparently is adapted to an aquatic life. It devours fish, fish eggs and water snakes and also feeds on insects and worms.

The *common European hedgehog* has an armor of short, stiff, sharp gray spines which are *not barbed* as in the porcupine and which

are *not* discharged. When irritated, the hedgehog rolls itself into a ball with its head tucked between its feet. Hedgehogs feed on slugs and insects, but also eat small mammals and frogs, and are protected on account of their value as snake killers. Some Europeans are very fond of the flesh of the hedgehog.

Fossil Relatives of the Insectivora.—The living families of moles, shrews and hedgehogs arose in the Eocene period. Related forms occurred in the Jurassic. R. C. Andrews has discovered in Mongolia fossil skulls with teeth of the insectivorous type, indicating the pattern from which insectivores, carnivores, and possibly primates may have evolved.

Order IV. Chiroptera.—Clawed animals with fore-limbs modified for flight, the bones, especially those of the second to the fifth digits, being greatly elongated so as to support a broad web of skin extending back to the hind-limbs. The sternum has a keel for the attachment of the pectoral muscles, which are important to the movements of flight. The dentition is complete. The cerebral hemispheres are smooth and do not overlap the cerebellum. Anal glands, furnishing a strong, even offensive smelling secretion, are common. Although bats are swift fliers they do not have air spaces in their bones as do some of the birds. There are more than six hundred species of bats, which at first were classed with birds.

The *Megachiroptera* are large, diurnal forms, sometimes called *fruit bats*, *fox bats*, or "*flying foxes*." They destroy fruits and on this account have been barred from admission into some states. The larger fruit bats are eaten by the natives of the East Indies. The *hammerheaded bat* is found in Africa.

The *Microchiroptera* include the *leaf-nosed bats*, the *vampire bats* and the smaller common forms. The *leaf-nosed bat* is found in California and Mexico and has a wedge-shaped leaf of naked skin just behind the nostrils. The *javelin bat*, ranging from South America to Mexico, is a *vampire* or blood-sucker, attacking horses, cattle and men. It reaches a length of four inches. An extremely large form from South America, *erroneously* called the "*great vampire*," is not at all injurious, but feeds on fruits and nuts. It is twenty-eight inches in length.

The *naked bats* of Borneo have thick leathery skins and a scent gland on their neck. Under each arm they have a mammary pouch in which the young are carried and nursed until they are able to fly.

The *common bats* (*Vespertilionidae*) are found all over the world.

Of the two hundred species, there are less than twenty in the United States.

The commonest American species are the *little brown bat* (*Myotis lucifugus*) which is less than four inches in length, and the *brown bat* (*Eptesicus fuscus*) which is widely distributed throughout the United States. The *little red bat* is a swift flyer and as active as a bird. The *gray bat* is a large form reaching a length of three inches. It is found in the United States and Canada. The *big-eared bat* has ears half as long as its body and is found in the Southern States.

One family (*Molossidae*) seems more like the rat, for it is terrestrial.

Fossil Relatives of the Chiroptera.—Bats are known from the Eocene of Colorado.

Order V. Carnivora.—Clawed, furry mammals with at least four digits. Incisors small; canines large, curved and pointed; premolars and molars usually compressed; stomach simple, cecum small. Tapetum lucidum of eye very shiny. Clavicle lost or reduced, ulna and radius well developed. Teats abdominal, uterus bi-cornuate, placenta deciduate, usually zonary.

Sub-Order Fissipedia.—The cat family (*Felidae*) includes lions, tigers, leopards, and the like.

The "*saber-tooth*" cats were found in America and the Old World in the Tertiary period. The great "*saber-tooth*" tiger (*Smilodon*) was as large as our largest Kadiak bear.

The *puma*, *cougar* or "*mountain lion*," an American form, once ranged over the whole continent. It may reach a length of seven feet and a weight of two hundred pounds. While it is stated that the puma dreads mankind there are well-authenticated reports of attacks on children and grown men.

The *jaguar* is the largest and handsomest species of the cat family in America. It is found as far North as Southern Texas. It is an enemy of pigs, cattle, horses and wild mammals, but apparently afraid of man. It may reach a body length of five feet with a tail two feet long and weigh one hundred fifty pounds. (Figure 213.)

The *ocelot* or tiger cat, also found in Texas, is a small leopard, with horizontal black stripes on a yellowish ground color. It is about the size of a small spaniel and feeds on birds and arboreal mammals.

The *Canada lynx* is a small bob-tailed *wild cat* found in Quebec

and Ontario, but ranging southward into the United States. The *Bay lynx*, wild cat or bob-cat, is found east of the Mississippi in wooded areas, and extends westward to the Pacific coast states. It is a formidable enemy of cotton tail rabbits.

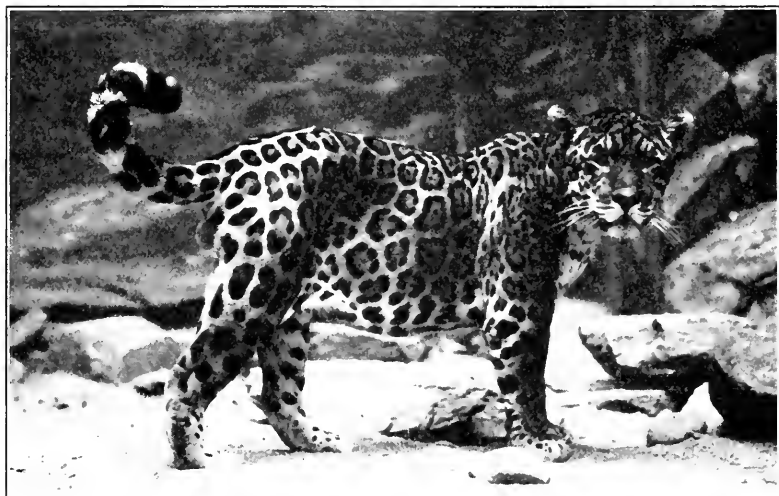

FIG. 213. Jaguar. (Courtesy of N. Y. Zool. Soc.)

The *lion* has been considered the king of beasts for centuries.¹ Amenemhat I. recorded proudly, 2000 B.C., "I hunted the lion." The lion, explorers state, is by no means the bold animal that it is traditionally supposed to be. The African buffalo is said to be more than a match for a single lion. The *zebra* seems to be the lion's favorite food. (Figure 215.)

The *tiger* is found in Persia, Siberia and Manchuria and ranges southward through China and the Siamese and Malay Peninsula to Java, but is not found in Borneo. Passing around the Bay of Bengal, it has never crossed to Ceylon. It is considered a far more dangerous animal than the lion. In 1927, the Indian Government reported 1,033 persons killed by tigers.

The *leopard* is a more active, sly animal than either the lion or the tiger, and is probably responsible for many more losses among sheep, cattle and ponies. Leopards killed 218 persons in India in 1927.

¹ The Marcomanni called the lions sent across the Danube by the Romans "dogs." Herodotus II. 69.

The *cheeta* or hunting leopard of Africa and India belongs to the genus (*Cynaelurus*) intermediate between the cat and the dog. It has been trained to capture game for its master in India.

The *common house cat* has descended from the single wild species (*Felis maniculata*) of Northeastern Africa. Egyptians prepared



FIG. 214. Canada lynx. (Photo by courtesy of Canadian National Railways.)

mummies of cats which indicates that they regarded them as beloved companions. A tablet in the Berlin Museum dating from 1800 B.C. is inscribed with the word, "mau," meaning cat.

The *Egyptian wild cat* of today (*Felis libyca*) is about the size of the domestic cat, generally yellowish in color with faint pale stripes which become darker on the limbs. There are today about

thirty races of cats, grouped into long-haired and short-haired varieties. There is also a Mexican hairless cat. (See p. 524.)

The *civets* (*Viveridae*) are relatively small animals with incompletely retractile claws. From their scent glands, "civet" perfume is secured.

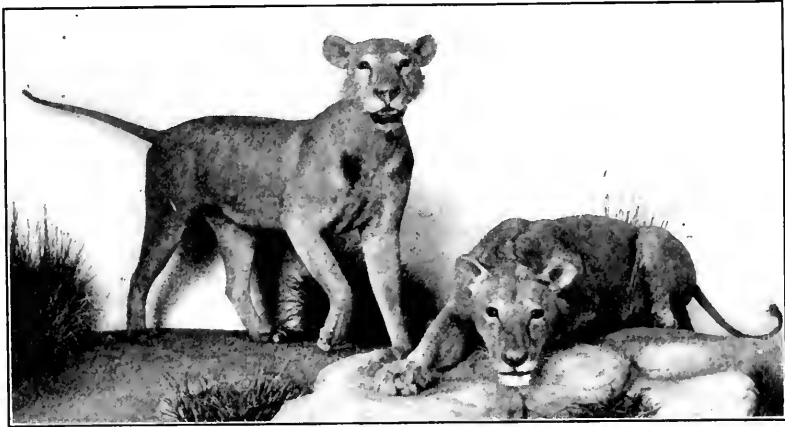

FIG. 215. Tsavo lions. Both specimens are males, but from an arid region of Africa where manes are lacking. They killed 135 men employed in the construction of the Uganda R. R. (Courtesy of Field Museum of Nat. Hist.)

The *mongoose*³ (*mungoos*) is found in Egypt where it is called the *ichneumon* and in East India where it goes by the native name, *mungoos*. It lives in thickets and in holes among rocks. It is an enemy of snakes, lizards, poultry and rodents and is said to occasionally chew the ears of native infants, left sleeping.

There are three species of *hyenas* (*Hyenidae*). They are found in Europe, Asia and Africa, where they are much despised. They are scavengers. They have a large dog-like head and strong jaws with thirty-four powerful conical teeth. Hyenas are able to kill donkeys, sheep and camels.

The *raccoons* (*Procyonidae*) are plantigrade like the bear family. They are found in the wooded regions of the Southern and Eastern states, especially in swamps. They live in hollow trees and are

³ In 1872 the mongoose was introduced into Jamaica to destroy the rats infesting the sugar cane. At first beneficial there, it began killing poultry until it proved a distinctly injurious form. Recently it has turned cannibal and relieved the situation.

omnivorous. They have the peculiar habit of washing (soaking) food before eating it.

The *bears* (*Ursidae*) are plantigrade (flat-footed) animals with long claws that are *not retractile*. They are terrestrial and omnivorous. Very few of them are able to climb trees. The *polar bear* has a pure white coat the year around. In the winter, it lives on fish, seals, walruses and the carcasses of whales, augmenting its diet in the summer by vegetable matter. It reaches a height of fifty inches and a length of over seven feet and may weigh over one thousand pounds. In captivity if polar bears are furnished with a large swimming pool, they can endure hot weather as well as the black bear (Hornaday).

The *brown Kodiak bear* of the Kodiak Island ranges from Sitka to the extremity of the Alaskan peninsula. It reaches a length of about ten feet, and weighs nearly two thousand pounds. It is, however, a timid animal. It feeds on salmon and small mammals, but in the summer almost becomes a vegetarian.⁴

The *grizzly bears* have high shoulders, brown hair with *silvery* gray tips and may reach a weight of about twelve hundred pounds. In Yellowstone Park, they have become celebrated for their excessive friendliness to visitors who at times are disappointed to discover that the animals are not as tame and harmless as dogs. (Figure 216.)

The *black bear* is a timid animal and an excellent climber. It is still to be found in the Adirondacks and the mountains of Pennsylvania and West Virginia. It feeds on berries and fish and robs "bee-trees." The black bear has a *brown* phase, brown (cinnamon) and black cubs sometimes being found in the same litter.

The *glacier bear*, found in Alaska, the smallest species of bear in America, reaches a height of but two feet. Its color is bluish gray except for the dark brown muzzle.

The *Mustelidae* are small, fur-bearing animals such as the otter, mink, weasel, marten, wolverine, skunk and badger. The North American *otter* is still found in the South and also in Northwest Canada and Alaska. It lives in a burrow usually under the roots of a large tree growing near the water. It reaches a length of about

⁴ In the spring when he emerges from hibernation the Kamschatkan brown bear eats sea-weed, later he grazes on herbage, and in the middle of June feeds on the migrating salmon. In August, he eats wild peas, in September he eats berries and in later October, just before hibernating, he feeds luxuriously on ground-marmots. (Elton.)

two feet. The *sea otter* is one of the most valuable of the fur-bearing animals. It is now *rarely* found except in Alaska. Its fur is a lustrous black and very thick and fine in texture. The *mink*, much smaller than the otter, lives along the banks of streams, but is not



FIG. 216. Bear and cub, in Yellowstone National Park. (Photo by V. J. Mele.)

an aquatic animal like the otter. The *pine marten* or "*American sable*" lives in dense forests of pine and spruce, and feeds on small rodents, birds and reptiles. It grows to the size of an ordinary house cat. Demand for their fur has reduced the number until but few of these shy animals remain. *Pennant's marten*, called the *black cat*, is rather large, sometimes reaching a length of three feet and a weight of eighteen pounds.

The *weasel*, the smallest of the *marten* family, is brown in summer, but becomes the white "*ermine*" in winter. It kills chickens and small mammals, being particularly valuable in the extermination of rats and field mice. The *ferret* is a domesticated variety of the English "pole-cat." Formerly used in this country in hunting rabbits and rats, it is rarely seen today. (Figure 217, *A* and *B*.)

The *wolverine*, "mountain-devil" or *Carcajou*, is the greatest thief among animals. It follows a "line" of traps, devouring the bait and sometimes stealing the trap. Cabins and caches are stripped of edibles and foodstuffs, too large to carry away, are

dragged in the dirt. Wolverines resemble a cross between the badger and the bear.

The common *skunk*, *Mephitis mephitis*, is a native of North America, found from Hudson's Bay to Guatemala. An allied form,

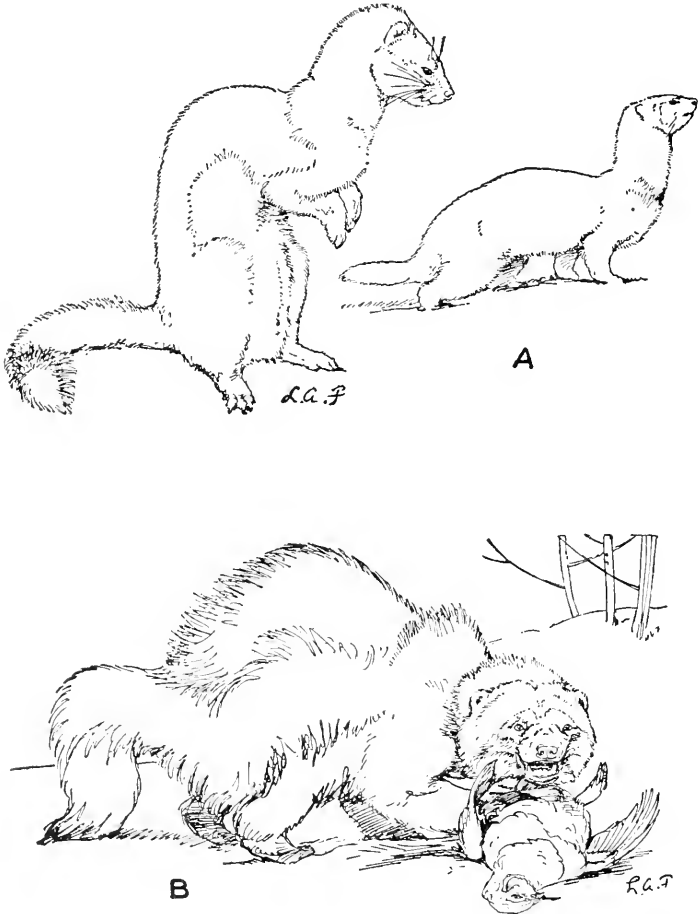

FIG. 217. A, ferrets. B, wolverine. (From L. A. Fuertes. Courtesy of Slingerland-Comstock Publishing Co.)

the *conepati*, is found in South America. Preëminently an insect eater, the skunk destroys more beetles, grasshoppers, and grubs than all of the other mammals together, and also devours vast quantities of mice in addition. The skunk is also partial to sala-

manders, snakes and the eggs of birds nesting on or near the ground. Under conditions of civilization his fearlessness⁵ renders him an important enemy of poultry. It is said that owls, eagles, and the puma prey upon skunks.

The *badger skunks* resemble badgers in that they are expert diggers. They are found in South America but range northward into Arizona. The *badger* lives in burrows and feeds on ground squirrels and prairie dogs. It has naked soles, short legs and a broad, flat body. In the United States, it is found in the Rocky mountains and westward to the Pacific coast. (Wisconsin is called



FIG. 218. Young red foxes. (Courtesy of A. B. Brooks.)

the "badger" State.) In Alaska it hibernates during most of the winter. The *European badger* lives in the woods. The *Asiatic badgers* have a strong musky secretion.

The **Dog family** (*Canidae*) have served as man's companion longer than any other domesticated animal. They are found everywhere except in New Zealand. The genus *Canis* includes **dogs, wolves, foxes, and jackals.** (Figure 218.)

The common *red fox* is found throughout the whole northeastern United States extending westward to the limit of trees. Foxes

⁵ Few there are who will brave the overpowering scent from the anal glands of a skunk, which can be discharged in any direction to a distance of ten feet. The scent is so powerful that it can be readily detected when a mile away, and it is capable of anesthetizing a person. The scent is *n-butyl mercaptan*, C_4H_9SH , the excretion of sulphur being quite characteristic of the scent glands as well as the *urine* of the meat eaters.

feed on small mammals and upon ground birds as well as on frogs, lizards, insects and fruits. Foxes are extremely cunning and are valued by hunters on that account. A rare phase of the red fox, the **black fox**, sometimes called the "silver gray" fox, is extremely valuable for its fur. A single black fox skin is said to have brought \$2,900.00. Fox farms are found in Canada and in the northern part of the United States. At the winter fur auction in New York City beginning January 23, 1928, it was reported that the silver fox pelts (over 800 in number) were worth more than \$1,300,000. The majority of these skins came from a single fox farm⁶ in Wisconsin.

The *Arctic fox* has two color phases, one, brown in summer and white in winter; the other, gray or black in summer and blue or black in winter. In the far north it is snow white the year round. In Iceland and the Aleutian Archipelago it is dark the year round and is known as the "blue" fox. In Labrador the blue phase is rare, while in Greenland, Alaska and Spitzbergen both are common.

The darker color makes the fox extremely conspicuous instead of protecting it. Roosevelt and Dugmore have both concluded that practically speaking there is no such thing as *protective* or *concealing* coloration. (See Thayer's theory, page 488.)

The *coyote* or *prairie wolf* is a cowardly animal, stealing poultry, pigs, lambs and sheep, but never attacking mammals larger than deer. Their cry is a dog-like barking howl. They are smaller than the gray wolf, but somewhat resemble it.

The *red wolves* have been so active of late in Texas, killing sheep, goats and poultry, that in the rural districts government hunters have been employed to kill them off. In the eight months preceding January, 1928, 100 of the animals were killed. Bounties as high as \$300.00 were offered in some Texas counties. The *red wolf*, like the coyote (prairie wolf), is a solitary nocturnal despoiler. A giant red wolf caught recently weighed 63 pounds.

The *gray wolf*, "*lobo*" or *timber wolf*, is a large strong animal ranging from Florida to Arctic America. They hunt in packs or in relays and destroy deer, antelope, cattle and young horses. In Alaska they grow to a length of over 4 feet and a height of 2½ feet, weighing over 100 pounds.

⁶ Fromm Bros., of Hamburg, Wis., received a single check for \$1,021,071.24 in payment for the silver foxes sold in New York at the auction of 1928. At other auctions that winter, they received \$267,203.00 additional.

The African and Oriental *jackals* are scavengers, but also rob hen-roosts. They feed on figs and fruits as well.

There are over 200 breeds of domestic *dogs*. They are derived from at least *seven* wild species, including the *jackals* of Asia, the *jackal-wolf* of Northeast Africa, the *gray wolf* and the *coyote* of North America.

Sub-Order Pinnipedia. (*Seals and Walruses.*)—The *Pinnipedia* are aquatic carnivores with their digits united by a membrane. The *Northern fur seal* (*Otaria ursina*) is not a true seal, but is a sea bear or sea lion, found on the Pribilof Islands. It spends about two-thirds of each year far out at sea, making a circuit of six thousand miles in the open ocean without touching land. The United States protects a large fur seal herd on the Pribilof Islands, Alaska. The *California sea lion* (*Otariidae*) feeds mostly on squids and octopi, but fishermen consider it injurious as a fish consumer. The *true seals* (*Phocidae*) have no external ears and their nostrils are dorsally situated. Among the common forms are the *harbor seal* and the *hair seal*. The bluish gray fur of the *harp seal* is extremely valuable. The *hooded seal* males have a nasal sac that can be inflated to a length of ten inches. *Elephant seals* (twenty feet long) are nearly extinct, but a few were discovered recently at Guadaloupe Island. *Walruses* (*Odobenidae*) are clumsy on land, but have extremely powerful tusks (canine teeth) and can wreck small boats. They eat shellfish, crustaceans and aquatic plants. Formerly supplying the Alaskan natives with fuel, light, harness and boats, the demand for walrus oil has led to their almost complete extermination.

Fossil Relatives of the Carnivora.—Primitive Creodonta are found in the Eocene of North America, Europe, and Africa, and are almost indistinguishable from the Insectivora and Ungulata of that period. Fossil dogs appeared in the Eocene of North America. Fossil cats are known from the Oligocene period where the huge saber-tooth tigers lived from the Miocene to the Pleistocene. Bears came in with the Miocene, and the great cave-bear (*Ursus spelens*) of Europe was hunted for food during the Pleistocene period. Seals and walruses have descended from primitive Pinnipedia of the Miocene period.

Order VI. Rodentia.—Vegetable-feeding, mostly of small size, with furry integument, clawed digits, and usually plantigrade limbs. Clavicle usually present. No canines, never more than *two* incisors in lower jaw and but two in the upper except in the Lepo-

ridae, all elongated, chisel-like, growing from persistent pulps; premolars few. Placenta deciduate and disc-shaped. Cecum large. (Figure 219.)

Rodents vary in size from the porcupine of three feet in length to the small mouse about three inches long. *Squirrels* (*Sciuridae*) are found everywhere except in Australia and Madagascar. Four species are found in the United States and Canada.

The *California ground squirrel* (*Citellus beecheyi*) (see Figure 220) lives in and on the ground, storing its food of fruits, nuts, and grain in the ear in its underground burrows. It is of particular interest since it carries *bubonic plague* caught from rats.

Other squirrels include the *Eastern Gray squirrel* which lives in the tree tops and the *rock squirrels* or "*chipmunks*" which live in fences and among the roots of large trees. The largest squirrel in the world is the great *Malabar squirrel* of India, which grows to be eighteen inches long, with a tail fourteen and one-half inches long.

The *Eastern chipmunk* (*Tamias striatus*) ranges from Illinois eastward. It is a lively little creature about ten inches long, and seems fond of nests in rocky crevices and decayed tree trunks. It usually has several entrances to its tunnel. It feeds on acorns, nuts, and grains but is also a consumer of mice, birds' eggs and insects. Its chief enemy is the weasel but it is also preyed upon by birds.

The *flying squirrels* (*Sciuropterus*) are *not* able to fly, but by means of a furry membrane spread from the anterior to the posterior limbs they plane from one tree or branch to another. The Asiatic flying squirrel reaches a length of eighteen inches.

The *prairie-dogs* (*Cynomys*) live in villages on the plains. They are a great pest in the cattle country. Rattlesnakes visit their burrows in search of young "*dogs*" and burrowing owls are frequently found in vacated burrows, but the "*happy family*" does not exist.

The *woodchuck*, or "*groundhog*," lives on clover and other grasses and may enter isolated gardens. He lives in a burrow and hibernates in November. It is traditional that he awakens on "*groundhog day*," February 2, and "*if he sees his shadow, sleeps six weeks longer, which means a cold spring.*"

The *gray marmot* is found in the Northwestern part of North America and is called the "*whistler*" on account of its danger signal.



FIG. 219. Red squirrel. (Courtesy of Canadian National Railways.)



FIG. 220. California ground squirrel (*Citellus beecheyi*). (Courtesy of Joseph Dixor, University of California.)

The *Alpine marmot* is a similar form, hibernating a dozen in a group, packed into a hair-lined burrow.

The *North American beaver* (Family *Castoridae*), an aquatic rodent, has a heavy body, webbed hind feet, and a large flat tail. Contrary to the statements of some nature fakers, the tail is not

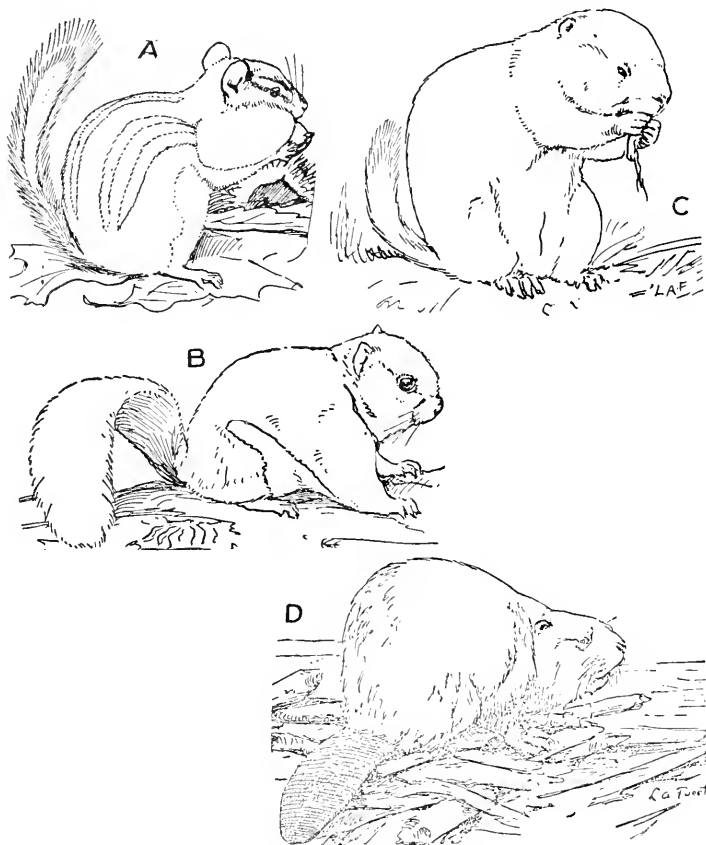

FIG. 221. *A*, chipmunk. *B*, flying squirrel. *C*, prairie dog. *D*, beaver. (From L. A. Fuertes. Courtesy of Slingerland-Comstock Publishing Co.)

used as a trowel or a sledge, but as a danger signal and in swimming and diving. The beavers fell trees up to eighteen inches in diameter and quickly dam streams to flood the entrance to their burrows.

The largest family of *rodents* and the most important economically is the family **Muridae** to which belong the rats and the mice.

The genus *Rattus* includes a number of species, all of which are important as disease carriers. (Figure 222.)

The *brown rats* (*R. norvegicus*) destroy grains, poultry and nesting birds, carry away eggs, sometimes cause fires, and even bite through lead pipes and cause floods. The *black rat* of England was the carrier of the "great plague" of 1665 which destroyed one hundred thousand people. Brown rats eventually drove the black rat out of England. It is now chiefly confined to ships. It disseminates *bubonic plague*, which is transmitted by *rat-fleas* to ground squirrels. Ships in port have three-foot metal discs guarding their hawsers. Poison baits and fumigants are used to destroy rats in ships and storehouses that are not rat-proofed.

The *Eastern wood rat* (pack rat, trade rat), the most handsome of the rats, is noted for its mental capacity. It stores food, but also steals tools, silverware and even watches, and stores them away. Vernon Bailey states that they are edible, "better than Gray Squirrels."

The *albino rat* is our most important mammal for experimental purposes, and has been inbred for nutrition and other studies (see p. 441).

The *common house mouse* (*Mus musculus*), a species introduced from Europe, is an important enemy of food stuffs and especially injurious in warehouses. The *field mouse* or *meadow mouse* (see Figure 223) is a short-eared,



FIG. 222. Brown rat infested by *Cysticercus fasciolaris*. (A. T. Hopwood, *Parasitology*, vol. 14, no. 1.)

short-tailed animal with a thick body. It feeds on roots and grasses and also turns its attention to young fruit trees, shocks of corn, and fields of alfalfa. The *pine mouse* is a burrowing mammal feeding largely underground. It is of great injury in truck gardens and has damaged many small trees.



FIG. 223. Meadow mouse. (Courtesy of W. Va. Exp. Station.)

Lemmings, short-tailed prairie-dog-like forms, have a maximal production which was in times past every four years, but now comes about every ten years. Their migrations (see p. 418) are a sign of over-production. It is interesting to note that in their enemies, hares, Arctic foxes, weasels and lynxes,

there is a corresponding cycle of increase.

The *musk-rat* or musquash is a small aquatic rat-like rodent with a broad blunt head, thick-set body and short legs. Its long tail is almost naked. Musk-rats are widely distributed through the United States. They are omnivorous, feeding on the stalks and roots of flags and reeds, and on animals such as insects, fish and shell fish. Musk-rat skins are dyed and sold as "Hudson Seal" or "electric Seal." The *dormouse*, a small form found in the Old World, resembles a small squirrel. It spends about six months of the year "wrapped in a profound sleep." It utters a shrill whistling snore surprising in its volume. The *American porcupines* are arboreal forms. They are well protected by spines which readily pull out and being barbed remain in the flesh of the enemy. *Ferboas* or *jumping-mice* (*Dipodidae*) (Figure 224 A) have kangaroo-like tails and hind legs and are reputed to jump ten feet.

The *pouched gophers* (*Geomysidae*) (Figure 224 B) are burrowing rodents found in Central America and the central plains of North America. The *red pocket gopher* is a vicious, thieving animal, tremendously injurious to fruit trees, grain and vegetables. It also honeycombs and weakens the banks of canals and irrigating ditches in the Mississippi valley. Farmers use traps and strychnin poisoned grain in an attempt to kill off the pests.

The *hare* and *rabbit* family (*Leporidae*) includes two quite distinct groups. The *rabbit group* (*Sylvilagus*) is represented in the United

States by the *gray rabbit* or "*cottontail*" which is found from New England to Yucatan. Although *cottontails* are small with relatively

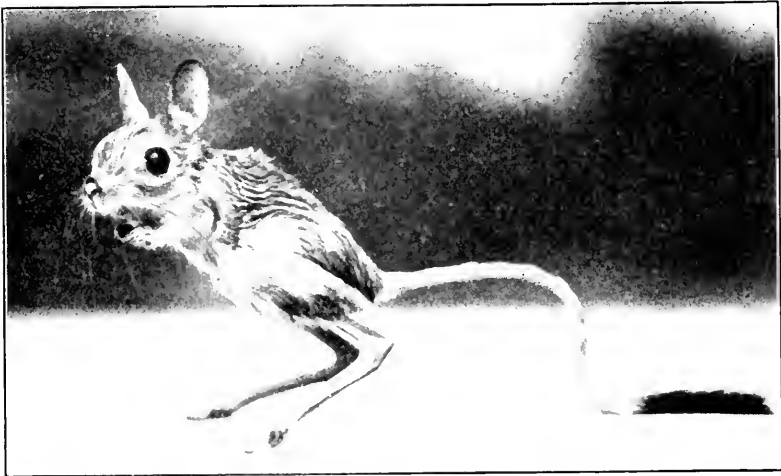

FIG. 224A. Egyptian jerboa. (Courtesy of N. Y. Zool. Soc.)



FIG. 224B. Pocket gopher (*Thomomys awahnee*). (Courtesy of T. I. Storer, Univ. of Calif.)

short, weak limbs, they are exceedingly cunning and burrow in cities and towns, rearing families in apparently quite accessible places. In the West, cottontail rabbits are such pests that rabbit-proof fences,

poison baits, trapping and hunting are all resorted to, in an attempt to decimate them.

The *hare* family (*Lepus*) includes the *Jack hare* (sometimes called the Jack rabbit), the *prairie hare*, the *varying hare* and the *polar hare*. The "*Jack hare*" can distance a speedy greyhound and some hunters insist that it can beat a rifle bullet! The hare is a large, long-legged, long-eared animal which does *not burrow*, but rears its young in a *nest*.

Hares and rabbits girdle trees and eat garden vegetables, clover and alfalfa. It is said that except when famished *hares* exhibit considerable delicacy of taste, selecting only certain varieties of soy-beans and alfalfa. Rabbits, introduced into Australia and New Zealand, spread rapidly and destroyed the grass so that sheep died of starvation.

Tularemia, a disease somewhat similar to spotted fever,⁷ is carried by lice and ticks from one rabbit to another. It may cause serious epidemics and reduce the number of rabbits and ground squirrels considerably. Man is susceptible to tularemia. It is transmitted from the bites of ticks or lice, or from handling diseased rodents.

Fossil Relatives of the Rodentia.—Rabbits and squirrels were first found in the Oligocene of North America, while the beaver, rats, and mice appeared in the Pliocene of Europe.

Order VII. Edentata.—Clawed, without enamel on the teeth; teeth absent from the anterior part of the jaw. Great number of sacral vertebrae, as many as thirteen in some armadillos. Brain sometimes low, sometimes of comparatively high organization.

There are three genera of South American ant-eaters (*Myrmecophagidae*), all lacking teeth, but with extremely long protrusible tongue, plentifully coated with a thick secretion developed from their salivary glands. They have long snouts and powerful bodies adapted to tearing bark from trees or ripping open ant hills. (Figure 225.)

The *great ant-eater* may reach a body length of five feet with a tail as much as two feet long. It is able to defend itself against dogs and snakes. The single offspring rides on the back of the mother, remaining with her a year. The *tamandua*, a small ant-eater found

⁷ R. R. Parker and J. S. Dade, Tularaemia in Sheep in Nature, Pub. H. Reports, vol. 44, Jan. 18, 1929, found *Bacterium tularense* in the flesh of sheep. Probably the wood tick, *Dermacentor andersoni*, transmits the disease from jack rabbits to sheep.

in South America, reaches a length of about two feet. It has very large front claws.

The *sloths* (*Bradypodidae*), found only in the New World, are arboreal forms, never descending to the ground if possible. They are nocturnal feeders and their hair usually contains quantities of *green algae*, causing them to resemble branches. The *three-toed sloth* has nine cervical vertebrae, while the *two-toed sloth* has six instead of the seven usually found in mammals.



FIG. 225. Giant ant eater. (Courtesy of N. Y. Zool. Soc.)

The *three-banded armadillo* (*Dasypodidae*) of Argentina is able to close itself into a tight round ball so that it resembles a nut. The *nine-banded armadillo* is somewhat larger and is found ranging from Texas to the central part of South America. It has been studied recently at the University of Texas, since it offers a most interesting example of quadruplets, *identical* of course. Armadillos eat insects and worms, and occasionally salamanders and lizards.

Fossil Relatives of the Edentata.—Fossil remains of the modern sloths and ant-eaters are unknown, but the extinct ground sloths (*Megatheriidae*) with the head and teeth of a sloth and the tail of an ant-eater were found in the Pleistocene, one species having reached the length of nearly twenty feet. A large armadillo-like form known as *Glyptodon* was found in the Pliocene of the Americas.

Order VIII. Ungulata.—Terrestrial, usually herbivorous, nearly

always hoofed. Clavicle absent, canines small or absent, premolars and molars well developed with broad crowns.

Sub-Order Hyracoidea.—The *hyrax* (*Hyracoidea*), a small animal found in Africa, is probably the form described in the Bible as "Cony." It has about twenty-two vertebrae that bear ribs. It has in addition to a cecum a pair of *rectal caecae*. Superficially it resembles the rabbit, having a hare lip and an extremely short tail. Its front feet have four toes, while the hind feet have three. (Figure 226.)

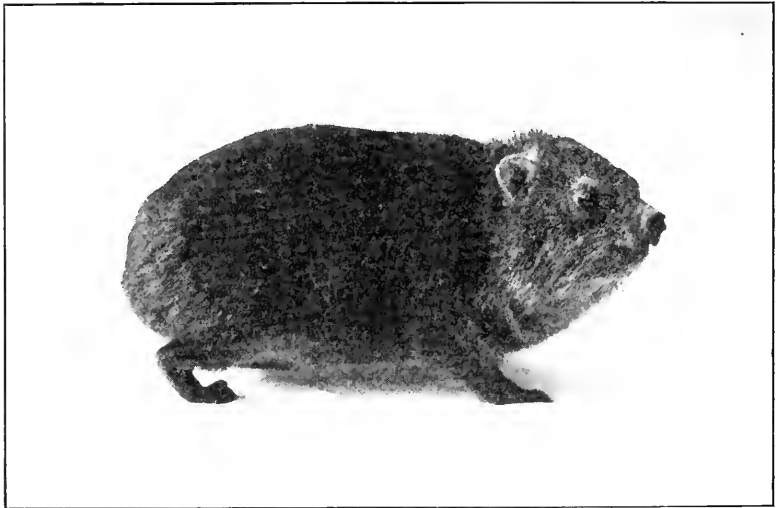

FIG. 226. Hyrax. (Courtesy of N. Y. Zool. Soc.)

Sub-Order Proboscidea.—The *elephants* have *no clavicle*. They have an extremely thick skin, huge five-toed legs and a long nasal proboscis. The incisors of the upper jaw grow to form tusks. *Elephas indicus* has been used as a beast of burden in India for many years.^{7a} It reaches a height of less than ten feet. It is more intelligent and docile as well as more powerful than the African species. *Elephas africanus* has a shorter, more rounded head than the Asiatic and its ears are enormous, covering the back of the head and the neck. Both the male and the female have tusks (elongated incisor

^{7a} Livy in describing Hannibal's passage over the Alps (Livy, Book 21, Chapter 28) discusses the manner in which historians supposed that his war-elephants were transferred across the Rhone River. Some reported that the elephants were induced to swim, while others described the manner in which they were ferried on long rafts.

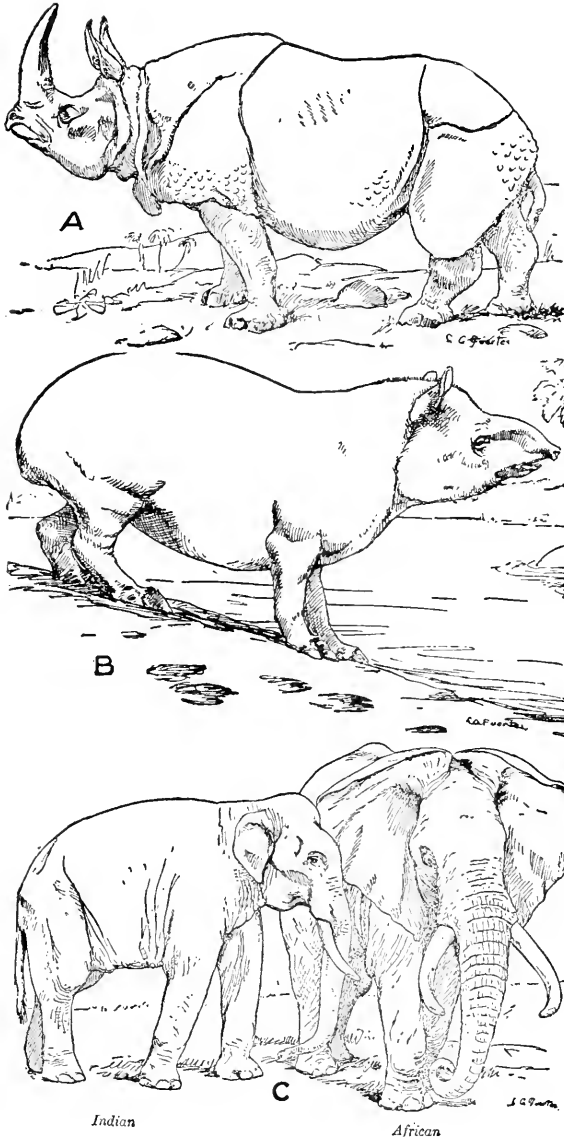

FIG. 227. *A*, Indian rhinoceros. *B*, South American tapir. *C*, elephants. (From L. A. Fuertes. Courtesy of Slingerland-Comstock Publishing Co.)

teeth) while the African form has three toes on its hind feet instead of four. It reaches a height of twelve feet. (Figure 227.)

Sub-Order Perissodactyla.—*Perissodactyla* are *odd-toed* Ungulata with an uneven number of digits; the axis of symmetry passes through digit three. Premolars and molars are completely folded. Stomach simple; *cecum* large. Gall bladder absent, teats situated in the groin and placenta diffuse. (Horse, tapir and rhinoceros.)

The *tapirs* (*Tapiridae*), found in tropical America and India, are as old a family as the horses (*Equidae*). They have four-toed fore feet and three-toed hind feet. The nose and upper lip are elongated into a proboscis. Tapirs are enemies of the cocoa plant. They are hunted for food and for their hides.

The *rhinoceroses* have extremely thick skin deposited in folds resembling plates of armor. The East Indian species has one nose horn, and the African white rhinoceros has two. Nose horns, outgrowths of skin like whalebone, grow at the base as the tip wears away. They are used as weapons, and powdered for medicines. The rhinoceros injures cane and melon fields, and cacao plantations.

The *horse* (*Equidae*) has a geological record back to the Eocene Epoch when the little *Eohippus* had four complete toes and the splint of a fifth on its fore feet, while the hind feet had three complete toes and a splint of the fifth. It was about the size of a small dog. (See p. 526, *The Evolution of the Horse*.)

All our horses have been introduced from the Old World. *Wild horses* are found at the present time in Asia (*Equus hemionus*, the Asiatic Wild Ass; and *Equus przewalskii*, Przewalsky's Horse) and in Africa (*E. asinus*, the African Wild Ass; and the Zebras, *Equus zebra*, *burchelli*, and *Quagga*).

The *African Wild Ass* has been domesticated and is utilized as our donkey. The White Ass was used in Africa as a means of transportation for the great, centuries ago. Andrews states that the *Asiatic Wild Ass* is capable of bursts of speed of 60 miles an hour.

Hybrids.—The "mule," a hybrid between the *horse* and the *ass*, is an extremely powerful draft animal. Male hybrids are as a rule infertile,⁸ and only a few cases of fertile hinnies⁹ have been reported.

⁸ Wodsedalek, J. E. 1916. Causes of sterility in the mule. *Biol. Bull.*, vol. 30, pp. 1-39, 1916.

⁹ Groth, of the Texas A. and M. College, has reported a case of "Old Beck," a fertile mule, who in 1920 produced a daughter, sired by a Jack, and later produced a son sired by a stallion. It is further reported that the horse-like colt has sired a healthy colt, making "Old Beck" a grandmother.

The United States Department of Agriculture has experimented with the *zebra* and the *quagga*, hybridized with the horse, but has been unable to secure any notable improvement over the *mule*. The African quagga is now extinct.

Artiodactyla.—**Artiodactyla** are even-toed ungulates in which the third and fourth digits form a symmetrical pair. Premolars are smaller than molars; stomach usually complex, cecum small. Placenta diffuse or cotyledonary.

The **Artiodactyla** are divided into the Ruminants and the Non-Ruminants. The Ruminants are that extremely important group of domestic animals which have been of service to man for thousands of years—**cattle, sheep, goats, and camels**; also such non-domesticated types as **antelopes, deer** and **giraffes**. The Non-Ruminants include **pigs, peccaries** and the **hippopotamus**.

The *African hippopotamus* or "river horse" once ranged over Europe and India. It is thick skinned and almost devoid of hair. Its perspiration is reddish. The *hogs (Suidae)* are important sources of food supply. The United States produces over one-third of the hogs of the world, and exports many. The *wild boar* has been hunted for centuries by the sportsmen of Europe. Its tusks are elongated canine teeth. The *African wart hog* has such a horrible appearance that it is said to be the ugliest of mammals. Another African form, the "*red river hog*," is one of the most beautiful of the Suidae, having long slender ears and a glossy coat. The *collared peccary* or *javelin* (hunted on horseback in Mexico) and the *white-lipped peccary* range from Mexico into South America, frequenting the upland jungles.

The *ruminants* are animals that have four parts to their stomachs and regurgitate the food from the rumen or paunch, chewing it as the "cud." (See Figure 241, page 454.)

The *Chevrotains* of India and Africa are hornless forms, resembling both the deer and the pig. They have in some cases four toes reaching the ground, do not chew the cud, and have simple stomachs with only *three* chambers. The "deerlets" have changed but little since the Miocene period.

The *Camelidae* are able to retain twenty quarts of water in the tightly closed water cells of the *rumen* of their stomachs, and march for a week over the sanded wastes. Their nostrils are guarded by valves, their tough cartilaginous mouth permits them to eat thorny vegetation, and they walk over the sand on padded feet. The *hump* of the camel is a reservoir of nutriment to the animal and a satis-

factory human food. The *one-humped Arabian camel* is very speedy. The *two-humped Bactrian* is short legged, and long haired. It is especially important in the heat and cold encountered in Mongolia. Camels were introduced to the United States in 1850 at the Gold Rush and later purchased for use in the Union Army. The *llama* is a Peruvian beast of burden. In Peru, Chile, and South Africa,

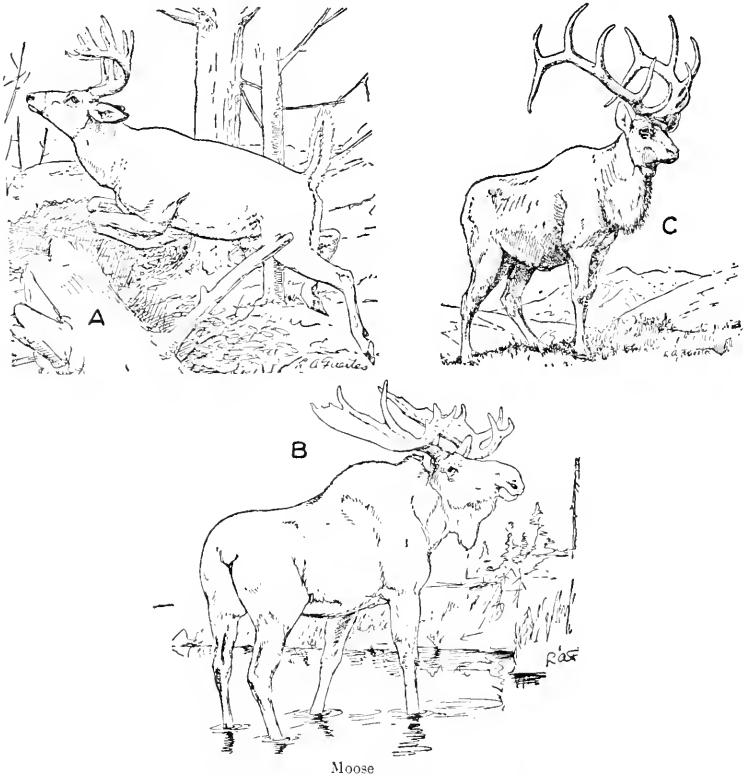

FIG. 228. A, Virginia deer. B, moose. C, elk. (From L. A. Fuertes. Courtesy of Slingerland-Comstock Publishing Co.)

the *alpaca (el paco)*, a somewhat smaller form, is bred for its valuable long hair.

The *deer family (Cervidae)* are differentiated from the other ruminants by the presence of bony antlers. The male deer of most species have solid horns which are shed once a year, close to the skull, and are fully renewed by rapidly growing out in a soft state

called the *velvet* (Hornaday). The first pair of antlers grown during the second year are two straight, slender spikes ("dag antlers"). The fully grown antlers branch several times. The *American Elk* or *Wapiti* (*Cervus canadensis*), tall as a horse, with a beautiful mane and a pair of large antlers, is termed by Hornaday "The king of the Cervidae." The *elk* browses and grazes. The *European red deer* are related to the elk.



FIG. 229. Mule deer in "velvet." (Photo courtesy of Canadian National Railways.)

The *mule deer* or *Rocky Mountain* "black-tail," (Figure 229) the largest of the North American "deer," ranges as far east as western Dakota, preferring a dry climate and a high altitude. It is difficult to keep in a park. The *Virginia deer* or "white-tail" deer is a forest animal noted for its tendency to hunt cover. Its antlers project forward.

The *American caribou* is a deer-like animal ranging farther north than any other hoofed animal except the musk ox. The *woodland caribou* shifts away the snow with its flanged horn and feeds on grasses, moss and lichen. Other caribous include the *Newfoundland*

caribou and the *barren ground caribou*. The *domesticated reindeer* in this country were imported from Siberia and Lapland to Alaska. In the reindeer, horns are present in both sexes. Caribou and reindeer are readily interbred. The *American moose* (*Alces americanus*) is the largest animal of the deer family, not excluding the celebrated "Irish elk." It stands over six feet high at the shoulder, its legs are four feet long and its heavy antlers spread over six feet in width. The male has a long strip of skin, the "bell," hanging down from its neck. The female lacks bell and antlers. The *musk deer* lacks horns and has musk glands highly developed in the male, which furnish the basis of many perfumes.

The *giraffes* (*Giraffidae*) of Africa, although somewhat like the deer, have *no antlers* but short horns covered with hairy skin. The giraffe, in spite of its tremendously long neck, has only *seven* cervical vertebrae. It reaches a height of twenty feet from its front hoofs to the top of its head. Its eyes are large and its face mild appearing, although it is adept at kicking in all directions.

The long neck of the giraffe has, according to the Lamarckian theory, developed as a result of the efforts of the animals to reach the elevated branches of tall trees. (See p. 514.)

It is believed that the parent stock, the *three-horned giraffe* (*Giraffe camelopardalis*), has given off the other species such as the *two-horned giraffe* of Southern Africa and the *six-horned giraffe* of Western Uganda. Giraffes are silent, even the female making no noise whatsoever.

The *North American prong-horn* (*Antilocapra americana*) has horns which in the male are branched like those in the deer. The horns of the female are unbranched. W. L. Finley reports that the pursued prong-horn antelope runs at a speed of about forty-five miles an hour.

The **cattle family** (*Bovidae*) include the *wild cattle*, *sheep*, *goats*, the *bison*, and the *antelopes*. There are many breeds of domestic sheep which are used for flesh and for wool. *Persian* and *Astrakan* lambskins are valued in fur trade.¹⁰ The *fat-tail sheep* of Asia have a tail that weighs as much as fifty pounds. The *Spanish Merino sheep* introduced into Australia, Africa and United States is valued for its fine long wool. There are six North American species of wild

¹⁰ Tight curled fur from a lamb 3 days old is called "broadtail." The same lamb at 6 to 10 days of age would give "Persian Lamb Fur." At three weeks the fur would be sold as Karakul.

sheep. Both male and female in Dorset sheep are horned, while the Suffolk breed are both hornless.

The *Rocky Mountain Bighorn* (Figure 230) is a large strong animal adapted to its life on the mountain top. It is valued for its massive horns and its flesh. The *Chamois* of the European Alps, like the Rocky Mountain goat, is termed a goat antelope. The



FIG. 230. Rocky mountain sheep. (Photo courtesy of Canadian National Railways.)

Rocky Mountain goat is not a true goat, but is our only native goat-like species. It has very high shoulders, thick legs and a long face. It lives just above the timber line on high mountains and has exceedingly sharp hoofs adapted to ice and snow.

The true **goats** include the Spanish Ibex, the Steinbock of the Tyrolean Alps and the Persian Wild goat. The goats of Cashmere and Thibet furnish extremely fine wool, while the *Angora goat* (Asia Minor) also furnishes a highly valuable silky hair. In Southern Europe, herds of goats are driven from house to house and milked at the customer's door.

The *ibex* is a large wild goat with horns that extend nearly straight up in a scimitar-like curve. Formerly found in the Alps, they are now limited to the Himalaya Mountains, Syria and Abyss-

sinia. The Himalayan *ibex* stands forty inches in height and has horns that reach a length of fifty inches. Another Himalayan goat, the *markhor*, has enormous black twisted horns, five feet in length, and a yellowish mane over one foot long. It is supposed to be the ancestor of the Angora goat.

The *antelopes*, also *Bovidae*, include the koodoos, elands, springbucks, gazelles, hartebeasts, gemsbucks, water bucks and black bucks found in Africa. Space does not permit a description of these forms.



FIG. 231. Asiatic ibex. (Courtesy of the Field Museum of Natural History.)

The *musk-ox*, found in the frozen north, has a remarkable ability to subsist on grasses and willows, covered by Arctic snows. The males have a strong musky odor.

The *wild ox* of Europe (*Bos primigenius*) is one of the ancestors of our cattle. From this primitive species it is supposed that most of the English, North German, and Holland cattle have descended. (See p. 494, Domestication of Mammals.)^{10a}

The *Wisent*, or European bison (*Bos bonasus*), somewhat re-

^{10a}It is related that bullfighting was introduced into Spain from Rome. The Romans, feeling that it was too brutal a sport to force animals to fight for their amusement, chose the *lesser* evil and used gladiators.

sembles our American bison or buffalo, but is considerably taller. It is a forest lover. Belated efforts have saved a few wisents in the Caucasus Mts. The *American bison*, or "buffalo," is not a true buffalo since it has a hump. It was first seen by white men in Anahuac, the Aztec capital of Mexico, in 1521. The "buffalo" once roamed over the plains of the West and migrated from North to South, thirty-six hundred miles, extending up the Western slope to the Canadian home of the musk-ox. From East to West it ranged about two thousand miles. The American Bison Society has prevented the complete extinction of the buffalo and there are now a number of flourishing herds.

Yaks are used in Thibet as beasts of burden, while their milk and flesh are excellent food. Their skins furnish clothing, harness and tent covers and their hair is twisted into ropes. Their dung is the only fuel available to the Thibetans, when snow hems them in.

The *Indian zebu* has a fleshy *hump* above the shoulders, a development of loose skin on the underside of the neck, a short, steep rump and quite long legs. Different breeds are found in Asia and Africa. "Brahman" cattle were introduced into the United States in considerable numbers in 1906, when A. P. Borden imported fifty-one head from India to Texas. In Texas, as well as in Brazil, pure bred zebras and hybrids are valued highly since both are free from ticks and cattle-fever, and remarkably resistant to drouth and heat.

Certain cattle called *Podolian* are found in Southwestern Russia (Podolsk) and in Hungary and are said to be descended from the *Giant Ox*, *Bos taurus primigenius*. Mature cows reach a height of nearly five feet and a weight of twelve hundred pounds, while bulls are even taller and weigh eighteen hundred pounds. Podolian cattle are not valued for milk production, but as draft animals. They are quite resistant to disease.

The True Buffaloes.—The *Cape buffalo* (*Bos caffer*) has thirteen pairs of ribs like the ox family. The hair of the back is directed backwards. The *African buffalo* lives in reedy swamps. Explorers fear the water-buffalo more than all other African game. The *Asiatic buffalo* has the hair directed forwards on the anterior portion of the back. The *Indian buffalo* is of large size with widely separated horns. It is stronger than the tiger and able to combat the elephant. All buffaloes are fond of water and cover themselves with mud to keep off the gad-flies.

Cattle Hybrids.—One of the oldest of the cattle hybrids has been that with the *bison*, or “buffalo.” (Figure 232.) Potent “cattalo” males are rarely produced and there is a relatively low percentage of fertility among the hybrid cows. In the Dominion of Canada, Galway cattle have been successfully hybridized with *yaks* in an attempt to produce a stock even more cold-resistant than the hardy Irish breed. *Zebu-cattle* hybrids, developed in Louisiana, Texas, and South America, are important additions to the breeds of beef cattle since they are disease resistant. The hybrid male is not fertile.

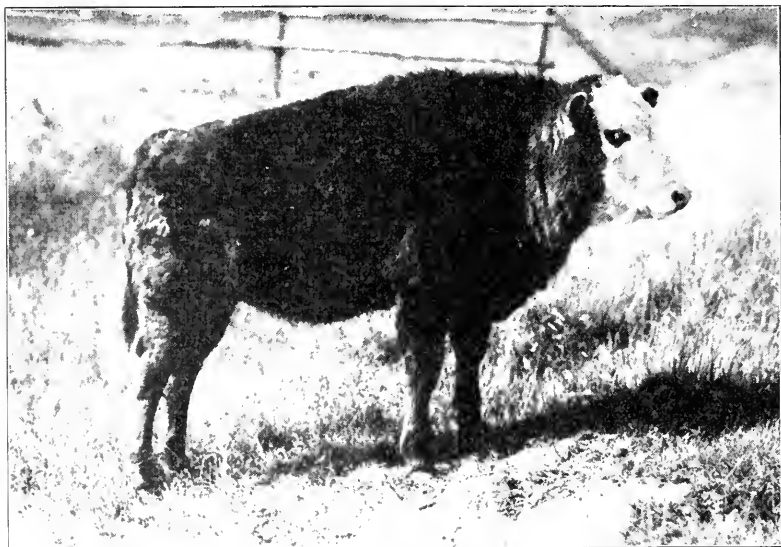

FIG. 232. Cattalo at Wainwright, Canada. (Photo courtesy of Canadian National Railways.)

Fossil Relatives of the Ungulata.—In the lowest Eocene the fossil ancestors of the clawed mammals (Unguiculata) are very much like those with hoofs (Ungulata). Both are five-toed, flat-footed forms with freely movable fore limbs. One of the most primitive forms which occurred in the lower Eocene (*Phenacodus*) reached the size of a large sheep. In North America the mastodon (*Mammuth americanum*) appeared in the Pleistocene. The mammoth (*Elephas primigenius*), a form whose height was usually less than nine feet, appears in the Arctic ice of Northern Siberia. The Imperial elephant (*E. imperator*) reached a height of over thirteen feet. The

horse family arose in the Lower Eocene of North America, and Eurasia. Its descent has been traced from a primitive five-toed Ungulate. True pigs (*Sus*) are known from the Middle Eocene.

The giraffes, found from the Pliocene to the present, were not confined to Africa, but were present in Eurasia as well. The llamas and camels were found on the North American continent in the Upper Eocene. Later they migrated into South America, Asia, and Africa.

Order IX. Sirenia.—Aquatic with moderate-sized head, depressed fish-like body, paddle-like pectoral limbs, pelvic limbs absent, horizontal tail fin. No dorsal fin. Integument thick, wrinkled and hairless. Snout inconspicuous, nostril openings paired and dorsal; cervical vertebrae unfused, clavicle absent. Fore legs pentadactyle, often with rudimentary nails; always a flexible elbow. Brain comparatively small, convolutions *not* highly developed. Testes abdominal; teats are two in number and pectoral in position. Uterus two-horned and the placenta non-deciduate and zonary.

The *dugong* is the only Old World Sirenian. It reaches a length of fourteen feet, and was once so abundant off the coast of Queensland that a dugong fishery was established at Moreton Bay (Hornaday).

The *manatee* or sea cow reaches a length of twelve or thirteen feet and a weight of twelve hundred pounds, superficially resembling a seal. Its tail, a rounded disc, is a powerful propeller. The *Florida manatee* reaches a length of about nine feet. Nearly exterminated, a fine of \$500 protected it till it is now on the increase. The flesh of the Sirenia is considered a delicacy by some. Monks in South America eat all *aquatic mammals* on fast days, as they consider them fish.

Steller's sea cow (*Rhytina*), the "Arctic sea cow," furnished food for Captain Bering when his ship was wrecked on Bering Island in 1741. Steller, the naturalist of the Bering expedition, reported their length as about twenty-five feet and weight as much as eight thousand pounds. The species was exterminated in 1854.

Fossil Relatives of the Sirenia.—The sea cows originated in the Eocene of Egypt, and the West Indies, and were later found in Europe and America. It is supposed that the sea cows and the elephants may have been derived from a form occurring in the Middle Eocene.

Order X. Cetacea.—Aquatic with large head, fish-like body, thick hairless skin, pectoral limbs paddle-like, pelvic limbs absent, horizontal caudal fin. So that animals may breathe while feeding, the larynx is prolonged into a tube extending through the pharynx to the *choanae*, from which the nostrils lead directly upwards to the *single* or paired external opening. Sole organ of respiration, nose. Eyes small, external ears lacking, mammae close to sexual opening. Teeth either present in large numbers, similar and conical; or outlined early, then *resorbed* and replaced by large horny plates of *baleen* (whalebone).

Baleen whales are toothless, but have plates or strainers of whalebone suspended from the upper jaw. The largest of the baleen whales is the great *sulphur-bottomed whale* which may reach a length of over one hundred feet. The "*right whales*," also whalebone whales, produce excellent oil. The *sperm whales* have a narrow beak-like lower jaw with heavy conical teeth arranged in a double row. They reach a length of eighty feet and could have swallowed Jonah. *Ambergris*, used by druggists and perfumers, is formed in the intestine of the sperm whale apparently as concretions around the beaks of cuttlefish. It is worth about ten dollars per ounce. (Figure 233.) Of the 27,566 whales caught in the season 1928-1929, there were 13,650 blue whales. Nearly two million barrels of oil were yielded. Whale meat is now used extensively for food in Japan, but Norway leads all countries in whaling and caught nearly 15,000 in 1928-1929.

The *dolphin* has a slender, cigar-shaped body, a small head and a long narrow beak. It reaches a length of seven and one-half feet. Teeth are present on both its jaws. The *short-beaked dolphin* found in the Pacific Ocean is the most attractive in appearance. The *porpoise* is jet black with a blunt head. It does not reach a length greater than four and one-half feet, and rarely leaps from the water. It feeds on herring and menhaden. (Figure 233.)

The *narwhal* (*Monodon monodos*) reaches a length of sixteen feet and the male has a long ivory canine tusk twisted from left to right and extending from six to eight feet. The *killer* "whale" (*Orca*) reaches a length of twenty feet and has a back fin from four to six feet in height. It kills whales, seals and sea lions, using its teeth as large as those of the largest whale. Hornaday mentions one killer "whale" that captured and swallowed alive four small porpoises. Another observer reported that a single *Orca* ate

twenty-four seals off the Pribilof Islands. The *black fish* reaches a length of about eighteen feet and has been taken in great quantities on account of its valuable jaw oil. It is able to elevate itself vertically in the water, standing on its tail. The *white "whale"* is found in the far North, where it is said to ascend the Yukon River, Alaska, for seven hundred miles.

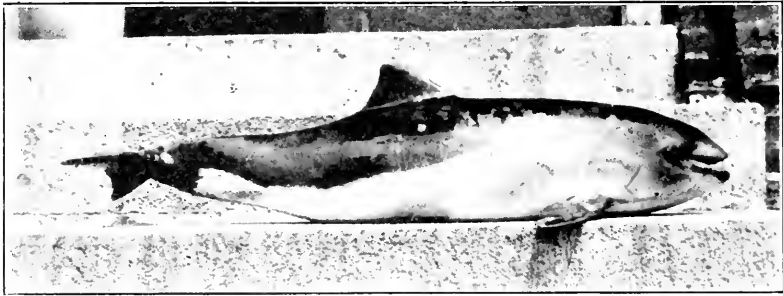

FIG. 233. Side view of porpoise at Woods Hole, Mass. (Photo by Julian Scott.)

Fossil Relatives of the Cetacea.—Certain primitive Eocene whales seem transitional from early *Carnivora*. The toothed whales are found in the Middle Tertiary, and the sperm whales appeared in the Upper Eocene. Whale-bone whales are known from the Miocene to the present.

Order Primates. (*Lemuroidea*, *Anthropeida*, *Hominidae*.)—The *Primates* include the Old and New World monkeys and the most highly developed Primate—man. For the most part the *Primates* inhabit a warm climate. Chiefly arboreal in habits, we find that with the exception of man, they feed on fruit, insects and birds, and do not engage in the chase after terrestrial prey.

Characteristics.—Primates have from 32 to 36 teeth, a closed orbit, and two pectoral mammae. They excel in the development of the nervous system, having large richly convoluted cerebral hemispheres, but are comparatively primitive when bones, muscles, teeth, and other organs are taken into account. Nearly all are adapted to an arboreal life; the limbs are prehensile owing to the pollex and hallux being more or less completely opposable to the other digits. There are nearly always five *nailed* digits. Clavicles are well developed. They have no foramen above the inner condyle of the humerus and the femur rarely has a third trochanter. The

stomach is generally simple. The placenta may be non-deciduate, or deciduate and metadiscoidal.

Lemurs (*Lemuroidea*), the lowest division of the Primates, include the tarsier, the aye-aye and the lemurs. They have long, fox-like muzzles, small ears and 32-36 teeth. In the center of the upper jaw there is always a toothless gap. The *ruffed*, or black and white lemur, the largest of the race, is about the size of a house cat, has a very long tail, and beautifully soft black and white fur. Other lemurs, the *mouse lemur*, the *dwarf lemur* and the *fat-tail lemur*, are much less beautiful than the black and white lemur. They aestivate during the hot dry seasons, living on stored-up fat. The "*slow*" *lemurs*, found in West Africa and East India, are extremely sluggish, live in trees and eat fruits, insects, birds' eggs and young birds. The *aye-aye* of Madagascar resembles a large big-eyed squirrel with the face of a weasel. It has but 18 teeth, with large incisors and no canines. Its third finger is extremely slender and elongated and is used in securing food and in making the animal's toilet. The female constructs a nest for her single offspring. The *tarsier* is found in the forests of Borneo and the Philippine Islands. It is about the size of a small rat, has a long tufted tail and hind legs considerably longer than the front ones. Its paws have long bony digits with pads enabling it to climb smooth bamboo trees. It is nocturnal, hunting for insects and lizards.

Monkeys.—The *Platyrrhina* (broad nosed), or *American monkeys*, have a wide space between the nostril openings which are directed outward. The larger species have prehensile tails.

The *marmosets* (*Hapalidae*) are the lowest in the scale of the American monkeys. They are small, delicate creatures with hairless faces, large eyes and very long tails. The hair is abundant and silky, standing up on the head in a ruff. Their tails are not prehensile. The *Saki monkeys* are black shaggy-haired animals with a long black chin beard and a large hairy, non-prehensile tail. They come from tropical South America east of the Andes and are of medium size. The *owl monkeys*, also from South America, have long, hairy non-prehensile tails and extremely large, owl-like eyes. The *squirrel monkeys* are extremely active and nervous and must be kept in cages. They are arboreal, preferring insects as their food. The *Cebidae*, found in South America, have 36 teeth, flat nails and frequently have a prehensile tail. The *capuchin*, or "ring-tail" monkey (*Cebus*), comes from Central and South America. It has a

white throat and forehead with a brownish or black body. It is frequently seen in captivity. There are six species of *howling monkeys* (*Mycetes*). They have a large sound-box, developed from the hyoid bone, and their concerts may be heard more than a mile. The *spider monkeys* (*Ateles*) have long slender legs and tails and small, round heads. Their long, prehensile tails are used to swing by and with limbs outstretched they do somewhat resemble a spider. They are found as far North as Mexico. They are frequently carried by organ grinders.

The *Old World monkeys* (*Catarrhina*) have their nostrils close together and directed downward. Unlike the New World form, they have open cheek pouches. The tails are non-prehensile or absent.

Macaques (Fam. *Cercopithecidae*) have cheek-pouches; range from one to three feet in length and are found in Asia. The *pig-tailed* monkey of the East Indies (a macaque) is trained to throw down ripe cocoanuts. The *baboons* (*Cynocephalus*), found in Africa and Arabia, are the fiercest of the Primates, explorers stating that hungry lions will not attack them. Their canine teeth are long and sharp. They go in troops of a score, robbing grain fields, but also feeding on birds. They are terrestrial but do not walk erect. The *Asiatic holy apes* (langurs) represent to the Hindoos, Hanuman, the Monkey God, who assisted Rama, a mythical hero. The pious Brahmins protect them so that they are great pests. The *wanderoo* of Ceylon and the *Nose Monkey* of Borneo are other interesting types. These forms have a sacculated stomach, in the first chamber of which leaves are stored for a time, obviating the necessity of cheek pouches.

The *anthropoid apes* (*Simiidae*) assume an erect posture when they come to ground, although they are arboreal in their habits. They lack cheek pouches and ischial callosities (except in the gibbon). Their arms are much longer than the legs, they have an opposable pollex and a vermiform appendix. The *gibbons* (*Hylobates*), the smallest of the man-like apes, are found in the Indo-Malayan region. They have long jaws with extremely long canine teeth and their arms are the longest of any of the group. They leap remarkable distances from branch to branch. Although naturally timid, they often exhibit surprising courage in the defense of their young. The *Siamang* of Sumatra is jet black and has a throat pouch that distends as the animal shrieks. The *brown orang-utan*,

found in Borneo and Sumatra, lives in tree tops, but comes to the ground for water. It is easily tamed when young, but as it approaches maturity becomes savage. It is about two-thirds the size of a gorilla, reaching a height of four and one-half feet. It sleeps in a nest of broken branches in the fork of a tree.

The *gorillas* are the largest and most powerful of the monkeys. They have a tremendous barrel-like chest and massive frame and are able to acquit themselves with distinction in any battle. Since

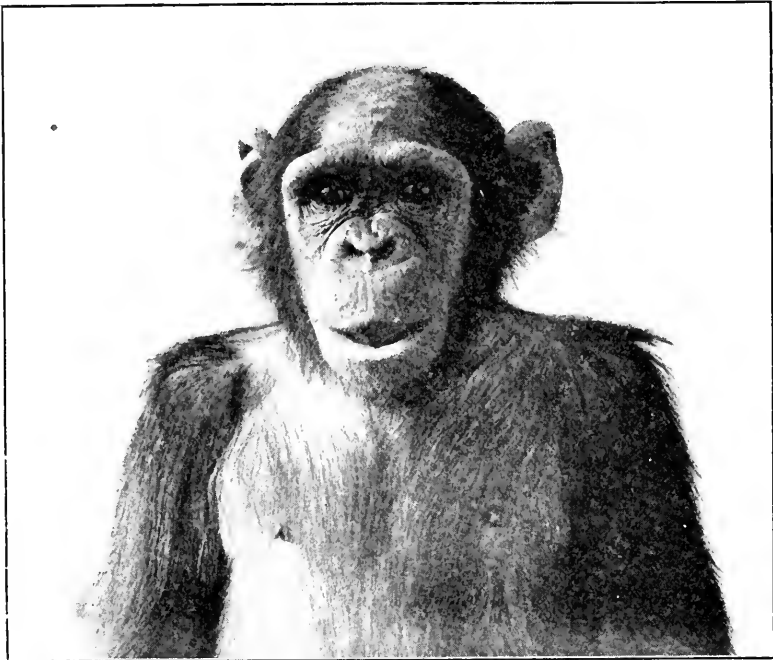

FIG. 234. Chimpanzee. (Courtesy of N. Y. Zool. Soc.)

the time of Du Chaillu, gorillas have been regarded as most ferocious beasts. The late Carl Akeley believed however that the gorillas of Western Africa rarely attack man unless forced to a fight. Gorillas reach a height of six feet and weigh as much as five hundred pounds. The *chimpanzee* (Figure 234) is a third smaller than the gorilla and has a large brain and the keenest mind of any ape. It is easily taught and when young is quite popular with directors of animal films. The two species of chimpanzees are natives of equatorial Africa.

Hominidae.—Man resembles the lower vertebrates in general characteristics and differs less in structure from the higher apes than do the monkeys. The *Hominidae* differ from the *Simiidae* chiefly in the development of the brain and in those characteristics associated with an erect posture.

Among the most striking of the characteristics differentiating man are his increased brain development and power of articulate speech; reduced canine teeth, spinal column adapted to erect posture with four distinct curves; basin-shaped pelvis which supports viscera; arms shorter than legs and with opposable thumbs, arched (shock-absorbing) feet. Whether loss of hair has come from the wearing of clothes is a subject for conjecture. (Figure 235.)

Fossil Man.—Human fossils are very rare, and when found are either in river valley deposits or in those limestone caverns that served as homes and later as burial places.

The **Java ape-man** (*Pithecanthropus erectus*), consisting of a cranium, a femur and four teeth, was discovered by E. Dubois in a river deposit at Trinil, Central Java, in 1891. The age of the geological formation was estimated at about 500,000 years (Early Pleistocene). The teeth were more human than in the gibbon and the skull capacity was about two-thirds that of man. *Pithecanthropus erectus* was about five feet, seven inches tall.

The **Heidelberg jaw**, representing the oldest recorded European race (*Homo heidelbergensis*), was discovered in 1907 in a gravel pit seventy-nine feet below the surface, at Mauer, near Heidelberg, S.

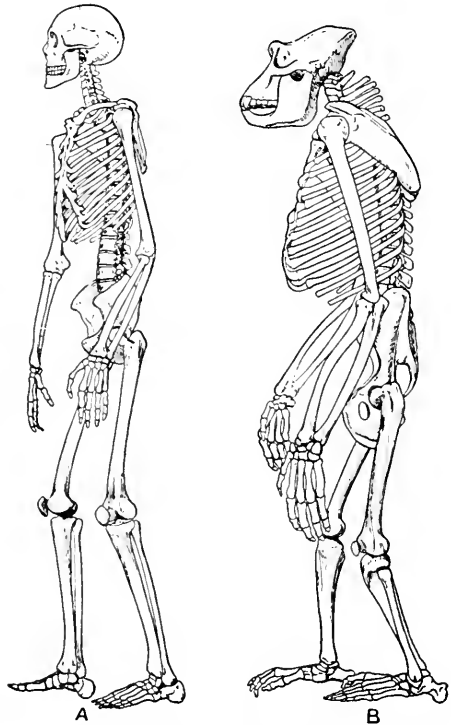

FIG. 235. Skeletons of man and of gorilla. (Lull. Courtesy of The Macmillan Co.)

Germany, by Dr. O. Schoetensack. The mandible was found fully equipped with teeth.

The *Pittdown man*¹¹ (*Eoanthropus dawsoni*), found in 1911 by Mr. Charles Dawson at Sussex, England, consisted of fragments of the cranial walls, nasal bones, a canine tooth and a mandible. The brain case was typically human except for the thickness of the walls. The forehead was high and lacked the prominent supraorbital ridges of the Neanderthal man. The jaw was apparently more apelike.

The first specimen of the *Neanderthal man* was discovered in 1856 near Dusseldorf in Rhenish Prussia. In a cavern high up on the side of a ravine an entire human skeleton was found, but it was at first thought to be an idiot soldier from an expedition of Napoleon. Later ten related skeletons were found in various places in Western Europe. They were short, the males reaching a height of only five feet, five inches. Neanderthal man is supposed to have lived during the third interglacial and fourth glacial periods. The Neanderthal people were cave-dwellers and made tools and weapons of flint. They buried their dead, leaving weapons and food for use in the future world. Whether they were destroyed or amalgamated seems debatable. One European Professor of Anthropology living a few decades ago was himself described as a "typical Neanderthal man."

At Aurignac, France, seventeen skeletons of *Cro-Magnon man* were found in 1852, but were buried in the village cemetery and lost to science. In 1868 five more skeletons were discovered at Cro-Magnon, France, and shown to belong to a highly developed prehistoric people. Physically they were superb, some of them reaching a height of six feet, four inches. Their brain was larger than the average brain of the white race of today. Cro-Magnon men came from either Asia or Africa and replaced or absorbed the Neanderthal type. Along with them developed a high type of art as shown by bone and ivory carvings and cave paintings. Like the Neanderthal man their burial customs indicate a belief in life after death. Following the Cro-Magnons and perhaps absorbing them came migrants from Asia, establishing the narrow-headed

¹¹ Osborn, H. F. 1929. Note on the geologic age of Pithecanthropus and Eoanthropus. *Science*, vol. 49, no. 1782, pp. 216-217. Osborn states that Eoanthropus, the Pittdown man, is now believed to be of greater geologic age than Pithecanthropus of Java.

Mediterranean and the broad-headed Alpine types which persist today.

The Peking Skull.—In December, 1929, Mr. W. C. Pei, who was in charge of excavations at Chou Kou Tien, near Peking, discovered the skull of a primitive man. It was possible to fix the age of the Peking Man at the beginning of the Pleistocene (Ice) Age. The brain was apparently advanced over that of the *Pithecanthropus*, and had a slight frontal bulge. Further study is being made, and should be most important since the cranium is complete. Pére Teilhard de Chardin and Dr. Davidson Black are engaged in studying the skull and in searching for eoliths.

Races of Man.—We have chosen from the various classifications of *Homo sapiens* a division into three predominant varieties, the Negro, Mongolian and Caucasian, first describing the most primitive race now living, probably related most closely to the Negroid.

The *Australian race* have a chocolate brown skin, long black woolly hair, a long skull (dolichocephalic), prominent eyebrows, large canine teeth and are tall with long limbs. They are still found in Australia and are the most primitive of living men.

The *Negroid race* have a black or brown skin with short woolly hair, a dolichocephalic skull with flattened nasal bones, prominent sloping teeth and thick lips. They are found in Africa from the Sahara Desert to the Cape of Good Hope.

The *Mongolian race* have a yellowish brown skin, straight black hair, scanty beard, a short head (brachycephalic), flat nose, small oblique eyes and teeth of medium size. They include the Chinese, Japanese, Tartars, Polynesians, Esquimos, North and South American Indians, Lapps and Finns.

The *Caucasian race* have a white skin, soft straight hair, a well-developed chin, thin lips, small teeth and a narrow nose.

(a) The Mediterranean race are short, slender, long-headed with eyes and hair brown or black. Members of this race, found originally along the shores of the Mediterranean, are ancestral to the slender and short-limbed brunets of the British Isles and the Continent.

(b) The Alpine race are of medium height, round-headed with eyes gray or brown to black. The Central French, South Germans, North Italians, Austrians, many Poles, Turks, Armenians and Persians are of Alpine ancestry.

(c) The Nordics are tall and long headed, with blonde hair, and

blue or gray eyes. They include the Scandinavians, North Germans, many French and Dutch, English, Scotch, most Irish and the Americans and Canadians of early immigration.¹

Race Mixture and the Evolution of Man.—While it has been demonstrated in some parts of the world that the offspring from the union of distinct races are of an excellent type, we are jealously guarding these United States against swamping our best stock with poorer lines, Caucasian though they may be. For many years it was common in some European countries to banish criminals and defectives, and even to furnish them transportation to the land of the free. Today we find judges in some of our states most generously warning petty criminals to get out of the state (and into another). But the stringency of our present immigration laws now prevents many undesirables from entering the country.

Charles W. Eliot thought Zangwill's phrase the "melting pot" most inapplicable to America. He agreed with the one who suggested a new symbol—"America should be a symphony orchestra, playing with intelligence, good will, and self control."

Mammals as Migrants.—Relatively few mammals migrate. Those that do migrate include the bison, reindeer, fur seal, dolphin, bat and lemming. The *bison* formerly ranged over North America from north to south about thirty-six hundred miles; from east to west about two thousand miles. The *reindeer* of Spitzbergen migrate to the central portion of the island in summer and back to the sea coast in the autumn, where they feed upon sea weed. *Fur seals* breed on the *Pribilof Islands* in the Bering Sea, from about May 1 to September 15. Then they go out to sea and spend the winter, making a total circuit of about six thousand miles. The *dolphin* travels up the Amoor River for four hundred miles just as the ice breaks up. *Bats* have seasonal migrations of considerable distances. The *lemmings* of Norway and Sweden are small rodents (relatives of the mice) about three inches long. Periodically the increase in their numbers is so great that they migrate down from the mountains and traverse the Scandinavian Peninsula in hordes. It is

¹ Brouzas is studying the physical characteristics of the ancient Greeks. He reports that Inge believed the Spartans were almost pure Nordics, and the Athenians almost pure Mediterraneans. Brouzas holds that the principle of like attracts like must be accepted, and that the Greeks admired blond hair because they themselves were blond. (Consult Brouzas, C. G., 1930, Proc. Amer. Phil. Assoc., vol. 61, pp. xxvi, xxvii.)

traditional that they devour all the vegetation in their pathway, and continue to travel overland and across streams until they reach the sea where they perish. If it were not for their enemies, the Arctic foxes, weasels, and lynxes, they would ruin the territory through which they pass.

Homing Instinct.—Many instances are cited indicating the remarkable ability of the common house cat and the dog to find their way home after having been transported by train or automobile. Undoubtedly the roving habits of both these animals have given them a rather wide knowledge of adjacent territory. It is most difficult, however, to conceive of their finding landmarks a hundred miles away.

In the savage state, man evinces an uncanny ability in travelling through forests and swamps, and emergencies have proved to many a city dweller that he has a well-developed, although unused ability in that line. Keen, though unanalyzed, powers of observation prove to be the solution of many unexpected achievements in the wilds.

CHAPTER XX

MAMMALIA—PHYSIOLOGY

MAN IS an animal. We see this more and more as we study the structure and vital phenomena of other animal organisms. *Comparative Anatomy* shows the structure to be comparable and animals have been grouped in a series ranging from the simple one-celled animal to man in all his complexity. *Embryology* shows us that man conforms to the Law of Development just as inflexibly as does the simplest invertebrate. *Comparative Embryology* shows a striking similarity between the embryo of man in its early stages and the embryos of other mammals at corresponding periods in their development. But it is in the study of the vital phenomena, *Physiology*, that we find the greatest similarity. There is a wide variation in the degree of specialization of organs for certain functions, but there is in all living animals a property that separates them from the non-living by a seemingly unbridgeable chasm.

The late Jacques Loeb, of the Rockefeller Institute, artificially fertilized the eggs of the sea urchin and the starfish by chemicals, and to his great disgust, the *reporters* announced that he had produced *life*. Jarring, varying temperatures, and differences in the salinity of the water produce the same effect in Nature. All sciences have theories regarding the origin of life, but no theory is without a flaw. Granting that chemicals can be combined to produce life, we have proved nothing. We have pushed back the question a little farther. We have not shown the nature of the phenomenon which causes the chemicals to combine. This is life perhaps. Electricity may be life in one sense. However, we cannot prove the *spontaneous generation* of life. We are able to vary conditions in the case of developing eggs and get different results but we cannot introduce the spark of life. Lovatt Evans said (1928) in his address before the British Association for the Advancement of Science: "Science can not fathom the mystery of life."

MAN VS. THE HIGHER APES

In man and the higher apes the similarity of structure is carried out even to the finer details of the brain. The brain weight and

histological development of the cerebral hemispheres in the higher apes is about that of a microcephalic idiot. The behavior of the apes shows many human traits in that capacity for learning and intelligent acts can be interpreted.

The work of Yerkes ("Almost Human") and of Köhler has shown the ability of the chimpanzee, and to a less extent the gorilla, to recognize complex relations in problems set the animals and has indicated a capacity to plan solutions and to utilize simple tools.

Man has developed a remarkable reasoning power and has brought with him a high development of conscience and a religion. Even the most degraded savage worships something. The discoveries of archaeologists show that wherever human remains are found, tokens of idol or deity worship accompany them.

Man is continually at warfare with other animals and with his fellow men. As man's religion and sympathy become more strongly developed we find that his attitude towards gaining possessions by aggressive warfare decreases.¹

It is necessary for the life of any organism that it be properly adjusted to its environment. The more plastic the mind, the more easily does life continue. The very process of education tends to keep the mind open and to prolong the period of mental adolescence.

PHYSIOLOGY OF THE VERTEBRATE ANIMAL

In the vertebrate type of animal we distinguish from a physiological point of view the following principal organs: those of *digestion, respiration, circulation, excretion, reproduction, muscular system*, which is the organ of movement, and the *nervous system*, the organ of control.

The body is made up of a bony framework, the skeleton, with muscles and fat covered with skin. *Food* is taken into the mouth, *digested* by the *alimentary system*, the *wastes* are carried off by the *excretory system*, the *lungs* and the *skin*, and the sustaining portions are carried around to the tissues by the *blood* which brings the *wastes* from the tissues to the excretory system. The *lungs* serve to aërate and purify the blood before its return to the organs of the body. The interdependence of the various systems calls for a *governing* and *correlating* center, the *nervous system*. It is constantly functional in

¹ "The human animal cannot be aware of beauty except in self-forgetfulness, and it cannot produce beauty except in self-forgetfulness." Arthur Clutton-Brock.

bringing about rapid readjustments to external conditions, as well as in keeping the natural relations between the systems and organs. The *organs of digestion* include the alimentary canal and its accompanying secretory glands, the liver and pancreas, which have as their function the preparation and absorption of food.

The *organs of respiration* comprise the lungs and skin. Their function is the exchange of gases between the organism and the atmosphere. The *organs of circulation* are the heart, arteries, veins, and capillaries with fluid contents. Their function is distribution and renovation of blood throughout the organism. The *muscle fiber* is the essential element of this system. The main *organs of excretion* are the kidneys, which are supplemented by the action of the lungs, the skin, the liver and the blood. Their function is the separation of *urea* from the blood. The active element is the epithelial cell. The *organs of reproduction* are the *ovaries* and the *testes*. The essential elements are the ovum and the spermatozoan, both of which are derived originally from epithelial cells.

The *muscular* and *nervous systems* form an organ which is both master and servant to the entire organism. The *nerve centers* receive information through the *sense organs* and *nerves* regarding the outer and inner needs of the entire organism and, acting through the *motor nerves*, bring about muscle activity producing those movements that satisfy the demands of the situation.

The principal nerve centers are the *brain* and *spinal cord*. The principal sense organs are the skin, eye, ear, nose and tongue. Many of our most important body functions are carried on, without fret or worry, by the *sympathetic* system.

MAMMALIAN PHYSIOLOGY

External Anatomy and Locomotion.—For the most part the mammals are quadrupedal in locomotion. Even in man, the biped, whose upright posture has been fashionable for ages, it has been shown that resumption of the quadrupedal method of locomotion may benefit cases of prolapsed viscera.

The *plantigrade* animals like man and the bear are usually five-toed. The *digitigrade* forms such as the cat are four-toed. In the horse, a *digitigrade* or *unguligrade* animal, the original four toes (with a rudimentary fifth) have degenerated to a single toe. The horse and the antelope seem particularly adapted for speedy flight.

Most mammals *except* the *ungulates* have a perfected *digitigrade* gait, having developed special sole-pads for the absorption of the shock. The *elephant*, however, is said to be *rectigrade*, its weight resting on heavy pads, the foot not moving independently. In the *camel*, the feet are provided with *two* broad cushion-like *pads*, while the hoofs are reduced to *nails*.

The only true *flying* mammals are the *bats*, but other forms, such as certain squirrels, are able to plane through the air. Extensions of the skin on the inside of the fore and hind limbs are drawn taut when the limbs are extended, and furnish a flat surface.

Some forms like the mole and the gopher are able to *burrow* in the ground. In these forms, particularly in the mole, one finds heavily developed shoulder girdles. Depending on the degree of subterranean life, one finds degeneration of the eyes.

Certain *aquatic* mammals such as the whale have undergone degeneration of the hind limbs, with a great development of the pectoral appendages for swimming. In marine mammals, we find that the caudal fin is horizontal instead of vertical and that it has two symmetrical halves.

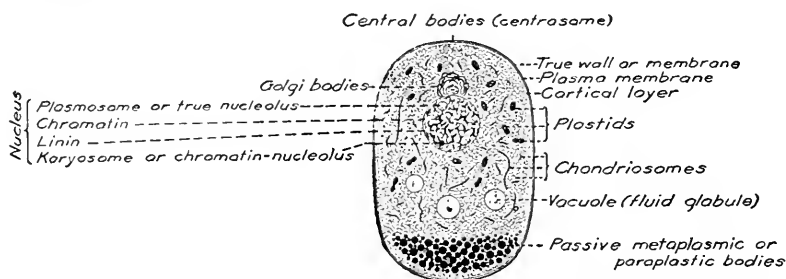

FIG. 236. Diagram of a generalized cell. (After Wilson, *The Cell in Development and Heredity*. Courtesy of The Macmillan Co.)

Histology. Cells and Tissues.—All living bodies are composed of organic constituents called cells. In the Metazoa we find one fundamental characteristic, that of division of labor. Certain cells, grouped together for the purpose of reproduction, are called *germ cells*, while others which carry on all processes except reproduction are called *somatic cells*. The argument between the Lamarckian and the Weismannian schools is based upon the question of possible influence of environment upon the germ cells. (See page 514.) (Figure 236.)

A cell is a minute portion of living substance or protoplasm, sometimes inclosed by a cell membrane, and at some stage of its development containing a nucleus. It is a physiological unit. (See page 423.)

When cells, similar in structure and originating from the same germ layer of the embryo, are grouped together to perform some special function, they are called *tissues*.

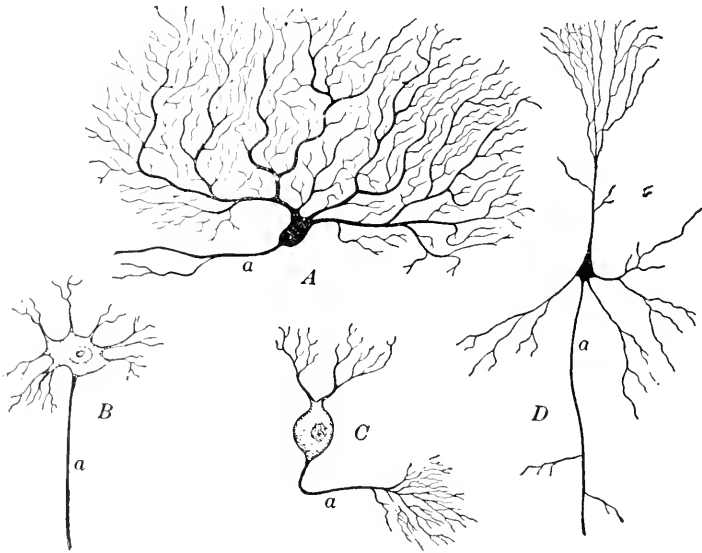

FIG. 237. Four nerve cells. *A* and *C*, from the cerebellum; *B*, from the gray matter of the spinal cord; *D*, from the cerebrum; *a*, the axon. The cells *A* and *D* are stained so that the main body and the dendrites (p. 76) are a uniform black; *B* and *C*, so as to show the nucleus and cytoplasm. (Hough and Sedgwick, *The Human Mechanism*. Courtesy of Ginn and Co.)

We may classify tissues as *Epithelial* or bounding tissues, and *Connective* or supporting tissues. *Epithelium* is a tissue which is distinctively cellular with its cells usually similar in size and form, and united by a small quantity of intercellular substance. (Figure 237.)

Epithelium is found covering all outer surfaces and all inner free surfaces and is protective and secretory. It is the first tissue found in the embryo. *Pavement epithelium* is found lining the mouth, on the inside of the lungs, and covering the body. It is

constantly being worn off and replaced. *Cubical epithelium* is found in the bronchioles of the lungs and in the ducts of certain glands of the digestive system. *Columnar epithelium* is found lining the alimentary canal of vertebrates and a peculiar type of "ciliated" columnar cell is commonly found in the trachea and bronchi and lining the oviduct and the central canal of the spinal cord. *Glandular epithelium* consists of epithelial cells so differen-

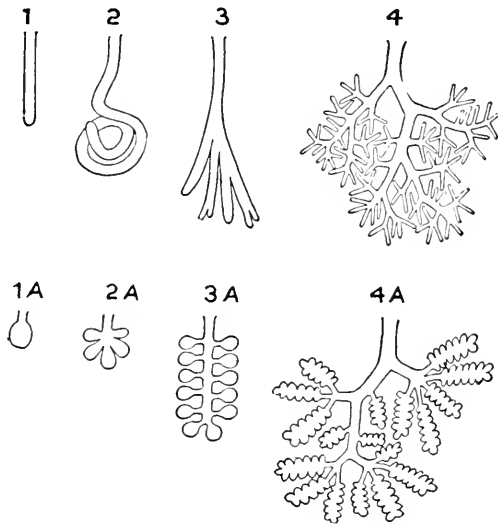

FIG. 238. Diagram illustrating different forms of glands. Upper row, tubular glands; 1, 2, and 3, simple tubular glands; 4, compound tubular gland. Lower row, alveolar glands; 1a, 2a, and 3a, simple alveolar glands; 4a, compound alveolar gland. (From Bailey's *Histology*. Courtesy of Wm. Wood and Co.)

tiated as to be capable of forming compounds given off as secretions. The simplest type of glandular cell is the unicellular gland called the "goblet" cell. This type of mucus-secreting cell is found in the hypodermis of the earth worm and occurs also in the intestines of vertebrates. *Neuro-epithelium* is found lining some of the ventricles of the vertebrate brain. Certain cells are aggregated into end organs of special sense. The sensory cells are spindle-like with hair-like processes extending as fine fibers at the inner end and establishing connection with the nerve. Ordinarily these cells are surrounded by supporting *sustentacular cells*. *Germinal* or *reproductive epithelium* is found in the gonads. The sexual cells arise

from epithelium derived from the primitive mesoderm or in some cases from ectoderm or endoderm. When the sexual cells develop (somewhat as glands form) they frequently starve the adjacent cells.

Connective tissues are derived from the *mesoderm*. **Mucous** tissue is found in embryonic animals. The umbilical cord and the vitreous humor of the eye are mucous tissue. *Reticular* tissue is fibrous connective tissue in which the inter-cellular substance has disappeared. It is found in adenoid tissue and in lymph glands, in the spleen, and in the mucous membrane of the intestinal canal.

Fibrous tissue consists of areolar, tendinous and elastic tissue.

(a) *Areolar* tissue consists of bundles of white fibers with a few fibrils of elastic tissue. The inter-spaces are filled with lymph.

(b) *Tendons* and *ligaments* consist of dense white fibrous tissue.

(c) *Elastic* tissue consists of yellow elastic fibers, frequently found in bundles.

Adipose tissue consists of a matrix of areolar tissue containing cells, the nuclei of which are a-central.

Cartilage may be hyaline, elastic or fibro-cartilage. (a) Hyaline cartilage is jelly-like and found in embryonic bones and at the ends of bones. It has a homogeneous matrix and prominent cells. (b) Elastic cartilage is found in the lobe of the ear, in the epiglottis and in the Eustachian tube. (c) Fibro-cartilage is found in inter-vertebral substance and in the sesamoid bones. It consists of groups of slightly flattened nucleated cells enclosed in capsules and scattered among fibers.

Bone.—Bony tissue may be either compact and dense like ivory or spongy and cancellous with many interstices. The outer layer is called the *periosteum*. In true bone we find fine fibers in a calcified ground substance with branched cells, the *bone corpuscles*, lying in cell spaces called *lacunae* situated in folds or *lamellae* around a cavity called the *Haversian canal*. Ramifying passages which contain cell processes are called *canaliculi* and radiate in all directions from the lacunae.

Muscle substance is a specialized contractile tissue which is the agent of active movement. It is distinguished from undifferentiated protoplasm since it *contracts* in one *direction*. In invertebrates such as protozoa, sponges, and coelenterates we find primitive contractile fibrils, but in worms, molluscs and arthropods, muscular tissue is highly developed. **Non-striated** or *smooth muscle* cells are involuntary. The cells are long, spindle shaped, and somewhat

flattened. Each cell has an oval or rod-shaped nucleus. The cell substance is longitudinally striated but has no cross striations. It is found in the walls of the intestine, trachea, and bronchi, the urino-genital system, blood vessels and hair follicles of mammals and in the foot of the mollusc. **Striated muscle** consists of long cylindrical fibers made up of fibrils arranged end to end in small bundles and enclosed by a sheath or sarcolemma. This outer connective tissue covering is continued into *tendons* which attach to the skeleton. Nuclei are situated in the liquid protoplasm under the sarcolemma. The striated appearance is due to the presence in muscle substance of different chemical compounds of protoplasm arranged in light and dark bars which give a different staining reaction. It is supposed that the wider bar is the contractile substance.

Cardiac muscle is a peculiar type of involuntary striated muscle. The fibers consist of primitive fibrils which are aggregated into oblong masses each with a nucleus in the center. Muscles are well provided with nerves and blood vessels. In cardiac muscle intercellular bridges are found. (Clark, 1927.)

Skin.—The skin covers the body completely, the epithelium changing at the openings of the internal passages to a soft delicate mucous membrane. It varies in thickness, becoming extremely heavy in man on the palms of the hands and the soles of the feet. In the cat it is well developed on the pads of the feet and in the neck region, where it is protective against the bites of enemies. The skin consists of the epidermis, cuticle or outer skin, and the dermis, corium or true skin.

The *epidermis* consists of two layers, the stratum Malpighi and the horny layer, or stratum corneum. Although bony plates are lost in the mammals, one finds heavy armor in some forms, the rhinoceros having a skin over three inches thick. The *dermis*, cutis vera or true skin, consists of fibrous connective tissue with many glands, blood vessels, lymphatics and nerves. The appendages of the skin are the *nails*, and the *hairs*, with their sebaceous glands and sweat glands. They are all developed as thickenings and down growths of the *Malpighian* layer of the epidermis. The *sebaceous* glands are small saccular glands, the ducts from which open into the mouths of the hair follicles. Both the ducts and the saccules are lined by epithelium which becomes charged with fatty material. The *sweat* glands, so well developed in terrestrial forms, are much reduced in aquatic mammals.

Claws or Nails.—Claws or similar structures, nails or hoofs, are found in all the mammals except the Cetacea. They are thickenings of the epidermis. In the cat there are five claws on each fore foot and four on the hind foot. The dermis forms a crescentic fold at the root of each claw.

Hair.—All mammals are born with a thin covering of very fine hair, *lanugo*. It can be noted on a child from the day of birth to two or three days of age, when it disappears. It is replaced by a protective covering of more noticeable hair, as the child grows older. The cat has long coarse hairs on each side the nose called *vibrissae*, which function as tactile organs. In the marine mammals, although fetal hair appears, the majority have lost their hair, except for a few bristles around the mouth. The fur seals retain a thick under coat of fur—"seal skin." In the *white whale* and the *narwhal*, even the fetus has lost its hair. Those mammals without hair develop a thick layer of *fat* under the skin. The skin is richly supplied with tactile and temperature perceiving corpuscles.

Perspiration.—The body is continually throwing off perspiration which we term *insensible perspiration*. Excessive amounts appearing as droplets are termed *sensible perspiration*. In man, the insensible perspiration is estimated to be from one to two quarts in twenty-four hours. Increased exercise, pilocarpin, strychnin, nicotine, nausea or mental excitement will increase perspiration markedly.

In the dog and the cow with perspiration limited by the nature of their skins, we find that the muzzle shows evidence of considerable evaporation. In the horse, it is estimated that about fourteen pounds of insensible perspiration are extruded in a day, through the skin, of course.

Digestive System. Mouth. Teeth.—Mammals have two sets of teeth, the deciduous or milk teeth, and the permanent teeth. The whalebone whale has a fringe of *baleen* hanging down from the upper jaw and acting as a strainer for the small fish and crustacea eaten by these monsters of the deep. The duck-mole (*Ornithorhynchus*) has its teeth composed of thick strong plates.

Salivary Glands.—The mammals possess parotid, submaxillary and sublingual glands. These glands are serous, mucous and mixed, but in some animals the submaxillary is mucous and the sublingual is mixed, while in others the reverse is the process. Salivary glands are lacking in the Cetacea. The vampire bat has a buccal gland

secretion that prevents the clotting of blood. In man, the watery secretion from the parotids contains the enzyme *ptyalin*, while the submaxillary and sublingual glands furnish the viscid mucin. The salivary glands and the mucous glands lining the buccal cavity furnish about three pints of saliva in twenty-four hours.

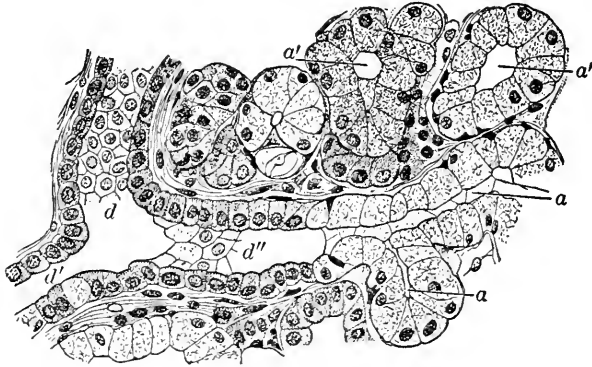

FIG. 239. Section of a portion of a salivary gland, magnified 500 diameters. The duct *d* divides into the two branches *d'* and *d''*, one of which ends in the alveoli, *a, a*. Neighboring alveoli, *a', a'*, whose ducts are not in the plane of the section, are also shown. (After Koelliker. From Hough and Sedgwick, *Human Mechanism*. Courtesy of Ginn and Co.)

Tongue.—The mammalian tongue is well supplied with tactile and gustatory papillae. The human tongue has three kinds of papillae. The *filiform* papillae are the smallest and are scattered over the dorsal surface of the tongue except at its base. In the Carnivora the conical tips of these papillae are heavily armed with horny epithelium, so that it is possible by their use to scrape bones clean of muscles and even tendons. There are about four hundred *fungi-form papillae* found over the middle and front of the tongue. They are bright red in color. The *anterior* portion of the tongue is sensitive to *sweet substances*, while the *lateral* portions are sensitive to *sour* and *salt*. The *circumvallate papillae*, about twelve in number, lie near the base of the tongue in a v-shaped group. They are richly supplied with nerve fibers and specialized sensory cells and are especially sensitive to *bitter* substances.

In the mouth the food is divided, moistened, formed into a ball and prepared for swallowing. Some of the starch, acted upon by *ptyalin*, the enzyme of saliva, is changed into *maltose*.

The *esophagus* is similar in structure to the pharynx but with well-developed mucous glands secreting an oily fluid that lubricates the canal. In man, it is about nine inches long.

Stomach.—The mammalian stomach is divided into three distinct regions, the *cardiac* at the anterior end, the intermediate

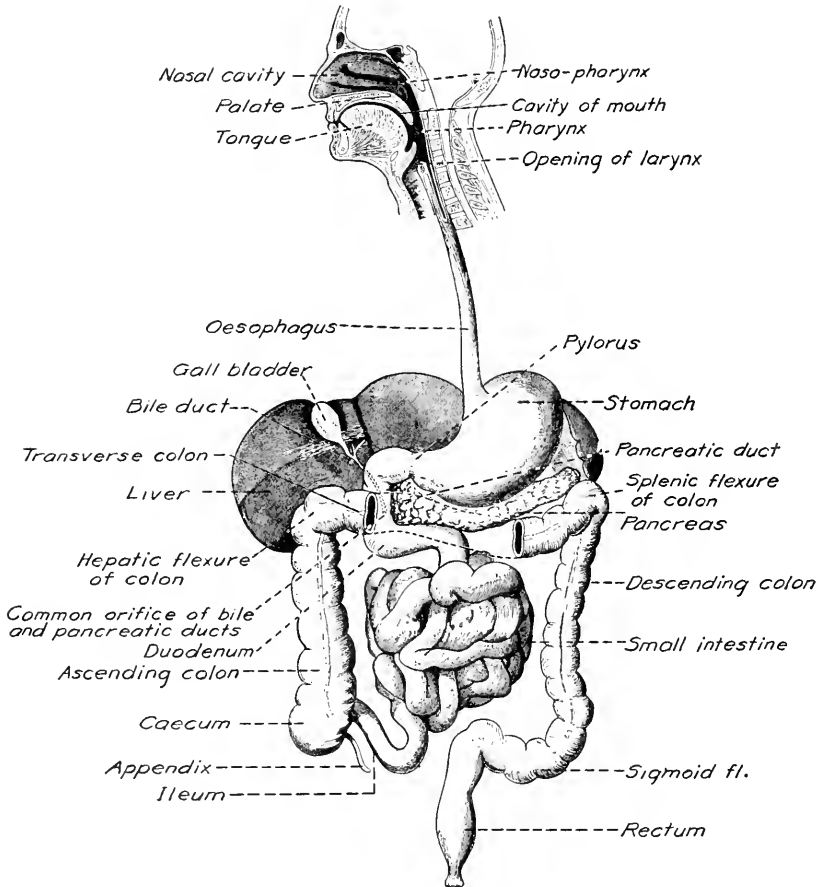

FIG. 240. General view of the digestive system. (Cunningham, D. J., *Textbook of Anatomy*. Y. J. Pentland, Pub.)

fundus and the *pyloric* at the right or intestinal end. A well-developed *pyloric sphincter* muscle is situated at the entrance to the *duodenum*. The acidity of the *chyme*, when it reaches the pyloric region of the stomach, induces the sphincter to open. In adult

man the stomach is about ten inches long, four inches wide and deep, and holds about three pints.

Gastric juice is a pale yellow fluid, rich in HCl. It arrests the process of changing starch to sugar, producing *chyme*. It contains *pepsin*, which changes albumen and gelatin to a soluble form called *peptone*; *rennin*, which curdles milk; and *lipase*, which emulsifies *neutral fats* and fatty acids, but has no effect on non-emulsified fats.

Digestive Action in the Stomach.—The action of the saliva upon starch is arrested, and the larger lumps of masticated food are broken up into a thick, grayish soup-like *chyme* which consists of starch unchanged by saliva; oils and fats set free in the gastric digestion; undissolved proteins; dissolved proteins; and debris of indigestible materials such as cellulose.

The *small intestine* consists of the duodenum situated on the right side of the body with a wide curve embracing *pancreatic* and *bile ducts*, the *jejunum* situated on the left side, and the somewhat constricted *ileum* which leads to the *cecum* and the *large intestine*. The human small intestine is twenty-three feet in length.

The semi-digested acid food from the stomach, as it passes over the bile duct, causes a flow of *bile* and *pancreatic juices* which tend to neutralize the acid *chyme*, but the contents of the duodenum do not become distinctly alkaline until they have *reached* a point at some distance from the pylorus. The valve of the common duct is closed when the *chyme* is rendered alkaline, and is opened when the acid *chyme* arrives again.

The *liver* is of a dark red-brown color, situated just below the diaphragm. It is the largest gland in the body. The principal function of the liver is the formation of glycogen, sometimes called "animal starch." The glycogen is given out into the blood in the form of dextrose, into which it is changed by an enzyme in the hepatic cells. The liver thus acts as a reservoir for food, storing it up when it is in excess and expending it gradually to tide over periods of fasting. The liver forms bile and urea and is most important in the purification of the blood. The *gall bladder*, present in the cat as in man, is not found in all mammals, some *rodents* lacking it entirely. It stores up the bile and liberates it periodically, through the *bile duct* which enters the anterior portion of the *duodenum* as the common bile duct, together with or close to the *pancreatic duct*. The liver weighs between three and four pounds in man and secretes nearly three pounds of bile in twenty-four hours. *Bile* is alkaline,

greenish yellow in color and bitter to the taste. It is passed from the bile duct to the duodenum, where it neutralizes chyme and thus facilitates the action of the pancreatic juice. In higher vertebrates, bile has a weak ferment that acts on fats, aiding in their emulsification. It has slight amylotic and proteolytic ferments. American packing houses sell *gallstones* from cattle to the Chinese and Japanese who use them as medicine.

The *pancreas* is a rather long narrow organ, pinkish-yellow in color and situated at the posterior end of the stomach, extending along its greater curvature. A duct traversing the gland enters the duodenum via the common bile duct or quite close to it. The pancreas secretes digestive enzymes and is also responsible for an internal secretion which regulates the liberation of sugar from the liver. (See p. 445.)

Pancreatic juice is alkaline, its sodium carbonate neutralizing the acid food from the stomach. The enzyme *trypsin* is at first secreted in the form of *trypsinogen* and converted into trypsin by the action of *enterokinase* formed by the intestinal glands. Trypsin converts proteins into amino-acids which are reconvertible into proteins when needed. *Amylopsin* (*diastase*) digests carbohydrates, thus continuing in an alkaline medium the action of the salivary glands stopped by the acid gastric juice of the stomach. *Steapsin* (*lipase*) splits fats into soaps, fatty acids and glycerine. Dissolved fats are absorbed in the intestinal walls and later combined to form fat in the cells.

The human pancreas secretes about one pound of pancreatic juice in twenty-four hours. In the pancreas of the cow, which weighs but seventeen ounces, eleven pounds of fluid are secreted per day.

Digestive Action in the Small Intestine.—The change of starch into sugar is resumed; proteins are largely dissolved by the action of the bile, pancreatic juice, and the intestinal juices. Starch is converted into sugar and the sugar is in part converted into lactic and other acids. Fats are emulsified and to some extent saponified by the steapsin of the pancreas.

The Cecum.—At the point where the ileum joins the large intestine there is a pouch, the *cecum*, relatively small in the cat and man, but large in herbivores, where *cellulose* is dissolved by bacterial action. In man, the cecum has attached to it an attenuated *vermiform appendix*, frequently the seat of inflammation. Foreign sub-

stances, impacted feces, or parasitic worms, such as the *pin-worm* (see p. 90), cause appendicitis.

The Large Intestine is divided into the ascending colon, the transverse colon, and the descending colon which terminates in the rectum. In the carnivora the large intestine is short; but is well developed with sacculated walls in the herbivora. The human large intestine, five feet long, is estimated to absorb four hundred cubic centimeters of water in twenty-four hours.

Digestive Action in the Large Intestine.—The contents become slightly acid due to the fermentation of the contents of the intestine. Beneficial bacteria are very important. *Absorption* is very active. The great absorbent vessels are the veins and *lacteals*. The lacteals carry *chyle* to the *thoracic duct* at the receptaculum chyli. Food passes through the digestive tract of man in a few hours, but takes three days in the horse and five days in the cow.

Digestion in the Ruminant (Example: the cow).—The cow lacks incisor teeth on the upper jaws and is therefore unable to cut it as she feeds, but rips loose a tuft of grass by pressing the lower incisor teeth against the upper jaw and giving a jerk of the head. After rolling the morsel between the molars a short time it is swallowed down the esophagus to the rumen or paunch.

The stomach of the cow is large, occupying three-fourths of the abdominal cavity, and holds 45 gallons. It consists of four parts, the *rumen*, the *reticulum*, and the *omasum*, constituting the proventriculi; while the *abomasum* or “rennet” is the true stomach.

The *esophagus* opens into the stomach on a dome formed by the rumen and the reticulum and is continued through the reticulum to the omasum by esophageal grooves.

The *rumen* is partly divided into dorsal and ventral sacs. Large papillae, sometimes reaching a height of one-fourth inch, stud its brownish mucous membrane. The muscular coat reaches a thickness of one inch. The food is stored in the paunch till a favorable time for rumination after which it is passed into the reticulum.

The *reticulum*, or honeycomb, is the smallest of the four parts and contains mucous folds one-half inch high enclosing four, five and six-sided spaces (honeycomb) as well as many small papillae. At the reticulo-omasal orifice, there are small horny papillae, curved like birds' claws. The muscular coat has two oblique layers. Little balls of food are prepared in the honeycomb cells and then regurgitated for thorough mastication and mixture with the salivary secre-

tions. The cow moves her lower jaw once in one direction and then chews the other way. Subsequent to mastication the food is swallowed again and passes through rumen and reticulum to the omasum or psalterium.

The *omasum* or psalterium, sometimes called "the maniples," has 100 longitudinal folds or laminae which spring from its dorsal and lateral walls. A dozen of the largest have a convex attached edge and a free concaved ventral edge. The food is pressed into

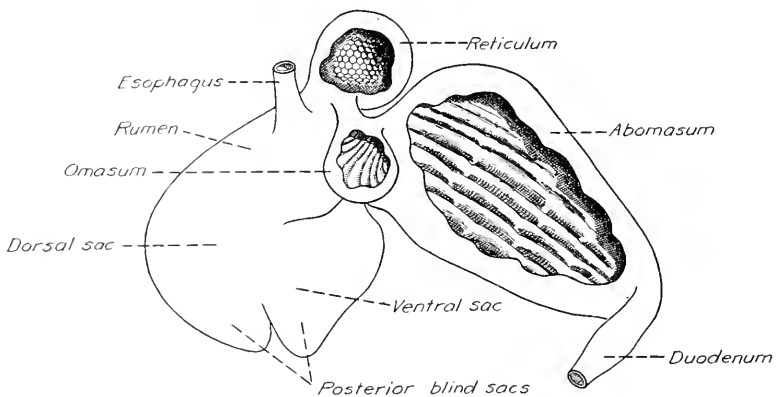

FIG. 241. Stomach of a ruminant. (Drawn by W. J. Moore.)

thin layers in the spaces between the laminae and reduced to a fine state of division, by being ground down by minute horny papillae studding the surface of the folds. From the omasum the food passes into the true stomach.

The *abomasum*, or true stomach, is divided by a constriction into two regions, the fundus and the pylorus. It has a mucous coat and longitudinal and circular muscles, strongly developed to form the pyloric sphincter. In the abomasum the acid gastric juice functions as in other mammals.

REFERENCES ON THE RUMINANT STOMACH

- REYNOLDS, M. H. 1911. *Veterinary Studies for Agricultural Students*. Macmillan and Co., N. Y.
- SCHALK, A. F., AND AMADON, R. S. 1928. *Physiology of the Ruminant Stomach*. Bull. 216, North Dakota Agr. Exp. Sta., Fargo, N. D.
- SISSON, S. 1914. *Anatomy of Domesticated Animals*. 2d ed. W. B. Saunders Co., Phila.

Chemical Characteristics of Protoplasm.—When we attempt an analysis of the chemical constituents of living protoplasm, we induce important changes. By weighing the material before treating it, and then comparing the weights of all substances determined, we find that it is possible to learn most of the constituents, except that all-important one—LIFE. Protoplasm consists of proteins, carbohydrates, fats, inorganic salts, enzymes, water and the “vitamins.”

Proteins are compounds with high molecular weights, which contain carbon, oxygen, hydrogen and nitrogen. Usually they contain sulphur, and sometimes phosphorus. They are apparently a condensation of the molecules of numerous amino-acids and by hydrolysis they yield amino-acids in different quantities and of different characteristics.

Proteins differ in their color reactions and are readily classified by such reactions. Proteins also differ in precipitation reactions. Some are precipitated by the mineral acids such as nitric, hydrochloric, and sulphuric, others by salts of the heavy metals, particularly mercuric salts. The alkaloidal reagents which precipitate the vegetable alkaloids are precipitants for proteins. Eggs, rich in proteins, are used as an antidote for copper, lead or mercury poison, since they render the metallic compounds insoluble so that they may be removed by the stomach-pump or laxatives.

Colloids.—Proteins are colloids. The term “colloid” which comes from the Greek word for “glue” referred at first to substances like glues and gums, but now is used to indicate finely divided matter suspended in any medium. Colloids may include *liquid* dispersed in a *gas* or another *liquid* or even a *solid*; or may refer to solids similarly dispersed. Blood, lymph, bile and the various digestive secretions are common examples of colloidal solutions.

Proteins, as colloids, do not readily *diffuse* through *membranes* nor go into solution. They readily absorb substances however and in the cell they synthesize and oxidize them. Protein individuality is such that the blood of one order cannot, as a rule, be *transfused* successfully into the circulation of another order without fatal results. *Foreign* proteins are apparently incompatible. It is interesting to note, however, that human blood may be successfully administered to certain of the anthropoid apes. Clumping together (agglutination) of blood corpuscles occurs when incompatible blood is transfused.

Precipitin Reaction.—An interesting test for the detection of human blood in murder cases is dependent on the solubility of blood protein. It is said that soluble protein will give the test after a period of fifty years. The serum of an animal (a rabbit is ordinarily used), injected with the blood or blood serum of another animal, will, when added to a homologous serum, precipitate the *albumin* in the form of a light flocculent precipitate. (See p. 528, Evidence for Evolution.)

Carbohydrates consist of *carbon, hydrogen and oxygen*, and occur in both the crystalline and colloidal state. Carbohydrates can be converted into fats. In plants the starches are commonly distributed, but glycogen is the only example of animal starch. Glycogen occurs in all the growing cells of the animal body, but is found chiefly in the *liver* and muscles (see page 444).

There are three chief groups of carbohydrates. The monosaccharids with one sugar group include dextrose or grape sugar. The disaccharids include cane sugar, milk sugar and maltose. Several monosaccharid molecules become united into a polysaccharid. Corn and potato starch and wheat flour are common examples of polysaccharids. The monosaccharid, dextrose ($C_6H_{12}O_6$), is formed in the leaf of a green plant from carbon dioxide and water. Plants manufacture *carbohydrates* from carbon dioxide and water. Recently Professor E. C. C. Baly of Liverpool University has produced sugar synthetically in his laboratory by utilizing *ultra-violet* rays on quartz vessels of water in which carbon dioxide was dissolved. With small quantities of either iron or aluminium compounds as catalysts (see page 440) he obtained sugar. In nature, sugar is made through the action of the sun on chlorophyll-containing plant cells, and from this sugar other foods are formed by the addition of different chemical elements. Sugar, then, is the source of all food, and the process just mentioned, "photosynthesis," is the most important chemical reaction in nature.

Fats contain carbon, hydrogen, and oxygen in different proportions, containing much *less oxygen* in proportion to the carbon than in the carbohydrates. Fats can readily be converted into carbohydrates. They are found in seeds and nuts, and in animals occur in the connective tissue called *adipose*. *Lipins* contain carbon, oxygen, hydrogen, and nitrogen, and may contain phosphorus also. The lecithin of egg yolk is an example of a *lipin*. Fats of the body are derived not only from the fatty substances consumed, but are

also formed from *carbohydrates* and *proteins*. Fats contain twice as much heat energy as carbohydrates and are essential in maintaining the proper body temperature.

Substances that contain at some point in the chain two carbon atoms united by more than one bond are said to be "unsaturated," and are able to form additive compounds with the halogens chlorine, bromine, and iodine. The "iodine number" of an oil or fat is a measure of its ability to absorb iodine. *Unsaturated fats* act antienzymatically, and undoubtedly function in the animal body in taking up iodine. Excess fat in the diet may predispose to goiter.

Experiments by Chidester and associates have indicated the importance of unsaturated fatty acids in the treatment of Vitamin A deficiency, when combined with ferrous iodide. The author is also continuing experiments with the idea that the efficacy of wheat germ oil, hempseed and other oils used in the recovery of animals deficient in Vitamin E is in part due to their highly unsaturated condition. The degree of unsaturation decreases rapidly in seeds during their period of germination. Coconut oil has a high degree of saturation, and is ineffective.

Chemical Elements of Protoplasm.—Carbon compounds are the primary materials of protoplasm. Carbon unites with oxygen to form carbon dioxide and water and to liberate energy.

Hydrogen is taken into the bodies of plants and animals in combination with oxygen as *water* and is also excreted in this form. Oxygen is found in the free state and unites with various compounds of protoplasm, the process of oxidation, releasing energy.

Nitrogen is essential to protoplasm. It forms 79 per cent of the atmosphere. Taken into plant bodies usually in the form of nitrates, the plants utilize it in the manufacture of proteins. Ammonia, a nitrogen compound, formed in the *catabolism* of plants and animals, is changed by certain bacteria into nitrates which are then absorbed by plants.

Mineral Salts.—Proteins, carbohydrates, and fats are *not* the chief foods of man. The most important foods are *mineral salts*, *water* and *air*.¹ If mineral salts are withheld from the body, death ensues much more quickly than from the withholding of proteins, carbohydrates, and fats. The salts of the body in *solution* aid in providing the *proper medium* for living tissues while those in *combination* with organic substances furnish the proper elements for

¹ Of course not all food constituents necessary to man have been evaluated.

the formation of tissues. The mineral salts are necessary to maintain normal physiological equilibrium and purposeful activity in the organism.

Sulphur is absorbed by plants and used in the manufacture of some amino-acids. *Phosphorus* is essential to the formation of nuclein and lecithin of living cells. *Calcium salts* are necessary in the coagulation of blood and milk. Apparently the normal beating of the heart depends on the relationship of calcium to sodium and potassium salts. The condition known as rickets is due to a failure to maintain the proper ratio between the calcium and phosphates of the food. Cod liver oil is a cure for rickets (see page 443, Vitamin D). *Silicon* and *fluorine* are required in small quantities for the proper formation and growth of bones and teeth. They are secured from milk and fibrous vegetables. The ash of hair shows 40 per cent of silicon dioxide. *Sodium* as NaCl is essential to herbivorous animals, but the carnivores do not take salt. Raw meat protects the Greenland Eskimo from scurvy, rickets, and avitaminosis.

Chlorine is important to the animal in maintaining the secretion of gastric juice and in keeping the optimum osmotic pressure. The acid-secreting cells of the stomach select for their use the NaCl of the blood. *Potassium* salts are indispensable in the synthetic processes of organic combination. They aid in the formation of glycogen from glucose, of fats from glycogen and of proteins from peptones. The liver, the source of glycogen, contains twice as much potassium as sodium. Potassium is found in red blood corpuscles and also in the brain and is apparently necessary to the normal function of organic life. *Magnesium* is found in greater quantity than calcium in the muscular tissues and the nervous system. The salts of magnesium aid in the formation of the albumin of the blood, reduce foreign matter and waste and maintain the *osmotic pressure* of the blood. Irradiation with ultra-violet light is said to *decrease* the magnesium content of rats. Magnesium requires the presence of calcium salts for proper function and is in fact injurious in the absence of calcium. An excess of magnesium in the blood is said to cause glycosuria. Magnesium has been proved necessary for the growth and maintenance of white mice. The chlorophyll of green plants is always associated with magnesium. *Copper*, found in the earth in metallic form, occurs in minute quantities in most vegetable and animal tissues. It *may* act as a *catalyzer* in the production of hemoglobin.

Iodin.—It has long been known that *iodin* is extremely important in connection with the normal functioning of the *thyroid gland* and that the latter is a powerful regulator of metabolism. It increases the rate of oxidation. Minute quantities of iodine are necessary, the human thyroid containing about one-fifteenth of a grain of iodine, but lack of the essential amount may cause a disease known as *cretinism* in which bodily and mental development are both subnormal. Iodine is an important constituent of vegetable foods and is found in large quantities in the plants and the animals of the ocean. In all probability it is in part responsible for the preservation of the carnivorous Eskimos of Greenland. It has been successfully used in the treatment of pernicious anemia, given as thyroid extract.

Recent discoveries would seem to indicate that the iodine-fat balance is important in several of the so-called vitamins, and that the effectiveness of cod liver oil in certain diseases is really due to the very small quantities of iodine present. The author of this text would also like to link the iodine-fat balance with his own theory of Fish Migration, since it is possible that the eel, fattened in fresh water, may need iodine to induce development of its gonads, while the anadromous fishes, like the salmon, possibly need to seek water of lower iodine content and finally to go into fresh water before their iodine-fat balance is reached, and eggs mature. (See page 263.)

R. McCarrison (1919) and later the Mellanbys (1921) have emphasized the importance of iodine-fat balance in goiter, but until certain studies on the Vitamins were made (Chidester, Eaton, Thompson, Speicher, and others, 1928-) the significance of their finding was not appreciated.

Arsenic, found in the earth as a sulphide, occurs in minute amounts in animals and vegetables. Gautier and more recently Bertrand have emphasized the importance of *arsenic* as a constituent of the living cell. The *yolk* of the hen's egg usually contains *twice* as much *arsenic* as the *white*. Arsenic enters into the composition of the epidermis and its appendages, the thyroid and the mammary glands, and the central nervous system. Arsenic resembles phosphorus in its chemical affinities. It is reported that the Tyrolean mountain climbers habituate themselves to quite considerable doses of arsenic, for its energizing effects.

Iron is an important constituent of both plants and animals. It is necessary for the formation of chlorophyll in plants. Without

the iron in blood, oxygen could not be carried to the tissues. Iron is requisite to *oxidative* processes and is contained in hemoglobin. With an ample supply of *calcium*, the body needs less iron. Lack of iron leads to insufficient nutrition, anemia, and death. Certain wave-lengths of ultra-violet light increase the blood content of iron. Although not a constituent of the chlorophyll molecule, iron acts as a *catalyzer* in the production of *chlorophyll*. Millikan has said, "From an engineering standpoint, the universe may be said to be made up of the primordial positive and negative electrons, and of four elements built out of them; namely, helium, oxygen, silicon, and iron."

Manganese.—Lindow and Peterson have presented data (1927) on the manganese content of eighty-four materials, covering the principal classes of human foods. Pineapples, beet-tops and blueberries contained relatively large amounts (122–134 mgm.). Hog liver contained 12.2 mg. per kilogram of dry material while beef spleen and round steak contained none. The liver of young animals is the storehouse for the body's reserve of manganese and other mineral elements apparently necessary for the maintenance of physiological equilibrium. The human body contains only one-half ounce of manganese, but a deficiency results in disease. McCarison reports (Ind. Jour. Med. Res., vol. 14, p. 641) that daily doses of manganese chloride, 0.0327 mgm., caused accelerated growth in rats, especially marked in the males. Manganese is said to increase in amount as *plants* grow older.

Bromine, boron, zinc, and aluminium are present in small quantities in plants and are important to the life and growth of the plant. Their exact significance as food for the living animal is not fully understood. Bradley (1904) found zinc in the blood of the gastropod *Sycotypus (Fulgur) canaliculatus*.

Enzymes are produced in living cells, some of which, the glands, are specially modified to produce important bodily secretions (pancreatic juice). Enzymes are able as *catalysts* to hasten chemical reactions, but do not form a part of the end products of the reaction. An example of catalysis to which we have already referred (page 436) is that of iron which in the presence of light hastens the combination of hydrogen and oxygen to form water. The *genes* are said to act as *auto-catalysts* in that they increase their own substance prior to each mitosis. (See page 500.)

Nutrition and Vitamins.—Since 1911, a great mass of literature has accumulated, largely consisting of the further enumeration of food substances characterized as belonging to groups of vitamins. The wholesale advertising of essential foodstuffs such as milk and green vegetables has resulted most favorably. A fuller appreciation of the virtues of cod liver oil and the tremendous importance of the *ultra-violet* and *infra-red* rays has also been a product of vitamin study. But perhaps too much time has been wasted in biological tests of foods long known to be chemically allied.

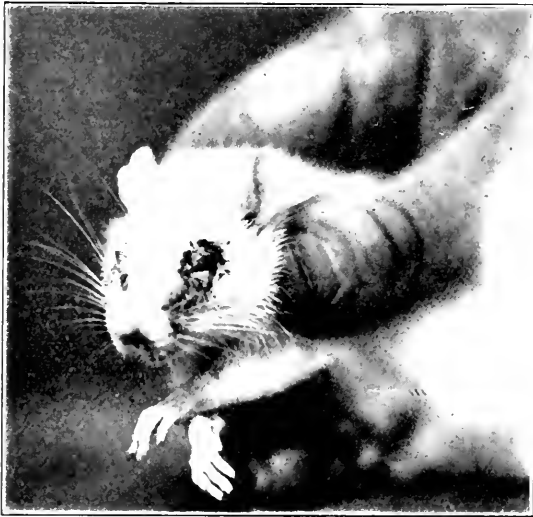

FIG. 242*f*. Rat in advanced stage of xerophthalmia due to lack of Vitamin A. (Courtesy of Eli Lilly & Co.)

Vitamin A is found in cod liver oil, butter, cream, cheese, whole milk, egg yolk, liver, heart and kidneys, spinach, lettuce, cabbage, tomatoes, carrots, sweet potatoes, parsnips, green peas, and many other substances. Deficiency in Vitamin A results in an anemic condition, with failure of ovulation and retardation of growth. The sense organs are diseased and pus laden, the eyes being typically affected by *xerophthalmia* with conjunctivitis and corneal degeneration. Vitamin A is fat soluble. Exposure to the air and forced oxygenation renders it inactive. Commercially canned tomatoes (no oxidation) were as rich in vitamins at the end of three years as fresh tomatoes. While it is generally considered that the vitamin

is completely recoverable from the unsaponifiable fraction of oils and fats that contain it, the writer is convinced as a result of experimentation that there are really two factors in Vitamin A, one which aids in curing or preventing the keratinizations characteristic of Vitamin A deficient animals and drawing on the stored up fats of the animal body, while the other, a factor belonging to the unsaturated hydrocarbons and fats, is the growth factor.

It may be significant that carotin ($C_{40}H_{56}$) is an unsaturated hydrocarbon, and that it is transformed by the rat into Vitamin A,

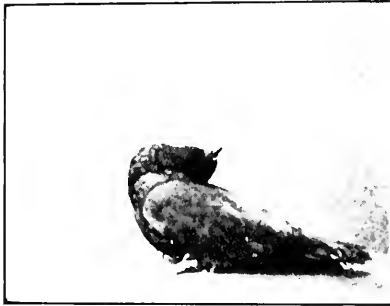

FIG. 242B. Pigeon with polyneuritis following a diet deficient in Vitamin B. (Courtesy of Eli Lilly & Co.)

when furnished in *arachis oil*, itself unsaturated. In those cases where carotin and even chlorophyll have been able to induce growth in Vitamin A deficient rats, it is worth mentioning that the experiments were not run long enough to determine the point where the vitamin substitute ceased drawing upon the stored up foods of the animal's own body. The writer holds that the complete Vitamin A contains both the

catalyzers and the growth factor, and includes iodine, (ferrous) iron, and unsaturated as well as saturated fats.

Vitamin B is found in the heart and kidneys of animals. It is not found in the meat of chickens, turkeys, ducks and guinea fowls. It is most abundantly distributed in roots and tubers and all green plant tissues. Cereals and the germs of seeds, yeast and wheat germ contain it. In man the disease known as *beri-beri*, with a failure of some nerves to function, and a disturbance of the appetite and digestive processes, results from eating polished rice. There is a resultant atrophy of the lymphoid tissue, and an hypertrophy of the pancreas, spleen and certain other glands of the body. In birds a disease called *polyneuritis* is caused by similar lack of the seed coat in food. Vitamin B is soluble in water and alcohol. It is destroyed by high temperature ($130^{\circ} C.$).

There has been so much confusion over the terminology connected with the factors contained in Vitamin B that a Committee on Vitamin B Nomenclature has recommended (*Science*, vol. 69, p. 276,

1929) that the term "Bios" be used to denote the factor encouraging the rapid growth of yeast cells; that the term "B" be used to designate the heat labile, antineuritic factor; that the term "G" be used to denote the heat stable, water soluble, dietary factor called *pellagra preventive*, which has to do with maintenance and growth. Alcoholic extracts of yeast lack the *pellagra preventive*.

Evans and Lepkovsky showed that the glycerides of the *saturated* lauric, capric and myristic acids were beneficial to animals deprived of the anti-neuritic Vitamin B. In the treatment of "black-tongue" in dogs, which he considered the analogue of human *pellagra*, Goldberger had, without emphasizing its importance, added "syrup iodide of iron, U. S. P." to the successful diets. Perhaps Vitamin B may also involve the fat-iodin balance.

Vitamin C, the anti-scorbutic, is found in lemons, oranges, tomatoes, cabbage, lettuce, spinach, green beans, peas and turnips. Oysters are rich but meat is poor in Vitamin C. Deficiency in Vitamin C causes a disturbance of respiratory and circulatory systems, loss in weight, necrosis of the teeth, with swelling of the gums, and the bones become friable. The disease known as *scurvy* may continue to hemorrhages and death. Infantile scurvy occurs in children brought up on proprietary foods. Vitamin C is soluble in alcohol and is destroyed by heat in the presence of oxygen, especially in an alkaline solution. Tomatoes, cooked in the can, are found to retain the Vitamin, and canned spinach is reported to be equal to orange juice in its Vitamin C content.

Vitamin D controls lime and phosphorus utilization in the formation of bone. It was formerly included under Vitamin A. Egg yolks, cod liver oil and whole milk are rich in it. The mercury lamp and the sun are effective in activating it in the body and in foods. Irradiated ergosterol is an important source for experimental work at present. Absence of Vitamin D produces "rickets" and bone deformity. It is soluble in alcohol and oils.

Excess of Vitamin D leads to an excessive precipitation of calcium in the body. An imbalance between calcium, sodium and potassium might be injurious, and iron assimilation might also be affected by excess calcium. Commercial preparations of *irradiated ergosterol* should be used only under the direction of a physician.

Vitamin E, which prevents sterility, is found in all natural foods. It is especially abundant in lettuce and the germ of seeds, but is also found in milk and meats. It is concerned in the normal function

of the placenta, and perhaps related to the metabolism of iron. It is not affected by ordinary temperatures.

The writer holds that resorption of the young in female rats on a Vitamin E deficient diet is really an iodine effect, comparable to that induced in a shorter period of time by excess iodine. Wheat germ and hemp seed oils that are so effective in the treatment of Vitamin E deficiency are rich in the highly *unsaturated* fatty acids during their effective period. The effectiveness of these oils is lessened as the period of germination advances and the oils become more saturated. (See page 437.)

What Are Vitamins?—The author holds that the “vitamins” are really proper combinations of minute quantities of chemicals that are functional as catalyzers, and make available not only the proteins, carbohydrates and fats that are in combination with them in food-stuffs, but that they also furnish the proper medium for the liberation of food-stuffs stored in the organism. The influence of these potent chemicals is felt in all glandular function, and particularly of course in the activation of the *endocrine glands*.

The Organs of Internal Secretion. Endosecretory Glands with a Duct. Testis.—In addition to sperms, an external secretion, the testes furnish an internal secretion responsible for the male secondary sex characters. Steinach found that transplantation of the testes into spayed female guinea pigs induced masculinization. Lydston and others have transplanted human testes, with temporary benefit.¹

Ovary.—The ovary produces eggs and regulates the female secondary sex characters. In the fowl Goodale found that removal of the ovary causes the bird to take on male plumage. Domm found that a compensatory testis-like structure developed on the right side. Steinach found that castrated male guinea pigs could be feminized, by implanting ovaries in their body cavities.

In early or normal menopause, and in epilepsy, ovarian extracts, notably corpus luteum and folliculin extract, are beneficial. Allen and Doisy have cured some cases of sterility with follicular liquid.

Liver.—The liver secretes bile externally, and produces *glycogen*, a “negative internal secretion” which is an important body food, and transforms harmful ammonia into harmless urea. A hormone extracted from liver has been most successful in the treatment of pernicious anemia.

¹ Consult Moore, C. R. 1926. Qu. Rev. of Biol., vol. 1, pp. 4-50.

Pancreas.—The digestive enzymes of the pancreas act on proteins, carbohydrates and fats. The internal secretion, ~~pancreatin~~, successfully isolated by Banting¹ and associates in 1922, was secured from the Islands of Langerhans of the pancreas of fetal calves. J. J. Abel has since then prepared pure crystalline insulin, so powerful that only 1/100 of a grain is the daily dosage for a diabetic. Many lives are now saved annually by the use of "insulin."

Endosecretory Glands without a Duct. Thyroid.—The thyroid glands contain ten times as much iodine as any other organ in the body. Iodine in food and water must be optimum, or goiter may result. The thyroids stimulate carbohydrate and calcium metabolism and bear an important relation to body fats. Pioneer studies by Gudernatsch with tadpoles indicated that if fed thyroid extract, they metamorphosed rapidly into small toads. Uhlenhuth has shown that *anterior lobe* substance from the pituitary gland will stimulate the thyroid and induces precocious metamorphosis in amphibia. In *hypersecretion* of the thyroids, *goiter* or *exophthalmic goiter* may result. In the latter, the eyeballs protrude and the pulse is greatly accelerated. *Hyposecretion* results in *colloid goiter*, *cretinism*, or *myxedema*. *Cretins* are dwarfed, with low mentality, and are frequently deaf mutes. *Myxedema* (mucous fat) is accompanied by great increase in weight, retarded bone growth, brittle teeth, slow pulse, thickened, wrinkled skin and slow metabolism. *Thyroxin* (Kendall) and thyroid extract have been used in the treatment of cretinism, myxedema, and endemic goiter. It is dangerous to start to furnish a community additional iodine in drinking water, as some goitrous persons may be injured. But the campaign of education about the importance of sufficient iodine in food and water (McClendon, Minnesota; and the South Carolina Board of Health) is admirable.

Applying the discoveries of Bloor, Hill, Sperry and others that under certain intestinal conditions *iodine* may be discharged from the body in considerable quantities in the *feces*, Chidester has suggested that in the cases of *water-borne goiter* recorded by McCarrison and others, it is quite likely that certain *bacteria* will cause the liberation of *iodine* and that subsequent demands made on the thyroid by the excess of *unsaturated fatty acids* in the intestine will cause thyroid

¹ But Banting and Best in the *Journal of Laboratory and Clinical Medicine*, 1922, Vol. 7, p. 467, gave full credit to E. L. Scott for his pioneer studies, described in 1912 in the *American Journal of Physiology*, Vol. 29, p. 306.

hypertrophy. Possibly disturbance of the calcium-iodin balance will also account for non-bacterial cases due to water.

The writer cannot resist the opportunity to again pay tribute to McCarrison for his initial discovery of the significance of the iodine-fat balance and to deplore the fact that it is now receiving such belated recognition, more than twelve years after its discovery, in 1919.

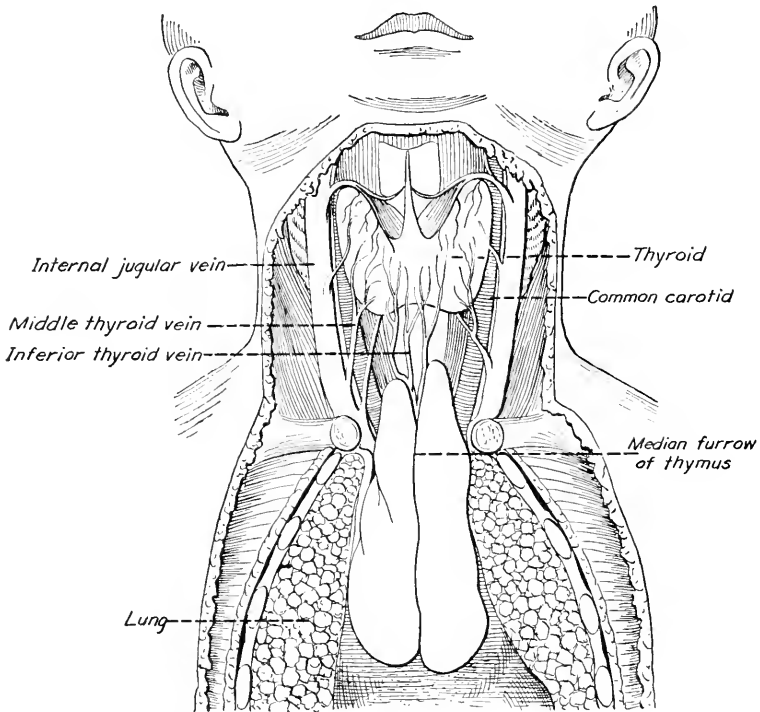

FIG. 243. The thyroid and thymus in a child of six months. (Sappey.) (Schafer's *Text Book of Mic. Anat.* Courtesy of Longmans, Green & Co., London.)

Parathyroids.—The parathyroids have been operatively removed with the thyroids, and death ensued, after a condition of tetany. The parathyroids influence calcium metabolism, and also affect sugar metabolism, and aid in preserving the nitrogen balance.

Thymus.—The thymus gland degenerates at puberty, and *may* be concerned with both the thyroids and the gonads. Soli, and later, Riddle, believed that the thymus was concerned with calcium

metabolism and shell formation in the birds. Crew reported (1928) that removal of the thymus had no effect on calcium metabolism in fowls.

Suprarenals.—It has long been known that the suprarenal glands are essential to life. The suprarenal medulla is the source of epinephrin (adrenalin) which was the first hormone to be isolated chemically (Takamine) and is extremely potent, one part in eight billion producing reaction in the rabbit intestine. Wheeler and Vincent found that as long as an adequate amount of cortex survived, destruction of all of the medullary tissue led to no ill effects. Addison's disease is caused by pathological changes in the cortex and is characterized by reduced blood sugar, subnormal temperature and a peculiar pigmentation of the skin, with muscular weakness.

In October, 1927, Rogoff and Stewart described the results obtained with 0.9 per cent NaCl or glycerol extract of the cortex. They treated completely adrenalectomized dogs. Of thirty dogs treated, six lived longer than the longest of the control animals. They did not give the average survival of treated animals as compared with controls, which should have been done. In the same month, 1927, Hartman, MacArthur and Hartman described the first method for preparing an epinephrin-free extract of the adrenal cortex. By the use of such an extract, the average survival period of completely adrenalectomized cats was markedly increased (21 days) over that of controls (6 days). This average included all cats treated, even those complicated by infections.

In March, 1930, Swingle and Piffner described a method of preparing a concentrated extract of the adrenal cortex sufficiently potent to maintain the lives of adrenalectomized cats indefinitely. Their process was very complicated and their extract contained much epinephrin and inert material. In June, 1930, Hartman and Brownell described a much simpler method of preparing a concentrated extract of the adrenal cortex containing less than 1:100,000 epinephrin. With this extract it is possible to maintain the lives of adrenalectomized cats indefinitely. One animal was kept alive for 268 days, dying because the extract was discontinued. This substance, found in the adrenal cortex, which is essential to life, has been called cortin. Both Swingle and Hartman have furnished extracts to clinicians who have successfully treated cases of Addison's disease with them.

Suprarenal virilism is found in some women with diseased

adrenals. Cannon¹ demonstrated the effect of increased suprarenal activity on blood sugar, muscular activity, and recovery from fatigue. Fear or anger enables one to fight better or run faster!

Pineal Body (Epiphysis).—In cases of pineal tumor, causing deficient secretion, there is a tendency to obesity and individuals may be sexually precocious with premature ossification of the bones. Pineal extract has been administered to cases of retarded mental development, with reports of gratifying improvement. But we really know very little about pineal function.

Pituitary Body (Hypophysis).—The pituitary has two lobes, an anterior one and a posterior one, each with distinct functions. In cases of *hypersecretion* of the *anterior lobe*, acromegaly and gigantism may result. The hair is excessive, teeth are widely separated, the extremities are elongated and the fingers become broad and spade-like. The skin is thick and wrinkled and the sweat and sebaceous glands are excessively active. *Glycosuria* and excessive gonadal development may also occur. The stimulating influence of anterior lobe substance on the thyroids has already been noted (p. 445).

P. E. Smith and E. T. Engle (Am. Jour. of Anat., vol. 40, pp. 159-217, 1927) have shown that the implantation of *anterior hypophyseal* substance in infantile female rats and mice will induce sudden and extensive ripening of the Graafian follicles. After 3 days of implantation they induced the ripening of 48 ova in a 22-day mouse. There is correlation between the sizes of rabbits and the number of young. Larger breeds are thus affected in growth and ovulation by the anterior hypophysis. *Hyposecretion* of the *anterior lobe* results in infantilism, obesity, a thin, smooth, dry skin, scanty hair, slender fingers, and dwarfism with the torso longer than the extremities. The oxidative metabolism is low.

Hypersecretion of the *posterior lobe* causes contraction of the smooth muscles, resulting in a rise in blood pressure. Pituitrin is used in obstetrics since it keeps smooth muscle contracted longer than does adrenalin. Sugar tolerance is decreased in hypersecretion of the posterior lobe. *Hyposecretion* of the *posterior lobe* results in subnormal temperature, increased sugar tolerance and adiposity accompanied by drowsiness (Dickens' fat boy). Epilepsy frequently occurs.

¹ Consult Cannon, "Bodily Changes in Pain, Hunger, Fear and Rage."

Dr. Oliver Kamm reported ² (December, 1928) the isolation of two hormones from the posterior lobe of the pituitary. The *alpha* hormone is effective in obstetrics, contracting the uterus, while the *beta* hormone raises blood pressure and also controls the excessive output of water and its utilization in the body tissues. Fleshy people (the physiological wets) are extremely sensitive to the action of the beta hormone, while slender scrawny ones (the physiological dries) quickly return to normal after the administration of this hormone. Both hormones act immediately to increase the sugar of the body and thus offset an overdose of insulin.

REFERENCES ON THE ENDOCRINES

- BARKER, L. F. 1925. *Endocrinology and Metabolism*. D. Appleton and Co.
- COOPER, E. R. A. 1925. *The Histology of the More Important Human Endocrine Organs at Various Ages*. Oxford University Press.
- DODDS, E. C., AND DICKENS, M. A. 1925. *The Chemical and Physiological Properties of the Internal Secretions*. Oxford University Press.
- FALTA, WILHELM, AND MEYERS, M. K. 1923. *Endocrine Diseases*. P. Blakiston's Son and Co.
- SHARPEY-SCHAFFER, E. *The Endocrine Organs*. Part I, 1924, and Part II, 1926. Longmans, Green and Co., Ltd.
- VINCENT, SWALE. 1925. *Internal Secretion and the Ductless Glands*. Physicians and Surgeons Book Co.

The Circulatory System.—The blood vessels are a system of tubes completely closed except where the lymphatics open. In one place the system is dilated into a large complexly formed rhythmically contractile organ, the heart, which is the central portion of the circulatory system and, according to the studies of O. C. Glaser (1931), works *basally* against the resistance offered by the system of enclosed tubes. According to the author, objections may be offered to this view because of its apparent simplicity which does not seem to take account of the numerous influences which may temporarily modify the tubal resistance. There are several kinds of channels in which blood flows: (1) Vessels taking blood from the heart—arteries. (2) Vessels taking blood to the heart—veins. (3)

² Kamm, O. *Science*, vol. 67, p. 199, 1928; *J. Am. Ch. Soc.*, vol. 50, p. 573; *Science*, vol. 69, p. 85, 1929.

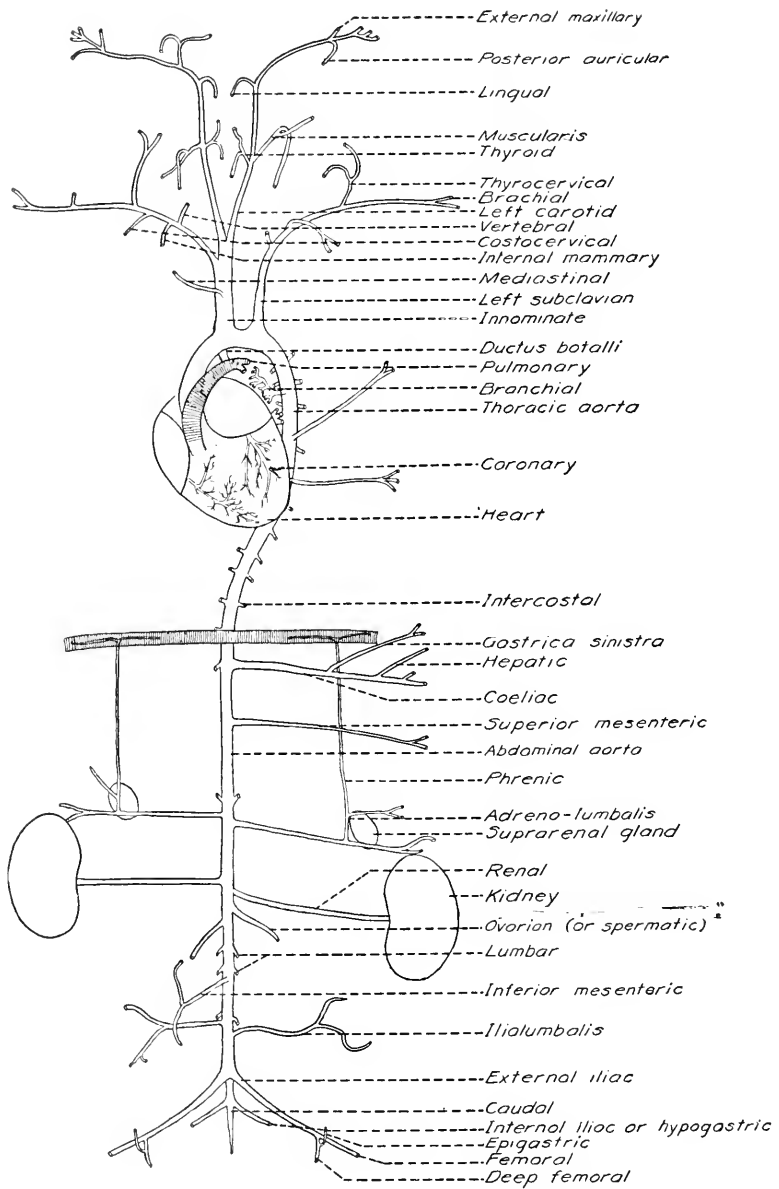

FIG. 244. Arteries of the cat. (Drawn by W. J. Moore.)

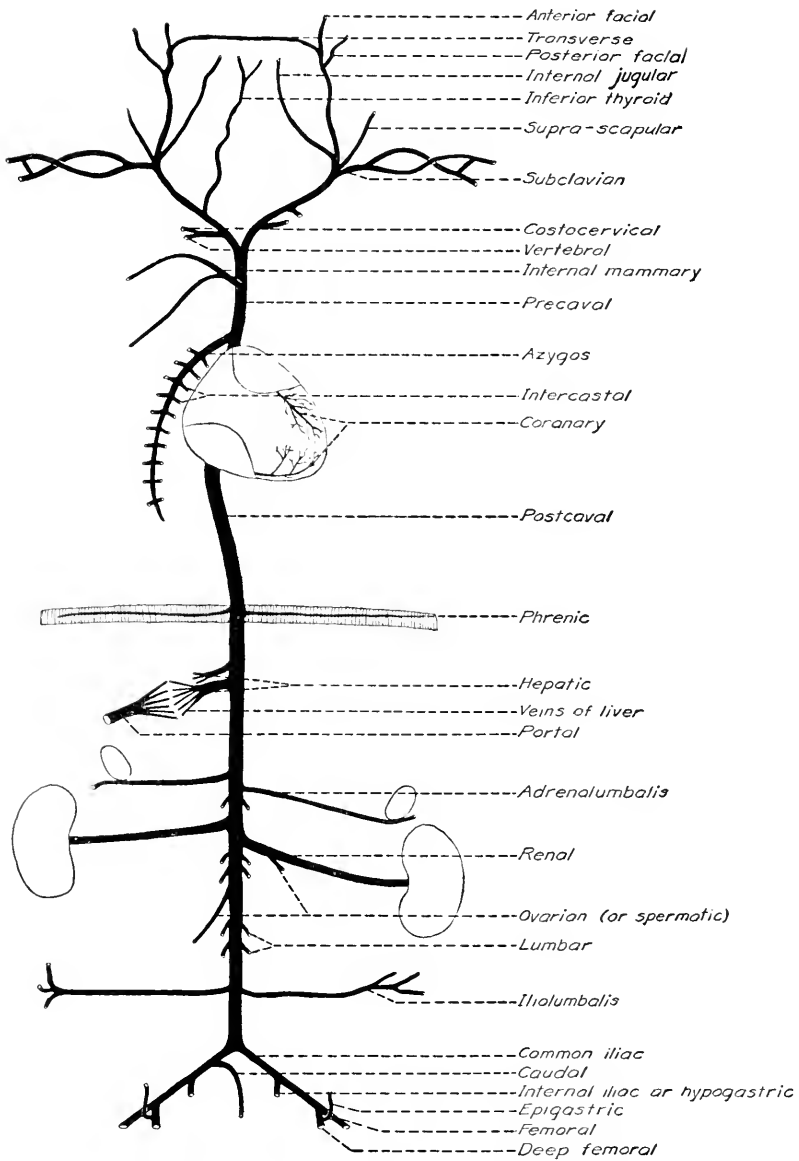

FIG. 245. Veins of the cat. (Drawn by W. J. Moore.)

Vessels conveying blood to tissues and intervening between arteries and veins—capillaries.¹

The **heart** is a thick, muscular, hollow organ with great blood vessels originating from the broad anterior part. It is enclosed in a sac of fibrous tissue lined with epithelium called the *pericardium*. It consists of 4 chambers, 2 of which are called *auricles* and 2 *ventricles*.

The auricle and ventricle of the right side are completely separated from those of the left side. The auricles open into the ventricles by valved apertures and *valves* guard the openings of the great vessels. Between the right auricle and right ventricle is the *tricuspid valve*. Between the left auricle and the left ventricle is the *mitral* or *bicuspid valve*. Between the auricles is a partition (auricular septum). Between the ventricles is the ventricular *septum*.

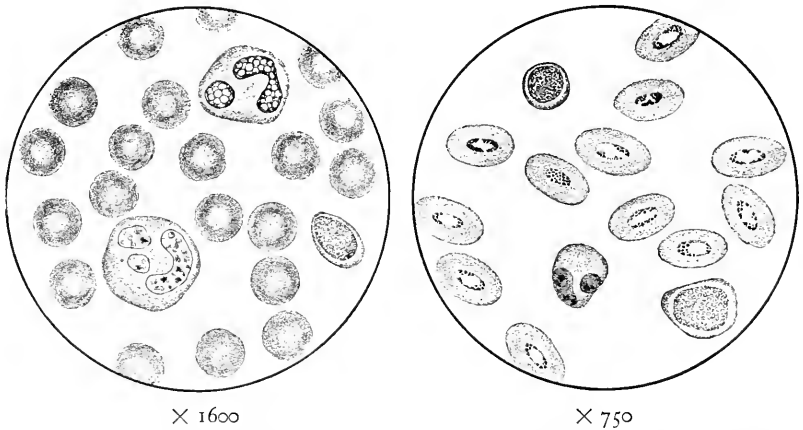

FIG. 245a. Red and White Corpuscles of Human (Left) and Frog (Right) Blood.
* (Drawn by Norris Jones.)

There are two large veins which empty into the *right auricle*. The *superior vena cava* descends, while the *inferior vena cava* ascends. The *coronary veins* come from the heart substance itself. Into the *left auricle*, *four pulmonary veins* enter, two coming from the right and two from the left lung.

From the *right ventricle* arises the large *pulmonary artery* which divides into a branch for each lung. From the *left ventricle*

¹ In the portal system (page 453) the capillaries in the liver intervene between the *hepatic portal vein* and the hepatic veins.

the large *aorta* originates. These arteries are guarded by semi-lunar valves which consist of three pouches with the convex side towards the ventricle.

Action of the Heart.—The right ventricle pumps blood through the lungs, while the left ventricle forces it through the rest of the body. Closely following the contraction of the auricles is the con-

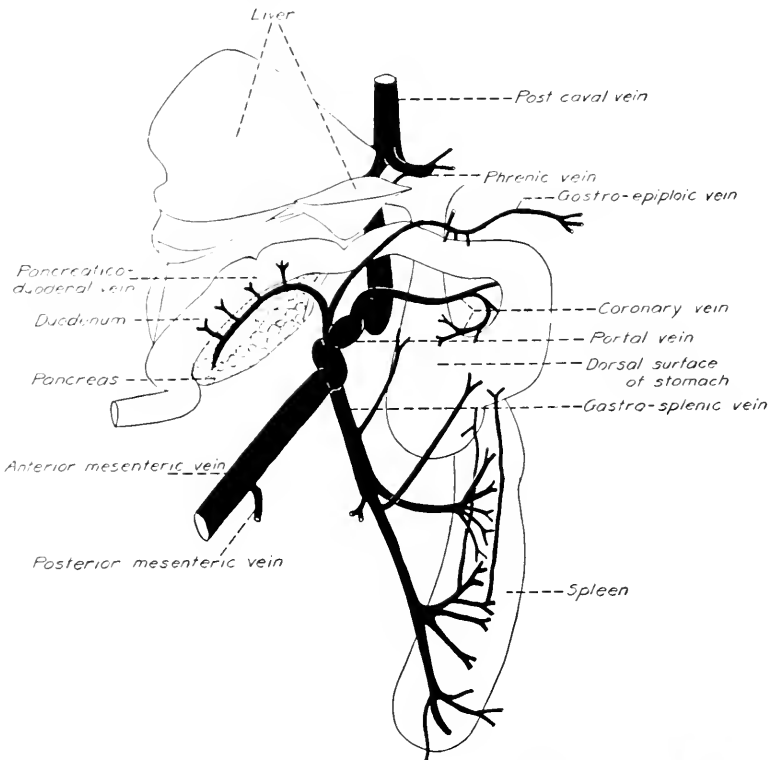

FIG. 246. Portal system of the cat. (Drawn by W. J. Moore, after I. M. Wilder, *Anat. Rec.*, 1919.)

traction of the ventricles and in this case the thick-walled left ventricle contracts with more force than the right. Contraction is termed *systole*. Relaxation is termed *diastole*. Besides systole and diastole there is a short passive period in which there is neither contraction or relaxation.

Pulse.—In men the average frequency of the pulse is from 60 to 70, while in women it varies from 65 to 80 beats per minute. There

is a quite definite correlation between *longevity* and the *rapidity* of the *pulse*. (See tables, pages 496 and 498.)

Portal Circulation.—The blood which comes to the spleen, stomach and intestines passes first through the capillaries of these organs and then by their veins into one, the *portal vein*, which goes to the liver and there breaks up into capillaries, then passes from the liver into the post cava. The wastes are conveyed from the liver by way of the bile duct which leads into the digestive tube. But bile acids and salts are extremely important.

The Comparative Anatomy of the Portal Systems.—In a *portal system* the blood is collected in capillaries, passes through a vein to an organ of purification, thence by capillaries to another vein that brings the purified blood into the heart.

(1) The *hepatic portal system* consists of the union of veins from the stomach, intestine, spleen and pancreas, which passes into the liver as the hepatic portal vein, then breaks up into capillaries, its blood mingling with the blood brought into the liver by the hepatic artery. Capillaries in the liver unite to form the hepatic veins which send the purified blood into the sinus venosus. The hepatic portal system persists throughout the vertebrates.

(2) The *renal portal system* arises in the Elasmobranchii and almost completely disappears in the Aves.

Elasmobranchii.	The caudal divides into right and left portal veins which pass to the kidneys. The course thence is to the cardinal veins.
Teleostii.	The caudal divides into two branches, of which the right continues into the corresponding cardinal and the left breaks up in the kidney.
Amphibia.	Salamander. The caudal divides into two renal portal veins. The efferent renal veins form the postcaval.
	Frog. The femorals each divide into a dorsal and a ventral branch. The ventral branch, the pelvic vein, unites with its fellow to form the abdominal vein. The dorsal branch becomes the renal portal, receives the sciatic and passes to the kidney.
Reptilia.	The turtle has no renal portal system. In the lizard the caudal divides into two pelvics which become the renal portals. As in the salamanders, the efferent renal veins unite to aid in forming the postcaval.

- Aves. In the birds the renal portal system has almost completely disappeared. The two renal portal veins formed by the division of the caudal send off only a few branches to the kidneys, known as the efferent renal veins, the main vein passing through the substance of the kidney and joining the femoral vein from the leg to form the iliac vein. The two iliacs unite to form the postcaeval.
- Mammalia. There is no trace of a renal portal system in the mammalia.

Blood. Functions of the Blood.—1. Carries food-stuffs to the tissues.

2. Carries oxygen to the tissues.

3. Medium of transmission of the internal secretion of certain glands.

4. Removes waste products from the tissues and carries them to the organs.

5. Aids in equalizing the temperature and water content of the body.

AMOUNT OF BLOOD IN PER CENT IN DIFFERENT PARTS OF THE BODY

Spleen.....	0.23 per cent
Spinal cord and Brain.....	1.24 per cent
Kidney.....	1.63 per cent
Skin.....	2.10 per cent
Intestines.....	6.30 per cent
Bones.....	8.24 per cent
Heart, Lungs and Blood vessels.....	22.76 per cent
Resting muscle.....	29.20 per cent
Liver.....	29.30 per cent

CHEMICAL COMPOSITION OF THE BLOOD. (SCHMIDT)

Water.....	788.71 per cent
Proteins and extractives.....	191.78 per cent
Fibrin (from fibrinogen).....	3.93 per cent
Hematin (and iron).....	7.70 per cent
Salts.....	7.88 per cent
	<hr/>
	1,000.00 per cent

Blood constitutes about 7 per cent by *weight* of the human body, a man having about 5 liters of blood in his body. Its specific gravity varies from 1,050 to 1,055 in children and women, and from 1,057 to 1,062 in men. The specific gravity of the corpuscles is about 1,105, and that of the plasma, about 1,030. The specific gravity is generally in direct proportion to the *hemoglobin* percentage

and the volume of (red) corpuscles. According to Schmaltz, blood with a specific gravity of 1,059 has 100 per cent of hemoglobin, that with a specific gravity of 10,575 has 90 per cent hemoglobin, while blood with a specific gravity of 1,049 will have a hemoglobin content of but 60 per cent.

Blood has an *alkaline* reaction; this is at a maximum after meals as the acid gastric juice is then in the stomach. The alkalinity is at a minimum after exercise because of the HCO_2 formed by contraction of the muscles. Blood has a salt taste and a faint smell. Coagulation of blood is promoted by heat and standing, and retarded by cold and the salts, sodium phosphate, sodium citrate and magnesium phosphate.

Blood consists of erythrocytes (red corpuscles), leucocytes (white corpuscles), platelets, hematokonia or blood dust. Salt solution swells the corpuscles and pure water will dissolve out hematin from the red ones. Water has no action on the white ones. We consider the red blood corpuscles as dead and the white ones as very much alive.

"Thrombocytes, usually spindle shaped, occasionally spherical, are found in all of the vertebrates except mammals, in which only thromboplastids (minute, cytoplasmic platelets) are found. Both thrombocytes and platelets are associated with the clotting of the blood. Lymphocytes are uniformly present in all classes of vertebrates. Monocytes or, large mononuclear leucocytes, are also uniformly present in all vertebrates. In man the neutrophilic leucocytes predominate numerically." (A. B. Dawson.)

The proportion of white to red corpuscles is as 1 : 300 or as 1 : 500. There are many more white corpuscles shortly after meals. The reds vary in number as one goes from sea level to the mountains.

<i>Animal</i>	<i>Size of reds in microns</i>	<i>Number of reds in 1 cubic mm.</i>
Elephant.....	9.	
Man.....	7.2-7.8	5,000,000
Monkey.....	7.0	6,355,000
Guinea Pig.....	7.48	5,859,000
Dog.....	7.2	6,750,000
Horse.....	5.58	7,403,000
Cat.....	6.2	9,900,000
Spanish Goat.....	4.25	19,000,000
Napu Deer.....	2.0	

(From Rollett and Bethe in Böhm-Davidoff-Huber's Histology, W. B. Saunders Co.)

Red corpuscles or erythrocytes consist of water, hemoglobin, nucleoproteid, lecithin, cholesterin and salts of potassium and of phosphoric acid. The erythrocytes of fishes, amphibia, reptiles and birds are oval and nucleated and the leucocytes are frequently found to be without nuclei. The erythrocytes are biconcave discs in all mammals except the *Camelidae* in which they are *oval*, but in healthy animals, *non-nucleated* in adults as in other mammals.³ Sometimes in man after anemia or severe hemorrhage, nucleated reds are called forth from the red bone marrow where they are formed in adults. In the embryo, the liver and the spleen produce nucleated reds, but in the adult the spleen devours worn out reds and furnishes some lymphocytes. The spleen probably takes some of the iron from worn out red blood corpuscles while the liver takes iron and uses hemoglobin in forming bile-pigment, bilirubin. The thymus, tonsils and other lymphoid glands supply leucocytes, acting as foci of multiplication for the cells which originate as *myelocytes* in the bone marrow.

When blood is treated with OsO_4 it shows colorless, round disks, which are unstable, and also granules. The disks are "*thromboplastids*" or *blood platelets*.⁴ The proportion of red corpuscles to platelets is as 80 : 1 or as 20 : 1. They are foci where coagulation of the blood is hastened. F. F. Lucas has photographed blood platelets with ultra-violet light and discovered that they have "naked, sticky surfaces" such that they are able to glue themselves together with available blood corpuscles and facilitate rapid blood clotting. Howell believes that platelets are *more* than mechanical agents in causing coagulation of blood and lymph.

Blood Groups.—In blood transfusions, it is necessary that the blood of the donor and the recipient be alike, and that the substance known as a hemolysin be absent. In hemolysis, a substance is produced which has the power of dissolving the introduced red corpuscles. Hemolysis does not occur without *agglutination* (clumping) (see page 458) and it is therefore only necessary to test

³ Since two texts of recent date have published the erroneous statement that *Camelidae* have nucleated erythrocytes, the question was referred to Dr. W. H. F. Addison and to Dr. Noback, both of whom reported that they are oval, biconvex and non-nucleated. A paper by Ponder, Yeager and Charipper, *Haematology of the Camelidae*, *Zoologica*, vol. 11, no. 1, Dec. 5, 1928, furnishes additional proof.

⁴ Corson, Irwin and Phillips found (1930) that irradiated ergosterol (Vitamin D) increased the number of thrombocytes in the blood of rats, and materially shortened the time of coagulation. Blood calcium was increased.

for the agglutinins, before utilizing the blood of a donor. In 1901, Landsteiner showed that human beings may be divided into three groups according to the interactions of their *sera* and blood cells. Later his pupils, Decastello and Sturli, added a fourth group. Blood from two persons of the same group will mix freely, but the blood from two different groups will *clump* or agglutinate.

LANDSTEINER'S TABLE OF THE CONSTITUTION OF THE FOUR BLOOD GROUPS

Group	Serum	Cells
O	Agglutinates cells of three other groups; contains agglutinins alpha and beta.	Inagglutinable; contain no agglutinogen.
A	Agglutinates cells of groups B and AB; contains agglutinin.	Agglutinated by serum of groups O and B; contain agglutinogen A.
B	Agglutinates cells of groups A and AB; contains agglutinin.	Agglutinated by serum of groups O and A; contain agglutinogen B.
AB	No agglutinative effect; contains no agglutinin.	Agglutinated by serum of groups O, A, and B; contain both agglutinogens A and B.

Moss's classification of blood groups has to some extent replaced the earlier ones of Landsteiner and Janksy. Hooker and Boyd of the Evans Memorial Hospital, Boston, have studied (1929) the chances of establishing a child's paternity by blood grouping tests. A child's blood may belong to the same or a different blood group from its mother. Some investigators believe that the characteristics follow the Mendelian Law and may be inherited from the grandparents.⁵

Lymph.—Except for those red corpuscles accidentally present in it, lymph may be considered to be blood minus the erythrocytes. Lymph bathes every cell and tissue of the body, and mediates interchanges between the tissues and circulating blood. It has several important functions: (1) The conveyance of food and of oxygen inward from the capillaries to the cells and the external transportation of the tissues' waste. (2) The absorption of fat from the digestive tube. (3) The lubrication of great serous surfaces. (4) The upkeep of fluids in the brain and spinal cord. (5) The maintenance

⁵ Consult K. Landsteiner, *The Human Blood Groups*, pp. 892-908; R. Ottenberg and D. Beres, *The Heredity of the Blood Groups*, pp. 909-920; in Jordan, E. O., and Falk, I. S., *The Newer Knowledge of Bacteriology and Immunology*, U. of C. Press, 1928; and the summary by L. H. Snyder, *Arch. Path. and Lab. Meth.*, vol. 4, pp. 215-257, 1927.

of the optimum composition of the blood, even at the expense of the constancy of lymph.

Lymph consists of nutritive material absorbed from the walls of the alimentary canal and colorless food materials in the blood not yet utilized. After meals the color of lymph becomes whitish from the admixture of *chyle*, and many fat droplets are present. Lymph coagulates when drawn, since the fibrin factors are present; but the process is less prompt and the clot is less firm than in the case of blood. Lymph contains three proteins, fibrin, serum-globulin, and serum-albumen. It contains, in common with plasma, cholesterolin, sugar and inorganic salts. The proteins are less abundant than in plasma. The amount of urea is greater than in plasma.

Lymphatics.—From the alimentary canal, materials pass in part directly into the blood vessels surrounding the canal, and in part into vessels called *lacteals* which are found in the intestinal villi. Lacteals transport *chyle* to the receptaculum chyli of the thoracic duct.

The lymphatics and the lacteals form a simple, branched vascular tree which opens into the jugular veins at their bases by two trunks, the left-thoracic duct and right-lymphatic duct. Throughout the course of the lymphatic vessels are many lymphatic glands which are the foci of multiplication of white blood corpuscles and act as strainers for poisons. (Figure 246.)

Flow of Lymph.—No organ corresponding to the heart keeps the

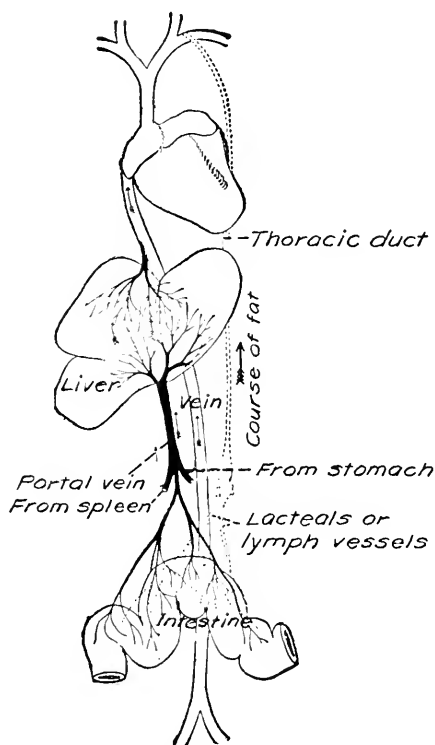

FIG. 247. Diagram of paths of absorbed food from the digestive tract. (From Conn and Budington. Courtesy of Silver, Burdett and Co., New York.)

lymph current in motion. The main cause for its direction from the extra-vascular spaces toward the veins in the neck is the degree of pressure to which it is subjected in those spaces as compared with the small pressure near the ends of the great ducts. Lymph flow somewhat resembles that of venous blood, but is less regular and more sluggish, though not so slow as might be supposed.

Spleen.—While the mammalian spleen may be operatively removed, it serves several important functions: (1) During embryonic life and even after birth, in cases of anemia, the spleen forms red corpuscles. (2) It contains large quantities of organic iron and probably aids in the preparation of hemoglobin. (3) It destroys old worn-out red corpuscles and takes up pigment and other wastes from the blood. (4) It increases in size during digestion and after the fifth hour slowly decreases to normal size. It is excessively vascular during digestion.

Respiratory System.—In the cat the respiratory system is not greatly different from that of man. Air inhaled at the anterior nares goes through the nasal passages and out from the posterior nares into the naso-pharynx. Lucas⁶ finds that in the monkey the cilia of the septum, the middle concha (*turbinata*), and the middle meatus sweep the mucus downward toward the floor and hence *backward* into the naso-pharynx (not upward as senior authors have claimed). The trachea of the cat consists of forty-five cartilages (16–20 in man) which are held in place by fibrous membrane which embeds them. In the cat the *trachea* is three-fourths of an inch in diameter and four and one-half inches in length. The *lungs* consist of three lobes on each side with a fourth lobe on the right side which is divided into two parts, and lies a little to the right of the middle of the body. The *cartilaginous rings* extend two-thirds of the way around the trachea, the third not supported by the rings resting upon the *esophagus*. The *lungs* are supported in the chest by paired bronchi and the pulmonary and bronchial arteries, veins and lymphatics. The *bronchi* also have incomplete irregularly arranged cartilaginous rings. Each *lung* is covered by a delicate serous membrane, the *pleura*, which is reflected over the inner surface of the thorax. The lung consists of many lobules of *air-cells* with extremely thin walls and is richly supplied with minute capillaries as well as many veins and arteries. In the trachea and the bronchi,

⁶ Lucas, A. M., in Chapter 11 of *Special Cytology*, 2d edition, edited by E. V. Cowdry, 1931.

the ciliary movement is *upward* towards the throat. Inhalation of chloroform stops ciliary activity, while ether does not (Lucas). Hach found (1925) that morphine slowed the rate of movement of pollen injected into the trachea of dogs, but that caffen increased the speed of its transportation.

Respiration.—During the first year of life, the average rate of respiration in the human infant is about forty-four per minute. It gradually reduces to a rate of about fourteen or fifteen per minute in the adult.

TABLE OF RESPIRATION RATES OF VARIOUS ANIMALS. (BERT⁷)

Hippopotamus.....	1	per minute
Lion.....	10	“ “
Horse.....	10 to 12	“ “
Pig.....	10 “ 15	“ “
Ox.....	15 “ 18	“ “
Dog.....	15 “ 20	“ “
Sheep and goat.....	18 “ 20	“ “
Cat.....	24	“ “
Pigeon.....	30	“ “
Eel.....	50	“ “
Rabbit.....	55	“ “
Sparrow.....	90	“ “
Rat (asleep).....	100	“ “

How Long Can Aquatic Mammals Submerge?—It is well known that by practice it is possible for man to remain submerged for over two minutes (see page 157). Parker, in some recent observations, has shown that the Florida manatee can remain submerged sixteen minutes. The whale, reported to submerge for an hour, has been found by Parker to remain twenty minutes under water.

Voices of Mammals.—In man, the dog, the sheep, and the horse, the voice is produced by *expiratory* blasts of the lungs producing vibrations of the vocal cords. The pitch of sound and tones depends on the tension of the vocal cords, a low-pitched tone being produced by relaxed cords. In the cat, the pig and cattle, the voice is an *inspiratory* act. The whale, the dolphin, and the giraffe are mute.

The Excretory System.—The urinary system of the mammal consists of paired *kidneys* where solid products of decay that cannot be eliminated by the lungs are excreted in the urine which passes from the kidneys by way of the ureters to the ventrally situated

⁷ Dearborn, G. V. N. 1908. Human Physiology. Lea and Febiger, Philadelphia.

urinary bladder. From thence it is transported by means of the urethra to the exterior. The kidneys expel water, urea and a little CO_2 . The average amount of urine secreted in man per day is fifty ounces. The lungs exhale CO_2 and water with a trace of urea, while the skin excretes as the lungs do and also functions in place of the kidneys when they are diseased (see Perspiration, page 428). The liver, by means of its hepatic portal system (see page 454), separates out the impurities from the blood and passes them into the duodenum. Intestinal excretion plays an important role in the economy of the animal.

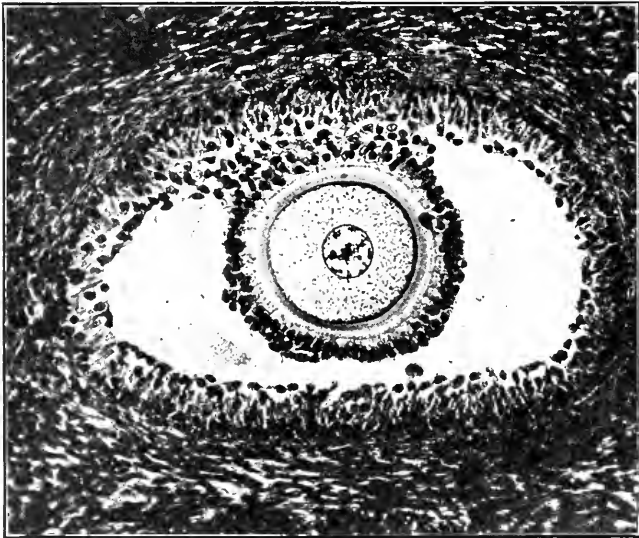

FIG. 248. Graafian follicle and ovum of the cat, within the ovary. (Photograph through the courtesy of Dr. B. F. Kingsbury.)

Reproductive System.—While in the lower vertebrates there is an extremely close relationship between the urinary and the reproductive system, evidenced in the frog, for instance, by the passage of sperms through the kidney and out through the common Leydig's duct, we find that in the mammal, at birth, such connection largely disappears.

Female.—In the cat there are two small oval *ovaries*, which produce Graafian follicles and send the ova therein contained down the elongated Fallopian tubes, the lower portions of which, as horns

(cornua) of the *bicornuate uterus*, retain the embryos until they have matured. The *body* of the *uterus* in the cat does not receive the implanted ovum. Subsequent to the extrusion of the ovum, the follicular epithelium of a Graafian follicle degenerates, collecting in a mass of cells of a yellowish color called the corpus luteum (see p. 444). In higher mammals (cow, man) the Fallopian tubes or oviducts function merely to convey sperm and to carry the eggs to the body of the uterus. Parker finds that, in reptiles and birds, a proövarian tract of cilia conducts the sperms upward, and an extensive ab-ovarian tract propels the ova downward. Parker has recently (1931) shown that in the rabbit muscular contractions and ciliary activity together move the sperms upward and the ova downward. The effective stroke of all cilia is toward the uterus. The Fallopian tubes and the uterus are suspended by the broad ligament attached to the dorsal abdominal wall. The delicate round ligament also aids in the suspension of these structures. The body of the uterus continues posteriorly to form the vagina. From the urinary bladder leads the female urethra which ends in the cat at the vestibule, about one-half inch from the external opening of the vagina, the vulva. On the ventral surface, just posterior to the opening of the urethra, appears the clitoris, which is the homologue of the penis of the male. Bartholin's glands are situated lateral to the vestibule with ducts opening into it. The vagina, uterus, and the Fallopian tubes are all lined with mucous membrane richly supplied with glands.

Male.—The paired *testes* of the cat consist of numerous minute coiled tubules, the seminiferous tubules, which in each testis

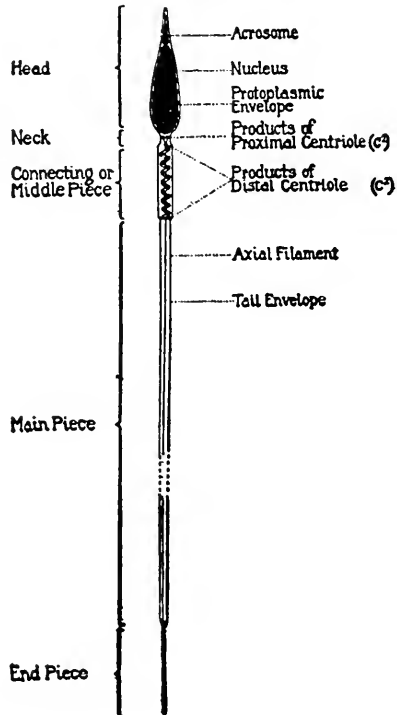

FIG. 249. Diagram of animal sperm as in mammals. (After Wilson, *The Cell*. Courtesy of The Macmillan Company.)

unite into a few beneath the elongated epididymis which continues to form the vas deferens. These canals transport the spermatozoa to the urethra. By the activity of the ciliated epithelial cells lining the efferent ducts, the then immotile spermatozoa are slowly passed toward the epididymis. The penis, by means of which sperms are transferred, receives the urethra. The prostate glands surround the urethra dorsolaterally a short distance from the urinary bladder. They secrete a fluid which serves as a medium for the spermatozoa. The spermatozoan has a long flagellum, and its activity is affected

by changes (CO_2 , acidity) in the seminal fluid, just as the beat of the cilia may also be affected. Cowper's glands are situated posterior to the prostate glands and secrete a viscid fluid which passes into the urethra by a duct from each gland.

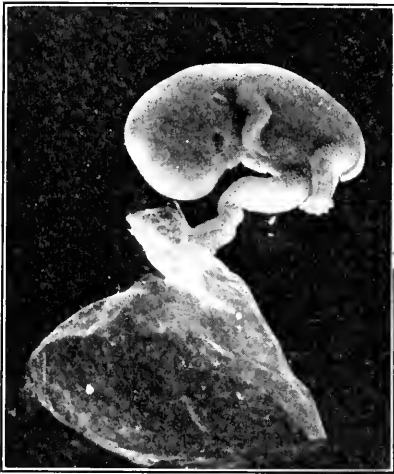

FIG. 250. Human embryo at six weeks.
(Photo by Newton Miller.)

Propagation Rate in Mammals.—In the lower vertebrates, such as the cod fish, it is stated that of six million eggs spawned, less than a third are fertilized. In birds and mammals, a limited number of eggs are matured at one time. Sometimes a single ovum develops at the expense of others.

Marshall quotes Arai to the effect that the ovary of the rat at birth contains 35,100 ova, which are reduced by degeneration to 11,000 after 23 days, and to 6,000 by the 63d day. Smith and Engle, by the implantation of anterior hypophyseal substance in infantile female mice, succeeded in inducing the ripening of ova such that one of the animals produced twenty young. (See Hypophysis, p. 448.)

The Nervous System.—There are two main groups of activities in the vertebrate organism which have determined the general plan of organization of the nervous system.

Reactions toward the *external world* consist in the finding and capturing of food, fighting with other animals, preparing nests or

homes for protection against the physical elements, and many minor reactions such as changes in heat, light or moisture.

PERIOD OF GESTATION ⁸

<i>Mammalia</i>	<i>Gestation Period</i>	<i>Condition of Young at Birth</i>
Monotremata		
Ant eater		Hatched from eggs. Very immature.
Marsupialia		
Kangaroo		Size of small rat and very helpless. Sheltered in pouch.
Rodentia		
Rat	21 days	Eyes closed, small, helpless.
Mouse	21 days	
Rabbit	28-32 days	
Guinea pig	62-80 days	Development far advanced. Eats corn in 2 or 3 days.
Ungulata		
Blackfaced sheep	21 or 22 weeks	Well advanced but suckling some time.
Cattle	9 months	
Pig	16 weeks	
Mare	11 months	
Elephant	20 months	Well advanced.
Camel	45 weeks	
Cetacea		
Whale	10 months	
Porpoise	10 months plus	Young able to follow mother about.
Carnivora		
Cape hunting dog (<i>Lycan</i>)	80 days	Lustier than dog.
Wild dog (<i>S. America</i>)	2 mos. (59-63 days)	Young helpless.
Domestic cat	56-63 days	
Wild cat	68 days	
Lioness	15 to 16 weeks	
Tigress	22 weeks	
Puma	15 weeks	
Brown bear	7 months	
Grizzly	8 months	
Ferret	40 days	
Polecat	40 days	
Walrus	1 year	Lactation two years.
Primates		
Monkeys	7 months	
Man	280 days	

⁸ Compiled from F. H. A. Marshall, 1922, Physiology of Reproduction.

The *internal activities* include all the processes related to metabolism, the distribution of nutritive material to various parts of the organism, and the various processes connected with the formation of the reproductive elements and the nutrition of the embryo.

Sensory Nerves.—The nerve fibers and central mechanisms which have to do with the stimuli affecting the welfare of the animal in its surroundings are the *somatic afferent* or *somatic sensory* division of the Nervous System.

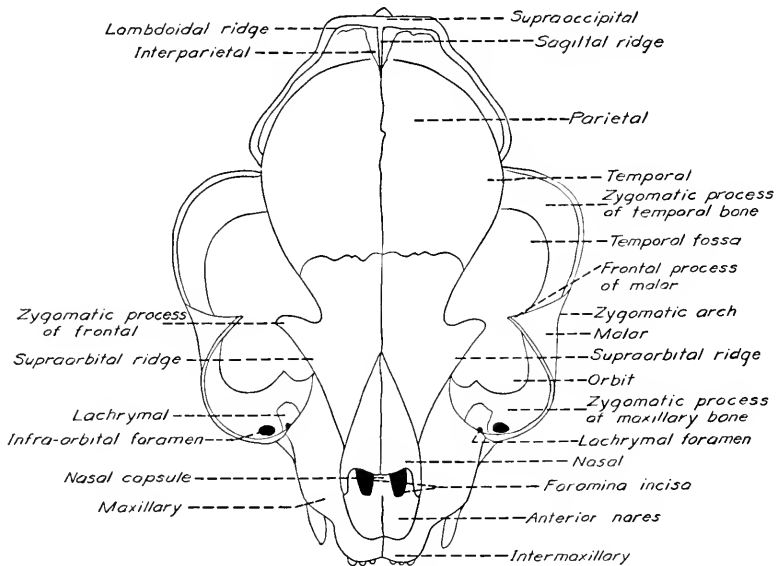

FIG. 251. Dorsal view of the skull of the cat. (Drawn by W. J. Moore.)

All the nervous structures concerned with impulses arising in the viscera, in the taste organs, and in the olfactory organ are closely related and constitute the *visceral afferent* or *viscero-sensory* division of the nervous system.

Motor Nerves.—All the usual movements of locomotion, of offense and defense are directed ordinarily in response to stimuli from without. Somatic movements are also performed in response to gustatory and olfactory stimuli and have for their object the capturing of food. In general, while somatic movements may be called forth by visceral stimuli, they are more typically called forth by somatic stimuli, and are more precise when they are directed in response to them.

The nerve centers and peripheral nerves which direct somatic movements constitute a distinct portion of the Nervous System which we may call the *somatic (efferent) motor* division.

The visceral activities consist of contractions of the visceral muscles, secretory processes and vaso-motor regulation. All these contribute directly or indirectly to the processes of nutrition in the widest sense or of reproduction. Just how far they may be called forth by somatic stimuli is not known. We know that the sight of food may cause salivary secretion. Respiration is called forth by rise in temperature within the body. The nerve centers and fibers which control the activities of the viscera make up the *visceral efferent* or *viscero-motor* division of the Nervous System.

To summarize, in any vertebrate animal there are four kinds of nervous activity: (1) Reception of somatic stimuli. (2) Direction of somatic movements. (3) Reception of visceral stimuli. (4) Direction of visceral movements and activities.

The mammalian **brain** exhibits marked superiority over that of the lower vertebrates in the development of large richly convoluted *cerebral hemispheres* and a *cerebellum* not surpassed in any form except the bird. The *olfactory lobes* situated ventrally at the anterior portion of the cerebral hemispheres are highly developed in many of the lower mammals. In common with the reptiles and birds, the mammals have *12 pairs of cerebral nerves*. There are *31 pairs of spinal nerves* in man, and *38 pairs* in the cat.

Both the brain and the spinal cord consist of gray and white nervous matter but in the *brain* the *gray* is on the *outside* and the white is within while in the *spinal cord* the *gray* is on the *inside* and the white is external. White matter is chiefly composed of nerve fibers while gray matter is much more vascular and composed of nerve cells which give rise to nerve fibers. Nerve fibers are *non-medullated*—(a) Naked axis cylinder, (b) Axis cylinder with primitive sheath, and *medullated*—(c) Primitive sheath absent, (d) Primitive sheath present. Medullated fibers are present in greater quantity than non-medullated in the cerebro-spinal system. The mass of white substance of the brain, spinal cord, and optic nerve has medullated fibers without the primitive sheath. Both brain and the spinal cord are covered by three membranes, the outer *dura mater* with a thin delicate membrane, the *arachnoid*, which serves as a sheath for the nerves and is separated from the *dura mater* by a narrow sub-dural space. A vascular membrane, the *pia mater*, is

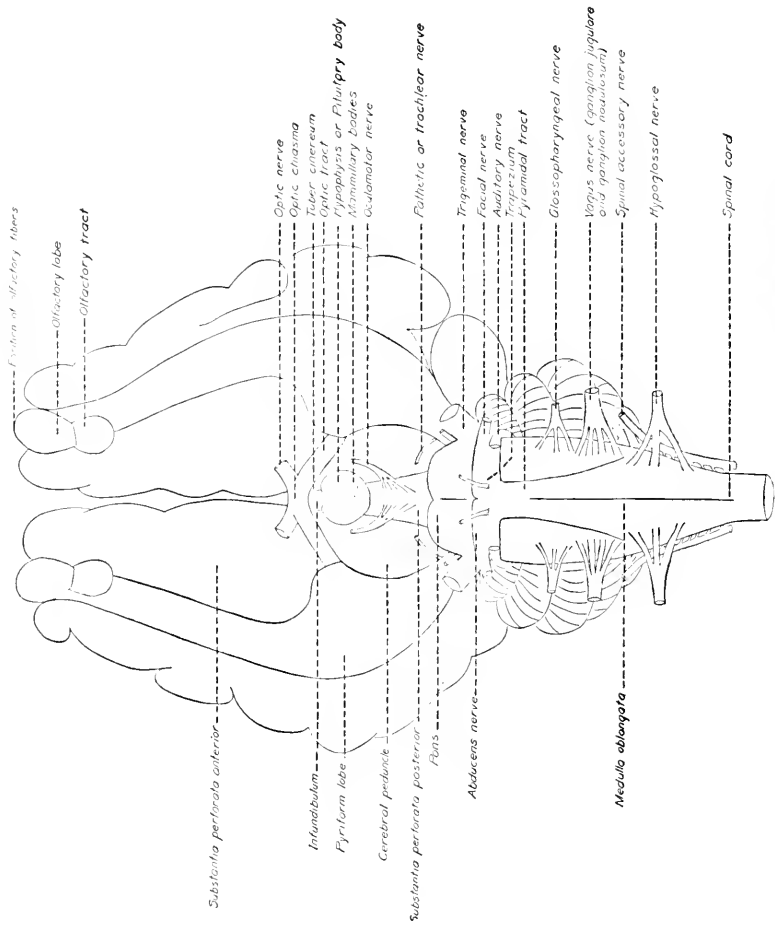

FIG. 252. Sheep brain, ventral view. (Drawn by W. J. Moore.)

loosely connected with the arachnoid by strands of connective tissue forming a spongy network but there is considerable space between the two called the sub-arachnoid space. This space contains a fluid called the cerebro-spinal fluid which differs from ordinary lymph (1) in its small per cent of proteins, (2) in the absence of cells and (3) in the absence of a fibrin ferment.

Cerebro-spinal fluid is colorless and alkaline, having a specific gravity of between 1,006 and 1,008. It consists mostly of water. The solids include a trace of protein, chiefly globulin; if the membranes of the brain or cord are inflamed, there is much more protein present. A small amount of carbohydrate as glucose and the salts found in blood plasma occurs, with occasionally a few leucocytes and a large quantity of CO₂. It contains no antitoxins, opsonins, nor alexins which are present in blood plasma and in tissue fluid.

Cerebrum.—Much of the *cerebral cortex* is occupied by large triangular cells called pyramidal cells, the largest of which is one-six hundredth of an inch. These cells are agents in the psychic activity of the cortex.⁹ Cajal called them psychic cells. The fibers of white matter of the cerebral hemisphere consist of projection fibers and association fibers. The projection fibers are those which project the impulses of the outside world upon the sensorium, or the reverse. These are *cortico-afferent*, leading from lower levels to the cortex, or *cortico-efferent*, leading from the cortex to lower levels. The *association* fibers which correlate cortical areas are of two types, the *arcuate* which correlate areas of the same hemisphere, and the *commissural* which correlate areas of the opposite hemisphere. The most important commissures in the mammalian brain are the *corpus callosum* and the *anterior*, *middle* and *posterior* commissures. The fibers of the cortex myelinate late, none receiving the medullary sheath in the human brain until the ninth fetal month. (See page 479.)

Cerebellum.—The **cerebellum**, important in coördination, consists of an outer clear gray molecular layer with an inner reddish gray granular layer. At the junction of these two layers are the large flask-shaped cells called the *Purkinje cells*. It is by contact and not by continuity of structure that nervous impulses are transmitted. The system of the cerebellum shows not only this but shows that different parts of the same cell may be supplied with terminal fibers from quite different sources.

⁹ "Learning without thought is labor lost; thought without learning is perilous." Confucius.

TABLE OF CEREBRAL NERVES AND THEIR COMPONENTS IN MAMMALS

<i>No.</i>	<i>Name</i>	<i>Components</i>	<i>Cells of Origin</i>	<i>Distribution</i>
I.	Olfactory	Special viscerosensory	Nasal mucous membrane	Mitral cells of olfactory bulb.
II.	Optic	Special somatic sensory	Ganglion cells of the retina	External geniculate, pulvinar of thalamus; superior colliculus.
III.	Oculomotor	Special somatic motor	III. Nuc. at level of sup. coll.	Superior, inferior, internal recti and inferior oblique muscles; levator palpebra superior.
		General visceromotor	Nuc. of Edinger-Westphal	Preganglionic fibers to ciliary ganglion, postganglionic fibers to intrinsic muscles of eye.
IV.	Patheticus or Trochlearis	General somatic sensory		Mixed with motor fibers of four muscles.
		Special somatic motor	IV. Nuc. at level inf. coll.	Superior oblique muscle.
V.	Trigeminal	General somatic sensory		Mixed with motor fibers to superior oblique muscles.
		Special visceromotor	Motor V nuc.	Mandibularis nerve to temporal, masseter, external and internal pterygoid, tensor palati, tensor tympani, anterior belly of digastric and mylo-hyoid muscles.
		General somatic sensory A. Exteroceptive	Semilunar ganglion. (Gasserian g.) Periph. br. to skin, mucous m. of head; central br. to brain	Ophthalmic, maxillary and mandibular nerves.
VI.	Abducens	General somatic sensory B. Proprioceptive	Mesencephalic V	Mixed with motor fibers to masticatory muscles.
		Special somatic motor	VI. Nuc. dors. pons.	External rectus muscle.
		General somatic sensory		Mixed with motor fibers to external rectus muscle.

TABLE OF CEREBRAL NERVES AND THEIR COMPONENTS IN MAMMALS—*Continued*

No.	Name	Components	Cells of Origin	Distribution
VII.	Facial	General visceromotor	Salivat. sup. nuc.	Preganglionic fibers in chorda tympani; postganglionic fibers from sub-maxillary ganglion to submax. and sublingual glands.
		Special visceromotor	Motor VII nuc.	Stapedius, posterior belly of digastric, stylohyoid muscle.
		General viscerosensory	Geniculate ganglion	Sup. petrosal, chorda tympani, tympanic plexus.
		Special viscerosensory	General ganglion	Chorda tympani and lingual nerve to taste buds on anterior two-thirds of tongue.
VIII.	Acoustic	Special somatic sensory	A. Vestibular ganglion. B. Spiral ganglion of cochlea	Semicircular canals, sacculus, utriculus. Organ of Corti of Cochlea.
IX.	Glosso-pharyngeal	General visceromotor	Motor IX root. Nuc. salivatory inf.	Preganglionic fibers in tymp. and sup. petrosal nerve; postganglionic from otic ganglion to parotid gland.
		Special visceromotor	Nuc. ambig.	Stylopharyngeus muscles. (Unstriped pharynx.)
		General viscerosensory	Ganglion petrosal IX	Sensory fibers to pharynx, posterior one-third of tongue. (Lingualis IX.)
		Special viscerosensory	Ganglion petrosal	Tastebuds of post. one-third of tongue.
		Somatic sensory	Ganglion superior IX	Tactile corpuscles of posterior one-third of tongue.
X.	Vagus or Pneumogastric	General visceromotor	Dorsal motor nuc. of X	Preganglionic sympathetic fibers to pharynx, stomach, heart, lungs, trachea.
		Special visceromotor	Nuc. ambiguus	Superior and inferior laryngeal and pharyngeal nerves to striated muscles of pharynx and larynx.
		General viscerosensory	Ganglion nodosum	Nerves from viscera, larynx, pharynx, lungs, heart, and sympathetic connections.
		Special viscerosensory	Ganglion nodosum	Internal laryngeal nerve.
		General somatic sensory	Ganglion jugulare X.	Ramus auricularis vagi. (Behind ear.)

TABLE OF CEREBRAL NERVES AND THEIR COMPONENTS IN MAMMALS—*Continued*

No.	Name	Components	Cells of Origin	Distribution
XI.	Spinal accessory	General visceromotor Special visceromotor.	Dorsal motor nuc. of X. Nuc. ambiguus	Preganglionic fibers distributed with the vagus. Striated muscles of pharynx and larynx and rami to trapezius and sterno-cleido-mas-toid muscles.
XII.	Hypoglossal	Special somatic motor.	XII. nuc.	Hypoglossus nerve to muscles of tongue.

In the I, II, III, IV, VI, and VIII nerves the organs of special sense are supplied, while the V, VII, IX, X, and XI cerebral nerves have visceral functions predominating.

Consult Johnston's Comparative Neurology and article by C. J. Herrick in Reference Handbook of Medical Sciences, entitled the Cranial Nerves.

The bodies of Purkinje cells are surrounded by the *basket terminals* of the stellate cells of the molecular layers, while their protoplasmic processes are in contact with the *efferent* fibers that arise from more distant portions of the nervous system.

Medulla Oblongata.—The **medulla oblongata** controlling heart beat and respiration, the enlarged anterior portion of the spinal cord, sends off the cerebral nerves from the fifth to the twelfth inclusive. It receives columns of fibers originating in the spinal cord and may be considered a great switch station for impulses passing up and down the cord.

Spinal Cord.—In all vertebrates having well-developed limbs the two regions of the **spinal cord** with which the nerves of the limbs are connected are somewhat thicker than the rest of the cord and are known as the thoracic and lumbar enlargements. Each of the spinal nerves has a *ventral anterior root* and a *dorsal posterior root* with spinal ganglia, containing nerve cells and fibers which are usually *afferent*, conveying impulses from the parts and organs of the body to the central nervous system. The *ventral root* is not ganglionated and its fibers are *efferent*, conveying impulses from the neuron outward. The cranial nerves are twelve in number on each side in reptiles, birds and mammals. Only the trigeminal or fifth present a double-rooted arrangement similar to a spinal nerve. Several however have ganglia comparable to those of the dorsal roots of the spinal nerves. Besides the fifth or trigeminal these

include the seventh (facial), eighth (auditory), the ninth (glossopharyngeal) and the tenth (pneumogastric).

Origin and Structure of the Neuron.—A *neuron* consists of a cell body with all of its processes. The entire nervous system is composed of cells with one or more processes. These cells develop early in embryonic life from certain ectodermal cells (neuroblasts) of the neural canal (which is formed by a dorsal invagination of the ectoderm). The *neuroblasts* develop secondary processes, many in the neural canal, others after wandering from it, and by this process of budding become nerve cells. The primitive processes continue to extend until they reach the periphery of the body, are invested with medullary sheaths supplied by connective tissue of the region through which they pass, and become *nerve fibers*. *Nerve fiber* and *nerve cell* are therefore parts of the same histological unit.

The processes are of two kinds: 1. (a) unbranched; (b) uniform in diameter with lateral offshoots called *collateral branches*. These are generally the central part of a nerve fiber and are called neurites or *axones*. 2. Processes which branch soon after leaving cell body and break up into smaller branches called dendrites. Thus the neuron consists of a cell body containing a conspicuous nucleus, nucleolus and cytoplasmic granules, protoplasmic processes called dendrites, an axis cylinder process which passes into a nerve fiber, and a final termination in the form of a branching tuft. Golgi's idea that protoplasmic processes or *dendrites* subserve nutrition of the cell is without foundation. Many circumstances show that they *transmit impulses*.

The Sympathetic Nervous System consists of a pair of elongated ganglionated cords extending from the base of the skull to the lumbosacral region, connecting on the one hand by a series of branches to the spinal nervous system, and on the other hand giving off an irregular series of branches to the viscera. At its cephalic end, each sympathetic cord is continued in a plexiform manner into the cranial relationships with certain cranial nerves. Caudally, the two cords are joined by fine filaments and connected by the coccygeal ganglion.

The *sympathetic system* rearranges and distributes fibers, derived from the cerebro-spinal system, to the viscera and vessels of the splanchnic area. It transmits afferent fibers from the viscera to the cerebro-spinal system, and sends fibers to the vessels, involuntary muscles and glands in the course of the somatic divisions of the

spinal nerves. Its fibers are called *white rami communicantes* (medullated) and *gray rami communicantes* (non-medullated).

Sense Organs.—

KULPE'S CLASSIFICATION OF SENSATIONS BY ORGANS¹⁰

1. Vision.
2. Audition.
3. Cutaneous.
 - Cold
 - Warmth
 - Pressure
 - Pain
4. Olfactory.
5. Static sense.
 - Ampullar (dizziness)
 - Vestibular
6. Gustatory. (See page 477.)
7. Kinaesthetic.
 - Muscular
 - Tendinous
 - Articular
8. Organic.
 - Hunger
 - Thirst
 - Nausea
 - Suffocation
9. Reproductive.

Vision depends on the proper function of the complicated eye. Sensation passes from the layer of *rods* and *cones* of the *retina* through its *nuclear* and *molecular* layers to the ganglion cells from which nerve fibers transmit the impulse to the *optic tracts* leading to the brain. (See p. 468.)

Visual sensations include hue or quality, brightness and saturation. The stimuli are the ethereal vibrations ranging between 400,000 and 800,000 billions per second. Color is stimulated by the wave length while the height of the wave gives the brightness and the form of the wave determines the degree of saturation. It is said that in certain tapestries in Milan there are 1,800 colors while in some Italian mosaics there are 30,000 colors.¹¹

Color Blindness.—Some people are unable to distinguish all of

¹⁰ Consult Murchison, C. 1929. The Foundations of Experimental Psychology. Clark Univ. Press.

¹¹ Consult Herrick, C. J. 1931. Introduction to Neurology. W. B. Saunders.

the 160 color tones. In *total color blindness* one cannot distinguish between any other colors than gray. *Partial color blindness* is the inability to distinguish between a certain group of colors.

Audition.—The mammalian *ear* receives sound waves and transmits them by the *tympanum* to the *ossicles* and from the ossicles by way of the vestibule they pass to the liquid in the *cochlea*. The movement is continued to the *basilar membrane* where vibrations of the fibers in unison with the tone affect definite *hair cells* and the sensation is transmitted to the brain by way of the eighth nerve. (See p. 468.)

The *Organ of Corti* in the *cochlea* of the ear is the *receptor* involved in hearing. Numerous theories of the activation of the constituents of this organ by the vibrations of fibers imbedded in the *basilar membrane* have been advanced.

The human ear is sensitive to vibrations with a frequency of from *thirty to thirty thousand* per second.

Hearing in Aquatic Mammals.—The *whale*, like the seal and the porpoise, lacks external ears. It has *blow-holes* on the top of its head, which are closed by means of elastic cartilage valves. The *cachalot* has an external opening, about 1 inch long in the full-grown whale. The external auditory tube is closed by bony growth, protecting the ear drum from the pressure encountered at great depths. It is claimed by Kellogg that the *whale-bone whales* now actually hear through their *noses*, and that the ear drum is *non-functional*. The *bullae*, a structure coiled like a conch shell, is said to receive the sound waves. Whales are able to detect sounds very readily.

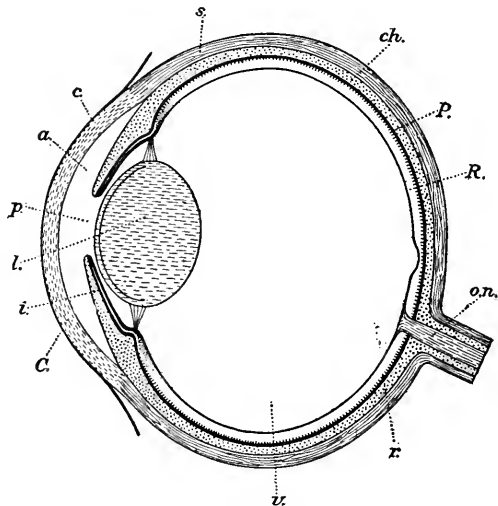

FIG. 253. The vertebrate eye. *a*, aqueous humour; *c*, conjunctiva; *C*, cornea; *ch*, choroid; *i*, iris; *l*, lens; *o.n.*, optic nerve; *P*, pigment layer; *p*, pupil; *R*, retina; *r*, layer of rods; *s*, sclerotic; *v*, vitreous body. (From Kerr. Courtesy of Macmillan and Co., Ltd.)

Cutaneous Sensibility.—Besides light touch we have sense organs for *deep pressure sense* and *pain*. Adjacent to each other there are end organs for sensibility to *cold* and *heat*. It is said that there are over 250,000 *cold spots* and but 30,000 *warm spots*. Sometimes a paradoxical sensation of cold may be aroused by a hot stimulus. The cheek is relatively insensitive to pain.

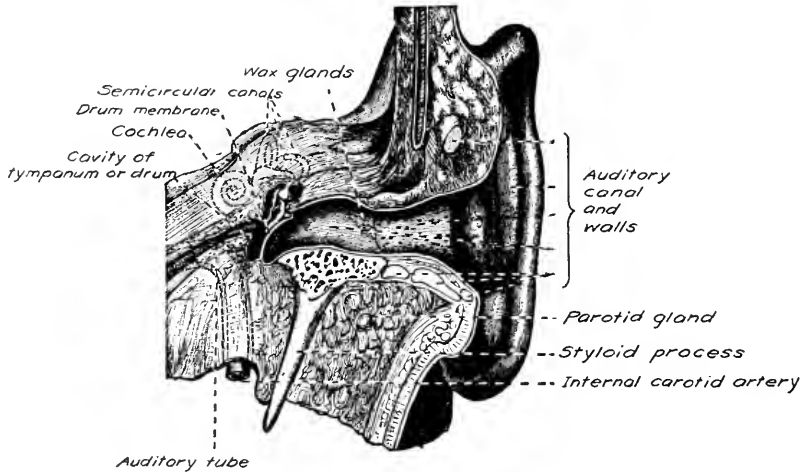

FIG. 254. Diagram of the human ear. (After Morris. Courtesy of P. Blakiston's Son & Co.)

Olfactory Sense.—Olfactory sensations are served by the *nasal mucous membrane* which has end-organs leading to the olfactory nerves. The end organs for the sense of *smell* are limited to the upper part of the nasal cavity. The epithelial layer consists of columnar supporting cells and several layers of nerve cells which are elongated in shape and nucleated. The prolongation of the cell *peripherally* between the columnar cells terminates at the surface in from six to eight hair-like processes while the *central* prolongation continues as a non-medullated nerve fiber to the olfactory lobe where it arborizes in relation to the dendrites of certain "*mitral cells*" whose *axones* transmit impulses by the olfactory fibers.

Static Sense.—The organs of equilibration are the *semicircular canals* of the internal ear.

Gustatory Sense.—The organs of *taste* consist of sensory cells found in the *taste buds* of certain papillae on the tongue. (See page

429.) There are four types of taste: Sweet, sour, salt and bitter. In eating one receives sensations from taste, smell, cutaneous sense and temperature sense. The child prefers sweets while sour and bitter are unpleasant. Children have more taste organs than the adults since some of the taste buds atrophy as age advances. One section of the tongue is wholly *insensitive* to taste. The *anterior* portion of the tongue is *sensitive* to *sweet* substances, the *lateral* portions are *sensitive* to *sour* and *salt*, while the *posterior* portion is extremely sensitive to *bitter* substances.

Kinaesthetic Sense.—Certain kinaesthetic sense organs are contained in the *skeletal muscles, tendons* and *joints* and transmit to the brain knowledge of positions of parts of the body.

Organic Sensations.—Many subconscious sensations concerned with visceral activities are carried to the brain by the aid of organs connected with the digestive, respiratory and circulatory systems. Unusual stimuli may produce thirst, hunger, nausea or suffocation.

Weight of the Brain.—The brain of the average adult human female weighs 44.5 ounces and that of the male 49.75 ounces. Cases have been recorded in which the brain attained a weight of 74.8 ounces, one case being that of an idiot. The weight of the brain of the gorilla is 15 ounces. In the healthy body the relation of the weight of the human brain to that of the body is 1-41.

Transmission of an Impulse.—From a sense organ in the skin an impulse passes to the sensory fiber of a *spinal nerve*, in at the dorsal (posterior) root to the *dorsal horn* of the cord and to a *spinal sensory cell*. Thence it goes up the *dorsal column* to the *sensory cell* of the optic thalamus. From the *optic thalamus* it passes to the *sensory cell* of the *cortex* in the localized area indicated by its original source. Then the impulse to act, beginning at the motor cell of the cortex, passes across to the motor cell of the *corpus striatum* (see Figure 256), thence down the anterior *ventral column* of the spinal cord to a *spinal motor cell* in the *ventral horn*, out at the *ventral root* of the

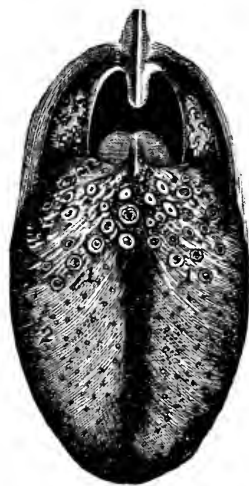

FIG. 255. Upper surface of the tongue. 1, circumvallate papillae; 2, fungiform papillae. (After Brubaker, from Kellogg, *Animals and Man*. Courtesy of Henry Holt & Co.)

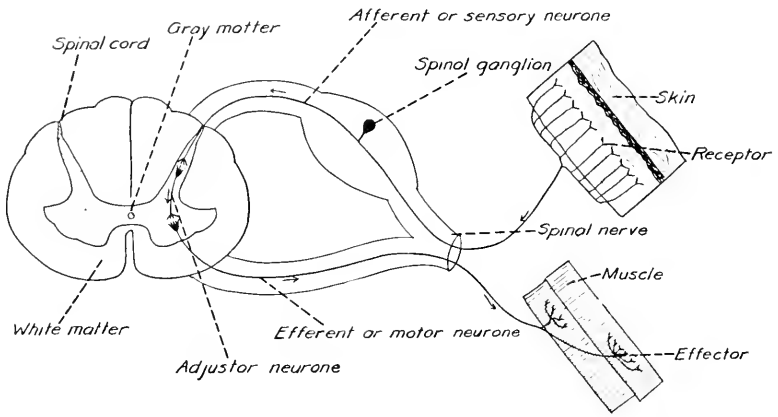

FIG. 256A. Reflex arc. (Drawn by W. J. Moore.)

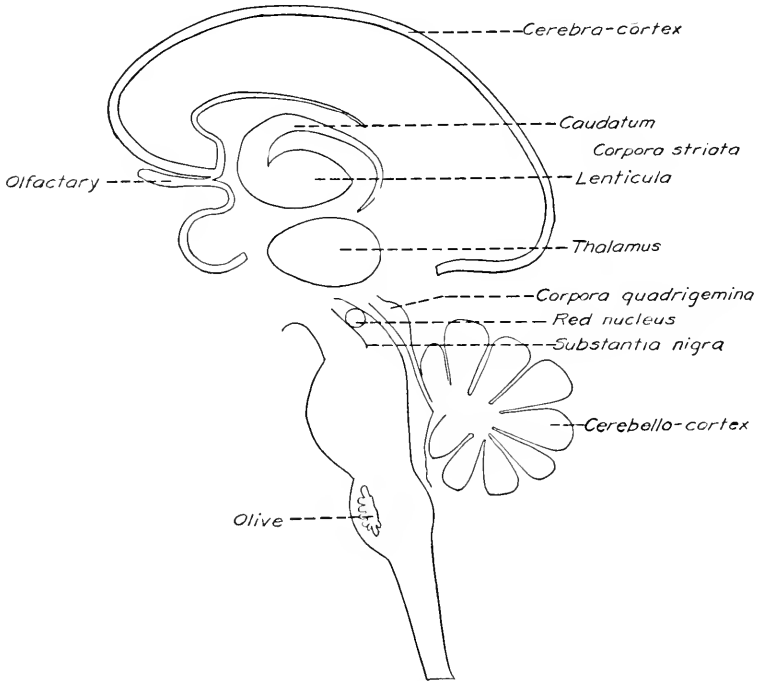

FIG. 256B. Chief ganglionic categories. (After Spitzka.)

cord to a spinal nerve and thence to the proper muscle. As many of the fibers cross to the opposite side, we find that a lesion of the brain on the right side will cause paralysis on the left side of the body.

Reflex Action.—In a simple reflex, we never find as few as two neurones involved. The impression from the sensory cell passes into the spinal cord and from the *spinal sensory cell* across (by two or three intermediate neurones) to the *spinal motor cell*. Thence it passes to the proper muscles. Sensation and reaction are almost immediate and the proper movements have been made without awakening consciousness in the cerebrum until later.

A Triumph of Coördination.—A celebrated pianist has actually been ascertained by Sir James Paget to have played 5,995 notes in four minutes and three seconds. Paget estimated that there were at the rate of 96 transmissions of force from the ends of the nerve fibers along their course to the brain, in each of the same seconds during which there were 72 transmissions going out from the brain along other nerve fibers to the muscles. The notes were played in due time and place, and with the sentiment of the music. (J. A. Med. A.)

Fatigue in the Nerve Cell.—In some important studies made a number of years ago (1892) Hodge demonstrated the effects of fatigue on the nerve cell. He showed that after prolonged stimulation of a nerve fiber its cell body and nucleus tended to shrivel, and degeneration of the cytoplasm became apparent. The whole structure might be compared to a shriveled apple. Later studies by Dolley¹² confirm Hodge's conclusion. There is only slight evidence of increased CO₂ in the *nerve fiber* after stimulation.

Regeneration in the Nervous System.—Since there is no neurilemma in the spinal cord and in the brain there is no complete regeneration. The nerves of the body will readily regenerate, provided the nucleus of the nerve cell is uninjured.

Myelination.—Recently the entire process of **myelination** of nerve fibers¹³ has been seen by Speidel (J. of Exp. Zoöl. in press) in the transparent tail fin of living frog tadpoles. Individual nerve sprouts and sheath cells were watched for long periods (ten days to

¹² Hodge, C. F. 1892. Jour. of Morphol., vol. 7; Jour. of Physiol., 1894, vol. 17. Dolley, D. H. 1917. Jour. Comp. Neurol., vol. 27, pp. 299-324.

¹³ Nerve cells and sheath cells may readily be cultivated in vitro, and the growth of nerve fibers observed, but the formation of the myelin sheath has never been obtained in artificial media.

several months). Primitive sheath cells on the early unmyelinated nerves multiply and migrate to the advancing "myelin-emergent" sprouts and myelin segments are added distally in an orderly manner. Each segment is formed through the combined action of a sheath cell and a myelin-emergent fiber. Myelin of a segment first appears near a sheath cell nucleus and extends progressively in both directions. Unmyelinated gaps between adjacent myelin segments may be filled in later by the intercalation of new segments. End-to-end anastomosis of segments sometimes occurs with complete obliteration of the intervening node of Ranvier. A portion of one segment may be appropriated by another segment, accompanied by the establishment of a new node. (Courtesy of C. C. Speidel.)

Hibernation and Aestivation in Animals.—Certain amphibia, reptiles and mammals are able to go into a sleep when the temperature falls. *Hibernation* is marked by a reduction of all body processes to the minimum. For example, the hibernating dormouse periodically takes a dozen respirations, then ceases breathing for several minutes. Normally, when awake, it respire at the rate of 80 times a minute. A summer resting period, known as *aestivation*, is characteristic of the mudfish (*Protopterus*) and of certain amphibia, reptilia, and a few mammals.

Organs That Man Can Lose.—A leg, an arm, an eye, his tonsils, gonads, spleen, appendix, gall-bladder, part of his lungs, part of his brain, and as much as twelve feet of his intestine may be removed without serious results. Entire lobes of the lungs have been removed, with beneficial results.

Statistics of Vitality.—Muscles of the human heart are alive 2 hours after *normal* heart beat and respiration have ceased. The body muscles are alive 5-6 hours thereafter. Muscles of a rabbit will live $8\frac{1}{2}$ hours after the death of the animal. Those of a sheep survive $10\frac{1}{2}$, those of a dog $11\frac{3}{4}$ and those of a cat $12\frac{1}{2}$, those of a frog 24-30 hours.

Susceptibility of Mammals to Poison.—The porcupine or "hedgehog" takes with apparent enjoyment a dose of *cantharides* that will kill several persons under excruciating pains. In rabbits and dogs, *morphine* causes vomiting and then light sleep, but more depression in the rabbit. The rabbit can take more *morphine* than can a man fifty times the animal's weight. *Morphine* first causes wild excitation in the cat and other Felidae and then depression of

the intelligence. Small doses of *morphine* produce sleep in the goat, horse and ass. *Amygdalin* does not affect dogs, but kills rabbits. An especial degree of tolerance to *atropine* is found in the herbivora. *Atropine* effects pass off in rabbits' hearts sooner than in other animals by the active decomposition of the alkaloid which occurs in their plasma. Rabbits are not susceptible to *belladonna*. Rats' hearts are much less susceptible than rabbits' to *digitalis*. Doses of *lead* and *nicotine* sufficient to kill a man do not injure the goat.

CHAPTER XXI

SOCIAL LIFE OF ANIMALS

ASSOCIATION OF DIFFERENT SPECIES

Living Free.—Free living forms are those that are at liberty to range independently. They feed upon animals, and are then called *carnivorous*, or they feed upon plants, usually destroying them although not necessarily causing their death, and are called *herbivorous*.

Commensalism. (Lat. *com*, together; and *mensa*, table.)—Commensalism as we shall treat it consists in an association for mutual benefit less permanent than symbiosis. Commensalism may be for *protection*, *transportation* or *food*.

The best known example of commensalism is the case of the *hydroid* colony living on the shell of a hermit crab. As the hydroid furnishes the crab with camouflage and protects it from enemies by the use of its stinging cells, it renders some service in return for transportation and for particles of *food* broken up by the crab.

Symbiosis. (Gr. *syn*, together; and *bios*, life.)—The term symbiosis has by some been applied to all intimate associations between organisms (including parasitism); by others to relations between organisms in which benefits are mutual; and by still others to plants living within the body of animals in a presumably beneficial relationship. Until recently, zoölogists considered symbiosis in the broad sense, holding that it refers to *animals* or *plants* living together for *mutual benefit*. It is now applied to relationship between plant and animal; animal and animal; or plant and plant; it always being understood that no parasitism occurs. Lull calls it the *most* intimate association for *mutual benefit*, an extremely close commensalism. We shall consider symbiosis in the latter sense.

Symbiosis may be between a green chlorophyll-bearing *plant* and an animal; between a chlorophyll-bearing plant and a colorless one; or between *two animals*. Bacteria living in the digestive tracts of animals are to be considered as an example of symbiosis since they seem beneficial. Certain ruminants, apes, and South American rodents are able to digest cellulose by means of the *Ophryoscolecidae*,

which are ciliated Protozoa inhabiting their digestive tracts (p. 30).

An example of *animal-animal* symbiosis is the case of termites which live in beneficial relationship with the flagellates, *Trichonympha* and allied genera (p. 29).

Parasitism. (Gr. *para*, beside; *sitos*, food.)—In Biology, *parasitism* is the condition of an organism which obtains its nourishment wholly or in part from the body of another living organism and which usually brings about some modifications in both guest and host. In true parasitism, the bodies of the host and the parasite must be in temporary or permanent contact other than that involved in preying and capturing. The presence of the parasite must *not* be beneficial. *Ectoparasites* may be temporary such as plant lice, caterpillars, mosquitoes, flies and the leech; or permanent, such as bird lice (for the bird), body lice and chigoes (chiggers). *Endo-parasites* include intestinal worms like the tapeworm, hook-worm, and pin-worm; and blood parasites such as the malarial sporozoan and the filarian worms.

The Effects of Parasitism.—1. *On the Parasite.*—Any parasite may undergo some degeneration. In many cases, little remains but the *reproductive apparatus*.

2. *On the Host.*—The host may be very resistant, and by gathering extra food render the parasite harmless; many white blood corpuscles may be assembled and carry away the organisms. The host may enclose the parasite in a cyst; it may develop counter poisons, killing the parasite; or anti-bodies may neutralize the injurious substance formed by the parasite. The host, for some time apparently uninjured, may have its resistance so lowered by the rapid multiplication of the parasites that it will succumb to what ordinarily might be a minor ailment or injury.¹

ASSOCIATION OF THE SAME SPECIES

Colonies.—(1) Certain hydroids have a diverse differentiation of the individuals. Coelenterate polyps are modified for feeding, reproduction and locomotion. (2) The "Portuguese Man of War" has specialized structures for feeding, reproduction and protective and aggressive activities. (3) Sponges have cellular differentiation for protection, ingestion, storage, distribution of food and reproduc-

¹ See Stunkard, H. W. 1929. Parasitism as a biological phenomenon. Sc. Mon., vol. 28, pp. 349-362, April.

tion. Some biologists are disposed to regard the higher organisms as *colonies* of lower forms.

Communities.—(1) Bees have a queen (reproductive), the male drones (reproductive) and the workers which are only short-lived laborers. The chosen queen is fed “bee bread.” (See Sex Determination, page 533.) (2) Termites or “White ants.” The workers are small, blind, wingless, pale in color and sexually immature but with strong jaws. The “soldiers” are blind, wingless, immature but have highly developed *scissors-shaped* jaws and an enlarged head, both heavily chitinized and darker in color than the rest of the body. The complementary females and males are blind, wingless, and not completely mature, but may develop to supplement in the production of young if the true sexed individuals are not sufficient. The true or chief females and males are darker in color than the other castes, winged and with well-developed visual organs. They live above ground; the others are either subterranean or with covered tunnels. (3) *True ants* consist of *winged males and females, workers and soldiers*. We find that there is a social evolution in ants as in man. (Wheeler.) *Foraging* or *marauding* ants, like *Eciton*, have officers and scouts. *Slave-holding* ants, like *Polyergus*, have become unable to dig, care for their young, or store up food without *slaves*. The *herding ants* live in beneficial association, keeping aphids for their milk, “honey dew.” The harvester ants store up grains and seeds. The thief ants (*Solenopsis molesta*) feed on the larvae and pupae of larger ants, escaping into burrows too small for the avengers to follow. The *commensal* ants include *Leptothorax emersoni* which secure food and shelter from *Myrmicae brevinoides* and in return act as barbers and manicures, probably removing parasites and keeping their benefactors more healthy. (Wheeler.)

Gregariousness.—Herds of buffalo, packs of wolves and schools of whales collect for protection and food. In sheep, a leader or sentinel is characteristic of such groups. The same is true in many other animals. Pallas states that the saiga antelopes of Siberia *change* sentinels. In the wild reindeer, females act as sentinels and are also said to *change places* when wearied by standing.

When cattle or even sheep are attacked in the wilds, they form a circle with the males and the most powerful females directing their horns outward, while weaker females and the young are huddled in the center. Man is sometimes less concerned for the welfare of his own.

Men are not sheep, but they have two of the dominating characteristics of sheep. They are gregarious and they are easily frightened.

—Ramsay MacDonald.

Polygyny (many wives), and **Polyandry** (many husbands).—In the ostrich of South America the cock bird lives with five or six hens (*polygyny*). All the hens lay their eggs in one nest, but incubation is done by the male alone, and after hatching, the young chicks follow the father. Each female cowbird mates with several males (*polyandry*). The female deposits her eggs in the nest of another smaller species. (See p. 349.)

Cases in Which the Sexes Live Apart.—In the case of many antelopes the herds divide according to sex between one pairing time and another. After the pairing season is over, wild sheep and other ungulates live in herds composed of one sex only. In Indian and African elephants the sexes form herds of their own, herds of females being accompanied by their young and led by a female. At breeding time a male temporarily takes possession of a herd of females. Migrating salmon travel separately, shoals of males appearing first, followed later by the females. The same is true with the salt-water minnow (*Fundulus heteroclitus*).

Societies Composed of Different Species.—Different species of dolphins form groups led by one individual. Wild zebras, asses, yaks, and horses are sometimes seen together, while wild buffaloes associate with elephants.

Monogamy.—All species of parrots are monogamous, while rose-colored starlings, sparrows, house pigeons and mallards are monogamous, but nest gregariously. In the weaver bird two couples often share a common nest in which both the hen birds lay their eggs and hatch them out.

Seasonal Mateships.—Seasonal mating occurs in a number of beetles, the couples living in associations, not societies. Lions choose a fresh mate at each pairing time while in some marten species the two sexes live together until after the young have been reared. Foxes live monogamously and the father brings food to the young. Wolves, foxes, and bears live mated for a short time.

Types of Families. (1) **Parent Families.**—In the wood-boring beetles, the parents feed the larvae and watch over the chrysalis. Both the male and the female of certain species of fishes guard the nest, the hatched young returning to the nest every evening for two

or three weeks. **Parasitic egg-laying.** A South American duck (*Metopiana*) lays its eggs in the nests of other birds such as the coot and sea-gull, while the *European cuckoo* lays her eggs in the nests of other birds. The American cowbird has the same habit of seeking foster parents for her offspring. (See Friedmann, H. 1929. The Cowbird. C. C. Thomas Pub.)

(2) **Father Families.**—The male obstetric frog (*Alytes obstetricans*) carries the eggs with him in a long string wound around his hind legs until the larvae emerge. The male *Rhinoderma* carries the eggs in his gular vocal sac until the metamorphosis of the young is complete. In some species of frogs the tadpoles are carried on the back of the male.

The male stickle-back fish builds a nest and entices several females to deposit their eggs in it. Eggs and young are guarded by the father. In a number of fish species the male seizes in its mouth young that have strayed away and brings them back to the nest. It is said that the male *Amia* (the bow fin) leads its family of young for four months.²

(3) **Mother Families.**—The females of some species of leeches carry their offspring about, the young attaching themselves to the body of the mother with their suckers and always returning to her. The female earwig (*Forficula*) guards her eggs and young in a hole which she digs herself, collecting them together if they get scattered. The female mole cricket digs a hole for the eggs and guards them, but turns *cannibal* occasionally.

In crayfish and spiders the mother carries eggs and young around with her. Female scorpions carry young on their backs. In a number of species of fish the females lead their young for some time after hatching. In some species of *Chichlidae* the female carries the eggs in a pocket on the back and the female *Pipa* (a toad) carries its young in pouches of skin on its back until metamorphosis has occurred.

Female crocodilia watch over the eggs, ^{and when the young} open them by means of a well-developed egg tooth, and lead the young to the water. Mother families are the rule among birds. Mother families are found in the cat family, in foxes, polar bears, and seals.

(4) **Child Families.**—Certain processionary caterpillars (*Thaumtopaea*), emerging from the same mass of eggs, remain together

² Consult Gill, Theodore. 1905. Parental Care Among Fresh Water Fishes. Smithsonian Rep., pp. 403-531.

permanently. Herring of the same spawning form schools which remain together permanently.

REFERENCES ON ANIMAL RELATIONSHIPS

- ALVERDES, F. 1927. *Social Life in the Animal World*. Harcourt, Brace & Co., Inc., New York.
- BORRADAILE, L. A. *The Animal and its Environment*. Henry Frowde and Hodder and Stoughton.
- CLEVELAND, L. R. 1926. Symbiosis among animals with special reference to termites and their intestinal flagellates. *Qu. Rev. of Biol.*, vol. 1, no. 1, pp. 51-60.
- DÖFLEIN, F. 1914. *Das Tier als Glied des Naturganzen*, from R. Hesse and F. Döflein, *Tierbau und Tierleben*, Bd. 2. Leipzig and Berlin.
- ELTON, C. 1927. *Animal Ecology*. Macmillan Co., New York.

PROTECTION

Masking.—The caddis fly lives in a sand case. Certain crabs cut off the tunic of a sea squirt and drape it over their carapace. Others plant sea weed on their backs.

Flounders cover themselves with sand while the toad puffer or swell fish distends its body with air and escapes many enemies. Other fishes cover themselves with sea weed.

Color Resemblance.—Temporary alternations of color are due to the amount of dilation of chromatophores. In the cuttle fish and the squid we find that blushing occurs if they are irritated, but they return to normal pale color shortly.

Fishes, such as the flounder and the minnows, are able to adapt themselves to the background. If they are blinded, color change is impossible. Frogs, toads and chameleons are able to alter their pigment (*melanophores*) to suit the background, although Ditmars holds that the chameleon is not immediately successful.

Partridges and ptarmigans change their pigment to suit the background. The arctic hare changes from brown to white when winter comes. In the mammals we find that change in color depends on the oxidation of melanin pigment.

Some animals with a brilliant hue are bad tasting. The excreted material makes the color bright. The skunk is an example of a brightly colored form which has a distinctly obnoxious odor.

Thayer, Poulton and others have emphasized the influence of coloration on the survival of many animals. Except in the arctic

regions we find that the body is *darker* on the parts ordinarily illuminated by the sun and sky, while the most shaded parts are usually *lighter* in color.³ In the tiger and the zebra the colors are broken by lines and the animal blends with its background. During the World War, battleships were wonderfully camouflaged by lines and patches of alternating light and dark color.

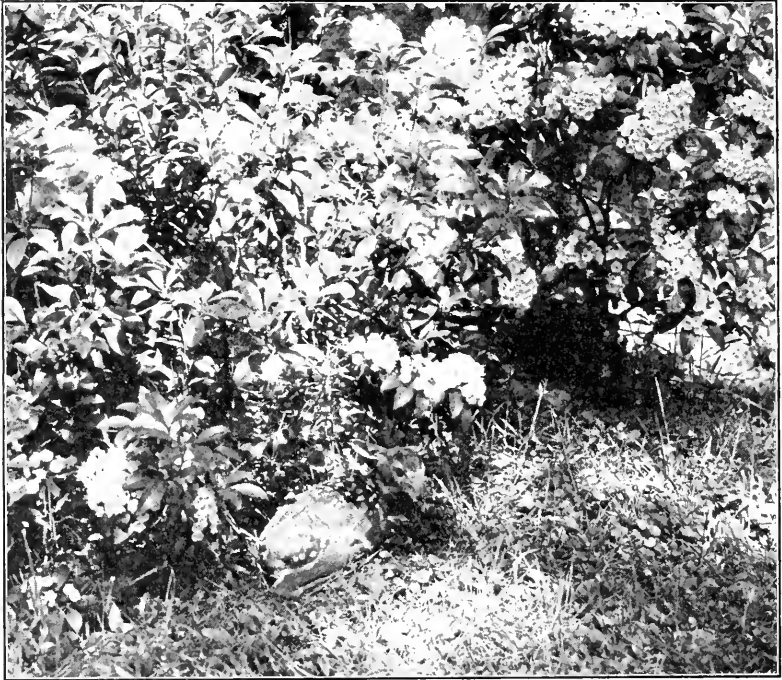

FIG. 257. Young fawn in mountain laurel, Monongahela National Forest, W. Va. (Photo courtesy of U. S. Forest Service.)

Thayer has pointed out that even in the case of some animals that are quite conspicuous to *man* and seem to stand out against the sky, we must remember that the chief enemies of the forms under consideration are not tall animals. He once convinced a group of zoölogists at Woods Hole, Mass., in a striking manner, by having them crawl around in the grass, gazing up at life-size card-board figures of deer.

³ Wild cats are striped on the ventral side and hence almost invisible in the trees (W. R. B. Robertson).

Mimicry. (Protective Resemblance.)—Some butterflies resemble a leaf, certain beetles mimic the wasp, certain harmless flies mimic bees and are preserved from destruction by birds. The walking stick insect resembles twigs. Some harmless snakes resemble in markings venomous forms such as the coral snake. (See Fig. 176.)

REFERENCES ON ANIMAL COLORATION

- BEDDARD, F. E. 1892. Animal Coloration.
 POULTON, E. B. 1890. Colors of Animals.
 ROOSEVELT, T. African Game Trails.
 THAYER, A. H. 1909. Concealing Coloration in the Animal Kingdom.

GEOGRAPHICAL DISTRIBUTION

A similar environment does not always explain the appearance of like forms. If we are to accept the theory that all forms are derived from a common ancestor, we can readily explain some of the following facts:

(a) The llamas of South America have as their nearest living relatives the camels living in the deserts of Asia. In Oregon one finds fossil llamas. (b) The Australian kangaroo has no relatives nearer than the opossum. Neither is found in its native home, which was Europe. How did they reach South America and Australia? (c) The plants of Madagascar are not related to those of Europe while both plants and animals of North America and Eastern Asia are similar. Why?

Explanation.—Present barriers have not always existed, and land connections that once joined continents have disappeared, separating closely related forms. Climatic changes have also produced cataclysmic effects.

Dispersal of Small Forms.—In the case of smaller forms, we find that dispersal is effected quite readily. Protozoa and the eggs and larvae of numerous worms and Rotifers are transported by birds and other animals, as well as attached to wind-blown or floating debris. It is well known that the glochidia of fresh water mussels are carried long distances attached to the gills and fins of fishes.

Again, driftwood bears strange companions to far distant islands. Beebe on his Arcturus voyage counted on one floating log 54 species of marine crabs, worms and fishes.

Barriers.—(1) The *salt* of the sea proves a barrier to fresh water animals. Amphibia are almost never found in salt water. It has been found that the salinity of water determines the species of salt marsh mosquitoes in a given region, while the P_{H_2O} of the water is apparently important in determining the distribution of Arthropod species and of fishes. Sometimes species changes occur as in the brine shrimp, *Artemia*, which alters its characteristics in fresh water (p. 170).

(2) Elton quotes various authors who have shown that *water supply* is an important limiting factor in determining the ranges of wild birds and mammals. In the Burmese forests the occurrence of elephants, buffalos, tigers, panthers, pigs and monkeys is determined in dry season by the proximity of water-holes. In the case of rooting and digging animals, such as pigs and moles, distribution is determined by softness of the ground which of course depends on the water supply. In Mesopotamia the black partridge (*Franco-linus vulgaris*) is never found more than a hundred yards from water, which it requires for drinking purposes.

(3) *Depth of water* proves an effective barrier. Certain of the shore fishes of Hawaii are not found in the waters of California.

(4) *Temperature* proves most powerful in preventing the dispersal of many animals and plants. Some animals are found in hot springs or in the Arctic ice, however.

Dr. Nellie Payne has given us important information on the survival of insects at low temperatures. Consult Payne, N. M., 1926 (Freezing and Survival of Insects at Low Temperatures, Quart. Rev. of Biol., vol. 1, pp. 270-282). Brues, C. T. (Animal Life in Hot Springs, Qu. Rev. of Biol., vol. 2, no. 2, pp. 181-203, June, 1927), has summarized the literature and shown that *Ameba limax* was found in water at 50° to 52° C. (112°-126° F.), while Ciliates were found in water at 46° C. (115° F.). The crustacean *Cyclops* was found in water at 36° C. and turtles appeared in water at 44° C. (111° F.). Gudger, E. W. (Snow Worms, Nat. Hist., vol. 23, no. 5, pp. 450-456, 1923), cites cases of *Enchytraeid* worms and other annelids besides insect larvae occurring in snow and ice.

(5) *Mountain ranges*, with the factors of temperature and amount of oxygen available, prove most effective barriers to many forms. Thus, in some cases, individuals have been unable to reach new regions because of barriers; in other instances they reach the new field but are unable to survive because of lack of adaptation and

extreme competition. In the "Struggle for Existence" they perish.

(6) Winds also prevent some dispersal of certain insects as in the case of the heavy trade winds. (N. A. Cobb.)

DOMESTICATION OF ANIMALS

Cat.—The *house cats* are derived from a single wild species, the dun wild cat, *Felis maniculata* of Northeast Africa. There are now about 30 races of domesticated cats, grouped into two main classes, the long haired and the short haired. The Mexican hairless cat and the tailless Manx cat are interesting *mutations*. (See p. 524.)

Horse.—The horses of today have been traced to two wild ancestors, *Equus przewalski* of Northern Asia, from which have been derived the Oriental, the Arabian, the Mongolian, the North African and the Eastern European races; the *Equus caballus fossilis* of Europe, from which have sprung the German, Norman, English and West European horses. In South America and in Europe, the bones of human beings have been found with those of horses. In Europe, prehistoric horses are associated with human relics of the Bronze Age. The New World type, *Eohippus*, has been found in the Wasatch Mts. of Western North America, in the Eocene period. It was about the size of a fox with four toes and a fifth digitary splint on each hind foot. In the middle Eocene, *Orohippus* was about 14 inches high, with four toes on its front feet and 3 toes, but no splints, on the hind feet. In the Oligocene period, *Mesohippus*, about the size of a dog or coyote, had three toes on all its feet. In the middle Miocene, *Protohippus* was the size of a Shetland pony, with one long toe and two short ones on each foot. In the Pleistocene, *Equus* appeared with only one developed toe and splints of the second and fourth on each foot. Remains of the Old World type, *Hyracotherium*, have been found in the London clay and the Eocene formations of Europe.

Donkeys have been derived from two wild species, the Nubian desert donkey, *Equus taeniopus*, and the *onager*, *Equus onager*, of Eastern Asia. The *Asiatic wild ass* is exceptionally fleet. There are today three varieties, the largest, called the *kiang*, found in Thibet and up to the snow line. The second, the *ghorkkar* or *onager*, found in the plains of Afghanistan, is smaller and silvery white. The third variety, found in Persia and Syria, is the one described in the Bible. The *African ass* is found throughout Northeastern Africa.

It ranges westward on the deserts and is exceedingly speedy.

Dog.—The dog is supposed to be the oldest domesticated animal. From the savage Australian Bushman to the cultivated people of the world's greatest cities, we find that the dog is a companion and servant. He seems happiest in caring for the possessions and person of his master and will follow and protect the drunken sot or the filthy beggar.

There are about 200 breeds of dogs, 50 breeds being sporting dogs. Theories of the origin of the dog place his ancestry as from the wolf or a jackal-wolf hybrid, although there are seven wild species which may have been contributory. The reputed ancestors include the jackal of Western Asia, the jackal-wolf of northeast Africa, the landga of India, the walgie of Thibet, and the coyote and gray wolf, both of America. Fossils of the American dog are found in the Southern Appalachian Mountains near the Cumberland Gap in Eastern Tennessee.



COLLIE. (Photo by courtesy of James B. Vallyly.)

SENATOR VEST'S EULOGY ON THE DOG

"Gentlemen of the Jury: The best friend a man has in this world may turn against him and become his enemy. His son and daughter that he has reared with loving care may become ungrateful. Those who are nearest and dearest to us, those whom we trust with our happiness and our good name, may become traitors to their faith. The money that a man has he may lose. It flies away from him when he may need it most. Man's reputation may be sacrificed in a moment of ill considered action. The people who are prone to fall on their knees and do us honor when success is with us may be the first to throw the stone of malice when failure settles its cloud upon our heads. The one absolutely unselfish friend a man may have in this selfish world, the one that never deserts him, the one that never proves ungrateful or treacherous, is the dog.

"Gentlemen of the Jury: A man's dog stands by him in prosperity and poverty, in health and in sickness. He will sleep on the cold ground, when the wintry winds blow and the snow drives fiercely, if only he may be near his master's side. He will kiss the hand that has no food to offer, he will lick the wounds and sores that come in encounter with the roughness of the world. He guards the sleep of his pauper master as if he were a prince.

"When all other friends desert, he remains. When riches take wings and reputation falls to pieces he is as constant in his love as the sun in its journey through the heavens. If fortune drives the master forth an outcast into the world, friendless and homeless, the faithful dog asks no higher privilege than that of accompanying him, to guard him against danger, to fight against his enemies, and when the last scene of all comes and death takes his master in its embrace and his body is laid away in the cold ground, no matter if all other friends pursue their way, there by his graveside will the noble dog be found, his head between his paws and his eyes sad, but open in alert watchfulness, faithful and true even to death."⁴

⁴ The dog that called forth this tribute to canine affection and fidelity was Drum, a foxhound, owned in Johnson County, Missouri. He was shot by a man who was later sued for damages by Drum's owner. Learned counsel were engaged by both sides and the case was finally tried before a jury in the State Circuit Court, in 1870. The late U. S. Senator George G. Vest made the closing plea for the plaintiff, the peroration of which is printed above. Court, lawyers and audience were entranced by it. Heavy damages were awarded the plaintiff, and Vest's Eulogy on the Dog stands as the most eloquent and touching tribute ever paid to man's faithful friend. Courtesy of American Humane Education Society, Boston.

Pigs.—Our modern hogs are descended from two wild races, the European Wild Boar, *Sus scrofa*, and the species *Sus vittatus*, found in Eastern Asia. From the Asiatic form have descended most of the European races. The Chinese domesticated the hog centuries ago.

Cattle.—Present races of cattle have descended from two sources, the wild *banteng*, *Bos sondaicus*, of South Asia, from which have come the *zebus*, the Egyptian *loughorns* and the Spanish and Alpine cattle of Europe; and the European wild ox, *Bos primigenius*, from which have come the English, North German and Holland cattle. The latter form, sometimes called the Aurochs, reached a height of 7 feet at the withers. It had horns 6 feet in length, one of which held three quarts of wine. In India there now live four species of wild oxen closely related to the aurochs.

Goats are descended from three wild races, *Capra aegagrus*, of Western Asia, *Capra falconeri*, and *Capra jemlaica*, of the Himalaya Mountains.

Sheep originated from three wild sources, *Ovis musimon* of South Europe, *Ovis tragelaphus* of North Africa and *Ovis arkal* of Western Asia. The last named form was the ancestor of our American races. The species best known is the *Mouflon* which is still hunted in the mountains of Corsica and Sardinia. Early Assyrian drawings show fat-tailed domesticated sheep. In the Himalayas, one finds the great *guljar* or Marco Polo's sheep which ranges 18,000 feet above the sea in the summer. Old rams are almost white with circling horns, five feet on the outside curve.

Rabbits.—There are over 70 species of rabbits, and the 15 races of *domesticated* rabbits originated from wild species found in Spain and Southern France. The original European wild rabbit was grayish brown.

Pigeons.—All the domestic pigeons descended from a single wild species, *Columba livia*, the common *rock dove*, found in Europe, Asia and Northern Africa. The Romans were pigeon fanciers 3,000 years ago. Homing pigeons were used by the crusaders who sent messages back from the wars.

Fowls.—Modern races of chickens are supposed by naturalists to be descended from the jungle fowl, *Gallus bankiva*, which is found through most of the islands adjacent to India. The heavier breeds are probably descended from the Malayan fowl called the Aseel.

Ducks.—The wild duck, *Anas boschos*, the ancestor of our domestic species, is found both in China and in Europe.

Geese are the oldest birds tamed by man. The ancestor of our races is *Anas cinereus*. The early Egyptians tamed the Nile goose, *Chenalopex egyptiaca*.

Peacocks.—Domesticated peacocks have descended from the wild Indian species, *Pavo cristatus*.

Turkeys have descended from two wild North American species, *Meleagris gallopavo* and a Mexican variety. We now have four wild sub-varieties. (Robertson.)

TISSUE SURVIVAL OUTSIDE THE BODY

The pioneer in tissue culture, Dr. R. G. Harrison of Yale, showed many years ago that fragments of frog embryos isolated from the organism would develop for a number of days. His classic experiment on the development of *neuroblasts* in a hanging drop paved the way for much important experimentation. Montrose Burrows was another important figure in the development of the technique of tissue culture.

Dr. Alexis Carrel, of the Rockefeller Institute, started the cultivation of minute fragments from the *heart* of a chick embryo on January 17, 1912.⁵ Since that time he and his associates have carefully subdivided the culture, washed it in Ringer's solution and cultivated it again in a medium composed of diluted plasma. Carrel states that if the tissues had been able to survive for 16 years without trimming or hindrance, the mass would now be greater than that of the solar system. He emphasizes the fact, however, that cells massed together as a closed system must necessarily undergo the process of aging.

The immortality of protozoa (see page 33) is due to their ability to eliminate products of metabolism directly into the outside world.

Carrel mentions the property of cell proliferation found in *iris* epithelium and *thyroid* epithelium, which have been cultured at the Rockefeller Institute for several years.

⁵ Carrel, A. 1924. Tissue culture and cell physiology. *Physiol. Rev.*, vol. 4, no. 1, pp. 1-20.

Fischer, A. 1925. *Tissue Culture*. Wm. Heinemann, London.

Sundwall, J. 1912. Tissue Proliferation in Plasma Medium. *Bull.* no. 81, Hygienic Laboratory, U. S. P. H. S.

Willmer, E. N. 1928. Tissue culture from the standpoint of general physiology. *Biol. Rev.*, vol. 3, no. 4, pp. 271-302.

E. N. Hoppe, 1928 (Tissue Culture of Guinea Pig Cardiac Muscle, Arch. Zellforsch., vol. 7, p. 352), devised a very simple technique for the continuous cultivation of normal tissue of mammals without the introduction of foreign plasma or other substances. It is uncomplicated enough to use as a *routine* experimental procedure. The author has used it to study the action of toxins on tissues.

Its superiority over the ordinary technique of tissue cultures lies in the fact that *homologous* plasma is used. In ordinary tissue

TABLE OF LONGEVITY

Longevity of Mammals

<i>Animal</i>	<i>Reputed Age</i>
Elephant	30 to 80
Horse family	15 to 40
Rhinoceros	37
Hippopotamus	35
Cattle	30
Dogs	30
Lions, tigers	25
Cats	23
Giraffe	20
Sea lions	18
Llama	17
Tropical fruit bat	17
Badger	14
Hare and rabbit	10
Mice and rats	5

Consult P. C. Mitchell, On longevity and relative viability in mammals and birds. Proc. Zoöl. Soc. of London, 1911, pp. 425-548, for a more accurate report on mammals and birds in captivity. He records data on over 20,000 species.

Longevity of Birds

<i>Animal</i>	<i>Reputed Age</i>
Parrot	100
Swan	70
Eagle, owl	68
Golden eagle	60
Pelican	52
Duck	50
Goose	33
Fowl	20
Canary	20

Longevity of Reptiles

<i>Animal</i>	<i>Reputed Age</i>
Giant tortoise.....	100
Indian crocodile.....	100
American alligator.....	40
Boa constrictor.....	23
Sphenodon, lizard.....	14
Chameleon.....	4

Consult S. S. Flower, Contributions to Our Knowledge of the Duration of Life in Vertebrate Animals. III. Reptiles. IV. Birds. Proc. Zool. Soc. of London, 1925, p. 911 and p. 1365.

Longevity of Amphibia

<i>Animal</i>	<i>Reputed Age</i>
Frog.....	12 years
Toad.....	36 years

Longevity of Fishes

Eel.....	60 years (in Roman ponds)
----------	---------------------------

Longevity of Arthropods

River crayfish.....	20 years
Ant.....	15 years
Spider (tarantula).....	15 years
Beetle.....	5 years
Queen bee.....	5 years
Worker bees.....	6 to 8 weeks

Longevity of Annelida

Leech.....	27 years
------------	----------

Longevity of Coelenterata

Sea anemone.....	59 years—recorded
------------------	-------------------

The Passerine birds are extremely short lived, most of them not exceeding 5 years in captivity.

culture work, bird plasma is added because it lacks the *blood platelets* and therefore does not clot so quickly. (See page 457.)

At the spring meetings of the American Association of Anatomists in 1929, Dr. W. H. Lewis demonstrated moving pictures of rabbit ova developing in autoserum. The fertilized eggs were removed from the uteri at 21 to 71 hours and kept in autoserum, sometimes augmented by embryonic juice.

PULSE FREQUENCY

That there is a quite definite correlation between longevity and rate of pulse beat was strikingly manifested to the writer on comparing his tables with the records furnished in Clark's studies on the physiology of the heart.⁶ The rodents with a life span of from 5 to 10 years range in pulse frequency from 200 to 520 pulse beats a minute. On the other hand the cat, known to live 23 years, has a pulse rate averaging about 200, while the dog, with a life span of 30 years, has a pulse rate of from 105 to 125 per minute. In birds the canary and the goldfinch, with a longevity of about 20 years, prove to have a pulse rate of about 1,000 per minute, but ducks and geese, with a longevity of 30 to 50 years, have a pulse beat of but 150 to 300. In the cold-blooded animals, the pulse rate is much reduced, but a correlation exists as seen in the crocodile which is said to live 100 years, and which has a pulse rate of from 22 to 47 a minute.

Reading this section in galley proof, O. C. Glaser stated that such a relationship appears to be in harmony with the results obtained by himself (1931) on the relation between heart beat and age in fishes, birds, and mammals.

⁶ Clark, A. J. 1927. *Comparative Physiology of the Heart*. Macmillan Co., N. Y.

CHAPTER XXII

EVOLUTION, HEREDITY, EUGENICS

BIOLOGISTS recognize the existence of two factors responsible for the characteristics of living organisms. These are *heredity* and *environment*.

Heredity includes what is handed on from parent to offspring. Sir Ray Lankester says: "Our body cells are merely a husk to protect the germ cells until they are set free to multiply and to start a new individual or husk enclosing in its turn a certain number of cells of the initial germplasm."

Environment, beginning before birth and continuing until death, includes all physical and chemical forces, acting from without on the germ, embryo, larva, and adult. Profound changes are induced before puberty, and for that matter all through life, as food-stuffs, temperature, oxygen and other factors stimulate or retard the glands of the body regulating growth and metabolism.

The development of civilization is said to be dependent upon six factors: geographic or climatic conditions, race characteristics, food, social heredity, physical heredity and health. Studies made by the Army and by the United States Public Health Service indicate that not more than fifty per cent of our population are physically fit. It has been demonstrated repeatedly that with improved conditions of health, vice and crime diminish, civilization advances and the whole standard of living improves to the point where past luxuries become the every day equipment of a family.

Germplasm and Somatoplasm.—For centuries observers have been impressed by the resemblance which children bear to their parents. There seems to be a transmission which is certain but which appears to obey no law, apparently affecting insignificant details and transmitting them with striking fidelity.

Careful study of the body of an organism shows that there are two kinds of cells, the *body cells* and the *germ cells*. The body or *somatic* cells are those that differentiate to form the tissues of the body. The *germ cells* are those which are destined to give rise later to an independent organism. Both male and female germ cells

arise from primordial cells. Early in embryonic development it is difficult to tell whether these cells are to form male or female gonads.

Cell Division.—The multiplication of cells by the process of cell division continues after maturity, and in most cases throughout life. *Cell division* consists of direct division or *amitosis* and, most commonly, of indirect division or *mitosis*.

Direct Cell Division—Amitosis.—In this form the nucleus divides into two daughter nuclei without any apparent preliminary change in its structure. The division of the nucleus may or may not be followed by division of the cell body.

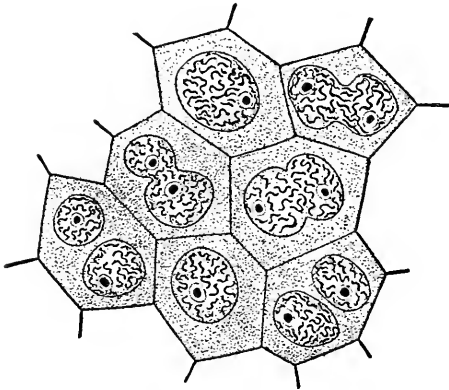

FIG. 258. Epithelial cells from ovary of cockroach. (From Bailey's *Histology*. Courtesy of William Wood & Co.)

Amitosis is found in the epithelium of the bladder, and in the placenta. It is apparently normal in, although not exclusively characteristic of cartilage, tendon and bone-marrow. Some hold that it is a sign of degeneration, while others believe it to be a sign of rejuvenation.

In Protozoa (page 42) it regularly occurs, as does mitosis also, but in the germ cells and in early embryonic cells division is indirect, e.g. by *mitosis*.

Indirect Cell Division—Mitosis.—In this form of cell division the nucleus gives rise to two daughter nuclei, but only after the chromatin content has undergone certain characteristic changes.

I. Prophase: (a) As the cell prepares for division there is a transformation of the *nuclear substance* involving both physical and chemical changes. The chromatin loses its net-like arrangement, increases in staining power and eventually forms a definite number of *chromosomes* characteristic of the species.

At first the chromatin is transformed into a convoluted, closely coiled thread, the skein or *spireme*. In many species a longitudinal split in the chromosomes becomes apparent at this time. The closed *skein* gradually opens, the nuclear membrane disappears, and the nucleoli are merged in the skein. In some forms the chromo-

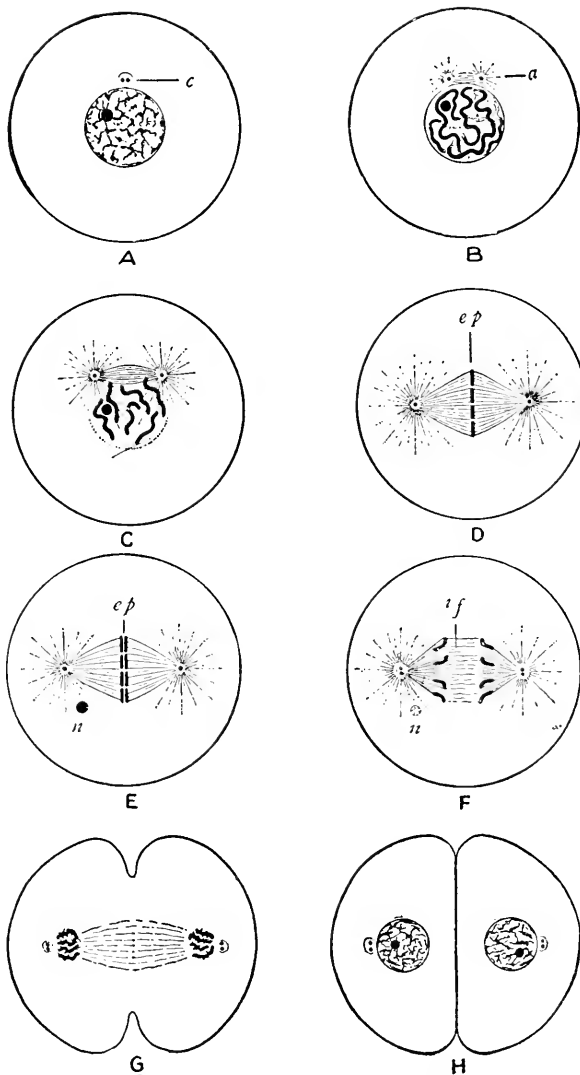

FIG. 259. Mitosis. *A*, resting cell with nucleus and true nucleolus; *c*, attraction sphere with two centrosomes. *B*, early prophase. Spireme formed; nucleolus still present; two centrosomes connected by fibers of achromatic spindle to form amphiaster. *C*, later prophase. Spireme segmented to form chromosomes; achromatic spindle; polar rays; nuclear membrane fading. *D*, end of prophase. Monaster, with mitotic figure complete; chromosomes aggregated at equator of nucleus; centrosomes connected by fibrils of achromatic spindle. *E*, metaphase. Longitudinal cleavage; splitting of chromosomes to form daughter chromosomes, *ep*; *n*, cast-off nucleolus. *F*, anaphase. Daughter chromosomes passing along fibrils of achromatic spindle toward centrosomes; division of centrosomes; *if*, interzonal fibres or central spindle. *G*, late anaphase. Formation of diaster; beginning division of cell body. *H*, telophase. Reappearance of nuclear membrane and nucleolus; two complete daughter cells, each containing a resting nucleus. (From Wilson, *The Cell*. Courtesy of The Macmillan Co.)

somes develop from the nuclear reticulum without the formation of a *spireme*.

The *centrosomes* move apart and about each centrosphere appears a group of radiating lines called the *aster*. Between the centrospheres other lines form the spindle. The spindle and asters, staining lightly, are called the achromatic figure, or *amphiaster*.

The chromatin thread (*spireme*) breaks into segments called *chromosomes*, which group themselves in the equator of the spindle, forming the chromatic figure called the *equatorial plate*.¹

II. Metaphase.—The chromosomes which have split lengthwise now separate into two exactly similar groups. As we shall see later this *equal* distribution of chromatin has great significance.

III. Anaphase.—As the chromosomes divide, the daughter chromosomes draw apart and diverge in two groups to opposite poles of the spindle. The two masses are connected by a bundle of achromatic fibers, called *interzonal connecting fibers*. In the later anaphase stages, the cell membrane shows signs of the constriction which will later produce two daughter cells.

IV. Telophase.—The entire cell divides into two by a *plane* passing through the equator of the spindle. This is often indicated before division takes place by a peculiar modification of the cytoplasm in the equatorial plane outside the spindle.

Each daughter cell receives a group of chromosomes, half of the spindle, and one aster with its centrosome. The daughter chromosomes become thickened, and form a daughter spireme, similar to that of the mother nucleus.

Then the prophases are to some extent retraced, in inverse order, the chromosomes returning from the spireme to a chromatic network. The astral rays disappear, and the nuclear membrane returns.²

¹ Heilbrunn, studying the *viscosity* of protoplasm in the eggs of echinoderms annelids and molluscs during mitosis, found two maxima of increase, one in the prophase and a second just prior to cleavage. Chambers, using the micro-dissection needle, found also that the viscosity of the aster decreases from the center towards the periphery. (Consult L. V. Heilbrunn, *The Colloid Chemistry of Protoplasm*. Protoplasma Monographien, Geb. Borntraeger, Berlin, 1928, and *The Viscosity of Protoplasm*. Quar. Rev. of Biol., vol. 2, pp. 230-248, 1927.)

² In the sea urchin, 7 successive divisions, giving rise to 128 cells, may occur in 3 hours. During the life of an individual, dividing cells are to be found at all times. Jolly reported that in the salamander, the prophases took 50 minutes, the metaphase but 4 minutes, the anaphase 48 minutes, and that reconstruction took but 39 minutes.

Gametogenesis (*gametes*, spouse; and *genesis*, root or origin).—The essential organs for reproduction are the ovaries and the testes. In the *ovary* are formed the *ova*, or eggs, and in the *testes* are formed microscopic elements called *spermatozoa*. Except in a few of the lower animals, the development of an ovum into a new individual is made possible only by its fertilization by a spermatozoön. (See page 506.)

Prior to the process of fertilization there are certain preparatory changes which have an important bearing on the condition of the mature eggs and sperms. During these preliminary changes, we find a series of *mitoses* (see page 500) accompanied by a rather striking method of *reduction* in the number of *chromosomes* such that only one-half the original number is present in egg and sperm when fertilization takes place. In the body cells and the early germ cells, the chromosomes occur in duplicate series, one member of each series being derived from the male and the other from the female parent. The gametes (mature germ cells) each contain a single (*haploid*) group, while the fertilized egg (*zygote*) contains a *diploid* group.

Since the chromosomes are the only structures known to be contributed equally by the two parents and since offspring inherit equally from both parents, except in regard to *sex* and *sex-linked characters* (see page 535), the chromosomes are believed by most biologists to be the bearers of the hereditary *determiners* or *genes*. (See page 538.) Correlated with this view is the belief that each chromosome maintains its individuality through the various phases of mitosis. Evidently, then, the number of chromosomes would be doubled at each fertilization without some mechanism for keeping it constant.

Fogg (Jour. Morphol., 1930, vol. 50) has a new and striking conception of chromatin diminution quite at variance with the texts and monographs now extant. He holds that the diminution of chromatin is not directly concerned with genetic variations, and plays no primary essential part in differentiating the germ line from the somatic.

In *Ephestia*, Fogg shows that it is clearly non-genic. It is to be considered rather as the casting out of residual material sooner or later in the mitotic stages.

Spermatogenesis (formation of spermatozoa).—The *spermatogonia* undergo a period of multiplication by mitotic divisions (see

page 500) at the end of which they are transformed into *first spermatocytes*. At this time each cell increases in size and *like* or homologous chromosomes, which are already split longitudinally, become associated in pairs (pseudo-reduction), the usual process being a side-by-side *synapsis*, forming a quadruple chromosome known as a *tetrad*. Two of the parts are maternal and the other two, paternal in origin. Any two parts are known as *dyads*.

Two *maturation divisions* follow in rapid succession without further splitting of the chromosomes, and separate the four parts of each tetrad into different cells. The two maturation divisions acting as a unit separate the parts of a chromosome that were derived from one parent from those that were derived from the other. This reduction (segregation) may occur at either maturation division. If a tetrad chromosome divides along the *lengthwise* split (equationally) at the *first maturation division*, then each dyad is one-half paternal and one-half maternal in origin. For such dyads, the *second maturation division* segregates the maternal part from the paternal.

On the other hand, those tetrads which separated at the *first maturation division* along the line of *synapsis* give one dyad of paternal and one dyad of maternal origin. That is, *segregation* for such a pair occurs at the first maturation division, and the second division is consequently *equational* or longitudinal.³ In either case the four resultant cells are called *spermatids*, each containing one-half the number of chromosomes found in the original spermatogonium. But while a complete haploid series is maintained, the spermatids differ as to the parental source of the various chromosomes, now *monads*, the assortment being a random one. Such a process of segregation (reduction) is characteristic of the maturation divisions.

From the spermatids develop the mature spermatozoa, each with a head which contains the chromosomes, a body, and a slender tail, used in locomotion. The question of *accessory*, "sex determining" chromosomes will be discussed on page 533.

Oögenesis.—As in the development of the male germ cells, we find that the oögonia undergo a period of multiplication, dividing by ordinary mitosis (page 500).

At the end of their preliminary mitoses, the oögonia are called *primary oöcytes*. They rapidly increase in size and their longi-

³ Both divisions are longitudinal.

tuinally split chromosomes meet (*synapsis*) in pairs, each of which is composed of one maternal and one paternal chromosome. Thus a quadruple chromosome (*tetrad*) is formed as in spermatogenesis.

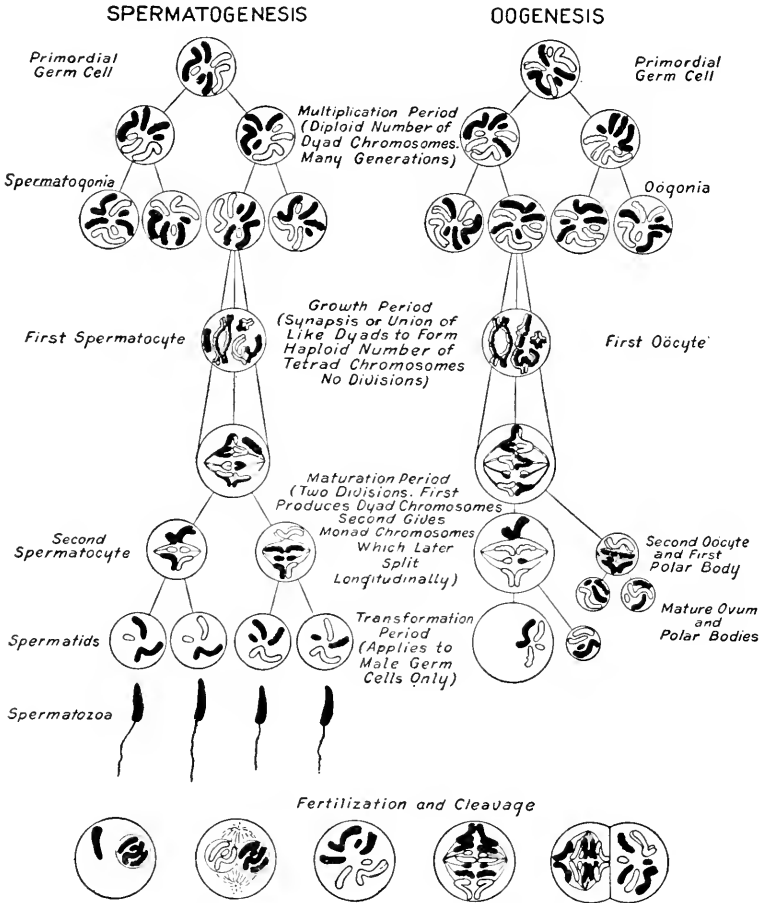

FIG. 260. Diagrams of spermatogenesis, oogenesis, and fertilization. Chromosomes derived from female are shown in solid color, those from male in outline. Sex-chromosomes are shown with roughened contours. The diploid complex consists of a double series, both as to size and shape, with the exception that the male has only one sex chromosome. Note that it is always derived from his mother. (Courtesy of E. Carothers, 1931).

Subsequently, in the *first maturation division*, the tetrads divide into *dyads*, then in the *second maturation division* they divide into

single components, called *monads*, just as in the development of the spermatid.

During the *first maturation division*, the spindle appears near the periphery, and the nuclear material is divided equally, but the cytoplasmic material most unequally, so that the resultant budded "*first polar body*" is extremely small. It may later divide, but becomes degenerate and of no significance. The larger cell is called the secondary *oöcyte*.

In the *second maturation division*, the members of the *dyads* of the secondary *oöcyte* are separated but the cytoplasm is again unequally distributed and the *second polar body* is given off. The larger cell undergoes no further changes (in contrast to the spermatid) but becomes the *mature egg*. Just as in the spermatozoa, we find that the eggs contain one-half the number of chromosomes present in the *oögonia*.⁴

Fertilization.—In many of the lower animals we find that fertilization takes place after the eggs are laid, but in higher forms, such as reptiles, birds, and mammals, it occurs in the oviduct of the female.

In some forms the spermatozoan enters the egg before the polar bodies are formed, in others it may enter after the first polar body is formed, but before the second has been produced, and in still others, maturation of the egg has been completed before a spermatozoan is admitted. *Polyspermy* is not unknown, but in most animals only a single spermatozoan penetrates the egg.

The spermatozoan forms a *male pronucleus*, which unites with the *female pronucleus*, and subsequent divisions are by ordinary mitosis.

Two species of fishes, having different shaped chromosomes, were hybridized by Dr. Moenkhaus, who showed that there can be no question that subsequent multiplication of the cells of the fertilized ovum is accompanied by the equal distribution of chromatin from each parent.

The chromosomes split longitudinally into two parts, separate, and group themselves in two clumps around the poles of a delicate spindle; then the cell divides. Thus by *mitotic* division beginning

⁴ Carothers, E. E. 1926. The Maturation Divisions in Relation to the Segregation of Homologous Chromosomes. *Quart. Rev. of Biol.*, vol. 1, pp. 419-435. The sections on mitosis and gametogenesis were corrected by Dr. Carothers.

Union of the Haploid Groups. Fertilization.

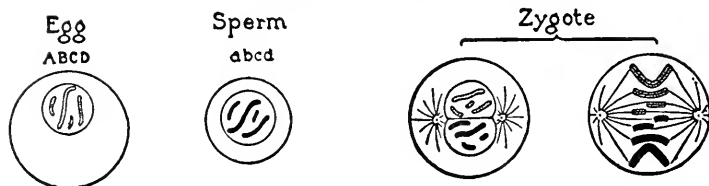

Division of the Diploid Group. Mitosis.

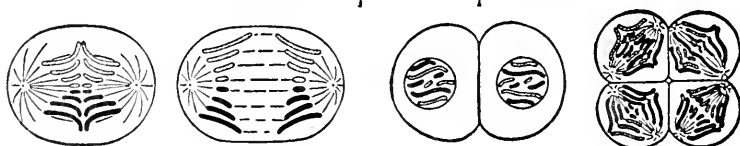

Reduction of the Diploid Groups to Haploid. Meiosis.

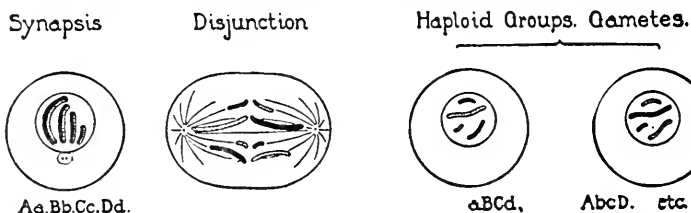

Recombinations in Fertilization.

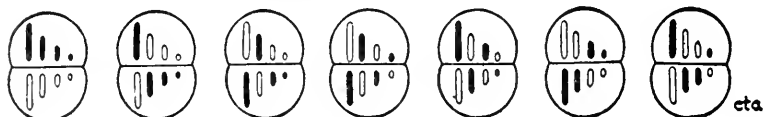

SUMMARY OF CHROMOSOME BEHAVIOR AND RELATIONSHIP

In the germ cells, egg and sperm, the chromosomes are not paired. The four shown for illustration are distinguished by relative lengths. The maternal elements are shown in outline and identified as A, B, C, D; and the paternal in black, as a, b, c, d. On fertilization the zygote acquires the double or diploid number of chromosomes—that is, it now has four *pairs*, one of each pair from the mother (egg) and one from the father (sperm). The constitution of the new individual is, Aa, Bb, Cc, Dd. In the course of normal cell division (Mitosis) each member of each pair divides into two; and each daughter cell has a full complement of chromosomes, continuing the composition of the zygote. When new germ cells are being formed the diploid number is again *reduced* (Meiosis), the members of each pair going to two different cells—but the separation is random. Thus, the two new gametes illustrated show the combinations aBCd and AbcD, sixteen different combinations being possible for four chromosomes (4^2). When fertilization takes place, with 16 types of sperms and 16 types of eggs, mating is random and there are 256 possible combinations (16^2), of which seven are shown. From Wilson, *The Cell in Heredity and Development*, published by The Macmillan Company.

FIG. 261.

1, 2, 4, 8, etc., the germinal substance is transformed by "cleavage" into the new organism.⁵

Cleavage and Organ Formation.—Subsequent to fertilization certain changes take place converting the egg cells into cells that multiply and form the embryo. *Cleavage* may be *complete*, and *equal* as in *Amphioxus* or *unequal* as in the frog. On the other hand it may be *partial*, and either *superficial* as in the eggs of *Arthropods* or *discoidal* as in the chick.

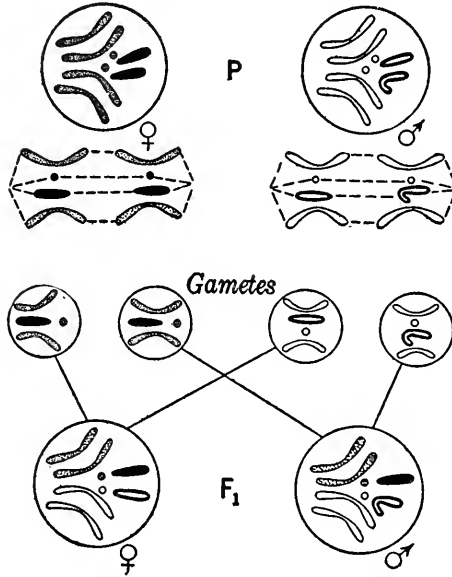

FIG. 262. Reduction Division in Relation to Sex Determination. (After Gruenberg, *Evolution*, published by D. Van Nostrand Co., Inc.)

The chromosomes of the male (light) parent (*P*) differ from those of the female parent (dark) in the form of the *Y* chromosome. As gametes are formed, one of each pair of the *X* chromosomes (black) goes to each egg. In the formation of sperms, however, half get the *X* chromosome and half get the *Y* chromosome: there is only one kind of egg, but there are two kinds of sperms. In the following generation, *F*₁, the sperms containing the *X* chromosomes give rise to females, and those containing the *Y* chromosomes give rise to males. Both males and females of this generation, however, derive half the chromosomes from the father and half from the mother.

One of the most fascinating studies imaginable is that of *organ formation* from the primitive embryonic state. It is possible to follow the development of some invertebrate types such as worms and molluscs from the one-cell stage to the actual development of complete organs. Their condition of semi-transparency and the distinctive colors of certain developing organs render this task quite easy. The nervous system has been traced to the two-cell stage in *Crepidula*, a mollusc, by Dr. E. G. Conklin.

Germinal Layers.—At the end of cleavage (segmentation) the egg is

⁵ Consult the paper by H. B. Goodrich, 1929, Mendelian inheritance in fish. *Qu. Rev. of Biology*, vol. 4, no. 1, pp. 83-99, March.

divided up into cells which very early become arranged in two layers, the outer ectoderm (epiblast) which covers the surface of the embryo and the inner entoderm (hypoblast) which lines the interior. Between the ectoderm and the entoderm, a third layer of cells, the mesoderm (mesoblast), arises, usually coming directly or indirectly from the entoderm.

The *ectoderm* gives rise to the epidermis covering the body, the hair and nails, and to organs derived from the epidermis-nervous system including the retina, epithelial lining of the mouth and anus, buccal glands and enamel of the teeth.

The *entoderm* gives rise to the notochord and the epithelium lining the alimentary canal and its diverticula-including glands of the digestive tube, the lungs, bladder, hepatic cells of the liver and secretory cells of the pancreas.

The *mesoderm* gives rise to structures lying between the ectoderm and the entoderm including all connective or supporting tissues except neuroglia. From it originate striated and most smooth muscle, blood vessels and lymphatics, peritoneum, skeleton and the epithelium of the genito-urinary system except the urethra and part of the bladder.

Theories of Heredity and Evolution.—Hypotheses and theories of heredity are legion and we shall mention only a few of the older and less tenable ones before taking up the ones that are believed in at the present time. The theory of *Epigenesis* supposed that development came about through the agency of mysterious external forces. The theory of *Preformation* supposed that the germ contained all the parts that were to develop from it. We believe, however, that the union of the *germinal elements* gives rise to a new organism that may have *different* qualities from the parents. We recognize the fact that combinations may be produced by the environment, and that apparently new types may be examples of *reversion* and due to the *chromatin* that has been handed down from some remote ancestor.

History of the Evolutionary Idea.—Many people have heard so much of the Darwinian theory of Evolution without getting any accurate first-hand knowledge of what Darwin said that they are inclined to believe that Charles Darwin gave us the first idea of evolution. This is far from the truth, however, since from the time of the earliest Greeks traditions have been handed down regarding the origin and development of man.

The early Greeks and Romans possessed an inborn inquisitive spirit. They lived on the shores of the Mediterranean where many interesting natural phenomena were visible daily. Their speculative inquiry resulted in the formulation of quite definite although frequently erroneous ideas regarding the origin of life, the composition of matter and the reasons for extinction of some animals while others survived.

Thales (624-548 B. C.) is credited by Aristotle with the following beliefs:

1. The earth floats on the water. 2. Water is the material cause of all things. 3. All things are full of gods; and the magnet is alive, for it has the power of moving iron.

Thales was the founder of Ionic physical philosophy and therefore the founder of Greek philosophy. He discarded the mythical explanation of things and asserted that a physical element, water, was the first principle of all things. He was the first to question the origin of the earth, but believed that God is the mind which formed all things from water.

Anaximander (611-547 B. C.) suggested the transformation of *aquatic* species into *terrestrial* and the especial *adaptation* of such terrestrial forms.

Empedocles (495-345 B. C.) is called the "Father of Evolution," because he suggested the possibility of the *origin* of the *fittest* forms through chance. He thought that there were four kinds of matter, fire, air, earth and water, and that these were acted upon by two opposing forces, Love and Hate. He suggested that the independent parts of horse and man could fuse to make a Centaur. He was one of the earliest students of Embryology.

Aristotle (384-322 B. C.), the most important of the Greek philosophers, believed in an *internal perfecting tendency*. He postulated a gradation from the mineral to the plant, the plant-like animal, the lower animals and finally man. He said, "Nature makes only those fit for a purpose and makes those fit for their several uses." Osborn says,⁶ "If Aristotle had accepted Empedocles' hypothesis of the origin of the fittest through *chance* rather than through design, he would have been the literal prophet of Darwinism." Aristotle appealed directly to Nature for facts and stimulated inquiry in anatomy and physiology. As instructor of Alexander the Great, he secured a subsidy of 800 talents, sufficient

⁶ Osborn, H. F. 1908. From the Greeks to Darwin. The Macmillan Co.

to support as many as 100 collectors bringing animals and plants from all over the known world.

Pliny the Elder (23-79 A. D.) was a Roman who, although of great learning and an enthusiastic student of Nature, did more than any of his contemporaries to *hinder* the development of the scientific method and spirit. He prepared 37 volumes of natural history and published the first cyclopedia. An honest compiler, he perpetuated much nonsense. Since he was considered an authority on natural history, his writings turned the minds of people away from science to books.

From the time of Aristotle to the 16th century, the period of the Anatomists, Fabricius and Vesalius, anatomy and zoölogy were at a standstill.

Galen (130-200 A. D.) was a great *Anatomist* whose studies on lower mammals were very carefully made, but who erred in concluding that the human body had the same structure. The writings of Galen were used as texts, and anatomy was not independently treated until the field was enriched by the vigorous original work of Vesalius.

Vesalius (1514-1564 A. D.) published several tables of anatomy and in 1543 brought out a work on the Anatomy of the Human Body, the earliest accurate and authoritative human anatomy.

Studying the *human* subject, Vesalius raised anatomy to a degree of accuracy hitherto unknown. Galen, from his studies of the lower mammals, had taught that the lower jaw of man is divided. Vesalius showed on the contrary that it is a *single* bone in man. Vesalius announced, much to the discomfiture of the *theologians*, that man had the same number of ribs as woman. When pressed too hard, Vesalius said that he would leave the question of an *indestructible* "resurrection bone" to be decided by the *theologians*, as it was not an anatomical question.

The aim in Biology in the Middle Ages was apparently devoid of spirit and method. Much of it was in the Medical line. Medical writers were concerned with healing. They had charms *against* disease. The dominant powers thought, even up to the time of Newton, that the devil possessed the power to give men new ideas.

Nicholas Copernicus kept a fearful secret for thirty years, his idea that the sun and planets do not revolve around the earth, but that the earth revolves around the sun.

Giordano Bruno was bolder, but after stating a similar belief

he was hunted from one country to another, imprisoned in the dungeons of the Inquisition at Rome for six years, and finally was burned alive because he would not recant.

Among the first in the new liberty of the Renaissance was the great *William Harvey* (1578-1657). He was graduated from Cambridge and finished his medical education at Padua under the anatomist Fabricius. *Vesalius*, by his studies on the human body and his observation on the valves of the heart, and Fabricius (1537-1619), by his studies on the veins of the heart, had paved the way for Harvey's discovery of the circulation of the blood. *Harvey* lectured first on the circulation of the blood in 1615, completed his work in 1616, and after years of demonstration before the Royal College of Physicians finally published his little book on *The Movements of the Heart and of the Blood*, in 1628. He established the fact that the arteries are responsible for the pulse, and that muscular contraction of the heart causes the circulation of the blood. He greatly stimulated *morphological* and *physiological* work, and revived the *experimental method* lost since the Greeks.

John Ray (Wray) (1628-1705), a contemporary of Harvey, did excellent systematic work. He is called the "Father of Modern Zoölogy." Ray applied the term *species to individuals* derived from *similar* parents. He noted variations but did not conclude that they were of constant character.

Just prior to Lamarck, Ray and Linnaeus defined a *species*, thus calling attention to the characteristics of animals and plants. The idea of the *fixity of species* became the opinion of many biologists as well as theologians. A few less sheeplike clung to the idea that *species* were *changeable*; and were naturally ripe for the reception of the evolutionary hypothesis.

Buffon (1707-1788), while not a contributor to technical scientific literature, was of a philosophical turn and definitely popularized natural history. In his *Histoire Naturelle* he set forth the idea of the *gradual production of different types* of forms. He noted the ills of slavery, the presence of rudimentary organs in animals and the fact that in man a poor quality of food determined degenerative changes.

Linnaeus (1707-1778), a Swede, was the founder of modern, systematic biology. He established one principle that is more to his credit than anything else. He invented Binomial Nomenclature.⁷

⁷ In 1623, Kaspar Bauhin published a treatise, *The Pinax*, in which he overthrew the alphabetical arrangement of plants and started the system of using two names to indicate the plant under consideration.

The names being in Latin, a fixed language, are understood by all people. Linnaeus was a systematist; Sachs calls him a "classifying, coördinating, sub-ordinating machine." Sachs states: "Linnaeus' greatest and most lasting service was in the certainty and precision which he introduced in the art of describing." He was behind his own time in Physiology, while his work in Morphology was superficial.

Erasmus Darwin (1731-1802), the grandfather of Charles Darwin, was born in England. He was a distinguished physician, philosopher and poet. Osborn called him the Poet of Evolution. He asked questions directly from Nature. "Do some of the genera perish by increased power of the enemies?" "Do some animals change in their nature?" "Why do plants have poisonous juices?" "Many plants have arms, spines and stings for protection."

His research and thought helped Charles Darwin. He perceived the significance of color for protection. "Frogs vary color according to environment." He noticed the *adaptation of limbs* to environment. He saw that the *strong males propagate* the species and believed a little in the "Survival of the Fittest." With E. Darwin's final work in 1802 culminated the ideas of the time. He had not formulated any theory. He became the pioneer, setting up the landmarks which served as the guides for subsequent investigations.

Jeanne Baptiste Antoine de Monet—Chevalier de Lamarck (1744-1829).—The name of Lamarck is intimately associated with the first formulated theory of Evolution. He was a contemporary of Erasmus Darwin. Many of the views of Lamarck had been anticipated by E. Darwin. Lamarck advanced a theory in 1809 that accounted for variations by supposing that *environment* brought them about directly or else through the efforts made by the animal to adjust itself to its environment. Lamarck's theory perforce admitted the *transmission of acquired characters*.

Haeckel says: "To Lamarck will always belong the glory of having worked out for the first time the theory of descent as an independent scientific theory of the first order and as the Philosophical foundation of the whole science of Biology."

Lamarck's Four Laws of Evolution.—

1. Life by its proper forces continues to increase the volume of every body which possesses it as well as to increase the size of its parts up to as great limits as it can bring itself.

2. The production of the new organ or part in the animal body results from the supervention of a new need or want which continues to be felt and of a new movement which this need initiates and causes to continue.
3. The development of organs and their force or power of action are always in direct relation to the employment of those organs. (Law of use.)
4. All that has been acquired, impressed upon or altered in the organization of individuals during the course of their life is conserved by the generation and transmitted to new individuals which have descended from those which have survived these changes.

Following the death of Lamarck in 1829, the theory of Evolution was forgotten for a time and ceased to impress the scientific world. Erasmus Darwin's views were not revived until the time of his grandson, Charles Darwin.

Cuvier (1769-1832), the founder of Modern Paleontology, was a keen student of anatomy, beginning with Invertebrates. He is termed the founder of Comparative Anatomy, as he established a system of classification based on the comparative anatomy of internal organization instead of the superficial external characteristics employed by his predecessors. He defended his erroneous "cataclysm theory," that periodically a great revolution destroyed all life on the earth and that a new world of unchangeable species arose. This theory was later, in 1832, shown to be false by Lyell, in his "Principles of Geology."

Charles Darwin (1809-1882).—According to Charles Darwin, in 1858, *chance variations* afford the opportunity for the factor of *natural selection* to pick out those best *adapted to survive* in the tremendous *struggle for existence* and the *propagation* of species.

Darwin took *variations* for granted. His long observations, together with the suggestive work of Malthus on Population, convinced him of the tendency towards *over-production* in plants and animals. This, he noted, led to a *struggle for existence*. He pointed out the fact that struggle for existence might be between fellows, when stags fight stags in the clearing, or between foes as in the case of the mongoose and the snake; or finally it might be a struggle with fate, as in the case of "two canine animals which in time of dearth struggle with each other which shall get food and live."

The three processes, *overproduction*, *struggle for existence* and *survival of the fittest*, result in *Natural Selection*. Favorable *adaptations* enable the *fit* to live while the others perish. Tied up with these ideas was the one regarding *sexual selection*, in which Darwin attempted to show that in the birds, for example, secondary sexual characters such as brilliant plumage and beautiful songs attracted the female, who selected or chose the male. This last factor has been much debated, but we cannot gainsay the very important point that the healthy and *best adapted* forms, able to survive, will be able to *reproduce*. Certainly vigor exhibits itself in brighter color and purposeful activity.

Darwin wrote out a sketch of his theory in 1842, and in 1844 gave his completed theoretical conclusions, showing the paper to his friends Lyell and Hooker. But the public announcement of his chief contribution was postponed until 1858, when he shared with A. R. Wallace the credit for the idea of "evolution" from the *Natural Selection* of those *fit to survive*.

A. R. Wallace (1822-1913), another Englishman, was so enthusiastic after reading Darwin's Journal of the Beagle Voyage in 1845 that he embarked in 1848 on an exploration of the Amazon and Negro Rivers lasting 4 years. Later, after he had explored in the Malay Archipelago, he prepared while at Sarawak (1855) a paper in which he concluded that every species that had come into existence in Nature was related to a species that preceded it. He, like Charles Darwin, read Malthus, *On Population*, and in February, 1858, he sent Darwin a short paper entitled: "The tendency of varieties to depart from the original type."

Darwin at first thought most unselfishly to present Wallace's paper to the Linnaean Society without comment. His friends, including Dr. J. D. Hooker and Sir Charles Lyell, persuaded him that after 20 years of careful observation had resulted in the formulation of theories backed by many facts unmarshalled by Wallace, the correct procedure was to present his own views in a paper to be read at the same symposium.

So far as the oft-quoted idea of the survival of the fit, later paraphrased into Nietzsche's term the "super-man," is concerned, we have no finer or more noble instance of the humanity of man to man than that of Darwin and Wallace, the co-discoverers and crystal-lizers of the principle of Evolution, vying with each other over the

privilege of yielding to the other man the honor and glory of the public presentation of such a world-shaking hypothesis.

Accordingly, in the spring of 1858, Sir Charles Lyell and Dr. J. D. Hooker communicated to the Linnaean Society Wallace's paper just mentioned and brief extracts from Darwin's unpublished works together with an abstract of a letter to Professor Asa Gray. The two papers, with the many striking examples supporting Darwin's theory, stirred the scientific world.

Polemics were issued by the theologians and more attention was thus focused than otherwise. The result was that when Darwin published his book in 1859, the first edition was sold out in a day. So bitter was the fight waged by prominent theologians that it took the most strenuous efforts of *T. H. Huxley* (1825-1895), the "bull-dog of Darwinism," and of other less militant scientists to turn the tide.

When the average person thinks of "evolution" he is likely to confine himself to garbled statements of the Darwinian theory. Recently, when Bateson of England in a public address mentioned the fact that modern Biologists do not accept in all details Charles Darwin's theory, the opponents of evolution seized upon the statement and announced that the great biologist denied evolution. Although all biologists do not agree about the method of evolution they believe in it as an established law.

A recent paper⁸ by Henry Fairfield Osborn, of the American Museum of Natural History, points out that man has an age-old history. Man, we find from the discoveries of archeologists, has always had a religion and a soul. He has always worshipped and revered something, except of course during his own period of adolescent outbreak.

Biologists, like other men of science, are neither atheists nor iconoclastic in their attitude toward religion. As the distinguished Sir William Bragg said (1928) in an address before the British Association for the Advancement of Science, "Science is not setting forth to destroy the soul, but to keep body and soul together."

Clark's Zoögenesis Theory.—A. H. Clark of the Smithsonian Institution has formulated a most stimulating theory which he has been kind enough to summarize for this text.

⁸ H. F. Osborn. 1928. Recent discoveries relating to the origin and antiquity of man. *Science*, vol. 65, no. 1690, pp. 481-488.

“While within each of the major animal groups or phyla the interrelationships of the various included types as they appear in successive geological horizons are such that they may be represented in the form of a tree—the so-called phylogenetic tree—there is no real evidence, paleontological, embryological or structural, that any of the phyla were derived from any of the others, although all of them must have been derived from a primitive single cell. Each of the phyla represents a special and definite structural complex basically different from the structural complex represented by any other.

“The protozoans differ from all other groups in the complete separation of the cells after division. The sponges are unique in the more or less irregular adhesion of the cells after division in the early embryonic stages. All other groups pass through a gastrula or its equivalent, and the gastrula is the last stage common to them all.

“It is therefore assumed that, so far as the major groups of phyla are concerned, evolution was a more or less simultaneous process of radiation from the gastrula stage, and that the phyla never were connected by intermediate types any more closely than they are at present.

“This conclusion agrees with the determined facts of paleontology and embryology, and furthermore accords with our interpretation of conditions on the earth at and subsequent to the first appearance of life.”

Significance of the Darwinian Theory.—We owe to Darwin the first successful vindication of the evolution idea. It was not his own, nor was he its first champion, yet we think of Darwin and the Doctrine of Descent together. The central idea of evolution is that the present is the child of the past and the parent of the future. It is the idea of progressive change from phase to phase without loss of continuity. Crampton says, “The Origin of Species has proved a veritable Magna Charta of Intellectual liberties, for as no other single document before or since it has released the thoughts of man from the trammels of unreason, conservatism and dogma.”

Darwin's Pangenesis Theory.—Charles Darwin is responsible also for a theory of inheritance units. He supposed that each cell of the body throws off little particles which he called *gemmules*, which are somehow gathered together in the germ cells. When these develop, the *gemmules* reproduce in the body of the new individual the characters of these cells of the parent from which they were derived. With this the transmission of acquired characters is perfectly natural. The theory is called the *pangenesis* theory because it assumes that all parental somatic cells are concerned in the formation of the new individual. It is interesting to note that in spite

of the fact that Charles Darwin, like many others, ridiculed Lamarck's laws, particularly the one that suggested the inheritance of acquired characters which had arisen through a new need, his *pangenesis theory* attempts to explain the *inheritance of acquired characters*.

As we have not yet determined the method by which somatic characters may be transmitted to the germ-cells, we cannot accept this theory. Our knowledge of the importance of biochemical systems such as the *hormones* may increase to a point where it will in time be possible to accept a modified gemmule theory.

A. Weismann (1834-1914) in his book, *The Germplasm*, published in 1893, denied the formation of the germplasm from the body tissues of the individual, and maintained that its sole origin was from the *germplasm* of the parent of the individual. The germplasm, according to Weismann, is handed on from one individual to the next descendant unchanged by environment. Since the *body cells* are not inherited, there is no possibility of the inheritance of acquired characters.

His theory is that sexual reproduction⁹ is a mechanism for doubling the possible variations in the offspring. In such permutations and combinations of the qualities of the uniting germplasm, chance and the factor of *natural selection* may both become effective.

He believed that the germplasm consists of hereditary units called *determinants*, and that still smaller units called *biophors* are made up finally of molecules and atoms. As the determinants are grouped together to form granules of chromatin (*idants*) making up the chromosomes (*ids*), it is quite evident that the microscope cannot be used to study these units.

Unknown Units.—Other biologists have suggested ultramicroscopic units similar to the biophors and determinants of Weismann and the gemmules of Darwin. De Vries called them pangenesis; Spencer named them physiological units; Galton, stirps; Hertwig, idioblasts; Naegeli, micellar strands; and Weisner, plasomes. We accept the fact that there are units which like chemical radicals are always found united, yet preserve their individuality in different combinations. How these ultramicroscopic units behave we are still conjecturing.

Francis Galton (1822-1911).—A law of heredity formulated by

⁹ Amphimixis is biparental parentage. (See page 125.)

Francis Galton in 1889 seemed to some to satisfy the theoretical requirements.

Galton's Law of Ancestral Inheritance in essence was that the two parents between them contribute $\frac{1}{2}$ of each inherited faculty, the grandparents together contribute $\frac{1}{4}$, the great grandparents $\frac{1}{8}$. (The individual, $1 = \frac{1}{2}$ plus $\frac{1}{4}$ plus $\frac{1}{8}$ plus $\frac{1}{16}$ and so on.) Since this theory does not apply to individual cases and takes no account of prepotencies or the domination of the characters of one parent, it is not accepted.

Gregor Mendel (1822-1884).—The Austrian monk, Gregor Mendel, having worked for eight years with bees and garden peas, in 1865 published an account of his work in the Proceedings of the Natural History Society of Brunn, Moravia, but this was overlooked until 1900 when De Vries, Correns and Tschermak, independently arriving at similar conclusions, brought the earlier work to light. In 1902, Bateson, an Englishman, pointed out its great importance and since then we have been much interested in experiments which seem to substantiate the early conclusions and carry the work on to a point where it is being applied in practical work with cattle, poultry and plants.

Mendel's First Law: The Law of Dominance.—When mating occurs between two animals or plants unlike with reference to a single unit character the “hybrid-character resembles one of the parent forms so closely that the other either escapes observation completely or cannot be detected with certainty.” The character of one parent only thus exhibited is called “dominant” while the other latent character is called “recessive.”

If the dominant determiner is absent, and the recessive determiner is duplicated, the recessive character is exhibited. Thus we may have a “dominance of recessiveness.”

When the hybrid offspring of such a cross are in turn crossed with each other, it is found that 25 per cent will be like the dominant grandparent, 25 per cent like the recessive grandparent, and 50 per cent like the parents that resemble the dominant grandparent.

We have therefore by crossing two DR's: $\frac{1}{4}$ DD plus $\frac{1}{2}$ DR plus $\frac{1}{4}$ RR.

When a pure dominant is crossed with a mixed dominant recessive, the offspring will all show the dominant character, though of course one-half of them are DR's. $DD \times DR$ equals 2 DD plus 2 D (R). The DD's are pure and the D (R) is like any other hybrid

and yields the 1 : 2 : 1 offspring if two are hybridized. When the recessive is crossed with a mixed DR we get 2 D (R) plus 2 RR.

Mendelian Inheritance

(Garden Peas)

Dominant

R. round
Y. yellow
T. tall

Recessive

W. wrinkled
G. green
D. dwarf

Pure dominant crossed with pure recessive yields DR hybrids.

Monohybrids.—R × W equals first filial generation: R (W).

Representing the hybridization as followed by crosses of male and female germ cells bearing the combined R (W) we have by Punnett's method of squares the following Monohybrids:

Male	R	W	
R	R R	R W	F ₂ generation
W	W R	W W	
Female			

This equals RR plus 2 R (W) plus WW.

Likewise DR × DD is expressed:

$$\begin{array}{cc} R & R \\ \times & = 2 \text{ RR plus } 2 \text{ RW.} \\ R & W \end{array}$$

Again, dominant-recessive DR × pure-recessive RR equals 2 DR plus 2 RR as:

$$\begin{array}{cc} R & W \\ \times & = 2 \text{ RW plus } 2 \text{ WW.} \\ W & W \end{array}$$

Complete dominance is rare, however, as Mendel discovered in the case of certain peculiar hybrid forms.

(a) The law of dominance is not of universal application. Mendel found this true in crossing different *heights* of peas.

(b) There may be an *intensification* of the characters of one parent. Brown seeded peas may be darker than the parents.

(c) The cross bred may have a character entirely different from either parent. The hybrid may possess its *own* character.

In the case of the Blue Andalusian fowl we have a good example. The parents are: Dominant—black; recessive—white with black splashes. The hybrid is blue. When two hybrids are crossed the offspring are found to be $\frac{1}{4}$ black; $\frac{1}{4}$ splashed white; and $\frac{1}{2}$ blue.

Mendel's Second Law: The Law of Segregation or Purity of Gametes, Called the Law of the Splitting of Hybrids.—Both body cells and germ cells of the F_1 parent, before reduction divisions, contain the determiners (genes) of both alternative characters and are hybrid in character, but during maturation the alternative genes (allelomorphs) are segregated, and we have the law that the hybrid, whatever its character, produces ripe germ cells which bear only the pure characters of one parent or the other. A gamete then is never hybrid with reference to any single character.

Dihybrids.—The usual Mendelian proportion for crosses where the parents have two pairs of characteristics each is: 9 : 3 : 3 : 1.

YR crossed with GW results in offspring in the (first filial) generation, YR (GW). The germ cells are of four types, excluding the obviously impossible RW and YG,¹⁰ and may be arranged in squares to indicate the crossing:

Sperm gametes	YR:	YW:	GR:	GW:
Egg gametes	YR:	YW:	GR:	GW:
	YR	YR	YR	YR
	YR	YW	GR	GW
	YW	YW	YW	YW
	YR	YW	GR	GW
	GR	GR	GR	GR
	YR	YW	GR	GW
	GW	GW	GW	GW
	YR	YW	GR	GW

While there are sixteen possible combinations, called *genotypes*, we must note that recessive characters are latent in the presence of dominant, so that we have but four types of peas so far as appearance goes. These are called *phenotypes* (see page 538).

The possible combinations, when added together, result in 9 YR plus 3 YW plus 3 GR plus 1 GW (YWGR is really a YR, and so on).

¹⁰ Every germ cell is pure as regards any given character. (See Second Law.)

There may also be a *masking* of characters. If gray rabbits are crossed with albinos, the first filial generation are all gray. The second filial generation become 9 gray, plus 3 black, plus 4 albinos. (1) Pigmentation is A and albinism is a.¹¹ (2) Gray is B and black is b. When these are crossed we get a gray hybrid.

The gray hybrids follow the rule for dihybrids, resulting in 9 AB (gray), plus 3 Ab (black), plus 3 aB, plus 1 ab (4 albinos). The albinos are not all the same kind, however, for we have: 1 aBaB, 2 aBab and 1 abab.

By crossing each type with a black we get aBaB \times Ab — AB all gray; aBab \times Ab — 1 AB gray plus 1 Ab black; abab \times Ab — Ab all black.

Trihybrids have three pairs of independently segregating characters.

RYT \times WGD produces the hybrid RYT (WGD).

We must eliminate RW, YG and TD as impossible of exhibition (Second Law), and then we have the following combinations for male and female germ cells: RYT RYD RGT RGD WYT WYD WGT WGD.

Placing the male germ cells in a horizontal row and the female germ cells in a vertical row and superimposing the squares we may secure 8 \times 8 squares of possible matings or sixty-four matings.

Results: 27 RYT plus 9 RYD plus 9 RGT plus 9 WYT plus 3 RGD plus 3 WYD plus 3 WGT plus 1 WGD.

Mendel's Third Law: The Law of Independent Assortment of Different Allelomorphs.—"The relation of each pair of different characters in hybrid union is independent of the other differences in the two original parental stocks."

This law becomes apparent when we try to follow the inheritance of more than one character at the same time. Modern investigators believe that the *genes* that show independent assortment are located in different chromosomes (see page 500).

Mendel's Fourth Law: The Law of Recombination.—Mendel stated that "the constant characters which appear in the several varieties of a group of plants may be obtained in all the associations which are possible according to the mathematical laws of combination." We find that the *genes* occur in all possible combinations according to the law of chance.

¹¹ Where many factors are involved, it is desirable to use R for the dominant character and r for the recessive, as is done in the case of the discussion of rabbits herewith.

EXAMPLES OF MENDELIAN INHERITANCE IN MAN

From E. G. Conklin, *Heredity and Environment*, 1920, pp. 116-118. (By permission of the Princeton University Press.)

	<i>Dominant</i>	<i>Recessive</i>
Hair		
curly		straight
dark		light to red
Eye color		
brown		blue
Skin color		
dark		light
normally pigmented		albinism
Countenance		
thick lower lip and prominent chin		normal
Temperament		
nervous		phlegmatic
Intellectual capacity		
average		very great or very small
General size		
normal size		dwarfish
dwarfs with short limbs but normal bodies and heads		normal
Brachydactyly: short fingers and toes		normal
Syndactyly: webbed fingers and toes		normal
Polydactyly: supernumerary fingers and toes		normal
Skin		
keratosis—thickening		normal
epidermolysis—blister form		normal
hypotrichosis—hairlessness and lack of teeth		normal
Nervous system		
normal condition		epilepsy
		feeble-mindedness
		insanity
		alcoholism
		criminality
		hysteria
		chorea
		St. Vitus' dance
		multiple sclerosis
Huntington's chorea		normal
Eyes		
cataract		normal
glaucoma		normal
Ears		
normal		deafmutism
normal		otosclerosis (rigidity of tympanum and hardness of hearing)

REFERENCES

- CONKLIN, E. G. Heredity and Environment. Princeton Univ. Press.
 METCALF, M. M. 1911. Organic Evolution. Macmillan Co.
 MORGAN, T. H. 1916. A Critique of the Theory of Evolution. Princeton Univ. Press.
 NEWMAN, H. H. 1925. Evolution, Genetics and Eugenics. Univ. of Chicago Press.
 WALTER, H. E. 1930. Genetics. Revised edition. Macmillan Co.

De Vries' "Mutations-Theorie."—In 1901, Hugo De Vries (1848–) of Holland announced that his studies of inheritance in the evening primrose, *Oenothera Lamarckiana*, had led him to conclude that new species arose suddenly by what he called mutation. These mutants or "sports" explained the origin of a new species in nature. Some mutants were retrogressive and others progressive. Later work by R. R. Gates showed that from the cytological basis the new types came about through analysis of the chromatin. The appearance of a new type was to be explained by a change in the chromatin.

Some of the workers with the fruit fly, *Drosophila*, once suggested that the so-called mutants of De Vries are the emergence of factors recessive in the ancestral stock and brought out by the favorable cross. The production of mutations by high temperature, x-rays, and other physical agents (see page 540) will give new impetus to cytological correlations.

Examples of mutation include the celebrated Ancon sheep, which was short legged, many instances of taillessness and hornlessness in cattle, and supernumerary or reduced numbers of digits in various animals.

If we can eventually control the appearance or disappearance of factors in the germplasm, we will produce an experimental evolution. If not, we must confine ourselves to selection and to those influences of environment that tend to bring out the qualities desired.

THE ORIGIN OF NEW SPECIES ACCORDING TO LAMARCK, C. DARWIN,
 A. WEISMANN, MENDEL, AND DE VRIES ¹²

Lamarck.—New species result from variations induced by use and disuse. Variations are inherited directly or improved in succeeding generations.

¹² Modified from Locy, *Biology and Its Makers*.

C. Darwin.—Variations assumed. Variations of use are perpetuated by inheritance. The *fit* survive and propagate. Each cell of the body sends off minute *gemmules* which enter the germ cells and transmit changes that have taken place in the individual. (This really admits the *inheritance of acquired characters*.)

Weismann.—Variations are due to permutations and combinations of the germplasm. Germinal selection takes place in the union of the germ cells. Germplasm has an *unbroken continuity* with an extremely complex organization. Body cells are *not* inherited.

Mendel.—New species are due to new combinations of chromatin. Dominance and recessiveness are always to be considered.

De Vries.—New species are due to sudden mutations or “sports.” Mutations are sudden variations that breed true. De Vries says, a mutant is “a change of wide amplitude which tends to be stable because it involves acquisition of a new unit by the germplasm, but which is necessarily stable only when the individual possessing it mates with a similar individual.” It has been suggested that mutations may occur through the addition or subtraction of *single characters*.

Evidences for Evolution. Paleontology.—In studying the strata of the earth’s crust we find that there is a gradual progression from types with primitive organization to the highly developed. Many groups of animals and plants reached the climax of specialization at relatively early geologic periods and became extinct.

The evolution of vertebrate classes is more satisfactorily shown than that of any other group, probably because they represent the latest phylum to evolve and most of their history coincides with the period within which fossils are known, while most of the invertebrate phyla had already undergone more than half of their evolution at the time when the earliest fossil remains were deposited.

Fossils Classified. *Class 1.*—*Actual remains* of recently extinct animals and plants. (a) In Arctic ice—the mammoth. (b) Insects preserved in resin-amber. (c) Mollusk shells, teeth of sharks, pieces of buried logs and bones of animals buried in asphalt lakes and peat bogs have been found in well-preserved condition.

Class 2. Petrified fossils, seen best in plants. *Class 3.* Casts and impressions. These are the impresses of soft-bodied animals left in mud which later solidified. The celebrated Pompeian dog is a striking example. The most remarkable are found in the oily shales of British Columbia. Even soft invertebrates are found in casts.

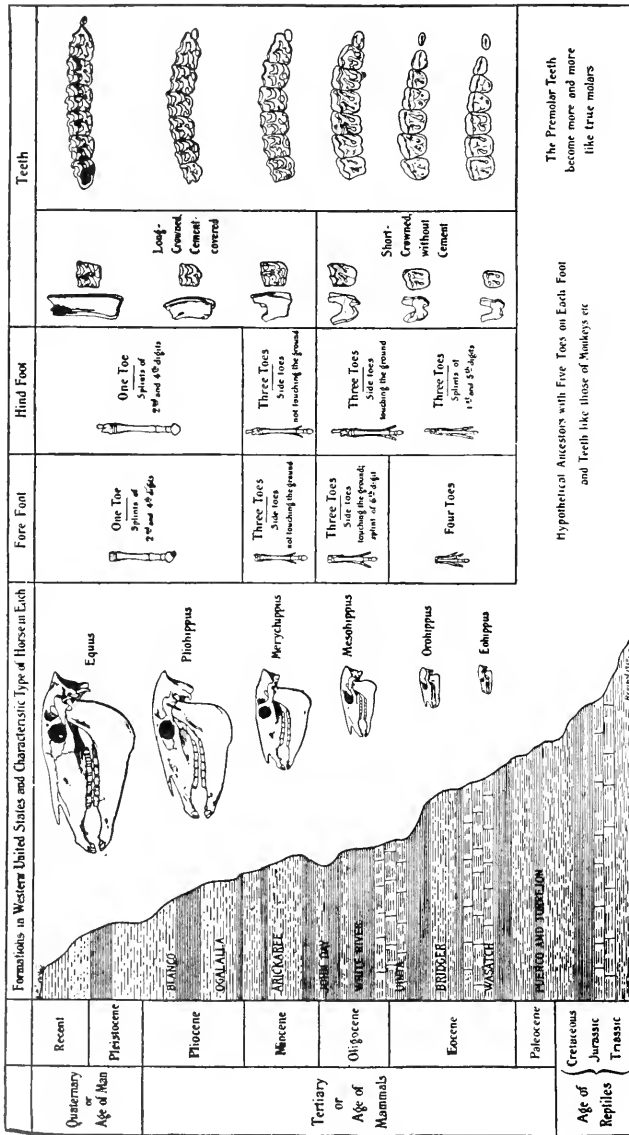

FIG. 263. Evolution of the horse. Fossils of successive periods show marked and consistent difference in size, in shape of skull, in the bones of the feet, and in the character of the teeth. (After Matthews. Courtesy American Museum of Natural History.)

The pedigree of the horse is the best known. Paleontological evidence is complete for the evolution of the horse from a five-toed ancestor.¹³ The pedigrees of the camel and the elephant are both worked out quite satisfactorily also. The pedigree of man has been worked back successfully for many centuries with accompanying flint weapons and implements.

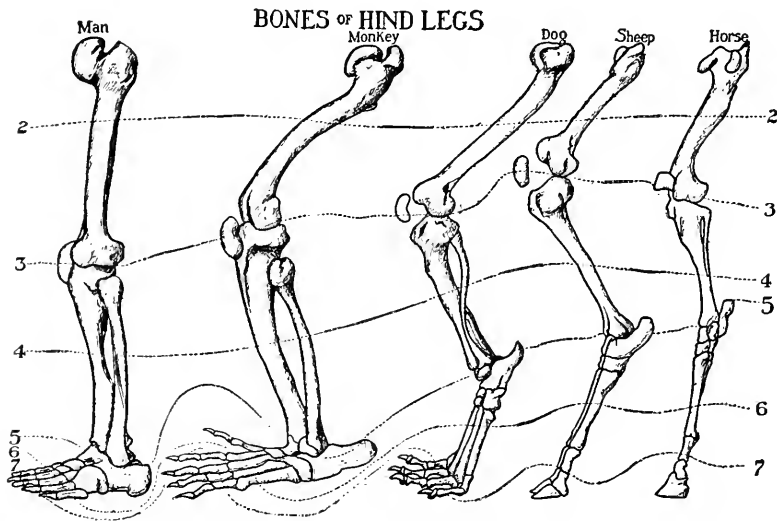

FIG. 264. Hind limb bones of man, monkey, dog, sheep and horse. (After LeConte. Courtesy of Amer. Mus. of Nat. Hist.)

Evidence from Comparative Anatomy.—If we accept the Principle of Evolution it is easy to explain the similarity in make up of the wing of the bird, the foreleg of the seal and the arm of man, all of which are “homologous” structures. Likewise, we can explain the fact that man has 180 vestigial structures which now have no significance to him. The muscles of the human external ear and the subcutaneous muscles in the forehead and scalp persist, although useless.

The nearest allies of man in the quadrumanous species lack a tail. Man has one at 6 weeks embryonic life, longer than the hinder limbs. Rarely, a human infant is born with a tail. The tail muscles persist as vestiges. The vermiform appendix of the cecum,

¹³ Consult W. D. Matthew, The evolution of the horse. *Quart. Rev. of Biol.*, vol. 1, April, 1926.

functional in the herbivores, is a menace to the health of man. A little blunt point projects from the inwardly folded margin or helix of the ear. It is the vestige of the point in lower animals. A tiny third eyelid is still found in man. Adult man has rudimentary *hairs* over most parts of the body. At the sixth fetal month the fetus has long hair over the body—"lanugo"—which in most cases is shed before birth.

Evidence from Blood Tests. Precipitation Method.—Freshly drawn human blood is allowed to clot, then the serum drawn away. Small quantities of the serum are injected at intervals of one or two

days into the veins of a rabbit and cause the formation in the rabbit's blood of an antibody, analogous to antitoxin obtained from a horse after injection of diphtheria virus. After the last injection, the rabbit is allowed to live several days, then is bled and the serum drained off and preserved. This is "anti-human" serum and is a delicate test for human blood, not only when it is fresh, but even when in the form of old and dried blood stains. Into an "unknown" solution of blood, a few drops of the anti-human serum are passed, and, if the stains are human blood, a white precipitate is formed and thrown down, but if the stains are of some domestic animal—pig, sheep or fowl—no such reaction (precipitation) occurs. This

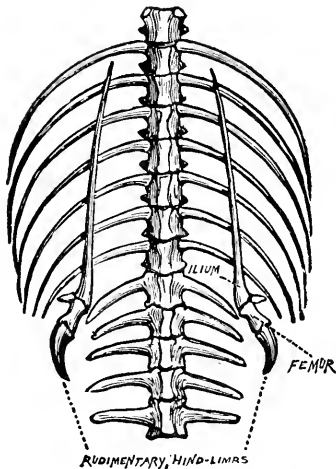

FIG. 265. Vestigial pelvic girdle and hind limbs of the python. (From Romanes, *Darwin and After Darwin*. Courtesy of Open Court Publishing Co.)

test is used in the detection of crime. Nuttall and others have shown that if sufficiently strong solutions be used and time enough be allowed, a relationship between the blood of all mammals is made evident.

Nuttall says: "The evidence which I published upon my tests with precipitins shows that reactions obtained with the blood of Simiidae (Manlike apes) closely resemble those obtained with human blood, the bloods of Cercopithecidae (Old World monkeys) came next, followed by those of Cebidae and Hapalidae (New World

monkeys and marmosets) which gave but slight reactions with antihuman serum, whilst the blood of Lemuroidea gave no indication of blood relationship.”

Evidence from Embryology.—All animals, even man, begin as a single cell, and develop in a parallel manner for a short time. We have considerable evidence to support the *Recapitulation Theory*

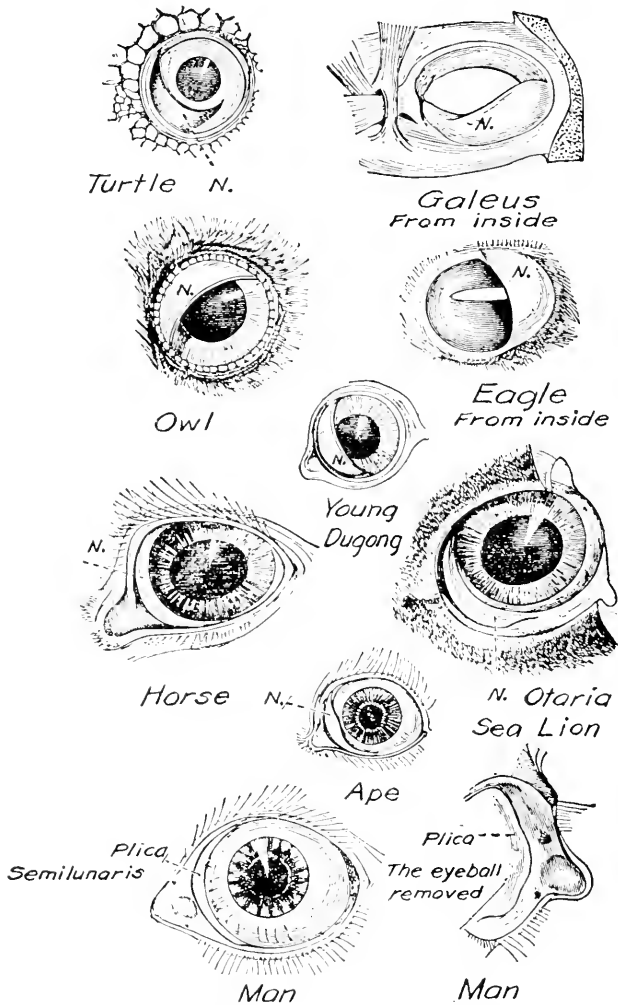

FIG. 266. Illustrations of the nictitating membrane in the various animals. (From Romanes, *Darwin and After Darwin*. Courtesy of Open Court Pub. Co.)

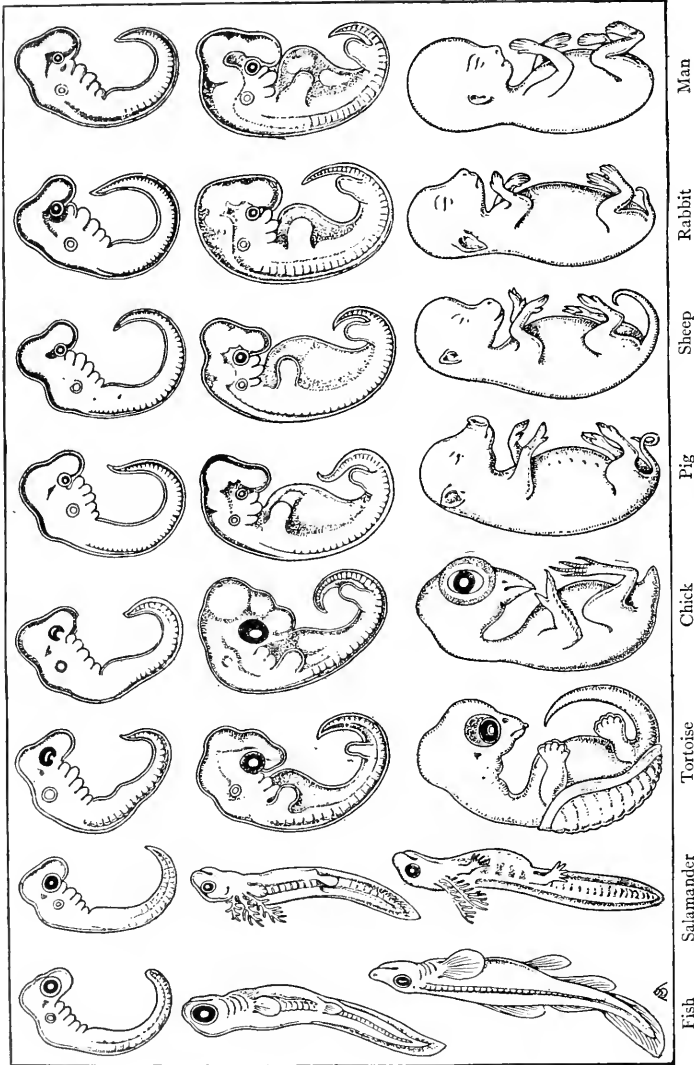

FIG. 267. Parallelism in development of backboneed animals. The three rows of embryos represent distinct stages of development. In the first row the stages of the different species are very much alike; in each succeeding stage they are more distinctive. (From Gruenberg, *Elementary Biology*, published by Ginn & Company.)

that the history of the individual is a recapitulation of the history of the race, but we cannot escape the observation that there are notable differences, each species introducing its own specializations.

Evidence from Classification.—The very assumption underlying classification is that the closest fundamental similarities between animals are found in those forms most closely related, and that the greatest differences are found in those forms that are distantly related. That we can place the animal kingdom in an orderly progressive series is an indication of such a thing as Evolution.

Evidence from Geographic Distribution.—The evolutionary theory furnishes an explanation of the phenomena of distribution of animals and plants. A species arises at one place and spreads out over large areas, becoming modified as it goes, and new species are formed from old through modification after isolation from the parent stock. We find cosmopolitan groups, those with the widest distribution being the ones to whom no barriers are sufficient to check migration; such as parasitic worms carried by man and other animals; and birds able to span large bodies of water (Newman). Restricted groups are those to which barriers are readily set up, and are frequently the only remnants of a once successful fauna or flora. Again the faunas and floras of continental islands are what we should expect on the basis of former land connection with the nearest continent, since they are like those of the nearest mainland and include types most readily blown there by wind or carried on floating debris.

CHIEF SOURCES OF THE FOREGOING SUMMARY

DARWIN, C. *Origin of Species*. D. Appleton and Co.

NEWMAN, H. H. 1925. *Evolution, Genetics and Eugenics*. U. of Chi. Press.

NUTTALL, G. H. F. *Blood Immunity and Blood Relationship*. Camb. Univ. Press.

SCOTT, W. B. 1911. *The Theory of Evolution*. Macmillan Co.

THOMSON, J. A. 1909. *Darwinism and Human Life*. Henry Holt & Co.

Sex Determination.—The theories of sex determination afford an opportunity to test the relative importance of the chromosomes as opposed to environmental influence. Since there are but two sexes, it must be conceded at the start that any theory of sex determination will appear to be right, one-half of the time.

One of the earliest known theories of sex determination, first put forth by Aristotle, is based on the *alternate functioning* of the *ovaries* and on evidence from pregnancies after one ovary has been removed. The right ovary is supposed to produce eggs that develop into males. Experiments with mammals and statistics from hospitals prove this theory worthless. The age and vigor of the parents have also been shown to be of no importance.

In cattle, Thury, Russell and later Raymond Pearl have produced considerable evidence to prove that matings which take place at the *beginning* of heat produce a preponderance of *females*, while those taking place in the period of heat produce *males*. In pigeons the eggs produced in the *early* part of the breeding season will develop into *males*, while those from the *latter* part of the breeding season develop into *females*. Whitman and Riddle have brought out this fact most clearly.

Riddle believes that sex is a *quantitative modifiable character*. The *males* have a *higher* rate of *metabolism* than the *females*. He concludes¹⁴ that from the egg-stage onward through embryonic and adult life the oxidizing powers of the male tend to exceed those of the female, and that it is this tendency which ultimately decides whether male or female shall develop. According to Riddle the two diverse chromosome combinations which ordinarily determine sex really accomplish this by thus providing an "internal genetic pull toward a lower or a higher metabolic rate." This genetic tendency can, however, be overridden by means which specifically establish an opposed rate of metabolism over prolonged periods, particularly over early and critical periods in the differentiation of sex.

As Riddle has pointed out (Science, 1927, vol. 65, page 139), Goldschmidt (Science, 1926, n. s., vol. 64, page 299) has made no reference to the earlier work of Riddle when (Science, 1912, n. s., vol. 35, page 462) he first gave evidence for his quantitative theory of sex. Riddle gladly credits Goldschmidt with the discovery that the genes influencing sexuality in the autosomes were not of equal potency in certain races of moths (see Goldschmidt's Enzyme Theory, page 534).

Certain Germans, including Pryll, Zölner, Ismer and Siegel, published papers during the Great War, indicating that earlier ova develop into males while the later, more mature and possibly better

¹⁴ Riddle, O. 1916. Sex control and known correlations in pigeons. Amer. Nat., vol. 50, pp. 385-410.

nourished ova produce females. Statistical studies negative this hypothesis and indicate that the sexes are about evenly distributed regardless of the lunar cycle.

Schenck suggested that the *ripe eggs* develop into *males* and the unripe into females. He fed women nitrogenous food, induced complete metabolism and males appeared, part of the time, of course. In wasps and other insects it is well known that an abundance of food induces greater numbers of females. In bees the queen is procured by special "bee bread." H. D. King has shown that neither food nor temperature is a factor in sex determination in the frog.

In Rotifers, D. D. Whitney and others have shown that a larger number of male grandchildren are produced by feeding the female a green unicellular organism, while if she is fed a colorless organism, the offspring are practically all females. Shull and Ladoff showed that oxygen excess produced males but Whitney contended that oxygen was not a factor.

Robinson advanced the theory that the *adrenals* determine the sex of the offspring, maintaining that an excess of adrenalin produces males, and that a smaller amount causes the development of females. He based his conclusions on fifty clinical cases. Experiments do not prove his theory, however.

That there is an intimate relation between the genital glands and the adrenals, the pituitary and the thyroids, cannot be denied. To prove a specific physiological basis for the generally accepted action of the chromosomes is a most difficult problem.

The Accessory or Sex Determining Chromosome.¹⁵—In 1891, Henking found in the Hemipteran *Pyrrhocoris* a "peculiar chromatin-element" which passes undivided to one pole while the other eleven chromosomes are equally divided. He labeled it "X," and finally termed it a "nucleolus."

In 1901, McClung recognized the chromatin nucleolus of Henking as a chromosome which he traced (in the grasshopper *Xiphidium*) into the first spermatocyte, where it passed undivided to one pole, then divided in the second spermatocyte, giving rise to two types of spermatozoa. McClung was the first to suggest the bearing of two kinds of spermatozoa on the determination of sex, and in 1902 he called the sex chromosome the "accessory chromosome."

¹⁵ Consult General Cytology, Chicago Press, 1924, and Wilson, E. B., The Cell, 1925, Macmillan and Co.

Miss N. M. Stevens and E. B. Wilson, working independently on insects, and Boveri, working on sea-urchins, found that all of the eggs at maturity have one extra or *accessory* or so-called "X-chromosome." The sperms are of two types, one-half containing the X-chromosome and the other half lacking it. Wilson clarified matters in 1905, showing that the female has in each of her body cells one more chromosome than the male, her chromosome groups containing *two* X-chromosomes, and those of the male containing but *one*, while other chromosomes are distributed identically in the two sexes.

Following some earlier work by others, faulty in technique, Von Winiwater demonstrated in 1912 that in man there are 48 chromosomes in the female and 47 in the male. *Oögenesis* results in the appearance of 24 chromosomes in each matured egg (23 plus X); but after *spermatogenesis*, one-half the sperms have 23 plus X, and the other half have only 23. The egg fertilized by the sperm with the X-chromosome develops into a female, while the other type of sperm without an accessory chromosome produces a male at fertilization. Painter has also found the Y-chromosome, and concludes that the male has 46 plus X, plus Y; and the female has 46 plus 2 X. The Y-chromosome has apparently no significance except as the bearer of somatic characters.

Goldschmidt's Enzyme Theory of Sex Determination.—Goldschmidt has attempted to reconcile the fact that the gonads produce hormones which apparently under certain circumstances are able to override the influence of the chromosome constitution, producing *intersexes* or even reversing the sex completely.

Goldschmidt suggests that the X-chromosome carries the *gene* (factor) of an enzyme-producing character which determines femaleness, while the Y-chromosome, or possibly the cytoplasm, carries the gene of a male-determining enzyme. In the fertilized egg with two X-chromosomes, the female enzyme is present in double quantity and produces a female. If but one X-chromosome is present, the cytoplasm (or possibly the Y-chromosome) produces an enzyme which "overpowers" the female producer and a male results. Goldschmidt and others have stressed the point that the variability of intersexual types depends on the degree of strength of the two sex-producing factors or enzymes, these varying in speed of action. (See Goldschmidt, R., 1916, *Science*, n. s., vol. 43, p. 98.)

Sex-Linked Characters.—Along with the accessory chromosome go certain “sex-linked” characters. Morgan has shown that there are more than 100 such characters in the fruit fly. In man, we know of five which appear in the male when simplex and in the female when duplex with reference to accessory chromosomes. These are *Gower's muscular atrophy*, *haemophilia* (slow clotting of blood), *color blindness* or Daltonism (red from green), *nightblindness*, and *neuritis optica* (progressive atrophy of the optic nerve). These sex-linked characters require *two* determiners for the *female*, and but *one* for their appearance in the *male*. It is interesting to recall the fact that Charles Darwin long ago noted that male albino cats with blue eyes are usually deaf.

Identical vs. Fraternal Twins.—It has long been known that there are two kinds of twins, one type like ordinary sisters, brothers, or brother and sister, coming from different eggs, and called *fraternal* twins; while the other kind, produced by the division of one egg cell, always appear to have the same characteristics and are always of the *same sex*. These last are called *identical* twins and furnish evidence that goes far towards substantiating the theory of sex determination *before cell division*. Likewise, studies on the armadillo, which produces from *one ovum* four identical offspring of the same sex, would seem to clinch the matter as to the time of sex determination.

Earlier workers were wont to rely upon the types of fetal membranes in determining the origin of twins. The assumption that all *monochorional* twins are *monozygotic* and all *dichorial* twins are *dizygotic* has met with considerable opposition, since several remarkable exceptions to the rule have been reported. In a paper by Curtius (1930), three strikingly identical sets of dichorial twins are reported as monozygotic. In these cases, it is probable that the twinning took place during early cleavage, possibly as far back as the four-cell or the eight-cell stage. It could not have occurred at the two-cell stage, as this is not equational. Newman (1931) has discussed such remarkable cases, and pointed out that studying the finger prints of twins should be regarded only as a final check on diagnoses.

REFERENCES ON TWINS

- CURTIVS, FR. 1930. Nachgeburtsgefunde bei Zwilligen und Ahnlicheite-diagnos. Arch. f. Gynäkologie, Bd. 140, Heft 2 u. 3.
NEWMAN, H. H. 1917. The Biology of Twins. Chicago Press.

- NEWMAN, H. H. 1923. The Physiology of Twinning. Chicago Press.
- NEWMAN, H. H. 1931. The finger prints of twins. Jour. of Genetics, vol. 22, no. 3.
- NEWMAN, H. H. 1931. Palm print patterns in twins. Jour. of Her., vol. 22, no. 2, pp. 41-48.
- PATTERSON, J. T. 1927. Polyembryony in animals. Qu. Rev. of Biol., vol. 2, no. 3, pp. 199-426.

Hermaphroditism and the Free-Martin.—Sex intergrades or hermaphrodites are found in many of the Invertebrate Phyla, and in all classes of vertebrates. Crew has described an instance of sex reversal in a frog which changed from a normally functioning female to a male that was capable of fertilizing eggs and had 774 offspring, all females. Crew also described a fowl that changed from a fertile female to a fertile male. Riddle reported sex reversal in the pigeon.

Intersexuality in the lower mammals is quite common. It has been described in cattle, sheep, pigs, goats and rabbits. Some of the most interesting studies have developed in connection with "free-martins." The "*free-martin*," known for years to stock breeders, is an incomplete female born co-twin with a male.

The chorionic membranes of the two embryos are fused together and the blood vessels anastomosed so as to produce a common circulation. The testis of the bull calf develops more rapidly than the ovary and its embryonic interstitial gland supposedly exercises a masculinizing influence.

Tandler and Keller (1916) and Lillie (1916 and 1917) independently showed that in the free-martin the twins come from two eggs. They concluded that the free-martin is a female whose gonads have been transformed into a testis-like organ by male hormones from her twin brother. Willier has said, "the primordium of each male structure developed in the free-martin gonad is present in the ovary at the time of sex differentiation." Bissonnette has shown that the free-martin began as a female and developed as such for some time, then became modified in the male direction *internally*, though almost never *externally*.

REFERENCES ON FREE-MARTINS

- BISSONNETTE, T. H. 1924. The development of the reproductive ducts and canals in the free-martin with comparison of the normal. Am. Jour. of Anat., vol. 33, no. 2, pp. 267-345.

- CREW, F. A. E. 1923. Studies in intersexuality. I. A peculiar type of developmental intersexuality in the male of the domesticated mammals. Proc. Roy. Soc., B, vol. 95, pp. 90-109. II. Sex reversal in the fowl. Proc. Roy. Soc., B, vol. 95, pp. 256-278.
- DOMM, L. V. 1927. New experiments on ovariectomy and the problem of sex inversion in the fowl. Jour. Exp. Zoöl., vol. 48, pp. 31-174.
- HARTMAN, C. G. 1920. The free-martin and its reciprocal in the opossum, man, dog. Science, n. s., vol. 52, pp. 469-471.
- LILLIE, F. R. 1917. The free-martin: a study of the action of sex hormones. Jour. Exp. Zoöl., vol. 23.
- LILLIE, F. R. 1923. Supplementary notes on twins in cattle. Biol. Bull., vol. 44, pp. 47-78.
- WILLIER, B. H. 1920. Structures and homologies of free-martin gonads. Jour. Exp. Zoöl., vol. 33, pp. 63-127.

Hen-Feathering in the Seabright Bantam.—We have elsewhere referred (see p. 444, Internal Secretions) to the work of Goodale and others in removing the *ovary* from the fowl, with the result that the bird took on the plumage and the behavior of the cockerel. T. H. Morgan, having observed that the cockerel of the Seabright bantam is normally hen-feathered, performed experiments (1915) which he thought furnished sufficient evidence that hen-feathering in the male was due to endocrine action from luteal cells in the testes. Roxas showed (1926) by cross transplantation of the testes of Seabright and Leghorn fowls that no special hormones are produced by the hen-feathered Seabright bantam, as the *soma* of the Seabright bantam reacts to either the male or the female hormone by hen-feathering. Domm (1927) ovariectomized Leghorn fowls, and noted that a compensatory testis-like organ developed on the right side, but that subsequently the plumage became hen-like. This state resembled that of the Seabright bantam, in which the sexually male bird is hen-feathered. Riddle (Anat. Rec., 1925, vol. 30, pp. 365-384) had previously shown that when the ovary was removed in the bird testicular tissue developed.

Danforth (1928), having made exchange grafts between hen-feathered and cock-feathered male bantams, has shown that the differential factor is inherent in the skin.

REFERENCES ON HEN-FEATHERING

- DANFORTH, C. H. 1928. Proc. Soc. Exp. Biol. and Med., vol. 26, p. 86.
- DOMM, L. V. 1927. Jour. Exp. Zoöl., vol. 48, pp. 31-174.

MORGAN, T. H. 1915. Proc. Soc. Exp. Biol. and Med., vol. 13, p. 31.
 ROXAS, T. A. 1926. Jour. Exp. Zool., vol. 46, p. 63.

Genes.—Johannsen has given the name *genes* to those hereditary germinal *factors* that may sometimes need to combine to produce a visible *somatic character*. *Genotypes* are individuals having the same germinal composition, while *phenotypes* are a group of individuals with similar external features. Genes may act in single pairs or in *several* pairs. Plural genes may be alike in separate effects but *cumulatively* may produce another effect. Again they may be *complementary* or *supplementary* to other factors or they may be *lethal*.

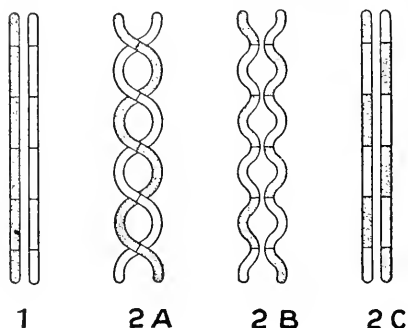

FIG. 268. Crossing over during synapsis of homologous paternal and maternal chromosomes. The segments indicate the assumed linear arrangement of the genes with allelomorphous genes opposite each other. I, pair of chromosomes which have entered and emerged from the synaptic state without any crossing-over; IIa, chromosomes winding about each other at synapsis; IIb, separation of these chromosomes, involving breaking at the points of crossing; IIc, their emergence from synapsis with the members of the pairs of allelomorphous genes interchanged. (After Wilson, from Woodruff, *Foundations of Biology*. Courtesy of The Macmillan Co.)

gand his students, who suggested that when the paired chromosomes are side-by-side at synapsis (Fig. 260) the *factors* of the two chromosomes may become exchanged. If two genes are close together, crossing-over of the two factors is unlikely to occur, but as the distance between them increases, the chances of *crossing-over* are much greater. By this means, Sturtevant, Bridges and others

Chromosome Maps and Crossing Over.

—Morgan and his coworkers have adequately demonstrated that Roux's conception of the chromosomes as a *linear series* of smaller bodies was the correct one. The theory of linear aggregation of genes (Sturtevant) is one that furnishes a satisfactory explanation of such phenomena as linkage and recombination involved in the "cross-over." Janssens' theory¹⁶ of the *chiasmotype* was elaborated by Mor-

¹⁶ Janssens, F. 1909. La theorie de la Chiasmotypie. La Cellule, Tom. 25; also *ibid.*, 34, 1928.

have been able to locate factors in particular chromosomes, mapping out their relative positions.¹⁷ Bridges has recently emphasized the probability that the genes are possessed of tremendous catalytic activity.

Lethal Factors.—It has been found that in the fruit fly (*Drosophila*) a number of lethal factors are in the X-chromosome. Females with the lethal factor in both X-chromosomes will die; and males with the lethal factor in their single X-chromosome likewise die. The males that survive are those that lack the X-chromosome and its lethal mutant factor. Lethal factors exist in some other chromosomes besides the accessory or X-chromosomes.

Non-Disjunction.—In 1913, Bridges discovered that unexpected individuals obtained in his breeding experiments with white-eyed *Drosophila* might be explained by assuming that the X-chromosomes did not disjoin and go to the two poles during maturation division of the egg but remained attached to each other, and passed to one pole. This would leave the other pole without any X-chromosome and in the resultant eggs one-half would possess two X-chromosomes, while the other half lacked the X-chromosome. Cytological evidence supported the hypothesis.

Parthenogenesis.—In parthenogenesis the offspring may be male, female, or parthenogenetic females. In the *Hymenoptera* fertilized eggs develop into females and unfertilized eggs into males. In the *Rotifers* and *Daphnids* the fertilized eggs produce females, but during parthenogenesis males come from small thin-shelled eggs while females develop from larger glycogen-laden eggs. Even in the frog, Parmenter has found that parthenogenetic eggs develop into males and females.

Evidence For and Against the Inheritance of Acquired Characters.

I. Are Somatic Acquirements Transferred as Such to the Germ Cells?—Weismann cut off the tails of mice for nineteen generations without effect on future generations. Blood transfusion refuted the Pangenesis theory. There may be passive transmission of certain dyes, syphilis, white diarrhea, pebrine, and Texas fever. There is

¹⁷ But H. Przibram (*Quanta in biology*, Proc. Roy. Soc. of Edinburgh, vol. 49, pt. 3, pp. 224-231, 1929) suggests that crossing-over may be regarded as a "crosswise substitution of atoms or groups of atoms, the chain of genes remaining unbroken." (Consult T. H. Morgan, *The Theory of the Gene*. Yale Univ. Press, New Haven, Conn., 1926, and C. E. McClung, *The chiasmotype theory of Janssens*. Qu. Rev. of Biol., vol. 2, pp. 344-366, 1927.)

no certainty about maternal inheritance of tuberculosis, but it is possible that there is inherent predisposition. Antitoxins and immune bodies may apparently be transmitted through the egg.

Monstrosities in fishes and echinoderms by alteration of the salt constituency of the water are not heritable. Roberts increased the size of vestigial wings in a race of *Drosophila* by high temperature. Under normal temperature the effect did not persist. Castle and Phillips transplanted guinea-pig ovaries, black to white, demonstrating that the soma has no influence in determining color of the offspring. Griffith found that direction of rotation of rats is specific in the type of disequilibrium produced. Kammerer supplied light stimulus to cave animals and procured eye development. Pictet fed gypsy moths walnut instead of oak leaves, and induced a lighter color, which persisted for only two generations. Johannsen proved that the effect of parental starvation wears off in just a few generations.

II. Can Environment Induce Mutations?—Arsenic, quinine, morphine, alcohol, ether, and other poisons affect the first generation only in *Drosophila*.

Plough (1917), by two consecutive days' exposure of the females to high temperature (31.5° C.), was able to increase the percentage of crossing over in chromosomes II and III of *Drosophila*. His study showed that crossing over in *Drosophila* does not take place in the early oögonial divisions. He considers that his work does not bear on mutations but explains the mechanism of crossing over.

Mavor (1921) x-rayed female *Drosophila* and produced non-disjunction (page 539) of the X-chromosomes, as shown by an increased number of exceptional males and exceptional females in the first generation. These females continued to produce exceptional offspring! Later (1924) as a special case of non-disjunction, he produced gynandromorphs. Mavor and Svenson (1924) increased the percentage of crossing over in chromosomes II and III of *Drosophila* by x-raying the virgin females one day prior to mating.

Little and Bagg (1924) used x-rays on mice, with results suggesting induction of a new gene. Muller (1927) exposed sperms of *Drosophila* to rather heavy doses of x-rays and produced "gene mutations" in a large number of the germ cells. He succeeded in producing with the treated sperms a number of familiar mutants such as "white eye" and "forked bristles" as well as other en-

tirely new mutants. Mutations were produced with x-rays in barley and corn by Stadler, and in tobacco by T. Goodspeed.

Blakeslee produced mutations in *Datura* by exposing the parent plants to cold at flowering time. Goldschmidt (1929) by subjecting early larval stages of *Drosophila* to high temperature (37° C.) secured quite definite mutations. Further important studies have been carried on by ~~Muller~~ Jollos (1930), who claims to produce increasingly graded effects by continued exposure to the same high temperature.

III. Is There Parallel Induction or Independent Simultaneous Modification of Germplasm and Soma?—Stockard and Papanicolau used alcohol fumes on guinea pig parents, producing corneal irritation and opacity in their eyes; their offspring showed a different type of defect. Types of defects appearing in the offspring were abortion and stillborn litters, nervous disorders, eyelessness and monophthalmicum asymmetricum, and body deformations. Parents were unaffected. McDowell and F. Hanson have made important studies on alcoholic effects in mammals, and R. Pearl has concluded that in the fowl alcohol kills the unfit germ cells.

Standfuss, working with butterflies, and Fischer and Schröder, with moths, produced melanism by use of extreme temperature. Some of the offspring showed the character. Harrison and Garrett induced melanism in *Lepidoptera* by adding manganese sulphate and lead nitrate to their diet, and found melanism appearing in certain of the subsequent broods. Schröder reported success in modifying the pupation instinct in certain caterpillars, and feeding habits in others, with the acquirements transmitted. Tower reported modifications in the potato beetle, as a result of temperature and humidity regulation, which were inherited if applied during the germ cell maturation period, but not if treated at other times.

Brown-Sequard produced nervous disorders apparently heritable by injuring sciatic nerve, spinal cord, or brain of guinea pigs. But an epileptic condition is often found in the species.

Kammerer extended the area of yellow on the European salamander by use of a yellow background. The effect persisted in the offspring, regardless of any kind of background. Castle suggested simple selection as the cause. Kammerer also was able practically to change reciprocally the species *Salamandra atra* and *S. maculosa*, not only in reproductive habits, but in other respects as well. Modifications: 1. Number of young greatly reduced (2-7); 2. Intrauterine

fats of eggs and embryos approached that of black salamander; 3. Color almost totally black. (These characters persisted.)

Guyer and Smith injected pulped rabbit lenses into fowls, and injected serum from those treated into pregnant rabbits, without effect on the adult; the offspring showed nearly 15 per cent defective eyes, suggesting antibodies. The defects were transmitted in reciprocal in-and-out crosses through nine generations. Szily, J. Huxley, and other investigators have criticized the experiment severely, and efforts at repetition on the part of several have failed to procure similar results.

Sumner used a cold room on mice to produce shorter tails and feet. Offspring from gestation at ordinary temperature showed the character in three cases, but in the fourth the appearance was reversed. Pavlov trained mice to come for food at ringing of a bell; the number of lessons was reduced from 300 in the first generation to 100 in the second, 30 in the third, and 10 in the fourth. In later generations as few as five lessons were required. Others have not found training effects inherited.

REFERENCES

- DETLEFSEN, J. A. 1925. The inheritance of acquired characters. *Phys. Review*, 5, pp. 244-278.
- GOLDSCHMIDT, R. 1929. Experimentelle Mutation und das Problem der sogenannten Parallel-induktion. *Biol. Zbl.*, 49.
- JOLLOS, V. 1930. Studien zum Evolutionsproblem. *Biol. Zentr.*, Bd. 50, H. 9, S. 541-554.
- MAVOR, J. W. 1921. On the elimination of the X-chromosome from the egg of *Drosophila melanogaster* by X-rays. *Proc. Soc. Exp. Biol. and Med.*, vol. 18, pp. 301-304.
- MULLER, H. J. 1927. The Problem of Genic Modification. *Z. induct. Abstammungslehre*, Supplbd. 1.
- PLOUGH, H. 1917. The effect of temperature on crossing over in *Drosophila*. *Jour. Exp. Zool.*, vol. 24, no. 2, pp. 147-209.

Is There Such a Thing as Inheritance of Disease?—We must at once distinguish between (1) prenatal infection; (2) prenatal injury to the germ or the embryo; (3) the inheritance of weakness predisposing to disease; and, finally, (4) true inheritance due to germinal transmission.

1. Prenatal Infection.—This may occur through the mother in utero or by the infection of either egg or sperm. In all probability,

the majority of cases are those of actual infection before birth. It has been shown that in the fowl the eggs may be infected while in the oviduct with the organisms causing bacillary white diarrhea. There has been some argument over the filterability of the tuberculosis germs, but it is quite probable that even if a child escapes prenatal infection, it will become diseased shortly after birth.

2. Prenatal Injury to the Germ Cells or the Embryo.—Besides weakening the embryo, it has been found that drugs and alcohol may produce anomalies of the brain and eyes, particularly, and in guinea pigs it has been proved that the germ cells may be affected so that the effect will persist for several generations. A mother with goiter may produce defective and goitrous children.

3. Inheritance of Weakness Predisposing to Disease.—Almost any system may be subject to weakness inheritance. The blood-forming organs may be weak and a family line may be unable to resist minor diseases that would ordinarily not prove fatal. A defective pancreas may predispose to diabetes, or one may inherit a general weakness of body, particularly of brain, that predisposes to the use of a stimulant, such as alcohol or some drug.

4. Inheritance through the Germinal Substance.—Insanity, feeble-mindedness, idiocy and allied mental diseases are apparently transmitted through the germs. They may appear in the offspring from two family lines in which the defect has been recessive (not apparent) for several generations. It is therefore wise to know the defects in both strains before marriage, and avoid the production of children defective or abnormal.

Five types of defects are closely tied up with the germinal determiners producing sex. These are Gower's *muscular atrophy*; *hemophilia* (*slow clotting of blood*); *color blindness* or Daltonism (inability to distinguish red from green); *night-blindness*; and a peculiar disease, *neuritis optica*, causing atrophy of the optic nerve. Males inherit these defects and females may transmit them without showing the abnormality. In order to produce them in females it requires a double dose of the determiner. (See page 534.)

Maternal Impressions.—One of the oldest superstitions is the one that if a pregnant mammal is obsessed or frightened by seeing a deformed or peculiarly marked animal, the offspring will resemble the object of interest. The only truth in the idea of maternal impressions lies in the influence of foods and of the emotions on the nutrition of the very early embryo. As reports of maternal im-

pressions are usually based on accidents *long after* the organs and systems of the embryo are developed past the probability of being affected by slight nutritional disturbance, the maternal impression idea must be dismissed as unproved.

Eugenics.—The old cry of the politician (seeking a heavy labor vote) that we must infuse new blood into our land to prevent the decay incident to *inbreeding* of the race becomes less forceful when we view in an unprejudiced way the important work of Doctor King and others in connection with the problem of inbreeding.¹⁸ Doctor King has definitely proved that in the white rat it is possible to select within a line, until, by a long continued process of inbreeding, a stock far superior to the original was produced. We have much evidence also from the long continued inbreeding of race horses and hunting dogs, as well as the vast amount of work on plants.

It matters little whether we are able to determine exactly the acquired characters that are inherited, if we do not exert ourselves to control both the *germplasm* and the *environment*. Certainly degeneration may occur. As Sancho Panza said, "we are as God made us, and some of us even worse."

Believing that there has been an evolution in the differentiation of races, we are attempting to apply our knowledge of heredity to increase the number of superior beings. But these superior persons must be given something besides mere education. As the Iron Duke said, "Gentlemen, if you are only going to educate the children, you are only going to make them clever devils."

With the forces of evil rampant, and with the descendants of reputable people taking on all of the vices and but few of the virtues of certain savages who are trying to make the world a chaos, it would seem that drastic measures must be taken.

Children are shot down in our streets by warring gangsters, and still the so-called "intelligentsia" continue to demonstrate to *their own children* the depths to which people will descend, people who are not willing to conform to the laws of common decency merely because some one has said that it is "fashionable" to break laws. Meanwhile the social aristocracy of our land continue to live decently, and to deplore the degradation of the social climbers who think they are having a "perfectly swell time."

¹⁸ Dahlberg, G. 1929. Inbreeding in man. *Genetics*, vol. 14, no. 5, pp. 421-454. East, E. M., and Jones, D. F. 1919. *Inbreeding and Outbreeding*. J. B. Lippincott & Co.

Negative Eugenics.—One important factor in negative eugenics consists in the regulation of *immigration* by the exclusion of idiots, insane, and otherwise inferior persons from our country. *Segregation* of some of our unfit, so that they are not menaces to society, is another measure in favor at present. *Sterilization* of the most defective individuals is now legal in a number of states. This measure consists in either searing or severing the Fallopian tubes of the female, and in the male the operation of vasectomy, i.e., severing the vas deferens. In neither case does the person lose the benefits of the internal secretions (page 444) but the defectives are unable to reproduce.

Positive Eugenics.—Education is the foremost agency in positive eugenics. By lectures and tracts, the American Eugenics Society is attempting to have as many persons as possible fill out records of their family pedigrees and send them to the Eugenics Record Office, Cold Spring Harbor, L. I. It is also encouraging those best fitted to do so to produce four children per family.



APPENDIX

	Wave-length
Ultraviolet radiation.....	0-390m μ
Extreme region.....	0-200
Gamma rays (arbitrary limits) 0 to 0.01m μ	
Röntgen rays (arbitrary limits) 0.01 to 50m μ	
Middle or intermediate region.....	200-300
Near region.....	300-390
Visible radiation.....	390-770m μ
Violet.....	390-430
Blue.....	430-470
Blue-green.....	470-500
Green.....	500-530
Yellow-green.....	530-560
Yellow.....	560-590
Orange.....	590-620
Red.....	620-770
Infra-red radiation.....	0.77- ∞ μ
Near region.....	0.77- 20
Infra-red photography to 1 μ	
Fluorite prism to 10 μ	
Rock salt prism to 20 μ	
Intermediate region.....	20-500
Selective reflection from rock salt to 50 μ	
Selective reflection from potassium chloride to 61 μ	
"Restrallen" method up to 354 μ	
Electric oscillator method up to 500 μ	
Extreme region.....	500- ∞
Electric waves such as that radiant energy studied by Herz, that used in wireless electric circuits, that resulting from high frequency currents, and that due to ordinary alternating currents complete a long range of wave-lengths to beyond 12 km. in wave-length.	

The More Accurate Equivalents Used for Exacting Computations.

1 cubic inch of water =	251.889	grains
1 inch =	25.4001	millimeters
1 yard =	$\frac{3600}{3937}$	meter
1 U. S. wine gallon =	3785.33	cubic centimeters or 3785.33 grams of pure water
1 meter =	39.370432	inches
1 fluid ounce =	29.5737	cubic centimeters
1 liter =	33.814	fluid ounces
1 pint (O.) =	473.179	cubic centimeters
1 milliliter (cc.) =	16.23	minims
1 gram =	15.43235639	grains
1 grain =	64.7989	milligrams
1 apothecary ounce =	31.1035	grams
1 ounce (av.) =	28.35	grams
1 pound (lb.) =	453.592	grams
1 kilogram (Kg.) =	2.20462	pounds

GLOSSARY

- Absorption** (Lat. *absorbere*, to swallow down): the process by which liquid food or other substances are taken through cell walls.
- Adaptation** (Lat. *adaptare*, to fit): changes in organisms which fit them to their environment.
- Afferent** (Lat. *ad*, to; *fero*, bear) fibers: those conveying stimuli to sense organs, brain or spinal cord.
- Albu'men** (Lat. *albumen*, white of egg): protein residing in white of egg.
- Allan'tois** (Gr. *allas*, sausage; *eidos*, form): membranous organ growing out of the hind gut in the embryos of reptiles, birds and mammals, and serving for respiration and excretion.
- Altricial** (Lat. *altrix*, nurse): birds that are helpless on hatching.
- Am'nion** (Gr. *amnos*, a lamb): membranous sac which encloses the embryos of reptiles, birds and mammals.
- Amphib'ian** (Gr. *amphi*, both; *bios*, life): animals able to live on land and water.
- Anat'omy** (Gr. *ana*, up; *temno*, cut): the science of gross bodily structure.
- Ar'tery** (Gr. *acer*, air; *tereo*, keep): vessels conveying blood from the heart to the organs.
- Ax'on** (Gr. *axon*, axis): main outgrowth of a neuron.
- Blas'tomere** (Gr. *blastos*, embryo; *meros*, part): a cell produced by segmentation of a fertilized egg.
- Blas'topore** (Gr. *blastos*, embryo; *poros*, passage): the external opening of a gastrula.
- Blas'tula** (Gr. *blastos*, germ): the stage at the end of segmentation when the embryo is a hollow sphere with no opening.
- Bronchus**, pl. bronchi (Gr. *bronchos*, windpipe): one of the two large subdivisions of the trachea.
- Calorie** (Lat. *calere*, to be hot): amount of heat required to raise one kilogram of water one degree Centigrade.
- Capillary** (Lat. *capillus*, a hair): the microscopic blood vessels uniting arteries with veins.
- Carbohy'drate** (Lat. *carbo*, coal; Gr. *hydro*, water): food stuffs made of carbon, hydrogen and oxygen, the hydrogen and oxygen being in the same proportion as water.
- Carniv'orous** (Lat. *caro* (carnis), flesh; *vo'rare*, to eat): flesh-eating animals and plants.
- Car'tilage** (Lat. *cartilago*, gristle): the elastic animal tissue forming parts of organs or bones.
- Caud'al** (Lat. *cauda*, tail): pertaining to the tail.
- Cell** (Lat. *cella*, a small room): the unit of living things. A mass of protoplasm inclosing a nucleus, and usually inclosed in a cell wall.
- Cellulose** (Lat. *cellula*, a little cell): an organic substance found in the walls of plant cells, and in the Tunicates.
- Cere** (Lat. *cera*, wax): a fleshy growth at the base of the bill of some birds.
- Chitin** (Gr. *chiton*, a gown or tunic): the outer covering of the bodies of insects and other animals.
- Chlor'ophyll** (Gr. *chloros*, green; *phullon*, leaf): the green substance enabling green plants to utilize sunlight to build up food.

- Chrom'atin** (Gr. *chroma*, color): a stainable constituent of the nucleus.
- Cil'ium** (Lat. *cilium*, an eyelid with eyelashes): a tiny hair-like protoplasmic projection attached to the surface of a cell.
- Cocoon** (Lat. *concha*, shell): the hairy or silken covering of the pupa of some insects; the egg case of spiders and earthworms.
- Coe'iom** (Gr. *koilos*, hollow): the body cavity; location of organs.
- Coleop'tera** (Gr. *coleos*, sheath; *-pteron*, wing): an order of insects with hard wing covers over the flying or true wings: the beetle.
- Conjuga'tion** (Lat. *con*, with; *jugare*, to join): the temporary union of two similar cells for the purpose of exchanging nuclear protoplasm.
- Cor'puscle** (Lat. *corpusculum*, a little body): the floating cells in the blood.
- Cor'tex** (Lat. *cortex*, bark): the fleshy portion of a root surrounding the central cylinder and covered by epidermis.
- Crusta'cea** (Lat. *crusta*, a crust): a class of invertebrates characterized by a hard exoskeleton, as crayfish.
- Cytoplasm** (Gr. *kytos*, vessel; *plasma*, anything formed): the form of protoplasm making up the main part of a cell. It incloses the nucleus, and is inclosed by the cell wall. The protoplasm of a cell excluding the nucleus.
- Den'tine** (Lat. *den(t)s*, a tooth): the inner portion of a tooth.
- Dermis** (Gr. *derma*, skin): the true skin, lying beneath the epidermis.
- Di'aphragm** (Gr. *diaphragma*, a partition wall): the sheet of muscle separating the chest cavity from the abdominal.
- Diges'tion** (Lat. *digestio*, the dissolving of food): the preparing of food for absorption.
- Dip'tera** (Gr. *di*, twice; *pteron*, wing): an order of insects having only two wings, as fly and mosquito.
- Ec'toderm** (Gr. *ectos*, outside; *derma*, skin): the outer layer of cells of animals.
- Ec'toplasm** (Gr. *ectos*, outside; *plasma*, thing moulded): the outside layer of unicellular organisms.
- Em'bryo** (Gr. *embryon*, an embryo): an organism within the egg membrane.
- Embryol'ogy** (Gr. *embryon*, an embryo; *logos*, a talk or discourse): the study of the early development of organisms.
- Encyst'ment** (Gr. *en*, in; *kystis*, a bladder): the inclosing in a resistant covering; forming of a cyst.
- En'docrine system** (Gr. *endon*, within; *krinein*, to separate): all the tissues of internal secretion; the ductless glands.
- Endoderm** (Gr. *endon*, within; *derma*, skin): the inner layer of cells in animals.
- En'doplasm** (Gr. *endon*, within; *plasma*, substance): the inner portion of the protoplasm in unicellular animals.
- En'dostyle** (Gr. *endon*, within; *stulos*, pillar): ventral glandular groove in the pharynx of Amphioxus.
- En'zyme** (Gr. *en*, in; *zyme*, leaven): a substance secreted by organisms which induces chemical changes, as digestion.
- Ephemer'ida** (Gr. *ephemeris*, for a day): an order of insects which live only a few hours.
- Epiph'ysis** (Gr. *epiphysis*): the bony disk or pad, derived from a separate center of ossification, found at either extremity of limb bones and vertebrae.
- Epithel'ium** (Gr. *epi*, upon; *thelc*, teat): a sheet of tissue covering or lining a surface.
- Eryth'rocyte** (Gr. *erythros*, red; *kutos*, cell): a red blood-corpuscle.
- Eugen'ics** (Gr. *eugenes*, well-born): the study of heredity for improvement of offspring.

- Evolu'tion** (Lat. *e*, out; *volvo*, roll): organic descent.
- Excre'tion** (Lat. *excretus*, separated out): waste products removed from the protoplasm.
- Excur'rent** (Lat. *ex*, out; *currere*, to run) stem: a stem extending from base to tip without dividing, as spruce and cedar.
- Exhal'ant** (Lat. *ex*, out; *halo*, breathe) pore: the central opening at the top of a sponge through which water passes outward.
- Ex'oskeleton** (Gr. *ex*, out; *skeleton*, a dried body): outer covering of animals.
- Exten'sors** (Lat. *ex*, out; *tendo*, stretch): muscles which straighten an appendage at the joint, as arm.
- Fe'ces** (Lat. *faeces*, dregs): wastes from the digestive system; excrement.
- Fertiliza'tion** (Lat. *fertilis*, from *fero*, bear): the union of the sperm nucleus with the egg nucleus to form a new organism.
- Fibrin'ogen** (Fr. *fibre*, a fiber): the blood substance inducing clotting by the production of fibers when exposed to air.
- Flagel'lum** (Lat. *flagellum*, a whip): a long protoplasmic projection, used chiefly for locomotion.
- Flex'ors** (Lat. *flectus* (flecto), bend): muscles that bend the joints; those which oppose the extensors.
- Func'tion** (Lat. *functio*, performance): the normal action of organisms.
- Gall** (Lat. *galla*, gallnut): a growth produced on certain leaves by the action of insects; the bile.
- Gan'glion** (Gk. *ganglion*, tumor): an aggregation of nerve cell-bodies.
- Gene** (Gr. *genos*, origin): heredity factors which segregate according to Mendelian principles.
- Gen'us** (Lat. *genero*, beget): a group of organisms containing one or more species.
- Giz'zard** (Lat. *gigeria*, cooked entrails of poultry): the muscular chamber for grinding food in birds.
- Glomer'ulus** (Lat. *glomerio*, make a ball): minute rounded bodies in the cortex of a kidney; a knot of blood vessels; a Mapighian body.
- Glott'is** (Gr. *glotta*, tongue): the tracheal opening.
- Glu'cose** (Gr. *glykys*, sweet): constituent of sucrose found in fruits; the product of the digestion of starch.
- Gly'cogen** (Gr. *glykys*, sweet; *gen*, producing): animal starch stored in the liver.
- Go'nad** (Gr. *gonos*, reproduction): an organ of sexual reproduction (ovary or testis).
- Hab'itat** (Lat. *habito*, inhabit): dwelling-place; region of activity.
- He'moglobin** (Gr. *haima*, blood; L. *globus*, round): the red coloring matter in blood, concerned with the transport of oxygen.
- He'morrhage** (Gr. *haima*, blood; *rhegnymi*, break): the discharge of blood from a ruptured blood vessel.
- Hemip'tera** (Gr. *hemi*, half; *pteron*, wing): an order of insects whose wings are hard anteriorly and membranous posteriorly.
- Hered'ity** (Lat. *heres*, a hair): the passing on of characters of parents or other ancestors to offspring.
- Hiberna'tion** (Lat. *hiems*, winter): a death-like torpor and rigidity brought about by extreme cold in some animals.
- Histology** (Gr. *histos*, web; *logos*, discourse): the study of tissues and cells.
- Homop'tera** (Gr. *homos*, same; *pteron*, wing): a group of insects with wings of the same texture throughout as contrasted with Hemiptera.

- Hor'mones** (Gr. *hormacín*, to excite): substances secreted directly into the blood in one part of the body which incite action in another part of the body.
- Humor** (Lat. *humere*, to be moist): the transparent liquids of the eyeball.
- Hymenop'tera** (Gr. *hymen*, a membrane; *pteron*, wing): an order of insects (including bees) with membranous wings.
- Ichneu'mon** (Gr. *ichneuo*, hung): a hymenopterous insect which lays its eggs on the larvae of other insects or in them; a helpful parasite.
- Immu'nity** (Lat. *immunis*, free from duty): the condition which prevents a person from contracting infectious diseases.
- Incis'or** (Lat. *incido*, cut into): a cutting tooth.
- Insectiv'ora** (Lat. *insectum*, insect; *voro*, to eat): order of insect-eating vertebrates, including moles.
- Inser'tion** (Lat. *insertus*, from *in*, in; *sero*, join): the place of attachment of a muscle.
- Integ'ument** (Lat. *in*, in; *tego*, cover): an outer covering or envelope, as the skin.
- Intes'tine** (Lat. *intestinus*, internal): the alimentary canal in vertebrates between the stomach and the anus.
- I'ris** (Gr. *iris*, rainbow): the colored portion of the eye.
- Irritabil'ity** (Lat. *irritabilis*, from *irrito*, excite): reaction to stimuli.
- Joint** (Lat. *jungo*, join): meeting-place of two bones; an articulation.
- Lep'idop'tera** (Gr. *lepis*, scale; *pteron*, wing): the order of insects characterized by scaly wings, as moths and butterflies.
- Leu'cocyte** (Gr. *leukos*, white; *kutos*, vessel): a white blood-corpuscle.
- Lig'ament** (Lat. *ligare*, to bind): a band of tissue binding one bone to another.
- Lip'oid** (Gr. *lipos*, fat; *eikos*, like): a substance found in the nervous system which is dissolved by anaesthetics or narcotics.
- Locomo'tion** (Lat. *locus*, place; *motus* from *moveo*, move): movement from one place to another.
- Lymphat'ic** (Lat. *lympa*, clear water): a vessel conveying lymph.
- Mala'ria** (Lat. *malus*, bad; *aer*, air): a disease caused by parasitic protozoons which live in the mosquito, *Anopheles*, during part of their life history, and part in the blood of man to which they are transmitted only by the bite of this mosquito.
- Mam'mary** (Lat. *mamma*, breast) glands: the milk-secreting glands, characteristic of mammals.
- Man'dible** (Lat. *mandere*, to chew): the cutting part of the mouths of crustaceans.
- Marsu'pials** (Gr. *marsipion*, a little pouch): an order of mammals having a pouch in which the young are carried, as opossum, kangaroo.
- Medus'a** (Gr. *medousa*, the gorgon): a name given to the main free-swimming type of Coelenterate, the jelly-fish.
- Mes'entery** (Gr. *mesos*, middle; *enteron*, intestine): tissue which suspends the intestine from the dorsal wall of the abdomen.
- Metamor'phosis** (Gr. *meta*, beyond; *morphe*, form): a life history in which the organism passes through abrupt changes of form, as the butterfly, frog.
- Mesotho'rax** (Gr. *mesos*, middle; *thorax*, thorax): the middle section of the thorax of an insect.
- Metab'olism** (Gr. *meta*, beyond; *ballein*, to throw): the chemical processes which take place in a living organism.
- Migra'tion** (Lat. *migro*, move): moving from one locality to another, as birds, salmon.

- Mim'icry** (Gr. *mimikos*, imitative): resemblances in form or color shown by some organisms to other objects, to protect themselves.
- Mito'sis** (Gr. *mitos*, thread): the processes in typical nuclear division.
- Mollusks** (Lat. *mollis*, soft): a group of animals having soft bodies, usually covered by one or two shells.
- Morphol'ogy** (Gr. *morphe*, form; *logos*, discourse): study of structure and form.
- Motor** (Lat. *moveo*, move) fibers: nerve fibers which convey impulses to the muscles, producing motion.
- Mu'cous** (Lat. *mucus*, slime) membrane: the lining of the alimentary canal and respiratory tract.
- My'osin** (Gr. *myo*, muscles): the form of protein found in muscle.
- Myriop'oda** (Gr. *myrioi*, ten thousand; *pous*, foot): a group of crustaceans having four legs on each segment.
- Neuroblast** (Gr. *neuron*, sinew; *blastos*, germ): an embryonic nerve cell.
- Neu'ron** (Gr. *neuron*, sinew): a nerve cell with all its processes.
- No'tochord** (Gr. *notos*, the back; *chorde*, a string): a rod of cells in all vertebrate embryos.
- Nour'ishment** (Lat. *nutrio*, nurse or feed): growth-promoter; food.
- Nu'cleus** (Lat. *nucleus*, a kernel): specialized protoplasm.
- Nutri'tion** (Lat. *nutrio*, nurse or feed): that which promotes growth.
- Odon'a'ta** (Gr. *odontos*, toothed): an order of insects, including dragon flies and damselflies.
- Oesoph'agus** (esophagus) (Gr. *oiso*, will bear; *phagein*, to eat): the alimentary canal between the pharynx and stomach.
- Oper'culum** (Lat. *operculum*, lid): the gill cover in fishes.
- Optic** (Gr. *optikos*, sight) nerve: nerve which conducts stimuli from retina to brain.
- Or'ganism** (Gr. *organon*, instrument): a living body.
- Or'thogen'esis** (Gr. *orthos*, straight; *genesis*, descent): evolution in a definite direction.
- Orthop'tera** (Gr. *orthos*, straight; *pteron*, wing): a group of insects whose outer wings meet in a straight line in the middle of the back, as grasshoppers and crickets.
- Osmo'sis** (Gr. *osmos*, pushing): the passing of soluble substances through a moist membrane, the greater movement being towards the denser liquid.
- Par'asite** (Gr. *para*, beside; *sitein*, to feed): an animal or plant which lives upon another living organism injuring its host.
- Parathyroid** (Gr. *para*, beside): a small ductless gland near the thyroid controlling the calcium metabolism of the body.
- Pec'toral** (Lat. *pectus*, breast) girdle: the bones which support the anterior limbs of vertebrates and attach them to the trunk.
- Pericar'dium** (Gr. *peri*, around; *cardia*, heart): the membranous sac inclosing the heart.
- Perios'teum** (Gr. *peri*, around; *osteon*, bone): the membrane which adheres to and covers the bones.
- Peristal'sis** (Gr. *peri*, around; *stalsis*, constriction): the squirming motion in the intestine caused by its muscles.
- Perspira'tion** (Lat. *per*, through; *spiro*, breathe): the watery secretion of the perspiratory glands.
- Pha'gocytes** (Gr. *phagein*, to eat; *cytos*, sac): the white corpuscles of the blood which act as scavengers.

- Photosyn'thesis** (Gr. *phos*, light; *synthesis*, putting together): food-making by green plants in presence of sunlight.
- Phylum** (plural phyla) (Gr. *phulon*, tribe): one of the main groups of the animal kingdom; about twelve groups are recognized.
- Physiol'ogy** (Gr. *physis*, nature; *logos*, discourse): the study of the life processes of organisms.
- Pin'eal** (Lat. *pinea*, a pine cone): an organ of doubtful function situated anterior to the corpora quadrigemina of the brain.
- Plas'ma** (Gr. *plasma*, formative material): the liquid portion of the blood of vertebrates.
- Plecop'tera** (Gr. *plectos*, plaited; *pteron*, wing): an order of insects having plaited wings, as stone flies.
- Poi'son** (Lat. *potio* from *poto*, drink): any substance harmful to the system of an organism.
- Polyp** (Gr. *polus*, many; *pous*, foot): the sessile type of Coelenterate having numerous tentacles.
- Por'tal** (Lat. *porta*, gate) vein: the large vein that carries blood to the liver.
- Pro'tein** (Gr. *protos*, first): a compound of oxygen, hydrogen, carbon and nitrogen, with traces of other elements.
- Pseudopod'ium** (Gr. *pseudes*, false; *pous*, foot): a projection of protoplasm used by protozoons for locomotion.
- Pro'toplasm'** (Gr. *protos*, first; *plasma*, form): the physical basis of life; the living substance contained in organisms.
- Pro'tozoon** (plural protozoa) (Gr. *protos*, first; *zoon*, animal): a unicellular animal.
- Pty'alín** (Gr. *ptyalon*, spittle): the enzyme in saliva changing starch to sugar.
- Pylor'us** (Gr. *pyloros*, gate-keeper): stomach-intestinal opening.
- Rapto'res** (Lat. *rapere*, to ravish): an order of birds having sharp hooked beaks and strong, sharp talons; birds of prey.
- Reces'sive** (Lat. *re*, back; *cedo*, yield) characters: those not appearing in a hybrid, owing to the dominance of other characters.
- Rec'tum** (Lat. *rectus*, straight): the terminal portion of the alimentary canal.
- Re'flex** (Lat. *re*, back; *flecto*, bend) action: non-mental action.
- Re'genera'tion** (Lat. *re*, again; *genero*, beget): restoration of a lost part by growing a new one, as the tentacle of a hydra.
- Reproduc'tion** (Lat. *re*, again; *pro*, before; *duco*, lead): begetting like; like producing like.
- Respira'tion** (Lat. *re*, again; *spiro*, breathe): oxidation of protoplasm releasing energy and producing carbon dioxide.
- Ret'ina** (Lat. *rete*, net): the black inmost layer of the eyeball which receives the stimuli of light rays and conducts them to the brain through the optic nerve.
- Ru'minant** (Lat. *rumen*, throat): an animal which chews its cud, as cow.
- Sali'va** (Lat. *saliva*, spittle): the natural moisture in the mouth secreted by the salivary glands.
- Sclerot'ic** (Gr. *skleros*, hard) coat: the tough outer coat of the eyeball.
- Scute** (Lat. *scutum*, scale): one of the large scales on the snake's abdomen.
- Scutel'lum** (Lat. dim. of *scutum*, shield): the shield-shaped cotyledon lying under the embryo in grains.
- Sex'ual** (Lat. *sexus*, sex) reproduction: a new individual arising from the union of an egg and sperm.

- So'ma** (Adjective, somatic) (Gr. *soma*, a body): the part of the organism limited to its individual life; non-reproductive.
- Sperm** (Gr. *sperma*, from *speiro*, sow): the male element in sexual reproduction.
- Sphinc'ter** (Gr. *sphiggo*, bind tight): a circular band of muscle which closes an aperture by its contraction.
- Spu'tum** (Lat. *sputus*, from *spuo*, spit): expectorated matter characteristic of certain diseases.
- Steap'sin**: a digestive ferment found in the pancreatic juice which assists in the digestion of fats.
- Ster'ile** (Lat. *sterilis*, barren): free from bacteria of every kind; infertile.
- Stig'ma** (Gr. *stigma* from *stizo*, prick): any agent that excites to organic action.
- Stom'ach** (Gr. *stomachos* from *stoma*, mouth): the sac or enlarged portion of the digestive tract between the esophagus and intestine.
- Sucto'ria** (Lat. *suctus*, from *sugo*, suck): an order of insects which have sucking mouths, as fleas.
- Su'ture** (Lat. *sutura*, from *suo*, sew): the joining of two bones by mutually serrated edges, forming an immovable articulation, as in the bones of the skull.
- Symbio'sis** (Gr. *syn*, together; *bios*, life): the close relationship of two organisms for mutual benefit.
- Tar'sus** (Gr. *tarsos*, any flat surface): the ankle; the scaly part of a bird's leg; the terminal segment of an insect's foot.
- Ten'don** (Lat. *tendo*, stretch): the connective tissue ending of a muscle which attaches it to other structures.
- Ten'tacle** (Lat. *tento*, touch, try): a jointed flexible appendage of the head used for touch, grasping, or motion; a feeler.
- Tes'tis** (Lat. *testis*, a testicle): an organ in a male animal where sperms are produced.
- Thy'roid** (Gr. *thurcos*, shield; *idos*, form) gland: a large ductless gland on the outside of the trachea below the larynx which secretes thyroxin ($C_{15}H_{11}O_4N_4$).
- Tra'chea** (Gr. *tracheia*, windpipe): the air passage from the pharynx to the lungs; an air tube in insects and spiders.
- Tra'cheole** (dim. of *traches*): one of the fine branches of the Tracheae.
- Trichinel'la** (Gr. *thrix*, hair): a small round worm sometimes found in pork living as a parasite, and the cause of trichinosis in man.
- Tri'chocysts** (Gr. *thrix*, hair; *kystis*, bag): dart-like organs of offense and defense found in paramecium.
- Tro'chanter** (Gr. *trochanter*, from *trecho*, run): the second joint of an insect's leg.
- Tryp'sin** (Gr. *tripsis*, a rubbing): an enzyme of the pancreatic juice.
- Tur'gid** (Lat. *turgeo*, swell): distended with air or liquid; swollen.
- Ungula'ta** (Lat. *unguis*, nail): a group of mammals characterized by hoofs.
- Ure'a** (Gr. *ouron*, urine): a nitrogenous compound ($CO(NH_2)_2$), the chief waste product discharged in mammalian urine.
- Ure'ter** (Gr. *oureter*, from *ouron*, urine): a tube, one of two, leading from the kidneys to the bladder and carrying off the nitrogenous waste in the urine.
- U'ropod** (Gr. *oura*, tail; *pod*, from *pous*, foot): the modified swimmerets on either side of the last segment of a crayfish. These, together with the telson (the modified last segment), make up an appendage useful in swimming backwards.
- Ven'tricle** (Lat. *ventriculus*, a little belly): one of the lower chambers of the heart.

- Vermi'form** (Lat. *vermis*, worm; *forma*, form) appendix (Lat. *ad*, to; *pendo*, hang): a slender tubular pouch of the large intestine near its juncture with the small intestine.
- Ver'tebrates** (Lat. *verto*, turn): the group of animals having backbones.
- Villi** (Lat. *villus*, a hair): the minute projections which cover the lining of the small intestine; organs of absorption.
- Vis'cera** (Lat. *viscus*, an organ of a cavity of the body): the organs of the abdominal cavity.
- Vi'tamin** (Lat. *vita*, life): certain substances in foods necessary for the proper functioning of vital processes.
- Vivip'arous** (Lat. *vivo*, live; *pario*, bear): producing young alive, as cat, man.
- Zy'gote** (Gr. *zygon*, joined together): the cell produced by the fusion of gametes in sexual reproduction.
- Zy'mase** (Gr. *zyme*, a ferment): the ferment; a digestive enzyme.

TABLE OF THE ELEMENTS.
SYMBOLS—ATOMIC NUMBERS—ATOMIC WEIGHTS.

	Symbol	At. number	At. weight		Symbol	At. number	At. weight
Aluminum	Al	13	26.97	Mercury	Hg	80	200.61
Antimony	Sb	51	21.77	Molybdenum	Mo	42	96.0
Argon	A	18	139.91	Neodymium	Nd	60	144.27
Arsenic	As	33	74.96	Neon	Ne	10	20.2
Barium	Ba	56	137.37	Nickel	Ni	28	58.69
Beryllium	Be	4	9.02	Nitrogen	N	7	14.008
Bismuth	Bi	83	209.00	Osmium	Os	76	190.8
Boron	B	5	10.82	Oxygen	O	8	16.000
Bromine	Br	35	79.916	Palladium	Pd	46	106.7
Cadmium	Cd	48	112.41	Phosphorus	P	15	31.027
Calcium	Ca	20	40.07	Platinum	Pt	78	195.23
Carbon	C	6	12.000	Potassium	K	19	39.096
Cerium	Ce	58	140.25	Praseodymium	Pr	59	140.92
Cesium	Cs	55	132.81	Radium	Ra	88	225.95
Chlorine	Cl	17	35.457	Radon	Rn	86	222
Chromium	Cr	24	52.01	Rhenium	Re	75	188.7
Cobalt	Co	27	58.94	Rhodium	Rh	45	102.91
Columbium	Cb	41	93.1	Rubidium	Rb	37	85.44
Copper	Cu	29	63.57	Ruthenium	Ru	44	101.7
Dysprosium	Dy	66	162.52	Samarium	Sm	62	150.43
Erbium	Er	68	167.7	Scandium	Sc	21	45.10
Europium	Eu	63	152.0	Selenium	Se	34	79.2
Fluorine	F	9	19.00	Silicon	Si	14	28.06
Gadolinium	Gd	64	157.26	Silver	Ag	47	107.880
Gallium	Ga	31	69.72	Sodium	Na	11	22.997
Germanium	Ge	32	72.60	Strontium	Sr	38	87.63
Gold	Au	79	197.2	Sulfur	S	16	32.064
Hafnium	Hf	72	178.6	Tantalum	Ta	73	181.5
Helium	He	2	4.000	Tellurium	Te	52	127.5
Holmium	Ho	67	163.5	Terbium	Tb	65	159.2
Hydrogen	H	1	1.008	Thallium	Tl	81	204.39
Indium	In	49	114.8	Thorium	Th	90	232.15
Illinium	Il	61		Thulium	Tm	69	169.4
Iodine	I	53	126.932	Tin	Sn	50	118.70
Iridium	Ir	77	193.1	Titanium	Ti	22	47.90
Iron	Fe	26	55.84	Tungsten	W	74	184.0
Krypton	Kr	36	82.9	Uranium	U	92	238.17
Lanthanum	La	57	138.90	Vanadium	V	23	50.96
Lead	Pb	82	207.22	Xenon	Xe	54	130.2
Lithium	Li	3	6.940	Ytterbium	Yb	70	173.6
Lutecium	Lu	71	175.0	Yttrium	Y	39	89.0
Magnesium	Mg	12	24.32	Zinc	Zn	30	65.38
Manganese	Mn	25	54.93	Zirconium	Zr	40	91.22
Masurium	Ma	43					

INDEX

Numbers refer to pages. Bold face numbers indicate Figures and Tables.

- ABDOMINAL PORES, 236
Abel, 445
Abomasum, 434
Absorption, 109
Acanthocephala, 96
Acarina, 201
Accessory chromosome, 533
Acid secreting glands, octopus, 158
Ackert, 93
Actinozoa, 63
Action of the heart, 453
Adaptation of fishes, 261
Adaptation of leech, 117
Adaptations of reptilia, 332
Adhesive pads, 310
Adipose, 426, 436
Adrenals, 447
Aedes, 189
Aelosomatidae, 105
African buffalo, 407
African crocodile, 309
African "hairy frog," 291
African lung-fishes, 252
African wart hog, 401
African Wild Ass, 400, 491
Age, Piltdown Man, 416
Aglossa, 293
Agglutination, 458
Akeley, 414
Albatross, 339
Albino rat, 393
Alcohol and snake-bite, 329
Allen, 444
Alligator snapping turtle, 305
Alpaca, 402
Alpha hormone, 449
Alpine marmot, 392
Alpine race, 417
Alpine salamander, 267
Alternate functioning of the ovaries, 532
Alternation of generations in *Obelia*, 59, 60-61
Aluminium, 440
Alveolar theory, 8
Ambulacral plates and pores, 132
Ambystoma, 268
Ameba proteus, 22
Amenhat I, lion-hunter, 381
American alligator, 309
American bison, 407
American black snake, 315
American caribou, 403
American "chameleon," 313
American crocodile, 309
American eagle, 345, 346
American elk or wapiti, 402
American golden plover, 342, 366
American goshawk, 346
American hook-worm, 92
American monkeys, 412
American moose, 402, 404
American porcupines, 394
American woodcock, 343
Amia calva, 242
Amitosis, 500
Amitosis in the cockroach, 500
Ammocoetes, 223
Amnion and Allantois, 302
Amniota, 302
Amphibia, 265-301; classification, 265; characteristics, 265; economic importance, 300; fossil relatives, 300
Amphidiscs, 50
Amphioxus, 214
Amphioxus Theory, 217
Amphipoda, 173
Amphitrite, 104
Amphiumidae, 267
Amylopsin, 432
Anabolism, 8

- Anaconda, 314
 Anadromous fishes, 263
 Anamniota, 302
 Anaphase, 501
 Anas boschos, 495
 Anatomy, 526
 Anatomy and Physiology of Birds, 354
 Anatomy of lobster, 164
 Anaximander, 510
 Angel-shark, 228
 Angora goat, 405
 Anguillulidae, 91
 Anguis fragilis, 309
 Animal starch, 431
 Annelida, 100-120; characteristics, 100;
 economic importance, 119-120
 Annelid Theory, 219
 Annulata, 100
 Annulated snake, 316
 Anophelines, 189, 190, 191
 Anseriformes, 339
 Antelope, 404, 406
 Anthropoid ape, 413
 Ant lion, 185
 Anti-venin serum, 329
 Ants, 197
 Anura, 269
 Aortic arches, 109
 Aphids, 185
 Aphrodite, 102
 Apoda, 266
 Apoidea, 198
 Appendix, 430
 Aptera, 178
 Apteryx, 335
 Aquatic mammals, 423
 Arachnida, 201
 Arachnid Theory, 218
 Araneida, 201
 Archeopteryx, 370
 Archeornis, 371
 Archeornithes, 334
 Archi-Annelida, 100, 101
 Archosauria, 331
 Arctic fox, 388
 Arctic tern, 366
 Arenicola, 104
 Aristotle, 510
 Aristotle's lantern, 138
 Armadillo, 397
 Army worm, 186
 Arrow poison from toads, 301
 Arsenic, 439
 Artemia fertilis, 170
 Artemia salina, 170
 Arterial circulation of skate, 233
 Arterial system of salamander, 294
 Arteries of cat, 450
 Arteries of frog, 280
 Arthropoda, 163-219; classification, 163;
 characteristics, 163
 Arthropod Theory, 218
 Artiodactyla, 41, 401
 Ascaris lumbricoides, 88, 89
 Ascending colon, 433
 Asiatic badger, 387
 Asiatic buffalo, 407
 Asiatic holy apes, 413
 Asiatic Wild Ass, 400, 491
 Asp, 318
 Aspidium, for tape-worm, 81
 Association of the same species, 483
 Asterias forbesii, 130, 131
 Astylosternus, 291
 Atlantic flying fish, 244
 Atlantic green turtle, 304
 Atoke, 118
 Atoll, 66
 Atomic weights, See Appendix
 Audition, 475
 Aurelia, 62
 Aurochs, 494
 Australian ant-eater, 376
 Australian black snake, 319
 Australian lung-fish, 252
 Australian race, 417
 Auto-catalysts, 440
 Autolytus, 102
 Autotomy, 139
 Aves, 334-372; classification, 337; fossil rel-
 atives, 370; economic importance, 368;
 speed of flight, 368; migration in, 366
 Axis for coral colony, 64
 Axolotl, 268
 Axone, 473
 Aye-aye, 412

- BABOONS, 413
 Badger, 387
 Badger skunk, 387
 Bagg, 540
 Balanoglossus, 210
 Balanus, 171
 Baleen, 428
 Baleen whales, 410
 Baltimore oriole, 366
 Baly, 436
 Bankia, 150
 Banta, 170
 Banting, 445
 Barba amarilla, 323
 Barbour, 328
 Bark lice, 179
 Barn owl, 349
 Barnacles and colors, 173
 Barracuda, 243
 Barred owl, 349
 Barriers, 490
 Basilar membrane, 475
 Bataillon, 299
 Bateson, 516
 Bauhin, K., antedated Linnaeus, 512
 Bayer, 29
 Bay lynx, 381
 Bdelloura, 72
 Beaded lizards, 310
 Beaks of birds, 356
 Bean weevil, 195
 Beché de mer, 141
 Bed-bug, 184
 Belted king fisher, 350
 Beri-beri, 442
 Best, 445
 Beta hormone, 449
 Big-eared bat, 380
 Bilateral symmetry, in Echinodermata,
 140
 Bile, 432
 Bilirubin, 457
 Binary fission, 26
 Binomial nomenclature, Bauhin, 512
 Biology, 1
 Biophors, 518
 Bios, 443
 Bird-lime, 154
 Bird Migration, 366
 Bird of paradise, 351
 Bird Songs, 363
 Birds as insect enemies, 200
 Bishop, 268
 Bissonnette, 367, 536
 Biting lice, 179
 Black, D., 417
 Black bear, 384
 Black duck, 341
 Black fish, 411
 Black fox, 388
 Black-head in turkeys, 29
 Black rat, 393
 Black-tongue, 443
 Black widow spider, 203
 Bladder-worm of Cestodes, 79
 Blakeslee, 541
 Blastula, 160
 Blattidae, 180
 Blind-worm, 309
 Blood calcium, 457
 Blood Groups, 457
 Blood of Camelidae, 457
 Blood, of fish, 254; man, 452; snake, 327
 Blood platelets, 457
 Blue Andalusian fowl, 520
 Blue-bird, 352
 Blue crab, 175
 Boa constrictor, 315
 Bobolink, 353
 Bob-white, 343
 Body louse, 185
 Body sensations, 477
 Bone, 426
 Bonito, 251
 Book-lice, 179
 Boring sponges, 51
 Boron, 440
 Bot-fly, 188
 Botryllus gouldii, 211
 Bowen, 6
 Bow fin, 241
 Brachiopoda, 127
 Bradley, 440
 Bragg, 516
 Brain, earthworm, 115
 Branchinecta packardii, 171

- Branchiopoda, 170
 Branchiostoma, 214
 Branchipus, 170
 Bridges, 539
 Brine shrimp, 170
 Brittle stars, 135
 Britton, temperature extremes, 260
 Bromine, 440
 Brooks, 3
 Brook trout, 243
 Brouzas, 418
 Brownell, 447
 Brown Kodiak Bear, 384
 Brown Orang-utan, 413
 Brown rat, 393
 Brown-Sequard, 541
 Brow spot, frog, 273
 Brues, 490
 Bruno, 511
 Brush tongued parrots, 349
 Bryozoa, 127
 Bubonic plague and rat fleas, 194
 Buccal glands, 359
 Buckland, toads in stone, 300
 Buddha images in mussel, 150
 Budding in Coelenterata, 69
 Buffalo-moth, 195
 Buffon, 512
 Bufonidae, 270
 Bulbus cordis, 282
 Bull-frog, 272
 Bull head, 244
 Bumble-bees, 198
 Burrell, 374
 Burrowing owl, 349
 Burrows, 495
 Bursa Fabricii, 361
 Bushmaster, 321
 Butcher bird, 353
 Butterfish, 259
 Butterflies, 187
 Butterfly wings, color in, 188
 Button, of rattlesnake, 327

 CABBAGE BUG, 184
 Cabbage butterfly, 188
 Cacique, 366
 Caecoma radicolica, 91
 Caddice fly, 185, 186, 487
 Caimans, 309, 326
 Calcareous sponges, 47
 Calciferous glands, 107
 California condor, 347
 California ground squirrel, 390, 391
 California sea lion, 389
 Caligus mutabilis, 172
 Camels, 401
 Cameos, 152
 Canada lynx, 380, 382
 Cannibalism of lobster, 168
 Cannon, 448
 Cantharides, 196
 Cape buffalo, 407
 Cape viper, 320
 Capuchin or "ring-tail" monkey, 412
 Carbon, 9
 Carbohydrates, 8, 436
 Carbon tetrachloride in nematosis, 97
 Carcajou, 385
 Cardiac muscle, 427
 Cardiac stomach, starfish, 132
 Care of the young of Reptilia, 327
 Carinatae, 334, 337
 Carnivora, 380
 Carnivorous, 482
 Carothers, 505, 506
 Carotin, 442, 505
 Carpet beetles, 194
 Carrel, A., 495
 Cartilage, 426
 Casselberry, 330
 Cassowary, 335
 Cat, 491; and birds, 200
 Catadramous fishes, 264
 Catalysts, 10, 436, 440
 Cattalo, 408
 Cattle, 494
 Cattle tick, 201
 Caucasian race, 417
 Caudata, 266
 Cave-fishes, 244
 Cave salamander, 268
 Caviar, 241
 Cecum of snake, 326; of cony, 398; of
 cat, 432
 Cells and tissues, 424

- Cell division, 500
 Cell wall, 5
 Centipedes, 177
 Central nervous system of lobster, 167
 Centrosome, 5
 Cephalochorda, 214
 Ceratitis capitata, 193
 Cercaria, 78
 Cerebellum, 469
 Cerebral cortex, 469
 Cerebral nerves of fishes and amphibia,
 290
 Cerebro-spinal fluid, 469
 Cerebrum, 469
 Cetacea, 410
 Chaetopoda, 100, 101
 Chaetopterus, 103
 Chalcid fly, 196
 Chalk, 25
 Chambers, micro-dissection needle, 502
 Chameleons, 313
 Chamois, 405
 Chandler, A., 98
 Characteristics of Craniata, 221
 Characteristics of Cyclostomata, 22
 Characteristics of skate, 227
 Cheeta, 382
 Chelonia, 304, 331
 Chemical characteristics of protoplasm,
 435
 Chemical composition of the blood, 455
 Chemical elements of protoplasm, 437
 Chenopodium for tapeworm, 81
 Chevrotain, 401
 Chiasmatype, 538
 Chief ganglionic categories, 478
 Child, axial gradient theory, 83-84
 Child families, 486
 Chilodon, 35
 Chimaeroid fish, 227, 230
 Chimney swift, 352
 Chimpanzee, 414
 Chinese alligator, 309
 Chipmunk, 390, 392
 Chiroptera, 379
 Chitin, composition of, 205
 Chiton, 151
 Chlorine, 438
 Chlorocruorin, 109
 Chloroform and snakes, 329
 Choanocytes, 49, 53
 Chondrostei, 240
 Chordata, classification of, 209
 Chromatin diminution, Fogg, 503
 Chromosomes, definition of, 7; behavior,
 507; maps, 538
 Chromatophores, 254
 Chrysoidea, 198
 Chrysolmelidae, 195
 Chyle, 433, 459
 Chyme, 430
 Cicada, 184
 Ciliata, 30
 Circulatory system, 449
 Circulatory system of lobster, 165; Rep-
 tilia, 327
 Circumvallate papillae, 429
 Cirripectida, 171
 Civets, 383
 Cladocera, 170
 Clam, 144
 Clark, A. J., 498
 Clark's zoögenesis theory, 516
 Claspers of male skate, 237
 Classification, 12-20
 Classification of insects, 178
 Claws, 428
 Claws of birds, 356
 Cleavage, 508
 Cleavage, frog's egg, 296
 Clepsine, 118
 Cleveland, 29
 Click-beetle, 195
 Cliona, 51
 Clitellum, 106
 Clothes moth, 187
 Cobb, 87
 Cockatoos, 349
 Cockroaches, 180
 Cocoons, earthworm, 113
 Cocoons, of Planaria, 74
 Cod, 251
 Codling moth, 186
 Cod liver oil, 438
 Coe, 86
 Coelocilians, 266

- Coelenterata, 17, 18, 54-70; characteristics, 54; economic importance, 69-70
 Coker, 368
 Cold spots, 476
 Coleoptera, 194
 Cole, 141
 Collar cells, 49, 53
 Collared peccary, 401
 Collateral branches, 473
 Colloids, 8, 435
 Colloid goitre, 445
 Colonies, 483
 Coloration of fishes, 253
 Color blindness, 474, 535
 Color in fossil butterflies, 188
 Color of birds, 356
 Color resemblance, 488
 Colpoda cucullulus, 35
 Colubrinae, 315
 Colugo, 377
 Columbae, 344
 Columba livia, 494
 Columnar epithelium, 425
 Commensalism, 482
 Commercial sponge, 48
 Common toad, 270, 271
 Communities, 489
 Comparative anatomy of the portal systems, 454
 Comparison of vertebrates and invertebrates, 209
 Compound eyes of Crayfish, 168
 Conditioned response, 118
 Conepatl, 386
 Congo eel, 267
 Conjugation, earthworm, 112
 Conjugation in paramecium, 33, 34
 Conklin, 152, 508
 Connective tissues, 426
 Contact-odor sense of Crayfish, 167
 Coordination, 479
 Copeland, 118, 158
 Copepoda, 171
 Copernicus, 511
 Copper, 438
 Copperhead snake, 321, 322
 Corals, 64, 65, 79
 Coral islands, formation of, 65
 Coral reef, 65
 Coral snake, 319, 320
 Cormorants, 339
 Corrodentia, 179
 Cort, 93
 Cortex, cerebral, 469
 Cotton-boll weevil, 196
 Cotton mouth moccasin, 321, 322
 Cotton spinners, 137
 Cottontail rabbits, 395
 Cotylosauria, 330
 Cowdry, 6
 Coyote or prairie wolf, 388
 Crampton, 517
 Crane fly, 192
 Craniata, 221
 Crepidula, 152, 508
 Crested newt, 267
 Cretinism, 445
 Crew, F. A. E., 536
 Cristatella, statoblast of, 127
 Cristispira, 29
 Crocodilia, 309
 Cro-Magnon man, 416
 Crop, 107
 Crop, leech, 116
 Crop of birds, 359
 Crop rotation, 200
 Crossing over, 538
 Crossopterygii, 240
 Cross-section Amphioxus, 215
 Crotalus cerastes, 325
 Crow, 352
 Crustacea, 165, 170
 Cryptobranchus, 294
 Cryptobranchus, arteries, 294
 Cryptobranchus, veins, 295
 Cryptocotyle lingua, 78
 Crystalline style, 144
 Ctenoid scales, 254
 Ctenophora, 66
 Cuban boa, 315
 Cuban toad, 273
 Cubical epithelium, 425
 Cuckoos, 349
 Culex, and bird malaria, 189
 Culicidae, 189, 190, 191
 Curtis, 82

- Curtius, 535
 Cutaneous sensibility, 476
 Cuticle, 107
 Cuvier, 514
 Cyanea arctica, 68
 Cycloid scales, 254
 Cyclops, 96, 171
 Cyclostomata, 221, 222
 Cyclostomes, 222
 Cynthia partita, 211
 Cypris, 170
 Cytoplasm, 5
- DADDY-LONG-LEGS**, 201
 Danforth, C., 537
 Daphnia pulex, 171
 Darters, 339
 Darwin, C., 119, 515
 Darwin, E., 513
 Darwin's Pangenesis Theory, 517
 Dawson, A. B., 456
 Dawson, J. A., 41, 43
 Decapoda, 165, 173
 Dendrites, 473
 Dendrocoela, 72
 Dengue, 191
 Depth of water, 490
 Dermal teeth, 231, 253
 Dermis, 427
 Desor's larva, 220
 Determinants, 518
 Detlefsen, 542
 Detweiler, 299
 Development of Aurelia, 63
 Development of backboned animals, 530
 Devonian Age, 264
 De Vries' "Mutations-Theorie," 524
 Diadem spider, 203
 Diagram of animal sperm, 463; maturation, 505
 Diamond back rattlesnake, 323
 Diamond back terrapin, 305
 Dichorial twins, 535
 Dictyophyme renale, largest nema, 92
 Diffusion, 5
 Digestion in the Ruminant, 433
 Digestive system, 428
 Digestive system of birds, 359
 Digestive system, grasshopper, 183
 Digestive system of lobster, 165
 Digestive system of skate, 232
 Digitalis and amphibia, 301
 Digitigrade, 422
 Dihybrid, 521
 Dinobryon, 28
 Dinosauria, 331
 Diopatra, 102, 103
 Diphycceral tail, 255
 Diploid, 503
 Dipnoi, 250
 Diptera, 188
 Direct cell division, 500
 Discoidal, 508
 Dispersal of small forms, 482
 Dissected grasshopper, 182
 Distribution, earthworms, 117
 Dobson fly, 185
 Dodds, G., 171
 Dodos, 344
 Dog, 491
 Dogfish, 225
 Dogs (domestic), 388
 Doliophis, 319
 Dolley, D., 479
 Dolley, W., 193
 Dolphin, 410
 Domesticated reindeer, 403
 Domestication of animals, 491
 Domm, 444
 Do mother snakes swallow their young?, 329
 Donkeys, 491
 Doodle bug, 109
 Dormouse, 394
 Dorsal hearts, 109
 Dorsal pores, 111
 Dorsal view of dogfish brain, 238
 Dourine, 29
 Draco volans, 311, 312
 Dracunculus medinensis, 96
 Dragon flies, 179
 Drosophila melanogaster, 192
 Drum-fish, 253
 Duck, 339, 495
 Duck-bill, 374
 Du Chaillu, 414

- Ductus botalli, 294, 450
 Dugong, 409
 Dyads, 504, 505
 Dytiscidae, 194
- EAGLE RAYS, 227
- Earthworm, cross section, 114
 Earthworm, internal anatomy, 108
 Earwigs, 180
 Ecaudata, 269
 Ecdysis, 205
 Echinodermata, 129-141; economic importance, 141; characteristics, 130; classification, 129
 Echinorhynchus gigas, 96
 Ecology, 3
 Economic gain from crayfish, 169
 Economic importance, amphibia, 300
 Economic importance of Amphioxus, 216
 Economic importance of birds, 368
 Economic importance of fishes, 261
 Economic importance of Porifera, 51-52
 Economic importance of Reptilia, 332
 Economic importance of Tunicates, 213
 Economic importance, starfish, 135
 Economic loss from crayfish, 169
 Ectoderm, 55, 58, 509
 Ectoparasites, 483
 Edema, amphibian, 274
 Edentata, 396
 Edible birds' nests, 365
 Edwards, Vinal, 297
 Eels, 245
 Effects of parasitism, 483
 Egg case of skate, 237
 Eggs of humming bird, 351
 Egyptian wild cat, 382
 Eider duck, 340
 Eigenmann, cave fishes, 244
 Elapine snakes, 317
 Elasmobranchii, 225
 Electric eel, 260
 Electric ray, 227
 Electropaxes, 230
 Elephant bird, 335
 Elephantiasis, 95
 Elephants, 398, 399
 Elephant seal, 389
 Elephas Africanus, 399
 Elephas Indicus, 399
 Elytra, 102
 Embryology of pond snail, 160
 Embryology of the barnacles, 173
 Empedocles, 510
 Emu, 335
 Emys europaea, 306
 Enchytraeus albidus, 105
 Encystment, 43
 Endocrine glands, 10
 Endoderm, 55, 58, 509
 Endo-parasites, 483
 Endosecretory glands with a duct, 444
 Endosecretory glands without a duct, 445
 Endostyle, tunicate, 212
 Enemies of lobster, 168
 Engle, 448
 Ensis, 149
 Entameba buccalis, 27
 Entameba histolytica, 26
 Entameba intestinalis, 26
 Enterokinase, 432
 Entomostraca, 170
 Environment, 499
 Enzymes, 10, 440
 Eoanthropus dawsoni, 416
 Eohippus, 491
 Epeira, 202
 Ephemerida, 179
 Ephestia, 503
 Epidermal sense organs, 115
 Epidermis, 427
 Epigenesis, 509
 Epiphysis, 448
 Epithelium, 424
 Epitoke, 118
 Equatorial plate, 501
 Equilibrium of crayfish, 168
 Equus, 491; caballus fossilis, 491; przewalski, 491
 Erythrocytes, 456
 Esophageal papillae, 326
 Esophagus, 430
 Eugenics, 544; Record Office, 545
 Euglena, 28
 Eugyra, 211
 Eumenidae, 197

- Euplexoptera, 180
 European badger, 387
 European "green lizard," 310
 European hookworm, 93; red deer, 403;
 wild boar, 494
 Evidence from comparative anatomy, 526
 Evidences for evolution, 525
 Evisceration in sea cucumber, 140
 Evolution, 3, 525
 Evolution of the horse, 526
 Examples of Mendelian inheritance in
 man, 523
 Excretory system, 166, 363, 461
 Excretory system of Reptilia, 327
 Exophthalmic goitre, 445
 Eyes, of leech, 117
- FAIRY SHRIMP**, 170
 False coral, 127
 False coral snake, 319
 Fangs, rattlesnake, 321
 Fascia, 275
 Father families, 486
 Fatigue in the nerve cell, 479
 Fats, 9, 436
 Fat-tail sheep, 404
 Feathers, 355
 Fer-de-Lance, 322
 Ferret, 385, 386
 Fertilization, 505, 506
 Fibrillar theory, 8
 Fibro-cartilage, 426
 Fibrous tissue, 426
 Field mouse, 394
 Fierasfer, 259
 Fig-wasp, 196
 Filaria bancrofti, 95
 Filaria perstans, 95
 Filiform papillae, 429
 Finger prints, 535
 Finger sponge, 48
 Fire-toad, 270
 First polar body, 505
 Fischer, 495
 Fish, 224-264
 Fish ducks, 340
 Fissipedia, 380
 Fitness to survive, 10
 Flagellates, 27
 Flamingoes, 340
 Flatfishes, 249
 Fleas, 194
 Flesh-fly, 188
 Flicker, 350
 Flint, 25, 52
 Floated oysters, 150
 Florida manatee, 409
 Flow of lymph, 460
 Fluorine, 438
 Fly-catcher, 352
 Flying dragon, 311
 Flying foxes, 379
 Flying frog, 272
 Flying mammals, 423
 Flying squirrels, 300, 392
 Fly-wing, vibration of, 188
 Fogg, 503
 Follicle mite, 201
 Food of the lobster and crayfish, 168
 Foraminifera, 25
 Fossil Coelenterata, 68
 Fossil man, 415
 Fossil Nemas, 98
 Fossil relatives of birds, 370
 Fossil sponges, 52
 Fossils classified, 525
 Four day chick embryo, 372
 Four-eyed fish, 258
 Fowls, 494
 Fox bats, 379
 Free-martin, 536
 Freezing and resuscitation of fishes, 260
 Friedmann, the cowbird, 486
 Frigate birds, 339
 Frog, arteries, 280; brain, 288; heart, 282;
 muscles, 276
 Fruit bats, 379
 Fruit flies, 193
 Functions of the blood, 457
 Function of Zoölogy, 1
 Fundulus heteroclitus, female, 246
 Fungi-form papillae, 429
- GABOON VIPER**, 320
 Galapagos penguin, 338
 Galen, 511

- Gall flies, 197
 Gall gnats, 192
 Gallinae, 343
 Gallstones, 432
 Gallus bankiva, 454
 Galton's Law of Ancestral Inheritance, 519
 Galtsoff, 145
 Gamble, 105
 Gambusia affinis, 245
 Gametogenesis, 503
 Gannets, 339
 Ganoid scales, 241, 253, 254
 Ganoin, 254
 Gape-worm, 92
 Gar pikes, 241
 Gases, as repellents, 199
 Gastric juice, 431
 Gastric mill, 165, 173
 Gastric pouches, Aurelia, 62
 Gastrula, 160
 Gates, R. R., 521
 Gavial, 308
 Gavials, 309
 Geckos, 310, 311
 Geese, 339, 495
 Gemmules, 50
 Genes, 7, 440, 538
 Genital pore, leech, 116
 Genotypes, 521, 538
 Geoduck clam, 149
 Geographical distribution, 489
 Geranium and Japanese beetle, 200
 Germ cells, 423
 Germinal elements, 509
 Germinal epithelium, 425
 Germinal layers, 297, 508
 Germplasm, 499
 Ghost crab, 176
 Giant fibers, 115
 Giant leech, 118
 Giant tortoise, 304
 Giant water bug, 184
 Giardia muris, 29
 Gibbons, 413
 Gila monster, 310
 Gills, clam, 145; crayfish, 166
 Giraffes, 404
 Gizzard, 107, 359
 Glacier bear, 384
 Glands, 425
 Glandular epithelium, 425
 Glaser, echinoderms, 138
 Glaser, heart and pulse frequency, 449, 498
 Glass snake, 310
 Glochidium, 146, 147
 Glycogen, 8, 431, 444
 Glycosuria, 448
 Goats, 494
 Goby, 247
 Goffin, R., 297
 Goiter, 445
 Goldberger, 443
 Golden eagle, 345
 Golden pheasant, 343
 Gold-fish, 244
 Golgi apparatus, 6
 Goldschmidt, R., 532
 Goldschmidt's enzyme theory, 534
 Gonads, of Aurelia, 62
 Goodale, 444
 Goodrich, H., 508
 Goose fish, 249
 Gordiacaе, 96
 Gorillas, 414
 Gower's muscular atrophy, 535
 Grantia, 49
 Granular theory, 8
 Grave, B., 151
 Gray, Geo. M., 298
 Gray marmot, 390
 Gray rami communicantes, 474
 Gray wolf, 388
 Great ant eater, 396, 397
 Great Auk, 337
 Great bustard, 341
 Great crowned pigeon, 344
 Great horned owl, 349
 Great musk shrew, 377
 Great white shark, 225
 Grebe, 337
 Greene, 135
 Green frog, 272
 Green-glands of lobster, 166
 Green lizard, 310

- Green turtle, 304
 Gregariousness, 484
 Gregory, W. K., 219
 Grey, Z., 247
 Grizzly bear, 384, 385
 Ground beetle, 194
 Ground hog, 390
 Ground spiders, 202
 Group of ratite birds, 336
 Guano, 368
 Gudernatsch, 445
 Guinea worm, 96
 Guljar, 494
 Gulls, 338
 Gustatory sense, 476
 Guyer, M., 542
 Gyrinidae, 194

HADDOCK, 251
 Hag-fishes, 222
 Hague, 139
 Hair, 428
 Hair-necks, 93
 Hairworm, 96
 Hake, 250
 Halibut, 251
 Hammerheaded bat, 379
 Hanson, 541
 Haploid, 503
 Hares, 396
 Hargitt, C., 70
 Harlequin snake, 320
 Harp seal, 389
 Harrison, R. G., 299, 495, 541
 Hartman, 447
 Harvey, W., 512
 Harvey, E. N., animal light, 261
 Haversian canal, 426
 Hawks-bill turtle, 304
 Head fish, 247
 Head kidney, 258
 Heads of coral snake and rattler, 321
 Hearing in aquatic mammals, 475
 Hearing of crayfish, 167
 Heart, 452
 Heart beat of the frog, 285
 Heart of pigeon, 362
 Hectocotylized arm, 156
 Heidelberg jaw, 415
 Heilbrunn, 138; viscosity of protoplasm, 502
 Heliozoa, 25
 Hell-bender, 267
 Helminthicides, 97
 Hematokonia, 456
 Hemichorda, 210
 Hemiptera, 184
 Hemolysis, 457
 Hemophilia, 120, 535, 543
 Hen-feathering in the Seabright Bantam, 537
 Hen's egg, 372
 Hepatic portal system, 234
 Herbivorous, 482
 Herding ants, 484
 Heredity, 499-545
 Hermaphroditism, in Turbellaria, 82; and free-martin, 536
 Hermit crabs, 175
 Herons, 340
 Herrick, C. J., 472, 474
 Herrick, F. H., 346
 Herring, 244
 Hesperornithiformes, 371
 Hess, 112
 Hesperornis, 371
 Hessian fly, 192
 Heterodera schachtii, 91
 Heterotricha, 30
 Hexapoda, 177
 Hexylresorcinol, 97
 Hibbard, 6
 Hibernation and aestivation in animals, 480
 Hind limb bones of dog, sheep and horse, 527
 Hippopotamus, 401
 Hirudin, 116
 Hirudinea, 100, 115
 Hirudo medicinalis, 115
 Histology, 423
 Histology of hydra, 58
 Histology, stomach, 278
 Histomonas meleagridis, 29
 History of the evolutionary idea, 509
 Hoactzin, 371

- Hodge, W., 97
 Hodge, C. F., 479
 Hog, 401
 Holocephali, 227
 Holostei, 241
 Holotricha, 30
 Homo diluvii testis, 300
 Hog-nosed snake, 316
 Homing pigeons, 344
 Homing instinct, 418-419
 Hominidae, 415
 Homoptera, 184
 Honey, 198
 Honey-bag, 205
 Honey-bees, 198, **199**
 Hooded seal, 389
 Hooker, 515
 Hoppe, E., 496
 Horn-bills, 350
 Horse-hair worms, 96
 Horned rattlesnake or sidewinder, **325**
 Horned toad, 311
 Horned viper or asp, 320
 Horny sponges, 47
 Horse, 400, 491, 526
 Horse-fly, 188
 Horse-shoe crab, 203
 House-fly, 188
 Howling monkey, 412
 How long can mammals submerge?, 461
 Hubrecht and the pilidium, 220
 Hudson seal, 394
 Human embryo at six weeks, **464**
 Human ear, **476**
 Humming-bird, 350, **351**
 Hurst, 45
 Huxley, J., 542
 Huxley, T., 516
 Hyaline cartilage, 426
 Hydra, 55
 Hydrogen, 9
 Hydroids, 58
 Hydrophinae, 317
 Hydrozoa, 54
 Hyena, 383
 Hylidae, 270
 Hymenoptera, 196
 Hypersecretion of the thyroids, 445
 Hypodermis, 107
 Hypophysis, 448
 Hypotricha, 30
 Hyracotherium, 491
 Hyrax, **398**
 IBEX, 405, **406**
 Ibis, 340
 Ichneumonidae, 197
 Ichthyopterygia, 331
 Ichthyornis, **371**
 Idants, 518
 Identical vs. fraternal twins, 535
 Idioblasts, 518
 Ids, 518
 Immigration, 545
 Inbreeding, 544
 Incurrent pores, 50
 Indian buffalo, 407
 Indian rat snake, 315
 Indirect cell division, 500
 Infra-red, 441
 Infusoria, 30
 Inheritance of acquired characters, 539
 Inheritance of disease, 542
 Inheritance through the germinal substance, 543
 Inheritance of weakness, 543
 Insecta, 177
 Insecticides, 199
 Insectivora, 376
 Insulin, fishes, 256; mammals, 445
 Internal anatomy of spider, **202**
 Internal organs, frog, 277
 Internal view, heart, **282**
 Invertebrates versus vertebrates, 210
 Iodin, 439
 Iodin, in parthenogenesis, 139
 Iron, 440
 Irradiated ergosterol, 443
 Isopoda, 173
 Isoptera, 179
 JACKALS, 388
 Jack hare, 396
 Jaguar, 380, **381**
 Janssens, 538
 Japanese beetle, 195

- Java ape-man, 415
 Javelin bat, 379
 Jay, 352
 Jejunum, 430
 Jerboa, 395
 Johnston, J. B., 472
 Jollos, 542
 Jones, 114
 Jumping mice, 394, **395**
 June bug, 195
 Just, 138

 KAMM, O., 449
 Kammerer, 541
 Kangaroos, 376
 Katabolism, 8
 Katydids, 180
 Keber's organ, 146
 Kendall, 445
 Killer "whale," 410
 Kinaesthetic sense, 477
 Kindred, J., 141
 King cobra, 318
 King crab, 203
 Kingfisher, 350
 King snake, 316
 King vulture, 347
 Kiwi, 335
 Knutti, R., 45
 Kofoed, 27
 Köhler, 421
 Kommodo lizard, 312
 Krait, 319
 Külpe's classification of sensations, 474

 LACERTILIA, 309
 Lace-winged flies, 185
 Lacteals, 433, 459
 Lady-bird beetles, 194
 Lake trout, **243**
 Lamarck, 513
 Lamarck's four laws, 514
 Lampreys, 223
 Land leeches, 117
 Landsteiner, 458
 Langdon, 115
 Lanugo, 429
 Large intestine, 433

 Large mouth black bass, **248**
 Larval ascidian, 212
 Lateral line organs, 239
 Lateral neural blood vessels, 111
 Lateral view of Amphioxus, **214**
 Law of segregation, 521
 Leaf-nosed bats, 379
 Leaf-rollers, 186
 Leopard, 381
 Leathery turtle, 304
 Lecane inermis, eggs of, **125**
 Lecithin, 436
 Leeches, 115
 Leishmaniasis, 29
 Lemmings, 394
 Lemurs, 412
 Leodice, 102
 Leonard, 97
 Lepas, 171
 Lepas anatifera, **172**
 Lepidonotus, 102
 Lepidoptera, 186
 Lethal factors, 539
 Leucocytes, 456
 Lewis, 299, 497
 Leydig's duct, 289-295
 Ligula, 83
 Lillie, 139
 Limestone pyramids, 25
 Limicolae, 341
 Limnoria, **174**
 Limulus, 203, **204**
 Linin, 5, 7
 Linnaeus, 2, 512
 Linton, E. 81
 Lion, 381, **383**
 Lipase, 431
 Lipins, 436
 Little, C., 540
 Little brown bat, 380
 Liver, 431, 444
 Liver fluke, 74, **75**
 Living and non-living matter, 4
 Living free, 482
 Llama, 402
 Loa loa, 95
 Lobosa, 25
 Lobster, 165

- Locomotion of Ameba, 23; fishes, 253
 Locusts, 180-181
 Loeb, artificial parthenogenesis, 134, 299
 Long-eared owl, 349
 Long-eared sunfish, 248
 Longevity of amphibia, 497; annelida, 497; arthropods, 497; birds, 496; coelenterata, 497; fishes, 497; mammals, 496; reptiles, 497
 Longhorns, 494
 Longipennes, 338
 Long-nosed gar, 241
 Long snouted Echidna, 374
 Loon, 337
 Lubber grasshopper, 180
 Lucas, A. M., 460
 Lumbricidae, 105
 Luna moth, 187
 Lure-crops, 91
 Lyell, 514, 515
 Lymph, 458-460
 Lymphatics, 459
 Lymph of fishes, 257
 Lymphocytes, 456
 Lynch, R., 123
 Lyre bird, 351
- MACAQUES, 413
 Macaws, 349
 Mackerel, 249
 Macrochires, 350
 Madreporite, 130
 Magnesium, 438
 Malacostraca, 170, 173
 Malay gavial, 309
 Malay tapir, 400
 Male-determining enzyme, 534
 Mallard duck, 341
 Mallophaga, 179
 Malpighian tubules, 183
 Malthus, 10, 514
 Maltose, 429
 Mammalia, 373-419
 Mammalia-physiology, 420-481
 Mammals as migrants, 418
 Mammoth, 408
 Manatee, 409
 Mandarin duck, 340
 Manganese, 440
 Mantis shrimp, 175
 Man. vs. the higher apes, 420
 Marco Polo's sheep, 494
 Marmoset, 412
 Marsupialia, 375
 Marsupium, 146
 Masking, 487
 Massasauga, 323
 Mastigameba, 7, 45
 Mastigophora, 27
 Mastodon, 408
 Maternal impressions, 543
 Mathews, 135
 Maturation divisions, 505
 Mavor, 540
 May-flies, 179
 McCarrison, 439
 McClendon, 445
 McClung, 533
 McDowell, 541
 Mead, A., 135
 Meal moth, 186
 Meal worm, 196
 Mecoptera, 185
 Mediterranean fruit fly, 193
 Mediterranean race, 417
 Medulla oblongata, 472
 Megascolecidae, 105
 Melanophores, 254, 487
 Meleagris gallopavo, 495
 Melia, 175
 Mellanby, 439
 Mendelian inheritance, 519
 Mercaptan, 387
 Mermis subnigrescens, 96
 Mermithidae, 96
 Merostomata, 207
 Mesenterial filaments, 67
 Mesoderm, 509
 Mesoglea, of Hydra, 55, 58
 Mesoglea, of sponge, 49
 Mesohippus, 491
 Mesonephros, 258
 Metabolism, 8
 Metamorphosis of frog, 296
 Metaphase, 501
 Metazoa, 4, 13, 46

- Metchnikoff, 170
 Methods of insect control, 199
 Metoncholaimus pristiurus, 97, 98
 Micellar strands, 518
 Mictic rotifera, 125
 Midges, 193
 Mid-wife toad, 270
 Migration in fishes, 263
 Migration of storks, 366
 Milk snake, 316
 Miller, N., 271, 464
 Millikan, 440
 Millipeds, 177
 Mimicry, 489
 Mineral salts, 9, 437
 Mink, 385
 Mitochondria, 6
 Mitosis, 501
 Mitral cells, 476
 Mnemiopsis, a comb jelly, 66
 Moa, 335
 Mocking bird, 354
 Moenkhaus, 506
 Mola mola, 249
 Mole cricket, 180
 Molgula arenata, 211
 Molgula manhattensis, 211
 Mollusca, 142-162; economic importance, 161; classification, 142; characteristics, 143
 Molluscan growth, 160
 Molluscoidea, 127
 Monads, 506
 Monarch butterfly, 188
 Mongolian race, 417
 Mongoose, 383
 Monitor, 312
 Monochorial twins, 535
 Monocytes, 456
 Monoecious, 111
 Monogamy, 485
 Monotremata, 373
 Monstrosities in fishes, 540
 Moore, C. R., 444
 Morgan, 299, 537, 538
 Morphology, 2
 Morula, 160
 Moss's classification of blood groups, 458
 Mother families, 486
 Motor nerves, 466
 Mouflon, 494
 Moulting, in Arthropoda, 205
 Mountain ranges, 490
 Mourning dove, 345
 Mouse lemur, 412
 Mouth, 428
 Mucous tissue, 426
 Mud crab, 176
 Mud-cel, 268
 Muggger, 309
 Muggger crocodile, 309
 Mule, 400
 Mule deer in velvet, 403
 Muller, 540
 Mummichogs, 245
 Muridae, 392
 Murine opossum, 376
 Muscles of frog, 276
 Muscle substance, 426
 Muskellunge, 245
 Musk-ox, 406
 Musk-rat, 394
 Mussel with Buddha images, 150
 Mustelidae, 384
 Mutation, 524
 Mya, 149
 Myelination, 479
 Myriapoda, 177
 Myristic acid, 443
 Mytilus edulis, 148
 Myxedema, 445
 Myxinoids, 222
 NAILS, 428
 Nais, 104, 105
 Naked bat, 379
 Narwhal, 410
 Nasal mucous membrane, 476
 Neanderthal man, 416
 Nectar from rhododendron, 199
 Necturus, 268
 Necturus, branchial vessels, 267
 Necturus maculosus, 269
 Negative eugenics, 545
 Negri bodies, not protozoa, 45
 Negroid race, 417

- Nelson, 144
 Nemas, 87-99; characteristics, 87; classification, 87; longevity, 88
 Nematelminthes, 87
 Nematocysts, 54, 55, 57
 Nemerteans, 85
 Nemertean Theory, 220
 Neornithes, 334
 Neoteny, 268
 Nephridiopore, 111
 Nereis, 101
 Nerve cells, 424
 Nerve net in Coelenterates, 67
 Nervous system, earthworm, 112; lobster, 166
 Nervous system of ascaris, 90; of birds, 364; of mammals, 464-480
 Nest and eggs of humming bird, 351
 Neuritis optica, 535
 Neuroblasts, 495
 Neuro-epithelium, 425
 Neuroptera, 185
 Neurotoxin, 328
 Nicotine, and the goat, 481
 Nictitating membrane in various animals, 529
 Nietzsche's super-man, 515
 Nighblindness, 535
 Nile goose, 495
 Nile monitor, 312
 Nine-banded armadillo, 397
 Noctiluca scintillans, 27
 Noguchi, 328
 Non-disjunction, 539
 Non-striated, 426
 Nordics, 417
 Norman, 135
 Norris, H. W., 237
 North American beaver, 392
 North American otter, 385
 North American prong-horn, 404
 Northern fur seal, 389
 Nose monkey, 413
 Notochord, 209
 Nuclear membrane, 7
 Nuclear substance, 500
 Nucleolus, 7
 Nucleus, 7
 Nummulites, 25
 OBELIA, 58, 59
 Ocelot, 380
 Odonata, 179
 Odontoglossae, 340
 Ogliole, 64
 Old World monkeys, 413
 Olfaction in the bee, 207
 Olfactory sense, 476
 Oligotrichida, 30
 Omasum, 434
 Ommatidia, 168
 Onager, 491
 Onychophora, 175
 Oögenesis, 500, 505
 Operculum, 152
 Ophidia, 313
 Ophiuroidea, 135
 Ophryoscolecidae, 30; 482
 Opisthoglypha, 316
 Opossum, 376
 Orb weaver, 202
 Orca, 410
 Organ of Bojanus, 145
 Organ of Corti, 475
 Organ formation, 508
 Organic sensations, 477
 Organs of internal secretion, 444
 Organs that man can lose, 480
 Orohippus, 491
 Oroteidae, 268
 Orthoptera, 180
 Osborn, H. F., 416, 510
 Osburn, R. C., 128
 Osculum, 50
 Osmotic pressure, 5
 Osphradium, 147
 Ostia, sponge, 50; grasshopper, 183
 Ostracoda, 170
 Ostrea, 150
 Ostrich, 335
 Otocysts, molluscan, 147
 Ovaries, 55, 111
 Ovary, 444
 Ovum of the cat, within the ovary, 462
 Owl monkey, 412

- Oxygen, 9
Oxyuris vermicularis, 90
 Ox warble attacking man, 189
 Oyster, 150
 Oyster crabs, 175
 Oyster, opened by starfish, 135
- PACK RAT, 393
 Paddlefish, 240
 Painted crabs, 175
 Painted terrapin, 305
 Painter, T., 534
 Palatal folds, of *Crocodylia*, 326
 Paleontology, 525
Palinurus vulgaris, 175
 Palolo worms, 101, 102, 118
 Paludicolae, 341
 Pancreas, 432, 445
 Pancreatin, 445
 Pangenes, 518
 Papanicolaou, 541
Paramecium caudatum, 31; 30-36
 Parasites of the Annelida, 118
 Parasitic castration, 96
 Parasitic egg-laying, 486
 Parasitism, 483
 Parathyroids, 446
 Parental care, in Amphibia, 299
 Parent families, 485
 Parker, 50, 51
 Parker, on senses of fishes, 258
 Parmenter, 299
 Paroquets, 349
 Parrots, 349
 Parthenogenesis, 539
 Parthenogenesis, in Amphibia, 299; in
 Echinodermata, 134, 135
 Passenger pigeons, 344, 345
 Passeres, 351
 Pasteur, 1
 Patten, W., 218
 Pavement epithelium, 424
 Pavlov, 542
Pavo cristatus, 495
 Payne, N., 490
 Peacock, 495
 Pea-fowls, 344
 Pearl, R., 532, 541
 Pearl-oyster, 148
 Pecten, the scallop, 147
 Pedicellariae, 130
 Pedipalpi, 202
 Pei, 417
 Peking skull, 417
 Pelicans, 339, 340
 Pellagra, 443
Pelodera pellio, 118
 Penguins, 338
 Pennant's marten, 385
 Pennock, S. S., and starling, 368
 Peptone, 431
 Perches, 247
 Pêre de Chaudin, 417
 Peridinians, 28
 Perihæmal system, 134
 Period of gestation, 465
 Periosteum, 426
 Peripatus, 177
Perissodactyla, 400
 Peritricha, 30
 Persian lamb, 404
 Perspiration, 428
 Petrels, 338
 Petrified fossils, 525
Petromyzontia, 223
 Pffiffer, 447
 Phalangidae, 201
 Phalaropes, 342
 Phenotypes, 521, 538
 Philpott, 328
 Phoebe, 352
 Pholas, 151
 Phoronidea, 128
 Phosgene and snakes, 329
 Phosphorescent organs, fishes, 260
 Phosphorus, 438
 Photophores, 254
 Photosynthesis, 436
 Phrynosoma, 313
Phyllobates limbatus, 273
 Phyllopoda, 170
 Physiological units, 518
 Physiology, 3
 Physostomous teleosts, 264
 Piano playing, speed of, 479
 Pici, 350

- Pickerel, 245
 Pigeon hawks, 345
 Pigeons, 494
 Pigeon's milk, 359
 Pigment of sponges, 48
 Pigmy rattlesnake, 323
 Pigs, 494
 Pike, 245
 Piliidium, 85, 220
 Pilot black snake, 316
 Piltdown man, 416
 Pineal body, 448
 Pine marten, 385
 Pine mouse, 394
 Pinnipedia, 389
 Pin-worm, and appendicitis, 90
 Pipa, 269
 Pipe fish, 246
 Pipe-moss, 52
 Piranha, 243
 Pisces, 224-264; classification, 224; characteristics, 224; economic importance, 261-263; migration, 263; fossil relatives, 264
 Pithecanthropus erectus, 415
 Pituitary body, 448
 Pit vipers, 321
 Placenta, 303
 Placoid scales, 253
 Placuna placuna, 150
 Planaria, 72
 Plant eating beetle, 195
 Plantigrade, 422
 Plant-lice, 185
 Plants and animals, 12
 Plasomes, 518
 Plastids, 6
 Platyhelminthes, 17, 18, 71-84; characteristics, 71
 Platypus, 374, 375
 Plecoptera, 179
 Pliny the Elder, 511
 Plough, 540
 Plover, 342
 Plural genes, 538
 Podophyra, a suctorian, 35
 Poison glands, fishes, 254
 Poison of female mosquito, 191
 Poisonous Amphibia, 300
 Poisonous honey, 199
 Poisonous reptiles, 328
 Poisonous spiders, 203
 Polar bear, 384
 Pollock, 251
 Polyandry, 485
 Polycirrus, blood-worm, 104
 Polydon, 240
 Polygordius, 101
 Polygyny, 485
 Polynoe, 102
 Polypterus bichir, 240
 Polyspermy, 506
 Porcupine fishes, 247
 Porifera, 17, 18, 47-53
 Porocytes, 50
 Porphyrin, 109
 Porpoise, 410, 411
 Portal circulation, 454
 Portal system, 453, 454
 Portuguese Man of War, 60, 61
 Positive eugenics, 545
 Potassium, 438
 Potato beetle, 195
 Pouched gophers, 394
 Prairie-chicken, 343
 Prairie dogs, 390, 392
 Prawn, 175
 Praying mantis, 180
 Precious corals, 70
 Precipitin reaction, 435
 Preformation, 509
 Prenatal infection, 542
 Prenatal injury, 543
 Primary oocytes, 505
 Primates, 411
 Principles of population, 10
 Proboscidea, 398
 Processionary caterpillars, 487
 Proglottid, 79
 Propagation rate in mammals, 464
 Prophase, 501
 Prostomium, 100, 106
 Protective resemblance, 488
 Proteins, 8-435
 Proteroglypha, 317
 Protohippus, 491

- Protoplasm, 4, 7, 8, 9, 10
 Protoplasm, chemical elements, 9
 Protoplasm, properties, 8
 Protoplasm, structure of, 7
 Protozoa, 17, 21-46; characteristics, 21;
 economic importance, 46
 Proventriculus of birds, 359
 Przibram, 539
 Pseudopodia, of Hydra, 57
 Pseudopodia, of protozoa, 7, 22
 Psittaci, 349
 Psychic cells, 469
 Ptarmigans, 344
 Ptyalin, 429
 Puff adder, 320
 Puffer fish, 248
 Pulse, 453
 Pulse frequency, Glaser, 498
 Puma, 380
 Purple death adder, 319
 Purple martins, 354
 Pycnogonida, 203
 Pygopodes, 337
 Pyloric caeca, 256
 Pyloric caeca, starfish, 132
 Pyloric sphincter, 430
 Pyloric stomach, starfish, 132
 Pyralidina, 186
 Pyramidal cells, 469
 Python, 314
- QUAGGA, 400
 Quanta in biology, 539
- RABBITS, 395, 494**
 Rabies, 45
 Raccoon, 383
 Race mixture and the evolution of man,
 418
 Races of man, 417
 Radial nerve of starfish, 135
 Radiolaria, 25
 Radula, of gastropods, 158
 Rails, 341
 Rana goliath, 273
 Rana pipiens, 273-291
 Rand, H. W., spiracles, 231
 Ranidae, 271
- Ratitae, 334, 336
 Rat-tailed larva, 193
 Rattle of the rattlesnake, 327
 Rattler preparing to strike, 324
 Ray, J., 512
 Rays, 229
 Rectal caeca of birds, 360, 361
 Rectal gland, 231
 Rectigrade, 423
 Rectum, earthworm, 109
 Rectum of birds, 360
 Red ant, 197
 Red coral, 64
 Red fox, 387
 Red-bellied terrapin, 305
 Red-headed woodpecker, 350
 Redi, 1
 Red kangaroo, 376
 Red mite, 201
 Red pocket gopher, 395
 Red sponge, 48
 Red squirrel, 391
 Red wolf, 388
 Reduction division and sex determination,
 508
 References on animal coloration, 489;
 animal relationships, 487; birds, 369;
 bird songs, 363; endocrines, 449;
 ruminant stomach, 434
 Reflex arc, 478
 Reflex action, 479
 Regal python, 314
 Regeneration in Annelida, 119
 Regeneration in Hydra, 68
 Regeneration in Planaria, 83
 Remoras, 247
 Renal portal system of skate, 234
 Rennin, 431
 Reproductive system, cat, 462
 Reproductive system of birds, 363, 364
 Reproductive system of lobster, 166
 Reproductive system of reptilia, 327
 Resistance of amphibia to poisons, 301
 Respiration, amphibian, 285; cat, 460;
 fish, 253; insect, 206; bird, 362; lobster,
 166; reptile, 326
 Reticulum, 433
 Reticular theory, 8

- Reticular tissue, 426
 Retractor bulbi muscles, 293
 Rhabditiis, alternation of generations in,
 90
 Rhabdocoela, 72
 Rhea, 335
 Rhinoceroses, 400
 Rhinoceros beetle, 195
 Rhodeus amarus, 247
 Rhomaleum micropterum, 180
 Ribbon snake, 315
 Richards, conduction of nerve impulse,
 159
 Riddle, O., 532, 537
 Right whales, 410
 Ringed gecko, 311
 Ringhals, 319
 Ring necked snake, 316
 Robber crabs, 175
 Rock borer, 151
 Rock crabs, 175
 Rock pigeon, 344
 Rock wallabies, 376
 Rocky mountain bighorn, 405
 Rocky mountain goat, 405
 Rodentia, 389
 Rotifer, 122
 Rowan, 367
 Royal jelly, 198
 Royal purple, 152
 Roxas, 537
 Ruffed grouse, 343
 Rumen, 433-434
 Russell's viper, 320
 Ruthven, 315

 SABELLARIA, 118
 "Saber-tooth" cats, 380
 Sacculina, 172
 Sacred African crocodile, 309
 Sacred beetle, 195
 Sagartia, 68
 Sailfish, 251
 Saki monkey, 412
 Salamandrinae, 267
 Salientia, 269
 Salivary glands, 428-429
 Salmon, 242

 Salpa cabotii, 211
 Salt water crocodile, 309
 Sampson, 138
 Sand collar snail, 153
 Sandhill crane, 341
 Sand natter, 320
 Sandpipers, 343
 San Jose scale, 185
 Santonin, 97
 Sarcodina, 22
 Sauropterygia, 331
 Saururæ, 370
 Sawfish, 227
 Scab parasite, 201
 Scale insects, 184
 Scales of fishes, 254
 Scallop, 149
 Scarlet king snake, 316
 Schistosoma, 77
 Schröder, 541
 Scolex, 79
 Scolopendra, 177
 Scorpaenoid fish, 257
 Scorpion flies, 185
 Scorpionidae, 201
 Scott, E. L., 445
 Scutigera forceps, 177
 Scyphozoa, phosphorescence in, 61
 Sea anemone, 63
 Sea basses, 247
 Seabright bantam, 537
 Sea-cucumber, 137
 Sea egg, 137
 Seahorse, 247
 Sea lizard, 312
 Sea slug, 137
 Sea snake, 317
 Seasonal mateships, 485
 Sea squirt, 213
 Sea urchins, chiseling rocks, 136
 Second polar body, 500, 505
 Secretary birds, 348
 Secretory granules, 6
 Segregation, 545
 Selachii, 225
 Seminal receptacles, 111, 113
 Sense of smell in birds, 365
 Sense organ, Arthropoda, 207

- Senses of crayfish, 167
 Senses of fishes, 258
 Senso, from toadskins, 301
 Sensory nerves, 466
 Serpula, 104, 118
 Sertularia, "air-plant," 69
 Sesamoid bones, 426
 Setae, 106
 Seventeen year locust, 184
 Sex determination, 531
 Sex determining chromosome, 533
 Sex in Cladocera, 170
 Sex-linked characters, 535
 Sexual dimorphism, Triton, 267
 Sharks, 225
 Sharks of various types, 226
 Shark suckers, 250
 Sharp-shinned hawk, 345
 Sheep brain, ventral view, 468
 Sheep, 494
 Shelford, herring sensitivity, 260
 Short-nosed sturgeon, 241
 Short-tailed shrew, 377
 Shrews, 377
 Shrike, 353
 Shrimp, 175
 Skull, 123
 Sidewinder or horned rattler, 325
 Significance of the Darwinian theory, 517
 Siliceous sponges, 47
 Silicon, 438
 Silk-worm moth, 187
 Singing earthworms, 115
 Siphonophora, 60, 61
 Sirenia, 409
 Sirenidae, 268
 Skate, 227
 Skate sucker, 118
 Skeleton of birds, 357-358
 Skeleton of Cistudo, 306
 Skeleton of garden toad, 292
 Skeleton, of gorilla, 415
 Skin, 427
 Skinks, 312
 Skin of fishes, 253
 Skull of the cat, 466
 Skunk, 387
 Slave making ants, 197, 484
 Sleeping sickness, 29
 Slime tube, earthworm, 113
 Sloths, 397
 Smallest adult snake, 323
 Smallest lizard, 312
 Small intestine, 430-359-360
 Smell and taste of crayfish, 167
 Smilodon, 380
 Smith, H., 236
 Smith, P. E., 448
 Smoky shrew, 378
 Smooth muscle, 426
 Snake tongue, 326
 Snapping turtle, 304
 Social life of animals, 482-489
 Societies, 485
 Sodium, 438
 Soft shell clam, 149
 Soft-shelled turtle, 305
 Solitary wasps, 197
 Somatic cells, 423
 Somatic sensory, 466
 Somatoplasm, 499
 Sound producing organs of drum-fish, 253
 Sound production, fishes, 253
 South American lung-fish, 252
 South American tapir, 400
 Spade-foot toad, 270
 Spanish mackerel, 251
 Sparrow, 353
 Sparrow hawks, 345
 Spectacled cobra, 317
 Speed of flight, 368
 Speidel, 479
 Spermaries, 55
 Spermatheca, 184
 Spermatogenesis, 503
 Spermatogonia, 500
 Spermatophores, earthworm, 113
 Sperm whales, 410
 Spicules, 47, 49, 51, 52
 Spider crab, 176
 Spider monkey, 413
 Spinal cord, 472
 Spinal nerves, 467
 Spiny ant-eater, 373, 374
 Spiracles, 183
 Spiral valve, 255

- Spireme, 501
 Spleen, 460
 Sponge, 50
 Sponge fisheries, 52
 Sponges, characteristics, 47; classification, 47; pigment of, 48; symmetry of, 48
 Spongilla, 50
 Spontaneous generation, 1
 Spoonbill, 341
 Sporocysts, 75
 Spotted salamander, 268
 Squamata, 309
 Squash bug, 184
 Squirrel monkey, 412
 Squirrels, 390
 Stalked barnacles, 172
 Starfish, 131
 Star-nosed mole, 378
 Static sense, 476
 Statistics of vitality, 480
 Statoblasts, 49, 50
 Steganopodes, 339
 Stegocephalia, 300
 Stegomyia fasciata, 192
 Steinach, 444
 Steller's sea-cow, 409
 Sterilization, 545
 Stewart, 139
 Sticklebacks, 246
 Stigmata, 183
 Stiles, and hookworm, 93
 Stirps, 518
 Stockard, 541
 Stomach, 430
 Stomach-intestine, 109
 Stomach poisons, 199
 Stone flies, 179
 Storks, 340
 Stough, 115
 Stratum corneum, 427
 Stratum malpighi, 427
 Striated muscle, 427
 Stridulation, in fishes, 253
 Strong, O. S., 289
 Strong, R. M., 357
 Strongylidae, 92
 Structure of the cell, 4-7
 Structure of the neuron, 473
 Stunkard, 78, 483
 Sturgeon, 241
 Sturtevant, A., 538
 Suberites domuncula, 52
 Subneural gland, 212
 Suctoria, 30
 Sulphur, 9, 438
 Sulphur-bottom whale, 410
 Sumner, 542
 Sun bitterns, 341
 Sundwall, 495
 Superheating flour mill insects, 200
 Suprarenals, 446
 Surinam toad, 269
 Surra, 29
 Susceptibility of birds to poison, 365
 Susceptibility of mammals to poison, 480
 Susceptibility of snakes to poison, 329
 Swallow, 354
 Swans, 339
 Sweat glands, 427
 Swift, 311
 Swingle, 447
 Swordfish, 249
 Symbiosis, 482
 Symbiosis between termites and protozoa, 29
 Symbiosis of Radiolaria, 26
 Sympathetic nervous system, 473
 Synapsis, 504, 505
 Synapta, 137
 Synura uvella, 28
 Syrinx, 362
 Syrphus fly, 193
- TABLE OF CEREBRAL NERVES,**
 470-472
 Table of longevity, 496
 Table of respiration rates, 461
 Taenia solium, 78
 Tails of fishes, 255
 Takamine, 447
 Tamandua, 396
 Tapirs, 399
 Tardigrada, 204
 Tarpon, 242
 Tarsier, 412
 Tasmanian marsupials, 376

- Taste buds, 477
 Taxonomy, 2
 Teeth, 428
 Teleostomi, 240, 242
 Telophase, 501
 Temperature, 490
 Temperature in birds, 355
 Tennant, 138
Teredo navalis, 151
 Termites, 179
 Terns, 338, 339
 Terrapins, 304
 Testis, 444
 Tetrad, 446, 504, 505
 Texas rattlesnake, 323, 324
 Thales, 510
Thamnophis, garter snake, 315
 Theories of heredity and evolution, 509
 Theories of the origin of vertebrates, 216-220
 Therapsida, 300, 331
 Thibetan Yak, 407
 Thief ants, 484
 Thoracic duct, 433
 Thorn-headed worms, 96
 Three banded armadillo, 397
 Three-toed sloth, 397
 Thresher shark, 225
 Thrips, 180
 Thrombocytes, 456
 Thymus, 446
 Thyroid, 445
 Thyroxin, 445
 Thysanoptera, 180
Thysanura, 178
 Ticks, 194
 Tiedemann's vesicles, 132, 133
 Tiger, 381
 Tiger beetle, 194
 Tiger salamander, 268
 Tinamous, 335
 Tissue survival outside the body, 495
 Toads in stone, 300
 Tongue, 429
 Tongue in the humming bird, 359
 Tongue in the woodpecker, 359
 Top minnow, 245
 Tortoises, 304
 Toucan, 350
 Touch of crayfish, 167
 Toxicity of snake venoms, 328
 Transmission of an impulse, 477
 Treatment of snake bite, 329
 Tree crickets, 180
 Tree frogs, 270
 Trematoda, 74
 Trembley, 68, 70
 Trepang, 141
Trichinella spiralis, 95
 Trichinellidae, 95
 Trichinosis, 95
Trichocephalus, 94
 Trichocysts, 32
 Trichoptera, 185
 Trichuridae, 93
 Trihybrids, 522
 Trilobites, 207
 Trochelmintes, 121-126
 Trochophore in Annelida, 101
 Trochophore larva, of Rotifera, 125
 Trochophore, molluscan, 146
 Troost's terrapin, 305
 Tropic birds, 341
 Tropisms, 25
 True buffaloes, 407
 True crickets, 180
 True pigeons, 344
 True seals, 389
 Trumpeter swan, 339
Trypanosoma gambiense, 29
 Trypsinogen, 432
 Tse-tse fly, 29
 Tubifex, 105
 Tubinares, 338
 Tularemia, in rabbits, 396; in ruffed grouse, 343
 Tuna, 249
 Turacin, 356
 Turbellaria, 71, 72
 Turkeys, 495
 Turkey buzzard, 347
 Turtles, 304
 Tussock moth, 187
 Twins, *Lumbricus*, 113
 Two-humped Bactrian camel, 402
 Two-spined stickleback, 246

- Types of families, 485
 Types of nests, 365
 Typhlosole, 107, 114, 145
 Tympanum, grasshopper, 183
 Tyrian purple, 152
- UHLENHUTH, 445
 Ultra-violet, 441
 Ungulata, 397
 Unguligrade, 422
Unio gibbosus, 148
 Unsaturated fats, 437
 Upper surface of the tongue, 477
 Urea, 279
 Urinogenital system of male bull-frog, 286; female, 287
 Urinogenital system of male skate, 235; female, 236
 Urochorda, 211
 Urodela, 266
 Uroglena, 28
- VAMPIRE BATS, 379
 Van Beneden, 90
Varanus komodoensis, 312
Vasa efferentia, 289
 Veins, frog, 281
 Veliger, 146, 160
 Venous circulation of skate, 234; salamander, 295; cat, 451
 Ventral view of dogfish brain, 239
 Ventral view of nervous system of frog, 289
 Venus, the quahog, 144
 Vergil and bee culture, 198
 Vermiform appendix, 430
 Vermilion spotted newt, 267
 Verrill, 86, 102
 Vertebrate embryos with their membranes, 302
 Vertebrate eye, 475
 Vesalius, 511, 512
 Vespoidea, 197
 Vestigial hind limbs of the python, 528
 Viperidae, 320
 Virginia deer, 402
 Visceral sensory, 466
 Vision in birds, 364
 Vision of crayfish, 167
 Vision of fishes, 259
 Vischer, J. P., 173
 Visual sensations, 474
 Vitality, statistics of, 480
 Vitamins, 10, 441-443
 Voice box of birds, 362
 Voice of Reptilia, 327
 Voices of mammals, 461
 Vocal sacs of frog, 285
- WALKING STICKS, 180
 Wallace, A. R., 516
 Wall lizard, 310
 Walrus, 389
 Wandering albatross, 368
 Wanderoo, 413
 Warbler, 354
 Ward, 99
 Warm spots, 476
 Wasps, 197
 Water-borne goitre, 445
 Water fleas, 170
 Water moccasin, 321
 Water shrew, 377
 Water snakes, 315
 Water-tiger, 194
 Water vascular system, starfish, 132, 133
 Weasel, 385
 Weight of the brain, 477
 Weights and measurements, Appendix
 Weismann, A., 518
 Wells, 88
 West India Boa, 4, 314
 Whale sharks, 225
 Wheat germ oil, 444
 Whirligig beetle, 194
 White Ass, 400
 White breasted nuthatch, 354
 White fish, 242
 White-lipped peccary, 401
 White rami communicantes, 474
 White whale, 411
 Whitney, 124
 Why birds migrate, 367
 Wild banteng, 494
 Wild boar, 401
 Wild ox, 406

- Wild turkeys, 343
Willier, 536
Willmer, 495
Wilson, 8, 171
Wilson's snipe, 343
Window-glass shell, 150
Winds, 491
Wisent, 406
Wolverine 385, 386
Wood-boring ship worm, 150
Woodchuck, 390
Woodpecker, 350
Wood rat, 393
Wood terrapin or turtle, 306
Woodthrush, 352
Woodward, 138, 139
Worm snake, 314
Wren, 354
- X-CHROMOSOME, 534
Xerophthalmia, 441
Xiphidium, 533
- Y-CHROMOSOME, 534
Yellow algal cells, 26
Yellow-bellied sapsucker, 350
Yellow bellied terrapin, 305
Yellow cells, of earthworm, 107
Yellow-fever mosquito, 192
Yellow hammer, 350
Yellow jackets, 197
Yellow perch, 252
Yerkes, 421
Yolk granules, 5
Young brown thrashers, 353
Young Cooper's hawk, 347
Young fawn in mountain laurel, 488
Young nymph of May-fly, 179
- ZEBRA, 400
Zebu cattle, 407
Zinc, 440
Zoögeography, 3
Zoönerythrin, 48

Some Recent Van Nostrand Books

Botany. A Textbook for College and University Students. By W. J. ROBBINS, PH.D., *Professor of Botany, University of Missouri*, and H. W. RICKETT, PH.D., *Associate Professor of Botany, University of Missouri.* \$3.75

A Laboratory Manual of Botany. Prepared by the same authors, presenting the same order of subjects and terminology. \$1.50

The Book of Bird Life. A study of birds in their native haunts; with photographs by the author. By ARTHUR A. ALLEN, PH.D., *Professor of Ornithology, Cornell University.* \$3.50

An Introduction to Organic Chemistry. By ROGER J. WILLIAMS, PH.D., *Associate Professor of Chemistry, University of Oregon.* \$3.50

An Introduction to Biochemistry. By ROGER J. WILLIAMS. \$4.00

Elements of Geology. With special reference to North America. By WILLIAM J. MILLER, *Professor of Geology, University of California at Los Angeles.* \$3.00

An Introduction to Geology. (Physical and Historical.) With special reference to North America. By the same author. Intended for the convenience of those teachers who prefer a single volume for use throughout the year. \$5.00

Astronomy—An Introduction. By ROBERT H. BAKER, PH.D., *Professor of Astronomy, University of Illinois.* \$3.75

Inorganic Chemistry for Colleges. By WILLIAM FOSTER, A.M., PH.D., *Professor of Chemistry, Princeton University.* \$3.90

Photography—Its Principles and Practice. By C. B. NEBLETTE, *Member of the Faculty, Texas A. & M. College.* \$6.50

Van Nostrand books sent post paid and on approval to residents of the United States and Canada. General Catalog sent free upon request.

