

APR 26 1983

WITHDRAWN

From the collection of the

1

San Francisco, California
2008

BUSINESS SCREEN

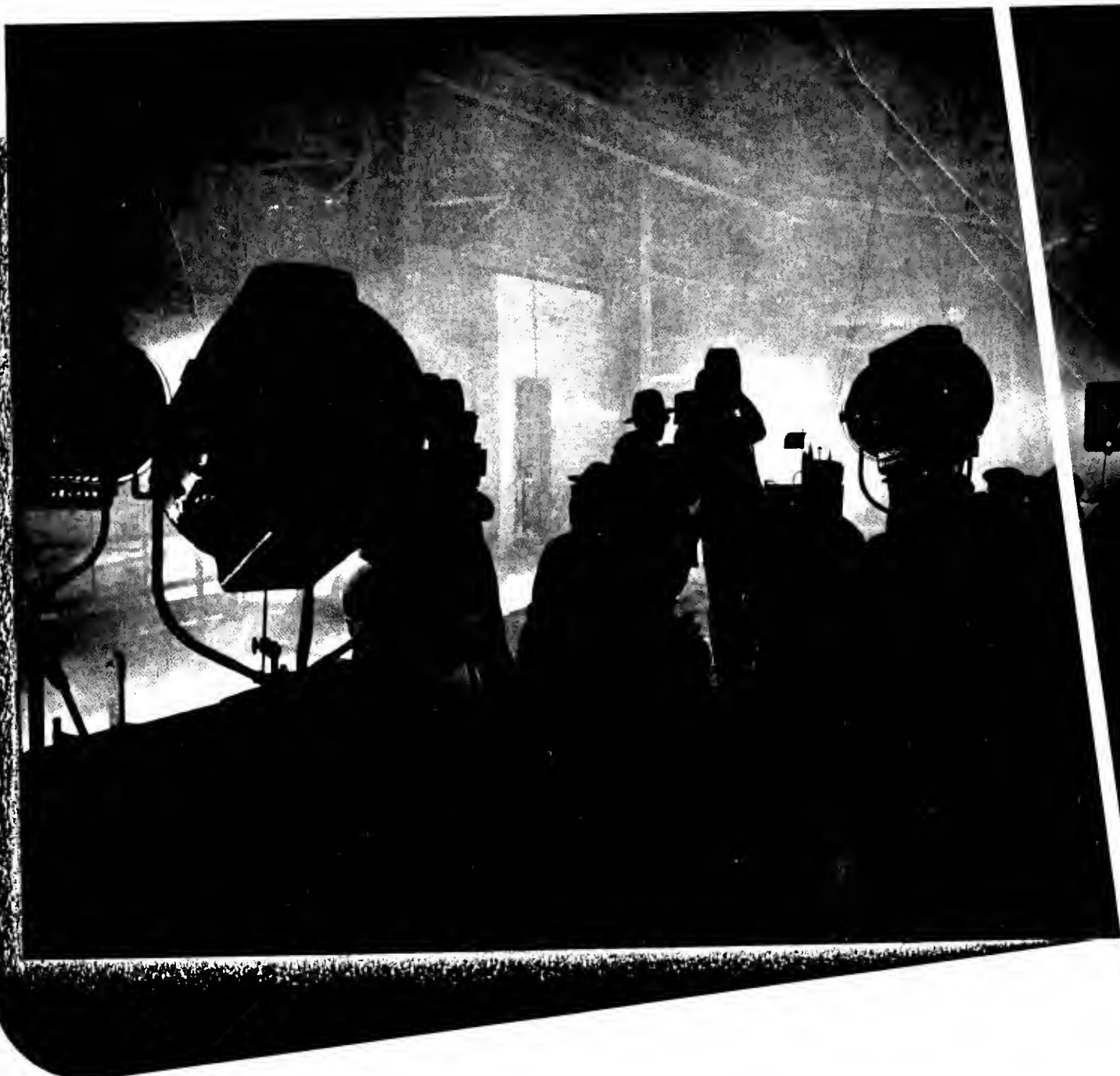

NUMBER ONE

...geared to reach **ONE** customer or **20 MILLION**

PROOF

If you want proof that Caravel
Pictures get results, check with

Atlantic Refining Company, Inc.
Wallace Barnes Company
Beck, Koller & Company
Bethlehem Steel Company
Black & Decker Manufacturing Company
Calco Chemical Company, Inc.
S. H. Camp & Company
Cluett, Peabody & Company, Inc.
Congoleum-Nairn, Inc.
Davis & Geck, Inc.
Dictaphone Sales Corporation
Eastman Kodak Company
Ford Motor Company
The B. F. Goodrich Company
Gulf Refining Company
Jenkins Bros.
Johns-Manville Corporation
Kenwood Mills
National Biscuit Company
National Lead Company
Goodall Company (Palm Beach Suits)
Raybestos-Manhattan, Inc.
Socony-Vacuum Oil Company, Inc.
E. R. Squibb & Sons
Talon, Inc.
U. S. Industrial Alcohol Company
OR ANY OTHER CARAVEL CLIENT

HOW many customers and prospects does it take to justify a picture? And make it pay?

We know of one instance where a Caravel picture, shown to a single prospect, switched a \$12,000 contract — after it had been awarded (though not delivered) to a competing company.

On the other hand, we venture the opinion that out of some twenty odd million motorists in the United States there's hardly an owner who sooner or later doesn't get better service — buy more oil, tires, accessories — because of dealer-educational and franchise-building programs produced by Caravel.

So, too, when Mr. and Mrs. Consumer are in the market for certain food products, drug items, wearing apparel, articles for home consumption, their purchases — in thousands of cases — are directly influenced by Caravel dealer and consumer programs.

When Caravel film programs lead to increased sales repeatedly, maybe it's only a coincidence. But the fact that we produce pictures for the same clients year after year suggests a different explanation. Worth investigating? Others have found it so.

CARAVEL FILMS

INCORPORATED

New York • 730 Fifth Avenue • Tel. Circle 7-6112

Chicago • Tribune Tower • Tel. SUPERior 3422



Not Worth a Dime
 ... unless he wins



ONE hundred and fifty thousand dollars worth of pitching skill and baseball brains . . . but he's not worth a dime unless he wins! So it is with your business motion pictures. Their value can be measured only in terms of *results*.

Here is a simple formula to insure the success of your commercial film program. Consult a good industrial film producer. Profit by his experience in this specialized field. Then choose projection equipment that will bring your story to the screen in flickerless, brilliant pictures . . . accompanied by voice and music reproduced so realistically that your audience will be aware only of your film message . . . forgetful of the mechanical miracle that makes modern sound-film projection possible.

FILMOSOUNDS have been chosen to project the screen stories of Chrysler, Ford, General Motors, Purina Mills, Coolerator, C. G. Conn, Republic Steel, and hundreds of other firms. It is not surprising that these projectors offer a host of exclusive features contributing to easier operation and finer performance—for they are built by the same skilled Bell & Howell craftsmen who have fashioned the preferred studio equipment of Hollywood for more than thirty years.

Write now for complete information on how Filmosound Projectors best meet the requirements for exhibition of industrial films. Use the coupon. Bell & Howell Company, Chicago, New York, Hollywood, London. *Established 1907.*

Insure Theater-quality Shows with Filmosound

New Filmosound 138—now supplied in two models—single-case for maximum portability, two-case (pictured) for most quiet operation. Both models incorporate reverse projection and still projection features. Ideal for use in salesroom, showroom, moderate-sized auditorium, or hotel room. There are other, more powerful Filmosounds for larger audiences.

Showmanship—Today's Formula for Selling

BOOKLET—Executives will enjoy reading this crystallized story of modern industrial talkies—what they are doing for others and can do for you, how to go about making a sales-building film, and how best to present your sales film. We shall gladly send you a copy of this 36-page book upon request.



BELL & HOWELL COMPANY
 1808 Larchmont Avenue, Chicago, Illinois

Please send full information on () Filmosound Projectors, () Silent Filmo Projectors. Also send () special book, *Showmanship, Today's Formula for Selling.*

Name.....
 Company.....
 Address.....
 City.....State.....

BS 6-38

BELL & HOWELL

REC'D. IN B. I. B. 12-18-39

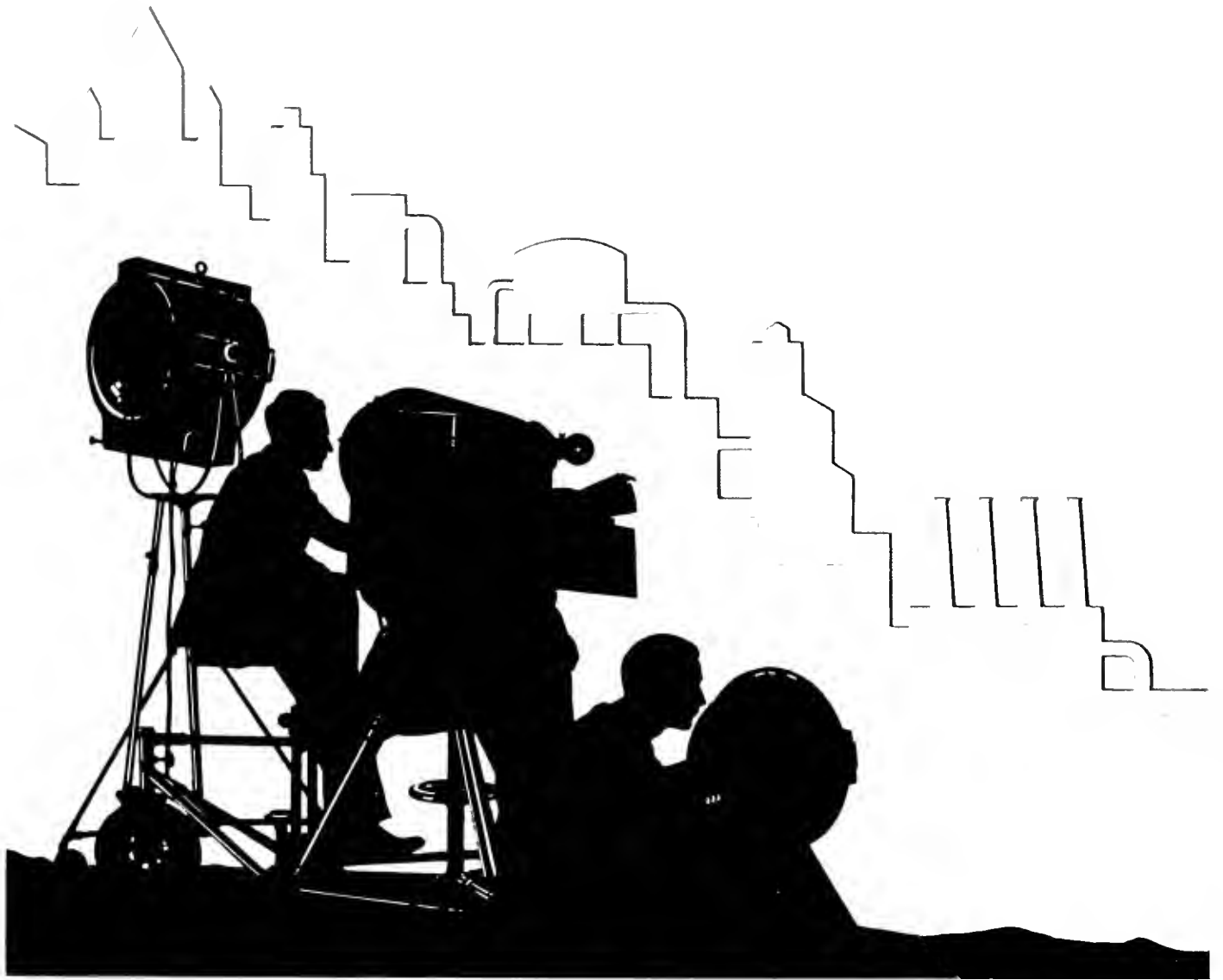

CRAFTSMANSHIP - *Plus*

BURTON HOLMES FILMS, INC.
7510 NORTH ASHLAND AVENUE CHICAGO, ILLINOIS

Created by Master Builders

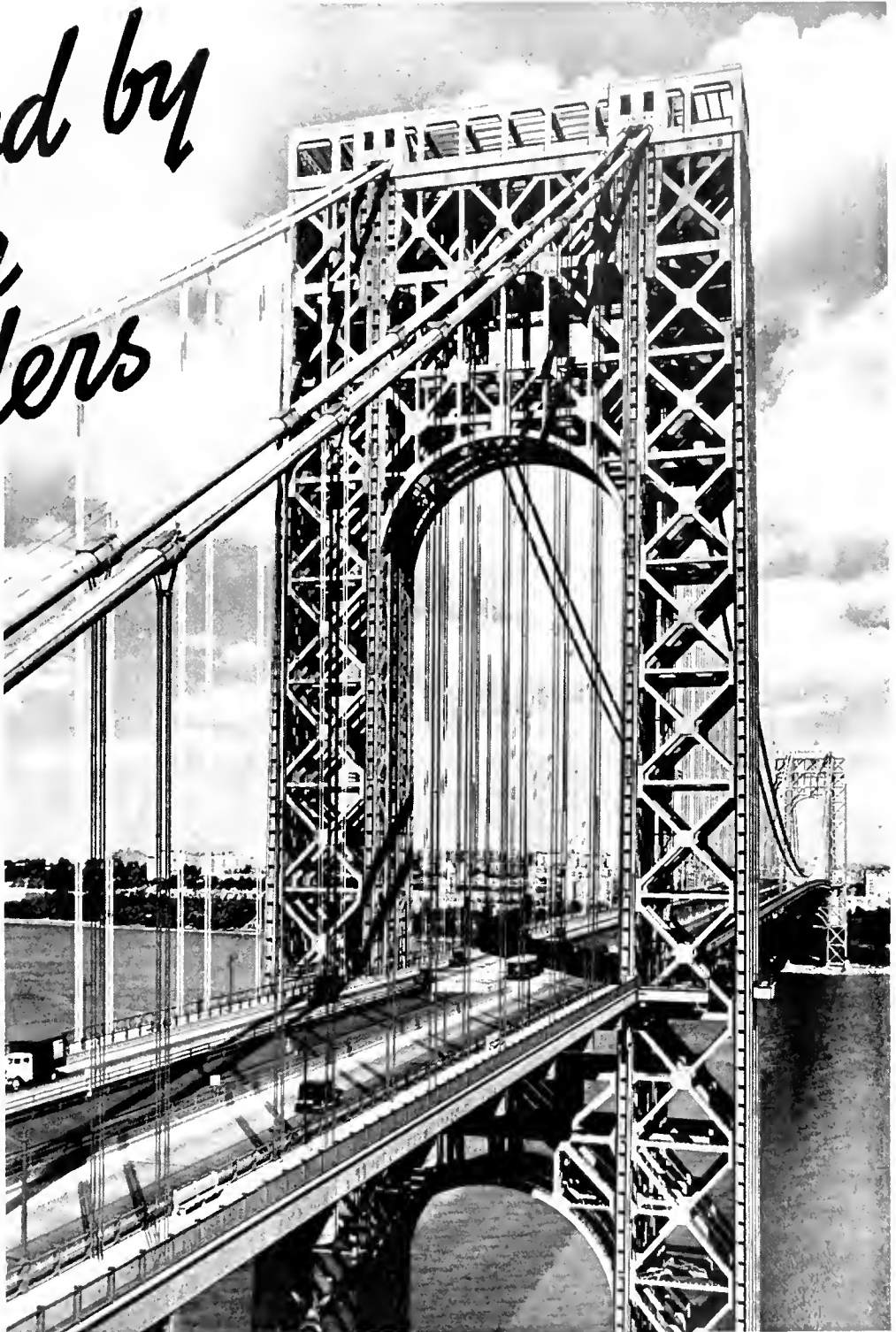

SPUN into the maze of steel and wire in a great bridge is the genius of three Master Builders . . . the Creative Genius that envisions its entirety . . . the Engineering Genius that makes this vision practicable . . . the Production Genius that calls it into being! Because so much vital, human contact depends upon its mighty span, every factor in its building must evolve from the best thinking of these three, skilfully co-ordinated into one perfectly blended achievement.

So it is with Wilding Sound Pictures, that irresistible medium which bridges the gap between your Client and his Market! Each step in Creation, Direction and Production is the work of Master Builders, trained through years of association with the Picture Industry and broadened by long contact with dozens of famous Clients. Only from such a background can your Client hope to obtain Sound Pictures that are fully co-ordinated to extract the maximum of dramatic Selling Power from his operation . . . and then convey it directly to the Field!

More convincing than any words of ours are Wilding Pictures themselves . . . a line on your stationery will arrange a presentation of some of these unusual Sound Pictures.



... buy Wilding!

WILDING PICTURE PRODUCTIONS

INCORPORATED

NEW YORK • CHICAGO • DETROIT • CLEVELAND • HOLLYWOOD

FILM FORUM



A DEPARTMENT OF LETTERS EDITED BY
& FOR THE READERS OF BUSINESS SCREEN

POINTS DISTRIBUTION NEED

Editor of Business Screen:

In 1935 and 1936 we engaged in a moving picture activity in our dealers' showrooms, rented halls, etc., as a purely advertising venture.

Surveys of the effectiveness of the program showed that the influence of the moving picture on the prospective purchaser was extremely high but that the coverage we secured was very low. The net result was that the bad offset the good to an extent that it was impractical to spend further monies to secure larger audiences.

More recently, moving pictures have been used in our business as a medium of sales education. In this respect I can say that nothing has proved more effective. While the cost has been high we have been amply repaid for the expenditures.

In reply to your question as to my opinion on the needs and future aims of the commercial film business, I can only say that the biggest obstacle to be overcome is to get coverage at a cost that is somewhere reasonable. This—of course—does not preclude the need for good scripts, good direction and a good cast . . . all of which are essential to a successful production.

Yours very truly,

G. R. Browder
Assistant General Sales Manager
Oldsmobile Division, Gen. Motors

Our editorial thanks to Mr. Browder for his frank reply to this editorial solicitation for prepublication comment. It is such letters as this which help much to shape our future editorial course.

CANADIAN INDUSTRIES LTD. WRITES

Editor of Business Screen:

I was greatly interested to receive your letter this morning as it happened to coincide with a meeting we held yesterday to discuss the subject of institutional merchandising and educational films.

We have in the past prepared several silent films for some of our Divisions, but, like so many industrial shorts, they have been unsatisfactory in many respects and their content has restricted their circulation. Irrespective of what we may do with movies, the Publicity Bureau is at present building a series of glass and film slide lectures which will be used in schools and before clubs.

Yours very truly,
Canadian Industries Limited
C. P. C. Dohman
Publicity Manager

Business Screen hopes that its content material may in some measure guide the film destinies of Canadian Industries, Ltd. Welcome, indeed, will be comment after a reading of the first issue.

DICTAPHONE'S ADVERTISING MANAGER:

Editor of Business Screen:

Enclosed is a small booklet which describes briefly the story of the Dictaphone talking motion picture "Two Salesmen in Search of an Order." As it indicates, it is a lesson in salesmanship that speaks for itself.

In developing the picture, we endeavored to provide an entertaining yet informative story which would describe some of the many advantages of the Dictaphone System. Care was taken to avoid too much direct sales propaganda. With that in mind, the picture was written around the universally interesting subject "Salesmanship." In "Two Salesmen in Search of an Order" we depict both the good selling technique and the bad. During the course of this general treatment, many features of the Dictaphone System, not fully appreciated by the general public, were emphasized as part of the selling technique.

The picture has been in use for about a year and a half. It has been shown before many important groups throughout the country.

The picture is used for two purposes—-one is to train our own sales staff in the proper technique of selling Dictaphones, and the other is to interest and educate the public

in the conveniences of the Dictaphone System. It is shown before civic and business groups, sales clubs, and before many large sales organizations. In addition, many private showings have been arranged in local offices of prospects. We have had very good results from our use of this talking motion picture, not only in the widespread interest it has created in our equipment but also in a number of sales which can be credited directly to the picture itself.

Yours very truly,
R. T. Harris
Advertising Manager,
Dictaphone Sales Corporation

The subject of the full-length article in an early issue, Dictaphone's experiences with the film medium are well summarized in this courteous reply to our prepublication query. Business Screen joins the business men who have profited from Dictaphone's fine sales picture in thanking Mr. Harris.

NATIONAL BISCUIT COMPANY:

Editor of Business Screen:

We enclose herewith a copy of the May-June issue of our "N.B.C. Magazine". On pages 6 and 7 you will find a short story about "Romance on Main Street". Since that time the results have been equally gratifying.

Several months ago we used a sound slide film entitled "What Makes a Good Cracker Good?" This was exhibited to our salesmen and was well-received.

Yours truly,
S. N. Holliday,
NATIONAL BISCUIT COMPANY,
Advertising Department

Newspaper clipping files of the magazine are generously filled with items noting the wide popularity of N.B.C.'s *Romance on Main Street*, now in its second year of successful showing. A review of *Winners With Wheat*, latest in the N.B.C. film family appears on page 37 of this issue.

FROM CATERPILLAR TRACTOR:

Editor of Business Screen:

We are pleased to attach an article dealing with the use of motion pictures. To go with this we are including some photographs that might be useful for illustration purposes.

It is a great pleasure to supply this material, and if we can be of further service in future issues of your interesting publication please say the word.

CATERPILLAR TRACTOR CO.
Very cordially yours,
P. C. Smith
Advertising Department

A full-length feature article on the Motion Picture Department at Caterpillar is thus reposing in our files. Knowing that our readers will appreciate sharing the experiences of this great manufacturer, Business Screen will bring it to them in an early issue. For the careful preparation and generous cooperation exhibited by Caterpillar's correspondent, we are indeed grateful. In return, it is our sincere hope that the pages of this book may repay a service in bringing the valuable experience of others to Caterpillar.

FROM ELI LILLY & CO:

Editor of Business Screen:

Mr. Clark has referred to this department your letter asking our views on the use of motion pictures in business. We were pioneers in making motion pictures of our business—-that is, in this industry

—-and we were also pioneers in bringing out what we believed to be the first sound picture produced in the pharmaceutical industry.

We have no contact with the layman. Our films are shown before drug audiences and medical groups and so we are unable to give you the reaction that might be expected from lay audiences.

We hope that when Mr. Clark has had an opportunity to look at "Business Screen" he will send it to us because we will be interested in looking it over.

ELI LILLY AND COMPANY
Very truly yours,
H. S. Noel
Director Trade Relations

Here is a field as yet little discussed and yet possessing vast opportunities for the film medium. Medical films are, of course, widely used, but the extent of potentialities among lay audiences awaits Business Screen's first thorough survey of the field.

DENNISON MFG. COMPANY:

Editor of Business Screen:

We are adding your name to our mailing list so that you will receive our house organ "What Next?" regularly.

We have no recent film production in which you would be interested, although we are now working on one which might possibly furnish some material for your magazine when it is finished.

I shall look forward to seeing the first issue of "Business Screen" as soon as it is issued.

Yours very truly,
DENNISON MANUFACTURING CO.
W. J. Walker
Advertising Department

When Dennison is ready to release news of its latest film-in-production, Business Screen hopes to tell about it.

WOOL ASSN. WRITES:

Editor of Business Screen:

Thank you for giving us information about your publication. We have considerable promotional data as well as photographs from both our films "The Seven Wonders of Wool" and "Suitability Sells Suits", both of these being department store training films. We also have considerable data in the way of comments from leading department stores.

If you will advise me just how many photographs you can use, and whether you wish to run the first article on our initial film "The Seven Wonders of Wool", or to cover both of them, we shall be very glad to furnish you with the necessary data. For your information almost 60,000 people have viewed our "Seven Wonders of Wool" film, the bulk of these being in department stores. We are enclosing for your information a copy of the Leader's Guides on each of these films, together with one of the small follow-up books that is distributed to the individual after they have viewed the film. As the supply of these books is rather low at the moment, we would ask that you hold these for further notation when you write your story.

Very truly yours,
Mrs. Minna Hall Carothers,
Director, Dept. of Retail Sales Promotion
ASSOCIATED WOOL INDUSTRIES, INC.

A complete section on the use of slide films and motion pictures in the department store field is a feature of this first issue. The section is not a "one-time" affair but the beginning of a determined effort to aid department store executives. In this issue, Business Screen has scheduled some of the material supplied by the Wool Association and

(Continued on Page 9)

THE DA-LITE MODEL D

One of the most popular table models. Its Da-Lite Glass-Beaded Screen is roller-mounted in a leatherette-covered box. Single collapsible support locks automatically when screen is raised. 10 sizes from 22" x 30" to 72" x 96" inclusive.

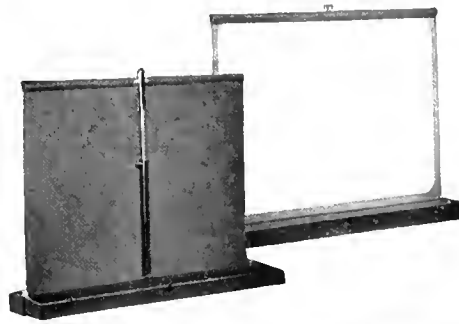

DA-LITE BUSINESS SCREENS

MEET EVERY PROJECTION REQUIREMENT

For brilliant, professionally smooth presentations of your business films — equip with Da-Lite Business Screens. They are made in many styles to meet the diversified projection requirements of homes, offices, auditoriums, training class rooms and other places where films might be shown. They include table models, tripod models, rear projection screens, hanging screens, and regular theatre sound screens. The Da-Lite Electrol, a new large hanging roll screen, is electrically operated and can be controlled from any part of the room.

Da-Lite surfaces include Mat White, Silver and Glass Beaded. For the average projection requirements, the Da-Lite Glass Beaded surface is recommended. It reflects the maximum of light without sparkling or glare. The beads are guaranteed shatter-proof.

Da-Lite portable screens are light in weight, easy to set up and fold to compact size for easy carrying. All Da-Lite Business Screens are built of quality parts by skilled craftsmen, to give the utmost in long, economical service.

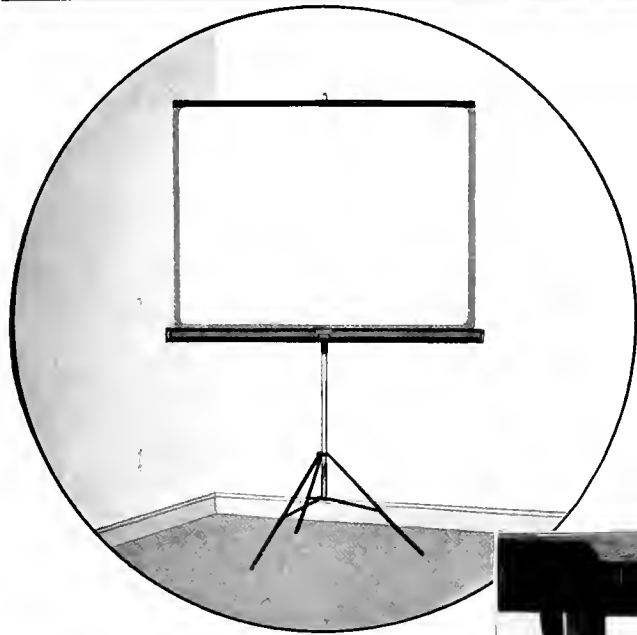

THE DA-LITE CHALLENGER

For unequalled convenience, experienced film users prefer the Da-Lite Challenger. It consists of a Da-Lite Glass-Beaded Screen, roller-mounted in a metal case to which a tripod is pivotally and permanently attached. It can be set-up in 30 seconds. Square tubing in the center rod and extension support (an exclusive Da-Lite feature) prevents the case from turning and throwing part of the picture out of focus. Fully adjustable in height. Square sizes (for showing slidefilms) can be adjusted to rectangular shapes (for showing motion pictures). 12 sizes from 30" x 40" to 70" x 94" inclusive.

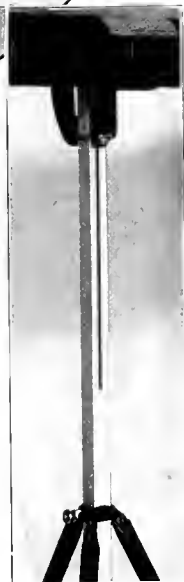

FREE! SCREEN DATA—Every Film User Needs

Gives you facts and charts on the light reflective properties of various screen surfaces, pointers on the care of screens, and full details on the world's most complete line of Business Screens.



Mail Coupon Now!

DA-LITE SCREEN COMPANY, INC.
Dept. 6 B, 2723 No. Crawford Avenue, Chicago, Illinois

Send your FREE SCREEN DATA BOOK at once.

Name _____
Firm Name _____
Address _____

**Quality Screens for
Twenty-Eight Years**



Reg. U.S. Pat. Off.

Movies At
Point-of-Sale

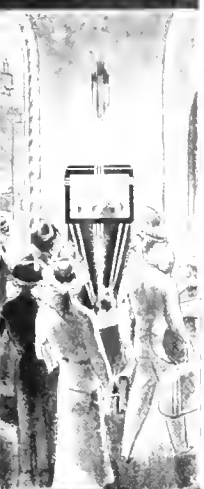

In
Hotels and
Club Lobbies



In all Types
of
Retail Stores



In
Transportation
Terminals

Flolite

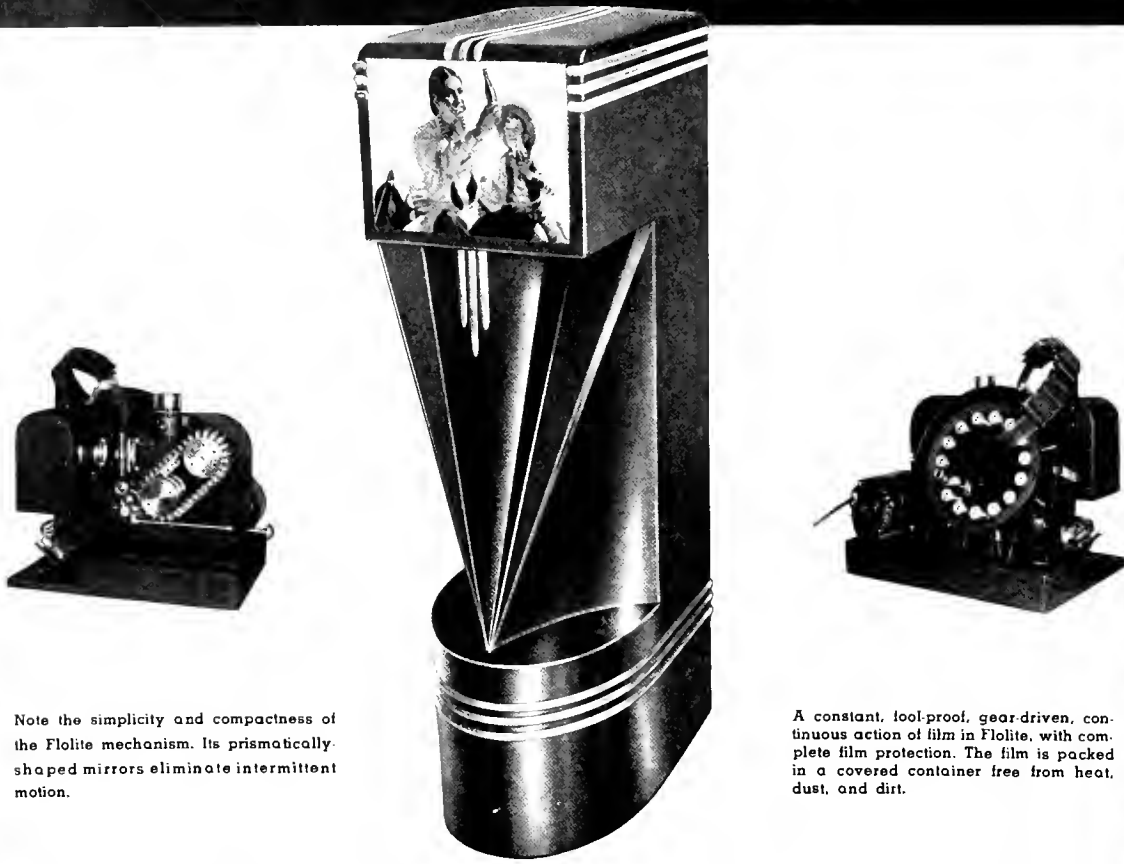

Note the simplicity and compactness of the Flolite mechanism. Its prismatically shaped mirrors eliminate intermittent motion.

A constant, fool-proof, gear-driven, continuous action of film in Flolite, with complete film protection. The film is packed in a covered container free from heat, dust, and dirt.

THE WORLD'S FIRST SUCCESSFUL AUTOMATIC CONTINUOUS PROJECTOR

Heretofore, film advertising has been confined to theatrical and non-theatrical screens. With Flolite it is possible to distribute your commercial films in as many locations as desired, in any community, City or State, in retail, food, drug and cigar stores, department stores, cafes, depots, window and store displays, hotel, theatre, club and office lobbies, conventions, public buildings and numerous other similar places.

Flolite is a miniature theatre, combining mechanism, screen, motor, sound and speaker. Through a series of prismatically shaped mirrors, it eliminates intermittent motion and flicker. Flolite is equipped with a special General Electric lamp, guaranteed for 500 operating hours, as compared with 25 or 50 hours on projectors using higher wattage lamps.

Through a series of specially designed reflectors, it is possible to project brilliant pictures, even in broad daylight or under artificial light . . . darkness is not necessary. Flolite has a capacity up to 1,000 feet of 35 mm. film which automatically repeats as long as you want it to. Flolite is 61" high, 25" deep, 19" wide and weighs only 85 pounds. The cabinet is made of solid walnut, artistically inlaid. The screen is 15" x 12" with absolutely no "dead lighting spots".

Take advantage of this media for circulating your commercial films. Consult your own producer or write direct to us for our new fourteen page color booklet.

Flolite congratulates Business Screen for filling an important need in film advertising. It seems coincidental that both Flolite and Business Screen make their bow at the same time.

Flolite world preview at Booth 7, Advertising Federation of America 34th Annual Convention and Exposition, June 12, 13, 14, 15, 16, Detroit.

FLOLITE MOTION PICTURE CORPORATION
FORMERLY ADVITAGRAPH CORPORATION
Producers-Distributors of Advertising Motion Pictures • Manufacturers of FLOLITE Continuous Projectors
540 NORTH MICHIGAN AVENUE • CHICAGO
 HOLLYWOOD, CALIF. NEW YORK CITY DETROIT, MICH. LOUISVILLE, KY.
 ROCHESTER, N. Y. MINNEAPOLIS, MINN. ST. LOUIS, MO. and other principal cities
Members • Advertising Federation of America

Movies At
Point-of-Sale

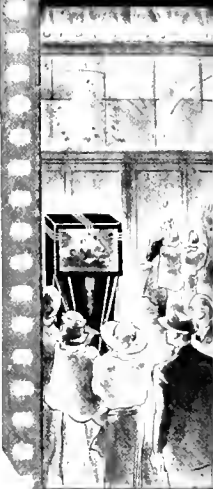

In
Theatre
Lobbies



In
Window and
Store Displays



In Conventions
and
Expositions

FILM FORUM: a Department of Letters

a more complete story of the work of this organization will appear later. Business Screen favors a widely varied supply of training and promotional films for extensive use in department stores and hopes that national advertisers will appreciate the opportunities offered for a major cooperative drive to perfect distribution of good consumer films to department store audiences. The present lack of facilities in such stores further stymies the many excellent productions. However, a complete program of such pictures made available to department stores on a national scale would soon make the small investment required in audience facilities cost worth while. In that event, the several applications of films suggested in sketch-book fashion on other pages of this issue (29-36) would then become much needed actualities. Store executives interested in this program may also secure information from the offices of the National Retail Dry Goods Assn., 101 West 31st Street, New York City, addressing the Personnel Group.

NATL. ASSN. of MANUFACTURERS:

Editor of Business Screen:

In the past four years we have made four motion pictures, all for mass theatre audiences. Our pictures have all been designed to recreate in the minds of the mass audience a respect for the American Industrial System with its rewards and its opportunities. Naturally we have not been interested in advertising any particular product or industry but have used the screen to get over a mass impression to a mass audience.

Under the circumstances we have been highly satisfied with the results achieved to date and we have found that the pictures we have produced so far have been popular and highly acceptable with theatre managers and theatre audiences. I am afraid we have not gone sufficiently into the motion picture field to make any further observations on the subject. We have made no pictures for the purpose of creating a better understanding between the employer and the wage earner and do not feel competent to comment upon that subject.

On the basis of our own experience we have planned to go further into the motion picture field and hope within the near future to produce more pictures.

Sincerely yours,
James P. Selvage
Director of Public Relations

Two recent productions of the Manufacturers' Association have recently been seen by theatrical audiences throughout the country. One of these, *Frontiers of the Future*, is summarized on page 37. The need for better understanding is well served by these films. That their distribution is directed to theatrical audiences is also extremely interesting. From our own experience gained while witnessing one of these pictures, we can agree that a theatre audience *did* find the picture highly acceptable.

DEPARTMENT of INTERIOR:

Editor of Business Screen:

Your plans for the magazine "Business Screen" seem good and I feel certain there is a spot for the sort of publication you have in mind. I appreciate your asking me to contribute to an early issue and I shall respond with a story on our activities within the next two or three weeks.

Would you like to have pictures with the story? We can furnish them of our camera and laboratory work and of scenes from our films. They might help the story along. Paul Rotha, the young British producer, spent a while with me here in Washington last week and mentioned your publication plans. He agrees that there is a place for your

magazine. If you have not already done so, it might be advisable for you to write him care of The Museum of Modern Art Film Library, 485 Madison Avenue, New York City. Please let me know if there arise occasions when I can be of assistance in getting your new publication on its way. Ten years in the newspaper business have injected into me a perpetual interest in new publishing ventures.

Sincerely yours,
Fanning Hearon,
Director, Division of Motion Pictures
U. S. DEPARTMENT OF INTERIOR

Since correspondent Hearon's letter, he has been on leave directing the production of Mr. James Cromwell's much discussed *In Defense of Capitalism*. Which makes for some kind of a paradox but probably illustrates how very stable we commercial film folk really are. Poetic justice has apparently triumphed in New-Dealer Hearon's defense of Mr. Cromwell's *Capitalism*. Seriously, the excellent work of the Department of the Interior has been responsible in no small part for millions of enjoyable vacations on the Seeing-America-First-Plan; for a better understanding of a thorough government service and for the sponsoring of such important programs as forest conservation.

A VOICE FROM THE AUDIENCE:

Editor,
Clarksville (Ark.) Herald-Democrat

When I decided to attend the showing of "*The Star in My Kitchen*" the moving picture cooking school now showing each afternoon at the Strand theatre, I was unprepared to witness such a really enjoyable demonstration of how to prepare good things to eat, or to see unfolded a really thrilling love story as well.

I went to see the picture merely because I thought I would see some of the usually highly advertised products on display and possibly gain some few ideas for the preparation of food.

The love story which runs through "*The Star in My Kitchen*" so uniquely unfolds the methods of properly preparing various dishes by the activities of the feature actors, a young girl and boy who become lovers, thus producing the situations which bring about the demonstration of the proper preparation of food.

It has been my pleasure to attend several cooking schools of one kind or another but never before have I witnessed a more interesting presentation of the proper preparation of so many attractive dishes. I could of course tell of the many interesting situations which are solved in the picture but to do so would be to spoil the pleasure of those of you who see it.

My only advice to women is to see this interesting and entertaining picture and if possible get friend husband to go with you as you will both enjoy it

Mrs. Ed. Schultz

Business Screen presents this unusual contribution — not from a reader but from a member of that all-important sorority, the women who see commercial films. Not the first enthusiast. Miss Schultz is our typical movie-goer of the month and her reactions are directed to the home town papers which help promote the showing of *Star in My Kitchen*. *Star in My Kitchen* is the best way we know to get over the real selling job being done with consumer films. The Pictorial Cooking School production has literally filled our press book with clippings from the many cities where it is being shown. Co-operative newspaper promotion in this manner has been profitable to publishers and film producers alike and the national advertiser has gained tremendous favor as well as real sales results.



"SYNC!"

Technically — motion pictures are *synchronized* (voice matched to lip movement) with "clap-sticks".

But technical production is only one part of our work. For the past twelve years, our creed has been "Every picture produced must synchronize with the client's particular needs."

Our rapidly growing list of clients attests to the success of this policy.

INTERNATIONAL HARVESTER CO.
STEWART-WARNER CORP.
JOHN MORRELL & COMPANY
ALLIS CHALMERS MFG. CO.
LIBBY, McNEILL & LIBBY
CATERPILLAR TRACTOR CO.
ROCK ISLAND LINES
MONTGOMERY WARD & CO.
AMERICAN COLLEGE OF SURGEONS
ELGIN WATCH COMPANY
REID MURDOCH & COMPANY
CULVER MILITARY ACADEMY

CHICAGO FILM LABORATORY, INC.

SOUND STUDIOS

18 West Walton Place
CHICAGO, ILLINOIS

MOTION PICTURES - SLIDE FILMS
RCA ULTRA-VIOLET RECORDING

WE TIP OUR HAT TO BUSINESS SCREEN..

And

Take a Bow for Successful
"MINUTE MOVIE"
 campaigns for such ad-
 vertisers as

LUCKY STRIKE... ALKA
 SELTZER... QUICK ELAS-
 TIC STARCH... CHEVRO-
 LET . . . WESTINGHOUSE
and many others!



These prominent film com-
 panies are our co-distributor mem-
 bers. They are the only ones in the
 General Screen Advertising set-up.

Alexander Film Co. 3200 N. Nevada St. ColoradoSpr'gs, Colo.	Screen Adettes, Inc. 925 N. W. 19th Ave. Portland, Ore.
---	---

Green's Adv. Agcy. 625 Market Street San Francisco, Calif.	Screenad Exchange 158 State St. Binghamton, N. Y.
--	---

Tad Screen Adv. Inc. 4310 Bryan St. Dallas, Texas	Ray-Bell Films, Inc. 2269 Ford Road St. Paul, Minnesota
---	---

Greetings to Business Screen and to our more-
 than-a-score of successful clients.

To other advertisers we say simply this: We
 can take YOUR product and introduce its
 merits to your prospects from the motion pic-
 ture screen (7500 available theatres from coast
 to coast!). Such Minute Movies can thor-
 oughly, completely demonstrate your mer-

chandise and describe its merits. It *shows 'em*
and tells 'em—that's why it *sells 'em*! Make a
 date with your prospects at the Movies—the
 one time when you can be assured of individ-
 ual attention. No pages to flip—no dials to
 turn—your advertising will be *seen and heard!*
 Write today for full details and for *campaign*
 results experienced by present users!

GENERAL SCREEN ADVERTISING, INC.

Member A. F. A.

WRIGLEY BUILDING CHICAGO, ILLINOIS

MINUTE MOVIES
 NATION WIDE ADVERTISING



National Sales Representatives:

MACY & KLANER, INC. Wrigley Building	Chicago, Illinois
---	-------------------

JAM HANDY THEATER SERVICE, INC. 230 Park Avenue New York City	General Motors Bldg. Detroit, Mich.
---	--

EDITORIALLY WE HAVE TAKEN LITTLE recognition of what appears to the advertising and amusement press as the commercial film "subject of the hour." This concerns the distribution in "entertainment" theatres of "advertising" movies. We prefer to think that almost everybody concerned has been guilty of over-statement. The advertising appearing on the screens of over 7,000 theatres throughout the country will very likely continue to appear there just as it has for more than twenty years. Economic circumstances, as a matter of fact, point to an increase in the number of theatres exhibiting short features and "minute movies."

ASIDE FROM THE CONTINUED IMPROVEMENT in color and subject matter of the "minute movie" and theatrical distribution of such subject material as the animated cartoons used by *Metropolitan Life*, *Ipana* and *Fisher Body*, the field in which the motion picture medium has found its greatest opportunities for service is that of "natural distribution." Perfection of distribution programs by existing organizations and the availability of the film medium to the great marketing fields offered by all types of retail establishments is here regarded as the most important subject of the hour. To that end we devote special departments such as the present section "Motion Pictures in the Department Store" in this first issue.

AS THE FIRST ISSUE OF BUSINESS Screen goes to press, only a few random thoughts remain in the fatigued mind of the editor. Thousands of words, few of which seem to measure up to the significant power which the motion picture medium alone possesses, repose unprinted among the left-overs of a first issue. Also left in our bulging files are hundreds of case histories which illustrate successful applications of films to all types of business problems. Merchandising surveys, charts, tables and columns of editorial comment whirl in one chaotic mass past our weary and regretful gaze.

NOTEWORTHY AMONG THE CONTRIBUTIONS included in this first issue are those offered by Paul Rotha, by H. M. Beresford and the interesting department store sketches arranged specially for Business Screen by Barnes & Reincke, our consulting industrial designers. We hope to have the time and the space in our next issue to introduce many of these contributors to you.

One further thought occurs—a sincere vote of thanks is offered here to the leaders of the commercial film industry who have expressed their faith in this publication by their unhesitant advertising support of our program.

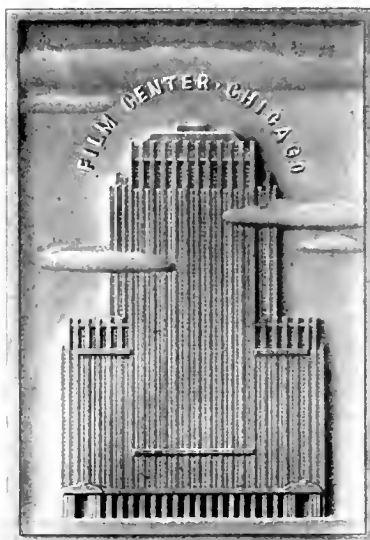

THE MAGAZINE OF COMMERCIAL & EDUCATIONAL MOTION PICTURES

C O N T E N T S

Cover Illustration and Design by William Kosloff

Film Forum	6	Films on My Budget?	22
The Power of Films to Sell	13	Sales Results with Pictures	23
International Harvester	14	This Animating Business	24
New Dimensions in Advertising	17	British Documentary Films	25
Salesmen Get the Idea	19	Motion Pictures in the Department Store	29
Technicolor Tells the Story of Steel	20	Brief Reviews of Current Releases	37

PROMOTION AND DISTRIBUTION

Coolerator Movie Sets Audience Records	45	The Commercial Newsreel	50
Films for the World Fair Millions	48	You Ought to Read	56
Standard Oil Film Wins Rural Friends	49	Equipment Review Section	59

BUSINESS SCREEN MAGAZINE, ISSUED BY BUSINESS SCREEN MAGAZINES, INC., TWENTY North Wacker Drive, Chicago, Illinois. Editorial Director, O. H. Coelln, Jr.; Art Director, Henry Harringer. Printed in the U. S. A. Subscription price: domestic, \$5.00 a year; 50c the copy; foreign, \$6.00 a year. Publishers are not responsible for the return of unsolicited m. s. unless accompanied by stamped, self-addressed envelope. Entire contents Copyright 1938 by Business Screen Magazines, Inc., Chicago. ISSUED TEN TIMES A YEAR - PLUS TWO SPECIAL ANNUAL NUMBERS

THE SIGN OF GOOD SHOWMANSHIP



YOUR PRODUCT probably has more romance, thrills, humanity, history, and downright friendliness than could be found in two volumes of a best seller. We think people would like to know about it—to look beyond your product's label—to see it live and hear how their own lives could be benefited through your product. Movies are the modern medium for doing exactly this. But like the pudding, the proof of a movie is in the showing. ■ That's why our network of 41 cities throughout the United States has been set up to provide you with projection

service any time, any place, anywhere; that's why a competent personnel has been trained in the exploitation and booking of motion pictures; and that's why our organization is equipped to work out with you a national campaign for circulating your talking pictures, to the better buying power. Through theatres, through clubs, through specific audiences, any time, any place, anywhere, with maximum coverage. ■ Advertisers everywhere are taking advantage of the Modern way of meeting their consumers. Don't be left behind. Write now for complete information.

MODERN TALKING PICTURE SERVICE, INC., NINE ROCKEFELLER PLAZA, NEW YORK, NEW YORK

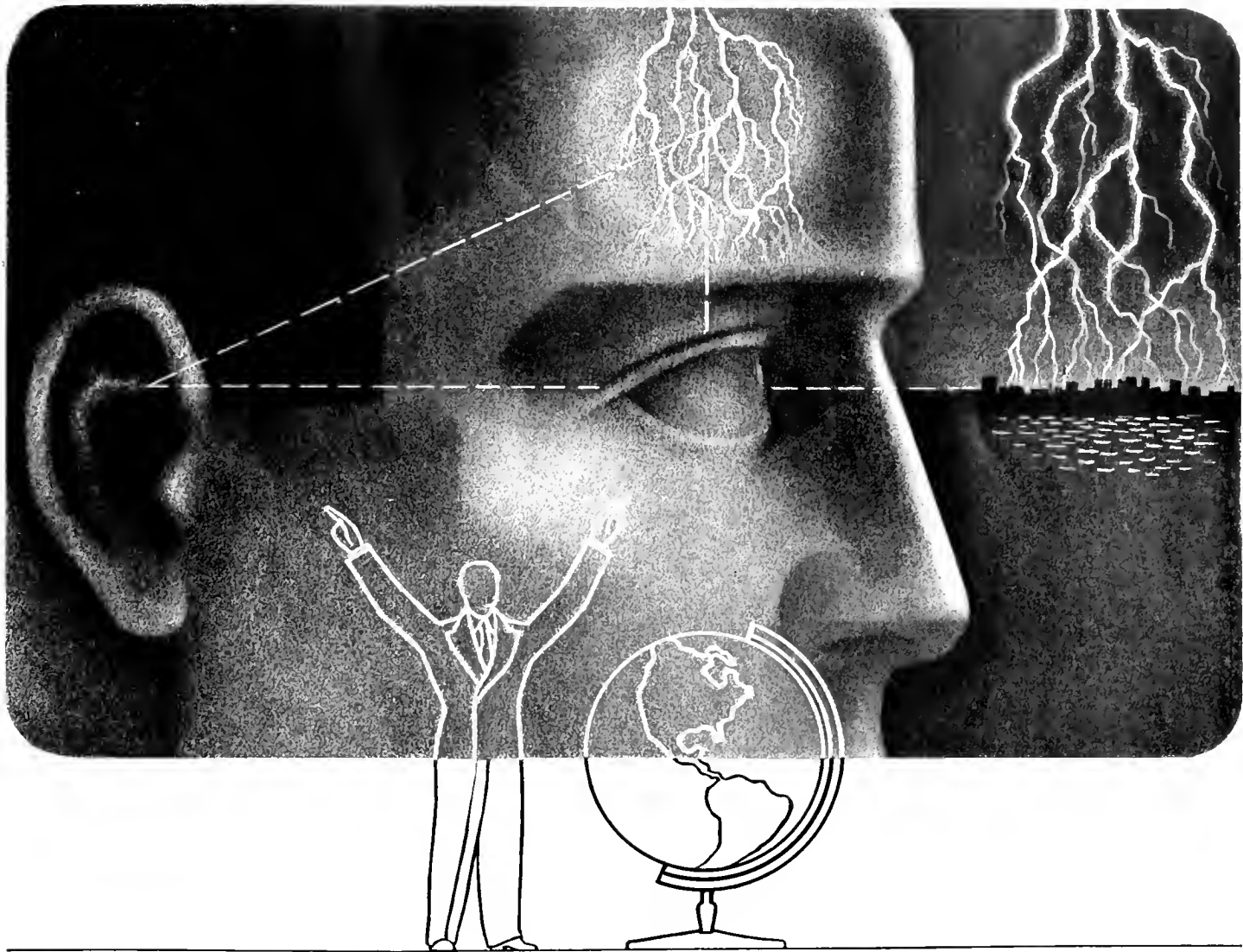

The power of films to sell

Here is a man with the world at his command. He is the salesman of your business and he carries with him on his calls a film projector in which is threaded your tried, tested and most successful sales story. As he chooses, an audience of several million may await this man; otherwise, he may "tell" this story to a single other individual and return the profits of a year's labor. Multiply this salesman by a thousand and ten — equip each one with the right message and they'll sell America out of "recession" in twenty-four hours!

For ever since the birth of motion pictures and matching the development of the medium for entertainment — industrial and educational films have moved apace, beside the glamour that is Hollywood. But business films have little in common with that mythical kingdom for theirs is a world of sober,

realistic fact. In recent years, the realization that these facts possessed tremendous dramatic power has given rise to a new and greater era of motion picture development. Together with untold technical advancement in color and sound they are giving millions of Americans a new educational form, a new advertising medium, a new method of sales training, a new way of getting understanding of significant events... and all of these far greater in effect and result than any other method of idea communication in modern business.

The mastery of this tool is not yet complete. When a near-perfect production with a significant purpose achieves its goal... audiences cheer and applaud its accomplishment. Even the numerous pitfalls of artistic and technical imperfection into which many films fall do not hinder them from a measure of

success... so excellent is the medium and so simple and complete is its means of getting the message understood by its audience.

To increasing numbers of commercial and industrial concerns throughout the country, motion pictures are becoming a vital part of advertising, sales training, public relations and other activities. The significance of the motion picture's changeless perfection of detail, its vast panorama of scene and the direct, positive personality of its delivery to the onlooking audience are important factors in the upward trend of the commercial motion picture industry during 1937 and 1938. The motion picture competes with no other medium of expression — it excels all of them as the most perfect medium for advertising and selling yet known to business.

INTERNATIONAL HARVESTER

A pioneer of 1911 shows the way in 1938

TWO YEARS ago, almost eight million people attended thirty-six thousand performances of business motion pictures prepared and shown by America's pioneer exhibitors, the International Harvester Company. Harvester has used films since 1911.

That the totals for 1937 approximate well over 10,000,000 people is a reasonable estimate. From December, 1934 to the present, Harvester has released 17 reels of sound motion pictures. None of these are intended for pure entertainment purposes. All of them have the sober and earnest task of selling Harvester products to potential Harvester customers. Nor is this selling confined within the boundaries of the United States. Recently Harvester films have added French, Spanish and German sound tracks. Foreign shipments to Canada,

South America, Europe, South Africa and Australia are now fairly common.

In the early months of 1938, there were 2800 prints of recent Harvester film productions being circulated. These consisted of approximately forty different subjects and a total of about seventy prints were needed to supply the demand for each of the subjects. Harvester motion pictures first sell their audiences the value of farm machinery and then dwell upon the advantage of Harvester products. Naturally, most of the showings are made possible during the winter months when farm activity is at its lowest ebb. Then Harvester's 8,000 dealers have made most of their headway in arranging shows.

Harvester pioneered the business film field when it produced a



film entitled *Back to the Farm in 1911*. The first Harvester film starred Beverly Bayne, famed star of that era, and was as popular as its descendants with rural audiences. The advantages of modern farm equipment were pictured. The motif is changed somewhat today, but the motive remains the same. Harvester produces on a large scale to aid its selling organization. For machinery demonstrations, the medium is unexcelled and Harvester's dealers are able to bring to their customers, field performances of their equipment — now an indispensable element in the local sales program.

Harvester's use of pictures in 1911 practically dates the application of this medium to industrial and advertising uses except for isolated experimental attempts. Since that time, Harvester officials say, their pictures have been produced in great variety and each individual picture has had its specific purpose. Sales promotion, institutional publicity, sales organization training and entertainment have all figured largely in the Harvester film program.

In the days of its silent films, Harvester's picture production was handled entirely within its own organization except for laboratory work and some photography. Before the introduction of sound, Harvester had built up a sizeable library of silent motion picture films covering the activities of the Company. With the introduction of sound, the Company abandoned its silent film program and began to build a new library of sound films. The Company's sound picture program has made it necessary for Harvester to rely on the services of industrial film specialists and the Company for the first time assigned complete production of several films to studio organizations. Control and supervision of narrative ideas and sales objectives however is carefully maintained by Harvester. Mr. L. A. Hawkins of the Chicago headquarters office is in charge of the visual program.

The method of distribution of these films has been made more or less standard. Pictures produced each year are made for the primary purpose of showing at "power-farming entertainments," which are held in farm communities during the winter months. Harvester dealers hold these entertainments in cooperation with the regional branch house organization. These programs are arranged with the use of equipment which is maintained at each of these regional branch houses. At the close of the season, prints are returned to the Company for distribution through various motion picture film circulation channels to schools, colleges, Rotary and Kiwanis Clubs, theatres, etc. But all motion picture projection equipment remains at the branches and it is the duty of one of the men in each branch house organization to make local arrangements for the showing of films throughout the rest of the year.

While films produced each year follow closely the anticipated sales organization, Harvester does not make a definite attempt to tie up its films with other advertising activities. Neither does the Company consider the direct sale of equipment an important aim for its film program. Although this occurs from time to time, the films are considered as sales promotional background which definitely assists salesmen and dealers in closing their orders.

Entertainment is an important element in all Harvester productions. Pictures made in the rice fields of Louisiana are popular with the wheat farmers of South Dakota and Canada. Likewise, an interchange of subject material brings supplementary entertainment to relieve direct selling films. Harvester publishes a promotional booklet entitled the "Short Course Plan. A Community Meeting for Farm



Folks and Town Folks." This booklet outlines a thorough promotional program used in setting up a local entertainment. Here Harvester bases the greater part of its promotional activities on local participation and advises the appointment of numerous local committees. These committees aid the local dealer in conducting large meetings and they bring hundreds of additional people by their enthusiastic activities. Some printed promotion is used, such as tickets, invitational folders, posters and badges. And the local programs are accompanied by recognized speakers on farm subjects. This is extensively done in the case of agricultural extension meetings and agricultural short-course programs. The film company's activities, therefore, may be summarized as three-fold. Its basic power-farming entertainments account for the largest general circulation and direct sales efforts. The short-course agriculture extension programs are somewhat similar. Finally, the general circulation of these numerous subjects in the Harvester sound motion picture library accounts for the rest of its approximated audience of 10,000,000.

A list of Harvester sound motion pictures made since 1934 furnishes the best sort of evidence of the consistency of the Company's program. Some of these were entirely made in the studios of industrial film specialists; many of the others were made through the use of local producers' facilities in the regions which Harvester wanted to add to its library. For example, considerable footage on rice farming is arranged for through an industrial producer in that territory, the film story of Boulder Dam was the work of a Pacific Coast producer. Productional units in the North West, on the Atlantic Seaboard, in Florida and Texas and in the many other states in which Harvester equipment is in daily use were engaged by the Chicago department. In such cases, editing of footage supplied by these professional producers is done in Chicago, and all of the Company's laboratory work is also purchased there. Titles of the productions listed herewith tell the rest of Harvester's story.

RECENT HARVESTER SOUND MOTION PICTURES
1935 PRODUCTIONS

	REELS
The Story of Binder Twine (Canada)	one
Skimming the Cream (Canada)	two
Made in Canada (Canada)	four

The Building of Boulder Dam	Reels: one
The Farmall Does the Job	one
International Harvester Diesel	three
Farm Inconveniences	one
Terracing to Save Our Farms	one
McCormick-Deering Corn Planter Tells Own Story	one
International on the Job	one
Pay Dirt	one
International Power in Industry	one
Looking Into the Farmall 12	three
Soybeans for Farm and Industry	one
School Days	one

1936 PRODUCTIONS

International Trail to Transportation Economy	four
A Farmer Talks About Tractor Service*	one
When Snow Comes (16-millimeter only)	one
Canadian Trail (Canadian)	four
My Modern Farm	one
Popular Features of Farmall 12	one
Quickest On! Quickest Off!	one
Power on the Potato Field	one
To Market and Home Again	one
International Logging	one
From Trees to Lumber	one

1937 PRODUCTIONS

Romance of the Reaper (Revised)	three
Practical Magic	two
When You Think of Moving	one
Message for Webber	one
Our Daily Bread	one
Earth Moving	one
The Right Material in the Right Place	two
Power for the Oil Industry	one
Harvester-Threshers for Every Farm	one
Rice, the World's Oldest Food Crop	one
Power Units for Power	one

* All Voice-Over Sound-Except (a)



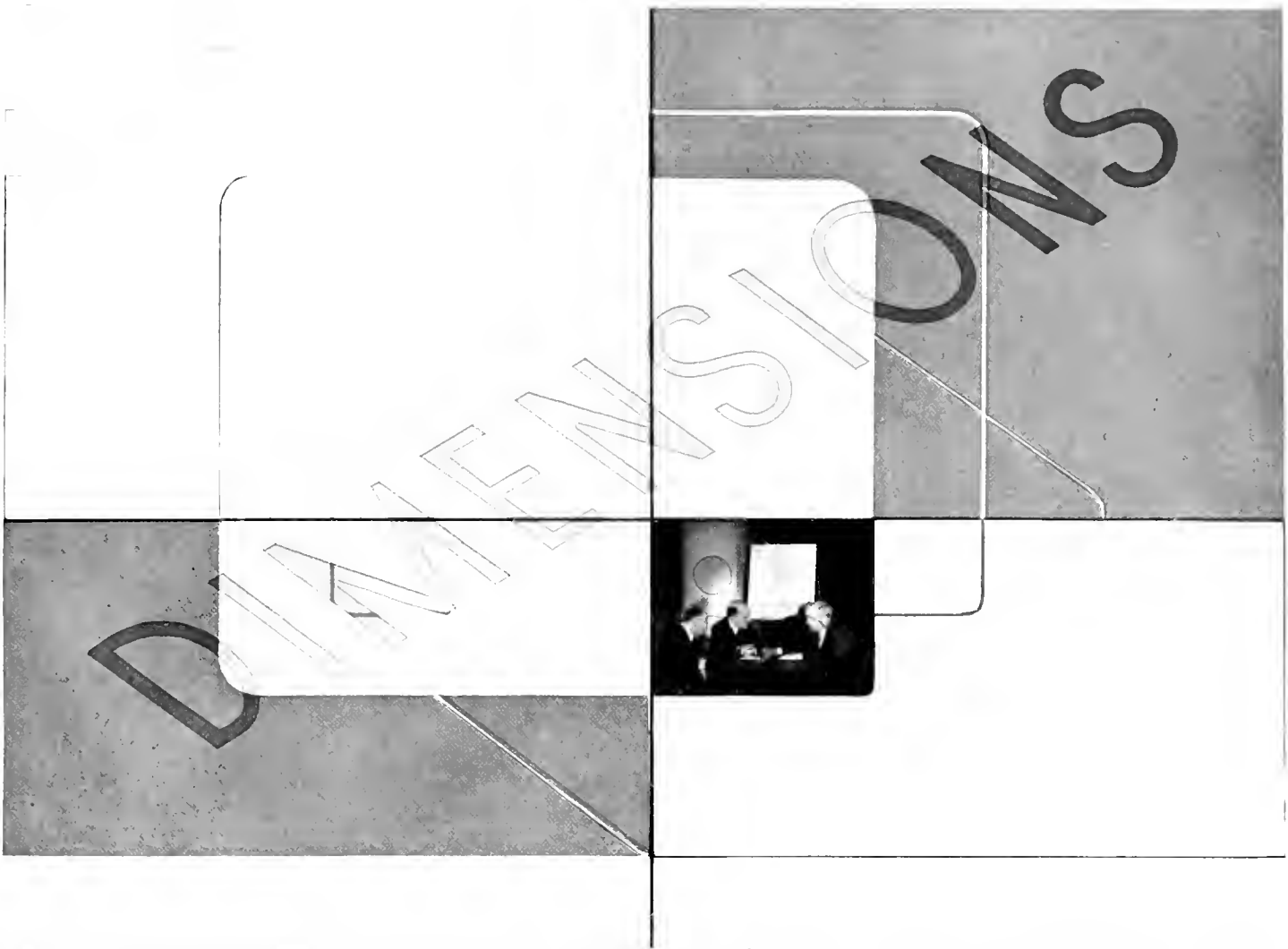

A "BUSINESS FILM" is, in essence, a sales tool. Its function is to tell a sales story to the potential consumer audience. Its sales appeal may be direct or indirect; it may be timed to tell its story in two minutes or two hours; it may have cost \$100 to make or \$100,000; it may be shown on a salesman's projector across a prospect's desk, or it may have gala presentations in the finest motion picture theaters rented for the occasion. Essentially its purpose is to *sell* the product offered by the film sponsor.

The universal popularity of the motion picture needs no proof. The fact that 80 per cent of the American public's amusement dollar goes for motion picture entertainment may be taken as conclusive evidence. The fact that thousands of progressive school teachers look upon the motion picture as a dynamic educator, and regard it as the most forceful interest-compeller in their entire arsenal of teaching tools, is corroborative.

For the business man, and particularly for the advertising and

sales promotion executive, the motion picture quickly demonstrated itself as a unique, powerful medium to catch attention, hold interest, carry conviction, and impel favorable action toward the product or services presented by means of the film.

Advertising men are a canny lot. It is their business to know human thought-processes and how to influence them. They were among the first to recognize how "eye-minded" is the human race. From the earliest wood-cut illustrated advertisements, calling for the apprehension of runaway slaves, to the luscious, highly-colored, double-page spreads offering automobiles, refrigerators, bananas, or shoe-laces, the advertising man has been far ahead of the Chinese sage who is supposed to have uttered the well known bromide that "one picture is worth more than 10,000 words."

No advertising man would be crazy enough to use 10,000 words, because nobody would read that many. The smart advertising man uses as many pictures and as few words as possible. The *smartest*

NEW
DIMENSIONS
IN
ADVERTISING



use movies, easily the most perfect of all modern advertising media.

The advertising man is a keen student of psychology, both experimental and applied. He knows that a light is the first stimulus that can attract and hold the wandering eye of a very young human infant. If the light (or its embodiment in a brightly colored object) is set into *motion*, the attraction of the human eye toward this stimulus becomes irresistible. If sound is added, we complete the trinity of primary attention-getters — light, motion, and sound — which enjoy a virtual monopoly of sensory approach all through life.

The talking motion picture combines these three prime movers of the human mind in a degree that is not possessed by any other medium. The printed page uses the attractive power of light through speed lines, cartoon sequences, and successive motion picture stills — the highest compliment, attempted imitation of the motion picture. The radio uses only sound, and its groping in the direction of television is in itself a confession of a realization of its primary shortcomings. The talking picture is the only medium that combines *all three* primary lodestones of attention — light, motion, and sound.

Some results reported by devotees of the “business screen” will probably be of interest. A large steamship line reported that 3,379 showings of its films reached 975,000 persons. An automobile manufacturer topped this attendance by showing a baseball film to two million persons in a year.

In some lines, specialized coverage means more than mass attendance. A pharmaceutical house set out to “detail” 107,884 members of the medical and allied professions; at the end of a year they had reached 105,873 — 98 percent of the quota. By spending \$67,232.93, all told, on a film program, they did their job at 62½¢ per head; other-than-film methods had previously cost \$2.13 per head for the same job.

An anti-freeze manufacturer spent \$13,500 for a direct-sales film, and sold \$600,000 worth of his product at net prices at shows arranged by his dealers and jobbers. A motor manufacturer spent \$5,000 for a film, featuring an item selling at only \$70 — but added 11 per cent to his profits on that item alone — besides the indirect benefit of general advertising and dealer recognition.

To get good results, it takes a good film — well made, properly

shown, and well adapted to its purpose. The question of quality is a difficult one to discuss. It is just as hard to say what makes a “good” business film as it is to say what makes a good cigar. Too many factors enter into the question. The tobacco itself, the blending, the workmanship, packing, and merchandising, all play their part. But in the last analysis, a lot depends upon the smoker — and upon “audience.” The smoker’s own preference and “technic,” and the extent to which he “harmonizes” with those around him, all contribute to a composite idea of what makes a “good” or “bad” cigar. Similarly with pictures; the product to be presented, the way the story is prepared, the showmanship routine worked out to bring it to its audience, the effectiveness with which the sponsor’s story is told in terms that will be favorably received by its audience, all must be considered in judging the quality of a film.

A survey also indicates that in most business films direct advertising is kept at a minimum. There are exceptions, certain films made specifically as direct advertising media. A few pictures are as direct in their invitation to buy as a department store advertisement in a daily newspaper; and a considerable number of pictures, growing in importance, are devoted solely to teaching salesmen how to sell.

There have been business films almost since the birth of the motion picture. Some producers boast of more than 20 years of continuous production of industrial films. But it is a far cry from the early “factory run-arounds” and “good-will” productions to the smart, fast-moving, subtly dramatized sales “punch” that goes by the name of “business film” today. The modern producer of industrial films has a staff comparable to those of theatrical studios in ability, imagination, and often downright genius. His job is really much harder; whereas the studio men strive solely to pick an appealing story and dish it out in a way they hope the public will like, the industrial producer must take the other fellow’s story of cheese or pig-iron, and dress it up in such a way that the public not only will like it, but will spend their money, not for the film, but for the product plugged by the film.

Editor’s Note: This is the first of two articles from an address to the Society of Motion Picture Engineers made by Mr. W. F. Kruse. The next will appear in an early issue, together with interesting charts and tables.

SALESMEN GET THE IDEA

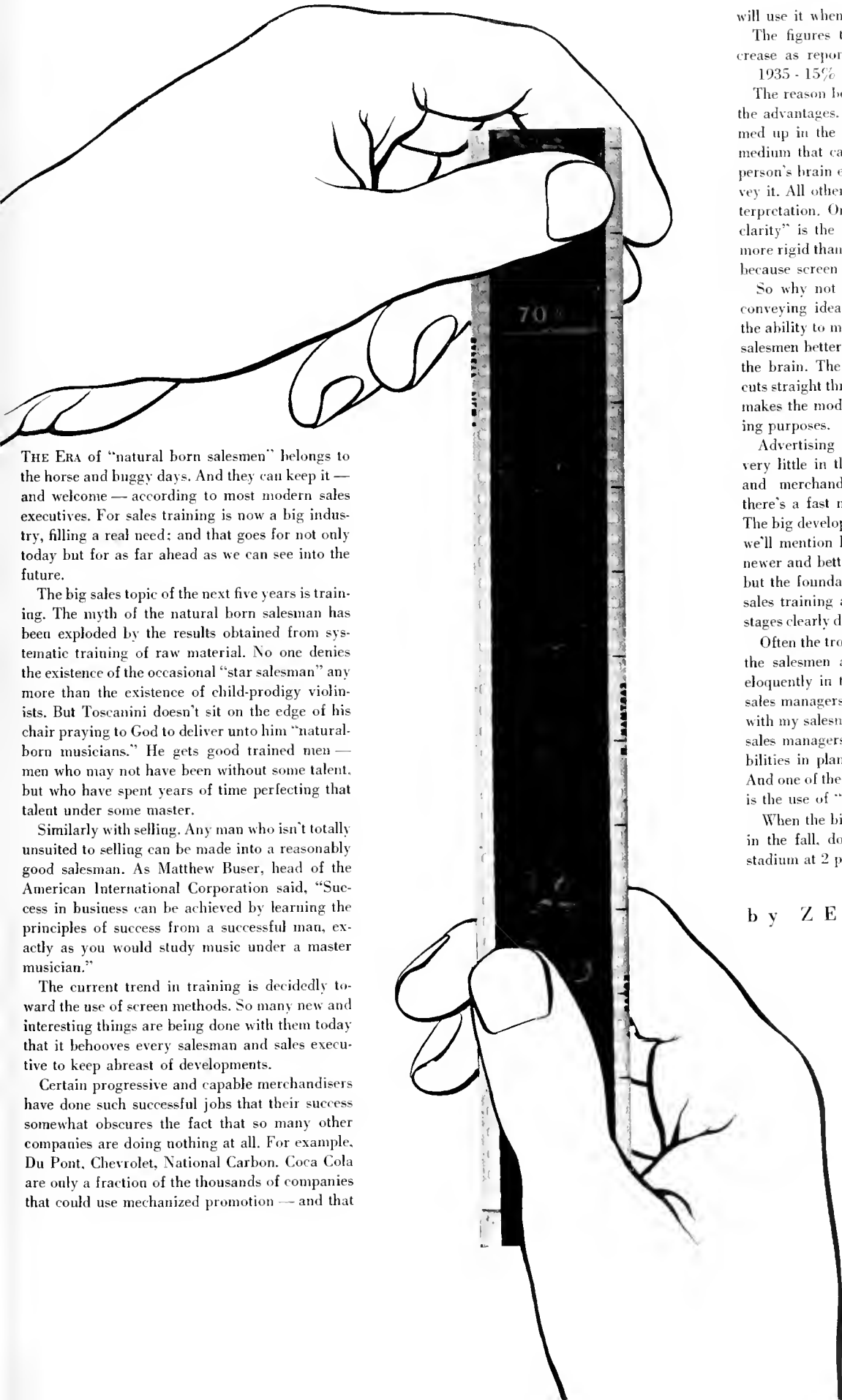

THE ERA of "natural born salesmen" belongs to the horse and buggy days. And they can keep it — and welcome — according to most modern sales executives. For sales training is now a big industry, filling a real need; and that goes for not only today but for as far ahead as we can see into the future.

The big sales topic of the next five years is training. The myth of the natural born salesman has been exploded by the results obtained from systematic training of raw material. No one denies the existence of the occasional "star salesman" any more than the existence of child-prodigy violinists. But Toscanini doesn't sit on the edge of his chair praying to God to deliver unto him "natural-born musicians." He gets good trained men — men who may not have been without some talent, but who have spent years of time perfecting that talent under some master.

Similarly with selling. Any man who isn't totally unsuited to selling can be made into a reasonably good salesman. As Matthew Buser, head of the American International Corporation said, "Success in business can be achieved by learning the principles of success from a successful man, exactly as you would study music under a master musician."

The current trend in training is decidedly toward the use of screen methods. So many new and interesting things are being done with them today that it behooves every salesman and sales executive to keep abreast of developments.

Certain progressive and capable merchandisers have done such successful jobs that their success somewhat obscures the fact that so many other companies are doing nothing at all. For example, Du Pont, Chevrolet, National Carbon, Coca Cola are only a fraction of the thousands of companies that could use mechanized promotion — and that

will use it when they realize its big possibilities.

The figures that follow show the rate of increase as reported by three leading producers:
1935 - 15% 1936 - 25% 1937 - 40%

The reason becomes obvious when you analyze the advantages. The chief advantage can be summed up in the statement that films are the only medium that can deliver a message into another person's brain exactly as the sender wants to convey it. All other mediums are at the mercy of interpretation. One index of this great "power of clarity" is the fact that screen censorship is far more rigid than radio or press. It has to be simply because screen impressions are so powerful.

So why not use this power when it comes to conveying ideas to salesmen? Sound films have the ability to make poor salesmen good, and good salesmen better, because they deliver ideas f. o. b. the brain. The combination of sight and sound cuts straight through — fits words to deeds — and makes the modern business movie tops for training purposes.

Advertising techniques will probably change very little in the next decade. Same with selling and merchandising. But sales training! — ah, there's a fast moving, sure stepping proposition. The big developments of the past few years, which we'll mention later, are already making way for newer and better things; and these, in turn, seem but the foundation for a future destined to make sales training a regular process, with its various stages clearly defined as in other academic courses.

Often the trouble with salesmen really isn't with the salesmen at all. Bill Burriss summed it up eloquently in the title of a talk that he gives for sales managers' clubs. He calls it, "What's wrong with my salesmen — or can it be me?" Too many sales managers have shut their eyes to the possibilities in planned and systematic sales training. And one of the bets that too many have overlooked is the use of "mechanized" or "screen" methods.

When the big leagues sign up their ball players in the fall, do they say "report for play in the stadium at 2 p. m. on May 1?" No, they say, "re-

(Continued on Page 62)

by ZENN KAUFMAN

TECHNICOLOR

Tells the Story of

STEEL



YEARS AGO "big steel" learned the potency of motion pictures for public relation stories and for the handling of innumerable sales problems. The Republic and Bethlehem Steel Corporations, of recent years, have contributed brilliant examples. The commercial motion picture industry has benefited immeasurably from the pioneering efforts of these steel manufacturers . . . but in the latest offering of this most colorful of American industries, may be discerned real advances . . . advances which proclaim excellence of technique, showmanship, and photography of the highest rank.

Steel has been truly glorified. After nearly a year of painstaking efforts, United States Steel announces the release of two all-color productions, *Steel, Man's Servant*, and *Men Make Steel*, and a third in black and white, for later release. And with the addition of color, plus superb photography, direction, and treatment, The United States Steel Corporation may truly boast that here are subjects which are sure to find widespread demand among educational institutions of our country, as well as among clubs, societies, and countless other groups.

Silent films had early demonstrated their usefulness to the far-visioned minds of big steel. And with the advent of sound, the demand for steel films was greatly quickened. The commentator's voice gave significant information. New brilliance was added, with the authentic rhythms, the clashing, cacaphonic sounds, the roar of the blast furnace, the hiss of onrushing molten steel after "tapping", the bustle and noise that to America meant renewed production and prosperity!

If black-and-white films had been so successful, reasoned U. S. Steel executives, how truly impressive and realistic would be one in full color. For steel-making is essentially colorful.

In April, 1938, under the direction of Ronald Reed, production was commenced. Charles Underhill, of Batten, Barton, Durstine, and Osborne, was placed in charge of supervision. The job was to be no easy one. Indeed, it was the first time that so wide-scale and difficult an assignment had been undertaken. Many peculiar problems presented themselves, but the work moved steadily forward.

Only the best of equipment was used — including a modern Technicolor camera, which demands a terrific amount of light, and which must photograph onto three films simultaneously — one for each primary color. Lighting equipment, capable of generating "one half sunlight", was employed when needed.

Action, sound, and color were faithfully photographed and recorded. The soft, suppressed colors of earth and sky in the open-pit mining operations were captured. The shifting blue-greens of the lake waves, as gigantic ore freighters plowed on their ways to the mills . . . the flaming reds and yellows which burst truculently from Bessemer converters, illuminating the open-hearthths with ghostly splendor . . . these were faithfully transplanted onto the delicate negatives.

Charles Boyle, Technicolor cameraman, watched with practiced eye. Camera angles calculated to



prove most effective were carefully chosen. Powerful batteries of lights were placed where needed in the gigantic interior "sets", calculated to bring out an important highlight here, to kill an objectionable shadow there. "Gobos" — large, opaque screens — helped to shield away the light from the sensitive camera lenses . . . and the gigantic "cast" — thousands of workmen, laboratory technicians, huge cranes, converters, ladles . . . went into action in a story of awesome beauty which may be justly labeled "colossal" . . . a story of men, and of the great demigods of machines which serve humanity.

Filming was started in Hibbing and Duluth, Minnesota, with the mining of the raw ore. From these points, the camera crew, with its director and supervisor "followed" the ore until it finally reached the ore docks of Lake Superior.

In Gary, Indiana, the 21-man production crew photographed almost every phase of the steel-making operations. Thus, such colorful and interesting scenes as charging the open hearths, tapping and pouring hot metals, "stripping", soaking, and rolling ingots . . . were photographed, in all their dramatic realism. The rail-axle, and wheel-mills were "shot" in sequences which will give audiences a true picture of big-steel production.

Later, the traveling company visited and photographed scenes in the plants at South Chicago and Waukegan, Illinois; and those at Cleveland, and Lorrain, Ohio; at Pittsburgh, Homestead, and McKeesport, Pennsylvania.

To initiate audiences into the mysteries of steel-making, Edwin C. Hill, newspaperman, and radio-commentator, graphically describes each step. Thematic music by the well-known Robert Armbruster, follows the varying "moods" of the machinery . . . the molten metals as they rush into the moulds, the great hoists, ladles, and cranes — each with its identifying musical sounds, heard above the din of production.

Of these films, the U. S. Steel News explains: "Every effort has been made to present steel-making realistically. To the eye these films bring the most accurate reproduction possible — for they incorporate motion and natural color.

"The ear is addressed by the many different sounds which accompany steel operations, and the mind is helped to understand these processes, as Edwin C. Hill . . . describes each step."

The task of filming the world's first Technicolor film of steel operations has at last been completed. One reel of the color film of eleven minutes screen-time, is to be shown in theatres from coast-to-coast. The other, intended for theatres, schools, conventions in steel districts only, is a thirty-seven minute production. In addition, a 16mm. reduction print, in black-and-white, is to be made, for distribution to schools and other organizations having 16mm. projectors. It is to be seven reels in length.

Steel, with its complicated problems, has again turned to movies to help in an endless and mightily-important task of public relations. And U. S. Steel, pioneering in this worthwhile task of selling America with the very latest methods of presentation, deserves credit and high praise.

THE FAMILIAR QUERY:

Films on My Budget?

THE ANSWER:

Plus-Results Prove Value!

"WE THINK talking pictures are a first-rate medium but they cost too much".

This remark is commonly heard in selling circles, and for that matter in business circles generally. It is the attitude of a large percentage of advertising men and Sales Managers, and the viewpoint prevails pretty generally in the agency field.

The fact is lost sight of that there are certain things which no other medium but the talking picture screen can do in the field of communication, education and selling so that the question presented really is: is the achievement of this objective worth what it costs?

For instance: talking pictures will demonstrate in motion and sound, heavy machinery at points far distant from where it is made or operated. No other medium can do that. The value of such a privilege may be cheap at any price. On the other hand, a folder or circular will provide a passable demonstration of a fountain pen at very small cost, and for such a purpose a picture may be too costly. Only the motion picture will permit an executive to talk to his organization in a hundred or more places at one time, and if it is of sufficient value to have him do so, the cost of the movie itself is beside the point.

It is true that top quality talking movies cost anywhere from \$5,000 a reel and up, that theater circulation costs money, that prints in quantities must be bought and that projection equipment must be bought or rented to roadshow the picture if that method is adopted. At the outset, let it be said that today an acceptable talking picture can be produced for any budget within reason that the user wishes to spend. Length is not the determining factor of cost. Compromise in the interests of economy is easy, and usually safe depending upon the individual situation. Heavy expenditure doesn't always assure an effectual result on the screen in commercial pictures, and circulation can cost from nothing to five dollars a head or more. A given script can be filmed for \$50,000 and the same script filmed for much less. It all depends upon how much the user is willing to invest, and how much the job the picture has to do warrants.

♦ Too many buyers of commercial talkies consider the initial cost of the negative rather than what it is worth to get across the message effectively and satisfactorily and in a manner that produces results.

It is difficult to make direct comparisons between talking pictures and other mediums as to

results and the cost of results. While this may be done in the case of commodities advertised on the picture theater screen where tests in regions are tied in with check-ups on dealers' shelves before and after the projection program. This figure has been as low as .0426 per bearer-looker including negative and print costs and distribution. Few national advertising mediums deliver readers at so low a figure. Then, too, the hundred per cent concentration assured plus the vividness of the illuminated screen, musical accompaniment, motion plus sound comprise factors that must enter into any cost reckoning.

In the field of dealer education — that is, road-showing a feature commercial talkie nationally — one leading corporation in the automotive field considers 43 cents per audience member — service station owners and helpers — a bargain. Always considering the greater effectiveness of the talking picture over most mediums commonly used for this purpose, namely, talks, lectures, printed booklets and so on.

Many talkies of the commercial-industrial-informational type with advertising subordinated, are reaching hearer-lookers at a cost to the owner of a fraction of a cent each. Distribution is through non-theatrical booking agencies and college visual education channels wherein the owner of the picture merely supplies prints or copies.

♦ In considering the cost of the talking picture medium to do a job of sales making or sales training, it is a fact that an exact cost per man reached can be arrived at before even the scripts are written. Such pictures invariably are projected and promoted in regional meetings by the owner's field men or those of his jobber. The cost factors are immediately at hand, the expenses of the entire undertaking can be pre-determined in advance, the probable attendance calculated, and the cost divided accordingly giving the per head rate. These elements in a typical show of this kind are:

- (a) Negative cost
- (b) Print cost
- (c) Hall rental (if any)
- (d) Refreshments
- (e) Door prizes (if any)
- (f) Promotion matter
- (g) Time of men holding shows
- (h) Rental or projector purchase

Having arrived at the cost per head, the prospective user of the screen asks himself the question: is it worth that much to get the message across effectively and efficiently? If he thinks it is,

the question of talking picture cost becomes a secondary proposition, and the enterprise is on a common-sense basis.

There is little gamble in getting what is sought at the price per estimated. Large users of talking pictures for dealer and salesman education are getting as much as 93 per cent of their dealers and other interested people into their talking picture shows. The percentage is lower in such lines as drugs and groceries because of the fact that the dealer's natural interest in a single item or group of items among the hundreds on his shelves is not sufficiently keen to warrant the time spent looking at a movie relating thereto.

Looking, for the moment, at the bare question: do movies cost too much? few business executives unacquainted with the cost factors in talking picture production can judge this matter soundly. To make such a claim is as logical as to say that "houses cost too much". A house with three bathrooms naturally costs more than a house with one. A house with an electric kitchen costs more than a house with none. Yet, either house can be lived in comfortably.

It is much the same with pictures. If the producer is compelled to travel camera crews to fifteen widely scattered cities to shoot that many plants for inclusion in the owner's production, it will cost more than if all factory shots are made in one place. And, often, the one place offers every necessary scene to make an acceptable final result on the screen.

A given picture story with very simple studio sets may cost \$20,000 while the same story with more complete and elaborate sets will cost \$50,000 or even more. The addition of a big name to a business picture cast alone can double the cost of filming it.

The fact is that all these items are under the control of the picture buyer. He can even establish a price per head for getting his result, whatever it may be, and then budget a picture so that it will deliver the result for that price.

Consequently, to say that "pictures cost too much" is a statement that always must be qualified. It is better business to forget the cost of the picture and its showing entirely and decide what it is worth to get the story over effectively to the people for whom the story is intended.

The cost of any medium is high or low depending upon what the value of the result is to the buyer. Always considering relative effectiveness, the cost of getting over a message to salesmen or the public via the talking picture screen is usually considerably below most of the competing mediums. In the case of sales training, it is nearly always lower than are correspondence courses. It is seldom so high as a good manual, with the tremendous advantage of 100 per cent attention that pictures always get.

Editor's Note: Since the problem of the cost is one of the outstanding questions preceding extensive use of the film medium, an entire series of articles is planned, of which the above is an introductory "first" on this important subject.

SALES RESULTS WITH PICTURES

Johns-Manville uses extensive film program

"YOU ARE INVITED to attend a showing of the talking motion picture, *'Heat and Its Control.'*" Thus, simply, begins a promotional folder describing one of the Johns-Manville Company's latest film releases. Amply and richly illustrated with film "blow-ups" and descriptive data which have "sold" many an educational institution, club, and other organization, the folder typifies the thoroughness and sincerity of J. M.'s motion picture efforts.

The Johns-Manville Company — whose history has been a series of marketing successes — is one of this country's oldest users of industrial films. Along with International Harvester and the Ford Motor Company they have contributed many important improvements and innovations in industrial film production and exploitation procedures.

"We were among the first organizations which used films to spread a knowledge of our operations," a J. M. executive recently told *Business Screen*. "About twenty years ago we produced a picture on asbestos, showing the process of extracting the mineral — demonstrating, too, many of its unusual properties. Distributed by the Bureau of Mines, *Asbestos* has been shown in numberless schools and colleges throughout the country, with occasional revisions from time to time. This film still maintains its position as one of the most popular films on the Bureau of Mines' list. A new version is being prepared this year to take its place."

The Johns-Manville Company has always — since its adoption of the motion picture medium in the early silent days — been a sincere believer in well-planned "industrials." With the advent of sound, company officials decided to put the new medium to work with greater energy than before. More films were to be used, more subjects were to be treated. The company definitely decided its films must "tell the stories of its many products to ever wider and more diversified audiences." And the interim between the release of its first silent

An interview with one of America's ace merchandisers brings forth some significant and interesting data on industrial films. This is the first of a series of intimate interviews with successful film users, to be presented in future issues of Business Screen. — The Editor.

film, *Asbestos*, and the latest J. M. film, *Beneath the Surface*, does indeed show remarkable progress.

NO SEPARATE FILM DIVISION The company, despite its many clearly-defined departments, found it best to keep motion pictures directly in the Advertising and Sales Promotion departments. It prefers to consider motion pictures as an advertising weapon — "an extremely important weapon." Its film campaigns come under the jurisdiction of H. M. Shackelford, Sales Promotion Manager, with production problems in the hands of E. A. Phoenix, Assistant Sales Promotion Manager in charge of Industrial Materials. Mr. Phoenix, who is responsible for the films in their final form, works closely with the producers.

Those films, however, which feature the company's building materials are personally supervised by Mr. Shackelford. The story script is written to sell the product — such as home-insulation. Professional talent only is secured. The production must be thoroughly "Hollywood" in its technical quality, and to this end production facilities must be of the finest obtainable.

SALES AND PUBLICITY-FILMS EQUALLY IMPORTANT Johns-Manville does not confine its films to set types. The films are rather designed to meet such specific needs as may arise — be they sales-promotional, publicity, or institutional in nature.

A definite sales problem was brought to light by the comparatively new Transite pipe — a composition of asbestos and cement. The new pipe was to be introduced to members of water commissions,

in both large and small towns—to men with widely varying degrees of technical knowledge. *Under the Surface* was made. The film, it is said, "offers a far more comprehensive exhibition of the qualities of Transite than any field demonstration could possibly undertake, and offers it in the comfort of the (prospector's) office. After the picture is run off, there is usually a period for questions. Dramatic in its presentations, it has been found to sway many skeptics: questions and answers clear away slight misunderstandings that may have arisen previous to the showing."

Last year's film, *The House that Ann Built*, was made to help solve sales problems which involved the consumer prospect. It is a story calculated to please grown and juvenile audiences alike . . . tells how Ann Stone effects a reconciliation between her mother — who desires a new home — and her father — sentimentally attached to the homestead. Johns-Manville building material makes the new home out of the old one, in a really convincing renovation. More than a hundred thousand people, it is estimated, have viewed this film. Its running time is about 35 minutes, and the company has been using forty 16mm. prints, six 35mm.

Like *The House that Ann Built*, *When Winter Comes* was slanted toward the consumer prospect . . . contains much interesting material, an enlivening story, with unobtrusive publicity brought down to a minimum footage. A demonstration — this time featuring the value of insulation for keeping out the cold — plays an important "role" in the picture. Twenty-five prints in circulation have "done a good job toward publicizing insulation material".

The ever-popular humorous treatment is resorted to in *Those Hot Summer Days*, a counterpart of the above-mentioned film. It, too, has been instrumental in selling many consumer prospects on Rock Wool Home Insulation.

(Continued on Page 55)

Heat rays melt ice in J-M's "Heat & Its Control"



Convection currents illustrated by shadowgraph



This Animating Business

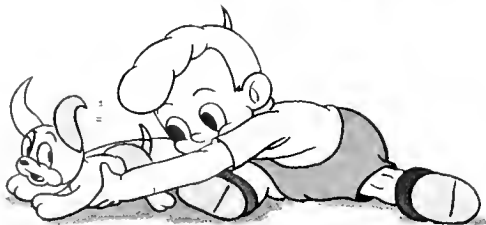

Scenes from the new all-color cartoon "Boy Meets Dog" sponsored by the Bristol-Myers Company for Ipana and now showing to theatrical audiences.

THE ADVANTAGES and possibilities of the animation technique were pretty widely recognized in commercial film work long before the Disney era. The value of this treatment in demonstrating processes and principles, in achieving a light-hearted comedy cartoon sequence and in the vast field of education has been ably represented in the animated films of General Motors, Metropolitan Life Insurance Company, Brown and Williamson Tobacco Company and recently in a Technicolor release for Bristol-Myers Company entitled *Boy Meets Dog*, a noteworthy commercial subject.

A recent survey of theatrical audiences to whom *Boy Meets Dog* was shown in several Eastern states showed practically unanimous acceptance. An extremely short advertising sequence on behalf of Ipana toothpaste was held unobjectionable in this thoroughly entertaining cartoon. In this case the sponsor's investment in talent proved worthwhile and the music by Frank Churchill, composer of "Snow White", the symphonic-swing orchestra directed by Nathaniel Shilkret and the direction of Walter Lantz left little to be desired. The subject runs nine minutes; the advertising a few seconds.

A short excerpt from an advertising brochure recently published contains an interesting viewpoint on the animating angle:

"Cartoon and technical animation often serve to lift a production from the commonplace. And to demonstrate a complicated idea or mechanism, animation is frequently the only means by which the objective can be accomplished. A trade-mark comes to life and directs a scene. Mother Goose tours the country in her new runabout, demonstrating safety in driving. A sectional view of a Diesel engine slowly changes shape as a piston moves up and down. Anything can happen in animation!"

In his article for Nancy Naumburg's "We Make the Movies," Walt Disney says of the animated cartoon technique:

"The world of the animated cartoon is the world of our imagination, a world in which the sun and the moon and the stars and every living thing obey our commands. We pluck a little character from our imagination, and if he becomes disobedient we liquidate him with an eraser. No dictator has power half so absolute. Our materials are anything which the brain can imagine and the hand can

draw — all human experience: the real world and dream worlds, color, music, sound, and above all, motion. A fascinating business, but to explain it we must talk of registering pins and exposure sheets, frames and layouts, basic tempos and sweat-box sessions, acoustical beats and audio-frequency oscillators. It is all very technical and confusing to a layman. Often we spend an afternoon showing visitors how cartoons are made, and at the end they timidly inquire, 'But what makes the little drawings move?'

"Well, as a matter of fact, all motion on the screen is just an illusion. When a motion-picture camera shoots a scene, it breaks the action into a series of still photographs, showing progressive stages of that action. When these photographs are projected on the screen, at the rate of sixteen hundred a minute, the illusion of motion results. This is because the eye-brain combination cannot register the images as fast as we can project them on a screen, so it overlaps them and the illusion of motion results. This persistence of vision was discovered by Peter Mark Roget in 1826. The same principle explains why our drawn figures seem to move. We make a series of drawings showing the progressive stages of an action. Then we photograph these on regulation motion-picture film and project them on a screen at standard speed. They seem to move for the same reason as the flip books of your childhood, when you thumbed the pages of a pad of drawings and figures moved from cover to cover: the persistence of vision.

"There has been a great improvement in the mechanical end of production. In the old days before sound came into existence most of the cartoon equipment used was makeshift and crude. Gradually we have improved our cartoon technique by improved equipment, so that today the cartoon is steady and flickerless and the animators produce better and smoother action. But the main improvements have been in our understanding of the medium, better artists, drawing and story technique."

Business can well afford to study the many applications of this technique to short sales and advertising films. What has been done most successfully in the world of make-believe (as witness "Snow-White") can be done as well in the realm of actuality. The cost need not be excessive — in fact it can be well controlled in animation.

British Documentary Films

by
Paul Rotha

Foreign Editor of *Business Screen*

OFFER AMERICAN BUSINESS SOME NEW OPPORTUNITIES

APART FROM the commercial success of films like the *Private Life of Henry VIII*, which was largely made by non-British technicians, and the popular crime films of Alfred Hitchcock, the one important contribution made by Great Britain to the world of cinema is the development of the documentary film. Although protected by Government tariffs, the British film industry has always adhered closely to what was thought to be the Hollywood system of film production. Many British film producers have done their best to prevent their films from looking British. For the most part, familiar aspects of national life have been avoided. Instead, the British film has presented a make-believe world which is alien to the British character. There has, moreover, never been an English avant-garde movement. But the growth of the British documentary film is something unique in film history as a subsidized form of film production.

In 1927, the British Government set up the Empire Marketing Board. Its mission was to "bring alive" the tradition of the British Empire in terms of its contemporary activities. Its aim was to dramatize the statistics found in "Blue" books and trade reports. To do this, well-known painters, writers, architects, and publicists were enlisted to propagate the "Buy British" campaign. John Grierson, a young Scotsman who had just spent three years in the United States studying, among other things, the art of social science, persuaded Sir Stephen Tallents at the Board to add films to its activities. In 1928, the Treasury commissioned Grierson to make a film about the North Sea Herring Fleet, although he had no practical knowledge of film making to that date.

♦ *Drifters* was the first example of the British documentary method of film making. Made at trifling cost, it was a dramatic account of the labor, danger, and romance of the men who worked day and night at the herring catch. Its traditions lay in the films of Robert Flaherty (*Nanook of the North* and *Moana*) and the Russian cinema (*Potemkin* and *Mother*). Without using a story or professional actors, Grierson took real people and real endeavour and caught the bravery of labor and the poetic drama of the storm at sea. As a result of the successful reception of *Drifters* in the public theatres, where it was shown on the strength of its "entertainment appeal," the Board asked Grierson to form a film unit. Around him Grierson grouped young men and women drawn from the fields of painting, journalism, education and social science and who would work on a collective basis. The aim was to produce not one film at a time but a steady flow of films to depict every phase of British and Empire life which came within the scope of the Empire Marketing Board. Best-known of these was



Superb casting distinguishes the film "North Sea" made by the Post Office Film Unit



from "Big Money" a Post Office film



Scene from "A Job in a Million"

Industrial Britain, to make which Robert Flaherty himself was engaged and upon which most members of the Unit worked. Because of their human appeal and because audiences had been starved of films showing authentic British life, many of these documentary films were presented in the public theatres where they created wide interest. The Press, also, realized that there was an attempt at a sincere portrayal of British national life on the screen at a time when so much of Britain's screen space was occupied by American product. Where the Government led, public utility bodies and industrial concerns were quick to follow. *Contact* (1932) was made for the Imperial Airways and Shell-Mex oil; *The Voice of the World* (1933) for The Gramophone Company. Through the Board's connections abroad, Grierson was able to arrange for members of his Unit to travel. Basil Wright brought back a series of films from the West Indies and was soon to depart for Ceylon to make the prize-winning film *The Song of Ceylon* (1935) which was produced for the Ceylon Tea Propaganda Board.

♦ Although subsidized, these films should not be confused with commercial advertising films such as are produced in great numbers in England and America. The documentary film was the outcome of a public relations movement and came about as a result of a desire on the part of the Govern-

Selling America

A Remarkable Motion
Picture on the Art of
Handling People



based on actual incidents in the life of

BEN FRANKLIN

that will help your salesmen get the business

Young Ben Franklin didn't have the knack of getting along with people. He was argumentative and opinionated. He was a poor speaker. But early in life he set up a few simple rules to guide him in his relationships with others . . . and they proved to be

a tremendously helpful factor in shaping his illustrious career.

• "SELLING AMERICA" • produced by the Jam Handy Organization, gives you these invaluable rules—and shows how they can be made to work as effectively for you and your salesmen as they did for Franklin.

BE SURE TO HAVE YOUR SALESMEN SEE IT!

Executives are invited to preview this sound motion picture and get rental prices.

The JAM HANDY Organization

Slidefilms • Talking Pictures • Sales Conventions • Playlets

New York, 230 Park Avenue, *MURray Hill 9-5290*
Chicago, 35 East Wacker Drive, *STAtE 6758*

Detroit, 2900 East Grand Boulevard, *MADison 2450*
Hollywood, 7046 Hollywood Boulevard, *HEmpstead 5809*

ment, Industry, and other Public Bodies to create a deeper sympathy between their activities and public understanding in Great Britain. And because they were technically well made and approached real life from a dramatic point of view, many of these films were circulated widely in the ordinary public theatres on a normal entertainment basis.

In 1933, the E. M. B. was closed down for reasons of national economy. But the Film Unit, with its by-then extensive library of films, was taken over by the Department of the Post Office. The documentary group attacked the problems of communications in terms of telephones, telegraphs, mails and radio. The size of the group increased. Alberto Cavalcanti, the French experimentalist director of *Rien Que Les Heures*, joined the Unit, which had just been equipped with sound apparatus. In the new films, many experiments were made with sound; use being made of specially written music, different narrators and original ideas in the writing and delivery of commentary. The films, of course, were not intended for export.

As time went on creators from other fields contributed to the work of the movement: J. B. Priestley, the novelist, A. J. Cummings, the journalist, W. H. Auden, the poet, Britten and Leigh, composers, William Coldstream, the painter. And apart from the work at the Post Office Film Unit, expansion of the method into other aspects of life was rapid. By 1936, documentary films had been made of airways, shipping, railroads, education, slum clearance, nutrition, books, electricity, gas, and for other Government Departments such as the Ministry of Labor; all by producers and directors who had started at the original E. M. B. Film Unit. In 1937, over forty documentary films were made in Great Britain and over sixty people were working in the movement.

In addition to being shown in the public theatres, many of these films had reached the schools. At once it became clear that by dramatizing everyday life on the screen, documentary films could fill an important gap in modern education. They could provide a basis for discussion, both adult and juvenile, of some of the vital social issues of current life. They could link the individual with the outside world. By creating a picture of how people live and how public services work, the film

THE OLD WAY: *Old-fashioned school seen in "Children at School"*



Young England in "Children at School"

could enter into the field of civics. Thus many recent documentary films carry a sociological purpose. *Housing Problems*, *Enough To Eat?*, and *Children At School*, all produced by the Gas Industry, are films dealing with problems of not only national but international appeal. *Today We Live* and *Eastern Valley*, produced by Social Service Councils, are studies of the unemployment problem which is by no means peculiar to Great Britain. *We Live In Two Worlds*, made by the Post Office, contrasts nationalism and internationalism in present-day Europe.

♦ Technically and aesthetically the documentary film includes most of the innovations of the past ten years with the difference made by the purposive use of an unconsciously developed instrument. But it is important to remember that aesthetic purpose has always come second to sociological aim. The first E. M. B. films used an impressionist technique because it was the easiest

way of arousing audience response. Later, films like *Coal Face*, *Night Mail*, and *Cover to Cover*, used poetic verse to emotionalize their content. Distinct from this creative, dramatic style, films like *Housing Problems* used the camera and microphone in their fundamental capacity to record interviews. The drama lay in the naked reporting of fact. *Today We Live* used real people as actors and invented a slight story. But whether the documentary film is impressionistic or journalistic in its approach to real life, it is always realistic. It is a dramatization of actuality. Its makers are thoroughly familiar with their subjects before they film them. Through historical research, through social reference, they try to bring the ordinary spectator closer to the world which is intimately his own, the world of real fact and feeling.

Sponsorship by Industry and Government, support from the Press and public, have thus put the documentary film to the forefront in Britain. The men who lead the movement — all of them young and all of them trained to the job — have united to consolidate the ground gained for their films in the past eight years. Their several units work in cooperation, exchange personnel, ideas, advice, emphasizing the common goal and exploring new fields. They work collectively on behalf of a movement and not individualistically as is found in the commercial studios. They have captured public audiences by exciting technique. They have organized the educational lecture bodies into an appreciation of the usefulness of the film as an educational force. They have given Government, Industry, and Public Service an opportunity to account for their conduct of public affairs. As more documentary films are made, their producers pursue the aim of bringing the schoolchild closer to the life he will eventually live, of helping the ordinary citizen to understand the social and economic forces which govern his living. In picturing the modern world of common interests, the British documentary film is trying to make it possible for the citizen to judge the complex activities of the expert and the specialist. And in thus helping the citizen to delegate his authority intelligently, the British documentary film is trying to play a part in the revitalization of citizenship, without which, its makers believe, democracy cannot continue to exist.

V.S. THE NEW: *Modern school in "Children at School" documentary film*



CURRENT DOCUMENTARY FILMS BEING SHOWN IN ENGLAND

CHILDREN AT SCHOOL *Produced by the Gas Industry*

This film reviews the whole system of public education in England, shows the best and worst sides of the schools and presents the facts of the problem.

AIR OUTPOST *Produced by Imperial Airways*

This picture shows the arrival and departure of an air-liner at the town of Sharjah on the Persian Gulf. The film is one of a series made about the England Australia air-route.

EASTERN VALLEY *Produced by Subsistence Production Scheme*

The study of a cooperative subsistence scheme to relieve unemployment in one of the distressed South Wales Valleys.

HOUSING PROBLEMS *Produced by the Gas Industry*

The problem of slum clearance is international. By means of personal interviews, this film tells what the occupants of slum houses themselves think about the matter.

THE SMOKE MENACE *Produced by the Gas Industry*

The evils of smoke pollution are an international problem. In this film some of the causes and effects of smoke are shown, together with some of the attempts being made to overcome this menace.

AUDIO PRODUCTIONS INC.

PRODUCERS OF SOUND MOTION PICTURES

35-11 THIRTY FIFTH AVENUE, LONG ISLAND CITY, N.Y.

Announce

TECHNICOLOR IN THE EAST!

THE PERMANENT ESTABLISHMENT of a three-color Technicolor camera unit and Technicolor-trained personnel at Audio's production headquarters, Eastern Service Studios.

COMPLETE FACILITIES for the newest and best in three-color Technicolor productions are now available to Audio clients.

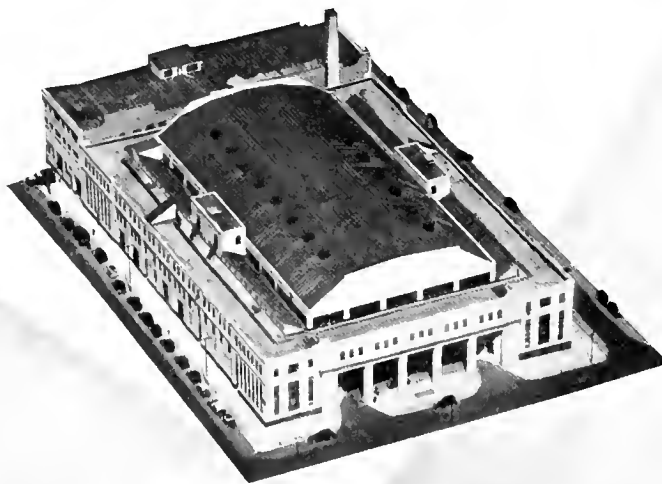

Western Electric
SOUND SYSTEM

HOW TO USE FILMS IN BUSINESS



THIS SECTION IS THE FIRST OF A MONTHLY SERIES of editorial features for the advancement of the screen medium — originated by the editors of *Business Screen* — with all creative designs and sketches by Barnes & Reinecke, noted industrial designers, who have been retained on our regular editorial consulting staff.

MOTION PICTURES IN THE DEPARTMENT STORE

SALES training directors of large department stores have long been familiar with the usefulness of manufacturer-supplied films for educating clerks in the fine points of successful selling. Too, the amateur camera departments have experienced successful holiday sales of popular motion picture equipment to rapidly growing numbers of amateur movie fans. But, by and large, the film is yet an unfamiliar medium to the advertising and merchandising manager and as such, is almost entirely unused in perhaps the largest natural field for its most acceptable application. Facing public agitation for consumer

education, the manufacturer and the retailer might will cooperate to their mutual advantage — and the consumer's satisfaction — in the production and distribution of filmed merchandise demonstrations. The simple answer to the countless losses caused by employment turnover may be found in the widely acknowledged power of sales training films, easily adapted to the individual problems of individual stores. Not only department stores in major metropolitan centers but all sizeable retail outlets should thoroughly examine the film medium and its many applications modern merchandising . . . see page 4a

FOUR PURPOSE

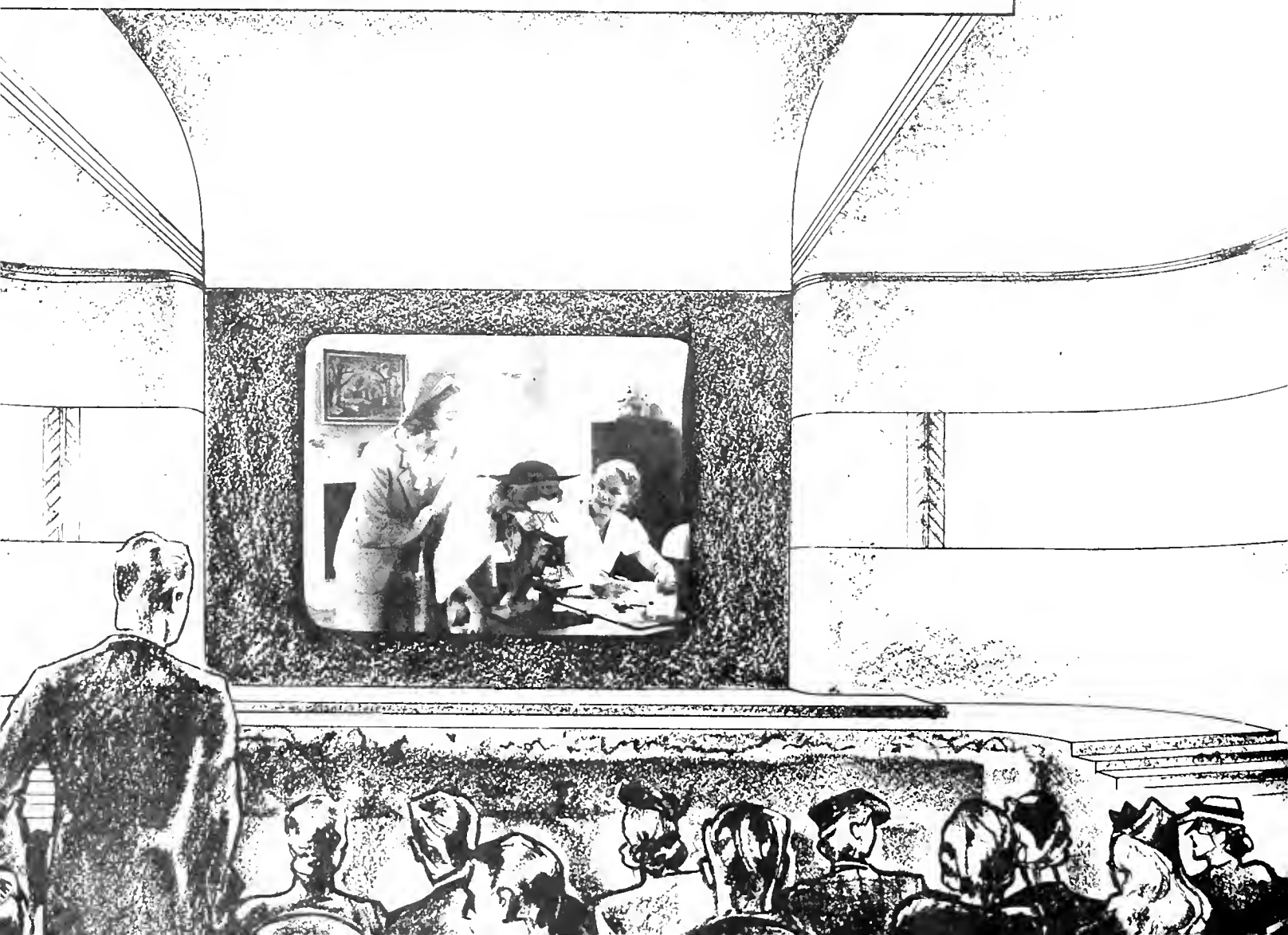
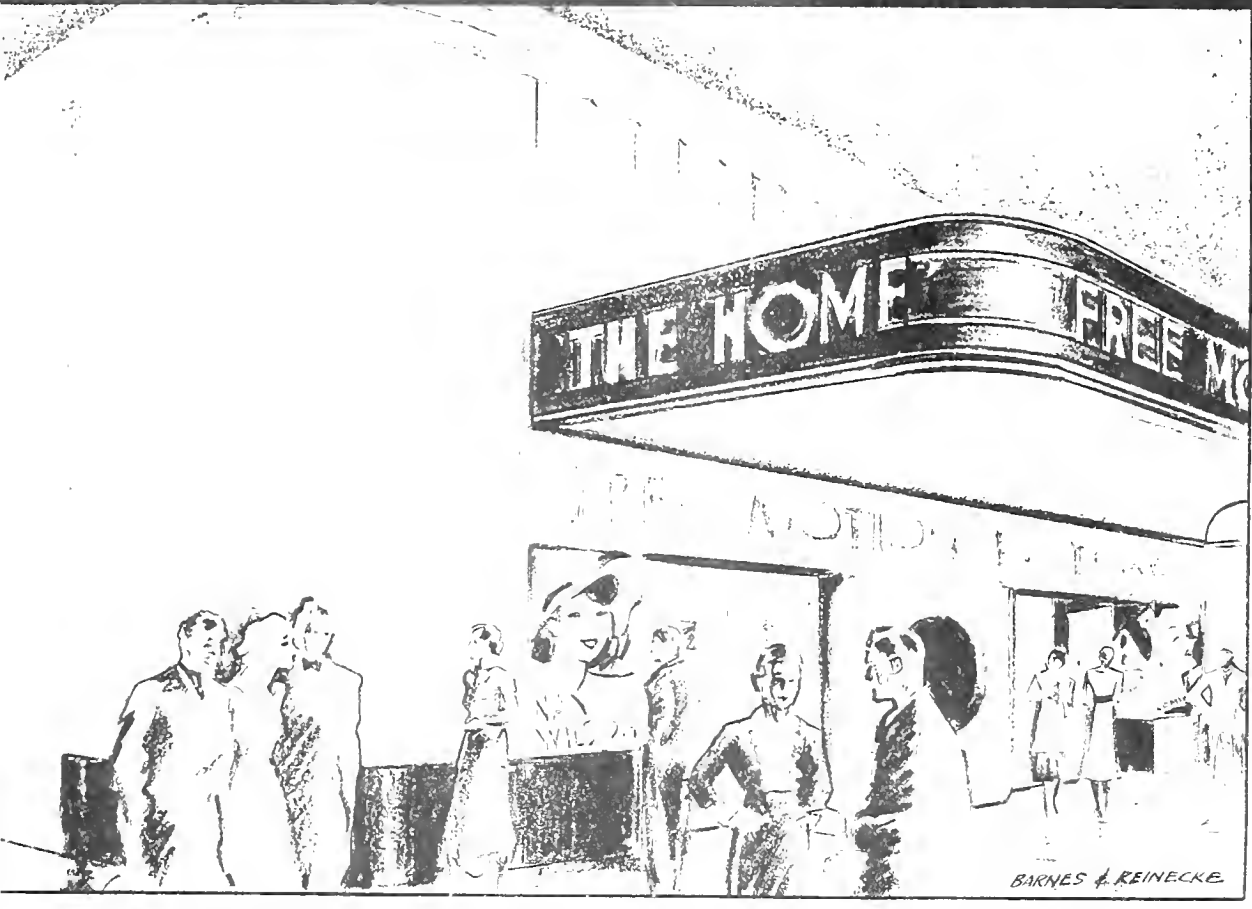

AUDITORIUM FOR 1 MOVIES

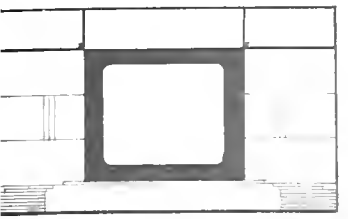

STAGE

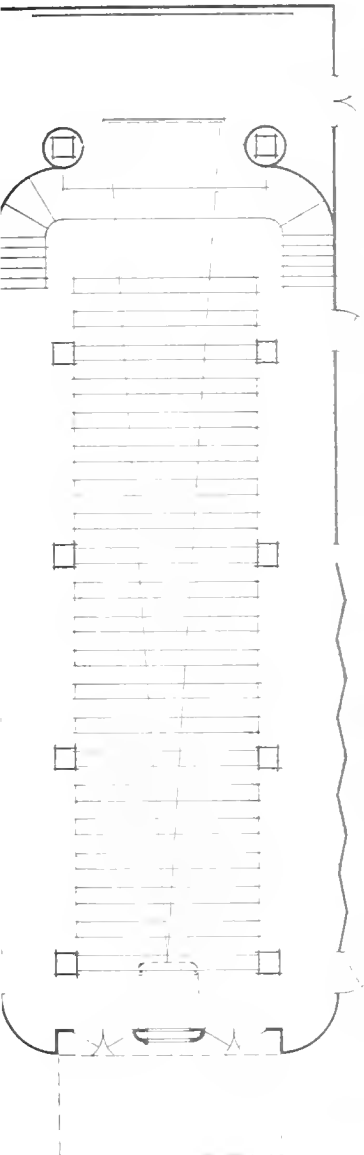

PLAN

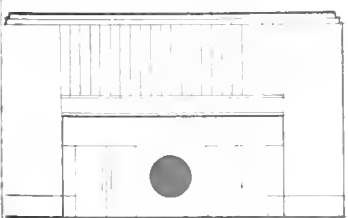

ENTRANCE

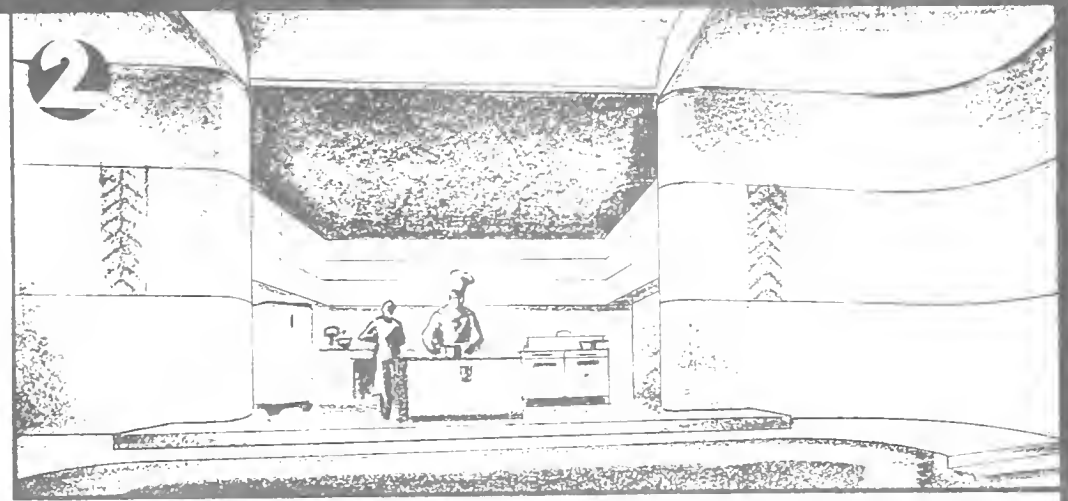

2

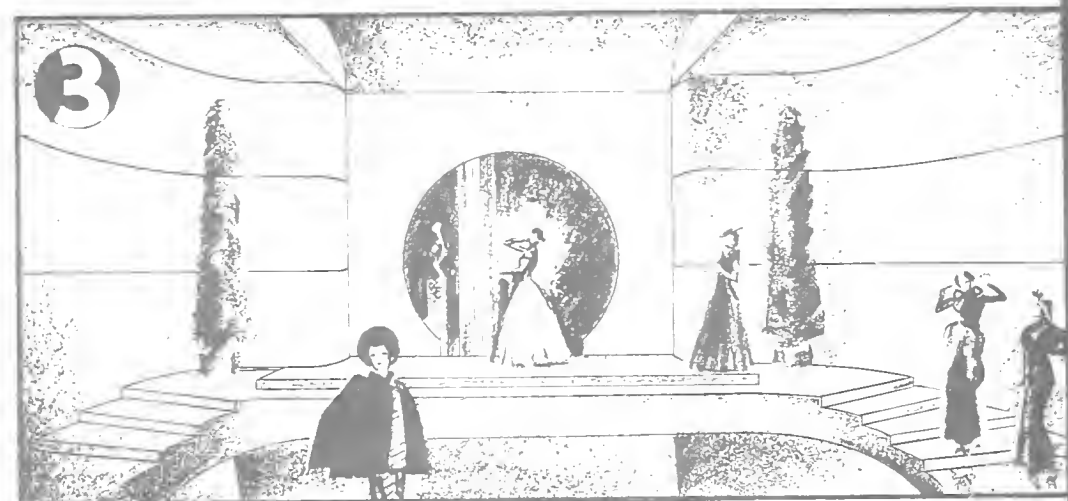

3

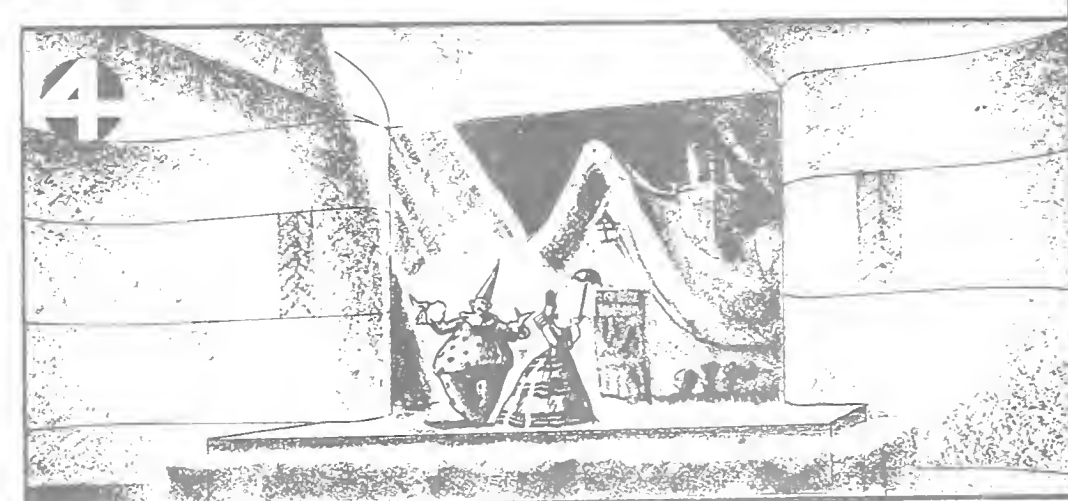

4

2 DEMONSTRATIONS 3 STYLE 4 SHOW

GOOD WILL ENTERTAINMENT

BARNES & REINECKE



TRAINING SALES CLERKS



EDUCATING RETAIL BUYERS



SPECIAL PROMOTION TIE-UPS



MOTION PICTURES IN DEPARTMENT STORES

Practical Suggestions for Film Programs

(Continued from the first section page) has developed. Mens' wear stores, utility supply shops, and all types of ready-to-wear specialty shops have found the screen medium extremely helpful. The point is that films have proven their merit; have been successfully applied but are not consistently used. Such consistent use depends on (1) familiarity with the medium, (2) information as to its many applications to various uses, (3) ownership of a minimum amount of suitable equipment, and (4) the same amount of enthusiasm that makes all other forms of sales promotion and training successful—nothing more or less than aggressive pursuit of the idea!

What Kind of Equipment?

★ First of all get a good soundslide film projector. The most complete models cost around a hundred dollars; others may be obtained at half that much. Once you own one, the door to hundreds of excellent films is opened wide. Obtain lists from the National Retail Dry Goods Association; from the offices of this magazine or from the Retail Store Service of Audivision, New York City, and you'll find a plentiful assortment of excellent training and promotional subjects ready to go to work for you.

Have your own slide films made by a competent producer and you can apply the direct personality of your store policies into this powerful visual medium. The cost is surprisingly low and new subjects may easily be afforded from time to time. (See the Chicago survey on following pages for a host of other ideas.)

The next logical step is the ownership of a good 16mm. sound projector. Very likely you've sold many machines of this and the amateur silent type. The commercial sound projectors advertised on these pages are used by 99.99 per cent of all industrial concerns. An adequate supply of literature and demonstrations may be easily arranged for. Film libraries from which to supplement your programs with entertainment material are also offered by all these concerns. A very few additional accessories are required to maintain this department.

Two Kinds of Showings

★ Two kinds of shows may now be arranged. First: you can teach your employees how to sell in after-hours meetings or at the regular training school session and, Secondly; you can put on the varied types of programs for your customers pictorially described on these pages. Do these programs draw customers to the store? The answer is a unanimous YES! But you must develop supporting promotion; set up a

well-rounded program and apply the same elements of showmanship to these performances as your local movie theatre.

Customer shows should be well-balanced. A lecture subject on "buymanship" may well be accompanied by a short entertainment subject on a family subject. Arrange programs to key with special departmental promotion and the daily sales. Here the place in which you show the film can make a lot of difference in the day's revenue. A few suggestions will help:

Where to Show Movies

★ The classroom or personnel department can easily be adapted to sales training film lectures but the placement of your customer performance is important. Here, again, two points are important: (1) The area must be large enough to accommodate a good-sized audience and it must have fairly good acoustics. (2) The space should be placed to draw customers through departments featured on the program. A bulletin issued by the Associated Wool Industries offers some interesting points: (a) The room should be large enough to lose the feeling of informal compactness. (b) It should be reasonably quiet so that all discussion may be audible to everyone in the room. (c) While an absolutely dark room is not necessary, a room which can be fairly well darkened is a great advantage and will add materially to the success and enjoyment of the showing. Arrange all seats in front of the projector.

What Kind of Films Available?

★ The organizations already mentioned supply sound slide films for sales training and many of these are adaptable to consumer promotion. Regular distribution organizations such as the YMCA Motion Picture Bureau, Jam Handy Picture Service, and Modern Talking Picture Service and many producers are sources of sound film supply and such organizations can also furnish the exact equipment required. Many national advertisers place all their films with such distributors. Household Finance Corporation, Heinz, Coty, Hudnut, Coca-Cola, Kenwood Mills, Frigidaire, Associated Wool Industries and other national organizations offer films without charge.

★ The important point is that when department stores have sufficiently organized with adequate equipment, promotional knowledge and an appreciation of the power of this medium in promotion and sales training, the many hundreds of subjects which should be available will be made by national manufacturers who today are hesitant only because of the lack of distribution facilities in this market.

PORTABLE PROJECTION IDEAS

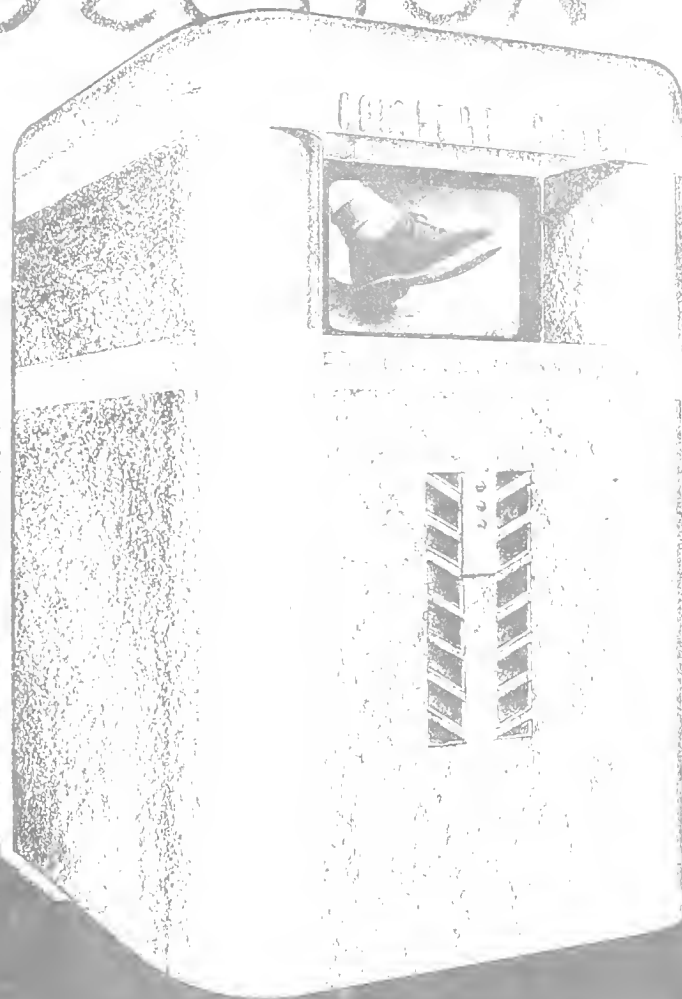

Effective sales demonstrations may also be accomplished within specific departments through the use of a compact portable projection unit housed in a smart movable cabinet. A typical unit of this type, utilizing a standard projector, is shown. Other styles already available include those with continuous projection which eliminates film rewinding, adjustments, etc. Short length demonstrations of manufacture, tests, etc., make ideal film subjects.

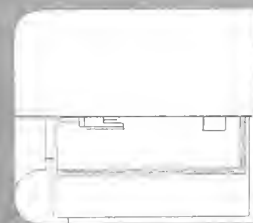

TOP SECTION

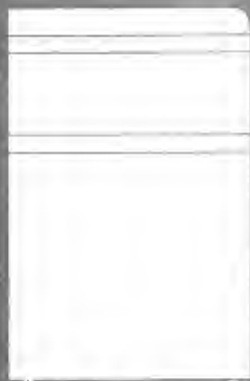

SIDE

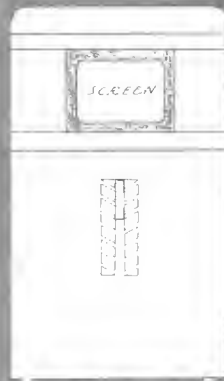

FRONT

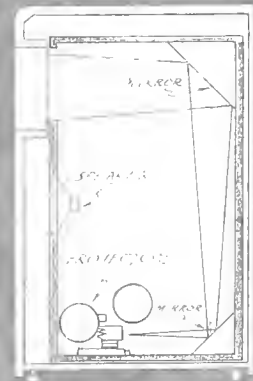

SECTION

IDEAS FOR PORTABLE UNITS

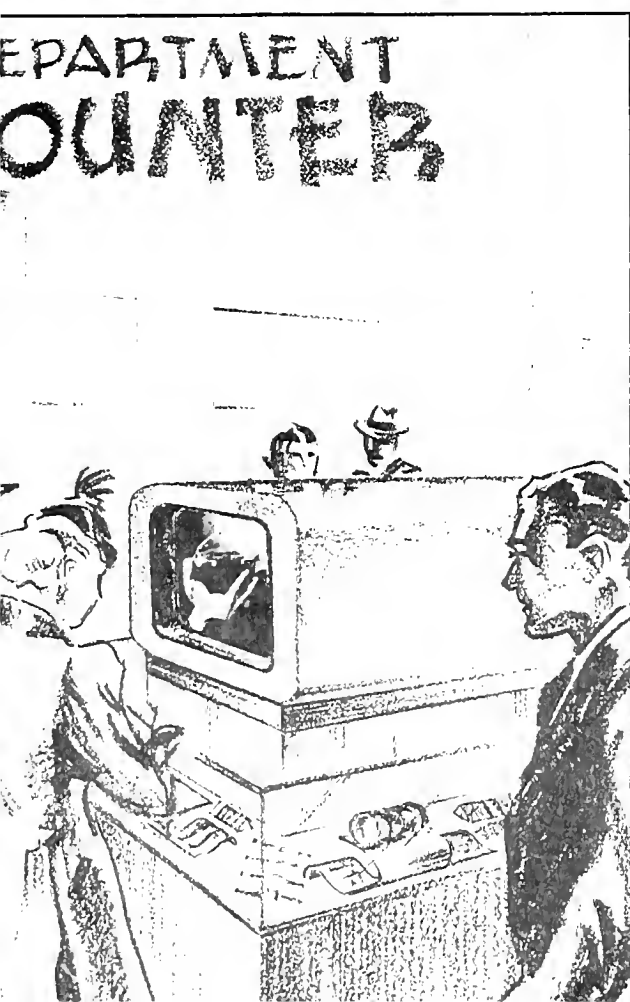

HOW TO USE MOTION PICTURES IN THE DEPARTMENT STORE

A Film Survey of Chicago Department Stores

"HOW DO YOU use motion pictures in your store? What significance do you attach to film presentations? What direct—or indirect—results have you observed?"

These questions were asked of Chicago department store officials to determine the extent and practicability of motion pictures in department store merchandising.

The five department stores selected for the survey were: Marshall Field and Co., Carson, Pirie Scott and Co., Mandel Brothers, The Fair, and Goldblatt Brothers—stores which form a fairly representative group—whose utilization of films extended over periods of time sufficient to justify authentic opinions.

The survey offers some interesting data on both the qualifications and limitations of department store movie setups. Officials were frank to admit that efforts in many cases have been pioneering ventures. But they were emphatic in declaring that motion pictures have definitely proven their ability to sell department store merchandise and services.

★ It is interesting to note the double task assigned to movies, as reflected in the Chicago survey. Said one official, "We consider the job of movies is to sell goods—make no mistake about that! But we consider it just as important to sell our salespeople on the merits and advantages of certain products, as to sell the actual purchaser".

In this significant statement we find a keynote of the department store movie sales program. Motion pictures, supplied by alert manufacturers, associations, bureaus, and by the stores themselves, are used for the purpose of training employees. Movies, aptly co-ordinated with special department drives, direct mail appeals, general advertising . . . stimulate customer purchases. Thus, a program involving the important job of "backstage selling" is co-ordinated with consumer-prospect appeals—which are being worked out with varying degrees of showmanship.

Carson, Pirie Scott & Company Sponsor Own Sales Films

★ About a year ago, Carson Pirie department officials decided to test the value of a store-made movie. A simple 16mm. film was "produced". The subject—"How to Bathe An Infant"! Filmed by a salesman, the film was hardly comparable to some of the craftsman-like jobs usually seen, but it proved interesting to large audiences of mothers. The store's graduate nurse supplied the "sound track" in her lecture which accompanied the

film. Sales of infants' wear went up. The film made a real hit.

A second film was soon completed, showing proper methods of preparing a baby's feeding formulas. It proved even more successful than the first. The Baby Department, at least, was well on its way to stardom!

There followed a number of films for parents. Such subjects as: Making Up a Crib, Selecting a Layette, Children's Self-Help Clothing, Choosing Toys for Children of Various

the goods depicted on the screen are traceable immediately, say Carson Pirie department heads.

The picture showing proper selections of toys for the various ages of children is given outside—as well as store-distribution. It is shown before Women's Clubs, Auxiliaries, and before various other appropriate groups.

"Enter the Sales Slip"

★ The enthusiasm of Carson Pirie executives for infants' wear and toy department films, rapidly permeated other departments. With the store's Dramatic Club as a cast, a personnel-training film was created to show the multiple effects of wrongly-entered sales slips.

Tracing humorously the difficulties caused—from the time the slip had been entered to the final step wherein the customer's complaint must be rectified, the movie "shows, as no amount of mere lecturing could do, the extra work thrown upon the various departments through which the slip passes". This picture has proven valuable for reminding old employees of an important matter, and for breaking in new groups.

The Carson Pirie American Legion Post passes in colorful reviews in a film which portrays its multiple activities. The film not only possesses fine publicity value, but tends to inculcate pride, Americanism, and to foster store loyalty among Carson employees.

Marshall Field & Company Among Store Movie Pioneers

★ Five years ago "Field's" turned to movies . . . found them to be a powerful merchandising accessory. Today motion-pictures are an intrinsic and important unit in their aggressively modern system.

In the Luggage Section, for example . . . Here films on travel subjects—(furnished by various travel agencies) are frequently presented . . . found to be an excellent stimulus to sale of travel-needs.

The Toy Department, catering to juvenile audiences on Wednesdays and Saturdays, and sometimes on holidays, has its own Children's Theatre. It has a seating capacity of 300. Parents, of course, accompany the children, and the double selling job thus affected is consummated in the nearby Toy Department. Besides various children's films—including animated cartoons, film playlets, etc., films on toy selection are given for the benefit of the parents.

Motion pictures "take" drapery prospects

HOW FIVE CHICAGO STORES USED COMMERCIAL FILMS

Check this list for your own application of films to your promotion and training

- Trained Clerks With Syndicated Films
- Trained Clerks With Own Films
- Entertained in Toy Departments
- Promoted Entire Maternity Center
- Sold Travel With Regular Programs
- Promoted Own Manufactured Lines
- Built Food Department Sales
- Aided Club Bureau Activities
- Sold Luggage With Travel Films
- Improved Packaging Dept. Results
- Aided National Advertising Sales
- Special Department Sales Aids

Copyright, 1938 Business Screen, Inc.

Ages . . . followed in rapid succession.

The department's officials had hit upon a strikingly effective means of stimulating interest and subsequent purchases. The pictures (which were 16mm. silent, four of them in color, presented with accompanying lectures) drew lively responses . . . aided purchases in other departments as well . . . and "have demonstrated tremendous crowd-drawing power when mentioned in the store's advertising".

The customer films of Carson Pirie are tied-in with national events. For example, special promotion of the baby films precedes National Baby Week. The pictures are, during Baby Week, presented every day. One or more of the films, during the remainder of the year, are presented each Wednesday afternoon, in the Infants' Goods Section. Sales of

HOW TO USE MOTION PICTURES IN THE DEPARTMENT STORE

through Field's curtain factory in Zion, Illinois . . . in comfortable seats where sales resistance is greatly lessened. Similarly, women prospects are shown the care and accuracy of manufacturing Field's dresses — presented in some of the various dress sections of the store. As in the great majority of department-store-films — all Field's films are of the 16mm. safety type. Some of the subjects are presented with continuous projectors, which, of course, require no attention during the day.

Sales Training at Field's

For the initial training of sales-people, "Making Good", and "12 Principles of Selling" are in use. These films were made in the store — were handled by professional directors, with professional actors. Sales employees also appear in "background" bits.

Both films — shown every week to new employees in training — were designed to demonstrate proper conduct of sales persons; courtesy in dealing with the public is brought out forcefully; the need of accuracy convincingly portrayed.*

In order to train extra packing clerks and inspectors taken on during the Christmas rush, films on packing and inspection were made in the store, and were used with signal success during the past several seasons.

"How to Sell and How Not To Sell", made in 1935, is a 300-foot comedy designed to humorously convey the advantages of "right" selling and the disadvantages of an unsalesmanlike behavior.

Marshal Field officials, alert to the advantages of manufacturing and association films, utilize innumerable product films in the training of sales employees. Teaching their sales-people the fine points of merchandising, and of the various lines handled has had a tangible effect upon sales-ability. Among films recently shown, in the several departments involved, are technical, descriptive, and sales-expository subjects such as Rayon, Rugs, Coty's perfumes, Pyrex glassware, Wedgewood, and Copeland-Spode chinaware. The films are presented in special sectional meetings, either on projectors owned and operated by the store, itself, or through arrangements with the various manufacturers, who, in many cases, supply both sound-projectors and operators for store showings.

Summing up his opinions on department store motion picture pro-

grams, a high official of Marshall Field and Company stated: "Whether used in teaching salespeople or telling the public about the products we handle, motion pictures put the message across in a manner which we believe could not be as effectively handled in any other way. A good picture combines the merits of the printed word with those of a visual demonstration and a spoken lecture. All this interests the audiences, enabling them to absorb important information with redoubled thoroughness."

Mandel Brothers Favor Films

★ Mandel Brothers, unlike Field's or Carson, Pirie Scott, have not as yet utilized store-made films. All their films are secured from outside sources. This organization has, however, had strikingly effective success with movies in both consumer-showings and sales-training ventures.

Motion pictures are consistently used in the Woman's Club Bureau. Quarters provided within the store for various women's club meetings encourage an intimate and social atmosphere. Movies are frequently run in these headquarters, illustrating various items and accessories — furnished by manufacturers and associations. Direct sales have been traced to these motion picture presentations.

Mandel's Travel Bureau, operated as a concession, also makes frequent and telling use of numerous travel film subjects which are sent by railroads, steamship, and airlines. The Sales-Training Department of Mandel

Brothers extensively employs expertly-produced films of numerous manufacturers, such as the Lux and Ivory Soap films, and Coca Cola's recent "Along Main Street".

Movies at The Fair Store

★ The Fair Store's Travel Bureau, with a set-up similar to those cited above, offers travel subjects every Friday morning. This it has done "for the past three years, without having to repeat any picture, and with good results in the sale of trips."

Announcement of the free travel showings, according to the Fair Store department heads, has obtained much valuable newspaper publicity for the store. In addition, it has aided in building up a regular Friday morning clientele — audiences averaging 600 persons. Increased business has been observed not only with respects to trips, but in innumerable miscellaneous purchases made throughout the store by the attenders.

The Fair also uses a number of manufacturers' films for sales-training in various store departments.

Goldblatts Active Users

★ A signally successful Cooking School promotion, in Goldblatt Store in Chicago, employs motion pictures to real advantage. With a splendid variety of food-pictures to pick from, programs of definite and varying "flavor" have been found possible. Presented every Tuesday and Friday afternoons before women audiences, the various menus illustrated are real sales-stimuli. Sales of foodstuffs, seasoning, grocery staples, and the various food-items featured have been favored a marked increase, following these movie-stage presentations, say Goldblatt officials.

Juvenile entertainment films, shown in a special auditorium of the downtown store, have attracted many parents and children Saturday mornings.

Call in Branch Men

★ Goldblatt Brothers not only advocate movies for consumer-prospect cultivation, but find them equally successful for extended sales-promotional activities. Significant manufacturers' films are shown to department managers, who are called to the State Street Store for special screenings of them. The managers go back to their respective departments better qualified to sell merchandise, and to instruct and aid their sales-clerks.



* When these films were shown at a recent meeting of the National Retail Dry Goods Association, hundreds of letters were received by the store, requesting use of the pictures.

"STAR IN MY KITCHEN" — 12 reels



Sponsors:
Pictorial Cooking School
Produced by:
Wilding Picture Prod.
Type: Syndicated national advertising feature for consumers.

STORY: In the best Hollywood manner, girl-meets-movie-star and successfully proves to be girl-in-the-kitchen to happy ending.

DISTRIBUTION: Entirely consumer in rented theatres with local newspaper ad tieups.

Brief Reviews of Current Releases

Sound Motion Pictures Now Being Shown
To Various Audiences

"FRONTIERS OF THE FUTURE" — 1 reel



Sponsor:
Natl. Assn. Mfrs.
Produced by:
Audio Productions
Type: Public Relations

STORY: Lowell Thomas points out to America that opportunity again knocks through science. Research in "big business" produces greater opportunities—presages industry of tomorrow.

DISTRIBUTION: Theatrical and special group showings.

"DAYLIGHTING THE PADRES TRAIL"—2 reels



Sponsors:
Southern Pacific R. R.
Produced by:
Castle Films
Type: Promotional travelogue for group showings, schools, etc.

STORY: Scenic trip Los Angeles to San Francisco on the streamlined "Daylight" of the Southern Pacific attractively photographed, graphically told.

DISTRIBUTION: Showings by request to clubs, travel-minded groups, schools, etc.

"THE FOURTH KINGDOM"—3 reels



Sponsor:
Bakelite Corporation
Produced by:
Audio Productions
Type: Institutional selling.

STORY: Chemist explains development of Bakelite plastics in test tube. Shows development of vast industry, thousands of products. Science is "Fourth Kingdom" of Nature.

DISTRIBUTION: General group showing, colleges, etc.

"HEAT AND ITS CONTROL"—4 reels



Sponsor:
Johns-Manville Corp.
Produced by:
Caravel Films
Type: Institutional selling.

STORY: Physics of heat explained through skillful use of historical background, diagrams, graphs, etc. with explanation of part J-M materials play in its control very subtly explained.

DISTRIBUTION: Industrial, engineer groups, etc. plus general educational distribution by request.

"DIESEL — THE MODERN POWER"—2 reels



Sponsor:
General Motors Corp.
Produced by:
Audio Productions
Type: General distribution educational-public relations film

STORY: The principle, development and operation of the Diesel engine is effectively demonstrated in technical animation and modern application to power plants, boats and streamline trains illustrated in newsreel manner.

DISTRIBUTION: General public through groups, etc.

"THE BENEFICENT REBROBATE"—4 reels



Sponsors:
National W.C.T.U.
Produced by:
Burton Holmes Films
Type: Institutional public relations.

STORY: Educational theme with historical background in discovery of alcohol; industrial uses and personal hazards of use illustrated in university tests. Extremely authentic research, entertaining presentation.

DISTRIBUTION: YMCA Bureau, schools, groups on request.

"THE FIRST CHAIR"—4 reels



Sponsor:
C. G. Conn, Ltd.
Produced by:
Wilding Picture Prod.
Type: Consumer showing, dealer aid

STORY: Entertaining background to subtle sales theme of Conn's instrument craftsmanship. Encourages band participation; use of better instruments by members.

DISTRIBUTION: Selected young groups and parents through dealer showroom arrangements.

"THE CHANCE TO LOSE"—1 reel



Sponsor:
Plymouth Div. Chrysler Corp.
Produced by:
Wilding Picture Prod.
Type: Public relations with subtle advertising

STORY: Third in a series of prize-winning semi-altruistic safety films. Endorsed by National Safety Council, police depts, etc. as spearhead of campaign for better driving.

DISTRIBUTION: Designed for theatrical release plus special group showings (safety meetings, etc.) and dealer showroom display.

"WINNERS WITH WHEAT"—1 reel



Sponsor:
National Biscuit Co.
Produced by:
Castle Films
Type: Educational-advertising

STORY: Coach presents story of food values in cereals; introduces college coaches and athletes. Trip through Niagara Falls Shredded Wheat plant also seen.

DISTRIBUTION: Chiefly schools and colleges, younger groups in YMCA's, etc.

"GOLFING WITH THE MASTERS"—3 reels



Sponsor:
Wilson Sporting Gds. Co.
Produced by:
Atlas Film Co.
Type: General consumer selling

STORY: Atlanta, Ga. Masters' Tournament pictured with narrative interludes on golf equipment, ball making and introduction of outstanding golf personalities.

DISTRIBUTION: To country clubs, club groups, etc. (Reviews Continued on Page 62)

Don't  coddle your dollars

DRIVE 'EM HARDER! 

AudiVision's best customers are hard-boiled executives—unresting searchers for new ways to sales.

When sales resistance stiffens and budgets shrink, their answer is:

GET BUSY, YOU SALESMaking DOLLARS! DO MORE WORK!

These men get more work from their salesmaking dollars through AudiVision productions which carry a wallop to their buyers, jobbers, dealers and salesmen.

♦ ♦ ♦

AudiVision productions actually increase sales! Yet they're not expensive.

They're practical—down-to-earth—based on fundamental principles of selling, promoting and merchandising that have been proved successful in scores of industries. The AudiVision clientele includes the leaders in all kinds of industries:

General Foods, U. S. Rubber, U. S. Cane Sugar Refiners Association, Keystone Lubricating, Dixie-Vortex, Bakelite, J. I. Case, Coca-Cola, Stromberg-Carlson, D. L. & W. Coal, Goodrich, Texaco, G. R. Kinney, National Association of Ice Industries, Squibb, General Electric.

For these and a hundred other companies of equal standing, AudiVision produces:

- movies, talking and silent
- slide-films, talking and silent, in black-and-white or in natural color
- recordings without pictures
- staged skits and other special features
- training and trade promotional programs

♦ ♦ ♦

Perhaps AudiVision can offer a budget-saving, profit-making suggestion to YOU. Why not find out? It costs you nothing!

Run through the list of brief, factual reports at the right. Check the ones that interest you. We'll gladly send whatever you ask for—no charge, of course, and not the slightest obligation.

Then if you want to talk—that's up to you.

A U D I V I S I O N I n c
 2 8 5 M A D I S O N A V E N U E
 N E W Y O R K C I T Y

Check

THE TOPICS THAT INTEREST YOU

AudiVision has recently issued the following brief, factual reports of what other executives are doing to make their selling dollars more productive.

- 1. *Taking Your Story to the Public.* How to put over your sales message to selected groups and make it stick.
- 2. *Making More Sales Through Department Stores.* Describes a unique, well-tested system for getting retail salespeople to step up your sales.
- 3. *Turn on the Daylight.* How to make a persuasive, commonsense presentation of facts about your business.
- 4. *Conducting Profitable Sales Meetings.* Reducing their expense while increasing results.
- 5. *Larger Orders From Your Jobbers.* Cites records, not theories, about methods of winning the active cooperation of jobbers' salesmen.
- 6. *Business Needs Its Own Movies.* How to avoid "too much Hollywood" and how to obtain genuine sales-slanted showmanship.
- 7. *Bigger Sales Per Stop.* Converting route drivers into real route salesmen.
- 8. *Natural Color in Slide-Films.* A straightforward explanation of the uses and costs of faithful rendition of color on the slide-film screen.



In addition to the special reports here listed, you will want a copy of the AudiVision descriptive booklet called *Jolting the Joneses.*

SOUND SLIDE FILMS

THE RANGE AND NUMBER of business concerns successfully using the sound slide films reads like a general index to the country's best merchandisers. To a few of these concerns, as in the case of most small companies, the talking slide film has been the introductory medium with which they first began to use visual selling and training methods. For the great majority today, a constant stream of these simple and comparatively inexpensive units is rolling off the production lines!

These striking advantages the talking slide film *does* possess: it has *adaptability* and thus can be as readily applied to the door-to-door selling job of a single individual as it is generally used in *group* training. It offers maximum *economy*—thus is available for repeated use. Production of a slide film series enables the user to schedule all-important followup meetings; to adapt selling and training programs to varied circumstances and seasons; achieves the same effective results as the continuous advertising campaign.

The *simplicity* of the slide film which, as the elementary user knows, is merely a series of single still pictures accompanied by a recorded voice, is really its greatest single advantage. Motion and dimension are aided by the voice which accompanies each projected scene. The stop-motion effect possesses an educational force of real merit. *Simplicity* is again an advantage in the *portability* and *ease of operation* which distinguishes the slide film apparatus. The simplest device is the tiny pocket projector which uses a silent slide film; the most elaborate, a record machine weighing perhaps thirty pounds and capable of addressing an audience of a thousand or more persons.

Many concerns have added another element of adaptability to their film programs with a *series* of slide films which accompany or supplement sound motion picture features. Thus, again, slide film sequences have been very successfully added within full-length sound motion pictures to again demonstrate the advantages in instructional values of slow-motion.

♦ Within recent weeks, the most illuminating example of the potentialities being discovered by business in its every day use of the talk slide film may be read from a letter addressed to a professional producer of such films by L. A. Kling, vice-president of the Frank Presbrey Company, advertising agency. Mr Kling says, in part:

"I have just completed a trip for the Schwitzer-Cummins Company. Manufacturers of Stokol Hydraulic and Silent Triplex Stokers, Furnace Units, Blowers and Home Ventilators, which I believe is a record of some kind.

"In less than five weeks traveled 8800 miles . . .

held 21 all-day meetings before approximately 1500 Stokol dealers. And a very large part of our achievement can properly be credited to the showing of *The Midwinter Night's Dream*—the dramatized slide film which you produced for us on both bituminous and anthracite Stokol equipment. This film of 183 frames and 20 minutes of solid selling makes it possible for new dealers and inexperienced salesmen to sell Stokol in competition with most skillful people in the organization.

"The day of visual selling has arrived. A combination of conditions has brought this about. Sales training methods of a few years ago are obsolete. There is no substitute that I know of for the slide film as a vehicle for sales training and group selling."

♦ To the manufacturer of low-price articles, use of sound picture selling has often appeared impractical. The experiences of the Coca-Cola Company, however, in merchandising a five cent article bears high testimony to the efficiency of the medium. To Coca-Cola's seven hundred bottlers this year went the fifth series of merchandising meetings entirely based on six slide film productions as the keystones of sales instructions. Here's how Coca-Cola's promotional brochure to dealers describes them:



This humorous scene illustrates a point in Coca Cola's recent talking slide film, "Under the Lid"

"The Merchandising Service is a sales promotional program built for the bottler and his sales organization. It keeps the bottler abreast of the latest developments for building sales of Coca-Cola. It teaches salesmen the fundamentals of merchandising Coca-Cola and shows them how to put these fundamentals into effective use. It provides the thought and material for a well-rounded sales program. The Merchandising Service is offered in the form of a series of sound-films to show the individual Coca-Cola sales organizations, together with instructions for the plant manager, bulletins for posting in plant and on trucks, and printed ma-

terial covering the subject of the meeting for the personal use of each salesman. The Merchandising Service also makes available to subscribers such accessories as handbooks, refrigeration charts, survey sheets, etc. — whatever is necessary to put into effect the well-rounded program suggested.

"Through The Merchandising Service every plant has the means to keep in step with the most effective sales promotion methods. The salesmen have the opportunity to learn merchandising by seeing and hearing what merchandising is and how it should be done. In developing material for a Merchandising Meeting the most important problems connected with the sale and promotion of Coca-Cola are analyzed. New plans and ideas of the most progressive bottlers are investigated and tested in the field by trained men who contact managers, ride with salesmen, call on dealers. Then those plans found most successful are given to subscribers of this service. In this manner the experience of 1,100 bottling plants is digested and condensed for the benefit of all. Renewed subscriptions from hundreds of bottlers each year is convincing testimonial of the value of this service. The Coca-Cola Company confidently recommends it to all bottlers."

To summarize Coca-Cola's activities in the visual field is to restate these important points:

1. The company is one of the earliest users of the slide film medium.
2. It is one of the most consistent users of talking slide films.
3. It has experienced universal and consistent success in its use.
4. A 5c article is successfully merchandised, proving the adaptability of the medium to all classes of goods and services.
5. The company using the medium is recognized for its merchandising alertness.
6. Coca-Cola has, finally, accomplished what one authority terms an "almost insurmountable job of converting drivers into salesmen."

Slide film productions for this company are turned out by any experienced and capable producer of this type of film. A complete service is offered the dealer and bottler. This includes the purchase of equipment and the offer, also, of a library of back meetings which have been smartly edited so that they remain completely re-usable.

♦ Excellent slide films which possess strong entertainment value or worthwhile educational material are used with real success for consumer showings. National users who apply this economical medium to the consumer field have long ago dismissed the

(Continued on Page 43)

YOUR SALES CURVE

upped

by the Helping Hand of Brobuck

YOU spend thousands of dollars to perfect your product—thousands more to maintain its quality...You spend still more in advertising and sales promotion. Worthwhile, of course, because they lead buyers toward your product.

But then...WHAT HAPPENS AT THE POINT OF SALE?

How far would your sales curve be upped if more of your salesmen closed more sales?

Business films are accepted as the one most effective way to train salesmen to close more sales. Proof? The list of companies using them speaks for itself. (*)

Investigate. Apply "Picturized Presentations" to YOUR sales problems. They are stimulants for stubborn sales. Get the most from your business film program. Check your producer on these five essential requirements:

1. FULL UNDERSTANDING

Does your producer understand sales problems? Brobuck's staff is as widely experienced in salesmanship as it is in showmanship. Both are necessary.

2. THOUGHTFUL PLANNING

Can your producer plan a result-getting program? Brobuck's staff is trained to think straight through to the heart of a sales problem. Sound sales planning is necessary.

3. ACCURATE INTERPRETATION

Can your producer write scripts that properly interpret your story? Brobuck's staff knows, by experience, how to combine selling punch with human interest. Both are necessary.

4. PROFESSIONAL PRODUCTION

Can your producer turn out shows of professional quality? Brobuck's staff has had long years of experience in the production of business films. Quality is necessary.

5. EFFECTIVE FOLLOW-THROUGH

Can your producer help you get your program used in the field? Brobuck's staff is expert in putting sales programs into practice. Proper follow-through is necessary.

We invite you to make us prove it—our representative will gladly call in answer to your inquiry—no obligation, of course.

BROBUCK
INCORPORATED
Picturized Presentations

GEORGE BROSCH, President
15 E. Bethune, Detroit

R. L. BUCKINGHAM, Exec. Vice-Pres.
35 E. Wacker, Chicago

(*) Among BROBUCK'S clients:

- Chrysler Corporation:
Plymouth Division
Chrysler Motors Service Department
- Ford Motor Company
- J. I. Case Company
- Packard Motor Car Company
- International Ass'n of Milk Dealers
- The Simoniz Company
- Chicago & Northwestern Railroad
- Allen Electric & Equipment Company
- The Perfect Circle Companies
- The Orange Crush Company
- Kent-Moore Organizations, Inc.
- The Rough Notes Company, Inc.
- Wagner Electric Corporation
- The Studebaker Corporation
- The Flintkote Company
- Williams Oil-O-Matic Heating Corporation

ON A continuing release basis of one production per month, the International Association of Milk Dealers has embarked on an ambitious sound slide film program. The headquarters of the Association is in Chicago, but its membership, drawn from leading milk distributing companies, reaches from coast to coast.

The first film of the series, *Collection Time Is Selling Time* is already in the field and has been outstandingly successful, according to R. E. Little, executive secretary of the Association. The second production, *Know 'Em and Hold 'Em* is being released this month. Two more films, *The Road That Leads To Sales* and *Winning Back Lost Customers* are now in production.

"Interest in the slide film program has been remarkably keen," Mr. Little says. "The success of the first picture has convinced us that we have found the ideal medium for getting across to milkmen the basic principles and methods that will win and hold the good will of the customers on their routes. Reports from our members indicate that their milkmen have evidenced remarkable interest in the slide film program."

Route sales training has been one of the major activities of the Association for several years. A survey just completed by the association reveals an astonishing degree of sales effectiveness resulting from the use of "The Balanced Job" manual issued by the Association in 1937. Sales reports



A scene from one of the recent sound slide films released by the Milk Dealers Association.

were received by the Association last year from a group of milk companies who were not using the Association's 1937 sales training program. Records were also received from a group of companies of similar size, location and sales potential who *did* use the program. The result was that the group using the training program showed a sales increase of more than fifteen per cent over the group of non-users within five months after the start of the program.

"The result of this analysis," Mr. Little says, "convinced us that money spent on sales training is a very profitable investment. It was on the basis of this survey that we decided to proceed in 1938

with a more ambitious program of driver training and to experiment with sound slide films as the training medium, as a complement to our training program.

"Reports received from our members as the result of the first showings convince us that we have made no mistake in co-ordinating this highly dramatic, human interest form of training with our regular program based on "The Balanced Job." We have letters from various parts of the country stating that milkmen have found it extremely easy to put into actual practice on their routes the sales methods and ideas they see in the pictures. One letter from a milk company in Pasadena, California, says: "One of our routemen decided to try out the ideas he had seen in the picture. Before noon on the day after the showing, this man had phoned in for eleven extra cartons of cheese and eight of buttermilk."

"There is no doubt, in my mind, that our slide film program will result in some very marked sales increases for the companies that use it."

Members of the Association's committee that has responsibility for the program are: W. A. Baril, Borden-Wieland, Chicago; Allen S. French, French-Bauer, Inc., Cincinnati; E. F. Hagemann, St. Louis Dairy Co., St. Louis; T. K. Hamilton, Diamond Milk Products, Columbus, O.; E. J. Larson, Bowman Dairy Company, Chicago; Gerald Meeker, McDonald Dairy Co., Flint, Mich.; and E. V. Mitchell, Polk Sanitary Milk Co., Indianapolis.

1938 BUDGETS LEAVE NO ROOM FOR UN- TRIED EXPERIMENTS IN SALES TRAINING

THAT'S WHY three hundred industrial concerns — large and small — selling everything from soft drinks at a nickel to tractors at a thousand dollars have purchased over 20,000 Illustravox projectors and are getting greater value from sound-slide films this year than in any year since 1933.

They know from experience that sound-slide films make better salesmen at lower cost. They know, too, that Illustravox tells the story of their product as they want it told every time. It never forgets, never gets tired, never gives up.

If you have five or five hundred salesmen — twenty or two thousand dealers — you will want to

INVESTIGATE ILLUSTRAVOX NOW!

ILLUSTRAVOX SOUND SLIDE FILM EQUIPMENT

THE COCA-COLA COMPANY NOW USING ILLUSTRAVOX AND SOUND-SLIDE FILMS FOR FOURTH CONSECUTIVE YEAR FINDS IT A MARVELOUSLY EFFECTIVE MEANS OF DEVELOPING PROMOTIONAL CAMPAIGNS AND OF TRAINING SALESMEN IN PROPER MERCHANDISING. YOU, TOO, WILL FIND ILLUSTRAVOX YOUR MOST DEPENDABLE, ECONOMICAL AND INDISPENSABLE SALES TOOL. IT GETS THE BUSINESS WHEN BUSINESS IS HARDEST TO GET.

Write for More Information!

ELECTRO-ACOUSTIC PRODUCTS COMPANY
Subsidiary of The Moogrovox Co.
FORT WAYNE - INDIANA

BETTER PICTURES ... BETTER SOUND

with the **VIS-O-PHONE**

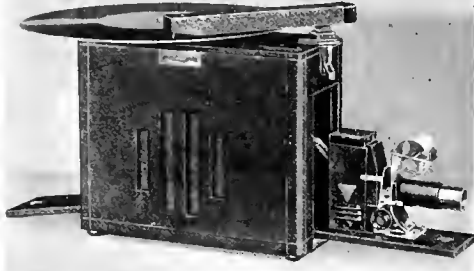

Model L-103 for audiences up to 100 illustrated. Other models for audiences up to 500.

A new advance in slide film sound projectors. Approved by both producers and users of industrial films. Plays 10, 12 and 16 inch records. AC or DC current. Self-contained screen. Self-contained record compartment. 100 watt projector. See, hear, operate the new VIS-O-PHONE. For details and demonstration see your film producer or write

SOUND PROJECTS COMPANY
3140 WALTON STREET CHICAGO

LIGHTER
MORE
COMPACT
SET UP IN
A MINUTE
EASIER
TO CARRY
CONVENIENT
TRIPCORD
FOR
CHANGING
SLIDES



From "The Fall Guy"

Sound Slide Reviews

FILMS USED IN VARIED FIELDS

Sponsor: U. S. Rubber Mutual Tire Dealers Corp.
Title: "Meet Bill Todd"

♦ Bill Todd, a typical service station owner, and an old friend, the U. S. Rubber representative, exchange reminiscences about the growth and progress of Bill's business from its beginning to its present prosperity via a balanced selling plan.

Since the production is designed for oil company outlets and U. S. dealers all over the country, the film develops its theme on how balanced selling builds profits from *all* service station items, and interesting flashes of selling technique are dramatized as concrete examples of successful salesmanship.

Sponsor: U. S. Cane Sugar Refiners' Association
Title: "It Could Happen Here!"

♦ The film is addressed primarily to labor and consumer groups in an endeavor to interest them in protesting against legislation which militates against U. S. sugar refiners.

Through the medium of a conversation between several refinery employees, this film explains the situation of domestic cane sugar refiners in relation to the present quota system.

Sponsor: General Foods Corporation
Title: "A Case for Better Business" and "The Cereal Bowl Revue"

♦ These two half-hour productions are designed to interest the sales force in capitalizing on 1933 plans for advertising and promotion.

"A Case for Better Business" emphasizes how saleability of the sponsor's products is already proved by investigations among thousands of housewives. Newspaper ads, magazine tie-ups, store displays are all illustrated to show how completely the campaign "follows through" to back up sales efforts.

"The Cereal Bowl Revue" develops the pulling power of advertising plans for radio audiences.

Sponsor: Charis Corporation
Title: "Good Fittings Make Good Customers" and "Stepping Stones to Bigger Business"

♦ These two films are part of a series which Charis Corporation has made during the past two years for training its fitters and saleswomen all over the country.

The correct methods of corset fitting are explained in "Good Fittings Make Good Customers". Pictures of actual demonstrations in close-up and clear verbal instructions make this film extremely successful for training purposes.

"Stepping Stones to Bigger Business" lists various types of figures and continues the training begun in the previous films.

Sponsor: Chek-Chart Corp.
Title: "Profits from Merchandising Lubrication"

♦ A new sound slide film showing profits which can be derived from more effectual merchandising lubrication service through the use of Chek-Chart has just been released.

The film is an attention-getter from the start. Woven into the drama of a service station operator who did not want to be "told" is the story of how he learned many things about selling lubrication and how to make his lubrication department the "SALES ARENA" of his business to boost the sales and profits of other products and services.

Sponsor: National Safety Council
Title: "The Fall Guy"

♦ A new sound slide film illustrating hazards to safety has just been released for distribution by the National Safety Council to business organizations. Hazards in daily work are graphically illustrated in this sound slide film subject.

In the Forthcoming

WORLD'S FAIR EDITION

of

BUSINESS SCREEN

are included—

These Important Articles

PLEASING FAIR CROWDS

YOUR EXHIBIT & MOTION PICTURES

WHAT CHICAGO'S FAIR SUGGESTS

and a complete section of

Exhibit Layouts and Plans Drawn by
Nationally Famous Industrial Designers

Unit Production Up

PLAN SLIDE FILMS IN SERIES



from "YMCA Forward"

(Continued from Page 39)

the thought that the lack of action limited the field of distributing of slide films. Household Finance Corporation, for example, distributes a series of talking slide films on *Better Buymanship* to women's groups throughout the East and Middlewest. Authoritatively edited by home economists, unbiased and frank in the exposition of their subjects, these films have earned widespread praise. Similarly, newspaper files reveal that a recent historical slide film "A Century of Progress", made for the Norfolk & Western railroad, is now extremely popular among club groups, etc., in the South Atlantic states to which its distribution has been limited.

The most recent editorial bulletins graphically describe the wide variety of uses to which slide films are being put. Among the productions just completed or being made are those for Westinghouse, General Electric's Hotpoint division, the Chekchart Company of Chicago, and the first of a series for the National Safety Council entitled "Fall Guy". Cooper's *Streamlined Men*, and several for Standard Oil, Williams Oil-O-Matic, Simoniz and the Modreen Company of Racine partially checks a long list of recently produced films.

♦ The Cleveland Y.M.C.A. forward movement has issued a sound slide film which played an important part in its fund-raising drive.

The New Era of Visual Selling

We are creators of an utterly new technique in talking slide films for direct selling and sales training. Clients say that our films move faster and pack more selling. You will understand why when you see one of our productions.

Our script and continuity writers have had years of experience. Our studio men are experienced showmen who appreciate the importance of time in completing a production. Our field men are experienced merchandisers skilled in holding sales meetings. By concentrating exclusively on slide films, we are able to accomplish substantial savings. Comparative prices will prove this.

We refer you to any of our clients, such as the Crane Company, Fairbanks-Morse, Investors Syndicate, United Air Lines, and Schwitzer-Cummins Co.

Without obligation we would like to show you a few recent productions and submit a plan for your consideration.

TALKING SALES PICTURES, INC.

540 N. MICHIGAN AVE.
CHICAGO, ILL.

480 LEXINGTON AVE.
NEW YORK, N. Y.

*Increase Sales
This
Summer*

With Slidefilms
shown by

**PICTUROL
PROJECTORS**

To put more punch into selling, aggressive merchandisers, in rapidly increasing numbers, are turning to slidefilms, both silent and sound. This modern tool dramatizes your sales message and insures the correct telling of it every time. When slidefilms are shown by S. V. E. Picturol Projectors, you are sure of brilliant, sharply defined screen images. The optical system in these projectors is the result of 19 years of engineering leadership by the originators of the slidefilm stereopticon.



As Used
With Sound

MANY STYLES

The S. V. E. line of slidefilm projectors includes styles and sizes for every requirement from pocket size units for contact salesmen to high powered projectors for auditorium use. Mail coupon below for complete facts.

Also Ask About S.V.E. AUTOMATIC FILMSLIDE TAKE-UP

The first practical take-up device for slidefilms automatically rewinds the film as it is being shown, and places it in its storage can ready for use. Fully protects film emulsion. No more tangling! No finger marking! No embarrassing delays! The S. V. E. FilmSlide Take-Up fits all S. V. E. Picturol Projectors now in use.

STANDARD IN ILLUSTRAVOX

And Other Quality

Sound Slidefilm Units

Electro Acoustic Products Co., and other manufacturers of high grade sound slidefilm equipment have standardized on S. V. E. Picturol Projectors because of their compact design, efficient projection and convenient operation.

Chosen By Successful Merchandisers

Thousands of S. V. E. Picturol Projectors are being used by manufacturers in many lines of industry. Chrysler Corporation, Crane Co., Ford, General Electric, General Motors, Iron Fireman, Servel, Standard Brands, Standard Oil Co., and hundreds of other progressive companies engaged in intensive merchandising have selected S. V. E. equipment on the basis of its performance.

Insist on time-tested S. V. E. Picturol Projectors for your slidefilms! Mail the coupon below for interesting folder entitled "Salesmen Are Made" covering the advantages of slidefilms and illustrating the many types of S. V. E. projectors which are available.

FREE LITERATURE Mail Coupon Now!

SOCIETY FOR VISUAL EDUCATION, INC. • Dept. 6B, 327 S. LaSalle St., Chicago, Ill.

Send immediately your free folder "Salesmen Are Made" describing S. V. E. Picturol Projectors.

Tell us more about your new S. V. E. Automatic FilmSlide Take-Up.

Name _____

Firm Name _____

Address _____

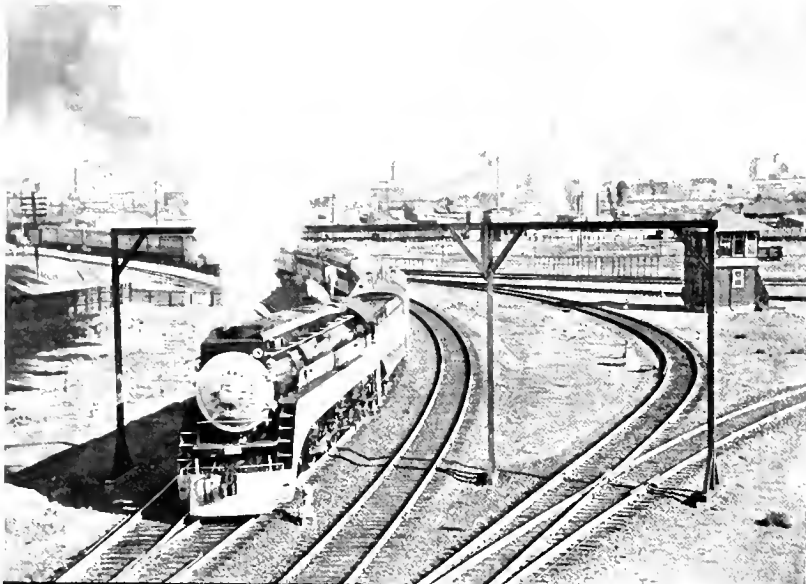

SOUTHERN PACIFIC



PORT OF NEW YORK AUTHORITY



VERMONT MARBLE

These are the
names behind the
name that
CASTLE BUILT!

Castle not only makes business motion pictures—
Castle sees to it that they are seen. That is why, year
after year, names like these stand solidly behind the
Castle reputation.

Nation-wide facilities for planning, producing and
distributing business films are available through three
complete units.

See a Castle representative and learn what modern
business motion pictures can do for you.



SUNKIST



PRODUCERS • DISTRIBUTORS
EXHIBITORS OF BUSINESS FILMS

NEW YORK
RCA BLDG

CHICAGO
WRIGLEY BLDG.

SAN FRANCISCO
RUSS BLDG.

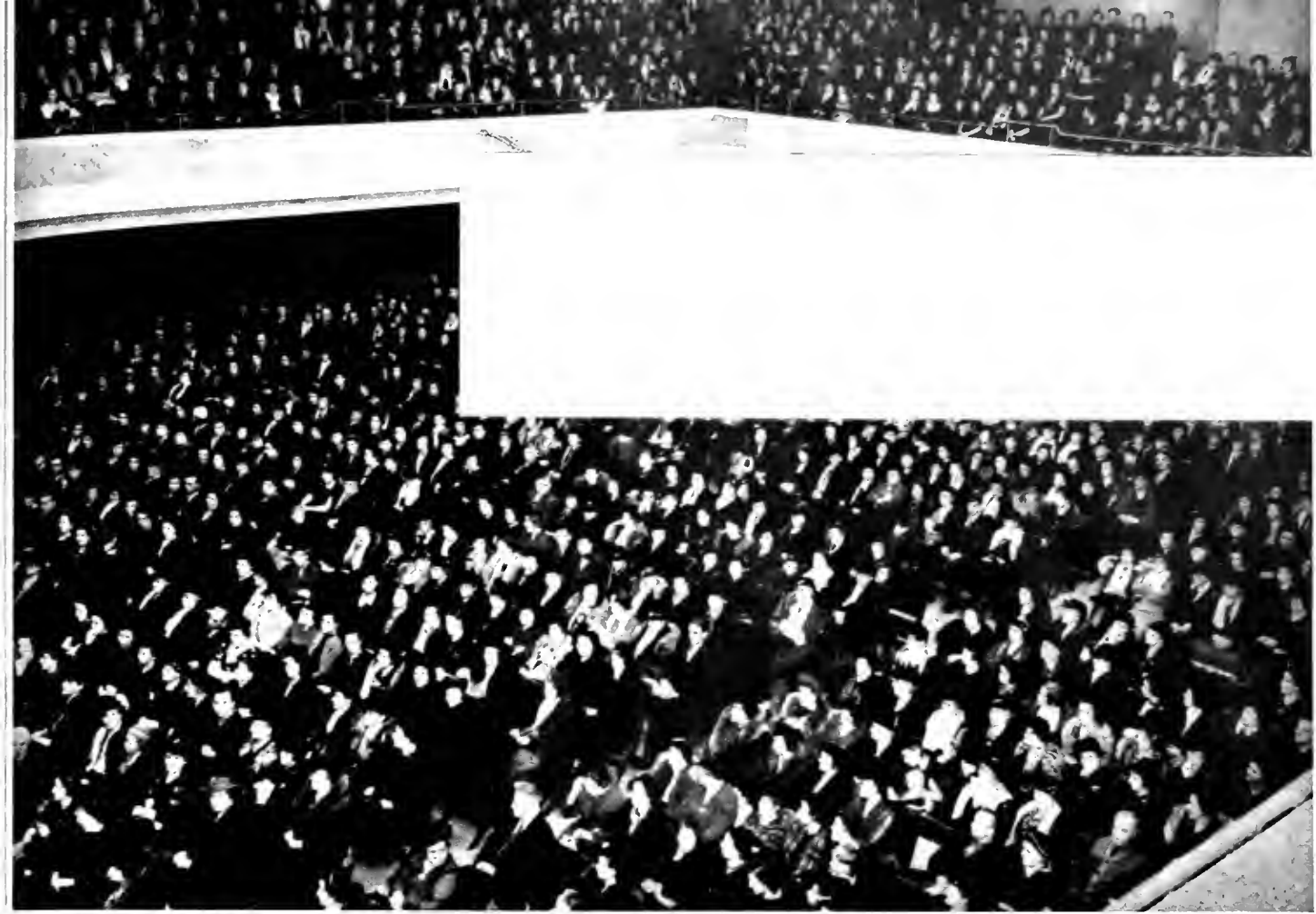

Coolerator Movie Piles Up Audience Records

by H. C. BERESFORD

Advertising Manager, The Coolerator Company

movie, had been built up over a period of three years since general national distribution had been obtained. This had been accelerated through our

use of national magazines and an ever-increasing sales force and concentration of sales activities. The movie, then, was intended to close the gap between the consumer's being *aware* of our product and her becoming *specifically interested* in it and thus eventually *sold* on Coolerator advantages.

Since refrigerators are used chiefly in the home and prejudices for a particular kind are built up in the minds of housewives, a direct appeal to them is made in the Coolerator movie. This begins with the title *Husbands Are Good For Something*. In reality, the picture is of a homemaking and cooking school type. A plot, with the opening scene at the Friday Afternoon Card Club, quickly sets the stage for a demonstration of the culinary art and homemaking ideas.

The dominant leads in the story are shared by Marion Penneck, capable home economist, who is now the proud owner of her second Coolerator, and Eileen Harrison, the artistic but indifferent young housewife, whom she teaches to become a successful cook.

The show comes to its climax and a happy ending when Eileen Harrison learns the importance of a good ice refrigerator—Coolerator—in pre-

(Continued on the following pages)

COOLERATOR'S DECISION to use a movie was made only after considerable deliberation on our part because we are not a large company and the budget required for a 4-reel, dramatic type of picture represented a large investment to us.

However, we realized the power of the "movies", having used visual selling in one form or another for the past several years, and realizing its value, decided to proceed with the movie as a necessary element to complete our selling and advertising plans for 1938.

Selling an ice refrigerator through ice companies presents so many problems because of lack of merchandising organization that there were a number of possible uses for a movie. Looking for a shortcut to put us in a position to tell our story to the public—our prospective customers—a mass selling type of approach was decided upon.

In selecting this approach we had considered the necessity of better trained sales people, a more comprehensive understanding of merchandising problems on the part of dealers, and while the Coolerator movie is essentially a consumer picture, nevertheless the other points of view were continually in the backs of our minds throughout the writing and production of the show.

The stage setting, permitting the use of the



IT'S A SWEET MOVIE
Everybody who sees the new feature...
IT WAS MADE IN HOLLYWOOD
There's one best place to sell...
IT SELLS COOLERATOR AND ICE
The plot line shows the actress...
WANTS FREE TO YOU
The use of the excellent...
THE COOLERATOR COMPANY
DULUTH MINNESOTA

What is this COOLERATOR MOVIE? **HOW WILL I BENEFIT**
By Showing It?

A brief (15 minute) feature motion picture appealing particularly to women... Gives valuable suggestions on cooking and housemaking... At the same time holds the interest with a dramatic and enterprising plot... Through it all is expertly woven one of the most convincing explanations of the advantages of modern ice refrigeration ever made.

WHAT COOLERATOR DEALERS HAD TO SAY:

- "64 SALES IN ONE DAY!"
Oklahoma City, Oklahoma
- "BEST MONEY EVER SPENT"
Boise, Idaho
- "EVERY SEAT TAKEN"
Hanford, California
- "RESULTS UNBELIEVABLE"
Richland, Missouri
- "WORTH MANY TIMES THE COST"
Moose Jaw, Sask.
- "TWO SALES FOLLOWING SHOW"
Salisbury, Maryland
- "HIGHLY PLEASED"
Easton, Maryland
- "MANY PROSPECTS WERE SECURED"
Richmond, Virginia
- "RESULTS ARE GOOD"
Weyauwega, Wisconsin
- "PLAN A RE-SHOWING"
Monroe, North Carolina
- "SOLD 23 COOLERATORS"
Tampa, Florida
- "MANY PROSPECTS SECURED"
Edenton, North Carolina
- "HELPS OUR SALES"
Bicknell, Indiana

Coolerator Sets Audience Records

(Continued from Page 45)

paring palatable dishes. She delights her family by quickly absorbing Marion Pennock's instructions and wins a buffet supper contest over a strong field, including Amy Lawson, who has been the critical thorn in her social life at the bridge club.

The important questions are: Does the movie *entertain*, does it hold *interest*, does it give prestige to ice refrigeration and Coolerator and *actually sell* merchandise? We believe the answers are definitely — *yes!*

A vital problem for every user of commercial motion pictures is distribution. Our movie is shown in two general ways: One, the idle hour theater show, using 35mm. film; the other, club shows, using 16mm. film.

The most spectacular results have been gained from the theater shows which have been staged in large metropolitan centers such as Milwaukee and in the smallest hamlet boasting of a theater. The formula for showing is simple; the film is made available to Coolerator dealers free. The responsibility of staging the local show is the dealer's. An outline of the procedure to follow is supplied (the illustrated press book) and when this outline is followed, results are certain. The plan, in addition to reaching a large group of prospects in a forceful and effective manner, obtains information as to present equipment (its age and kind) and offers the sponsoring dealer a survey of his community with specific information as to his logical prospects with the *added advantage* of these prospects being *more than half-sold before personal solicitation is made.*

Our use of the motion picture is not new. It is, however, entirely new in the ice refrigeration industry, and as a pioneer we have met some ob-

stacles in obtaining full use from the movie because of fear on the part of the dealer that he would be unable to stage the promotion. At this writing more than 500 shows have been run, with prospects for many more, and with a minimum of 500,000 patrons guaranteed for the first six months of the use of the film. On these pages are a number of excerpts from reports from Coolerator dealers throughout the country which give an indication of the character of the reception the film has received.

An interesting sidelight on film distribution has been that a number of our dealers have purchased 16mm. projectors and films and are now equipped to handle future programs with economy and efficiency. In one metropolitan center, more than 10,000 patrons have seen the 16mm. presentation. Another company with outlying properties has staged over 60 16mm. club shows. The balance of the club shows in general are being handled by Modern Talking Picture Service.

Undoubtedly, a large share of the credit for the success of the movie can be attributed to the excellence of the picture, its appeal to the women we want to interest, which begins with the title and commands their interest through to the final curtain where they have been carried along by an intriguing plot, and at the same time have been tactfully and forcefully sold on the advantages and prestige of Coolerator and ice refrigeration. Production of "Husbands Are Good For Something" was entirely handled in the studios of an experienced commercial film concern, specialists in turning out the type of picture we needed. Its success attests the wisdom of our choice in the use of the film medium for this national merchandising program.

THEY COME, THE

When SHALL I SHOW THE MOVIE?

How SHALL I GO ABOUT SHOWING?

It is a good idea to show the picture in a THEATRE SHOW ROOM or in a STORE where the public can see and hear the picture and hear the dealer's explanation.

- 1. Show the picture in a THEATRE SHOW ROOM or in a STORE where the public can see and hear the picture and hear the dealer's explanation.
- 2. Show the picture in a THEATRE SHOW ROOM or in a STORE where the public can see and hear the picture and hear the dealer's explanation.
- 3. Show the picture in a THEATRE SHOW ROOM or in a STORE where the public can see and hear the picture and hear the dealer's explanation.

How WILL COOLERATOR HELP ME?



The Club Show



Editor's Note: A typical letter from a Coolerator dealer, published in the company house organ, reveals interesting data on the actual working of this unusual film in the field:

♦ "Six years ago I bought a small projector and a film entitled, "Why Mrs. Jones Chooses Ice." With this visual selling equipment I went into a number of homes. Usually my audience was ONE—usually I made ONE sale.

"Today Coolerator has made it possible through their film, "Husbands Are Good For Something," to increase the audience to more than a thousand. "Due to the fact that I saw the merits of visual

selling I took advantage of the Coolerator picture, "Husbands Are Good For Something," and had it shown at one of our local theatres on March 15th. We had over a thousand in attendance. The picture was entertaining and created favorable comment.

"Immediately following the close of the picture, customers started for our display room — three customers beat me back to the office. Next, people began telephoning to the extent that at times three telephones were kept busy in the refrigerator department. People came into the display room stating that they had seen the picture. People who had mechanical boxes telephoned us to come out and

appraise their mechanical box, stating that they had seen the picture and were interested. The next thing I did was to employ a lady to write up delivery orders, contracts, and to assist the ice servicemen in checking their prospects.

"Three months ended 1933 shows an increase in total volume of sales of 103.9% with an average increase per unit of 25.8% over corresponding three months of 1937.

"Rough figures taken from my approval book show that during the month of March we placed over two-thirds as many Coolerators on approval as the total number of sales in 1937."



PRIMERGUS TACKING CROWD at the Tampa (Fla.) Theatre attending show courtesy of Cox Ice Delivery Company and Bermuda Ice Company.



ICE CAR used as traveling display by mass dealers called attention to the movie.



EVERYBODY wanted Recipe Book sent at the close of the show.



WAITING for the Yale Theatre at Oklahoma, Texas, to see Coolerator movie sponsored by Columbia Ice & Cold Storage Company.



THE SHOWS seen at the theatre for admission to Menard, Texas, at Salisbury, Maryland.



RAIN failed to deter movie crowd attending at Texas Theatre, Dallas, for the show put on by Egan Ice & Coal and English Ice & Food.

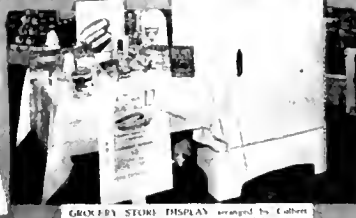

GROCERY STORE DISPLAY arranged by Culbert Spring Ice Company, (Abilene, Texas) to help promote movie and distribute books. Includes show company home each day.



1933 DISPLAY of Coolerators on one during week preceding show at the Caronde Theatre, Elizabeth City, N. C. Sponsored by Crystal Ice & Coal Corporation. Attendance, 950.



Ind. was pleased to receive a 2 pound can of coffee.

HAPPY WINNER of Coolerator at the Salisbury (Md.) show arranged by W. F. Mensch Ice Company.



HENRIARD (COLUMBIA) COMPANY shows the wonderful world for their show. "Look out retail and mass retail men."



CROWD of 1000 waiting to fill 622 seats at Mt. Vernon, Illinois, attending another show. In spite of heavy rain, 100 could not be accommodated. Consumers Ice Corporation was sponsor.

FILMS FOR THE WORLDS FAIR MILLIONS

TWO MAJOR WORLD FAIRS will occupy the attention of the entire nation in 1939 when San Francisco and New York throw open their respective gates for the millions of visitors who most assuredly will attend. On February 18, 1939, the World's Fair on San Francisco Bay will be formally opened. On April 30, of the same year, New York will commemorate the inauguration of George Washington as first president of the United States with the formal opening of the World's Fair located on Flushing Bay. The New York World's Fair will represent an investment of more than \$125,000,000. That fifty million visitors will pass through its turnstiles is the thoughtful estimate of Fair authorities, San Francisco, more conservative in its plans and program, estimates an attendance of twenty million visitors. Already 1500 regional and national conventions and international congresses have been planned.

Exhibits are the *raison d'être* of any fair. This is true today as in the era of the "showcase" exposition. But exhibits today are no longer of the "showcase" type. It is no longer enough merely to display products; the public must be shown the hows and whys and wherefors of these products. The New York World's Fair has set aside 390 acres for displays by business and industry.

To date 369 great corporations have pledged their aid for this task of fashioning the future. Many already have begun construction of exhibit buildings. Others are planning displays in the Halls of Shelter, Food, Production, Transportation and so on which the Fair itself is erecting. San Francisco has been equally successful. What are the plans of these exhibitors? How will they achieve the unenviable task of winning the attention of these visitors millions?

Valuable lessons learned at Chicago's Century of Progress Exposition in 1933-4 will undoubtedly aid the exhibit planners. They will remember that major exhibitors who provided comfortable auditoriums and enjoyable entertainment for their visitors won thousands of new friends; made equally untold thousands of new customers for their wares. If, at the same time, these exhibitors used motion pictures in their programs of entertainment they brought powerful selling messages to these audiences and gave them a well-remembered discussion of their products without lowering the quota of entertainment. Films proved their worth at Chicago's Fair. Today, with new developments perfecting the film, with color, sound and production improvements available to aid the selling message, the motion picture represents the finest medium of advertising and entertainment at the disposal of the exposition exhibitor.

NEW YORK WORLD'S FAIR

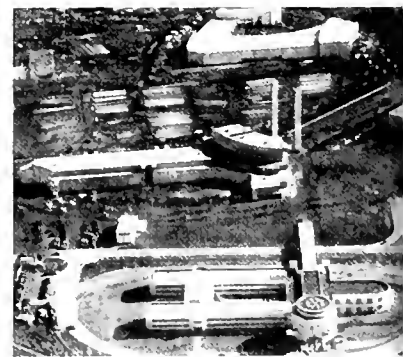

SAN FRANCISCO WORLD'S FAIR

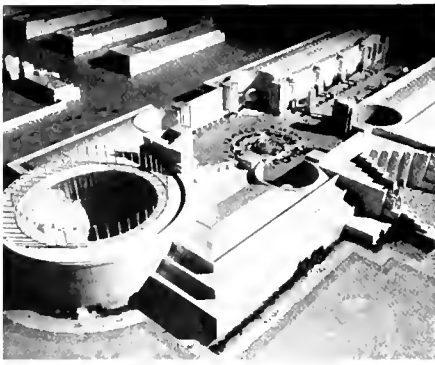



Standard Oil Film Wins Rural Friends

IN ITS SECOND YEAR "STAN" STILL
A FAVORITE WITH FARM AUDIENCES

THE ACID TEST of popularity for the industrial film lies in its ability to maintain long months of circulation without losing its sales vigor and the interest of its audiences. Among the outstanding productions from the standpoint of such popularity among the rural audiences to whom its sales message is directed is the film *Stan*, produced last year for the Standard Oil Company of Indiana.

The story of *Stan* logically begins with the planning and preparation of its basic idea by members of the Public Relations Department of Standard Oil. The task which *Stan* had to perform was one of promoting good will among the rural customers of its tank truck service. In order to build for its local dealers the spirit of community interest, the story of *Stan* is the story of a typical Standard Oil dealer and his relationship with his home town friends and customers.

Early realizing that real showmanship requires perfection in all details, the company engaged Homer Croy, well-known author, to write the narrative background. The screen adaption was furnished by Houston Branch, experienced Hollywood scenarist. Finally Standard Oil turned to a professional producer and engaged a talented and well-known cast which included such personalities as Robert Armstrong and Andy Clyde.

Scenarist, director and cast combined to produce a thoroughly entertaining movie. *Stan's* trials and tribulations in the pursuit of his business, his romance, and his family career are "sure-fire" box office. True, in the final editing of the feature, there were several flaws. An unexpected anticlimax and some imperfections in reduction printing are evident imperfections. The important conclusion, however, is that *Stan's* audiences consistently and enthusiastically applaud its each and every performance.

Behind this production and its good-will aim stands a thorough and well-developed promotional program. Field men equipped with 16mm. sound projectors travel in districts in which distribution is wanted and their efforts are infallibly successful in getting good crowds. Many performances are held evenings in the open air; others are held in

rented auditoriums or theatres. But before the screening of each show, the field representative and local dealer have cooperated in covering the local region according to a well laid out program.

Stan is promoted locally in the following manner . . . we quote from Standard Oil's promotional material:

1. "Have Standard Oil Dealers display the 28 x 44 posters in curb sign frames, and inform them when and where the film will be shown so that they can reply to inquiries about the picture.
2. Place Poster No. 2 in curb sign frames, or on poster boards, in front of and in the lobby of the hall or theatre where the picture will be presented. Write below the line—"Doors open at"—the day and hour the picture will be shown. If this Poster is used elsewhere, the name of the hall or theatre also should be noted.

The following steps are optional but desirable to fully round out the Publicity Program:

3. Distribute, either personally or through Standard Oil Dealers, the Hand-bill shown on another page which will be supplied by the Company. This Hand-bill may be imprinted locally at small cost to the Standard Oil Agent or Dealer with his name and the time and place the picture will be shown.
4. Mail Invitation No. 1 to a list of customers and prospects, particularly farmers and their families for whose entertainment the picture is primarily produced, and whom it may be impossible to invite personally. This Invitation may be printed on Government post cards locally at small cost, by using the matrix form or stereotype plate which the Company will supply through Division offices. The cost of printing is to be borne by the agent or dealer who makes use of it.
5. Distribute the Giant Ticket of Admission, shown on another page as Invitation No. 2, to customers and prospects. This hand-out may also be produced from matrix forms or stereotype plates supplied by the Company in the same way as Invitation No. 1.
6. Place advertising about the picture in the local newspaper, using the ready-made ads shown on another page, and inserting name of agent or

dealer who pays for the space, to identify himself more closely with the picture, and the time and place the film will be shown. Matrix forms or stereotype plates of the ads will be furnished."

Hundreds of thousands of rural audiences have now seen this film during the two years of its distribution. The cost per showing (groups average well over a hundred) is extremely economical according to Company officials. The cost is divided among the following factors: field representative's salary, print and equipment costs, the local advertising and printing budget apportioned for each showing, syndicated advertising expense, etc.

Standard Oil offers several important object lessons for the guidance of other users of industrial films. The comparatively large budget which was appropriated for the initial production expense of *Stan* has already returned very satisfying results on its investment despite the several handicaps mentioned. But in the work of the carefully trained field representatives and interested dealers lies the basic factor contributing to the success of *Stan*. The movie itself was good material on which to build these activities. It had a comparatively "big name" cast, the narrative was entertainingly told and the quality of production sufficiently high so that the audiences have been unanimously satisfied with what they have seen. How long an effective life *Stan* possesses, depends now on the number of local territories which have not seen the film and these are rapidly diminishing. After that, a similar feature picture may again renew the many friendships the Standard Oil Company of Indiana has undoubtedly made with *Stan*.

(Above) Promotional activity on behalf of "Stan" by local Standard Oil Dealers brings about such audiences as this crowd pictured below.



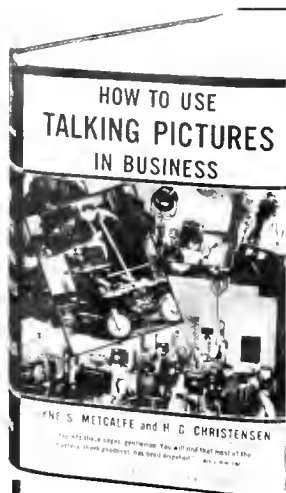

HARPER & BROTHERS
selected
LYNE S. METCALFE
and
H. G. CHRISTENSEN

—to write an authoritative book—the first on the subject—on “**HOW TO USE TALKING PICTURES IN BUSINESS**”.

The authors are members of the Permanent Staff of **WEST COAST SOUND STUDIOS, INC.** and have been since its inception.

THE services of both are reserved exclusively for clients of West Coast Sound Studios, in surveying picture problems, supplying ideas and plans, writing scripts, directing and producing talking pictures for business purposes.

WEST COAST SOUND STUDIOS, INC.

A Modern Talking Picture Studio —
RCA EQUIPPED

510-22 West Fifty-Seventh Street
New York, N. Y.

**GUARANTEED
CIRCULATION**

for

**Advertising Motion Pictures
Reaching
Consumer Audiences**

Write for a folder describing our service.

Motion Picture Bureau

NATIONAL COUNCIL OF YOUNG MEN'S
CHRISTIAN ASSNS.

347 Madison Ave., New York, N. Y.

19 South LaSalle St., Chicago, Ill.

The Bureau has been providing a *cooperative film distribution service* for National Advertisers since 1911.

NOTE — The Bureau does not produce pictures, but business concerns are invited to consult us in reference to **PRODUCTION** and **DISTRIBUTION** of Advertising Sales Promotion and Good Will Pictures. The 26 years experience of the Bureau serving American industries is at your service without obligation.

The Commercial Newsreel

National Visual Education Conference

♦ The eighth annual National Conference on Visual Education and Film Exhibition of the DeVry Foundation opens in Chicago on June 20 and continues through June 21, 22, and 23 at the Francis W. Parker School, 330 Webster Avenue.

Almost continuous showings of selected industrial and educational films as well as authoritative discussions of the problems of each of these fields will again feature the Conference gathering. Discussion will include photographic and scenario technique, advertising, sales and training values, and educational values. As a rule, representatives of producers and sponsors will lead discussions.

The anniversary banquet, in honor of the Foundation's founder, Mr. Herman A. DeVry who is observing his twenty-fifth year in the business, will be held on Wednesday evening, June 22nd. Among the speakers who will attend the conference are Mr. L. A. Hawkins, of the International Harvester Company, Chicago; Dr. E. I. Deer, of the Motion Picture Producers and Distributors of America, and Homer Buckley, President of Buckley Dement Company, Chicago.

Lough Addresses University Conference

♦ Mr. W. H. Lough, president of Audivision, Inc., New York City, was the featured speaker at Northwestern University's first conference on Visual Education & The Adult held in Thorne Hall on May 13 and 14. Mr. Lough discussed “Educational Problems in the Preparation of Industrial Training Films” and presented interesting standards of measurement which his organization so skillfully applies in its production of hundreds of sound slide films.

Flolite Preview at Detroit

♦ The Flolite Motion Picture Corporation, formerly Advitagrap Corporation, producers and distributors of commercial motion pictures, and manufacturers of Flolite continuous projectors, announce the world premiere showing of Flolite projectors at the Thirty-fourth annual convention of the Advertising Federation of America, to be held at the Statler Hotel in Detroit, June 12 to 16.

Word Magic Previews in New York and Chicago

♦ Elmer Wheeler, president of Tested Selling Institute, which he organized for the purpose of testing sales presentations and making them more effective, will make personal appearances on June 16 in New York and June 22 in Chicago at previews of “Word Magic,” a talking motion picture based on his well-known book, “Tested Sentences that Sell.” The New York showings will be held in the Sert Room of the Waldorf Astoria Thursday, June 16 at 3 and 5 P.M. In Chicago the film will be shown at the Hotel Stevens on June 22.

Audioscopiks Filmed by Industrial Producer

♦ One of the most successful novelties of the year, called “Audioscopiks”, the third-dimension picture distributed by Metro-Goldwyn-Mayer, was produced by an industrial film producer, the Loucks & Norling Studios in association with Mr. J. F. Leventhal. Mr. Leventhal and Mr. Norling are the inventors of the process. The prints for this subject are made in Technicolor.



A startlingly novel exposition of the emotional kinship between music and perfume, featuring Dr. Sigmund Spaeth, noted musical analyst. Produced for Coty, Inc.

*Selective Theatrical
Distribution
Guaranteed*



SALES FILMS

of unusual beauty — entertainment value — emotional appeal — mature conception — psychological soundness — dramatic effectiveness — to sell products, to train salesmen, to dramatize an institution.

Brilliant black and white and color photography, montages, special effects, cartoon and technical animation — the complete film, from script to screen, produced by our own staff.

For fifteen years we have been making successful films on a great variety of products — from steel to perfume. *We invite an opportunity to submit scenario ideas for your films without obligation to you.*

LOUCKS & NORLING STUDIOS
245 WEST 55th STREET
NEW YORK, N. Y.

"AUDIOSCOPIKS"
a series of third-dimension
novelties, released by
METRO-GOLDWYN-MAYER
produced by
LOUCKS and NORLING STUDIOS
with J. F. Leventhal



A N N O U N C I N G

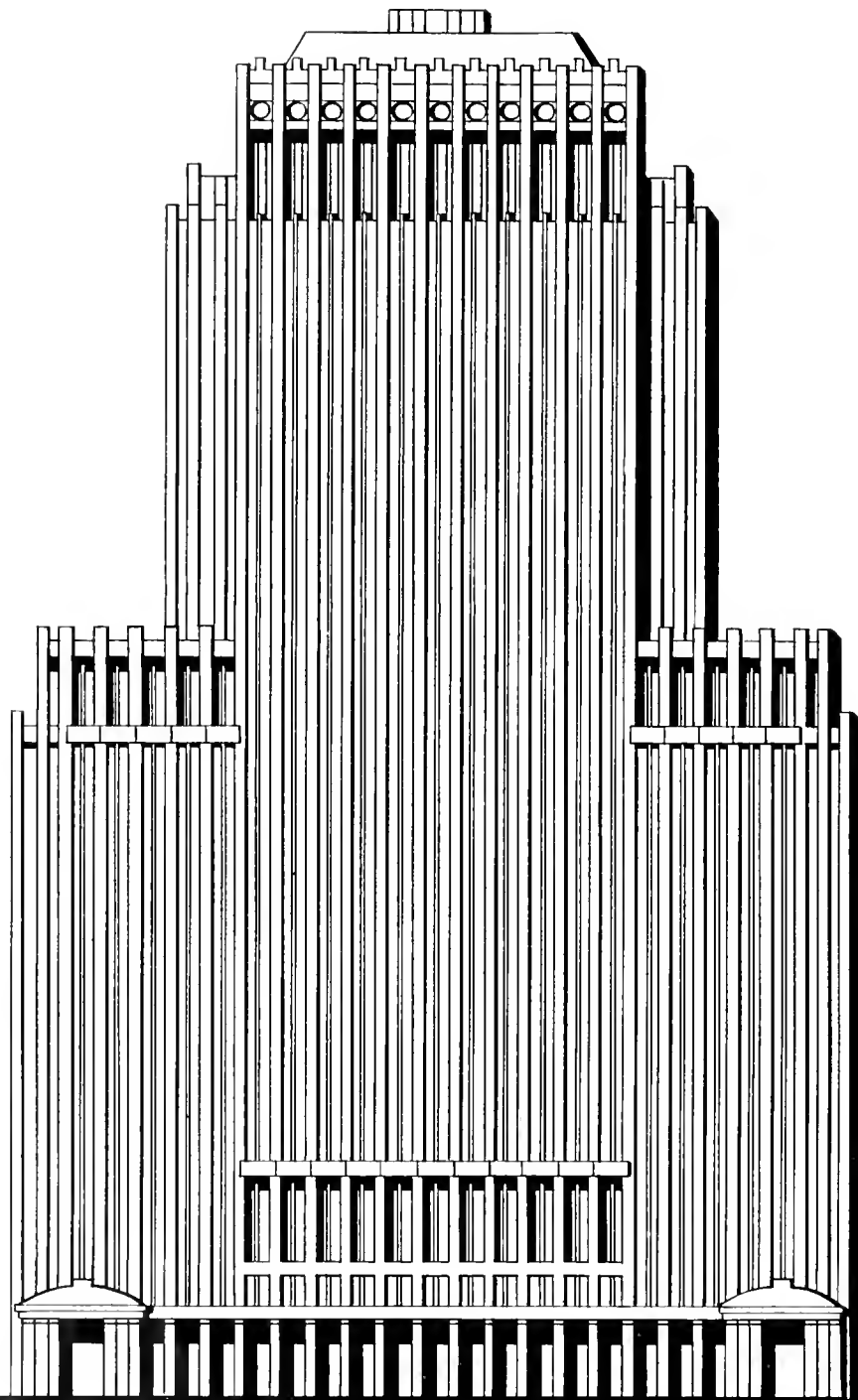

The unparalleled facilities of this Chicago building and three theatres now available to commercial and industrial business organizations

20 NORTH WACKER DRIVE BUILDING • CHICAGO

ADDRESS INQUIRIES TO THE OFFICE OF THE PRESIDENT • J.C. THOMPSON • 20 NORTH WACKER DRIVE • CHICAGO



This Film
CARRIED A VITAL SALES MESSAGE TO 8,000,000 PEOPLE.
May we tell you how?
WILLIAM J. GANZ CO.
 19 EAST 47th ST. NEW YORK, N.Y.
Producers & Distributors of Business Films Since 1919

**EASTERN ASSOCIATION
 of Non-Theatrical
 FILM PRODUCERS**

"The objects of this Association are to aid in coordinating the plans and activities of the various companies in this region engaged primarily in the production of motion pictures for non-theatrical purposes; to establish and maintain standards of fair practice; to disseminate knowledge concerning the selection and proper use of films for non-theatrical purposes; and generally to further all legitimate business film interests."

— Association By-Laws

LIKE MANY ANOTHER Trade Association, the Eastern Association of Non-Theatrical Film Producers dates back to the NRA, and to the early attempts to formulate a code for the far flung Motion Picture Industry. Early in the group meetings it began to appear that no common ground existed on which the entertainment or theatrical producers on the one hand, and the business or non-theatrical producers on the other hand, could meet.

The basic field of activity of the producers and distributors of industrial films is the development of business. It has in common with the film entertainment industry the one fact that it uses the same medium—motion picture film with pictures, titles, and sound recorded thereon. The standards, objectives, and practices of the two industries are otherwise radically different.

In the theatrical film industry, entertainment values, as determined by box-office response, is the criterion of success — a criterion which makes possible and justifies the expenditures of vast sums to produce results which, if successful, bring in vastly greater sums.

The business film industry is founded on training, advertising and sales promotion values. The purpose of its product is to stimulate efficiency and quality of manufacture on the one hand, and through advertising, publicity, and merchandising, to increase sales of the products on the other. In addition to a fundamental knowledge of picture-making technique, therefore, the efficient industrial producer must combine in his organization the training, experience, and ability of the management, marketing and merchandising engineers, the publicist, and the advertising expert.

In order to standardize the industry, to establish criteria of experience, knowledge, and ability to produce effective industrial and sales promotion films, and to maintain codes of ethics of fair business practices for the benefits of both the industry itself and its customers, the Eastern Association of Non-Theatrical Film Producers was established. In it are included the majority of the reliable firms in the East whose work is devoted primarily to the production of business films, whose standing, length of existence and facilities are adequate for making the type of picture in which they are engaged, and whose practices and standards are such as will give assurance of satisfactory and creditable performance to the advertising field. None of these producers have had less than 10 years experience and some date back 20 years or more.

Films of Commerce Co.
INCORPORATED
 21 WEST 46th STREET
 NEW YORK, N. Y.

**PRODUCERS AND DISTRIBUTORS
 of
 SALES PRO-MOTION PICTURES**
 skillfully and professionally made to fit
 a definite product and audience

REACHING OVER
5,000,000
GUARANTEED READERS
 through
28 distributing centers

The most graphic form of
 presenting your complete story
 to actual readers all of whom
 give it undivided attention

**AT BY FAR THE LOWEST ACTUAL-
 READER COST OF ANY PAID MEDIUM**

<input type="checkbox"/>	BIG BUSINESS TRAINED EXECUTIVES	<input type="checkbox"/>
<input type="checkbox"/>	MAJOR PRODUCER TRAINED SUPERVISORS	<input type="checkbox"/>
<input type="checkbox"/>	NEW YORK AND HOLLYWOOD PRODUCTION	<input type="checkbox"/>
<input type="checkbox"/>	LOW COST EFFICIENT MANAGEMENT	<input type="checkbox"/>
<input type="checkbox"/>	All kinds of films equipment and service for every purpose	<input type="checkbox"/>
<input type="checkbox"/>	565 Fifth Avenue, New York	<input type="checkbox"/>
<input type="checkbox"/>	211 E. Pleasant St., Baltimore	<input type="checkbox"/>
<input type="checkbox"/>	GENERAL	<input type="checkbox"/>
<input type="checkbox"/>	BUSINESS	<input type="checkbox"/>
<input type="checkbox"/>	FILMS, INC.	<input type="checkbox"/>



The "scientific approach" to
**MECHANICAL
 CHEMICAL
 METALLURGICAL**
 and other Industrial subjects combined
 with sane "showmanship" has distinguished Pathescope Productions
 for 25 years.

Our experience and skill gained in simplifying and dramatizing complicated technical subjects for many prominent manufacturers is available to you.

Send for our booklet:
 "Making Sales With Motion Pictures"
 and list of clients.

The Pathescope Co. of America, Inc.
 Offices: 33 W. 42nd St., N. Y. City
 438 Stuart St., Boston
 Laboratory: Long Island City

HOW MANY ANGLES TO A CAMERA?



A DIFFICULT question to answer, but Pathe knows two of the angles well. ● One is the news-angle. The news-angle made Pathe famous, gave it a head-start in the field back in 1909 and has kept it ahead ever since on the news-fronts of the world. ● The other is the sales-angle. Relatively new, yes — but for seven years Pathe has been constantly demonstrating the potency of a camera's sales-angle wherever salesmanship is needed . . . in direct merchandising . . . in sales-training . . . in dealer-promotion . . . and in the all-important sphere of public relations and visual education. ● Frankly, Pathe employs no solicitors. Nor does it own a distributing set-up for commercial or educational pictures. It has everything else, however . . . complete, new mechanical facilities . . . the world's largest film library . . . technicians surpassed only by Hollywood . . . and sales-minded executives whose ideas on showmanship and film distribution you will find immensely valuable to your business. ● These executives are interested in talking to men who have problems which may be solved by a film, and who have funds available for its production. ●



PATHE NEWS INC.

FREDERIC ULLMAN, jr., Vice-President

35 WEST 45th ST., NEW YORK CITY

JOHNS-MANVILLE FILM PROGRAM

(Continued from Page 23)

HEAT AND ITS CONTROL, A KEY FILM Of all its many films, the Manville organization is most proud of the recent, *Heat and Its Control*, a production which required over a year to film. Tracing historical, scientific, and even religious significances of heat, it spans the era from the time man worshipped the sun as his only source of heat and light, down through the age of the steam engine . . . the discovery of heat's true nature . . . down to present-day methods of developing and manufacturing materials to conserve a precious and essential force.

Minute attention to detail, unending research . . . the painstaking care taken during the preparation and production of *Heat and Its Control* were responsible for a motion picture which elicited praise of authorities. Best of all, it has been in constant demand. Schools, engineering societies, trade organizations, and other industrials use the prints constantly.

Here is a film designed not for direct sales or promotion purposes, but definitely for institutional publicity, goodwill. Its indirect influences—say Mansville authorities—have been splendid. Animation, shadowgraph sequences, actual recordings of important factual experiments have contributed to its success. Naturally, it has been in steady demand in classrooms and laboratories, too, as the film offers perhaps the only completely authentic record of its kind on the science of heat. Its usefulness as an institutional medium has not been impaired by company "plugging", as only three brief, indirect, and entirely natural mentions of company affiliation are brought into the picture. Trade names of the company's products are not brought in at all.

DEFINITE PLANS FOR ADVANCE PROMOTION

The success of Johns-Manville film campaigns, in the opinion of Business Screen editors, has been due not only to the quality of their productions, but also to consistent, carefully-planned promotional exploitation. It is not enough that a good film has been made. That film must be *used*, must be capably promoted. With the J. M. organization, distribution is not a haphazard venture, but a carefully laid-out series of campaigns, coordinating the various significant units of the sales structure.

Capitalizing upon the enthusiasm and interest instilled by *Heat and Its Control*, prospects are handed a reference book, called "Heat." The treatise is further publicized in promotional literature as " . . . a handbook which provides in concise, usable form, a wealth of information on this important subject—a book that every engineer, student, and layman interested in the subject of heat conservation will find most interesting".

Salesmen form an important unit in the presentation of J. M. shows. They work hand-in-hand with local dealers. They arrange consumer shows,

take care of such details as renting a commercial theatre for a morning, extending invitations to women's clubs and social organizations to attend the presentation. With smaller groups, local halls and other meeting-places are rented.

District offices, too, are tied-in with promotional plans. Distribution of Industrial-Product pictures, and Building-Material pictures is handled usually through the district offices—each of which is equipped with from one to four 16mm. sound projectors, and trained operators.

A new advertising, publicity program has been begun which will even further entrench the effectiveness of the *Heat and Its Control* film. The story is to be presented, Life fashion, with large, attractive scene-reproductions, and forceful accompanying text—another keynote in an intelligently planned promotional campaign.

FILMS FOR SALES-TRAINING While the Johns-Manville Company feels that its feature-length productions should be created by an organization specializing in motion-pictures, it nevertheless encourages the taking of silent 16mm. amateur pictures. Many of the various sales departments have been furnished with 16mm. equipment, which is used for filming installations, servicing, and so on. The films, cut down to five or six minutes' running time, suitably titled, make excellent sales-training material, and have also been adapted to convention and exhibition showings, at which continuous projectors are used.

Summarizing its many years of experience with films—from the elaborate Institutional type, down to the homely amateur production, Johns-Manville has found in movies "unquestionably one of our most effective sales weapons". And it has found too that such films as the Transite Pipe picture "accomplish a job that no other agency could approach—the job of painlessly educating both salesmen and potential customers to the merits of our products."

DISCUSS FILMS AT AD FEDERATION

Experts on advertising and merchandising will speak at the Advertisers' Conference in conjunction with the 34th annual convention and exposition of the Advertising Federation of America at Hotel Statler in Detroit, here June 12-16.

Practical demonstrations of sound motion picture advertising and packaging developments will be a feature of the Visual Advertising Conference.

Among the speakers will be William T. White, sales promotion manager, Wieboldt's, Chicago, who will talk on "What's Wrong With Dealer Helps—Why Most of Them Never Get to First Base," and J. S. Sayre, sales manager, Bendix Home Appliances, Inc., South Bend, Ind., will speak on "How National Advertisers and Retailers Get Together to Sell a Product." Ralph L. Yonker, advertising manager, J. L. Hudson Co., Detroit department store, will preside at this conference.

THE **BERNDT-MAURER** CORP.
117 EAST 24th STREET • NEW YORK CITY

2 + 2 = 4

BERNDT-MAURER

16mm.

Sound-on-Film Recording
Equipment (sold direct to
producers of Business and
Educational Films).



PRECISION
FILM LABORATORIES

specializing in process-
ing and duplicating 16mm.
Sound-on-Film, and pro-
ducing 16mm. optical re-
duction prints from 35mm.
negatives.



Superior picture and sound
quality for the Producer of
16mm. Talking Pictures.

PRECISION
FILM LABORATORIES

A DIVISION OF BERNDT-MAURER CORP.
21 WEST 46th ST. • NEW YORK CITY

Theatre Screen Advertising

A low-cost medium that gives front-page attention, dramatic interest, persuasive voice, natural color, demonstrative action, life-size, selective coverage.

7,782 THEATRES
Alexander Film Co. has 7,782 theatres under contract to display short length film ads before more than 25,000,000 movie-goers each week.

DEALER-FAVORED
32 manufacturers use Alexander nation-wide Dealer-Cooperative theatre-ad campaigns which take the showroom demonstration to preferred prospects.

AUDIENCE-APPEAL
Send for a free copy of "Scenarios," which tells how to prepare lively, colorful and convincing action-ads that will appeal to theatre audiences.

Write to
**ALEXANDER
FILM CO.**
Colorado Springs
Colorado

New York Office
230 Park Ave.

Chicago Office
1020 Wrigley Bldg.

You Ought to Read:

TO RECEIVE LITERATURE
SIMPLY TEAR OUT PAGE &
MAIL TO BUSINESS SCREEN

Editor's Note: Here are the latest booklets and other literary productions from the advertising and promotional departments of film producers and equipment manufacturers. Business Screen recommends that you merely check in the square indicated and drop this column into an envelope addressed to the Screen Service Bureau, 20 North Wacker, Chicago, including a card or letterhead.

MOTION PICTURE PRODUCTION

BURTON HOLMES FILMS, INC. have just published a complete and well-written booklet addressed to aid individuals who make their own movies "for purposes of record or for promotional dealer or sales training." The booklet discusses the subject impartially and offers many helpful suggestions to aid in this difficult undertaking.

PLEASE FORWARD THE ABOVE TO ME

HARPER & BROTHERS have published "How to Use Talking Pictures in Business," by experienced authors Lyne S. Metcalf and H. G. Christensen. A copy of the book may be obtained at your local book dealer's or from Harper & Brothers, Publishers, 49 East 33rd Street, New York City, for \$3.50. This is the first and only full-length book to be devoted to the subject.

"**WILDING PICTURE PRODUCTIONS, INC.**" a splendidly illustrated book outlining the extensive facilities and picturing recent productions of this concern, has recently been published for limited distribution to executives directly concerned with motion picture problems.

PLEASE FORWARD THE ABOVE TO ME

RODNEY GILLIAM COMPANY have issued a handsome brochure illustrating their viewpoints and describing the company's outstanding production achievements. Address the concern at 7904 Santa Monica Blvd., Hollywood, California or write to Business Screen for a copy.

PLEASE FORWARD THE ABOVE TO ME

SLIDE FILM PRODUCTION

AUDIVISION, INC., of 285 Madison Avenue, New York City, has published a pictorial booklet, "Jolting the Joneses," which defines the slide film plan, purchase and use. A copy may be obtained by addressing Audivision.

PLEASE FORWARD THE ABOVE TO ME

MOTION PICTURE EQUIPMENT

BELL & HOWELL are reprinting "Showmanship," an interesting booklet on the use, production and distribution of commercial motion pictures which has achieved wide and deserving popularity among film users. A copy may be obtained by writing to Bell & Howell at 1801 Larchmont Avenue, Chicago, Illinois.

PLEASE FORWARD THE ABOVE TO ME

AMPRO CORPORATION of Chicago supply descriptive material on projection equipment, catalogs and price quotations at your request. A brochure is yours for the asking.

PLEASE FORWARD THE ABOVE TO ME

VICTOR ANIMATOGRAPH CORP. of Davenport, Iowa offer an assortment of thorough equipment folders which may be obtained without obligation directly or from Business Screen.

PLEASE FORWARD THE ABOVE TO ME

DEVRY CORPORATION of Chicago sends out their *Movie News* on request to advertising and sales executives interested in commercial motion pictures. Your name can be on the list without obligation simply by addressing *DeVry* or Business Screen. Other literature is issued from time to time.

PLEASE FORWARD THE ABOVE TO ME

SLIDE FILM EQUIPMENT

ILLUSTRAVOX, widely-known sound slide film projectors, will be pleased to send descriptive literature to interested executives. Address: Electro-Acoustic Products Company, South Bend Indiana.

PLEASE FORWARD THE ABOVE TO ME

SPINN-BITZEN STUDIOS
Producers and Creators
of Animation
**TECHNICAL... CARTOON
MEDICAL... INDUSTRIAL**
INLAND-IRVING BLDG. CHICAGO

REVIEWED LIKE A HOLLYWOOD ★ ★ 4 STAR FEATURE ★ ★

VARIETY

"Extraordinarily executed . . . the most dramatic scientific picture many exhibitors will play all year . . . most interesting educational subject in color yet contrived for the screen."

MOTION PICTURE DAILY

"The film is the best industrial so far . . . red hot steel leaping in vivid color from the screen . . . will go into the nation's theatres to compete with Hollywood made shorts."

FILM DAILY

"A very impressive and most graphic production . . . The film is a swell industrial . . . Will be distributed in U. S. theatres."

CUE

"It is by far the finest educational short that the screen has yet seen . . . has never been approximated in Hollywood's most spectacular attempts to rival nature."

ROLAND REED PRODUCTIONS

LATEST TECHNICOLOR INDUSTRIAL
MEN MAKE STEEL

Produced for the U.S. Steel Corp.

The first feature length commercial picture in technicolor . . . Unquestionably the most successful industrial picture ever produced . . . Unanimously praised from coast to coast by the motion picture industry and the press . . . A dramatic example of the opportunities now available to American industry through Roland Reed Productions to present their selling story to millions of Americans in living, talking, commercial pictures, either in technicolor or black & white.

OTHER RECENT OUTSTANDING ROLAND REED TECHNICOLOR PRODUCTIONS "LUCKY SNAPSHOTS"

Produced for the American Tobacco Company Seven minute movies in technicolor that played in a hundred New England theatres that never before ran commercial movies.

"32 WESTINGHOUSE PLAYLETS"
All in technicolor . . . were shown to over eighteen million paid admissions in movie houses from coast to coast.

ROLAND REED PRODUCTIONS

SELZNICK INTERNATIONAL STUDIOS
CULVER CITY, CALIFORNIA

TECHNICOLOR & BLACK & WHITE PICTURES PRODUCED BY OUR COMPANY ARE DIRECTED EXCLUSIVELY BY HOLLYWOOD FEATURE DIRECTORS

Now A LOW COST "ALL-IN-ONE" Quality Sound Projector



VICTOR MODEL "33"
\$295
COMPLETE
ANIMATOPHONE

All enclosed
DURING OPERATION

VICTOR . . . Manufacturer of the WORLD'S MOST WIDELY USED 16MM SOUND PROJECTORS . . . has devoted over two years to developing a unique new ANIMATOPHONE that literally answers the commercial traveler's "prayer" for a smaller, more compact, more convenient QUALITY Sound Motion Picture Projector!

MODEL 33 ANIMATOPHONE has everything that it takes to make it easier for industrial and commercial users to more profitably employ the greatest of all modern sales tools . . . For carrying, it assembles into one small, compact unit, YET IS ENTIRELY ENCLOSED DURING OPERATION.

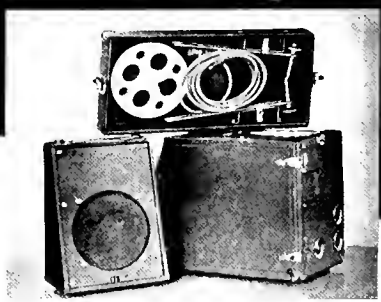

Model 33 assembles into one small compact unit. Removable top of case houses reel arms, reel and attachment cord. Speaker in baffle case is easily detached.

A standard feature of Model 33 is the famous PATENTED Automatic Film Protection Device that has saved untold thousands of dollars worth of film for other VICTOR users! "Film Protection that Really Protects," is positively exclusive with VICTOR!

Fidelity of tone and the crisp clarity of Model 33's rendition, insure SOUND REPRODUCTION that is pleasing, natural and wholly understandable. Its brilliant, flickerless projection (at both silent and sound speeds) does full justice to the finest photographic quality.

A SMALL, HANDY MICROPHONE may be plugged into 33's amplifier, thus providing "loud speaker" facilities for sales talks, announcements, comments and demonstration "spiels."

A COMPACT PHONO-RECORD TURNTABLE (with or without record changer) also plugs into the 33 to provide musical background for silent films, or entertainment during reel changes, banquets, etc.

Model 33 accommodates up to 1600 feet of film . . . has sufficient volume for audiences of 300 or less . . . plugs into any A.C. outlet (50-60 cycle, 90-125 volts), 25-50-60 cycle and A.C.-D.C. models can also be supplied. There are other models of the Animatophone for every purse and purpose. Write for literature. Demonstrations—without obligation—will be gladly arranged.



VICTOR ANIMATOGRAPH CORPORATION
DAVENPORT-IOWA
CHICAGO • LOS ANGELES • NEW YORK

FOR TECHNICAL DATA, PRICES, ETC., ON EQUIPMENT DESCRIBED HERE ADDRESS MANUFACTURERS DIRECT OR WRITE: THE SCREEN SERVICE BUREAU, 20 NORTH WACKER DRIVE, CHICAGO, ILLINOIS

NEW EQUIPMENT

NEWS OF the latest developments in the field of projection and production equipment is garnered for these pages from voluminous technical reports filed with the cooperation of all leading manufacturers. *Business Screen* has also arranged to attend practical demonstrations of newly developed equipment and our consulting technical advisors will thus be able to bring detailed information of real merit to the many film departments operated by readers.

In addition, the services of our *Screen Service Bureau*, now being set up for the benefit of readers, are available to furnish complete and authoritative information on projection problems; to answer any and all questions with impartial accuracy and to perform such informational duties *without solicitation*.

A thorough *equipment digest* is now in preparation and will be published later as a special annual number. In addition, special charts and tables on projection, etc. are also in preparation and the feature "Tips for Better Shows" will be supplemented in each succeeding issue with a "Questions of the Reader" department to which

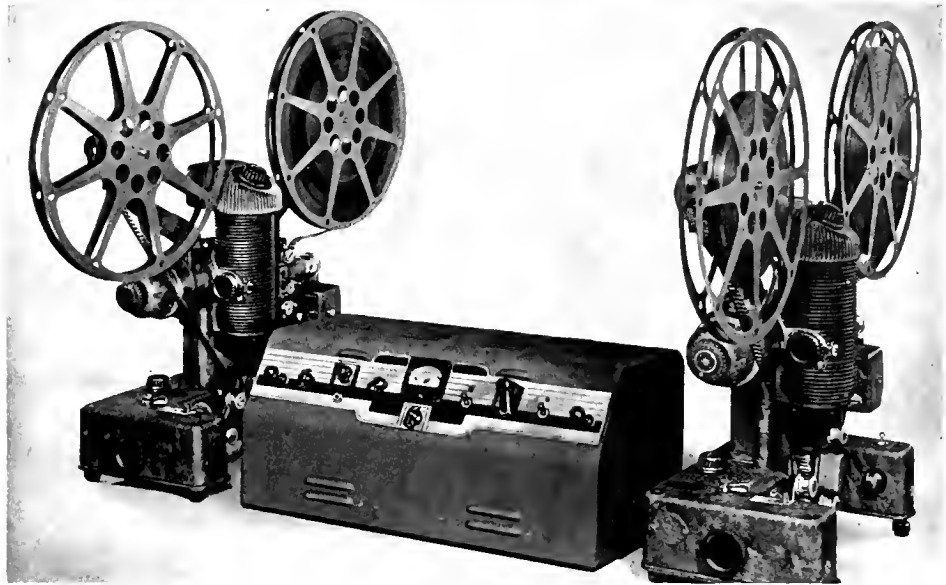

The Filmosound Model 130, Bell & Howell 16mm. sound-on-film projector, which has been increased in illumination from 1000 watts to 1200 watts. The manufacturers claim that careful tests prove the new lamp to furnish 45% more light than the 1000-watt unit. Pictured above is a dual-projector installation which provides uninterrupted programs of any length. A change-over switch is on the amplifier.

you are invited to address your personal queries on equipment problems. The day of 16mm. perfection is at hand and with improvements now

available the industrial film department can achieve efficiency of operation and program perfection undreamed a few years ago.



(above) One of the later models added to the Neumade line of equipment for the storing of 16mm. film, this cabinet—30" wide and 70" high—is equipped with individual compartments for 36-400 foot and 9-1600 foot reels. Each compartment has a chrome handle.

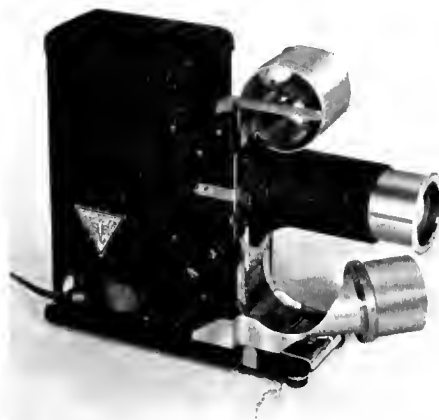

The thousands of users of slidefilms will be glad to learn that a device has been perfected which automatically rewinds the film as it is being shown and places it in a storage container ready for use. It is the new S.J.E. Automatic Slidefilm Take-Up. This ingenious device eliminates delays and confusion.

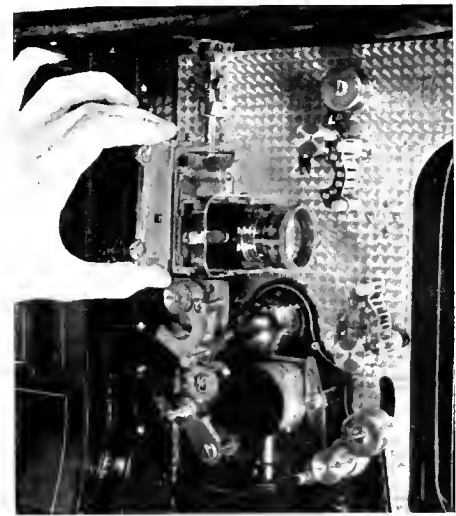

Close up of the new DeVry Sprocket Intermittent 16mm. projector, showing removable single piece aperture plate. Film pressure pad, at base and top of aperture have a release-spring arrangement to prevent scratching of sound-track or picture. This is an exclusive feature of DeVry projectors.



Send for
this FREE

New
Cine-Bass
Bargaingram
#234

Fifty-two pages filled with cine news and bargains to delight the movie fan. Tyro, advanced amateur and professional alike will marvel at the completeness of this catalogue. Special sections for sound cameras and projectors — 8mm. and 16mm. Lists all popular makes of cameras, projectors, projection equipment — hundreds of accessories, in fact a real cine encyclopedia. Write Dept. BU.

Bass
CAMERA CO.

Dept.
BU

179 West Madison Street
CHICAGO, ILLINOIS

**CONTINUOUS
MOTION PICTURES**
FOR
EXHIBITS and DISPLAYS
Action in Advertising



AUTOMOTION Continuous 16 mm Motion Picture Projectors show clear, brilliant pictures in day or electric light.

AUTOMOTION is the pioneer and leader in this field; designed and built to meet the heavy duty requirements of continuous motion picture projection.

WORLD'S FAIR and other well planned exhibits will use AUTOMOTION Projectors for a low-cost sales message to thousands. Write for full details.

ADVERTISING PROJECTORS, INC.
10 West 33rd St., New York, N. Y.
Telephone · PEnnsylvania 6-8567

FIVE TIPS FOR BETTER SHOWS

1. DON'T USE INEXPERIENCED OPERATORS

Here is a Number One *don't*. We have personally seen many otherwise excellent shows ruined by poor projection, due to the bungling efforts of "I know-all-about-it" operators. If your salesman or dealers put on shows, make sure they know how to handle equipment, and that they are properly supplied with spare accessories — proper size screens, lenses, extra Mazdas, exciter lamps, proper take-up reels, etc.

2. GIVE THE AUDIENCE A BREAK

Don't present uninteresting films (i. e., supplementary ones), nor films that have not been properly inspected before the show. Their condition should be carefully checked . . . torn, poorly-patched films should be avoided. Brittle, "raw" (untreated) film should also be assiduously avoided. Check condition of sound track. Also avoid films that are too long, planning your show carefully in advance. Make sure speakers are on hand, and on time. Don't make your audience stand; seating should be adequate, and comfortable.

3. WATCH FILM "LOOPS"

A generous upper loop should be left. Lower loop (between aperture and sound-head) must be correct, or sound will be seriously affected. Too much loop will cause sound to be "out of sink", as will also too little loop. The number of frames between center of film aperture and center of sound drum (i. e., sound slit) should be twenty frames on 35mm. projectors, 25 frames on 16mm. projectors.

4. REPAIRING FILMS

Use a good splicer for repairing broken film or torn splices. Use also a good brand of film cement, one that will *hold*. It is a good idea to rub a cloth moistened with processing fluid over new splices to prevent possible catching or binding of film during projection. After splicing, the portion of sound track which has been exposed (from scraping off of emulsion) should be painted over with india ink to avoid issuance of an undesirable noise from speaker, which will otherwise be caused as splice passes over sound slit.

5. THREADING THE PROJECTOR

It is highly important, both from the standpoint of better shows, and from that of protecting the film against harm, that the projector be correctly threaded. Film must be properly engaged in all sprocket teeth, and in aperture; take-up belt or spring in place of take-up reel pulley; film placed properly on upper spindle and take up spindle; emulsion side of film toward projection-lamp.

New in the commercial film industry is the Vis-O-Phone slide film projector illustrated here, (right) a product of Sound Projects Company, Chicago. Introduced about six months ago, Vis-O-Phone is available in several models to producers and users of industrial films. Light weight, small size, and improved sound tone are new features.

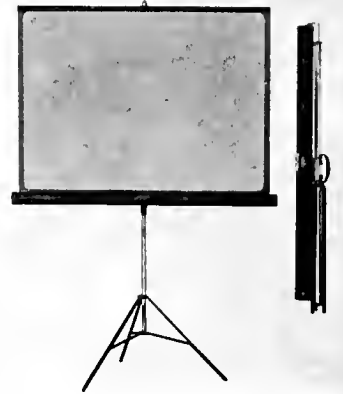

The Da-Lite Challenger, one of the most popular styles of portable screens for industrial, educational and amateur use, is now made in 12 sizes. Three of the new sizes are square screens especially suited for the projection of slidefilms. They can be adjusted to rectangular proportions for showing motion pictures. All sizes are roller-mounted.



In the Automotion Projector, shown above, the film revolves in a circle composed of rollers and is driven by a leather belt with perforated holes in the center, which is in turn motivated by a patented pulley sprocket with pins which engage the holes in the belt. These holes are spaced to synchronize with the sprockets on the machine. There are only two sprockets used, and they merely act as guides to lead the film to and from the projector head.



MOVIE



NEWS

1913 TWENTY-FIFTH

ANNIVERSARY YEAR — 1938

No. 2, Vol. XI • MAY-JUNE, 1938 • Published by DeVry Corporation • 1111 ARMITAGE AVE., CHICAGO

Talkies Great for Selling Heavy Machinery

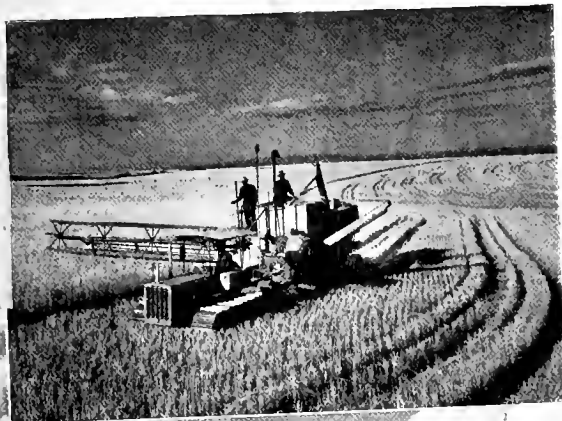

(1) Caterpillar Tractors, International Harvester Company Harvesters, Allis-Chalmers Tractors and Harvesters Shine as Movie Stars

Movies seem to be the special Gift of the Gods to heavy machine manufacturers. Modern movie photographic technique frequently shows these huge Leviathans of Industry to better advantage than the machines themselves — and think of the saving in freight, time and expense involved in staging demonstrations in various parts of the country, especially when demonstrations are out of the question, due to seasonal changes.

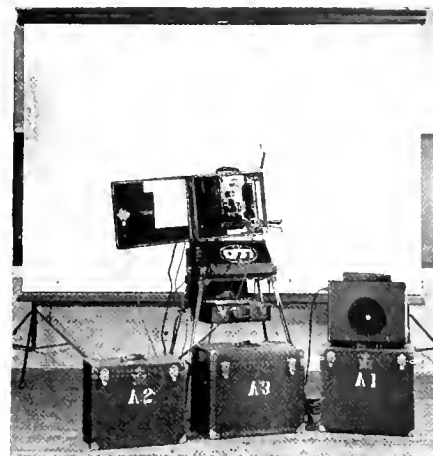

(1) Shows a Caterpillar "Diesel" pulling John Deere combine at Fen, Idaho.



(3) Above — In foreground, International T40 Tractor, and Bucyrus-Erie Bull Grader, at work in Virginia.

(2) DeVry 16 mm. Sprocket Intermittent Sound Projector and Amplifier. Caterpillar now has similar units for use in their various territorial districts.



(4) Allis Chalmers tractor pulling an All-Crop Harvester in a wheat field.

It is significant that all of the three great manufacturing companies mentioned above have purchased a large number of DeVry sound projectors for their selling organizations — in order to make sure that their splendid talkie productions will receive the best projection available in America. Steady and prompt servicing do their part toward the repeat orders that these firms are constantly sending in.

Other examples of leading industrials who have purchased DeVry Equipment, some of them in large quantities, are: Ford, Goodyear, Pure Oil, Firestone, Armstrong Cork, Socony Vacuum, Shell Petroleum, American Steel & Wire, General Electric, Standard Oil of Indiana, etc. — an Honor Roll of American Business.

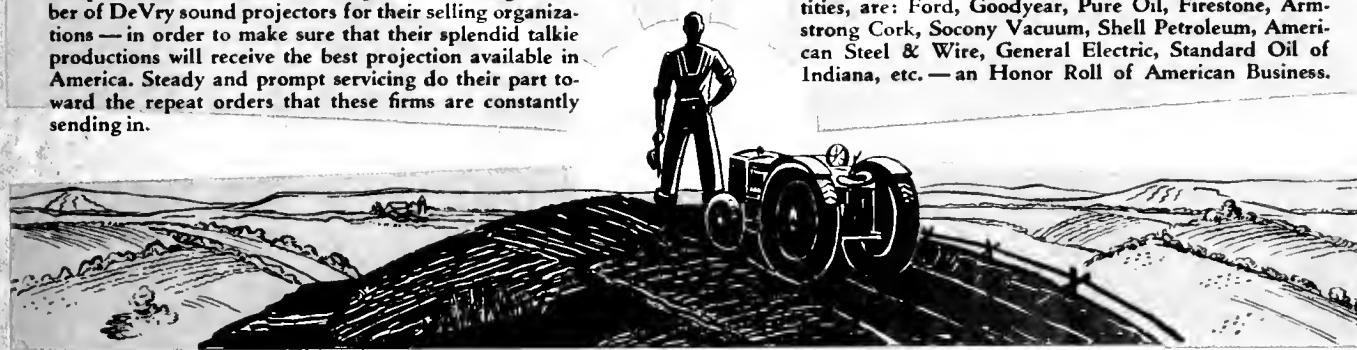

See the Stories of the Notable Movie Campaigns of Standard Oil, and International Harvester Co. on Pages — and — in this issue "Business Screen"

Sign the Coupon for Your Free Subscription to The DeVry Movie News

DeVry celebrates its 25th ANNIVERSARY with the purchase of an additional factory. Now manufacturing the largest and most complete line of Motion Picture-Sound equipment in the world — both 16 and 35mm

DEVRY CORPORATION
1111 ARMITAGE AVE. CHICAGO, ILLINOIS

PLEASE SEND LITERATURE
16mm. Movie Equipment
35mm. Movie Equipment
DeVry Movie News
Industrial Service Letter
Clarity Your Product
National Conference on
Visual Education June 20-24
inclusive
Name _____
Address _____



TRADE MARK
Sales and Service Stations
in principal cities and in
foreign Countries.

New York

Cable HERMDEVRY

Hollywood

BETTER MOTION PICTURE PRINTS AND SLIDE FILM 35 mm - 16 mm

LABORATORIES FOR THEATRICAL - INDUSTRIAL AND HOME MOVIES

Our job is to deliver quality prints in a hurry and when you want them.

Our capacity 35M/M or 16M/M prints 1,000,000 feet per week.

Our executive and laboratory staff composed of skilled experts with upwards of 30 years of active service in the motion picture field.

Unexcelled facilities for film storage in approved special constructed vaults.

Cutting rooms, moviolas, comfortable projecting rooms, provided for industrial or theatrical picture producers.

We will be grateful for the privilege to quote on any size job—large or small.

AMERICAN FILM CORPORATION
PRODUCERS — LABORATORIES — DISTRIBUTORS
6227 N. Broadway, Chicago, Illinois

RECENT RELEASE BULLETINS

Films to be reviewed in the next issue of Business Screen Magazine

ALUMINUM COMPANY OF AMERICA: "Aluminum" a lengthy institutional picture showing manufacture: uses of product previewed in June. Sound version in preparation.

WEYERHAEUSER TIMBER COMPANY: "Trees and Men" comprehensive 5-reel sound picture of the timber industry recently completed by Dowling & Brownell, Hollywood. Theme: timber harvesting; conservation programs. Distributed now through Modern Talking Picture Service to interested groups.

STEWART-WARNER COMPANY: Dealer film series continues with completion of third film by Chicago Film Laboratory.

VERMONT MARBLE COMPANY: Architects, builders, etc. are being shown "Mountains of Marble" just completed by Castle Films. Visit to Vermont Marble plant, etc.

UNDERWRITERS LABORATORY: Sound film explaining tests, scientific background of Underwriters famous testing labs recently produced by Atlas Film Company.

GENERAL MOTORS, AMERICAN TELEPHONE & TELEGRAPH, CAST IRON PIPE ASSOCIATION, DU PONT, ETHYL GASOLINE, PUBLIC SERVICE OF NEW JERSEY & WESTERN ELECTRIC pictures now scheduled for production by Audio Productions. To be reviewed as released during coming months.

SALESMEN get the IDEA

(Continued from Page 19)

port for practice in the south on March 1." Six to eight weeks of careful preparation—that's what the athletes get each year. And even the Babe Ruths and the Lou Gehrigs never get too good for this. So why not the same consistent training for salesmen? It almost always helps those at the top as well as those in the cellar and in-between.

When you get a pain in your tooth or tummy you don't look for a "natural born" dentist or doctor. You seek a medico with the best training you can find: you want skill and knowledge and make no mistake about that! It's the same with salesmen—the best ones have a skill and technique that seldom "comes natural." They are developed and perfected through long and careful training.

All sorts of sales problems, in a widely diversified list of industries, are now being covered by films. Many large companies have adopted year-around programs that include both slide and motion picture films. In specialty selling, where the unit of sale is large, the possibilities are truly gigantic.

"Selling America" a sales training film recently produced for Frigidaire but released for general distribution, points a parallel between modern sales methods and those used by Benjamin Franklin in helping found and promote America. The Honorable Mr. Franklin fades in and out of various settings to give an excellent practical demonstration of the right and wrong methods in commercial selling. Rightly so, for he was America's foremost salesman-diplomat.

Products covered by recent industrial films include—spark plugs, tires, washing machines, electric refrigerators and ranges, automobiles, shoes, milk, gin, and dozens of others.

The reason for all this activity, all this interest, all this broadening of effort? Well, that's not difficult to answer. Here it is in one summary paragraph:

A recent survey on results from industrial film sponsors disclosed only one case of dissatisfaction, compared with many cases of complete satisfaction and a dozen so completely happy that they wanted everything about their films kept mum so competition would not be encouraged!

(Just released)

"TO THE LADIES" — 2 reels

Sponsor:

Milwaukee Lace Paper Company

Produced by:

Burton Holmes Films

Type: Dealer selling, women's orgs.

STORY: Princess Alexander Kropotkin, famed social arbiter, is presented as film educates women in uses of lace paper in home for entertaining, everyday use. Film producer also laid out complete sales promotional program for sponsor, including booklets, etc.

DISTRIBUTION: Special showings to company salesmen at meetings, to jobbers and dealers and general non-theatrical distribution to women's organizations nationally.

CURRENT RELEASES contd. from page 37

"SUNKIST FOR PROFIT" — 4 reels



Sponsor:

Calif. Fruit Growers Ex.

Produced by:

Castle Films

Type: Dealer education

STORY: Pictures merchandising display program for dealers to improve display merchandising, better selling. Latest of series now used for 11th year. Contains color sequence.

DISTRIBUTION: Natl. by 22 Sunkist projectionists to fruit dealers and grocery groups in marketing communities.

"TWIN POWER" — 2 reels



Sponsor:

The Massey-Harris Co.

Produced by:

Audio Productions

Type: Consumer education-selling

STORY: Latest in tractor development pictured as Massey-Harris demonstrates gasoline-powered tractors. Lowell Thomas announcing.

DISTRIBUTION: Dealer salesrooms, selected groups as tieup with Ethyl Gasoline Corp. for "Twin Power" showing.

"THIS MOVING WORLD" — 3 reels



Sponsor:

Fisher Body Div. of General Motors Corp.

Produced by:

Wilding Picture Prod.

Type: Institutional-public relations

STORY: Lad enters model car in contest sponsored by Fisher Craftsman's Guild—muses on beginnings of transportation. Historical sequences show advance of transportation.

DISTRIBUTION: Through Fisher "Craftsman's Guild", Schools, etc.

(Just released)

"SELLING AMERICA" — 4 reels

Sponsor:

Frigidaire Division General Motors Corporation

Produced by:

Jam Handy Picture Service

Type: Sales Training-Institutional

STORY: Ben Franklin instructs a present-day salesman in the art of selling as it was known to the man who "sold America" to the nations of Europe. Advertising minimized.

DISTRIBUTION: General group showings, salesmen, executives.

Hollywood is Headquarters for *Commercial Movies, too!*



— and this Hollywood studio
is ready to put the latest dramatic effects, technical
excellence and entertainment value—in other words, "Box
Office"—into this powerful, modern advertising medium

What we are doing today in Commercial Motion Pictures is as different from ordinary commercial "shorts" as day is from night.

We are proud to have raised the standards to a real entertainment level. And we are proud to have helped great corporations increase substantially their sales results from using this medium.

(This issue of *Business Screen* carries an article on the success of Standard Oil of Indiana's recent commercial film. We worked with them closely, and built this picture from the ground up.)

There are reasons why we are able to produce results for advertisers.

We are right here in Hollywood, the motion picture capital of the world.

Hollywood has the facilities for producing the finest of pictures . . . commercial or otherwise.

The sponsor of any commercial movie effort must realize that here in Hollywood lie his opportunities—for here are concentrated the finest directorial, writing and performing ability, as well as technical excellence.

We maintain that commercial pictures should be as good as the neighborhood theater

program, with the "plug" as entertainingly handled as possible. We can do that in Hollywood—do you know where it can be done anywhere else?

Perhaps you have a great idea for a commercial film—but feel it's impossible to produce. Don't discard the idea—get in touch with us—it will cost you nothing. We have the writers, the directors and the casts. We have the facilities and we know our stuff. We have done and are doing the "impossible" in commercial movies—at surprisingly low cost. Let us weave your merchandising message into an entertaining screen play.

We'd like to help you put real "Box Office" in your film advertising!

Scenes from
Standard Oil of
Indiana's sales-
getting commercial
full-length
feature "STAN"
—produced by
Raphael G. Wolff,
Incorporated.



Raphael G. Wolff Incorporated

MOTION PICTURE DIVISION
1714 North Wilton Place—Granite 6126—HOLLYWOOD



**AMPRO SOUND MODEL "U"
SPECIFICATIONS AND FEATURES**

Sound Head Features in Model U

Film Path—All parts which contact film are designed to prevent scratching picture and sound track. Sole tension on sound track side, and pressure pad tension on sprocket side of film assures smooth, steady projection.

Film Protection—A triple claw is used for moving film, engaging three sprocket holes simultaneously. Film with two adjacent torn holes can be successfully used. Ampro patented "kick-back" movement lifts the claws from the sprocket holes before withdrawing, eliminating film wear. Take-up compensator prevents starting strain.

Sound Drum and Filter—Mounted on precision ball bearings. The rotating type of sound drum avoids slough action between the drum and film—prolongs film life and maintains high quality sound. Carved film guides before and after sound drum eliminate weaving and "bell" action.

Sound Optical System—Projects filament image of exciter lamp directly through cylindrical lens, eliminating mechanical slit and mirror. (No cleaning required.)

Simplified Threading—Same as threading silent projector, with exception that film also loops around sound drum, eliminating locking film over a third sprocket. Film guides assure correct, easy threading.

Starting Switch—Automatically disconnects sound when in "OFF" position, preventing noises or hum while projector is coming to rest or being threaded.

Prefocused Exciter Lamp—Cannot be inserted wrong, requires no adjustment.

Approval—All Amprosound Models are approved by UNDERWRITERS' LABORATORIES.

License—Licensed under Western Electric Patents.

Amplifier Features in Model U

Class A Plus Amplification—Highest quality as used in broadcasting. Permits heavy overloading.

Sound Reproduction—Matches one or two speakers without internal changes.

Speech Tone Control—For crisp, sharp speech reproduction.

Speaker-Hiss Eliminator—Enables the operator to obtain full volume without hiss even at low voltage.

Amplifier Signal Light—Indicates when amplifier is on and also designates location of volume and tone control knobs on the amplifier when rooms are darkened.

Rugged Speaker Cable—Two wire cable heavily insulated with rubber. Has non-breakable telephone jack for trouble-free connections.

Acoustical Adaptation—With good acoustics, have doors of speaker open and strong natural bass frequencies will be reproduced. If acoustics are poor, close speaker doors for sharp, crisp speech, without confusion of bass frequencies.

Torpedo Speakers Available—Have directional properties which throw sound directly down on audience, preventing side reverberation.

Standard Accessories—A 1600 ft. reel, 10 ft. line cord, 50 ft. speaker cord, lamp, 2 inch lens, bottle of Ampro oil can, cleaning brush, box of fuses, extra exciter lamp, instruction book and carrying case. Standard finish is Ampro Brown (crinkle-baked enamel with Chromium Plated and Stainless-Steel fittings).

Microphone and Phonograph Receptacle—On all Amprosound Models.

Microphone Switch—Permits speech from microphone to accompany silent films.

12 Inch Auditorium Speaker—With permanent magnet field has extra jack for multiple speaker operation.

Unconditional Guarantee by Ampro—Against defective material and workmanship. (The guarantee for lenses, lamps and tubes is set by the manufacturer of these items.)

For lamps, lenses, screens, speakers, tubes and all other accessories write Ampro.

The 33 Standard Ampro Projection specifications listed on "silent" catalogue sheets are incorporated on all Sound-On-Film Models.

Ask for prices, free demonstration or further information about Ampro's complete line of 16 mm. projectors, silent, sound-on-film and convertible models.

THE AMPRO CORPORATION • CHICAGO, ILLINOIS
2839 • 51 NORTH WESTERN AVENUE

Incorporated in United States of America

For the
FACTS
about modern
16 mm.
Sound Projectors



Complete detailed specifications as above appear on the back of each illustration of every Ampro model.

Send for this new

AMPRO 1938 CATALOG

The page reproduced above is typical of the detailed facts that Ampro provides in its description of each of its models. This particular page shows the sound specifications of the recently announced new powerful 750 watt A.C. operated Ampro-sound Model "U" — that lists at only \$395 — this year's outstanding value in Sound-on-film projectors! Similar detailed, factual descriptions are given on all Ampro silent sound and convertible projectors. With these facts as a basis — rather than mere claims — you are in a better position to judge projector values scientifically. Truly — this latest Ampro brochure is a text-book on modern projectors. Send for your copy Today!

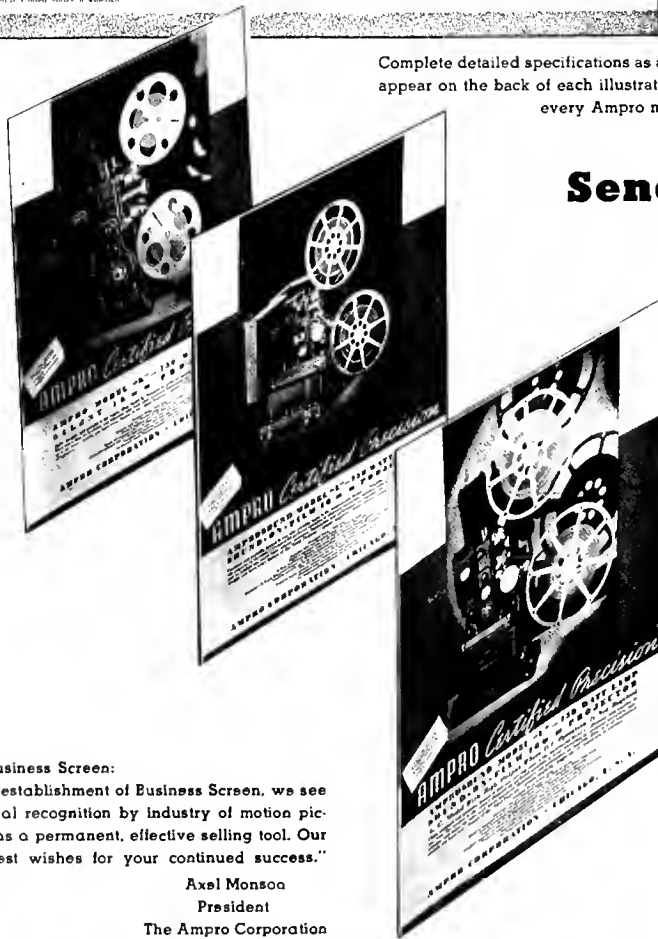

"To Business Screen:

In the establishment of Business Screen, we see the final recognition by industry of motion pictures as a permanent, effective selling tool. Our sincerest wishes for your continued success."

Axel Monson
President

The Ampro Corporation

AMPRO
PRECISION CINE EQUIPMENT

Ampro Corporation, 2839 N. Western Avenue, Chicago, Ill.

AMPRO CORPORATION

2839 N. Western Avenue, Chicago, Illinois

Please send me the new 1938 Ampro catalog. I am particularly interested in

- Ampro 16 mm. Silent Projectors
- Ampro 16 mm. Silent Models that can be converted into sound
- Ampro 16 mm. Sound-On-Film Projectors

Name _____

Address _____

(Ampro distributors are established all over the world. Write for name of dealer most convenient to your locality.)

BUSINESS SCREEN



**EXHIBIT
EDITION**

**NO 2
1938**

2

MILES FROM NEW YORK MIDTOWN AREA

MILES FROM NEW YORK WORLD'S FAIR

producers of sound motion pictures

AUDIO PRODUCTIONS, Inc.

Waspert Electric
SOUND SYSTEM

and Technicolor



35-11
Thirty Fifth Ave
Long Island City
New York



August 1st... yet the salesman
walked in with a *Blizzard!*

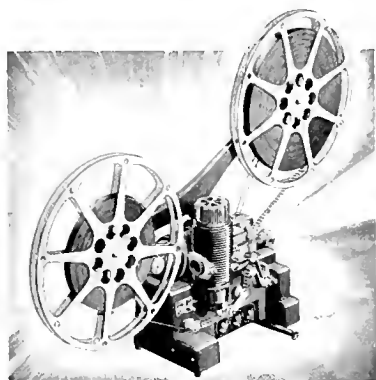

THIS FILMOSOUND GIVES THEATER-PERFECT PERFORMANCE
New Filmosound 138, pictured above, is compact, convenient, and capable of theater-quality sound-on-film presentations in salesroom, showroom, hotel room, or moderate-sized auditorium. There are other, more powerful Filmosounds for even the largest of audiences.

DEMONSTRATING snowplows in August or teaching grocery clerks how to sell... carrying the sales story down through every part of the distribution channel and ending up with compelling impact on the ultimate buyer. These are the everyday accomplishments of the modern commercial sound film.

The better the film, the greater its sales accomplishment. But, however good, *no* sales film can convey more to the prospect than the *projector* can reproduce.

To insure the success of *your* sound film program, have a film made by a competent industrial film producer. Then arrange to show that film with projectors which will transmit your story to the screen in steady, flickerless, brilliant pictures, accompanied by faithful sound reproduction. Projectors so easy to handle that your men will gladly show your film. Projectors which permit real showmanship to characterize

every presentation... *Bell & Howell Filmosounds!*

This is the sound film success formula of Chrysler, Ford, General Motors, and the hundreds of other firms, large and small, whose careful study has led to their choosing Filmosounds. You'd expect Filmosounds to offer many distinct advantages, for they are built by the same skilled Bell & Howell craftsmen who have fashioned the preferred studio equipment of Hollywood for more than thirty years.

Write now for complete information about Filmosound Projectors for industrial film exhibition. Bell & Howell Company, Chicago, New York, Hollywood, London. *Established 1907.*

SHOWMANSHIP—Today's Formula for Selling

Sales and Advertising Executives will enjoy reading this crystallized story of modern industrial talkies. Here is information on what others are doing with industrial movies, what you can do—and how to do it. We shall gladly send you a copy of this 36-page book upon request.

BELL & HOWELL COMPANY 85-7-38
1808 Larchmont Avenue, Chicago, Illinois
Please send full information on () Filmosound Projectors, () Silent Film Projectors. Also () send special book, *Showmanship, Today's Formula for Selling.*

Name _____
Company _____
Address _____
City _____ State _____



BELL & HOWELL

Now A LOW COST "ALL-IN-ONE" Quality Sound Projector

VICTOR MODEL "33"
\$295
COMPLETE
ANIMATOPHONE

All enclosed
DURING OPERATION

VICTOR . . . Manufacturer of the WORLD'S MOST WIDELY USED 16MM SOUND PROJECTORS . . . has devoted over two years to developing a unique new ANIMATOPHONE that literally answers the commercial traveler's "prayer" for a smaller, more compact, more convenient QUALITY Sound Motion Picture Projector!

MODEL 33 ANIMATOPHONE has everything that it takes to make it easier for industrial and commercial users to more profitably employ the greatest of all modern sales tools . . . For carrying, it assembles into one small, compact unit, YET IS ENTIRELY ENCLOSED DURING OPERATION.

A standard feature of Model 33 is the famous PATENTED Automatic Film Protection Device that has saved untold thousands of dollars worth of film for other VICTOR users! "Film Protection that Really Protects," is positively exclusive with VICTOR!

Fidelity of tone and the crisp clarity of Model 33's rendition, insure SOUND REPRODUCTION that is pleasing, natural and wholly understandable. Its brilliant, flickerless projection (at both silent and sound speeds) does full justice to the finest photographic quality.

A SMALL, HANDY MICROPHONE may be plugged into 33's amplifier, thus providing "loud speaker" facilities for sales talks, announcements, comments and demonstration "spiels."

A COMPACT PHONO-RECORD TURNTABLE (with or without record changer) also plugs into the 33 to provide musical background for silent films, or entertainment during reel changes, banquets, etc.

Model 33 accommodates up to 1600 feet of film . . . has sufficient volume for audiences of 300 or less . . . plugs into any A.C. outlet (50-60 cycle, 90-125 volts); 25-50-60 cycle and A.C.-D.C. models can also be supplied. There are other models of the Animatophone for every purse and purpose. Write for literature. Demonstrations—without obligation—will be gladly arranged.

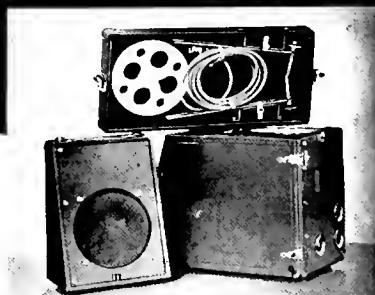

Model 33 assembles into one small compact unit. Removable top of case houses reel arms, reel and attachment cord. Speaker in baffle case is easily detached.

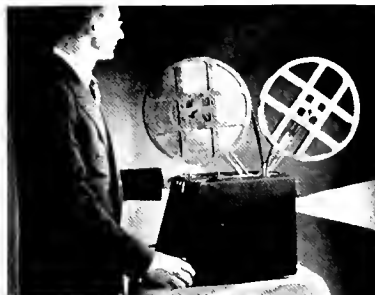

VICTOR ANIMATOGRAPH CORPORATION
DAVENPORT-IOWA
CHICAGO • LOS ANGELES • NEW YORK

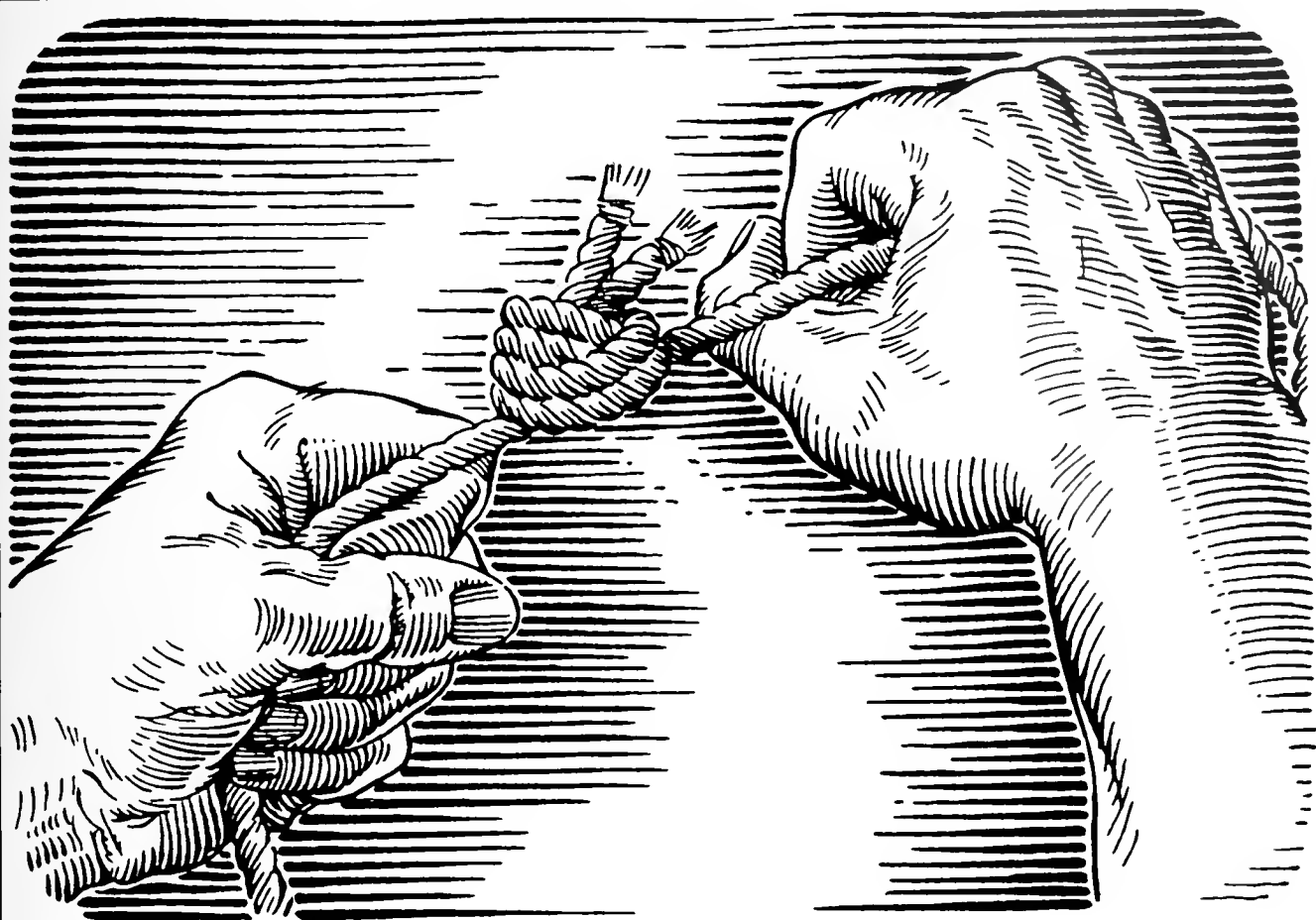

... THERE IS A KNACK IN TYING KNOTS ...

And there is as much a knack in untying them. In both cases it pays to employ the services of men familiar with knotty problems . . . and their solutions. Wilding knows the "ropes," knows the time, money and labor saving devices that make for successful production in economical and effective sound motion pictures and slide films. Wilding's permanent, especially trained staff has been untying knotty merchandising problems for prominent clients since the introduction of motion pictures for commercial application. That this work has been satisfactory is attested by the fact that over 80% of the Wilding annual volume comes from clients for whom pictures have been produced in the past. Investigate *NOW* the medium that tells your story exactly the right way every time; that delivers precisely the message of your concern with all the emphasis and clarity of dramatic action. Allow a producer, nationally known for distinguished sound pictures and effective distribution, to co-operate with you in bringing the best thinking of your management direct to the sales firing line.



To Reach
THE
IRRESISTIBLE
BUY LINE

... buy Wilding!

WILDING PICTURE PRODUCTIONS, INC.

NEW YORK • CLEVELAND • DETROIT • CHICAGO • HOLLYWOOD

Close-ups and Long Shots

THE NEWS REVUE OF THE BUSINESS FILM WORLD

♦ Abandonment of employe sports activities for Studebaker workers and substitution of entertainment and educational programs for employes and their families were announced last week by Walter S. Gundeck, director of industrial relations for the company. At the first meeting, held recently in the company's athletic clubrooms in South Bend, Ind., 4,000 persons, instead of an expected crowd of 1,000 attended the showing of instructive films. Concerts and employe singing groups will be on future programs, which supersede athletics that had been open to proselytizing, Mr. Gundeck said.

Radio and Films Combined

♦ 1,500 persons attended the meeting of the Esso Dealers of Allegheny county, Pa., held recently in the ballroom of the William Penn hotel in Pittsburgh. A showing of the Esso Marketers new motion picture, *Design for Power*, was the high spot of the evening. Dealers also saw a broadcast of THE ESSO REPORTER program and special radio and stage shows featuring widely-known stars. Esso Dealers who attended rated it the largest and most successful dealer meeting ever held.

Appoint Chicago Representative

♦ Associated Sales Company of Detroit has announced the opening of a new Chicago office. B. M. Ikert, formerly an educational and merchandising director for manufacturers of automotive products, now is the executive in charge.

Craighead In New Position

♦ Norman D. Craighead of Jam Handy Theatre Service, Inc., has been appointed to the creative contact staff of Jam Handy Picture Service, Inc., according to Jannison Handy, president of both organizations.

New Agency Film Department

♦ Centralization and coordination of the agency's various facilities for handling all types of commercial motion pictures has been effected by J. Walter Thompson Company which announces the formation of a Motion Picture Department headquartering in their New York office. Fred H. Fidler, former St. Louis office manager for the company, will manage the new department with Wallace R. Boren heading the creative group.

The department will act for clients on all creative and production phases of motion pictures and slide films for use as consumer advertising and for public relations, sales training and merchandising work.

McCall's Critic on Industrials

♦ The recent McCall's whose movie critic, Pare Lorenz, is already well known to audiences and producers alike as an able film documentarian, features a discussion of *Men Make Steel*, recent all-color production. Of importance are Critic Lorenz' remarks, reprinted by arrangement:

"The most exciting picture I have seen in many weeks is neither a short nor a feature; there are no stars, and there is no plot or romance in the production. It was produced for the U. S. Steel Corporation . . . and photographed in Technicolor, and is called, none too aptly, *Men Make Steel*.

"This four reel color movie, on strict grounds of dialogue, editing and music, is not a first-class piece of work. You have to listen to Edwin C. Hill's roaring voice; the musical score is weak and inept, and the film editor jumps from one location to another leaving you a bit confused.

"But it is paradoxical that this industrial educational movie should turn out to be the most beautiful color picture ever made, and for the color alone, I recommend *Men Make Steel* to you: the dull blues of the gigantic furnaces, the red and gold fountains of molten steel; the squat Bessemer's pouring their great ladles against a dark sky—these are thrilling and awe-inspiring photographs.

"As far as Hollywood is concerned, the producers will say, "It's an advertising picture and has no box office worth," and let it go at that—that is, they will say that if they continue the policy they have maintained for years in the movie industry.

"But whatever they say, within the year these so-called industrial pictures are going to have a significant effect on the entire movie world. I have discussed this before, but now there is visible proof that by their own limitations Hollywood producers have lost millions of potential customers.

"For the past ten years we have been thinking a great deal about the facts of this country:

If . . .
you are a combination
writer and contact man

. . . experienced in writing commercial motion pictures and sound slidefilms and can work with executives of large corporations, there may be an opening for you in a large, well-known producing organization. Write and SELL us you are the man we need. Give your age, weight and height. Replies confidential. Members of our staff know this ad is being published. Box 31, Business Screen Magazine.

of its land, its social and economic problems, and about its great factories.

"Yet in the last decade no movie company has even attempted to use the actual drama of our national life as photographic material. To be sure we did have the gangster cycle, but when you saw *Underworld* you saw them all.

"If a movie company spent several hundred thousand dollars making four-reel pictures, there is no question they would eventually go bankrupt, and I can accept the argument from a producer that U. S. Steel can afford to spend more money making a short picture about the steel business than any company that has to live by selling movies to theaters.

"On the other hand, if Hollywood demands the right—or at least has the power, at present, to make all the pictures we see on all the screens in the country; if they consistently refuse, through ignorance of the country they live in, to experiment with new subject material, and new methods of using it, then, no matter who produces the picture, some organization, or group of organizations, will inevitably produce better and more imaginative movies.

"And that is why I stated earlier: that within the year the so-called industrial film should have a profound influence on the motion picture business.

"Many corporations for years have been producing short pictures: for their salesmen, for educational groups, and for home projectors.

"Next year, however, there are two World's Fairs (you couldn't expect us to be content with just one World's Fair) and there will be probably over a hundred movies made by business firms, and industrial organizations, and government movies to show along with their exhibits.

"Offhand, that sounds like a rather dull business, but consider this: the corporations, unlike some Hollywood producers, have learned quite a bit about movie making during the past ten years, and they will probably spend a great deal of money on these movies.

"But the real value of these pictures is that they will show millions of people for the first time just how many bewildering machines, processes and gadgets make up an industrial civilization.

"Thus, as has happened before, it may be that a group of non-theatrical corporations may come to the rescue, and make the factual film exciting enough to give audiences once again a curiosity about movies.

"The great German directors rescued Hollywood in the twenties with their new technique and their new material, and after them the Russians gave the technicians some new ideas. It would not be too far-fetched to predict that U. S. Steel has offered them still a new, and, as yet, unexplored photographic world in which to work: that is, the world in which we happen to be living." (Continued on Page 46)

DYNAMIC PACE IN PICTURES THAT SELL!



PRODUCED BY CASTLE FILMS means pictures in the tempo of today—films that will accomplish their purpose.

Castle's complete, permanent staff is both picture-minded and merchandise-minded.

Castle films have a technical excellence second to none. They are moderately priced and sold at a predetermined, all-inclusive cost.

When a film is completed, Castle facilities are available for its successful exhibition from coast to coast. In a word, Castle does your job from script to screen.

20 years' experience in production and exhibition is your guarantee of top product, dynamic pace, full value for every dollar spent.

CASTLE FILMS

PRODUCERS • DISTRIBUTORS
EXHIBITORS OF BUSINESS FILMS

NEW YORK
RCA BLDG.

CHICAGO
WRIGLEY BLDG.

SAN FRANCISCO
RUSS BLDG.



**A "LAUGH A MINUTE"
COMEDY SOUND SLIDE FILM
FIRST OF A NEW LOW-PRICED
SALES TRAINING SERIES**

**To be released
August Fifteenth!**

• Here's an opener for your next sales meeting! This syndicated talking slide film is packed with humor and suitable for any sales organization. Subsequent films in this series will feature proper methods of selling, etc. Get this first one now at the unbelievably low prices noted below!

SINGLE COPY (FILM AND RECORD) \$15

TEN OR MORE COPIES PER COPY \$12.50

SOUND SLIDE PROJECTION EQUIPMENT & SCREENS FOR RENTAL OR PURCHASE

TALKING SALES PICTURES, INC.
540 N. Michigan Ave. 480 Lexington Ave.
CHICAGO NEW YORK

FILM FORUM



LETTERS & ANSWERS
FROM OUR READERS

♦ Have you any questions or problems concerning the use of the film medium in business or education? The editors of *Business Screen* invite your correspondence. Questions of a technical nature will promptly be referred to a competent authority and promptly answered.

VOTE OF THANKS DEPT.

Editor of Business Screen:

May I take this means of congratulating you, not only for the quality of your publication, *Business Screen*, but for its publication.

As you probably know, General Electric has for many years made use of motion pictures and filmstrips as part of its publicity program, and so it is in a position to appreciate what your magazine really means. You have my sincere best wishes for a successful continuance and growth.

With the thought that you may be interested in material, I am suggesting that you write Mr. Sylvan Harris, Secretary, Society of Motion Picture Engineers, Hotel Pennsylvania, New York City, either for a copy or for clearance so that I may send you a copy of a paper which was presented at the Spring, 1938, Convention of the Society in Washington, D. C., which you are welcome to print in full or in part, if it meets with your approval.

Sincerely yours,
John G. T. Gilmour
Visual Instruction Section Publicity Department
General Electric Co.

For which, our editorial thanks. *Business Screen* sincerely hopes that its policy of creative help in this field may reach its desired ultimate and aid in some measure the experienced film user.

REQUESTS GLADLY SUPPLIED

Editor of Business Screen:

As I have recently been selected as Chairman of the Motion Picture Committee for Illinois Congress of Parents and Teachers, I would be pleased to receive sample copies of your new magazine. Any other information concerning films will be appreciated. Quote rates of subscription.

Yours truly,
J. Kay White, Chairman
Motion Picture & Visual Education, I. C. P. T.

To reader White's group go copies of *Business Screen* and to any similar organizations which request them.

A SAMPLE COPY, ANYWAY

Editor of Business Screen:

In accordance with your offer made at the National Conference on Visual Education to furnish the magazine, *Business Screen* at no cost to those interested, I would appreciate having my name added to the list of those receiving this magazine. I have just completed reading the first issue furnished at the conference, and I believe that you have started a long needed medium in the field of visual education.

This company has prepared and used a sound slide film entitled, "They Always Open the Door First" which is available for presentation to automobile dealers and their salesmen to point out why mohair velvet is the most desirable automobile upholstery. This presentation explains in a sales minded way that car buyers, especially women, are always interested in the car's interior, and they invariably "open the door first" to get a better view of the inside. The film depicts the practical selling points of upholstery. This film presentation is available for showings upon request to this company.

Wishing you the best of success in your new venture, and assuring you of all possible cooperation, we are

Very truly yours,
L. C. CHASE & COMPANY, INC.
F. L. Warren

For the story and the nod, editorial thanks.

ON WPA FILM ACTIVITIES

Editor of Business Screen:

It was my pleasure and privilege to hear you talk about your new magazine *Business Screen* at the recent Visual Education Conference in Chicago. Although your magazine is primarily concerned with the possibilities of motion pictures in advertising, I thought it might be of interest to you and of some advantage to us to have you know about the films made and distributed by the Works Progress Administration.

We are therefore attaching brief summaries of these films which are available in 16 and 35mm. sound for return transportation charges only. We are also attaching material prepared about them for us by Dr. Edgar Dale, College of Education, Bureau of Educational Research, Ohio State University, Columbus, Ohio; a letter from Mr. Mark Starr, Educational Director of the International Ladies' Garment Workers' Union, indicating the value of the motion pictures for trade union or adult education groups; a comment from Emil Ludwig about the film *Hands*; and reviews of the films which appeared in *Scholastic* magazine.

We shall hope to hear from you.
Very sincerely yours,
Rebecca Hourwich Reyher
Acting Director
Motion Picture Section

A long-promised story on government film activities is in type to appear in an early number of *Business Screen*.

READER RESPONSE

Editor of Business Screen:

I would appreciate it very much if you would put the names of Mr. W. M. Bastable and J. W. Gaffill, International Harvester Company, 180 North Michigan Avenue, on your mailing list to receive personal copies of any future editions of *Business Screen*. I believe you told me that you already had my name on the list, but if not, I surely hope you will see that it is included.

I have read most of your magazine rather carefully and find some very interesting and helpful special subject matter. I have had some inquiries already regarding our film activities as a result of people reading the article you published concerning International Harvester's motion picture program.

Yours very truly,
L. A. Hawkins
International Harvester Co.

A sequel to our film story in No. 1 (on Harvester's slide films) appears in this issue.

EXHIBIT EDITION REQUESTED

Editor of Business Screen:

Would appreciate your advising us if the World's Fair edition of *Business Screen Magazine* has now been published, which we would very much like to receive.

May we please hear from you in this connection?
Very truly yours,
"The 'Junket' Folks"
S. Musica

To many requests preceding the publication of this Exhibit Edition — goes the same answer — a copy of *Business Screen* and our sincere hope that its material will prove helpful in the planning of future exhibit material using films.

NEEDS SALESTRAINING PIX

Editor of Business Screen:

In my various capacities as a salesmanager and salesman in the field, I have encountered slide films and motion pictures on various occasions and have been struck by the lack of organized distribution of these materials. As I understand it, many good films are produced which have general interest for various types of sales groups but I have not, until seeing a copy of your publication recently, encountered any lists offering films which I might show to my men.

Can you tell me if such material is available and where it may be obtained?

Bismarck, S. D.

Very truly yours,
H. E. Daviston

Make a
**BRILLIANT
SUCCESS**

OF YOUR *Business Film* SHOWS!



**DA-LITE
BUSINESS SCREENS**



Assure Professional Presentations



DA-LITE STANDARD CHALLENGER

Screen, case and tripod are all in one unit.

Can be set up instantly. Yet folds compactly for easy carrying.

GIVE your motion pictures and slide films theater — quality brilliance — project them on a Da-Lite Glass Beaded Screen! Made by the leading manufacturer of theatrical screens, Da-Lite Business Screens with Glass Beaded surfaces bring out details and gradations of tone with remarkable realism. Da-Lite's advanced process of applying glass beads to the screen fabric produces a light reflective quality, unequalled by any other method. Pictures are brighter, sharper, clearer; yet there is no sparkling or glare. The beads are guaranteed not to shatter off.

Although Da-Lite business screens are available also with Mat White or Silver

surfaces, the Glass Beaded surface is recommended as the most efficient for average projection requirements. It is available in many styles and sizes for use in halls, auditoriums, clubs — wherever business films are shown. Write for complete information.

**FREE!
DATA BOOK**

Gives you facts and charts on the light reflective properties of various screen surfaces, pointers on the care of screens and full details on the world's most complete line of business screens.

Mail Coupon Now!

DA-LITE SCREEN COMPANY, INC.
Dept. 7B, 2723 N. Crawford Ave., Chicago, Ill.
Please send your free screen data book.

NAME _____
COMPANY _____
ADDRESS _____

EVEN SALESMANSHIP NOW COMES IN CANS!

IN a special section of Pathe's film vaults are miles of master negative belonging to clients of the Commercial Department. All the skill and craftsmanship acquired through three decades of Pathe picture-making have gone into these negatives — and from them, at a moment's notice, can be struck off new prints to be shipped wherever salesmanship is needed. ● Through seven years of putting up salesmanship in cans, Pathe has consistently demonstrated film's potency as a selling medium — whether for direct merchandising, sales-training, dealer-promotion, or for public relations or visual education ● Pathe employs no solicitors, but its sales-minded executives welcome talking to men with problems which a film may solve, and who have funds available for its production. ●



PATHE NEWS INC.

FREDERIC ULLMAN, jr., Vice-President

35 WEST 45th ST., NEW YORK CITY

● FEATURED IN THIS MONTH'S ISSUE are the writings and sketches of several noted industrial designers, Gilbert Rohde, Raymond Loewy and Donald Deskey, who have contributed interesting discussion material on the use of motion pictures in exhibits. Grover Whalen, affable president of the New York World's Fair, has also graciously acknowledged the extensive use of film projection at that forthcoming show and we have the word of Captain Claude Collins, director of motion pictures for the Fair, that business and educational film material is playing a most important part in the promotion of the exposition. Altogether, with the interesting creative sketches by our own consulting design staff, Barnes & Reinecke of Chicago, some original suggestions on the use of motion pictures and slide films are apparently yours for the reading.

IMPORTANT AMONG THE CONTRIBUTIONS to appear in the next issue of *Business Screen* is a sequel to our exhibit discussions of the month in which Robert Shaw, director of the Museum of Science and Industry in New York City gives plenty of material on the use of films in the modern industrial show. *Portrait of a Woman*, the remarkable motion picture produced for S. H. Camp Company and now being shown nationally to women's groups is the subject of an article. The feature of Issue Three will be an entire section devoted to the explanation of *all important processes of color* now available for motion pictures and slide films with thorough technical descriptions by the most competent color authorities. An article on the extensive possibilities in the medical film field has already received the approval and endorsement of concerns in that field and will appear shortly. With the co-operation of the Alemite division of Stewart-Warner, our editorial staff has secured a good yarn on their most interesting experiences with films. Among other important slide film stories are those on Standard Oil's program, another on recent Cooper films and the sequel to this month's discussion on costs, etc.

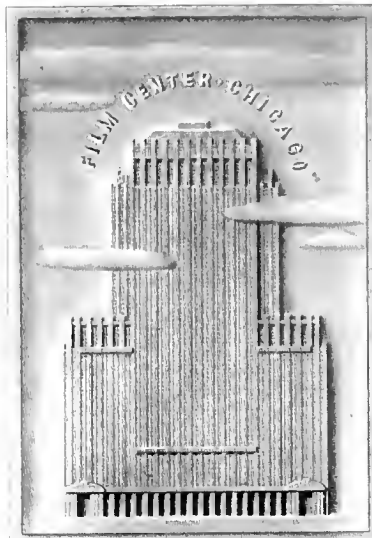

THE MAGAZINE OF COMMERCIAL AND EDUCATIONAL FILMS

C O N T E N T S

Cover Illustration — A New York World's Fair Design by Donald Deskey (Interior, the Communications Building)

Closeups and Longshots 6	News of New Equipment 35
Film Forum, a page of letters 8	Contributors of the Month 37
The Case for Slide Films 13	Can Business Use Realism? 39
Symphonies in Celluloid 19	Brief Reviews of Current Releases 40
America's First Salesman 30	Safety Lessons We All Need 41
The New GE Slide Films 31	This Is a Slide-Film 41

SPECIAL EXHIBIT SECTIONS

New Fields for Films 15	Showmanship in Industry 18
Films Rediscovered 16	The Fair's Movies 19
The Designer Looks at Pictures 17	Films & Your Own World's Fair 21

Business Screen Magazine, Issued by Business Screen Magazines, Inc., Twenty North Wacker Drive, Chicago, Illinois. Editorial Director, O. H. Coelln, Jr.; Printed in the U. S. A. Subscription price: domestic, \$5.00 a year; 50c the copy; foreign, \$6.00 a year. Publishers are not responsible for the return of unsolicited m. s. unless accompanied by stamped, self-addressed envelope. Entire contents Copyright 1938 by Business Screen Magazines, Inc., Chicago, Illinois. ISSUED TEN TIMES A YEAR - PLUS TWO SPECIAL ANNUAL NUMBERS

Make your salesmen **WINNERS!**



YOU can make your salesmen **WINNERS**—by showing them how other winning salesmen work. "Firing-Line Films"—a brand new service—a newsreel-type talking slide-film every month—brings your salesmen factual, inspiring reports of the selling methods currently used by the most successful salesmen in America. No theories—no preaching—just facts—for salesmen—by salesmen.



FIRING-LINE FILMS show HOW! How the Winners put over selling points. How they demonstrate. How they overcome price resistance. How they close. And the Sales Manager's Guide that accompanies the films shows you—how to make the film work. How to put new life in sales meetings. How to generate and apply scientific salesmaking ideas.

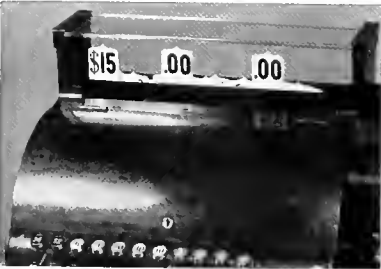

YOU start to cash in right away! The stimulating ideas and thought-provoking suggestions in Firing-Line Films make poor salesmen more successful, and good salesmen more productive. Your salesmen will like them. You'll like them. And you'll both make money out of them!



FIRING-LINE FILMS are designed for YOU. They are sponsored and endorsed by many of America's greatest sales executives, under the leadership of R. C. Borden—symposium leader of the Round Table Programs of the Sales Executives Club of New York.

The introductory fee is almost negligible. Write for a descriptive folder—still better, wire or phone today for a demonstration.

**A U D I V I S I O N
I N C O R P O R A T E D**



**285 MADISON AVE.
NEW YORK, N. Y.**

BUSINESS SCREEN PRESENTS: THE CASE FOR SLIDE FILMS

IN A LITTLE LESS than a decade, the *usefulness* and *efficiency* of slide films have amply demonstrated their value to business and education. No apologies need be given or asked for the medium which is daily proving one of the most valuable weapons in the training and selling programs of many great national organizations. Today, with the advent of fine color and many technical improvements in both projection and sound, the possibilities of the slide film have been tremendously advanced.

First — consider the many fields in which these continuous strips of illustration are now predominantly successful. In the field of sales-training, for example, the recent introduction of syndicated sales-training slide films (notably, the *Firing Line* series) has opened an entire new phase of training potentialities. The enormous group of smaller businesses employing from five to fifty salesmen, sometimes operating a small number of branch offices and which, heretofore, have been unable to afford the custom-built training film, are now to get excellent syndicated materials. In the department store, in other lines of retail dealer education and in almost every field of selling activity, the slide film is proving its useful and permanent place.

Other fields of use include those of public relations and consumer education. In the several installments which will follow this comparatively general introduction (in subsequent issues of *Business Screen*), many programs for large national corporations will be discussed. The National Association of Manufacturers, Household Finance Corporation, Coca-Cola and Associated Wool Industries are sponsors of notable series in these fields. A slide film produced for a national pipe manufacturer, for example, proved to be a powerful factor in improving employee relations when it showed the lowly tobacco clerk ways and means of achieving new stature in his livelihood. More than 600,000 women have seen the educational slide films released by Household Finance which achieve good will through constructive advice on better home management.

Another field of use for the slide film has been demonstrated in its extensive replacement of bulky charts and tables usually carried for technical lectures and sales meetings. One company, International Harvester, makes a number of films each year for this purpose alone and saves many thousands of dollars as well as the wear and tear on its executives.

In general, when the question is asked, how am I to decide whether to use a motion picture or a slide film for my problem?—the question of cost is not the most decisive element. It is true that the slide film is immeasurably more economical since it consists of a number of "still"

1. The Extent of Their Use

This is the first of a series of articles on the use and appreciation of slide films.

photographic illustrations to which a synchronized sound record is added. The printing of these "strips" of illustrations is comparatively inexpensive. The differences in usefulness are a great deal more definite than mere price indicates, for many motion picture producers will frankly advise the slide film and maintain excellent departments for their production when such use is indicated by subject matter.

This assertion is by no means a startling one, as indicated by the fact that many industrial concerns use *both* sound slide films and motion pictures. Each has its own peculiar qualifications and limitations. In many ways, their differences are as wide as the differences separating direct mail and radio advertising.

What are these limitations and qualifications? In what jobs does the sound slide excel and to what task is the motion picture film particularly well suited?

♦ In general, we have found that where *action* is a predominant essential element in the proper presentation of your story the motion picture is the proper medium. When that story can be as effectively presented with a series of stills supplemented by the illusion of motion

and the sound commentary, the sound slide is a very satisfactory medium to employ.

Thus, in presenting sales promotional material involving methods of creating effective displays, the sound slide is admirably suited to the task. A sufficient illusion of action in dramatically-posed stills stimulates interest in the production as a whole and is adequate. Window-display methods of placing counter cards, mass displays, store "traffic" locations, et cetera, come in this category. Similarly, where a set of still poses of characters may be used to "highlight" certain points, this medium is entirely acceptable.

For example, the clerk in a retail store may be shown proper ways of greeting a customer, of displaying stocks, et cetera. The narrative voice here performs the function of getting across the proper way of addressing the customer, putting over sales points, et cetera. It would, indeed, be foolish to "burn up" eighteen or twenty feet of motion picture film when a single frame would as effectively get across a single point. Similarly, if the picture is to be predominantly devoted to charts, drawings, graphs, and the like, the sound slide may be the more practical medium.

♦ The best of the sound slide producers are frank to admit the limitations of the medium. When, for example, a narrative theme must be predominant in your story, it is usually essential to have motion in order to sustain interest from sequence to sequence.

Where equipment must be shown in operation, the movie film is naturally more desirable. Thus, for a film on lubrication, a punch press in operation or a tire going through a number of processes involving motion, the moving picture is preferable.

In general, it may also be said that, where movement of thought is relatively slow and good attention is to be concentrated upon a single subject, the sound slide film is preferable. If, on the other hand, we must carry our audience rapidly from one subject to another through a series of fast-moving, interrelated thoughts, the movie is to be considered more desirable.

There are, of course, exceptions to all rules, and the above comments are not to be considered final and binding. They are merely our observations on the successful slide films and motion pictures we have seen.

It should also be noted that the *major content* of your film problem should be established. Thus if it is predominantly composed of ideas best expressed in action, a motion picture treatment is indicated; but, if the majority of thoughts to be conveyed need not be expressed in movement, the slide film is the answer.

(To be continued in Issue Three. Additional material appears on Pages 31-44-45).

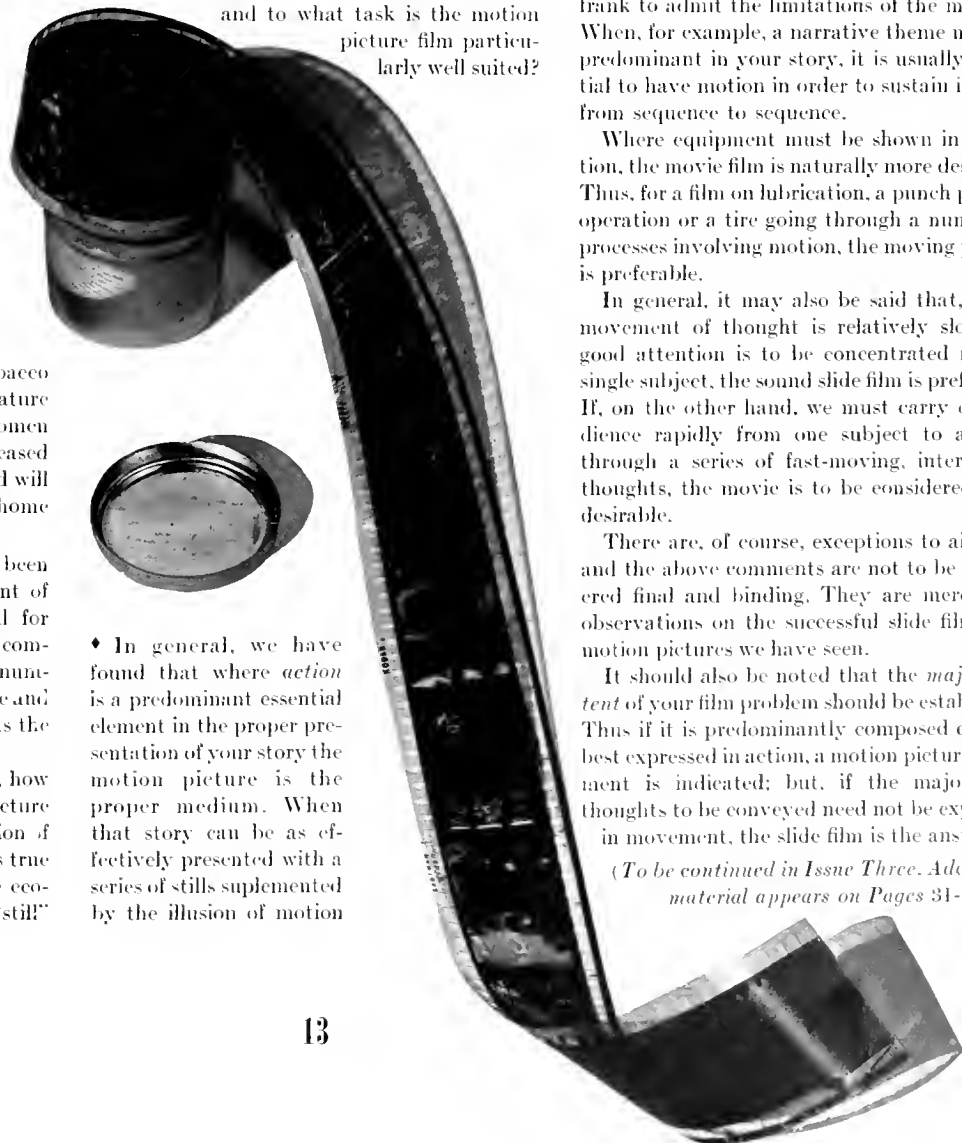

**I'LL CERTAINLY GET
MORE VALUE OUT
OF MY FAMILY IN-
COME AFTER SEE-
ING THAT FILM BY
HOUSEHOLD FINANCE
CORPORATION.***



**One of thousands of audience reactions taken at the 1894 showings so far staged by Modern Talking Picture Service for Household Finance Corporation.*

*H*AVING a story to tell is the most important reason for producing a motion picture. Finding audiences to watch and listen is the most important procedure when the film is ready for release. Modern Talking Picture Service has a "packaged" distribution service, ready to arrange programs to meet the needs of any commercial film. Modern has men trained to handle your contacts. Modern has equipment—the best they can design. Modern has a reputation and performance record

that will give you the highest dollar value from industrial motion pictures whether you want to give consumer shows—whether you want to distribute films to schools—whether you want to book one reels in theatres—or whether you want to train your own men or your dealers with your own pictures or those which Modern distributes. ■ Modern Talking Picture

Service is making movies produce profitable results for others—ask them how they can do it for you.



MODERN TALKING PICTURE SERVICE, INC., NINE ROCKEFELLER PLAZA, NEW YORK, NEW YORK

NEW FIELDS FOR FILMS AT NEW YORK'S FAIR

by Grover Whalen

President, New York World's Fair, 1939

A NEW HIGH mark in the use of motion pictures for educational purposes, for the betterment of living conditions, for the advancement of science, for the improvement of health, and for the distribution of the products of industry will be reached on the thirtieth of next April when the New York World's Fair opens its gates.

The largest number of film subjects ever to be assembled for a single enterprise will be shown upon the 1216 acres of the exposition at the New York World's Fair site. A conservative estimate of the number would be 350. Three hundred of these will be sponsored by the Fair itself.

The greatest space ever devoted to the purpose of a screen will be used for the sound-picture portion of the presentation of the World of Tomorrow within the 200-foot Perisphere in the Theme Center where sixty million Fair visitors will be our guests at a magnificent portrayal of life in the future.

The use of commercial films to demonstrate the value of a product, the scientific aspects of its manufacture, the precision methods of its assembly, or its proper function in the scheme of life, will receive the most hearty impetus in the history of motion pictures. Even at this early date, dozens of exhibitors have advised us of their intention to include commercial films to highlight their displays.

Not only will motion pictures be shown on the grounds, but in three instances they will be made at the Fair. Two other feature pictures, made on the exposition site with the Fair used as a setting, will be shown throughout the world concurrently with the operation of the exposition.

Three hundred of the best short subjects available selected for their educational, scientific and health value will be rotated in a continuous performance open free to the public fourteen hours a day, seven days a week, in an especially constructed theatre.

In an area to be known as Children's World, artists will be shown drawing the pictures to be incorporated in an animated cartoon feature. All steps in the manufacture of these pictures will be exhibited and the completed product will be displayed in a lounge nearby.

A novel use of motion pictures will make possible another form of entertainment in the same area. Children will ride on ponies which will be walked on treadmills. As they ride, they will watch motion pictures of travel scenes so projected that the youngsters get the effect of riding along the paths



Rear screen projection of motion pictures tells the theme story in the Communications building at New York's Fair. Another view of the design by Donald Deskey on our cover.

and through the streets of foreign countrysides and cities.

A steady flow of newsreel subjects will be made on the grounds, featuring international dignitaries, important events and spectacular presentations. One or two newsreel theatres within the Fair will offer these films.

Nearly every important exhibitor and dozens of smaller ones will include a commercial film in their exhibits, in many cases to complete the story of their presentation from the raw material to the finished product.

A feature picture to be called "Cavalcade of America" will form an important part of the United States Government's \$3,000,000 exhibit at the Fair.

Still another effective use of motion pictures will be made by the designers of the Fair's six huge, free focal exhibits where the screen will enhance the general effect by emphasis or will carry the thread of the story between the animated and mechanical portions of the show.

For example, in the focal exhibit on transportation the story of transportation will be told by motion pictures thrown upon a wide, maplike screen, beginning with a film depicting the caveman trotting through an aboriginal forest, to be followed by shots of his immediate descendants learning to use a sled, and so on. When the films reach the story of transportation as it exists today, a model rocketport will go into operation as a climax to the exhibit.

We are constantly expanding our plans for motion-picture participation in the Fair, but enough has been developed to make certain that we shall usher in a new era of appreciation of the power of this form of education and entertainment.

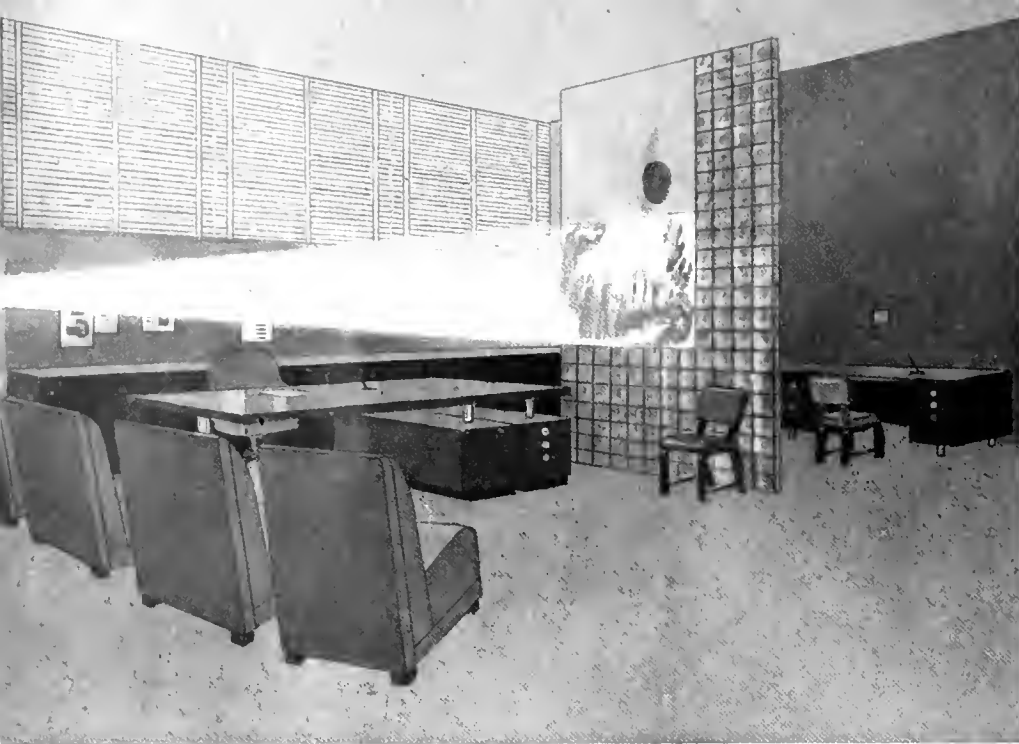

FILMS REDISCOVERED

by Gilbert Rohde

THE OBJECTIVE of the Petroleum Industry in its exhibit at the New York World's Fair is to point out to the great masses of visitors that the Industry has done a good job. The purpose is typical. It is the objective of every big industry today to tell the story of the good work it has done, not only at World's Fairs, but year in and year out; and how to tell this story is a major problem of every big business executive today.

The story of oil — or of steel, or lumber, or coal, or railroads — is epic. Each is as exciting, as colorful, as dramatic as an Arabian Night's Tale. But the story of accomplishment that industry wishes to tell is also a story of service and public relations; and here we get into a maze of statistics and complex literary ideas. To tell these requires words and facts and figures which the public will not read. This problem leads inevitably to the motion picture as a medium, either alone or in combination with other dramatic techniques. Such a form gives, first of all, the spoken word, but most important, it is completely fluid — it provides literally unlimited scope for the imagination — dull facts can be clothed in exciting and amusing form.

The need for such a versatile form was immediately recognized in the case of the Petroleum Exhibit; and since the telling of the

story of service is the major objective of the exhibit, this dramatic performance was given the position of major importance. An entirely new dramatic form based upon the motion picture was developed for the purpose, more flexible and dramatic than any form ever before conceived, the character of which cannot, of course, be revealed at this time.

The case of Petroleum is cited merely as typical. Since the objective of the industry and the problems of the service story are identical with those of other industries, the prediction is made that other designers directing other exhibits will also make important use of dramatic form and that the World's Fair may disclose nearly as many new and imaginative variants of the motion picture as there are important industrial exhibits. One thing is certain — that the pictures to be shown at the World Fairs will open new horizons for the motion picture for entertainment, educational, or commercial purposes. Exhibit technique will be greatly enriched by the application of this dramatic form, but the importance of the new revelations will far transcend their immediate value as Fair exhibits. A new formula will be disclosed for advertising and selling, for education, and for public relations purposes that merits the attention of all agencies interested in these activities. As new powers of the mo-

tion picture are disclosed, new uses will be realized.

I think that the motion picture will be taken as a matter of course in selling in the future. No one will think of planning an office without a projection screen in comfortable view of the executive's desk. The office shown on these pages represents the exhibit I am arranging for the San Francisco Fair's own exhibit. Its plan emphasizes the importance of the motion picture in the business world.

Business executives may be skeptical of these forecasts of the importance of the motion picture. When "commercial pictures" are mentioned, they throw up their hands in dismay. "What! you mean one of those things like that salesman's picture we made? I fell sound asleep at that. Who wants to see a lot of pictures of how our pipe is made?"; or "Ah, you mean one of those little boxes with those films that repeat? Yes I saw one at the auto show. It showed an automobile skidding, or something. No, I don't think we want that for our exhibit."

As it began in the classroom, the motion picture was at first intended to be merely a statistical record of a physical event in motion. This beginning, in which emotional values had no play, seems to have established the idea that the educational picture couldn't be different — and thus the development of a medium of unlimited dramatic potentials was stultified from the beginning.

To gain a glimpse of the potentials of the motion picture at this time — before the Fair pictures are disclosed — we must forget all "commercial" or "educational" pictures that we have ever seen. The only thing that can give a suggestion of the latent dramatic values is a "documentary" film such as Pare Lorentz's "The River" which sends shivers down your spine without the use of a single professional actor. Compare this to the usual "educational" film. For a suggestion of imaginative possibilities — but just the barest suggestion — we can point only to one or two Russian and Hungarian films.

Yes, that the business man does not show interest when we mention motion pictures is no mystery. The mystery is that they have remained undiscovered as an educational and advertising medium for so long after they were developed to a highly finished form as entertainment. But the prediction is that they are on the threshold of discovery as a new medium.

☆☆☆

* Gilbert Rohde is designing the Petroleum Industry Exhibit at the New York World's Fair, the focal exhibit for the Fair's own Shelter Building, and several others at the New York Fair, as well as an invitation exhibit for the San Francisco Fair.

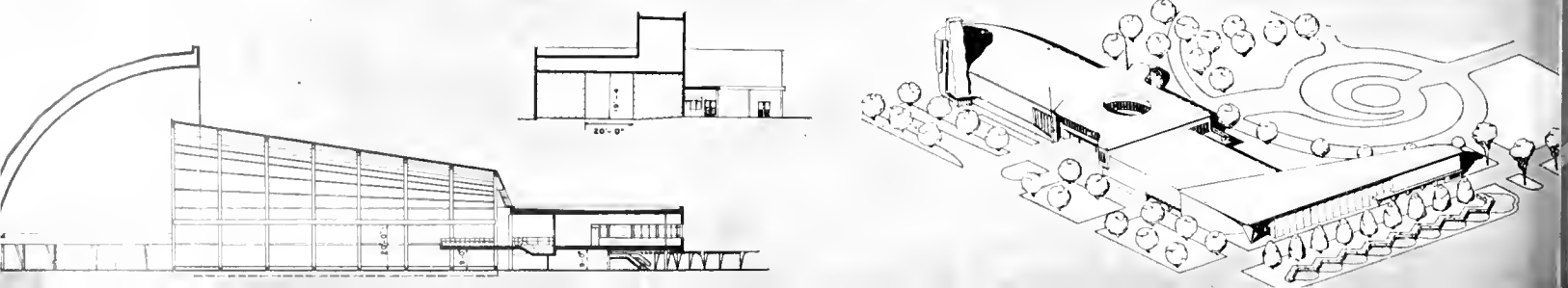

The Designer Looks at Motion Pictures

by Raymond Loewy

THE INDUSTRIAL DESIGNER has frequently been labelled a Showman. While his work has a far deeper and more important significance in the industrial world, his sense of the dramatic is often the element that makes a design click — it is that indefinable quality that we term visual appeal. The forthcoming World's Fair is affording the industrial designer unusual opportunities to make even broader use of this sense of showmanship and large manufacturers have been turning to him for original ideas in backgrounds and display.

The creation of World's Fair exhibits requires a highly trained and specialized technique. The problems involved are entirely different from any other type of merchandising or display. The most important thing to consider is the mental attitude of the person visiting a Fair. He is first of all in a kind of gay holiday mood. While he is interested in factual information and expects to derive some educational benefit from a visit to a World's Fair, he wants his information in the form of entertainment.

A good exhibit must first of all attract attention. It must then hold that attention and to be successful it must create a lasting impression — put over a message — tell a personal story. In designing the focal exhibit for the Transportation Building, we were confronted with the problem of telling the story of transportation progress in a terse but compelling way. We estimated that three minutes should be the maximum time allotted to the unfolding of this historical epic and it was decided to do this by means of the moving picture. Here was a medium that could tell a quick outline story in a dramatic and interesting way.

The moving picture alone does not and cannot make a good exhibit. It must be supplemented by other factors such as color, sound, movement, etc. as part of the exhibit. In approaching the problem of an exhibit, the important questions to be answered are:

- What is the problem?
- What are we trying to say?
- What is the best way to say it?

If the story to be told is long and detailed, movies are undoubtedly the best medium. On a 3 x 5 screen it is possible to give visualization to ideas that would require fifty times the

INDUSTRIAL showmanship in '39 by Donald Deskey

THE NEW YORK WORLD'S FAIR of 1939 will, I believe, set a new high for exhibit technique. Static product display will yield place to the super colossal feature attraction. Manufacturers and industries are alert to the necessity of exhibits that possess consummate showmanship. The industrial designer, long schooled in the technique of product design, display and exploitation, has welcomed Exhibit Design as a new field in which he can utilize his experience and imagination.

Every device for the dramatic presentation of products and ideas is being probed. The motion picture is being used in many cases as an important part of the display. However, the use of the sound film alone is a standard theatre setting is nothing new to the visitor from the crossroads. But as an instrument for the visualization of ideas, it is being incorporated into more elaborate mechanical devices; stage presentations for industry with the motion picture as an integral part.

In practically every exhibit of any importance which I have planned the motion picture is being used in some form or other. In my opinion new and dramatic uses of this medium will be revealed at the New York World's Fair which will be a directional signpost for industrial showmanship of the future.

amount of space if some other medium were used. In depicting the various phases of transportation, one might, of course, resort to models, animated diaramas, living actors or posters and pictures. A World's Fair exhibit,

however, should in no way suggest a museum. Movies and newsreels have an educational and entertainment value and they easily lend themselves to quick, dramatic presentation.

Focal exhibit for transportation at the New York Fair shows Raymond Loewy's utilization of a tremendous screen (the world map) on which films depict progress in travel.

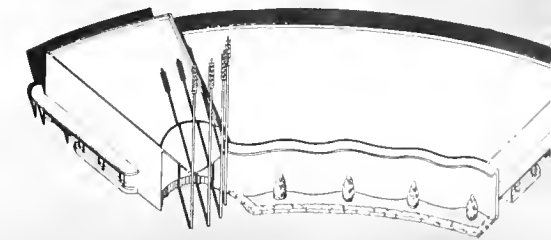
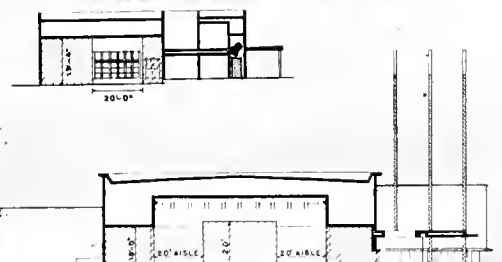
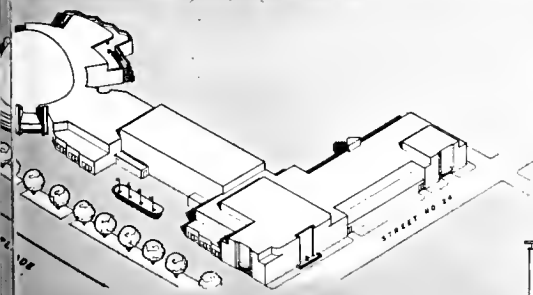

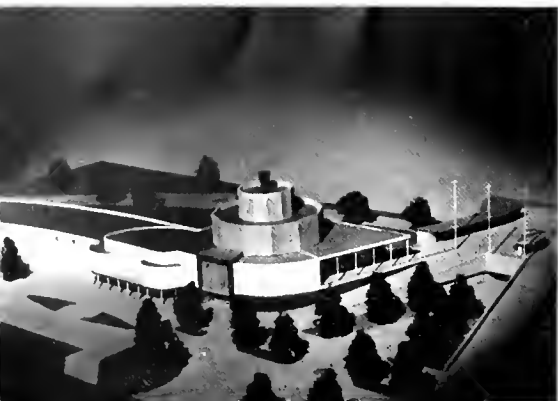
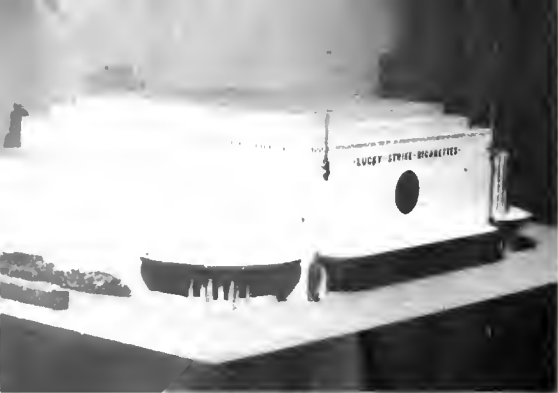

FAIR MOVIES

by Capt. Claude Collins,
Director, Films, N. Y. Fair

THE NEW YORK World's Fair is the first great exposition to undertake a definite program for the dissemination of its publicity through all mediums of the motion picture field.

Under the supervision of our motion picture department an extensive program has been worked out and as a result several precedents already have been set in obtaining widespread screen publicity although the opening of the World's Fair still is many months away.

The motion picture publicity program for the Fair takes advantage of every avenue of the industry. Considered of first importance are the newsreels, both American and foreign. To properly serve these news film services an impressive set-up is planned to house their representatives. Several thousand feet of floor space in the Press building in the Fair grounds has been set aside to be used exclusively by the newsreels. As headquarters for the newsreels this space will be so divided as to provide offices for each of the five reels, with an extra office for use by foreign newsreel representatives. In conjunction with each office will be individual darkrooms to be used for loading and unloading cameras and magazines and for test developing of film. Each reel also will have a storeroom for camera equipment, film and lighting paraphernalia. There also will be a spacious assembly room for newsreel cameramen, soundmen, contactmen, electricians and helpers.

Each of the five newsreels will have at least one staff sound crew assigned to cover the Fair as soon as it opens, who will be stationed in newsreel headquarters. Meantime each reel already has a regular contactman and sound crew

to cover preliminary activities at the World's Fair. During the past few months these crews have been almost as busy as they will be after the Fair opens. No exposition, or any other enterprise, ever before has gotten so much screen publicity in such a short period as has the Fair.

Starting with the World's Fair Preview and Parade on May 30th, on which the newsreels had more equipment assigned than to any other news story, this coverage has included fashion shows, novelty subjects, construction of the Fair, the recent visit and the two speeches made in the Fair grounds by President Roosevelt, and lastly the Howard Hughes' flight. Up to this time more than a score of subjects have been covered and released in the newsreels. These subjects have been shown on the screens of every motion picture theatre in America and in every other civilized country. It is estimated that more than 240,000,000 people throughout the world have now seen newsreel pictures of the New York World's Fair.

In addition to publicizing the Fair through the newsreels plans include the use of trailers, a nation-wide screen contest, educational pictures, travel shorts to be shown in clubs, colleges and other schools; technicolor and black and white shorts to be released in theatres, and tie-ups with exhibitors to assist them in the production and exhibition of their pictures.

To furnish news pictures for foreign newsreels and dissemination through other sources the Motion Picture Department of the Fair may in addition maintain its own motion picture camera staff to be available at all times for feature and spot news assignments.

*These fair buildings feature films:
(Above) Lucky Strike, Cosmetics,
Textiles, Federal court and
(right) the Petroleum Building.*

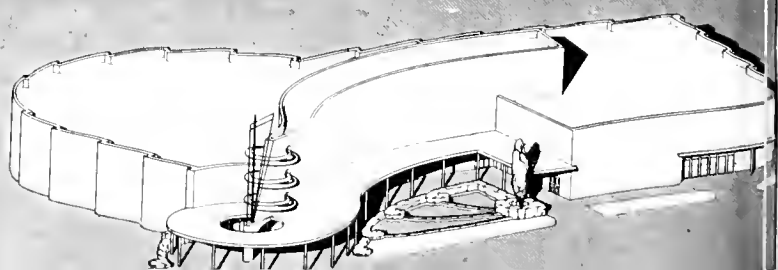
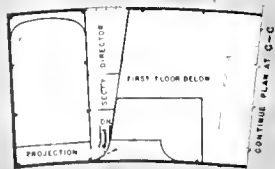
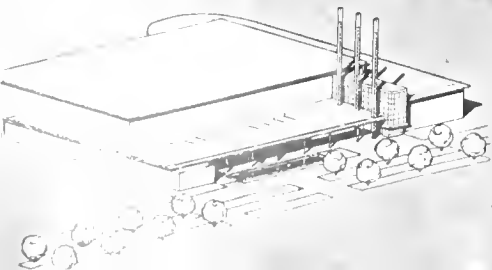
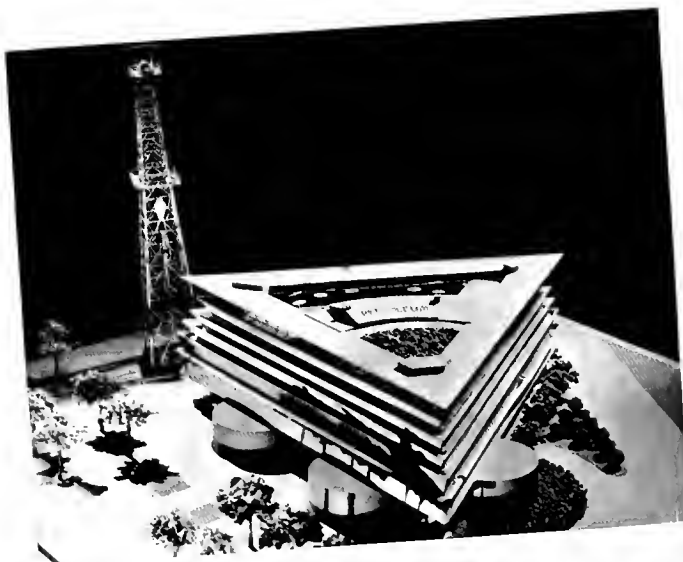

TWO FILMS
TEACH
WOMEN
BEAUTY ARTS



AN INTERVIEW
WITH
W. B. NEUBURG,
OF COTY, INC.

FACED WITH two definite and difficult sales problems, Coty, Inc., turned to the sound-visual medium, which, in the estimation of W. B. Neuburg, was adapted to present and make real the intangible and subtle properties of perfume and of face-powder.

The problems involved, first, the portrayal of the desirability of Coty perfumes; secondly, the offsetting of ill-advised propaganda. This propaganda, directed against all manufacturers of cosmetics by the guinea-pig interests, had caused Miss Schoolgirl and Madam Housewife to believe that the cosmetics for which they paid a dollar were worth in reality but a few cents.

Not easy problems, these. Their successful handling, in the two Coty films *Symphonies in Fragrance*, and *Air Spin*, points to the versatility of the celluloid medium.

Thousands of women and girls have witnessed the Coty presentations . . . the story of fragrances . . . the breath of rare flowers, the silky-softness of powder whirled into the air at the speed of 1200 miles an hour . . . to provide luxurious beauty for the American woman.

Allure, charm, grace, poise, seductiveness — these are portrayed in the Coty pictures. Charming model "types" personify the definite moods of certain perfumes. The subtle relationships between various types are brought out in a manner calculated to convince, and to sell.

Symphonies in Fragrance evolves about musical patterns — keys, rhythms, melodic and harmonic patterns. The emotions are aroused, imaginations stimulated through picturing of appealing girl types, each of whom personifies a perfume "mood". Music is used to form an interesting theme and introduction. Musical patterns are likened to the skillful blend-

ing of rare essential oils, costly fragrances blended to produce the desired types.

"Both music and perfumes produce moods — very subtle, but very real." This explanation was offered by Mr. Neuburg. "The composer blends his melodic, rhythmic, and harmonic patterns. Similarly, the skilled perfumer blends his harmonies in fragrance."

To create interest and introduce a theme with possibilities of continued, sustained interest, Dr. Sigmund Spaeth introduces the underlying theme in *Symphonies in Fragrance*. He explains how a few basic musical notes may be combined in various patterns to produce whole compositions. He describes how various orchestral instruments, each with its own individual characteristic, or color, adds its contribution to the complete, well-blended symphonic composition.

In a whirl of gay, kaleidoscopic patterns, the picture carries forward its theme. The camera takes us on a tour of many lands. We see attar of roses evolve from the rose plantations of France . . . voluptuous Spain with its own rare yields. Moods of laughter, languid peacefulness, seductiveness, spirited gaiety . . . each is woven into the musical patterns of the film's sound track, with photographic composition matching each mood. The commentary brings forth the idea that perfume has its moods, that good perfumes are imbued with blends of fragrance which give them definite, desirable characters.

"Perfumes", states Mr. Neuburg, "are intangibles". We must deal with their results, rather than with their physical properties. It is their romantic and emotional appeals that we seek to emphasize in *Symphonies In Fragrance*. This is a film for direct selling. We want the women who see it to say to

themselves, 'Well, maybe these perfumes can do something for me.'

"In setting out to do this film, we saw immediately the analogy between music and perfumes. We made that our theme. Both produce moods, you know. And very real moods."

Air Spun is shown along with *Symphonies in Fragrance*. To the latter picture was assigned an additional task. "For the past few years", Mr. Neuburg pointed out to a Business Screen representative, "women have been fairly deluged with literature from the Guinea-pig people. Various Consumers' bulletins told them that the cosmetics for which they pay a dollar actually cost the manufacturer but a few cents — five cents for a container, six cents for contents. Of course these folks completely forget many items — such as the imposing expense of labor, research, and processing. The impression they seem to give is that cosmetics — even of the best sort — are turned out in the second story of a garage.

"Thus was our problem outlined for the picture *Air Spun*. We were faced with the very realistic problem of showing people what goes into our product, how it was actually made . . . impressing them with the fact that Coty uses a special process of manufacture — the Air Spun process, which, incidentally, cannot be duplicated by any other manufacturer. One way to have done this would, of course, be to have invited people to visit our factory. A simpler, and certainly a more sensible way, was to bring our factory to the people. And that is precisely what we have done in *Air Spun*."

Air Spun is a graphic screen portrayal of the part played by science in the evolution of new aids to beauty. Produced within Coty's own hospital-clean laboratories, it shows how scientific research has brought about important innovations in the creation of new and superior cosmetics. "Our special machines are shown which spin powder in the air-floating process at the rate of 1200 miles per hour . . . demonstrated in operation."

How Coty Films Are Shown

* The Coty films, each a reel long, are shown together on one program. Both are definitely sales films, with the company's name and the identity of the packages clearly but appealingly portrayed, the films being pervaded with a consistent air of femininity throughout.

The films are distributed by Modern Talking Picture Service. There are twenty-six prints of each available, in 16mm. sound — placed in key cities throughout the country. Coty, Inc., pays the expense of distribution. Projectors and operators are furnished by the distributing people. Monthly at-

tendance and showing-reports being furnished.

Large department stores are the principal exhibitors of these films. The pictures are generally fitted into a regular store program, the twenty minutes of film being incorporated in a fashion show, a lecture on home economics, or some other suitable presentation . . . offered in the auditorium, lobby, or special exhibition-place of the stores. Audiences are primarily, but not exclusively, composed of women.

"Any organization which put intelligent effort into the promotion of the show drew good crowds," was Mr. Neuburg's comment. "The effect of the pictures was invariably soon made evident. Tie-ins were in many cases effected — such as the announcement, during the film showing, of free samples at the toilet goods counters. These directed the crowds from the showing place to a Coty display, with definitely-increased sales resulting."

Typical examples of the film's reception and its effect may be found in the following reports: At the Wm. H. Block Co. (Indianapolis) the film was exhibited for three consecutive days before audiences averaging 2700. Standing room only remained in the Block Company's auditorium. At the H. Lee & Company's store in Allentown, Pa., the Coty films were viewed by more than 4,000 women. An audience of 1500 remained after a fashion show — specifically to see the pictures.

In the Stern Brothers' large New York department store, the film was presented for an entire week as sales-educational material for the staff — presented during the half-hour period before the store opened in the morning.

Other shows have been arranged for women's clubs, church organizations, home economics clubs, schools, college classes. King Cole — handling the distribution in New York City, gave a premiere showing in a certain New York City school — and was subsequently deluged with requests for showings in a dozen other New York high schools.

. . . All of which proves that sales appeal in a film is not in the least objectionable, provided that sales appeal is subtly and interestingly handled. No one can measure the exact amount of goodwill created by a worth-while, fascinating sales film. Nor can any one measure the exact effect of goodwill upon sales volume. But if "the honesty and integrity of its maker" is truly the Priceless Ingredient, then it appears that motion pictures have ahead of them a most important job, as in the Coty films, of showing the true-worth of this ingredient, thus creating the immeasurably strong sales stimulus of goodwill.

1. Department store showings and layouts for motion picture exhibitions were discussed and illustrated in the inaugural issue of Business Screen.



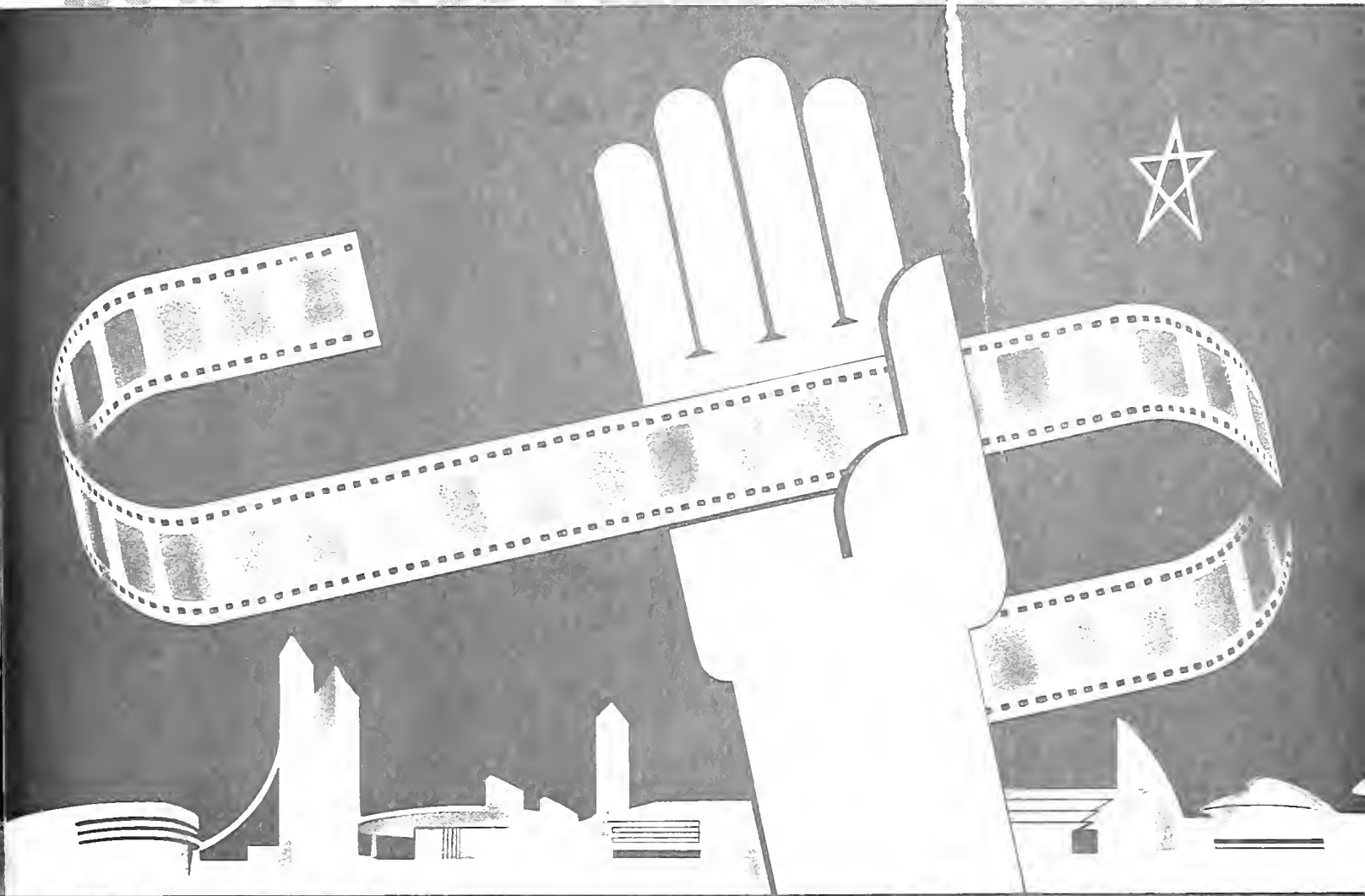

Films

AND YOUR OWN WORLD'S FAIR

★ The major role which films of all types will play at both the New York and San Francisco expositions lends considerable credence to the idea that a good industrial motion picture or slide film is, essentially, a modest World's Fair in itself. With celluloid and light business may capture, on a worldwide scale, the theme of its existence, a reflection of its progress and a forecast of its future. These, basically, are the motives of the modern exposition which, with acreage and a galaxy of colored lights added, wins the attention of those millions of Americans who break visitor records at each succeeding show. So, take a tip

from the World's Fairs and for your next exhibit consider the usefulness of a motion picture or slide film projector for the telling of your business story.

One complete exhibit area has been sketched on these pages by Barnes and Reinecke, design consultants for Business Screen, which involves many good suggestions for the use of film in any type of exhibit hall or display room. The influence of exposition design has made itself felt in many fields such as the department store, automotive display rooms, etc. and in these places projection of films may be easily adapted. Showmanship! This must be

ATTENTION

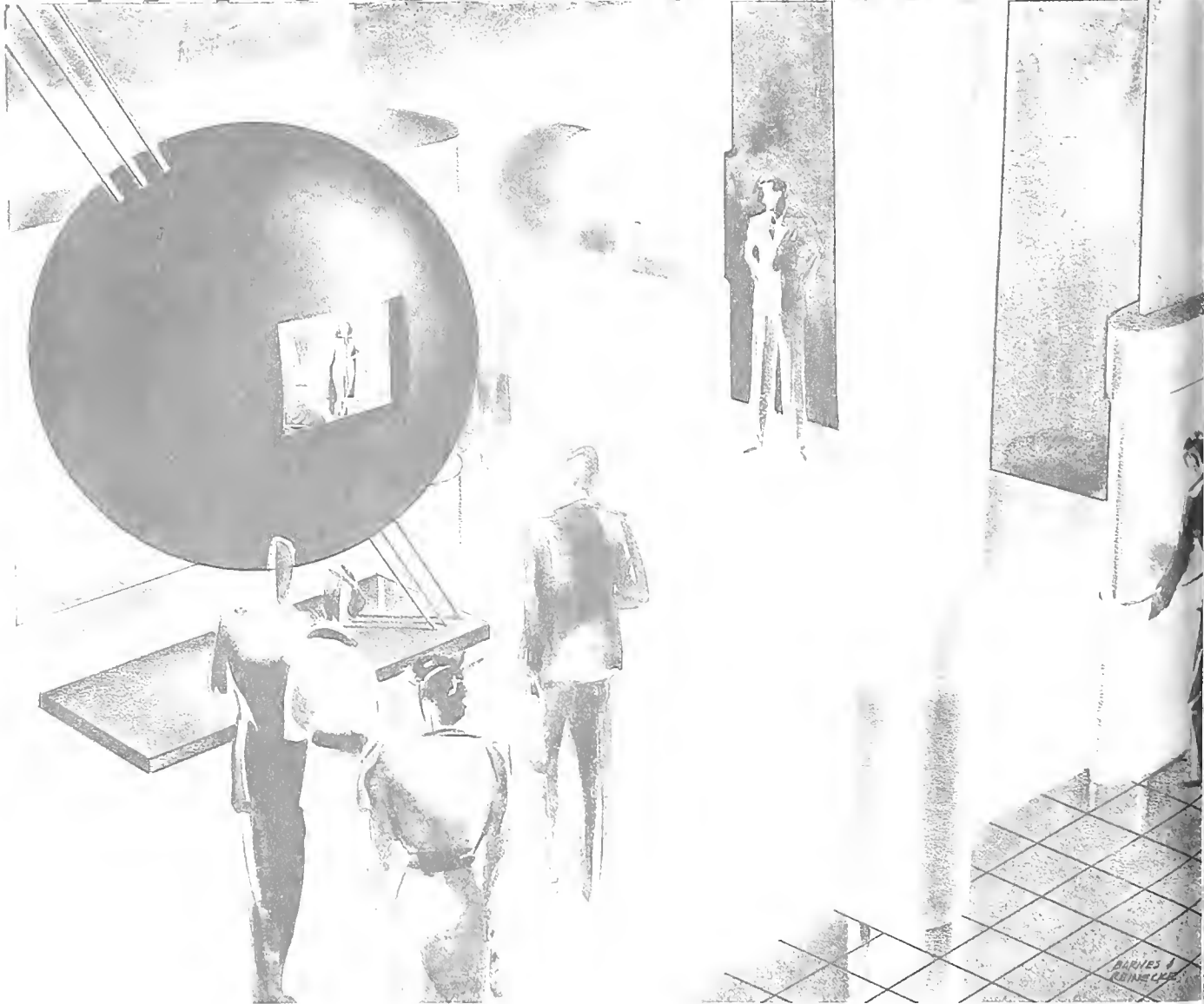

the keynote, the theme of all business exhibits whether at the annual sales convention or in your own store windows. Such an attribute need, by no means remain the sole property of a World's Fair exhibitor alone. Smart merchandisers have learned that in glamor and romance and the unequalled interest of visual instruction there is real, solid "cash-register" appeal — whether the item be gasoline for the family automobile or a household appliance. Products, services are not limited to prosaic film treatment. The celluloid medium can dramatize so unimportant an item as a five-cent drink or sanitary cleaning rags for in-

dustrial use . . . invest in regal raiments the most insignificant items and then display these items in a modern exhibit of real interest.

The World Fairs have taught us that "The Show's the Thing!" These meccas of excited, fascinated people offer merchandisers real lessons . . . convince us that those methods which picturize, educate interestingly and which add the spices of drama and narrative . . . are the ultimate in sales-appeal. So take a tip from the fairs . . . and consider your salesroom . . . your office . . . or your salesman as a potential World's Fair when you put films to work.

A SURVEY ON THE USE OF FILMS AT RECENT EXPOSITIONS

THERE ARE, according to a comprehensive survey of past expositions conducted by a national projector manufacturer, several distinct functions performed by films in exhibit work, closely paralleling their function in other forms of advertising activity. It is important that the contents, length, form and presentation methods of exposition films be carefully considered in the light of the **function** the film is intended to perform. These functions may be classified.

- a) To attract attention of passers-by.
- b) To tell the story of the product exhibited.
- c) To sell that product to the audience.
- d) To teach others to sell the product.

For the first type of use, just to attract attention, it is obvious that the film should be short, extremely striking, obtrusive, its form much more important than its contents. A short animated talking picture cartoon, visible to people in the aisles, is typical of films serving this function. The second type, which is part of the exhibit itself, and frequently the major part, has a much wider latitude both of form and contents. The third type, the direct sales film, must be so designed that interest will be held clear through to the "clincher". The fourth type is really a training picture, and should be kept away from the general public.

What Is the Job to Be Done?

★ The methods by which films are shown, and the equipment selected, are also conditioned by the kind of job that is to be done by the film. It does not pay to skimp on either film cost or equipment — the main consideration is that your story be told as it should be, with a maximum of quality and a minimum of interruption.

In the more than five months of the Century of Progress Exposition of 1933 in Chicago, ten to twelve hours per day, and for 169 days, the equipment used received as much use as it would have had in from ten to thirty years of normal business or educational usage. Furthermore, much of this use was under more adverse conditions of high temperature, dusty surroundings, unskilled operation, etc., than would normally be encountered. The cost of film and equipment is small in comparison to the price of exhibit space, fixtures, personnel, etc. It is therefore only simple economy to purchase the best equipment and to make adequate arrangements for maintenance — motion pictures are **expensive** only while they are NOT running.

If the job is essentially one of attracting attention, of

KEY TO DESIGNS ON THESE PAGES

1. Attention: arrested by a striking projector unit
2. Another type of exhibit projection for a wall
3. The motion picture theatre with many exits
4. Devote a Corner to your customers
5. The pushbutton will be a favorite of visitors

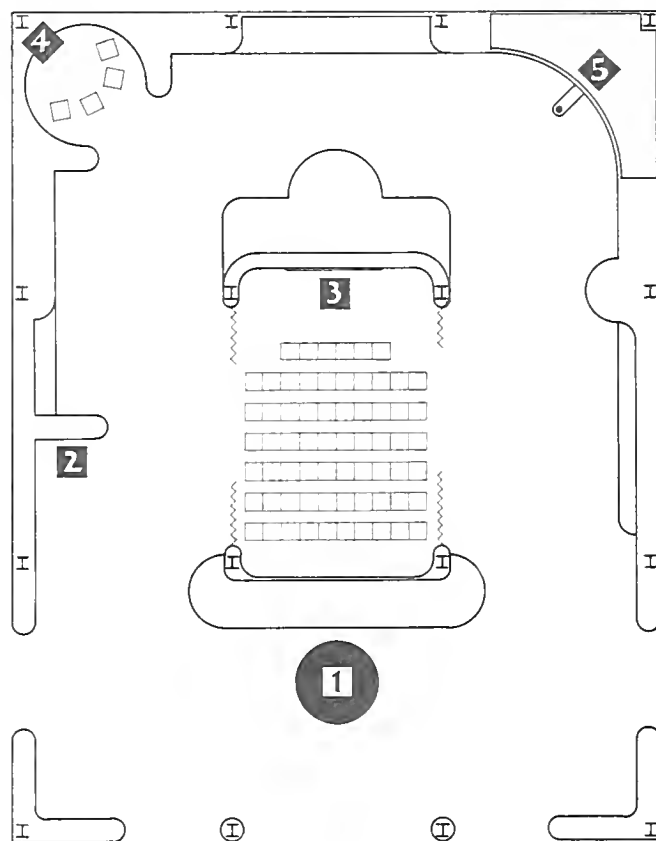
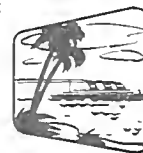

"ballyhoo", a very short sound film, shown right on the aisle, may be recommended; if a more extended educational exhibit is wanted, quieter and less crowded settings should be arranged. At the Century of Progress, some projectors were housed in special cabinets, some were built into regular exhibit fixtures, some worked right out in the open with the picture projected across aisles or booth space, while others were concealed behind walls, beneath floors or above ceilings! Projectors may be in front of the screen or behind it, either in a straight line, or, where space limitation forbids this, with the use of mirrors

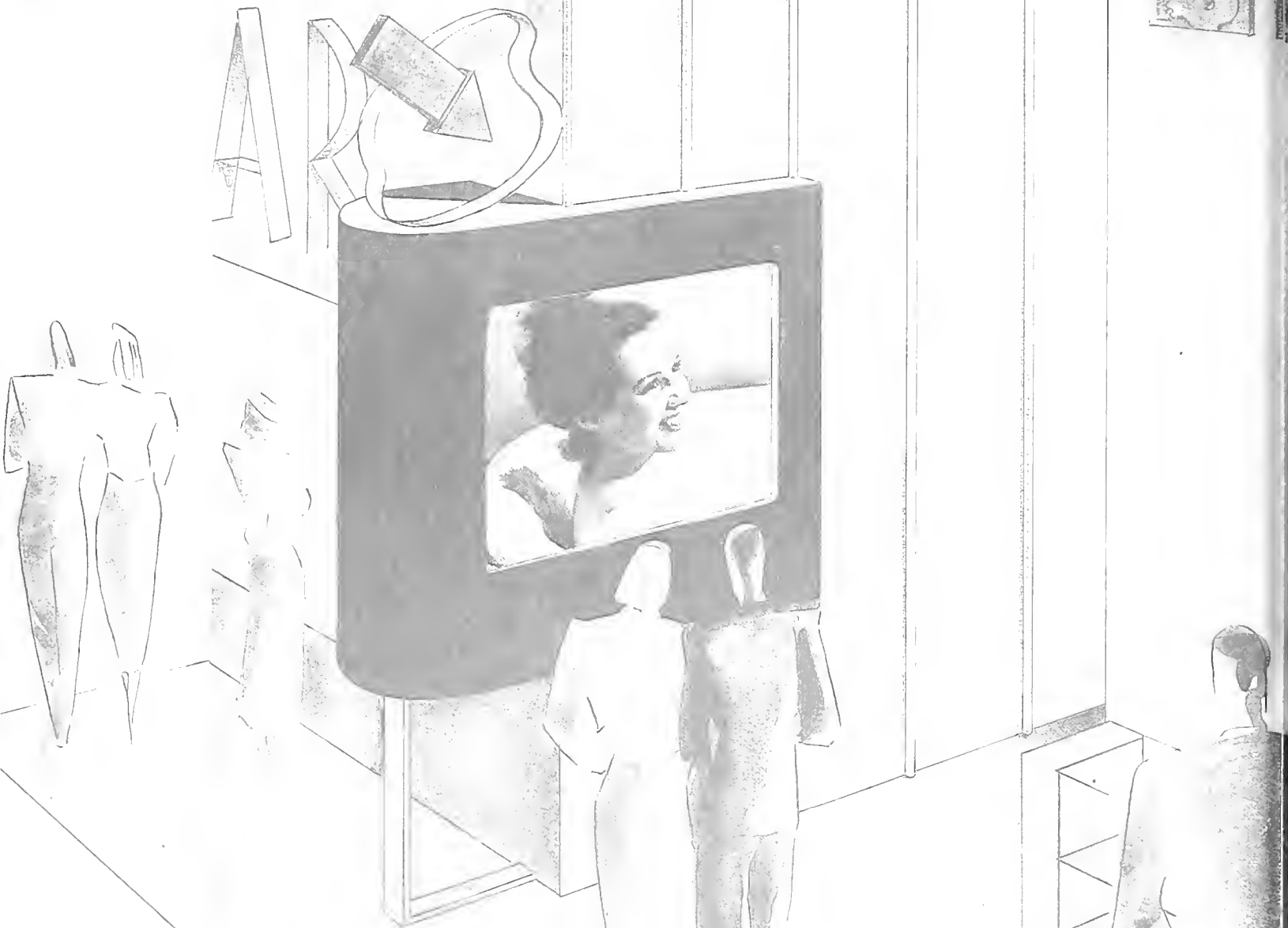

to make possible what otherwise could not be done. No 16mm. projector using safety film ever needs be enclosed in a booth, it involves no fire hazard whatever.

Will It Be 16mm. or 35mm.?

★ The following data was assembled by the national projector manufacturer primarily on his own machines but also giving consideration to other makes. It is supplemented by the results of a questionnaire tabulated by an experienced industrial film producer, and attendance and other data furnished by exhibitors. It is thought that the actual experiences of motion picture users may be found helpful by those exhibiting in future expositions.

The 16mm. projectors outnumbered the 35mm. machines eleven to one. Twenty-two commercial users re-

ported 16mm. machines as against five for 35mm. outfits, the latter mainly in professional theatrical situations, with exceptionally large pictures and long throws. The advantages of the 16mm. set-up are:

- (1) Much lower cost of prints and equipment.
- (2) No fire hazard, hence no restrictions on placement of machines.
- (3) Much easier operation, hence no requirement for licensed operators.
- (4) Much less bulk, hence conserving expensive exhibit space and fitting into difficult projection conditions.
- (5) Possibility of continuous-automatic and audience-controlled or electrically-controlled cyclical operation.
- (6) Possibility of using "home made" or semi-professional 16mm. films of installations, etc.

Theatre

Free access to the rest of your exhibit space should be a feature of your movie theatre layout to gain best results.

EXIT TO DISPLAYS



As to expenses — once the original negative is completed, additional prints on 35mm. film cost about \$60 each, the same film in 16mm. width costs about \$20. Anywhere from ten to thirty prints are used up during five months' operations, depending on the length of the film and other factors.

As to fire hazard — only slow-burning (acetate cellulose) film can be bought in 16mm. width, therefore you KNOW you are safe. Municipal ordinances and electrical codes specifically exempt 16mm. projectors from license and other regulations. A quarter million such outfits are used with complete safety in homes, schools, hospitals, etc.

As to bulk — The over-all dimensions of a typical silent projector, set up ready to run manually, with 400' reels in place, are 13½" long, 7½" wide, 18" high. With the 600' continuous attachment in place, 19½" long, 16" wide, 16½" high. The projector aperture, from which all close measurements should be computed, is 7½" from back of projector, 9½" from bottom, 6" from motor side, 2½" from lamp side.

The dimensions of a typical sound projector are only slightly greater — the machine itself in its carrying case measures 17" x 9½" x 15". With reels in place the over-all

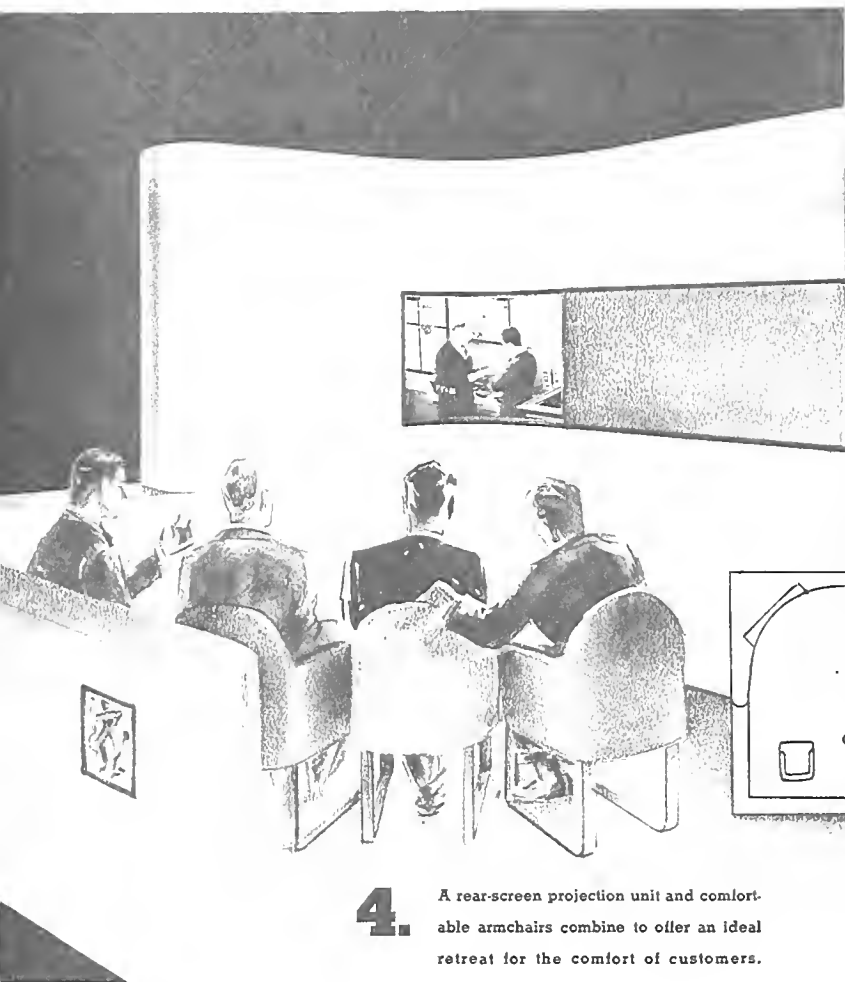

4. A rear-screen projection unit and comfortable armchairs combine to offer an ideal retreat for the comfort of customers.

DEVOTE A CORNER TO

CUSTOMERS

dimensions would have to be increased only in length, by adding 20½" for 400' reels, 31" for 1200' reels, and 33" for 1600' reels. Fitted with 600' continuous attachment in place over-all dimensions are 30" x 16" x 16½".

What Advantages Has Sound?

★ For the first type of film usage — that of attracting the attention of the passerby — the great advantage of the talkie is obvious. Light and motion are the two basic eye-catchers inherent in the motion picture — to this the talkie adds sound, the greatest ballyhoo medium known. However, the sound must be clear, pleasant and well modulated, and stay that way, so that there will be no objection from fellow exhibitors who will certainly be up in arms if "sour" and uncontrolled sound is employed.

For other types of motion pictures, the extent to which the talkie is superior to the silent film depends on the subject matter, and on the conditions under which the films are shown. The great advantage of the talkie is that in addition to showing your product you can tell the audience about it, always in the identical carefully-prepared words, with full recourse to the world's finest music and to telling

sound effects which add a "fourth dimension" to exhibit salesmanship.

By eliminating long explanatory titles the talkie gives about 25% more footage for your picture story, as well as overcoming loss of interest among people averse to reading. The footage gain is offset, however, by the greater speed at which talkie film is run.

Continuous-automatic operation and control is practicable only where used with 16mm. projectors of highest dependability. For the 1934 Fair a new 600' attachment was perfected by a projector manufacturer for a standard model. This 600' continuous attachment has proved to be so satisfactory, particularly in meeting the severe demands encountered in exhibit work, that it is the only type of continuous attachment which this company now supplies, whether the film to be run is 600' or shorter. An automatic safety control stops the projector in case of film trouble, and push-button devices can be furnished to enable audience or attendant to start a film cycle at will. Those continuous projectors can also be arranged to fit right into an electrical or mechanical cycle-control-device, so that motion pictures will serve as a definite part of some broader demonstration program.

Should the Audience Be Seated?

★ Whether or not to provide seats for your audience while they are looking at your motion picture is a question that depends upon just what the film is expected to accomplish, its length, its role in the rest of your exhibit, the location and amount of space available, and other factors.

A short snappy ballyhoo film intended to bring people into an exhibit rather than tell the whole story itself, certainly does not call for seating arrangements. Some of the very best uses of motion pictures, such as those developed by Union Carbide with its seven projectors or by International Harvester (with five), provided no seats for their movie audiences. So great were the crowds in front of their screens that there would have been no room for chairs in any case.

Experience at the Century of Progress proved that it was possible to hold a crowd for a 15-minute talking picture piano recital without any seating arrangements — yet it may well be argued that the results would have been still better if seats had been provided.

The survey furnished to Business Screen indicates that 34 projectors played to seated audiences, while 53 did not. A producer's questionnaire indicates that 14 of the exhibitors replied that they had provided seats, while 13 answered they had not. Of these latter 13, eleven replied to another question that the audience did **not** remain for the entire picture, whereas all 13 exhibitors who replied that the audience **did** remain for the whole picture are among the 14 who report providing seats. "Several exhibitors with small auditoriums seating from 24 to 224 persons reported that their theatres were filled to capacity during most of the Fair period", states this questionnaire survey.

When designing the original continuous attachment (150') the projector company made a survey of crowd habits at various trade shows and found that on the average a man would stand and look at a motion picture not more than 4 minutes. This determined the capacity of the projectors, 50% over this observed average, yet the users of the continuous attachments insist on longer cycles, even to four times the original film capacity.

Crowd habits have not changed — if anything, people at so variegated a spectacle as the Century of Progress are less inclined to stand for long periods at any exhibit, even a talking motion picture. If it is necessary that your audience be held to the finish of a picture longer than four minutes, possibly even longer than two minutes, it should be made as easy and as comfortable as possible for them to do so. Under such conditions seats are clearly indicated.



CONTINUOUS PROJECTION

The modern designer can contribute many original ideas from which to build a suitable setting for the useful continuous projector. One of the dependable continuous machines now being marketed can be easily adapted to a cabinet such as Barnes & Reinecke have sketched above. This unit can be carefully matched to the design of the complete exhibit.

The location of an exhibit also has a bearing on whether or not seats should be provided. Exhibits close to entrances have less need for seating arrangements than those further away. As people tire they are drawn to those exhibits where they can rest while they look and listen. The wise exhibitor takes this into consideration, and gets much of the crowd that his less thoughtful colleague forfeits.

What Size Pictures?

★ The size of screen image employed is also of serious moment. The effectiveness of a large screen is generally considered to be in proportion to its area, yet this should

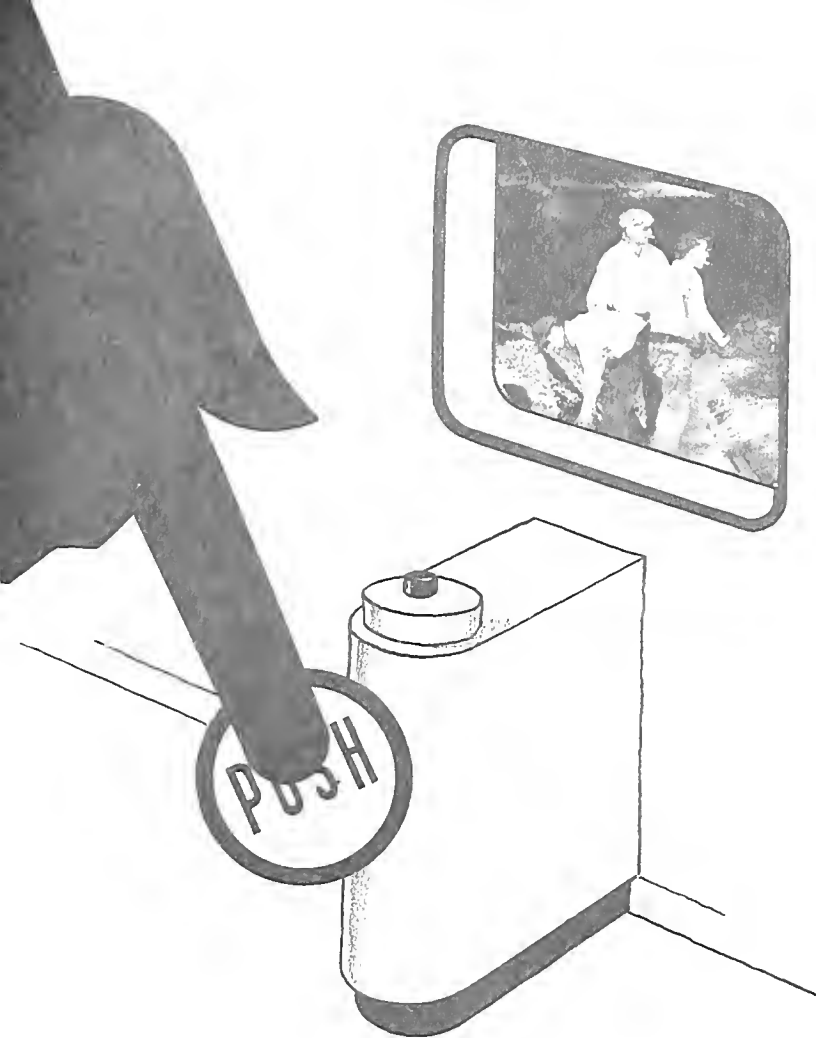

PEOPLE LIKE PUSHBUTTONS

The pushbutton is both a practical and interest-catching addition to the motion picture exhibit. Practical because it saves projector wear and economizes electricity it is also a never-failing curiosity attraction which gives the visitor chance to work something to his own satisfaction. Especially used with a continuous projector which automatically rewinds at the conclusion of the show.

The breakdown of types of screen material used gives us the following picture:

Beaded Screen Material for Direct Projection . . .	17
Painted Wall Surface	15
Translucent Fabrics, for Rear Projection	34
Glass, for Rear Projection	11

The lenses used to obtain these pictures, were of the following focal length:

3"—5; 2½"—3; 2"—29; 1½"—22; 1"—13; ¾"—7; .64"—6; (all of these are generally considered standard lens)

It should be noted that the 2" lens is the most efficient from the point of light passed, and that the 1½" lens is only slightly less fast.

The question of front projection or rear ("Translux") projection through a translucent screen material is also of interest:

Front projection	32
Rear projection	56

☆ ☆ ☆

EXHIBIT showmanship differs according to the product and the type of audience. The rules developed from experiences at Chicago's Century of Progress and disclosed in the survey above may easily be applied to the individual problem. Readers are invited to address their problems, with a sketch of the contemplated exhibit area or other space in which projection may be used if possible, to the offices of Business Screen. Competent, experienced technical assistance will be freely given without the slightest obligation. In subsequent numbers of the magazine many additional applications of exhibit projection will be illustrated, including an article on the remarkable Museum of Science and Industry in Rockefeller Center, New York.

Editorial credit is due to the technical staff of Bell & Howell and to Burton Holmes Films of Chicago for much of the valuable information contained in the survey presented this month.

by no means be looked upon as an absolute rule. The size of the screen depends on what the job is, and in what surroundings. A small brilliant screen proportionate to the size of a decorative pylon flanking a wide aisle may be more effective than a vast screen in a still more vast hall crammed with interesting floor exhibits.

If a motion picture is to be the principal feature of an exhibit it must be shown on a size commensurate with its importance. If, on the other hand the picture is only incidental or contributory to a general exhibit, it should be fitted into proper scale.

The size of the image is determined by the projection distance available, and the focal length of the projector lens employed. As a guide, the following table of screen sizes used at the 1934 Fair in Chicago will be of interest.

SCREEN SIZE	PROJECTORS
Up to 12"	5
12" to 20"	20
20" to 30"	13
30" to 40"	32
40" to 50"	7
50" to 60"	6
60" to 96"	2

Anyone can Make a Movie...

PROOF

If you want proof that Caravel Pictures get results, check with

Atlantic Refining Company, Inc.
Wallace Barnes Company
Beck, Koller & Company
Bethlehem Steel Company
Black & Decker Manufacturing Company
Calco Chemical Company, Inc.
S. H. Camp & Company
Cluett, Peabody & Company, Inc.
Congoleum-Nairn, Inc.
Davis & Geck, Inc.
Dictaphone Sales Corporation
Eastman Kodak Company
The B. F. Goodrich Company
Jenkins Bros.
Johns-Manville Corporation
Kenwood Mills
National Biscuit Company
National Distillers Products Corporation
National Lead Company
Goodall Company (Palm Beach Suits)
Raybestos-Manhattan, Inc.
Socony-Vacuum Oil Company, Inc.
E. R. Squibb & Sons
Talon, Inc.
U. S. Industrial Alcohol Company

OR ANY OTHER CARAVEL CLIENT

THOSE movie shots you made of the baby, the dog, the family outing are all interesting to you and your family. But—have you ever had to sit through an hour or two of the other fellow's movie?

So, too, that film you plan to make of your plant, your manufacturing processes, will interest your executives and employees. But—will it sell your dealers, customers, and prospects?

Building a successful business film is a specialist's job. Back of every Caravel film is a staff of specialists—writers, directors, and technicians with more than fifteen years of specialized experience. They command a modern studio—the latest cameras, lights, sound equipment. They have a decided flair for motion picture showmanship.

Results continually surprise even consistent users of Caravel films: Six thousand new and desirable dealers! An order stepped up from 250 to 350 units (an increase of approximately \$20,000)! Purchases by one of America's largest stores built up from ten to fifty thousand dollars!

How does Caravel plan its motion picture programs? An inquiry might prove well worth while.

CARAVEL FILMS

INCORPORATED

New York • 730 Fifth Avenue • Tel. Circle 7-6112

Chicago • Tribune Tower • Tel. SUPerior 3422





Scenes on this page are from the film "Selling America" and are reproduced by courtesy of the Jam Handy Picture Service and Frigidaire.

America's First Salesman

FROM THE TRULY INSPIRATIONAL sales training sound motion picture, *Selling America*, recently released under the sponsorship of the Frigidaire division of General Motors comes a very great deal of thought for today's selling and the salesmen whose job it is to do it. America's first and greatest salesman, Benjamin Franklin, has been reincarnated to show how well his principles adapt themselves to modern selling. But let a word synopsis of the picture story tell the rest:

Ben Franklin did not claim that the rules covering his man-to-man relationships were of his own devising. He picked them up from men of wisdom who had lived centuries before his

time. In writing them down for the benefit of his descendants, he realized that the passage of years would in no way affect their validity. And that they hold as true today as in Franklin's time is the message of *Selling America*.

They apply, with equal force, to every one of us in every walk of life — to salesmen of all kinds, to executives, to plant foremen, to doctors, to lawyers. The list could be drawn out indefinitely, as it would include everyone whose vocation involves, in any way, contacts and relationships with other people.

Today, naturally, we might phrase the rules differently, put them in modern form, but their meaning would be unchanged:

The first rule, for instance — "Virtue is obtained rather by the use of the ears than by the tongue . . . Put on the humble inquirer" — we should probably modernize as: "*Get The Other Person to Talk — Ask Questions.*" Neglecting to follow this, generally results in the failure to grasp what is in the other fellow's mind — what his needs are, his interests, or, possibly, his complaints. Only by getting him to talk can we learn his viewpoint.

Rule number two, "Argument is productive of disgusts and perhaps enmities" — we can bring that up to date as: "*Don't Argue.*" However great the provocation, arguing is to be avoided as an expensive, as well as risky, luxury. Once begun, there is no telling where an argument will lead — except that it will certainly not lead to a satisfactory settlement of the matter under consideration.

Rule number three, "In answering an opinion, observe that in certain cases or circumstances, the opinion would be right" — could be expressed: "*Answer With a 'Yes, But.'*" By using this technique it is possible to correct the misconceptions or erroneous ideas of others without offense, and without an argument.

Rule number four, "Forbear all direct contradictions to the sentiments of others, and all positive assertions" — becomes today: "*Don't Contradict. Don't Be Too Positive.*" As Franklin learned early in life, failure to follow this rule sets up a feeling of opposition in the other person, frequently creates animosity.

Rule number five, "Lose no time; but let each part of your business have its time" — is, in modern usage: "*Don't Waste Time — But Tell a Complete Story.*" The effectiveness of our dealings with others — whether we wish to exchange ideas, goods, or service — is in direct proportion to the degree of thoroughness with which we make our presentation.

Here, then, are the rules — rules as old as history — rules that worked in the remote past — rules that worked for Ben Franklin — rules that, given a chance, will work for you:

1. *Get the other person to talk — ask questions.*
2. *Don't argue.*
3. *Answer with a 'yes, but'.*
4. *Don't contradict. Don't be too positive.*
5. *Don't waste time — tell a complete story!*





The proof of the pudding is in the eating — and when prospects discover they can shave without practice and without a mirror, they cough up \$15 with remarkable uniformity.



A salesman for a set of books had to repossess a set. He couldn't carry it a mile to the bus station — so he loaned it — and found another customer.



Dale Carnegie says that some people are so "salesman conscious" that they get the jitters at the very sight of one.



A champion automobile salesman became a champion when he learned to make his prospects do the demonstrating. Now he just makes them find out for themselves just how much headroom there is in his car.

A New Sales Training Series of Slide Films

Presented by the

**RADIO DIVISION OF
GENERAL ELECTRIC**

Starring

DALE CARNEGIE & R. C. BORDEN



A woman who couldn't be sold an automatic ironer "because she could never learn to use one" signed the order without a struggle when the shrewd salesman got her in front of a machine and persuaded her to iron a handkerchief.

*Pictures on this page through
courtesy of Adivision, Inc.*



A hard-boiled "looker" becomes an enthusiastic buyer when he has pressed the keys, wiggled the controls, and in other ways demonstrated the key features of the new GE line to his own surprise and amazed pleasure.



A weary vacuum cleaner salesman stumbled on a secret that made him top man in his own territory . . . guess what it was.



A bicycle salesman creates a market by teaching neighborhood boys to ride — free. Somehow or other, they soon find the money to buy their own bikes.

"HOW TO WIN SALES"

Dale Carnegie sells the "free home trial" idea in this 72-frame sound slide film which is used to pre-sell dealers on the principle of urging hesitant buyers to accept home demonstration. Actual stories of other sales successes based on that principle are related.



R. C. BORDEN, a member of the well-known sales training team of Borden and Busse and the famous Dale Carnegie are starred in two of three new sales training films recently produced for the Radio Division of General Electric and already used with outstanding success in the field.

In the third of this new series, in which color
(Continued on the next page)

"LET GEORGE DO IT!"

R. C. Borden tells how salesmen for electric razors, etc. all hang up sales records by persuading their prospects to demonstrate the products to themselves. This 80-frame slide film is used to impress dealers on the value of GE sales features — all of which can be "worked" by the prospect.



MODEL "D"

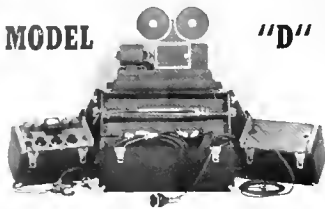

16 mm. SOUND RECORDING SYSTEM

A PROFESSIONAL 16mm DOUBLE-SYSTEM SOUND RECORDING EQUIPMENT FOR INDUSTRIAL AND EDUCATIONAL TALKING PICTURES.

**ALL A. C. OPERATION
EXACT SYNCHRONIZATION
RELIABLE COMPLETE**

READY TO OPERATE WITH YOUR SYNCHRONOUS MOTOR DRIVEN CAMERA

1985⁰⁰_{NET}

IMMEDIATE DELIVERY

DEMONSTRATION REEL AVAILABLE

THE **BERNDT-MAURER** CORP.
117 East 24th Street • New York City

Extra Effort and Care...

in 16 mm. sound-film release printing from 35 mm. or 16 mm. negatives results in a Business Film presentation of outstanding technical excellence.

PRECISION

FILM LABORATORIES
A DIVISION OF BERNDT-MAURER CORP.
21 WEST 46th ST. • NEW YORK CITY

SALES FILMS...cont'd.

(Continued from Page 31)

is used for the first time in a film of this type. E. H. Vogel, manager of the General Electric Radio section appears to make a straightforward and enthusiastic presentation of the new GE line. The other two subjects, described in adjoining columns are for general dealer education use and with the two stars, make a real contribution to this field. Both of these are produced in a dramatized style with sound and the photography is of the "candid" type noteworthy for its realism. The running time of Carnegie subject is approximately fourteen minutes; the Borden film is eleven minutes long with a slightly faster frame movement.

★ ★ ★

♦ *Word Magic* stars Elmer Wheeler and his *Tested Sentences That Sell* technique. It is a feature length sales training sound motion picture.

The adaptation and dramatization of the *Five Wheelerpoints* as brought out in the picture, *Word Magic*, based on Elmer Wheeler's best seller, "*Tested Sentences That Sell*," will help all persons in sales work. These word combinations and selling methods are based on buyers' reactions at the point of sale and analysis of selling situations. These have been tested on more than 19,000,000 people by Mr. Wheeler through his work with the Tested Selling Institute.

In connection with his development of the best probably selling sentences and techniques, it is pointed out by Mr. Wheeler that consumer buying motives are frequently entirely different from what the manufacturer, advertising man or salesman thinks they may be, and that a test in the field under normal selling conditions is necessary to determine constant percentages of consumer reactions to selling sentences and techniques.

The scenario treatment of *Word Magic*, as developed by the producers, is unique as it enables them to release that portion of the film dealing with the *Five Wheelerpoints*, for rental as well as having them available as a prologue to additional reels developed for clients who later develop their own sales training pictures embracing the *Five Wheelerpoints* as applied to their own individual sales problems.

♦ The development of syndicated salestraining sound slide films is a notable trend of the month. An excellent example of this type is a series entitled "*Firing Line Films*" which stars well known salestraining authorities such as R. C. Borden. Another series, now being released in the Midwest features the salestraining aids developed by the editorial staff of the Dartnell Corporation, business book and magazine publishers.



An example of the "Ask Which — Not If" formula. "Wheeler-Point #4" — the salesman asks, "Which do you prefer, Mr. Widgett?"



The Clerk: "Yes, Madam, they're square — and they won't roll." Back up your words with showmanship. This girl proves her points by dropping the clothespin on a slippery counter.



An example of Wheeler Point #3 — "Say it with flowers." The Clerk: "A five cent cigar? Or one of these two for a quarter ones — the kind that won't unravel in your mouth?"



Clerk: "One egg, or two, sir?" Customer: "Eh, one will do." And the clerk makes an added sale, the cash register gets an added nickel —

SALES MANAGERS!

Spend less TO SELL

WITH PICTURES!

(And we won't quote the old Chinese proverb!)

*Your complete sales story...compact
as a lunch box...for the price
of a good hat!*

SO LOW IN PRICE YOU CAN EQUIP
EVERY SALESMAN... SO LIGHT AND
SIMPLE EVERY SALESMAN IS
DELIGHTED TO USE IT.

ONLY
\$15

POWERFUL 100-WATT
PROJECTOR WEIGHS
ONLY 6¾ LBS.

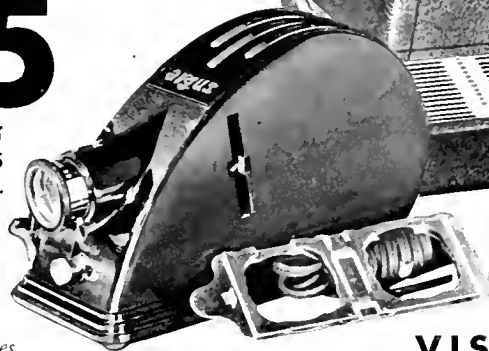

*Your office boy can
easily make the slides
from your 35 mm negatives
at low cost with the equipment
described below.*

ARGUS GLASS SLIDE KIT

Contains 24 pieces of 2" x 2" selected clear slide glass, 12 patented silver binding stickers, 12 film centering masks—sufficient for making up 1 doz. slides... Price 75c.



ARGUS SLIDE BINDER KIT

Includes one Arguslide Binder—a cleverly designed, patented device of aluminum and sponge rubber which semi-automatically seals the slide glasses together quickly and neatly—and six of the Argus Glass Slide Kits described above—sufficient for 72 slides (saving \$1.00 to buyer of complete kit)... Price \$5.00.



argus VISUAL SALES PORTFOLIO

● **COLOR** plays such an important part in merchandising today...why not show YOUR products in FULL NATURAL COLOR...dramatically, convincingly projected, life size at a cost of only a few cents a picture? This compact little case 4¾x8x9¼ containing the simple, attractive, streamlined ARGUS projector and 75 sales slides is all the portfolio your salesman need carry. With this attention-holding, sales-producing ARGUS Visual Sales Portfolio, he can show new models, new

styles, new fabrics, new designs in black and white or natural color. The customer arrives at selections more promptly. Your salesman is quickly on his way for the next order.

Use the Argus projector for training your sales staff. Have your salesmen use it for training distributor salesmen, jobber salesmen, retail salesmen, and for demonstrating your products to customer groups. Ask any photographic dealer for a demonstration. Write us for full particulars.

*Light, compact,
easy to carry.*



INTERNATIONAL RESEARCH CORPORATION • • • 228 FOURTH STREET, ANN ARBOR, MICHIGAN



SHOWMANSHIP



Selling has long since been lifted from its rut of a mere order-taking technique. "The Show's the Thing!" acquires new significance. Industry has fast learned that motion pictures are a valuable tool in the sales-kits of its representatives.

A good picture is most important. It must be carefully planned. It must be made by a reliable producer . . . designed to accomplish definite objectives. Showmanship must be a part of that picture. But showmanship does not end there. For your picture also must project its message clearly . . . unhampered by any possible mechanical difficulties.

THE DE VRY LINE

16mm. Sound and Silent Projectors
35mm. Sound and Silent Projectors (Portable, and Permanent)

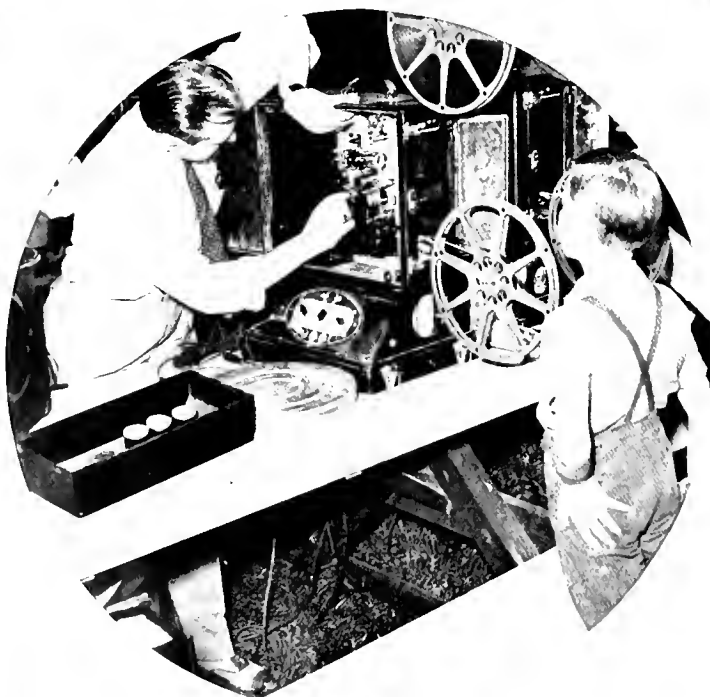

Sound and Silent Cameras.

Complete accessory lines.



Estab. 1913

AND RESULTS!



Smart merchandisers have learned they can count on De Vry projection. That is why Standard Oil, Allis Chalmers, International Harvester, the Ford Motor Company, and many other firms rely on precision-built equipment . . . made by a company specializing for 25 years in the manufacture of projectors and cameras.

They came, they sow, they heard — and they bought! Officials with their fingers on the pulse of sales know the answer. They know that their motion picture messages can be put over with all the vigor and reality put into them . . . on De Vry equipment. Let us help you secure theatre-quality shows.

YOURS FOR THE ASKING!

De Vry Movie News, no charge
Report of the Nat'l. Conference on Visual Education — 50c per copy
Industrial Service Letters, no charge

DE VRY CORPORATION
1111 ARMITAGE AVE. CHICAGO, ILLINOIS

FOR TECHNICAL DATA, PRICES, ETC., ON EQUIPMENT DESCRIBED HERE ADDRESS MANUFACTURERS DIRECT OR WRITE: THE SCREEN SERVICE BUREAU, 20 NORTH WACKER DRIVE, CHICAGO, ILLINOIS

NEW EQUIPMENT

No SUMMER DOLDRUMS have been experienced in the commercial and education projection equipment field insofar as new and important development work is concerned. Greater strides have been made this season than ever before and many improvements are noted.

♦ From Bell & Howell Company comes news that Filmosound 138 is now regularly equipped with a new, more powerful amplifier which doubles former sound volume.

This means that audience capacity is also doubled. Instead of showings being limited to about five hundred people, as formerly, the more powerfully amplified Filmosound 138 provides sound volume ample to be heard distinctly by audiences of a thousand or more.

Bell & Howell states further that the new double-volume amplifier is now included in Filmosound 138 at no increase in the reduced prices recently announced.

♦ Sound Projects Company, Chicago, announces a new slide-film sound projector capable of running on a six-volt current. It may be operated by an auto battery, or the regular 110 volt current, either AC or DC.

Edward L. Foertsch, sales manager of the Sound Projects Company states that the new machine will give the same quality of performance as the standard equipment of this type. "There is a demand," Foertsch states, "for sound and slide-film equipment that can be used where the customary electrical outlets are not available. The new machine meets that demand. With it, users will be able to hold sales

A typical ArgusScreen Kit provided by the International Research Corporation includes one of the new 100 watt portable Argus projectors, with slide box of 100 capacity and an adjustable projection screen 30" by 32", all compactly enclosed in a sturdy protective carrying case. Priced complete at \$30.00.

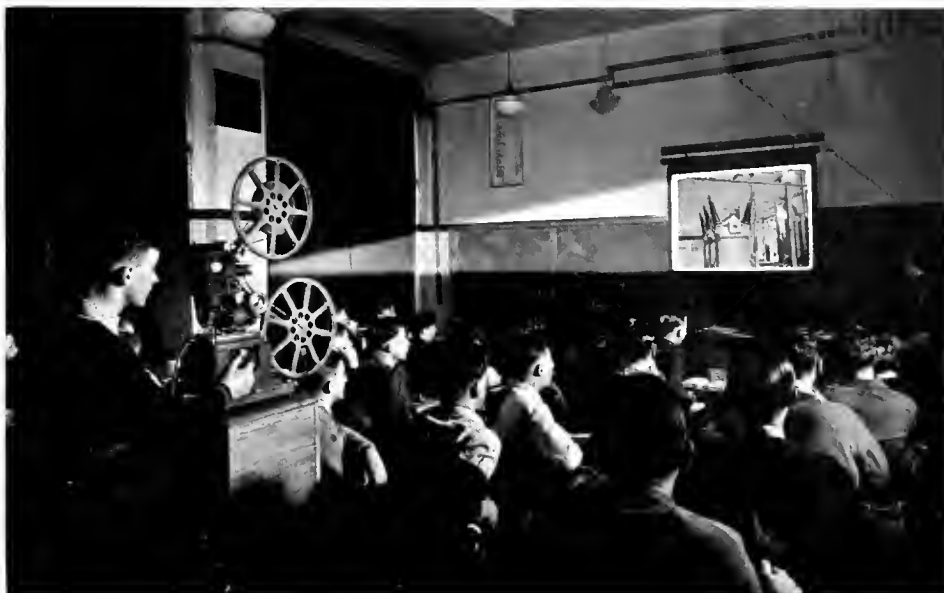
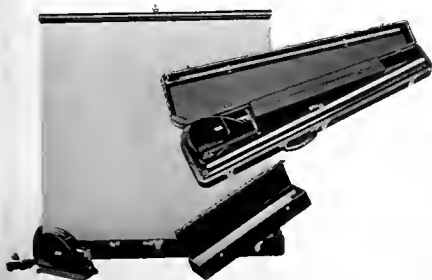

A typical classroom scene in a modern high school shows an educational talking film projected by an advanced modern 16mm. Ampro sound-on-film projector. Representatives of this company report that on a recent visit to one of the world's largest high schools they found projectors in use by classes preceding and following one they attended — while 2,000 students were attending the presentation of another educational talking film in the school auditorium.

meetings, sales demonstrations etc. almost anywhere. It will be particularly advantageous in the sale of farm equipment, mining machinery and similar 'on-the-spot' sales."

♦ The Victor Animatograph Corporation announces that animatophone sound quality, which has consistently rated as 16mm's finest, has been improved.

Specifically, the changes are as follows: (1) Model 26 Universal (AC-DC) — Volume increased to Nine Watts; 750 Watt lamp and 12-inch Hi-fidelity Speaker are now supplied as standard equipment. Price remains at \$395.00.

(2) Model 25AC — Old 10 Watt output "upped" to 18 Watts with 1 speaker, 30 Watts with 2 speakers. Price remains at \$415.00 with Twelve inch Hi-fidelity P. M. Speaker. Extra speaker, \$40.00.

(3) Model 38 — (Formerly 30 watts with 2 speakers) Stepped up to 30 watts with 1 speaker, 50 Watts with 2 speakers. A new 15-inch Hi-fidelity P. M. Speaker is now standard equipment. \$545.00 with one speaker; \$595.00 with two. . . . Above wattage outputs are NOT based on any overload! With A. C. models, the full rated output is obtained with a maximum harmonic distortion of only 2 percent; says the company's recent release to *Business Screen*,

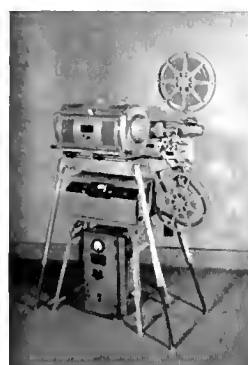

The new Filmoarc, Bell & Howell 16mm. sound-on-film projector, in the adjustable-stand model. Three times as brilliant as the 1200-watt incandescent-lamp Filmo 130 projector, this is tops.

♦ Quantity discounts, long a thorn in the side of progressive equipment manufacturers, particularly in the 16mm. projection lines, are now subject to careful regulation and an improved market condition is the result. The Ampro Corporation and other leading projection manufacturers have announced terms of a "fair-trade" agreement which protects both the small consumer and the dealer in

the matter of unfavorable price discounts to larger purchasers.

♦ The Berndt-Maurer Corporation, manufacturers of a complete line of 16mm. direct "sound-on-film" recording equipment announces an increasing interest in this type of equipment on the part of business film users.

**SEE—HEAR
SOUND
PROJECTS
EQUIPMENT
BEFORE
YOU BUY!**



Model L-105 for audiences up to 500.
Other models for every use.

Buy no slide-film sound projector until you see this new line! *Exclusive, patented features* insure finest projection and reproduction—easier, quicker handling. Endorsed by many leading users and producers of industrial film. *We invite investigation and comparison on every point.* Ask your film producer for details and demonstration—or write us direct.

WEIGHS LESS
EASIER TO HANDLE AND SET UP
TRIPCORD FOR SLIDE CHANGES
SELF-CONTAINED RECORD COMPARTMENT
AC or DC CURRENT

SOUND PROJECTS COMPANY
3140 WALTON STREET CHICAGO



Distinguished

The Drake offers every luxury and convenience of fine living on Chicago's Gold Coast, overlooking Lake Michigan.

A. S. Kirkeby, Managing Director

The Drake

LAKE SHORE DRIVE • CHICAGO



(Continued from
Page 35)

♦ Camera fans and sales managers everywhere interested in the new vogue of projecting their 35mm. miniature camera negatives on the screen can now entertain family and friends or use them in business in this way at slight expense. This popular method of showing interesting shots to whole groups at one time without the inconvenience of passing around albums or loose prints is now brought within the reach of almost every miniature camera owner through the introduction of a clever, low-priced combination screen kit by the makers of Argus Speed Cameras.

The Arguscreen Kit includes one of the new 100 watt portable CP Argus projectors, with slide box of 100 capacity, and an adjustable projection screen 30" x 32" made of finest quality flexible movie screen material, all compactly enclosed in a sturdy protective carrying case.

♦ Telco Color process announced this month at their plant, located at 1257 N. La Brea Avenue, Hollywood, that this plant has started production of color prints for several major studios who are contemplating the use of the Telco color process for 1938-39 productions.

Working from any set of color separation negatives, the new Telco Color print-processing machine is a mechanical color process in which color is applied mechanically and controlled electrically rather than being a chemical or imbibing process.

Test reels have shown, according to the company, that Telco can produce uniform color prints with controlled color density, producing delicate pastel shades, coupled with natural flesh tones, and giving a rich brilliancy of delicate color, at a high rate of speed without loss of quality and with perfect register throughout a reel, having a black-and-white sound track.

Telco first startled the film industry in 1936 when Universal's News Reel used the Telco Color Process to take pictures of the opening day

ceremonies of the Dallas Centennial, and six hours later showed a full color print of the festivities on the screen of the Majestic Theatre, in Dallas, at the same time that black-and-white pictures of the same events were being released in other theatres in that city.

Business Screen will bring a complete description of this and other color processes in the next issue.



George K. Spoor, film pioneer and founder of the famed Essanay Studios, congratulates Herman A. DeVry on the occasion of the recent banquet in Chicago celebrating Mr. DeVry's 25th anniversary.



O. N. Wilton, export manager for Bell & Howell Company, examines his Filmo as he prepares to sail on an extended vacation jaunt to Europe with Mrs. Wilton. *Bon Voyage!*

The Commercial Newsreel

A DEFINITE PART of the editorial program of *Business Screen*, the pages of sketches and designs which appear each month on some phase of motion picture use in business are the work of our design consultants, J. F. BARNES and J. O. REINECKE, industrial designers. The nationally known manufacturers whom they serve, laid end to end, reach to bigger and better sales. And that, they will confide, doesn't annoy them a bit, because while they are committed to the policy of turning out the best designs in the best taste they know, they are at the same time sufficiently hard-headed business men to feel that the best test of product design is "will it sell?"

Designing movie auditoriums and portable projection units is not exactly a new field for our designers. Before they went into product design they were designing, manufacturing and selling permanent and semi-permanent displays and interiors for conventions, conferences and exhibits. They wound up this phase of their activity with a blaze of glory, designing twenty-five major exhibits for Chicago's Century of Progress exposition.



J. F. Barnes and J. O. Reinecke

ANDREW BUCHANAN is the editor of the Gaumont-British Newsreel and an active participant in British film circles. He is also the author of several works on film production, notably, "Film Making, From Script to Screen" and "Films, the Way of the Cinema." His article on "Can Business Use Realism?" which appears on page 39 is a continuation of the discussion of British film trends in the commercial-documentary field.



Andrew Buchanan

An abundance of editorial material, most of which descended on the offices of *Business Screen* during the last weeks of July at presstime presages some excellent articles for the coming Issue Number Three. *Modern Packaging Magazine* has contributed a fine background story on their film *Over the Counter and Off the Shelf*; Household Finance, Stewart-Warner (Alemite), Standard Oil of Indiana, Republic Steel, Edison and other outstanding organizations have cooperated in assembling remarkable case-histories of their film activities.

Complete technical background material on various color processes such as Technicolor, Cinecolor, Dunning Process, Brewstercolor, Dufaycolor, Kodachrome and similar methods will be thoroughly discussed. The tremendous increase in interest accorded color by both motion picture and slide film users has been justified by the excellent product now being turned out.

"Men Make Steel" To Be Shown At Chicago

An unconfirmed report received as *Business Screen* was going to press for this month states the recent United States Steel all-color motion pictures, *Men Make Steel*, have been booked to appear on the screen of the Chicago Theatre, Balaban & Katz Loop deluxe house during August. This outstanding example of the best in industrial film production has met with extremely favorable audience reaction wherever shown. It is discussed by Pare Lorenz, movie critic of *McCall's*, on page six of this issue.



Dramatize WITH SLIDEFILMS!

For stop-action pictures, that show exactly what takes place . . . there is no substitute for SLIDEFILMS. Your sales message or employee training program, presented via this medium will make a dramatic and lasting impression . . . SLIDEFILMS, the ideal visual aid, serve best when

SHOWN AT THEIR BRIGHTEST BY

S. V. E. PICTUROL PROJECTORS

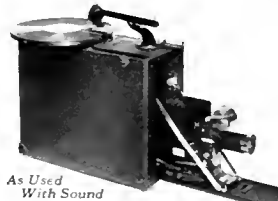

As Used With Sound

The advanced optical system in each S. V. E. Picturol Projector reproduces every view on the screen at its brightest and clearest, with details sharply defined. It is the result of 19 years of leadership in slidefilm projection equipment, by the originators of the slidefilm stereopticon.

THOUSANDS IN USE

The roll call of users of S. V. E. Picturol Projectors includes hundreds of progressive companies such as Chrysler, Coca Cola, Crane, Firestone, Ford, General Electric, General Foods, General Motors, Goodrich, Goodyear, Household Finance, Iron Fireman, Milk Dealers Asso., National Safety Council, Servel, Standard Brands, Standard Oil, Stokel, U. S. Rubber, Westinghouse, Williams Automatic.

Specify S. V. E. PROJECTORS in your Sound Slidefilm Units

For brilliant pictures, utmost convenience in showing and adequate protection for your film, be sure that your sound slidefilm units have S. V. E. Picturol Projectors. Other projectors may look like S. V. E. equipment but none can duplicate its patented features and time-proved superior performance. The interesting folder on Slidefilms entitled "Salesmen Are Made" illustrates S. V. E. Picturol Projectors for every requirement. Mail coupon now for your copy!

FREE LITERATURE — Mail Coupon!

SOCIETY FOR VISUAL EDUCATION, INC. • Dept. 6B, 327 S. LaSalle St., Chicago, Ill.

Send immediately your free folder "Salesmen Are Made" describing S. V. E. Picturol Projectors.

Tell us about your new S. V. E. Automatic FilmSlide Take-Up.

Name _____

Firm Name _____

Address _____

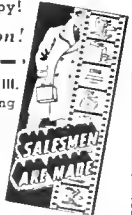

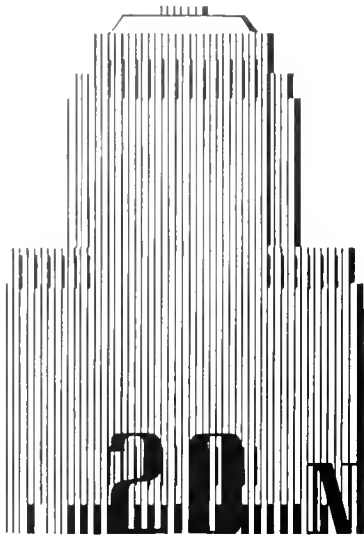

**Make your office headquarters near
Chicago's finest sales meeting and
convention facilities—now available at**

20 NORTH WACKER DRIVE

Consider the advantages of 20 North Wacker as your office headquarters in Chicago. Within the walls of this great building are five luxurious theatres, seating from 75 to 4,000 persons; a fine club with superb dining accommodations; floors of exhibit and display space! Here you can present your sales programs, project commercial films or even hold a good sized convention!

20 North Wacker meets the growing demand among national business organizations for these complete accommodations under one roof. Efficient and economical office facilities — unusually light and airy — are available for large or small concerns. Plentiful and friendly service by a large and experienced staff is accorded here to every tenant.

Centrally located just outside the congested area, 20 North Wacker soars 44 stories, over the neighboring business district. Principal street car, elevated and motor coach lines to all sections of Chicago pass our front doors. Just a few minutes away are the Northwestern, Union and LaSalle stations and other principal railroad terminals.

Let us show you how 20 North Wacker can cut your convention and sales meeting budgets — how truly economical and efficient our superb office facilities really are — why so many great national organizations have moved their headquarters to 20 North Wacker in Chicago!

A typical small theatre within the 20 North Wacker Drive building



Fine office facilities at economical rentals for desirable tenants



Another unusual theatre for group meetings and business gatherings



ADDRESS INQUIRIES TO THE OFFICE OF THE PRESIDENT · J. C. THOMPSON · 20 NORTH WACKER DRIVE · CHICAGO

Can Business Use Realism?

ANOTHER VIEW ON THE BRITISH
FILMS — BY ANDREW BUCHANAN

THOUGH BRITAIN has failed financially, not technically, to win success with her feature films, she has no equal in an entirely different class of picture which is growing in importance every day — the Documentary. Now what is this kind of film all about? Why does it have such a ponderous, austere name? Because it provides evidence of existing conditions—good or bad. It presents facts, and dramatizes reality without falsifying it. It projects the soul of a nation instead of merely its supper parties. I believe, with a few others, that the true function of film is to show what other media cannot, instead of always feeding on the legitimate theatre and the novel. Consequently, I favor Documentary films, because they feature real backgrounds instead of studio settings.

Documentalists in England are a race apart, having little connection with the makers of fictional features. They work economically. Their overheads are not crushing. They utilize the living material around them. Their films are created out of industry, education, housing, travel, and all kinds of ordinary things. They contain no entertaining stories. The characters are real people going about their usual jobs.

Therefore, the average Documentary lacks glamour. It must necessarily do so, but it appeals to people who prefer facts. Moreover, it is encouraging the film to establish itself as a medium capable of portraying material which no other can attempt to present. That is the vital point. The finest and most intelligent

Andrew Buchanan is editor of the Gaumont British News and familiar with the movement around which the many commercial documentary film activities in England are centered.

craftsmen have concentrated upon Documentary film-making and industrialists and educationalists are becoming increasingly film-conscious by reason of those efforts.

Many Documentary films are sponsored by great industries and corporate bodies, but do not confuse the results with advertising films. They are bigger than that—far bigger. The resources and ramifications of a nation can be projected clearly and dramatically by a well-made Documentary production.

But I advocate carrying this vital work a stage further, for I contend that as on the one hand, we have failed, through possessing only a limited market, to make feature films which secure profits, and, on the other, have succeeded in making first-class Documentaries, we should extend the work at which we succeed into the sphere in which we fail, and create the Fictional-Documentary film — that is, employ documentary principles to the creation of Fictional stories.

What does that mean? That our features would be enacted against real backgrounds



that could never be recreated in a studio. Make industry, city life and scenic splendour form the backgrounds against which our dramas and comedies would be enacted. It has been done several times. There is a film called *The Edge of The World* that is a fine example. Many American features have been framed by realistic surroundings, but the Documentary angle has not been sufficiently emphasized, and artificiality has crept in as usual. The great expensive system of making motion pictures has established a belief throughout the world that there is only one way to make them, but the world outside the studio is offering an alternative. In time, the pioneer work of Documentalists will mould picture-making into new shapes, and backgrounds will star equally with the players.

However, apart from the Fictional-Documentary of the future, which will surely place Film in a category as being an independent medium of expression which has no need to borrow its material, the present perfection of

(Continued on Page 43)

EVERYTHING YOU NEED

CREATIVE STAFF
CAPABLE CREWS
HOLLYWOOD EQUIPMENT
LARGE MODERN STAGE
EFFICIENT LABORATORY

TO PRODUCE YOUR PICTURE

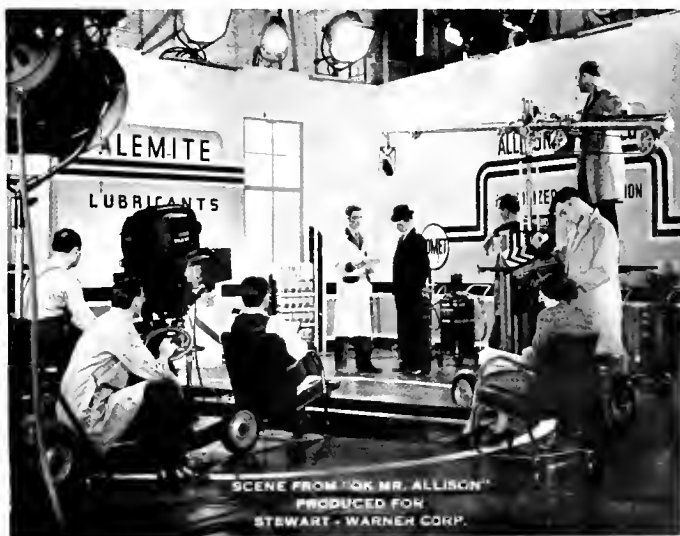

CHICAGO FILM LABORATORY, INC.

SOUND STUDIOS
18 West Walton Place
CHICAGO, ILLINOIS
MOTION PICTURES · SLIDE FILMS



BRIEF REVIEWS OF RECENTLY RELEASED

Short summaries on interesting new productions for business and educational group distribution; sales-training and other uses.



"CENTURY of SERVICE"

Sound slide film. **Length:** 30 minutes. **Sponsor:** Norfolk & Western Railroad. **Produced by:** Vocafilm. **Type:** Historical narrative. **Story:** One hundred years of railroad history are telescoped into this 30 minute sound slide subject which is unique in several respects. First, an immense cast of 250 railroad employees was used to depict the historical characters and, secondly properties were made in the railway shops. **Distribution:** In Norfolk & Western territory, among club groups, business and trade organizations. Other showings on request.



"THE STORY of a HOUSE"

Sound motion picture. **Length:** 2 reels. **Sponsor:** Public Service Gas & Electric Company. **Produced by:** Audio Productions, Inc. **Type:** Public relations with subtle advertising. **Story:** Around a romantic narrative of two young people is woven the theme of modern homebuilding with its labor-saving appliances as contrasted with the drudgery of yesteryear. Remodeling angle is similarly stressed. **Distribution:** To clubs and other non-theatrical groups upon request from the producer or the sponsor.



"DOUBTING THOMAS goes to TOWN"

Sound Motion picture. **Length:** 4 reels. **Sponsor:** The United Fruit Company. **Produced by:** West Coast Sound Studios, N. Y. **Type:** Dealer education, primarily. **Story:** This picture starts off with a 2-reel prologue "Hands Across the Sea" depicting banana culture in Central America and a second picture of 4-reels tells the story of a grocer who has his business improved by modern marketing methods illustrated. **Distribution:** Being shown to groups of grocers throughout the country. Display men and fruit market executives principally.



"YOUR COMPANY'S VOICE"

Sound slide film. **Length:** 20 minutes. **Sponsor:** New York Telephone Company. **Produced by:** Vocafilm. **Type:** Public relations, educational. **Story:** The correct way to use the telephone in business and personal affairs is graphically illustrated in this excellent training-type film. Particularly good for salespersons in department stores, clerks, etc. who need good "voice-approach" training. **Distribution:** Through salestraining groups, department stores, etc. on request from the sponsor.



"SEALTEST"

Sound motion picture. **Length:** 1 reel — 12 minutes. **Sponsor:** National Dairy Products Company. **Produced by:** Castle Films, N. Y. **Type:** Inter-organization only for company use. **Story:** This is the modern way of taking the chief executive of a national concern to some 70 subsidiary companies throughout the country. Mr. E. I. Finneran, General Sales Mgr. of National Dairy Products addresses these 70 groups at the outset of the selling season each year. **Distribution:** Through company subsidiaries only.



"ROMANCE of INDUSTRY"

Sound motion picture. **Length:** 7 reels. **Sponsor:** Carborundum Company. **Produced by:** Audio Productions, Inc. **Type:** Institutional Selling. **Story:** This film tells the story of the discovery of carborundum and follows with an interesting resume of its widespread applications throughout industry, including authoritative technical data on the products, etc. **Distribution:** Non-theatrical, school and engineering groups principally, on request from the sponsor to responsible interested groups.

MOTION PICTURES AND SLIDE FILMS

For information concerning films described on these pages address producers or sponsors or the service bureau of Business Screen



"MOUNTAINS of MARBLE"

Sound motion picture. **Length:** 2 reels; 18 minutes. **Sponsor:** The Vermont Marble Company. **Produced by:** Castle Films, N. Y. **Type:** Business education to interested trade groups, technical men. **Story:** Visualization of the immense plants, quarries of the Vermont Marble Company and applications of its fine products in building, etc. A 20 minute film of a two weeks' visit to the plants. **Distribution:** Continuously exhibited by several traveling crews and by projectionists in all leading cities to architects, builders and other interested groups.



"STEP UP SALES PLAN"

Sound slide films. **Length:** varying lengths. **Sponsor: (and producers)** Brobuck, Inc. and the Dartnell Corporation, publishers. **Type:** Syndicated salestraining slide films for general sale. **Story:** This new series, built on the experience of the sales authorities who write for Dartnell, business publishers, contains a great deal of commonsense sales training pointers. Now made available to groups who cannot afford specific personalized subjects. **Distribution:** Sold in sets; information on request from the producer or sponsor.

"PORTRAIT of a WOMAN"

Sound motion picture. **Length:** 3 reels. **Sponsor:** S. H. Camp & Company. **Produced by:** Caravel Films, Inc. N. Y. **Type:** Educational, consumer film, intended for women only. **Story:** Around the interesting theme of Camp's famous "Transparent Woman" is woven the theme of perfect posture and the importance of proper support garments is skillfully suggested. A Broadway cast of competent actors and actresses make this a fine production. **Distribution:** Through department stores, etc. to women's groups, exclusively.



"BRINGING the CUSTOMER BACK"

Sound motion picture. **Length:** 4 reels. **Sponsor:** Talon, Inc. **Produced by:** Caravel Films, Inc., N. Y. **Type:** Dealer education. **Story:** The sound business lessons of good clothing merchandisers are accompanied by a narrative theme on the advantages of the slide-fastener, particularly in the men's clothing field. Illustrations of poor merchandising technique and of the good make this a valuable contribution to the menswear film library. **Distribution:** By projectionists to department stores, etc.



"A BETTER RUN FOR YOUR MONEY"

Sound motion picture. **Length:** 2 reels. **Sponsor:** Ethyl Gasoline Corporation. **Produced by:** Audio Productions, Inc. **Type:** Consumer selling. **Story:** A demonstration of the Ethyl Clinic in operation, featuring John D. Kennedy. The picture stresses the importance of proper motor adjustment as well as the advantages in use of the Ethyl gasoline product. **Distribution:** To dealer and service station groups and other non-theatrical showings by arrangement with the sponsor upon written application.



"THE TUTTLE TUGGER"

Sound motion picture. **Length:** 4 reels. **Sponsor:** Deere & Company. **Produced by:** Wilding Picture Productions, Inc. **Type:** Consumer; public relations. **Story:** Entertaining background of the third public relations subject Wilding has made for Deere & Company in two years. As usual, the Deere product is brought in subtly and the story concerns the adventures of a city salesman contacting buyers of farm implements. **Distribution:** Farm and rural audiences; on request for such groups.



"With the Compliments of 'X' Company, Ma'am"

All over the country, every day, cheerful, efficient, smartly uniformed Postal Telegraph messengers are delivering samples and other advertising materials—adding punch and emphasis to the sales messages of smart merchandisers everywhere.



A breakfast food manufacturer distributed millions of samples throughout the U. S. . . . a hair-oil manufacturer tested the market for a new product . . . an automobile concern distributed in 1,100 cities more than a million and a quarter invitations from its president to prospective customers to visit the showing of a new car . . . a nationally known manufacturer of surgical appliances distributed messages and show cards to more than 20,000 drug stores in one day, tying into a national newspaper advertising campaign . . . and so it goes. Hundreds upon



hundreds of manufacturers, jobbers, retailers and agents during the past six or seven years have used Postal Telegraph's special messenger service as an integral part of their advertising and sales promotion campaigns.

Here is a service, which for quick coverage of a nation, a section, a city or a neighborhood, may be used to reach any number of persons in a highly individualized manner—and at a cost which is surprisingly low. A Postal Telegraph representative will call at your request.

Postal Telegraph

BUSINESS SCREEN IS DISTRIBUTED BY POSTAL TELEGRAPH MESSENGER

TIPS FOR BETTER SHOWS

1. SCREEN ILLUMINATION:— Improper illumination may be due to one or more of the following causes: dusty or dirty objective or condenser lenses; misalignment of optical system; a soiled or inefficient screen; too long a throw for the light source available. Lenses should be cleaned before every showing with a soft cloth or Kleenex. Misalignment of optical system should be corrected by a factory expert. For most purposes the glass-beaded screen is the best. It may be washed, from time to time, with soap and water, or may be reconditioned at the factory. Wider angle lenses, although giving a larger picture, cause greater light dissipation.

2. GOOD REELS ARE CHEAPER THAN NEW PRINTS— One of the most foolish "economies" of some commercial film users is the continued use of worn or bent reels, or flimsy reels. Costly prints should be protected, both in transit and during projection, by well-constructed reels, in good condition.

3. PRESENT A VARIED PROGRAM— Showmanship— both in slide-film and movie presentations— is a most important factor. This means a careful choice of film subjects and correlated program material. For both dealer shows and consumer shows, be careful to select films that will appeal to the group in question. If possible, preview supplementary films. It is often a good policy to add a brief comedy, travelogue, or other subject to slide-film shows.

4. CHECK LINE VOLTAGES— Operators should check up on line voltages when giving road shows. This is most easily done by removing a lamp from its socket and noting the reading thereon. Most amplifiers (sound slide or motion picture) are made for operating on 50-60 cycle current. For twenty-five cycle current, a special transformer on amplifier is needed. Note also that all amplifiers must be operated on alter-

nating, not direct current. In the event direct current only is available, use a small converter.

5. HELPING TO OVERCOME POOR ACOUSTICS— Acoustics of halls are by no means always uniform. Experiment with various angles for speaker. If hall is wider than it is long, two speakers should be used, their beams crossed. Empty pasteboard cartons placed behind the speaker in "barny" structures often helps greatly to overcome reverberation.

6. PROTECT RECORDS AND FILM STRIPS— Many a sound-slide showing has been hindered through using a scratched record or badly scratched film strip. Film slide strips should be kept in their metal containers. It is a good idea to keep records within their envelopes at all times, and separated from loose parts, needles, etc., which might scratch or damage them.

Documentaries—

(Continued from Page 39)

realistic production is interesting. Industry, perhaps, provides the greatest chance to creative people, for they make mechanical processes seem as exciting as a car chase, by the ingenuity of their cutting, their dramatic camera angles, and the illustrative music which increases the general appeal. Britain possesses some of the loveliest and most historic back-grounds in the world and is realizing that they offer ready-made screen material gratis.

This film will ultimately be the means of recording reality, fictional or otherwise, and from each nation there shall flow films *which could not have been made in any other nation*, yet possessing world appeal. Just how important that is may be realized by pointing out that *a film made in Britain is by no means a British film*, if it has been produced entirely within studio walls.

JOHN R. FREULER

Invites You

TO TRY THIS UNIQUE LABORATORY SERVICE



SPECIALIZING IN
THEATRICAL, INDUSTRIAL,
HOME MOVIES
AND SLIDE FILMS

Our scientific laboratory equipped with automatic developing machines, printing machines, picture and sound track reduction printers, cutting rooms and projection rooms and our personnel with 30 years active service in the motion picture field guarantee you both skill and speed. Our capacity . . . 35mm. and 16mm. . . is 1,000,000 feet per week. You won't appreciate how excellent your photography is until you have American make your prints. Ask us to quote on your next job.

SPECIALLY CONSTRUCTED VAULTS
FOR FILM STORAGE

American Film Corp.

6227 N. BROADWAY, CHICAGO

PRODUCERS . . . LABORATORIES . . . DISTRIBUTORS

11,500

PERSONS STOPPED
before one grocer's store window, while only

654

paused at the grocery
window next door!

WHY?

Because THE NEW DAY-LIGHT REPEATING MOVIE PROJECTOR is a revolutionary SYSTEM of point-of-sale advertising. Clocked by one of the Nation's leading advertising agencies—



A DETAILED BREAKDOWN OF THIS SURVEY WILL BE SUPPLIED ON REQUEST

It is of value to every advertiser in America

The DAYLIGHT REPEATING PROJECTOR gives a clear picture—even in bright sunlight. Long film life. Silent. One minute interlude, automatically, between each show.

LET US DEMONSTRATE IT FOR YOU

National Sales Representatives
WEST COAST SOUND STUDIOS, INC.
510-22 West Fifty-Seventh Street
New York Circle 7-2062 N. Y.
Producers Of Sound And Silent Pictures For
Business Purposes

SPINN-BITZEN STUDIOS

Producers and Creators
of Animation

TECHNICAL... CARTOON MEDICAL... INDUSTRIAL

SHLAND-IRVING BLDG. CHICAGO, ILL.

Safety Lessons We All Need

NATIONAL SAFETY COUNCIL FILM
WAGES WAR AGAINST HAZARDS

AFTER EIGHT years' experience in augmenting safety training with silent films, the National Safety Council has just produced a sound slide film which promises to be an outstanding first in a new series for industrial distribution.

This test production, dedicated to the prevention of accidents by falls, is quite appropriately named, "The Fall Guy", and was planned to fill a definite need since 26,000 people were killed by falls in the United States last year. Fatalities due to these accidents average seventy-three daily.

Since June 1st, when this production was completed by the producer assigned to the job, the National Safety Council has been swamped by demands for industrial showings. Although only an eighteen-minute talking film, composed of eighty-three frames, "The Fall Guy" carries a load of human interest. Public acceptance has even exceeded the hopes of E. I. Woodbury, Assistant Art Director of the Council, who championed the film cause through his organization's planning conferences. It was found they had given industry something that filled a great demand and yet at prices hitherto unheard of in sound film. Members of the National Safety Council were offered this additional safety service at the low cost of \$7.50 for film and record. Or copies could be rented at the very small charge of \$2.75 for the first week and \$2.25 for each additional week. The fact that the National Safety Council is a non-profit organization made these prices possible.

Just a short paragraph in the June issue of the "National Safety News", the Council's magazine to industry, created such a large response that a re-order of prints and records was necessary to fill the demand. One hundred and seventy-five copies have been distributed to date. It is estimated that to date over 400,000 workmen have seen this entertaining and educating subject.

As may be seen in the edited film published in this issue, a unique treatment of presentation is adopted which contributes to sustained interest and arouses emotions. For the most part, the production is a dialogue between a careless worker, who becomes "The Fall Guy," and Death as symbolized by the skeleton. The careless worker falls from a stack of boxes and strikes his head a terrific blow. It is while in this state that he has a dream which results in a rendezvous with Death. The conversation with the skeleton might have been very gruesome and revolting under less capable direction, but the skeleton's voice is light rather than gruesome and the film avoids becoming a

slapstick burlesque to become a modern fable in fantasy. The skeleton is even witty at times and refuses to take seriously the workman's vows to be careful in the future. Throughout this clever dialogue the various causes of dangerous falls are revealed by word and picture, and ways of prevention are clearly pointed out.

The film carries enough human appeal to balance its safety training points which carry a real message for any assembly of industrial employees. However, it is excellent for children as well, for it shows how falls kill and injure people, not only at work, but at home, on the street, or at school.

Organizations that have shown the most interest in securing this production are various industries, transportation and insurance companies, schools, local safety councils, chambers of commerce and departments of municipal government, although it was planned originally for industries alone. Of course, distribution will be made through these local organizations, who either have their own projection and sound equipment or rent it locally for the purpose at \$10.00 a week.

Naturally, "The Fall Guy" has paved the way for an entire safety series and the National Safety Council is already planning the second sound slide film which will be devoted to infections and infected wounds. This picture is planned for release about September 1st and will have considerably more frames. After that, the Council will produce four talking safety films annually to educate the careless in industry, business, school and home. And with ideas as clever as those in "The Fall Guy", sound slide film should do the job well.

THIS IS A SLIDE FILM ▶

With a few final scenes excepted, an entire slide film is presented in the adjoining strips, illustrating the photographic methods used in this visual medium. Together with its all-important sound record, the slide film merely consists of a series of individual scenes printed together on a convenient strip of celluloid. But this continuous strip, possessing no actual motion effect, has a rare magic of persuasion which makes it an ideal medium for economical presentation of sales training material, actual sales portfolios, and for many other uses. Today, with color as a fourth dimension, it is achieving vast new significance. (Scenes from "The Fall Guy," produced for The National Safety Council for general industrial distribution.)



ACCIDENTS
ARE COSTLY!

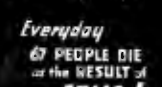

Everyday
67 PEOPLE DIE
as the RESULT of
FALLS!

WHEN—
3m4
—**RUN!**

NEVER USE IT
MAKE-SHIFT!

ALWAYS
KEEP RISLES
CLEAR!

(Continued from Page 13)

◆ WHILE SALES MANAGERS are pulling their hair out by the handfuls these days and worrying about the inefficiency of their sales forces, one of the leading slide-film producers joins forces with the Dartnell Corporation to launch a new program of sales training that is harnessed to the medium of visual-auditory education.

Tests have shown that salesmen seeing a talking slide-film remember five times as much as they do hearing a lecture. So the Dartnell Company, who have spent more than twenty years in gathering and disseminating selling information, have collaborated with a commercial slide-film concern to produce a syndicated service of sales training through this medium. It consists of a series of eight 15 minute productions, each dealing with basic fundamentals necessary to successful selling. "The Step Up Sales Plan", as it is called, teaches salesmanship as applied by successful salesmen in many lines of industry. Covering many lines and types of products and showing the successful methods of thousands of salespeople throughout the country, the series is readily adaptable to any type of business and any kind of sales person.

True, big industry has for years afforded its own private slide-films devoted to sales recruiting, dealers' organization and even sales training. But the entire company's program of training and an elaborate background of the institution were often crowded into one 20 minute production. No salesman could possibly digest the meat of the story in less than a dozen showings. Each of these training films is devoted to a single step in the presentation of a time-proven sales procedure suited to any commodity or service.

Statistics tell us that 30% of the men on every sales force make 70% of the sales, while 70% of the salesmen make but 30% of the sales. If it is possible, through effective visual media for this great 70% to be fundamentally trained and improved, the future of American Industry will rest securely on the capable shoulders of the nation's salesman.

A scene from the recent historical slide film produced for the Norfolk & Western railroad for local Southeastern distribution. (reviewed on Page 40 of this issue)



business
or pleasure

it is Results you
want . . . so select the

RCA 16 mm
Sound on Film

camera and be assured of getting results you can be proud of . . . Bass engineers have perfected accessory apparatus assuring you of successful work . . . made as easily as "silent films". Our special department for

Industrial apparatus for making moving pictures is at your service. Come in or write us of your needs.

Write for special Cine Bass Bargaingram No. 234 . . . listing thousands of items 8 and 16mm. — sound and silent . . . all real values.

Bass
CAMERA CO.

Dept.
BU

179 West Madison Street
CHICAGO, ILLINOIS

Mr. Advertiser . . .

When you contract for space in a newspaper, trade paper or magazine, you are simply leasing white space to serve you in selling. What goes into that white space is what determines the result you obtain.

You make a dandy layout. You make a fine halftone, you carefully go over your copy. After it's set you're disappointed. Why? Because the typographer did not interpret your message correctly. It takes lots of training and artistic ability to be able to put type together in such a way that it tells a good story.

Here at Advertising Typographers we have the training and the artistic ability to interpret your message and present your story in the best possible manner. Let us do a Typography Job for You and see if you don't like the way we do things.

ADVERTISING TYPOGRAPHERS, INC.
341 EAST OHIO ST. TEL. SUP. 0813

NEW PUBLICATIONS

Copies of which may be obtained, without any obligation, simply by addressing the Screen Service Bureau of this magazine at 20 North Wacker Drive, Chicago and attaching your letterhead or card to a clipping of this column.

★ ★ ★

REEL NEWS, a tabloid newsmagazine published by Wilding Picture Productions, 7635 Grand River Avenue, Detroit, Michigan contains interesting informational material on films in production.

PLEASE FORWARD THE ABOVE TO ME

INDUSTRIAL SERVICE LETTER, a monthly publication issued by the DeVry Corporation, 1111 West Armitage Avenue in Chicago offers helpful personalized pointers on the use, distribution, etc. of your industrial films. Sent on request to executives.

PLEASE FORWARD THE ABOVE TO ME

WE SECOND THE MOTION, is a well-illustrated 36-page book of "pointers and suggestions for those who produce their own business motion pictures" and is issued by Burton Holmes Films, Inc. at 7510 North Ashland Avenue, Chicago. Sent to interested firms and individuals upon written request.

PLEASE FORWARD THE ABOVE TO ME

VICTOR ANIMATOGRAPH COMPANY of Davenport, Iowa publishes an interesting catalog of modern 16mm. projection equipment which contains much helpful information. A film directory is also published annually by this well known equipment concern. Address them directly or write our Screen Service Bureau for equipment catalog material.

PLEASE FORWARD THE ABOVE TO ME

PROCEEDINGS of 8th SESSION, National Conference on Visual Education and Yearbook on Visual Education. An authoritative document containing the speeches and proceedings of the 1938 Conference in Chicago and a yearbook section containing valuable data on recent developments in the audiovisual education field. Circa 130 pages, bound in heavy cover stock and priced at 50c a copy. Address the National Conference of Visual Education at 1111 West Armitage Ave., Chicago.

PLEASE FORWARD THE ABOVE TO ME

EDUCATIONAL FILM CATALOG published by H. W. Wilson Company of New York with periodical supplements contains listings of pictures released for educational distribution. This splendid record contains accurate and fairly complete records of films in this field. Address the H. W. Wilson Company, 950 University Avenue, New York City.

PLEASE FORWARD THE ABOVE TO ME

Mail this with Card or Letterhead to
SCREEN SERVICE BUREAU
20 NORTH WACKER DRIVE - CHICAGO

Close-ups and Long Shots

THE NEWS REVUE OF THE BUSINESS FILM WORLD

(Continued from Page 6)

◆ One of the significant statements of the month is contained in this excerpt from the recent report of President Hutchins of The University of Chicago, which under the heading of "New Developments" calls particular attention to the progressive work being done on the University's extensive film program. The statement is an ideal summing-up of the University's progress in this direction.

"In 1932 the University entered upon the production of educational sound pictures with Erpi Picture Consultants, a subsidiary of the American Telephone and Telegraph Company. Twenty-eight pictures have now been made; two more are in production. They are used in schools and colleges all over the country, and are a regular part of the instruction in our own general courses. The University has made a valuable contribution to the development of new methods of teaching and one which is certain to be more and more important as a complete film library is built up. The saving of time, money, and effort; the improvement in instruction which the pictures make possible; and their effectiveness as teaching devices all point to widespread use of this medium at all levels of education."

◆ The new \$250,000 plant of Cinecolor is now being built in Burbank, California near the Warner Brothers studio. The two story building will have 24,000 square feet of floor space and facilities to handle a million feet of film weekly. A. J. McCormick is president; Howard C. Brown, vice-president of the concern.

◆ Ted Eshbaugh Studios, Inc., 35 West 45th Street, New York City, announce that William

Russell, N. B. C. baritone, has been engaged as narrator for a series of commercial animated cartoons for the Aetna Life Insurance Company and the National Carbon Company.

◆ Something new in commercial film production will be released shortly by Caravel Films of New York. A world-famed troupe of puppets have been cast as the principal stars of a new film series for a national account and some entirely fresh and original effects are the pleasing result.

◆ A last-minute news release received from Electrical Research Products, Inc., announces the perfection of a new 16mm. sound film recorder which is now ready for the industrial and educational film market.

◆ In its eighth session the National Conference on Visual Education and Film Exhibition drew a gathering of over 600 enrollees.

Outstanding visual educators, motion picture executives, industrial film producers, and representatives of various commercial organizations using motion pictures met June 20 to 23 inclusive, Chicago, to view the latest educational and commercial film releases.

Among the films exhibited were: *German North Sea Coast* by Fred Semb of the German Railroads, Chicago; Fireman's Fund Insurance Co.'s *Remember Jimmy*; DeVry School Films; Social Security Board's *Today's Frontiers*; WPA's films *Hands and We Work Again*; International Harvester Co.'s *Modern Education at Beaverton Consolidated Schools*; Borden-Wieland's *The 80 Years*; World's Peaceways, *Thunder Over the Orient*; Ford Motor Co.'s *Making Safety Glass* and *Yellowstone National Park*; and a large number of other films of the government documentary, advertising, training, and classroom study types.

Sessions were devoted to open-forum discussions conducted by such authorities as Dr. I. E. Deer of the MPPDA on "Human Relations Films"; A. P. Hellin of Lane Technical High School on "Movie School Production Problems"; Stuart Grant of Pure Oil Co. on "Laboratory Problems in Film Production"; L. W. Cochran of the State University of Iowa on "School Distribution and School-made Films"; Wm. E. Morse, Co. Supt. of Schools, Malad, Idaho on "The County System of Film Distribution"; O. H. Coelln, Jr., editorial director of *Business Screen* on "The Correlation of Educational Films and Industrial Problems"; and George Rilling, Supt. of Schools, Anna, Ohio on "School Films".

TEAR OUT PAGE ALONG THIS LINE AND ENCLOSE WITH CARD OR LETTERHEAD ADDRESSED TO BUSINESS SCREEN, 20 N. WACKER DRIVE, CHICAGO, ILL.

YOU may be the man we want . . .

If you are a contact man of executive stamp and advertising account executive type, experienced in commercial motion pictures and slide-film sales training programs — and capable of meeting on an equal footing executives of large companies, a letter telling WHY you are the man we want may lead to an adequate straight-salaried position with a large producer. Appearance must convey impression of forceful maturity. Man of large stature preferred. Send photograph and complete details about yourself. Our organization knows of this ad. Box 23 Business Screen Magazine.

Now You Can Get **QUALITY** Sound Projection at **LOW COST**

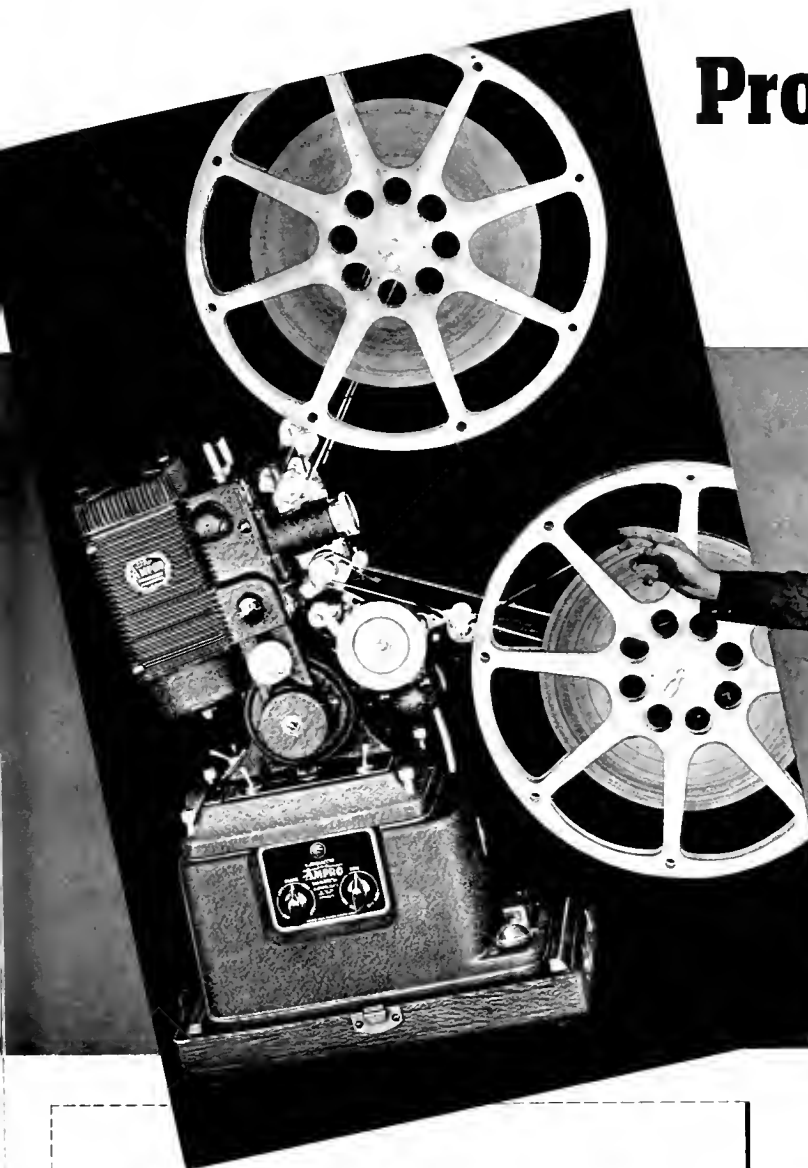

THIS NEW POWERFUL AMPRO A.C. MODEL "U" HAS AN UNDISTORTED AMPLIFIER OUTPUT OF 15 WATTS - ENOUGH FOR AUDITORIUMS SEATING UP TO 1500-750 WATTS ILLUMINATION-ALL THE REGULAR AMPRO QUALITY FEATURES-AND COSTS US ONLY \$395

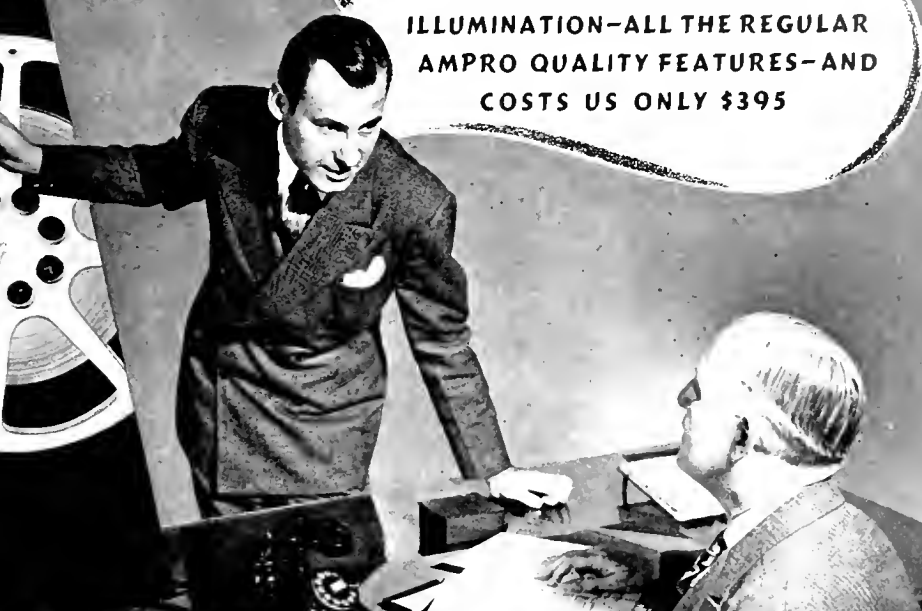

BUILD MORE SALES



WITH THIS AMPRO CONTINUOUS PROJECTOR

For window displays, floor displays, lobbies, conventions, special meetings, — wherever crowds pass or gather — the Ampro Continuous Projector has proven a remarkable attention getter and sales promoter. Ampro's continuous Projectors have been rigidly tested by years of operation. Soundedly engineered, carefully built, they automatically repeat both sound and silent films over and over — with an absolute minimum of service attention. For full details and prices of various models, check the proper square in the coupon below.



Truly this is good news for sales executives who want to extend their use of sound films.

Here is the powerful new Model "U" Amprosound — incorporating all the projector and Sound Head features that have won for Ampro its exceptional reputation for quality — featuring 750 watts illumination with unusual power having an undistorted amplifier output of 15 watts, and at the remarkable low price of \$395.00. This is today's outstanding Sound Projector value!

This model is designed for A.C. current. For use with D.C. current a 150 Watt Converter is required for the amplifier only. It is ideal for auditoriums seating up to 1500, and industrial sales work where maximum illumination and performance are required. It is light, compact, portable and housed in two

easy carrying cases. Projector with Amplifier in one case, the Speaker in the other. Some of its features include:

- Standard Focus 2-inch Lens
- Operates with any Standard Lamp, 750 Watt or under
- Model "U" is equipped with F 1.65 Objective Lens and Pilot Light
- Housed in Blimp Case, \$20.00 extra
- 12 inch Auditorium Speaker with extra jack for Multiple Speaker operation
- Amplifier operates on 50-60 cycles A.C. current ONLY. For D.C. operation use 150 Watt converter
- Projector Motor operates without converter on both D.C. or 25 to 60 Cycles A.C.
- Furnished with carrying case and accessories approved by the Underwriters' Laboratories.
- Licensed under Western Electric Patents
- For full details and specifications, mail coupon below today

Other Ampro sound-on-film models, both A.C. and A.C.-D.C. are available to meet your special requirements. Send the coupon for the complete list.

SEND FOR NEW 1938 CATALOG

AMPRO CORPORATION, 2839 N. Western Ave., Chicago, Ill.
Please send me the new 1938 Ampro catalog. I am particularly interested in

- Ampro 16 mm. Silent Projectors
- Ampro 16 mm. Sound Projectors
- Ampro 16 mm. Silent Models that can be converted into sound
- Ampro 16 mm. Continuous Projectors Silent or Sound

Name _____

Address _____

B5738

AMPRO

PRECISION CINE EQUIPMENT

Ampro Corporation, 2839 N. Western Ave. Chicago, Ill.

Chevrolet Motor Division
General Motors Sales Corporation
P R E S E N T S

A Coach for Cinderella

Western Electric
SOUND SYSTEM
Arrangement: Audio-Cinema

Produced by
The Jam Handy
Organization

COPYRIGHT MCMXXXVII



BEFORE 14,000,000 PEOPLE

This animated cartoon comedy in Technicolor is the first of a new series produced in our Detroit studios. The selling content is blended with entertainment values of the highest order. Technicolor now provides 3-color facilities for commercial

motion pictures in New York as well as in Hollywood.

Our theatrical department is set up for supervised distribution in every part of the United States, with more than thirty theatrical motion picture successes to its credit.

The **JAM HANDY** Organization

Slidefilms • Talking Pictures • Sales Conventions • Playlets

New York, 230 Park Avenue, *M*urray Hill 9-5290 Detroit, 2900 East Grand Boulevard, *M*Adison 2450
Chicago, 35 East Wacker Drive, *S*Tate 6758 Hollywood, 7046 Hollywood Boulevard, *H*Empstead 5809

BUSINESS SCREEN

NO. 3 SEPTEMBER

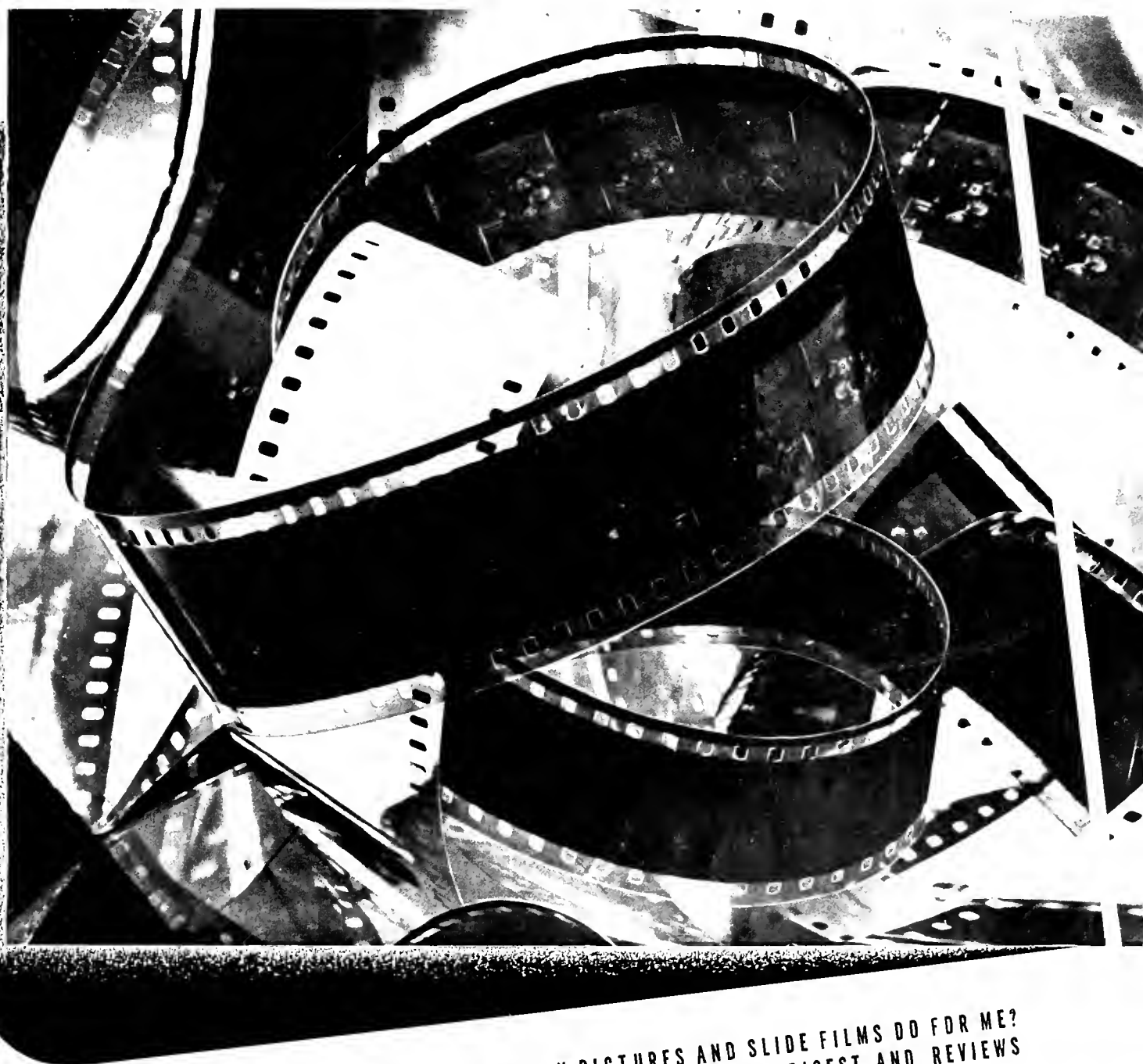

1933

IN THIS ISSUE: WHAT CAN MOTION PICTURES AND SLIDE FILMS DO FOR ME?
COLOR SELLS IT; HELPING THE SCHOOLS; EQUIPMENT DIGEST AND REVIEWS

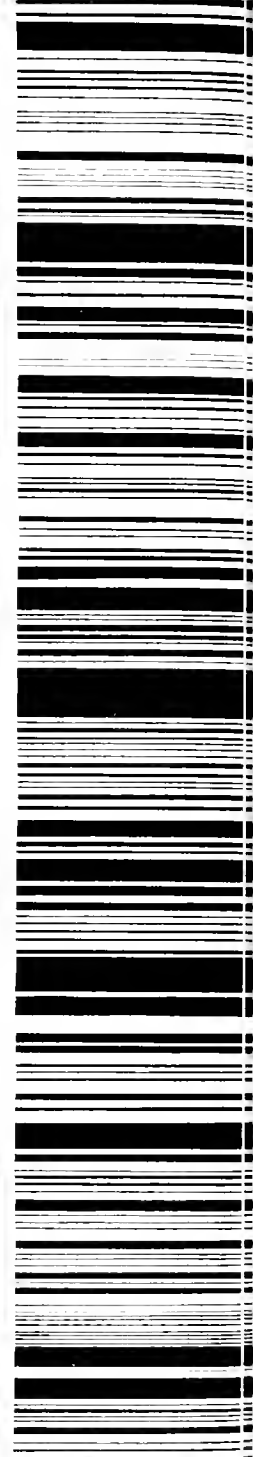

from **NEW YORK'S LARGEST FILM STUDIOS**
 35-11 THIRTY-FIFTH AVENUE, LONG ISLAND CITY, N. Y.

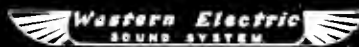

"The President Speaks!"



The company's best salesman . . . the president . . . calls with every salesman who is equipped with sound movies and the

Filmosound PROJECTOR

NOT ONLY the president, but also the salesmanager, the research head, key workmen—even a few of the company's star customers—can accompany salesmen to make *calls that make sales*. With sound movies, the *whole* sales story can be told vividly, interestingly, and convincingly.

TWO RULES FOR SUCCESSFUL BUSINESS FILMS

To insure putting every ounce of sales punch into your commercial talkie, secure the aid of a seasoned industrial film producer.

Then, insure getting the most out of your film by making a careful choice of projection equipment. Select on results! Remember, the very best projection equipment represents only a fraction of your motion picture dollar.

Remember your salesmen. Select easy-to-operate projectors that will guarantee smooth, uninterrupted presentations.

Remember your company. Select projectors with a self-evident quality of appearance that will im-

FAVORITE PROJECTOR FOR INDUSTRIAL FILMS

Single-cassette Filmosound 138, as shown, is preferred for the showmanlike presentations which it affords in salesrooms, showrooms, hotel rooms, or moderate-sized auditoriums. A new, doubly-powered amplifier greatly extends the use of this compact projector for even larger audiences.

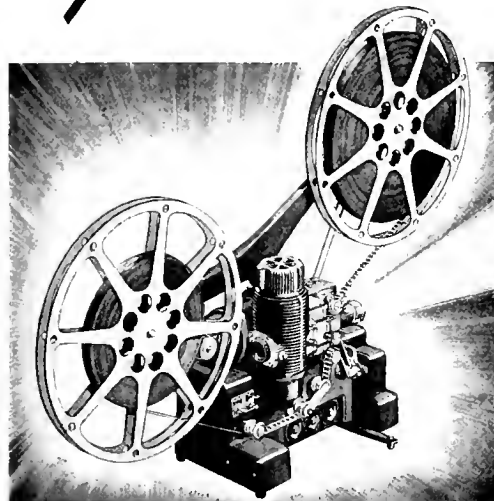

press the gathering audience with the importance which you place on the proper presentation of your film.

Remember your audience. Select theater-quality projectors that will transmit every detail from film to screen in beautiful, brilliant pictures accompanied by crystal-clear reproduction of voice and music.

FILMOSOUND Projectors have been chosen to project the screen stories of Chrysler, Ford, General Motors, Goodyear, Purina Mills, Household Finance, Cunard, and hundreds of others. Because of their performance, Filmosounds are preferred by these experienced industrial film users, just as the Bell & Howell studio equipment has been preferred by Hollywood for more than thirty years.

Write for Filmosound catalog. Bell & Howell Company, Chicago, New York, Hollywood, London. *Established 1907.*

COMPLETE STORY OF INDUSTRIAL FILMS CONDENSED INTO A 36-PAGE NUTSHELL

Interesting booklet—*Showmanship, Today's Formula for Success*—is a crystallized story of modern industrial talkies. How others use them. How to prepare and present an effective sales film. We shall be glad to send you a copy upon request.

SEND FOR FILMOSOUND CATALOG

BELL & HOWELL COMPANY 85 00-34
1808 Larchmont Avenue, Chicago, Illinois
Please send full information on () Filmosound Projectors, () Silent Film Projectors. Also () send special book, *Showmanship, Today's Formula for Success*

Name
Company
Address
City State



BELL & HOWELL

Now A LOW COST "ALL-IN-ONE" Quality Sound Projector

VICTOR MODEL "33"
\$295
COMPLETE
ANIMATOPHONE

All enclosed
DURING OPERATION

VICTOR . . . Manufacturer of the WORLD'S MOST WIDELY USED 16MM SOUND PROJECTORS . . . has devoted over two years to developing a unique new ANIMATOPHONE that literally answers the commercial traveler's "prayer" for a smaller, more compact, more convenient QUALITY Sound Motion Picture Projector!

MODEL 33 ANIMATOPHONE has everything that it takes to make it easier for industrial and commercial users to more profitably employ the greatest of all modern sales tools . . . For carrying, it assembles into one small, compact unit, YET IS ENTIRELY ENCLOSED DURING OPERATION.

A standard feature of Model 33 is the famous PATENTED Automatic Film Protection Device that has saved untold thousands of dollars worth of film for other VICTOR users! "Film Protection that Really Protects." is positively exclusive with VICTOR!

Fidelity of tone and the crisp clarity of Model 33's rendition, insure SOUND REPRODUCTION that is pleasing, natural and wholly understandable. Its brilliant, flickerless projection (at both silent and sound speeds) does full justice to the finest photographic quality.

A SMALL, HANDY MICROPHONE may be plugged into 33's amplifier, thus providing "loud speaker" facilities for sales talks, announcements, comments and demonstration "spiels."

A COMPACT PHONO-RECORD TURNTABLE (with or without record changer) also plugs into the 33 to provide musical background for silent films, or entertainment during reel changes, banquets, etc.

Model 33 accommodates up to 1600 feet of film . . . has sufficient volume for audiences of 300 or less . . . plugs into any A.C. outlet (50-60 cycle, 90-125 volts); 25-50-60 cycle and A.C.-D.C. models can also be supplied. There are other models of the Animatophone for every purse and purpose. Write for literature. Demonstrations—without obligation—will be gladly arranged.



Model 33 assembles into one small compact unit. Removable top of case houses reel arms, reel and attachment cord. Speaker in baffle case is easily detached.



VICTOR ANIMATOGRAPH CORPORATION

DAVENPORT-IOWA

CHICAGO • LOS ANGELES • NEW YORK

"He Still Loves Me..."

**HE'LL BE HOME FOR DINNER
ON AN AMERICAN FLAGSHIP™**



★ Hundreds of miles away this afternoon—but his wife won't be husbandless and lonely tonight! He'll come home rested and refreshed—the modern way! Relaxing, reading, smoking in a luxurious Flagship, flying serenely over dust and noise—saving travel hours for the pleasures of his home.

American Airlines' convenient schedules between major cities give travelers more nights at home, freedom from tedious days and nights on the road. Restful comfort enroute keeps them more efficient, more alert and more alive to the joys of living—takes the fatigue out of travel.

Wherever you're going—whenever you're going—let Flagships give you extra hours where you want to spend them. Daily flights between important cities—and luxury Skysleepers over the Southern All-Year Route from coast to coast. And fares are surprisingly low. Meals are complimentary—and you save 10% on round-trip flights.

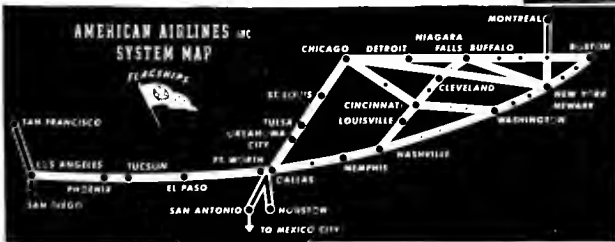

Ask Your Travel Agent or:

AMERICAN AIRLINES *Inc.*

THE AMERICAN STANDARD OF SERVICE

*Flagships are Air Conditioned at Terminal Airports
and Kept Cool by Nature in Flight*



We've GOT TO BAT 10000%! IN THIS LEAGUE!

Wilding Sound Motion Pictures and Sound Slide Films MAKE A HIT EVERY TIME! Each member of the Wilding Merchandising-Creative and Production Staff is a hard-hitting "Regular" with many years of experience in the Big League of American Business. Sizzling hits zoom to every corner of the country from a staff especially equipped to produce them.

HITS mean SCORES and SCORES mean ATTENDANCE in any man's ball yard. The largest yearly attendance at any baseball park in America will be less than half the attendance resulting from just ONE Sound Motion Picture produced by Wilding for a nationally known advertiser.*

Another nationally known advertiser couldn't get to first base in selling an appliance to its dealer organization. A new message, dramatized in film, so changed the batting style, stance and stride of the campaign that the product came out of its slump! Within 30 days sales increased almost 200% over the rate prior to the showing of the Picture. Furthermore, the sales curve clung to the new level for seven months following the first showings. Sales are still running 150% above the level of last year at this time. A Wilding Picture went to bat 225 TIMES at Dealer Meetings—Result: 225 HITS.*

Possibly you are faced with a merchandising angle that is doing tricks with a sales curve. Get in touch with Wilding now . . . allow this producer to demonstrate his ability to step up to your sales curve and bat out the kind of a Hit that will start your Sales Department cheering! Always a Hit . . . No errors . . . And no one left on base!

*Upon your request we not only will be pleased to furnish you with names and case histories of these and other Hits but, by appointment, will be glad to demonstrate Sound Pictures, Motion and Slide, in our Screening Rooms in New York, Cleveland, Detroit, Chicago, San Francisco and Hollywood. YOU BE THE UMPIRE!

WILDING PICTURE PRODUCTIONS, INC.

NEW YORK • CLEVELAND • DETROIT • CHICAGO • SAN FRANCISCO • HOLLYWOOD

BUSINESS GETS THE

idea



MOTION PICTURES AND SLIDE FILMS
OPEN NEW FIELDS OF SELLING

● "The most perfect way of putting ideas into men's heads that ever came into selling" is the definition given by one national sales executive* for the useful purpose of the sound slide film and the sound motion picture. In a recent presentation of its "mass selling" program to dealers, an automobile company calls attention to the 169,603 *showings* of its 89 films to a total attendance of 132,278,912 *persons!* In 33 cities last month, the national sales organization of another automobile maker brought to its dealers' attention the extensive use of motion pictures contemplated in its forthcoming sales campaign. At the same time, literally hundreds of comparatively smaller concerns were discovering the many successful applications of

sound slide films and motion pictures to their own dealer problems, to the training of their salesmen and for the perfect demonstration of their goods and the methods of manufacture.

● Contrary to the Hollywood legend, business is getting the important idea that these media are *not* expensive; that both the slide film and the motion picture may be downright economical because, in many cases for the first time, the sales and dealer job is being done completely and, therefore, done right! The *simplicity* and *economy* of the slide film has made it possible for the very smallest organization to enjoy the fruits of the convincing power of sight and sound selling. The superb *realism* of the sound motion picture is the perfect answer to the con-

fusion and complexity of the business structure.

● A reflection of the amazing possibilities still being discovered in these fields is contained in each succeeding number of Business Screen. National advertising and sales authorities contribute to its pages; industrial designers and skilled film technicians supply invaluable research material. And throughout its pages is maintained a spirit of service to the reader — which goes beyond mere type — into the functions of the several service departments which Business Screen maintains without obligation for the advice and guidance of present and potential users of slide films and motion pictures.

*R. C. Grant, vice-president, General Motors Corporation

MODEL "D"

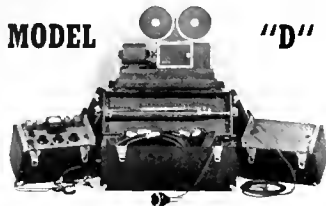

16 mm. SOUND RECORDING SYSTEM

A PROFESSIONAL 16mm. DOUBLE-SYSTEM SOUND RECORDING EQUIPMENT FOR INDUSTRIAL AND EDUCATIONAL TALKING PICTURES.

ALL A. C. OPERATION
EXACT SYNCHRONIZATION
RELIABLE COMPLETE

READY TO OPERATE WITH YOUR SYNCHRONOUS MOTOR DRIVEN CAMERA

\$1985⁰⁰
NET

IMMEDIATE DELIVERY

DEMONSTRATION REEL AVAILABLE

THE BERNDT-MAURER CORP.
117 East 24th Street • New York City

Extra Effort and Care . . .

in 16 mm. sound-film release printing from 35 mm. or 16 mm. negatives results in a Business Film presentation of outstanding technical excellence.

PRECISION

FILM LABORATORIES
A DIVISION OF BERNDT-MAURER CORP.
21 WEST 46th ST. • NEW YORK CITY

CAMERA EYE



NEWS AND COMMENT OF THE STUDIOS

SIGNIFICANT TRENDS: Major automobile companies this month reaffirmed importance of sound motion picture and slide film promotion. New films released by Plymouth were cheered at 51 dealer assemblies throughout the country as the features of the 1939 models were screened. The first sequences in Cosmicolor were included in the new Plymouth films. Chevrolet blanketed its dealer field with a "mass selling" edition of the Dealer News which called attention to its 89 productions which have been shown to 169,603 audiences or a total attendance of 132,278,912 persons!

Chicago's largest automotive retail trade gathering of the year, numbering more than 5,000 specialists, dealers and garagemen. Eight reels of sound motion pictures, the "1938 Eveready Prestone Anti-Freeze Review" were shown in this, the most elaborate of the 750 such gatherings which the National Carbon Company is sponsoring throughout the country. In this program a humorous animated cartoon, a sound camera tour of the big plant in Virginia; an engineering film combining animated mechanical drawings and pictures and a prologue reel dramatizing the use of Prestone by the Thaw motor safari over Africa are all combined to make the eight reel show!

NEW BUSINESS: The Waldorf-Astoria hotel, New York City, has offered to produce a sound movie on hotel front office practice which will be distributed to hotels throughout the country by the membership of the Hotel Greeters of America. The National Professional Baseball League has a new historical film in the cutting-room stage, produced in cooperation with advertising sponsors. *Something ought to be done about a picture for the pro footballers and probably will.* Red Grange and Pure Oil are experimenting with a college football subject for dealer distribution only. There's been too little material available on the subject of heating the household for direct consumer consumption through clubs, etc. Probably because fuel selling is a localized affair except in the oil burner and coal stoker field. Now that the "war" is over, we predict a wave of contract-signing for important commercial film productions which have been postponed — when, as and if . . . check the New York's World's Fair on those contracts for individual exhibitors within buildings . . . same psychology there.

STUDIO AFFAIRS: Eastern Service Studios busy on fall productions . . . Audio has delivered *Cool Heads* to du Pont for Zerone dealer promotion . . . *Guilty or Not Guilty*, sponsored by the Ethyl Gasoline Corporation was also wrapped

up for the dealer field last month. Both absolute clicks. Caravel has a winner in American Can's *Jerry Pulls the Strings*, keystone in the national coffee promotion campaign now on. *The 1938 Eveready Review* was staged and screened by West Coast. Bill Ganz' shoe production for Melville is cutting a wide swath on the club circuit. Those additional 1500 showings which Hiram Walker ordered for its movie through Modern will set real audience records. The Wisconsin Bankers are having Ray-Bell do some pioneering in this field for them; a new picture is in the making. American Airlines will have something to announce pretty soon.

WITH THE INVENTORS: There are a dozen Einsteins at work on those super-continuous projectors (with perpetual motion and Technicolor probably) and one or more of them is going to come up with the goods yet. Satisfactory 16mm. continuous units are available through various manufacturers but the continuous slide film strip and various other perfections of color screening, etc. are keeping the lads up nights. Advertising Projectors and West Coast out of New York City and Ampro and Bell & Howell in Chicago cover the national field with good 16mm. silent motion picture units.

Speaking of continuous units, the Radio City exhibit rooms of the Socony-Vacuum people attract thousands of visitors each day to an advertising-educational exhibit of the company's products. The feature of this show — seen by an average of 6,000 persons daily — is those continuous units around which the crowds gather. The exhibit manager reports few breaks and top-notch interest in the films.

GALLERY OF HORRORS: This department has the makings of a book. A very big book, say about the size of the Encyclopedia Britannica, and loaded with "stills" from the "flop" industrial movies and slide films which would crowd its pages. Reserve a section for those short commercial subjects being produced for the local butcher, baker and candlestickmaker trade by some of the "boys" along Hollywood Boulevard, Broadway and Wabash Avenue in those respective film centers.

* * *

♦ The contract of C. King Charney with C. King Charney, Incorporated, distributors of Agfa Motion Picture Films, the expiration date of which was October 15, 1938, has been amicably terminated.

The name of C. King Charney, Incorporated, will be changed to Agfa Raw Film Corporation, and the company will continue its business at its present quarters in Hollywood.

... a good film is known by the **MERCHANDISE** it sells

PROOF

If you want proof that Caravel
Pictures get results, check with

American Can Company
Atlantic Refining Company, Inc.
Wallace Barnes Company
Beck, Koller & Company
Bethlehem Steel Company
Black & Decker Manufacturing Company
Calco Chemical Company, Inc.
S. H. Camp & Company
Cluett, Peabody & Company, Inc.
Congoleum-Nairn, Inc.
Davis & Geck, Inc.
Dictaphone Sales Corporation
Eastman Kodak Company
Goodall Company (Palm Beach Suits)
The B. F. Goodrich Company
Jenkins Bros.
Johns-Manville Corporation
Kenwood Mills
National Biscuit Company
National Distillers Products Corporation
National Lead Company
Raybestos-Manhattan, Inc.
Socony-Vacuum Oil Company, Inc.
E. R. Squibb & Sons
Talon, Inc.
U. S. Industrial Alcohol Company
OR ANY OTHER CARAVEL CLIENT

HOW many customers and prospects does it take
to justify a picture? And make it pay?

We know of one instance where a Caravel picture, shown to a single prospect, switched a \$12,000 contract — after it had been awarded (though not delivered) to a competing company.

On the other hand, we venture the opinion that out of some twenty odd million motorists in the United States there's hardly an owner who sooner or later doesn't get better service — buy more oil, tires, accessories — because of dealer-educational and franchise-building programs produced by Caravel.

So, too, when Mr. and Mrs. Consumer are in the market for certain food products, drug items, wearing apparel, articles for home consumption, their purchases — in thousands of cases — are directly influenced by Caravel dealer and consumer programs.

When Caravel film programs lead to increased sales repeatedly, maybe it's only a coincidence. But the fact that we produce pictures for the same clients year after year suggests a different explanation. Worth investigating? Others have found it so.

CARAVEL FILMS

INCORPORATED

New York • 730 Fifth Avenue • Tel. Circle 7-6112

Chicago • Tribune Tower • Tel. SUPerior 3422



FILM FORUM

READERS ARE INVITED TO ADDRESS



A PAGE OF LETTERS
FROM OUR READERS

INQUIRY TO THIS PAGE

● **Editor's Note:** To the hundreds of new readers of *Business Screen* who have acknowledged their interest and appreciation of our efforts, the editors extend this note of thanks. Since this department is solemnly dedicated to letters of inquiry and to the service function, we can hardly say more and stay within the bounds of modesty.

Editor, Business Screen:

Thanks for the copies of your publication "Business Screen" which have now been received. Since our main media is the slide film we believe that we would be justified in relating to you our experience with this type of training.

Our slide films are not made for public relations, but are confined strictly to the training of salesmen, announcing programs to dealers and providing service instruction. We have been using this medium for the past four or five years and have found no adequate substitute. Over 5,000 of our dealers are equipped with slide film projectors and receive all releases as scheduled. In this way a very high percentage of our dealer organization receives exactly the same story. We are assured that the presentation is identical in every case and the story, of course, is picturized.

We believe that the most effective release in our history was a kit of sales training records released last winter. Each dealer who used the slide film service received a case in which were eight 12" records. The case was constructed so that the lid held the eight film cans. The eight records and films provided an adequate training in the fundamentals of selling automobiles. Each subject was covered on one side of a record, which made it possible for a dealer to conduct the 10 minute meeting in the morning, follow up the slide film with a 10 minute discussion on the subject, and perhaps take another 10 minutes to cover general routine. In this way it was possible for him to have a snappy half hour sales meeting in the morning and at the same time have it highly instructive. Four records covered the product and the other four covered selling procedure. In this way, eight points on the construction of the car were presented, and eight steps on selling procedure were covered.

Hundreds of letters from dealers seemed to indicate that this type of release was being well received. Trusting this information will be of some assistance to you, we are,

Yours very truly,
Ford Motor Company
E. M. Chamberlin
General Sales Department

Ford's able sponsorship of all types of film subjects and their pronounced success, suggests an interesting yarn on this subject.

WANTS TRUCK SAFETY FILMS

Editor, Business Screen:

The National Safety Council, Chicago, has referred us to you regarding sound safety films dealing with long haul trucks or commercial vehicles.

We have been using for the past year a film entitled, "The Truck and the Driver" produced by Welsh Studios of Philadelphia and have had good results from it, but we are in need of some new material.

We would appreciate your advising us whether or not you have a film 16mm size available to answer our needs.

Yours very truly,
H. O. McShan
Motor Carrier Insurance Agency

The first installment of a new safety film survey appears in this issue. It has been prepared in cooperation with several safety organizations.

DEPARTMENT STORES SURVEYED

Editor Business Screen:

In a recent release by the Business Journalists we note that you have produced a special eight page section on "how to use films in business." Included in the excerpts is a commentary on how some department stores have already used these films to advantage.

We operate a chain of small department stores and are

wondering what might be available for our use. Kindly refer this inquiry to your associates in the industry, requesting that they send us all the data available.

We will appreciate your cooperation in this matter.

Norman W. Raies
Sales Promotion Manager
Koppers Stores

To the potential user of films in this field, the specialized retail store service of Audivision; the sales-education films of Modern Talking Pictures and other special subjects are recommended.

SALES TRAINING LIBRARY

Mr. H. E. Daviston
Bismarck, South Dakota

We were very much interested in your letter which appeared in the "Film Forum" section of the current issue of *Business Screen* lamenting the fact that you were unable to find an organization distributing sales training films. When you concluded with, "Can you tell me if such material is available and where it may be obtained?" we felt that you ought to know about Modern.

Sales training picture distribution, on a nation-wide basis, has always been a vital part of Modern's business. Available now on a rental plan are the two talking motion pictures and three sound slide films produced by those eminent professors of sales training, Richard C. Borden and Alvin C. Busse. So great was the demand for their personal appearance to train salesmen of large organizations that Professors Borden and Busse have made their services available through motion pictures and sound slide films.

In addition to the above, Modern Talking Picture Service, Inc. has just obtained exclusive distribution rights to "Word Magic", a picture demonstrating the "tested selling" points of Elmer Wheeler, the much talked about, much read about man who has won fame and success by creating sentences that sell.

Another attraction is the MacVeagh foremen's training course—a group of six sound slide films which have special appeal in industrial organizations because of the honest, down-to-earth fashion in which they are presented.

All these pictures and sound slide films are available on a rental basis through Modern. Modern will be glad to provide in addition to the films complete projection facilities—operator, equipment, screen.

In order to make it easier for you to visualize the purpose of each film, we suggest that you drop us a line at 9 Rockefeller Plaza, New York, New York, and we will forward you some descriptive literature on each picture.

Sincerely yours,
F. H. Arlinghaus
President,
Modern Talking Picture Service

Reader Daviston is thus answered by Modern's able director. Since the letter was typical of a

number received, the answer will suffice for the entire number. Thank you, Mr. Arlinghaus.

RELATES COLOR EXPERIENCES

Editor of Business Screen:

Your Exhibit Edition just came to me last night and it has a thought-stimulating quality I like in the things I read. If my thoughts are of editorial value to you, you are free to use them in their original form or butchered to suit yourself.

Two years ago, while visiting a Tulip Trial Grounds in a nearby city, with another seelismen friend, we both took a few pictures. My friend's were with 35mm Kodachrome and mine were in black and white of the same size. His shutter ceased to function and because he knew I had never tried Kodachrome, he asked me to finish my film and try a roll of Kodachrome he had beyond his needs of that day.

With the help of his Weston meter and my little Argus, with which I was not at all familiar because it was my first day with it, I obtained fifteen pictures good enough to use as slides and which, incidentally, have been shown on the screen to a good many hundreds of garden club members who have asked us to deliver garden lectures.

Right there I went off the deep end and in our own Tulip Trial Grounds in Cleveland, where we have in bloom more than four hundred different varieties of Tulips each spring, with a total planting of more than 10,000 bulbs, I started to shoot with 35mm Kodachrome in earnest. The results were shown to friends engaged as I am in the seed and bulb business and as a result, I now have a little private group, three members of which are in California, two in Chicago, one in Detroit, one in Cleveland and one in Columbus who are using these little slides to further their business and pronouncing them the best new tool for selling that the seed business has seen in a long, long time.

You can imagine my surprise and pleasure, when in June a year ago, while presiding at the 37th annual convention of the American Seed Trade Association, I was presented with a complete Leica outfit. And since then, my work with 35mm Kodachrome slides has improved and my library of slides has increased several hundred fold.

The use of movie films, (on three trips to Europe, starting in 1925 I have taken a good many thousand feet for use in Garden Club lectures for the promotion of our business), is quite expensive for a small firm. Then, too, distribution has serious limitations unless the film has been made and marketed by a firm capable of doing such work.

But there are thousands upon thousands of small firms which can, without much of an outlay, use slides in this small size to carry directly to the view of buyers, the kind of a message every business man is able to conceive. He can arrange as we have for duplicate pictures of new things to be made and exchanged by non-competing competitors. He can show them in his store, in his office or have his salesmen show them when calling on prospects and customers. Even without previous photographic experience, any man with patience and ability to understand printed instructions can do his own photographing.

It is from these small businesses that the large businesses of the future will come. A tool like this 35mm outfit, may be the means of bringing about the change from small to large size.

A year ago, the All-America Selections Committee of the American Seed Trade Association, whose chief aim is to see that the new varieties of flowers and vegetables that are offered to the gardeners of America get something really new and different when they buy new kinds, gave the highest Gold Medal Award for a new Morning Glory by the name of Scarlett O'Hara. This has a shade of red unlike the red in any other flower that I have ever seen. The work of the Committee is kept confidential until after the award. The result is that when October comes around and the award is announced, it is pretty late to get good photographs. My Leica, and Kodachrome A film, plus Eastman's processing, gave me a remarkably fine register of Scarlett O'Hara's true color. My Garden Club Audiences were able almost simultaneously with the announcement of the award to see the flower in natural colors.

If what I have said about my use of slides is as thought-provoking to you as your latest issue was to me, you have something here for a future issue. If not, pardon me, please.

Floyd Bradley
President,
Templin-Bradley Co.
Cleveland, Ohio

The experiences of reader Bradley illustrate the numerous fields of use for visual media. The inexpensive glass slides of these Kodachrome subjects were his way of realizing the values of the medium—a step from this beginning stage here suggested is the utilization of Kodachrome on strip film for convenient showing.

COMING EVENTS!

of interest to our readers

Issue No. 4

Published on November Fifth!

Special articles on the Medical Film Field; Department Stores-2; Color-2; Travel and the Film. Another special section of Film Review; Equipment News & Reviews

Issue No. 5

Published on December Fifth!

Annual Survey Number with a complete directory of all national film concerns; annual library directory of all sponsored films now in circulation; equipment directory and national classified section on laboratories and producing concerns.

What a DIFFERENCE The RIGHT Screen Makes!

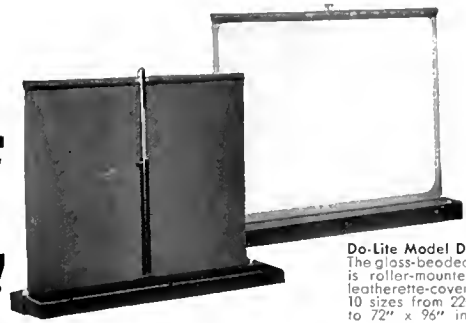

Da-Lite Model D Screen
The glass-beaded screen
is roller-mounted in a
leatherette-covered box.
10 sizes from 22" x 30"
to 72" x 96" inclusive

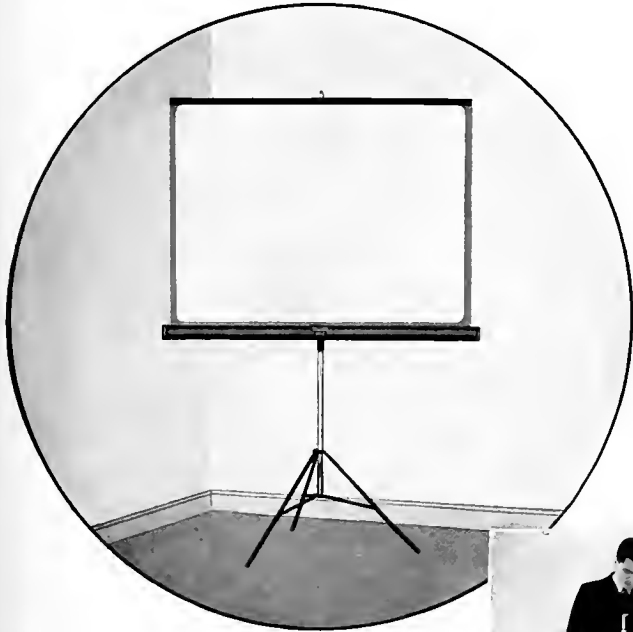

In Greater Convenience

Da-Lite Business Screens have many advanced exclusive features that make for easier operation. The Challenger shown at the right can be set up in 15 seconds. It consists of a Da-Lite Glass-Beaded Screen, roller-mounted in a metal case to which a tripod is permanently and pivotally attached. It is adjustable in height. Square Tubing (an exclusive Da-Lite feature) in the tripod and the extension support, holds the screen rigid and in perfect alignment.



In Brighter Pictures

COLOR pictures shown on a Da-Lite Glass-Beaded Screen are more brilliant; and black and whites have greater sharpness and detail. Da-Lite's advanced process of applying the beads to the screen fabric produces light reflective qualities unequalled by any other method. The beads are guaranteed not to shatter off. The screen stays white longer than any other white surface and remains pliable indefinitely. Da-Lite Glass-Beaded Screens are available in many types of mountings including table models, the famous Challenger with tripod attached and the new electrically operated Da-Lite Electrol hanging screen.

FREE DATA BOOK! This 24 page book answers your questions about the light reflective qualities of various screen surfaces and illustrates and describes the world's largest line of business screens. Mail the coupon below.

DA-LITE BUSINESS SCREENS



In Longer Service



Da-Lite Business Screens stand up well under the rough handling they receive in visual selling. The construction of the handle on the Challenger is typical of the extra care used in manufacturing Da-Lite Screens. The handle is mounted on a sturdy bracket which encompasses the square tubing and the case so that there is no strain on the side wall of the metal case.

DA-LITE SCREEN CO., INC.

Dept. 9B, 2723 N. Crawford Ave.,
Chicago, Ill.

Please send your Free screen data book.

Name _____

Firm Name _____

Address _____

30 YEARS A JOURNALIST
... 7 YEARS A SALESMAN



TWICE a week, for 30 years, filmland's most famed personality — Pathe's rugged, revered, old rooster — has played news-reporter to movie-goers throughout the world. Learning with age, he gets better, more vital, more comprehensive, as the years go by. ● Since 1932 this ace of journalists has been gaining new laurels in another field. Today he is also the ace of salesmen, for during the past seven years he has impressed scores of clients with his ability to drive a sales-message home. Employing the indelible medium of sight, sound and action, he has ably demonstrated his potent force wherever salesmanship is needed ... in direct merchandising ... in sales-training ... in dealer promotion ... in public relations and visual education. ● Backed by complete new mechanical facilities and by the world's largest film library, he works for a group of sales-minded executives who are interested in talking to men with problems which a film may solve and with funds available for its production.



PATHE NEWS Inc.

FREDERIC ULLMAN, jr., Vice-President

35 WEST 45th ST., NEW YORK CITY

● SEPTEMBER'S PASSING WILL BE welcomed almost everywhere, especially as it brings new hope of peace abroad and a good world's series battle at home. America can be fervently thankful that our dictatorships are pretty thoroughly confined to the Yankees' domination of the American League. The serious side of it is that the democracies are being challenged everywhere and the value of all media for imparting truthful information is being severely tested. The film, used with equal effectiveness by the dictatorships and the democracies, appears most likely to succeed in imparting the lowest measure of false propaganda and the highest percentage of accuracy and truthfulness.

● ELECTION OF ENERGETIC STANLEY A. Knisely, advertising manager of the Republic Steel Corporation, Cleveland, to the presidency of the National Industrial Advertisers Association was noted with gratification by his many friends in the industrial film world. For many years, Mr. Knisely has been responsible for interesting technical film material product by his company and is something of a pioneer in the development of this type of film.

● THE MOTION SLIDEFILM IS COMING into its own. Development of the "still" picture sequence on motion picture film for convenient projection of motion picture equipment has also afforded the user the opportunity of inserting short action sequences. The smooth flow of sequences and technical advantages of "wipes" distinguishes this technique.

● CREDIT FOR THE EDITORIAL MATERIAL contained in the article "Superman" which appears on Page 29 of this issue goes to Bill Dietz, advertising manager of Wilding Picture Productions who literally took the words right out of our mouth. Mr. Dietz will be remembered as the editor of Advertising Agency. Due credit also to Jack Coffey of the Jam Handy Organization; to Walter Brooks of Audio and to Burnham McCleary of Caravel Films. These and a few others like them have been tireless workers in behalf of the user of commercial films and, thus, very helpful to our columns.

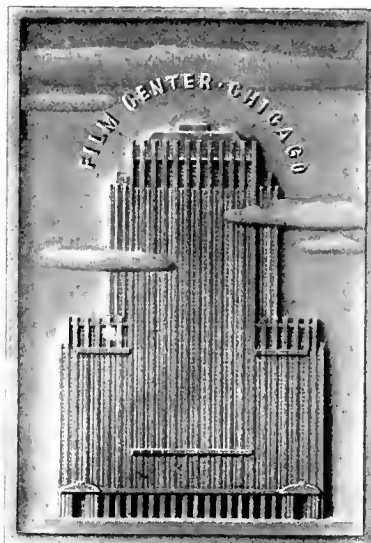

THE MAGAZINE OF COMMERCIAL AND EDUCATIONAL FILMS

C O N T E N T S

Cover Photograph is by Will Connell, noted Hollywood photographer, and is from the book "In Pictures" published by T. J. Maloney, Inc.

Business Gets the Idea	7	Educating the Dealer	20
Camera Eye, A Column of News	8	Superman, the Merchandising Writer	29
Film Forum, A Page of Letters	10	Industrial Exhibits & Films	30
So You Want to Be In Pictures!	15	Coopers' Slide Film Program	34
What it Takes to Make a Film	17	Equipment Review Notes	42
Color Tells It and Sells It	18	Brief Reviews of Recent Releases	45

FILM REVIEW SECTION

Jerry Pulls the Strings — Reviewed	22	Greyhound Makes Travel Film	25
To Save A Life-Safety Film Survey	23	Aluminum Company of America Pictures	25
National League Picture-Making	24	Better Films in the Schools	26

Business Screen Magazine, Issued by Business Screen Magazines, Inc., Twenty North Wacker Drive, Chicago, Illinois. *Editorial Director*, O. H. Coelln, Jr.; *Art Director*, R. C. Danielson; Subscription price: domestic, \$5.00 a year; 50c copy; foreign, \$6.00 a year. Publishers are not responsible for the return of unsolicited m. s. unless accompanied by stamped, self-addressed envelope. Entire contents Copyright 1938 by Business Screen Magazines, Inc., Chicago, Illinois.

ISSUED TEN TIMES A YEAR - PLUS TWO SPECIAL ANNUAL NUMBERS

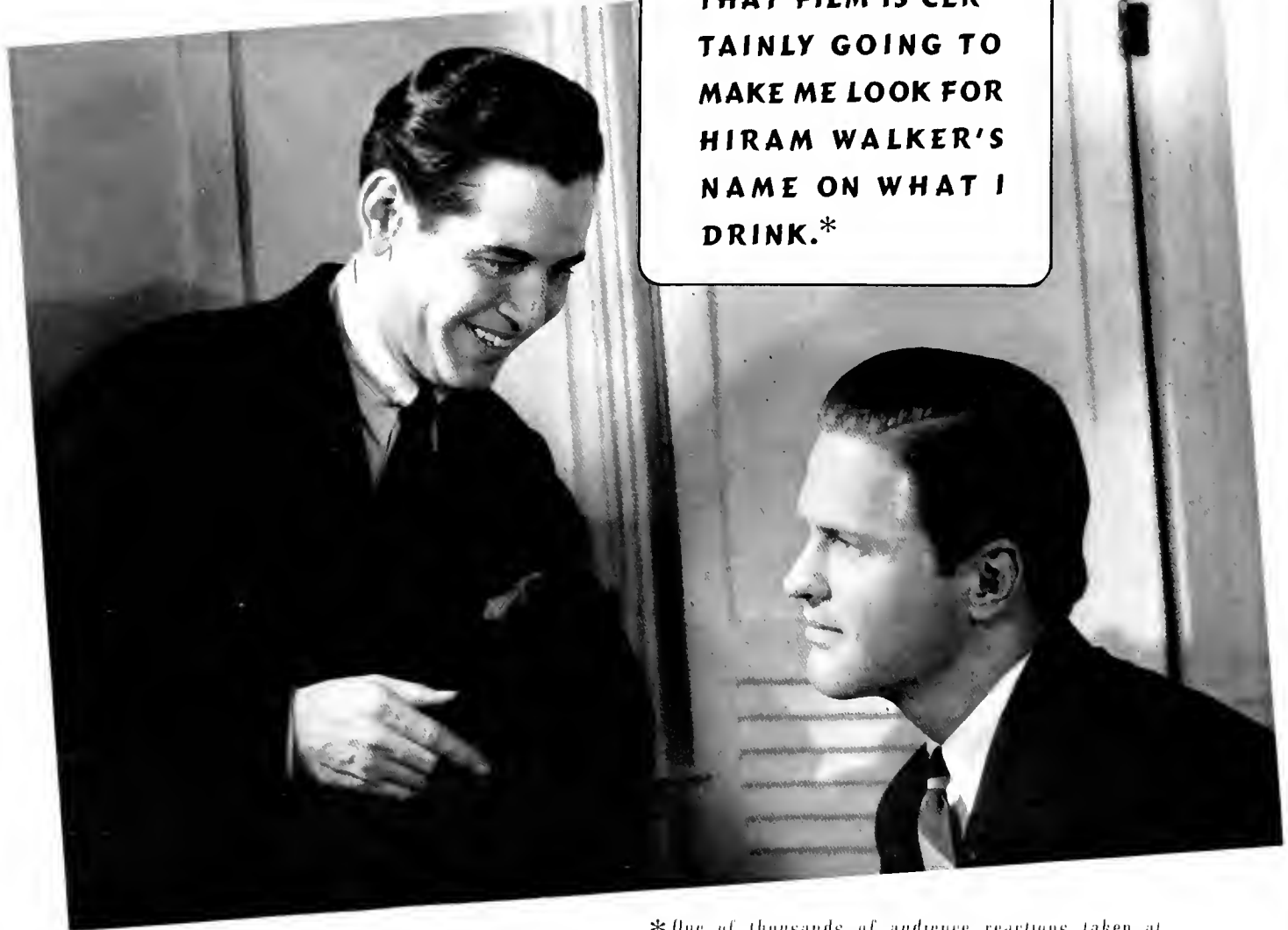

THAT FILM IS CERTAINLY GOING TO MAKE ME LOOK FOR HIRAM WALKER'S NAME ON WHAT I DRINK.*

**One of thousands of audience reactions taken at the 1816 showings so far staged by Modern Talking Picture Service for Hiram Walker Incorporated.*

*Y*OU are probably not a distiller, but MODERN'S club show service is as adaptable to your specific needs as it was to those of Hiram Walker Incorporated. They wanted their picture shown to adult male audiences only. They wanted to show them that all distilleries are not alike, that Hiram Walker's huge investment in modern plant equipment and their care in operating it was reflected in their product. Your product too has subtle hidden values which can best be brought out in motion pictures. We will secure the

audiences and show your picture. ■ In 45 cities MODERN has men—trained to realize what you as an advertiser want. MODERN has equipment—the best they can design. MODERN has local acceptance—a reputation and performance record they are glad to live with. MODERN TALKING PICTURE SERVICE, INC., will give your distribution the flexibility of specialized service with economies made possible by standardization. Call on us for a distribution plan to meet your specific needs.



MODERN TALKING PICTURE SERVICE, INC., NINE ROCKEFELLER PLAZA, NEW YORK, NEW YORK

● The title of this article, like the familiar song lyric, must be written in the affirmative. The universal desire to get the business story told "in pictures" has sent its roots deep and what may have seemed to be a fad when reflected in the popularity of the picture magazines and amateur photography last year may now be accepted as a fundamental trend to realism which has its counterpart in the selling field. Beyond a doubt this era, in which general acceptance of the film medium by business will carry with it a sharp increase in sales-making efficiency, will also show a corresponding decline in wasteful spending for the familiar "pressuring up" of sales volumes.

The film is no "cure-all". But motion pictures and slide films have achieved such definite and widespread success in almost every field of industry that their effectiveness deserves careful study by the alert sales and advertising executive who is looking for a sure straight road to better business in these days of see-saw prosperity. "Okay," you say, "that kind of talk listens well enough, but I gotta have results. What can motion pictures and slide films do for me?"

The A-B-C's of industrial films (which too many present users, both successful and unsuccessful, have forgotten) are simply a matter of knowing what results you want to get and what the film offers in getting them. If that sounds vague, take the example of a big corporation which recently spent a hundred thousand dollars (and then some) for a film about its product. The thrilling pictorial qualities of this picture are about the only measure of value which the client received, for salesmanship was not the objective here and if improvement of public relations was desired little or nothing was apparent in that direction. *Good planning is a first essential in the use of films.*

Today's best bet in the use of films (or of any other medium for putting ideas in the other fellow's head) is to *get down to facts*. Forget about Goldwyn and Gable—industrial films may be printed on the same kind of stuff as Mae West's curves but beyond the irresistible urge which both possess on the screen, there are worlds of difference! *Not* the dream-worlds of Hollywood but that universe of interest with which films present ideas to prospects and salesmen in a clearer and better way than any other now known! Let's get down to facts and see what films are doing:

1. They are working for all grades and classes of business from the small local merchant to the largest national advertiser.

Reason: the economical, efficient slide film puts a powerful sight and sound message on the screen and fits many a little fellow's purse. Mo-



tion pictures for business purposes don't use replicas of ancient Rome and don't require hundred-thousand dollar star salaries but get the points that make the sale across just the same—and sometimes better.

2. They are making consistent business-getters out of "dubs" in thousands of sales organizations and doing the same thing for the sales-managers.

Reason: You can print a salesman's manual—but you can't make him read it! You can shout like der Fuehrer but you can't keep him awake! But put the view and the voice together on a screen and the results are amazing!

The film has a wonderful way of unraveling the complex mazes into which merchandising programs have a habit of getting. The tire people found this out long ago and so use the medium extensively to keep the dealer field from short-circuiting on their many annual improvements, price changes and selling techniques. Again, case-history number one for the commercial film business lies in the automobile industry's continued success with sales-training slide-films and movies and with film features of all types for consumer audiences. *Therein lies the unparalleled, two-fold advantage which the film medium alone possesses: its primary success in man-for-man sales training and its equally successful consumer appeal!* A good merchandising film can sweep the cobwebs from the dealer's mind and then turn right around and do the same thing with each and every one of his customers!

How do you get to those customers? If they are, in the largest sense, retail buyers—the task is comparatively simple. On a national scale you have your choice of theatre audiences, of thousands of clubs and organizations who are consistent users of film programs for the information and entertainment of their members, of schools and colleges and of dealer-promoted groups arranged for and invited under his auspices. Restricted distribution is sometimes all

that is wanted and here the film can be *personalized* and *directed* in controlled circulation with the added advantage of unflinching success in delivering its message to each important prospect.

Can you do all this yourself? Can you make the pictures—record the sound and then ship the films around to audiences? Perhaps you can; a few concerns with big dealer organizations have found film production departments useful—*within limits*. Equipment and experiments are expensive. The skilled technicians required to produce pictures with punch and appeal are hard to get and then hard to keep busy unless frequent additions are made to the film program or a comparatively restricted setup maintained. *(Such as the useful direct 16mm. units.)*

There is another advantage of importance to consider: *A good film has a long life*. It can be repeated for the education of new dealer salesmen from time to time; its audience-distribution may go on for years and thus pile up tremendous totals. The films used by one national automobile manufacturer have been seen by 132,000,000 persons and many are still in circulation. Thus, while most concerns have found it worthwhile to limit their mechanical participation to the *showing* of pictures, a good many of these supplement commercially-produced films with useful and effective localized subjects.

A summary should conclude with the frank statement that successful business films are seldom accidentally born of genius. The user has at his command a weapon which is infinitely more powerful than the printed message or spoken word but one which, by the same token, requires greater skill. Carefully aimed (by *thorough planning and preparation*) your film will shoot straight to the mark for that all-important bulls-eye of better sales results. First by improving your salesmen and finally by telling your customers *the complete story* which is the prerequisite of good selling everywhere.

MOTION PICTURES & SLIDE FILMS—WHAT CAN THEY DO FOR ME?

● As everyone knows, the year 1938 has not dealt kindly with the automobile dealer. His problems have been multiplied due to a disposition on the part of the public to "wait and see what was going to happen." As a consequence he found himself more in need of an effective merchandising plan than ever before.

A timely solution to this problem was a new plan that was launched this year by the Alemite Division of Stewart-Warner Corporation. It involved the offering of a 30,000 Mile Guarantee against motor, gear and bearing failures on all new cars purchased from dealers using Alemite Lubricants and Motor Oil, providing the owner had his car serviced at the recommended intervals. Such an Alemite guarantee promised the car dealer continued patronage

ALEMITE USES FILMS

*an interview with F. R. Cross
Advertising Mgr. Stewart-Warner Co.*

of his service department by all new car purchasers, better trade-ins to handle in his used car department, and additional inducement to prospective new car buyers.

With this masterful sales promotion plan for Alemite perfected, Stewart-Warner's advertising manager, F. R. Cross, was called upon to choose the most effective medium of telling the story to prospective dealers. And since films had been responsible for successful merchandising three times in the past two years for Stewart-Warner products, it was only natural

that Mr. Cross should again call on a talking movie to sell this Alemite plan. He holds that this medium exceeds any other way of putting over a sales story.

The sales story was written by Mr. Cross himself and then dramatized by J. J. Kieley, professional scenario writer of a Chicago studio. Such an amount of care was taken in casting that the production was held up for three weeks while some of the actors were brought from New York and Hollywood. The forty minute, 4 reel film, *Okay, Mr. Allison*, was then produced very inexpensively by a Chicago commercial film producer and was released by the Stewart-Warner Corporation the first of June.

Distribution of *Okay, Mr. Allison* is handled through forty Stewart-Warner distributors and their salesmen, located in principal cities throughout the country, and shown to dealers in small groups.

The story concerns an automobile dealer by the name of Allison who finds business falling off in all departments. He brings his worries home and his charming daughter pries into them. Finally Allison gives her permission to come down to the office to see what she can do. The first thing she does at the office is to receive the Alemite salesman who couldn't get in to see her father. She listens to his story and then prevails upon her father to hear it. After spending hours with the salesman in a discussion the audience is not in on, Allison has a chart made on a large blackboard and calls a meeting of his department heads. These include the new and used car sales managers, the head of the service department and the company bookkeeper. (The latter is the comedy relief of the show as he is so typical of all bookkeepers in manner and looks) The sales plan is told and illustrated on the chart by Allison, a much more effective presentation than it would be if done by the "Alemite salesman". All department heads are heartily in favor of the guarantee lubrication plan, and the bookkeeper is greatly relieved to learn that Alemite assumes all responsibility. The plan goes into effect at once, and the company's business increases as the months go by. The plan is shown as it works in every department of the dealer's organization.

The picture is uproariously funny in many places and groups of dealers find it entertaining as well as profitable. Showings are usually limited to groups of eight and salesmen are always on hand to complete the selling when the picture is over. Larger groups are hard to contact and are apt to forget that the showing was for more than entertainment.

Although *Okay, Mr. Allison* has been shown in the field only since the first of June, it has already achieved definite results in securing new Alemite dealers and in reviving the service activities of regular dealers.

An Experienced User of Slide Films Suggests this Outline:

WHAT THE CLIENT EXPECTS OF A SLIDE FILM PRODUCER

● Here are some of the important contributions which the experienced slide film producer must make to the prospective client. This outline was prepared by a client after long experience with the medium.

1. GATHER MATERIAL

The producer should gather all of the material that may help to solve the problem that the client is facing. It is understood that the client must identify the problem and desire a solution for it. The client should turn over to the producer all literature, experiences and observations that may help solve this problem.

2. ANALYSIS OF PROBLEM

The producer should discuss the problem with the client in order to arrive at a clear-headed understanding of the problem. Then, the producer should analyze this problem and identify all of its elements. He should go to all possible outside sources also to gather materials, facts and fundamental principles that may apply to the solution.

3. OUTLINE OF METHOD OF TREATMENT

The producer, after completing the analysis of the problem, should work out a rough outline of a plan of treatment that he proposes to use in solving the problem. This rough outline should indicate in a general way how the producer proposes to go about solving the problem. He should warn the client stoutly against attempting to cover too much material in one film treatment. It is the producer's responsibility to guard the client against cramming too much into one picture treatment. If a slide-film flops because of too much content it must be blamed always on the producer. If, on the other hand, the client is obstinate and insists on too much content, the producer must either refuse to produce the picture or ask the client to sign a waiver of responsibility for failure in this respect. If a producer fails to do this, the client should have the right to refuse the production upon its completion.

4. PLOT

Next the producer should furnish a story or an interesting plot on which the solution to the problem can be hung. This plot should be so well worked out that it lends itself to a solution of the problem.

5. POINT -- CONTINUITY

The "point-continuity" is a breakdown of the plot into sequences of thought to show how the solution to the problem can be applied to the plot. Better still, the point-continuity should show how plot lends itself to a solution.

6. COMPLETE SCENARIO

The producer should next submit a complete scenario in final form showing on the left hand side of the page the description of each frame as it appears in the picture and on the right hand side of the page the exact words in the dialogue for each character in the presentation. The client should be privileged to make word changes in the final script that may conflict with company policies.

7. EDITING

The client should not be expected to make more than minor word changes in the script. If any major changes are to be made, these should be discussed and then left to the producer to make in the form of editing.

8. CARTOONING AND DRAWING

Many times a cartoon or an air-brush drawing serves to illustrate the point better than a photograph. The producer should always be on the lookout for opportunities to use special methods of illustrating that makes the visual presentation more forceful. The producer should never resort to cheap line drawings, black on white, because they allow too much light to hit the screen and thus cause glare and eye strain. Charts and diagrams should be put in reverse while special drawings should be done with the use of the air-brush.

9. PHOTOGRAPHY

An ordinary "bulb pusher" does not make a good slide-film photographer. The producer should furnish a good illustrator—a photographer who knows how to illustrate a subject—to take the pictures for a slide-film. The photographer should know how to direct the eyes of the audience to the facts brought out in the dialogue. He should never show a close-up of a man addressing the audience because when this is done the film loses its illusion of action through sound.

10. RETOUCHING

The producer should furnish all retouching of pictures such as vignetting, bringing out objects to be emphasized, eliminating undesirable parts, etc.

11. MODELS AND ACTORS

The producer should furnish first class models and actors who are professionally trained to pose for illustrating. If a good slide-film presentation is desired, amateur models and actors should be avoided.

12. MODEL RELEASES

The producer should handle all model releases and payments of models. The client should never be liable for any work done by models or actors in any manner whatsoever.

13. PRINTING

The producer should furnish the client with one paper print (glossy) of each frame as it appears in a slide-film. On the back of each paper print should be written the title of the film and the frame number. The producer should furnish the client with a legal release on each print authorizing the client to use the print in any manner whatsoever when continuing to solve the problem treated in the film.

14. TITLES

The producer should give some thought to developing attractive title frames. A title to a picture that is too prosaic and a title frame that is unprofessional looking can spell failure for a picture before it is seen.

15. DIRECTION OF PHOTOGRAPHY

The producer should provide an experienced director to work with the camera crew while taking the pictures. The director should understand the objectives of the film presentation. He should discuss the script thoroughly with the writer and editor. If the picture requires sequences at several locations the director should be furnished with a trained script girl who can check the detailed properties furnish these services including those of a property man.

(to be completed in the next issue)

GOOD PICTURES ARE THE RESULT OF CAREFUL PREPARATION AND RESEARCH PLUS THE SKILL AND EXPERIENCE OF THOSE WHO ACTUALLY PRODUCE THEM

1. PRODUCTION STAFF

Supervisor	Assistant Property Man
Director	Company & 2nd Grips
Production Manager	Make Up Man
Assistant Director	Stand By Carpenter
Script Clerk	Stand By Painter
Company Property Man	Special Effects Man

2. STORY AND CAST

Salaries & Expense	Principals
Rights	Supporting Cast
Adaption	Silent Musicians
Scripts	Doubles
Additional Dialogue	Singers & Dancers
Typists	Extra Talent

3. SET AND STANDBY LABOR

Technical Director	Carpenters
Art Director	Painters
Construction Foreman	Grips
Construction Labor	Laborers Watchmen
Materials	Meals Not Location
Striking & Rigging	Transportation

4. PROPS & SET DRESSING

Dresser	Inserts
Checker	Set Dressing Rentals
Clothing Man	Food Used in Picture
Dressing Labor	Hand Prop Purchases
	Hand Prop Rentals

WHAT IT TAKES TO MAKE A FILM

• Behind those convincing images on the business screen lies a vast field of detail — of creative and mechanical skills which contribute to the arduous planning and preparation unequalled by any other form of advertising. Actual production costs outlined on this page are minimized when the million-fold audiences who see these pictures are considered. First in importance, however, are the extensive research and merchandising facilities of the experienced commercial film producer — anybody can take a picture — but the successful ones are made by experts.

5. WARDROBE

Wardrobe Manager	Wardrobe Rental
Wardrobe Lady	Wig Rentals
Seamstress & Labor	Damage Allowance
	Costume Purchases

6. LIGHTING

Offer	Purchases & Damage
Electric Labor, Rigging	Electrical Current
Timing & Operating	Generator Man
Equipment Rental	Transportation
	Globe Rental

7. FILM AND LABORATORY

Positive Raw Stock	Printing Track
Negative Raw Stock	Devel. & Prtg. Stills
Still Negatives	Master Print
Developing Action	Insurance Print
Developing Track	Composites-Replacem.
Printing Action	Lovenders, Leaders

8. CAMERA—TITLES—INSERTS

First Camera Man	Misc. Titles
Operator-Camera Men	Dissolves
First Asst. Cam Man	Lap Dissolves
Second Asst. Cam Man	Fades
Still Man	Wipe Offs
Main & End Titles	Stock Shots,
	Inserts, Etc.

9. SOUND

Order	Sound Truck Rental
er	Other Equip. Rental
e Men	Domestic Royalties
nd Grip	Foreign Royalties

10. SCORING AND DUBBING

Main & End Titles Music	Lyric Writer
Arrangements	Rental Instruments
Royalties	Sheet Music
Musicians	Records
Director	Copying
Music Writer	Dubbing

11. FILM EDITING

Cutter	Dialogue Continuity
Assistant Cutter	Cutting Continuity
Negative Cutter	Codeing
Projection	Cutting Room
Movieola Rental	Misc. Purchases

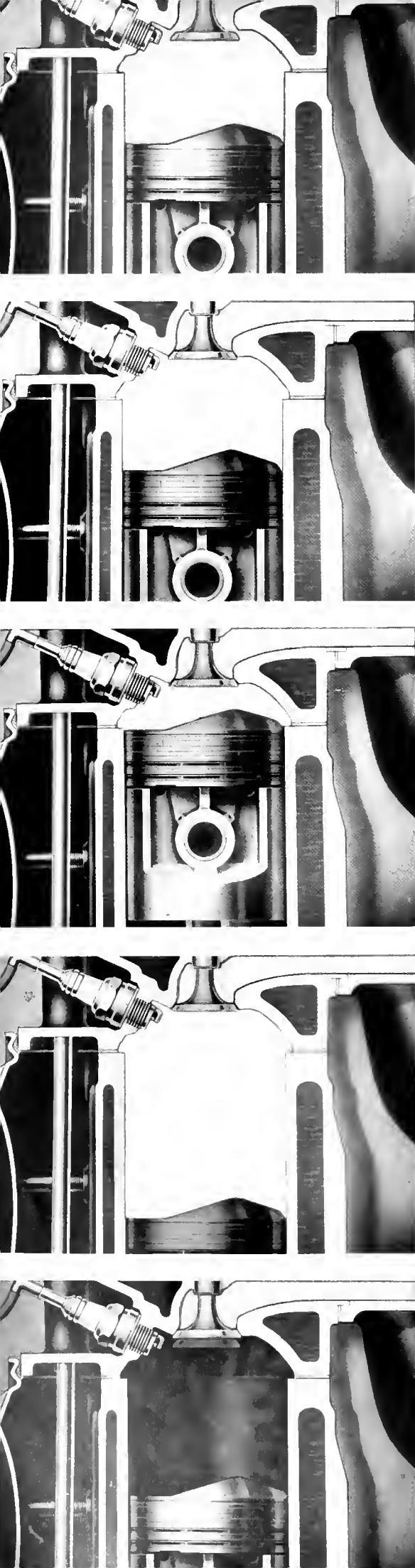

COLOR TELLS IT AND IT!

• The realistic powers of film salesmanship are being considerably enhanced by the rapid development of color processes for slide films and motion pictures. Because color tells the story of the package or the process more completely than ever before, its selling powers are more certain and convincing.

Add to this element of conviction, the attractive glamour of the well-planned color sequence and you have achieved a high degree of entertainment. That color is sure-fire "box-office" will not be questioned by the average moviegoer. In the industrial-commercial field its success has been equally prominent and generously attended, moreover, by increased sales results. Short advertising subjects for theatre distribution have made considerable use of color. Here two important factors dictated its use: the importance of eye-appeal, *viz*: pleasing the theatrical audience and, secondly, the reasonable additional cost which was minimized by the short length of the subject (especially in the so called "minute movie") and the large number of prints over which the cost was distributed.

Two questions are asked by the prospective user of color. The first, is whether the additional expense is warranted by the increased effectiveness of the film. The other question most widely asked is—what are its limitations?

The bewildering array of new color processes now available to the photographic amateur may be disregarded by the average user of business films. Here the important problems are dependable accuracy in duplication for the necessary distribution prints and an acceptable original which retains the highest degree of exact color reproduction at a reasonable cost.

The popular and widely used Kodachrome and Dufaycolor processes may be successfully applied to slide film strips which involve a series of individual still pictures just as they are convenient and economical for singly-mounted glass slides. But motion picture color which must be adaptable to the varying demands of industry has to be handled by skilled technicians and has been generally limited to Technicolor, a universally accepted "subtractive" three-color process, and to the economical "additive" method offered by Cinecolor.

TECHNICOLOR ANIMATION USED IN "BUICK ENGINEERING"
 HERE TECHNICOLOR ANIMATION PROVES AN IMPORTANT ASSET IN DEMONSTRATING AND PROVING THE VALUE OF A NEW PRINCIPLE OF PISTON DESIGN WHICH ELIMINATES THE "PING" CAUSED BY TOO-RAPID ACCELERATION WHEN LOWER-PRICED GASOLINES ARE USED.
 1 Intake-charge of gasoline shown in blue. 2. Compression-valve closed; heat by compression indicated. 3. Burning; the start of the explosion within the cylinder. 4. End of Power Stroke; exploded gasoline shown in red, pushing down piston. 5. Exhaust; burnt gases about to be exhausted. (Sponsor: Buick Division, General Motors Corporation. Audience: primarily Buick's wholesale organization, dealers and salesmen but usable for prospect showings.)

Cosmocolor, a newcomer with fine possibilities and the advantage of speedy processing, and the well-known Dunningcolor are achieving excellent results. Motion picture-taking for these processes is in 35mm and a satisfactory color-controlled method of reducing this for 16mm prints has been long-awaited.

Direct 16mm color movies, such as those offered the amateur, have been successfully made in Kodachrome and Dufaycolor but the commercial subject matter here is limited to outdoor scenic material where most favorable light conditions are present. Similarly, excellent reduction prints have been made in color from 35mm originals but consistent accuracy of register and true color has been demanded by the commercial film producer and he has been hesitant, therefore, in offering it to the advertising and sales promotion user. Important announcements along this line may be expected shortly from the color laboratories.

Color is safe, dependable and an invaluable aid to better selling in many instances. Important technical descriptions of processes and methods of manufacture, etc. where the addition of color is the only logical means available for a satisfactory explanation is just one field of use. Thus the entire field of technical animation has a powerful ally in color. Again, the artist-drawn cartoon subject attains a double-measure of entertainment when color is applied. Disney's *Snow-White* has its counterpart in the Fisher Body Technicolor cartoon *A Coach for Cinderella* and in Ipana's recent *Boy Meets Dog*.

Color sequences are performing notable tasks in the field of dealer merchandising. Such concerns as Proctor and Gamble and Sunkist will attest the value of package and product reproduction in full, glowing color. A Sunkist sequence in the new *Sunkist for Profit* production illustrates the methods of improving dealer displays of oranges. Modern Packaging Magazine is the sponsor of a nationally-distributed film to which a color sequence added an important touch.

Few concerns have capitalized as yet on the unusual drawing power of pictures in color in the commercial field. A trail-blazing exception is U. S. Steel whose splendid Technicolor production is now being shown in theatres throughout the country. Here, for the first time, the entire story of steel-making is filmed in awe-inspiring color. Aside from the one reel of this picture, theatrically-distributed color subjects have been generally restricted to the "minute-movie" type of which Alka-Seltzer, Frigidaire and other prominent national advertisers have been enthusiastic users. The subjects are short and the distribution on a national scale. The

cost, as has already been mentioned, is therefore negligible. At this point it would be well to summarize some of the types of color processing now in favor for the commercial film:

SLIDE FILMS IN COLOR

• The demand for color in slide film productions is gaining momentum. Slide film producers as well as the advertising and sales promotional heads of large corporations are quickly sensing the added appeal of color. However, the desire is more easily reached than satisfied. Existing methods of slide film color are few, and those in use are characterized by high production costs, various complexities, and lengthy time schedules necessary to completion of the production. Thus, to many in the field today, color is synonymous with headache tablets and hours of lost sleep.

Kodachrome, shortly after its inception, was destined to become the answer to some of these problems. It was not long after 35mm. Kodachrome became a reality that duplicating processes were heard of and various trick cameras for multiple exposures began to form on the drafting board. However, it was some time before any worth while results were reached. Recently a favorable process has been perfected for utilizing Kodachrome in slide films.

The simplicity of the process speaks for itself. From Kodachrome originals made with any of the well known "candid" cameras, single frame copies are made in sequence on a strip of 35 mm. perforated Kodachrome film. A system of color filtering has been devised whereby accurate reproduction is maintained even though variations in the film stock or processing are apparent. Presently the film is obtainable in 15 foot lengths which allows for some two hundred odd frames, ample in the great majority of cases. Certain defects in originals can be overcome by color balancing and undesirable portions excluded in the final result.

The process allows for remarkable flexibility and ease of operation. Original Kodachromes are made quickly and inexpensively. The finest of a collection of slides are selected for use, and without much ado a test color strip is submitted for approval. Any necessary changes are made and within the space of one week finished strips are ready for use. Although tests have shown that the film will wear as well as black and white stock, a chemical treatment insures prolonged life and minimizes any chance of color fading.

THE CINECOLOR PROCESS

• The Cinecolor Process covers a method of processing color motion pictures from virtually any type of color separation negative. Bi-pack or Du-Pac is most generally used to date. The Bi-pack system consists of a pair of negatives, one being substantially orthochromatic, the

other panchromatic. On the emulsion surface of the ortho negative is a red filter in the form of a dye, this filter being equivalent to a Wratten 23A filter. The two negatives are threaded through the camera with their emulsion surfaces in contact and are photographed in that manner. Colors of the blue-green end of the spectrum are recorded onto the ortho negative and colors of the red-orange end of the spectrum are photographed onto the panchromatic negative at one time.

The negatives are developed to a definite gamma and printed onto what is termed duplitzed positive film. This is a positive film having an emulsion on either side of its transparent base. The emulsions are impregnated with a water soluble yellow dye to prevent the rays from the printer lights from penetrating to opposite emulsions. During the development of the film, the yellow dye washes out and is of no further use.

After the positive images are developed, fixed and washed, they are subjected to certain selective coloring solutions which convert the silver images into color lakes. The images from the ortho negative are colored yellow to red and the images from the panchromatic negative are colored blue-green. After the positives are processed and dried, they are submitted to a process which renders the emulsions impervious to projection scratches, while not affecting the life of the celluloid base.

Prints made from negatives made with beam

splitter cameras or those made with straight Wratten filters are also processed by Cinecolor, the results in the main being akin to those made by Bi-pack negatives.

Although Cinecolor is, at present, what is termed a two-color process, it is able to obtain a great range of colors with true fidelity.

"FILMED IN TECHNICOLOR"

• In the earliest days of the Technicolor development, it was recognized that the ultimate goal of workers in the field of color cinematography must be a process that would add a full scale of color reproduction to the existing black-and-white product without subtracting from any of its desirable qualities, without imposing any complications upon theater projection conditions, and with a minimum of added burden in the cost of photography and in the cost of prints. These considerations seemed clearly to indicate a three-color subtractive printing process capable of ultimate low cost of manufacture.

The Technicolor three-color camera photographs the three primary aspects of a scene (red, green, and blue) upon three separate film strips, simultaneously, at normal speed, without fringe or parallax, in balance, and in proper register with each other. These separate strips are developed to negatives of equal contrast and must always be handled as a group.

From these color-separation negatives, we
(Please turn to Page 38)



THE COLOR CAMERAMAN IS THE IMPORTANT LINK BETWEEN THE BEAUTY OF FINE PHOTOGRAPHY and the practical realism of the best "selling angles" in commercial film production.

Technicolor animation subjects courtesy of the Jam Handy Organization. The photo above is from the Cosmo-color set of Wilding Picture Productions.



Audio Prod.: Massey-Harris
Audio Prod.: Bakelite

EDUCATING THE DEALER

TAKING THE CHANGE OUT OF YOUR SALES PROGRAM WITH FILMS

● The man at the point-of-sale rules the destinies of business. The job of stimulating the dealer's enthusiasm for the product can and does involve a good portion of the advertising dollar, of the sales promotional budget and untold hours of thoughtful planning on the part of advertising and sales executives. For the dealer, as one editorial recently pointed out, is not alone the distributor's best customer but he is also, which is vitally important, the distributor's ally in the further and final task of selling the ultimate consumer, the public.

Spending money for prestige-building radio hours and national advertising space is not enough. Lavish appropriations for special "deals" may sharpen the sales curve but *fundamentals* alone can *keep it up*. The first of these is a thorough knowledge of the product and equally important, of the tried and tested techniques which will help the dealer sell it.

We take too much for granted when we put the success of carefully planned lines of merchandise into the hands of \$15 a week clerks. To entrust the merchandising of expensive technical items to such unskilled help is a patent weakness which costs heavily in sales results. The dealer himself, in thousands of small organizations, is problem enough but the multitudes of untrained retail clerks, service station attendants and other sales persons represent a major issue. Here is where the film medium can play a vitally important part.

Its unequalled success in acquainting the dealer with the nature of the product itself is best illustrated in the technical films of Johns-Manville, E. I. duPont de Nemours and the various automobile companies. J-M's film *Heat*

and its *Control* was a thorough exposition of insulation and its showing at local trade meetings to plumbing dealers has usually been followed by repeat requests and even by return visits from members of previous audiences in distant towns. Service station attendants have been generously benefited by the numerous slide films and motion pictures made available to them by parent companies and by various accessory concerns.

The theory that helping the salesman helps the sale has been accepted by national merchandisers with "complex" items — but how about those with inexpensive commodities? Sunkist, Coca-Cola, National Biscuit, Libby's and many others have stories to tell in this field.

Eight years ago Sunkist put out a "talkie" for the fruit and grocery trade. That was *Partnership for Profit* and today's subject is *Sunkist for Profit*, a four-reel picture story which tells how to display and sell California citrus fruits. All the showings of *Sunkist for Profit* are being arranged through the company's thirty-four merchandising representatives. With the objective this year a total of at least 500 showings to an average audience of 100 persons, the total attendance will approximate 50,000 Sunkist dealers!

The versatility of the film medium is found in the extensive successful use of an economical series of slide films by Coca-Cola for the improvement of merchandising techniques. Here a lowly five-cent item benefited immensely through visual dealer aids. National Biscuit and Libby's, with motion pictures and slide films, have accomplished remarkable results.

Sometimes the dealer's enthusiasm exceeds

the mere showing of films subjects to his clerks. A Ford dealer in an Oregon city of less than 20,000 inhabitants, for example, is selling as many automobiles as the dealers in larger metropolitan areas. Comparatively inexpensive 16mm. sound movies are made of *local* sales opportunities and shown to prospective buyers. These supplement the extensive national slide film and motion picture programs which Ford has always made available to his dealers.

Both wholesalers and retailers often cooperate in setting up film programs. This is especially true in the department store field where Marshall Field and Company have sponsored films on their manufacturing activities. Montgomery Ward has also done an outstanding job in this respect for the improvement of its retail dealer setups.

The usefulness of the film medium may be illustrated in another way. It is an excellent focal point around which many local jobber meetings are now being built. Because the film has a simple and interesting way of presenting otherwise heavy fare, attention seldom lags.

What do the dealers think of these film programs? Definite check on their reactions may be obtained from the bulging letter files of the Standard Oil Company of Indiana. From the showing last year of its movie, *Stan*, this oil company has received hundreds of commendatory letters. In this case *Stan* accomplished a double-barrelled job with an extensive consumer distribution but the sound slide films of the same company receive the same kind of enthusiastic reception. In the East, Esso Marketers, Socony-Vacuum and Pennzoil have earned universally favorable results with dealer films.

Is the dealer's education expensive? That, of course, all depends on the number educated and the amount of schooling to be expected of a film. Here the series method of individual sound slide films has been found effective. *No attempt should be made to pack too much training into a single subject, even in a full-length film!* A dozen "short-jabs" are worth just that much more than a single jolting up-bercut. For that reason, also, the dealer meeting should not be a long, tiresome affair. As the experienced user will testify, it is much more successful when it is broken up (when necessary) into shorter sessions, each possessing a maximum of interest. The expense can begin with the making of a single economical sound slide film. Since this consists of a series of individual "still" pictures with a synchronized record, it is comparatively inexpensive. Perhaps if a test-meeting program can be arranged, the mere rental of one of the many general "syndicated" sales films will offer a beginning point. When the motion picture is contemplated one factor only need be remembered — every dollar spent wisely in this medium has returned generously on its investment.

(Please turn to page 34)

FILM REVIEW



RECENT INDUSTRIAL FILM RELEASES • SAFETY • EDUCATION ARTICLES



"JERRY PULLS THE STRINGS"

AMERICAN CAN ANNOUNCES A NEW EDUCATIONAL PICTURE
PREPARED IN THE INTEREST OF THE COFFEE INDUSTRY

● At the annual convention of the Associated Coffee Industries recently held at French Lick Springs, Indiana, the American Can Company presented the world premiere of its new educational picture on coffee.

Produced after months of planning and preparation, the film gives promise of setting a new style in educational and commercial films because of the novelty of the technique employed. The subject matter of the film called for many scenes in foreign countries as well as excerpts from history and legend that would have been difficult, if not impossible, to portray with a feeling of reality on actual location. To overcome this difficulty and yet to picture the scenes in their lovely charm and fantasy, puppets, or marionettes as they are technically called, were decided upon. Of course, there are "live" actors as well, but the magnificent group of puppets easily steal the show.

The film tells the story of young Jerry Spenser, a puppeteer, who proves to his prospective father-in-law, a coffee packer, that even in the business world puppeteering can be an important work by having his puppets tell "The Story of Coffee" as it has never been told before. Jerry, who also appears as a puppet for the purposes of the play, visits the coffee plantation of Miguel Ricardo dos Santos Prado, to learn at first hand what makes the coffee business tick. Miguel, a colorful raconteur, tells Jerry the story of coffee by means of a series of fast moving, utterly charming puppet scenes which dramatize legends, dances, literature, history, and industrial development as they apply to coffee.

First, Jerry learns the fanciful story of Kaldi and his goats to whom legend attributes the discovery of coffee. Next, the scene changes rapidly to one of oriental splendor in which is featured the Dance of the Prince and the Princess from the ballet *Scheherazade* by Rimski-

Scenes on this page are from the remarkable puppet motion picture produced for the American Can Company by Caravel Films, Inc. The lifelike acting of the puppets makes this a noteworthy contribution to the field of educational-business films.

Korsakov. This ballet was inspired by the Arabian Nights tales as told in the coffee houses of Constantinople. In this ballet the Prince and Princess, supported by eight lovely ballerinas, are all so expertly manipulated that strings disappear, puppets shed their doll stature and come alive. So alive in fact, that the strings purposely have been kept very much in evidence in order to preserve the puppet atmosphere.

There are further puppet scenes, too, having to do with the coffee plantation, coffee picking, coffee drying, in which tiny people, tiny animals, miniature trees, and miniature props all contrive to "tell the story of coffee as it has never been told before". Shortly before the end of the picture puppets and "live" actors appear in the same scene. One of the puppet characters induces the coffee packer to take him on a short tour of his plant where we see how green coffee is blended, roasted, ground, and finally packed in vacuum cans, "the only sure method of packing to keep coffee really fresh until you are ready to use it".

The picture was written and supervised by National Tie-In, Inc., Chicago. Production was under the direction of Caravel Films, Inc. New York, and all details of puppets and live scenes were worked out at the Caravel Studios in Hempstead, L. I. An original musical score runs through the entire picture.

Although designed primarily for educational work in schools and other similar groups, the excellence of the photography, the unusual technique employed, the accuracy in reproduction, and beauty of the sets make "Jerry Pulls the Strings" a picture worthy for any theatre screen. Miss Isabel N. Young, Home Economics Director of the American Can Company who is in charge of promotion and distribution estimates that more than 1½ million people in grade and high schools, church and club groups, and trade organizations will view this film. Prints are available in 16 mm. and 35 mm., silent or sound. The film runs about 40 minutes. Requests for showings should be addressed to the Home Economics Department, American Can Company, 230 Park Avenue, New York City.



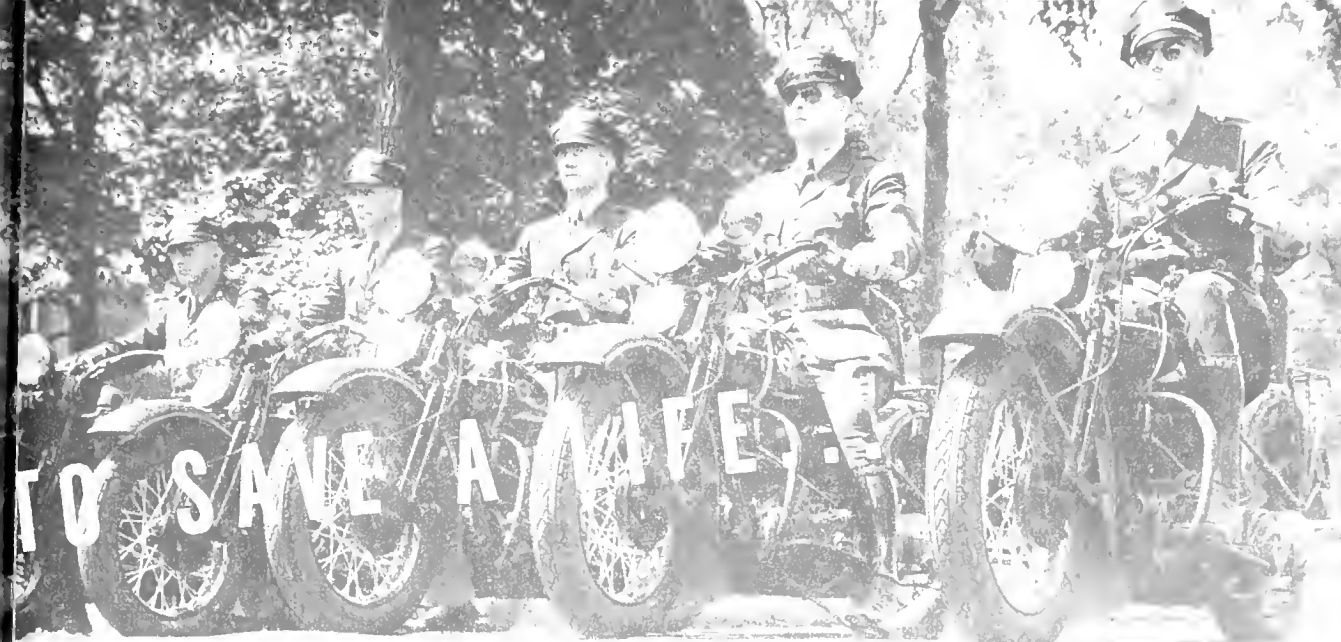

Left: Scene from *There's a Big Boy in the Hat*, Harley-Davidson Company. With it, by the De Witt & Co. from *Save a Life*, made in cooperation with the National Safety Council.

MANY NOTABLE SAFETY FILMS SERVE INDUSTRY AND PUBLIC . . .

• Two prize-winning safety films typify the spirit of unselfish service which this type of production represents in American industry. *We Drivers*, the widely-shown one-reel subject produced for General Motors by the Jam Handy organization won the National Award for the outstanding contribution to safety in 1936. Third in a series of semi-altruistic object lessons in motoring safety produced for the Plymouth Division of the Chrysler Corporation by Wilding is *The Chance to Lose*. Endorsed by the National Safety Council and police departments, this film has been the spearhead of many recent campaigns for more intelligent driving. In both subjects, the sponsor's advertising is obvious but unobjectionable since the topic is one which certainly requires the use of the product and, moreover, one of mutual interest between the motor car manufacturer and the public his products serve.

Since the appalling total of traffic deaths is one of our greatest problems, the numerous other safety films provided by insurance companies, automobile concerns and various sponsors have a big job to do and they are doing it well. The audience-report file of Business Screen lists literally hundreds of recent showings of these subjects to clubs, schools and other group meetings and the distribution of these and other such famed safety films as Metropolitan's *Once Upon a Time* (animated cartoon) has included first-run entertainment theatres throughout the country.

While the subject of "public safety" is predominant, excellent material has been produced in the field of industrial safety. The National Safety Council offers its membership several sound motion pictures and slide films in this group including the recent *Fall Guy*, a sound-slide film on the hazards of falls and *Artificial Respiration*, *The Blue Flag*, *The Handicap* and *Hindsight v. s. Foresight*. The United States Steel Corporation, Chevrolet, and the Travelers and Liberty Mutual insurance companies are sponsors of industrial safety films.

The contribution of the Northwestern University Safety Institute includes several fine sound slide films. The slide film appears to be an extremely useful weapon in the safety campaign and *Get There First*, a traffic-police picturization sponsored by the Harley-Davidson Motor Company for showing to traffic educational groups is one of the best of this type. *Safety in Numbers*, a community safety program for organizations sponsored by Metropolitan Life, is another.

The Aetna Life Insurance company of Hartford, an active sponsor of safety subjects, lists the following: *Saving Seconds*, a highway safety film; *The Truck and the Driver*, a film on truck-driving safety; *Let's Be Skillful*, a set of 34 slides and a talk outline; and a minute-movie subject, *How to Park Your Car*. Aetna's fire prevention material is equally complete: *The Bad Master*, a film on fire carelessness; *Sounding the Alarm*, an educational subject on the various means of reporting a fire and fire department procedure. *Sentinels of Safety*, a home accident prevention film, shows the dangers that lurk inside the home. Most of the above subjects are obtainable in either sound or silent versions from the local representatives of Aetna or the Safety Educational Department in Hartford.



RECENT SAFETY FILMS & THEIR SPONSORS

Motion Pictures

An introductory list of available subjects

SUBJECT	TYPE	Obtainable From
<i>Chance to Lose</i> , The	1-reel, traffic safety	Plymouth Motor Company
<i>Once Upon a Time</i>	1-reel, cartoon-traffic safety	Metropolitan Life (1)
<i>We Drivers</i>	1-reel, motoring safety	General Motors Corp. (1)
<i>Always Trust a Lifeguard</i>	4-reels, entertaining production with safety angle	Goodyear Tire & Rubber Co.
<i>Human Mileage</i>	2-reels, auto accidents	General Tire & Rubber (1)
<i>Over Here</i>	2-reels, highwaysafety	B. F. Goodrich Co. (1)
<i>Why Not Live?</i>	1-reel, first aid knowledge	American Red Cross
<i>Knights on the Highway</i>	1-reel, night driving	Chevrolet Motor Company
<i>Cross Road Puzzle*</i>	2-reels, traffic regulations	American Automobile Assn
<i>The Reason Why*</i>	2-reels, industrial safety	United States Steel
<i>Sentinels of Safety</i>	1-reel, Home Safety	Aetna Life Insurance
<i>Factory Safety</i>	1-reel, factory safety	Chevrolet Motor Company
<i>The Bad Master</i>	1-reel, fire prevention	Aetna Casualty & Surety
<i>Sounding the Alarm</i>	1-reel, fire alarm dangers	Aetna Casualty & Surety
<i>Accident Prevention</i>	Prevention of accidents	Glen Falls Indemnity Co.
<i>Ambassadors of Safety</i>	General safety knowledge	Durkee-Atwood Company
<i>Why Be Careless?*</i>	1-reel, correct driving	John Hancock Life Ins. (2)
<i>Bicycling with Safety</i>	1-reel, school-age bicycling	The Calvin Company
<i>Artificial Respiration*</i>	1-reel Exposition of the method	National Safety Council
<i>Remember Jimmy</i>	1-reel, traffic hazards	Firemen's Fund Ins. Co.
<i>Gambling With Death*</i>	1-reel railroad grade crossing hazards	New York Central R. B.
<i>The Outlaw*</i>	1-reel, factory accidents	Liberty Mutual Ins. Co.
<i>Ask Daddy*</i>	2-reels, child safety educ.	National Safety Council
<i>Carbon Monoxide*</i>	1-reel, hazards of gas	U. S. Bureau of Mines
<i>The Blue Flag*</i>	1-reel, railroad safety	The Pullman Company
<i>Highway Mama</i>	2-reels, driving practices	New Jersey Motor Vehicle Comm. (2)
<i>Hell Wouldn't Have Him</i>	1-reel, truck driving	Bruce-Dodson & Co.

* silent version only

Sound Slide Films

<i>Lady Luck's Husband</i>	Features industrial safety	Travelers Insurance Co.
<i>The Fall Guy</i>	Prevention of falls	National Safety Council
<i>Death Takes No Holiday</i>	Motor traffic training	Nat'l Conservation Bureau
<i>Inertia & the Other Fellow</i>	Community traffic	The American Legion
<i>Safety in Numbers</i>	Community safety program	Metropolitan Life Ins.
<i>Safe Seeing-Driving</i>	Lighting and safety	General Electric Co.
<i>You Bet Your Life</i>	Comedy on highway safety	Travelers Insurance Co.
<i>Stop, Look & Live</i>	Pedestrian & traffic safety	American Legion

(1) Available through the Motion Picture Bureau, N. M. C. A.

(2) Released through Modern Talking Picture Service offices.

New Fall Productions Show Ver

SPORTS

NATIONAL LEAGUE MOVIES TAKE A CHAPTER OUT OF BASEBALL HISTORY

● The sun beat down mercilessly on the arid fields but General Grant's headquarters tent was pitched in the kindly shade of giant elms. Horses on the nearby picket line hung weary heads over the hitching rail, lacking the energy to cock a wary ear to the distant sounds of battle. Dispatch riders and staff officers came and went away again without interrupting the General, for Grant was deeply engaged in conversation with a distinguished guest.

The guest sat on a camp stool near Grant's table strewn with maps and plans of strategy. His long figure slouched lankly, his bearded chin rested heavily on his lean breast, and his deep eloquent eyes watched shadows flocking the waters of a little stream which flowed placidly at his feet. General Grant, standing across the table from his guest had asked him a question and there had been a long silence.

"But this is important, Mr. President", said Grant impatiently.

"Yes", replied President Lincoln pulling himself out of his reverie, "I suppose so. Most things are important, General." A wistful smile played about his loose lips. "I was just thinking of that baseball game the New York soldiers were playing against an Illinois regiment. That was important too, General."

General Grant shifted his cigar nervously from one side of his mouth to the other. "But, Mr. Lincoln", he began. Lincoln held up his hand. "If you want something really important" he said solemnly. "It's to get the men in both armies back home where they can play ball on their own grounds!... and now that's over will somebody for the love of Mike give me a Coca-Cola!" A soldier hurried to Mr. Lin-

coln's side with a cool bottle and another for General Grant. Both drank thirstily. For them the war was over.

"Hank!" Nate Watt bellowed at his assistant. "Tie a little rock on General Grant's watch chain so the darned thing will stay in his pocket!" Then, turning to the others: "Let's shoot it again. Quiet, everybody!"

For Nate Watt was on from Hollywood to direct the production of the National League's film on baseball. Next year marks the hundredth anniversary of Abner Doubleday's epochal creation of the national game substantially as it is played today, and in celebration of the centenary, the National League of Professional Baseball Clubs commissioned Burton Holmes Films, Inc. of Chicago, to produce a four reel centennial film.

Ford Frick, president of the National League, has dedicated his film to youth and the production has been designed to exemplify the spirit of the dedication. The first half of the film is devoted to the high-lights in the history of the game since 1839 and the latter half to inspirational and instructive shots of various players and their technique. All of the instructional scenes are put on the screen in a manner which will interest any audience of baseball enthusiasts regardless of age, but they are primarily intended to instruct youthful players in the finer points of baseball playing. One phase of the historical material which will hold special interest for spectators, is the cause for, and the method by which, the National League was formed in 1876. The prime mover in the creation of the National League was one William A. Hulbert. Hulbert was a native of Chicago and lies buried in Chicago's Graceland ceme-

tery. His job of rescuing baseball from the evil days upon which the game had fallen was one of the most dramatic incidents in the story of organized sport.

Associated with the National League as co-sponsor of the film is General Mills, Inc. of Minneapolis. The Wheaties broadcasts of the game during the past several seasons made General Mills a "natural" for such an association but the company has been more than modest in its demands for screen recognition. Nevertheless the Wheaties plug is in the picture; once with the National League on the main credit title as co-sponsor; once as a window display used unobtrusively as background for a scene in a country store; once when Stan Hack of the Chicago Cubs is photographed with his charming wife and tiny son at breakfast; and once again when "Red" Barber of radio fame is broadcasting a game. All of these plugs are natural to the action and in no case intrude upon, or interfere with, the development of the baseball theme.

When released for public exhibition, which will be this autumn, the film will be loaned free to all schools and colleges, and to any established organizations such as fraternal orders, American Legion Posts, Youth Movements, churches, etc., etc. The National League is setting up its own distributing offices to the end that orders for the free loan of the film may be made to National League headquarters in Radio City, New York, or to any office of the eight clubs which make up the National League, or to the producer, Burton Holmes Films, Inc. at 7510 North Ashland Avenue, Chicago, who will handle the physical distribution and servicing of the picture.



ility of Films..

TRAVEL

SEEING AMERICA FIRST WITH GREYHOUND

● The new Greyhound film, *They Discovered America*, has Eleanor Stewart, Robert Kent, and Gayne Whitman in the principal roles, but some of the star attractions of this movie aren't actors at all. They are the exciting places that form the nation-wide background before which the action takes place. Hundreds of America's scenic wonders serve as the setting for this gay, amusing talkie. While there's plenty of interesting travel in this film, it's far more than a travelogue. The plot, though light, is entertaining — the music delightful — and the comedy well handled.

Beaumont & Hohman, Inc., Greyhound's advertising agency, planned and supervised the picture. Under the agency's direction, a roving photographer covered the country from coast to coast, taking background shots of the nation's scenic and historic highlights. The picture was produced by Wilding Picture Productions, Inc.

They Discovered America, as distributed, is a three-reel, 16mm. sound film. Its running time is approximately 30 minutes, making it ideal for luncheon club showings where time is limited. The very nature of the product Greyhound has to sell — travel — makes it easy to inject a more universal appeal into this picture than into most commercial subjects. As it is, every age group, as well as every class of audience, finds this movie appealing. The film is being shown by Greyhound traffic representatives throughout the country and is also being distributed through the YMCA Motion Picture Bureau.

INDUSTRY

MINES TO METALS

IN FILMS ON ALUMINUM . . .

● Two new sound motion pictures of the educational-institutional type have just been completed for the Aluminum Company of America by the Jam Handy organization. The first, *Aluminum, Mine to Metal*, has been produced in both a sound and silent version and is two reels in length. Simply and directly, with a minimum of advertising, this film tells the interesting story of the mining of bauxite, the manufacture of alumina and the final production of aluminum. The second two-reeler, *Aluminum Fabricating Processes*, is also made available in both silent and sound versions and describes in detail the processes by which the metal is rolled, drawn, extruded, cast and forged; the many basic aluminum products are also shown. Finally, the picture briefly outlines the methods employed in forming and assembling aluminum structures.

The distribution of both films, entirely non-theatrical, is made on request to the sponsor, The Aluminum Company of America, 801 Gulf Building, Pittsburgh, Pa. The silent versions are available through the Bureau of Mines, Washington, D. C. These subjects are available in either 16mm or 35mm and either sound or silent. A scene from each of these is illustrated in an adjoining column on this page.

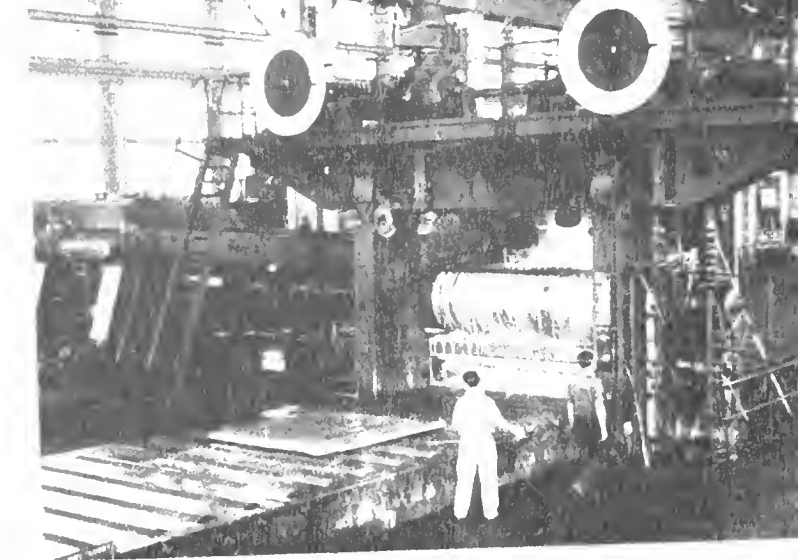



BETTER FILMS IN THE SCHOOLS

produce a successful film for educational distribution must please the teachers and the school administrators. If he doesn't, his picture will be stranded on first base. The manufacturer who cannot see further than today's sales will undoubtedly find more profitable uses for his money than the production of school-centered films, but the alert business man of far-vision and prophetic calling who would build good-will for his industry will find no better medium than industrial films prepared upon sound pedagogical principles specifically for educational distribution. He who would be greatest among you will serve our children unselfishly with no thought of immediate profit.

Yes, indeed, *industrial films that tell their story in a simple, straight-forward, and courteous manner have been, and will continue to be, welcome in our public schools.*

BUSINESS: FURN ON THE FACTS

BY FANNING HEARON

Executive Director, Association of School Film Libraries, Inc.

• A non-profit educational motion picture corporation known as the Association of School Film Libraries, Inc. was chartered in the District of Columbia on June 17 and established its main office in the Time and Life Building, 9 Rockefeller Plaza, New York, on July 15.

The corporation is a direct result of the often-expressed desire of American schools and colleges for one central source to which they may turn for help and advice in securing the films they need in determining the value of motion pictures in education.

The membership of the Association will be limited to educational institutions and non-commercial distributors serving the educational field. For these members the Association will obtain appraisals of films which are available and those which could be made available.

The Association would then do what it could to help its members obtain such films. It will

GOOD SUBJECTS WIN APPROVAL

BY HAROLD D. GRIFFIN

*Chairman, Visual Education Committee
North Carolina State Teachers College*

• The public schools are always in search of suitable industrial films which broaden the contacts of pupils. Pictures which do not violate the ethics of good teaching and which adhere to pedagogical principles will always find a warm welcome.

In general, teachers do not object to the presentation of one specified article or trade-name in a film anymore than they would hesitate to take their pupils on a school-journey to a factory that manufactured some one useful article of commerce simply because it bore a particular advertised name.

It is the methods of presentation rather than the products themselves which have made some schools wary of industrial films in the aggregate, while extending a hearty welcome to particular productions. That is the reason school systems tend to repeat their calls for certain pictures year after year. Thus, we have had the American Can Company's *Alaska's Silver Millions* three times within one calendar year. We would rather repeat a picture of proved

pedagogical value than experiment with an untried production.

Under present methods of distributing films there is little opportunity for a teacher to preview a picture and organize a teaching technique around it. For a truly satisfactory learning unit, a teacher should be somewhat familiar with a picture before it is presented to the students.

An adequate industrial film for school purposes must be adjusted to the educational level of the group to which it is presented. The documentary type of picture probably will have the most educational significance. Processes should be recorded in sufficient detail to make further steps intelligible, but ordinarily they should not be dwelt upon exhaustively. Commentators should employ elastic language, good grammar, be clear and precise, and avoid shouting. No matter how successful the methods of the circus-barker may be in selling a product to the masses, a film addressed to a school audience is no place to exhibit such techniques. "Go to your neighborhood dealer now," may bring in sales over the radio and in a public demonstration, but such an approach in a school picture will not bring a second invitation there.

Primarily then, the industrialist who would

Educational Survey Points Way to Improvement

not itself rent or produce films, but will be simply a helpful, impartial liaison unit between picture makers and picture users.

To be helpful is the Association's primary aim — helpful to those who recognize the educational possibilities of the moving film but aren't certain how to put them into effect. It's a strong young medium introducing new factors and problems — factors and problems not difficult to understand in the right light. Our business is to help turn on the light.

We hope the experiments and achievements in this field may be coordinated through the Association and that those who have hesitated to adopt films as a medium of instruction because of uncertainty as to their value or inadequacy of educational film libraries may now proceed with assurance.

The film deserves this recognition as a medium of enlightenment come very much of age. With sight, sound, and motion as its ingredients, it has no informational or persuasive equal. It is time it were used for what it is so perfectly suited.

Though the new Association is interested primarily in motion pictures made expressly for educational purposes, it is actively aware

of the fact that there is a great deal of good, straight-forward information in the films made by commerce and industry "to sell something" and that there very probably is a place for the best among these films in the educational picture.

An educational organization such as this certainly will not use its facilities to sell outright advertising under the white banner of education, but just as certainly it should exert influence to promote production of honest good-will films by business concerns whose public attitudes have come of age.

Because the user market is so uncertain — in fact — unknown, people who make strictly educational films rarely know what return they will realize from print sales or rentals. Unless there is important financial backing, the result is often an uninteresting, cheaply-produced film, the educational value of which approaches zero. These producers can not be too severely criticised for this because they aren't in business for love — and must hold production costs within a safe guess-on-return radius.

On the other hand, Commerce and Industry are (at least, should be) concerned with making "selling" films as interesting and technically perfect as the current production minds will

permit — because they should be good to get the desired effect.

The point being made is that Business can accomplish its purpose and yet make important contributions to Education — by simply turning off the ballyhoo and turning on the facts; erasing the adjective and applying the noun and the verb. The news story is far more interesting and effective than the editorial; otherwise, it, too, would be back with the rupture belt ads and not out front.

The public relations film will have arrived in America when firms confine their appearances to the presentation title, and occasional, unmentioned intrusions of product into story — or maybe no intrusions at all. What a day, for example, when a farm implement company presents "The Nation's Bread Basket" and tells the story of wheat from planting, through trading pit, to stomach; or when a railroad, an airline, or bus company presents "American Transportation," which is really the story of our growth — and all this without even those sly closeups of hubcaps and emblems.

There will be plenty of farm implements and trains and planes in the picture. What are wheat and transportation anyhow?

• Having worked in the field of visual education for many years, I have naturally been greatly interested in the projects of many industrial concerns in the making of the industrial type of educational film. In this field of industrial motion pictures, some very fine educational material has been made available, but on the other hand many of the films distributed in the schools were made entirely for sales purposes and not for use by school children.

Some advertising agents in industry have been misled, in my estimation, in the manner of producing and distributing of industrial films. Many films are produced and distributed for educational purposes that were made for advertising at sales meetings or at other meetings where the sale of a certain product is the motive for the showing of the film. This type of film was not produced for educational needs, and by all means should be kept from showings in the schools because it is in many cases detrimental to the industry to have such a film shown in the school.

I do not mean to imply that I do not believe in the industrial film's use in education; in my opinion it has a great future. The better type of industrial film can be made a great asset to both education and the industry represented in the films. The big problem is to get the producers of industrial films to distinguish between the

INDUSTRIALS GREAT FUTURE

BY LEE W. COCHRAN

*Department of Visual Instruction
The University of Iowa*

sales film and the industrial educational type.

In our distribution of industrial films over a period of years, we have found that *the sponsored film telling its story in a clear, concise manner, giving educational advantage, will be used by schools year after year* if the direct advertising is omitted. The type of film using direct advertising, even if it is a super-production, will hardly in any case be repeated in the schools, due to criticism by pupils and teacher. The teacher using motion picture films is faced with the task of presenting a problem or a lesson, and therefore must select the type of film that will not have an excess of advertising that would have a tendency to discount the educational advantage of the film.

The educational film has been accepted by education, the advertising film has been accepted by industry, and from this combination I feel confident that American industry and

Editor's Note: Other articles in this survey will be presented in the next issue.

education can combine interests to produce a superior type of industrial film that will be of advantage to both groups. The problem of industry is to produce a film that will give advertising advantage to the groups before which it is presented in order to justify to the board of directors of the company the expense of production. The educational problem is to secure motion pictures that will help visualize the course of study. It is only natural that the educator should turn to industry for motion pictures of an industrial nature. However, the presentation must be of a nature acceptable to educational standards and methods or it cannot be used with any great success.

Visual Education has made tremendous strides toward a new ideal in the past five years; yet it is still in its infancy. The industrial film has a definite place in modern education if industry will co-operate in making the type of factual film acceptable to the schools. Many concerns have excellent films available for education now, while others are in production, but a close co-operation between the industrial producer and the educator will have to be maintained if the films are to be a success with the modern school child in our institutions of today. The motion picture has tremendous emotional appeal, and should be directed in the right manner for the best advantages of all concerned.

Industrial Film Subjects Offered for Classrooms

• If the various companies and organizations making educational distribution of industrial films would give about one-tenth as much time and thought to the technical construction of these films as is given to radio advertising, the educational institutions of the country would make wider and far better use of this modern tool of teaching and learning.

Since audio-visual education is in its infancy and has not, until of late, gained significance as a powerful and most effective force for education as well as for entertainment, development of films on a colossal and gigantic scale has been slow. Thus, it is not surprising that industrialists have not given more thought and attention to their development.

To eliminate arguments for and against the use of industrial films, the industrialists might well take cognizance of some of the factors that cause some educators to reject these films and so produce the industrial films that would serve the children of all our schools unselfishly.

Specific suggestions for the mutual benefit of industrialists and educators are:

1. A humanizing of films to provide a more realistic vocational study and experience for the pupil.
2. Films having a running time of from twenty to thirty minutes.
3. Perfect sound by an expert commentator. If reduced from thirty-five mm. to sixteen mm., perfect recording is essential.
4. Appropriate musical accompaniment with

RAISE EDUCATIONAL VALUES

BY WILLIAM E. MORSE, JR.

*Superintendent of Public Instruction
Oneida County, Idaho*

majority of direct advertising at beginning and end of film except incidental advertising.

5. Films so made as to be teachable and universally acceptable to all teachers as a means of making teaching and learning dynamic in regular classroom situations by incorporating history, poetry, music, geography, physics, chemistry, electricity, government, safety, health, etc., are needed, probably to be done on a series basis.

SERIES FILMS NEEDED

The history of any particular industry could be portrayed in one of the series and outstanding events paralleling each episode could be presented in sequences, and costumes, music, modes of transportation could be presented quite incidentally.

In progressing to present day manufacture, more of the life of the worker could be portrayed rather than a simple presentation of the mechanized factors and operations, thus producing fine vocational guidance lessons.

With such a system, industrial films would become excellent teaching films and, if furnished as they are at present, would supplement

the regular classroom films in ideal classroom procedure for a vital and intelligently coordinated program. Producers of classroom teaching films would welcome such a change in industrial films because practically all teachers would use these films and requisition the regularly produced classroom teaching films.

Where the county-wide system of audio-education has been effected with projection equipment in each school and a cooperatively owned and directed film library has been established, series of industrial films could be rented for longer periods and fitted into the teaching schedule or curriculum of the various teachers of the various schools of the county or district at the precise moment when needed by the teacher and would be of more value because, by their various natures, they could be correlated with units of regularly organized curricula.

Such a system would supersede all previous attempts, many of which have been greatly beneficial and appreciated, and make necessary a larger number of high quality sound films made under direction of experts to correlate with latest ideas in curriculum construction. This would help make them acceptable for classroom use, as well as presenting the industrialist's story to better advantage.

Industrialists, wake up to these advantages! Make your films teaching films for the children attending our schools and other groups, instead of merely adapting teaching films meant for salesmen.

SEQUEL STORIES IN THIS SURVEY WILL BE PUBLISHED IN AN EARLY ISSUE; REPRINTS AVAILABLE ON REQUEST FROM THE OFFICES OF BUSINESS SCREEN, 20 NORTH WACKER DRIVE, CHICAGO

THE FILM PRAYER

I am celluloid, not steel; O God of the machine, have mercy. I front dangers whenever I travel the whirring wheels of the mechanism. Over the sprocket wheels, held tight by the idlers, I am forced by the motor's might. If a careless hand mis-threads me, I have no alternative but to go to my death. If the pull on the take-up reel is too violent, I am torn to shreds. If dirt collects in the aperture, my film of beauty is streaked and marred, and I must face my beholders — a thing ashamed and bespoiled. Please, if I break, don't attempt to fasten me together with pins or clips; simply stop the machine, and over-lap the ends around the take-up reel — a sufficient distance to hold — then proceed with the showing. Don't re-wind me unless necessary — my owner wants the privilege,

so that he may examine me, heal my wounds, and send me rejuvenated upon a fresh mission. ♦ I travel many miles in tin cans. I am tossed on heavy trucks, sideways and upside down. Please see that the paper band is wrapped snugly around me on the reel and fastened with a string, so that my first few coils do not slip loose in my shipping case, and become bruised and wounded beyond the power to heal. Put me in my own can. Scrape off all old labels on my shipping case so I will not go astray. ♦ Speed me on my way. Others are waiting to see me. The next day is the last day I should be held. Have a heart for the other fellow who is waiting, and for my owner who will get the blame. ♦ I am a delicate ribbon of film — misuse me and I disappoint thousands; cherish me, and I delight and instruct the world.

A. P. Hollis

From *Motion Pictures for Instruction* By A. P. Hollis, Educational Director Herman A. DeVry, Inc

SUPERMAN

• "There are no dull subjects . . . only dull writers!" The tale wags the dog in the Commercial Motion Picture and Slide Film industry. And emphatically!

A radio promotion executive recently announced that his department had "millions of ideas but found it difficult to find anyone who could transfer ideas to paper." And that is primarily the difference between many writers' pros and cons. That is one very good reason why capable merchandising-creative writers are scarcer in the Commercial Picture Industry than dental floss for hens' teeth!

Early in the game, "Creative men" in the commercial film world were tagged "Scenario Writers" or "Script Men." These were two abortive definitions borrowed from Hollywood that should have been given back to that adjective-propounding branch of the film industry. Frankly, it's an awful insult to call a man who is at once salesman, teacher, showman, entertainer, dramatist, humorist, critic, economist and diplomat . . . "Scenario Writer" . . . It's comparable to calling a President of a concern "Assistant Typist" because he dictates letters typed by his secretary!

Sally Rand had some pretty feathers in that fan but she had Technique. (Plenty of it) The secret of every crowd pleaser is Technique—the best way to do the right thing. No matter how elaborate the equipment for its production a Sound Picture sinks or swims on the skill of the merchandising-creative writer. A Commercial writing staff with the type of individuals you want for your own picture has, possibly, the rarest combination of qualifications in contemporary business. These Specialists qualify on six counts:

First: A thorough understanding of Sound Business Practices, particularly marketing problems.

Second: Successful sales experience in a variety of fields, both on the firing line and in executive capacities.

Third: Advertising Agency experience, both in copy-writing and as account executives.

Fourth: Mature business judgment of the kind that deservedly inspires the confidence of the client-executives with whom they work.

Fifth: A comprehensive knowledge of Visual Education, the technique of the Drama and the Short Story.

Sixth: Long Sound Pictures writing experience that combines all the arbitrary "can't's"



G. P. O. Film Unit

and "musts" of Sound Picture technique.

Such men aren't easy to find nor are they to be had cheaply. They are a quick-thinking temperamental lot, in most instances, with backgrounds that make Gulliver and his travels a poor second. They can quote parables in nothing flat and can outsee the electric eye on your new radio set for tone and quality. The Greeks may have had a word for it but in plain English it is just "Specialist."

Most of them think the Jordan automobile ads created many years ago are still the best ads ever created and printed. You can never mistake one for a college boy but there aren't many thick-waisted men in the business. Invariably one of them will spend an hour telling you that a sentence is too long, and convince you of the fact. They think "bouncing babies" are fallacies and without half trying can compare anyone or anything to a piece of machinery.

An ace-commercial writer is one who can intelligently understand the client's problem and translate accurately into the Sound Picture the best thinking of the Sales, Sales Training and Sales Promotion executives. The writing of a script is just about the last thing a commercial writer has to do!

When the writer comes to that stage of a job where he starts writing script his job is almost done. By the time he's figured out who's going to see his picture, under what conditions it will be shown, what the sponsor wants to show,

what the audience will stand (and sit) for, how much the client has to spend, what the cost will be to present the best story economically and effectively—and how all the "musts," "whats," and "hows" can best be treated without departing from sound showmanship . . . by that time the business writer has really mastered his subject . . . then and only then is he ready to start writing.

First of all a member of a producer's permanent creative staff must know what he is writing about . . . he must deal with facts. He must be able to organize his material logically and with a keen appreciation of the important vs. the non-essential, the dull vs. the dramatic among his facts. He must then arrange his presentation so that its objectives are crystal clear from the very beginning; he must tell his audience immediately what he is going to do, he must tell them several times during the presentation what he is doing and, at the end, he must tell them forcefully what he has done.

The Commercial Screen Writer must be able to talk the language of an advertising agency because he frequently must create the picture along the lines that best fit the agency advertising program for a client. He must be a practical merchandiser so he can talk the language of the product-customer and field force. He must have theatrical knowledge to make his product-picture compete with Hollywood theatrical productions. (Strangely enough if an intelli-

(Please turn to Page 45)

THE MERCHANDISING - CREATIVE WRITER COMES INTO HIS OWN

Visualizing the Industrial Exhibit

BY ROBERT P. SHAW

Director, The New York Museum of Science and Industry

● THE FIELD of exhibit presentation and display, the industrial motion picture has established itself as an invaluable aid.

Both to those whose profession is the planning, organizing and setting up of exhibits, and to exhibitors themselves who have a story to tell the general public by means of dramatized displays, industrial films serve as one more tool with whose help exhibitions may be rendered at once more effective and more efficient.

Speaking from the viewpoint of the former, we at the New York Museum of Science and Industry have found that by the use of the industrial motion picture the scope of practically any exhibit can be considerably enlarged. In translating its message into terms of architectural housings and construction, a single individual exhibit can go only just so far. This is true for a number of good reasons, of which the best and most common, perhaps, is the limitation of space which must be taken into consideration under practically all circumstances.

The motion picture, however, is held within no such narrow boundaries. Even in the small span of a single reel, it can compress a story that might require an acre or so of floor space to portray by ordinary exhibition means, while given several reels the motion picture camera can place before the eyes of the observer panoramas, processes and miscellaneous activities which he otherwise would have to travel miles and consume a great deal of time to see and to understand.

To illustrate from our own use of industrial motion pictures in the Museum, we have in our textile division at the present time an exhibit demonstrating the manufacture of rayon, organized for us by the American Viscose Company. The exhibit itself consists of a long glass case of modern design, divided into three sections, and a continuous motion picture shown

on a small hooded screen placed on top of the center section.

In the first section, is a display showing the raw materials that go into the making of the viscose solution that, when spun, becomes rayon yarn, together with samples of these materials taken at various stages of the chemical process. There is a block of spruce wood, then a pile of spruce chips, some sheets of cellulose, a pile of the sawdust-like crumbs of white alkali cellulose, the orange-colored cellulose xanthate, and, finally, a beakerful of viscose solution.

Large photographs lining the walls and sides of the case make it clear that cotton and spruce together are converted into the sheets of cellulose; that the sheets are then mercerized by steeping in caustic soda solution and then shredded into large crumbs, after which liquid carbon disulphide is added, causing the crumb to turn orange and become xanthate, and, finally, how this xanthate crumb, dissolved in weak caustic soda solution, becomes viscose, resembling strained honey.

From this, the visitor passes to the center section of the display, which is an operating exhibit giving a close-up demonstration of how viscose is converted into thread by being pumped through a spinnaret placed on the end of a feed pipe immersed in acid, and then, when the acid strikes it, is hardened and drawn off in the form of a thread by a spindle.

In the third part of the exhibit, the thread is shown as it comes from the spinning in cake form, and finally as gleaming finished yarn. Lengths of rayon in various patterns and color are draped in the background to show the final stage of the manufacturing process.

So far so good. After viewing these three sections of the exhibit, the Museum visitor has a very fair general idea of the various stages through which spruce wood chips must pass in order to become cloth. He knows, for instance, that the chips become sheets of cellulose and that the cellulose sheets are turned into large white crumbs. But he does not know just how these miracles are brought about, and to find out — to actually see before his eyes wood chips being turned into cellulose sheets and cellulose sheets into crumbs — the average person would have to get some one in the industry to take him through a rayon manufacturing plant.

Here, then, is where the moving picture comes in, bringing the whole exhibit alive and giving it unity and significance. After studying the various displays in the case, the visitor sits down comfortably on a chair before it and sees, in five minutes, the step-by-step process of rayon yarn manufacture presented in a series of animated diagrams, as entertaining in their way as Mickey Mouse cartoons. Presented under the title of "The Romance of Rayon," the diagrams give a lively version of the viscose process by which Crown Rayon yarn is made. Sheets of cellulose go flying through the air on their way from the machine that made them to the acid bath that will change them into crumbs; crumb-filled containers dump their contents unceremoniously into the next receptacle where chemical is added and the mixture converted to viscose; viscose miraculously is turned into filaments.

The second part of the diagram is concerned with the actual spinning of the yarn. Here, too, ordinarily inanimate things take on personality and lead themselves a merry chase. Coils of thread fling themselves at the reeler, take a brisk ride and jump off as skeins. The skeins leap in to a washing machine, a bleaching machine and eventually drop to a wrapping table

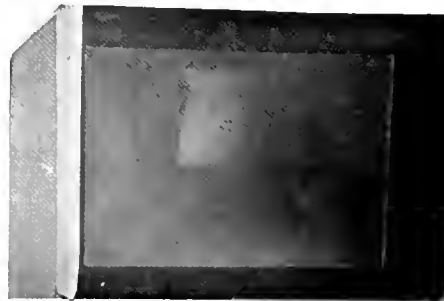

MANUFACTURE OF RAYON AMERICAN VISCOSE CORPORATION



SAFE!

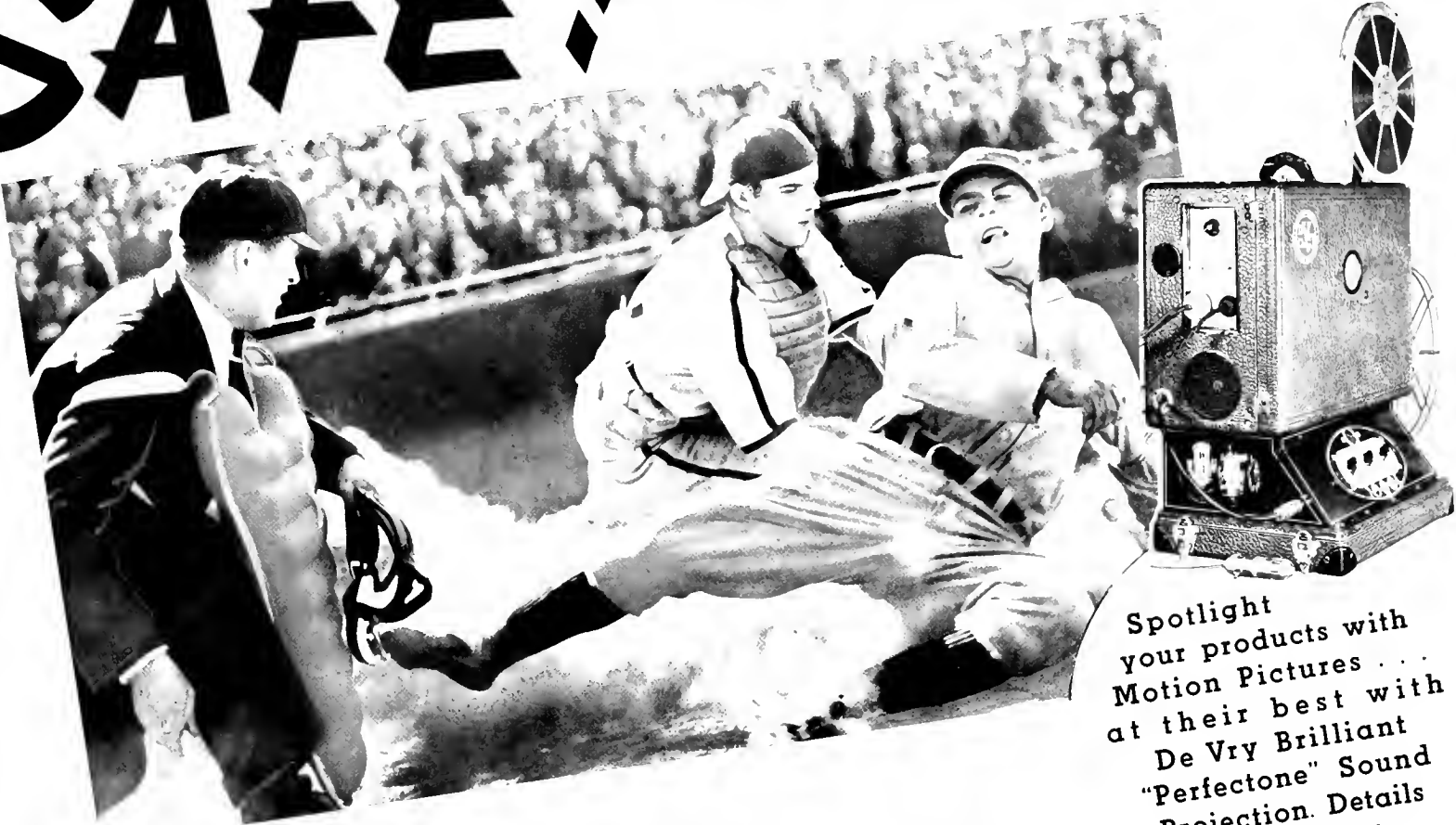

Spotlight
your products with
Motion Pictures . . .
at their best with
De Vry Brilliant
"Perfectone" Sound
Projection. Details
gladly sent.

Play safe with the "SPROCKET"*

SAVE YOUR FILMS . . .

Years ago the claw, or "shuttle" type intermittent movement was discarded in theatre projectors. Its "punching" action was considered hard on film . . . it did not give as steady a picture as the rotary type "Geneva" movement. Counterpart of this modern 35mm. Geneva Movement is the De Vry 16mm. 'Sprocket Intermittent action — EXCLUSIVELY A FEATURE OF THE DE VRY SPROCKET INTERMITTENT SOUND AND SILENT PROJECTORS. Film prints are valuable. Protect them with the smooth, rolling action of this professional type mechanism.

How It Protects Film . . .

Film is propelled intermittently by a compactly-designed oil-filled rotary intermittent action. Protects the sprocket holes because film is supported at all points, and because strain is divided between 5 sprocket holes instead of between 2 or 3, as with the shuttle type projector. Protects the delicate sound-track, because, with the sprocket intermittent, FILM CANNOT GET OUT OF ALIGNMENT.

— Also a Complete Line of 35mm. and 16mm. Equipment.

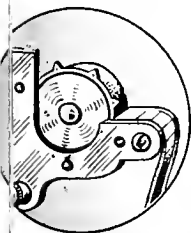

PROTECT YOUR FILMS
WITH ITS GENTLE
ROLLING ACTION

DEVRY "FANS"

- Ford Motor Company
- International Harvester Co.
- Caterpillar Tractor Co.
- Firestone Tire & Rubber Co.
- Standard Oil (Indiana, N. J., La., Va.)
- B. F. Goodrich Company
- Allis Chalmers
- Pure Oil Company
- American League Ball Clubs
- Bell Telephone Company
- Goodyear Tire & Rubber Co.
- General Electric Mfg. Co.
- Calumet Oil Co.
- Chicago and Northwestern Ry. Co.
- American Steel and Wire
- Armstrong Cork Co.
- Edward G. Budd Mfg. Co.
- California Fruit Growers' Ass'n.
- Buick Motor Co.
- Crowell Publishing Co.
- Dollar Line
- Grace Line
- Cunard White Star Lines
- Erie R. R. Co.
- Marshall Field and Co.
- H. J. Heinz Co.
- Jewell Tea
- Kelvinator Co.
- Pan American Airways
- Swift and Company
- Brown and Williamson Tobacco Co.
- and many, many others

THE SHOW WILL GO ON

SINCE ALMOST THE BEGINNING OF MOTION PICTURES the De Vry organization has served industrials, schools, AND THEATRES . . . with equipment designed for widely varying requirements.

"The Show Must Go On!" is a slogan not taken lightly in the De Vry organization. Every executive, every employee has been schooled in the rigid and exacting requirements of theatre projection.

Needless to say, the same high standards of workmanship and materials have become part and parcel of De Vry 16mm. equipment . . . built to last . . . built to "take it" . . . built to insure, even under most adverse of conditions, that the show will go on!

For example . . . the De Vry exclusive double-exciter lamp system means—in the event of failure of one exciter—that without stopping the projector or show, the other may be immediately switched into position.

Help For Your Shows

De Vry Industrial Service offers you, without cost or obligation:

- (1) Consultation on production and Distribution problems.
- (2) Monthly bulletins covering all phases of business movies.
- (3) Valuable assistance and advice in planning film campaigns.

SEND FOR IT TODAY

"GLORIFY YOUR PRODUCT"
A VALUABLE FREE BOOKLET ON
INDUSTRIAL FILMS.



Estab. 1913

DE VRY CORPORATION

1111 ARMITAGE AVE. CHICAGO, ILLINOIS
NEW YORK CHICAGO HOLLYWOOD

"With the Compliments of 'X' Company, Ma'am"

All over the country, every day, cheerful, efficient, smartly uniformed Postal Telegraph messengers are delivering samples and other advertising materials—adding punch and emphasis to the sales messages of smart merchandisers everywhere.



A breakfast food manufacturer distributed millions of samples throughout the U. S. . . . a hair-oil manufacturer tested the market for a new product . . . an automobile concern distributed in 1,100 cities more than a million and a quarter invitations from its president to prospective customers to visit the showing of a new car . . . a nationally known manufacturer of surgical appliances distributed messages and show cards to more than 20,000 drug stores in one day, tying into a national newspaper advertising campaign . . . and so it goes. Hundreds upon



hundreds of manufacturers, jobbers, retailers and agents during the past six or seven years have used Postal Telegraph's special messenger service as an integral part of their advertising and sales promotion campaigns.

Here is a service, which for quick coverage of a nation, a section, a city or a neighborhood, may be used to reach any number of persons in a highly individualized manner—and at a cost which is surprisingly low. A Postal Telegraph representative will call at your request.

Postal Telegraph

BUSINESS SCREEN IS DISTRIBUTED BY POSTAL TELEGRAPH MESSENGER

where a piece of cloth wraps itself dexterously around them and whisks into a centrifugal extractor to have surplus moisture removed. Thence to an unwrapping table, and the skeins, free once more, hurl themselves at a rod where they dangle, shaking themselves out into fluffy strands. A quick trip to a dryer, a sorter and a weighing machine, and the skeins hand themselves over to a bundler to be made ready for packing. The last seen of them, they are leaping into a packing case, the lid closes down on them and they are off to be made into the shining fabrics that are shown to complete the film.

ANIMATION IS POPULAR

To accomplish the particular purpose for which this film was used, that is, to supplement and round out the exhibit and thus give the visitor, as concisely as possible, a good general idea of a specific manufacturing process, the animated diagram is an ideal type of industrial motion picture. It covers the desired ground comprehensively and yet briefly; it strips the subject of technical mysteries and puts it into understandable language for the layman; and it does all this with a light touch that has an entertainment value all its own.

Another current exhibit in which we are using an industrial motion picture is one dealing with the historical development of locks and keys. Arranged by the Yale and Towne Manufacturing Company, it consists of a large number of ancient and modern locks, beginning with a replica of a 4,000-year-old Egyptian device, the oldest known form of lock, and finishing with a group of modern bank locks.

Many of the locks are arranged with their mechanisms either openly exposed or with a transparent cover, so that visitors, locking and unlocking them at will, may observe the actual movement of the mechanical parts as they do so. Others are in continuous operation by themselves. One entire side of the exhibit is devoted to the development of the bank lock, in the circular center panel of which is a large modern combination safe lock which the visitor manipulates in accordance with printed instructions explaining the combination. Above, at one side, is the small motion picture screen, upon which, when the visitor presses a push button, appears a picture which, in effect, takes him actually inside a bank and shows the workings of its vault. Instead of an animated diagram, this picture presents the people of the bank going about their business in connection with

the vault. Close-ups of the mechanism of the lock's operation are shown, and when the two-minute film has run itself out, those who have been watching it have a pretty good idea of what a vault means to a bank and how it operates. If they haven't, and want to set themselves a bit straighter on some of the fine points, all they have to do is to press the button again and run the film once more.

Here, again, another of the great virtues of the motion picture as an exhibit aid becomes clear. Wherever desirable, the film may be set so that the visitor himself can start it, and can do so as many times as he wishes to see the picture. Thus he has a unique opportunity for studying, without interference, any process or operation that particularly interests him.

In an exhibit of modern business machines sponsored by the International Business Machines Company, still another motion picture is used. This one, like that in the rayon manufacturing exhibit, is continuous, running some five or six minutes. It gives a detailed step-by-step demonstration of the punched card method of electrical accounting, the actual machines doing this work being shown as part of the exhibit itself. In the exhibit, the visitor sees the machine methodically turning out the cards; in the picture, he sees what actually goes on inside the machine itself as it does its work, enabling it to count, sort, punch in the proper places, and otherwise virtually "think like a man."

FILMS ON VARIED SUBJECTS SHOWN

Other films being shown in Museum exhibits at the present time are a push-button-operated one picturing the manufacture of asbestos, running in connection with an asbestos exhibit sponsored by the Johns-Manville Corporation; a continuous picture demonstrating the use of the pola-screen in photography, this as a feature of a Polaroid exhibition; a three-dimensional motion picture in color, also part of the Polaroid exhibition; and two push-button-operated films used in connection with an exhibition called *The Story of Man*, dealing with the movements of the stomach and of the intestines respectively. These two are displayed in a rather unique manner, the moving picture screen in each case being built into a large wooden figure of a man, in order that the pictures may appear in the exact location of the organs whose function and operation are being shown.

Robert P. Shaw
Director, New York
Museum of Science
and Industry,
Rockefeller Center.



Photo by
Associated News

The most extensive use being made of industrial motion pictures in any single exhibit at present in the Museum is in an exhibition of the manufacture, fabrication and applications of stainless steel, organized by the Allegheny Steel Company and the Ludlum Steel Company's *Steels of Today and Tomorrow*.

STAINLESS STEEL SHOW

Here, a large and varied group of displays lines both sides and the ends of a long aisle, terminating in an artistic and compact little motion picture theatre, specially built for the occasion with a proscenium arch and general architectural decoration of stainless steel. All along the aisle, individual exhibits in continuous motion, push-button displays and unusual operating demonstrations that visitors may work themselves make this one of the most outstanding and colorful exhibitions of its kind that the Museum has ever presented.

In all, four different short films are shown in the course of the demonstration. The first of them follows the lecturer's remarks on stainless steel in the home, in which he stresses the new paper-thin stainless steel and the new colored product, in which the color is actually in the steel itself. The picture then shows how the paper-thin steel, or Ludlite, can be cut by scissors and easily applied to walls of a kitchen or bathroom, or to the walls of such a plant as a dairy. Moving on to the next section, the lecturer pauses to explain the properties of stainless steel, such as heat and corrosion resistance, and so forth, following this with a film showing stainless steel utensils in the making. A third stop, and the lecturer tells his audience how stainless steel is used in the field of transportation, on land, sea and in the air.

(Please turn to Page 46)



SEES ALL-PLAYS ALL
UNIVERSAL 16
SOUND PROJECTORS **MM**

New All-Purpose Model

Combined utility is offered in this newly designed 16MM Sound Projector. Precision built. Completely flexible for the varied demands of classroom and auditorium.

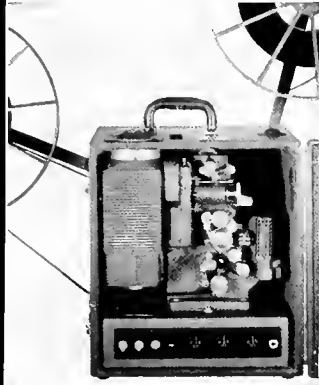

Complete, ready to operate
Universal Sound Projector

SENTRY SAFETY CONTROL CORP.
1923 Oxford St., Phila., Pa.
Show Room—1600 Broadway, N. Y. C.

**Cooper's Slide Films
Aid Trade Revival**

• No longer than five years ago, the entire men's underwear business was in the doldrums.

Underwear manufacturing reflected the sadly depleted state of men's dressers. Over a period of a few years, the value of the average man's underwear inventory had dwindled from almost \$15 to something under \$4. The decrease reflected the accepted change in male underwear habits from a variety of weights for various seasons to the wearing of nondescript broadcloth shorts clear around the calendar.

The situation was inevitably reflected in thousands of stores across the country. What had once been a profitable underwear department in most of these stores had become little more than a necessary nuisance and, in thousands of cases, an expensive, space-occupying money-losing nuisance.

How all this came about is without the province of this article. But it meant that another important industry was dragging anchor on the shoals of trade stagnation. The underwear busi-

ness was by no means the first to experience such a condition. Some industries are in similar shape right now. And others have been pulled out of these seemingly permanent slumps by what have been little less than merchandising miracles.

That is exactly what happened in the field of men's underwear. The lightning struck in Kenosha, Wisconsin, a garment manufacturing city of modest size north of Chicago on the shore of Lake Michigan, and the home of Coopers, Incorporated, which was just another money-losing concern in the manufacturing end of the underwear business.

REDESIGN IDEA FIGURES

Coopers' method of lifting an entire industry almost by its bootstraps isn't exactly new. It involved the basic ideas which other businesses and industries have used to alter national habits and thereby transform big, bad losses into neat net profits . . . such ideas as re-designing a line to include really worth while features and with emphasis on style.

Initiative, ingenuity, designing and re-designing finally gave birth to Jockey underwear for men. The same thorough experimenting and testing that developed the line were employed to prove its merchandising possibilities on a test scale. And now Coopers were ready to let go both barrels on what wasn't just a new line of men's underwear but on something that added up to a marvelous merchandising opportunity.

Of course, every idea, however good, has to be sold. And the problem to be solved in this instance was composed of thousands of underwear retailers, scattered across the nation, and long since rendered apathetic by the chronic slump into which the men's underwear business had descended.

Coopers' has wholesale outlets. And the factory also keeps 75 salesmen of its own constantly in the field. But these men are underwear salesmen, not sales promotion men. They aren't public speakers or showmen. They aren't supposed to be. They don't even know the lingo of sales promotion. And selling the trade Coopers' new Jockey line and Jockey promotions wasn't just a selling job. It was a sales promotional job as well.

SLIDE FILMS SUGGESTED

So, though Coopers' had a story of trade salvation to tell, progress in getting it across was at first discouragingly slow. Then, one day, a representative of a commercial film producer suggested to Coopers' that they make a modest test of sound slide film possibilities. And the

(Continued on Page 36)

IT TAKES SPECIALISTS...



Dramatic highlight from "Critical Moments" a minute short featuring "Eveready" Batteries and made for the National Carbon Company.

to plan, write and produce movie playlets — to combine *effectively* sound and action that vividly visualizes, maintains suspense, packs a real sales punch, and develops a climax — all in a picture on the screen for only 60 seconds.

Playlets, in experienced hands, provide a new, dynamic, selling power. The best proof of this fact is seen in the many repeat orders from West Coast clients whose screen advertising investments have brought definite returns in increased sales.

Let us tell you all about it.

DISTRIBUTION

The appointment of West Coast Sound Studios as a national sales representative for Screen Broadcast Corporation, distributors of minute playlets, rounds out a complete 4-point service for users of these pictures. All phases of a theater

campaign, from script writing to delivery of the message on more than 6000 theater screens can now be bought as a single package. Write for a copy of "Guide To Effective Theater Advertising".

4 POINT SERVICE

- CREATION
- DIRECTION
- STUDIO FACILITIES
- DISTRIBUTION

WEST COAST SOUND STUDIOS, Inc.

310 WEST 57TH ST., NEW YORK, N. Y. • CIRCLE 7-2062

National Sales Representative—Screen Broadcast Corporation

Globe-Union Builds Sales Campaign on Slide Film Programs

• Early in 1938 the Battery Sales Department combined all forces to help Globe Battery Dealers sell more batteries more profitably.

"Spinning Power=Profit Power" was the slogan adopted to unify all activity.

Although numerous types of visual presentations had been used by Globe salesmen in their contacts with active and prospective retail dealer outlets, the slide-sound type of presentation had not been previously employed.

The film produced contains 98 carefully selected photo frames and a double-side record. It was produced under the supervision of the Company's own department. Films, records and the new junior-size sound slide machines were supplied to all salaried salesmen.

The general content of the presentation can be classified in this manner:

1. A View of the Battery Market
2. 1938 Sales Promotion Plan
3. Equipping the Battery Sales and Service Department.

At the outset of the 1938 campaign, Globe dealers were greeted as "Battery Merchants," and their side of the profit story — profit from selling the battery with "Spinning Power"—originated with the market. The analysis of the market, as presented in the film and supplementary manuals and mailing pieces, registered very effectively in the minds of the majority of these "New Day Battery Merchants."

This view of the market represented a logical starting place:

When do Failures Occur?

65% of all battery failures occur before 8:30 A.M.

20% of all battery failures occur during the daylight.

15% of all battery failures occur at night after 7:30 P.M.

Where do Battery Failures Occur?

75% of all batteries fail in the motorist's garage.

25% of all batteries fail elsewhere.

What do Car Owners do to Remedy the Failure?

45% telephone for rental service.

45% drive to the station after being pushed or towed.

9% walk to enlist service.

1% miscellaneous ways.

♦ Since 75% of all battery failures occur in the motorist's garage — right in the Merchant's own neighborhood — this fact was given major emphasis on the first page of a permanent sales manual. Copies of this manual which contains much of the material presented in the sound-

(Continued on Page 37)

ILLUSTRAVOX

A proved

SALES STIMULANT

The value and efficiency of sound-slide films as a sales training medium and business stimulant have been proved by 300 companies — large and small — using 20,000 Illustravox units.

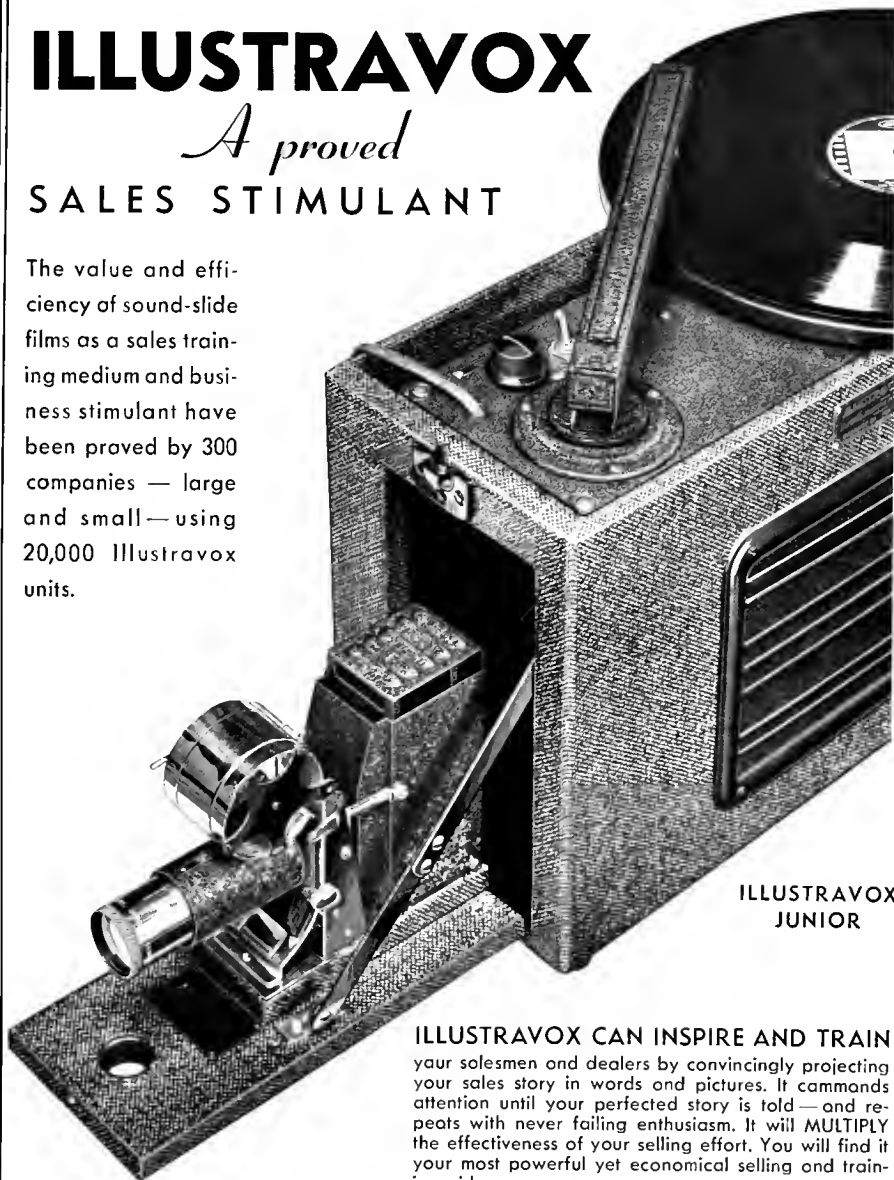

ILLUSTRAVOX JUNIOR

ILLUSTRAVOX CAN INSPIRE AND TRAIN

your salesmen and dealers by convincingly projecting your sales story in words and pictures. It commands attention until your perfected story is told — and repeats with never failing enthusiasm. It will MULTIPLY the effectiveness of your selling effort. You will find it your most powerful yet economical selling and training aid.

Investigate its application to your business by conferring with film service companies or—

ELECTRO-ACOUSTIC PRODUCTS DIVISION

The Magnavox Co., Incorporated • FORT WAYNE, INDIANA

THINGS TO COME:

- Metals — and the Film Industry
- Department Store Promotion — by Zenn Kaufman
- Government Films and Bureau Activities
- Color! — A Sequel to this month's color article

these and many other noteworthy features will be seen in the pages of the forthcoming issue number four of Business Screen, The Magazine of Commercial and Educational Films.

ANOTHER OUTSTANDING DEVELOPMENT by SOUND PROJECTS

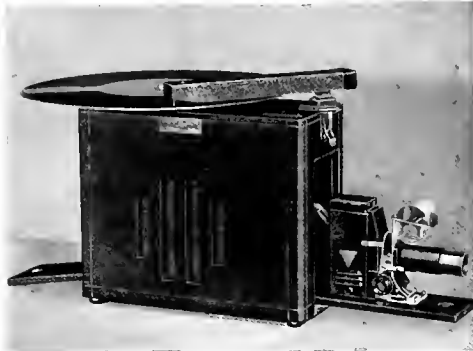

WEIGHS LESS
EASIER TO USE
RECORD COMPARTMENT
MORE COMPACT
TRIPCORDER FOR FRAME CHANGING
PRICED RIGHT

Model L-103 shown above. Suitable for audiences to 100. Other models available.

A new unit emerges forth this month, identical in appearance to the model 103 as illustrated above, but expressly designed for rural or industrial 'on the spot' sales where conventional current is lacking. Made to operate from 6 volt storage batteries. Excellent tone quality and ample illumination provided. Learn more about this and other models by contacting your dealer or write to us direct.

SOUND PROJECTS COMPANY
3140 WALTON STREET CHICAGO

Superb Living



An address of prestige where the discriminating traveler may relax in an atmosphere of refinement. Under the same management as The Drake and The Blackstone in Chicago.

A. S. Kirkeby, Managing Director

The Town House
ON WILSHIRE IN LOS ANGELES

EDUCATING THE DEALER

(Continued from Page 34)

factory soon after sent its first production, *Streamlined Men*, into the field.

Thanks to ingenious organization, that first slide film, confined to a 12-inch recording, did double duty. One side of the recording told a dramatized nine-minute story about Jockey underwear that not only led up to the story of the merchandising program for retailers but also served as an interesting show for civic groups, luncheon clubs — in fact, any organization that gathers men together in one place.

FILM REVOLUTIONIZES RESULTS

Coopers' had no difficulty in showing the first half of the sound slide film to hundreds of consumer groups.

And that first film immediately revolutionized results with the trade.

"Where it had been difficult, in many cases impossible, for our salesmen to tell the complete story just to the buyer, the slide film enabled them to tell the story, not only in complete detail but also to everybody in a store in any way concerned with men's underwear," reports A. R. Kneibler, vice president and sales director of Coopers'.

"Usually our salesmen first show the film to the underwear buyer and, in large stores, to his assistant. Getting this first showing is easy. All they need do is express a desire to put on a show. Then, after the boss has seen our film, the salesman in most cases couldn't avoid showing the film to the entire underwear department, even though he wanted to.

"The group showing is generally made at the store before or after business hours. Occasionally the salesman gets the group together at his hotel. But, however he chooses to set up his group showing, a slide film is always the perfect kick-off for an enthusiastic meeting on local Jockey underwear promotion.

SUCCESS NOT THEORETICAL

"With slide films we've licked a problem that began with our own sales organization and extended into every town in the United States.

"Our success with films isn't just theoretical. In the year since we first started using the medium, we've been able to obtain close promotional cooperation in the outstanding stores in every state. With films, we've been able to educate several thousand sales people in practical, specific, result-getting sales methods. It is a provable fact that our business has steadily increased in almost every store where a slide film has been shown and the pickup is always immediately discernible after the film showing.

"Our first slide film also enabled us to open hundreds of new accounts. And, while results of a promotional effort can rarely if ever be

(Please turn to Page 38)



The graphic power of the film strip seen in Coopers' "Hothouse Legs", Wilding Picture Productions.

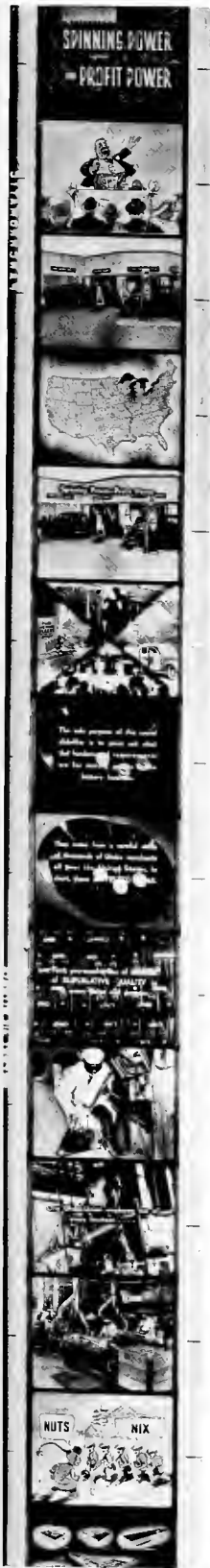

Globe-Union slide film introduction is reproduced above. (Wilding)

EDUCATING THE DEALER

(Continued from Page 35)

slide presentation were handed to Battery Merchants immediately after holding their first showing of the sound slidefilm.

With this complete sales manual, "The Dawn of a New Day," Battery Merchants were able to review the contents of the film at their own leisure and convenience.

The second section of the film, as well as the manual, briefly introduced 6 promotion plans to help the Merchant increase the volume of his battery sales. The promotions were also illustrated and fully described in large, three-color broadsides which are released at regular 6-week intervals.

1. With the purchase of 6 batteries the Merchant was entitled to a choice of three-color, metal identification signs.
2. A free battery tool set is supplied as the plus value to Merchants who purchase 6 batteries with their merchandising display and battery tester.
3. Free government postal cards are given to Merchants who sign up for the Warn-O-Meter promotions and 6 standard batteries. The Warn-O-Meters are given free to new customers.
4. A Giant Window Cutout Display is given to Merchants on the fourth promotion.
5. With an order for 6 batteries an attractive, window-flasher, electric-sign is given away.
6. Finally, as announced in the film and the manual patterned after the film, described in a separate broadside mailing, is a group of 5 government postal cards printed attractively in two colors to keep motorists coming in for free battery service.

♦ The third step in the campaign, as originated in the film, is an urge to equip stations thoroughly for service. The importance of the hydrometer test, battery testing apparatus, and charging equipment is covered in detail. And, a tried and proven system for consumer follow-up — both by mail and by telephone is recommended.

As evidenced by the steady flow of favorable film showing reports, Globe salesmen and distributor salesmen have made splendid use of their first sound slidefilm.

With the aid of the standardized sales presentation in printed form, "The Dawn of a New Day," Merchants have succeeded in making their personnel more conscious of the possibilities of effective battery operation.

And, with the series of six follow-through broadsides, jobber salesmen have very successfully kept Merchants' stock complete, fresh.

During the generally difficult months of the passing recession, the curve of Globe battery sales has traveled contrary to the trend. Sales during the past few months have greatly exceeded comparable periods for 1937.

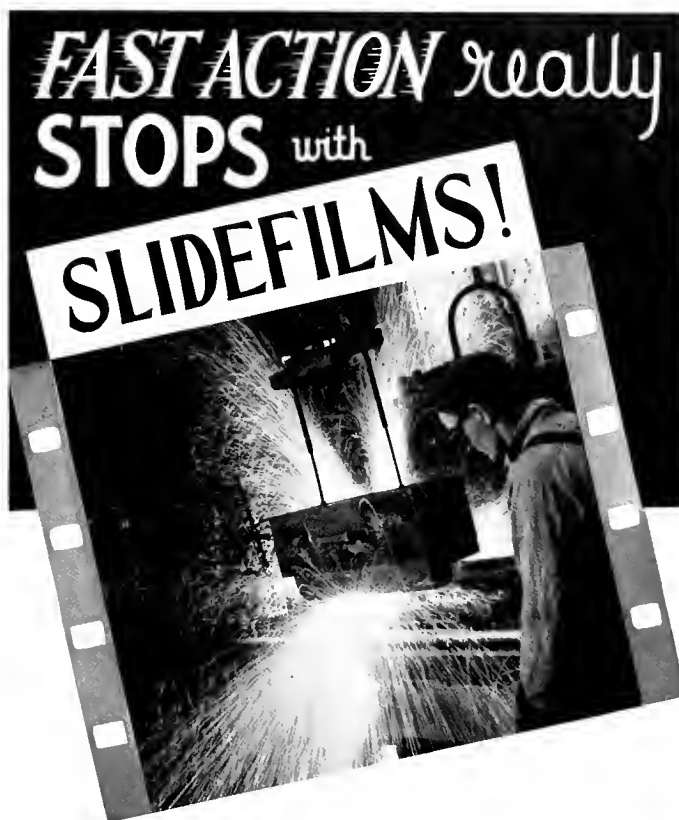

The Modern Way To Dramatize Your Sales or Training Program



Progressive companies, more and more, are using slidefilms, silent and sound, in personnel work, dealer relations and consumer selling not only because of the economy of this medium but because it alone permits dramatic effects impossible with other visual aids.

MANY STYLES
Silent or Sound

For brilliant theater-quality pictures specify S. V. E. Picturol Projectors in your sound slidefilm units.

S. V. E. PICTUROL PROJECTORS

Today's critical audiences expect theater-quality projection. S. V. E. Picturol Projectors have proved their superior efficiency for more than 18 years. Thousands of units in the service of such well known firms as Chrysler, Coca-Cola, Crane, Firestone, Ford, General Foods, General Motors and Standard Brands are daily presenting slidefilms at their brightest and best. Other projectors may look like S. V. E. equipment but none can duplicate its patented features and time-proved superior performance. Write for your free copy of the interesting folder "Salesmen Are Made" which illustrates S. V. E. Picturol Projectors for every requirement.

SOCIETY FOR VISUAL EDUCATION, INC.
Dept. 98, 327 S. La Salle St., Chicago, Ill.

Send immediately your free folder "Salesmen Are Made" describing S. V. E. Picturol Projectors.

Tell us about your new S. V. E. Automatic FilmSlide Take-Up.

Name _____

Firm Name _____

Address _____

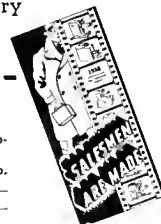

But

KODACHROME is Practical— NOW...

MOST of your clients prefer color but fear prohibitive costs. Banish this fear with our practical service for slide film producers which reproduces slide film in natural color from copy or Kodachrome transparencies. Write today for complete details regarding low cost and rapid delivery.

color ILLUSTRATIONS
INCORPORATED
152 West 42nd St., New York, N. Y.
LONGue 5-9255



business or pleasure

it is Results you want... so select the

RCA 16 mm Sound on Film

camera and be assured of getting results you can be proud of... Bass engineers have perfected accessory apparatus assuring you of successful work... made as easily as "silent films". Our special department for

Industrial apparatus for making moving pictures is at your service. Come in or write us of your needs.

Write for special Cine Bass Bargaining No. 234... listing thousands of items 8 and 16mm.— sound and silent... all real values.



Dept. BU

179 West Madison Street
CHICAGO ILLINOIS

COLOR TELLS IT AND SELLS IT! — from page 19

print by projection through the celluloid upon a specially prepared stock, which is then developed and processed in such a manner as to produce positive relief images in hardened gelatin. These three hardened gelatin reliefs are then used as printing matrices which absorb dye. This dye is then transferred by imbibition printing to another film strip which, when it has received all three transfers, becomes the final completed print ready for projection. To carry on the process of imbibition, it is necessary merely to press the matrix film into close contact with a properly prepared blank film and hold it there for several minutes. Matrices, of course, can be used over and over again.

The art of the color cinematographer is intermediate between that of the painter and that of the stage artist. The painter has to work with pigments having a limited range of contrast but has great freedom of choice as to composition. The stage artist works with light, and so does not encounter the pigment limitation; but he must select his costumes, backgrounds, etc., to be harmonious in a great variety of arrangements, most of which are more or less out of his control. In color cinematography the difficulties of both are combined; there is the pigment limitation combined with the comparative lack of control of composition.

In color photography, it is necessary to operate at rather high levels of illumination. If one is not careful, this may lead to a condition like this: given only relatively weak light-sources, one finds it necessary to use a great many of these sources, in order to attain an adequate level. The widespread distribution of these units then tends to kill all shadows and eliminate modeling on faces. If, then, the attempt is made to provide modeling by superimposing a localized shaft of light, as from a spot-light, the face is burned up, blotchy, and generally unrecognizable. The way out of this dilemma is to recognize that modeling should properly be produced by shadows, and to use fewer and brighter sources or to mass the sources of illumination so that shadows have a chance to exist. In other words, it is just as important for the cameraman to determine directions from which light shall *not* come as it is to determine directions from which light *shall* come.

While color contrasts will occasionally produce a pleasing result when flatly lighted, that is not the way to get sharp photography, nor in general, the most pleasing photography. The Technicolor process is capable of reproducing a full scale of contrasts and those effects of light and shade (*chiaroscuro*), and those directional effects so striking in black-and-white are even more effective in color. These considerations apply not only to the lighting of figures and faces but also to the design and lighting of

sets. In the design and painting of sets, the art director should have in mind the cameraman's problem of achieving the necessary light levels with a minimum number of sources of illumination. Under these conditions, it is always much easier to keep parts of a set in low key by keeping light away from them, than it is to paint them dark and then be forced to illuminate them strongly.

It is the policy of the Technicolor Company to organize and maintain a nucleus camera department and color art department for the purpose of accumulating experience and disseminating information and advice as to the skillful and effective use of Technicolor. Beyond this nucleus the policy is to invite cooperation from the studio organizations and especially from those cameramen and art directors who desire to continue to lead in their respective fields. These men will generally be surprised, first, at the extent to which their conscious sense of color has become atrophied through lack of use while working in black-and-white; second, at the speed with which they can regain it; and, third, at the utter inadequacy of black-and-white photography in comparison with good color photography.*

* from "The Technicolor Process of Three-Color Cinematography" by J. A. Ball, Vice-President and Technical Director, Technicolor Motion Picture Corp., Hollywood, California, originally presented at a meeting of the Technicians Branch of the Academy of Motion Picture Arts and Sciences and reprinted from the Journal of the Society of Motion Picture Engineers, Vol. XXV, No. 2.

COOPER'S SLIDE FILMS . . .

(Continued from the previous page)

measured right down to the last nickel's worth, the fact remains that our first slide film had a lot to do with increasing our business to a point where we were justified in doubling our advertising appropriation for 1938, only a few months after that first production.

"There's another value we've enjoyed as a result of our use of sound slide films that can't be measured in monetary terms but that is just as important. By introducing the use of the sound slide film into the men's underwear field, on top of our development of Jockey underwear, we scored another "first" and thus helped build up the reputation we are constantly seeking as the source of modern merchandise and alert merchandising."

Coopers' latest slide film production, *Hot House Legs*, just released to every Coopers' salesman, is devoted to the merchandising of Jockey Longs which last season made a definite start toward putting long underwear back on the finest flower of American manhood during the shiver season. *Hot House Legs* is also organized to serve for consumer as well as trade shows and in the latter case is shown introductory to a second film which covers Coopers' current advertising and merchandising.

THE COMMERCIAL NEWSREEL

♦ Announcement that Uiram Walker had contracted for an additional 1500 showings of the instructional sound motion picture *Keeping Nature on Its Course* was made last fortnight by Frank Arlinghaus, president of Modern Talking Picture Service who have been distributing the film since its first release. The showings will be made during the present fall and early winter season.

♦ Another announcement of great interest was that of the inaugural of Photo-Sound, the sound slide film division of Sarra, Inc., nationally famous illustrative photographer. Shirley MacDonald, well-known in soundslide film circles and an extremely capable producing director of these subjects was formerly with Vocalpix and Spoor and Abbe. Miss MacDonald will be assisted at Photo-Sound by Harry Lang.

♦ The adaptation of the popular Castle Films home movie subjects to commercial programs by such concerns as Shell Oil and others brings to mind that these newsreel and short subjects are ideal as program openers and offer a sustained interest unequalled by the most golden-voiced salesman stalling for time on a film program. *American Legion—Los Angeles — 1938. See Number 4. Preview of the World's Fairs*, and other typical subjects will be useful and are, of course, extremely economical.

♦ In the extensive color-section sequel to this month's introductory color articles, *Business Screen* will feature descriptive comments on the new Cosmocolor, an exclusive Wilding feature, and on Dunningcolor, Telco-Color, Brewster-Color and several other current methods. The advantages, pro and con, will be thoroughly aired.

♦ A non-Commercial, scientific movie in color was recently made at the Sherwin-Williams plant in Newark, N. J., by the Vitaphone Shorts, 321 W. 44th Street, New York City. The film, sponsored by *Mechanics Illustrated*, will be released during August and September to more than 8,000 theatres. Automotive jobbers, refinishers and others interested in seeing how paint and varnish are made may get details on when and where the movie will be shown, by writing to the movie company at the above address. — *The Autobody Trimmer & Painter*.

♦ Back of the growing move for sponsored films, besides the desire to get advertising for commercial accounts into domestic theatres, is the urge to get the advertising plugs into foreign countries. American national advertisers see films as a means of introducing their products in countries, mainly British, and some continental European countries, that bar advertising from the air. With governmental restrictions against commercial broadcasts, these American advertisers see a way to reach big European audiences through Hollywood films. — *The Hollywood Rep.*

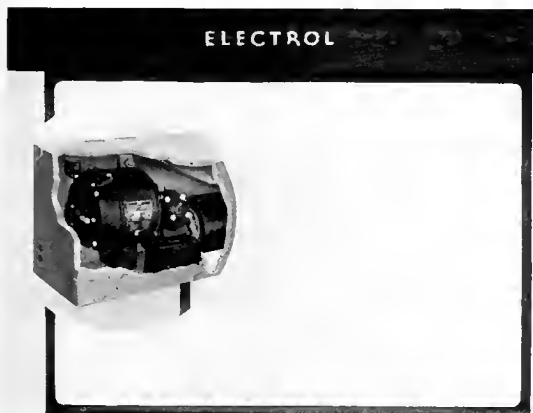

THE "ELECTROL", a motor-driven model, is the latest development in the DA-LITE line of dependable projection screens. The ELECTROL is especially adapted to conditions in school rooms, churches, clubs, small theatres, etc.



EXPANSION

The latest business expansion move made necessary by Cinecolor's consistent progress is the magnificent new \$250,000 plant now being erected in Burbank and shown above in architect's drawing — another monument to the widespread acceptance of this remarkable color process!

CINECOLOR



Distinguished

The Drake offers every luxury and convenience of fine living on Chicago's Gold Coast, overlooking Lake Michigan.

A. S. Kirkely, Managing Director

The Drake

LAKE SHORE DRIVE • CHICAGO

YEARS AHEAD

AND YET . . . COMPLETELY IN STEP WITH TODAY'S NEEDS

• Modern selling demands new techniques in sales meetings and conventions. Motion pictures and slide films, dramatic playlets, all play their part in the drama of salesmaking. 20 North Wacker Drive, with its three theatres (Civic Opera, Civic Theatre, Electric Theatre, and two Studios) including the facilities of a luxurious club, offers the finest location for such occasions plus most convenient office headquarters.

You are invited to visit 20 North Wacker Drive and to see for yourself its many unusual advantages.

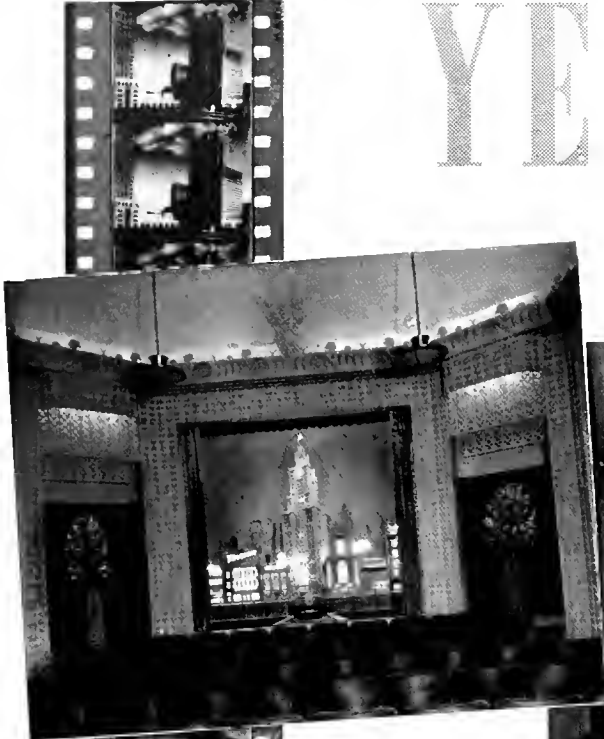

Two typical small theatres are ideal for sales meetings

More than just a business address, 20 North Wacker Drive's superb facilities include a luxurious luncheon club, meeting rooms for groups from three to three-thousand persons and complete accommodations for sales meetings, conventions and trade shows superior to any in Chicago! Here, under one roof, are all sizes of modern offices and in addition, the convenience of conference and group meeting rooms, private dining rooms for luncheon or dinner gatherings or the most extensive and complete stages and theatres for a national convention. Studio theatres suitable for motion picture and slide film presentation are available for large or small groups. 20 North Wacker Drive has the unusual advantage of central location with most of Chicago's major railroad stations and local transportation lines within a few minutes radius. Towering over the entire business section, 20 North Wacker affords incomparably light and airy facilities for your office headquarters in Chicago. Plus reasonable rentals and the economy of its many convenient meeting rooms, theatres and restaurants.

Address Inquiries to the Office of the President, J. E. Thompson
20 North Wacker Drive (The Civic Opera Building) Chicago

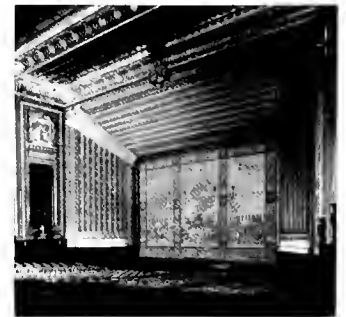

The Civic Opera Theatre is a world-famous center



The Civic theatre — a perfect setting for dealer shows



20

NORTH WACKER DRIVE

BRIEF REVIEWS OF THE LATEST FILMS

● New films released for distribution during recent weeks are reported by this department prior to their screening in the prevue theatre of Business Screen. Sponsors are invited to submit film subjects for review to the *Screen Service Bureau* of Business Screen, Twenty North Wacker Drive, Chicago.

EASTMAN KODAK COMPANY and J. E. Brulattour, Eastman film distributor screened the company's new industrial feature *Highlights and Shadows* in prevue showings recently. A 55-minute feature, the film covers every phase of the activities of the Eastman Company at Rochester with emphasis on the production of motion picture stock, the basic product of the entire film industry. First-rate photography, of course, is a notable part of this production.

DELAWARE, LACKAWANNA & WESTERN COAL COMPANY has been showing a new film on its *Blue Coal* before dealer and salesmen groups



"Life Is What We Make It" is the title of the Dairy Council film from which the above scene is taken.

in fourteen cities the past month in anthracite consuming territories. Later to be available for other uses, the film is a one-reel production by the Jam Handy Organization and presents the story of the mining, processing and marketing of the product.

THE HAJOCA CORPORATION of Philadelphia has been conducting a series of FIA meetings at which its new movie, *The Making of Brass Work*, is shown.

F. E. MYERS AND BRO. CO. of Ashland, Ohio have just finished a full length silent movie entitled *Running Water*. In two parts, the film is intended to appeal to rural audiences only.

AMERICAN CAN COMPANY showed its new coffee promotion film *Jerry Pulls the Strings* to groups in New York and at French Lick Springs. The film is reviewed at length in the Film Review section. Caravel Films produced.

NATIONAL CARBON COMPANY has a series of 8-reels of sound motion pictures titled *The*

Eveready Prestone Review which it is showing to national dealer groups and which will be distributed by company representatives thereafter. Produced by West Coast Sound Studios, the pictures include reels of animating, (cartoon and technical) a news travelogue and a product merchandising film of 4 reels.

E. I. DU PONT DE NEMOURS, Inc. have released *Cool Heads* to interested automobile agents and service stations. Produced by Audio Productions, Inc., *Cool Heads* is a 3-reel exposition on Zerone, the du Pont anti-freeze solution.

ETHYL GASOLINE CORPORATION's new sound motion picture is the 3-reel feature *Guiltly or Not Guilty* which was produced by Audio Productions, Inc. Made primarily for dealer training, this swift-moving commercial is being shown to service station groups throughout the country.

NATIONAL WOMAN'S CHRISTIAN TEMPERANCE UNION has issued *Pay-Off*, a 2-reel production in the interest of alcohol education. Social and economic studies taken from the case records of Family Welfare Bureaus offer a powerful argument for temperance and a fitting sequel to *The Beneficent Reprobate*, the organization's previous film. Produced by the Jam Handy Organization, *Pay-Off* will also be nationally distributed by the Motion Picture Bureau of the Y.M.C.A.

DAIRY COUNCIL OF BALTIMORE has a new film *Life Is What We Make It* which was produced by Stark Films of Baltimore. An extremely interesting and well-produced short subject which is also being sponsored by other dairy groups nationally, this film is the second of a series. The first, *Admirals In the Making* is now being used in 55 centers throughout the country. No trade names are used and excellent distribution attained through theatres.



Scene from "The Pay-Off," recent W.C.T.U. film.

*SOCONY - VACUUM & NEW YORK MUSEUM OF SCIENCE & INDUSTRY

Selected

AUTOMOTION CONTINUOUS PROJECTORS

for "Action" at Radio City Exhibits

*See pages 8 and 30 of this issue

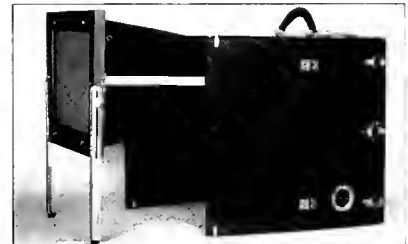

AUTOMOTION Continuous 16mm. motion picture projectors were designed and built for long, heavy duty, continuous projection, and have been successfully used for 14 years throughout the world. AUTOMOTION should not be confused or compared with home projectors with gadget attachments.

Write for "Action in Advertising"

ADVERTISING PROJECTORS, INC.
10 West 33rd St. New York, N. Y.

SPINN-BUTZEN STUDIOS

Producers and Creators
of Animation

TECHNICAL... CARTOON MEDICAL... INDUSTRIAL

ASHLAND-IRVING BLDG. CHICAGO, ILL.

NEW EQUIPMENT

♦ Taking up about as much room as a large typewriter on the executive's desk, the Argus Microfilm Reader, a new product of International Research Corporation, literally puts the world's sources of vital information at arm's reach. To-day's executives can order on microfilm (35mm. perforated film) the facts, charts, and illustrations, they need as the basis for new plans. The world's great libraries and special-



The Argus Microfilm Reader opens a vast new field of use for the film medium in business by condensing records, charts, documents and thus solving storage problems for many.

ized sources of information furnish microfilm reproductions from their books and journals for as little as a cent a page. A page is reduced to a single frame or less — the Argus magnifies them back to original size on its reading screen.

This versatile machine also projects 35mm. and 16mm. film on walls or screens, and a printer frame attachment will soon be available for \$5.00 to make enlargement paper prints at negligible costs. Without darkening the office, the business man may study his microfilms, or view his sales films in perfect comfort — and at whatever time he chooses. This technique saves valuable time; increasingly supplants costlier and less accurate research methods; and daily finds new uses in stepping up the efficiency of modern business routine.

♦ The new Junior Illustravox is a high quality, sturdily constructed sound-slide film machine especially designed for individual selling presentations or for small groups. The projector drops into correct operating position when the front door is opened. A portable desk screen is self-contained and can be set up instantly on desk or table.

Because of its small size and portability, salesmen will use the New Junior more consistently — more effectively — in delivering your sales story to dealers, salesmen and prospects. It is equipped with the Model "Q" 100 watt projector. An excellent picture is projected on the small screen — or a large six foot picture can be projected on a separate screen. Sound emanates from both sides of case so that re-

ception is clear and distinct to audience seated on either side of machine. The new Junior is small, compact and easily carried. It will play 12" or 16" records and accommodates a number of 12" recordings. However, if 16" records are carried, a separate record compartment or envelope may be attached to the side of the case at small additional charge. Literature may also be carried in this compartment.

♦ The S.V.E. Patented Automatic Film Slide Take-Up can be easily attached to various models of S.V.E. Picturol Projectors. No longer is it necessary to let film slides fall to the floor, where they gather dust and may become tangled. Hand-rewinding of film, with its inevitable finger-marking, is also eliminated.

The S.V.E. Take-Up device automatically rewinds the film as fast as it is shown. It places it in its storage can — ready for the next showing.

♦ It was learned recently that Bell & Howell Company, pioneer manufacturer of motion picture equipment, has been expanding sales representation on the Exakta line of still cameras made by Ihagee Kamerawerk, Dresden.

The projection booth of the Standard Oil Company's conference room-theatre in Chicago showing various types of equipment used in such an arrangement.



(Photo courtesy of DeVry Corporation)

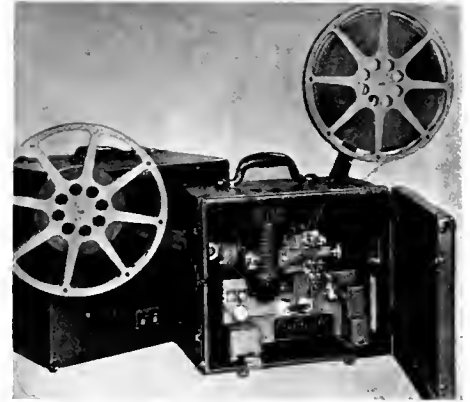

The ever-popular Filmosound projectors made by Bell & Howell (a typical sound model is shown above) list several important improvements this season for the industrial user.

Questioned regarding this epochal activity in the still camera field, a Bell & Howell official stated that the company had been experimenting for some time in the supplemental use of "stills" with motion pictures for both personal and educational purposes.

It was pointed out that whereas the fundamental characteristic of motion pictures is action, fine scenic "stills" in either black-and-white or natural color could be taken "on location" and projected as supplements to the motion picture action. In educational work, for example, movie projection could be stopped at

Leaves from a Managing Editor's Notebook*

Memo 8-1-'38

Editorial plans complete for "Managing Salesmen in 1939", with sections on:
Hiring Salesmen
Training Salesmen
Paying Salesmen
Equipping Salesmen
Controlling Salesmen
Stimulating Salesmen

Figure on 120 pages or more with color runs.

Memo 9-2-'38

October 10th issue has to be good. July cross-section subscriber check shows it to be most popular single feature appearing during year in Sales Management's complete editorial program!

* * * * *

Order photos on best new sales tools—kits, portfolios, visual presentations, etc.—we've found this year.

Memo 8-3-'38

Two more good articles cleared for 10-10—one on missionary salesmen, one on junior salesmen.

Query: Has the Armstrong Cork Company delivered special pictures to be used to illustrate the excellent article on their sales training system?

Memo 8-4-'38

Reserve at least 25 pages in Oct. 10 dummy for annual review of best industrial films of the year. Both slides and movies to be included as usual. Note continuously broadening uses to which films are being put in American business. Get examples of pictures of all types, so far as possible.

Memo 8-5-'38

Subscribers are so keen about Pictographs—why not arrange about five of them for Oct. 10? Send note to advertising dept. that five swell preferred positions will be available opposite these.

* * * * *

Check up on that idea for "salesmanship test" we discussed at staff meeting two weeks ago.

Memo 8-8-'38

Sent to printer: excellent article by Rados, "The ABC's of Successful Sales Training". All done with charts—arrange for color run on these.

* * * * *

Clean up survey on company policies in 50 firms on salesmen's pensions, vacations, sick-leave, group insurance, etc., etc.

Memo 8-9-'38

Philadelphia editor has delivered De Long Hook & Eye story about Charles Wiers' most successful sales bulletins for wholesaler's and retailer's salesmen. Reports company making all-time high in sales volume this year.

* * * * *

See if we can clear that survey on branch managers' compensation plans for the October 10 closing date.

Memo 8-10-'38

To Associate Editor Wright: You're to see that at least half a dozen bang-up stories on the best sales contests of the year are ready not later than September 10—for "Managing Salesmen in 1939", of course.

* * * * *

Reserve space in dummy for six new advertisers who have already ordered space—list on Reed's desk.

Memo 8-11-'38

Sent to printer: story from San Francisco editor on those amazingly successful Tide Water Associated Oil "road show" conventions.

* * * * *

Also re. conventions: get advance galleys on the "Check List for Convention Planning" for promotion department.

* This is a behind-the-scenes glimpse of the wheels going 'round in preparation of the annual "Managing Salesmen" issue of Sales Management magazine. This, of course, is the issue devoted entirely to man-power problems in selling. Due off the press October 10. You can obtain a copy by subscribing to Sales Management now—26 issues, \$4. Single copies of Oct. 10—\$1. Scrawl a note on your letterhead today, to: SALES MANAGEMENT, Inc., 420 Lexington Avenue, New York City.

a certain point while a still or series of stills were shown, permitting elaboration on some special scenic point by the educator.

♦ The Ampro Corporation of Chicago, manufacturers of 16mm. motion picture projectors, have extended their line with the advent of their NEW 16mm. "Ampro-Are" Sound-on-Ampro's new 16mm. Are projector is now available for industrial or school use requiring the larger auditoriums for picture performances.

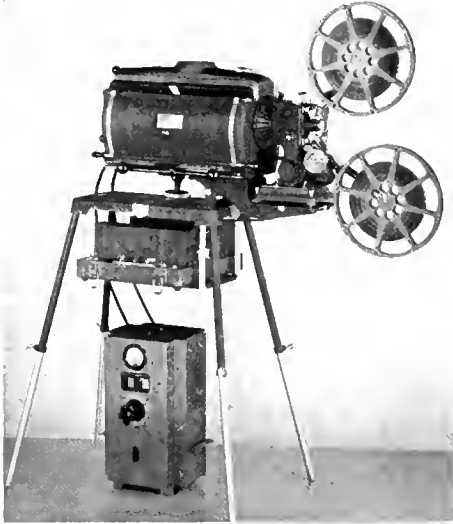

NEW EQUIPMENT . . . 2

Film Projector which has *FIVE* times the brilliance of the ordinary 750 watt projector.

The new projector with its ease of operation, its ruggedness and quality manufacture, opens a new epoch for 16mm. projection with its *Superior Screen Brilliance and Powerful Natural Tone Quality Volume* so necessary for the largest of auditoriums.

♦ The Berndt-Maurer Corporation has felt for a long time that the business and educational sound film could never come into wide and successful use unless costs of promotion were materially reduced. To this end they have developed, since 1933, a complete line of 16mm. "High-Fidelity" direct Sound-on-Film recording equipment, which they sell outright to the purchaser to use as he sees fit, and with a two year operating guarantee regardless of the footage of film produced with the machines.

Berndt-Maurer has also established the Precision Film Laboratories, a B-M division set up to guarantee quality results in the 16mm. medium. While B-M also manufactures 35mm. equipment and Precision Laboratories is completely set up to handle 35mm. work as well as 16mm., the entire organization of manufacturing plant and film laboratory are specialists in



When "still" subjects are useful, the Exakta "candid camera" is an asset.

16mm. "High-Fidelity" Sound-on-Film.

The B-M 16mm. equipment includes cameras, recorders, amplification equipment and film-laboratory equipment, designed to produce professional results directly on 16mm. Sound-film, but equipped for operation by non-professionals if necessary. (The sales manager of a large New England concern, with the help of two of his regular salesmen and a professional editing service in New York, produces advertising and sales films for his company, in full natural color, with sound, which are remarkable in their quality and scope. B-M 16mm. equipment is used throughout. While this New England concern had been interested in the film medium for many years, the expense had been prohibitive until B-M direct 16mm. sound equipment was available.)

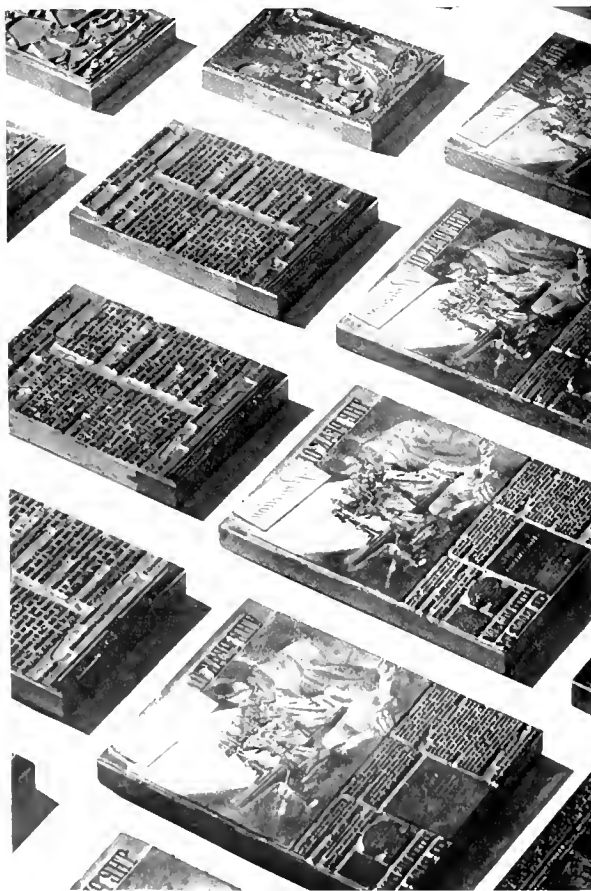

FIRST

IMPRESSIONS

are important

FIRST impressions are certainly important in every day life, but where electrotypes are concerned last impressions spell the difference between good and bad. Nobody wants to divide his job into A and B classes because of electrotypes going flat and losing their punch early in the run; yet that's just the chance you take with ordinary electro preparation.

Nu-Era electrotypes capture and hold the finest detail through long runs and their last impressions are like the first — good ones.

ASSURE yourself of saving in the long run by taking advantage of Nu-Era's complete service. We are fully equipped to furnish you art work, photographs, engravings, electrotypes, and stereotypes.

NU-ERA PHOTO ENGRAVERS, INC.

CHICAGO PLANT: 637 SOUTH DEARBORN STREET • TELEPHONES: WABASH 4796-7-8
KANSAS CITY PLANT: 304 WEST 10th STREET • TELEPHONE: VICTOR 1673

SUPERMAN

continued from page 29

gence IQ were given to a cross section of a theatrical audience and a commercial audience, the latter would rate so far above the theatrical a comparison could hardly be drawn.) The same audience that sees a Commercial Picture compares it immediately with a theatrical production seen some time before and is quick to lose interest if the Commercial picture is in any way under the quality of theatrical films

If you take the "Boy Meets Girl" element away from theatrical entertainment films you will find left a prologue of title and an interesting fadeout . . . and very little to tie the introduction and end together.

All this is not meant to be critical of the creators of those amazing, stupendous and colossal Hollywood dramas but is intended to draw attention to the sharp differences between commercial screen writing and theatrical writing. In most cases Hollywood theatrical writers are given free access to Old Man Dollar Bill as long as something can be produced that can burn a patron's celluloid collar to cinders. But Commercial Screen Writers burn the midnight oil figuring out how to squeeze the client's appropriation dollar until the eagle screams! A boy may meet a girl in the commercial picture but if he does, you can bet your tin-type one is selling something to the other or is in the process of selling the sponsor's product to someone else.

A Commercial Writer has an enormous job when compared to theatrical motion picture writers. If you recall the screen credits given in many theatrical films you will remember that listed were:

The original author of the story.

The adapter of the author's story for the screen.

The continuity and the dialogue writers.

It is particularly significant that the Commercial Screen Writer has to not only act as each of the four mentioned but in a number of instances works on the shooting set to aid in the direction of the picture. This is interesting because a writer in Hollywood takes his life in his own hands when he even gets close to a set. The director usually experiments with the script to a point where it is hardly recognizable by the writer. The Commercial Screen Writer makes sure that every word and action is made exactly as the client okayed it. The director on a commercial set interprets the writing but doesn't dare change it.

Before we go much further let's define a "staff"—Creative or otherwise. Webster tells us that a "staff" represents a body of assistants serving to carry into effect the plans of a superintendent or manager. Let's change the words "superintendent or manager" to client and we find we have a situation that is vitally important to any business contemplating the

addition of Sound Pictures to an advertising campaign. The point cannot be too strongly made that *one man* is not a writing staff. He is either good in one branch or the other. Pioneer Producers assembled over the years *staffs* with Specialists in every line of industry. New men are added to growing staffs and the older members grow to be a part of the industry.

Big business annually spends billions for the best brains it can hire. Specialized Brains! To accomplish their objectives, then, producers have to secure the equivalent in their staffs or a *better* quality of specialized brains for every industry they serve.

Frequently when an executive decides that a Sound Picture is indicated in one of his training or marketing programs he will simply call for "bids" among a random group of "producers" and automatically select the lowest bid! Indeed it is known that one great manufacturer for a long time insisted on buying Sound Slide Films through his *Purchasing Department!*

This frequent lack of analysis has cost a number of otherwise cautious executives many thousands of dollars; dollars that could have been saved by a thorough understanding of the medium and by insistence on the criterion of *Specialization* when selecting a Producer. It is literally true that only a *Specialist* can produce good Sound Pictures; only a *Specialist* with broad experience and tremendous resources, both physical and financial, can possibly hope to fulfill all the obligations of creating in this complicated new medium.

Time was when anyone with a camera, a typewriter and plenty of brass felt qualified to be a Sound Picture Producer. The phenomenal success of long established pioneers raised a veritable swarm of these pseudo "producers."

In past years too many hundreds of such fly-by-night enterprises were born, fluttered about

(Continued on the next page)

20 of the 43 COOPERATING SPONSORS reaching CONSUMER AUDIENCES with their motion pictures through our **GUARANTEED CIRCULATION**

The American Brass Company
Armour & Company
Bakelite Corporation
Crane Company
E. I. du Pont de Nemours & Company
General Foods Corporation
General Motors Corporation
Great A & P Tea Company
Greyhound Lines
Johns-Manville
The Kolyos Company
Metropolitan Life Insurance Company
National Lead Company
The Pennzoil Company
Standard Oil Company of N. J.
United States Rubber Products Co., Inc.
United States Steel Corporation
Western Electric Company
Weyerhaeuser Sales Company
Wilson Sporting Goods Co.

WRITE FOR FOLDER DESCRIBING
OUR COOPERATIVE SERVICE

MOTION PICTURE BUREAU
National Council of the YMCA's
347 Madison Ave., New York, N. Y.
19 So. LaSalle St., Chicago, Illinois

WHAT ABOUT THE RAILROADS?
Read about their extensive use of
film promotion in the forth-com-
ing Issue Four of Business Screen

The best way to read Microfilms

Use the compact ARGUS MICROFILM READER to view and edit your sales films in the comfort of your office. The quickest and most economical way for Sales and Advertising Managers to feed their branches with illustrated copy. Brings to your desk the libraries of the world. For a few pennies you can order information, statistics and facts on microfilm available in no other way. Put this new modern tool to work for you now.

Write us; tell us your problems;
and we'll tell you how to make
this \$75 investment pay dividends.



argus MICROFILM READER
INTERNATIONAL RESEARCH CORP., ANN ARBOR, MICH.

He then shows them a film picturing the making of a stainless steel streamlined car. The last stage of the demonstration-talk concerns stainless steel in construction, and after the lecturer has explained the place of this material in modern building, pointing out its use in such immense construction projects as the Empire State Building and the Rockefeller Center group, he turns on a film showing a roof being covered with Ludlite.

The listening group is then guided into the little theatre, where a sound motion picture in color—the first 16mm. sound and color film ever made—takes them into the plant and shows them just how stainless steel is made.

♦ Of outstanding value to the Museum from the exhibition standpoint is the use made of motion pictures at our front door. The main entrance into the Museum is from the lobby of the RCA Building, directly inside the Sixth Avenue door. Inside this entrance we have a number of spectacular operating exhibits designed to catch the attention of people passing by. Some of them, of proven attention-arresting value, are more or less permanent fixtures on this front-door screen. In the place of others, we have been experimenting with different types of features and with varying success. Some drew more people; some less.

One day we put in a motion picture called *Saving Seconds*, designed in the interest of automobile safety on the highways. Running continuously, it had not been showing half an hour before the operating department of the building called up to ask if it could not be turned off as the lobby was so crowded with people watching the film that it was difficult to pass through. Eventually, a schedule was arranged whereby the picture was shown for three minutes and then turned off for three minutes to disperse the crowd.

The reason for this film's pulling power was simple; it dealt with automobiles, a subject of unending interest to almost everybody in the world, and it dealt with them in spectacular terms of hairbreadth escapes from accident.

♦ *Saving Seconds*, in its three short minutes, combined all three of what we here at the Museum look for as the prime essentials of the motion pictures we show, namely, subject matter of interest to the average person; simplicity in interpreting that subject matter; and ingenuity in presenting it.

With an infinite variety of tools at its command—its color film, its animated diagrams and cartoons, its trick photography, its angle shots—the modern industrial motion picture can put on as dramatic and exciting a show as anything to be seen on the screen today. And to producers of this type of picture, the field of modern exhibit presentation offers possibilities that have as yet scarcely been touched.

Camera Eye

♦ Mr. Frank Arlinghaus, President of Modern Talking Picture Service, Inc. of New York, has appointed Kimball, Hubbard & Powel, Inc., New York, to handle his advertising and promotion.

• The feature of Bonwit Teller's "Fall Tonic Session" which was presented to the public at the Hotel Plaza September 19 through September 23, was the motion picture, *Ugly Duckling Into Swan*. Jointly sponsored by Bonwit Teller and Mademoiselle magazine, the picture was produced by Willard Pictures, New York, and records the transformation of an awkward girl into a glamorous beauty through the efforts of Bonwit Teller's experts.

♦ Wilding Picture Productions, Inc. have announced the opening of a new San Francisco office under the direction of Richard M. Budd, vice-president in charge of Western sales. This marks the second Wilding office on the West Coast and joins the New York, Cleveland, Detroit, Chicago and Hollywood divisions in presenting Wilding facilities and services from Coast to Coast.

♦ West Coast Sound Studios, Inc., producers of commercial talking pictures, have completed production on five dealer-education talking pictures in series, dealing with *Eveready Prestone* anti-freeze. The program will be shown to the personnel of practically every automotive service station in the United States and Canada in the next three months.

♦ Norman B. Terry, who has been handling the exploitation of the sales training sound motion picture, *Selling America*, in St. Louis, has been transferred to the editorial staff of the Jam Handy Organization, according to Jamison Handy, president.

♦ W. Halsey Johnson, Jr., has been named exploitation supervisor in New York city for the sales training sound motion picture, *Selling America*, Jamison Handy, president of the Jam Handy Organization, announced today.

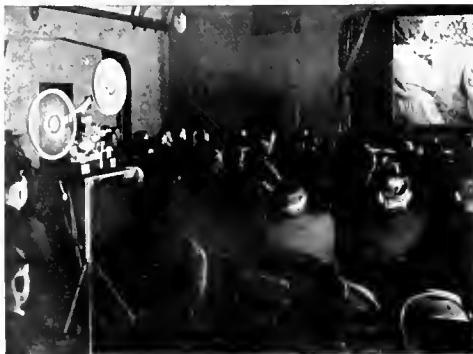

for a short time and flickered out to be forgotten in a fortnight.

"Producers" with checkered suits, long black cigars and addresses, that if checked would lead to a hotel, told uninformed business men that they could produce a picture with Hollywood's best cameraman, could have the scenario written by the same guy who wrote three of Marlene Garbo's best hits and "could do it at a price that would amaze the client!"

These pictures did amaze the clients! In fact they amazed clients to such an extent that it sometimes took a legitimate concern months to correct the bad job done by the "free-lancer" who delivered a couple of thousand of feet of film in a tincan. What had happened?

First: These so-called "producers" didn't have the merchandising experience and background to analyze the client's problems. The client was sold on showmanship; the "producer" had only that to fall back on and due to the lack of a legitimate budget didn't even have the time to get the customer's viewpoint.

Second: When the cost of the picture ran up to a point where it interfered with the profit of the "fly-by-night", production ceased—the client got what was left.

Third: The client had been convinced on false "ample distribution" for his film.

There is ample distribution for the right type of Sound Picture. But it is *planned distribution* and the picture is written, directed and released with that fully in mind by legitimate Producers. However, the fly-in-the-ointment producer used legitimate lists and sources of distribution to advance his dastardly deed. He produced educational films that were so filled with client advertising that no sensible school group would distribute them. He produced Hollywood entertainment films to act as a Sales Promotion and Sales Training wedge for salesmen. He spoke about theatrical distribution with the help of a neighborhood movie manager. The poor client was intrigued by a maze of figures on distribution assembled on acceptable pictures made by legitimate producers . . . and usually was stung!

Fourth: He spoke of "ample facilities." He told the client how easily he could rent everything from directors' chairs to gawd-forsaken attics. But he didn't tell the client that permanent merchandising-creative staffs and other extensive *permanent* facilities were maintained by dependable pioneer producers.

Any one of these things could have been solved quickly and honestly by what is popularly termed "The Commercial Scenario Writer" and the Producer anxious to call his client a "repeat customer."

Don't let the forest hide the trees. Ask the Producer not only how many "Watts" it takes to light a set but how many "Whats" his merchandising-creative staff have in their minds!

OVER 2,100 HOURS

of Continuous Operation

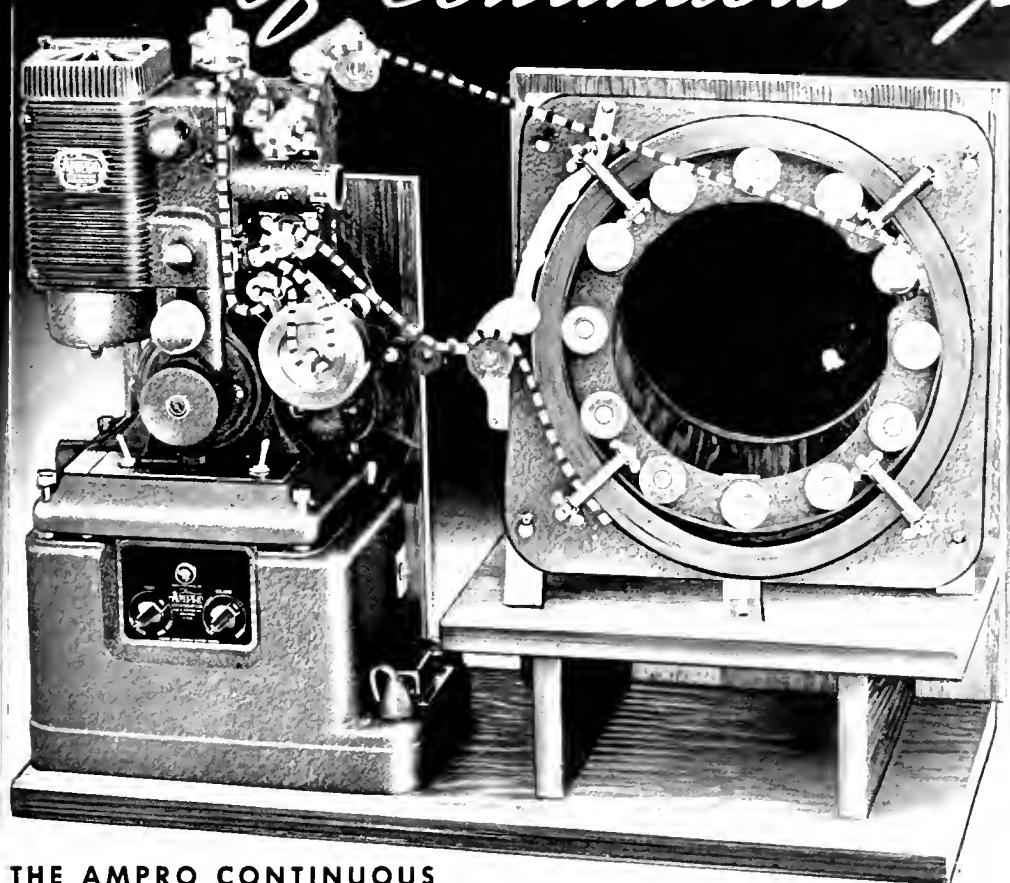

AT CHICAGO'S
CENTURY OF PROGRESS
WORLD'S FAIR
EXPOSITION



**THE AMPRO CONTINUOUS
SOUND PROJECTOR**

Your Assurance of Satisfaction

Performance speaks more convincingly than mere words. These two letters from Century of Progress exhibitors tell volumes. The gruelling test of continuous projection, hour after hour, day after day, week after week, for almost seven months — was passed with flying colors by Ampro Continuous Units.

Certainly, if you are considering continuous movies, either silent or sound, for use in 1939 at the World's Fair in New York or San Francisco, or if you are contemplating using this powerful sales medium for any display or exhibit purposes — you should get the complete story of Ampro Continuous Projectors. We shall be pleased to send you the list of large industrial concerns who are now using Ampro Continuous Units, and who can tell you specifically how their machines have passed the acid test of actual operation in the field.

A Complete Line of Continuous Models

The Ampro Continuous line includes both silent and sound-on-film models housed in light portable suit-case, or installed in attractive display cabinets to meet your requirements. For detailed specifications, illustrations, and price list, fill out and mail the coupon below:

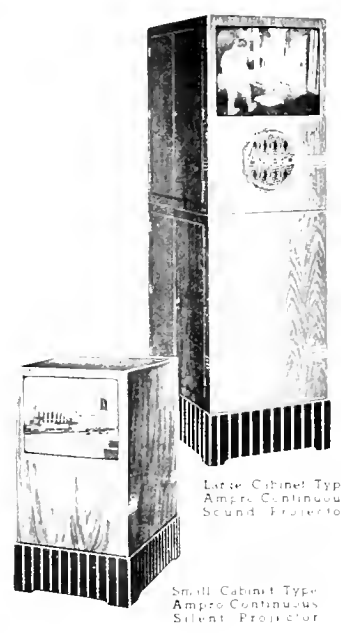

Large Cabinet Type
Ampro Continuous
Sound Projector

Small Cabinet Type
Ampro Continuous
Silent Projector

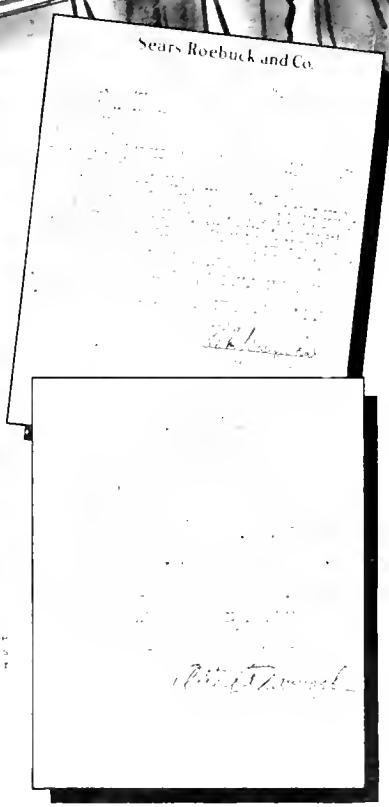

AMPRO
PRECISION CINE EQUIPMENT
Ampro Corporation, 2839 N. Western Avenue, Chicago, Illinois

AMPRO CORPORATION 2839 N. Western Ave. Chicago Ill.
Please send me the new 1938 Ampro catalog. I am particularly interested in
Ampro 16 mm. Continuous Projectors — Silent or Sound
Ampro 16 mm. Silent Projectors
Ampro 16 mm. Sound Projectors
Ampro 16 mm. Silent Models that can be converted into sound

Name _____
Address _____

12,000,000 PEOPLE

Saw THIS
WEDDING..
AND THE PRODUCT



**. . . in a Technicolor short
produced for Alka-Seltzer**

This Technicolor "Minute Movie," produced by one of the Jam Handy permanent Hollywood production units, has been exhibited in more than 3,600 theatres.

Twelve million people were entertained and sold. The advertising was so deftly blended with entertainment values that the powerful selling content became as easy to take as Alka-Seltzer itself. Often the audience reaction was reflected in spontaneous applause.

Sales of any mass appeal product, sold nationally or sectionally, can be stepped up to a high degree with screen advertising, and at surprisingly low cost per person reached.

The **JAM HANDY** *Organization*

Slidefilms • Talking Pictures • Sales Conventions • Playlets

New York, 230 Park Avenue, *MURray Hill* 9-5290 Detroit, 2900 East Grand Boulevard, *MADison* 2450
Chicago, 35 East Wacker Drive, *STAt*e 6758 Hollywood, 7046 Hollywood Boulevard, *HEMPstead* 5809

BUSINESS SCREEN



1933 No 4 IN THIS ISSUE: A FILM PRIMER; STAGING YOUR 1939 CONVENTION
SLIDES OR MOVIES? THE TRAVEL FIELD AND EQUIPMENT DIGEST

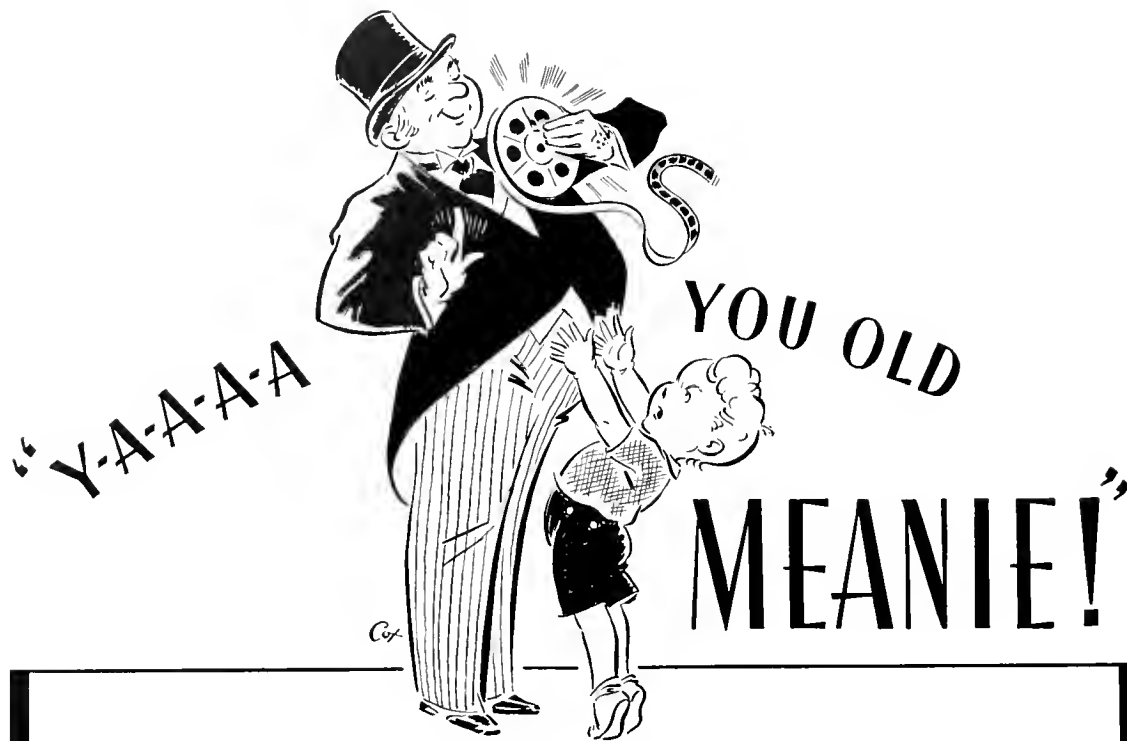

IT'S a conspiracy.

The self-satisfied but rather selfish gent is not a retired capitalist but a composite drawing of present-day users of Minute Movies. Swell fellows—but they refuse us permission to publicize the results of their campaigns. This, in spite of the fact that—

Minute Movies—the youngest of the national media—are turning in some of the most outstanding sales results per dollar spent in some of the toughest markets in the United States:

Case A: Well-known advertiser in grocery field. Long a manufacturer and seller of a low priced article which has been a slow mover. After running Minute Movies in ten cities over 500,000 each in size, plus literally hundreds of smaller communities, this advertiser found sales increased more than 200% in six-week campaigns in each market! Increased distribution and grocery

store displays were important by-products!

We work closely with this advertiser and know many of the actual figures. But we're not allowed to print them. And, until we find an advertiser willing to share his good news story with others, all we can say is—

We have many case histories to tell you about. We have some remarkable new consumer motion picture advertising productions to show you—take a look and learn for yourself how Minute Movies breathe new life into a sales story by combining SIGHT—ACTION—SOUND simultaneously.

National Sales Representatives:

MACY & KLANER, INC.	
Wrigley Building	Chicago, Illinois
JAM HANDY THEATRE SERVICE, INC.	
230 Park Avenue	General Motors Bldg.
New York City	Detroit, Mich.



GENERAL SCREEN ADVERTISING, INC.

Member A. F. A.

WRIGLEY BUILDING CHICAGO, ILLINOIS



**"Right now I'm making a sales talk
in SIXTY different cities . . .!"**

S A I D T H E P R E S I D E N T

AND it could just as easily be six hundred different cities! For a sales story in sound-movie form can be told simultaneously in cities from coast to coast if your merchandising strategy demands a nation-wide impact. Or, if your promotional plans are geared for

a long pull, a sound film will tell the story of your products week after week, month after month, with undiminished enthusiasm.

For effective screen selling, choose the FILMOSOUND, a projector that will bring your sales story to the screen in flickerless, brilliant pictures . . . accompanied by voice or music reproduced so realistically that your audience will be aware only of your film message . . . unaware of the mechanical miracle that makes modern sound film projection possible.

Experienced users of business films like General Electric, Socony-Vacuum, DuPont, all of the major automobile makers, and hundreds of others insure

Theater-quality Filmosound for Industrial Films

New Filmosound 138—For use in salesroom, showroom, hotel room, or moderate-sized auditoriums, this compact, single-case Filmosound Projector, illustrated, provides theater-perfect projection and sound reproduction. Other more powerful Filmosound models for larger audiences.

uninterrupted programs by using FILMOSOUND Projectors. For FILMOSOUNDS are famous for their simple, gadget-free construction and their proved dependability. Built by the makers of Hollywood's preferred studio equipment, FILMOSOUNDS cost but little more originally—cost less ultimately.

Complete information about FILMOSOUND Projectors for industrial film exhibition will be sent on request. Bell & Howell Company, Chicago, New York, Hollywood, London. *Established 1907.*

SHOWMANSHIP—TODAY'S FORMULA FOR SELLING

Booklet—Send coupon for a complete story of industrial motion pictures crystallized into 36 brief illustrated pages. Learn how other firms use films. Learn how to go about making and presenting a hard-hitting sales film for your own organization.

SEND COUPON FOR FULL INFORMATION

BELL & HOWELL COMPANY 95 11-38
1308 Larchmont Avenue, Chicago, Illinois
Please send full information on 1) Filmosound Projectors, 2) Silent Film Projectors.
Also send special booklet, *Showmanship, Today's Formula for Selling.*

Name _____

Address _____

City _____

State _____

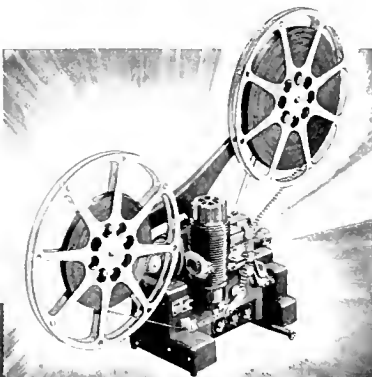

BELL & HOWELL

Now - a Fool proof portable **CONTINUOUS** **PROJECTOR** in 16 mm Silent or Sound

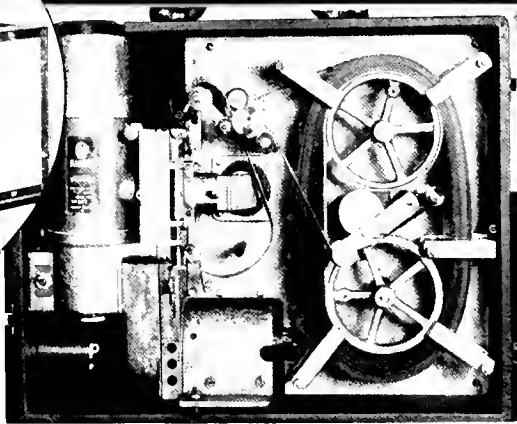
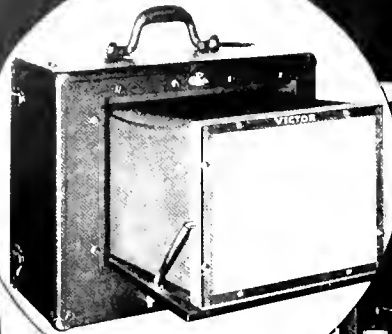

"CONTINUOUS" FEATURES

- PATENTED "advance-feed" principle does away with film binding and breakage and minimizes surface wear.
- VICTOR Automatic Film Protection stops projector in emergencies, preventing damage to films.
- Brilliant, Flickerless Projection . . . (Choice of high wattage lamps).
- Safer, More Efficient Ventilation . . . Longer Lamp Life.
- Built-in, Collapsible rear-projection screen.
- Capacity of film magazine - 500 ft. (Greater capacities to order).

and

HERE IS THE "LAST WORD" IN LOW COST, QUALITY *all-enclosed, portable* SOUND PROJECTORS

The new, simplified VICTOR MODEL 33 ANIMATOPHONE complies with every possible demand for a smaller, more compact, more convenient QUALITY Sound Motion Picture Projector! For easy portability, it assembles into a single unit — during operation it is entirely enclosed. This model makes it easier for industrial and commercial users to obtain the utmost return from the greatest of all modern sales tools!

Other features include: PATENTED Automatic Film Protection . . . exclusive with VICTOR. Clear, crisp, natural reproduction of sound.

A SMALL, HANBY MICROPHONE may be plugged into the 33 amplifier for sales talks.

A COMPACT PHONO RECORD TURNTABLE (with or without record changers) may be used to provide music for silent films, or for any other occasion.

If you are using or contemplating the use of sound films, ASK to see this latest VICTOR contribution to modern selling.

Again VICTOR scores . . . this time with a 16mm. continuous projector that eliminates the operating "headaches" and high upkeep costs previously associated with continuous motion picture projection! A patented, "advance-feed" principle, that provides positive regulation of the amount of film fed from the magazine to the projector intermittent, does away with strain on the film, prevents binding and breakage, and minimizes surface wear. Here, for the first time, is real freedom from the operating troubles and excessive replacement costs with which 16mm. continuous users have always had to contend. Film in the magazine of the VICTOR CONTINUOUS remains almost entirely in a "free", air-cushioned state, and projection stops instantly and automatically in the event of any emergency. VICTOR'S reputation for superior sound and picture quality is your assurance of screen presentations that will do your product or service real justice. NOW you can safely and confidently use continuous projection for show window, convention or personal sales promotion. ASK FOR DEMONSTRATION . . . there is no obligation.

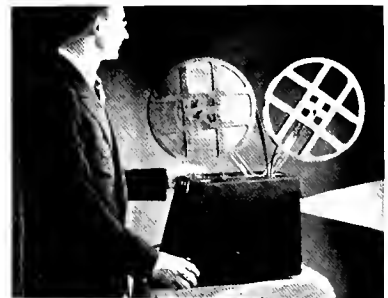

VICTOR ANIMATOGRAPH CORPORATION

DAVENPORT - IOWA

CHICAGO • LOS ANGELES • NEW YORK

To All Executives Who Appreciate GOOD SELLING

PROOF

If you want proof that Caravel
Pictures get results, check with

American Can Company
Atlantic Refining Company, Inc.
Wallace Barnes Company
Beck, Koller & Company
Bethlehem Steel Company
Black & Decker Manufacturing Company
Calco Chemical Company, Inc.
S. H. Camp & Company
Cluett, Peabody & Company, Inc.
Congoleum-Nairn, Inc.
Davis & Geck, Inc.
Dictaphone Sales Corporation
Eastman Kodak Company
Goodall Company (Palm Beach Suits)
The B. F. Goodrich Company
Jenkins Bros.
Johns-Manville Corporation
Kenwood Mills
National Biscuit Company
National Distillers Products Corporation
National Lead Company
Raybestos-Manhattan, Inc.
Socony-Vacuum Oil Company, Inc.
E. R. Squibb & Sons
Talon, Inc.
The Texas Company
U. S. Industrial Alcohol Company
OR ANY OTHER CARAVEL CLIENT

WE invite you to see a Caravel picture and investigate results.

Why? Because Caravel pictures are designed for only one purpose—to increase sales. And that's exactly what they do.

For example: Six thousand new and desirable dealers. An order stepped up from 250 to 350 units (an increase of approximately \$20,000). Purchases by one of America's largest stores built up from ten to fifty thousand dollars.

True, your business is "different."

But—selling is selling, whether it's blankets or biscuits, collars or corsets, paint or pipe, dyes or Dictaphones!

Among the pictures we have made—to meet repeatedly a wide variety of selling problems—there's a picture that will suggest for your company a highly profitable motion picture program.

You owe it to yourself to see that picture, either in our local projection rooms or at your own headquarters.

CARAVEL FILMS

INCORPORATED

New York • 730 Fifth Avenue • Tel. Circle 7-6112

Chicago • Tribune Tower • Tel. SUPERior 3422





You CAN Be In Two Places
at Once . . . or 2,000

THROUGH the magic of sound motion pictures, the various divisions of the Chrysler Corporation were enabled to hold hundreds of *identical*—and practically *simultaneous*—dealer meetings this fall to introduce their 1939 motor cars.

So was Oldsmobile. And so were—and so are—many of America's leading industrial organizations able to supplant the old-time, costly sales convention with local, individual meetings—pre-arranged and *pre-proved* on motion picture screens!

Wilding Picture Productions are constantly playing an ever-increasing part in this *modern*—and far more effective—merchandising and selling procedure.

There is *no substitute*—NOT EVEN EXCLUDING ACTUAL PERSONAL CONTACT—for the *dramatic, effective* and absolutely *fool-proof* presentation of a product or a selling method (to dealers or consumers) provided by *good* sound motion pictures!

Wilding will appreciate an opportunity to discuss *when* and *how* to use sound motion pictures and sound slide films in *your* business—and, even more important, when and how NOT to use them.



**WILDING PICTURE
PRODUCTIONS, Inc.**

NEW YORK — CLEVELAND — DETROIT — CHICAGO — SAN FRANCISCO — HOLLYWOOD

VOLUME 1

NUMBER 4

BUSINESS SCREEN

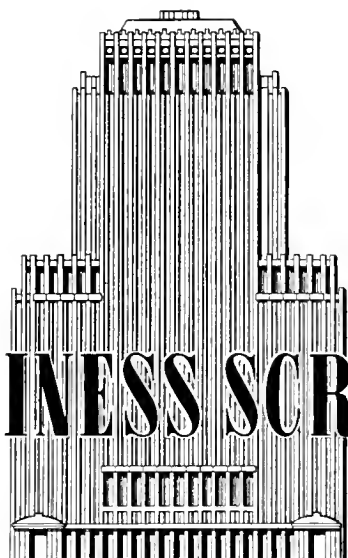

THE MAGAZINE OF COMMERCIAL & EDUCATIONAL FILMS

C O N T E N T S

This month's cover photograph is from the new feature motion picture "Highlights and Shadows" produced by the Eastman Kodak Company

Film Forum, A Department of Letters . . . 8	Staging the Convention 14
Camera Eye, Studio News and Comment . 11	The Birth of the Sales Film 16
The A.B.C.'s of Business Film Making . . 13	Films in the Department Store 17

FILM REVIEW SECTION

Cover Subject by Will Connell 19	A Design by Barnes & Reinecke 23
Value of Films for Travel Agents 21	Better Films in the Schools 24
What the Railroads Are Doing 22	The Filmslide-An Educational Aid 26

TECHNICAL & EQUIPMENT SECTION

Color Films Announced 31	The Client & Slide Film Producers 38
News of Equipment Improvements 32	New Developments Department 36
Display Device Gets Attention 35	Buick Uses Newsreel Technique 41

Business Screen Magazine, Issued by Business Screen Magazines, Inc., Twenty North Wacker Drive, Chicago, Illinois. *Editorial Director*, O. H. Coelln, Jr.; *Art Director*, R. C. Danielson; Subscription price: domestic, \$5.00 a year; 50c copy; foreign, \$6.00 a year. Publishers are not responsible for the return of unsolicited m. s. unless accompanied by stamped, self-addressed envelope. Entire contents Copyright 1938 by Business Screen Magazines, Inc., Chicago, Illinois.

ISSUED TEN TIMES A YEAR · PLUS TWO SPECIAL ANNUAL NUMBERS



Auto-

● THIS HAS BEEN A YEAR OF PIONEERING and research on the part of the editors of *Business Screen*. As a deliberate course, an irregularity of issue was determined upon until the most effective issue dates and numbers could be chosen. We are, indeed, flattered by the unabated interest which our readers have shown during the six months past. Four books have been issued of which this is the fourth and to relieve the minds of those who have awaited the morning postman with anxious eyes, it is now our pleasure and privilege to announce that advertising and publication schedules have now been achieved on a definite basis and *Business Screen* will appear exactly ten times during the coming year plus two special annual numbers. Because the primary task of *Business Screen* is that of service to all the users and potential users of commercial motion pictures and slide films, the editors wish to announce that the two special numbers are included in the twelve-time schedule. Ten other numbers will be considered as the regular issues of the periodical. The two special numbers include an annual directory of all firms in this industry and an annual equipment review number of projector and production developments.

● IN THE FACE OF EXTERNAL CONDITIONS which have shaken the world, both slide films and motion pictures have been produced in increasing quantities and numbers, not only among the large national advertisers who have found results most favorable, but in increasingly larger numbers by smaller industrial firms and local business organizations. An encouraging sign!

MODEL

"D"

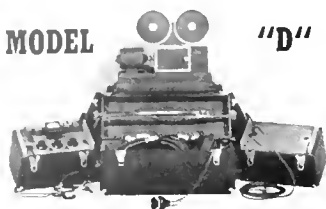

16 mm. SOUND RECORDING SYSTEM

A PROFESSIONAL 16mm. DOUBLE-SYSTEM SOUND RECORDING EQUIPMENT FOR INDUSTRIAL AND EDUCATIONAL TALKING PICTURES.

**ALL A. C. OPERATION
EXACT SYNCHRONIZATION
RELIABLE COMPLETE**

READY TO OPERATE WITH YOUR SYNCHRONOUS MOTOR DRIVEN CAMERA

**1985⁰⁰
NET**

IMMEDIATE DELIVERY

DEMONSTRATION REEL AVAILABLE

THE **BERNDT-MAURER** CORP.
117 East 24th Street • New York City

Extra Effort and Care . . .

in 16 mm. sound-film release printing from 35 mm. or 16 mm. negatives results in a Business Film presentation of outstanding technical excellence.

PRECISION

FILM LABORATORIES
A DIVISION OF BERNDT-MAURER CORP.
21 WEST 46th ST. • NEW YORK CITY

FILM FORUM

READERS ARE INVITED TO ADDRESS



A PAGE OF LETTERS FROM OUR READERS
INQUIRIES TO THIS PAGE

Subject For An Article

I have just had an opportunity to look over your Volume 1 Number 3 issue and must compliment you on your publication.

I have just had four films completed for a client, a macaroni manufacturer. We are preparing to release these films, but want to merchandise them to the grocer and remind the housewife when she comes to the store that she saw a 60 foot macaroni short last night.

Frankly, I have found film advertising the most difficult of the media to merchandise to the trade, as well as to try to tie in with, such as window or floor displays.

If you know of any outstanding merchandising plans that have worked, I would appreciate knowing of them. Maybe I could get a new angle on the plan.

I am also mentioning this to you as possible material for a future article. More successful merchandising would certainly help sell more film advertising. Thank you.

GERALD F. CONWAY
David, Inc.
Advertising Agency

Plan Illustrated Lectures

The use of industrial motion pictures as well as film and glass slides for lecture purposes is still a moot question with us, but we hope to make a start on a programme of illustrated lectures sometime within the next few months.

We have, as I may have already told you, one or two commercial movies: two on explosives, "The Story of Dynamite" and "Power for Industry" which are generally in circulation but quite naturally have a limited appeal; and two merchandising movies, in the possession of our "Cellophane" Division — "The Lady Who Couldn't Say 'No'" and "Split Second Selling" — both again with restricted audiences.

It is our hope to build a library of film and glass slide lectures which will have a decided educational value, and when we have accomplished this and know the reception they receive, perhaps I could give you a short item on our experience. When we have something definite to offer the public we shall, of course, carry a story in C-I-L. Oval as you suggest.

C. P. C. DOWNMAN
Canadian Industries Limited
Publicity Manager

Wants Sales Training Films

Would you please advise me if you have prepared classified lists of films that may be used in sales training classes? If none are available through *Business Screen* would you inform me where I could obtain such reference lists?

In connection with our programs of vocational training for workers throughout this State engaged in merchandising and selling, we very often have occasion to use motion pictures of both the specific merchandise information and general sales training types. The films would be shown in classes and groups composed of salespeople and owners and managers of all

types of businesses such as groceries, department stores, men's and women's specialty shops, furniture stores, service stations, drug stores and others.

W. R. BLACKLER
Bureau of Business Education
California State Department of Education

Educational Responses

The No. 3 September issue of the magazine, *Business Screen*, came to my desk a week ago. I have spent some time examining the magazine, and I am certainly impressed with the contents of this issue.

I spent two years as secretary-treasurer of the Department of Visual Instruction of the National Education Association, and in that capacity had occasion to get a fairly good overview of the use of visual aids; particularly the use of the motion picture in the business field as well as in the field of education. It has been my conviction for the past several years that we in the schools and the people in legitimate business have been missing a wonderful opportunity for mutual benefit. Any attempt to divorce the field of education from actual life situations is foolish, and the sooner we in the educational field realize this, the sooner we can depend upon popular public support of our educational system. This magazine has done a splendid job tying together industrial and educational interests.

May I take this opportunity of congratulating you on this issue. I shall stop in and talk with you sometime in the near future.

E. C. WAGGONER
Director of Visual Education
Elgin, Illinois

* * *

Thank you very much for the "Film Review." This compilation of industrial films is something that has been needed for a long time and we are very glad to see that you have done such a good job with it.

What would be very useful in connection with it would be a brief synopsis of each industrial film which you have listed. One of the biggest problems we have in using educational pictures is to find out what they contain. At the present time it is almost a necessity to preview all films before booking them for classroom showings.

There are many departments here at the University who would like to have a copy of this "Film Review" and I wonder if it is possible for you to send me about 2 dozen copies of it.

I was not able to ascertain from your notice whether or not these "Reviews" would be published periodically. I certainly hope they will be.

I also wish to compliment you on your magazine "Business Screen." It is a fine publication and has already proved useful to us.

HAROLD B. JENSEN
Visual Education Service
University of Minnesota

Only

COMPLETED Passes

Count!



FOR sales-making presentations of your business films, you need **BRILLIANT PERFORMANCE** in **SCREENS** as well as in **PROJECTORS**. The projector throws the picture. But, unless the screen "completes the pass" and shows the picture with all of the brilliance and realism the camera has captured, the film may fail to make the impression that you desire.

Da-Lite Screens have been famous for brilliant performance for 28 years. They are available with Glass-Beaded, White or Silver surfaces to meet any projection requirements — to show your business films with "camera-eye" fidelity.

Exclusive utility features such as the single collapsible rear support on the Challenger and on several of the other portable models make Da-Lite Screens more convenient to use — more popular with your men . . . Compare and you will agree that in picture quality, convenience and durable construction, Da-Lite Screens offer you more. Da-Lite Screen Company, Inc., Dept. 10B, 2723 N. Crawford Ave., Chicago, Ill.



DA-LITE STANDARD CHALLENGER

This light, easily carried screen can be set up anywhere in 15 seconds. 12 sizes, 30" x 40" to 70" x 94" inclusive.

The roller-mounted Glass-Beaded Screen, metal case and tripod are all in one unit.



FREE Data Book!



DA-LITE

BUSINESS SCREENS

Mail the Coupon!

DA-LITE SCREEN COMPANY, Inc.
Dept. 10B, 2723 N. Crawford Ave., Chicago, Ill.

Please send your free 48 page data book on screen surfaces, mountings, screen care and other facts that I should know about screens.

Name
Company
Address

**EVERY
BUSINESS
HAS SOMETHING
TO CROW ABOUT . . .**

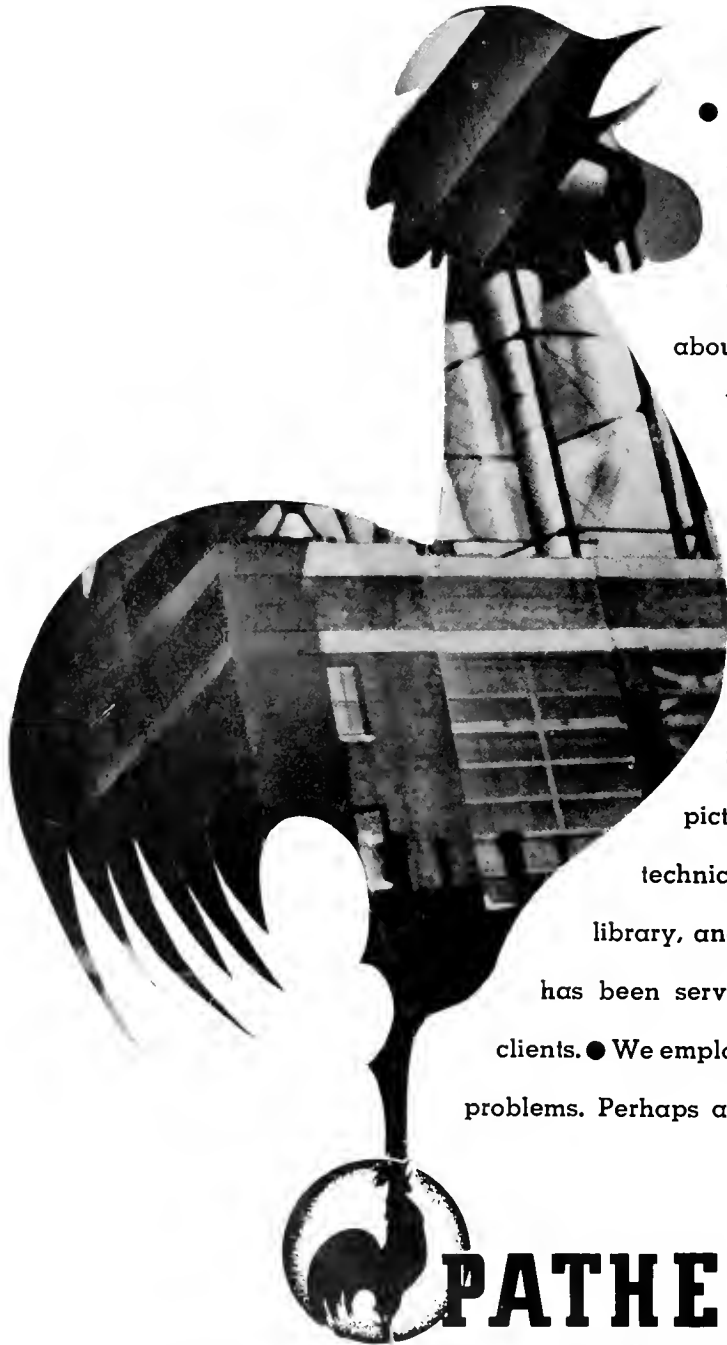

● ● and every business grows greatly when it crows (in a nice way) to the right people — able-to-buy prospects who will enjoy and benefit from the product or service offered. One of the nicest — and most effective — ways of crowing about your business is through a commercial film by Pathé. Whatever your selling problem . . . direct merchandising . . . sales training . . . dealer promotion . . . public relations . . . the sight, sound and action of a Pathé film can do an outstandingly successful job for you — a job that frequently cannot be done any other way. ● All of which leads us to a little crowing about ourselves. For 30 years the name Pathé has paced the world of newspapers. For seven years, Pathé — with expert and experienced technicians, the finest mechanical equipment, world's largest film library, and executives who are masters of showmanship in selling — has been serving successfully an ever increasing number of important clients. ● We employ no solicitors, but we invite you to discuss with us your sales problems. Perhaps a Pathé film is just the answer you have been looking for.

PATHE NEWS Inc.

FREDERIC ULLMAN, jr., Vice-President

35 WEST 45th ST., NEW YORK CITY

Which were the Best Business Films of 1938?

CAMERA EYE



NEWS AND COMMENT
OF THE STUDIOS

THE INSIDE STORY: In preparation for early 1939 releases are several important Business Screen surveys. Most significant of these is the first generally accurate reporting of the volume of slide film and commercial motion picture production for the past year. Practically as helpful to the user of this medium is the intensive study of theatre screen advertising now just beginning to get under way. A third broad survey to be made is the census of all production, distribution and equipment concerns active in this industry which is to be released in a first annual "directory" edition, contemplated for December but so difficult a task that it will be released in late January instead.

The advertising film buyer will be interested in several illuminating discoveries made early in the research for theatre screen facts. First, that the publicity accorded the so-called "banning" of theatre screen advertising by national-theatre chain operators had very little foundation in fact principally because some of those theatres had never shown sponsored films; others were continuing to show them as they had for months previous because local controlling influences had noted their acceptance by the public. Again, the number of theatres accepting "minute movies" is undiminished and the number accepting the longer one-reel subjects (on general topics such as safety, etc.) was growing. Note that Chicago's deluxe Roosevelt screened U. S. Steel's magnificent color documentary as have hundreds of other class houses throughout the country.

THE NEWS BUDGET: Standard Oil of Indiana has another feature in the cutting room for 1939 distribution. Agency participation in commercial film production is growing; its growth will be healthy and profitable if those in charge are smart enough to use the brains and experience already in the field. Which brings to mind that a definite and thoroughly recognized policy regarding agency commission would help unite all the producing forces and stimulate production. Film departments are impractical for all but a few of the agencies but an experienced contact executive and close liaison between the research staffs of producer and agency might result in better production for the client.

How about "big-name" talent? Industrial films have often drawn upon Hollywood stars for their casts — of more importance is the demand for stellar technicians; great directors, etc. It ought to be generally recognized that

major producing organizations in this business film field already employ that kind of talent and that outstanding cameramen, scenarists and directors are on their permanent staffs or under contract to them. A little publicity for these unsung heroes would go a long way. The addition of more of this kind of talent would contribute to the progress of the industry.

SIGNIFICANT TRENDS: The realization that the arrival of television may well bring to commercial film producers another outlet for the screen subjects purchased by the advertiser makes this subject worthy of editorial note. To all queries addressed to this department we advise reference to remarks of Zenith Radio Corporation's president, Commander E. F. McDonald, Jr.

General use of television in the homes is just around the corner for the stock salesmen only," he says. "The offering for sale of television receivers at this time in view of the present state of the art is, in my opinion, unfair to the public, and premature, both for economic and technical reasons. Such premature introduction of television commercially will result in loading the public with undue experimental replacement cost." That television will eventually figure importantly is evidenced by Zenith's currently active research.

THE SCREENING ROOM: Among the new films is *Safeguarding the Speechways* — sound motion picture portraying the manufacturing processes of the Western Electric Company. It was completed at the studios of Audio Productions, Inc., and is ready for release to interested audiences throughout the country. The film is one of a series of new pictures, arranged by P. L. Thomson, Director of Public Relations, and W. A. Wolff, Advertising Manager of Western Electric, to describe production activities at the various plants of the Company, in line with a new appreciation of industrial information which has been recently demonstrated.

Commenting on this factor of "box-office" appeal for industrial relations, *Time*, the news-magazine, in a recent issue, said: "Last May, Western Electric held open house at the Haw-
(Please turn to Page 39)

FROM AMONG THE HUNDREDS OF SUCCESSFUL COMMERCIAL MOTION PICTURES AND SLIDE FILMS PRODUCED LAST YEAR BUSINESS SCREEN editors will soon announce a selection of those noteworthy for various achievements. Will these include the sound motion picture *Highlights and Shadows* (Pictured at top, right) or *Men Make Steel*, the Technicolor industrial gem (just below)? Cooper's slidefilm *Hothouse Legs* or American Can's *Jerry Pulls the Strings* (bottom right) had jobs to do and are doing them extremely well. Any other nominations? . . . Please write and tell us of your choices!



BUSINESS SCREEN SURVEYS, THE FIELD AND PREPARES FOR ITS FIRST ANNUAL AWARDS



The great Boston department store of
**WM. FILENE'S SONS
 COMPANY**

wrote at the conclusion of the showing
 of the Coty talking pictures in their
 Auditorium:

*"Our audiences totaled approxi-
 mately 4,500 for the week, Monday
 through Saturday, and they all
 seemed particularly appreciative of
 the instructive entertainment."*

Coty
GOES TO MARKET

CONVINCED that many women fail to appreciate the care and technical skill which a great cosmetic house devotes to the preparation of its aids to beauty. Coty decided to show women the inner workings of its famous establishment.

Coty could not take the women of America to the Coty Laboratories, so there was nothing to do but take the laboratories to them.

Through the power of talking motion pictures the romantic story of the creation of Coty cosmetics was filmed with accuracy and dramatic detail.

To bring these romantic, living scenes before women throughout the country, Coty called upon the national organization of MODERN TALKING PICTURE SERVICE, with the result

that tens of thousands of women quickly, effectively and economically were shown and told how Coty creates in the service of beauty.

Coty is but one of many great companies which have used the nation-wide presentation service which *only* MODERN TALKING PICTURE SERVICE can render.

If you have a film we can provide maximum distribution. We can assure your getting the utmost of sales energy out of it.

If you are a producer, we offer you full cooperation in giving the advertiser the information he needs to arrive at a favorable decision.

Send for details of our service; or let us call and discuss your problems.



MODERN TALKING PICTURE SERVICE, INC.

9 ROCKEFELLER PLAZA • NEW YORK CITY

THE A.B.C.'S

OF BUSINESS FILM MAKING

• Are you the camera "bug" in your firm? Do you, when visiting the "movies" envision the possibilities of this entertaining medium for the attraction of buyers to your product or the training of your salesmen, etc.? Then if your organization is small or large, turn that interest into profit through this A.B.C. approach to the use and making of motion pictures and simple, economical sound slide films.

A great deal of publicity may be too often given the glamorous feature-length type of advertising films. These possess national interest and of course, have an important place to fill; but there is plenty of good work being done by very economical pictures which find a useful and valuable niche in the activities of many smaller business organizations. Clearly, among smaller concerns having limited capital and a limited potential market, the national motion picture campaign is out of the question. Again — where the "3-A" organization may divide its costs many ways — due to its expansive national markets — thus securing splendid, nationwide coverage at a low cost-per-person . . . the small company would find even the initial production investment too costly.

The question of using motion pictures in smaller organizations, then, simmers down to a discussion of the factors of primary costs. That movies and slide films can be successfully exploited by small (industrial or commercial) organizations of this country may be seen through an examination of facts: They are being widely and successfully used among firms of even less than \$50,000 capitalization.

Producers will tell you that there are many factors which affect the price of a film production. Some of these may be controlled with careful planning. An organization may thus, through a careful advance consideration of all possible factors, find access to a film campaign in keeping with its usual budgets. Let us first consider a few of the items affecting costs. Then we may also see how, in the actual examples cited, similar programs may be applied to small or "middle-sized" concerns.

SOUND OR SILENT: Sound films are, of course, more expensive than silent ones. A good silent film has possibilities for certain

uses but of course sound offers the perfection worth striving toward.

MOTION PICTURE OR SOUND-SLIDE: Sound-slide films are less expensive than motion picture productions — or at least, less in cost than sound motion pictures. These are being used with a high degree of success in many ways, and in many industries. They are particularly useful for sales-promotion and sales training. Good producers frankly admit certain advantages in each medium, and advise whether or not the sound-slide method is advisable.

FEATURE PLAYERS, OR "UNKNOWN'S": "Big name" players naturally boost costs. Sometimes they are used where nothing whatever is actually added to the significance of the picture. With well-known, widely advertised commodities "big names" mean "box-office." In other cases, they may be too costly. Technical productions seldom need names. However, real talent is always worth the price.

ANIMATION, COLOR, STOP-MOTION, TIME-LAPSE, OTHER EFFECTS: Special processes such as the above naturally add to the cost of the film. The manufacturer should not arbitrarily decide upon their use; sometimes a hard-headed decision to use these, or not to have a film, has allowed other more practical-minded competitors to "scoop" the manufacturer with a film which stayed within a limited budget, but which substituted other, less expensive methods. One or more of these processes may, of course, be necessary (As color, in *Over the Counter and Off the Shelf* — selling advantages of good, colorful packaging.)

CHOICE OF SETS: "Natural sets" may often be substituted for built-up sets — as scenes in your own laboratories, workshops, etc. Similarly, costs may be cut, when necessary, by eliminating unnecessary but costly scenes.

FILMING PROCESSES—USE OF 35MM. TO 16MM. REDUCTION, OR STRAIGHT PRODUCTION ON 16MM. The advantages of 35mm. are apparent;

16mm. is gaining favor for certain fields of use and is worthy of study by the small user.

LENGTH OF PRODUCTION: Executives sometimes decide that a long production is necessary, simply because it requires a corresponding length of time to "put across" a given idea in, for example, a sales-meeting. Producers, however, know many short cuts. Running time of a film naturally determines much of its cost.

USE OF "ROYALTY MUSIC", ORCHESTRAS VS. RECORDINGS, ETC.: The above items, very clearly, affect costs. Again, the producer is in the best position to decide upon the relative importance of a "name orchestra" vs. unknowns, etc.

TREATMENT, CHOICE OF SUBJECT MATTER, ETC.: A script may be rewritten, or a "thematic idea" changed to get over the same basic idea, but saving greatly in costs. Many manufacturing concerns have learned that the extensive experience of producers is valuable in this respect.

HOW A NUMBER OF SMALLER ORGANIZATIONS HAVE SOLVED COST PROBLEMS

♦ The D. F. Gallagher Co., of Boston, Mass., some years ago decided that its methods of constructing and erecting "prefabricated steel buildings" were worthy of publicity. Direct-mail advertising was—and is—used, but it was difficult to show in printed literature the various operations, and to portray the relative importance of each. The market for such buildings is, of course, a limited one. Therefore a widespread motion picture campaign could not be considered. Finally, it was decided that

(Please turn to Page 28)



STAGING

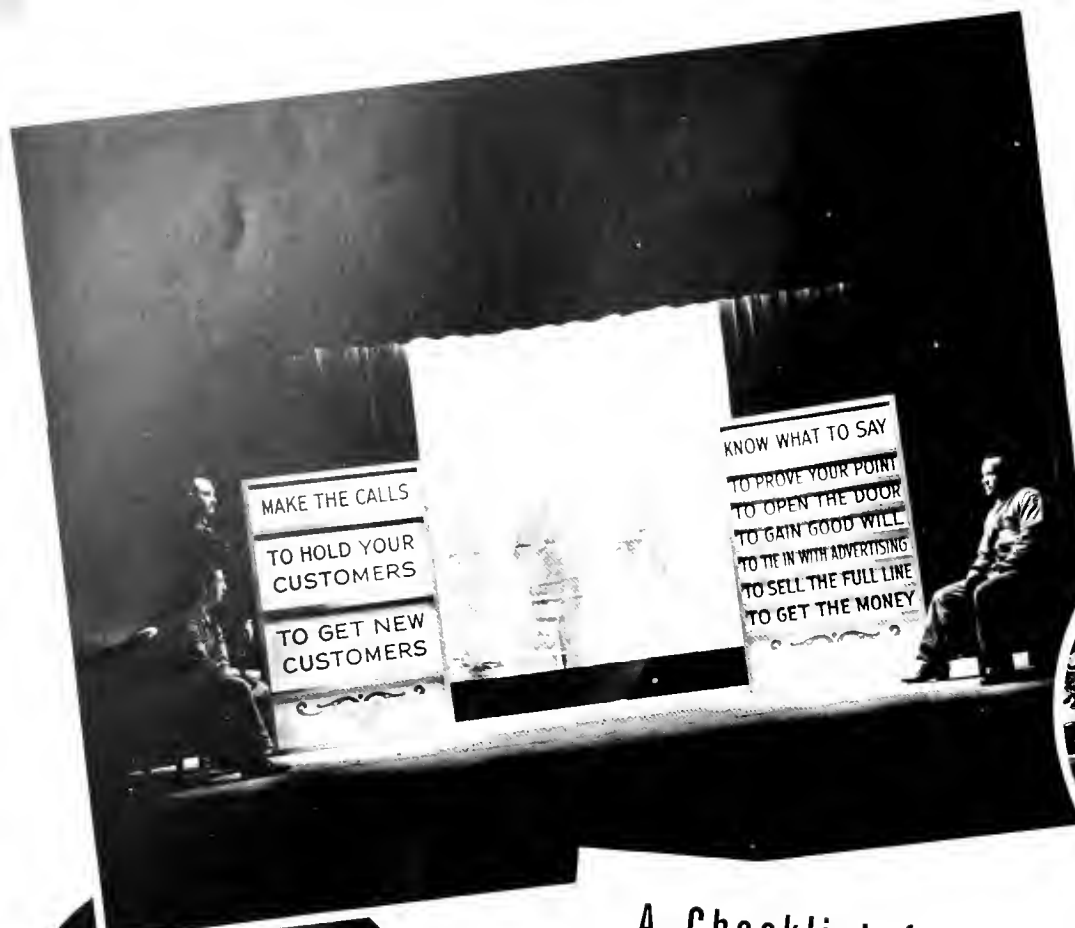

A Checklist for Your Sales Convention Plans

A. FACTORS CONSIDERED IN MODERN CONVENTION PLANNING:

This outline is suggested by a similar analysis used by a prominent convention service organization

1. Planning the Meeting
2. Selecting the Place
3. Designing Properties, Banners, Sets, etc.
4. Adapting Properties
5. Training Speakers
6. Staging the Meeting
7. Writing and Rehearsing
8. Providing Projection Equipment
9. Furnishing stage manager and personnel
10. Furnishing auxiliary equipment.

B. THESE IMPORTANT ELEMENTS SHOULD BE CHECKED:

1. How much time for each subject?
2. In what order should subjects be taken up?
3. What will give the program variety?
4. Will the program permit Showmanship?

C. HOW SHOULD WE PRESENT THE MATERIAL?

(Discussed in the order in which circular pictures appear on this page)

1. **THE PLAYLET** is a useful medium. Several different techniques: the scrim (a transparent screen as shown in the photograph above); the black-out or the usual straight drama or comedy.
2. **THE TALK** with improvements in dramatization, voice coaching and in the writing of the material presented is an old-stand-by of which a variation is shown in the picture to the left.
3. **THE CHART** may be illuminated or illustrated by various methods but its principle asset is legibility from any part of the audience and this element must be remembered in every case.
4. **THE PAGEANT** has tremendous appeal of an inspirational nature. Actors from within the organization may often do a splendid acting job. Professional direction should be employed.
5. **SLIDEFILMS OR GLASS SLIDES** projected on the screen drive home a chart of important illustration with telling effect. Even with sound the expense is very slight and variety considerable.
6. **MOTION PICTURES** can save time and effort plus having the advantage of rich appeal. The home factory, new processes, etc., can be shown.

PHOTOGRAPHS ON THESE PAGES BY COURTESY OF THE IAN HANCO ORGANIZATION, WILDING PICTURE PRODUCTIONS, A DIVISION, WEST COAST SOUND STUDIOS, AND E. W. WILBUR



he CONVENTION

SEE TREND TO FAST-MOVING VISUAL SHOWS IN 1939

• Gone are the convention yawns of yesterday, for today's planned business meeting is as streamlined as a gazelle. Indeed, the rapid-fire pace of one recent annual gathering lead a wag to remark that next year's late arrivals "had better not miss the first fifteen minutes or the whole show is likely to be over."

1939 conventions now being planned will save time for all in attendance and thus save plenty of company funds. More important, they will deliver the essential messages with vigor and directness and a greater percentage of material will be *learned* and *used* than ever before. Some of these gatherings, which heretofore burned up weeks of valuable executive time, will not even require the attendance of these officials. All of them which adopt a convention planning program will very likely find their attending audiences as wide-awake and interested as a football fan at the Rose Bowl classic!

The principal ingredients of this technique have been widely tested and most generally accepted in the automotive industries. Investigate "meeters" because of the nature of their distributor-dealer national sales organizations, the motor-car manufacturers have achieved an enviably high level of efficiency. Sound motion pictures, playlets, slidefilms, illuminated charts, carefully trained sales lecturers and even elaborate pageants are being used with telling effect and spring from the same fount of Showmanship which each year make the National Automobile Shows the country's most important business exhibitions.

Of all the media used in the staging of these

"streamlined" meetings, the sound motion picture is most typical and is enjoying increasingly greater acceptance. Because it can personally company officials, demonstrate new processes and illustrate in action various sales techniques, the movie is already replacing much of the deadwood associated with the slumber-sessions of the past. Many variations are possible: action scenes stop into still-life screen illustrations (slide-films) when a point is to be emphasized; short movie sequences fade into "real-life" playlets and "blackouts" on the stage.

These films make it possible to save executive time and travel: the president of National Dairy Products, Mr. Thomas H. McInerney and Sales Manager E. J. Finneran addressed seventy subsidiaries through the medium of a screen interview which explained the sales policies and merchandising campaign to those in attendance at the company's regular series of Spring sales meetings. Another large corporation now holds four annual one-day meetings on this "planned" basis and has eliminated completely the time loss of its executives wasted on the one week-long convention formerly held. This particular series is one of the fastest-moving shows on record.

Again the rapidly increasing importance of
(Please turn to Page 40)

ILLUSTRATED ON THIS PAGE IS THE CLAIROL THEATRE BOXOFFICE SETUP (top right); streamlined business shows and scenes used. The "Blue Coal" picture and Eveready Prestone's Revue film are illustrated at the right. Note the clipping



Prestone Host to 5,000
Chicago's largest automotive retail trade gathering of the year, numbering more than 5,000 specialists, dealers and garage men, was held Thursday night at the International Amphitheatre. Forty-third and Halsted sts., who played host at its annual "Eve ready." "Prestone" anti-rust party. Movies, being bought, refreshments were enjoyed by automotive men present.
The meeting was the most elaborate staged in over 750 years. The National Carbon Company is now sponsoring meetings throughout the country. Through the recent showings of pictures of an expedition showed "African" anti-rust test.

BACK TO THE OLD FARM

THE BIRTH of the SALES FILM

Back To The Old Farm, a one-reel feature film produced in August, 1914, by the famed old Essanay Company for International Harvester is said to be the first motion picture used for industrial purposes. However, the Harvester company had shown motion picture views of plants and equipment in portable tents at state fairs and similar gatherings for several years previous to 1914. There are indications that other industrial firms had used the medium also.

Back To The Old Farm has probably the more important distinction of being the first motion picture to apply showmanship to selling. At the Dunham farm near Wayne, Illinois, and in the old Essanay studios where the once-popular Keystone comedies were made, and Charlie Chaplin, Wallace Beery, and Beverly Bayne trod the boards, Business stepped into the drama of the screen for the first time.

Neither the Harvester company nor the producer had any idea they were making film history. Every year throughout the winter months Harvester dealers had held 'entertainments' for farmer customers. These groups eager for diversion were a 'ready made' movie audience. The revolutionary changes being brought about by tractor and engine power in farming supplied the sales drama.

Stripped of pantomime and melodrama typical of the early movies, *Back To The Old Farm* stands out as a remarkably successful first attempt to use motion pictures to sell machines.

At an infinitesimal cost per person it was shown to millions of farmers, and helped to bring the gospel of better farming into many far away places.

* * * *

The one remaining print, long since removed from circulation, takes a well earned rest on the top of the rack in the film vault. When the slightly rusted can is pried open there is a strong musty smell of camphor in the air. Although more than a quarter century old, its surface scratched and scarred, the film still projects legibly. Faithfully it unfolds the story of George Randall the farm boy who left behind him the drudgery of farming and his rustic sweetheart (Beverly Bayne) to seek his fortune in the city.

The years pass, George, now a successful business man, accepts an invitation to return to the old farm. There his sweetheart, grown to womanhood, shows him the changes ten years have made in methods of farming. Tractors are



1 George receives an invitation to spend his vacation on "the old farm."



6 She shows him how new machinery has taken the drudgery from farming.



2 That night, George dreams of the drudgery of farming as he knew it.



7 A "modern" gas engine generates current to separate milk, churn butter.



3 He recalls the labor of picking up the grain cut by the early reaper.



8 An "auto wagon", early International truck, hauls passengers, produce.



4 Of the nuisance of unhitching, feeding and watering a team of horses...

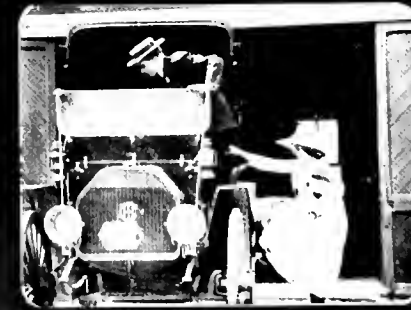

9 Childhood sweethearts, they elope in the farm's modern carriage.



5 On his return he surprises his boyhood sweetheart, Beverly Bayne.

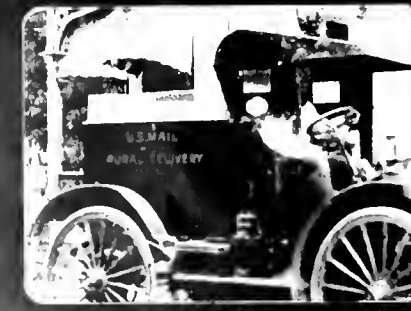

10 The mailman's International truck brings news of the happy finale!

at work plowing the ground. The grain is being cut and bound without the hardships of hand labor. And a gasoline engine drives an electric generator, furnishing current to operate a cream separator and churn. Perhaps strangest of all an "auto wagon" with high wheels necessary to navigate muddy farm roads, is busily hauling people and produce here and there. (Indeed many of the sights on the farm are stranger to us than they were to George.)

Following this pleasant introduction to farming "the modern way" the lovers lose no time, and in a moonlight scene whose romantic atmosphere is enhanced with sepia tinted film, they decide to elope.

The next day the mailman (appropriately driving an International truck) delivers a letter to the master and mistress of the "old farm".

"Uncle Jim," it reads, "you said the auto wagon was good for anything — it's good for midnight elopements. George".

And so with the proper degree of surprise from Uncle Jim, the first "commercial" movie with a plot comes to its dramatic conclusion.

Not only was *Back To The Old Farm* to make film history, but several of those who helped produce it were beginning careers of importance.

The script was written by E. L. Barker later known for his work on *Birth of a Nation*. Supervision of the production was the first assignment given Frank W. Heiskell just come to the advertising department of the International Harvester Company as assistant manager. Later Mr. Heiskell, as advertising manager, became known for his effective use of the medium he had pioneered. Under his guidance a motion picture department was set up where many reels of educational and industrial films on every subject from Diesel engines to farm comedies have since been made.

It is noteworthy that this first dramatic sales film, while definitely designed to show the advantages of farming with machines, did not plug the product to the exclusion of dramatic interest — a fact well worth remembering.

THE FIRST ADVERTISING FILM?

♦ The business movie has a historical edge on the entertainment product. Somewhere between 1896 and 1900 Kuhn and Webster produce a picture *Dewar's Its Scotch* which was projected by Edwin Porter (famed pioneer of the early movies who later directed and photographed *The Great Train Robbery*, first movie with a plot). Porter projected the film on a screen billboard facing Broadway at 34th Street in New York City. In the 40-foot length of the subject four men dressed to represent Scotchmen do a crude Highland Fling before a painted backdrop of Dewar's Scotch Whiskey.

Unfortunately, "the cameraman did not aim his camera properly," says Terry Ramsaye of it in his 'Million and One Nights', "for the fourth man and the word 'Dewar's' are only partially visible at the left."



S. H. Camp Co.

FILMS IN THE DEPARTMENT STORE

A Sequel to the Business Screen Survey by
Zenn Kaufman, Author of "Showmanship in Business"

• "All Gaul", it was once said, "is divided into three parts." To divide this subject into its natural parts — of which there are two — we find that films have two prime uses in the store field: 1. Training, 2. Selling.

The first, and, for the minute, the widest niche for films is in sales training work. Otho Hicks, of The National Retail Dry Goods Association, says that the big limitation of the training film is the general quality of the film, and Edward Weiss of the Grey Advertising Agency puts his finger on the sore spot when he points out that most of these films have been paeans of self-praise for the manufacturer, rather than sources of merchandise information for the girl behind the counter to use in her everyday selling. What she wants is basic merchandising facts and not a short history of every molecule that goes into the product, together with a series of glorified perspective shots of the manufacturer's plant. As an example of a practical film he mentions the one presented some while back by Kenwood Blankets. This film gives the girl definite phrases and bits of showmanship to use selling blankets.

A recent survey made by *Retailing* confirms

Hicks' point of view. *Retailing* interviewed a group of store personnel directors in New York, and found the opinion almost unanimous. The stores reported an average of from 4 to 6 showings per year. It might be pointed out, however, that New York stores are quite large and can afford to do their training in their own way. Whereas, the smaller out of town shops need ready-made training services. But, in further confirmation, a resident buying office reports the same feeling among out of town stores — that the films are too "selfish" — and not helpful enough.

One problem, of course, that bothers the retailer is the scarcity of projection equipment. Probably only a hundred stores — from coast to coast, own 16mm. sound projectors.

To meet this problem, Kenwood Mills handle all showings themselves. Burton Pfeiffer, of Kenwood Mills, goes from city to city with his film and equipment and personally puts on each show. He introduces the film, briefly, and then follows it with another short talk. The largest stores in the country have been glad to have him as a visitor and many of the stores have unhesitatingly said that Ken-



THREE SCENES FROM TYPICAL SLIDE FILM MATERIAL AVAILABLE TO THE TRAINING DIRECTOR OF THE DEPARTMENT STORE. PHOTOS right and left are from the Wool Industry series and the center illustration is from Cooper's recent underwear subject for the retail trade, described in a recent issue.

wood's *Bedtime Story* is the best sales talkie they have ever seen.

Why? Because the film deals with a practical selling situation. The story opens in a customer's home — husband gets up grouchy, because he nearly froze to death under a shrunken blanket. Refuses to buy wife a new hat. Scene changes to an afternoon bridge game, where our heroine is advised to buy a Kenwood. At the store we see her start to buy a cheap blanket — then the girl turns on the heat and sells the Kenwood. We see the customer interpose objections — we see how the clerk answers them. One nice bit of Showmanship is the spot where the clerk picks up the blanket by a few hairs to show how strong it is. This clicks so strongly that when the customer gets home, she repeats in front of her husband, P. S. He gets a good night's sleep — and wife gets the hat.

The film presents an almost perfect formula, both in plot and in handling. As Edward Weiss (Author of *How to Sell Thru Department Stores*) says — "What a store needs is a film that is not too heavily laden with prestige advertising or processes of manufacture — but rather a series of simple shots that tell the girl what to say to sell the product."

Grey followed this formula in *Knowing It — And Showing It*, a sound slide film they did for Printz-Biederman, coat & suit manufacturers.

Women's Wear gives considerable space in a recent issue to a description of this film. The story tells, in part, that "Knowledge of stock; knowledge of fashions and how to present them to different types of customers — these are the two basic principles which enable sales clerks in every department to sell more of almost any merchandise. This is the theme of the training film, *Knowing It — and Showing It*, prepared this season for Printz-Biederman by Audivision, Inc. The producers declare it to be the first film on sales-girls' training in ready-to-wear selling ever made in the women's outer apparel industry.

"In the early part of the film, which has dub-

bed-in musical and voice accompaniment, an experienced sales-person in a coat and suit department is shown pointing out to a new clerk that more sales are made through the simple device of the merchandise approach. The latter girl learns that the first and vitally important step in successful retail selling is to know all the fashion features and selling points of the goods in her department. Next, she is told that these facts should be selectively presented in phases which apply specifically to the individual customer. This practice immediately arouses the customer's desire to own the garment and tends to make a permanent customer for the store, it is maintained. Finally, the inexperienced clerk learns that, while certain deductions can be drawn from a customer's age and general appearance, it is never wise to assume that any customer is only interested in low-priced merchandise. It is always easier to "come down" than to "trade up", the girl is reminded."

SUPPLEMENTARY TRAINING MATERIAL NEEDED

Otho Hicks further points out that one of the greatest weaknesses in the present handling of sound slide film pictures is the absence of proper supplementary training material. He says, "The good effects of such a film evaporate very quickly unless they are tied down with good printed material."

Few manufacturers have provided any printed material to help supplement their training films. Much of the enthusiasm and educational work done by the film dissolves very rapidly unless crystallized in some permanent form. The Nashua Manufacturing Company, as an exception, provided department stores with a quiz sheet to be used in connection with their movie, *Cotton From Seed to Cloth*. The quiz sheet was to be handed out before the film was to be seen — then the film was to be run. The quiz sheet consisted of 25 questions,

many of which could be answered by filling in one blank space and by crossing out two out of three alternate answers. The quiz sheet included such questions as "What Country Grows the Most Cotton?" "Which is the Next Largest Producer of Cotton?" "Why is the following statement true: The Deeper the Nap, the Warmer the Blanket?" "The Calendar is a Machine which, (Starches, Roughs, Smooths or Naps) cotton sheeting.

Along the same line, The Wool Institute provided stores with a little booklet called "Remember." The booklet included a picturization of the sound slide film and across the bottom of each page, under the caption of "Remember" is a brief summary of the pertinent facts developed in the picture, such as Remember: Wool is Strong and Durable. Wool Institute also furnished stores with a script and guide and a "list of selling phrases which have been tested."

Many stores have used *Everybody Ski*, featuring Hannes Schneider, the famous Austrian skiing instructor. The film was made by the E. I. Du Pont de Nemours Company to do a constructive background selling job for Aridex, a water repellent used in treating ski wear.

Sears Roebuck is using a film of their own, *The True-to-Life Story of Mary*, to promote corset sales. It gives women a comprehensive and authoritative lesson in what proper corseting will do for the feminine figure and health. Carol Post, a corsetiere consultant, makes personal appearances with the film.

McCreery's, in New York, found a new use for movies, when they rented old time feature pictures from the Stone Film Library and showed them in their store auditorium (seating 300). The films proved to be a grand traffic getter, pulling over 5,000 people in their first week. People stood in line to see Wm. S. Hart and Mary Pickford, and between shows they flashed humorous merchandising suggestions, such as "Ladies will please remove their hats and go to the millinery department, where newest spring models are on sale." The results

(Please turn to Page 42)



NUMBER 4 • CONTENTS

The Value of Films for Travel Agents

What the Railroads Are Doing

A Selected List of Railroad Films

The Terminal Theatre
A Design by Barnes and Reinecke

Better Films in the Schools — II

Filmslides: An Educational Aid

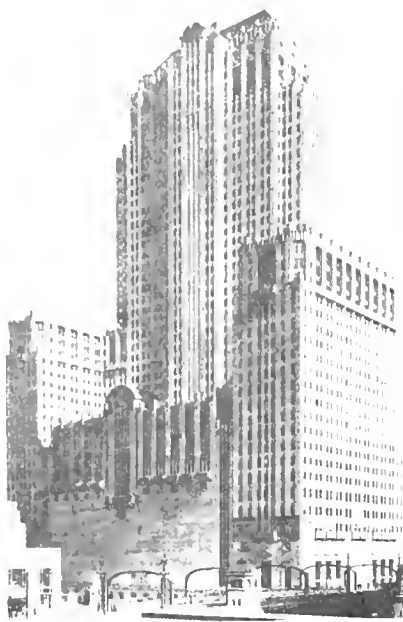

High over surrounding Chicago soars this 44-story building.



Light and airy office suites on every floor are available in varying sizes.

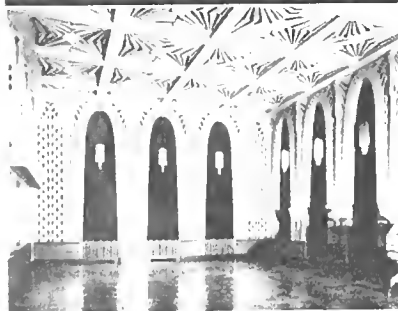

A typical studio-audience room ideal for your dealer meetings.

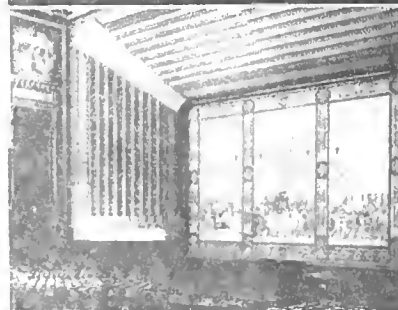

The world-famous Civic Opera Theatre offers thousands of seats.



A WORLD'S FAIR AT 20 NORTH WACKER DRIVE

HOME OF THE FAMED CHICAGO OPERA, LIGHTING INSTITUTE, CIVIC THEATRE, ELECTRIC CLUB AND OFFICE HEADQUARTERS FOR AMERICA'S LEADING NATIONAL BUSINESS ORGANIZATIONS

THE TOWERING WALLS of Chicago's most complete theatre-office building house a permanent exposition of modern business efficiency, engineering skill and a veritable World's Fair of cultural and educational attractions. Its world-famous theatres play host this season to great stars of the operatic and concert stage; its many meeting rooms and auditoriums welcome groups both large and small and of a thousand varied interests. The ever-popular Electric Institute, a fascinating exhibit hall of Electrical Progress, presents displays and lectures to thousands of visitors each month. In the luxurious lounges and dining rooms of its club floors, prominent Chicagoans relax to enjoy an unexcelled cuisine. Convenient public restaurants in the building serve visitors and office workers economically.

Because of its ideal central location with every type of local transportation at its immediate doors, Twenty North Wacker Drive is an efficient office headquarters for many large national business organizations. At the hub of Chicago's wholesale markets, it is also within a few blocks of the Northwestern, Union and LaSalle rail terminals. Not only the advantage of its location just outside the higher-priced parking zone, but its extremely light and airy office suites make Twenty North Wacker Drive a favorite business center. Add to these advantages the many large and small meeting rooms, exhibit halls and convention areas available for group and dealer meetings or national gatherings! Purchasing agents, sales managers, office executives and other company officials will profit by a tour of inspection.

For complete information concerning these facilities address the offices of the president, Mr. J. C. Thompson. No obligation.

20

**NORTH WACKER
DRIVE in CHICAGO**



The comfortable theatre of the Electric Institute is also typical of available audience rooms here.

The Value of Films for Travel Agents

by W. A. Probst, Motion Picture Division, Cunard White Star Line

• This year alert agents are forgoing ahead, making the most of such opportunities as motion picture showings open up to them. They are not just waiting for prospects to turn up, but are going out after them conscientiously. Attractive travel motion pictures do most certainly provide farsighted agents with a means not provided in any other way quite as effective to bring hidden prospects to light.

Steamship agents, in fact, are fortunate in that motion pictures of travel are in great demand by the public. Everyone's curiosity is aroused by the vistas of foreign lands. Everyone immensely enjoys an imaginative trip to other worlds and "gets a kick," as it were, out of seeing where the other fellow lives, how he lives, and what he does. For these reasons, the better kind of travelogue is always sought. Here, then, is the steamship agent's big chance; he thus has a means of doing something for a group gathering of prospects. The motion pictures, in other words, enable him to make desirable contacts, such as he might not be able to make in any other manner.

If one thinks it over he will come to the conclusion that most people worth cultivating belong to some organization or other, community affairs, or have social, religious, fraternal, educational or business interests of some sort; and that they are always anxious to learn something and to enjoy wholesome entertainment. The steamship agent should consequently, have little, if any, difficulty in inducing organizations to sponsor film travelogue showings.

Usually when approached, groups take up the idea with great pleasure. It is surprising to know the various ways in which they work the motion pictures into their programs and often draw out large attendances, which is to the benefit of the agent providing the showing. Some of the different types of program and an effective agent tie-in will be discussed in another article in order to place steamship agents in a position to offer suggestions, most beneficial to themselves, when they are arranging for showings.

Agents may wonder what organizations they ought to approach. There are, of course, a large number of different group types. For instance, there are schools, colleges, universities and other educational institutions (such as private

academies) where the films may be used for parent-teacher meetings, fraternity socials, faculty affairs luncheons. Then, also, there are lodges, clubs, societies, churches, employee welfare associations, particularly of large utility companies, fairs, conventions and many other types of group assemblages. Furthermore, there are groups of foreign peoples who have strong ties abroad and every reason for visiting their homeland. Any competent agent will know of them, where they meet and when. Finally, there are private groups where showings before small private gatherings may be quite effectively made. All such groups are at the disposal of the live agent. A travel film program

ment has been made in them. They show up well, even before large audiences and can be exhibited at little or no expense. They are of safety composition and, therefore, no restrictions hamper their free use. A list of the large number of Cunard White Star films available for free loan to steamship agents may be obtained on request.

Modern small size film projectors, too, are relatively low in cost. They are now made to use powerful lamps up to 750 watts and put a clear and bright picture on the screen. Projectors such as the sturdy machine manufactured by one national projector manufacturer (which the Cunard White Star Line use exclusively) are efficient and very simple to operate. Moreover, they are exceedingly reasonably priced. With the prices of modern, high-powered 16mm. projectors ranging from about \$50. net, for substantial machines, it is possible, consequently, for many agents to have their own projectors, and many agents now do have them, and to be able merely to borrow the free loan films and show them themselves, without further trouble or expense.

By special arrangement, the Cunard White Star Line provide an operator and full equipment to give showings before audiences of sufficient size and importance, in cooperation with nearby agents, in territories where the company's offices are equipped to render this service.

It is quite evident that there are many possibilities in movies for the steamship agent. These possibilities become even greater as time goes on and people have more leisure time and increased purchasing power. Motion pictures of travel are of value to steamship agents because they enable agents, first, to make desirable group contacts with large numbers of people and with excellent tie-in opportunities; second, to create an interest in steamship travel by graphic presentation of tours, trips, and cruises, and finally, to cultivate prospects quite effectively at little or no expense.

While motion picture showings certainly help to bring the agent an immense amount of goodwill and so are sure to have a favorable influence on his passenger bookings over a period of time, they often also bring him immediate results, according to the reports many agents make from time to time.

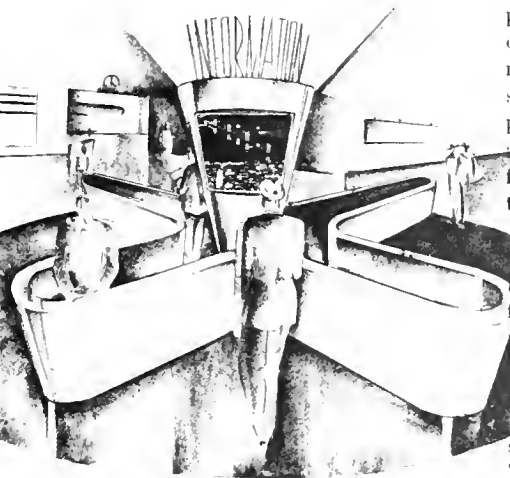

at their meetings has but to be offered them at the appropriate time. They will welcome the agent's suggestion and will gladly permit him to distribute his literature as well as to speak up for himself. All groups will give the agent a good boost in their publicity articles and platform or pulpit announcements.

It may be well here to mention something about the convenience of small size films, the low cost of fine highpowered projectors so much in use, and the small amount of equipment required to stage a showing.

The small (or 16mm.) size films are low in cost and are easy to handle, and the trend is definitely toward this type film for advertising and publicity purposes. Phenomenal develop-



What the Railroads are Doing

• The title of this article is in reality a tragic contradiction of an unrealized opportunity. The answer to the question it suggests is that, with few exceptions, American railroads are making too little use of a medium which far exceeds any other in their advertising and sales promotion budgets.

Here are a few factors for rail executives to consider:

1. The railroads need a constant level of business; advertising expenditures must produce vacation travel for all seasons.
2. The railroads need a public sympathetic toward their economic problems; an understanding still demanding of much education.
3. The railroads have widespread public interest; the normal romantic urge for travel requires only the most effective type of media for transforming such interest into sales.
4. Most railroad films are antiquated beside the standards of the average commercial sound motion picture and sound slidefilm of today. Neglected because considered too often as a "side-line", films are "dated" because of age and mostly silent.
5. Present-day production improvements will now afford natural color films, complete with sound, for less than the silent product of five or ten years ago. The unit cost-per-person reached will be as low as any medium now in the budget

based on the effectiveness achieved in producing actual sales of travel.

6. A final important point: the railroads have a greater employee-training task than many other industries; must train salesmen of passenger travel and freight, service employees and mechanical help often scattered over a large area.

WHAT ABOUT DISTRIBUTION?

Glance through the list of travel promotion films printed below. The stand-out pictures such as those offered by the Chesapeake and Ohio, the Union Pacific and Southern Pacific lines can get all the distribution wanted from schools, clubs, lodges and other groups of individuals who must be considered excellent travel prospects because of their community

SOUND SLIDE FILMS USEFUL

There is one bright, optimistic sign on the horizon in the widespread acceptance of the sound slide film in this field. The Association of American Railroads with its service films *Friendliness, Too* and *All Aboard*, the Illinois Central Railroad and the Santa Fe have been making these economical film strips. A Norfolk and Western historical subject is also noteworthy. These are made both for employee use and for group distribution among clubs, etc. by company representatives.

TYPICAL RAILROAD PROMOTIONAL FILMS

Selections from a list prepared by the American Association of Railroads

- ATCHISON, TOPEKA & SANTA FE: *Doing the South Rim* — Grand Canyon National Park, 1 reel, 16mm. & 35mm.; silent; *Old Trails & New* — The interesting Indian detour region of New Mexico; 1 reel, 16mm. & 35mm.; silent. *Four others listed*
- BALTIMORE & OHIO: *Pageant of American Inland Transportation* — Historical; 16mm. & 35mm., silent
- CHESAPEAKE AND OHIO: *George Washington's Railroad* — Story of the Chesapeake & Ohio Railroad, 16mm. & 35mm.; sound, 60 minutes. *The Coal Run of America* — Story of coal from mine to market; 16mm. & 35mm.; sound, 30 minutes
- CHICAGO, MILWAUKEE, ST. PAUL & PACIFIC: *The Trail of the Olympian* — Scenes along the route of the Olympian, from Chicago to Seattle, including Yellowstone, Mount Rainier and Mount Baker; 8 reels, 16mm. & 35mm., silent
- CHICAGO, RIO R. ISLAND & PACIFIC: *Outdoors in Colorado* — Colorado scenes, Rocky Mountain National Park; 16mm., silent; three reels, 40 minutes. *As Modern As Today* — Some phases of railway operation, using locomotives as theme; 16mm.; sound; 10 minutes. *Two others listed*
- CHICAGO & NORTHWESTERN RAILWAY: *Proviso Yards* — The immense railroad cross-section; 16mm.; silent; 1 reel. *Automatic Train Control* — The operations portrayed; 16mm.; silent; 1 reel. *The 400* — 16mm.; silent; 1 reel
- DENVER & RIO GRANDE WESTERN RAILROAD: *Thru the Rockies by Rail* — Scenes on trip from Denver to Salt Lake City via the Royal Gorge Route; 16mm.; silent; 40 minutes
- ILLINOIS CENTRAL SYSTEM: *Mexico* — Scenic attractions of Mexico; 16mm., silent, two reels. *Neath Sunny Skies* — Scenes along Illinois Central in the South; 16mm., silent, two reels, 11 minutes each; 16mm., sound, one reel, 22 minutes; 35mm., sound, one reel, 20 minutes. *Two others, both silent & sound, 16mm., listed*
- NEW YORK CENTRAL LINES: *Green Thunder* — Film featuring Niagara Falls; 16mm.; sound and silent; 1 reel
- NEW YORK, NEW HAVEN & HARTFORD: *Snow Trains of 1936* — Winter Sports film; 16mm. & 35mm.; sound, 25 minutes
- NORTHERN PACIFIC RAILWAY: *Westward Ho!* — 16mm.; silent; 17 minutes. *Ranch Holiday* — 16mm.; silent; 17 minutes. *Dude Ranch Vacations* — 16mm.; silent. *Six others, all silent, listed*
- SEABOARD AIR LINE RAILWAY: *Orange Blossoming in Florida* — 2 reels, 16mm. and 35mm., silent
- SOUTHERN PACIFIC RAILROAD: *Mexico and Its West Coast* — Scenes in Mexico; 16mm.; silent; two reels. *Four Ways Westward* — Scenes along Southern Pacific's four trans-continental routes; 16mm.; silent; two reels. *Daylighting the Padres' Trail* — Taken through the windows of the "Daylight" on its coastline run; 2 reels; sound
- SOUTHERN PACIFIC LINES: *Mardi Gras* — Scenes of Mardi Gras festivities, New Orleans; 35mm.; silent; one reel, 15-20 minutes. *Trail and Rail* — Scenes along Southern Pacific Sunset Route, Steamer New York to New Orleans, Southern Pacific rail lines New Orleans to San Francisco; 35mm.; silent; three reels; 15-20 minutes each. *Five others listed*
- UNION PACIFIC R. R.: *Southern Utah Parks* — Three travel films portraying the amazing beauty of Zion National Park, Bryce Canyon and other scenic wonders of Southern Utah; 16mm., also 3 reels in 35mm., silent. *Southern Utah Parks* — 35mm., in technicolor and sound; not for general distribution, but available for special showing at conventions. *Los Angeles* — *Wonder City of the West* — 35mm., in technicolor and sound; not for general distribution, but available for special showing only.

THREE SCENES (LEFT ABOVE) ARE FROM "DAY-LIGHTING THE PADRES' TRAIL" — FILM PRODUCTION for the Southern Pacific Lines by Castle Films. The trains below are from the Vocafilm *All Aboard* produced for the American Assn. of Railroads.

• Thousands of people will fly to the New York World's Fair of '38. This is the opinion of United Airlines' advertising and publicity personnel. And it is also their opinion that many of these customers will have been sold their trip by motion pictures.

Movies have, indeed, afforded a splendid vehicle for the advertising of air-travel. It is not an easy job to picture the comfort and delights of air travel to the ground-minded person.

But motion pictures can, almost literally, sweep Mr. and Mrs. Prospect off their feet . . . up into the "sky oceans". And Mr. and Mrs. First-Timer will enjoy the "trip" . . . find the sky smooth, the sensation of soaring far above the earth not at all bad.

Romance of the Mainliner shows . . . the careful takeoffs and landings . . . in every United airport . . . keeping planes directly on their courses through use of the radio beam . . . precise testing of instruments, motors . . . training of pilots".

The 31-minute movie takes the audience on a transcontinental flight, introduces them to all the thrills, beauties, and special comforts of sky-travel.

Romance of the Mainliner is being especially

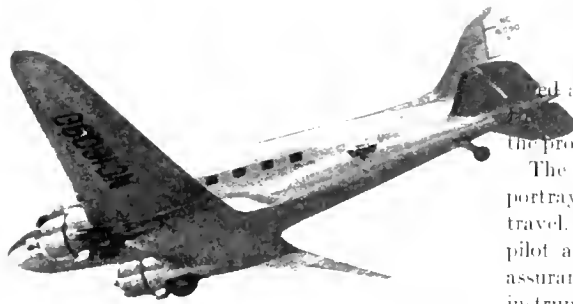

UNITED BRINGS THE SKYWAYS TO EARTH

edited into a "World's Fair edition". It may be adapted to sound, running about 20 minutes. Filming was handled by Bob Tavernier, under the direction of Elmo D. McGlone. Publicity Director Bob Johnson was responsible for editing the production.

The film was intended for showing in United's 25 branch offices. Its popularity, however, caused United officials to have a number of additional prints struck off. Six prints are kept busy in Chicago schools alone. Handled by the Y. M. C. A. film bureau, and many university libraries, it has in its short existence en-

joyed an exceptionally good distribution. The Shell Oil Company of California has shown the production to over 2,000,000 people to date.

The basic problem of this air picture was to portray flying as an entirely natural means of travel. This was accomplished by showing pilot and co-pilot navigating their ship with assurance, using the modern highly developed instruments . . . the steadiness of the plane as it rises, descends, lands, as viewed from another plane . . . comfortable, pleased passengers . . . a stewardess putting a child to bed . . . dinner high aloft, in a "bed" of fleecy cumulus clouds.

All of these attractive, natural features of sky travel have made it possible for *Romance of the Mainliner* to make the business of flying appear as it is — a modern, safe, and convenient mode of travel.

The picture, United officials are sure, has aided greatly in breaking down the barriers of ground-minded skeptics.

* * *

Editor's Note: At least one other major airline has films in preparation and announcement of this and other travel material in use will be contained in a sequel to this review of the travel field to be published in an early 1939 issue of *Business Screen*.

RAILROAD TERMINALS IN ALL PRINCIPAL CITIES AFFORD THE RAILROAD COMPANIES A REAL OPPORTUNITY to present their own travel films to the audiences created among waiting passengers. Barnes & Reincke, industrial designers on the consulting staff of *Business Screen*, here suggest a small theatre, similar in setup to the new steel auditorium in New York City's Grand Central Terminal.

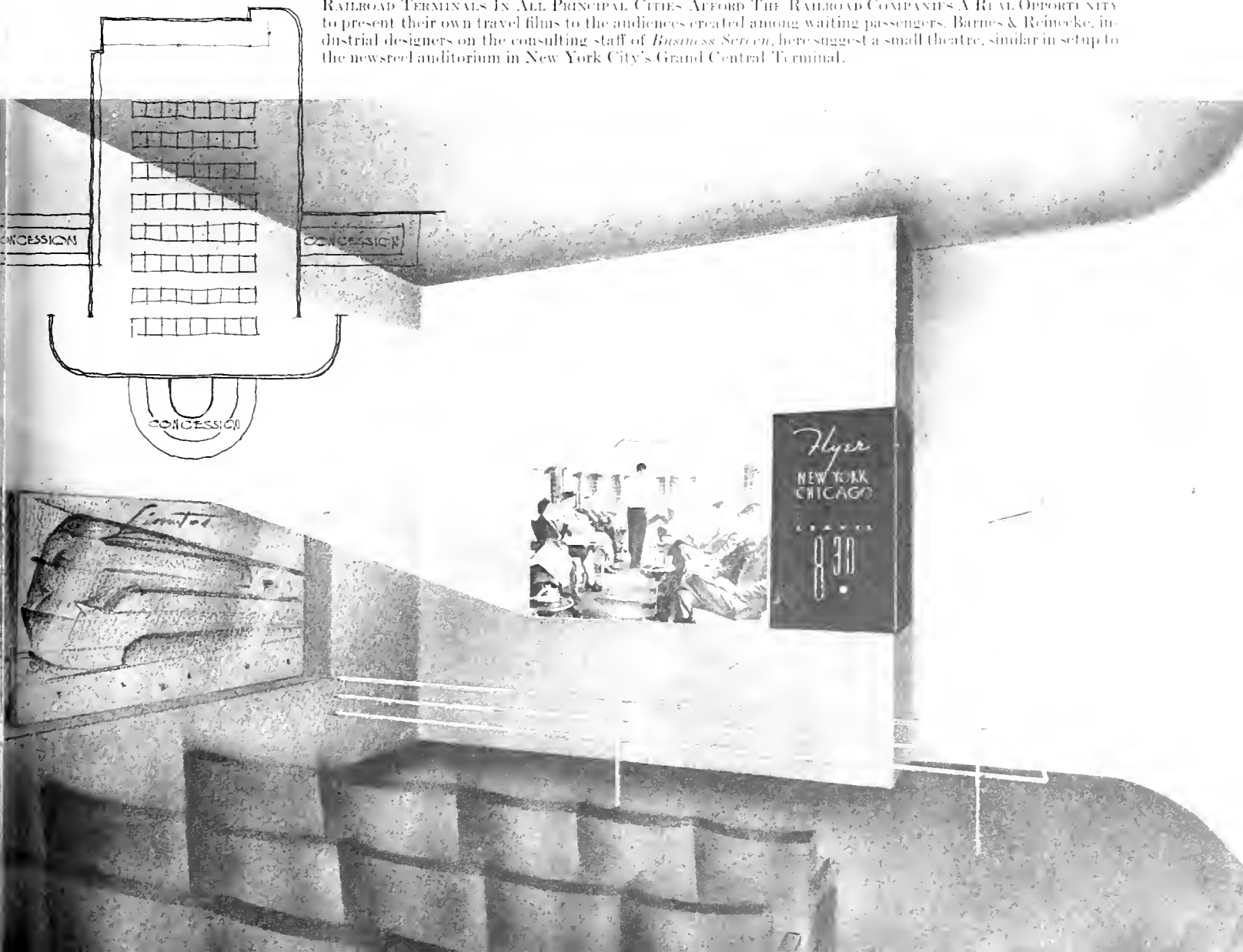



BETTER FILMS IN THE SCHOOLS

BUSINESS IMPROVES ITS EDUCATIONAL FILMS

BY ARCH A. MERCEY
*School of Public Affairs,
American University*

• Business is going to increase its use of motion pictures. Many of the new films will be used in schools. Education is growing increasingly critical of industrial films. The problem: How can business make films which the schools will accept?

Educators have long used industrial films because few others of merit were readily available. The indifference with which many of these films were made and distributed did little to elevate the standards of this type motion picture.

While progress has been rapid in many fields of education, one must reluctantly report that as far as motion pictures are concerned educators are in the main back in the horse and buggy age. Only a few glimpses of light dot an otherwise dark horizon.** Too often educators have lacked understanding, appreciation, and discrimination in the use of visual aids. Many teachers are wholly unconscious of the usefulness of new picture techniques in a rapidly advancing society.

A few leading educators are concentrating on the new problems presented by advances in visual education. A primary task of teachers is that of properly evaluating the place of the industrial film in the school. Business may soon expect schools to cease being the distribution pushover for any type of film it makes.

With new demands, new standards, and an exacting attitude on the part of educators, can industry expect to obtain distribution among the schools at all? The answer: a conditional "yes." The problem might be restated thus: business is going to increase its use of movies

** It remained for one not in education to make two outstanding contemporary contributions to the educational screen: Pare Lorentz's *The Plow That Broke The Plains* and *The River* which recently won the 1938 award as the best of 71 of the world's outstanding documentaries in the Venice Exposition.

and education is going to become increasingly critical of the business film. Query: is there an irreconcilable conflict?

Aside from much of the shallow ballyhoo which press agents write for trade association banquets about the "romance of business", the fact remains that industry has much to offer. In fact, business has a great deal more to offer than it has intelligently utilized in the past.

We are living in an age of technological tenuousness, mechanical miracles—a super-complex world of streamlined inventive genius. This world is a vastly exciting one. The million and one cogs making up the machine of business; the complex processes, methods and devices of modern life is a new frontier challenging the best of our film makers.

Hollywood has not realized the tremendous possibilities inherent in the machine age. The Federal Government has been too busy with its problems of human and natural resources to tap the reservoir of machine age possibilities. Business, therefore, must portray its own thrilling story. But how can business tell that story which will meet the demands of the educator?

FACTORS OF EVALUATION

1. *The films must be factual and not philosophic.* Education fears propaganda and business itself should be aware of internal conflicts which give rise to inter-industry propaganda. Propaganda in the past has kicked back on industry and there seems no reason to believe that history will not repeat itself in terms of new techniques. Moreover, the inter-industrial competition would seem to dictate an assiduous disregard of propaganda. For example, the brick man does not want his children to see films extolling the superiority of cement over brick or the cement maker does not want his youngsters seeing films that say brick or lumber is preferable to cement.*

2. *The films must be exciting and entertaining.* The old-fashioned "educational" is the epitome of dullness. Movies made their reputation by giving people entertainment and excitement in a new medium. Pupils can see Greta Garbo or Joan Crawford in a slick M-G-M production at the neighborhood theater for a quarter.

They will not be satisfied with a dull substitute in movie form even if it is free and given in the name of education. The films for school must have craftsmanship and class; cheaper articles will not suffice.

3. *The films must articulate the facts of industry honestly.* Research is becoming of greater importance in all phases of modern life; we therefore cannot tolerate industrial films which are made with the general authenticity of a publicity blurb.

4. *Honesty in listing and announcement of films is essential.* Business has not tried to mislead exhibitors, but some of the available lists are incomplete. For example, some film bureaus often list films without disclosing the maker or the name of the interested group which has an axe to grind. Even educational institutions' film libraries have omitted complete information. It is conceivable that educators might be misled if they book somewhat blindly without knowing what particular brand of bias they are getting.

5. *Industrial film makers might do well to organize a Council of Review* which will evaluate industrial films designed for schoolroom distribution. This council should include bona fide representatives of education, the consumer and business. Nor should the council be used as a rationalizing agency or a vehicle to give respectability to films which otherwise might not make the grade. This council might give a rating of industrial films ranging from AA (excellent production, entertaining and accurate, no propaganda) to E (poor production, dull, filled with interest-group propaganda).

SOME PROJECTS SUGGESTED

How, now, can some of these criteria be used in improving the business film to meet educational needs? Two types of films can be made: *direct* or *instructional* and *indirect* or *institutional*.* A General Motors film showing in detail the mechanics and operations of a diesel engine is direct while a documentary film on public housing made by U. S. Steel might be called institutional. What are some suggested films which might prove acceptable?

The railroads might film the evolution of the

streamliner or pictorialize the great system of signalling and dispatching.

Autos might produce technical instructional films on engine design, metallurgy, or testing while a film on some of the social and economic results of the automobile in the last quarter century would be a valuable documentary.

The exciting business of radio broadcasting offers dozens of opportunities for R. C. A., N. B. C., Columbia, Mutual or General Electric. A series of dramatic, factually accurate shorts on heroism and life saving through telephone or radio use might be made.

The insurance companies have a stake in public health. A series of documentaries on public health or preventive medicine would be a real contribution to education. A "Heroes of Health" series dramatizing some of the great historical landmarks in medicine might be made. These films could also be produced by great pharmaceutical houses like Eli Lilly and Company or firms like Johnson & Johnson.

Some of the great paper companies might dramatize the excitement of modern publishing or the graphic work of publishing a metropolitan newspaper like the New York Daily News or *New York Times*.

Some of the electric power companies might forget politics and concentrate on power for a change. Specialized instructionals on theory and mechanics of power service would find out-

lets in science and engineering classes, while an institutional fact-film on modern power can have immense excitement.

OTHER TEACHING AIDS

Business might well make films which would supplement laboratory experiments in physics, chemistry and biology. Films which not only show simple experiments with Boyle's law, the principle of Archimedes or other basic fundamentals might be amplified into present day film translations of those principles in action. This type instructional would be a contribution to the school, would gain goodwill for industry and would offer students improved learning devices good for an indefinite period.

Illustrations might be multiplied ad infinitum. The responsibility for doing intelligent films is industry's; the responsibility for what our children see in the public schools is education's — both must work together if we are to gain the greatest good from the modern motion picture. Business is missing a genuine opportunity for doing good for itself and for the schools if it does not assume its responsibility in the production of straightforward, honest, entertaining and edifying films for the schools.

* The social documentary type of film utilizes social data and with such must perforce utilize premises which are sometimes controversial. Hence this type of film is often charged with being a "propaganda" film. The business functional film pictorializes processes, devices, and methods and hence is able to avoid the use of controversial data

REVIEWING THE LATEST NEWS:

WASHINGTON, D. C.: *Business Screen* correspondent advises that the United States Government, through the facilities of the Department of Commerce has made plans for a new federal agency to undertake to aid the distribution and showing of industrial films for "consumer education" purposes. Through co-operation with the national Chamber of Commerce the new program will extend the present distribution furnished by the Bureau of Mines. Only films of four reels and longer will be distributed through local committees on consumer education to be set up in cities and towns.

Whether the newly established United States Film Service would figure in this program was not established but a centralized Washington distributing setup will serve the local committees with prints owned by the government and shipped under the Government franking privilege. The new organization is to be known as the Industrial Film Institute.

CHICAGO, ILL.: A new film slide technique coordinated with educational radio broadcasts was demonstrated at the Radio Education Conference held here at the Hotel Morrison on December 1st. A. R. Mayer, in charge of arrangements for a nationally syndicated film slide service to be furnished in connection with the American School of the Air programs of

the Columbia Broadcasting System, discussed the plan before educators in attendance.

ROCHESTER, N. Y. The Eastman Kodak Company announces the perfection and sale of three new motion picture raw film stocks. *Background X Panchromatic Negative* is highly desirable for key plates in the well-known projection background process and for outdoor takes. *Plus X Panchromatic Negative* doubles the speed of Super X with a definitely finer grain and is ideal for studio and outdoor takes. *Super XX Panchromatic Negative* is three times the speed of regular Super X; suitable for takes at dusk, at night and in adverse lighting.

CHICAGO, ILL.: United Films Service, Pacific Coast organization has opened offices in Chicago's Wrigley Building. Bruce Thomas, vice-president, is in charge of new offices.

NEW YORK CITY: Walter O. Gutlohn, Inc. has exclusive non-theatrical distribution of English documentary films made by the Strand Company and American distribution of French Films in conjunction with French Cinema Co.

CHICAGO, ILL.: The Chicago Park Board films produced by Chicago Film Laboratory with commentary by Bob Elson are getting extensive theatrical distribution through Balaban & Katz deluxers. Recently voted best public relations accomplishment of all city parks.



HEAT AND ITS CONTROL: sponsored by *Johns-Manville*, this 4-reel institutional produced by *Caravel Films* explains the physics of heat by use of historical background, diagrams, graphs. Subtle indirect advertising.



U. S. STEEL: first black and white 16mm. prints available of this documentary story of steel and the men who make it will furnish significant educational material. Prod. by *Hollywood Ind. Pictures*; also shown in 35mm. Technicolor in movie theatres.



THE FIRST CHAIR: 4-reeler sponsored by *C. G. Conn, Ltd.* and produced by *Wilding* for general consumers and dealers; advocates Conn instruments but principally band participation. Useful to music classes. Advertising general, entertaining story.



FILM SLIDES: AN EDUCATIONAL AID

BY WALTER S. BELL

Excerpts from a recent educational address reprinted by special arrangement with the Visual Review

WITHIN RECENT years there have been so many new developments in our civilization, that we must now teach a great deal more in a given time than ever before. The school teacher must heed to the call of modern civilization and speed up the teaching process and also, at the same time, turn out a better product. In fact, it will be necessary for education to set the pace for the new generation, or our civilization will not continue to progress. We must give education wings; we must add more power, we must streamline it, in order that the process of teaching and learning can be speeded up. One way of helping to do this is through the proper use of visual aids.

Why visual aids? The verbal method of teaching has been in use for many years and has been found practical, but words are often meaningless. There are hundreds, even thousands, of good American words that could be thrown on the screen just as well as these Chinese words¹ and still many educated persons could not comprehend them. The Chinese words in this picture may have had a message about this beautiful Chinese scene² but did you get it? With the picture before you, you are able to understand and comprehend a great deal. You can enjoy the beauty of the color, and you can understand many of the details. A picture makes an impression that few people can convey with words. Words have their place; they were probably invented to explain, and when you use the combination of words with pictures, you have a real teaching combination that will be hard to improve.

There are a number of different types of visual aids and each of them has its place in teaching, but of course, there is a great deal of overlapping in their usefulness. The particular visual aid that I am to discuss is the film slide, or as it is sometimes called, the "Picturol."³ The film slide is in reality a strip of 35 mm. motion picture safety film with a series of different pictures printed on it. It has most of the advantages of any still picture. The projection machine is noiseless in operation and does not distract the pupil's attention from the picture; the projection machine is about the simplest of all types of machines to operate; the pictures cannot be gotten out of their correct order and there is no danger of breakage if they should be dropped. The film slide requires small storage space and is easily shipped from one school to the next. It is one of the most economical types of visual aids available; the showing of the film slide, as with other types of projected pictures, has the capacity of centering the at-

tention of the class; each picture can remain on the screen as long as needed.

Teachers, at times, make the mistake of using a motion picture when a still picture would be better. There is nothing that can replace the motion picture when you need to show motion, or when you need continuity of action; but why show a motion picture of such inanimate objects as Stone Mountain, the Grand Canyon, or the cliff dwellings of Mesa Verde? Do you not lose something of the feeling of the stability of such inanimate objects when you see them in motion pictures? Please do not misunderstand me, I am not criticizing the motion picture as a visual aid, I think the motion picture is possibly the most valuable teaching aid that we have, when it is used for the purpose for which it was made, that is, to show motion. On the other hand, the still picture is a valuable teaching aid when it is used as intended.

If it is the school's function to train children so that the educational process will become a continuous process through life, even after formal education is ended, the tools of learning must be taught thoroughly. This does not mean that enrichment should be neglected. In spite of all that visual education can do, reading must still be taught in schools. Incidentally, observation is an educational tool also.

Miss Anna V. Dorris has said that "Life is rich and full only to the degree that we understand and appreciate the environment in which we live." In this age of speed, the world is becoming smaller and smaller. This means that the environment of the individual is becoming larger and larger. With the aid of the film slide the teacher can carry her pupils to all parts of their environment, which now includes the entire world. The children of Texas can see a Mangrove Swamp of Florida with its peculiar trees that lift themselves out of the water by their roots⁴.

"One picture is worth a thousand words," says an old Chinese proverb. There is certainly a great deal that can be learned from this picture of Angel Terrace in Yellowstone Park.⁵ There is the chemistry of the formation of the lime deposits; the study of the geological processes involved; the part that vegetable matter, principally algae, played in coloring the deposits. The beauty of such a place is something to be looked at, appreciated, and to be inspired with. However, much of this will be missed unless special attention is given by the teacher in pointing out these things. Visual education is more than just seeing pictures — it is seeing and correctly interpreting what is seen.

A pupil is not likely to realize that Mt. Fuji⁶ is in Japan and that it has been a great social influence upon the Japanese, unless these facts are pointed out.

Do you think that words can give adequate description of the great wall of China,⁷ or of this Chinese Temple,⁸ or of this beautiful mountain, the Jungfrau, in Switzerland?⁹ They can not. Even the picture cannot do them full justice, but it will give a much truer and more realistic conception than words.

With the film slide, the teacher can carry the individual to any part of our country, even across the water to Japan, China, and upon the majestic Eiger Glacier in Switzerland.¹⁰

It is even possible to some extent to turn back time and allow the child an opportunity to study the foundations of our modern civilization¹¹ and thus be able to better understand, appreciate, and live in the world of today.

The film slide is excellent for review work. When the pupil sees this picture, he is very likely to recall much that he has learned about how valuable the Robin is in helping destroy insects.¹² Also he is likely to recall what other birds can do in this respect.

The picture of the Fly Foot will bring back in a hurry, almost forgotten knowledge of the danger of the fly as a disease carrier.¹³ The knowledge is more firmly fixed than before and will be more easily recalled the next time.

I have tried to give you some suggestions as to how the film slide can be used as an educational aid in the classroom. The film slide is not the only visual aid. It has its place, and so do the others. Use them all and your visual education program will have a variety that will add interest to your program.



PUT IT UP TO AUDIVISION

What do you have on your mind *right now*? Pepping up your sales force? Making a big success of a merchandising campaign? Getting ready for a sales convention? Whatever the problem, so long as it has to do with salesbuilding, *put it up to AudiVision*.

AudiVision's real business is to help you solve those tough salesbuilding problems. For that purpose AudiVision maintains a genuine *creative* staff.

True, AudiVision turns out films — and good ones — at moderate prices. For that purpose AudiVision maintains a top-grade *producing* staff.

But always paramount are the key idea — the right conception of the job you want done — the thor-

oughly worked out plan for following through and getting maximum results.

That is why the AudiVision clientele is made up of organizations like Barrett Company, Dixie-Vortex, General Electric, General Foods, Hammermill, Lehigh Coal, National Association of Ice Industries, Squibb, Cane Sugar Refiners' Association, Tilo, United Fruit, U. S. Rubber. The real leaders in all lines of business know the value of broad experience and constructive thinking.

To get our suggestions will cost you nothing — will involve no obligation whatever. Maybe we'll contribute a thought or two or give the thing a different slant. Anyway, no harm in telling us to call. When?

AUDIVISION, INC.

285 MADISON AVENUE, NEW YORK CITY



We issue an interesting descriptive booklet about making talking pictures, both movies and slide-films. If you want a copy, please let us know. Free, of course.



Audio Prod.

PLANNING is the first element in the use of either motion pictures or sound slide films



Chicago Film

+ PRODUCTION by qualified and experienced technicians; minimum of wasted effort



West Coast

+ PROJECTION for dealers or jobbers, etc. by your salesman on simple, efficient equipment



= PROFITS which the well-planned visual program is bringing all business wherever used

THE ABC'S OF BUSINESS FILM MAKING

(Continued from Page Thirteen)

a number of short-silent productions would be made. These could be shown to prospective buyers, comments added by the representative, appropriate subtitles used.

Color seemed preferable, but it was found that sufficient "contrasty" film prints could be obtained through judicious use of color filters on the part of the producers . . . which showed, adequately, the differences in the various sections and units of the buildings.

The Fog-Nozzle Corporation, on the other hand, found the use of color imperative. Sound was not a requisite, as the primary function of its films was to demonstrate fire-fighting equipment to city fire officials, fire "schools", etc. The short, silent films showed adequately the various methods of fire-fighting, and the rapid "quenching" of the many types of fires encountered, as the equipment was brought into operation. The color, of course, aided greatly, since the red of the flames was discernible, and the rapid action of the Fog-Nozl equipment was shown upon these flames, as the fire was turned into white mist.

The California and Hawaiian Sugar Refining Corporation's *Hawaiian Harvest* was similarly an unpretentious film, but one which none the

less effectively presented two basic ideas: that the sugar of this concern was American-produced and that its products were made under most sanitary conditions.

If ever there existed an era of cooperative effort, it is today. Associations are rendering to smaller organizations a valuable service — and the association-sponsored motion picture is no exception. These campaigns are valuable both from the standpoint of lowering production costs per member, and of gaining, at a lower cost per organization, desirable distribution. The Tanner's Council, Consult-Your-Architect Motion Picture Council, and many others have aggressively promoted the use of sound-slide films, and motion picture films. Films on furs, fruits, ice-box refrigeration (Coolerator), hair-dressing, dress, cotton, orchids, and many other "products" have been cooperatively produced and distributed, enabling each individual member to tie-in his own promotion with films which could not possibly be made available, if used by only one of these organizations.

The factors discussed here and the examples given are intended to offer an elementary outline . . . a direct approach to the use of these valuable media will be discussed next.

A Brief Explanation of Sound Slide Films

"SOUND SLIDE-FILMS, or talking still pictures, are being used extensively by large national merchandisers as a sales and training medium. The programs, produced for these organizations on films and disks, are on the subjects of sales and service training, and for inspirational meetings, direct consumer solicitations, and on special subjects such as announcement of changes of company policies, ad programs, etc.

"These programs consist of a series of interesting still pictures illustrating the subject matter, manually synchronized with the audible text by the operator, who receives his cues for advancing the pictures from a melodious tone super-imposed upon the recording. The pictures are changed as frequently as necessary to follow the sequence of the continuity. Each picture is arrested long enough to illustrate a thought to be absorbed by the audience.

"Although the pictures are stills they express action, change with such frequency, and are of such wide variety that interest never lags. The average program of 15 minutes' duration is comprised of not less than 60 excellent pictures. The films are of standard 35mm. size, and the records are 12 or 16-inch disks, providing a program of 9 to 15 minutes per side.

"To most engineers, sound slide-film equipment, and perhaps the medium as a whole, appears very elementary. It is interesting to note, however, that the very simplicity of the medium and the equipment is the foundation of the commercial success that has been attained.

Although some efforts had been made to promote the use of sound slide-films since 1931, during the period of its development only a few commercial organizations adopted the medium, and then exclusively for sales training. In 1933 less than 500 machines were in the field. The excellent results achieved by those organizations using the medium were so conspicuous that, coupled with the aggressive promotion of the film producers and equipment manufacturers, over 200 of the largest national organizations are now operating more than 20,000 equipments distributed throughout this country and abroad. Here are some of the reasons:

- (1) The effectiveness of the medium.
- (2) The simplicity and low cost of sound slide-film productions.
- (3) The comparatively short time required to produce a complete show.
- (4) The cost of duplicates, which can be distributed at the cost of a few dollars per set.
- (5) The low cost of equipment, making wide distribution possible. This equipment is available at prices ranging from approximately \$40.
- (6) The portability of the equipment and the simplicity of operation."

* from an address by F. Friemann, executive of Electro-Acoustics Co. to the Society of Motion Picture Engineers.

THE COMMERCIAL NEWSREEL

♦ What with motion pictures and film slides the outstanding display media at the coming New York Fair, several announcements are of interest:

Three new institutional motion pictures, produced in Technicolor for industrial clients of Audio Productions, Incorporated, are announced by Frank K. Speidell, President. All three are to be used at the New York Fair and production is scheduled to start at the Long Island studio shortly.

Advertising Projectors, New York, are working on several exhibits for the New York Exposition which will be entirely new and unique from a mechanical standpoint in the presentation of continuous motion pictures, the firm's specialty.

Already announced in Business Screen are the breath-taking plans of such well-known designers as Gilbert Rohde, Donald Deskey and Raymond Loewy, among others. Motion pictures will dominate such important focal centers as Communications, Food and Transportation. Loueks & Norling of New York City are now in production on what promises to be an outstanding state exhibit, for the New York Fair, the entire theme of which is to be carried by a historical and descriptive motion picture.

Du Pont Raw Film Company will participate in both the Golden Gate and New York World's Fairs.

The Golden Gate Exposition at San Francisco will also have featured motion picture and slide film attractions. Among exhibitors using this medium are the Aetna Insurance Company, Armour and Company, the Golden Gate Exposition, the Kerr Glass Company, the National Biscuit Company, Owens-Illinois, Tubbs Cordage and the Union Pacific Railroad. The Western Pine Association is also said to be contemplating a motion picture exhibit.

"KNOW YOUR COAL" AVAILABLE

♦ The Consumers' Counsel, National Bituminous Coal Commission, has now available for free distribution a film entitled *Know Your Coal*. This is part of their program to educate the public in the intelligent buying of coal and also acquaints the public with the many unfair practices in the substituting short weight.

♦ The film department of the J. Walter Thompson Company, headed by Fred Filler will produce an exploitation picture for Shell Oil Company. The reel will be educational and for the interest of the employee.

WESTINGHOUSE IN PRODUCTION

♦ Hollywood Industrial Films will produce a series of 13 commercial reels for Westinghouse-Electric on the Selznick-International lot. Production is headed by Roland Reed and Lon Young. Five films have recently been completed for the Manufacturers Trust Company of New York.

NEW YORK DISTRIBUTION

♦ John E. Allen of Rochester, New York, has a service for the distribution of sponsored films that is designed to provide extensive distribution of such subjects at an economical price. This service is nation-wide or local depending upon the needs and desires of the sponsors. Covering such groups as public schools, private schools, colleges, Y.M.C.A., fraternal groups, employee groups, community groups, and museums, the service is complete. Inasmuch as Mr. Allen maintains a large rental library of non-theatrical rental subjects, he is in an enviable position to contact non-theatrical users for sponsored film bookings.

SQUIBB FILM COMPLETED

♦ A first picture has been completed for Squibb and 4 others are in production by Visavox, Incorporated, recently incorporated in New York. The Company will handle all production work in the East although offices are being opened in Chicago, Detroit, Cleveland and Los Angeles.

ARIAS A LA DETROIT

♦ With the co-operation of the Metropolitan Opera Association, the new Commercial Films Corporation formed by an auto manufacturing company, will produce condensed versions of operas. The pictures will be distributed nationally. Profits derived from the sale of 16mm. rights to universities will be turned over to the Metropolitan Opera Association reserve fund. The Metropolitan will also receive a flat sum for the use of its name. Only screen credits will mention the auto maker.

INDUSTRY . . .



THROUGH the EYES of

Camera inc

SPECIALISTS IN PICTURE PRODUCTION FOR INDUSTRY

A closely-knit organization specializing in planning and producing motion pictures and slide films, to fit sales, promotion and training problems of industry.

Complete production facilities and an experienced, permanent staff guarantee distinctive productions . . . and a maximum return on your picture investment.

• Our clients* are repeat clients . . . and they buy again because it's results that count! To us, it's the repeat business that counts . . . To our clients, only results will count repeats . . . Insure your film investment by investigating Camera Inc.'s services.

*Our repeat clients are leaders in American industry. Specific names on request.

Camera inc

864 North Wabash Avenue

Chicago, Illinois

Telephone SUPerior 5875-6-7

AMSTERDAM
BUICK MOTOR DIVISION
ELECTRICAL EQUIPMENT COMPANY
DeVRY CHALLENGER 16mm. Sound-On-Film Projector

in
GOOD COMPANY

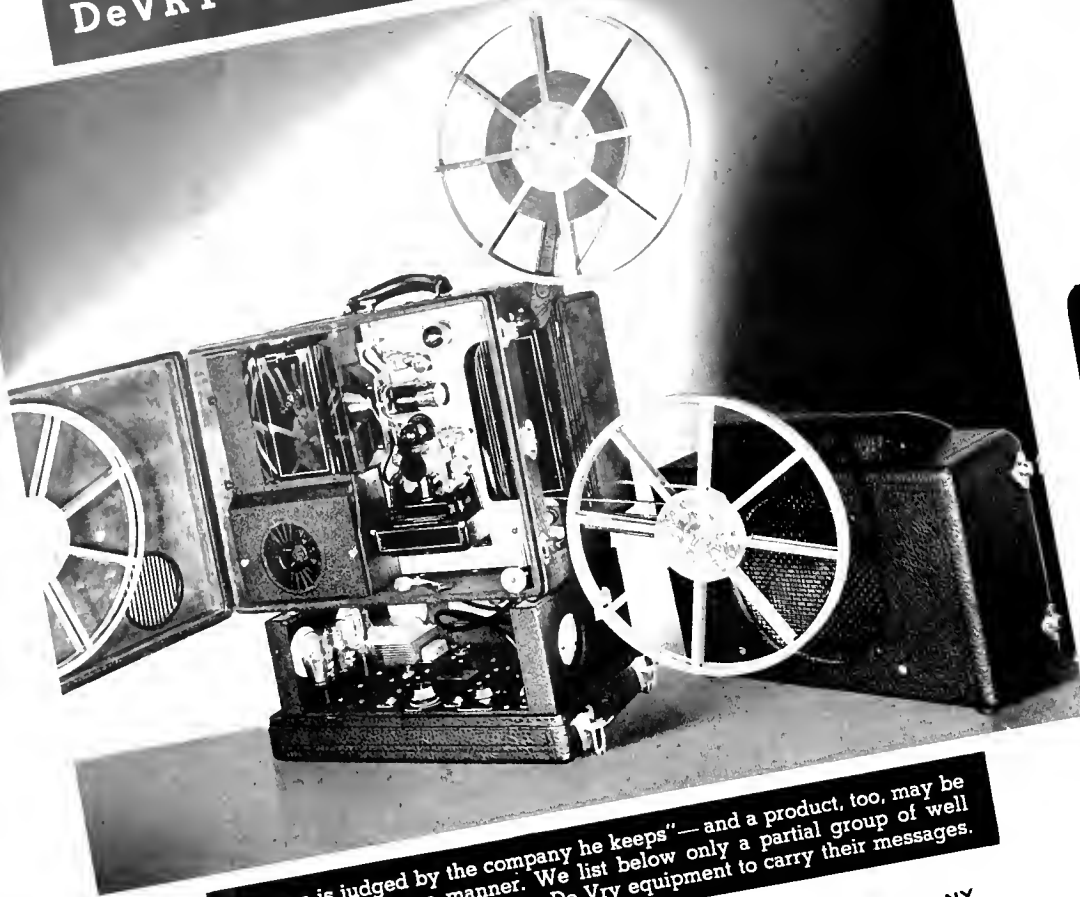



"A man is judged by the company he keeps"—and a product, too, may be judged in the same manner. We list below only a partial group of well known companies who rely on De Vry equipment to carry their messages.

 **BORDEN-WIELAND**
INTERNATIONAL HARVESTER COMPANY
CALIFORNIA FRUIT GROWERS EXCHANGE
AMERICAN STEEL & WIRE COMPANY
STANDARD OIL COMPANY 

Swift & Company 
GOODYEAR SHELL PETROLEUM CORPORATION
THE CROWELL PUBLISHING COMPANY
SOCOXY-VACUUM OIL COMPANY

 ALLIS CHALMERS MANUFACTURING COMPANY
 H. J. HEINZ COMPANY
Ford Motor Company WESTINGHOUSE

The B. F. Goodrich Company
UNITED STATES STEEL CORPORATION
 CALUMET REFINING CO.

 **Armstrong Cork Products Company**
BUICK MOTOR DIVISION 
THE PURE OIL COMPANY

 YOUNGSTOWN SHEET AND TUBE COMPANY
SUN-MAID RAISIN GROWERS ASSOCIATION
PUBLISHING COMPANY Swift & Company

STANDARD OIL COMPANY

Estab.  1913

DE VRY CORPORATION

1111 ARMITAGE AVE.

CHICAGO, ILLINOIS

• NEW YORK

• CHICAGO

• HOLLYWOOD

Investigate right now our complete line of 16mm. and 35mm. projectors and cameras; our free INDUSTRIAL SERVICE, to aid you in your promotional, sales, and advertising programs; — also free booklet, "GLORIFY YOUR PRODUCT"

The Book of Proceedings of The National Conference On Visual Education (shown at right) reports timely, up-to-date data on Educational-Commercial films, and addresses of leading authorities. Send for your copy. 50c, Postpaid.

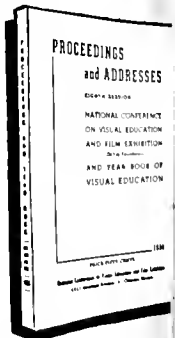

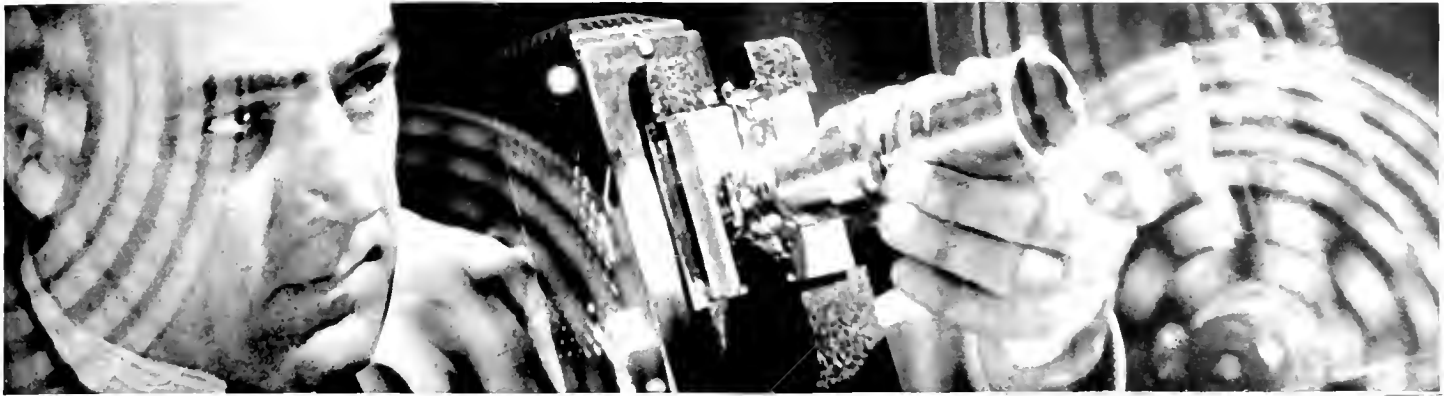

EASTMAN ANNOUNCES COLOR DUPLICATION

• Users of 16mm. motion picture cameras, either silent or sound, can now have their Kodachrome reels duplicated in full color, and in a quality comparing favorably with the originals, the Eastman Kodak Company announces from Rochester, New York.

Technical details of the duplicating process have been worked out at the Kodak laboratories in Rochester, and for the present all duplicates will be made there. Modestly priced, the duplicates will cost only a fraction more than an equivalent length of unexposed 16mm. Kodachrome Film.

Advantages of duplicating Kodachrome movie reels in the full color of the original will be apparent in many fields. Heretofore, a Kodachrome movie has been limited to the color

THE NEW SYNCHRONOUS MOTOR DRIVE DESIGNED BY BELL & HOWELL for use in screening films at exactly 24 frames per second while voice or sound effects are being "dubbed in." The mechanism is described in detail on Page 37 of this issue.

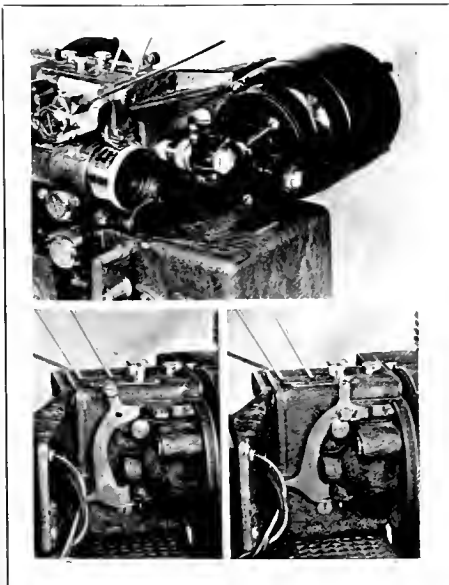

original and black-and-white duplicates. Now, a valuable original reel can be duplicated and stored, the full-color duplicate being used for everyday projection.

Any number of duplicates can be made from a chosen Kodachrome reel. This facility will be of particular value in the production of commercial and educational motion pictures, where a number of copies of one film must be available for widespread, simultaneous distribution. Use of duplicates makes this possible at small cost, and at the same time eliminates risk of damage to the original, which often could not be retaken.

All editing of the film can be done before it is sent in for duplication. Special effects in the original, such as fades, wipes, and lap dissolves, also appear in the duplicate. However, if these effects are not present in the original, they cannot be inserted during duplication.

When a silent film is to be duplicated, only the film need be sent to Rochester. But, when a sound film is sent in for duplication, the maker must include a 35mm. or 16mm. matched positive print of high quality — either variable area or variable density — and must indicate clearly and accurately the proper starting points on both the sound track and the 16mm. original.

Business film users may make use of Kodachrome through the facilities of their customary producers. The same skill in photographing and directing is required; in fact much more skill is required in setting interiors and in arranging material put before the camera for color. It is advisable that you consult your producer *before* writing the script.

CHRYSLER FEATURES FILMS

♦ Chrysler's 1939 Automobile Salon held in the Chrysler Building, New York City, recently featured the presentation of motion pictures concerning new features of the 1939 models and other films in which principal roles were taken by performers on the Chrysler radio programs. So popular were the films that there was standing room only for a considerable period of each day in the little theater where they were presented. Over 6,000 persons attended each day.

NEWS AND A DIGEST OF EQUIPMENT

- **KODACHROME DUPLICATES** are now offered by Eastman Kodak of 16mm. color films, silent or sound. A word of caution to the user on Page 32
- **COSMOCOLOR READY** for the business film field where an economical process is always needed Details on Page 32
- **NEW SOUND CAMERA** with interesting improvements now represented by Ampro Corporation . . for information see Page 34.
- **DISPLAY DEVICE ATTENTION** drawn to Photo-Vox, latest color-sound projector that seems "fool-proof" . . see Page 35
- **NEWEST DEVELOPMENTS** in Equipment shared by the Society for Visual Education and Victor's new continuous projector . . P. 36
- **CLIENT & SLIDE FILMS** and what he should demand of the producer — a survey outlined by a user of the medium — on Page 38
- **COMING EVENTS** in 1939 cast their shadow as additional color articles and the first annual directory number takes shape.

COSMOCOLOR READY FOR BUSINESS FIELD



TWO VIEWS (ABOVE & BELOW) OF THE NEW VICTOR 16mm. CONTINUOUS PROJECTOR NOW AVAILABLE IN EITHER SOUND OR SILENT models. Embodying several improvements, this compact unit is described further on page 34 of this issue.

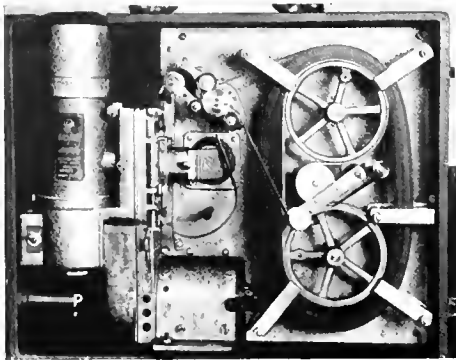

FOR THE BUSINESS "CANDID CAMERA" FAN, THIS ECONOMICAL ARGUS DUFAYCOLOR KIT CONTAINS A MODEL A CAMERA, CP PROJECTOR, slide material and Dufaycolor film. Ideal for Yuletide gifts to the executive who is picture minded.



MOTION PICTURE SCREEN & ACCESSORIES COMPANY FEATURES THE NEW "DUNBAR" SCREEN FOR PORTABLE, OFFICE OR AMATEUR USE. Retail at \$10 and has no buttons, strings or gadgets to break. It is shown below as set up for use.



Commercial producers have been holding a finger on the pulse of American advertisers long enough to realize that it doesn't take much argument to convince potential clients of the advantages of color in advertising films, but something had to be done to bring color to a point where it could as readily be used as black and white from the viewpoint of cost, mobility and production. Wilding claims to have found the answer in Cosmocolor, a color process exclusive with Wilding in the commercial Sound Picture field.

Cosmocolor is a two color process photographed through a regular standard motion picture camera with special attachments such as filters, intermittent movement and prism. Scenes are photographed on one film putting the two images on the same size aperture as is required today for a standard motion picture aperture. It was found that Cosmocolor reproduced all colors in their true brilliant values with the exception of light yellows, light greens and purple. Cosmocolor can be made, developed and printed during the same time it takes to develop ordinary black and white film.

After a scene has been filmed, negative is developed same as any black and white negative. From that negative an additive print, which in

reality is a black and white positive, is made from the original negative and when projected on the screen, through an additive lens, gives the color values of the finished picture. The prints that are used for exhibition purposes are called subtractive prints which is the finished color and can be used on any projector without any special attachment. Cosmocolor uses one negative — but two exposures.

Negatives can be developed in the Wilding laboratories and the black and white contact print, which is the additive, can be printed in the laboratories. It is then screened through the additive lens which gives the color values shown in the finished print. Interestingly, the subtractive print, which is the finished print, has more contrast than the additive print.

Due to its rapid film processing and developing, Cosmocolor solves a problem that has stumped "restricted budgets" since Color came to the screen. Revisions and retakes can be made while cast and crew are still available on the working set. *It is now possible to film a sequence in color, develop it, view and make retakes, if necessary, the next day.*

* * *

Editor's Note: Telcocolor, Brewstercolor, etc. will be described in the next Business Screen.

SUGGEST RECORDER USES

◆ Presto Recording Company tells of three uses of their equipment: A large manufacturer selling under the fixed price law had salesmen take recordings of telephone sales conversations in which dealers were quoting below the fixed selling price. These conversations were played back on a small portable machine to the dealers quoting below the selling price who were warned to discontinue the practice.

An air craft manufacturer submitted blue prints to the patent office and was told that a similar device had been presented just two weeks previously. Examination of the drawings proved that they were those of the aircraft company. A recorder was put on their branch telephone lines and this company is now collecting evidence to prove an employee guilty of taking the plans.

A large sales organization conducting many conversations over long distance wires is using Presto machines run at two speeds, 33 revolutions per minute and 78 revolutions per minute. The conversation is recorded at 33 r.p.m., played over the telephone at 78 r.p.m., and reduced to 33 r.p.m. to obtain the message. This saves on long distance telephone charges.

THE AMPRO-ARC 16mm. SOUND-ON-FILM PROJECTOR WITH ITS EASE OF OPERATION, AND RUGGEDNESS OPENS NEW FIELDS FOR 16mm. PROJECTION IN LARGE AUDITORIUMS. PRICED slightly over \$1,000 complete; projector has 1600 ft. capacity. The "Arc" type projector is especially useful for showings in halls and meeting rooms or conventions where a long throw is necessary or large crowds are in attendance. It has already proven dependable performance under many varying conditions.



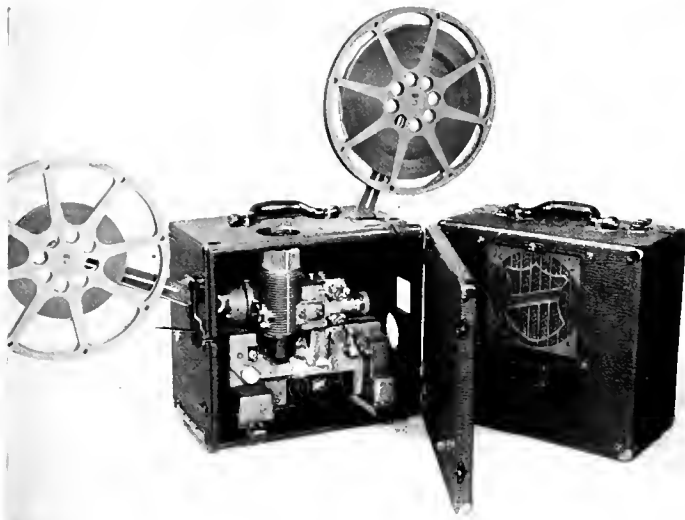

THE "ACADEMY" MODEL 138-P FILMOSOUND IS A NEW OFFERING BY THE BELL & HOWELL COMPANY WHICH SELLS AT \$298.00 OTHER NEW MODELS INCLUDE THE "COMMERCIAL" MODEL AND MODEL 142 and are described in detail in the column below. Commercial and educational users will find prices on all equipment now generally reduced and a favorable buying market at hand.

♦ National industrial film users whose prints are serviced by the Peerless Vaporate film treatment say that the process is an invaluable protective measure which is especially effective for guarding precious color pictures or delicate sound effects. The process is equally effective in resisting the ravages of time and climate on delicate films as well as protecting them against the blemishes of finger-marks, moisture, oil, and dirt, the scratches and wear of projection and other hazards of every day projection to which prints are subjected. Bell & Howell Company in the mid-west and the Craig Movie Supply Company in Los Angeles have Vaporate installations.

Scientifically measured chemical vapors are the basis of the Vaporate process and successive impregnations contribute long life to valuable prints. The cost is extremely economical, an entire 1200-foot reel, for example, costs only \$4.00.

THE GADGET CORNER

♦ Mogull Brothers, New York photographic and cinema suppliers, announce two unusual items: A projector stand that folds up like an umbrella and will hold the projector at any angle, at any height. Retail at \$6.49. Good news for projectionists; available at only 85¢ a dozen are Mogull's reel fingers. This clever little device fits any standard 16mm. reel and makes every reel a self-threader. The new Mogull price list is available to any interested reader of Business Screen on request.

♦ Extending its line of Filmosounds into lower price ranges Bell & Howell Company has introduced three new machines, "Commercial" Filmosound Model 138-0 at \$276.00, "Academy" Filmosound Model 138-P at \$298.00 and Filmosound Model 142 at \$410.00.

NEW "COMMERCIAL" FILMOSOUND MODEL 138-0: This is a one-case 750-watt Filmosound, similar in general design to the already familiar model 138 machines. However, to provide simplicity of operation, all controls unnecessary to the projection of industrial or educational films have been removed. This machine therefore does not include a clutch, a reversing mechanism, silent speed, or a microphone input system. Accordingly this is the lowest priced Filmosound ever offered—a machine that should be welcomed by "quantity" buyers and wherever a simple, straightforward presentation of sound-on-film productions is the prime requirement. Picture and sound qualities have in no way been sacrificed in this simplified machine. A 2 in. F. 2 lens is supplied as standard equipment. The amplifier is similar to that used in other 138 models having an output of from 5 to 7 watts. Thirty-five feet of speaker cable is supplied. Price \$276.00.

NEW "ACADEMY" FILMOSOUND MODEL 138-P. This is a two-case variation of the "Commercial" model described above, with general corresponding specifications except for the inclusion of *silent*

(Please turn to Page 34)

FOR *Emphasis*
USE SLIDEFILMS!

When you high-spot salient selling features with slidefilms, prospective buyers catch on quicker. Sales come easier—even for the most inexperienced man on your staff. Slidefilms give dramatic emphasis to any message—whether it is addressed to dealers, to users or to members of your own organization.

For CLARITY Specify

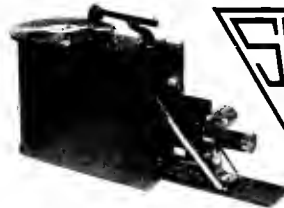

S.V.E. PICTUROL PROJECTORS

MANY STYLES
Silent or Sound
For brilliant pictures specify S.V.E. Picturol Projectors in your sound slide-film units.

Follow through on your investment in slidefilms! Make sure that each showing presents each picture at its brightest and best! S.V.E. Picturol Projectors have proved their superior efficiency for more than 18 years. Their advanced optical system assures brilliance and detail and gives convincing realism to every picture.

Patented features in S.V.E. Projectors produce results unapproached by any other equipment. Specify the genuine S.V.E. equipment when you choose your slidefilm units and be sure of time-proved superior performance. Write for your free copy of the interesting folder "Salesmen Are Made" which illustrates S.V.E. Picturol Projectors for every requirement.

SOCIETY FOR VISUAL EDUCATION, INC.
Dept. 108, 327 S. LaSalle St., Chicago, Ill.

Send immediately your free folder "Salesmen Are Made" describing S.V.E. Picturol Projectors.

Tell us about your new S.V.E. FilmSlide Rewind Take-Up.

Name

Firm Name

Address

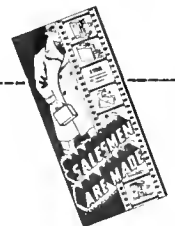

**SEE—HEAR
SOUND
PROJECTS
EQUIPMENT
BEFORE
YOU BUY!**



Model L-105 for audiences up to 500.
Other models for every use.

Buy no slide-film sound projector until you see this new line! *Exclusive, patented features* insure finest projection and reproduction—easier, quicker handling. Endorsed by many leading users and producers of industrial film. *We invite investigation and comparison on every point.* Ask your film producer for details and demonstration—or write us direct.

WEIGHS LESS
EASIER TO HANDLE AND SET UP
TRIPCORD FOR SLIDE CHANGES
SELF-CONTAINED RECORD COMPARTMENT
AC or DC CURRENT

SOUND PROJECTS COMPANY
3140 WALTON STREET CHICAGO

Superb Living

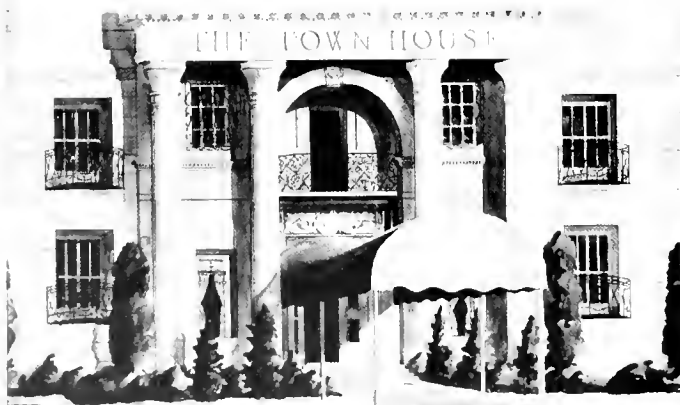

An address of prestige where the discriminating traveler may relax in an atmosphere of refinement. Under the same management as The Drake and The Blackstone in Chicago.

A. S. Kirkby, Managing Director

The Town house
ON WILSHIRE IN LOS ANGELES

speed. The projector is housed in a blimp case. Price \$298.00.

NEW FILMOSOUND MODEL 142. This new 750-watt Filmosound is similar in general construction to the original Filmosound, Model 120, with an oil-damped filter wheel. An amplifier having an output of from 18 to 20 watts is supplied with an unusually versatile microphone and phonograph input system. The projector is equipped with a 2 in. F 1.6 lens, reversing mechanism electric rewind and still picture clutch. The Magnilite condenser is included as standard equipment. Model 142 Filmosound is furnished only as a two-case model, including a blimp. Price \$410.00.



THE 16mm. SYNCRO-SOUND CAMERA. A SINGLE-SYSTEM unit using all types of film is shown and described in detail below.

NEUMADE CABINETS USEFUL

♦ The many important accessories which are necessary for the complete industrial film department are to be had in the stock of the Neumade Company of New York City. The Neumade catalog lists many types of film storage cabinets, splicers, rewinding equipment, etc. A movable steel projection table with a 14" variable tilt and rubber covered castors which lock into position, a notcher for films which eliminates splicing and a new line in 8, 16 and 35mm. brass reinforced fiber mailing cases for films are among the new items offered.

L. E. Jones, Manager of the 16mm. Equipment Department, invites inquiries from educators and business users of films. The complete Neumade line is described in the company's excellent catalog, sent on request to film users.

NEW KINO-PAN-TILT OUT

♦ The Kino-Pan-Tilt, a new device for panoraming and for tilting still or motion picture cameras has been announced by Kin-O-Lux, Incorporated of New York City. The new device offers smooth, even movement and a 360° swing to any horizontal or vertical position. Kino-Pan-Tilt accommodates either the smallest 8 mm. or the heaviest 16 mm. cameras and the jerky, uneven panning which ruins so many pictures is said to be eliminated with its geared operation. Priced at \$25.00, the weight of Kino-Pan-Tilt is only 2 $\frac{3}{4}$ pounds.

FOR LITERATURE AND PRICES ADDRESS THE SCREEN SERVICE BUREAU 20 N. WACKER • CHICAGO

• The Ampro Corporation of Chicago, manufacturers of 16mm. Silent and Sound motion picture projectors, announce that they have just completed arrangements as the exclusive United States sales agents (East of the Rocky Mountains) for the Syncro-Sound 16mm. professional sound-on-film camera as manufactured by Gumbiner Syncro-Sound, Inc., 3337 Wilshire Blvd., Los Angeles, California.

Many claims are made for this new Syncro-Sound 16mm. professional sound-on-film camera. Syncro-Sound makes it possible for the amateur to produce 16mm. sound pictures of professional quality, and realizing that this equipment will be used by unskilled operators, the manufacturers have constructed it so that it will give the best professional results and have the greatest flexibility of application with the minimum of operating controls.

The making of 16mm. sound motion pictures is recognized as a complicated and technical procedure. With the Syncro-Sound Camera, the manufacturers say, acceptable sound pictures can be made by anyone who understands the filming of home movies.

The Syncro-Sound camera is a precision, professional instrument that produces pictures and high quality natural sound. Exceedingly flexible—it takes single system pictures on all types of film, and can be synchronized with any camera for double system, or with any projector for recording narrative synchronous with a silent picture.

DISPLAY DEVICE GETS ATTENTION

◆ Newest and most novel of display advertising devices to engage the interest of sales promotion executives is Photo-Vox, a synchronized voice and picture unit which shows a number of scenes in full color on a translucent screen while describing them on an accompanying sound disc.

Although perhaps possessing less emotional appeal than the familiar continuous movie, Photo-Vox has the element of simplicity and economy to recommend it. The still scenes, projected from Kodachrome negatives, are attractive and the combination of the carefully synchronized sales talk makes for an irresistible audience stopper when used in retail stores or at any point of vantage.

When used with the "electric eye" or a trip device, Photo-Vox puts on its performance automatically when it has an audience. Sometimes this can be done with startling effect, especially when the machine swings into action on an unsuspecting passer-by with a "wait-a-minute-did you-hear-about-this" opening remark. Already tested in department stores, the unit has proven durable and its simplicity of operation leads to the belief that service and upkeep are inconsiderable items. Any number of scenes from 24 to 48 may be used in sequence and the length of the sales talk may be equally long although a 2½ minute talk has been

PHOTO-VOX, NEW SOUND-COLOR DISPLAY UNIT IS attracting the attention of sales and advertising executives who regard it as an excellent means of getting audience attention in retail outlets, etc.



found most satisfactory for audience turn-over on actual tests.

Applications of Photo-Vox include window display, railroad station and department store location as well as an excellent means of condensing exhibit space at conventions and fairs. The machine is supplied on a low-cost leasing arrangement which includes servicing guarantees and advertising materials. Information may be had from the manufacturer or from the Screen Service Bureau of *Business Screen*, 20 North Wacker Drive.

BERNDT-MAURER RECORDERS

◆ The new Berndt-Maurer Model "D" Recording Equipment brings to the commercial and educational motion picture producer, and to the advanced amateur, the means of producing high quality speech and music records directly on 16mm. film.

The usefulness of this equipment extends to all types of non-theatrical motion picture production. The outfit is light in weight, and can easily be transported to any location where alternating current power is available. It is convenient enough to be set up and ready for operation in less than ten minutes. Nevertheless it is sturdy enough in construction to give long trouble-free service, and it yields nothing in quality of performance to the most elaborate equipment.

The Model "D" equipment is of the "double-system," or separate recorder type. The most common use of this type of equipment is the recording of spoken commentary and incidental music to accompany pictures taken at another time and place. But the Model "D" equipment is equally suitable for making talking pictures that require exact lip-synchronization. For this purpose it may be used in combination with any synchronous-motor-driven camera.

DeVRY VIEWER NOVELTY

◆ A third dimension viewer manufactured by the DeVry Corporation, Chicago, for color or black and white 35mm. film.

The viewer has met with considerable success as a merchandising aid and may be used in connection with the exploitation of industrial films. Dealers are furnished with a sample viewer together with a strip of film containing copy and scenes in third dimension from a forthcoming production.

PROTECT YOUR FILM

DUST-PROOF • FIRE-RESISTANT STORAGE CABINETS

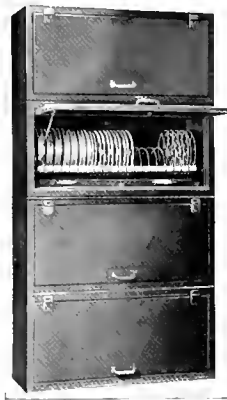

Valuable films require and deserve proper storage. Keep them the modern efficient way in a specially designed film storage cabinet — the result of NEU-MADE'S experience in supplying the motion picture industry with its storage equipment for the past twenty-two years. Constructed entirely of steel — they last a lifetime!

Complete range of sizes and models for the commercial, industrial, school or individual user. Whether you have ten reels or a thousand, NEU-MADE can supply the cabinet!



MODEL MM-20—INNOVATION (Illustrated). Can be built up in units like sectional bookcases as your library increases.

SHIP FILM SAFELY

No worries about damage in transit if a NEU-MADE shipping and carrying case is used. Either FIBRE or GALVANIZED (illustrated) cases available in all sizes.

ALSO — Projection tilt tables, inspection tables, reel bands, splicers, rewinders, measuring machines, etc. — COMPLETE LINE for both 16mm and 35mm!

WRITE FOR ILLUSTRATED CATALOGUE

Neumade Products Corp.

427 W. 42nd St. New York, N. Y.

SAVE TIME — FILM — SPLICES!

Notch out torn sprocket holes with this handy 16mm "V" notcher. No. V-2 only \$7.00

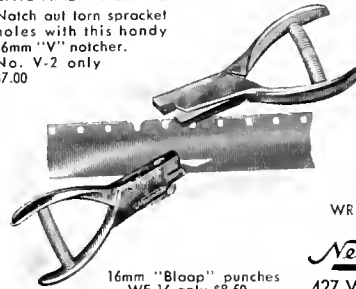

16mm "Bloop" punches — WE-16 only \$8.50



SHOULDER-TO-SHOULDER

One of the solid stones in Cinecolor's pyramid of progress is the keen, practical spirit of cooperation afforded producers who want consistent, lifelike color with Economy, Speed, and Flexibility.

CINECOLOR

**EDUCATIONAL
FILM CATALOG**

NEW YORK
THE H. W. WILSON COMPANY
1936

**THE
EDUCATIONAL
FILM
CATALOG**

offers

EXPERT GUIDANCE

IN THE SELECTION OF FILMS TO PURCHASE, RENT OR BORROW FOR BUSINESS, EDUCATIONAL OR OTHER NON-THEATRICAL PURPOSES.

The EDUCATIONAL FILM CATALOG is a list of the best educational films available. It is classified by subjects. In addition, there is a complete subject and title index which simplifies the finding of films or parts of films upon any given subject.

The Catalog gives a factual description of each film. It indicates the physical make-up of the film, tells where it may be bought, rented or borrowed and the cost under each plan. The selection of films in the catalog are made by groups of experts in various fields of knowledge.

THE EDUCATIONAL FILM CATALOG is a service consisting of a Foundation Volume (1936) which describes and evaluates about 1175 films. Supplemented by quarterly paper-bound supplements in January, April and July of each year followed by an annual bound volume in October. The annual volumes contain all entries for the year in one alphabetical arrangement and average about 1000 films each.

SPECIAL OFFER

To new subscribers the following generous introductory offers are made:

1. The 1936 Foundation Volume with bound annual supplements for 1937 and for 1938; and a continuous subscription to include three quarterly issues and a revised edition in 1939, and quarterly supplements and a bound volume in 1940.....\$6

or

2. The 1936 Foundation Volume and 1937 and 1938 bound annuals only.....\$2

THE H. W. WILSON COMPANY

*Since 1898 Compilers and Publishers of
Bibliographies, Indexes to Periodicals
and other Reference Works.*

950 University Avenue

New York City

NEW DEVELOPMENTS in EQUIPMENT

♦ A new, larger S.V.E. Tri-Purpose Projector with three times the illumination of the present Model CC has just been announced by the maker—the Society for Visual Education, Inc., Chicago.

The new Tri-Purpose unit—the Model AA—has a 300 watt lamp to provide greater power for long throws in large classrooms and auditoriums. Like the Model CC, the AA serves three purposes. It shows (1) single frame film strips (2) double frame film strips or (3) individual frames (color or black and white) mounted between 2" x 2" glass slides.

The new S.V.E. Rewind Take-Up, which rewinds in the proper sequence each roll or strip of film as it is being shown, is standard equipment for the Model AA. The film, instead of dangling on the floor, goes into a special take-up can and is thus fully protected against gathering dust, lint or finger marks. This feature makes the AA particularly suitable for use in schools, clubs and churches in showing professionally-made film strips or film-slides as well as film strips made with miniature cameras by members of the organization.

The Model AA Tri-Purpose Projector, complete with lens, lamp, Rewind Take-Up, double slide carrier and carrying case, retails for \$57.50. The model CC, complete with lamp, lens, double slide carrier and case but without the Rewind Take-Up, retails for \$35.00. For further details, write the Society for Visual Education, Inc., 327 South LaSalle Street, Chicago.

♦ A new 16mm. portable Continuous Projector, which is being placed on the market in both silent and sound models by Victor Animatograph Corporation, Davenport, Iowa, embodies a patented "advance-feed" principle which insures trouble-free performance and protection against film destruction that have never before been achieved in other types of 16mm. continuous mechanisms.

The great "bugaboo" of continuous projection always has been the eventual tightening up of and the loss of freedom in the film windings in the film magazine or around the film driving rollers. If a string is wound loosely around one's finger, it will gradually tighten up if one or both ends are pulled. Film in a continuous projector is bound to do the same thing unless it incorporates the "advance-feed" principle, as in the Victor. The backbone of this principle is the *positive regulation of the amount of film fed to the intermittent film-moving member of the projector.*

By eliminating all pull and strain, the new patented "advance-feed" insures perfect freedom from operating troubles caused by film destruction or binding of the film in the magazine.

Of equal importance is the fact that the usability of the film is greatly increased by a tremendous reduction in surface rub or friction between layers of film. The film literally winds and unwinds itself by dropping into place as it passes over the arc of the wheel. As a consequence, wearing and scratching of the film surface, which occur rapidly in machines that cinch and grind the film together, are minimized by this "free", floating action of the Victor continuous.

Added protection against film damage is provided by the Victor automatic film trips which automatically stop projection and film movement in the event film loops are lost because of damaged perforations, incorrect threading, or defective splicing.

Choice of 500 watt, 750 watt, and 1000 watt projection lamps insures screen brilliancy of the desired intensity, and a sharp, well-defined image even in broad daylight. The film capacity of standard models of the unit will be 500 feet. Special models with greater capacity can be supplied on order.

**FOR LITERATURE AND
PRICES ADDRESS THE
SCREEN SERVICE BUREAU
20 N. WACKER • CHICAGO**

THE ARGUS MICROFILM READER ENABLES BUSINESS organizations to condense bulky records into economical and compact film strips.

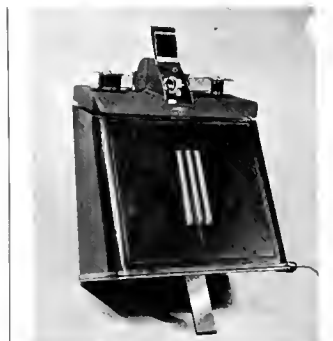

♦ The DeVry model G silent sound projector has been improved and is shown (right) with the new reverse switch, automatic rewind and stop-on-film feature. This machine now weighs less than ten pounds and has been placed in wide use in commercial and educational departments as a desk and showroom demonstration unit.

There are many fields of use for the silent projector applied in this way. One large company has employed over 1,000 of the units for local dealer use. Although sound has recognized advantages, the silent film is useful.

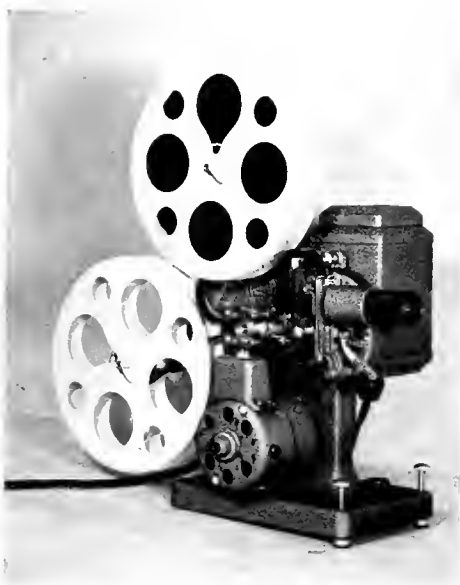

DISCUSS FILM REJUVENATING

• Business Screen quotes J. A. Norling and Albert P. Rippenbein, industrial film authorities, in these interesting remarks concerning the treatment for rejuvenating and preserving motion picture films:

"A photographic film contains colloidal systems which tend to change as the film ages. This change develops serious symptoms: the film shrinks and tends to become dry and brittle. The mechanical strains and stresses to which dry and brittle films are subjected during use soon cause a breakdown of perforations.

"The nature of the photographic emulsion and likewise, of the base makes it a receptive medium for accumulating moisture, oil and dirt. The substances of which the emulsion is composed are not highly resistant to abrasion, and scratches become receptacles for dirt. The dirtier a scratch, the worse it appears when projected. Therefore, when a film becomes scratched during the first run, which may occur on poor equipment or on good equipment improperly operated, subsequent use of the film will make these original scratches more and more apparent. In addition, new scratches will be added constantly, and, by the time the print arrives in the smaller theaters, it has acquired the 'rainy' appearance which has been a source of much perturbation.

"There are two treatments: (a) the rejuvenation or regeneration process, by means of which worn and damaged negatives and positives are restored to good condi-

tion, and (b) the impregnation-preservation process, by means of which new negatives and prints are given a longer life in service or in storage. The processes do not involve the use of lacquers or coatings, but depend upon the swelling and contraction of the film and the glazing of the surface in order to resist scratching and accumulation of surface dirt".

Mr. Rippenbein, co-author of the remarks quoted above, is an authority on this rejuvenation process and is connected with the firm of American Recono, Inc.

NEW "SYNC" MOTOR DRIVE

♦ To meet the needs of recording laboratories which must screen films at exactly 24 frames per second while voice or sound effects are being "dubbed in", Bell & Howell announces a synchronous motor drive designed for the Filmosound Model 138 and Filmo silent projectors Models 57 and 129. It is recommended that the installation be made on the Filmosound inasmuch as it can be used for projecting either sound or silent film.

The synchronous motor is used only to drive the projector mechanism, the projector motor being used to drive the fan, and in Model 138 Filmosound, the take-up also. To avoid overloading the synchronous motor or gearing it is essential that the projector be equipped with a clutch, which remains disengaged at all times when the synchronous motor is attached. Clutch installations are made by Bell & Howell. The synchronous motor drive is supplied on special order only, the installation being made by Bell & Howell.

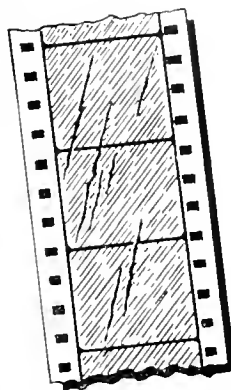

YOUR AUDIENCE

Sees "SCRATCHES" RAIN-DIRT!

You would "fire" the salesman who called on your customers dressed sloppily — THEREFORE

WHY NOT MAINTAIN THE PERFECT APPEARANCE OF YOUR FILM SALESMEN?

Film cannot be made scratch-proof — but there is ONE WAY of removing scratches — rain — dirt, and that is by **RECONO REJUVENATION.**

RECONO has been used exclusively by the Motion Picture Producers for the past 9 years. It is now being made available to the non-theatrical trade. **THE COST IS VERY LOW!**

FREE OFFER!

Send us a reel of positive (400 ft. 16mm. 1000 ft. 35mm.) and let us show you the improvement effected by **RECONO REJUVENATION TREATMENT AT NO COST TO YOU.**

AMERICAN RECONO, Inc.

245 West 55th Street • New York, N. Y.

P.S. You may not realize it but films put in storage may be deteriorating in the cans. Films should be inspected periodically. We have saved many an important picture for our clients. Avail yourself of our inspection service.



Distinguished

The Drake offers every luxury and convenience of fine living on Chicago's Gold Coast, overlooking Lake Michigan.

A. S. Kirkely, Managing Director

The Drake

LAKE SHORE DRIVE • CHICAGO



Send for
this FREE

New
Cine-Bass
Bargaingram
#234

Fifty-two pages filled with cine news and bargains to delight the movie fan. Tyro, advanced amateur and professional alike will marvel at the completeness of this catalogue. Special sections for sound cameras and projectors — 8mm. and 16mm. Lists all popular makes of cameras, projectors, projection equipment — hundreds of accessories, in fact a real cine encyclopedia. Write Dept. BU.



Dept.
BU

179 West Madison Street
CHICAGO, ILLINOIS



**Christmas
Memo:**

*The Ideal Gift
for the modern
Business Man...*

BUSINESS SCREEN

THE MIGHTY OF COMMERCIAL
INDUSTRY EDUCATION IN FILMS

★ He'll enjoy every page of this fascinating new magazine on the newest phase of modern advertising and sales promotion. Whether sales manager, advertising man or educator, there's an interesting article for him in every issue! *Twelve Numbers Sent For \$5.00, including a handsome gift card.*

ORDER FROM YOUR NEWSDEALER
or drop a line to
Business Screen 20 North Wacker
Chicago, Illinois

**WHAT THE CLIENT EXPECTS OF
THE SLIDE FILM PRODUCER**

Part Two of an outline suggested by an experienced user of sound slide films

17. **ART WORK** The producer should furnish trained artists who can work out impressive pictorial presentations that can be photographed. The artist should be on the lookout for opportunities to embellish pictures and photographs for the purpose of emphasizing facts carried in the script.

18. **LAY-OUT** The producer should be responsible for all lay-out work. The pictures should be simple but carry the points clearly. Charts, diagrams, and tables should be laid in such a manner that the audience cannot help but get the meaning intended.

19. **LABORATORY WORK** The producer should be responsible for all laboratory work necessary to produce good pictures. For example, the film should be printed so that the frames are uniform in density. Furthermore, the density of the emulsion on the film should be made to agree with the projection equipment owned and used by the client. The producer should never use "stock" shots unless such pictures agree in density with the rest of the pictures used in the film presentation.

20. **SOUND RECORDING** The producer should be responsible for all sound recording. He should use only the highest quality sound recording such as the R.C.A. High Fidelity Sound Recording, Western Electric or its equivalent. He should keep the client informed of the type of recording and thus recommend the needles necessary to reproduce the sound recorded.

21. **VOICE TALENT** The producer has the responsibility of the casting of voices and talent and should select only experienced stage artists, radio artists or announcers.

22. **DIRECTION OF SOUND** The producer will furnish an experienced recording director, thoroughly familiar with problem to be solved, method of treatment and materials to be used. Director should discuss script with writer and editor, rehearse cast and direct cast during recording of script.

23. **SOUND EFFECTS AND SPECIAL LOCATION SOUNDS** The producer is also responsible for all sound effects used to get illusion of action, for picking up and recording of special location sounds, and for re-recording these special location sounds as they should be used in the recording.

24. **MUSIC** The producer selects and records all music used in the film presentation. Music should be selected with extreme care so that it is appropriate to the thoughts carried in the script. Through careful music selection, the emotions of the audience can be controlled and swayed to agree with the script content.

25. **MUSIC RELEASES** The producer is also responsible for all music releases so that client can in no way be held for using arrangements without permission.

26. **COMPLETE DRAMATIC TREATMENT** The producer usually endeavors to use complete dramatic, rather than factual, treatment in presenting solution of a problem. This treatment reduces the number of facts that can be presented but "sugar coats" the solution so that it is easier for audiences to grasp. The conscientious producer will tell the client that the sound slide film in itself is not a "cure-all." Although one of the most effective media for presenting the solutions of a problem, it may be generally more effective when supplemented by other media such as personal contact, supervision, booklets, leaflets, and folders.

27. **MASTER NEGATIVE AND POSITIVE PRINTS** The producer should be responsible for the master negative and the positive prints on safety film, preserving master negative so that client may purchase additional prints at any time.

28. **SPEED OF FILM** The capable producer can be depended on to create a fast-moving film production, averaging 10 frames per minute. This requires highly-trained scenario writers who can produce script of this type without splitting thoughts. Each frame should carry one complete thought. The inexperienced scenario writer speeds up presentation merely by splitting one single thought over several frames; the experienced writer can express a single thought in so few words that the complete idea is presented in five seconds or less.

29. **RHYTHM** An average speed of 10 frames per minute does NOT mean that every frame should be exactly 6 seconds long. The film must have rhythm, or change in speed or pace at which pictures are presented on the screen. If frames are of equal time, the result is what is



A GENERAL ELECTRIC SALES TRAINING SLIDE FILM ILLUSTRATES a graphic point for the G-E retail radio salesman.

known as "monotonal fatigue" on the part of the audience. With some exceptions, such as laughs and technical terms, the length of time that a picture is allowed to remain on the screen should be governed by the content of the picture rather than of the script. Length of time per frame should probably vary from as low as 2 to as much as 22 seconds. Frames above 12 seconds should deal only with such "heavy" content as diagrams, charts, formulas and abstractions.

30. **EYE-SETS** The producer should provide scenario writers and adapters who understand the fundamental principles of "eye-set," or the length of time it takes the audience to see and interpret the picture on the screen. If the "eye-set" is too short, the audience fails to grasp the meaning intended and becomes irritated; if too long, the audience becomes weary and restless. The picture on the screen must agree accurately with the content of the script or the audience becomes disturbed.

31. **JUMPS** The good producer will provide experienced writers who know how to minimize the interference of the eye jump and the sound or script jump resulting from the gong. This can be done by seeing that a complete thought is pictured in a single frame or by providing a "spring board" between frames. A "spring board" is merely a device employed by the experienced writer to swing the mind of the audience from one frame to another. While the mind of the audience is "taking the spring," the gong is sounded as a signal to the operator. The audience is concentrating on the transition from one frame to another to such a degree that the gong itself becomes less distracting. To date, no writer has been able to eliminate the gong completely from the mind of his audience but it is important that the writer and photographer work together so as to lead the audience from one thought and one picture to the next smoothly, logically and without monotony.

32. **PRE-SELLING** The producer should recommend to the client methods for pre-selling a given slide-film production. This pre-selling must be done in such a way that a desire to see the picture is keenly aroused. Without revealing the story, pre-selling must prepare the audience for what it is going to see.

33. **FOLLOW-UP** The producer should also recommend to the client methods of following up the showing of a slide-film production with supplementary materials that help the audience understand the thinking that was built into the picture. These may take the form of leaflets, booklets, monographs, illustrated folders, or other more clever devices.

34. **MEASURE RESULTS** The producer can help the client by showing him methods to measure the results from a given slide-film. The producer's fund of information gathered in his work on the production enables him to help the client establish a list of facts intended for the audience to grasp. On the average, 75 per cent of the facts built into a slide-film production should register with the audience on first showing.

35. **COPYRIGHT** The producer should copyright the finished production to assure protection for the plot, subject materials, method of treatment, title, finished scenario and all phases of the completed sound slide-film that can be protected by copyright with all rights reserved, thereby protecting the client so that competitive and non-competitive companies cannot use the same materials and treatment.

Copies of the above outline will be furnished free on request from Business Screen Magazine



SKILLED LABORATORY TECHNICIANS SERVE THIS IMPORTANT PHASE of the commercial film industry. A complicated film printer is shown in operation in a typically well-equipped plant for this work.

Camera Eye

(Continued from Page 11)

thorne works, in Chicago, primarily for employees and friends. Last week . . . at its big Point Breeze plant near Baltimore. Most interesting to reporters: Far from being distracted, proud workers spruced-up more than usual, speeded-up production . . ."

Since *Time's* reporting, the Kearney (N. J.) plant has attracted as many as 6,000 visitors per day through two weeks of local interest in the business of making Western Electric products. The new film series will carry a pictured version of these processes to many more thousands than could have the opportunity to visit any near-by Western Electric plant. With both pedagogical and theatrical skill. Audio's cameras have visited these plants and created a close-up view of intricate and astonishing details, for the benefit, as *Time* says, of those who want to see "other jobs than their own".

♦ L. A. Weaver, Jr., has been appointed assistant to the director of the Motion Picture Advertising Department of J. M. Mathes, Inc., New York agency. Mr. Weaver, who has been connected with J. M. Mathes, Inc., since shortly after it was established, will work under Wilfred S. King, radio director, who also has supervision of the Motion Picture Department.

FILMS FOR BETTER GOVERNMENT

♦ Progressive city manager government has evidently adopted the visual medium for the explanation of its aims and principles to citizens in communities where this movement is active. Chicago adherents to the city manager program have already set aside funds for a slide film promoting the movement, and are also using all available motion pictures at their meetings.

American City Magazine reports that councilmen and citizens of Sewickley, Pa. are learning about their community problems through movies. Borough Manager, John C. Hiteshew, reports to the International City Managers' Association that he has introduced movie-reporting as a successful device to acquaint coun-

cilmen and citizens with details of municipal work and angles of specific local problems. The movies which Manager Hiteshew has made and shown during the past three months include such subjects as voting matters, the water-works system, needed street improvements, and operation of sewage-disposal plants in other towns, to compare with a proposed plant for Sewickley.

This winter, the local woman's club and civic clubs, the board of trade and the public schools will see the films upon request. Later they will be filed as a permanent record of Sewickley affairs.

SOUND SLIDES FOR FIELD'S

• Advertising Film Associates, Inc., have recently completed a sound slide film called *Fashion's Favorites* for Marshall Field & Company. The subject is Karastan rugs and the film runs about 25 minutes, consisting of approximately 160 frames. It is used for training department and furniture store sales people, and deals with the technique of handling different types of customers, also giving complete details on how Oriental rugs are duplicated by machinery in this country at a lower cost.

BEER ADS OUT OF THEATRES

♦ *The Christian Herald*, national religious paper, gives a nod to the Alexander Film Company of Colorado Springs which recently announced that it had abandoned all beer accounts, sacrificing an annual net income exceeding \$50,000.

Says the *Herald*, "They deserve credit for that for they are one of the largest producers of advertising film with 6,000 cities listed on their rolls".

MAGAZINE MOVIES SHOWN

♦ *Modern Plastics Preferred*, a sound and color motion picture dramatizing the plastics industry, was the feature of *Modern Plastics Magazine's* dinner held recently at the New Yorker Hotel. The new picture, an exposition and a review of achievements in the plastics field, is designed to bring about a greater appreciation of what is being done and what can be done with plastics. In addition, the picture presents the winners of this year's *Modern Plastics* Competition.

While this is *Modern Plastics Magazine's* first picture, the publisher, Breskin and Charlton Publishing Company has used pictures for the past two years for their *Modern Packaging Magazine*. The success of these films in reaching hundreds of thousands of people interested in packaging is responsible for the film debut of *Modern Plastics*.

After the presentation at the dinner, the film is now available for showing to advertising, business and industrial groups of all kinds. The picture was produced by Willard Pictures, New York. A 2,000-watt Bell & Howell arc projector will throw the color on a 12 foot screen.

STOPPER

11,575 PERSONS

stopped before one grocer's store window,

654

paused at the grocery window next door!

The new DAYLIGHT REPEATING PROJECTOR is a proven system for getting attention and making sales.

A detailed breakdown of this survey, made by a leading advertising agency, will be supplied on request.



Every Advertiser Can Use It

The new DAYLIGHT REPEATING PROJECTOR is a revolutionary SYSTEM of point-of-sale advertising. It gives a clear picture — even in bright sunlight. Long film life. Silent. One minute interlude, automatically, between each show. Manufactured under Kinofone patents.

WRITE FOR FULL INFORMATION

National Sales Representatives
WEST COAST SOUND STUDIOS, INC.
510-22 West Fifty-Seventh Street
New York Circle 7-2062 N. Y.

Producers of Sound and Silent Pictures For Business

SEES ALL-PLAYS ALL UNIVERSAL 16 SOUND PROJECTORS 16MM

New All-Purpose Model

Combined utility is offered in this newly designed 16MM Sound Projector. Precision built. Completely flexible for the varied demands of classroom and auditorium.



Complete, ready to operate
Universal Sound Projector
SENTRY SAFETY CONTROL CORP.
1923 Oxford St., Phila., Pa.
Show Room—1600 Broadway, N. Y. C.

* * *

A HAPPY NEW YEAR

is on the way for
readers of

BUSINESS SCREEN



1939 EDITIONS OF THIS stimulating magazine are now in preparation — bringing you fresh, vital information on the commercial and educational film developments of each month!



DON'T MISS THESE ARTICLES:

- * "Training Salesmen with Films"
- * "General Electric: A Motion Picture Survey"
- * "The Personnel Department Uses Visual Aids"
- * Edison Electric and Films by John Coakley.
- * Caterpillar Tractor Rolls it Own!
- * and many others!

PLUS

Two Special Annual Numbers

1. The First Directory Edition of the Commercial Film Industry.
2. The Equipment Review Special 1939 "Blue Book" Number.

Address Your Requests
for Sample Copies to

BUSINESS SCREEN
20 North Wacker Chicago



Tips for Better Shows . . .

1. **START "IN FRAME":** One of the little niceties that may mean the difference between a professional-appearing or highly amateurish showing is the starting of the film exactly "in frame". Rarely does one see in a theatre the beginning of a movie with the frame line of the film two high or too low on the screen; yet we have seen quite a few slide-film and commercial movie showings in which this has happened. To make sure the film is properly framed, the operator may observe either of the following procedures: (a) Before the start of the regular performance, throw picture on screen and make framing adjustment. Or, if audience is present, (b) open shutter of projector by turning the test-threading knob (all of the better projectors in the 16mm. class have some variation of this device). Hold a small flashlight between film aperture gate and lamphouse. Looking in through the lens, in front of the projector, at the film, the film may then be properly framed. With some makes and models this is difficult to do, but the same results may be obtained by holding a white card a short distance from projector; then, at silent speed, and with sound turned off, the picture is framed before the actual beginning of the film. With slide-films this is, of course, a very simple procedure.

2. **START IN FOCUS:** An approximate focus may be secured without film in projector before start of a show by "sharpening" the edges . . . adjusting the focus till aperture edges on the screen appear sharpest. During showing of title, focus should then be *gradually* adjusted till title appears as sharp as possible. The proper lens should be used to fill the screen (Chart to be published later), but if screen is not filled, picture should be balanced in the center of the screen.

3. **START AT THE BEGINNING:** The numerals following the threading-leader of a film are for the convenience of the operator, and are not intended for the audience. These should not be thrown on the screen. Most 16mm. operators know this, but many do not realize the effect upon the audience when, through carelessness, the numerals are allowed to flash on the screen. Start at the beginning — not before, and not after. In an emergency, light may be "doused" by holding a white cardboard close to the front of the projector until the last numeral has flashed, then removing the card quickly. It is better, of course, to do this preparatory work before the audience is seated, having the film properly framed — with the title ready to flash on when the projector lamp is switched.

4. **OPENING SOUND SHOULD FOLLOW PICTURE:** Operators should not turn on the exciter-lamp switch (sound) until projector has reached its

proper speed, as a most undesirable sound will in that case, be heard in the speakers. About two seconds is sufficient for the interval between turning on projector switch and projector lamp-switch (which in all 16mm. projectors is coupled with exciter switch).

5. **REELS SHOULD BE PROPERLY SPLICED TOGETHER:** Two or three hundred 400'-reels of 16mm. film are often spliced together to form the standard 16mm. reel of film. The producer often handles this splicing, sometimes not. Proper "breaks" have been allowed between the 400' reels, so that musical phrases or spoken phrases will not be rudely cut in half. However, an awkward interval between portions of spliced films often results from poor splicing, or failure to cut out sections of leader film between them, or the leaving of short patches of blank film or the "sink numbers" used on all 35mm. film (from which the 16mm. was reduced). Further, a poor splice may throw the picture out of frame. Splices should be carefully made, in accordance with instructions furnished with splicing devices. Unavoidable blank patches which may sometimes appear on the sound track between spliced sections should be carefully painted with a bit of india-ink to avoid a "blurping" sound.

STAGING THE CONVENTION

(Continued from Page 15)

motion pictures as a medium of sales promotion is indicated by the fact that Clairol, Incorporated, largest producer of hair coloring materials, devoted its entire exhibit at the New York State Hairdressers Convention to a motion picture presentation.

More than 15,000 beauty shop owners and jobbers attended the convention, held recently at the Hotel Pennsylvania in New York City. The usual procedure at this show is for each manufacturer to present demonstrations in his own exhibit room, and to offer merchandise for sale. This year Clairol's exhibit, however, was a miniature theater, complete with posters, box office and spotlights to give a preview atmosphere. Admission was by ticket only, the tickets being distributed by the jobbers who handle Clairol products.

Sound and color motion pictures offered a condensed training course in the use of Clairol products and a presentation of the latest hair and hat styles from Paris, which showed how famous hat designers and great hair stylists are working to gether in the creation of new fashions centering around the upswept style of hair dressing. Besides the showing at the Hairdressers Convention, this motion picture program is now being presented to similar audiences in more than 100 cities.



AN INTERESTING EXAMPLE OF REAR-SCREEN PROJECTION, ONE OF THE MOST FASCINATING "TRICKS" OF THE STUDIO. THE HISTORICALLY accurate "room" is merely a picture projected on the screen in the background for a perfect illusion.



HERE IS THE ACTUAL SCENE IN THE FILM MADE RECENTLY FOR THE CAST IRON PIPE ASSOCIATION BY AUDIO PRODUCTIONS. THE CHARACTERS appear to be standing in the room with a startling degree of reality thus achieved at minimum cost.

BUICK USES NEWSREEL TECHNIQUE

• During the summer of 1936 Buick officials faced an enviable problem. They had so many talking points for an advertising campaign that selectivity and concentration of ideas became difficult.

The past few years had brought new prosperity to Buick. Sales had mounted and continued to gain. Recent models had found public acceptance. The prestige behind Buick had been rekindled by its newest achievements. Relationships with its labor and its dealers were completely harmonious. Soon to be marketed, the 1937 cars incorporated many and important innovations. Above all, they were strikingly handsome.

Executives of Buick wanted to use all this information in telling the story of the 1937 car. To marshal these facts, to use all the sales arguments, a super-newsreel running about forty minutes was planned.

Through this medium the ideas could be broken up into segments, each independent of the other. Sincerity could shine through. The finished film was to mirror facts, and, like a newsreel, to stick to actualities clearly, forcefully depicted. Even though the reported news was to pertain to Buick only, the tempo inherent in news films was to be retained.

The producers selected by Buick and its advertising agency were peculiarly qualified. They ran a newsreel subsidiary and a business film unit.

THOROUGHLY EXPERIENCED IN FILM PRODUCTION AND SELLING

and able to furnish and develop original ideas that are tempered with a sound knowledge of the medium. My services are now available to either producer, agency or manufacturer and include a really wide knowledge of MERCHANDISING AND SALES TRAINING. Your investigation is earnestly solicited. Write Box 81, Business Screen Magazine, 20 North Wacker Drive, Chicago.

"Buick News" divided itself into fourteen separate news stories, each running from two to four minutes. Each episode was an independent unit of the whole.

The general format of a newsreel was maintained. The main title was frankly imitative of its prototype, familiar to theatre-goers. Subtitles between news stories were inserted. The swift pace of news films flavored the film, gave it vitality and zest.

The episodic nature of a newsreel gave it flexibility of use.

In late September dealers from all over the country were called to a series of meetings in Flint. The film in its entirety was presented — it heralded the preview of the new car.

Distributors and dealers were privileged to buy prints at cost. They found three ways to reach their prospects:

1. Some of them set up small theatres in their own display rooms and ran the newsreel in a continuous performance. (A manual was prepared telling the men in the field how to set up these newsreel theatres at low cost.)

2. Others arranged tie-ups with local theatres, and Buick News became a part of the picture program in these cinemas. Because the complete film ran forty minutes, the outright advertising episodes were deleted and thus the shortened version was acceptable to theatre managers both in length and in content.

3. A silent version of the film was printed in 16mm. size. Buick dealers, canvassing their prospects, found that many, if not most of them, owned projectors. Moreover, they learned that free film loaned for home showings was much in demand by those who owned these miniature machines. None of them dissented from the axiom that the best place to sell is in the home. Hence in this method of film distribution they reached well-to-do prospects with a hard-hitting message under ideal conditions.

DISTRIBUTION SERVICE . . .

In Western NEW YORK State . . .

Buffalo • Rochester • Syracuse
Utica • Binghamton • Elmira

• Try our efficient and economical service for the projection of your motion pictures before groups of all types.

• Utilize our facilities for physical distribution of sponsored films for theatrical and non-theatrical showings.

Emergency repair service and competent operators cheerfully supplied for company owned equipment.

"Expensive Films Deserve Extensive Distribution"

JOHN E. ALLEN 6 George Street
Rochester, New York

Rural Distribution by SPECIALISTS in FARM PRODUCTIONS

FOR 21 YEARS!

• **C. L. VENARD** •
(THE VENARD ORGANIZATION)

Our films have a larger distribution and enjoy a more favorable acceptance among rural leaders and audiences than those of any other producer.

702 S. Adams St. Peoria, Illinois

Our 27 years in commercial motion picture enterprises insure you quality results in production shots, or in distribution of your business films wherever you may desire to exhibit.

EDDY PICTURE SERVICE Sault Ste. Marie, Michigan

LABORATORIES — MIDWESTERN

LABORATORY SERVICE

16mm Exclusively!

Complete 16mm machine developing of both negative and positive prints.

SKILLED TECHNICIANS, MODERN EQUIPMENT
DESIGNED EXCLUSIVELY FOR 16mm FILM.
ACCURATE SENSITOMETRIC CONTROL
OF ALL PROCESSING.

MAKE OUR 16mm PRINTS OF
CONSISTENTLY HIGH QUALITY.

SOUND AND SILENT FILMS

Get our prices and test the high
quality of workmanship.

★ **PAN-AMERICAN** ★
FILMS, INCORPORATED

306 So. Wabash Avenue Chicago, Illinois



COMPLETE 16mm PRODUCTION FACILITIES and EQUIPMENT in Both Sound and Color

THE oldest photographic organization in the middle west now offers COMPLETE economical 16mm motion picture service. You can add sound and obtain duplicate prints from your Kodachrome or black and white films at a reasonable cost. Duplicate 16mm Kodachrome prints, silent 10c, sound, 12½c per foot.

WE WILL RECORD THE SOUND TRACK FOR YOUR SILENT BLACK AND WHITE OR KODACHROME 16mm PICTURES FOR AS LOW AS \$50.00 PER 400 FOOT REEL!



All types of sound and silent 16mm cameras, projectors and accessories for sale or rent.

FREE — Our 80 page catalogue 43-R of services and equipment — Write today!

"HEADQUARTERS FOR EVERY KNOWN PHOTOGRAPHIC NEED"

NORMAN-WILLETS CO.

318 W. Washington St.

Chicago, Illinois

A Christmas Gift Idea!

Business executives everywhere are finding *Business Screen* the key to many useful applications of visual media. 12 issues for \$5.00.

H
A
R
M
O
N
Y

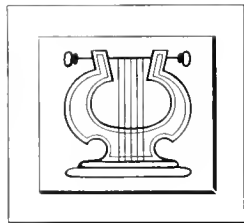

There is no secret formula for obtaining *harmony* in the use of type. Here at Advertising Typographers, constant study combined with practical experience have taught us how to use type harmoniously in the manner to produce better advertising results for you.

ADVERTISING
TYPOGRAPHERS, INC.
341 EAST OHIO STREET CHICAGO, ILLINOIS

DEPARTMENT STORES

(Continued from Page 18)

warranted holding over for a second week. Interest was developed by the use of a window display consisting of an intriguing collection of photos of early day film players and stills. Interest was further heightened by the personal appearance of Bill Hart — which gave McCreery a chance to crash the daily papers with a real news story.

As a result of the McCreery showings, the idea spread to other cities. In Philadelphia, Gimbel's ran the same show and advertised it in large display space on the theatrical page of the daily papers. Famous Barr in St. Louis then showed the pictures.

The following year, McCreery showed old movies again — this time tying the pictures in directly with definite merchandise. McCreery, through its buying office, Associated Drygoods, had arranged for the use of a style picture featuring bathing suits. Sensing the need for something to boost public interest, they rented, from Stone, some old Mack Sennett bathing beauty pictures. So, instead of seeing just a style picture, McCreery patrons saw a rounded show, with ample contrast between the styles of the nineties and the new fashions of the day.

ADVERTISE COLOR FASHION FILM

Saks 34th Street, sent a couple of girls to Bermuda with a photographer and took a beautiful fashion film in full color. It was a silent film, (16mm.) but Miss Wallach of Saks had a fashion talk recorded and synchronized to it. Newspaper advertisements invited folks to "See a motion picture in natural color, showing what two engaging young debutantes actually did, where they went, and what they wore, during a 10-day trip to Bermuda. Today and tomorrow there will be movie showings at 11:00, 12:30, 2:30 and 4:30 on our fifth floor. Between times, mannequins will parade in intriguing new North and South fashions. Come in to see it. You'll learn a lot — geographically and sartorially."

Coty has done some wonderful films for consumer use and many stores have used them. The general level of the Coty film is best indicated by the fact that while developed for commercial use, an abridged version of the picture was released by Paramount as a regular theatrical short.

Films have proved that they have a real place in the department store. But the situation today seems to be a series of temporary stymies. More equipment is needed. There's no doubt about that. But business conditions have not been favorable to the point of encouraging investments of from three hundred or four hundred up to six or seven hundred dollars for sound projectors. There are rental services, but the cost of rental runs high for small

groups. And, in the words of one resident buying office, "the number and quality level of manufacturers' films is not such as to encourage the stores to spend much money."

The manufacturer, on the other hand, hesitates to invest in good pictures, when distribution problems are so great. Some manufacturers, like Procter & Gamble or Camp or Kenwood, are solving the problem with their own equipment and own personnel, which, temporarily, seems to be the best way out. But otherwise the situation is at least partly stalled — with all wheels balanced at "dead center."

SLIDE FILMS DO CONSISTENT JOB

In the meantime, the sound slide film seems to be doing all right by itself. More or less neglected by some producers — treated as the Cinderella of the business — it is doing a fine consistent job for many advertisers. While it holds no power over consumers, it has proved its value in the training field and is showing as healthy an immediate growth as movies. Incidentally a continuous sound projector that really works and doesn't cost too much will have a place in window and interior display.

As we've suggested before — films are relatively new in the department store field. I have before me a letter from one of the country's largest resident buying offices to a member store in Atlantic City, N. J. It says:

"With reference to your letter of March 10th, we have not been able to locate any manufacturers who provide moving picture films of their products."

This letter is only five years old. While the records show sporadic use many years ago, it is only recently that they have been in really general use. The rough spots are being ironed out. Give them a chance and they'll come through.

MORE EQUIPMENT NEEDED IN FIELD

It seems that the largest single barrier to more extensive use of movies is the lack of equipment. In talking with one large resident buying office I found that only 10 out of 125 of their stores had 16mm. sound projection equipment. The consensus of opinion was that film producers should now try to meet the problem — a bottleneck that was holding back expansion, which could create unlimited market for their facilities.

People love movies. They pay millions of dollars every day to see them. And they'll gladly spend the time needed to see them in department stores if the level of the pictures is up to par. The whole tempo of department store selling is moving more and more toward a type of sales promotion in which movies fit like a "natural". The increasing use of Showmanship in retail stores almost demands the use of movies. As Christopher Morley says, in *Human Being*, he "discovered that a department store is not just an enormous pushcart but a kind of woman's theatre."

TO MEET *Every* NEED

A Wide Range of "Ampro"
16mm. Projectors

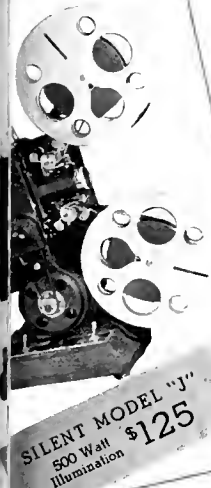

SILENT MODEL "J"
500 Watt Illumination
\$125



SILENT MODEL "K"
750 Watt Illumination
\$135



SILENT MODEL "NC"
750 Watt Illumination
Convertible to Sound
\$175

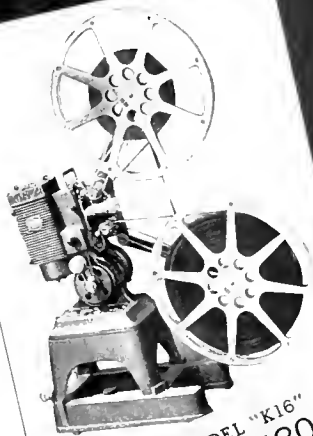

SILENT MODEL "K16"
750 Watt Illumination
1600 ft. reel arms
\$180

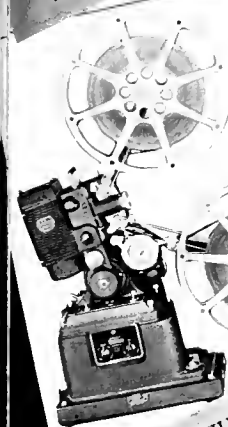

SOUND-ON-FILM MODEL "U"
750 Watt Illumination
For A.C. Operation
\$345

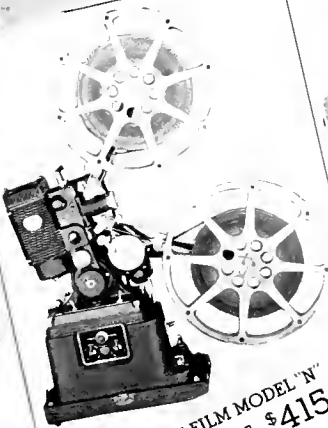

SOUND-ON-FILM MODEL "N"
750 Watt Illumination
For A.C./D.C. Operation
\$415

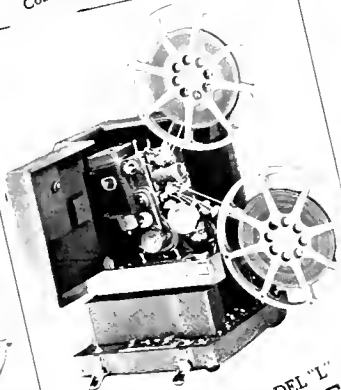

SOUND-ON-FILM MODEL "L"
750 Watt—A.C. Operation
For Larger Auditoriums
\$455

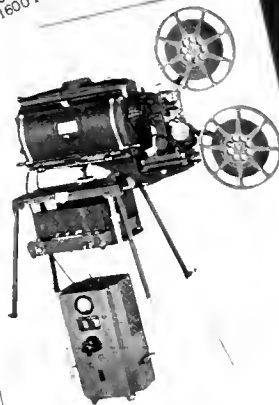

AMPRO-ARC
Sound Model "AA"
\$1210



EACH ONE EMBODYING
CERTIFIED PRECISION QUALITY

Performance speaks more convincingly than mere claims. The steady march of Ampro has swept around the world. In thousands of industrial concerns, schools, universities, clubs, churches and homes—Ampro precision workmanship and excellence of design has established Ampro as the standard of quality in both 16mm. silent and sound projection.

Today—Ampro projectors are approved and used by vast industrial organizations who insist on the best—by large metropolitan school systems who have made rigorous comparative tests. No matter what your requirements, there is an Ampro model that best meets your needs. The coupon to the right will bring you full details promptly.

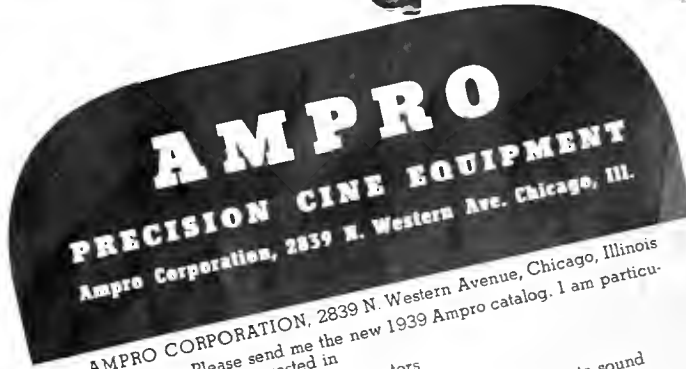

AMPRO
PRECISION CINE EQUIPMENT
Ampro Corporation, 2839 N. Western Ave. Chicago, Ill.

AMPRO CORPORATION, 2839 N. Western Avenue, Chicago, Illinois
Gentlemen: Please send me the new 1939 Ampro catalog. I am particularly interested in

- Ampro 16mm. Silent Projectors
- Ampro 16mm. Sound Projectors
- Ampro 16mm. Projectors that can be converted into sound
- New Ampro-Arc Sound-on-Film

Name _____
Address _____



Color SELLS

for Owens-Illinois Glass Company
in a Technicolor

This Technicolor slidefilm is one of a series that is helping sell applied color lettering for glass bottles.

These films are showing thousands of bottlers, drivers, and retail outlets how to become better salesmen and merchandisers by using colorful displays. The combination of an interesting approach with the appeal and power of color sells more bottles.

Everyone benefits — the manufacturer, the bottler, and the retailer!

Sales and promotion of any product that needs color for effective presentation can be produced by Jam Handy in these films — done finely and done economically.

Write for the facts! There's no obligation.

The **JAM HANDY** Organization

Slidefilms • Talking Pictures • Sales Conventions • Playlets
New York, 230 Park Avenue, *MURRAY HILL* 9-5290 Detroit, 2900 East Grand Boulevard, *MADISON* 2450 Chicago, 35 East Wacker Drive, *STATE* 6758 Hollywood, 7046 Hollywood Boulevard, *HEMPSTEAD* 5809



BUSINESS SCREEN

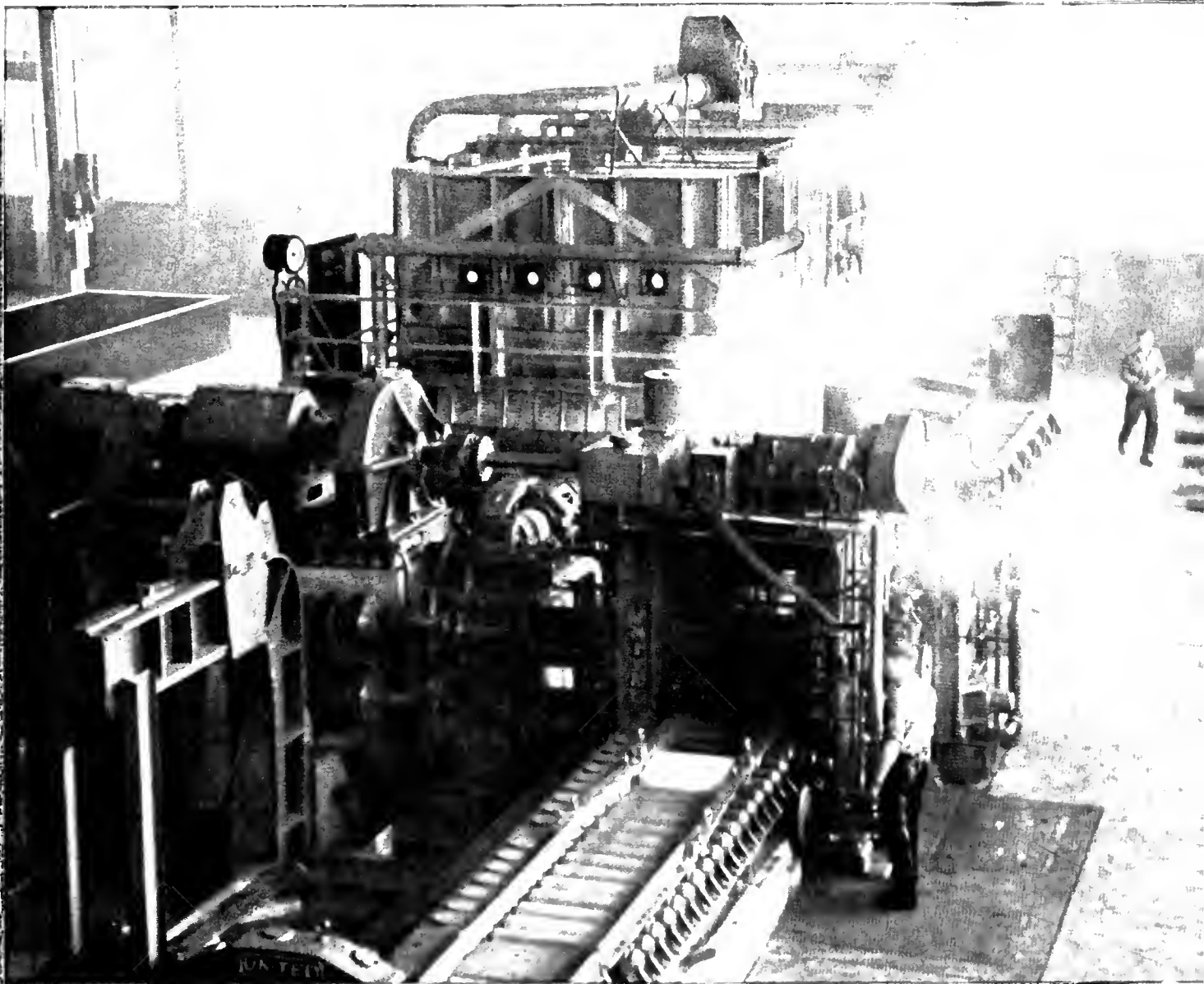

No 5 IN THIS ISSUE: BASEBALL FEUD STIRS FILM AUDIENCES;
COLOR IN INDUSTRY; PROMOTING THE PROGRAM, ETC.

INSTANT ACCEPTANCE

NEVER before have new negative materials been as enthusiastically received...as quickly put to use...as Eastman's three latest motion picture films. Fast, fine-grained *Plus-X*, for general studio work...high-speed *Super-XX*, for all difficult exposures...ultra-fine-grained *Background-X*, for backgrounds and all-round exterior work... Typically *Eastman* in uniformity and photographic quality, these films have won instant acceptance in the industry. Eastman Kodak Co., Rochester, N. Y. (J. E. Brulatour, Inc., Distributors, Fort Lee, Chicago, Hollywood.)

EASTMAN *Plus-X*...
Super-XX*...*Background-X

NOW! A NEW LOW-COST

Filmosound

DESIGNED ESPECIALLY
FOR BUSINESS FILM USE

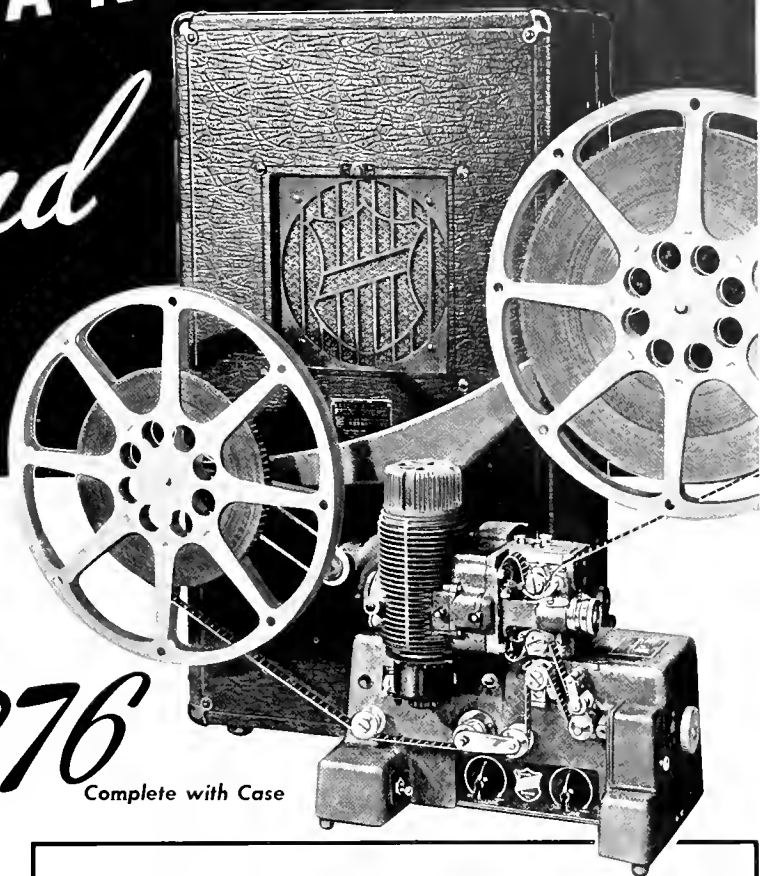

*Lowest Price
in Filmosound History*
ONLY \$276

Complete with Case

MOST business film users wouldn't sacrifice Filmosound quality and dependability for any saving in price. But now *all* can have a *Filmosound* of time-tested precision at no more than the cost of ordinary projectors!

For only \$276 you can obtain the new "Commercial" Filmosound—a 16 mm. projector designed *especially* for sound-on-film presentations of *commercial* films. Because it contains only those features essential for business use, it is extremely simplified; therefore, lower in price and easier to operate.

This new Filmosound has *everything necessary* for theater-like projection in offices or moderate-sized auditoriums. Its 750-watt lamp, powerful amplifier, and other features afford brilliant steady pictures and faithful full-range sound reproduction. In addition, it is compact. And it is durably built to give lasting satisfaction.

Write now for complete details on the new "Commercial" and other Filmosounds. One will meet your needs exactly. All insure the highest possible return on your film investment.

Check the coupon, too, for the 36-page booklet *SHOWMANSHIP, Today's Formula for Selling*, which tells how sound films serve industry, how to prepare and present effective talkies. Bell & Howell Company, Chicago, New York, Hollywood, London. Since 1907 the largest manufacturer of precision equipment for motion picture studios of Hollywood and the world.

- ★ Filmosound "Commercial" can be removed from its compact single case and put in operation in three minutes.
- ★ Its self-evident quality bespeaks the importance you attach to the showing of your business film.
- ★ Its simple, error-proof operation assures your representatives of masterful presentations without fear of interruptions of any kind.
- ★ In short, you can depend upon Filmosound as do Chrysler, Ford, General Motors, and hundreds of other experienced Filmosound users.

Send Coupon for
Full Information on All
Filmosound Projectors

Have your secretary send it today!

BELL & HOWELL COMPANY BS 12-38
1808 Larchmont Avenue
Chicago, Illinois

Send details on () New Filmosound "Commercial";
() Other Filmosounds. Also () send *Showmanship*.

Name.....
Company.....
Address.....
City.....State.....

BELL & HOWELL

After 25 Years . . .



IT HAS BEEN the privilege of Wilding Picture Productions, Incorporated, to create, produce, and distribute motion pictures and slide films—silent and sound—for the leaders of American business and industry for some twenty-five years.

That Wilding productions and services have consistently been *good* is eloquently attested by the fact that eighty per cent of the annual Wilding volume comes from clients for whom Wilding has produced in the past.

And so—as Wilding commemorates its Silver Anniversary—its first thought and its first word is one of gratitude to those *other* pioneers of *other* industries whose confidence in Wilding has made Wilding growth possible.

Through the quarter century that has witnessed the growth of the Wilding organization, its contributions to advertising and merchandising, to distribution, to sales training, and to salesmanship itself, have been many and varied.

These contributions have necessitated the steady expansion of an organization that today encompasses five fully staffed branch offices, spanning the continent. Complete studio production facilities are maintained at Detroit, Chicago and Hollywood.

We believe that when *you* seek out a producer to picturize your business and merchandise your product—through sound motion pictures or sound slide films—your search will inevitably lead you to Wilding . . . the *pioneer* that remains *pre-eminent!*

WILDING PICTURE PRODUCTIONS, Inc.

DETROIT

NEW YORK

CLEVELAND

HOLLYWOOD

CHICAGO



BUSINESS SCREEN

CONTENTS

VOLUME ONE * NUMBER FIVE

The Film Forum.....	6
A Challenge to Industry.....	9
Public & Industrial Relations.....	11
Baseball's Goodwill Ambassadors.....	14
New Films, A Page of Pictures.....	15
How Motion Pictures Move and Talk.....	16
General Electric, A Visual Pioneer.....	17
Casting the Characters.....	18
Hardly Hollywood but Highly Profitable.....	27
Add Entertainment to Your Film Program.....	28
Technical News and a Digest of Equipment.....	31
Organizing the Film Department.....	35
Where Are They Now?.....	37
Script Teasers.....	40

Cover Subject: by Kurt Schelling, Courtesy of The Bridgeport Brass Company, Bridgeport, Connecticut.

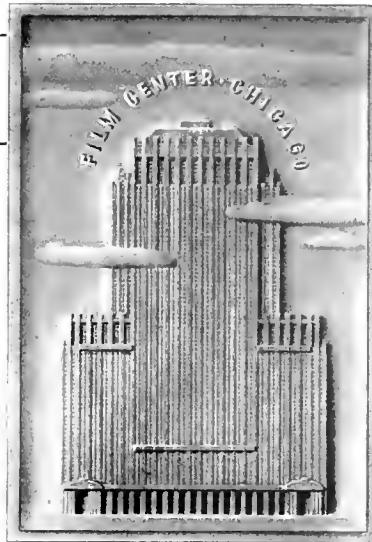

♦ Business Screen Magazine, Issued by Business Screen Magazines, Inc., Twenty North Wacker Drive, Chicago, Illinois on January 20, 1939. Editorial Director, O. H. Coelln, Jr.; Managing Editor, R. C. Danielson. Subscription price: Domestic, \$5.00 a year; 50¢ the copy; foreign, \$6.00 a year. Issued twelve times a year, including four Visual Education numbers. Publishers are not responsible for the return of unsolicited m's unless accompanied by stamped, self-addressed envelope.

ENTIRE CONTENTS COPYRIGHT 1939 BY BUSINESS SCREEN MAGAZINES, INC. TRADEMARK REG. U. S. PATENT OFFICE. ALL RIGHTS RESERVED.

THE MAGAZINE OF COMMERCIAL & EDUCATIONAL FILMS

Camera Eye. NOTES FOR AN EDITORIAL ON PRODUCTION STANDARDS

IN the countless hundreds of interviews which are the privilege of an editor, we have acquired the harest outline of a code of standards which someday should merit the consideration of those few who truly qualify to the title of commercial sound motion picture and sound slide film producers. Not so much because the standards are needed by *them* because they long ago accepted these as a way of doing business but there is a need for a few straightforward truths among the vast numbers of uninitiated and little experienced users and potential users of this all-powerful sales and advertising medium. That they are, incidentally, a defence against the wasteful destructiveness of the "free-lance" and experimenting amateur is a point worth consideration.

The distinct *clearage* between truly professional production according to theatrical standards and substandard *experimentation* is so definite it hardly needs mention. Yet it should be told again that the majority of films for business are produced with professional studio equipment in 35mm. and sound is most dependably recorded on one or another of the accepted 35mm. sound systems. These are not "Hollywood" standards although they are confirmed by every film there made. Films are made that way simply because it is the only way in which the vitally necessary qualities of excellence may be dependably captured for the screen and because the cost of such equipment is not the deciding factor in determining the cost of the film production for it is what

is put *before* the camera — the sets — the cast — and the other visible elements of the successful film sales story — which determine the *price* of the picture. Some good films have been made in 16mm., in *limited fields* and there largely among *smaller* concerns who might otherwise be deprived of a useful medium. Here the *value* of the medium may outweigh the importance of theatrical standards but the rule of the majority is safe, dependable and *basically important* to the success of the medium.

Personnel and *experience* would play leading roles in our presentation of a First Code. Research, writing and direction are the elements of personnel which the reliable producer must afford in liberal measure. Without these — fine equipment is useless — for the most experienced "free-lance" cameraman is quickly lost when he attempts to interpret the smallest part of this world of business. *Experience* would take into consideration the producer's past record of achievement and the years his organization has served its clients. Without it, the highly technical art of the film soon snares the otherwise ingenious copywriter; the talented advertising executive is washed overboard in an unabating flood of costly production budgets. Experience is really the most expensive ingredient of all and one in which too few men are willing to invest. Which again explains, finally, why there are few who truly qualify to the title of commercial sound motion picture and sound slide producers.

— O. H. C.



SAVOY-PLAZA

"The" PLACE
TO LIVE



In New York enjoy living at the Savoy-Plaza, overlooking Central Park, where every comfort is cleverly contrived to make your visit a memorable success. Fine shops, theatres and subway to World's Fair nearby.

Plan now to make the Savoy-Plaza your headquarters during your visit to the New York World's Fair, 1939.

Henry A. Rost, Managing Director
George Suter, Resident Manager

FIFTH AVE • 58th TO 59th STS • NEW YORK

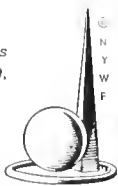

The FILM FORUM

A PAGE OF LETTERS FROM OUR READERS



Educating for Business

We have been playing with the idea of using moving picture sales efforts for one of our clients, a large middle western commercial college.

We are coming to you as absolute novices so far as this type of selling is concerned, with the request that you refer our inquiry to some of your advertisers who you think might have a solution for us.

We would like to show these pictures at arranged meetings which would include high school students in the various cities in our territory. We feel that the pictures should show the romance of industry and particularly should carry a theme where some young person or group of young persons take up commercial training and follow it through to show the type of concerns for which they work, the type of work they do there, and some of the home life and other advantages that they gain through taking up this kind of work.

It may be that some of your advertisers have already developed some films covering this type of material in a general way, that could be used here also. As I said, we have no idea what the cost of producing such film might be, so if there is some canned material on the market, it would perhaps be better or at least more within the reach of our clients to use such a film.

Will you please refer this letter to some such advertiser as I have mentioned or possibly you would prefer to give us some of their names so that we might make it by direct?

R. W. McPHERSON
Christiansen-McPherson Adv. Agcy.
Lincoln, Nebraska

Wants Training Films

Can you give me any information as to where I may get any existing "selling" films, which we could use in our organization to aid our salesmen?

Can you tell me if these films can be rented, or if they must be purchased outright?

Any information you can give me will be appreciated.

PHYLLIS L. NOBLE
Lincoln Oil Company
Boston, Massachusetts

Offers Slide Film

On page eight of your recent issue, Mr. W. R. Blackler, Bureau of Business Education, California State Department of Education, requests information on sales training films.

We have a sound slide film which was created for the purpose of training salesmen of automobile dealers on

the importance of the upholstery in their cars and a specific version of this film was made for the Pontiac Division which they distributed themselves to their field force.

Enclosed is a booklet entitled *They Always Open the Door First* which also is the title of the film and if you believe Mr. Blackler would be interested in this film, we will be very glad to lend it to him if you will give us his address.

H. J. ROSS
L. C. Chase & Company
New York, New York

Safety Films Requested

We are interested in getting in touch with someone who can give us a list of a source of supply of sound slide film strips. We are in the lumber manufacturing business and would want a film with some definite bearing on the safety subject. We are contemplating the purchase of an Illustravox machine and have secured one on approval and have also secured a film strip from the National Safety Council which is very interesting.

If you have a list of available film strips we would thank you very much to send this to us. We hold regular safety meetings and are interested in this kind of a program.

R. A. DARRRELL
Temple Lumber Company
Pineland, Texas

Cites Reference Value

You may be interested to know that we are planning in this State to make use of sales and product training films in our classes and conferences for workers in distributive occupations. As you may know, this program of training under the George-Deen Act is a cooperative effort of federal and state governments to provide vocational training of practical nature for workers engaged in distribution and sale of commodities and services.

In this connection, may I say that we have found "Business Screen" a valuable reference source and feel that it should be made known to supervisors and teachers of distributive education throughout the country.

W. R. BLACKLER
Research in Distributive Education
Berkeley, California

* * *

♦ Letters addressed to the Screen Service Bureau of Business Screen requesting information, etc. are not published on this page but will be promptly answered by qualified department authorities.

LEADING FILM PRODUCERS RECOMMEND DA-LITE SCREENS

CHICAGO FILM LABORATORY, Inc.

PRODUCER OF

"Okay, Mr. Allison"

STEWART WARNER CORPORATION'S
4 Reel Sound Motion Picture
For the Alemite Division

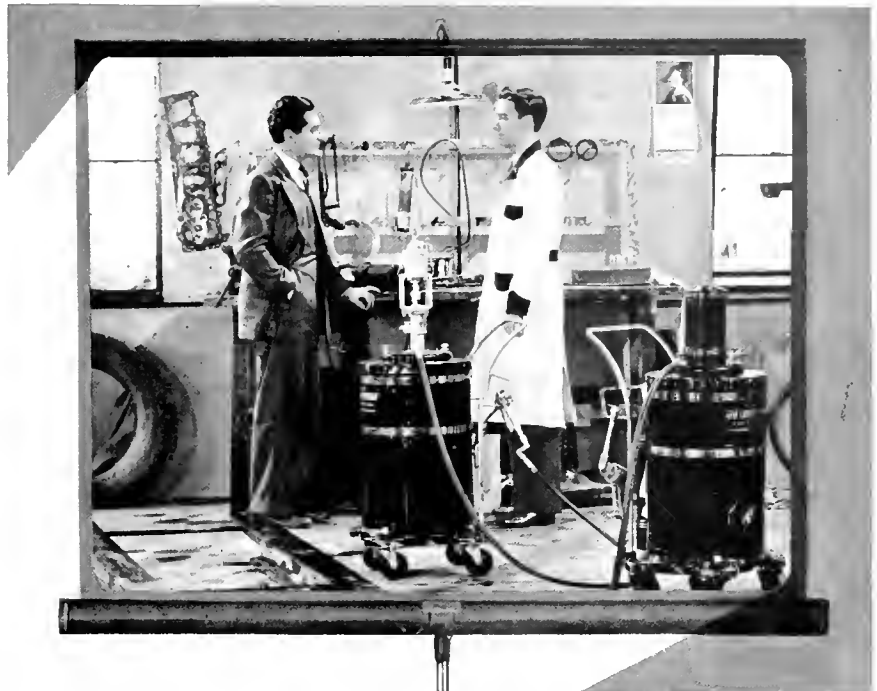

Scene from "Okay, Mr. Allison," as projected on a Da-Lite Challenger Screen. The Stewart Warner Corporation uses Da-Lite Screens exclusively and the Challenger model wherever portability is important.

"Okays" ONLY DA-LITE SCREENS FOR ALL OF ITS PRODUCTIONS



This light, easily carried screen can be set up anywhere in 15 seconds. 12 sizes, 30" x 40" to 70" x 94" inclusive.

DA-LITE STANDARD CHALLENGER

The roller-mounted Glass-Beaded Screen, metal case and tripod are all in one unit.

Mr. Frank Balkin, Sales Manager, Chicago Film Laboratory, Inc. writes:
"Comparative tests, long ago convinced us of the superiority of Da-Lite Screens in showing brighter, clearer pictures. As we want our productions shown always at their best, we urgently recommend to all clients the use of Da-Lite equipment."

The superior light reflective qualities of Da-Lite Glass-Beaded, White and Silver Screens are the result of 29 years of experience in screen manufacture. Continually improved, Da-Lite Screens embody many advanced features that make for better pro-

jection, easier handling and longer life. They are recommended by the leading film producers and are the first choice of a large and fast growing number of experienced users of motion pictures and slide films. There are styles and sizes for every need.

Other CHICAGO FILM Productions Being Shown on DA-LITE Screens
"Food For Thought"
Produced for John Morrell & Company
"Snow Fighters"
Produced for International Harvester Co.
"Solid Foods in the Infant Dietary"
Produced for Libby, McNeil & Libby
"New Yields from Old Fields"
Produced for Allis-Chalmers Mfg. Co.



Send for FREE 48 Page Data Book!

Mail Coupon Now!



DA-LITE SCREEN COMPANY, Inc.
Dept. 1B, 2723 N. Crawford Ave., Chicago, Ill.

Please send your free 48 page data book on screen surfaces, mountings, screen care and other facts that I should know about screens.

Name
Company
Address

AMERICA YOUR STOR

CHALLENGE

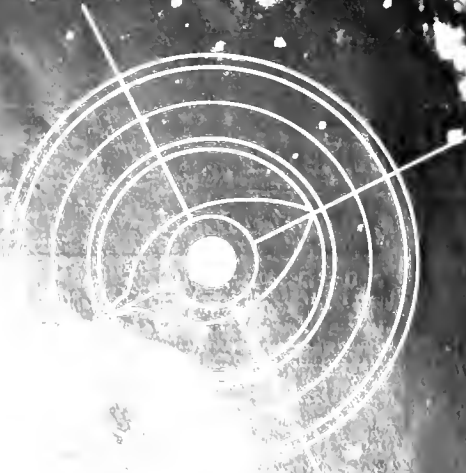

WITH FILMS



INDUSTRY . . .

★ *The field of service in which the motion picture and slide film have been most genuinely helpful to Industry is that of Public Relations. Nearly every classification of film usage in this field has somewhere aided in this activity—for to paraphrase the slogan, "its help to business has helped everyone" and the salesman or industrial worker who has been improved in his job by film training offers no small part of the evidence confirming this. The direct contribution of films which have taken the public into confidence among organizations both large and small can now be accepted as one of the most satisfactory solutions to the educational problem which Business faces today.*

It is important that business should add understanding to the surface knowledge which the public gains through the words of the demagogues and the headlines of the daily press. Most of us today exist in a world which prizes rumor and gossip far above their true values. Tonight's newspaper in a thousand towns will sell a waiting public rumors of war and peace, of victory and defeat. Tonight's news of business will be in most part a reflection of the day's trend on the Stock Exchanges and a liberal budget of more rumor and gossip, favorable and unfavorable to business, which emanates each day from the Nation's Capitol. "What will the public think?", is not the watchword — for as one public relations counsellor has already put it, "It is not the public's attitude which counts, but convictions founded on real knowledge."

The complex structure of business which is often the very heart of its success in affording lower prices for goods and in providing for increased employment is also responsible for the misunderstanding and misinterpretation upon which our demagogues so successfully play. Business need not answer these political critics if it has the understanding and knowledge of the public on its side. The readjustments which industry must face through changes in world and domestic economics should and can be made with the knowledge and cooperation of the public which it serves. There is no more powerful educational force for reaching the inner minds of men than films and the motion picture and slide film should be vigorously employed by all types of business wherever this need for the understanding of the public or of your own employees is realized.

There are able men who can successfully interpret your message in the "new language" of this medium. There are millions of Americans in audiences throughout the country who are waiting to hear and see your story told on the screen. It is self-evident that they will hear it in a more potent way than any other medium can offer. As "truth is light" so the potent force of the projector's beam has the power to bring understanding into the "knowledge" possessed by the public. Technical perfection has provided a perfect medium. The times have created this need. It is up to Business to put them together for the preservation of those precious heritages we recognize as "The American Way"!

NOTES...

- 1909 - Charles Pathe founded company which has since filmed 104 newsreels each year -
- about 3016 issues, plus thousands of short subjects

- Pathe has exhibited enough film to stretch 6 times around the world

- Pathe released more "shorts" than all other producers - before the days of double features

- Pathe owns largest stock shot library in world. Many scenes can't be duplicated - most are available to the company's customers

- Through RKO Radio Pictures, Pathe releases for theatrical distribution several series of shorts - About 5000 theatres run Pathe productions

... AND

COMMENTS

THIS wealth of accumulated experience is yours to draw on when you let Pathe produce your business films. For seven years, Pathe has been creating dramatic, successful motion pictures to help in all angles of selling — direct merchandising, public relations, sales training and dealer promotion. Pathe has men who know how to put the dramatic features of your business or product to work for you, expert technicians and the finest mechanical equipment. Pathe has no solicitors, but a member of its organization will call on you if you write:



PATHE NEWS, INC. • 35 WEST 45th ST., NEW YORK CITY

FREDERIC ULLMAN, jr., Vice-President

• Sometimes too much emphasis is placed on the education of the "masses" and the very important task of industrial relations left in the shadow.

Paul Garrett* says, "A company's public relations program, to get anywhere, must begin in the outer office and inside the plant. If the immediate family is not happy and informed, those whom it meets on the outside will not be. To outsiders those who work for a company are the company — outsiders judge the company by the folks in the company they know. But good relations with employees depend upon something more than high wages. The pay of course should be right always, but to most every employee a sense that he is being treated fairly is just as important as that he is being paid well.

"We have made no appreciable effort to explain the A B C's — the simple premises and processes — of the American plan; to explain that the standard of living for all goes up, and can only be made to go up, as the true price of goods for all is brought down.

... "Because so many have not had this understanding, have been viewing themselves as employers, or workers or farmers — rather than as consumers of goods — they have allowed their narrower outlook almost to blind them, and have put under scourge the source of their broader opportunities. Without realizing it, they have put business on the spot.

"Thrust by this turn of events into an awkward and unaccustomed place, conscious of past omissions and critical future needs, industry has been fervently taking stock of itself and submitting to frank, and frequently brutal self-examination. It has conducted a searching inquiry into the validity of its established principles and accepted doctrines. Out of that inquiry has come a great new interest in what we refer to as human, or public, relations as applied to business. For industry, like democracy, depends for its present success and its future existence upon people, upon those who partake of its responsibilities and its benefits — upon men and women — upon customers.

"Good community relations grow largely from the attitude of employees. As citizens of the community in which the company has its being, they are the best spokesmen for its policies. But beyond this, industry as a partaker of community benefits must consciously assume its share of responsibilities. Local management must make sure that it understands the community's wants and needs, and that in turn the community is made to understand what industry proposes to do and how.

"For the interests of industry and of the community are mutual and supplementary; industry contributes the economic atmosphere — the community determines the moral, cultural and civic atmosphere in which employees live. Unless industry has confidence in the
(Please turn to Page 12)

*Director, Public Relations, General Motors Corporation



IN THE NEXT ISSUE:

FILMS AND OTHER MEDIA . . . how magazines, newspapers and the radio use movies and slide films in effective promotional programs.

ROLL DOWN THE RED CARPET, by Zenn Kaufman. Together with a Business Screen feature section on promotional projects used by leading film users.

WE MAKE A MOVIE, a pictorial feature which takes you step by step through the research, filming and showing of your next commercial film.

• These years of social and economic change have brought new appreciation of the art of shaping public opinion.

We who have been satisfied to let the credit go for the building of our systems of industrial enterprise and for the land of opportunity to which these have so lavishly contributed are now finding these systems challenged by misunderstanding and misconception.

Certain it is that each challenge makes clearer the need for public explanation. The search now is for media which will bring understanding with the greatest possible effectiveness. In this regard, it would be well to appreciate the place which films now occupy in the public relations program of the government.

If you find a contradiction in the fact that the comfortable majorities enjoyed by the Roosevelt government has not decreased the size of this program than you do not understand the true purpose of public relations.

Today a million feet of informational film material is being circulated by various government agencies most of them now organized under the United States Film Service. In addition, much of the success of the new Latin-American goodwill program will depend on the films to be exchanged. The social-documentary pictures produced by Para Lorentz (*The Plough That Broke the Plains* and *The River*) are further evidence of the whole-hearted appreciation which the New Deal has of the film's effectiveness.

Equally effective and directly in behalf of industry are the Technicolor reels now being circulated by United States Steel and such outstanding films as *Hurricane's Challenge* (for American Telephone and Telegraph), *Materials* (Chevrolet), *The Birth of a Baby* (Mead-Johnson) and the four screen editorials issued by the National Association of Manufacturers.

These films and others which can and should be made have the power to reach the hearts of men with truths which the screen can make self-evident. Motion pictures are easy to understand; pleasant to watch. The universal language of sight overcomes the hazards of dependence on print and discussion. In relative value, the sound slide film has many qualities to recommend it for the same use. Simple, inexpensive, dramatic and convincing they can be shown with equal facility before a group of three or four, or an audience of a thousand.

The road lies ahead — if business will take it — and follow the example of many great leaders. Then the true definition of public relations — *better relations with the public* — will attain a new and wider meaning.

* * *

♦ "A view of life is forming that will include the industrial world among the finer arts of human service. But youth has not waited for philosophers to proclaim this; here as elsewhere life runs ahead of our philosophies, and youth with its unerring eye already has discovered this new heroic region. To youth the new race of Heroes belongs, because from youth it comes." — W. J. Cameron, Ford Motor Co



THE JOB BEGINS AT HOME

(Continued from Page 11)

community and the community has confidence in industry, how can the interests of either be fully served?

"Third: With good relations inside the plant, and good relations within the plant community, you have the base for good relations with the public outside. But you can never take those relations for granted. Living right is not enough. People must know us. Know our company. What we really want is good relations with many more people than would find out about us were we content to allow the deed to speak for itself without any aid in its wider projection.

"The art of public relations is in the art of multiplication—that is, the art of multiplying endlessly the good impressions of a company. It involves the honest but skillful employment of all the known media but, most important of all, a development of new approaches and a more advanced technique in their use than any we have as yet learned. The multiplier in public relations to work effectively must be a 1950 model.

"In conclusion let me say that none of these things are easy of accomplishment. But none of them are impossible of accomplishment. They will not even be very difficult, as events seem to be shaping now, once industry sets about its public relations with the same serious effort that in *cras* gone by it set about its financing, engineering, its production problems."

* * *

♦ *Good Employment Relations*, the second in the series of National Association of Manufacturers sound slide films included in the Management Policy Conference Service, brings employers the recommendations of 75 outstanding manufacturers and industrial relations experts, the N. A. M. Committee on Employment Relations. This brief summary of highlighted subjects illustrated on this page will be of interest (SEE ILLUSTRATIONS AT LEFT):

ANNOUNCER: "We offer, then, for your guidance these major factors in employment relations:

1. **WAGES.** "Remember, in the N.A.M. survey of employee attitude we found that 50% of them believe wage levels to be too low. Yes, wages are a vital factor."
2. **HOURS.** "And now we come to—Hours! Along with consideration of wages comes, naturally, hours. Here the Committee findings show that companies with the most satisfactory employee relations are those main-



HERE WORKERS IN A KANSAS INDUSTRIAL PLANT WATCH AN INDUSTRIAL RELATIONS FILM DURING A RECESS PERIOD. BRINGING THE STORY HOME TO YOUR OWN INDUSTRIAL COMMUNITY IN ONE OF THE REAL PROBLEMS OF PRESENT-DAY PUBLIC RELATIONS BEING SO SATISFACTORILY SOLVED WITH THE USE OF MOTION PICTURES AND SLIDE FILMS.

taining a general standard of working hours fully consistent with the welfare and health of employees . . . always keeping in mind the type of work, of course."

3. **WORKING CONDITIONS.** "Another factor, as important as wages and hours, is working conditions. A comprehensive study, devoted to this subject alone, is now occupying the attention of a new N.A.M. Committee on Healthful Working Conditions. Meanwhile the Employment Relations Committee report recommends the maintenance of good working conditions."
4. **GRIEVANCES.** "A big word in labor discussions today, but also a word which often breaks down to an accumulation of surprisingly trivial incidents."
5. **PROMOTIONS, TRANSFER, LAY-OFFS AND DISCHARGE.** "Build up versatility, flexibility and skill in the working force by encouraging transfer of employees between departments and by filling vacancies from within the organization wherever possible."

PUBLIC RELATIONS

INDUSTRY'S NO. 1 JOB

"Public relations, therefore, is not something that can be applied to a particular phase of a business—nor is it an umbrella covering everything but touching nothing. It is rather a fundamental attitude of mind—a philosophy of management—which deliberately and with enlightened selfishness places the broad interest of the customer first in every decision affecting the operation of the business."

"Public relations is not a specialized activity like production, engineering, finance, sales. It is rather something that cuts through all these as the theme for each. It is an operating philosophy that management must seek to apply in everything it does and says."

PAUL W. GARRETT

Director Public Relations, Gen. Motors Corp.

6. **ASSIGNMENT TO DIFFERENT RATED JOB.** "When an employee is transferred to a higher rated job, and fully qualifies, he should, get the established rate of pay for that job."

7. **HIRING.** "First of all, a new employee should be interviewed by one person or department charged with hiring responsibility . . . with final choice resting upon the department head under whom he is to work . . ."

8. **PROTECTION AGAINST RISKS.** "Cooperation with employees in making provision for needs arising out of death or old age and disability due to ill health or accidents."

9. **STABILIZING EMPLOYMENT AND EARNINGS.** "Management should make every effort to stabilize employment related to irregularity of work and in this connection should study the annual wages of employees in relation to their hourly earnings and the number of days per year the plant operates. Even seasonal industries often find it possible to extend employment over ordinarily inactive seasons . . ."

10. **PERSONNEL RECORDS.** "The Committee recommends keeping permanent employment records covering pay, work and conduct of all employees. In this connection the N.A.M. has prepared a booklet on the maintenance of proper employment records, copies of which may be had from the Association."

11. **AND FINALLY . . . COMMITMENTS. KEEPING FAITH WITH EMPLOYEES, IN BOTH LETTER AND SPIRIT.** "The committee feels that it is scarcely necessary to say that good business and fair play dictate the most scrupulous observance, in both letter and spirit, of all commitments by the company to its employees."

CASES IN PUBLIC RELATIONS

● The concensus of opinion among directors of public relations is that most educational film programs which take the public at large "behind the scenes" of their respective organizations are *more effective* and *less expensive* than other media simply because the realistic story can be faithfully enacted with the confusion of detail eliminated. Three typical programs are worthy of note.

◆ Weyerhaeuser's picture *Trees and Men* is representative of the type of public relations film which gives a broad, comprehensive treatment of an industrial subject suitable for showing to the general public. It illustrates the fact that while the motion picture medium is also being used extensively for subjects which are strictly limited in their appeal to a company's own employees or for special trade or dealer groups, the most effective function of the sound film is to present a generally informative and entertaining picture which will hold the interest of all classes of audiences and create good will toward an organization and its products.

Scenes for the picture were made after a detailed outline had been prepared in conference between the producer and officials of the Timber Company at its Tacoma headquarters. Selection of definite scenes to be photographed was done from the standpoint of illustrating the main

underlying theme of the subject rather than as an attempt to cover all of the many phases of the company's operations or products.

All of the picture and sound negative was produced in black and white on 35-millimeter film. When finally edited, the length was approximately 4,000 feet, running about forty-two minutes. A number of 35-millimeter size copies were used and then the bulk of the non-theatrical distribution was made with sound prints reduced to 16-millimeter size.

Following the release of the picture, a special ten-minute version was made, embodying the main idea of *Timber As a Crop*, this length being particularly suitable to show on regular theatre programs throughout the United States. In order to make this special version of the picture, a re-editing of the picture material was done, a different narration was written and timed to the picture, then recorded and blended with special musical score. To supply all forms of distribution, more than two hundred copies of the film have been issued to date.

HOUSEHOLD TEACHES THRIFT

◆ Advertising takes a back seat in the splendid public relations film programs of Household Finance Corporation, lender of small sums to American families in unexpected need. Thrift education, justified by the contention that the average family

needs budget advice as much as lending service, is the keynote of the films.

It is to reach the home executive, the American housewife, that Household employs films — both movie and slide. It is not to persuade her to borrow money, but to the contrary! Through these films she is told that she can avoid unnecessary debt if she *can* manage the family income — if she *can* recognize a bargain when she sees one — if she *can* learn to buy the necessities of life properly.

But there is no tug-of-war in the Corporation. As a matter of fact the helpful education in this constructive social policy is showing a splendid harvest in good will. Many hundreds of public and private schools and colleges are using consumer material in their class rooms or reference libraries. Hundreds of schools and women's groups are using both motion pictures and sound-slide films for inspiration and education.

Household was among the first of large corporations to establish a visual education department which devotes its entire time to the administration of film matters. Usually pictures and slide films are a side line for promotional, personnel, or advertising departments. Although only two and one-half years old, the department already has done a job which many a merchandise manufacturer would like to accomplish.

◆ A third facet in public relations is offered in the motion picture program of the National Association of Manufacturers. Four pictures featuring John S. Young and Lowell Thomas as commentators have been shown to an audience estimated at fifteen million people in thousands of theatres throughout the country. They have also been widely seen by school and groups. One of this series had its premiere at New York's Radio City Music Hall.



TOP LEFT: "MEN MAKE STEEL" IN THE CARNEGIE-ILLINOIS STEEL COMPANY'S PLANT WHILE THE TECHNICOLOR CAMERA FILMS THEIR TASKS. LEFT BELOW: Sound motion pictures are part of the National Association of Manufacturers program. Here is shown a typical scene.

TOP RIGHT: "TREES AND MEN" BRINGS HOME THE VIVID STORY OF TODAY'S LUMBER INDUSTRY FOR THE WEYERHAEUSER INTERESTS. BELOW: The American Association of Railroads has made good use of the sound slide film for public relations and employee education.

PRODUCTION ACKNOWLEDGMENTS APPEAR ON PAGE 33

A TYPICAL FILM STRIP FROM THE UNSELFISH EDUCATIONAL PROGRAM OFFERED HOUSEWIVES BY HOUSEHOLD FINANCE





Spirits run high in the Hot Stove League this season thanks to—

BASEBALL'S GOOD-WILL AMBASSADORS

• This is the fifth year in which the Fisher Body Division of the General Motors Corporation has sponsored the production of an official American League sound motion picture. Without cost or obligation to the audiences and *without advertising* these films have traveled the highways and byways of America to bring home to the public an appreciation of the great American game of baseball. Fifteen million fans have seen the pictures thus far.

At the rate of one hundred and fifty shows a day, serviced by the one hundred and fifty-five prints which are in circulation at the present time, fans are enjoying the latest edition of *First Century of Baseball* which observes the

centennial of the game with a historical story dating from the birth of baseball in 1839 to the present time.

Written and supervised by Lew Fonseca, Director of Promotion for the American League, these film "good-will ambassadors" are doing a great job, and not only for their sponsors and the game—for they inoculate all those who see them with a new spirit of fellowship! Talk to Lew Fonseca about this and you get an interesting slant on what these films have done to build the attendance of membership in clubs, lodges and other organizations who show the pictures. On the nights of these showings, membership rosters get a real boost and faces which haven't been seen for many a month are back once again for the night and perhaps for more of the comradeship which they thus suddenly regain.

"They're down the *other fellow's alley*", says Lew, "that's why the pictures are usually such naturals for any type of group-showing." Modestly, he refrains from mentioning the many showings which the sponsors have voluntarily given to inmates of institutions where the pictures have proven inspiring and regenerating. These despite the fact that there is scarcely ever an open date on the crowded schedule of club and lodge bookings.

The films are always shown without charge or obligation to the audience. They have been very successfully tied-up with promotional efforts by the sports departments of leading metropolitan newspapers. In Chicago, for example, the well-publicized feud between the National and American League baseball writers of the Chicago Daily News, resulted in a most interesting series of theatre showings at which the new National League picture, also recently produced, was screened at the same time. Here is an interesting side light on one of these sponsored showings:

"The American League's new baseball film had its public premiere today", says *The Chicago Daily News* of Dec. 27, "at the Sheridan Theater before more than 2,000 guests of 'The Voice from the Grandstand,' both major baseball leagues and Essaness theaters. This world premiere of *The First Century of Baseball* was held as the first part of the double feature which *The Daily News* sports department is

giving this week in three film theaters—the second feature being the National League's first film titled *Baseball*."

At the Byrd showing (in Chicago) Will J. Harridge, president of the American League, Lew Fonseca, director of *The First Century of Baseball*, and William McLean, executive of the Fisher Body Corporation which underwrote the film for the American organization, were present and introduced from the stage by John Carmichael, *Daily News* baseball writer.

The American League film dramatizes the historic angle with even more attention to the comic aspects of the game in the 1860's, 70's and 80's, when the catcher stood far behind the plate and the umpire, wearing a silk hat, occupied a chair on the line between home and first. It also shows in detail the invention of the curve ball by W. A. Cummings, and his discovery of the principle while watching billiard players put "English" on the ball with a cue.

Later on in the four-reel feature, the story of modern baseball is reenacted with scenes filmed at Chicago, Cleveland, New York, Philadelphia, Detroit and at the six Florida training camps. Baseball celebrities who appear in *First Century of Baseball* are Judge Kenesaw Mountain Landis; League President William Harridge; the late Col. Jacob Ruppert; Clark Griffith; Tom Yawkey; Walter O. Briggs; Connie Mack and, of course, all of the headline stars of the American League. Thrilling World Series action scenes are featured.

LEW FONSECA, DIRECTOR OF PROMOTION FOR THE AMERICAN LEAGUE, WROTE AND SUPERVISED THE LEAGUE'S LATEST OFFICIAL film "Century of Baseball" now being shown to millions of fans throughout the country.

(PRODUCTION ACKNOWLEDGEMENT ON PAGE 33)

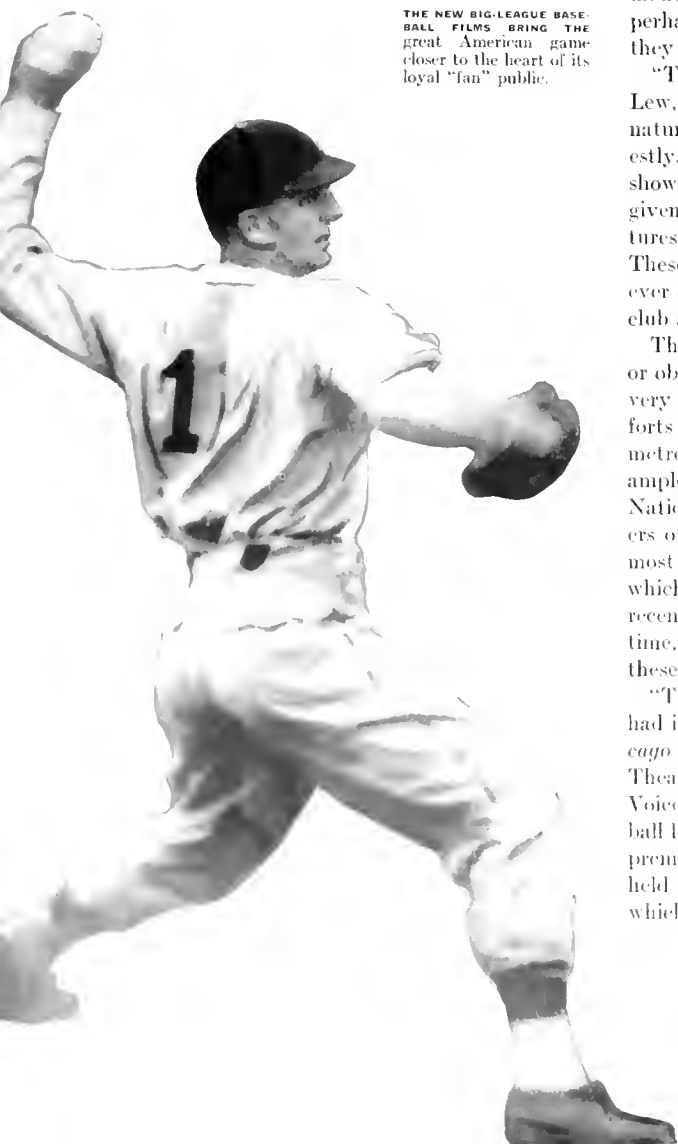

THE NEW BIG-LEAGUE BASEBALL FILMS BRING THE great American game closer to the heart of its loyal "fan" public.



NEW FILMS

• Football, baseball and New England travel are among the month's new pictures but it is the successful sales and dealer relations films which again confirm their claim to favored leadership.

Of these a notable example is the Bates Manufacturing Company's new sound motion picture *It's the Little Things that Count* in which Bates not only delivers to the office appliance salesman who will see the picture the advantages of its stapling machines and other products but manages to be thoroughly inspiring and genuinely helpful in general sales education.

The three-reeler was produced by Caravel Films, Inc., and features the appearance in a prologue of Charles P. Garvin, general manager of the National Stationers Association, and S. M. Babson, sales director of the Bates Company. A talented and experienced cast enact the sales story. First released to the trade in December, the film will be used by the Bates sales force (equipped with projectors) for exhibit before dealer groups.

♦ The Remington Arms Company decided to prepare a series of demonstration manuals on its line of fire-arms for the guidance of its own salesmen, and those of its jobbers. These manuals show how to take the gun apart step by step on the left hand pages, and what to say on the right. The purpose was to give the salesmen a demonstration pattern to follow in contacting firearms retailers.

The next problem was to get maximum use of the manuals and their contents among salesmen who for years have been selling guns without realizing the value of taking the gun apart, and putting it together again, showing how few parts there are, and that no tools are needed in the process. So Remington decided to produce a motion picture as a means of inspiring the men to its use as a sales procedure, to show how easy a demonstration is to make, with a little practice, to reveal its influence on the dealer to cause him to stock Remington products, and to indirectly show him how similar demonstrations on his part to his customers sell more guns.

West Coast Sound Studios, Inc., New York, were selected to write and produce a twenty five minute talking motion picture, *This Way*.

(Please turn to Page 38)



RECENT AND NOTEWORTHY FILM RELEASES

THE REMINGTON ARMS COMPANY presents *This Way Please* for its dealers and jobbers (top, left) and BATES MANUFACTURING COMPANY introduces to the screen in *It's the Little Things that Count*, two personalities of the office appliance industry, Charles P. Garvin, general manager of the NATIONAL STATIONERS ASSOCIATION and S. M. Babson, BATES' sales director (top, right). New England's travel industry gets strong support from its film *New England* (ship, center). GENERAL TIME sells the safety of a tire tread in the graphic presentation from its film (above, left). *Start the Music*, featuring Edgar Kennedy, is STANDARD OIL (of Indiana)'s latest film. CHIMAX MOLYBDEUM'S film has a historic angle (illustrated in part at the right). Below, THE AMERICAN ASSN. OF RAILROADS' sound slide film *Friendliness Too* is illustrated while at the bottom right, the NATL. FOOT-BALL LEAGUE'S picture *Champions of the Gridiron* is noted.

(PRODUCTION CREDITS ON PAGE 33)

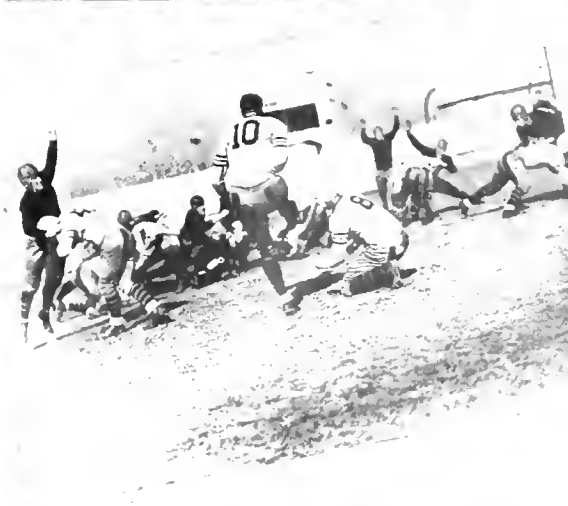

How Motion Pictures Move and Talk

ACKNOWLEDGMENTS
APPEAR ON PAGE 33

1. For a most noteworthy film feature, the editorial nod goes to this short subject originally prepared for purely educational distribution but worthy of this too-brief "screening" we present for our business readers.



2. Travel, adventure, education, and news appear in breath-taking succession on the screen. Here — a quick dissolve from the Hindenburg disaster to England's coronation.



3. The screen can teach the housewife how to buy and the salesman how to sell — to the betterment of both. Their education via the screen is deep-rooted and lasting as it gets results.



4. This same potent force brings home in living panorama the drama of geography, history, science and economics as visual education aids teachers in thousands of the nation's classrooms.

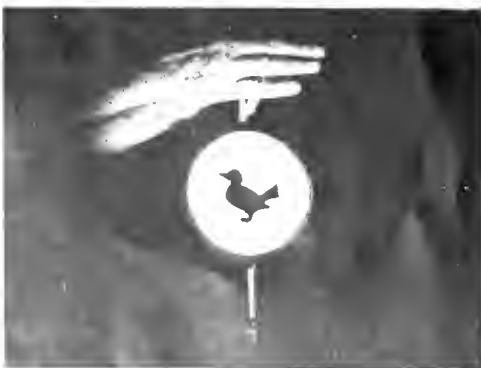

THE PICTURES MOVE

5. How motion pictures "move" — the illusion is based upon "persistence of vision" demonstrated by the Roget "top", which, when twirled rapidly, shows bird inside the now empty cage drawn on opposite side of card.



6. The principle is further explained by these successive paper pictures, flipped in rapid succession and applying motion to the old one-man projector, the Mutoscope.



7. The same method applied today by men who make animated cartoons. If sheets are flipped rapidly, the cartoon drawings appear to move.



8. In the modern projector, the succession of images is obtained mechanically — with incredible rapidity and acting precision.



9. The successive images are photographed in a professional camera: its fine high-powered lens is here focused by expert hands which will "shoot" the scene.

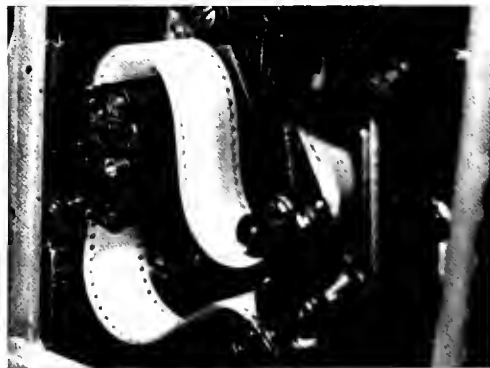

10. Inside the motion picture camera — the highly sensitized film moves with synthetic precision as the scene is photographed.



11. Accurate film movement depends upon its guiding perforations. These punches and die are finished to a precision of "plus or minus nothing".



12. The chemical development of exposed motion picture negative is explained in this "montage" of the dark room amateur's developing tray super-imposed on an intricate laboratory machine.



13. Metal walls vanish at will to reveal the photo-electric cell and amplifier tubes of the sound projector.



14. As the narrator (Alois Havrilla) explains how off-screen dialog is recorded, the actual "track" which reproduces the sound of his voice appears on the side of the screen.

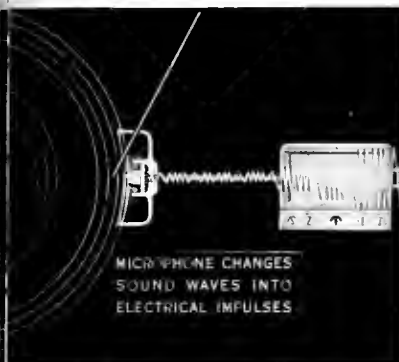

15. The mysterious invisible phenomena of sound recording are more clearly demonstrated by means of animation —

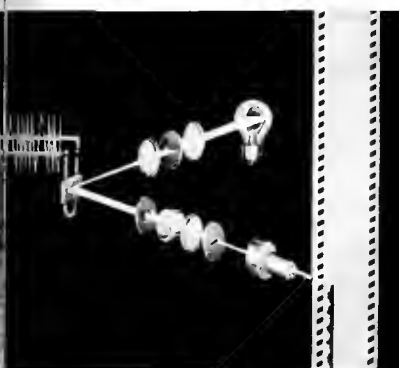

16. — here completed, when an electrically oscillated mirror changes a constant light beam into one that sweeps a sound pattern on a moving negative film.



17. In a studio, the "slapstick" marks a synchronization point on picture and sound track. Then follows the taking, developing, editing, and eventual presentation of the film production.



18. Finally—the identical production filmed in theatrical 35mm. size with its distribution prints reduced to 16mm. (two reels foreground) showing the advantages of less bulk, less weight, less cost, and freedom from fire hazard.

GENERAL ELECTRIC

A VISUAL PIONEER

• The first General Electric picture was made early in 1913. It was directed and edited by Mr. C. F. Bateholts, at one time a very active member of the organization; and it was shot by a cameraman recruited from the company's still photographic section. Using a Universal Camera, they made a pictorial record of the electrification of the Butte, Anaconda and Pacific Railroad. Processing of the negative and positives was done by the Edison Laboratories of East Orange, New Jersey.

About the same time, the old Essanay Company of Chicago produced a one-reeler to promote the sale of electrical appliances. The picture was well made and carried practically the same message that is in vogue today; namely, that the use of electrical appliances in the home makes for a healthier, happier and less costly mode of living. This film, however, was little used because its advertising was too direct for theatres, and the inconveniences of projection hindered the dealers in show room screenings.

In 1914, a picture showing the fabrication of Lynn Type motors was made as an engineering record. Six Bogue single arc broadsides furnished the interior illumination. The interested attention of several customers who saw this picture indicated that such apparatus films might be good publicity.

In the same year, a picture on the Panama Canal, much of whose electrical equipment General Electric furnished, was edited from a negative placed at the company's disposal by the government. Prints of this subject were screened before engineering societies throughout the United States and in many foreign countries. For the latter showings, versions were made with French, German and Spanish titles.

The use of motion pictures by industrial concerns was a unique undertaking and many people considered it a radical step. In General Electric's case, it was perhaps a natural continuance for Thomas Alva Edison had, among other items, not only developed the motion picture, but had been early associated with the activities of the company. Be that as it may, other people perceived that pictures of the right type could be used as a means of publicity and possibly as a more direct sales tool.

In 1917, *The Benefactor*, a three-reel portrayal of the life of Edison was shot in the Schenectady Works. A small room was converted into a studio; the ceiling was hung with banks of Cooper-Hewitts, and a few carbon arcs were placed along the walls; scenic reproductions of Edison's home and laboratory were constructed; professional actors were engaged. The picture received Mr. Edison's personal approval and was widely distributed and well received. Because it is the only authentic record of his early career and invention of the in- (please turn to page 42)



"REAL LIFE" PEOPLE can bring to the screen inspiring realism but this type of casting is the most difficult to direct.



HISTORICAL TYPES demand capable, professional actors who can hold the illusion. Here: Ben Franklin in *Selling America*.



"STAR" NAMES may be an asset for certain films but in most cases, are unnecessary for business audiences.



ACTOR TALENT From the ranks of type and bit players is the backbone of the "story" type film.



"EXPERT" PARTS are often drawn from employees in the laboratory and shop. They must be coached and most ably directed for results.

CASTING the CHARACTERS

• No article on the subject of selecting screen players should open with a mention of that former great American pastime—picking a heroine for *Gone With the Wind*. However, since all of us were wrong, this dire example may be a useful introduction. Unless, of course, you're still convinced that the boys were nuts and that Glenda Farrell was a cinch for the part.

The business of casting the sales training or advertising film offers several tough problems. Disaster has frequently overtaken executives who nipped otherwise promising film careers for their companies by appropriating this apparently alluring task as they began making that notable (and too often, painful) first film. Doakes, even as you and I, is a Lubitsch at heart and pretty soon he has forgotten dealers, jobbers, salesmen, home office and all. That is until they see the picture and someone asks what the hell was all that about especially the dizzy blond.

Honors go to a smart director when a truly believable, and inspiring business film unfolds a story that sends the sales curve zooming. If that story depends on a carefully constructed narrative, talented actors, wise in screen technique, will probably have a great deal to do with the punch and power of its message. Picking talent for the company's radio program is a cinch beside visualizing a typical organization character, understanding his technique and employing that ability to bring out a direct selling idea. It's a fairly easy job to buy the names you need for radio. A little luck and a lot of cash have worked miracles for many a sponsor. As one commercial film producer puts it:

"But, in motion pictures, unlike radio, you don't need names to attract your audience. In most instances, your audience is already established. Indeed, even if you can get first rank names (which you can't ordinarily because of contract restrictions) you wouldn't want them. Not only would they be prohibitive in cost but actually they would be quite likely to detract from the attention value of the picture. If that sounds paradoxical just set it down as one of the anomalies

of the industry — or better yet just try to imagine focusing your attention on the operation of the Little Giant can opener with Dorothy Lamour lurking in the background in a leopard skin.

"There are literally hundreds of actors in Hollywood who actually have greater ability (as actors) than the top-flight stars, yet who can be bought for a price well within a reasonable picture budget."

There is another side to the casting problem which is worthy of consideration. We sometimes disparage the simple form of industrial film as a "factory run-around" and are inclined to forget the audiences who will appreciate the honest and straightforward messages such films may bring them. This, again, gives rise to a consideration of the "documentary" treatment. The word is a misnomer applied more recently to government propaganda films both here and abroad. But the manner of its telling is important for it has the majesty of sincerity and the magic of high realism. Witness the commendable success of *The River in America*.

A point of view expressed by one of the ablest documentarians from Great Britain will be of value in understanding this "natural" technique:

"If we have individuals", says Paul Rotha* "let them be *typical* and let them be *real*. The documentary can have no use for the synthetic and fabulous caricatures that populate the ordinary storyfilm. There are hundreds of people in our everyday life that have never appeared on the screen. But before we can bring them into cinema, we must be prepared to go out and understand them. Our need is for characters who will be simply understood. They must be of the audience. We must go into the streets and homes and factories to meet them.

"The whole evil of the American star-system, which in its way is a kind of typage, is that it treats with types of a false economic and solical superiority. The star, for political and social reasons already explained, is nearly always an inaccessible creature living on a scale unobtainable by members of the audience."

* "Documentary Film" by Paul Rotha, 1937

TRAINING SALESMEN

THROUGH TALKING MOTION PICTURES

featuring

RICHARD C. BORDEN and ALVIN C. BUSSE

ELMER WHEELER

BENJAMIN FRANKLIN BILLS

ROBERT H. NUTT



DISTRIBUTED NATIONALLY THROUGH KEY CITIES BY
MODERN TALKING PICTURE SERVICE



IT TAKES SALESMEN TO SELL TODAY

THE pre-war salesman knew his job. But his job was easy. Equipped with a pocket full of cigars, some good stories, a ready smile, hearty laugh, a handshake that oozed friendliness, and some reasonably presentable samples, and the order was his.

Today salesmanship is a combination of science, art and engineering. MODERN TALKING PICTURE SERVICE KNOWS THAT TO BE THE CASE, because MODERN TALKING PICTURE SERVICE is a *sales-service*. For that reason we have incorporated with our nation-wide distribution of talking motion pictures designed to sell the consumer, a service devoted to training the salesman.

This syndicated service which provides business with tested sales instruction methods covering every phase of selling can be secured on a very modest rental plan.

Our Sales Training films present in work and picture every type of selling, from behind the counter where the sum involved may be the price of a pair of stockings or a shirt, to the sales approach and completion where the negotiations may involve an exchange of thousands of dollars.

These Sales Training films have been created by specialists who are the acknowledged masters of the science of selling and who have trained hundreds of men and women in salesmanship which *sells*.

Many of the country's largest, best known and most successful corporations and commercial institutions have had repeated showings of these films. They have been seen and recommended by business executives; by sales managers; by salesmen; and by those who have been receiving their first lessons in this most important of all the departments of business.

YOU WILL FIND ON THE FOLLOWING PAGES THE FACTS YOU NEED FOR SELECTING THE PARTICULAR SALES TRAINING FILMS BEST SUITED TO YOUR OWN PARTICULAR SALES PROBLEMS.

Among the hundreds of organizations which have used MODERN TALKING PICTURE SERVICE'S Syndicated Sales Training Talking Pictures are: Aetna Casualty and Surety Co.;

Bell Telephone Co. of New Jersey; Coca Cola Co.; Graybar Electric Co.; Hamilton Watch Co.; Libby McNeill & Libby; Pacific Gas & Electric Co.



RICHARD C.
BORDEN

formerly Professor of marketing at New York University, is Sales Executive with one of the country's largest organizations, consultant for a number of other companies and author of "Public Speaking as Listeners Like It" (Harper & Bros., New York); "How to Make a Sales Point Hit" (Prentice-Hall, Inc., New York); "How to Deliver a Sales Presentation" (Harper & Bros., New York).

ALVIN C.
BUSSE

is the Professor of Public Speaking at New York University, where he employs the years of sales research he and Mr. Borden have so successfully carried out in making his course of instruction practical. He is also co-author with Mr. Borden of that most successful book on selling, published by Harper & Bros., New York, entitled: "How to Win a Sales Argument".



YOU AND I WILL NEVER KNOW

just what might have happened had Messrs. Borden and Busse conducted the negotiations which Peter Minuit carried out in 1626 when he purchased Manhattan Island from the Indians for \$24. Whether or not Borden and Busse could have persuaded the Indians to throw in Staten Island, or reduce the cash outlay to \$19.99 must ever remain a mystery.

But as master salesmen, in this age when real salesmanship has come to be recognized as the first principle of success, Borden and Busse hold an unique position which they have gained by right of achievement.

Consider these Borden and Busse Sales Training films MODERN TALKING PICTURE SERVICE offers you on a modest rental basis:



← HOW TO MAKE A SALES PRESENTATION STAY PRESENTED

Here your sales force, and all those involved in any contacts with customers, will be given thirty minutes of intensive instruction in the fundamentals of true salesmanship. From gaining the attention of the prospect, to arousing his interest, to convincing him of the worth of your proposition, to making him see his need for your product; this dramatic film charts the course of a successful sale; and analyses the steps which make it successful. Produced by Sound Pictures Corp., Cleveland, Ohio.



HOW TO WIN A SALES ARGUMENT →

For thirty minutes Borden and Busse act out for you a technique for overcoming the obstacles which lie in the path to an order. For veteran salesman and latest recruit, there are selling lessons in this film of such inspirational value as to make them want to "go forth to conquer" the toughest prospect your company ever tried to sell. Whatever your product and whatever your sales problems, this convincing, instructive picture will prove a profitable investment. Produced by Tri-State Productions, Cleveland, Ohio.





ELMER WHEELER, President, Tested Selling Institute; author of the record breaking best seller, "Tested Sentences that Sell", (Prentice-Hall, Inc., New York) has been described as "the most interesting man in America today"; and is credited with having had such an influence over selling and sales management as to have changed the marketing methods of this country.



WHEN MODERN TALKING PICTURE SERVICE introduced this country to Elmer Wheeler's dynamic talking picture, "WORD MAGIC" it broadcast a revolutionary sales training force.

"WORD MAGIC" is a Sales Training film built to meet conditions today. It throws overboard the old-time easy-going rules for "how to make a sale" and teaches the salesman how to get results in a 10-second talk. It makes it invaluable to the "Over the Counter" salesman. **"WORD MAGIC"** inspires sales people, from the timid little girl behind the ribbon counter to the "Chairman of the Board" when he's out to close a million dollar deal.

No one can resist the *word magic* of this inspired sales demonstration. Produced by Industrafilm, Inc., Hollywood & New York.



HOW TO REMEMBER NAMES AND

After Robert H. Nutt, "America's Foremost Memory Expert" had given his famous lectures on memory training to such distinguished audiences as the members of the New York Stock Exchange, executives of Firestone Tire, Reynolds Tobacco, Coca Cola and other great industrialists, Borden and Busse joined with him in making this film on remembering names and faces. "The most important word in the whole dictionary of selling is not price but the name of the man you want to sell" said Richard C. Borden; and this picture *does* teach you how to remember names and faces. Produced by Luther Reed, New York City.



BENJAMIN FRANKLIN BILLS, Ph. B., J. D. Author of "Persuasion in Business" (The Gilbert Publishers, Chicago); is Chairman, The Bills Corporations; President, Incomes Properties, Inc.; Member of Chicago Bar; Special Lecturer in Salesmanship, Northwestern University; Dean of Brokerage Courses, National Association of Real Estate Boards.



"PERSUASION MAKES THE WORLD GO 'ROUND'" is more than a Sales Training Picture. It is, first, a serious analysis of the five steps a buyer's mind takes, before buying. From this foundation, the picture demonstrates the five complementary steps which must be taken to synchronize the sales approach with the buyer's interest. It is especially valuable for salesmen whose orders are received after a period of negotiations.

This picture illustrates the method to follow to prevent a prospect from saying "no" until he is ready to say "yes". The logical, convincing character of this talking picture makes it an impressive demonstration of the art of modern selling raised to its highest position. Produced by Tri-State Productions, Cleveland, Ohio.



FACES



This film actually proves to the members of the audience that these principles really work for them.



THE ART OF SELLING



AS SELLING IS THE FIRST PRINCIPLE GOVERNING ALL human actions it is obvious that success, *in anything*, depends upon selling ability. **THE ART OF SELLING** is a dramatic presentation of sales methods applied to the specific field of retailing. It trains sales people, through right and wrong examples, how to be successful in over-the-counter selling. Produced by Loucks & Norling, New York City, in cooperation with R. H. Macy & Co.



“BEWARE OF MENTAL-ITIS”

is a Will Rogers type of presentation of criticism which makes you “take it and like it”. Homely humor, chuck full of sound sense, joking us out of ruts and sharpening our wits.

“Doc” McIntire brushes the cobwebs off your brain, polishes up your thinking, and kindles your enthusiasm in “Beware of Mental-itis”. This picture works on the mental attitude of the salesman toward his job. Produced by The Calvin Company, Kansas City, Missouri.



HOW TO MAKE A SALES POINT HIT

This thirty-minute sound slide film illustrates six fundamental methods for giving a selling point its greatest value. This visual demonstration applies each of these six basic principles to *every* major field of selling.



HOW TO DELIVER A SALES PRESENTATION

For thirty minutes this sound slide film illustrates the tested principles which make for successful public speaking — facts every salesman today needs to *know* and *use*.



HOW TO SUPERVISE SALESMEN

Here's a sound slide film which, in a brief fifteen minutes, presents the eight established methods for handling salesmen which convert a sales manager from a driver to a leader.

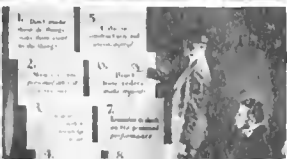

DO YOU WANT TO IMPROVE YOUR INTER-FACTORY RELATIONS, INCREASE OUTPUT, DECREASE COSTS, INCREASE SAFETY, DECREASE WASTE, INCREASE PROFITS?

MODERN TALKING PICTURE SERVICE offers you the answer to each of the above questions, if YOUR answer is "YES".

The answer is contained in Charlton MacVeagh's six sound slide films designed for use in connection with six Foreman Conferences.

MacVeagh created the scenes in these remarkable sound pictures from actual experiences and the scenes were taken in actual factories.

Such great American Industries as the Johns-Manville Corporation, Revere Copper & Brass Inc., International Business Machines Corporation and Wagner Baking Corporation have used and indorsed these films.

These are more than talking slide films. They are human documents especially designed for use in connection with a highly developed course which has repeatedly demonstrated its ability to guide foremen in all their dealings with workmen and so to develop teamwork which brings better conditions and better times for all, from apprentice to Chairman of the Board.

MODERN TALKING PICTURE SERVICE has a local unit near you. Let us discuss this course with you and show you some of these convincing pictures. A demonstration will gladly be given without any obligation or cost.

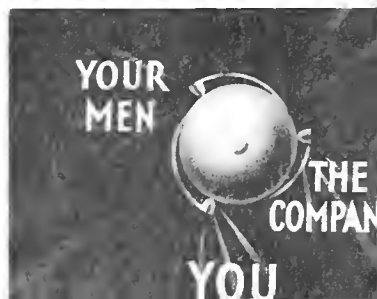
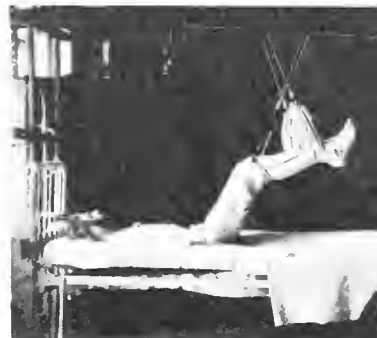

To Obtain Any Of The Programs Shown Here Consult MODERN TALKING PICTURE SERVICE In Any Of The Following Cities:

Albany, N. Y. Alb. 2-4835 114 Winthrop Ave.	Milwaukee, Wis. Mar. 7680 844 N. Plankinton Avenue
Atlanta, Ga. Wal. 5160 133 Peachtree Arcade	Minneapolis, Minn. Ken. 8670 2825 Hennepin Avenue, S.
Baltimore, Md. Lib. 1740 2114 E. Fayette Street	Newark, N. J. Mit. 2-5080 24 Commerce Street
Bethlehem, Pa. 972 509 West Broad Street	New Haven, Conn. 6-5125 Hotel Bishop
Boston, Mass. Bel. 1255 40 Hawthorne St., Belmont	New Orleans, La. Mag. 1948 218 S. Liberty Street
Buffalo, N. Y. Lin. 7224 79 Allen Street	New York, N. Y. Lex. 2-9850 203 East 26th Street
Charlotte, N. C. 5400 218 West Fourth Street	Oklahoma City, Okla. 7-2775 1706 N. Broadway
Chicago, Ill. Har. 1508 28 East Eighth Street	Omaha, Neb. Atl. 8477 1219 Farnam Street
Cincinnati, O. Main 4122 1021 Main Street	Philadelphia, Pa. Gra. 0150 4729 Ludlow Street
Cleveland, O. Main 6247 728 Film Building	Pittsburgh, Pa. Cou. 4000 42 Water Street
Columbus, O. Uni. 1419 1360 Hunter Avenue	Portland, Ore. Bea. 6181 504 Labor Temple
Dallas, Tex. 3-8131 4145 Commerce Street	Providence, R. I. Ga. 7256 95 Empire Street
Denver, Col. Tab. 0209 310 Fifteenth Street	Rochester, N. Y. Sto. 1245 6 George Street
Des Moines, Iowa. 4-8522 506 Youngerman Building	St. Louis, Mo. Cen. 1655 1531 Branch Street
Detroit, Mich. Fit. 4700 7629 E. Jefferson Avenue	St. Petersburg, Fla. 40-382 2727 13th Street, N.
Houston, Tex. Jac. 2-4078 3105 Louisiana Street	Salt Lake City, Utah. Was. 8248 35 Post Office Place
Indianapolis, Ind. Ril. 5805 615 N. Illinois Street	San Francisco, Calif. Mar. 7421 1050 Howard Street
Kansas City, Mo. Vic. 4658 Ozark Building	Seattle, Wash. Sen. 1611 Skinner Building
Los Angeles, Calif. Rep. 3187 1963 S. Vermont Avenue	Spokane, Wash. 1020 W. Riverside Avenue
Louisville, Ky. Jac. 1413 715 South Seventh Street	Springfield, Mass. 3-2932 334 Worthington Street
Lynchburg, Va. 250 407 Medical Arts Building	Toledo, O. Maine 7103 1825 Collingwood Boulevard
Memphis, Tenn. 8-3637 201 McCall Building	Washington, D. C. Dis. 3093 302 Homer Building
Youngstown, O. 76774 177 Benita Avenue	

IN ALL OF THE ABOVE CITIES MODERN HAS
FACILITIES FOR PROJECTING *YOUR OWN FILMS*



MODERN TALKING PICTURE SERVICE, INC., 9 ROCKEFELLER PLAZA, NEW YORK

Local units in 46 key cities

• "Each showing I have thus far made has been responsible for the sale of one or more batteries . . ." said one of our District Salesmanagers.

Another, using our films in cooperation with an industrial truck manufacturer's representative, demonstrated the applicability of a certain type of material handling unit to a given range of tasks in the plant of a prominent manufacturing company. The value of the resulting sales of equipment to this one firm in the brief period of one year was \$304,966. Nice going — eh?

Some other comments, recently received from other districts . . . "Our films have broken down resistances of long standing among competitive users . . ."

"The pictures help our sales picture when used just as business, under the fire of keen competition, is about to be closed . . ."

Briefly, our advertising activity on industrial storage batteries is directed to three groups: (1) electrical or other operation departments who originate requisitions for batteries; (2) purchasing departments; (3) officials whose approval is necessary on expenditures.

To reach the men in the first and second groups described, in addition to our films, we employ a house publication, a schedule of trade publication advertising and the use of two major business papers. Careful checking of results indicates that we have gained by this formula a reasonably thorough coverage in fields where our interests lie.

To reach the men in the third group, in which we find executives the average salesman cannot reach, we have used the business papers, a special direct mail formula and, more recently, our sound motion pictures.

These films, with each district office set up for exhibiting, enable us to localize our program with our objective not only the technical men, who customarily initiate requisitions for such equipment as we sell, but also the officials higher up who control the tension on the purse strings of our customer and prospect companies.

When we switched to sound motion pictures, having already been users of silent pictures for many years, we established a training school. Each District Salesman came into Orange and was given a thorough course in showmanship. Each office was equipped with fully portable 16mm. sound motion picture projectors, screen and all the necessary accessories. Our productions are all made 35mm., but exhibition prints are 16mm.

When the District Salesman returned, he imparted his newly acquired training to his own district organization. From Orange there followed a supplementary correspondence course in showmanship. This comprised the mailing of three instruction bulletins and periodically mailed additional data, all of which were specially written for our Film Activity by its director.

In preparing this material, we had first re-



Hardly Hollywood—but Highly Profitable

By JOHN A. COAKLEY, Advertising Manager, Thomas A. Edison, Inc.

viewed similar data issued for the training of the sales organization of large users of films. Some of this we adapted for our needs, then refined the resulting text to the point where we had it in the form of a simple and easily applied technique for sales showmanship. It was necessary to plan many new presentation techniques as the available material did not, by any means, match our need.

♦ In order to match top official against top official, we had the good fortune to be aided by a willing and hard working vice president of Thomas A. Edison, Incorporated, who tirelessly covered every territory in the country where business is controlled by large corporations. In these large customer and prospect companies a manifold sales problem existed.

For example, among the groups influencing the selection of air-conditioning equipment by a railroad are: electrical engineers, mechanical engineers, superintendents of motive power, passenger traffic managers, purchasing agents, car shop foremen, financial vice presidents and, in many instances, the president himself.

Our plan developed as follows. Our vice president invited the president of the road to bring his official family to a showing of a newly produced Edison film dealing with the subject of railway train car air-conditioning. The showing would invariably be held in a hotel room and usually would follow a luncheon or dinner. The film told the story concisely. It interested the audiences not only because the film was colored with railroading background to such an extent that it could not help but appeal to the men assembled for the showing, but also because the device was new enough to gain interest for the subject automatically.

Some of the reports dealing with such showings are pertinent in this review of our Film Activity. At one of these showings a certain influential person present was known to be prej-

udiced, at least to a degree against our offering. He would not listen to our men long enough for us to attempt to break down his objections to our product. He did, however, sit through the showing of our film, and this film was probably more of a revelation to this man on the subject of batteries in general than anything to which he had ever before been exposed. The discussion which followed served to bring out his views, clarified many of the points upon which he had doubts, cleared these up; in this discussion most of the operating officials joined.

One prominent prospect road asked to have the film shown to all of their operating men in their own auditorium.

A point that has often been made in reports covering film showings is that operating men in each instance at the showing of the films to large company groups expressed pleasure that their superior officials had also seen the picture. In many instances these men had had no little difficulty in selling their superiors on the desirability of making, what they easily recognized to be a wise investment and a longer-lived product.

Another comment from one of our salesmen in a report covering certain showings read as follows: "The effect that struck me as being most striking was the fact on subsequent occasions they made frequent reference to the Edison Battery and its advantages as voiced and shown by the film in the course of their conversations with various other people."

Let it suffice to say that in many instances, results were that the topmost officials relaxed their hold on the purse strings and made wise investments. That many of them, in this year of curtailment of expenditures, are doubtless thanking their good fortune for having done so is a certainty.

♦ In other articles so much has been written about production that I have not thought to re-

(Continued on next page)

ADD ENTERTAINMENT TO YOUR FILM PROGRAM



(Continued from Page 27)

view at any great length our production procedure in this story of our experience with industrial films. We have used the best producers and also those who produce a film of fair quality for a moderate price. We are confident that we have each time received just about what we have paid for, looking upon the work from a purely mechanical viewpoint. Also, we have undertaken our own productions and suffered the resultant headaches with the realization that the experience was undoubtedly extremely good for us. I can testify that these experiences were interesting and the yield was also satisfactory. In each case where we acted as our own producers, there were circumstances which mitigated against our using one of the established producing firms.

Today our production plan is pretty tightly organized. We have a contract arrangement with a good producer to do our requirements in films for this year. Much of the writing is being done in our own department as has generally been the case. At the outset, our advertising agency lent us their heartiest cooperation in the establishment of our program, and we leaned upon their experiences with visual sales devices to make sure that we made no major mistakes.

They emphasized that the important point in connection with the utilization of industrial films is that films are no good at all *unless they are properly put to work* — unless your market can be exposed to the sales messages which they present. And to get films out and get them working needs the whole-hearted cooperation of every man in your sales organization.

It needs, too, the burning enthusiasm of a genuine sales ensader. We were fortunate in having such a person. He is George E. Stringfellow, Vice President and Division Manager of the Edison Storage Battery Division of Thomas A. Edison, Inc. His enthusiasm for our Film Activity is at least partially explained by this statement which he has made: "*If I were to estimate the value of the film program to us, I believe I would be extremely conservative in stating it to be not less than half a million dollars.*"

Its cost to date has been little more than a tenth of that sum.

• The primary function of every good business film is to *sell something* but a measure of entertainment may sometimes be a very important factor in the successful reception of your sales story by the public or your own employees. A straight barrage of sales training or sales promotion may be somewhat heavy fare for the average individual but the appetite may be whetted and the digestion improved by the judicious employment of straight-forward entertainment if your film does not already possess some of this element.

The facilities of many fine libraries are available for this purpose and many of these are located in your city. The local camera store is also a potential source of film program material for in almost any sized town, you can find the national distributed reels of Castle Films Home Movie library. Some business organizations have already successfully adapted these short subjects to their programs; others have preferred to make special subjects of their own which tie up with the company's promotional plans. Houshold Finance Corporation is one of these latter and Alka-Seltzer has also recently incorporated its radio stars into an otherwise purely promotional dealer film for the drug trade.

Choice of subject matter is important for the film used must maintain the quality of excellence which the accompanying program has set for it. The nature of the subject matter is also important and non-controversial subjects such as travelogues, sport-reels and the like, may be preferable to reels showing news events and other matters of a debatable nature. Here are a few subjects being offered to national dealer distribution.

Everyone looks forward to attending an opening and especially to the premiere of two mammoth World's Fairs. The *Preview of the World Fair* offers a complete advance viewing of both the New York and San Francisco Expositions — the first glamorous pictorial record of the Fairs which next year will capture the attention and interest of millions from everywhere.

In *Baseball* — 1938, Castle Films cameras bring completeness of pictorial coverage in this

baseball review. The stars of the season — the notable games — and for a finale — the classic of them all — the World's Series show.

The *Castle See* subjects bring an ultra modern, fast-action picture review. *See* presents rare pictures — a mirror of unusual movies from all quarters of the globe. *Super-Tanks in Action* — amazing exhibition of American and French mechanical monsters . . . *Monkey Business* — a boxful of monkeys, a barrel of fun . . . *Chimpanzee Aristocrats* — almost human primate performs . . . *Motorless Flyers* — intrepid glider pilots soar from loft mountain tops . . . *Laughing at Fate* — airplanes crash into houses. And the thrill of thrills . . . *Human Cannon Balls* — first one daredevil is blown skyward, then two are exploded from mouth of Big Bertha.

The "big plays" of the season's gridiron classics . . . hundreds of thousands of fans pay millions of dollars to attend the nation's football events. This Sports Parade brings a permanent record of Football's outstanding plays in the 1938 season — the games that set the pace for the season — and all in one terrific action reel.

Hawaii — *Land of Enchantment* is a mirror Adventure, Romance and the Lure of the Tropics — action shots of the thundering volcano — marine shots — the Native Hula . . . and for a finale, the fastest movie of surf boat riding ever screened.

As already stated, the measure of entertainment used on the film program should be carefully programmed so that the main sales objective of the film and its educational purposes are not defeated by an over-abundance of unrelated subject matter. What frequently happens is that the entertainment is remembered and the sales message forgotten.

But let the martial music of an American Legion parade or the stirring college anthems of a football review light up your screen with a new vitality which will put the audience on its toes and thereby insure a better reception for the rest of the program!

"SNOW THRILLS" ONE OF THE LATEST OF THE CASTLE SHORT SUBJECTS IS ILLUSTRATED IN THE TWO SCENES SHOWN ON THIS PAGE. This and others are available in both sound and silent versions from your local dealer.



MOMENTUM...

... "THE FORCE OF MOTION ACQUIRED BY MOVING OBJECTS."
—WEBSTER

APPLY THIS GREAT FORCE TO *Sales...*

It takes ACTION to overcome the inertia of sales resistance.

Motion pictures, cleverly and carefully planned, supply this power . . . awaken prospect interest, help the salesman out of the doldrums of customer reticence.

May we suggest ways . . . Our Industrial Service Department specializes in planning films that add real momentum to sales efforts. Write us about your present or future film problems — and don't forget, when writing, to ask for information on our complete line of projectors and cameras for industrial use — some radically reduced in cost.

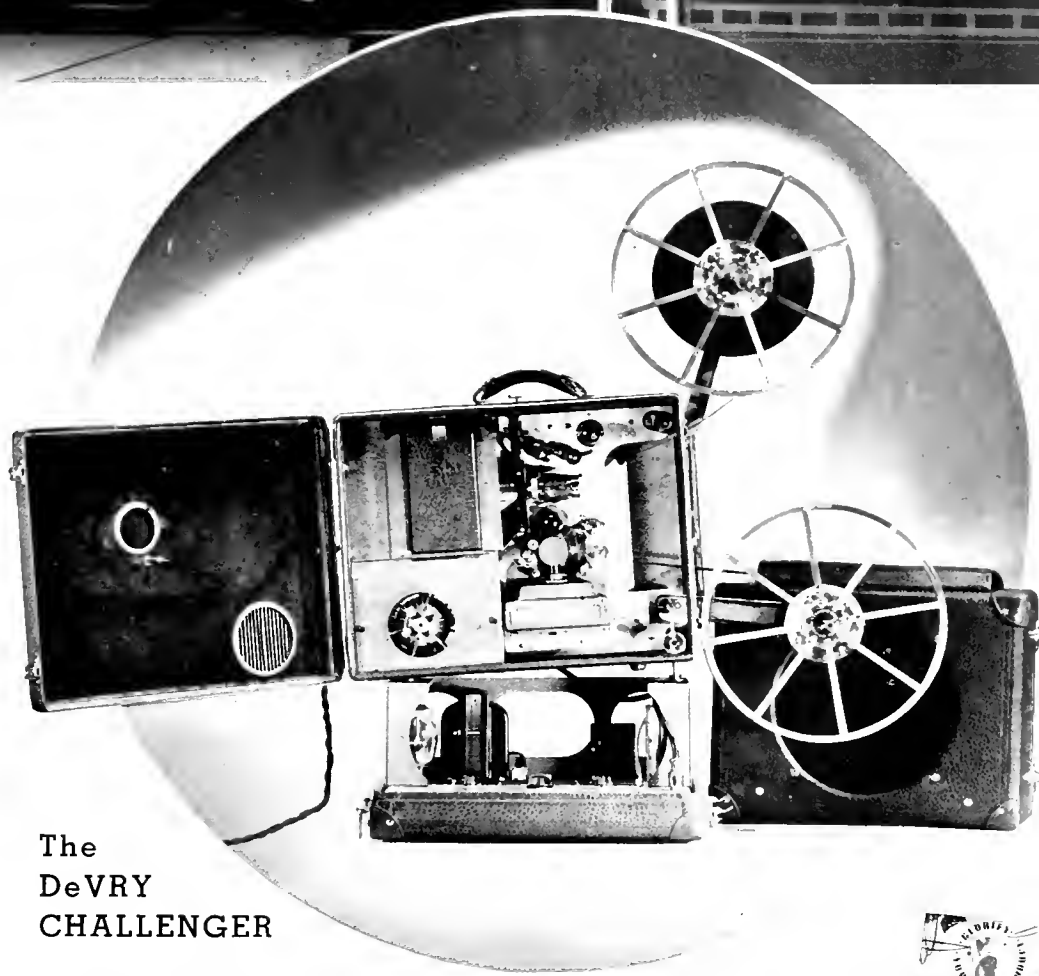

The DeVRY CHALLENGER

Above The projector of tomorrow! DeVry Challenger 16mm. sound projector . . . New "Film-glide" adds years of life to your film. Other new features include synchromatic threading and dual sound stabilizer. Send for complete data.

SEND FOR THIS BOOKLET: "Glorify Your Product" now in its third printing, has helped many organizations to modernize their film plans. Free for the asking



Estab. 1913

DeVRY CORPORATION
1111 ARMITAGE AVE. CHICAGO, ILLINOIS
• NEW YORK • CHICAGO • HOLLYWOOD

VICTOR REFUSED to "Let well enough alone"



So, THE WORLD'S MOST WIDELY USED 16 MM SOUND PROJECTOR GETS A New, Super Endurance *Mechanism!

ANIMATOPHONE Leadership dates from almost the very beginning of 16 mm. sound. Continuation of that leadership has been made secure, for LOOKING AHEAD, Victor has created for TODAY'S 16mm. PROJECTOR USERS a Super-Endurance *Mechanism that anticipates the performance demands of the future!

Not only does this epoch-making advance in mechanism design provide definite assurance of UNPRECEDENTED PERFORMANCE, but it dwarfs service and parts-replacement problems to a mere nothing! A five year study of servicing records and user reports . . . on machines definitely known to have seen greater than average use . . . served as the guiding influence in the creation of this new Master *Mechanism.

**New EFFICIENCY — Greater ENDURANCE
to MORE than meet modern-user needs
for heavier duty Projection Equipment!**

• • •

**Just a few of the highlights of VICTOR'S
new SUPER ENDURANCE MECHANISM are:**

FEWER MOVING PARTS . . . "STRIP-PROOF" GEARS . . .
LIFE-TIME BEARINGS that need NO OILING . . . 300 PER-
CENT STRONGER CAM-ASSEMBLY . . . NO FLICKER even
at sub-normal speeds . . . INCREASED FLATNESS OF FIELD
without loss of light . . . INCREASED SMOOTHNESS and
CLARITY in sound reproduction due to improvements in Filter
and Optics.

So . . . UP goes the efficiency curve and DOWN goes the up-
keep cost — if you choose the *new* ANIMATOPHONE . . . priced
at \$275 up! Demonstrations, without obligation, gladly arranged.
Write today!

* Available now in the New, Improved Model 33
31 and 36 Animatophones. Soon available in all
Animatophones and VICTOR Silent Projectors.



VICTOR ANIMATOGRAPH CORPORATION
DAVENPORT, IOWA
Chicago Los Angeles New York

ANIMATOPHONE 16mm SOUND PROJECTORS

PERSONALITIES in the NEWS

♦ Recent release of the official AMERICAN LEAGUE sound motion picture sponsored by the FISHER BODY DIVISION of GENERAL MOTORS was observed by the attendance at several premieres of Mr. William S. (Bill) McLean, Fisher's advertising manager and American League officials, including President William Harridge, and Director of Promotion Lew Fonseca. In Chicago, theatre ceremonies sponsored by THE CHICAGO DAILY NEWS brought sport editor Lloyd Lewis and baseball writer John Carmichael into the spotlight.

♦ Clinton F. Ivins, well-known in the industrial and commercial field, has joined AUDIO PRODUCTIONS, INC., in an executive capacity, according to an announcement made by Frank K. Speidell, president. Mr. Ivins has been vice-president of the PATHESCOPE COMPANY of AMERICA and associated with that concern through the past eighteen years. He assumed his new duties at Audio's Long Island studio headquarters as of January 1st, 1939.

Mr. Ivins is one of the pioneers in commercial film activities and has been active in organizing this branch of the industry for more than 15 years. He has served as chairman of the motion picture committee of the National Industrial Association and has been secretary-treasurer of the Eastern Association of Non-Theatrical Film Producers, Inc., since its inception. He is an active member of the Sales Executives Club of New York and was formerly president of the Princeton Engineering Association.

MR. CLINTON F. IVINS WHO HAS JOINED THE EXECUTIVE STAFF OF AUDIO PRODUCTIONS, INC.



MR. WILLIAM S. McLEAN, FISHER ADVERTISING EXECUTIVE AND PRESIDENT WILLIAM HARRIDGE of the American League talk over the feature movie "First Century of Baseball".

♦ J. H. McNabb, president of BELL & HOWELL, announces that the employees of this Chicago motion picture equipment manufacturing firm have accepted a comprehensive new plan of cooperative group insurance which includes not only life and permanent total disability insurance, but also accident and health benefits, and indemnity for hospital confinement and surgical operations. The new plan replaces a group life insurance plan which the company has carried for more than 12 years. Involving over \$2,000,000 for some 1100 employees in the Chicago and domestic branch offices, the entire new plan is underwritten by the Travelers Insurance Company of Hartford, Connecticut.

♦ Stanley W. Williamson who until recently was assistant head of the retail training department of the Jam Handy organization, has been appointed to the company's New York City executive contact staff in charge of retail sales training meetings for manufacturers using slidefilms, according to Jami-son Handy, president.



• Lower prices in the sound projector field feature the news of the month in business film equipment. Quality standards have been zealously maintained by all the first-line equipment makers but an economical schedule of prices has been achieved which will benefit concerns now outfitting their salesmen and other representatives with necessary equipment.

NEW DUFAYCOLOR SETUP

♦ Control of DUFAYCOLOR, Inc., has now passed from English to American hands and an exclusively American management has taken over operation of the company, according to a recent statement issued to *Business Screen* by *Pierpont M. Hamilton*, president of the new company, Dufaycolor Company, Inc., with offices at 30 Rockefeller Plaza, New York. The DUFAYCOLOR film was developed in England and introduced in this country several years ago under English auspices.

"The efforts of the new management will be intensively directed

toward supplying color film of high quality at the lowest possible cost, for both amateur and professional use, thereby promoting the widest possible use of color photography," Hamilton stated. "Our film can now be developed by anyone and we have recently introduced to the amateur simplified means of making color prints. It is our aim further to simplify these operations and reduce the present cost of prints and enlargements, both amateur and commercial.

"The new management also contemplates making DUFAYCOLOR immediately available to the motion picture industry. In this field, DUFAYCOLOR film makes it possible to take pictures in full color, using present standard equipment, the studio shooting the picture with a single strip of negative in its own cameras and doing its own processing and printing, thus making it possible to see 'rushes' as quickly as in black and white."

ELECTROL POPULAR

♦ The finest commercial screen now available is Da-Lite's new *Electrol*, an automatic remote-controlled glass-beaded screen which merits the finest business theatre setup. Its advantages, aside from the motor drive feature, are typical of Da-Lite Screens for it offers compactness, light weight, simplicity of operation and durability.

★
THE NEW AMPRO SOUND MODEL "X" ESPECIALLY DEVELOPED for industrial film users to sell at only \$275.00 and including 750-1000 watt illumination. This is "one-case" unit.

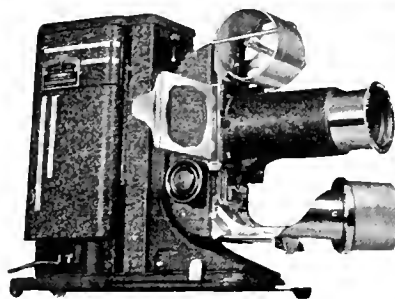

NOW AVAILABLE FOR LARGER BUSINESS AUDIENCES IS THE NEW TRI-PURPOSE 300 WATT MODEL AA S. V. E. SLIDE PROJECTOR with the new S. V. E. rewind takeup. Priced at \$57.50, complete with lamp, lens, double slide carrier, rewind and leatherette carrying case.

♦ NATIONAL MOTION PICTURE SERVICE of 236 West 55th St., New York, handles motion picture releases of the Grace Line and the Bermuda Line. These films depict South American travel.

PLANTER'S ANIMATION

♦ NEWEST PRODUCTION from the TED ESHBAUGH Organization, New York animation studios, is a "minute movie" for Planter's Peanuts. This picture carries the name of the sponsor only on a title frame and is an interesting educational study of the growth of the peanut plant. The Eshbaugh studios recently finished another animation sequence for a National Carbon film dealing with the cooling system in gasoline engines.

ISSUES SERVICE CARDS

♦ *John E. Allen* of Rochester, New York, is issuing service cards to firm representatives traveling in New York State with films and motion picture equipment. The cards will list emergency telephone numbers so that a complete service including emergency repairs, screens, parts, operators, and films, will be available day or night. The cards will also serve for identification and credit purposes. Companies interested may contact this firm at 6 George Street, Rochester.

♦ The surest way of getting your product before educational groups, says the Society for Visual Education, is through a projected picture and the least expensive way is by means of Pictorols (Filmslides). This special service will be the subject of a lengthy discussion in a forthcoming issue. Watch for it, for it offers an entirely fresh viewpoint on the subject of school-industrial subject distribution.

KODACHROME TITLES

♦ HORNE MOVIE SERVICE in addition to a complete photograph service has an imposing list of clients for whom they produce Kodachrome titles. Recently a large order was completed for the Union Pacific Railroad.

PROJECTION IN ST. LOUIS

♦ AUDIO VISUAL SERVICE, a film projection organization operated by *Thomas J. Brown*, veteran motion picture pioneer and *Francis Slička* SMPTE member, announce recently enlarged St. Louis offices in the Mart Building. Provision is being made for a modern motion picture screening room. An invitation will be extended all producers to avail themselves of this screening room service in St. Louis.

(Continued on next page)

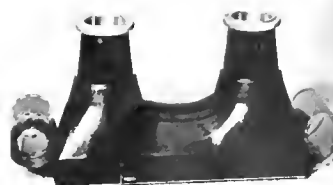
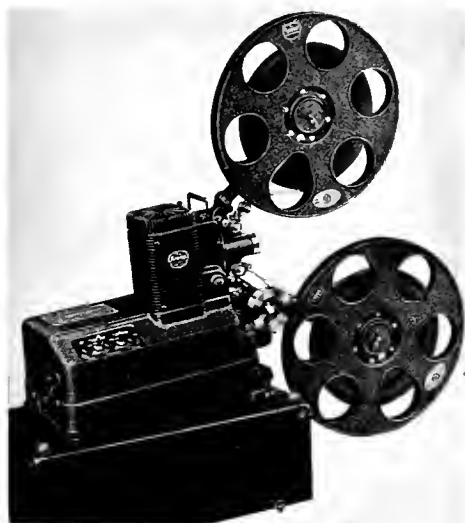

THE DEERY HAND STEREOPTICON VIEWER WILL BE A USEFUL ASSET AT MANY EXHIBITS DURING THIS year. Pocket-sized, it offers a novel way of using visual presentations.

Show SLIDEFILMS at Their Best

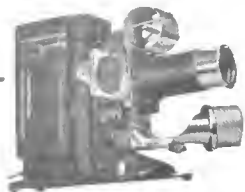

WITH POWERFUL
**PICTUROL
PROJECTORS**

THOUSANDS IN USE

S. V. E. Picturol Projectors are available in many types and sizes to meet every requirement — silent or sound — from handy light weight units for the use of contact salesmen to high powered projectors for auditorium use. Their superior performance has been proved by thousands of projectors in the service of hundreds of progressive companies such as Ford, General Motors, Chrysler Corp., General Electric, Westinghouse, Servel, Standard Oil Co., Crone Company, Standard Brands and Iron Fireman.

Slidefilms — the ideal visual aid for selling or employee-training — serve best when shown at their brightest by S. V. E. Picturol Projectors. The advanced optical system in each of these units reproduces every view on the screen at its brightest and clearest with details sharply defined. It is the result of 19 years of leadership in slidefilm projection equipment by the originators of the slidefilm stereopticon. Protect your investment in slidefilms with top quality projection. Mail the coupon below for complete facts now!

*Ask about NEW
300 WATT MODELS!

The AA, Tri-Purpose Unit shows single and double frame slide films, and 2" x 2" glass slides; the G shows single frame strips only; the AK shows 2" x 2" glass slides only.

Society for Visual Education, Inc.
Dept. 11-B, 327 S. La Salle St., Chicago, Illinois
Send illustrated free literature on S. V. E. Picturol Projectors including the new 300 watt models for large audiences.

Name _____ Address _____
Firm Name _____ City _____ State _____

SCRATCHES ON FILM CAN BE REMOVED!

★ ★ ★

RENOVATING DOES NOT REMOVE SCRATCHES
PROCESSING DOES NOT MAKE FILM SCRATCH-PROOF

SCRATCHES can be removed only by the
RECONO PATENTED **METHOD**

Your "Film-Salesmen" should always look their best
Restore your prints to original quality

WRITE FOR FREE TRIAL OFFER!

AMERICAN RECONO, Inc.

245 West 55th Street • New York, N. Y.

NEW UNIVERSAL LINE

♦ Shortly to be announced by UNIVERSAL SOUND PROJECTOR, along with their new models, is the fact that they are now manufacturing under the following licenses:

"Manufactured under licenses from Electrical Research Products, Inc., under United States patents of American Telephone and Telegraph Company and Western Electric Company, Incorporated, for use only in connection with the exhibition of motion pictures."

The improvements incorporated in the new projectors allow Universal to be one of the select few granted permission to operate under this license.

ADDS PILOT LIGHT

♦ BELL & HOWELL announces that a new automatic pilot light will be standard equipment on all MODEL 138 FILMOSOUND projectors effective with January production. The pilot light is so situated on top of the blower housing as to very clearly illuminate the projector film-moving mechanism and amplifier controls. The light is operative as soon as the projector current supply cord is connected with current source. The light is turned on automatically, simply by pulling the pilot light cap out of its housing. Pressing cap back into housing turns off the light. The lamp is easily accessible for re-

placement by unscrewing pilot light cap.

Through use of this new ever-ready pilot light the projector operator can perform film-threading operations and see to operate amplifier controls without resorting to other illumination. Information concerning installation of this pilot light on FILMOSOUND MODEL 138 PROJECTORS now in service may be had by writing the company.

FORMS FILM FIRM

♦ NATIONAL FILM PROGRAMS, INC., has been formed as a nucleus for organizations to obtain film programs suitable to their particular needs. This company recently took interesting films covering the National Amateur and the National Open Golf Tournaments which were given their first screening at the annual meeting of the Metropolitan Golf Association, held at the Hotel Vanderbilt in December.

NEW BOX-TYPE SCREEN

♦ An entirely new type of motion picture screen is said to have recently made its debut, incorporating notable improvements in mechanical design and reflecting surface. The new screen, known as the Nu-Matic Box-Type Screen, is manufactured in New York City by Motion Picture Screen and Accessories Company, and is distributed through the regular dealer channels.

THE STRANGE-LOOKING OBJECT ILLUSTRATED HERE IS A PRACTICAL, MODERN APPROACH TO "PERPETUAL MOTION". IT IS THE NEW 800 FT. CONTINUOUS ATTACHMENT OF UNIQUE DESIGN ANNOUNCED BY BELL & HOWELL FOR USE WITH FILM AND FILMOSOUND PROJECTORS; SHOWN MOUNTED ON A FILMOSOUND MODEL 138. It is stated that this new continuous attachment has been developed not only to provide greater "show" capacity than has previously been available in such a mechanism, but to incorporate features which add very appreciably to the life of the film used.

The new B&H 800 ft. Continuous Attachment is for use with 16mm. films, either sound or silent. Eight hundred feet of sound film, at 24 frames per second, provides a 22 minute showing; silent film at 16 frames per second provides a 33 minute showing, before repeating. Showings of these extra lengths are very much desired by those exhibiting at fairs.

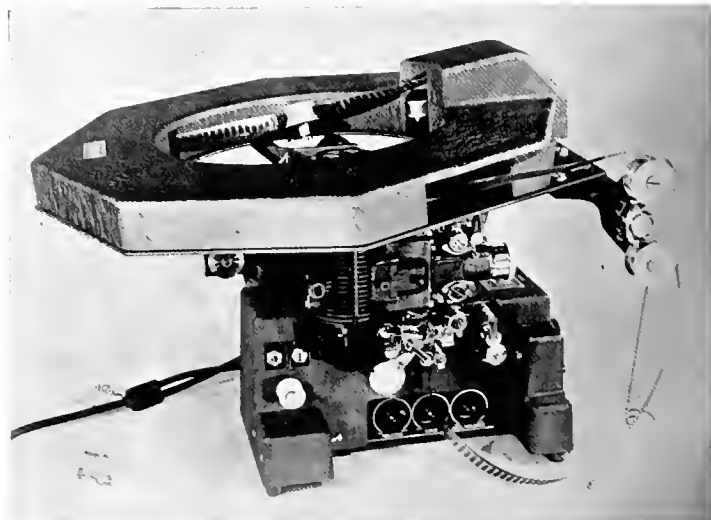

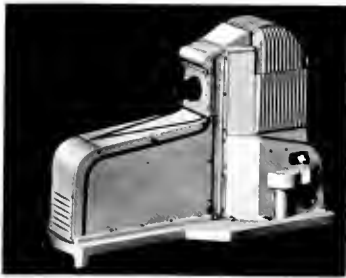

THE NEW DELUXE MODEL CONTINUOUS AUTOMATIC KODACHROME SLIDE PROJECTOR DEVELOPED by Color Illustrations, Inc., New York City, features screen brilliance in daylight plus perfect handling of delicate color transparencies. Takes from 3 to 48 slides. Further details on request.

AMPRO ANNOUNCES:

◆ THE AMPRO CORPORATION is announcing two new and improved low-priced 16mm. sound-on-film projectors, basically new in design, which provide quality sound projection at prices well within the reach of a moderate budget.

Clear, natural sound and tone faithfully reproduces speech, music. A new adaptation of Ampro's standard sound mechanism assures sound reproduction of the highest quality. With brilliant, flickerless picture projection—(750-1000 watt illumination) Ampro's quality features of projection have been developed to even higher standards.

Compact, quiet, easiest to operate—a truly simplified design—all in one case, small and portable, weighs only 49 lbs., including 1600 ft. reel, carrying case, accessories and cords. Operation so quiet that blimp case is unnecessary. All controls are centralized on a single illuminated panel—reel arm brackets are permanently attached and swiveled into position—no parts to set up and fasten. Simplified threading—only two sprockets—film guides to facilitate threading.

AMPROSOUND MODEL "X"—for industry—a real business builder—equipped with 60 cycle AC motor—sells at \$275.00.

AMPROSOUND MODEL "Y"—for education—ideal for classrooms and small auditoriums—equipped with Universal AC-DC motor with silent film speed and priced at \$295.00.

◆ Harold Weston of the Federal Display Corp. in New York City, has recently produced a very unusual screen for home and office use. A new feature of this PRO-VEL screen unit is the use of a proscenium surrounding the screen. The entire unit folds into a very remarkable light and small carrying case.

PICTORIAL CREDITS:

The editors are indebted to the following studios and cameramen for various illustrations appearing in this issue:

- ◆ ◆ ◆
- Audio Productions, Inc. & Natl. Association of Manufacturers... 9
- Natl. Assn. of Manufacturers & Vocafilm, Inc. 12
- Roland Reed, Dowling & Brownell; Audio Productions, Vocafilm... 13
- Household Finance Corp. & Coolerator Co., (outside column)... 13
- Wilding Picture Prods.; Chicago Daily News (lower left) 14
- West Coast S.S., New York; Jam Handy; Wilding Pic. Prods.; Caravel Films; Vocafilm and Industrial Pictures (top to bottom) 15
- Bell & Howell & Castle Films (producer) (How Motion Pictures Move & Talk) 16
- Paul Rotha; Jam Handy; Wilding Pic. Prods.; (3 & 4) Burton Holmes Films (5) 18
- John Coakley (top) 27
- Castle Films, Inc. 28
- Eastman Kodak Company (from Highlights and Shadows) top of page cut 31
- Ohio State Dept. of Visual Instruction 34

LINCOLN IN 16MM

◆ G. H. Hedwig, Sr., president of Nu-ART FILMS, INC., distributors of Abraham Lincoln starring Walter Huston, states that this film has broken all distribution records of any film in the 16mm. field to date.

It is being shown by educational institutions as well as industrial organizations throughout the United States and Canada. The film, which depicts the entire life of Lincoln, is said to be its director's and star's greatest achievement as Lincoln's character and greatness transcend nationalistic boundaries.

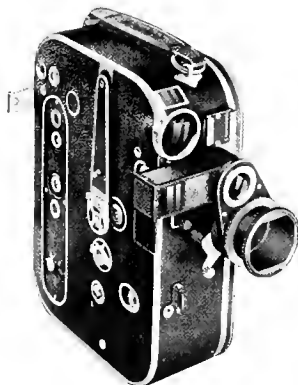

BASS CAMERA CO., CHICAGO, NOW OFFERS FOR THE FIRST TIME THE NEW ZEISS MOVikon precision 16mm. Cine Camera, equipped with a 50mm. F:1.4 Zeiss Sonnar lens, built-in auto focal range finder, hand crank as well as motor drive and variable speeds.

TRADE MARK
Neumade

STEEL FILM STORAGE CABINETS

Fire Proof — Dust Proof



"ST" SERIES — Individual sectional compartments for either one or two reels. Double wall construction of heavy gauge steel throughout. Each compartment has its own door, handle, index cord holder and card. Available in units of 5, 6, 8, 10 or 12 compartments for any size reel.

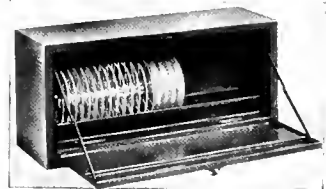

MM-102 — Floor model to accommodate 100 reels of 16mm film in a minimum of space. Generous storage compartment in lower portion for projector or other equipment. Doors equipped with three point locking devices, key locks and keys.

Rewinders ALSO Splicers
Measuring Machines Shipping Cases
COMPLETE LINE
8mm. — 16mm. — 35mm.

WRITE FOR ILLUSTRATED CATALOGUE

Neumade Products Corp.

429 W. 42nd St. New York, N. Y.



CHARACTER

Loyal to its original image . . . yielding to its user's needs . . . considerate of his budget — your obedient, industrious servant . . .

CINECOLOR



SURVEY REVEALS THAT WOMEN FAVOR SCREEN ADVERTISING

• The findings of the *Ladies Home Journal* in its recent survey on "What the Women of America Think About Entertainment" will be of interest to commercial film users. Fifty-seven per cent of the women said there was no objection to having advertising of products shown on the screen. Contrast this with the statement affirmed by sixty-percent of the same women that too much time is given to advertising on radio programs and critics of screen advertising are well answered.

What the findings might have been if the constant level of screen advertising were maintained at the high place attained by such films as those sponsored by U. S. Steel, Chevrolet, Metropolitan Life, Fisher Body and other notable productions as opposed to the too-numerous locally-made and badly presented retail advertising shorts shown in many towns would be interesting to know. Certain it is that the screen's great power needs safeguards against abuse.

COLOR IN INDUSTRY

♦ The cover subject of the month was selected as one of the finest examples of the recent trend to Kolorchrome noted among national users of printed space as well as users of commercial films in color. The recent new DeSoto series features this technique as do numerous other campaigns including the promotional brochures and excellent calendar issued by American Airlines which features the work of Don Wallace, Chicago color photographer. Kurt Schelling lensed the cover shot in the plant of the Bridgeport Brass Company.

CLOSE-UPS

♦ The 1939 Oil-World Exposition to be held in Houston, Texas April 24-29 of this year will provide motion picture facilities for all exhibitors. Field and plant operations to be covered in daily showings provided by the Exposition will include drilling, production, pipe line, natural gasoline manufacture, refining and transportation. Pictures will be open to all visitors.

* * *

THE INTERESTING GALAXY OF PHOTOGRAPHS AT THE LEFT ILLUSTRATES VARIOUS TYPES OF EQUIPMENT USED IN A LARGE VISUAL EDUCATION LIBRARY SETUP IN THIS CASE ONE OF THE WORLD'S LARGEST IS SHOWN FOR THIS IS THE Ohio State department under the direction of B. A. Aughinbaugh, Director of Visual Instruction. Such a setup may well be contrasted with the minimum of equipment needed by the average commercial film department as illustrated in the cut at the right.

Propose Film Bureau

♦ The Executive Editorial Committee of Business Screen, meeting in Chicago this month, has prepared a proposal for the establishment of a first Film Bureau for the commercial film industry to operate with offices in Chicago and New York.

The new Bureau, for which further plans are now being drafted, would undertake the task of continuing statistical research for the industry and of relating the medium to the many lines of business to which it may be adapted.

♦ For the benefit of small companies who are too often inclined to accept the idea that the film medium is out of their class, the recent advertising yarn about the big-league pitcher who developed a curve that baffled the cannibal batters may hit the right note. It seems that the coach of a good minor-league team discovered the secret twist and approached his star mound-man. "Nothing doing," was the pitcher's reply. "That may work fine in the Big leagues. But my problem is different. This is a MINOR league."

* * *

♦ Hills Brothers Coffee, sponsors of a new Cinecolor commercial "The Story of Coffee," finished shooting the film in San Salvador last month.

HOW ABOUT THIS UNIT?

AT THE SUGGESTION OF BUSINESS SCREEN'S EDITOR, ONE OF THE LARGE MANUFACTURERS OF FILM DEPARTMENT EQUIPMENT HAS DESIGNED THIS NEW COMPACT unit for the use of producers or commercial film departments. It contains a utility drawer, microfilm or slidefilm compartment drawer, racks for 14-400 foot reels and 12-1200 or 1600 foot reels of 16mm. size and a rack for 6-35mm. reels. There are also 16 shelves for 16" records. Rewinders, splicers, etc. can be mounted on the top surface and included as standard equipment. Write The Screen Service Bureau, 20 North Wacker Drive for further information if you're interested.

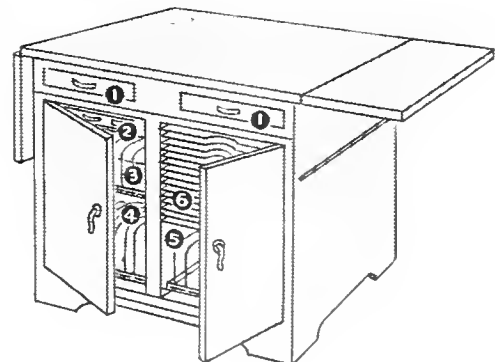

STEP UP *your* AUDIENCE APPEAL

with 16mm. Sound Shorts and Features that lend distinction and sparkle to your programs.

The Gutlohn Library of Entertainment and Educational films includes musicals, cartoons, comedies, travels, literary classics, science, sports, world affairs and novelties.

Send for catalog listing over 1200 subjects available for rental, lease or sale.



WALTER O. GUTLOHN, Inc.
35 West 45th Street New York



HOLLYWOOD.. WITHOUT the HOOEY

The "flicker city" out behind the foothills earned a reputation of being the wickedest — the screwiest — and most expensive glitter-bug joint in the world.

Maybe so — but you can't get away from the fact that it has the best motion picture technicians — the best equipment — the greatest variety of talent right down the line.

When it comes to industrial pictures, there is a Hollywood organization which knows how to take advantage of Hollywood's superior technical experience and facilities without Hollywood's reputed follies and extravagances.

Such a producing company — headquartered in one of Hollywood's finest studios but producing anywhere, is . . .

DOWLING and BROWNELL

6625 Romaine Street • Hollywood, California

Note: Dowling and Brownell made the first dramatized feature-length industrial sound picture ever made in Hollywood — many since.

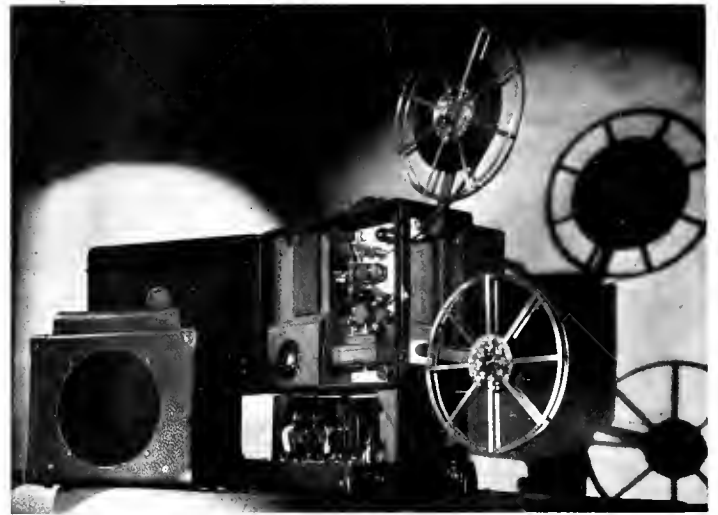

LATEST MODEL DE VRY CHALLENGER 16MM. SOUND-ON-FILM PROJECTOR INCLUDES MANY REFINEMENTS. FEATURES ARE SYNCHROMATIC THREADING WHICH SIMPLIFIES THREADING OPERATION, AUTOMATIC LOOP SETTER, WHICH MAKES IT POSSIBLE FOR THE OPERATOR TO SET HIS LOOP IN SYNCHRONIZATION WITH picture without stopping projector. Another innovation is the film stabilizer which automatically provides the proper tension on the film as it passes over the soundhead, keeping it close to the soundhead without undesirable friction and also eliminating both vertical and lateral "whip".

OBSERVES ANNIVERSARY

MOTION PICTURE CAMERA SUPPLY COMPANY of 723 7th Avenue, New York City, is observing its fifth anniversary year with a line of the latest type of motion picture equipment. The company handles sales, service and rentals, and has all types of professional studio equipment in stock. Exclusive eastern representatives for the Mitchell Camera Corp. and other prominent Hollywood equipment manufacturers, MPCs are among the first in the East to receive new equipment developed in Hollywood.

They have been furnishing equipment on rental to producers in East making features, shorts and commercials.

With the supervision of MPCs a health picture was produced for the National Tuberculosis Association entitled *Let My People Live*. This was made on location at Tuskegee, Alabama and the Tuskegee Institute choir was recorded as part of the picture in background music. Rex Ingram, recent lead in *Green Pastures*, was in the principal role and *Let My People Live* was the first film selected for the New York World's Fair. The company also has complete machine shop facilities for building and rebuilding and repairing all motion pictures, camera, laboratory, and recording equipment.

J. Burgi Center, president of MPCs, has been a motion picture engineer in sound, color, and photography for the past fifteen years.

♦ THE SPENCER LENS COMPANY of Buffalo, New York, manufacturers of microscopes and scientific optical instruments, have announced another new projector for 2" x 2" slides, the MODEL MK DELINEASCOPE. The basic unit will be priced at \$22.50. The manufacturers claim that this 100-watt projector is far more efficient than would be expected from its size and price, — that it remains cool enough to handle at all times, and assures safety for color film.

Accessory equipment will soon be available. The front of this instrument is so designed that it may be removed by loosening a knurled thumb screw, and accessory equipment to handle strip film in double frame or single frame, added later.

HERE THE NEW SPENCER MODEL MK DELINEASCOPE IS SHOWN IN ACTION AS IT IS SET UP FOR the business showing of your transparencies.



WHERE ARE THEY NOW?

*A Note of Recollection
About a Visual Pioneer*

♦ An article which has been in our editorial "hold" file too long is Edmund D. (Edd) Gibbs' story of his pioneering visual work with the late John H. Patterson, the National Cash Register Company founder. A glimpse into Edd's fascinating copy will give you an idea while we prepare to present his entire story in an early issue:

"I am a screen picture fan", he says. "a dyed-in-the-wool devotee of this great business miracle, and I have every right to be. I have been a user of every form of screen presentation since early in the 1890's. I was taught the value of the various forms of this medium by the man who was the very first to make a practical use of projected pictures — John H. Patterson, founder of the National Cash Register Company. He said, 'we must teach through the eye as well as through the ear', and saying this he proceeded to do it. An ordinary magic lantern and thick glass slides were all the equipment he could make available. I was his assistant, occupying the post of advertising director, and it fell to my lot to become actively engaged in the production and use of those old glass slides. We couldn't buy what we needed, so I got the job of designing them.

"You who know all about making slides or motion pictures will probably laugh when I tell you that I used to paste thin sheets of a very transparent paper on the plain glass slides and then sketch the pictures we wanted to show on this paper, as well as sketching in whatever reading matter that was needed. All of the slides that I made are still in the factory files and are constantly shown to many thousands of visitors yearly. Am I an artist? Well possibly some bright colored boy would say, 'Is you or is you ain't?'. The answer is that in those days, I just had to be one!

"I wish I could show here a picture I drew on a slide which showed the heads of about a dozen



LOBBY DISPLAY IN GARY THEATRE FOR UNITED STATES STEEL'S FAMED TECHNICOLOR FILM — NOW BEING SEEN THROUGHOUT THE country. Produced by Hollywood Industrial Pictures.

workmen. Their jaws were hitched to machinery similar to the crank shaft of an automobile so that the movement of the jaws of the men in the picture would turn this crank. What did it demonstrate? Well, Mr. Patterson used it to inform the men that there would be a decided profit to the Company if by some such arrangement as I had pictured the great amount of tobacco chewing done by the factory hands could be put to profitable use in driving machinery!"

"Words by John H. Patterson, illustrations by E. D. Gibbs — that was the combination for the first batch of instructive lantern slides prepared for Mr. Patterson's use."

JOB WANTS MAN

A stable, well-financed, fast-growing Detroit slidefilm organization needs an experienced sound slidefilm scenario writer — right now. It's a real opportunity — good starting salary, sky's-the-limit future. If you've had real experience, can submit guaranteed samples, are able to start right in and do a real job, write Box 41, Business Screen, 20 North Wacker Drive, Chicago, today.

Don't write unless you qualify. Experience in other writing fields won't do. Preferred age — 25 to 30. Members of our own organization know of this advertisement.

Attention!

INDUSTRIAL PRODUCERS

WE SUPPLY on rental all or any equipment necessary to make a Feature — Short or Commercial.

SOUND — SILENT — COLOR — SLOW MOTION

- Latest Mitchell Cameras
- Blimps — Dollys — Accessories
- Latest Type Lighting Equipment
- Variable Area Location Sound Truck
- Portable Recording Equipment
- Single System News Reel Type Cameras
- Moviolo Editing Equipment

SALES — SERVICE — RENTALS

EXCLUSIVE EASTERN REPRESENTATIVES
MITCHELL CAMERA CORPORATION

MOTION PICTURE CAMERA SUPPLY, Inc.

723 Seventh Ave. • New York, N. Y.
Phone BRyont 9-7754 Cable — CINECAMERA

make every note SING PROFITS!

Your customers are much easier to satisfy when the sound on your film is natural. Result? More business!

When you produce this natural sound, and do it with equipment so dependable and simple to use that you speed up all production schedules, you are sure to find an attractive increase on the black side of your ledger.

Berndt-Maurer 16 mm. sound-on-film Recording Systems give you the kind of sound quality that makes customers grow enthusiastic. Moreover, this equipment, professional in character, reliable in use, easily portable, enables even a small crew to obtain faithful 16 mm. sound film records of any subject.

Write today for complete information about B-M 16 mm. sound-on-film Recording Equipment . . . the equipment that produces highest quality talking pictures, consistently and economically.

THE BERNDT-MAURER CORP.
117 EAST 24th STREET • NEW YORK CITY

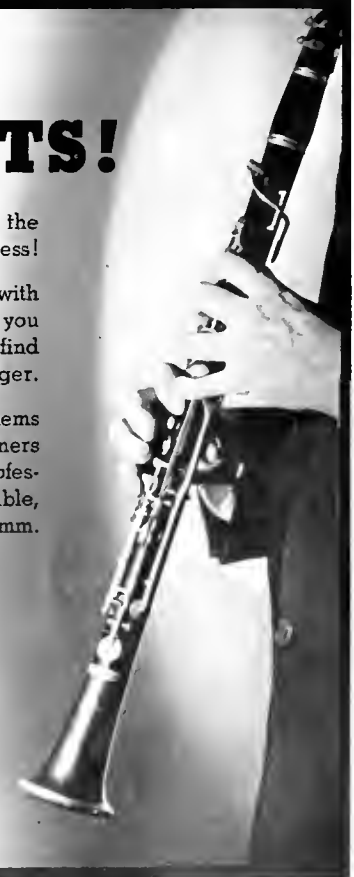



A NEW CROP OF BUYERS

Weyerhaeuser Timber Company's motion picture "Trees and Men" has shown several million people that "timber is a crop" and that nature renews the forests of the future.

It is an axiom of the motion picture business that, like other natural cycles, a new crop of theatre patrons grows up every four years, making old stories perennially new.

To make your sales story appeal to the new generation of buyers you have to have the latest and the most skilful of picture presentations.

The same producers who filmed "Trees and Men" can build your message into a well-told and thought-compelling picture; made sincerely — artistically — economically.

DOWLING and BROWNELL*

6625 Romaine Street

Hollywood, California

*The full story of our services and facilities will be sent to you on request.

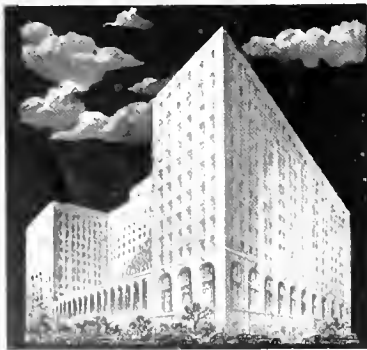

Distinguished

The Drake offers every luxury and convenience of fine living on Chicago's Gold Coast, overlooking Lake Michigan.

A. S. Kirkely, Managing Director

The Drake

LAKE SHORE DRIVE • CHICAGO

NEW FILMS:

(Continued from Page 15)

Please, for the purpose, Remington officials, and district managers at a prevue received the picture with enthusiasm.

The picture will be shown widely to salesmen in the trade by the Remington organization.

NEW STANDARD SHOW

♦ Motion pictures played important roles in sales conferences conducted by Standard Oil of Indiana during January in Minneapolis, Milwaukee, Detroit, St. Louis, Indianapolis, Kansas City, Des Moines, and Chicago.

In *Our Fifty Years*, President Edward G. Scubert addressed the conference from the screen on the business service of the company over the last fifty years and its vision of the future.

A brief *Jam Handy* picture was utilized by Wesley I. Nunn as part of his presentation of 1939 advertising plans.

Start the Music, a sales training picture which is to be shown later to dealers, demonstrates entertainingly some of the do's and don'ts of running a service station. Houston Branch, author of many theatrical pictures, was brought from Hollywood to collaborate with J. M. Prindle III of the Wilding organization in writing the scenario. Together they developed a farce comedy that keeps audiences in stitches while they learn.

The film was made by Wilding on the Selznick lot in Culver City with John Trent, Benny Hall, Irene Shirly, Eleanor Stewart, and Bill Franey among the cast supporting Kennedy and Gene Yarbrough directing. It runs about thirty minutes. The picture went over in a big way with audiences of company salesmen and sales executives and is expected to do a big job of both entertainment and education with dealers later.

CARAVEL FILMS STAFF MEMBERS AND CAST POSE WITH S. M. BARSON, DIRECTOR OF SALES FOR Bates Mfg. Co. as shooting of the new Bates film is successfully completed.



BEN FRANKLIN'S PRECEPTS AS THEY APPLY TO MODERN SELLING ARE THE REAL STARS OF *Selling America*, now available on a rental basis to sales organizations.

♦ *Selling America*, the *Jam Handy* sales training motion picture featuring Ben Franklin, has been found adaptable to almost every type of sales meeting. Just as Franklin's famous advice is universal—so sales managers in many fields find this rental subject inspiring to their men. Available on request for large or small meetings; address The *Jam Handy* Organization, 2900 E. Grand Boulevard, Detroit.

ALEMITE PREVUES

♦ In a fast-moving, talking picture, made in Hollywood by Cinema Sales, Inc., and entitled, *Mr. Sheldon Goes to Town*, the Alemite division of the Stewart-Warner Corporation has again demonstrated the potentialities of motion picture drama as a powerful sales force for industry.

In this unusual commercial film, roles were played by actors drawn from the large Hollywood studios, and full technical staffs were employed—115 persons being engaged in making the commercial drama. The picture, a three-reeler directed by Wallace W. Fox, and photographed by Harry Jackson, A.S.C., presents a dramatic story

The original script was prepared by Fred Cross, Director of Advertising for Stewart-Warner and adapted by John Thomas Neville. The film will be used internationally by Alemite distributors, and will be released to them in 16mm. form. The premiere of *Mr. Sheldon Goes to Town* took place at the Alemite distributors convention in Chicago, January third and fourth.

At the **CENTER** of Chicago Business!

The dominating tower of 20 North Wacker Drive not only soars high above every nearby building but its *strategic* location at the hub of Chicago's principal wholesale, publishing, and transportation districts make it an ideal location for your office headquarters.

Surface line, elevated and motor coach service is available at the doors. A few steps away are two principal railroad terminals serving the largest part of Chicago's commuter area. Such well located offices save time and money for the company, its employees and its customers. Thus, easy accessibility to transportation, to hotels and to principal office and business districts of importance are elements which you will want to consider in selecting your office headquarters in Chicago.

Here at 20 North Wacker Drive, the advantage of location is paramount but there are other assets which should be considered. Among these are the character of the building and the completeness of its services and other facilities. Without leaving the front door executives may bring their customers to sales demonstrations or conventions in one of the building's many available auditoriums. You may entertain your business guest in the exclusive facilities of a fine private club and conduct your routine business affairs in office quarters where light and air conditions are among the finest anywhere.

Why not inspect 20 North Wacker Drive at your earliest convenience? A visit to our many interesting floors here will convince you that the simple facts stated above can mean added profits for you in 1939. There is no obligation, simply drop in or write for further facts.

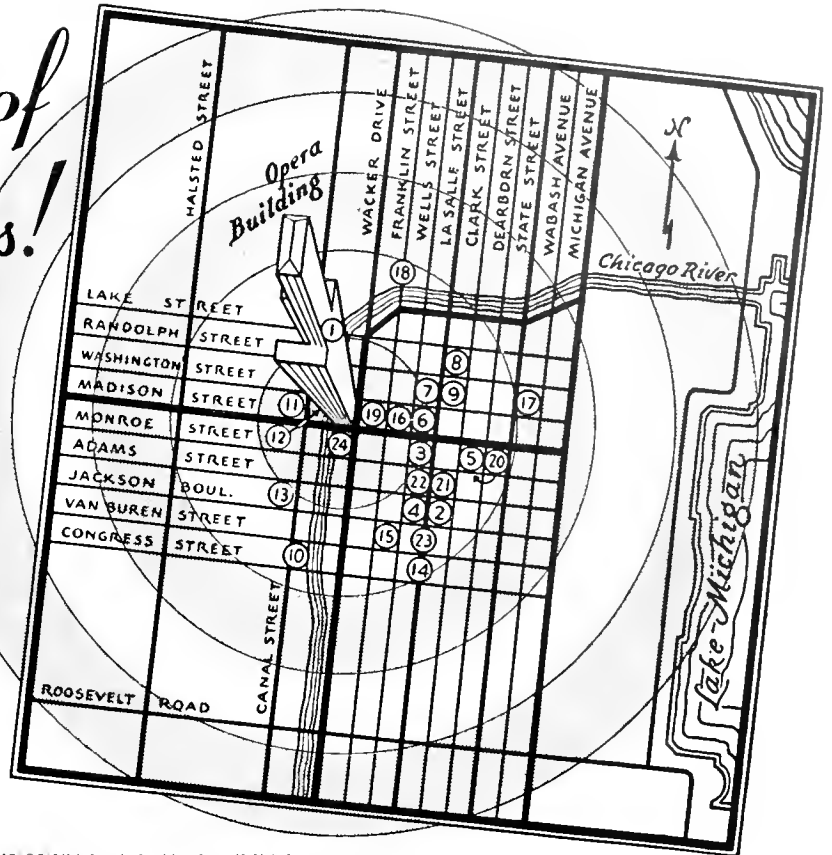

ADDRESS INQUIRIES TO THE OFFICE
OF THE PRESIDENT, J. C. THOMPSON,
20 NORTH WACKER DRIVE, CHICAGO



• KEY to the MAP •

1. 20 North Wacker Drive
2. Continental Illinois National Bank & Trust Co.
3. Northern Trust
4. Federal Reserve Bank
5. Morrison Hotel
6. La Salle Hotel
7. Bismarck Hotel
8. Sherman Hotel
9. City Hall & County Building
10. New Post Office
11. Northwestern R. R. Terminal
12. Daily News Building and Terminal National Bank
13. Union Station
14. La Salle Street Station
15. Aurora Electric Terminal
16. North Shore Electric and Elevated Lines
17. Marshall Field & Co. (Retail)
18. Merchandise Mart
19. Hearst Square
20. 1st National Bank
21. Harris Trust
22. Chicago Stock Exchange
23. Board of Trade
24. Carson, Pirie Scott

• 20 NORTH WACKER DRIVE •



"CRITICAL MOMENTS"

A great railroad had to clear its tracks. An entire train and train crew had to be enlisted, scenes shot at night, voices and natural sounds recorded on location—when the National Carbon Company decided to re-enact for the screen one of its thrilling "true experience" Eveready Flashlight Battery ads.

To meet these problems, National Carbon relied upon the technical skill, resourcefulness and facilities of West Coast Sound Studios. West Coast has made notable contributions to national screen advertising with this and other productions in the "Critical Moments" series.

Producing effective Screen-ads is a highly specialized art. Let us place our facilities and technical skill at your service when you consider Screen Advertising.

STUDIOS RCA EQUIPPED

WEST COAST SOUND STUDIOS, Inc.

510-22 West Fifty-Seventh Street
New York Circle 7-2062 N. Y.

Nat. Sales Rep: SCREEN BROADCAST CORPORATION

Bass Sound Engineers

offer a complete

Commercial Unit

in the latest

RCA 16mm S-O-F Camera

Now includes:

- 400-ft. capacity turret front camera.
- Three-stage high gain amplifier, 110-volt with crystal microphone
- 110 volt A. C. permanently attached motor, vibrationless, steady
- 400-ft. Bell & Howell Duplex magazine
- 1-in. Wollensak f 3.5 lens
- RCA Studio Recording galvanometer
- Lowest priced complete equipment at Bass (U. S. A. only) **\$935**
- Or equipped for 12 volt battery operation, incl. batteries **\$960**

Each instrument film-tested before shipped—and guaranteed by Bass.

Write
Dept.
BU.

Bass
CAMERA CO.

179 West Madison St., Chicago, Ill.

Script Teasers

(Editor's Note: This column is intended as a clearing house for creative writers throughout the industry. We believe that every commercial screen writer has a host of plot ideas, gags, puns, rumors, questions, titles, and what have you in his notebook that deserve to see the light of day. Any contributed material used will be given name credit. Thus, publication here may be considered an approach toward establishing the sources of original ideas. The column will be as successful as creative writers want it to be. So, throw us a life-line from *your* notebook!)

How can a creative writer expect to be happy? He's born into a world where, if he doesn't start crying immediately, he's spanked until he does!

• Of late, clients who put on sizeable motion picture programs each year for sales or dealer training have taken to devoting one film to entertainment. It develops a sales feature or a training point in a humorous manner. Wonder how long it will be before some quality can goods manufacturer produces: "Let's go to the can!" (for the quality story)?"

Also—many firms keep (or could quickly dig up) a collection of scandalously funny letters received from well-wishing but misguided individuals who write in to ask ridiculous questions or register unusual complaints. Using the "Dumbbell Letter" technique, each such collection could make an immensely entertaining film.

For example: *Chipso's best testimonial letter in years comes from a woman who reports it cured her husband's yen for the bottle. During one of his all too habitual binges, he mistook Chipso for corn flakes and ate a bowl of it. Caption: Chipso Cures a Dipso!*

Who was it that first used "cameraflage" to denote a doctored photo? Pretty neat.

"A pretty girl, a baby, a pup,
Will sell anything man can think up."
We write in pretty girls and babies, but seldom pups. In fact, we seldom make use of any animals for bits of business in commercial films. Yet surveys of theatrical audience reactions prove that animals have a more universal appeal than even slap-stick comedy. There's an idea there!

Titles: "Taking the Demon out of the Sales Demon-stration!"
"Show-woman-ship!"

THE SCREEN DIRECTORY

FILM DISTRIBUTORS — PRODUCERS

FREE SOUND FILMS FOR GROUP SHOWINGS



Four new "FREE LOAN" Sound Motion Pictures 16mm.

"BASEBALL"

"TO THE LADIES"

"THE ROMANCE OF FOODS"

"52 PAY CHECKS EACH YEAR"

Available to recognized organizations. You pay transportation charges only. Excellent films for employee entertainment and group showings. Write for catalog and descriptions.

Distribution Department

Burton Holmes Films, Inc.

7510 N. Ashland Ave.

Chicago, Ill.

DISTRIBUTOR — NEW YORK STATE

SHOWMANSHIP

IN WESTERN NEW YORK

Buffalo • Rochester • Syracuse
Utica • Binghamton • Elmira

Allow us to stage consumer, dealer, or sales showings of your film in the EMPIRE STATE.

The finest Western Electric sound projection equipment in the hands of courteous, competent operators insures the presentation of your program in a thoroughly professional manner.

Upon request, we will prepare a complete analysis of the distribution possibilities for your film in this region.

"Expensive Films Deserve Extensive Distribution"

JOHN E. ALLEN 6 George Street
Rochester, New York

DISTRIBUTOR — PRODUCER

A Unique Combination

FILM PRODUCTIONS that really tell the story of the products of the leading manufacturers of the country

DISTRIBUTION SERVICE that takes that story to hundreds of thousands of prospects anywhere and everywhere

Guaranteeing Results

• **C. L. VENARD** •

(THE VENARD ORGANIZATION)

702 S. Adams St. Peoria, Illinois

THE SCREEN DIRECTORY

FILM LIBRARY — DEALERS

ODDITIES BEYOND BELIEF

HIGHLIGHTS ON STRANGE THINGS
THE WORLD OVER

One Reel Subjects — Approximately 400 feet each

SOUND 16mm. films **SILENT**

FOR
DEALERS
ONLY



WRITE
FOR
DETAILS

145 W. 45th St. • Dept. 15 • New York City



"He never seems to miss"

"Superman" and like articles imply that all commercial creative writers are men. Wonder if there aren't a few gal writers hidden away in the crowd?

* *

At one time or another every creative writer vaguely starts collecting a "gag" file. Odd (when you realize their value) that so few of us ever get it to the card index stage. Is it the tedious, patient filing that stumbles us, or is there need for an adequate and efficient method of cross-indexing?

* *

For those who care to jump on and ride along, in the next six issues this column will go through the process of building a workable motion picture gag file, reporting in easy, practical steps the experience we gained collecting and classifying gags over a four year period.

* *

When a salesman fails to produce, one of two things is wrong. Either he's not working, or he's not working right.

* *

In every writer's notebook there are random titles which the author just never seems to be able to use for anything. BILL USKALI has one, "Happiness Half-Baked"; and JIM EDMONDS, "Chaos in Costume". We don't know what they could be used for either. But they're good!

* *

This column welcomes script ideas from directors, cameramen, sound engineers, salesmen, script girls, et al. Years of writing in the industry have proven to us (often enough to be embarrassing!) that youse people have ideas that make for darn swell stories.

* *

Apt phrases: She was a girl with a "code" in her head! What the well-dressed man will be aware of!

* *

Where are those fellows who yearn for Hollywood? Advance reports from the New York World's Fair indicate that television is but months away from commercial practicality. As suspected, films will form a large part of broadcasts. The thought occurs that creative writers in this field are perhaps best prepared for the miracle. They alone know how *visually* to combine entertainment and selling.

— J. K.

♦ The DeVry Corporation, projector manufacturers, Chicago, announce the appointment of the McJunkin Advertising Agency who will handle DeVry's national advertising.

FOR YOUR MOVIE! "SEA GOING THRILLS!"



Startling camera record of 85-foot sloop's daring adventure cruise around Cape Horn... Big fish... Violent, raging seas! A sensation for every 16 and 8mm projector owner... order your copy today!

AVAILABLE IN THESE SIZES

16mm. Sound on Film 350 ft. \$17.50
16mm. Silent 360 ft. 8.75
8mm. Silent 180 ft. 5.50

CASTLE FILMS

30 Rockefeller Plaza • New York City

MAIL
THIS COUPON
TODAY!

For NEW 1939 catalogue describing "Sea Going Thrills" and 50 Sport, Historic, News, Cartoon, Thrill and Travel Home Movies.

Name
Address
State

CATALOGS, INFORMATION BULLETINS ISSUED WITHOUT OBLIGATION TO EXECUTIVES: SIMPLY ADDRESS THE SCREEN SERVICE BUREAU, TWENTY NORTH WACKER DRIVE, CHICAGO.



COMPLETE 16mm PRODUCTION FACILITIES and EQUIPMENT

in Both Sound and Color

THE oldest photographic organization in the middle west now offers COMPLETE economical 16mm motion picture service. You can add sound and obtain duplicate prints from your Kodachrome or black and white films at a reasonable cost. Duplicate 16mm Kodachrome prints, silent 10c, sound 12½c per foot. Finest professional quality 16mm sound track recording at economical prices.

LET US HELP ANALYZE YOUR 16MM FILM PROBLEM. OUR PRODUCTION GUIDE SENT ON REQUEST WITHOUT OBLIGATION.



SLIDEFILM ESTIMATES, ALSO.

All types of sound and silent 16mm cameras, projectors and accessories for sale or rent.

FREE — Our 80 page catalogue 43-R of services and equipment — Write today!

"HEADQUARTERS FOR EVERY KNOWN PHOTOGRAPHIC NEED"

NORMAN-WILLETS CO.

318 W. Washington St.

Chicago, Illinois

MOGULL

"JAM HANDY" XPLAINER 35mm. Reg. \$45

Invaluable for demonstrating and Visual education. Uses S.V.E. Pictures and 35mm. strip film. Enlarges up to 4½x6 feet! 200 watt prefocused projection bulb and 4" optical lens.

ABSOLUTE FIDELITY IN PROJECTION AND COLOR

Every machine fully guaranteed like new! No distortion! Scientifically constructed, accurately adjusted. Simple operation.

Originally \$45.00 **\$1125**
Limited Quantity
Complete with carrying case and accessories



Send Check for prepaid shipment, C.O.D. if desired. Request MOGULL BARGAIN NEWS for other exceptional specials in Camera and Cine volves for personal and industrial use.

57 WEST 48th STREET
NEW YORK, N. Y.

SEWELL-FORDYCE COMPANY
Sensational offer of

THE GENUINE ARROW-ELECTRIC DRY SHAVER

at \$1.98 GUARANTEED FOR
TWO YEARS

POSTPAID—ANY-
WHERE in U.S.A.

Not At
\$7.50
or
\$10.00

110 Volt
A.C.
Only

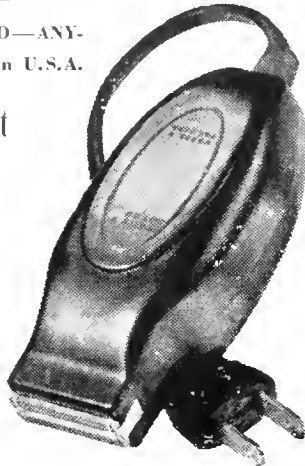

TROUBLE-FREE
PERFECTLY SIMPLE—NO ROTATING
PARTS—NO OILING—NO BEARING—
NO ADJUSTMENT—SIMPLY PERFECT.



GROUND, DOUBLE SHAVING HEAD OF
EXTREMELY THIN STEEL . . . DOUBLE
SPEED, SELF-STARTING, VIBRATOR
POWER UNIT IN A BAND FITTING CASE
OF LUSTROUS MOLDED PLASTIC . . .
COSTS LESS THAN FIVE CENTS A MONTH
TO OPERATE . . . COMPLETE WITH
CLEANER, GUARANTEE AND INSTRU-
CTIONS IN INDIVIDUAL BOX . . . GUARAN-
TEED FOR TWO YEARS AGAINST DE-
FECTIVE PARTS AND WORKMANSHIP
. . . NEVER BEFORE HAVE WE OFFERED
THIS SHAVER AT THIS PRICE . . . THE
ONLY THING CHEAP ABOUT THE AR-
ROW SHAVER IS OUR UNHEARD OF
PRICE OF \$1.98, POSTPAID.

Sewell-Fordyce Company, Dept. BS,
128 Market Street, Newark, N. J.

Enclosed is \$. . . for which please rush
. . . Arrow Shavers parcel post prepaid.
It is understood that cleaner, instructions,
and factory guarantee for TWO YEARS
are included with the shaver.

Name
Address
City & State Dept.

A VISUAL PIONEER

(Continued from Page 17)

candescence lamp, a two-reel silent and a one-reel sound version of the original production are still enjoying good distribution through the schools of this country.

King of the Rails, another railway electrification picture, but this time planned for public consumption, followed. It had its premiere at the Mark Strand Theatre on Broadway in New York, at that time the finest cinema house in the country. Audiences reacted favorably and the press gave the subject excellent notices, thereby stimulating its distribution, in addition to giving the company added publicity.

This picture's reception justified the belief of G. E. executives and so a section was formed as a function of the company's publicity department to carry on this activity. A Bell & Howell camera and a Schneider step printer were purchased, while a small rack and tank laboratory was constructed.

EARLY FILM SECTION

General Electric was, therefore, if not the first industrial concern, at least among the first, to maintain its own motion picture section; and is today one of the few large manufacturing companies which have their own motion picture production, laboratory, and distribution units.

With added facilities, more space, and an increased personnel, pictures were made featuring the application of electricity to various phases of industry. They were part of an advertising program designed to awaken an electrical consciousness and to create a keener appreciation for electric products. Because of their story, treatment, production, and freedom from advertising they received good theatrical distribution.

Naturally, as more pictures were made, technical improvements and equipment came along. Animated drawing sequences were resorted to in a picture on marine electrification. A vertical animation stand was designed and constructed. An ingenious solenoid stop-motion device was developed and is still in use. Other releases contained tinted and toned sequences, which were treated in the company's laboratory. Hand coloring for special showings was attempted. Lighting equipment was simplified and improved. Wherever their use could be put to story-telling advantage, time-lapse and stop-motion photography were employed. In general, the section's physical development paralleled on a lesser scale that of the industry itself.

During this period a few direct sales pictures were produced—pictures which went into much detail about a given product or closely associated line of products to be used by a salesman before interested customer groups. Their

EDITOR'S NOTE: This interesting article is taken from a recent SMPE address made by Mr. John T. Gilmour of GE's Visual Instruction Section.

full value, however, was restricted by the hazards and complications of 35mm. film and projection. The selling organization believed in them, but couldn't use them easily enough to justify their expense. When, therefore, 16mm. film and apparatus made their appearance around 1924, the company purchased an optical reduction printer and furnished its major sales offices with 16mm. projectors. This new development stimulated the use of sales films, and, as a result, more product and fewer institutional subjects were produced. Reduction prints of the growing library were made and distribution was increased. The availability of these 16mm. subjects, which were, as all releases still are, lent free but for transportation, assisted materially in the rapid development of the 16mm. business.

Around 1920, Mr. C. A. Hoxie of the company's General Engineering Laboratory, began a series of experiments to record sound on film. Since most of you are familiar with his work, its results at least, it need only be mentioned that the section cooperated fully. Its knowledge and equipment, both acquired over a period of time in which much trial and error experimentation had taken place, were called upon frequently during this early development of the variable-area method of sound recording and reproduction.

NEW UNIT IN 1927

About 1927, a complete new studio and laboratory were constructed so that more elaborate tests might be made. Thus, for a while, the section's activities were more concerned with research and engineering problems than with the actual production of promotional pictures. Since a new art was being created, new tools were required. Such commonplace today as double rewinders, sound editing machines, silent cameras, microphone booms, sound printers and the like were unknown. Much ingenuity was exercised in constructing equipment to meet the needs. A director's model moviola, for example, was rebuilt with a sound pick-up, amplifier, and head phones to facilitate sound cutting. The same apparatus, slightly improved, is in use today. Various systems of camera drive and silencing were tried out. Even the simple job of printing had to be changed to allow for proper masking. A bit later, Bell & Howell built a special printer for our use which simultaneously prints the sound and picture negatives correctly. Methods of laboratory control were solved after hundreds of tests involving the then intricate business of sensitometry and densitometry.

(To be concluded in Issue Six)

Now you can afford to use *talking motion pictures!*

NEW AMPRO SOUND MODEL "X"

The outstanding medium for sales training and business building — a light compact precision sound projector complete in one case . . .

\$275



● There is a great deal more sales punch—more human persuasiveness, more sparkle, life and interest—in motion pictures that utilize voice, sound and music. Until now many industrial users of 16mm. films have hesitated to employ sound pictures because of the high cost of sound-on-film projection equipment.

Today, Ampro announces two radically new and improved low-priced 16mm. sound-on-film projectors that open unlimited possibilities for the increased use of sound films. Mind you, these are not projectors "built down to a price" but basically new designs that provide quality sound projection at "within the budget" prices.

These new precision units offer BRILLIANT 750-1000

WATT ILLUMINATION, SUPERIOR SOUND QUALITY.

CENTRALIZED ILLUMINATED CONTROL PANEL and SIMPLIFIED THREADING.

Model "X" — equipped with 60 cycle A. C. motor, including 1600 foot reel, 8" dynamic speaker, complete accessories and cords, comes in one case all weighing only 49 lbs. \$275

Model "Y" — equipped with Universal A.C.-D.C. motor for both silent and sound film speeds, including complete accessories and cords, with 12" dynamic speaker, comes in 2 compact cases \$295.

(Model "Y" also is available in one case, complete accessories, with 8" speaker).
Send Coupon For Full Details.

Easy Cleaning Optical System — The reflector and condenser lenses are mounted on front cover. By merely unscrewing three knurled studs, the cover is removed exposing the lenses for quick cleaning.

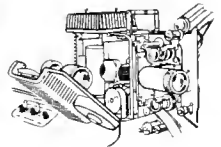

Centralized Control Panel — All switches and controls mounted on one illuminated panel to facilitate operation in darkened room. The compensator knob on this panel controls photo-cell hiss and exciter lamp voltage so there is surplus reserve amplification even at low line voltages.

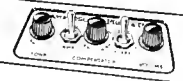

Compactness and Light Weight — Model X Projector and all accessories pack easily and quickly into one case weighing only 49 lbs.
Simplified Threading — Threading is as simple as threading silent projector; with exception that film also loops around sound drum, eliminating fiddling with over a third strike. Film guides assure correct, easy threading.

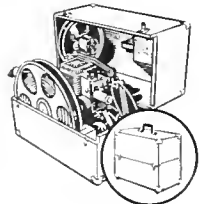

AMPRO

PRECISION CINE EQUIPMENT

Ampro Corporation, 2839 N. Western Ave. Chicago, Ill.

Please send me the new 1939 Ampro Catalog. I am particularly interested in:

- New Amprosound Models "X" and "Y"
- Ampro 16 mm. Silent and Convertible to Sound Projectors
- All Ampro 16 mm. Sound Projectors including Ampro-Arc
- Ampro 16 mm. Continuous Projectors (for Displays—World's Fair and Covention Exhibits)

Name _____

Address _____

City _____ State _____

BS139

“MEN
MAKE
STEEL”
is going over
with
4,500,000



National Coverage with
35 mm. Sound Motion
Picture Projection Service



THE story of steel is the story of mankind's escape from drudgery.

In Technicolor motion picture* form, the dramatic story of iron and steel is being shown before both theatrical and non-theatrical audiences.

The Jam Handy Organization is glad to participate in the success of this dramatic educational program by having these showings held through its theatrical and non-theatrical facilities for commercial picture distribution.

Produced in Technicolor for United States Steel Corporation by Hollywood Industrial Pictures, with the supervision of Batten, Barton, Durstine & Osborn.

The **JAM HANDY** *Organization*

Slidefilms • Talking Pictures • Sales Conventions • Playlets
New York, 230 Park Avenue, *MURRAY HILL* 9-5290 Detroit, 2900 East
Grand Boulevard, *MADISON* 2450 Chicago, 35 East Wacker Drive,
STATE 6758 Hollywood, 7046 Hollywood Boulevard, *HEMPSTEAD* 5809

B Business Secret

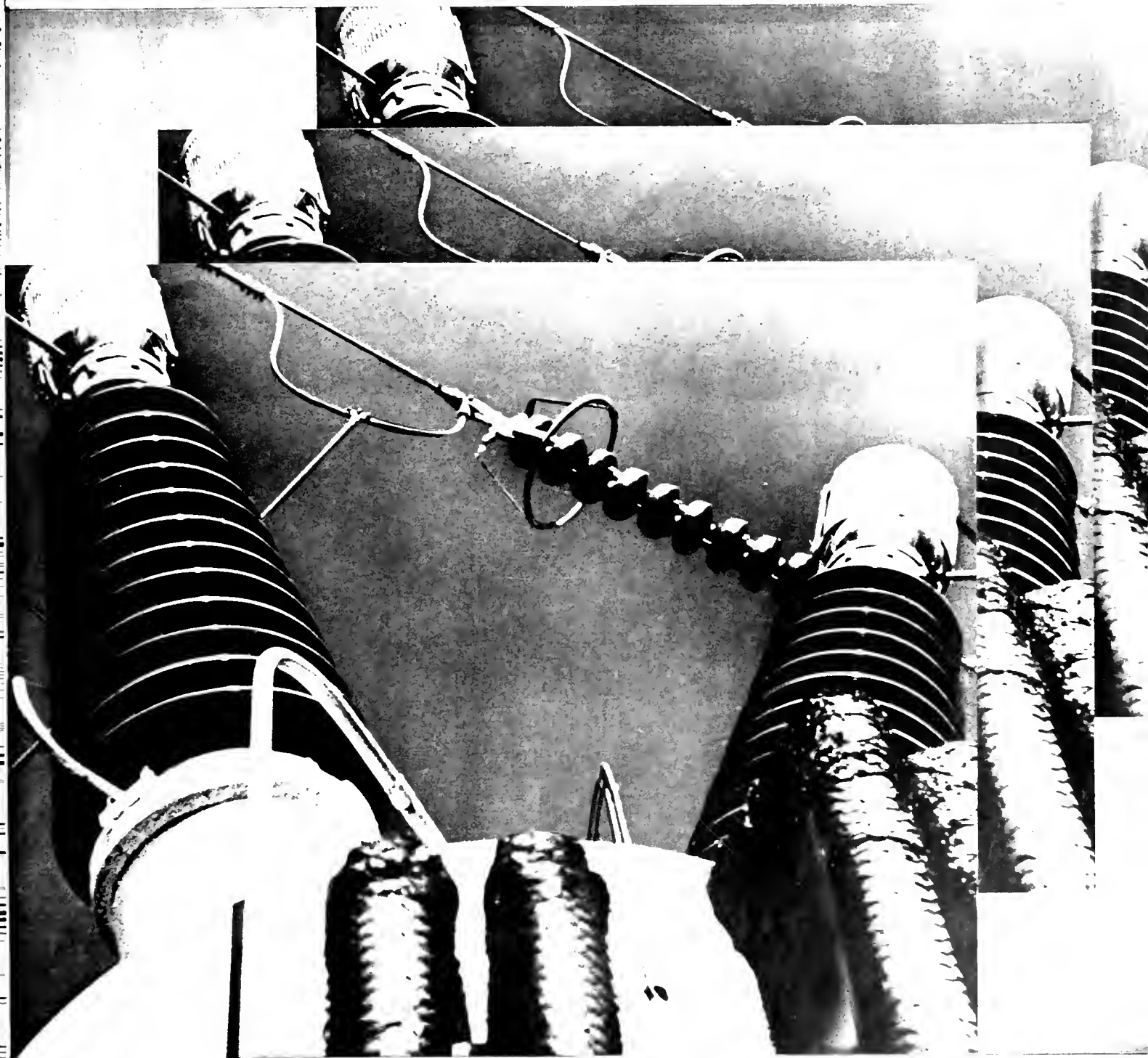

IN THIS ISSUE: FILMS & OTHER MEDIA; ROLL DOWN THE RED CARPET; EXHIBIT THEATRES AT THE FAIRS; AWARD NOTES

**M
U
S**

"MAYBE I'M YOUNG ...

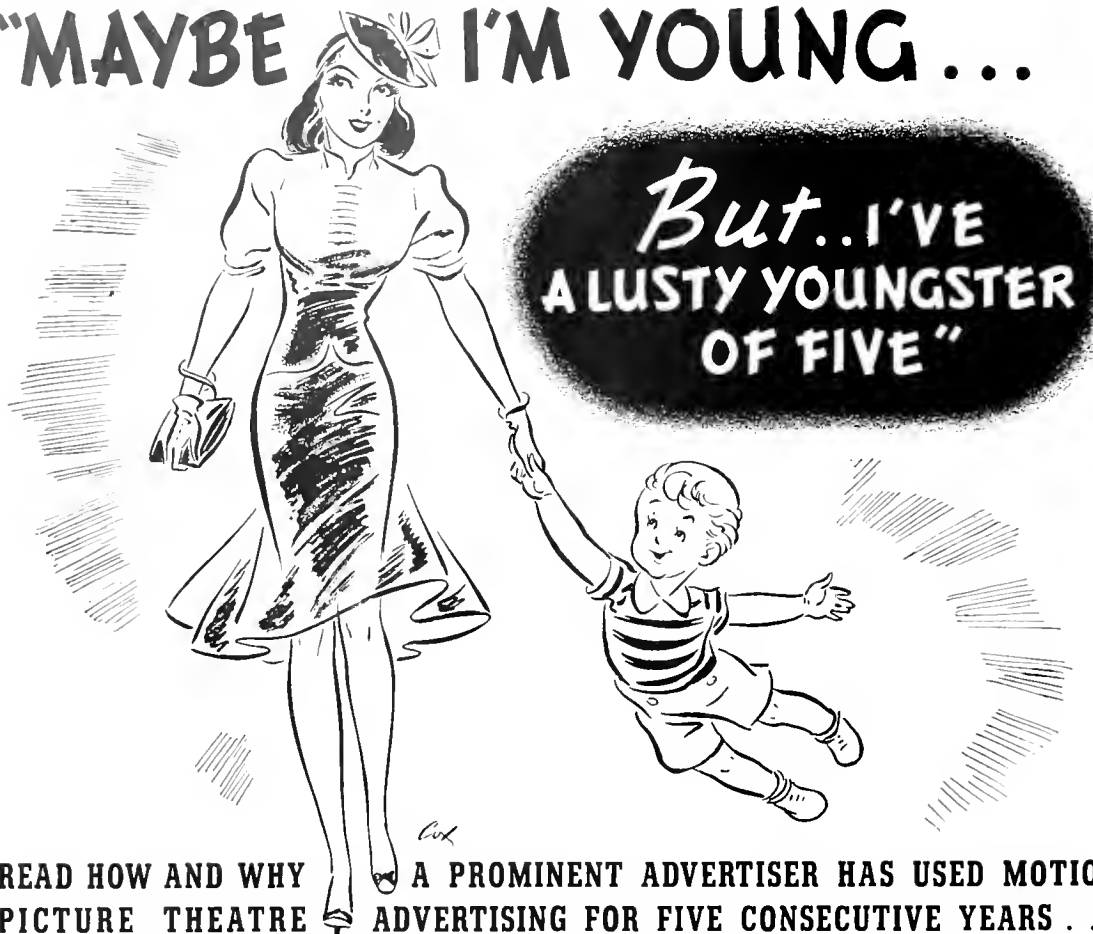

READ HOW AND WHY A PROMINENT ADVERTISER HAS USED MOTION PICTURE THEATRE ADVERTISING FOR FIVE CONSECUTIVE YEARS . . .

IN comparison with other national media, motion picture *consumer* advertising is young: the use of theatre screens for national advertising is less than six years old.

Young, yes—but already mature and strong enough to point to a family of happy clients—aggressive advertisers who are leaders in their fields.

For instance: Case History B. The client is the largest manufacturer of better type shoes in the country. In 1933 Minute Movies were tested with a full color playlet—demonstrating various technical features and showing new styles and colors. The company's dealers paid part of the cost of the

program. The Minute Movie was so successful in selling these high priced shoes that a large majority of the dealers decided to spend additional amounts of their own money if the company would use the plan again. It did—and has for eleven consecutive seasons.

To help you harness the sales punch of one minute films to your advertising program we offer more than 8,400 theatres from coast to coast. You may select as many or few as needed for your plans. Let us give you the results of other campaigns booked and serviced through our organization and let us show you some of the Minute Movies now in use.

GENERAL SCREEN ADVERTISING, INC.

MEMBER A. F. A.

WRIGLEY BLDG. • CHICAGO, ILL.

National Sales Representatives:
MACY & KLANER
 Wrigley Building Chicago, Illinois
JAM HANDY THEATRE SERVICE, INC.
 General Motors Bldg. Detroit, Mich.
 General Motors Bldg. Detroit, Mich.
 New York City



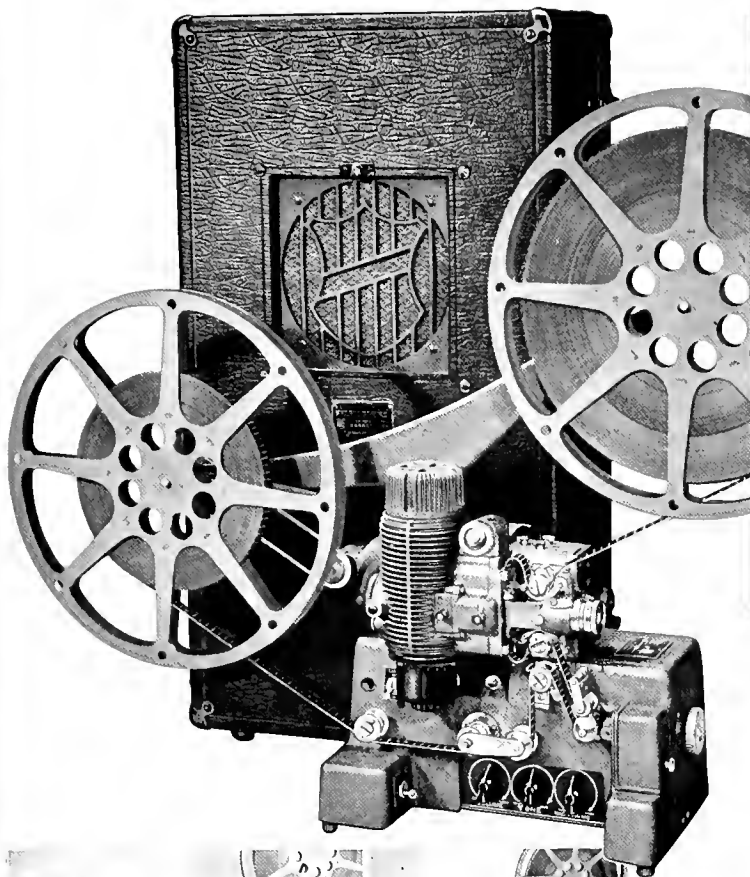

Filmosounds...
FOR EVERY NEED
and all
supremely fine!

FILMOSOUND "COMMERCIAL" (left). Those who show your business film will appreciate this compact, single-case Filmosound for office, salesroom, hotel room, or medium-sized auditorium. It is easy to carry, and easy to set up, too. No fuss, delay, or embarrassing complexities. Has 750-watt lamp, powerful amplifier, 1600-foot film capacity, speaker-hiss eliminator, "floating film" protection, and provision for using microphone or phonograph turntable. Quantity production and simplified controls make possible its new "bargain" price. Complete, only \$276

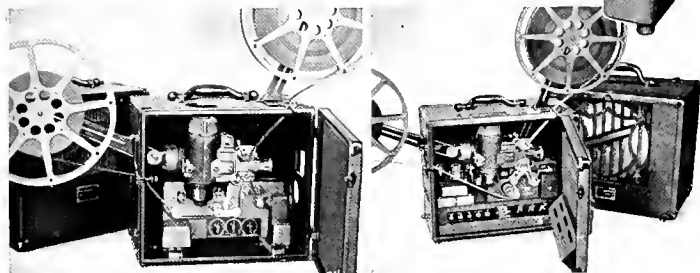

FILMOSOUND "ACADEMY" is the same as the "Commercial" except that (1) it is in two cases, one enclosing the projector for quiet operation, and (2) it projects both sound and silent film. Complete, only \$298

FILMOSOUND "MASTER." A powerful 16 mm. sound film projector for serving larger audiences. Offers the wide range of services of the "Utility," plus even greater audience-handling capacity. Price \$410

FILMOSOUND "UTILITY" offers all the features of the "Academy" plus greater picture illumination, greater maximum sound volume, clutch permitting still picture projection, and reverse lever for repeating sequences. Complete, now only . . \$369

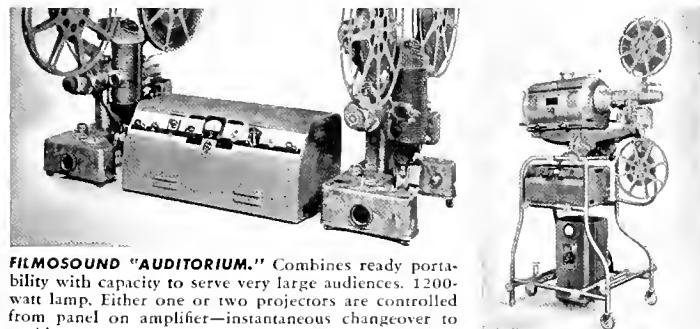

FILMOSOUND "AUDITORIUM." Combines ready portability with capacity to serve very large audiences. 1200-watt lamp. Either one or two projectors are controlled from panel on amplifier—instantaneous changeover to avoid program interruptions. From \$875

FILMOARC provides the ultimate in screen brilliance and sound volume in largest auditoriums. Yet it is simple to operate because of automatic carbon feed, centralized controls, and mistake-proof connections. Priced from . . \$1500

Here's Why You Need Filmosound Quality

WHEN you select projectors to show your business film, consider the task they must perform. They must project brilliant, flickerless pictures and reproduce sound faithfully and without distortion from tiny 16 millimeter film which races through the projector at a rate of 24 pictures every second! Your projectors must protect the delicate film from scratching and wear, must be easy to use, must make a showmanlike presentation *every* time.

These—and many more—are "musts" best met by Filmosounds, made by the makers of preferred Hollywood cinemachinery, and the choice of such leading business film users as Chrysler, Ford, General Motors, and hundreds of others.

There are many 16 mm. Filmosounds. Each serves certain needs best. Most have been recently reduced in price. All are of one quality—the finest! Mail coupon for details. Bell & Howell Company, Chicago, New York, Hollywood, London. *Established 1907.*

MAIL COUPON FOR DETAILS

BELL & HOWELL COMPANY BS NO. 6
 1808 Larchmont Ave., Chicago, Ill.
 Send details on 16 mm. Filmosounds for business use.
 Interested in models: () Commercial; () Academy;
 () Utility; () Master; () Auditorium; () Filmoarc.
 Name.....
 Company.....
 Address.....
 City.....State.....

PRECISION-MADE BY
BELL & HOWELL



BUSINESS SCREEN

VOLUME ONE

NUMBER SIX

Contents

Cover Subject: Insulators-Symbols of the New Power from the F. A. A. of Britain produced and directed by Paul Rotha for G. B. Instructionals, London.

Camera Eye.....	9
Films Sell Other Media.....	11
Telling the World About Magazines.....	12
Radio & Trade Paper Films.....	13
The Offscreen Voice.....	14
Roll Down the Red Carpet.....	15
Business Looks at Screen Advertising.....	17
The A-B-C's of Agency Film Activities.....	18
Business Screen Previews the Fair.....	19
Foreign Government Films.....	20
Get Over Into Clover.....	23
The Business Film Abroad.....	24
Technical Review of the Month.....	27
The Hormone Woman.....	34

♦ Business Screen Magazine, issued by Business Screen Magazines, Inc., Twenty North Wacker Drive, Chicago, Illinois on March 20, 1939. Editorial Director, O. H. Coehn, Jr.; Managing Editor, R. C. Danielson. *Acceptance under the Act of June 5, 1934, authorized February 20, 1939* Issued twelve times a year, including four *Visual Education* numbers. Subscription price: Domestic, \$5.00 a year; 50¢ the copy; foreign, \$6.00 a year (twelve numbers). Publishers are not responsible for the return of unsolicited m.s. unless accompanied by stamped, self-addressed envelope. Entire contents copyright, 1939, by Business Screen Magazines, Inc. Trademark Registered U. S. Patent Office.

The Magazine of Commercial and Educational Films

The FILM FORUM

A COLUMN OF LETTERS FROM OUR READERS



Training Retail Clerks

We greatly appreciate the consideration shown us in notifying various firms of our desire to secure information regarding slide films. We have written to several of these firms, and are trusting that we will receive same, as we feel that they can be used to a great advantage in our educational meetings with our sales force.

We operate a chain of 20 retail department stores, and it is my desire to bring my sales force together at stated times in an effort to better acquaint them with the manufacture and construction of different kinds of material and merchandise that we stock. I feel that motion pictures and slide films will be the best method to employ to bring about the desired results. I know that an impression received through the eye has more staying power than one received through the ear alone. I feel that if I can educate my selling force to the point where they will have a concise knowledge of the merchandise which they are selling; they will be able to present these facts to the customer in such a way that the customer will purchase the product, because he too will know the value of the article presented for sale.

I feel that a sales person who has seen a picture of the manufacture of wool from the time it leaves the back of the sheep until it is completed into a beautiful blanket will not only be able to make a sales talk that will result in a sale; but will at the same time appreciate the fact that she is offering something wonderful and beautiful, and will even in spite of herself radiate a certain enthusiasm, born of the confidence she feels in knowing her product, that will be contagious.

Not only will this work out in the completion of more sales, but I feel like a knowledge gained in this manner will also help the sales person to feel that he is an integral part of a set-up that has something to it other than just the across the counter contact. This feeling will physiologically tend to instill in the clerk a feeling of contentment, knowing that she is a part of such a great scheme of things; and it will lift her out of the humdrum of every day selling.

Your cooperation will be greatly appreciated.

JOE WOLENS

*K. Wolens Department Stores, Inc.
Corsicana, Texas*

The British Film Field

Business motion pictures in this country are not so widely developed as they are in yours and many rather

lamentable efforts have been pursued with the result that the Commercial Film has fallen into disrepute.

I want you to realize the great difficulty we have over here in flying the flag for Commercial Films. English businesses and audiences are nothing like so publicity minded as yours, with the result that Commercial Films have had to be produced largely as entertainment features or documentaries, and you will realize that the fund of ideas for both of these if, after a few years, becoming somewhat limited.

The Slide-Film is practically unknown over here, in fact it is, to my knowledge, only used in the cheaper form of "Trailer" for legitimate film entertainment.

I wonder whether you would be willing to co-operate with us in supplying material dealing with the production of films designed to teach the Fundamentals of Salesmanship. At the moment there is no organization over tackling this important side of the business.

A. CAMPBELL GIFFORD, *Editor
Commercial Film Review
London, England*

Bureau of Mines Films

I have read with very much interest articles appearing in *Business Screen* pertaining to activities in the educational film world.

We have at the present time approximately 5000 reels in our library that were shown last year on 100,352 occasions to an attendance of over 10,000,000 persons. All expenses incidental to the production of these films are paid for by American industry, as well as that of providing copies for Government distribution. The prints are loaned free of charge with the exception of transportation costs. During the past eighteen years members of the mineral and its allied industries have appropriated approximately \$1,000,000 in order to carry on this work.

M. F. LEOPOLD, *Safety Engineer
U. S. Dept. of Interior
Bureau of Mines*

Note of Appreciation

I wish to compliment you on the article in your recent issue entitled *Baseball's Good Will Ambassadors*. This subject was very capably handled, and we wish to extend our "thanks".

LEW FONSECA
*Director of Promotion
American League of
Professional Baseball Clubs*

LEADING FILM PRODUCERS RECOMMEND DA-LITE SCREENS

For Perfect Showings

of "THE TUTTLE TUGGER"

DEERE & COMPANY'S

NEW 4 REEL
SOUND MOTION PICTURE



WILDING

PICTURE PRODUCTIONS, Inc.

Advised— "Use DA-LITE SCREENS"

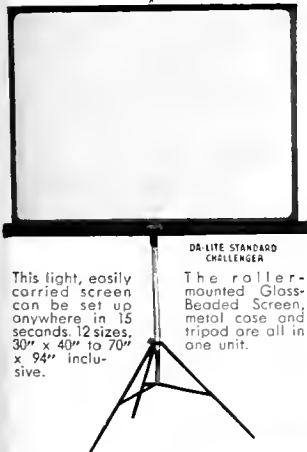

This light, easily carried screen can be set up anywhere in 15 seconds. 12 sizes, 30" x 40" to 70" x 94" inclusive.

The roller-mounted Glass-Beaded Screen, metal case and tripod are all in one unit.

Wilding Picture Productions, Inc., reports that it has used and recommended DA-LITE Screens for more than a dozen years with entire satisfaction.

"We have found no acceptable substitute for DA-LITE", says Mr. Norman E. Wilding, President, "and have urged its use by our clients. Some recent Wilding productions now being shown on DA-LITE screens include

"This Year It's Oldsmobile"

FOR THE OLDS DIVISION OF GENERAL MOTORS CORPORATION

"Let's Go Modern"

FOR THE CHRYSLER SALES DIVISION, CHRYSLER CORPORATION

"Dan Dope Marches On"

FOR THE WILLARD STORAGE BATTERY COMPANY

"They Discovered America"

FOR THE GREYHOUND MANAGEMENT COMPANY

Experienced users as well as leading producers of business films specify Da-Lite Screens for brilliant projection, unmatched convenience and long dependable service.

Scene from "The Tuttle Tugger" Deere & Company's new sound motion picture. Deere & Company use several types of Da-Lite Screens including the Challenger shown here which has a tripod attached and can be set up instantly anywhere.



NEW FREE DATA BOOK

Mail Coupon Now!

**DA-LITE
BUSINESS SCREENS**

DA-LITE SCREEN COMPANY, Inc.
Dept. 6B, 2723 N. Crawford Ave., Chicago, Ill.

Without cost or obligation to us please send your NEW data book on screens and the surfaces and mountings which are most suitable for showing business films.

NAME.....
FIRM NAME.....
ADDRESS.....

THE MOST COMPLETE STOCK SHOT LIBRARY IN THE WORLD . . .

OVER 19,000,000 feet of original negative is now available — and thousands of feet of new film are being added daily by Pathe's production and news departments ● Subjects include Army, Navy and Air Force maneuvers — strikes and riots — floods, explosions and other catastrophes — all sports — Important national and international personalities — Nationwide aerial shots — major industries, farming, mining and manufacturing — scenics, domestic and foreign ● Avail yourself of this wealth of material and slash production costs by eliminating transportation and location expense — reducing weather hazards — saving airplane charter — cutting studio costs ● Pathe offers you efficient selection and screening facilities, speediest delivery and quality prints from original negative ●



PATHE NEWS INC.

George P. Mills, Library Sales

35 WEST 45th ST., NEW YORK CITY

SO SIMPLIFIED —

A Novice Can Operate It

Because The New
AMPROSOUNDS Offer—
 • Centralized Operating Panel
 • Extreme Portability and Compactness
 • Quick Easy Set-Up

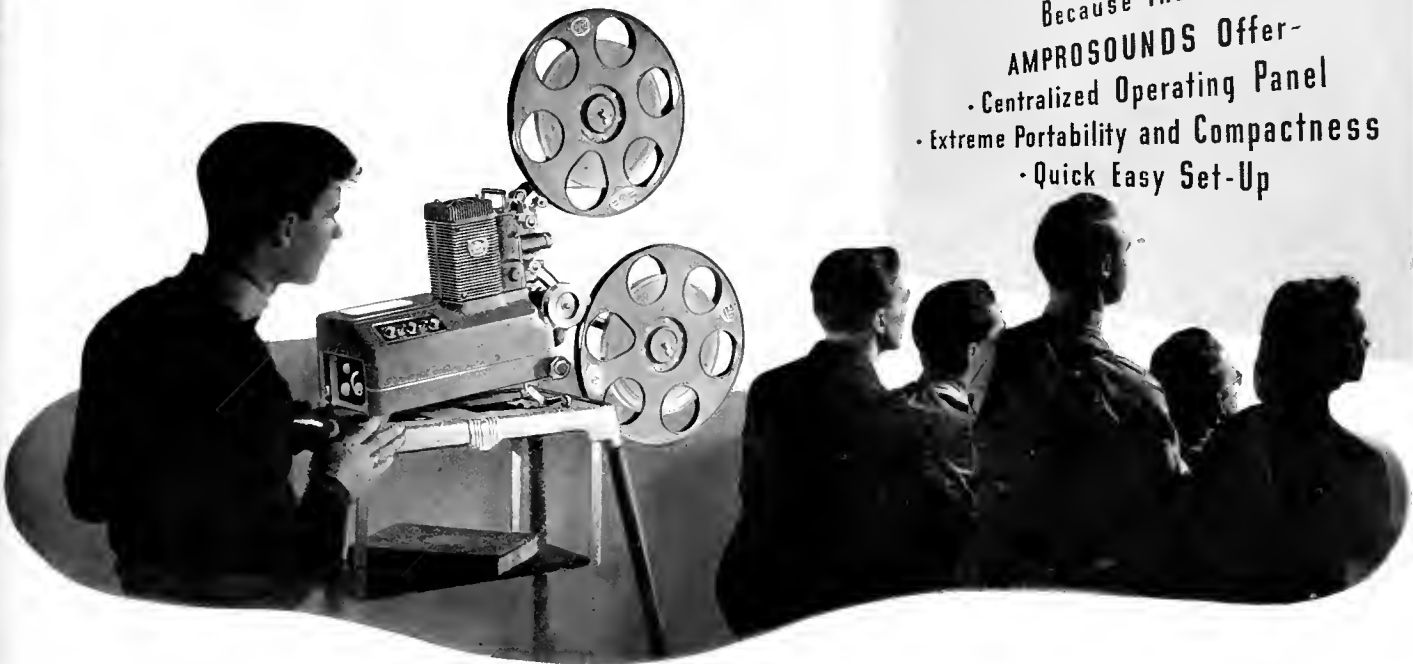

So Quiet... NO "BLIMP" IS NEEDED...

**... And So Low in Price
 Every Budget Can Afford It**

For school, home, church or industry — these remarkable new Ampro Sound Projectors now give you sound pictures inexpensively — anywhere and at a moment's notice! You simply set up the machine, plug it in and turn it on. It is as simple as that! All controls are centralized on one convenient illuminated panel. Threading has been simplified so that it is as easy as on the ordinary silent projector. Truly — the merest novice can operate these new units as easily as a radio.

Another important feature of Ampro's new Models X and Y is the **EXTREME QUIETNESS** of operation. There is none of the customary objectionable loud hum. When you are right next to the projector itself you are scarcely conscious

of its operation. The proof of all this is the fact that no case or "blimp" is required to cover the projector when it is being operated.

Convenient portability is another characteristic of the new Ampro sound models. These machines can be packed in a few moments time — they swing into operation as easily and as quickly as a portable typewriter!

MANY OTHER UNUSUAL FEATURES

In addition, the new Amprosound Units offer numerous other special features and advantages that make them today's greatest sound projector values. These include: A Quick-Cleaning Optical System; Economical Operation with the standard pre-focused projection lamps; New Simplified Design — it is just mechanically impossible to tear film perforation — and fast Automatic Rewinding. And to top these all are the new low prices — so that now even the most infrequent user of sound films can no longer af-

ford to be without efficient sound projection equipment. Send coupon below for full details.

—NEW LOW PRICES—

Model "X" — equipped with 60-cycle A. C. motor, including 1600-foot reel, 8" dynamic speaker, complete accessories and cords, comes in one case all weighing only 47 lbs. **\$275**

Model "Y" — equipped with Universal A. C.-D. C. motor for both silent and sound film speeds, including complete accessories and cords, with 12" dynamic speaker, comes in two compact cases **\$295**

(Model "Y" also is available in one case, complete accessories, with 8" speaker.)

Ampro
 PRECISION CINE EQUIPMENT
 2839 N. WESTERN AVE., CHICAGO, ILL.

Please send me the new 1939 Ampro Catalog. I am particularly interested in:

- New Amprosound Models "X" and "Y".
- Ampro 16mm. Silent and Convertible to Sound Projectors.
- All Ampro 16mm. Sound Projectors, including Ampro-Arc.
- Ampro 6mm. Continuous Projectors (for Displays — World's Fair and Convention Exhibits).

Name _____
 Address _____
 City _____ State _____

85239

BEHIND YOUR NEXT PRODUCTION

TECHNICAL SKILL ACQUIRED IN OUR YEARS OF SUCCESSFUL FILM PRODUCTION FOR MANY NATIONALLY KNOWN CONCERNS CAN SOLVE YOUR MOTION PICTURE & SLIDE FILM PROBLEMS

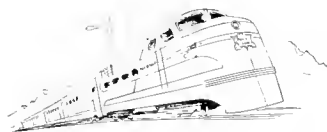

MERCHANDISING

"Food for Thought" — increased sales for John Morrell & Company, Libby, McNeill & Libby, Stewart-Warner Corporation, The Red and White Corporation and the Roquefort Association are some of the others who have profited from Chicago Film Laboratory merchandising presentations.



EDUCATION

"Fit for the Future", the absorbing story of life at Culver Military Academy. Other educational films currently in production include a dental hygiene film for Kynos and for the Chicago Park System, a series being released for theatre showings.

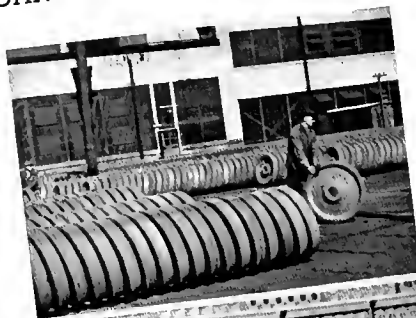

TRANSPORTATION

"The Story of the Chilled Car Wheel", a dynamic picturization for the American Association of Car Wheel Manufacturers — and from car-wheels to comfort — a series of films on travel over the Rock Island Lines.

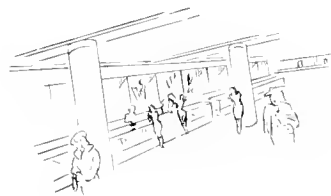

INDUSTRY

"Snow Fighters", produced for the International Harvester Company, stars modern industrial machines in a drama of men against nature. We are justly proud of our list of industrial clients, which includes Allis-Chalmers Mfg. Company, The Studebaker Corp., the Caterpillar Tractor Company, the Chain Belt Company and the American Seating Co.

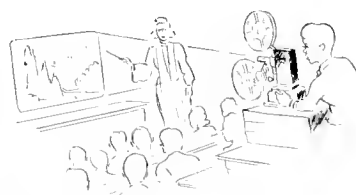

MEDICINE

Skill in production accurately records the skill of the surgeon — a scene from one of the fine obstetrical films made in collaboration with Dr. J. B. De Lee of Chicago's Lying-In Hospital. Among other clients in this distinguished field — the American College of Surgeons and the Petrolagar Laboratories.

CHICAGO FILM LABORATORY, INC.

MOTION PICTURES

STUDIO AND GENERAL OFFICE



SLIDE FILMS

18 W. WALTON PLACE • WHITEHALL 6971

CHICAGO, ILLINOIS

•How Does Hollywood do it? Not content with juggling double-features in all their class a-b-c-and x profusion, mixing it with the government on the trust charges and doing a little commercial production on their own, our feathered friends on Sunset Boulevard are now handing out, via the press and exploitation route, statements decrying the "menace" of theatrically-released commercials. These misleading remarks from the worst-informed members of this colony have no importance, particularly in light of the fact that the comparatively small theatre chains they represent, (as in the case of Warner's) have never shown commercial screen subjects since they prefer to sell their own shorts and to advertise, at considerable length, their own features.

The proposal of the Motion Picture Producers and Distributors to label all sponsored films with an "advertising" seal in the title frames has been publicized extensively by the amusement and advertising trade press. Nowhere has the important fact appeared that the MPPDA "controls" only about 1500 of the sixteen thousand theatres in America, that the majority of these have never shown "commercials" and that, finally, the audience and the exhibitor are the only important judges. Certainly there is not the slightest moral or ethical angle involved for these producers have exploited and encouraged advertising-feature tie-ups for the past three decades.



CAMERA EYE

NEWS AND COMMENT
ON BUSINESS FILMS

♦ That such a production as *Men Make Steel*, sponsored by the United States Steel Corporation and containing no "subversive" propaganda (unless the existence of that company and its plants is now considered subversive) is far better entertainment than the typical "musical short" sold to the exhibitor is not even questioned. Perhaps what is questioned is that the "free" film lost the entertainment producer a sale for his "short."

♦ WE HATE to do this, but the statistics compel us to announce that there are now twenty-one current business films beginning with the words *Romance* and *Romantic* and forty-four that start out with the very original *Story of*.

♦ ALTHOUGH TELEVISION, according to such competent observers as Commander Eugene McDonald, president of Chicago's Zenith Radio Corporation, is still far from ready for the market, the New York Fair ballyhoo surrounding the RCA-National Broadcasting Company exhibit has built up more interest in the commercial film angles involved. Certain it is, as we predicted some issues back,

that commercial pictures will be the most economical solution to present telecasting problems. For the moment, though, we believe that advertisers and producers alike can look upon this branch of the business as a "future" interest and concentrate on the very useful jobs which films can and should do in many unexplored fields.

♦ SOON-TO-BE-PUBLISHED: Articles by Nathan D. Golden, chief, Motion Picture Division of the Department of Commerce; by J. T. Gaffill on the subject of industrial film audiences; and the annual awards issue of *Business Screen*. A complete equipment digest is also in preparation for spring publication.

♦ NEW AND IN THE NEWS: Allegorical pictures illustrating the development of various phases of Canada, including farming, mining and manufacturing are to be produced by the Dominion Government under a National Film Board setup. *Show Your Colors*, a public relations picture dealing with traffic problems and sponsored by the Shell Petroleum Corporation is now being produced.



Unusually interesting to American audiences who have seen them are the "table-top" color-abstractions produced by Theo Gusten of Amsterdam, Holland for the advertising screen and now being viewed over here.



Motion Pictures (see page 27) bringing together both sound and the X-Ray are another recent importation showing in America. The little fellow above is a monkey featured in *X-Ray action*.



The typical scene from one of Alka-Seltzer's many screen ad shorts brings up the subject "Business Looks at Screen Advertising" which appears on Page 17 of this issue as the first of a new article series.

★ FIRST NOMINATIONS ★ by the Business Screen Awards Committee

SOUND MOTION PICTURES

Men Make Steel, U. S. Steel Corp.
Selling America, Iam Handy Org.
Jerry Pulls the Strings, American Can Company
First Century of Baseball, Fisher Body Co. & American League
All in a Day, Consumers Power Co.
New England, Yesterday & Today
This Way Please, Remington Arms Company
It's the Little Things that Count, Bates Manufacturing Company
Yankee Doodle Goes to Town, Collier's Magazine
Word Magic, Aetna Life Insurance Co.
Hurricane's Challenge, American Telephone and Telegraph Co.

SOUND SLIDEFILMS

The Fall Guy, National Safety Council
Glidden Paint Company, Slidefilm
Pittsburgh Plate Glass, Slidefilm
Spinning Power — Globe Union Co.
Hothouse Legs, Cooper's, Incorporated
How to Win Sales, General Electric Co.
Let George Do It — General Electric Co.
Your Company's Voice, N. Y. Telephone
Century of Service, Norfolk & Western R. R.
Step Up Sales Plan, Dartnell Corp.
Dealer Training Series — 1935, released by The Coca-Cola Company
Westinghouse Dealer series, 1935, Westinghouse Electric Co.
Buyership Series — Household Finance

OVER TWO HUNDRED FILMS HAVE BEEN REVIEWED AND THE SELECTIONS ARE BY NO MEANS COMPLETE. NOMINATIONS ARE STILL BEING ACCEPTED FROM SPONSORS AND PRODUCERS UNTIL APRIL 25, 1936.



Champions of the Grid-iron, sponsored by General Mills for national release and produced by Industrial Pictures of Detroit, will make you stand up and cheer as a year's review of pro football is screened.

THE POWER OF **MOTION** **SIGHT** **SOUND**

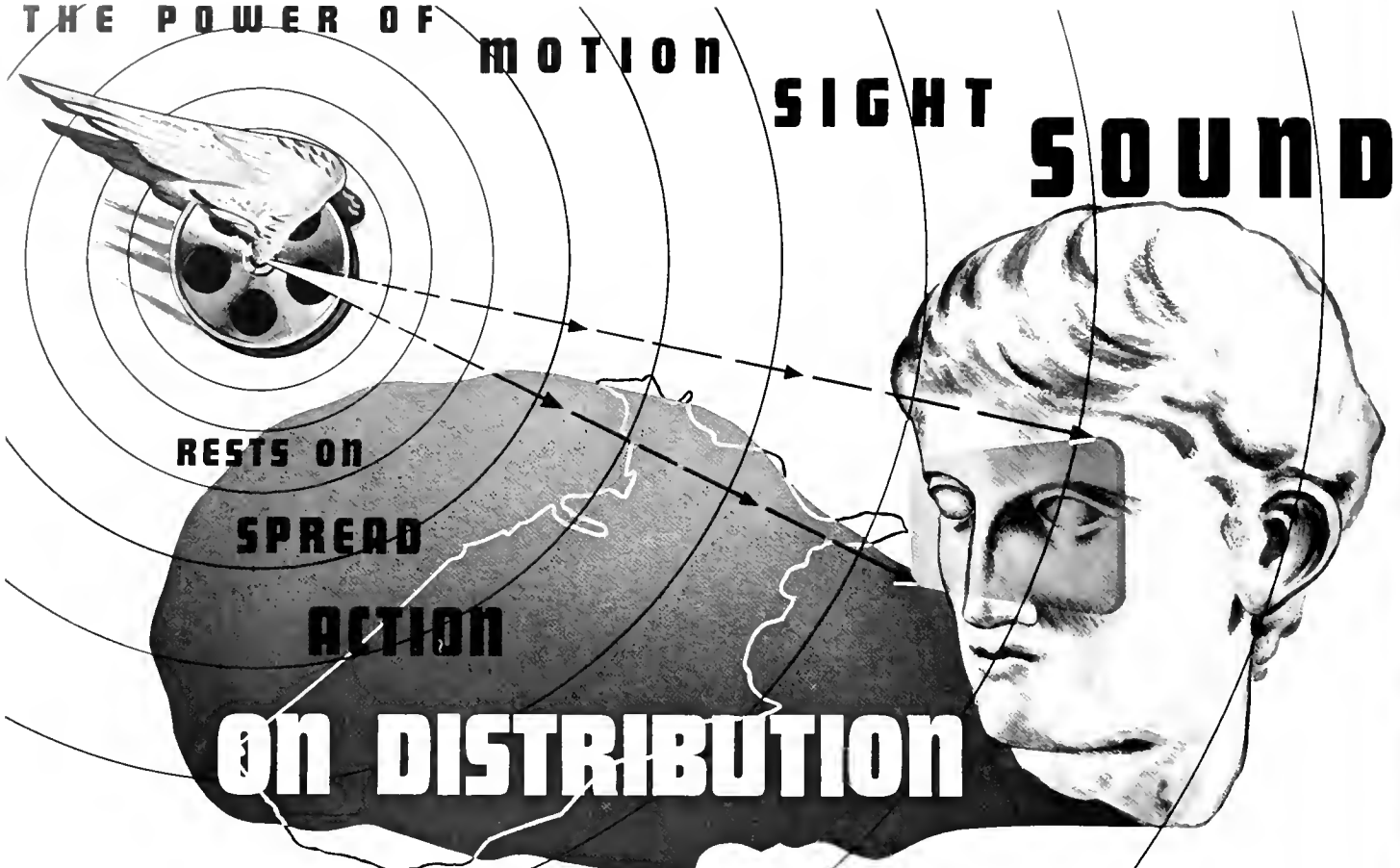

RESTS ON

SPREAD

ACTION

ON DISTRIBUTION

There is no substitute for the ability of the commercial talking picture in presenting the life, products and services of an organization. The talking picture creates a reality that is above competition.

But until the commercial talking picture commands its audience, until it has the spread and action of selective national distribution, it remains "gold in them hills"; gold awaiting release; gold to be turned into the profits which come through consumer acceptance. That is where MODERN TALKING PICTURE SERVICE gets into action with its national organization devoted entirely to the distribution and display of commercial talking pictures.

MODERN TALKING PICTURE SERVICE gives the power of distribution, selective, tested, *stipulated* distribution, to business films. It distributes and displays the commercial picture where, when and how the advertiser requires.

MODERN TALKING PICTURE SERVICE, through its national chain of fully equipped and technically staffed local units, provides geographic, class and sex distribution for business films.

MODERN TALKING PICTURE SERVICE numbers many of the greatest commercial institutions of this country among its clients. It would like to explain to any business executive just how its service can be applied to his advertising-sales problems.



TRADE-MARK REG U. S. PAT OFF

MODERN TALKING PICTURE SERVICE, INC.

9 ROCKEFELLER PLAZA (An Independent Organization) NEW YORK CITY

• THE FRIENDLY inter-relationship of motion pictures and slide films with magazines, newspapers and radio stations is now being generally realized in the widening use of these media for promotion, public relations and advertising sales.

No competitor of magazines or newspapers for the advertiser's dollar since the bulk of its revenues are drawn from sales promotional and public relations budgets, the business film's growing popularity as an unerring salesman and educator is especially noteworthy at the New York World's Fair and the San Francisco Exposition. The field of screen advertising, where some newspaper groups have expressed a feeling of potential competition, apparently offers little challenge due to the limited screen time actually available and, again, the limitations of types of selling which can be done in this manner.

A vastly larger field of subjects intended for non-theatrical showings to business and the public via organization meetings, exhibits, luncheon and dinner groups, etc. is being explored by the media. Two of the latest productions, *Yankee Doodle Goes to Town*, now being shown by *Collier's* and *I'll Tell The World* to be screened by Macfadden Publications in their New York World's Fair theatre illustrate the type of film being used. Literally hundreds of showings before almost every type of business group have been attained by *Collier's*. A large number of prints are kept constantly in circulation as requests continue to mount.

♦ Not only club groups but promoted audiences in department stores have applauded the color feature circulated by *House Beautiful Magazine* on the subject of the "bride's house" and its modern furnishings. *McCall's* has also been active in the consumer field and has used films as a part of its ingenious promotional programs.

Curtis representatives calling on *Ladies Home Journal* advertising prospects may find full-color slide-films useful in depicting the lavish color spreads which feature outstanding departments in the magazine. In this field, incidentally, full-color Kodachrome and Technicolor slidefilms are being more widely used than ever before to bring home to dealers the full power of the advertiser's own campaign. Swift & Company, Owens-

Illinois and others are recent users of this medium. A film to increase dealer interest in national advertising copy was employed by Commonwealth Shoe & Leather Company, maker of Bostonian and Mansfield shoes for men. Sequences illustrated the preparation of the national campaign for 1939 including the development of copy and illustrations through various stages at the company's agency, Fuller, Smith & Ross, New York.

In the field of trade magazines, some interesting pioneering effort has been undertaken by the Breskin & Charlton publications, *Modern Packaging* and *Modern Plastics*, two outstanding leaders. Both educational and prestige "angles" were employed in two sound motion pictures issued and short color sequences successfully employed to "sell" the publisher's awards in the respective fields. Other publishers in the industrial and marketing brackets have produced slidefilms, both silent and sound, and these appear to be destined for increasing use because of their flexibility and economy.

Newspapers and radio stations have not been nationally active in the adoption and use of the film medium but wherever anything has been done, the results have apparently been most gratifying. Such productions as the *Chicago Tribune* film, *Trees to Tribunes* and the educational films produced for the *New York Sun* and the *Baltimore Sunpapers* are typical examples. Film authorities who have reviewed these pictures believe that the metropolitan newspapers are missing a good bet by



not amplifying their own marketing stories, using motion pictures and slide films to depict reader families, neighborhoods and dealers served by the paper and thus add the production story of the "making" of the paper as a secondary sequence.

Incidentally, the use of local motion picture newsreel tieups for the promotion of metropolitan papers is an interesting sidelight wherein the best kind of local screen advertising of an indirect nature is used much as in the case of radio news.

♦ The production of *Yankee Doodle Goes to Town* for *Collier's Magazine* brings to the business screen a first-rate public relations-

educational feature employing the best in theatrical technique. Picturizing the value of advertising in relation to our national life, *Yankee Doodle* gains strength from the "universality" of its usefulness. Primarily intended to tell the story of national magazines and advertising, it has found enthusiastic reception among all kinds of business executives who are using it for dealer and sales groups within their own organizations for its very general inspirational and merchandising appeal.

Produced in one of the leading major studios of Hollywood in collaboration with the editors of *Collier's*, the picture's theme is narrated by John Nesbitt, featured MGM commentator and directed by Jacques Tourneur. In 23 trading areas, *Collier's* merchandising representatives arrange group meetings for distributors, dealers and salesmen of organizations wishing to sponsor showings. Both 16mm. and the standard 35mm. are used. Excellent "general interest" promotional material accompanies the film for distribution to the audience.

Excerpts from an Introduction to "Yankee Doodle Goes to Town"

"That's the story of this motion picture. How we got that way — and how one medium of public expression—the national magazine—did more to unify and diversify the thinking, living and buying of the people of the United States than any other. Since its very beginning, this country has believed in and acted upon the material found in the national magazines. Today, these magazines occupy one of the most important parts in our every day life. "Forget for a minute the local picture of your problems — because no matter where you live and where you sell, the national magazine is your local selling aid. In

fact, the people in your community can be judged as prospects by their readership of magazines; the richer the household, the more magazines in it. You know that yourself. . . . "So, enjoy this film which was made for Collier's, The National Weekly. And as you view its episodes remember that the potent force which has unified this country into one compact empire, which has given us more of the good things in life, is now — right now — working for you in your neighborhood, selling and telling your prospects your story . . . paving the way and making not only immediate sales but loyal customers for us all."

Collier's ★
presents
YANKEE DOODLE GOES TO TOWN



"Telling the World about Magazines and Advertising"



• WHAT WAS in the minds of executives of Macfadden Publications, Inc. when they decided to produce a film as the highlight of their exhibit in the Communications Building at the New York World's Fair?

Would they dramatize their publishing organization which has over sixteen million magazines come off the presses each month? Would they dramatize the original features of *True Story* or *True Detective Mysteries* or the health-building articles of *Physical Culture*?

It happened that the little daughter of Fulton Oursler, editor-in-chief of *Liberty*, came home from school one day and announced that her teacher had taught that there was no truth in magazine advertising, that advertising made products cost more, and that there were no end of frauds perpetrated by the advertising copy writers.

Mr. Oursler sat up and gasped. His daughter went on to say that her teacher had read aloud from the guinea pig books, which com-

pared human beings to guinea pigs, allowing themselves to be experimented on through the wiles and words of the copy writers.

The result of the little girl's surprising disclosure was a splendid series of articles in *Liberty*, "The American Way of Life" by George Sokolsky, which covered the advertising methods of practically every manufacturer from automobiles to tomato juice, definitely proving that there was no truth to what the teacher said, and giving the "lie" to the guinea pig books.

This then, would also be the subject matter of a film which Macfadden Publications would produce as the highlight of their exhibit at the New York World's Fair. And a rather unselfish move it was, too — as it did not sell their product from the presses, it sold the idea of advertising and American business methods to Mr. John Public and family.

To manage their exhibit, the publishing house engaged Herbert Crooker. Crooker rolled up his sleeves to tackle the intricacies of the script. And there were intri-

cacies. It had to champion advertising, put the guinea pig books in their place, tell an entertaining story, have love interest, and plenty of humor. It had to prove in an entertaining manner that advertising educated people to the better things in life, stimulated business, creating mass production which lowered prices and gave men jobs. It also had to prove — strange as it may seem — that in the final analysis advertising costs the manufacturer nothing, and the consumer nothing.

First, Joseph Burton, President of Burton's Buttons, came to life via the typewriter. He came to life as a stubborn, old-fashioned party whose business was in a bad way, but who refused to listen to his youngsters' modern ideas. There was his wife, a drab woman who knew little about his business affairs; there were the twins and a little daughter, Sue; and there was Mary, a modern young woman trying her wings in the business world, and admired by Jimmy Harkins, a young advertising agency man.

Love interest? Well, Mary loves Jimmy. But Mary contributes to the Burton household funds, so she has to keep on working. Jimmy wants her to quit her job and marry him. What to do — what to do! Well, it's up to Jimmy to wake up the old man, sell him a bill of goods to advertise and stimulate his failing business.

Humor? That's where Jimmy's sales talks come in. His eloquence is practically a waste of breath. Burton's stubbornness, his ridiculous replies, his absolute "confusion", are what is known as "sure-fire" in picture parlance. To illustrate business methods, Jimmy tells Burton how a soup manufacturer began his business in his own kitchen, but wanting to expand and establish a national product, invested in machinery, then borrowed enough to advertise his soup. Burton's reaction is a rising appetite — "You've made me hungrier than I've been in years. Let's go out and get some cream of tomato soup".

Entertainment is the watch word in Jimmy's advertising sales arguments. To illustrate his points, he describes how great industries were born, and how they grew to gigantic proportions. Included are the orange industry, the canned soup manufacturers, and the automobile industry. The cosmetic industry is introduced in a novel

manner by having Mrs. Burton inspired to do something about her drab appearance. Visiting a beauty salon for treatment and a new hair-dress she emerges with such an amazing transformation that it makes one gasp — and to give the sequence humor, Burton is all smiles when his wife comes to his office, not recognizing her for a moment. The health editorials by Bernarr Macfadden are cleverly put over by Grandpa Burton, an agile and humorous old party, who "can lick his weight in wildcats".

Now we've got somewhat of an idea about the picture, let's go into production. Crooker finished the script, titled it *I'll Tell the World*. Casting began. Jed Prouty, star of fourteen *Jones Family* pictures was signed for the father, Frank Albertson, juvenile star of many pictures, and of the Broadway stage play, *Brother Rat* became Jimmy. The Mauch Twins, (Billy and Bobby), stars of *The Prince and the Pauper* and the *Peurod* pictures, became the Twins. Betty Ross Clarke, of the *Hardy Family* pictures, became the mother, and Marilyn Knowlden, who played the little Princess in *Marie Antoinette* became Sue. Max Factor, Jr. appears in person as the beautician. Patricia Murray, of Jasper Deeter's Hedgerow Theatre, and also N.B.C.'s "Television Girl", became Mary. Miss Murray is also the "Liberty Girl" of the New York World's Fair, and will make personal appearances during the showing of the picture.

Within a few days after Director Lynn Shores began "shooting" the picture was cut and edited, then cut some more. It was time to add the industrial sequences which illustrate Jimmy's sales talks to Burton. These sequences caused concern because it was feared that their injection might break up the running story in spite of the fact that each one only runs around sixty seconds. But rather than detract, the industrial subject matter added to the picture, giving it what is known as "production value".

The picture will be the highlight of the publisher's exhibit at the New York World's Fair, and will be shown in the Macfadden Theatre in the Communications Building. The theatre seats around three hundred people, has a mezzanine, and is air-conditioned. Architecture is in keeping with the "World of Tomorrow" theme, set by the Fair. Admission is free.

Liberty Magazine

presents

"I'LL TELL THE WORLD"



• "The Cracker Barrel Era" is a phrase exploited by the Breskin & Charlton publication, *Modern Packaging* in its film *Over the Counter and Off the Shelf . . .* To designate the awkwardness, dissatisfaction, and unpleasant practices of old-fashioned packaging methods. The film takes the customer (hand in hand with the advertising man and salesman) back

Breskin & Charlton Use Films to the grocery store of not-so-long-ago . . . pictures graphically the lack of sanitation that prevailed. The useful "mouser" creeps about, dangerously near open food containers. Barrels, crates, baskets, cruet, tubs, open boxes typifies the containers of that day.

Modern Packaging selected the package "characters" from a prize contest featuring 21,000 packages entered in the 1937 All-America Package Competition, 62 having been chosen.

Three copies of the film are being routed steadily, before select groups in the U. S., Canada, Australia, England, France, Sweden, and Switzerland. Released free, the film was designed to educate executives, artists, commercial students in the advantages and salability of well-designed packages.

Reports from industrial, engineering and chemical clubs, chambers of commerce, advertising clubs, who have had an opportunity to see *Modern Plastics Preferred*, the first non-technical, non-commercial film on the subject of "plastics" have been gratifying. It was produced in sound and color for *Modern Plastics Magazine*, another of the Breskin and Charlton publications.

The film gives the first and most educational picture of America's youngest and fastest growing industry — plastics. It pictures the origin of the various plastic materials in the laboratory, their production in steel molds with pressure and heat, and also other processes and shows their application for products used in every conceivable industry, which are better looking and better functioning.

♦ "Komo-Kjr presents the Pacific Northwest" With

those words flashing across the screen, KOMO-KJR inaugurated the use of sound motion pictures to portray dramatically — forcefully — convincingly — to Eastern time buyers the potentialities and meaning of the great Pacific Northwest.

After an initial showing and some publicity in Seattle newspapers, requests for the film came from clubs, service groups and educational organizations until a few months ago the picture had been shown 234 times to 57,033 persons in the East and the Pacific North-

Recently the film showing the KOMO-KJR studios and facilities was shown to over 4,000 patrons of the Broadway Theatre in Seattle — after which it was booked for ten days at the Everett Theatre and the Granada Theatre in Everett, Washington.

The entire project has been a revelation according to station officials and the market statistics unearthed to build the film have supplied added ammunition

for sales drives. Not only has the production sold Seattle on KOMO-KJR, but it has sold KOMO-KJR's personnel on itself. It has given KOMO-KJR renewed impetus to sell its market, and it has helped other advertising media to sell not only their media, but the market as a whole.

♦ *Safety Engineering* of New York City has produced *The Truck and the Driver*, another type of film contribution by a trade publication.

Other Fields for Pictures In the graphic arts field, the sound film produced for Rapid Electrotape company of Cincinnati is noteworthy. This production shows all the company's plants as well as the various operations in the manufacture of electrotapes and matrices. The paper companies, including Sutherland, Kalamazoo, Hammermill and several others have also contributed educational and public relations material of interest.

RIGHT SCENES FROM the Chicago Tribune film *Trees to Tribunes*, produced by Wilding Picture Productions for the Chicago newspaper. Below and left scenes from *Tell the World*, the new Liberty Magazine-Mac-fadden film soon to be released.

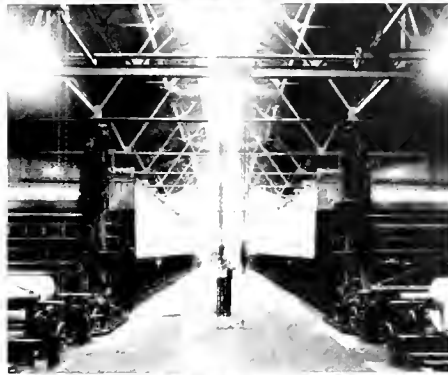

Newspapers & Film Promotion

IV. For bringing the institutional story behind the making of great metropolitan newspapers, a "natural" for exciting film drama, the motion picture and slidefilm are excellent. Here the film medium serves to humanize the paper with selected family groups of readers and to "sell" the paper to its advertisers.

From Trees to Tribunes Such pictures as *A Day With the Sun*, produced for the New York Sun, *Seeing the Sun*, for the Baltimore Sun papers, *From Forest to Newsboy*, *Modern News in a Modern Way*, *A Newspaper in the Making*, *Daily Paper*, and *Trees to Tribunes* are typical production efforts. The Chicago Tribune sponsored *Trees to Tribunes* for exhibition in colleges, schools and before local civic organ-

izations. It is supplied in 16mm. sound and runs approximately 30 minutes.

An absorbing film with professional production, excellent narration and background music, *Trees to Tribunes* presents a panorama of all major activities of this Chicago newspaper.

Bureau of Advertising Slidefilm In *Make It Your Business*, a new talking slide film produced by the Bureau of Advertising of the American Newspaper Publishers' Association for use by advertising salesmen among auto dealers, is the latest development. This slidefilm sells the value of newspaper advertising through the adventures of a progressive automobile dealer and features the introduction of four successful automobile dealers.



SOME PRETTY SAGE advice for the industrialist considering the use of films will be found in the observation of one public relations counsellor in Chicago who, in summing up his company's latest production for the dealer field, says:

"Our last picture cost us a little more, perhaps a little more than the "average" film of this type. But we can't help remembering that the folks who will see it are used to seeing movies for a quarter in their neighborhood theatres that possess the utmost in technical perfection and you can't drop below that standard without their noticing the difference."

Dean Towner, the *Business Screen* "reporter-at-large" brought in the yarn below and will have to vouch for its accuracy. To those of us who have forgotten that this business has a humorous side (after so many "prevues") it has a nice, light touch of human interest we've been needing.

Back in the days before the sound slidefilm was so widely used, a prominent stoker manufacturer had a dramatic slidefilm made for salesmen to use in direct selling. The idea was then a novel one and the stoker sales manager assured his men that the proper use of this medium would bring miraculous results.

"All you have to do," he told the boys, "is to let the prospect see and hear your complete story from the slidefilm — and then take his order for a stoker! No talking, no selling, just let the machine do the work!"

So each of the men, armed with full equipment started out. One young salesman was especially enthused over the possibilities of this "commercial machine gun". He had been



THE VOICE OF THE SCREEN

with the force six weeks without making a sale but this stoker film held dynamite, and he knew the *power* of the screen.

First he gave a home demonstration to a wealthy widow and spent the fifteen minute

showing time in planning the destiny of his commission check on this sale. However, for some reason known only to the widow, the sale was never born.

Disheartened, he gathered his paraphernalia and himself together. His miracle worker had failed him, but he would give it another trial.

Another demonstration before a housewife; a third to an elderly couple — and still the stokers refused to move. Only his own optimistic writing adorned his order book, this scientific panacea had not cleared his name of failure!

Going into a corner tavern to get a little courage he set the machine down by the rail and gave it a stern kick. The bartender asked what the contraption was.

"Oh, just a blankety picture machine", he said, "supposed to be used for selling."

"Yeah?" The bartender grinned. "What kind of pictures does it sell? Souvenir post cards?"

"Oh, no. They call it a slidefilm machine. There's a film in there that was made to sell stokers. But it's the bunk!"

"Well, let's see how it works", the bartender suggested, "things is kind of slow in here right now."

The salesman set the machine up on the bar, rather diffidently, and proceeded to run the film and record. By this showing he was completely bored with the story but the bartender seemed to enjoy it.

"By golly", he exclaimed at the conclusion, "a stoker would be a good idea for a tavern, wouldn't it?"

"Maybe." The salesman started to put the equipment away. This, for the fifth time that day and the task was becoming boresome.

"Yeah. They must save a lot of firing", the bartender continued.

"Uh-huh", the salesman mumbled as he hurriedly folded up the small screen and shoved it in the carrying case.

"Well, how much would a stoker like that cost?" the bartender insisted.

"Oh, they're not cheap —", then the nature of these light remarks came to the salesman with the shock of a crisis. **THE MAN WANTED TO BUY!**

With a nervous look the young salesman glanced behind him — and there stood three men who had watched the film from the start. Two of them asked him to take the film over to their homes to show their wives the story of his stoker and the third helped him write down the bartender's order!

How to Produce a Colossal Epic

TEN EASY WAYS TO SUREFIRE SUCCESS FOR THE AMATEUR

1. Who produces your epic isn't very important. After all, its your ideas that will wow the customers. Be sure to hire somebody without too much experience so you're sure to get that original touch.
2. You've seen plenty of swell movies. Get a beret and camp chair and direct this one yourself. It kind of helps the producer get your ideas straight. (It might, at that).
3. Cost? What do you care what it costs, just so it isn't over a couple hundred dollars. If necessary, leave out all the sets. Use the president's office for the entire picture.
4. Give 'em plenty of selling. After all it's for their benefit and besides they can't get up until the picture's over anyway.
5. A good cast is important so attend to this yourself. Besides you might find a part for your wife's brother.
6. Introduce all the "big shots" in your firm. Be sure and have President McWhiffen give his usual banquet address.
7. Writers don't know anything about your business. Change scenes here and there to get in lots of angles only you know anything about.
8. Take plenty of time explaining how each and every machine works. Remember that the average customer has the mentality of a 5-year-old.
9. Now give your epic a Name. Call it "The Story of Twinkle Tissue" or "The Romance of Twinkle Tissue" so folks will know it's a business film.
10. Keep the picture a secret. Don't even tell your salesmen or dealers until its ready to show. Surprise everybody! (and how!)

Moral: Now you know how it feels to lay an egg. Surprisingly enough this one may be barely edible and you'll probably have learned that films are a hardy, durable medium that often defy complete destruction.



ROLL DOWN THE RED CARPET

by Zenn Kaufman, author of "Showmanship in Business"

• When the Burlington Railroad inaugurated its new Zephyr, many celebrities were in the crowds that gathered in Chicago's Union Station to pay homage to a new and beautiful train. News stories flashed across the pages of thousands of papers as the press took fitting recognition of the achievement of getting to Denver, a distance of over a thousand miles, in less than 16 hours. In New York and scores of other cities, crowds poured out for days as the public grasped the opportunity to see the new train.

But for all its speed, its beauty of design, its luxurions furnishings and other features, the one thing that the crowds talked of more than anything else was the red carpet that stretched down the platform for the entire length of the train. This Sir Walter-Raleigh touch, fitting homage to a monarch of rail transportation, captured the imagination of the public.

The train — and the service it was to provide — represented many millions of dollars. In itself, the train represented a project that certainly rated an impressive reception in the minds of the travelling public. Still, one little gesture of showmanship provided the extra touch of "something" that — days later — kept conversations turned to the subject of the Burlington Zephyr.

In contrast, let's change the scene to your home and the time to tonight. And we'll then have a pair of object lessons that adequately introduce the gist of our story.

Suppose you had nothing particular to do this evening, and so you took your wife to the movies. After you got seated, without any particular announcement or ballyhoo, you discovered that in addition to the movie you paid to see, you were also going to see a heavy-weight championship prize fight or a Barnum and Bailey Circus. Somewhere between 50% and 90% of the thrill and excitement and pleasure and memory value of either of those events would be completely lost because you had not experienced the customary "build-up" that precedes an important and spectacular entertainment feature.

Yet all too many excellent films representing a heavy investment in money, time, skill and resourcefulness are rushed from the laboratory into the field and into a series of showings without making that slight additional investment of time and thought to provide a build-up and a follow-through which could so easily multiply the film's effectiveness.

I remember walking into McCreery's one day to see a show that represented a cool \$2,000 investment for a week. And the only promotion that was used inside the store, with thousands of people surging through it every hour, was a twenty-four inch 2-color poster at the door of the auditorium. And a uniformed girl managed to stand directly in front of the poster — thus hiding it most of the time. Manu-

facturers selling thru department stores have found to their dismay that the stores take half the value out of a film by showing it (whether to customers or clerks) in a perfunctory manner. To meet this situation, some manufacturers have taken the bull by the horns and have taken over the presentation of their films and send their own representatives along with the film to see that it gets proper buildup. Thus they are sure that advance newspaper ads run — that posters go up in the store — and finally, when the film is shown, that someone is on hand to introduce it suitably.

♦ A notable exception — and a good example of pre-promotion — is the job done by the Coolerater Company of Duluth, Minn., ice refrigerator manufacturers. Their film story is summarized in an eight page "Press Book" in two colors. The cover mentions a "\$40,000 dramatic movie — Free" and then tells how to put the picture over in real style. It gives full information on lobby display, a prize drawing, showing of an actual refrigerator, tie-in windows with local grocers, free tickets, hand-bills and local publicity. The book shows photos of typical publicity scenes, featuring Mayors and other public officials. Also 3-sheet posters, available at 95c each; truck banners, at 55c; newspaper mats, 15c.

General Electric advertised one of its pictures in full page space in Colliers. B. F. Goodrich ran a consumer prize contest in conjunction with *Love, Honor & Obey The Law*. The film dealt with safety infractions and the public was invited to spot the violations. To simplify this contest, they gave the audience a printed list of traffic violations and asked people to check off the violations in the picture. As a tie breaker, the contestants had to write a 200-word statement on "Safety".

For *Highway Patrol*, another picture, Goodrich used sound trucks and three sheet posters featuring a prize contest. S. H. Camp supplied mats for a 150-line newspaper ad featuring *Portrait of A Woman*. The National Industrial Council printed cardboard wall bulletins for *Men and Machines*. They also supplied publicity releases for local newspapers and suggestions for lobby displays. United States Steel, sponsors of *Men Make Steel*, suggested tie-ins with automobile dealers, hardware stores and other outlets featuring merchandise made principally of steel.

We cite above a few examples of good pre-promotion. But these are notable *exceptions*. In most cases the presentation — whether to theatre audience or a sales group — boils down to an attitude of "We have a picture. Here it is".

♦ The same situation applies in the use of sales training pictures.

A bunch of salesmen come in off the road for a Saturday morning sales meeting and learn



YOUR FILM PROMOTION CHECKLIST				
Promotions	Salesmen	Dealers	Customers	
Handbills				X
Letters	X	X		
Broadsides	X	X	X	
Post Cards	X	X	X	
Oral Mention	X	X		
Posters & Banners	X	X	X	
Tickets	X	X	X	
Trade Paper Ads	X	X		
Newspaper Ads				X
National Magazine Ads				X
Press Book		X		
Envelope Enclosures	X	X	X	
Contests	X	X	X	
House Organ	X	X		
Publicity	X	X	X	
Window Display				X
Truck Banner				X
Sales Contests	X			

there's to be a picture shown. They sit down, see the picture, then talk about their normal daily problems, and go home! If the picture was a particularly good one, they may make a few comments about it.

Contrast this with the same group who are notified in nine or ten different, successive, inexpensive ways over a period of three weeks to three months that this picture is coming. They are warned long in advance to cancel all conflicting engagements. Mention is made in house organs, bulletins, mimeographed letters, post cards addressed to their homes, and posters hung on the bulletin board. When they enter the meeting hall, some local official precedes the film showing by pointing out the importance of the particular sales problem that this picture bears on. He tells something of what brought it into being. He indicates the very real value they can get from it if they look for certain things at certain times. He indicates that it presents suggestions and ideas that they can put to work that very day. And he states finally that the next sales meeting, or the next two or three sales meetings, are going to be devoted to reports of individual results achieved from following the suggestions in the film.

After the film is concluded, and before the room lights go on, the same local executive is on his feet with a simple, forceful, planned follow-through program, an important part of which is calculated to rouse lively discussions among the members of the audience. Each man is not only given an opportunity, but is actually challenged to take sides. Whichever side he takes, he is challenged to defend his position. Each point discussed is brought to a conclusion and by the time the meeting is over, every man present has pledged himself to apply certain tested ideas to his own selling for the next period of time. Follow-up material, based on the film, goes out to these men automatically. It keeps them on their toes. It never lets them forget that they're going to be expected to report results. And in order to report results, they've got to try. And we know if they'll try, they'll raise their selling level — and their reports will be favorable.

♦ The blame should fall squarely on the advertiser. It's his picture. It's his money. The profits are his — if there are any. Still, the producer of the picture may be *partly* to

OFFICE APPLIANCE SALESMEN enjoy the new Bates Mfg. Co. film *It's the Little Things That Count* produced by Caravel.



The Screen Service Bureau and Surveys

Maintained by the editors of *Business Screen Magazine* for the benefit of business and advertising readers, the Screen Service Bureau now announces further development and the preparation of the First Annual Business Screen Surveys now being prepared in collaboration with independent research authorities. The interest and cooperation of our readers is earnestly requested for the benefit of all users of films.

• AMONG THE questions being considered for inclusion in the FIRST ANNUAL BUSINESS SCREEN SURVEY soon to be mailed to various groups using or affected by the use of business films are the following:

1. Number of sound motion pictures
2. Number of silent motion pictures
3. Number of slidefilms, silent & sound
4. Volume of dealer, group showings
5. Volume of educational distribution
6. Volume of film in theatre circulation
7. Number of 16mm. and 35mm. sound projectors in use for business
8. Extent of advertising agency participation and counsel
9. Extent and use of color processes
10. Methods and types of distribution
11. Comparative film results obtained
12. Number of years all types of films employed by firms
13. General types of films used in business; group selling, advertising, etc.
14. Frequency of film usage, etc.

Many other topics are under consideration for the form, which will be mailed on a nationwide basis. Individual returns will positively not be publicized. This fact is stressed by the editors. The importance of this survey to all users and potential users of films makes it imperative that complete cooperation and authority be applied in the handling of all statistical returns.

Supplementary surveys will also be undertaken in specialized fields as a matter of checks and balances against the general census. Although general estimates of the 1937-1938 volume of commercial films give \$25,000,000 as the extent of the business, the BUSINESS SCREEN SURVEY is expected to furnish the first accurate authoritative statistics confirming the amount.

Meanwhile, the activities of the *Screen Service Bureau* are increasing daily. Requests for information are being answered through reference to competent authorities without obligation.

blame. At least *one* producer admits it. His confession, which follows, is printed at length because he discusses not only his own responsibility but in addition adds a few pointed remarks about the need for more "build-up" for pictures. He says: "There is one great service that a competent producer is eager to perform for his customers, that in most cases he fails to perform because both he and his customer are human. I know this sounds like an alibi in advance, but I'm in dead earnest.

"Any good producer knows that this kind of build-up and this kind of follow-through will enormously increase the resultfulness of his film in the field. He knows that an emphatic increase in resultfulness will incline the customer to buy more and better films. Insofar as he is able, the producer tries to sell these ideas to his customer. But both producer and customer are human. The customer is so enthusiastic about his new film that he doesn't think it needs any build-up or any follow-through. He's so excited and impatient to get it into the field that he hesitates to delay his program by planning an elaborate build-up or follow-through."

"The producer may not want to interrupt his customer's current joy and excitement, nor does he want to raise doubts in his customer's mind as to the value of the film by pointing out that its effectiveness *can* be increased.

"By the same reasoning, the producer is difficult about focusing attention on this point at the time when he is trying to close the contract

for the picture. He wants the order. The budget is seldom big enough. Whatever he can lay his hands on, he wants to put into the picture in order to make it a *better* picture. And so he naturally hesitates to call the attention of his prospect to the fact that production cost of the picture is only one of the costs which should be considered in planning a picture program.

"By no stretch of the imagination would I put the producer in the printing business. He certainly has enough problems of his own now. But as counsel to his customer, the user, he certainly can take a positive stand in recommending a build-up program budget.

"Frankly, I don't know the answer. Perhaps it's the same answer faced in all fields of endeavor — slow education through painful trial and error. Already we find that the more experienced picture users have learned to establish an *additional budget* for the promotion planning, scheduling, ballyhoing, and follow-through."

Our correspondent adds that in those rare cases where this kind of program has been thoroughly and thoughtfully carried out, the results per dollar, or per picture, or per person, have soared to almost unbelievable heights. In the same letter, this producer adds: "Anything you can do to persuade business executives that the finest picture in the world is only a tool — and that the measure of its success will be determined by the care and thoroughness with which that tool is made to do its job — will both save money and make money for film buyers and will be ardently supported by every worthwhile producer."



Business Looks at Screen Advertising



• It was once said of Uncle Sam's open door foreign policy that he wanted the door wide open — until he got inside.

An advertiser sponsoring the open door policy for theatre screen advertising takes a different attitude — he wants to be sure the door remains wide open so that he can come back easily again and again with a full series of commercial announcements from the screen.

It is important for any advertiser, who now or in the future, is in a position to utilize this new advertising medium to understand the hazards and difficulties in keeping this door wide open . . . it's the purpose of this article to explore the "mysteries" and successful managements of various campaigns so that you will see how this has been accomplished.

Screen advertising as such is not really new. For nearly twenty years film ad companies have been busy selling syndicate and special film service to such local dealers as beauty parlors, banks, clothing stores, dairies, etc. They have also sold territorial accounts with special productions or with syndicate service, plus a specially prepared insert. It is very important to the national advertiser not to confuse this type of so-called local service with the national medium that has been created for his benefit.

The national division, however, did arise from the local set-up. The local film companies in the very early 1930's banded together for the purpose of combining their territorial screening privileges into a national network of motion picture theatres — so that all theatres accepting screen advertising could be offered through one organization to the national advertiser.

In 1933 some of the members dropped out and formed a rival organization. At the present time there are two national organizations active in screen advertising. One offers distribution through more than 8,400 theatres with an average weekly attendance in excess of 34,000,000. This is not a small town operation because campaigns have been screened by this

What About Screen Advertising?

Although its volume looms comparatively small in the mighty field of commercial motion picture and slide film usage, the medium of screen advertising gets a good deal of attention. Its facts and future are the subject of this and succeeding articles soon to appear in Business Screen.

organization in every city in the United States above 500,000 in size.

To understand the use of screen advertising, an advertiser must realize that unlike all other media the theatre is primarily in business for entertainment purposes, with advertising revenue decidedly secondary. Also, to a much greater degree than any other media, screen advertising must compete with the entertainment values — that is, it must measure up in interest and production values to high price, technically excellent feature pictures.

In order to find out what measures have been instituted to achieve this goal, let us briefly study the policies and functioning of the service organization.

In addition to furnishing advertisers and advertising agencies with basic circulation figures, costs, coverage, etc. (as do all media) this organization has to go much farther in running a complete motion picture advertising service. It maintains a creative scenario department for the purpose of working with advertising executives in translating their sales stories into 90 foot (one minute) scripts. This company associates itself with the production technicalities to the extent that it is willing to work with the selected producer in supervising the production of all one minute productions.

This service has since its very inception been offered without charge . . . it takes the stand that top notch "minute movies" are necessary to the life of the company itself.

All "minute movie" productions whether prepared in cooperation with the company or



independently must be screened by the company's board of reviewers and pronounced acceptable before this company will undertake the distribution of the films through its theatres.

It is interesting to note that in any number of important cases this company has turned down suggested scripts and even finished productions because of the type of scenarios involved or because of the absence of production excellence.

For the most part, the successful films now in use are fast-moving one minute "newsreels"—that is, factual presentation of one or more news elements about the product with off-stage, newsreel technique type of announcer or commentator. Some films, where the story lacks news elements or where the news elements do not lend themselves to photographic presentation, are produced in cartoon animation. It may be noted in this regard that there are frequent cases where the story can be told more clearly and more simply through the use of this audience-appealing type of technique.

Some advertisers build their playlets around the plot — using actual dialogue instead of off-stage voice. In every case a great deal of attention is given to the proper selection of actors, sets, photography, etc.

The majority of advertisers select the so-called "national" approach. That is, they prepare a series (from three to thirteen playlets) and, working in conjunction with their sales force, route the campaigns over the entire country market by market.

A variation of this is the "local market blast." Some companies whose physical set-up and profit margin is such that they cannot accomplish intensive cooperation of this type simply use "minute movies" as a blasting device in a number of "tough" local market situations.

The third use of the medium is the cooperation with a certain dealer outlet in each city. In the latter case the playlets are made 80 feet long, instead of 90 feet — allowing for a 10 foot dealer signature to be tacked onto the end of the message. This dealer signature features the name and address of the important dealer outlet. Naturally this signature changes with each town. In the case of specialties, such as Westinghouse refrigerators, the purpose of this is to get across the advertising message and then tie it up closely with the local outlet to direct traffic to the place of product distribution.

Evidence of this type of advertising when correctly handled as a potent sales weapon may be found in the list of people who are consistent users of the minute-length screen subjects.

A list would include — Florsheim Shoe Company, Westinghouse Elec. & Mfg. Co., Miles Laboratories, Inc. (Alka-Seltzer), The Hubinger Company, Paul F. Beich Company, Shell Oil & Refining Co., National Carbon Company, and Proctor & Gamble.

Many of these companies have used this medium on an increasingly large scale over a long period of time — in fact, one of them is now finishing its sixth consecutive year.

THE ABC'S

OF AGENCY FILM ACTIVITIES

• DESPITE OCCASIONAL press fanfare to the contrary, the news about agency film activity might almost serve as an indictment of this phase of agency service, so poorly equipped for counsel are the majority of the top-ranking agencies in regard to commercial motion pictures and sound slidefilms.

With a few notable exceptions, the agencies are reliving the early days of radio, their ostrich-like attitudes only occasionally interrupted by visions of million-odd circulations of theatre screen advertising at a minimum of effort, television, and the verbal kibitzing of self-appointed spokesmen of the Hollywood "entertainment" producers.

The intelligent counsel of advertising agencies based on their real understanding of the film medium and its possibilities would not only serve to advance the commercial picture medium beyond those barriers which misconception raises but, of equal importance, would earn commission revenues which clients are now hardly justified in paying for inexperienced and uninformed advice. The agency venturing into this field today finds a small but thoroughly able group of producers dealing directly with the user. If it finds both client and producers indifferent, the circumstances are very much of its own making.

But where do we go from there?

There are about thirty agencies of varying rank and size who are sufficiently active in the use of films to be regarded as "well-informed". From there on the field stretches away into a wilderness from out of which must come an informed majority if the functional possibilities of films are ever to be thoroughly and profitably explored. What lies ahead in the field of public relations, in the permanent organization of dealer education programs and in the development of the powerful merchandising potentialities which films alone possess will not be found out by a few isolated personalities already producing during certain periods at peak capacity which permits of little investigative research.

Nor will the demands of business and the public be answered until this service Personnel is increased. Here, then, is an opportunity for which agency organization was created. How is it being solved in existing setups?

A few top-ranking agencies with experienced executives in charge of production-buying de-

partments offer one solution to agency participation. In that category, the term "film department" can be acceptably applied in the Fuller, Smith and Ross Manhattan and Cleveland offices; the New York office of the J. Walter Thompson Company; Batten, Barton, Durstine and Osborn, New York; and on a lesser scale in the activities of Lord & Thomas, New York; N. W. Ayer, New York; Beaumont & Holman, Cleveland; Ruthrauff & Ryan, McCann-Erickson, Young & Rubicam, Roche, Williams and Cunningham, Chicago; and G. M. Basford, New York, all of whom have had recent experience in the super-vision of films. The list is by no means final for Lawrence G. Gumbinner, New York; Aubrey, Moore & Wallace, Chicago; William Esty, New York; Grey Advertising Agency; Brackett-Sample and Hummert, Chicago; and several others have counselled and actively cooperated with producers and clients in building successful screen programs for group, theatrical and inter-organization circulation.

The majority of these agencies, very sensibly, have no permanent production staffs and in most cases, have acted in the capacity of "liaison" contact in this producer-client relationship. Certainly no agency has sufficient volume to match the personnel of the major commercial producers and the prospect of having to pursue the complex details of production through to the final phase of distribution has justifiably seemed an unnecessary waste of expensive executive time.

One producer calls attention to the real function of the agency which he classifies thus:

"The agency's close relations with its clients — its knowledge of their merchandising problems, places them, if they know enough about the medium, in a position to recommend its use for specific purposes. Thus, the necessary contact selling work is greatly reduced. Finally, the cost of research and creative work is greatly reduced when we work cooperatively with agency men who already have the basic information needed to complete presentations, outlines and scenarios."

Finally, the need for field statistics and general information has been felt for some time by such groups as the *American Association of Advertising Agencies* and the *Association of National Advertisers*. The establishment of a bureau to answer these needs will help.



Moving pictures and slide films will be used at the New York World's Fair to a greater degree than at any other Fair in history. In several of the Focal Exhibits, in commercial and State displays and in the United States Government Building, they will play a preeminent part in enhancing the story-telling technique of the respective exhibits. It is estimated that more than eighty auditoriums in the exhibit area will include motion pictures as a part of exhibit displays.

The same technicians who collaborated on *The River* and *The Plow That Broke the Plains* will produce a picture, *The City*, initiated by the American Planning Institute and financed by the Carnegie Corporation through a grant made at the request of the Fair's Committee on Theme. This film will be shown in the Science and Education Auditorium which is projected as part of the Science and Education Focal Exhibit. One of the functions of this auditorium will be to serve as the scene of a series of short educational films on various topics. Unique use will be made of the motion picture technique in many Focal Exhibits as in the Production and Distribution Focal Exhibit where through the projection of a film, on seven separate screens, men, money, science and machinery will be displayed as producing goods which release consumers for leisure-hour cultural and recreational activities.

The history of transportation from the earliest times to the present will be told in an elaborate film to be presented in connection with the Transportation Focal Exhibit in the Chrysler Motors Building. Similarly, the Communications Focal Exhibit will use motion pictures to aid in depicting the development of communications over a long period of years.

Every major film company is co-operating in the production of a picture entitled *These United States*, portraying the history of the country from the time of the inauguration of George Washington, as first President, to the present. This picture will be shown in the United States Government Building. ★ The technique of both radio and motion picture will be combined in a television display in the Radio Corporation of

America Building. An amusing and fast-moving short film featuring puppets in its cast will augment the Petroleum Industry Exhibit. ★ The Aetna Casualty and Surety Company will feature sound motion pictures as an educational display of devices in each division of insurance protection. ★ The General Cigar Company exhibit will include a teletype machine which will flash world and sport news every minute on a Trans-Lux machine. ★ The Household Finance Corporation exhibit will include a 200-seat air-conditioned theatre where, continuously from 10 A.M. to 10 P.M., there will be a showing of sound motion pictures. One motion picture stars Edgar A. Guest, and another a typical young housewife.

In a 200-seat air-conditioned theatre, the Johns-Manville Sales Corporation will present an educational program in motion pictures — *The House That Ann Built*, *Those Hot Summer Days*, and *Heat and Its Control* — plus interesting and dramatic devices showing the behavior of sound and how it is controlled with acoustical materials. ★ A highly amusing and entertaining motion picture, *I'll Tell The World*, featuring a cast of Hollywood comedians and feature players will be an outstanding attraction. This will be the highlight of the exhibit of MacFadden Publications, Incorporated.

In the Communications Building a motion picture will show a day in the life of the average American family presenting their particular problems in this modern world and how the head of the family amusingly meets these problems and finds success. This feature is to be presented every half-hour in an air-conditioned theatre seating 300 persons. ★ The Metropolitan Life Insurance Company exhibit will include a theatre seating more than 100 persons in which will be shown sound films and stage entertainment. ★ The National Biscuit Company has constructed its own motion picture theatre in the Food Building #2. The theatre is air-conditioned, and seats 266 persons and provides continuous 15-minute programs of entertainment on the screen. A Technicolor film of Walt Disney's *Mickey Mouse's Surprise Party* will be

shown here. ★ The Bakelite Corporation will show in Technicolor, in the Hall of Industrial Science, a motion picture portraying the development of the modern plastics industry. ★ The Petroleum Industries exhibit, mentioned previously, will have a unique Technicolor film, using new and revolutionary motion picture technique, featuring puppet actors. ★ Planters Nut and Chocolate Company will feature a color animated motion picture of the peanut bush or plant showing the process of development of the seeds into mature peanuts.

The States of Nebraska and Texas will employ motion pictures to tell the story of their historical origin, industrial and social progress, and contemporary development. ★ The General Motors exhibit will feature four motion picture screens on which will be shown two 35mm. pictures and two 16mm. motion pictures. ★ The Ford exhibit will also include four 35mm. projection machines.

Among other commercial exhibits which will feature motion picture displays are the following:

- The American Chain and Cable Company
- The American Tobacco Company
- The Eastman Kodak Company
- Gas Exhibits, Incorporated
- Glass Incorporated
- National Dairy Products, Incorporated
- The Olson Rug Company
- Show Globe, Incorporated
- The United States Steel Corporation
- The Yale and Towne Manufacturing Company

In the Science and Education Building, there will be a program of motion pictures in addition to lectures, all chosen for their relation to science education and public health and cognate subjects. A program of between twenty and thirty motion picture films are now being selected by the Committees on Science Education, Welfare, and Public Health. ★ Eight-foot screens that announce happenings in today's world to the "World of Tomorrow's" visitors will be installed in about twenty spots on the Fair grounds, according to the News Casting Corporation.

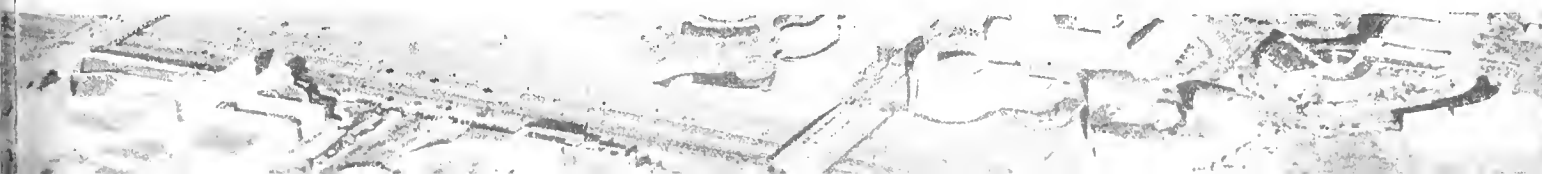

New Projection Techniques Used

Photo-Mural Projects Story of Distribution

BELGIUM: The Belgium exhibit will show seven 300-mm films entitled, *The Song of Work, Wool, Cotton, Copper, Works or Art, Scenic Belgium,* and *Economic Belgium.* This pavilion will show fourteen other motion pictures ranging from 150-mm to 550-mm.

DOMINICAN REPUBLIC: This government intends to show a 20-minute silent motion picture in natural color, that is, two reels of 16mm, or 800 feet showing various beautiful and scenic spots in the country. This film will run continuously and have sub-titles to describe the scenes.

FRANCE: The French pavilion will have four small motion picture theatres seating 50 people. In these theatres visitors will see continuous cinematic displays of French activities such as industries, amusements, agriculture, and travel. In addition, a larger theatre seating 300 persons will feature longer films, including musical and dramatic programs.

ICELAND: They will show two general films: the first, 16-mm colored film featuring the beauties of Icelandic landscape and the many tourist attractions the country has to offer, such as geysers, waterfalls, glaciers, volcanos, and so forth. There will also be views of the towns and the people; the second film will be a 16-mm black and white film dealing with Icelandic industries, mainly fisheries and agriculture and showing the life of the fishermen and farmers. These films will be run constantly on two reels located in shadow cases in the main hall of the Icelandic exhibit.

JAPAN: The Japanese pavilion will feature in the garden of their 300 B. C. Shinto Temple a new motion picture invention, making it possible, they report, to show motion pictures in the sunlight.

NORWAY: This government will show motion pictures of all forms of life and sport, both in city and in country.

PAN AMERICAN UNION will present: *The Story of Bananas:* (2 reels) Story of the World's largest agricultural development. *Rolling Down to Mexico:* (2 reels) A trip by automobile over the new Pan American Highway from Laredo to Mexico City. *Native Arts of Old Mexico:* (2 reels) Showing pottery and tile making, leather work, weaving figures out of straw reed, basket making, wood turning, etc. *Coffee — From Brazil to You:* (2 reels)

Note: These films are "sound pictures" and are available in both 16mm. and 35mm. widths.

RUSSIA: The Russian pavilion will contain a theatre seating 300 persons showing full-length feature Russian films. In addition, they will have an outdoor Trans-lux screen in the court showing Russian news pictures nightly.

SOUTHERN RHODESIA: This government has planned three feature sound films of Southern Rhodesia entitled *The Land of Rhodes, Highlands of Rhodesia,* and *Pioneer Trails.* These three films will delineate the attractions and industrial progress of Southern Rhodesia, showing native wild life, mining, urban activities and scenic beauties. All are 16mm.

The moving picture spectacle: *Three Thirds of a Nation* will be the principal feature of the New York World's Fair Focal Theme Exhibit on Production & Distribution. The spectacle is subtitled: *A Cinematic Mural* and involves the use of an entirely new kind of motion picture presentation. Seven synchronized projectors, all running simultaneously, will project a single picture on the longest moving picture screen in the world. The screen, curving in a great arc, will be approximately 100 feet long.

Egmont Arens, industrial designer who designed the focal exhibit, says: "I wanted to get the effect of an animated photo mural. As we got into production of the picture, we began to realize its dramatic possibilities. Now I believe we have developed an entirely new four-dimensional art form. Moving pictures give you three dimensions on a two-dimensional screen. By curving the screen on an arc we get three dimensional space with the illusion of an added dimension."

"The spectator, being within the curve of the screen, thus has the sense of being an active participant of the drama that is unfolded on all sides of him."

Three Thirds of a Nation will dramatize the amazing complex of activity that gets going in all parts of the country when Mrs. Jones wants her short ribs of beef and other products. Cowboys, herders, trainmen, stockyard workers, take up the call "Short ribs of beef for Mrs. Jones." The action moves from East to West and back again. Mrs. Jones, of course, is Mrs. United States. A musical score and script for

a commentator were especially written for this presentation.

Under the apron of the massive curved screen will be three subsidiary exhibits. These will depict "Man's Heritage of Power", "The Problems of Abundance" and "A Vision of Tomorrow."

Sound motion pictures produced by The Jam Handy Picture Service, Wilding Picture Productions (National Biscuit Company), Caravel Films, Inc. (American Can & Johns-Manville), Audio Productions (National Association of Manufacturers, American Telephone and Telegraph), West Coast Sound Studios (of New York City), and many other well-known "majors" in the field of commercial films, will be key exhibits at the New York and San Francisco Fairs. Complete details of every film and all the various projection and theatre setups used will be featured in the next issue of *Business Screen.*

Sailing Sheltered Seas to Alaska, produced by Dowling and Brownell of Hollywood for the Alaska Steamship Company, will be used in the television demonstrations at the R. C. A. building exhibit in New York. Several other commercial producers, including the Chicago Film Laboratory will have films transmitted during the broadcasts. The demonstrations are to begin about May first, according to the National Broadcasting Company who will telecast the pictures for reception on the several receivers located in the exhibit.

Below: The motion picture mural in the Focal Theme exhibit on Production & Distribution at New York





The air-conditioned theatre of the Household Finance Corporation exhibit in the Consumer Interests building will feature films on family finance matters as well as human interest entertainment. The exterior exhibits show visitors practical demonstrations of "better buymanship" and management of the family budget.

EXHIBIT THEATRES at the FAIR

✧ The National Biscuit Company announces that it will have at its New York World's Fair exhibit a specially produced Walt Disney motion picture entitled *Mickey's Surprise Party*. Officials of the national baking firm revealed that their organization has constructed its own motion picture theatre in Food Building North at the Fair. The air-conditioned theatre, seating 266 persons, will provide continuous 15 minute programs of entertainment on the screen during the life of the Fair and will also feature, for spectators outside, an animated display of puppets designed by Tony Sarg, well-known artist and illustrator.

The Disney picture will be in Technicolor and will feature Mickey Mouse, Minnie, Pluto and Fifi. During the entire program Walter O'Keefe will act as master of ceremonies on the screen and will also be the featured commentator in a second Technicolor film which will complete National Biscuit's fifteen minute program of gratis entertainment for Fair visitors.

✧ New York World's Fair visitors are to receive an eloquent and impressive interpretation of the star part which the cult of Charm and Beauty plays in the World of Today & Tomorrow. The world-wide interests of Coty, internationally known French perfumers and cosmeticians, are dedicating to Fair visitors a special

building which is to house exhibits of unusual fascination.

In the "Maison Coty" dramatic changes of scene and atmosphere greet the visitor. Here will be shown in continuous operation, and complete to the last mechanical detail, a demonstration unit of Coty's famous "Air-Spun" process for refining face powder. Exactly duplicating the hospital cleanliness of Coty laboratories, a crew of white-clad male and female operators will enact for the visitor the dramatic way in which "Air-Spun" Face Powder is given its unusual qualities by a method that is exclusively Coty's.

The tour through "Maison Coty" winds up in a luxuriously appointed motion picture theatre where there will be continuous showings of Coty's thrilling sound films that dramatize the romance of perfume and cosmetics creation.

New Cartoon in Kodachrome

Ted Esbaugh Studios, Inc. have announced a 10mm. color cartoon with duplicating prints was recently produced using the Kodachrome process. This first cartoon entitled *Mr. Peanut and His Family Tree* has been completed for the Planters Nut and Chocolate Company, and will be shown in connection with their World's Fair exhibits both in New York and San Francisco.

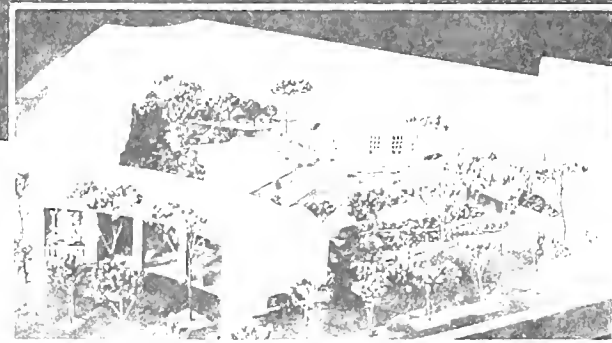

Above: The Consumer Interests building contains several new film feature exhibits including the Household theatre.

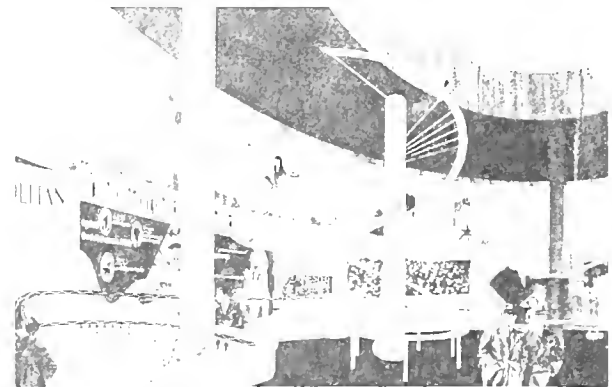

Above: The Metropolitan Life Insurance Company exhibit
Below: National Biscuit Company's motion picture theatre.



A Building as BIG as a CITY!

... its many unusual facilities ... ready to Serve you with all the Hospitality of your own Home ...

IN CHICAGO'S FINEST OFFICE BUILDING . . .

● The complete and unexcelled facilities of two famous theatres, a luxurious private club and many other conveniences are at your service.

Civic Opera House — this magnificent structure annually houses Chicago's famous opera company. Available out of season for business audiences where a large auditorium is required.

Civic Theatre — one of the world's finest small theatres, it is ideal for radio broadcast performances, lectures, sales meetings and the like.

The Lighting Institute — thousands of visitors attend the daily illustrated lectures in this modern museum of lighting progress on the 36th Floor.

Club & Meeting Rooms — for large groups or small, the building offers convenient meeting rooms with food service or without at most economical rates.

Restaurants & Private Dining Rooms — for employees and executives, fine restaurants are available for breakfasts, luncheon or dinner service.

Preview Theatres — two acoustically perfect studio theatres for film or radio previews are on the 42nd floor.

Sound Recording Studios — voice recording for business or personal use in available recording studios.

Safe Deposit Vaults — Chicago's finest vault facilities at economical rates for the convenience of tenants.

Convenient Shops — Deluxe barber shop, valet, and other personal service facilities await your needs. The Opera buffet, a candy shop, and cigar store on the ground floor.

SOME OF THE WELL-KNOWN FIRMS LOCATED AT 20 NORTH WACKER —

Allstate Insurance Company	Joslyn Manufacturing & Supply Company
Alvord, Bardick & Hewson	Lederle Laboratories, Inc.
American Airtlines, Inc.	Liberty Mutual Insurance Company
American Cyanamid & Chemical Company	Middle West Service Co.
Asacoda Wire & Cable Co.	Monroe Calculating Machine Co., Inc.
Chain Belt Company	National City Lines, Inc.
Chicago Lighting Institute	National Safety Council
Concordia Mutual Benefit League	Natural Gas Pipe Line
Dean Milk Company	Northwest Paper Company
Diamond Alkali Company	Okonite Company, The
Elliott Company	Pennsylvania Salt Manufacturing Co.
Encyclopedia Britannica, Inc.	Pick Hotels, Albert
Harnischfeger Corporation	Plee-Zing, Inc.
Herlby Mid-Centinet Co.	Sears Roebuck & Company
Illinois Chamber of Commerce	Standard Oil of Indiana
W. T. Grant Company	Subway and Traction Commission
Jenkins Petroleum Process Company	Walker, Hiram Inc.
Johnson Oil Refining Co.	Westinghouse Electric & Mfg. Company

... miles of spacious corridors ... unobstructed light and air from broad windows ... fast, smooth elevators ... plus many available shops and services!

HERE at Chicago's famed Twenty North Wacker Drive Building, there is an atmosphere of spaciousness and comfort not unlike the friendly feeling of a large, well-ordered private home. Executives and employees alike enjoy working under the favorable conditions which give every office unobstructed light and air from broad windows. Customers, too, find Twenty North Wacker Drive most convenient to all types of local transportation and unusually handy to economical parking facilities just outside the congested "Loop" area.

The miles of spotless and spacious corridors reflect the fine service staff in constant attendance for the comfort of our tenants. Efficient elevator service from banks of well-manned cars minimizes delay. Convenient shops and services of all types help make your office life easier throughout the year. Towering high above all surrounding buildings, Twenty North Wacker symbolizes the very finest in modern business "skyscraper" construction, yet the infinite care with which the management assures the personal comfort of each occupant makes this truly a "home away from home."

Perhaps that is why many leading national business organizations have chosen to make their Chicago headquarters at Twenty North Wacker Drive. For here, too, are the most complete facilities for all types of business activities such as conventions, sales meetings, exhibits, etc. Large and small meeting rooms, private dining rooms, five theatres of all sizes and other facilities await you. Why not make a personal tour of inspection at your earliest convenience? It will save your concern both time and money to "live" at Twenty North Wacker Drive in Chicago.

20 NORTH WACKER DRIVE

ADDRESS INQUIRIES TO THE OFFICE OF THE PRESIDENT, J. C. THOMPSON

"GET OVER into CLOVER"

is G. E.'s advice to dealers told
in new stage show and pictures

• GENERAL ELECTRIC'S spring show *Get Over Into Clover* now winning acclaim in its tour of 50 key cities, employs a unique combination of professional stage show and motion picture to carry its story to appliance dealers and distributors.

The show is being presented in the east and west simultaneously by two complete units, each with its special pullman car, baggage car, professional actors, stage sets, stage crew, and projection equipment.

"It has been several years since General Electric has conducted a spring show of any pretentious size," declares Carl M. Snyder, G-E appliance sales manager, "and never before have we attempted one of this type. We have a new story and intend to tell it in such dramatic fashion that it will stay told for some time to come. We do not propose to leave the slightest doubt in anybody's mind that General Electric means business in 1939."

The show represents months of intensive work on the part of General Electric's appliance promotional staff, and was produced under the joint direction of A. L. Scaife and Roy Johnson, advertising and sales promotion managers of the specialty and household appliance divisions respectively.

The theme was built into a play by Carle Robbins, editor of the General Electric "News Graphic," national dealer magazine. The plot was drawn from actual dealer experience. Principal characters are a typical dealer, his son, and the personalities who enter their private and business lives. Dealer problems and sales opportunities are dealt with as the play unfolds, yet not a single product chart mars the story.

The audience joins the dealer's son as he attends the presentation of a 30-minute talking motion picture which tells the story of General Electric's research and manufacturing background. Actors in the film include G-E executives, scientists, and factory workers. Alois Havrilla, well known radio announcer, is narrator. The picture won a spot in the program because of excellent results achieved by previous G-E movies in the appliance field.

Scenes were shot at company plants and buildings and in various research laboratories. While the movie is concerned primarily with G-E home appliances, it shows such activities as the manufacture and testing of giant turbines and generators, minute instruments, light sources, porcelain insulators, wire and cable, refrigerators, radios, and other products.

The human beings whose lives and jobs are



NO, THE DEALER ISN'T LOSING HIS PANTS in the appliance store. The figure in long underwear is an irate husband who calls after hours, receives unusual treatment from the G. E. service man and bellows, "I've never been in a place like this before!" A scene from the G-E spring road show *Get Over Into Clover* now being presented on national tour.

woven into the picture emerge as more important than the mechanical processes themselves — a point which General Electric stresses. The entire picture finds its inspiration in the query of a little girl who presses her nose against a streaming window pane during a thunderstorm and asks of her grandfather, "Grandpa, what is electricity?" Dr. Wills R. Whitney, G-E laboratory pioneer and a galaxy of men and machines, through the medium of the motion picture, answers her question as well as modern science has been able to answer it.

Get Over Into Clover carries magnificent sets for the stage presentation. The curtain goes up on the front of a white colonial home which is 43 feet wide, and 22 feet high. A stage depth of 22 feet is required.

The home is suddenly transformed as if by magic into a professional stage where other sets, equally professional and realistic in appearance, appear and disappear with few seconds intervening as the rapid fire show packs

comedy, romance and inspiration into each thrilling scene.

Professional actors, used in both the eastern and western companies, are signed to contracts approved by the Actors Equity Association. Professional stagehands and management help to assure a competent performance. Each unit is preceded by its own advance man. Each has a stage manager, union electrician, carpenter, property man, and motion picture operator in addition to the actors.

Get Over Into Clover left Cleveland after a preview showing January 27 before editors of national trade and consumer magazines, many of whom called it the most effective medium ever employed by a manufacturer to carry a sincere, inspirational story to appliance dealers and distributors. Dramatic critics, newspaper writers and veteran appliance merchandise men have concurred in that opinion at each showing. The western troupe will conclude its tour March 31, while the eastern company makes its final appearance at Buffalo April 5.

GENERAL ELECTRIC . . . THE STORY OF A VISUAL PIONEER

The Concluding Article from a Recent Talk by John G. T. Gilmour

• Realizing that a picture containing the results of this development and one compatible with the company's original function would offer the best presentation, we produced a five-reel synchronous picture featuring Dr. Irving Langmuir, Associate Director of our Research Laboratory, titled, *Oil Films on Water*; it portrayed some of the experiments on surface tension which later won for Dr. Langmuir the Nobel Award in Chemistry. Special portable sound projectors were built and crews were trained in their operation. This picture, believed to be the first industrial sound picture, was shown about the country to engineering and scientific groups, as well as in leading educational institutions. The acclaim given this picture by educators, business men and the press in addition to the company's own opinion

of the uses to which sound pictures could be put in our regular operations convinced executives that sound films were in order.

So district offices were outfitted with 35mm. portable projectors and the production of sound pictures was begun. The difficulties of production imposed by sound were many. An entirely new form of story-telling had to be worked out. Methods, satisfactory during development, proved impractical in regular production. Equipment was cumbersome and inadequate. The troubles were the same as those encountered by the industry itself and in proportion just as large and difficult. But, as in all things, when there are patience, a will-to-do, and encouragement, the problems were gradually eliminated and some form of production technique restored. (Please turn to next Page)

THE BUSINESS FILM ABROAD

by ANDREW BUCHANAN *Editor, Gaumont-British News*

As with silent films, the early sound films were institutional, attempting to create good will for General Electric by showing the application of its developments as a matter of public interest. Theatres used these earlier sound releases and audience response was good. Some sales films were made, but the district machines were much too complicated and bulky to permit easy showings. 16mm. sound was the answer to the major problem of making our pictures effective sales aids.

During the period of readjustment, we produced for the Lamp Department the first industrial sound picture in color. Titled *Stepping Ahead*, it was shot on Dupont bi-pack, developed in our own laboratory, and printed by Multicolor. Similarly produced sequences have since been used when color has been warranted.

There are many standards of judging a picture and probably as many variations of these standards as there are judges. Theatrical films are graded by box-office receipts; industrial pictures, General Electric's at least, are judged by their effectiveness in doing the job they were designed to do. *Their primary function is to sell — whether it be an idea or a product.* If entertainment is essential to creating the sale, then theatrical treatment is resorted to; otherwise, it is omitted and a straightforward, unadorned film is made. This does not mean that technically the picture should not be well produced, but that only essential story material be included. Thus, many of the pictures may seem very uninteresting and a waste of time and effort, but that opinion would not hold if you were familiar with the sales angles involved. It is in applying the advantages of motion pictures to the projection of an idea, whether simple or involved, which will influence ultimate sales favorably, that industrial pictures best serve their purpose. To do this, the Visual Instruction Section, though small, is physically well equipped.

STUDIO SPECIFICATIONS ARE GIVEN

♦ In one building is a studio some 40 by 30 by 15 feet. Because of its location within a noisy factory area, it is really a room within a room. The walls, floor, and ceiling are spring floated and the inner surfaces treated with Sabonite plaster and bats of rock-wool. A sufficient number of incandescent lighting units is available for most any type of lighting. Two kilowatt 19" spots and 1½ kilowatt rifles are most generally used, though 5 Kw bulbs of strip or broadside units may be used. These same units may also be used for location work though lately the department has been successful with some Art Reeves portable photoflood units.

Pockets, carrying 150 amperes each, are conveniently located on the studio walls, so the annoyance of cables all over the floor is reduced. Since height is at a premium, we use diffusers on most of the units and often add a

(Please turn to page 36)

• **THOUGH** BRITAIN's entertainment film industry remains in a critical condition (with a brighter future just appearing on the horizon), her non-theatrical film activities are making rapid progress.

Her output may be divided into three broad categories:—

1. Productions sponsored by industrial, agricultural, commercial, and other concerns, designed for road showing, and projection in halls other than cinemas.
2. Productions, similarly sponsored, but designed for general cinema release.
3. Five hundred foot direct advertisement films, designed solely for cinemas, but regarded as "additional" to the programme.

In Group One, production has increased considerably owing to growing interest on the part of industrialists, in the screen.

The now famous films made by the Gas Company, at the rate of about five a year, are a popular feature, and an excellent example. Complete film shows are given each winter of the new productions made during the preceding summer. The general appeal of these shorts is wide. Musical sequences, fantasy, humour, artists of repute — have all helped to capture the public. Production values are high, and infinite care is taken over preparation of scripts. There are a number of parallel examples of complete shows sponsored by important concerns, ranging from the films of car manufacturers to those emphasizing the advantages of certain chain stores. Political parties are making ingenious films for projection on fleets of vans, and certain agricultural groups have spent a great deal on the making of first class informative shorts, both for non-theatrical and cinema release.

Film Centre, in London, an advisory organization controlled by John Grierson and Arthur Elton, and including Basil Wright and Paul Rotha, can be regarded as the hub around which the non-theatrical documentary move-

Imperial Airways has been featured in one of the best documentaries produced in Britain.



ment revolves. The most prominent business groups have come to regard Film Centre as a reliable source from which to gain advice on all matters appertaining to film production.

The fundamental weakness of short films designed for general theatrical release in Britain is lack of adequate distribution. Double-feature programmes have reduced programme space to a minimum, and exhibitors regard shorts as unimportant fill-ups, which can be rented quite economically. In fact, it is primarily due to this position that the non-theatrical world has developed so rapidly, for leading documentalists have turned their attention to the task of building up their own audiences outside the cinema.

This universal cry that there is "no room" for shorts in the commercial cinema leads me to remark on the danger of being victimised by *Advertising Mania* — a disease from which most exhibitors appear to suffer. They declare their programmes have no room for shorts, however good, and yet they can devote ten, fifteen and sometimes more minutes to Trailers advertising next week's attractions. I know full well the value of these snappy excerpts, but it does seem somewhat illogical that space should be taken up to boost future attractions to the exclusion of current ones. An organist can play for, perhaps, fifteen minutes; a series of trailers can occupy another ten minutes (minimum); and an advertisement film (Group 3) can play for a further five minutes — thirty minutes in all, and yet there is no room for first class short films! How could there be? There is a place for everything, including advertisements, but a greater power of selection and understanding should be exercised by exhibitors in this particular respect. As I have explained, Group One contains sponsored films for showing outside commercial cinemas, but, equally if not more important, are the sponsored films designed for general release. Despite bad conditions, many do penetrate into cinemas, and achieve surprising success. They do not, of course, contain any direct advertising. Amongst these should be mentioned the excellent shorts made by the famous G.P.O. Film Unit — a group possessing small studios at Blackheath, on the outskirts of London. One of its latest efforts is *North Sea* — a fine three reel documentary on deep sea fishing, which has been booked up and down the country.

One may ask what has that to do with the General Post Office? But one should remember that ramifications of this vast concern extend into the most unexpected channels. Consider, for a moment, the unparalleled success, *Night Mail*, the two reel dramatic film telling the

When The Prospect Says:

"You'll have to Show Me!"

Your salesmen can show him, if they are equipped with DeVry Motion Picture Projectors. Yes, and without stepping out of your office you can be right on the job to help your salesmen personally. You can be there in talking motion pictures. You can show your product being made. You can show it in action. And you can tell the prospect about it in your own words — with your own voice!

With DeVry Motion Picture and Sound Equipment,

you can put the influence of your own personality behind every important sale. You can multiply the force of your own sales ability many times over.

And DeVry Equipment can serve your company in still another important way. It enables you to use sales training films — helps you train your salesmen to sell as you want them to sell. Write for complete information about DeVry Equipment and facts about what DeVry can do to help you plan better pictures at lower cost.

The DeVRY INTERPRETER

A 16mm. sound projector that sets new standards for clarity of pictures and fidelity of tone. Among its many advantages are: Synchronic Threading, Dual Sound Stabilizer, and new "Film-glide" that adds years of life to your film. Easy to carry, easy to operate, easy to buy.

Among the many nationally known industrial users of DeVry Equipment are: International Harvester Company, The Pure Oil Company, Standard Oil Company, Ford Motor Company, Firestone Tire and Rubber Company, Allis Chalmers, and many others whose names we shall be glad to furnish on request.

DEVRY CORPORATION
1143 ARMITAGE AVENUE • CHICAGO, ILLINOIS
NEW YORK HOLLYWOOD

Makers of the most complete line of 16 and 35mm. silent and sound projectors and cameras for professional and institutional use.

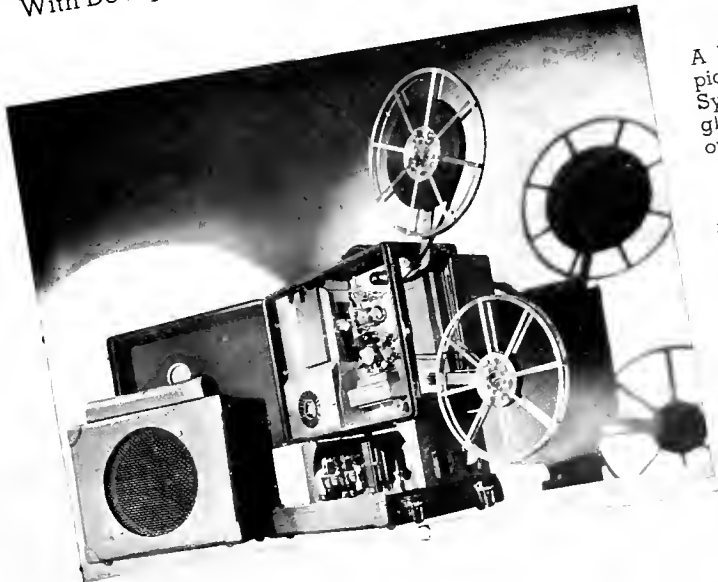

Thank You Mr. Kelley-

UNITED FRUIT COMPANY

PIER 7 - NORTH RIVER - NEW YORK, N. Y.

February 17, 1939

Mr. H. G. Christensen,
West Coast Sound Studios, Inc.,
510 West 57th Street,
New York, N. Y.

Dear Mr. Christensen:

The talking motion picture, "DOUBTING THOMAS GOES TO TOWN," which you produced for us, has been in use now for some months, and we want you to know that the power of this picture to hold the interest of our audience and to influence them to act upon the information and advice it conveys has been most gratifying.

Very truly yours,

John M. Kelley
Manager Fruit Transportation

Producing effective commercial pictures is a highly specialized art. Let us place our facilities and technical skill at your service when you consider talking motion pictures.

WEST COAST SOUND STUDIOS, Inc.

510-22 West Fifty-Seventh Street
New York Circle 7-2062 N. Y.
Nat. Sales Rep: SCREEN BROADCAST CORPORATION

Everything for

INDUSTRIAL PRODUCERS

WE SUPPLY on rental all or any equipment necessary to make a Feature — Short or Commercial.

SOUND — SILENT — COLOR — SLOW MOTION

- Latest Mitchell Cameras
- Blimps — Dallys — Accessories
- Latest Type Lighting Equipment
- Variable Area Location Sound Truck
- Portable Recording Equipment
- Single System News Reel Type Cameras
- Moviola Editing Equipment

SALES — SERVICE — RENTALS

EXCLUSIVE EASTERN REPRESENTATIVES
MITCHELL CAMERA CORPORATION

MOTION PICTURE CAMERA SUPPLY, Inc.

723 Seventh Ave. • New York, N. Y.
Phone BRyont 9-7754 Cable — CINECAMERA

BUSINESS FILMS ABROAD

(Continued from Page 24)

story of the journey of the night express to Scotland — and how letters are sorted en route. Railway communications, cable laying, the printing of stamps — all come within the G.P.O., and in *North Sea* — the wireless and telephonic communication system with ships at sea provides a fine example of a little known branch of the work of London's G.P.O. Direct advertisement is not needed. Indirect publicity, if one can so regard it, provides the foundation for most of the G.P.O.'s material.

The Strand Film Company must also be mentioned. Recently, it has made a series of Zoo films, original and imaginative, for general release, and simultaneously, a fine group of shorts dealing with air travel. One has to remember that the object of such films is achieved if a percentage of audiences becomes "air-conscious" — direct advertisement being entirely unnecessary. Very few people are likely to be induced to buy an aeroplane after seeing a film on aerial matters — hence such material finds a legitimate place in a cinema programme.

EXHIBITIONS IMPETUS TO PRODUCTION

Exhibitions have provided an additional impetus for non-theatrical production. Last year's great Glasgow Exhibition prompted the formation of the Scottish Films Committee, organized by John Grierson, and the result was the production of about six fine shorts depicting contrasting phases of Scottish life — sport, industry, fishing, and so on, made by different firms selected by the Committee. In addition, a small, but efficient company in Glasgow, Scottish Films Productions (1928) Limited, produced two powerful films on Steel. These, with the above mentioned Scottish shorts, were exhibited at the Glasgow Exhibition throughout the summer of 1938, and have since been acquired by renters in London for cinema release. Scotland is an almost untapped source of material, and the future will see it being projected in short films which should possess world appeal.

"*Children at School*" a documentary film on modern school construction was sponsored by the British Gas Industry.



Similarly, the forthcoming New York Fair provides an important opportunity for Britain to show her documentary progress, and already a continuous programme of her best films has been arranged. These will include many of the above mentioned subjects, and also a selection of the famous *Secrets of Life* series, made by Gaumont British Instructional. I am naturally not referring here to feature films to be shown at the Fair, but confining my remarks to non-fictional material.

Group Three. The short direct advertisement film, the distribution of which is paid for by the advertisers, has advanced in many ways, particularly in technical quality. Technicolor has been introduced in a number of instances, and the results have been first class. Gaumont Screen Services, which concentrates upon this class of film, embarked on colour last year, in a novel way. They made a short film boosting cigarettes, half in black and white, and half in colour. The former being scenes as seen through the eyes of an artist's dog — dogs being colour blind — and the latter being the same scenes, as seen by the artist himself. The contrast was extraordinary — the black and white photography seeming much more drab than it really was, when immediately preceded or followed by colour.

That broadly covers the activities of the three main groups of non-theatrical film-makers. Each reveals how advertisement, in varying degrees of directness is expressed via the screen, and the only remaining objective of non-theatrical producers is to increase the number of "film-conscious" business people. At the moment, despite the large number of understanding commercial groups, there are many more who can think of no other form of advertisement than the direct, crude appeal to the public, urging it to Buy this, or Use that commodity. They cannot understand why this type of message should not be included in legitimate cinema programmes, and they have not reached the stage of knowing the value and power of the indirect appeal.

PROGRESS EQUAL IN SEVERAL FIELDS

Thus, the lengthy sponsored road-showing film makes progress outside the cinema; the sponsored documentary containing only indirect messages penetrates into general release with growing success, whilst the little advertisement film wriggles into as many theatres as its sponsors can afford to pay for.

By far the most valuable form of publicity is, I feel, the perfectly made documentary which does reach the cinema public, for when an audience is assembled to receive entertainment, it is in its most receptive mood.

That summarizes Britain's business screen activities up to the moment, and I am confident that, irrespective of the fate of the feature producing concerns here, that the non-theatrical field will make even more progress during the spring and summer of 1939.

TECHNICAL PRODUCTION • PROJECTION EQUIPMENT • DEVELOPMENT

• Television will be a development in sound motion pictures, in the opinion of officials of commercial film producers whose technical staffs and studio facilities are well prepared for this departure in industrial film making.

Aside from the perfection of television itself as a process of sending visual as well as audible images by radio, the making and placing of program materials must also be provided for, and this will necessarily be conducted in terms of film production and distribution. The limited horizon which in television reduces the sending area of every local station to a radius of fifty miles may thus create an outlet for motion pictures greater than previous use of the medium for non-theatrical exhibition.

It is the studied opinion of expert authority that film programs will constitute the bulk of television broadcasting for the following reasons: (1) Duplicates with sound-on-film may be made cheaply (2) Such prints will provide an inexpensive chain system of distribution (3) Programs can be edited and rehearsal time necessary for letter-perfect performance can be eliminated (4) The technique of film production will further reduce program costs by modern studio methods (5) Production can be made at the most suitable location (6) Talent need not be forced to rigid program schedules (7) Subject matter of a commercial, scientific or descriptive nature now beyond the reach of direct broadcasting may be included.

With hundreds of local stations in prospect, each with full-time program requirements for sight-and-sound entertainment, there will be thousands of program-hours which cannot be supplied as live broadcasts outside of major talent centers. Thus a new field for motion pictures may be expected for television of the future, to create a vast new audience for industrial and commercial films.

1939 DeVry Conference Announced

♦ The ninth annual session of the National Conference on Visual Education and Film Exhibition (DeVry Foundation) will again be held at the Francis Parker School, in Chicago this year on June 19, 20, 21, and 22, according to the first public announcement made this month to *Business Screen* by A. P. Hollis, director of the conference and chairman, ex-

officio. The daily sessions, which advertising and business executives as well as educators are invited to attend without charge, feature showings of selected films as well as talks by prominent authorities in both fields.

This year's conference will include discussions of photographic and scenario technique, advertising and sales training values and the scope of educational usage of the film medium.

Produce Fire Prevention Films

♦ In production at the present time at Burton Holmes Films, Inc. is a forest fire film being produced for the Conservation Department of the State of Wisconsin.

One of the major problems of the Wisconsin Conservation Department is the prevention and fighting of forest fires in the State. Films have been made during the past few seasons of various forest fires in the State and of the effects of those fires. The new film will point out the economic loss to the State, the causes for fires, how they can be prevented, and it is hoped will arouse the citizens of the State to the forest fire problems. The film is intended for circulation throughout the theatres of the State as well as for a

wide non-theatrical circulation. The picture is one reel in length and will be recorded on RCA "High Fidelity".

Supply Fair Film Equipment

♦ Motion Picture Camera Supply Company, Inc., recently supplied complete color equipment for production of a short in cinecolor for the state of New Hampshire. This picture is to be shown at the New York World's Fair.

The camera crew just returned from Dartmouth College, where they photographed the complete sports sequences at the Winter Carnival. Complete camera and lighting equipment was also supplied for the making of a Coast Guard picture for the Federal Government.

New Projection Method

♦ United Motion Picture Industries Ltd. have just introduced a new idea of continuous projection; coupling seven continuous projectors and one sound reproducer, which reproduces the sound for the seven projectors and operates continuously. All machines are automatically controlled so (Continued on next page)

TELEVISION . . . experienced users and producers of commercial films will find themselves on familiar ground.

CINECOLOR LAB . . . an opening at Burbank gives the commercial field another big color service; described on Page 34.

X-RAY . . . Business Screen discovers it in motion pictures and wonders why advertisers don't get the idea, too, for that "inside" story.

NEW PROJECTOR . . . in fact, several of them. The Selectro-slide, the Ad-Slide are unique and apparently very workable . . . where to use them is indicated on Pages 29-32.

THE HORMONE WOMAN . . . a New York doctor designed her and films tell how she works for the benefit of visitors to the San Francisco Fair.



Of singular interest to users of business and educational films, are the unique X-Ray motion pictures produced on the Roentgen ray abroad and now being shown in America. The application of X-Ray photography to many business uses for the education and selling field is apparent. The convincing power of such a visual demonstration is beyond comparison. Heretofore only single X-Ray pi-



tures could be produced, but now modern science has made it possible to record action from the fluorescent screen to the talking picture negative. The film explains the generation of X-Rays and the immense significance of X-Ray photography. X-Ray in the diagnosis and treatment of disease is depicted. Studies of mice, hens, cats and monkeys in motion are shown. Then the hand, ar-



and knee movements—the heart and lungs at work—and picture of the chewing and swallowing act are revealed. The concluding part of the film shows for the first time the achievement of sound film photography, in which pictures and sound are recorded simultaneously. The structure and the functioning of the inner organs of living human beings are shown in 16mm. and 35mm. version



(from Page 27) . . . that if film is broken in one or more machines, the machine is tripped out automatically and stops, while the other machines continue projecting. This is now being used at the World's Fair.

On the Reading List:

♦ Number Six in a series of vest-pocket sized essays on business films to be released by the Atlas Educational Film Company of Oak Park, Illinois is entitled *Why Must Business Films Be Educational?* John Curtis of the Atlas Staff scripted the series.

♦ The new edition of the "Free Loan-Sound Film Library" catalog issued by Burton Holmes Films of Chicago lists the new National

League official film *Baseball; To the Ladies*, starring Princess Alexandra Kropotkin; and *The Romance of Foods*, all sound motion pictures now available for free showings to adult groups. Sent on request.

♦ Two useful volumes that should be in the film user's file are issued by the DeVry Corporation, equipment manufacturers, Chicago. *Free Films for Schools*, a 64-page listing of 1,400 free films from over 300 sources is published at 25c a copy. *The Proceedings of the Eighth Session of the National Conference on Visual Education and Yearbook of Visual Education* which contains addresses, statistics, etc. on this field and contains 130 pages of useful information is

available at 50c the copy from the company.

Medical Production Specialists

♦ *The Story of Novol*, a motion picture, was recently produced for a manufacturer of dental anesthetics by Joseph P. Hackel and the Photographic Fair, Ltd. Specialists in this type of production, the Photographic Fair organization offers a unique service to medical and scientific groups. In *The Story of Novol*, the complete story of production of this anesthetic is told, including the actual use of the product in typical oral surgical procedure.

Personnel Changes

♦ Norman Blackburn, writer and supervising director, has joined the film department of J. Walter Thompson, New York. Fred Fidler heads the department.

♦ Benj. Munsey has been named casting director of the Jam Handy organization production unit 305 E. 45th Street, New York, according to Jamison Handy, president.

Films and Libraries:

♦ Just previewed is the new Weyhaeser Sales Company sound motion picture *Let's Build Together* produced by Ray-Bell Films, Inc., St. Paul for distribution in the building trades. Chiefly a story of lumber as used by the building trades, the film runs 30 minutes and is obtainable in both 16mm. and 35mm. sizes by organizations in this particular field.

♦ A fascinating collection of unusual oddities make up the sub-

BUSINESS THEATRES — I



THE MODERN FILM preview theatre of Wilding Picture Productions located in the Argyle



Street, Chicago, studios of that organization. Typical equipment is available for use.

ject-matter of the film series *Oddities Beyond Belief* now available from the extensive library of Nu-Art Films, Inc., New York. Ideal for business group supplementary use, there are six editions, each of which runs approximately ten minutes, sound, or fifteen minutes, silent.

♦ Pictorial Film Libraries, New York has just released in 16mm. sound, a one-reel musical comedy with the famed Sophie Tucker singing her songs in her own inimitable manner. The subject is well-adapted for commercial pro-

EXPERIENCE IN PRODUCTION techniques saves time and expense: Below: a drawing is screened by rear-projection and combined with a foreground set to economize on unnecessary set building otherwise required to achieve the desired effect. Here the screen is shown without the actors and foreground set.



BUSINESS NEEDED ECONOMICAL LIGHT WEIGHT SLIDEFILM EQUIPMENT

Now Ready



PRICED AT ONLY
\$3750

1939 MODEL K102 JUNIOR

Sturdy and strong in construction, yet it weighs only 11 pounds! Sound Projects' new Model K102 Junior is easy for salesmen to carry — yet perfect in performance. Priced low enough so that the largest field sales organization can be equipped at tremendous savings over existing equipment. Model K102 Junior plays up to a 16" record; has sufficient "true-tone" volume for audiences from one to fifty persons. Projects a bright, clear screen image. Standard equipment carries a 50 watt projector; equipped with 100 watt projector for larger audiences. Overall case dimensions: 5 3/4" x 13"; weight only 11 pounds.

EQUIP YOUR ENTIRE FIELD SALES STAFF
(Usual Quantity Discounts Granted)

Model K102 Junior (AC only) \$37.50
Equipped for AC-DC operation, slightly higher

Address Inquiries to:



EASY TO CARRY YET STURDY
K102 Weighs Only 11 pounds

SOUND PROJECTS COMPANY

3140 WALTON STREET • CHICAGO • TELEPHONE: NEVADA 6261

Or Ask Your Local Producer For Full Details

BUSINESS THEATRES — II



A BATTERY OF DEVRY theatre projectors is used in many modern business theatres.



ANOTHER TYPICAL business prevue room showing latest type of theatre seating used.

grams, conventions and other business meetings.

♦ The United States Film Service has just announced the release in both 16mm. and 35mm. size of three sound motion pictures. The widely-known film, *The River*, which was written and directed by Pare Lorentz; *Good Neighbors*, produced by the United States Maritime Commission, and *Three Counties Against Syphilis* are the subjects now available.

♦ Two popular Standard Oil Company (Indiana) educational films, *The Story of Gasoline* and *The*

Story of Lubricating Oil will be shown visitors to the United States Bureau of Mines exhibits at the world's fairs in New York and San Francisco.

New York Prevue Theatre

♦ The 50th Floor Auditorium of the Chanin Building at 122 East 42nd street in New York is the Eastern counterpart of the Prevue theatre maintained in the offices of *Business Screen Magazine* in Chicago. A number of commercial film showings are regularly held in this 200-seat theatre, as well as sales conferences, broadcasts, etc.

New Silent 16mm Projector

♦ Three former Bell & Howell 16mm. silent projectors have been replaced by the new moderately-priced "Filmaster" an entirely gear-driven machine. It has no belts or chains, inside or out. The gears, enclosed by rigid aluminum-alloy die castings, are said to be exceptionally silent. The price; \$139.00.

Convention Dates

APRIL 25-30. National Newspaper Association, annual convention, Waldorf-Astoria, New York.

APRIL 25-28. American Newspaper Publishers Association, annual convention, Waldorf-Astoria, New York.

MAY 1-4. Chamber of Commerce of the United States, twenty-seventh annual meeting, Washington, D. C.

MAY 5-6. Advertising Affiliation, 1939 convention, Hotel Statler, Cleveland.

PRESTO — CHANGE-O: (BELOW) Here the camera photographs the scene with steps, properties and actors in place. The column on the extreme left was built in wood to match the columns in the projected scene. This column gave more depth to the scene. The edging of the rear-projection screen does not appear in the filmed scene.



NEW

CLASSIFIED DIRECTORY OF FILM SOURCES



50c per Copy
Send Order to
Directory Editor

Never before has there been such a clear cut Subject-Source Index with its many classifications and divisions tabulated in a film directory. It is unquestionably the most comprehensive film selection list ever published. Instead of the user wading through many classifications to find a certain subject, this New Directory permits him to consult the Subject-Source Index, where, under the proper subject headings, he will find a list of sources that have such films available . . . both silent and with sound. Sources are numbered and user then consults source listings to determine what each source can supply.

Another noteworthy innovation is an enlarged editorial section that provides pertinent information and data on all non-theatrical applications of the motion picture . . . featuring, in particular, the educational field.

This edition of the VICTOR Directory is the result of thousands of requests for a continuation of this VICTOR service to 16mm. users. As VICTOR was the first to publish a film directory years ago, it now carries on with the most complete and helpful film directory ever published.



FOR YOUR COPY, send 50c with complete and fully legible mailing address to the DIRECTORY EDITOR at the home office of Victor Animatograph Corp., in Davenport, Ia.

VICTOR ANIMATOGRAPH CORPORATION

DAVENPORT, IOWA CHICAGO LOS ANGELES NEW YORK

SCRATCHES
 SCRATCHES
 SCRATCHES
 SCRATCHES
 SCRATCHES

ON MOTION PICTURE FILM

CAN BE REMOVED ONLY BY
RECONO PATENTED **METHOD**

Write for Free Trial Offer

AMERICAN RECONO, Inc.

245 West 55th Street

New York, N. Y.



The PLACE
 to LIVE,

SAVOY-PLAZA

You will find that New York has more to offer when you stop at the Savoy-Plaza. This famous hotel provides unrivalled excellence in the spacious comfort of its cheerful rooms, in its tempting cuisine and its thoughtful service. Subway direct to the World's Fair at the door.

Plan now to make the Savoy-Plaza your headquarters during your visit to the New York World's Fair 1939

Henry A. Rost, Managing Director
 George Suter, Resident Manager

OVERLOOKING CENTRAL PARK • FIFTH AVE. 58th TO 59th STS. • NEW YORK

CINECOLOR OPENS NEW BURBANK PLANT

◆ AN EVENT of interest in current business film history was the formal opening last month of Cinecolor's new plant in Burbank. Erected on a site over three acres in size, the actual building covers 45,000 square feet of space and is one of the most modern and novel color laboratories in existence. Architect Robert V. Derrah designed the ultra-modern concrete reinforced structure.

Incorporated in the new quarters are facilities and equipment which were designed to bring new accuracy, flexibility, economy and speed to Cinecolor's recognized process. Almost as important, Cinecolor's new facilities are said to enable it to turn out film at the rate of two million feet a week! The cost of equipment exceeds \$150,000, while the actual cost of the building is approximately \$125,000.

STREAMLINED HANDLING

Cinecolor's technical department is under the capable direction of Alan Gundlefinger, well-known for his past exploits in color work. This important department embraces a complete patent research room, technical library, research room, control room, optical rooms and dark rooms.

The actual handling of film has been streamlined to 100 per cent efficiency by progressive layout of modern quarters for camera unloading, negative polishing, printing, inspection, positive cutting, waxing, optical printing, and shipping — as well as a special effects camera department and private cutting rooms for the use of customers. A complete machine shop is also included.

A single gigantic room — 14,000 square feet in size — is used for processing of all types of color prints. Here is contained vast machinery for the coloring and developing of positive films in 16mm. and 35mm. and in both two and three color. This is the department

that will ultimately enable Cinecolor's output to be stepped up to between four and five million feet of film a week.

All electrical wiring and pipes for water, gas and the fire sprinkler system have been installed in a specially ventilated tunnel, to prevent the possibility of their being affected by chemical fumes.

TAKE ALL PRECAUTIONS

DC sets are also located in this tunnel. Release deadline dates don't usually take into consideration such hazards as the failure of electrical power, so Cinecolor has had to construct an auxiliary power plant, which is also installed in the basement for use in emergencies. In the event of power failure the auxiliary plant will pick up the job with a maximum current interruption of only ten seconds!

The huge new vaults for storing film have been patterned after modern bank vaults and are protected by an undrillable steel door. Fire sprinkling systems and additional novel safety features assure further protection of these vaults.

Since the printing and handling of Cinecolor film calls for exacting control of the heat and moisture in the air, special air-conditioning equipment has been designed for regulating humidity and temperature throughout the building with individual sectional control.

A useful as well as decorative part of its facilities is Cinecolor's main theatre. Here rushes and test prints may be promptly viewed in attractive surroundings. A special study has been made of projection equipment to insure the picture being consistent with standard theatre equipment.

MCCORMICK EXECUTIVE HEAD

The entire construction and installation of equipment has been carried out under the supervision of William Prymme, secretary of the company.

The business staff of Cinecolor, headed by A. L. McCormick, president and treasurer, has been comfortably and conveniently established in ten modern executive offices. Among the other officers are Alan Gundlefinger, vice-president in charge of research; W. T. Crespinel, vice-president, and J. Henry Kruse, Sales Manager.



NEW DEVELOPMENTS in EQUIPMENT

♦ The new DeVry "Interpreter" features a new device which represents a major change in projector operation, applying an entirely new principle.

Quality of sound has been greatly enhanced through use of the new "film stabilizer." Not only is sound improved, but it also has proven invaluable in eliminating strain on film, actually making it possible to run "green" (untreated) film without difficulty.

The DeVry film stabilizer, in exhaustive tests, has shown a remarkable effect on quality of sound. Basically, it makes the film travel in an "undirectional" manner, completely eliminating lateral and vertical "whip." In other words, it keeps the film traveling at an even, constant rate of speed over the sound aperture, keeps it also tightly held to the sound drum, and assures its traveling in a perfectly straight line, thus doing away with "waves" and unwanted variations in pitch due to lateral or vertical whip, or variations in speed of the film as it travels over the soundhead.

The new Automatic Loop Setter completely eliminates the possibility of tearing film or sprocket holes. The moment a variation in speed occurs, due to imperfections in the film or loop, it is only necessary for operator to press a button which opens the aperture gate an instant, push the gate back, and automatically the film makes its own adjustment to correct posi-

tion. This is all done *without stopping* the motion of the film, or the continuity of the image on the screen.

Bearings are new glass-hard steel, bearing shaft self-lubricating by special self-oiling units which keep bearings thoroughly oiled at all times for a period of at least two years. Non-tarnishable chrome used on important exposed metal parts. New easy threading ("Synchrophonic threading"). A flick of the index finger opens all threading units of soundhead segment.

16mm Projection Advances

♦ A brief glance at the accompanying chart of a typical 16mm. sound projector reveals the many changes which have taken place in 16mm. talking picture projectors for industrial use. Today, for as little as \$275.00, there are available efficient sound-on-film projectors incorporating features formerly not found in much more expensive machines.

As exemplified by one of these, (the new Model "X" Amprosound developed by Ampro) the new type sound-on-film projectors offer, in addition to low cost, extreme compactness and portability plus a remarkable simplicity of operation. The Model "X" projector with all accessories, including speaker, is contained in one case and weighs only 49 pounds. All operating controls are centralized on one illuminated panel. Threading is very simple.

DIAGRAMATIC CHART SHOWING PRINCIPAL POINTS of improvement on a typical modern 16mm. sound projector, in this case the Amprosound, a product of Chicago's Ampro Corporation. Lower prices are another important feature of the great strides made by commercial film equipment in recent months.

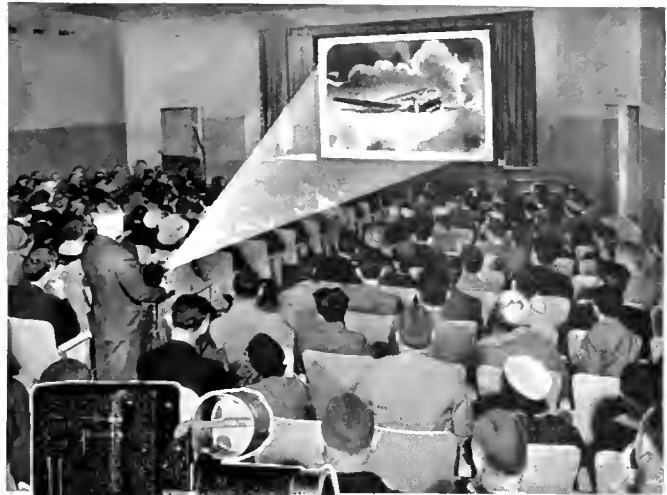
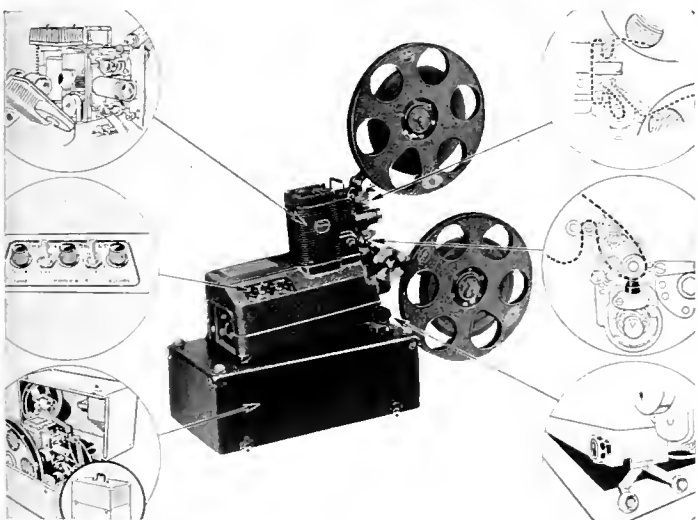

For Large Audiences

SHOW SLIDEFILMS

WITH



300 WATT

PROJECTORS

FOR more brilliant projection of slidefilms, S. V. E. Picturol Projectors are now available with 300 watt lamps.

Built on time-proved principles, the new high powered S. V. E. projectors provide greater brilliance, yet without increasing the heat on the film or the slide. The patented S. V. E. heat filter and releasing glass which moves back automatically when the film is turned, provides maximum protection for your film strips. Three styles of projectors are available, the AA Tri-Purpose unit which shows single or double frame film strips and 2" x 2" glass slides, the G which shows only single frame strips and the AK which shows only 2" x 2" glass slides. The AA and the G have as standard equipment the new S. V. E. re-wind take-up which re-winds the film in the proper sequence as it is being shown.

S. V. E. Model G 300 watt projectors are available in sound slidefilm equipment. Send for complete facts now. Use the convenient coupon!

Mail This Coupon Now!

SOCIETY FOR VISUAL EDUCATION, Inc.
Dept. 3B, 100 East Ohio Street, Chicago, Ill.

Without obligation to us, send complete facts about the new 300 watt S. V. E. projectors and the name of the nearest Producer-Dealers.

Name

Address

WORLD'S FAIR EXHIBITORS PROTECT YOUR VALUABLE FILMS!

• Keep your films fresh and clean — free from dust and dirt — properly humidified! Use a Neumade all steel cabinet — specially designed for films — the result of 25 years experience supplying the film industry.

DUSTPROOF · FIREPROOF TAMPERPROOF

Complete range of sizes and models for all kinds of film storage. Reels or strips 8mm. — 16mm. — 35mm.

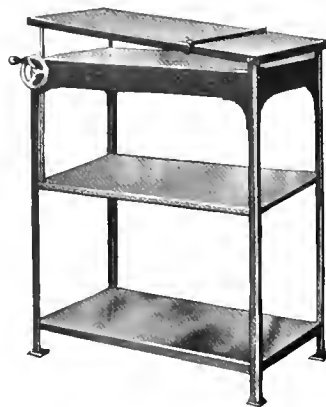

PROJECTOR TILT TABLE. Ideal for exhibit or business use. Adjustable to any tilt up to 10° rise. Sturdily built of heavy steel, 2 rigid shelves for reels, cassettes, etc.
T-134 (30" long, 16" wide, 36" high) \$49.50
With ball bearing, rubber covered casters \$6.00 extra.

WRITE FOR CATALOG

Neumade Products Corp.
CORPORATION

429 W. 42nd St New York City



MODEL DC-416
Suitable for the Sales or Advertising Manager's Office.

MORE TIPS FOR BETTER SHOWS

♦ In splicing sound film, either 35mm. or 16mm. width, wherever a square splice is used, it is the practice to paint out a section of the sound track on either side of the splice, in a diagonal fashion, to reduce the sound which the splice produces in the sound system as it passes the scanning beam. Because this painting eliminates a noise which sounds very much like the word "bloop", the painting is known as "blooping".

Research has revealed that the same effect as blooping is obtained when the splice is made diagonally. Thus, according to engineers in the Bell & Howell research department, when the B & H 16mm. splicer is used, the splice may be said to be automatically blooped.

When a diagonal splice passes the scanning beam, the width of the sound track becomes narrower, gradually decreasing the sound coming from this portion of the track, meanwhile increasing the sound from the track corresponding to the subsequent scene. This gives somewhat the same effect in sound as a very rapid lap dissolve in the picture.

Automatic blooping is an important sales point in favor of the diagonal splice, since it eliminates noise, due to splices and saves time by making it unnecessary to do painstaking bloop painting.

National Tie-Ins Moves

♦ NATIONAL TIE-INS, INC., of Chicago and New York, an organization devoted largely to unusual sales promotion and merchandising tie-ins, many of which include feature motion pictures, has moved its New York offices from 200 Madison Avenue to larger quarters in the Graybar Building, 420 Lexington Avenue.

THE WILDING CAMERA CREW tests between scenes while shooting the new Standard Oil film *Stunt the Music* starring Edgar Kennedy (seen in the uniform).

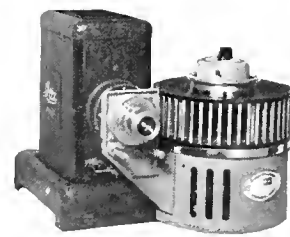

Automatic Slide Projection

♦ Something new in automatic slide changing projector equipment, the SELECTROSLIDE can be operated by remote control or by set automatic control for display purposes. The machine takes 2" x 2" color or black and white slides made from 35mm. film. It can be used to project pictures on a small screen in an office, or on a large screen in an auditorium that will seat hundreds. The exclusive new remote control feature is operated by means of a push button which the speaker holds in his hand. Slides are so changed when desired.

The possibilities of the SELECTROSLIDE for advertising and display purposes are said to be limitless for all kinds of advertising, both indoor and outdoor, and for sales promotion and presentations. The equipment carries an interchangeable magazine holding 48 slides in numbered slots. Once the magazine is correctly loaded, errors in projection are impossible. Changing the magazine requires only a few seconds, and so a great number of slides may be shown in rapid succession. This interchanging of magazines makes for great flexibility in subject matter. The SELECTROSLIDE is portable, weighing only 30 pounds. Inquiries addressed to the Screen Service Bureau of this magazine will be forwarded for immediate reply.

Filmosound Library List

♦ THE FILMOSOUND FILM LIBRARY BOOK just issued by BELL & HOWELL illustrates how this firm has provided a single film source adequate to meet the diversified demands of educational institutions, industry, homes and communities. It contains a valuable and varied collection of sound-on-film features, comedies, cartoons, adventure, nature subjects, music, religion, history, news reels, sports and teacher training.

Here, between its covers are sixty-four 8½ x 11 inch pages containing titles, description, classification and pricing of 2800 reels of sound film offered for rental or sale.



Distinguished

The Drake offers every luxury and convenience of fine living on Chicago's Gold Coast, overlooking Lake Michigan.

A. S. Kinkley, Managing Director

The Drake

LAKE SHORE DRIVE · CHICAGO

THE COMMERCIAL NEWSREEL

♦ The Jam Handy organization is doubling the size of its midtown offices and review rooms when new quarters are taken over in the Berkeley building, 19 West 44th Street, New York City, March 15, according to Jamison Handy, president. Herbert Depew is in charge.

The New York production unit at 305 E. 45th Street and the offices and review rooms in the General Motors building, 57th and Broadway, are to remain the same with George B. Finch in charge of the uptown office, Mr. Handy said.

Argus Executive Changes

♦ The International Research Corporation announced the appointment early in March of Ted Grange, former Argus advertising manager, to the position of territorial salesmanager for the Chicago district. Harvey Brown, formerly in charge of Argus sales promotion and editor of the Argus Magazine, *Argus Photography*, will replace Grange as advertising manager.

Karl H. Barleben, Jr., a Fellow of the Royal Photographic Society and a well-known photographic authority and writer, has been added to the Argus staff as educational director. Barleben conducts a column for *Travel Magazine* and is the author of *The Leica Data Book*, *Cash From Your Camera*, and *Travel Photography with the Miniature Camera*. In addition to his regular duties as technical advisor and expert, Barleben will also conduct a series of lecture tours in the near future which will be open to the general public.

Dufaycolor Prints Down

♦ As a result of recent laboratory developments, prices on Dufaycolor prints and enlargements will be reduced from 10% to 50% beginning February 20th. In announcing this reduction, Robert Jordan, Sales Manager, says: "Without doubt the reduced prices will bring about an expansion of the color market, since it puts natural color prints well within the reach of the most limited photographic budget."

On February 15th, a \$100 "Prize Picture" promotion will be offered all Dufaycolor dealers. Dufaycolor Company, Inc. will pay \$100 for every Dufaycolor transparency selected as the Dufaycolor "Prize Picture." For future exhibits and

advertising purposes, Dufaycolor will offer \$10 for selected transparencies which do not win the \$100 award.

Gutlohn Lowers Rates

♦ WALTER O. GUTLOHN, INC., of 35 West 45th Street, New York who distribute 16mm. sound film in the United States and Canada, with a library of over twelve hundred entertainment and educational features and shorts have found that the demand for their pictures in the commercial field has been growing so rapidly that they have been enabled to announce a new price scale for industrial rentals and sales far below former rates.

The Gutlohn library lists among its clients such well-known users of industrial films as Standard Oil of Indiana, Chrysler, Pontiac, General Electric, Shell Oil, U. S. Industrial Alcohol, Public Service Corporation of New Jersey, and in the ice cream industry, the Breyer, Pioneer and Horton Companies.

Increasing interest in the building up of program appeal with musical features, cartoons, comedies, etc., has proven most successful. According to Gutlohn officials, this development is one that most business film users should bear in mind when they plan their showings.

Cole Offers Fair Aids

♦ The presentation of non-theatrical motion picture shows has become an established business with the King Cole Sound Service of New York, for twenty years specialists in non-theatrical showings.

The equipment used is the most modern, and is operated by experienced projectionists and engineers. The standard projectors are thirty-five millimeter machines. The sixteen millimeter equipment is that manufactured by the Bell & Howell Company to specification so that Western Electric Sound Equipment may be used with the projectors. There is also available silent projection service, or sound slide film and public address systems.

Industrial organizations planning to hold sales conventions in New York during the Fair period will find this service useful. Many new products will be introduced to the selling force via portable machines set up in a hotel room or auditorium.



A FRESH VIEWPOINT

Many companies have worthwhile older films containing pictures difficult or costly to replace — but which should be brought up to date with new editing or partial new photography and modern sound and "dressing".

An important service of the Dowling and Brownell organization is just this type of job — making old picture stories new by expert treatment.

Send us your problem and your films to view, with your thoughts on changes or new requirements; and we will offer suggestions as to how your pictures can best be made to serve today's new audiences.

DOWLING and BROWNELL

6625 Romaine Street

Hollywood, California

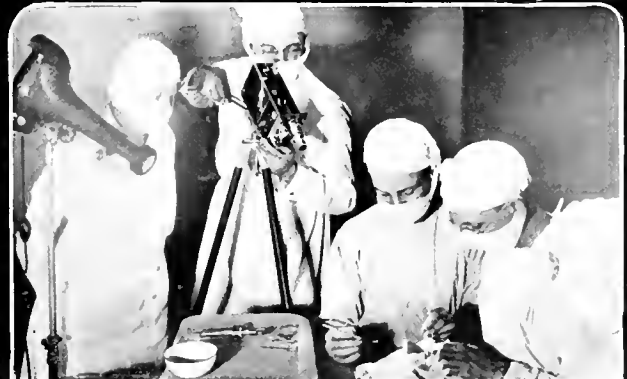

Let us Produce your Technical Films

With intelligent planning . . . careful preparation . . . alert, competent technicians and operators . . . ENGINEERING and TECHNICAL STAFF experts available for work on your problems.

Complete films from \$1000.00 up

We have produced unsurpassed scientific motion pictures in silent, sound, and color for leading manufacturers and pharmaceutical laboratories.

Write on your letterhead for booklet "I" describing our guaranteed distribution service.

CONSULTATION INVITED

JOSEPH P HACKEL'S

PHOTOGRAPHIC FAIR LTD.

PRODUCERS • DISTRIBUTORS • EQUIPMENT — A COMPLETE SERVICE
144 East 57th St. NEW YORK, N. Y. Wickersham 2-9742

Now It's

CINECOLOR!

Today Cinecolor throws the master switch in its new \$250,000 Burbank plant...as motors hum, vats swish and pulleys begin their ceaseless chores... a vital new milestone is passed.

Now equipped to add a million feet each week to the 40,000,000 feet of its film being shown throughout the world... Cinecolor is destined to push on to greater heights in *color accuracy, flexibility, speed and economy.*

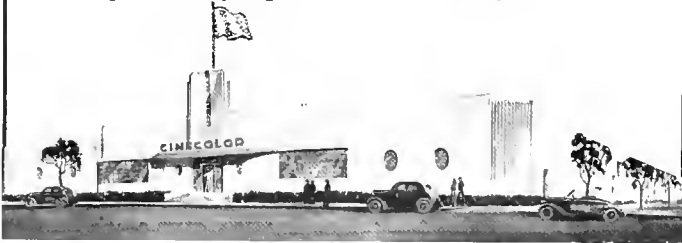

America's Finest

The chosen address of the most discriminating... home of the famous Zebra Room

Under the same management as the internationally famous Drake and Blackstone Hotels, Chicago

A. S. Kirkeby, Managing Director

The Town House
WILSHIRE BOULEVARD
LOS ANGELES

THE HORMONE WOMAN

A unique exhibit for the San Francisco Fair is explained

by Dr. Frank Netter

♦ In preparing their exhibit for the Golden Gate International Exposition, the manufacturers of a sex hormone preparation used in medicine asked me to work on a certain problem. They wanted to show the dramatic action of sex hormones, the changes that these hormones produce in the internal structure of women during the menstrual cycle, and when pregnancy occurs. They came to me with their problem because they had heard that I was a physician experienced in interpreting medical facts and stories to the public, through models and illustrations.

After considering various ways I conceived the idea of constructing a transparent figure of a woman, and then demonstrating the action of the glands within this figure. But the problem was complicated by the nature of the subject. It was not only necessary to illuminate the various glands at certain intervals in the story, but it was necessary for the various organs to actually change shape and size. For example, we wanted to show the growth of a baby within the womb, step by step; thus, it was impossible to actually construct these organs within the figure and illuminate them, for glass and such substances cannot be made to expand to contract. The next logical approach was to use the principles of projection.

A PLASTIC "THEATRE"

A figure of a woman was constructed of a transparent plastic of the acrylic resin group, namely, plexiglas. Considerable thought was applied to the pose of the figure, for the lady should be expressive of sex but not of vulgar sex. She must express womanhood. How well we succeeded the readers may judge from the photograph. I sketched many different poses before deciding on the one which most satisfactorily filled the bill, and from my drawings and paintings the transparent woman was constructed. The front half of the figure alone was made. An opening was cut in a ply-wood panel to exactly fit the silhouette of the figure and the transparent lady was mounted in it. Behind this figure, and flush with the rear opening, a rear-projection silk screen was placed. I found that this screen gave better diffusion

and better light transmission than did molded screens.

It was my desire to create the impression of reality. In other words, I wanted to make the audience feel that they were seeing, not projected pictures of organs, but that they were actually viewing these organs in three-dimensional reality within the figure. How then to achieve this illusion? It occurred to me that if the figure were tinted so as to impair its transparency just sufficiently so that light impinging on it from the front would be reflected, but light coming in from behind would pass on through, it might be possible to create this effect. That is, the figure viewed from the front, without any illumination from within, would appear opaque, as though she were constructed of alabaster or some such material. In this way the audience would not be conscious of the fact that there was a screen within the figure; only the pictures themselves as they were cast upon the screen would be illuminated and thus they would be the only things visible. If these pictures were properly rendered to give three-dimensional effect, by the use of light and shade, perspective, etc., the eye would be deceived into believing that the organ was actually there. The effect in one sense would be like that of theatrical gauze.

The problem of tinting the figure then became one of major importance in the entire project. After considerable experimentation, I chose an alcoholic soluble dye and sprayed it on to just the right density to achieve the proper degree of translucency. The vari-

Here is the completed figure designed and built by Dr. Netter.



NEW FILMS

Four recent sound motion pictures produced for the business field . . .



WISCONSIN BANKERS ASSOCIATION: Four Money & Mine an educational film telling the story of banks and bankers to the public and to bank employees.

Running time: 30 minutes

DISTRIBUTION: Wisconsin organizations and member banks, etc. Produced by Ray-Bell Films, Inc., St. Paul.



UNITED MOTORS SERVICE: I'll Say She Is an inter-organization sales training film on the New Delco Sales Stimulator.

Running time: 25 minutes

DISTRIBUTION: Dealers, branch representatives and service men nationally handling the Delco line. Produced by Industrial Pictures, Inc.



WESTERN AIR EXPRESS: Skyway to the Nation's Playgrounds an all-color sound Western travelogue, showing all scenery, parks, etc.

Running time: 30 minutes

DISTRIBUTION: Nationally to civic groups, luncheon clubs, schools, etc. Produced by Stith-Noble Corp. Ltd.



CALCIUM CHLORIDE ASSOCIATION: Low Cost Dustless Streets & Roads

Technical film on low cost road improvement showing use and application of calcium chloride in road building. Running time: 25 minutes, approx. DISTRIBUTION: To road commissioners, county officials, engineers and technical men. Produced by Industrial Pictures, Inc., Detroit.

ous markings, such as the eyes, nose, lips and folds of the body, etc., were slightly accentuated in this tinting, so as to emphasize the modeling of the figure.

The problem of projection methods now arose. My first idea was that of utilizing an animated motion picture but this idea was discarded because I felt that the flicker of the picture, slight as it was, would destroy the illusion of reality. Furthermore, as the display was to be shipped and maintained in San Francisco, three thousand miles away, for a period of nine months, I was a little afraid of trouble from film breakage, etc.

USES 16 PROJECTORS

The solution lay in the utilization of synchronized slide projectors. Having reached this conclusion, I took the matter up with Mr. Walter Schwanhäuser, chief engineer for the Beseler Stereopticon Company, at 131 East 23 Street, New York. We studied the script and found that we could procure the desired effect by utilizing sixteen small projectors together with a double dissolving projector; that is, eighteen projectors in all. The sixteen small projectors were utilized in the projection of organs in various parts of the body.

The script called for the various glands to light up in series, with moving arrows leading from one to the other. This part of the work, as I have said, was handled by these various projectors. The moving arrows were also produced by a series of these small projectors which lit up in sequence.

The problem of making the illustrations was a rather difficult one in view of the accurate registration which was required and also of the impression of reality which we were striving for. This effect which was required, we achieved by making a very careful rendering of the basic illustration, that is, the womb, in air brush and then painting in very accurately upon transparent celluloids the successive changes within that organ, very much like the procedure one would follow in making an animated motion picture.

Having completed our animated transparent lady, the effect which we had obtained dramatic and so striking. The process permits the demonstration of any physiological process within the human body, or for that matter, within any object, either animate or inanimate, such as the operation of an engine within an automobile, action with in a building; etc.

To the Ladies!

A BURTON HOLMES FILM WINS WOMEN CUSTOMERS FOR MILAPACO . . .



● Getting the woman's point of view is important to many film sponsors. "To the Ladies", a Burton Holmes Film production for the Milwaukee Lace Paper Company, is now showing to hundreds of appreciative women's groups everywhere . . . winning consumer acceptance for the product and sales for dealers.

Whether fur tractors or lace paper, our many years of experience in producing commercial motion pictures and slide films as well as theatrical "shorts" has been a consistent record of successes. We know how to combine these all-important ingredients: the customers' points-of-view, yours and your dealers!

Address Business Films Department

NOW AVAILABLE FOR FREE LOAN

"To the Ladies", starring Princess Alexandra Kropotkin, traces lace making from its inception to the application of die-cut lace paper to simple elegance and gracious living. Many famous Kropotkin recipes are prepared in her kitchen, many delightful Kropotkin table settings shown. Suitable for every women's group.

Available on application in 16mm sound film, mounted on 800 foot reels. Running time: 22 minutes.

Burton Holmes Films, Inc.

7510 North Ashland Avenue

Chicago, Illinois

PRODUCERS • DISTRIBUTORS • LABORATORY SERVICE

SHORTS—FEATURES

in 16mm. Sound Films

The GUTLOHN library of Entertainment and Educational films will lend distinction and sparkle to your programs. These pictures include outstanding musicals, cartoons, comedies, travels, literary classics, science, sports, world affairs and novelties.

Send for catalog listing over 1200 subjects available for rental, lease or sale.

We Supply Films for
SPONSORED SHOWINGS
including projection service.



WALTER O. GUTLOHN, Inc.

35 West 45th Street

New York

VAPORATE

YOUR FILM PERFORMANCE

deserves the improvements VAPORATE protection assures.

YOUR FILM BUDGET

deserves the economy VAPORATE protection provides.

INSIST ON PRINTS

VAPORATED

for better screening and longer useful life.

VAPORATE protects over five hundred million feet of theatrical, industrial, educational, rental and personal motion picture, slide and continuous display films annually, against damage from climate, scratches, wear, oil, dirt and finger marks.

CONVENIENT-ECONOMICAL

VAPORATE Service is available, through producers, dealers and laboratories in the United States, England, France and Italy.

NEW YORK Vaporate Co., Inc. 130 W. 46th St.
CHICAGO Bell & Howell Co. 1801 Larchmont
LOS ANGELES Craig Movie Co. 1053 S. Olive Street



FOR GOOD ADVERTISING

have your type set by a typographer because he will always give you greater value in general appearance and the satisfaction you can obtain only by purchasing the very finest.

ADVERTISING TYPOGRAPHERS, INC.

341 EAST OHIO STREET, CHICAGO

CALL SUPERIOR 0813

G-E A VISUAL PIONEER

(Continued from Page 24)

tin nose to reduce spill light. Simple but firm clamping structures hold the lighting units to the top of each set without sacrificing height or freedom to move set walls about for various camera angles. A Fearless turntable dolly and blimp which houses a modern NCMitchel Camera allow full flexibility and quietness during synchronous takes.

A recently designed Mole-Richardson boom, Type 103-B, supports one of several kinds of microphones the sound recordist may care to use for a particular job. Most of the synchronous recordings are made with either a standard velocity or semi-directional velocity microphone. An inductor type is used when possible for voice-overs or disk recordings. We have recently designed and constructed a complete new amplifying channel capable of mixing four different inputs with the highest quality. The overall frequency characteristic is flat from 30 to 10,000 cycles, plus or minus 2DB.

For film recordings, which will be played mostly on standard equipment, a rise in response at the high frequency end amounting to 8DB at 8000 cycles can be introduced. Recordings which will be reduced for 16mm. reproduction are peaked a similar amount at 4000 cycles with a sharp cut-off at 5000 cycles. Individual compensators are provided in addition for each of the four mixer positions giving an alternative of either 0, 9, or 13 DB loss at 100 cycles. This equipment is located in a room adjoining the studio. A sound-proof window of three floating glass panes allows the recordist full view of the studio.

RECORDING EQUIPMENT DESCRIBED

Film recording is done on a PR23 RCA Recorder with ultra-violet light and biased-shutter ground noise reduction. Disk recording is done on a Presto semi-portable machine. Both 78 and 33-1/3 recordings are made --- some for single use, others for processing. Inbuilt also are three turntables which may be used for playback or dubbing-in purposes. The output from these tables feeds into a separate three-position mixer which parallels the other mixer.

A reconstructed early type film recorder serves as a film phonograph. This is tied in by means of selsyn drive to a standard projector so that re-recordings and direct recordings may be made synchronously and with the lowest sound losses. For location work, a laboratory model recorder and a compact broadcast field amplifier are used. With this apparatus nearly all types of sound work which might be required are possible.

Auxiliary camera equipment consists of a silenced Bell & Howell equipped with a silent Unit "I" type shuttle and a direct-on-film 5 and 10 X focusing magnifier. This unit in a

blimp of our own construction allows two angles to be shot simultaneously when a sound take of a difficult-to-repeat action is called for. The preference is to shoot with one camera; light for each angle; and repeat the action. This same camera or an Akeley is used for most location work. The latter is particularly adaptable in factory shots or transportation sequences. Two Eyemos and a DeVry, all spring-driven, fulfill a useful service in the making of odd angle, insert, or grab shots. Because of their simplicity, they are often turned over to salesmen who may be traveling and can pick up a shot or two which will be satisfactory. Recently some footage of a trolley-coach installation in Honolulu was made by the sales engineer sent from the states to supervise their operation. Such procedure is of course a gamble; but so far the company considers that it has been lucky.

A second Bell & Howell, adapted to handle two films in perfect register and contact, as well as to run a single thickness, is in the laboratory. This camera is mounted on a vertical table-type stand for making animated drawing sequences. The stop-motion control is operated conveniently through solenoids and even illumination is supplied from Mazda lamps in soft-type reflectors. This same camera may also be mounted on a horizontal lathe bed mount for copy work, run up titles, etc. Dissolves, wipes, and simple montage effects are made with this camera by running the master positive and duplicate negative together, controlling exposure with the lens iris, and creating the effect through the reflection of light from black and white cards which are animated. Though slow and limited, this procedure has produced all the effects the department has thus far had occasion to need.

Two standard continuous Bell & Howell printers in addition to the optical reduction printer and the special sound printer previously mentioned, are in a small but adequate dark room. A D.C. generator and control panel provide constant voltage to the motors and lamps so that printing densities may be constant. All negatives are optionally timed by the man in charge for the first print. Changes in timing, if in order are made after conforming. Because all the negative processed is shot by the same cameramen, there is little variation, so visual timing is satisfactory. All 16mm. sound printing and some large printing orders for standard release are done by commercial laboratories.

ALL PICTURES IN FIVE GROUPS

♦ The pictures produced with this equipment are rather diversified, so it is somewhat difficult to draw sharp lines in classification. In general, however, they break down into the following groups:

1. Institutional or informative --- the subject matter of which may influence a general

(Please turn to page 38)

FILM LIBRARIES-NATIONAL

A TRIUMPH

For Novelty . . . Camera Angles . . . Editing . . . Dialogue . . . and Natures Wonders!
30—1 reel S.O.F. shorts called—30

SCREEN TRAVELERS

Film Daily says—"You are going to experience a delightful treat when you see this series on the screen. Superlative narration and photography. La Varre's voice and delivery make you feel as if you were right there with him as his camera catches the changing scenes with excellent accuracy."

WRITE FOR PARTICULARS
 145 W. 45th St., Dept. 15
 NEW YORK CITY, N. Y.



★ **ABBE FILMS** ★

1265 Broadway, New York, N. Y.

Invites your membership to their large 8mm. — 16mm. rental library. We supply suitable programs for conventions, etc.

Mail inquiries and orders solicited.

PLANNED 16mm. MOVIE PROGRAMS FOR ALL ORGANIZATIONS

SPECIAL SUBJECTS: 1938 National Golf Tournaments
 Garden Subjects in Color · Nickelodeon Movies

NATIONAL FILM PROGRAMS

INCORPORATED
 342 Madison Avenue New York City

—presenting—

"SOPHIE TUCKER"

in a musical filled with swing and rhythm
 1 reel . . . 16mm. sound

PICTORIAL FILM LIBRARY, Inc.

130 West 46th St. New York City

PRODUCER-DISTRIBUTOR

A Unique Combination

FILM PRODUCTIONS that really tell the story of the products of the leading manufacturers of the country

DISTRIBUTION SERVICE that takes that story to hundreds of thousands of prospects anywhere and everywhere

Guaranteeing Results

• C. L. VENARD •

(THE VENARD ORGANIZATION)
 702 S. Adams St. Peoria, Illinois

"How They Use Pictures"

REPUBLIC STEEL FILMS DO TWIN SELLING JOBS

REPUBLIC STEEL Corporation, Cleveland, Ohio, in recent years has enlisted the media of sound pictures to do two selling jobs, one for their product Enduro Stainless Steel and one for their Agricultural Extension Bureau on behalf of Republic's many products for the farm such as fencing, fence posts and wire.

The more recent of the two, entitled "Steel — Servant of the Soil" is a good example of an educational motion picture produced for commercial purposes. The three-reel film traces progress in fencing and farming methods and depicts some of the crude barriers which served as fences in early pioneer days. It unfolds the modern mining of iron ore and its conversion into molten metal and leads into a climax showing the manufacturing of fencing and the electrogalvanizing of wire—a new process recently developed by Republic.

Since the introduction of stainless steel on a commercial scale about ten years ago, it has been necessary to carry on an educational campaign on behalf of this product. When stainless steel first bowed to America everybody admitted that it was marvelous, amazing and wonderful but true to tradition, fabricators thought it was too hard to work, housewives thought it was nice but . . . makers of large equipment for textile, food, meat packing and other industries thought it was fine but . . . etc.

Over the years, these viewpoints have been changed and stainless steel is now accepted in its own right.

One of the methods used by Republic to bring this about is the movie entitled "Enduro — The Magic Metal of Ten Thousand Uses". The production is divided into three parts (1) production of stainless steel, (2) fabrication, and (3) uses.

Republic is well pleased with the results of these two pictures. The one on stainless steel is now in its fourth year and is still going strong. Bookings for the agricultural movie, in its first year, indicate that it is a success. Distribution is handled in the case of the former by assigning permanent equipment to centrally located district sales offices. The latter, being shown almost exclusively in midwestern states, is distributed from the Agricultural Extension Bureau's headquarters in Chicago, Illinois.

PROJECTION SERVICE

A COMPLETE MOTION PICTURE DISTRIBUTION SERVICE

In all phases for Theatrical and non-theatrical pictures. The non-theatrical service includes supplying projectors, screens, operators, etc., and transportation.

King Cole's Sound Service, Inc.

203 East 26th Street, N. Y. C. Lexington 2-9850
 Local operating points in upper N. Y.—N. J. and Conn.



We've scored again!

The outstanding motion picture of Banks & Bankers!

"YOUR MONEY and MINE"

Produced for Wisconsin Bankers Association

by

RAY-BELL FILMS, INC.

Saint Paul - Minnesota

Producing Business Films since 1910

Business Opportunity

With mid-western commercial film production company for man with well rounded slide film and motion picture experience. Must be able to contribute to the success of the organization in other than routine activities. Capital investment not essential. Write lully to Box 29, c/o Business Screen, 20 No. Wacker Drive, Chicago, Illinois.

PAN AMERICAN FILMS

Announces

NEW CHICAGO LABORATORY EXCLUSIVE 16MM SERVICE

Expert machine processing of 16mm. negative or positive film. Economical schedule of prices furnished on request to business or educational film producers and users.

Direct 16mm. sound recording on modern "noiseless" sound equipment plus the services of skilled laboratory and sound technicians.

16mm. SOUND OR SILENT FILMS EXCLUSIVELY



Free CONSULTATION SERVICE at your request!

PAN AMERICAN FILM LABORATORY
 325 WEST HURON STREET · CHICAGO

PUT YOUR STORY ACROSS

WITH **Diafant-**
PROJECTORS



Show your slide films to greatest advantage with this superb machine. Brilliance and precision in projection for all branches of sales activity.

Diafant offers highest illumination and optical perfection; shows sparkling, lifelike images under even the most adverse conditions. Advanced design plus scientific heat prevention prolong life of valuable films. Model illustrated takes 35mm film in strips, rolls or slides. Other models for larger film material.

Write for literature and prices. Special quotations on dozen lots and larger orders. Address inquiries to Dep't S-3



INTERCONTINENTAL MARKETING CORP.
8 WEST 40th ST., NEW YORK

Complete literature concerning any advertised product may be obtained from the Screen Service Bureau of this magazine. Simply address 20 N. Wacker Drive, Chicago.



CHICAGO BUSINESSES ARE Cutting Costs

WITH NORMAN WILLETS SOUND PRODUCTIONS

BECAUSE:

1. We've a quarter of a century experience in ALL the diversified branches of photography—and know ALL the angles in cutting the corners on costs.
2. Because we KNOW, we work smooth and fast—saving you a lot of time and more important—a lot of money.
3. Our studios are modern, equipment the finest, editorial and technical resources thoroughly reliable.
4. We employ the top-flight editorial assistance of the Ballard Film Service—they've scored many a screen hit for some of America's greatest industries.

Do you need sound films? JUDGE FOR YOURSELF by checking your business with the Norman Willets "Production Analysis", NOT a sales story, but a valuable business film "check-chart." Send for it today. No obligation.

N-W SOUND PRODUCTIONS
316 W. Washington Blvd., Chicago, Ill.

Dear Sirs: B539-1
Send your helpful Production Analysis. No obligation, of course.
Name _____
Company _____
Address _____
City _____ State _____
Norman Willets Sound Prod., 316 W. Washington Blvd., Chicago

G-E A VISUAL PIONEER

(Continued from Page 36)

audience to buy electrical and when they do so, to buy General Electric. Such pictures find release first through theatres, and then through schools, colleges, organized social groups and business clubs.

2. Sales — pictures in which the idea or products presented may influence special audiences to buy General Electric. Such pictures are also used within the organization to keep its own men abreast of developments. On occasion, they are presented before technical groups interested in the engineering phases of the subjects.

3. A third group might be termed "historical." Pictures of leading men or outstanding events are chronicled for posterity and for organization training. Such pictures acquaint the new men with some of the past and present leaders and with the company's history and ideals.

4. Special films for limited use at company meetings and the like form another group. Their theme is usually inspirational and their job is to stimulate the sales force.

5. The use by engineers in recording tests, or in the study of mechanical action, in analyzing rapid motion, by means of high speed photography, for example, or in showing methods of manufacture, comes within a fifth group.

DISTRIBUTION PROGRAM VARIES

The distribution of individual pictures, of course, varies with the subject, and their individual application is guided by the sales problems involved.

Theatrical distribution is handled through a regular agency. The booker is supplied with prints and he makes contacts, bookings, and handles the physical distribution. School and college requests are handled either directly from Schenectady or from our nine district offices located throughout the country, or from several educational centers, all of which have prints in both 35mm. and 16mm. widths on deposit. In passing, it may be noted that the demand for 35mm. prints is falling off with marked rapidity, while the requests for 16mm. are mounting rapidly. This situation prevails in both silent and sound films.

G-E district offices are also equipped, as also several of our local offices with 16mm. sound projectors, so that customer showings by salesmen are relatively easy. The only request, other than that of careful handling, made upon the user is the filling in of a report card, stating the number of times and before how many people a subject was shown, and the comments resulting from the showing. From these records G-E's last year's reported distribution showed an overall total of some twelve and a quarter million people from nearly eighty-one thousand

showings. If this figure amazes, it may be added that on certain types of films the company cannot meet the requests for showings.

Perhaps G-E's use of pictures can best be stated by quoting Mr. C. H. Lang, Manager of the Company's Publicity Department:

"FILMS ALMOST INDISPENSABLE"

"We have found that talking pictures provide a valuable approach to our many-sided educational work. They are almost indispensable in telling a broadly educational story to school and college classes and to groups which expect entertainment as well as instruction. We also make constant use of them in presenting engineering, manufacturing, and sales stories for the instruction of our own organization or to inform customers as to the making and use of our products. With such a story on film, we know that the facts will be presented in the way that we wish to have them presented. Factory methods and important manufacturing operations can be pictured and described in the most effective and realistic way.

"Talking pictures are a part of our exhibits, sales presentations, and traveling displays. We have used them, also in pointing out ways of improving factory methods to the members of our own organizations and for recording important engineering studies.

"Naturally with a staff and a studio available at all times, we use these facilities in many other special ways which are peculiar to our business. The general uses which I have mentioned indicate the value that we place on talking pictures as an important tool in sales-promotion work."

Coming Events:

Forthcoming features for the editorial and technical departments of Business Screen . . .

DEALER TIEUPS & THE BUSINESS FILM: How successful business film programs were worked out through local dealers. Examples of typical promotions.

THE FILMS & WINDOW DISPLAY: A folio by Barnes & Reinecke, noted industrial designers, showing the unique methods of applying existing motion picture and slidefilm equipment to all types of windows.

WORLD FAIRS & FILMS: Sixteen pages of complete theatre projection layouts, sketches showing the unusual projection setups at the New York and San Francisco Fairs and reviews of the pictures used.

THE TECHNIQUES OF SCREEN ADVERTISING: An authoritative article on the methods of making a screen advertising program; the good and bad elements.

ADVERTISING AGENCIES LEARN ABOUT FILMS: A Forum on the Business Screen by Leading Agency Executives of New York and Chicago.

SOON! THE ANNUAL AWARDS NUMBER!
ALSO: 1st ANNUAL SCREEN DIRECTORY.

THREE NEW STARS

EASTMAN'S new motion picture negative films . . . general-purpose *Plus-X*, high-speed *Super-XX*, ultra-fine-grain *Background-X* . . . add highly dependable performance to extraordinary special abilities. Their instant acceptance and constantly wider use by the industry mark them as today's outstanding raw-film stars. Eastman Kodak Company, Rochester, N. Y. (J. E. Brulatour, Inc., Distributors, Fort Lee, Chicago, Hollywood.)

**EASTMAN *Plus-X* . . .
Super-XX . . . *Background-X***

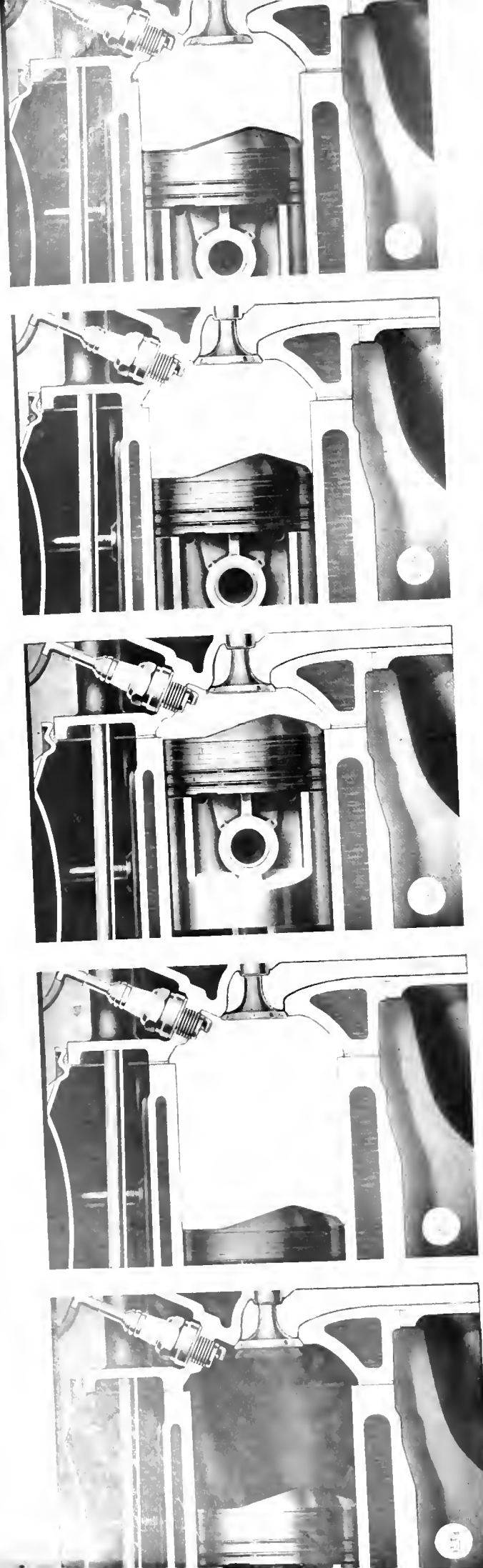

Every unseen value can be made visible and made vivid with or without color by the use of the newest Jam Handy animated drawing processes which will show the inside workings of anything whatsoever.

You can give dealers, salesmen, and prospects a quick "mind's eye" grasp of vital features and show them all that goes on out of sight.

A hidden sales feature can be brought out for all to see and understand.

The Jam Handy Organization can help you leap the gap between the minds of your experts and those of your sales organization or your prospects. On whatever you would like to have them know the knowing is made easy.

Technicolor animation vividly points out a hidden sales feature — why a new piston design eliminates pings caused by too rapid acceleration when lower priced gasolines are used.

- | | |
|--|--|
| 1. Intake — charge of gasoline | 3. Burning; the start of the explosion |
| shown in blue. | shown in blue. |
| 2. Compression — valve closed; | 4. End of power stroke; exploded |
| heat by compression indicated. | gasoline shown in red, pushing |
| | down piston. |
| 5. Exhaust; burnt gases about to be exhausted. | |

THIS TECHNICAL ANIMATION WAS PRODUCED IN OUR OWN COLOR STUDIOS EXCLUSIVELY UNDER OUR CONTROL.

JAM HANDY

Organization

Working Pictures • Sales Conventions • Playlets
 100 West 44th Street, MUMAY HILL 9-5290 Detroit, 2900 East
 6th Boulevard, MADISON 2450 Chicago, 35 East Wacker Drive,
 STAVE 6756 Hollywood, 7046 Hollywood Boulevard, HEMPSTEAD 5809

BUSINESS SCREEN

H



**IN THIS ISSUE: A CHALLENGE TO AVIATION
DISTRIBUTION FOR PROFIT; NEW SLIDEFILMS**

RULING FAVORITES

EASTMAN'S three new motion picture negative films have quickly established themselves as the favorites of the industry. *Plus-X* for general studio work . . . *Super-XX* for all difficult exposures . . . fine-grained *Background-X* for backgrounds and all-round exterior work. Each makes its special contribution, and all have that typical reliability closely identified with Eastman films. Eastman Kodak Company, Rochester, N. Y. (J. E. Brulatour, Inc., Distributors, Fort Lee, Chicago, Hollywood.)

**EASTMAN *Plus-X* . . .
Super-XX . . . *Background-X***

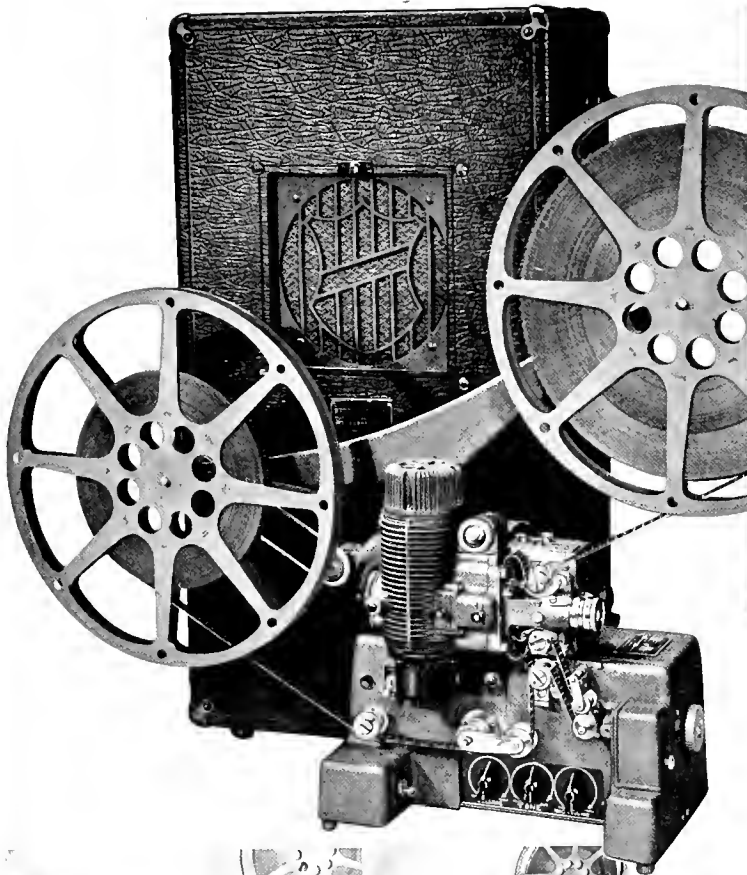

Filmosounds...
FOR EVERY NEED
and all
supremely fine!

FILMOSOUND "COMMERCIAL" (left). Those who show your business film will appreciate this compact, single-case Filmosound for office, salesroom, hotel room, or medium-sized auditorium. It is easy to carry, and easy to set up, too. No fuss, delay, or embarrassing complexities. Has 750-watt lamp, powerful amplifier, 1600-foot film capacity, speaker-hiss eliminator, "floating film" protection, and provision for using microphone or phonograph turntable. Quantity production and simplified controls make possible its new "bargain" price. Complete, only \$276

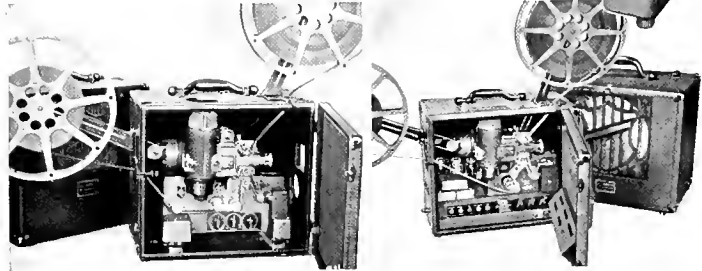

FILMOSOUND "ACADEMY" is the same as the "Commercial" except that (1) it is in two cases, one enclosing the projector for quiet operation, and (2) it projects both sound and silent film. Complete, only \$298

FILMOSOUND "MASTER." A powerful 16 mm. sound film projector for serving larger audiences. Offers the wide range of services of the "Utility," plus even greater audience-handling capacity. Price \$410

FILMOSOUND "UTILITY" offers all the features of the "Academy" plus greater picture illumination, greater maximum sound volume, clutch permitting still picture projection, and reverse lever for repeating sequences. Complete, now only . . . \$369

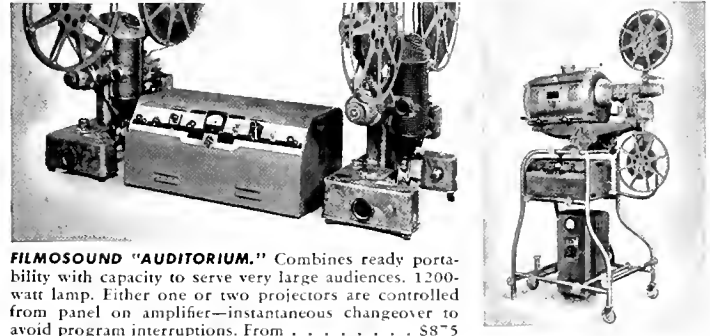

FILMOSOUND "AUDITORIUM." Combines ready portability with capacity to serve very large audiences. 1200-watt lamp. Either one or two projectors are controlled from panel on amplifier—instantaneous changeover to avoid program interruptions. From \$875

Here's Why You Need Filmosound Quality

WHEN you select projectors to show your business film, consider the task they must perform. They must project brilliant, flickerless pictures and reproduce sound faithfully and without distortion from tiny 16 millimeter film which races through the projector at a rate of 24 pictures every second! Your projectors must protect the delicate film from scratching and wear, must be easy to use, must make a showmanlike presentation *every* time.

These—and many more—are "musts" best met by Filmosounds, made by the makers of preferred Hollywood cinemachinery, and the choice of such leading business film users as Chrysler, Ford, General Motors, and hundreds of others.

There are many 16 mm. Filmosounds. Each serves certain needs best. Most have been recently reduced in price. All are of one quality—the finest! Mail coupon for details. Bell & Howell Company, Chicago, New York, Hollywood, London. *Established 1907.*

FILMOARC provides the ultimate in screen brilliance and sound volume in largest auditoriums. Yet it is simple to operate because of automatic carbon feed, centralized controls, and mistake-proof connections. Priced from . . \$1500

MAIL COUPON FOR DETAILS

BELL & HOWELL COMPANY
 1808 Larchmont Ave., Chicago, Ill.
 Send details on 16 mm. Filmosounds for business use.
 Interested in models: () Commercial; () Academy;
 () Utility; () Master; () Auditorium; () Filmoarc.
 Name.....
 Company.....
 Address.....
 City.....State.....

PRECISION-MADE BY
BELL & HOWELL

All pictures are begun in pencil

To most people, the creation of a motion picture means the peculiar glamor of production, the apparently chaotic hurly-burly that suddenly resolves itself into purposeful order as the make-up man hastily dashes forward to remove a last-minute bit of shine from an actor's forehead, and voices intone the significant — "Lights!" . . . "Quiet, everybody!" . . . "Roll 'em over!"

But all the talent and expertness of technicians, all the artistry of director, actor, cinematographer and film editor, are there for the single purpose of bringing to vital, breathing life on film a conception which already exists — a conception first given form by the application of a soft pencil to a piece of yellow paper.

Yes, all successful business pictures are begun in pencil . . . a pencil guided by the pooled experience of many minds . . . controlled by intensive research, study and analysis of your problem . . . inspired by the creative effort that welds experience, research and desired objective into a living, vivid pictorial solution that leads to concrete action through maximum selling impact.

Of course, good "pencil work" needs the best in production facilities. And we have studios specifically designed and built for the production of business films . . . a sound stage acoustically developed in collaboration with RCA engineers, proportioned and designed for maximum utility . . . the latest completely portable RCA High Fidelity recording equipment, permitting sound picture making anywhere.

Superior technical equipment and more efficient, designed-for-the-job studios mean that the clients of Industrial Pictures benefit from substantial economies in production costs.

But we feel that our refusal to economize on "pencil work" means a greater economy — for here, after all, are the makings of success, mediocrity, or failure.

Industrial Pictures invites your most careful consideration of this organization and its ability to serve you. We'll welcome an opportunity to discuss your problems with you at your convenience. Without obligation, of course.

Industrial Pictures, Inc.
4925 CADIEUX ROAD • DETROIT
MOTION PICTURES
ILLUSTRATIVE
PHOTOGRAPHY
SLIDE FILMS

The FILM FORUM

A COLUMN OF LETTERS FROM OUR READERS



ADDRESS LETTERS
ON TECHNICAL
QUESTIONS TO THE
BUSINESS SCREEN
SERVICE BUREAU

Explains Consumer Films

I am enclosing publicity concerning a series of films I am producing and which have received quite some attention both pro and con.

Knowing full well the editorial policy of your magazine and recognizing the validity and claim of the advertising and sponsored films you support, I feel certain our films, although considered inimical in a fashion, are still important and deserve credit for what they are trying to do.

Since our work is independently financed, we are able to maintain an open and unbiased editorial policy. Our main task is to give the consumer honest advice and hints as to what to buy, what to look for and how to get the best value. That certainly is a valid and worthwhile theme. I know that in many cases it is exactly such a thing which is in the mind of manufacturers who have films produced. I realize their point of view, but those films never quite achieve complete audience confidence.

Further, I have found much resentment to our work from those who were affected by our films. I respect their resentment, but they would have nothing to fear from us were there no serious facts to present. One thing is certain, the audience and the more intelligent theatre exhibitors have confidence in our work and appreciate our efforts. And that industry upon which we turn our spotlight will do likewise if we find no malpractice against the consumer. For instance, very shortly we plan to do a film on automobiles and in our research we discovered that only petty gypers indulged in dishonest practice against the consumer. Thus our film will take a line which will not only be helpful to the consumer but will also aid the retailer and prove of promotional and merchandising value.

Since I am basically a film worker and a producer of commercial subjects aside from this series, I contend that with time a trend of thought amongst advertising film producers will veer towards our type of human relation film. I suggest you read "Guinea Pig Movies" in *Advertising & Selling* magazine, March 1939, concerning our films.

JULIAN ROFFMAN
Contemporary Films

See Page Twenty-Seven

I have been reading your publication with a great deal of interest, and believe that it fills a real important place. Recently we have had some interesting experience in releasing a thirty minute sound slide film as part of a complete sales promotion plan. It is being used most effectively in a number of our marketing areas.

Under separate cover we are sending you a copy of the portfolio describing the complete plan called "Raise Your Sights". You will note that the thirty minute sound slide film entitled "Raise Your Sights" performs an important function in presenting the plan to groups of dealers.

In case you should feel that this would make an interesting story, particularly from the standpoint of using sound slide films as part of a merchandising program, we would be glad to get you additional information regarding its

use, including comments from our field organization and the results that have already been obtained in some areas.

W. P. MARQUAM
*Sales Promotion Manager
The Pure Oil Company*

Microfilm Usefulness

For an article on microfilm uses in business, it would seem that a few case histories taken from our files would be of maximum benefit. Here goes: In the months that we have been in production, we have found ready acceptance of the microfilm reader on the part of business firms. We have shipped readers to business firms from Bangkok, Siam to Stockholm, Sweden. A nearby chemical firm started with one reader in February — now they have five in their research department.

A food company on the eastern seaboard effected a saving on their production costs of baking that now amounts to over \$2,000 — with a 27c investment in a microfilm reproduction of a new German chemical formula. A legal firm saves \$2,850 a year on rental space by reducing the inactive files they must keep for legal purposes to microfilm, which takes less than 5% of the storage space required by the originals.

The engineering department of a large industrial corporation now puts its drawings and specifications on microfilm, thereby eliminating possibility of inaccurate typed copies of the original. The above are a few juicy examples taken from our experience. If I were asked to summarize the applications of microfilm to business, I would say that today a business man can order any information he requires, if it is in print or picture, and find it in existence somewhere in the world — on microfilm. The applications are tremendous.

B. D. GILBERT
International Research Corp.

On Agricultural Films

During the past year, the Illinois Agricultural Association produced a 5-reel sound motion picture, depicting the work of the organization. This was our first attempt in the visual education field, and in the first three months this film has been shown to approximately 30,000 Illinois farm people.

The question has now arisen as to the feasibility of using motion pictures or sound slide-films by our cooperative marketing departments and business services, in their educational and sales promotion work. Before deciding which path to follow, we are trying to get together as much information and advice as possible, and would appreciate any information or suggestions you could give us as to which of these two mediums would do the better job. If produced, these pictures would be shown largely to rural audiences, throughout Illinois.

In the case of the marketing pictures, we would want to use them to promote larger participation in cooperative marketing by farmers, production of higher quality products, etc.

C. L. MAST, JR.
Illinois Agricultural Assn.

Announcing

New Reduced Prices on



Where portability is important, the Challenger offers many advantages. Screen, case and tripod are all in one light-weight, easily carried unit which can be set up anywhere in 15 seconds. 12 sizes from 30" x 40" to 70" x 94" inclusive. New low prices now start at only \$12.50 (slightly higher in the Pacific Coast States).

DA-LITE BUSINESS SCREENS

FOR the second time in the past 3 years, Da-Lite reduces prices and puts Da-Lite business screens far out in front for value.

Leading theaters have repeatedly selected Da-Lite screens for the past 30 years. Da-Lite screens have also been the first choice of foremost users of business films since industry began using this effective selling medium. At the new low prices, Da-Lite equipment is more than ever the outstanding buy. Ask the producer of your business films or the supplier of your projection equipment about Da-Lite quality! Da-Lite screens are available in many styles with glass-beaded, silver or white surfaces to meet the specialized requirements of diversified applications.

NEW FREE CATALOG
Mail Coupon Now!

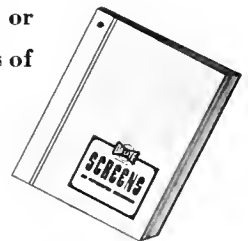

48 Pages of Facts You Should Have About Screens

Regardless of what make of screen you finally select, here is a data book that will help you now in choosing the right surface, the right mounting and the right size of screen for any projection requirement. Mail the coupon now for your free copy and the name of the Da-Lite supplier nearest you.

DA-LITE SCREEN CO., INC.

Dept. 7B, 2723 N. Crawford Ave., Chicago, Ill.
Without obligation to us, please send your new free 48 page data book on screens and the new low prices on Da-Lite equipment.

Name.....
Firm Name.....
Address.....

DA-LITE HANGING SCREENS

For sales training classes, convention halls, and similar installations, Da-Lite Hanging Screens are available in several styles, spring-operated or electrically controlled and in 28 standard sizes ranging from 22" x 30" to 20' x 20'. Surfaces are white, silver or glass-beaded. The Da-Lite Model B Screen shown above is a spring-operated unit in a metal case. 12 sizes from 22" x 30" to 63" x 84" inclusive at new low prices from \$7.50 up (slightly higher in the Pacific Coast States).

Compare Quality and Results!



IS "THE BUY"

Reg. U.S. Pat. Off.

This New Amprosound HAS EVERYTHING



Check the Features of This Radically New Projector

1. *Simplicity of Operation* — You simply set up the machine, plug it in and turn it on. All controls are centralized on one convenient illuminated panel. Threading has been simplified so that it is as easy as on the ordinary silent projector.

2. *Extreme Quietness of Operation* — There is none of the customary objectionable loud hum. When you are right next to the projector itself you are scarcely conscious of its operation. The proof of all this is the fact that no case or "blimp" is required to cover the projector when it is being operated.

3. *Convenient Portability* — These machines

can be packed in a few minutes' time — they are light in weight — they swing into operation as easily and as quickly as a portable typewriter!

4. *Numerous Other Features* — These include: A Quick-Cleaning Optical System; Economical Operation, with the standard pre-focused projection lamps; New Simplified Design — it is just mechanically impossible to tear film perforation — and fast Automatic Rewinding. And to top these all are the new low prices — so that now even the most infrequent user of sound films can no longer afford to be without efficient sound projection equipment. Send coupon for full details.

NEW LOW PRICES

Model "X" — equipped with 60 cycle A.C. motor, including 1600 foot reel, 8" dynamic speaker, complete accessories and cords, comes in one case all weighing only 49 lbs.

\$275

Model "Y" — equipped with Universal A.C.-D.C. motor for both silent and sound film speeds, including complete accessories and cords, with 12" dynamic speaker, comes in 2 compact cases.....

\$295

(Model "Y" also is available in one case, complete accessories with 8" dynamic speaker.)

AMPRO

PRECISION CINE EQUIPMENT

Ampro Corporation, 2839 N. Western Ave. Chicago, Ill.

Please send me the new 1939 Ampro Catalog. I am particularly interested in:

- New Amprosound Models "X" and "Y"
- Ampro 16 mm. Silent and Convertible to Sound Projectors
- All Ampro 16 mm. Sound Projectors including Ampro-Arc
- Ampro 16 mm. Continuous Projectors (for Displays — World's Fair and Convention Exhibits)

Name _____

Address _____

City _____ State _____

US 5-39

SO—You "Can't Afford" **a Motion Picture!**

PROOF

If you want proof that Caravel Pictures get results, check with

American Can Company
Atlantic Refining Company, Inc.
Wallace Barnes Company
The Bates Manufacturing Company
Beck, Koller & Company
Bethlehem Steel Company
Black & Decker Manufacturing Company
Calco Chemical Company, Inc.
S. H. Camp & Company
Cluett, Peabody & Company, Inc.
Congoileum-Nairn, Inc.
Davis & Geck, Inc.
Dictaphone Sales Corporation
Eastman Kodak Company
The B. F. Goodrich Company
Hart Schaffner & Marx
Jenkins Bros.
Johns-Manville Corporation
Kenwood Mills
National Biscuit Company
National Distillers Products Corporation
National Lead Company
Premier-Pabst Corporation
Raybestos-Manhattan, Inc.
Socony-Vacuum Oil Company, Inc.
E. R. Squibb & Sons
Talon, Inc.
The Texas Company
U. S. Industrial Alcohol Company

OR ANY OTHER CARAVEL CLIENT

WHEN an advertiser and his agency decide to stake a sizable proportion of a year's advertising appropriation on a motion picture—that's news!

And when so bold a stroke brings an immediate step-up in sales—plus the hearty cooperation of leading distributors from coast to coast—that's a tip no other manufacturer can afford to miss!

Says S. M. Babson, Sales Manager of The Bates Manufacturing Company: "Our new movie, 'It's the Little Things That Count,' has been received with an acclaim even beyond our fondest hopes."

Say jobbers and dealers—in scores of unsolicited letters of congratulation: "The finest piece of salesmanship it has ever been our pleasure to witness." . . . "Truly a dramatic contribution to sales education." . . . "Tied right in with our problems." . . . "It has prompted us to change our merchandising plans on Bates Products."

Write us for free leaflet descriptive of this film, and an up-to-the-minute story of results. Better yet, arrange to see the picture—either in our local projection rooms or at your general offices.

CARAVEL FILMS

INCORPORATED

New York • 730 Fifth Avenue • Tel. Circle 7-6112



BEHIND YOUR NEXT PRODUCTION

FOR THE COMPLETE EXPRESSION OF YOUR IDEAS—FOR THE SUCCESSFUL SOLUTION OF YOUR MOTION PICTURE & SLIDEFILM PROBLEMS

● Any motion picture or slide film is only as good as the facilities with which it was produced. It takes good facilities, practical experience, and trained personnel to produce productions of quality.

Our studios, cameras, sound equipment, editing and cutting laboratory, past production record, and skilled personnel are more than equal to your most critical assignments.



★ STUDIO

(Above) Behind-camera view showing the directing, camera, and sound personnel producing "Time for Graduation" for the Elgin National Watch Company.



Our studios are equipped with modern, highly-adaptable sets, are scientifically sound-proof, and contain a "drive in" for large trucks, cars, and heavy machinery.

(Above) Making a "lip synchronized" section of an educational film, using a typical doctor's office set especially erected for the purpose. Medical men and business executives frequently make sound films for use at conventions or sales meetings, so as to "appear" simultaneously at several gatherings.



★ LABORATORY

(Above) Films are edited and cut in our modern laboratory. Fully equipped for efficient, flawless work. In another section of the laboratory the films are printed . . . 16mm. and 35mm., both sound and silent. Included is a specially constructed developing machine, large capacity, fireproof negative and positive print vaults, animation and title department. Research is constantly carried on for the attainment of unusual and dramatic ideas . . . here in our laboratory originate outstanding film effects.

★ **EQUIPMENT** (Below-left) At the Chicago Film Laboratory the cream of modern production equipment is continually augmented by the newest developments, Bell & Howell and Mitchell studio cameras, Fearless Rlinop and Dolly, Mole-Richardson Microphone booms, a complete battery of lights for every commercial production requirement, a specially designed camera truck . . . every type of precision equipment built for both studio and "on location" needs.

(Below-right) Our overhead sound recording room. Equipped with the latest RCA Ultra-Violet recording unit, with extra facilities for recording sound track, disc or sound-on-film recording and production play back unit. Screening room equipped with Simplex theatre-type projectors and RCA High Fidelity Sound.



BE SURE YOUR PRODUCTION HAS THE ADVANTAGE OF CRAFTSMANSHIP THAT COUNTS!



CHICAGO FILM LABORATORY, INC.

MOTION PICTURES

SLIDE FILMS

STUDIO AND GENERAL OFFICE



18 W. WALTON PLACE • WHITEHALL 6971

CHICAGO, ILLINOIS

• **THE HIGHWAY TRANSPORTATION** industry ought to produce a bang-up public relations film to offset the general lack of knowledge concerning that industry's vast contribution to state tax funds and its service to business. Here's a job which films alone can do in bringing the realistic story of this industry before those who influence its destinies—government regulatory bodies and its customers.

A really great and wholly American document might well be created if the sponsors will stick to the truth in itself. There's glorification enough in the everyday labors of the trucker, sufficient prestige in the cold fact that 3,109,508 truck operators, employing over 6,000,000 people, serve every city and hamlet in the U. S. Not to mention the 48,492 communities unserved by railroad! That this accounts for only 5% of the nation's inter-city freight bill is evidence worth screening.

♦ **TECHNICIANS** and business film users who have heard of the new mercury lamps recently developed and demonstrated at the San Francisco Fair by General Electric know that this new water-cooled light develops tremendous illumination from an extremely small and comparatively cool tube.

That this invention will prove a great boon to the entire field of projection may be anticipated but at present the quality of light produced is not sufficiently white to give the best results, particularly in the case of color films. An up-to-the-minute and authoritative technical slant will be a feature of an early number.

♦ **SPONSORS** can draw a pretty liberal measure of confidence in the film medium as a result of the recent Eveready surveys made by Dr. Henry C. Link's Psychological Service. The facts and figures cost the sponsor a neat sum but we're in hopes that the very favorable conclusions which laid the foundation for Eveready's present widespread minute-movie campaign (900 theatres, following sales quotas) can be put into print in these pages someday soon. West Coast (NY) and Jam Handy produced.

♦ **EMBARKED** on a course of eight-time-a-year publication, *Business Screen's* dating schedule draws it plenty of reader correspondence of the "can't wait . . . why don't you come out oftener" variety, and a few digs from people who like to live on the calendar and read their magazines with the monthly bills.



CAMERA EYE

NEWS AND COMMENT
ON BUSINESS FILMS

To one and all the editors reply that they consider this publication's task one of creative and original leadership rather than that of news reporting; that a more liberal schedule favoring research is in these times to be preferred to an antedated system that brings out magazines on a newspaper basis and that sometimes pulls them out of existence by its irresistible force. As witness a lamented *Scribners*.

♦ **EXHIBITORS** at the recent Oil-World Exposition held by that industry in Houston used films with such effectiveness that the *Houston Press* business columnist, Paul Hochuli, was lead to remark:

"More and more exhibitors are turning to this form of presentation (films). Two or

more films are growing this year where only one unreeled during the last show. There should be plenty more at the next.

"A lot of the dryness has been taken out. You don't get a bunch of stills and blue prints. A number of the films have story structure upon which the product is exhibited. Some are in color, and there's lots of action in all."

♦ **NEW AND NEWSWORTHY:** Henry Hobart heads the recently opened New York offices (41 East 42nd Street) of Industrial Pictures, Inc., Detroit producer, it was announced by Herbert V. Book, president. Bertram Willoughby, who heads the Ideal Picture Company in Chicago, is the new prexy of the Allied Non-Theatrical Film



VOLUME ONE

NUMBER SEVEN

Table of Contents

Cover Subject: Field Mechanic: An Aviation study by Robert Yarnell Ritchie for American Airlines, Inc.

The Film Forum	4
Distribution for Profit	11
Seventh Row Center Is Restless	14
The New Films	15
Let's Sell It In Pictures	16
Speak Your Audience's Language	18
Wings for the World	19

An Original Business Screen Film Idea

The Tractor Dealer Tells 'Em	23
Publicity for Your Films	24
Esso Marketer Films	25
Slidefilms: Digest-Reviews of New Programs	27
Behind the Screen	29

♦ **Business Screen Magazine**, issued by Business Screen Magazines, Inc., Twenty North Wacker Drive, Chicago, Illinois on May 15, 1939. Editorial Director, O. H. Coelln, Jr.; Managing Editor, R. C. Danielson. *Acceptance under the Act of June 5, 1934, authorized February 20, 1939.* Issued 12 times annually—including 4 *Visual Education Numbers* (not circulated in the business field). Subscription price: Domestic \$5.00 for twelve numbers (of *Business Screen*). 50c the copy. Foreign, \$6.00. Publishers are not responsible for the return of unsolicited m.s. unless accompanied by stamped, self-addressed return envelope. Entire contents copyright, 1939, by Business Screen Magazines, Inc. Trademark Reg. U. S. Patent Office.

Association just organized. The Association will direct its activities against print bootlegging, duping; will fight adverse legislation, endeavor to get better releases and work for closer cooperation within the film distributing library business.

♦ **ANNOUNCEMENT** this month of Cinecolor's developments in the 16mm. print field has been noted with interest by business film users. The economy of this 2-color process will add an effective weapon to advertising armament if uniformity is achieved in the prints.

The news from the Coast also carries some interesting notes concerning Magnacolor and its possible adaptation to business films. Of all color processes the user will demand what only Technicolor has thus far always given—uniform, dependable quality; but perhaps this demand will now be met by technical standardization in the other processes as well.

♦ **SOMEDAY** the prospective sponsor of a commercial motion picture will call a producer into his office and say, "I want you to make a picture for us. One of those advertising movies like *Union Pacific*. We'll put on a premiere in Apple Junction that will make Omaha look like a whistle stop on the Toonerville Trolley."

If the producer belongs to the Goldwyn or Zannck menage he will spend the rest of the afternoon explaining that Hollywood's attitude on commercial tie-ups is that of appearing pleasantly surprised via its *exploitation* department if the *story* department happens to think of a yarn that somebody else will help the studio advertise via the newspapers, magazines, window displays and other forms of publicity.

But Goldwyn's Hollywood is a haven for simon-pure amateurism insofar as any advance selling of screen ideas is concerned. True enough, busses, motorcars, airplane travel, tractors, magazines, refrigerators, and ladies frocks are frequently "plugged" but those things are arranged on a basis of diplomatic reciprocity which can hardly be depended on as a substantial means of merchandising by any type of business. For what Hollywood giveth it often taketh away and today's pleasure jaunt in a Whooziz Eight is tomorrow's dizzy whirl ahead of a posse which ends suddenly in a spintering crash hardly fit for polite mention.



DEMAND!

*Insatiable, yet critical —
Ceaseless yet suspicious —
Ignorance thwarting acceptance.*

The problem of business is the problem of education. Consumer acceptance calls for consumer knowledge of the wares, services and methods of business.

There is but one channel through which consumer acceptance can be achieved to the point of complete satisfaction of consumer doubts.

Only the talking motion picture can bring the coordinated pressure of factual appeals to the eye, ear, mind and emotion.

MODERN TALKING PICTURE SERVICE complements the production of these essential business films

with a pre-determined, selective national distribution. MODERN TALKING PICTURE SERVICE presents your commercial film when, where, how and to whom you require.

MODERN TALKING PICTURE SERVICE, through its local units, blankets the country, if you want that, or it will pick out of the mass the particular men, or women, or children you want, and to the number you want.

MODERN TALKING PICTURE SERVICE invites you to ask for proof of its ability to serve you.

MODERN TALKING PICTURE SERVICE, INC.

9 ROCKEFELLER PLAZA (An Independent Organization) NEW YORK CITY



TRADE-MARK REG. U. S. PAT. OFF.

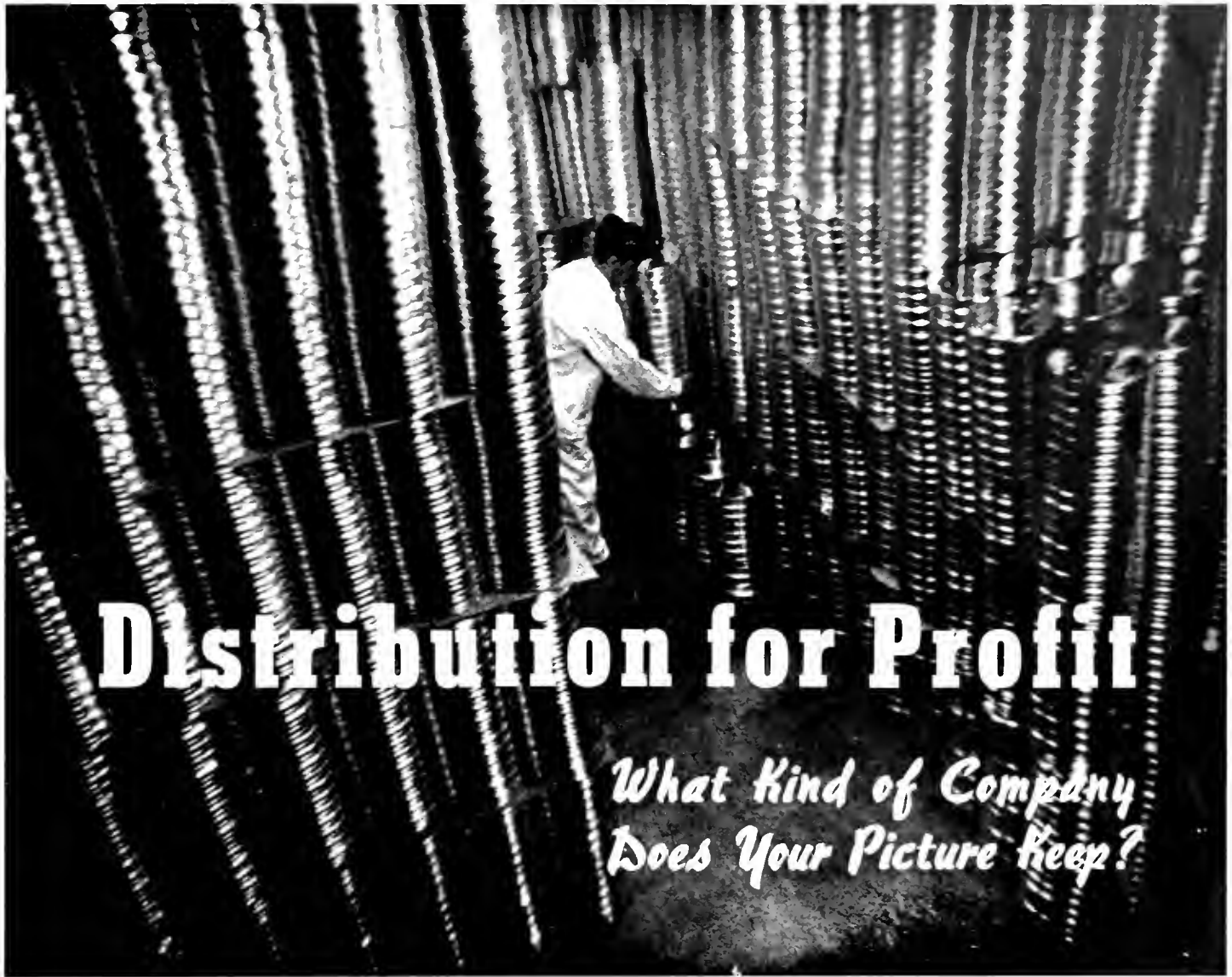

Distribution for Profit

*What Kind of Company
Does Your Picture Keep?*

• Every business day, over the editorial desk of *Business Screen*, sifts an allotment of press clippings gleaned from the newspapers and magazines of a thousand-odd towns and interests throughout the United States.

Each item contributes its small element of news, unimportant in itself, of a commercial motion picture showing. Heaped together, with a liberal budget of other news-worthy announcements concerning the progress of the film medium in business, the clippings reveal the tremendous activity connected with the distribution of commercial pictures. Even a hasty sampling of an average day's quota unveils the size and scope on which the showing of these films now operates:

Charlotte, N. C. — *Advertising Club* sees new *Goodrich* picture; *Morris, Ill.* — *Rotary* views *Trees and Men*; *Clinton, Mass.* — *Mercantile Committee* are guests at *Sunkist* showing; *New Kensington, Pa.* — *Kiwanis* see *Studebaker* film; *Danville, Ky.* — *Farmers* see *McCormick-Deering* equipment movies; *Com-*

mercial West, Minn. — *Wisconsin bankers meeting* features association's new picture "*Your Money and Mine*"; *Waterville, Me.* — *employees entertained with 1939 Frigidaire motion pictures* . . .

No rival for the Hollywood affections of the public, commercial films show to their audiences throughout the day; pile up attendance records among women at hundreds of weekday and crowded Saturday morning showings. Luncheon groups of the most active citizens, members of Kiwanis, Rotary, Lions organizations frequently see instructive-advertising reels. Evening showings at regular club meeting hours are brief, draw to the sponsoring organizations a larger attendance than usual, thus promote community spirit.

Last year's most conservative estimates, although difficult to compute because of sponsors' modesty and aided only by the accurate checking systems in use among projection service organizations (signed attendance cards, official reports, etc.) would place the total num-

ber of commercial showings at approximately 110,000, the total attendance at well over 100,000,000 persons. What does this figure include? Do round numbers of attending audiences accurately gauge the value of sound motion pictures? What kind of circulation, in the matter of incomes and influence, does this total indicate? Therein lies the "other half" of the Story of Business Films, to use a well-worked title phrase, and possibly the solution to its eventual future on the American business scene!

Well-established by its record of consistent results and the simplicity of its production and distribution is the entire classification of business films for the training and edification of the company salesman, the jobber and dealer and other types of employees and specific buying groups. Numbers as definite as the names on the company payroll (in fact, the same) or in the sales invoice files can be safely counted on as the circulation field for the proposed film. The problem is — (Continued on next page)

solely one of intelligent production by capable, experienced *business* producers.

Not so easily identified are the members of the business film's "mass public." The problem here is not one of attendance totals but of "selectivity" and of an understanding of the existent forms of distribution, their costs and the extent of their services.

Numbers may be the only criteria in the case of motion pictures relating to nationally merchandised products retailing at a dollar or less. Similarly, a picture with a public relations message intended for all classes of adults will not find it difficult to reach millions of persons providing it possesses a good quality of interest or entertainment. But as the price of the product rises and the buyer market thins, so the problem of distribution of films parallels that of the "class" periodicals aimed at relatively small sections of our national population.

At this point, the motion picture possesses a tremendous advantage in its ability to deliver a lengthy message with little loss of interest. Necessarily selective anyway because it must assemble its audience (of any size) before a centrally-located projector, the film is proving the most successful means of influencing public opinion with a minimum of wasted effort. That it can sell aeroplanes or silver fox furs better than any other form of sales material, including most personal salesmanship, can also be definitely arrived at on the basis of comparative results achieved in similarly limited fields of selling. A nickel soda-fountain drink or a million-dollar industrial enterprise are as easily sold.

Next to the unmistakable efficiency of films in the sales-training-dealer organization field, the least expensive and most effective form of distribution is that of the fair or exhibit showing. The New York World's Fair, despite the utterly ridiculous and high-handed intrusion of projectionists and other kinds of discouraging union activity, represents a model field for the distribution of general "consumer" pictures. Ready-made hourly audiences (most of them with sufficient means to pay their way into the Fair), inexpensive sponsor-owned theatre setups, and the unquestioned gratitude of attending thousands for the restful, interesting period afforded by the sponsor, brings the film medium out miles ahead of all competing exhibit forms excepting the most elaborate. Five hundred films sponsored by all types of business will bear sufficient and convincing witness at the New York Fair alone. That the film serves to "capsulize" an otherwise impossibly long public relations or selling theme is a final, self-evident advantage for all types of exhibit showings including those at conventions, etc.

But the film is, in itself, a *World's Fair*. To influential adult audiences in Burlington, Iowa; before women's clubs in Wheeling, West Virginia; down in Georgia, up in Oregon, the shadows on the screen and accompanying voice

hold spellbound with interest many millions of worthwhile persons who may never find it convenient to visit the New York or San Francisco Fairs. As group-minded citizens interested in community affairs are *good* citizens, these are very worthy audiences of excellent prospects for the products of the automobile manufacturer, the insurance company or the household products concern. The film alone can bring them the genuinely educational and welcomed



story of this product or that; from films they will get the desire for future travel or personal improvement; the knowledge for better living. How does the prospective sponsor of a picture reach this audience and what is the cost?

THE RIGHT KIND OF AUDIENCE

♦ Since the commercial talking picture's sole purpose in life is that of *selling* — either *products* or *ideas* — the problem is simply one of reaching *prospects* at the lowest possible cost per *prospect*. But the cost-per-prospect must also take into consideration (1) the tremendous power of the selling message delivered; (2) the length of the uninterrupted selling interval and (3) the absence of waste circulation.

Mass audiences are easy to get for certain kinds of pictures. Two baseball league films now in circulation could reach double their present audiences simply by providing the extra prints necessary to fill bookings now postponed or rejected. Similarly, sound movies of a general interest nature and of good technical quality such as *Materials*, *Men Make Steel*, *Trees and Men*, *An Evening with Edgar A. Guest*, *Symphonics in Fragrance*, and the like can reach as many audiences as the sponsor wants. For a great many pictures, *particularly those dealing with a product in the mass selling market or on matters of general public policy*, quantity distribution is desirable. The only limiting factors in this event are (1) The quality of the picture to be presented and (2) The size of the appropriation available to purchase necessary prints, projection service, equipment, etc.

But if the problem is one of *selectivity* in the matter of groups by income classification, marketing areas, age or other specialized needs of the sponsor (according to the character of the message or the price of the product), then the distribution setup is of a different character,

However, both "mass" and "class" audiences can be reached according to certain definite patterns of distribution and here are the existing outlets available:

I. SELLING IT TO THE MASSES:

♦ Two classifications, theatrical and non-theatrical distribution, account for film showings to the general public. The term "theatrical" includes only entertainment theatres where a paid admission is charged and does not account for showings in sponsor-rented or constructed theatres.

Theatrical Showings: Except for direct advertising films of the 60-second variety, familiarly known as "minute movies", this field is limited to one-reel subjects of a very general public relations character or of a variety show—entertainment type. Well-produced entertainment subjects in which the sponsor's sole interest is a credit title or the appearance of his product without mention in dialogue are widely accepted by exhibitors. One-reel subjects which perform some public service or offer information of a highly-interesting nature, i.e.

Men Make Steel (for United States Steel); *Once Upon a Time* (for the Metropolitan Life Insurance Company); *Frontiers of the Future* (for the National Association of Manufacturers); *We Drivers* (General Motors); *Trees and Men* (Weyerhaeuser); and *Accent on Youth* (Coty) are notable examples of the superb production, the high quality of entertainment-interest and the lack of direct advertising which are absolutely necessary to achieve widespread exhibition in this field. That the quality of these free "shorts" is often far superior to the Hollywood product offered the exhibitor is also worth noting.

The public and thus, the exhibitor, finds no objection to intelligent "documentary" screen subjects with either entertainment or educational values. If it did, such pictures as *Union Pacific*, *Wells Fargo* or *High, Wide and Handsome* would never have been made nor would they have played to such large and enthusiastic throngs.

If direct advertising, particularly of the "wildcat" local variety can be improved or removed from the theatre screen, public disapproval of commercial films in theatres would be in large measure completely dissipated. National screen advertising (minute movies) has recently attained a new high level with the addition of color, etc. Direct advertising via such films is accepted by approximately 8,000 theatres in both urban and rural markets.

II. AIMING AT YOUR PROSPECTS

♦ *Non-theatrical Distribution:* This includes three general fields: (A) *Group Showings* with company-owned equipment or by professional projection services and (B) *Promoted Audiences*, such as department stores, travel shows, rented theatres, etc. A third classification (C) would include *Request Distribution* by express to schools or groups owning projection

equipment and, finally, the large fields of "plus" circulation possible through film libraries accepting prints for circulation. This last group includes the state visual service libraries which supply schools and farm bureaus, etc. and private national distributing libraries.

Companies such as Standard Oil, International Harvester and other concerns having large field organizations put on their own shows with traveling representatives. The performance is staged in the dealer salesroom, in a rented hall or in an open-air park (in the summer). Needless to say, such showings are usually packed to capacity.

The services of professional projection organizations, on the other hand, facilitate the distribution of pictures before many club and other prospect groups in distant towns and enable the sponsor to put on uniformly perfect performances in many cities within a definite time period. The costs of both methods depend on the size of program desired. For one type, the ownership of projection equipment, supplemented with a schedule of other showings may do the required job. In another case, the quality of the film and the demand for showings may be so great that the sole distribution expense is that of expressing and print maintenance.

Economy in cost-per-person has lowered the cost of professional projection services; the improvement of sound projection equipment has raised its quality. Again, recent price economies in the sound projector field have again aided the important cause of distribution.

PRINCIPAL RETAIL MARKET AREAS SERVED

♦ One interesting summary furnished to *Business Screen* recently shows the efficiency with which projection services now operate in almost every principal retail market area. Only a few of the principal market centers are not served by some form of operation, either 35mm. or 16mm., and even in these it is possible to have professional showings scheduled.

The important conclusion is simply this: whatever its form or the nature of the production, some form of distribution must be accounted for in the *plan* of production. Certainly no picture can be intelligently planned without consideration of its potential audiences. That

fixes the field of distribution. Then the cost of that distribution must be squarely and honestly faced by the producer, the agency (if one is involved) and particularly by the sponsor. If that cost involves the purchase of projectors, of an adequate number of prints for all fields of possible use, or of the services of professional projectionists, it must be a part of the first and of the final budget.

There is no possible escape from this responsibility. If the producer seeks to escape it, he relegates his organization to the position of the printer or the photographer in the production of advertising. It is not the client's responsibility, particularly if the client is not a long-established user of the film medium and therefore unfamiliar with its phases. *For a commercial film without a well-determined course of distribution aimed at the right prospects for its message is like a magazine without circulation or a radio program without listeners.*

110,000 SHOWINGS; 100,000,000 PEOPLE attended reported sponsored film performances in 1938 and the totals rose sharply as millions more were recorded at dealer meetings and conventions; attending theatres showing entertaining, well-liked sponsored "shorts"; and visiting Fairs and exhibits where films were the favored means of capturing visitors' attention; "capsulizing" otherwise impossible sales messages. Selling the business of America to Americans; explaining beneficial products and processes; teaching the way to a better living for salesmen, clerks and their bosses — the film's job is a big one — which it does better than any other form of idea communication known to man.





SEVENTH ROW CENTER IS

Restless

It only takes one "unbeliever" to spoil an entire theatre audience for your screen advertising message.

by Lawrence M. Rosenthal

● This business is different!

Despite its triteness, this thought must be paramount in the minds of those who are confronted with the problem of preparing one-minute commercial motion picture shorts for theatrical distribution.

The conditions under which a minute movie is presented differs greatly from those surrounding any other advertising medium. Hence a clear knowledge of what types of production should be considered must first be preceded by an understanding of these differences.

Screen advertising is the only medium whose effect upon any one individual in the audience will influence reception by the entire audience. For instance: A magazine or newspaper advertisement may appear exaggerated (or even downright silly to some cynical reader. He thereupon gives vent to a mental "razzberry", sets down the publication and the matter ends right there. (Even professional "unbelievers" only put a "few friends wise"). Or, take a radio announcement. Over the air comes a plug for Thrill Cigarettes to relieve fallen arches. "Copies" of this ad go into individual homes. If a listener or the family group don't like it — well, a twist of the dial — and no harm is done except in that particular house. Meanwhile in both cases millions of readers or listeners drink in the publicity, believe it and act upon it.

Not so with motion picture advertising. Here, your advertising is presented to large group audiences — not individuals. Therefore your message must be planned not merely to

please the general average of people but must take into consideration the need for believability to the "cynics" as well. Remember if just one or two people in any given theatre audience find your presentation ridiculous, an immediately apparent reaction is set up. Restlessness . . . whispering . . . or laughter at (not with) will *instantly affect the entire audience.*

An understanding of the above condition points out that BELIEVABILITY is the biggest word in planning scenarios.

The second basic difference is the fact that a theatre audience *has* to see and hear the advertising message . . . it has no other choice. While this is a condition greatly to be desired by an advertiser as he need not fight secure attention, it can be a "boomerang". People who pay money for entertainment and instruction when they buy magazines or newspapers do not have to read the advertising. Even free entertainment via the radio carries no obligation to hear the advertising. But when a patron spends from 15c to 50c to be entertained or interestingly instructed for two or three hours, the screen advertiser must take this into consideration. His playlets then must contain some real news value or if they embellish the commercial with entertainment instead, the playlet must match in excellence the Hollywood entertainment part of the program.

The third peculiar condition which governs the presentation of commercial theatrical shorts is the viewpoint of the "publisher" — i.e., exhibitor or theatre manager. In all other

media the publishers are primarily in business for the sake of the advertising revenue. Hence, their censorship and restrictions are based solely on the desire for truthful, accurate advertising. But the copywriter and plan man who sit down to create minute movie scenarios must look at the movie publisher in a different light. In the first place the exhibitor is primarily in business for the money he makes from entertaining the public — *not for the advertising revenue.* Secondly, being a showman himself, he "knows" exactly what his audience likes and *doesn't like.* Within reason, his stand is well taken — the success of his theatre or theatres has been based, to some degree, on his ability to pick pictures that please the largest number of his potential audience.

Therefore you will find the exhibitor ready and willing to refuse to show minute movies which he thinks will not please his audience. No blatant commercialism for him — particularly if he is a big independent or a part of one of the better chains — *unless the sales story can*



really be turned into a "news ad" and contains the instruction value and fast tempo of ordinary news reels. The ability to handle production this way is dependent to a large extent not only on advertising brains and a knowledge of movie technique, but on a clear understanding of the exhibitor type of mind.

WHAT KIND OF PLAYLET TO USE?

A realization of the foregoing and a personal study of literally scores of minute movie campaigns makes possible the establishment of a few principles to help in selecting the type of minute movie that should be used.

1. THE NEWSREEL TYPE: Wherever a product can best be sold by demonstration, then the demonstration technique should be applied to movies. Here is the one medium that can — with sight, action, sound — actually put on a low cost controlled demonstration to large audiences, and is for this reason the writer's first choice of production technique for most sales stories. Care must be taken that the lead into the commercial exposition is interesting and logical . . . and that the demonstration itself is "newsworthy". If either of these elements are missing, the playlet becomes just another straight commercial — unliked by many exhibitors and resented perhaps by some of your audience.

2. CARTOON ANIMATION: The success of Walt Disney, the Pop-eye films, etc. and subsequent surveys showing Mickey Mouse and Donald Duck rating high, have given adver-

tisers great impetus in the use of cartoon animation for minute movie commercials. And from the standpoint of both the audience and the exhibitor, the use of this technique is especially desirable. However, cartoon animation can not logically be called the answer to the question in every case. After all, buying and selling are fundamentally serious business. And, it is true, that when a product is thoroughly and interestingly demonstrable it is well to remember that accurate photographic records carry a much greater note of authenticity and believability. However, the news values of some products are too deeply hidden from the camera's eye — in such cases consider the use of cartoon animation.

This popular technique has also found favor to solve the advertising presentation problem when the sales story contains no news value. Here, entertaining cartoon animation with off stage verse or song can lighten the commercial wallop and make it acceptable. Care should be taken, however, to make certain enough sales punch is left in the playlet as the tendency in this type of scenario is to go strong on entertainment and not contain enough reasons why the audience should buy.

3. PLOT AND DIALOG: Some advertisers, bearing in mind the success of dialog plot commercials on the air, have attempted to use this type of script for minute movies. The plot story is admittedly more dramatic and should logically have high retention value. But there are two drawbacks which must be overcome by excellence of production. First you have only one minute to one and a third minutes for the development, climax and sales story. Secondly, advertising plugs, spoken directly by the actors, generally sound artificial. "My dear — this new XYZ cleaning compound is wonderful because it contains a special active agent" — is stagey. It is not the natural way for people to talk and it has many times received ridicule from the theatre audience. This danger may be eliminated by using dialog and plot to set up a situation and then cut in with off stage commentation.

In the final analysis, no rule can be set down . . . no infallible reasoning can say this type of playlet is better than that. Careful consideration of the adaptability of the product to the screen plus an understanding of the objectives of the campaign . . . should be combined in each individual case with the peculiarities of the medium itself.

From the mixture will come the form to follow. Then, sharpen the pencils, take out the stop watch, and let creative imagination go to town.

* * *

♦ Unusual problems of production faced Audivision, Inc. executives who directed the Agrico (American Agricultural Chemical Company) film, *The Soil*. For one thing photographic crews "planed" to Florida, South Carolina, Maryland, Washington, Maine, upper New York State, Wisconsin and Minnesota to shoot the actual farm scenes which make up the bulk of the picture.

The extensive air traveling necessitated lightweight portable 16mm. camera production and not much regard for weather conditions.

The NEW FILMS

HIGHLIGHTING THE NEWS ON
CURRENT PRODUCTION ACTIVITY

♦ NEW AND IN PRODUCTION: American Airlines 20-minute sales picture (by Wilding) with an added educational short for possible theatre release. Three new Chevrolet safety films: *Quiet, Please!* which shows how automobile manufacturers do their utmost to keep noises out of the passenger compartment of the car; *King Cotton*, which demonstrates the importance of cotton products in the manufacture of automobiles, and *With Care*, which emphasizes the safe and courteous driving habits of the truck driver. Studebaker's new film, *Ahead of the Parade*, is based on the new Studebaker Champion models and is getting widespread dealer cooperation.

♦ Roland Reed Productions, Culver City, recently completed the Shell Traffic safety picture, *Show Your Colors*; also note the completion of a Technicolor production for the Bureau of Roads, United States Department of Agriculture. The picture covers the history of highways in the U. S. from 1539 to 1939 and is being shown in the Bureau's exhibit at the San Francisco Fair.

♦ Texaco's *The Surprise Party* screened for Business Screen recently in New York at our request, fulfilled all expectations. A topnotch sales training subject which has already won all kinds of acceptance among service station operators, *The Surprise Party* does its job simply, directly and emphatically as it turns the old success-story formula inside out to drive home the Texas Company's service station profit-building plan.

Cast in Hollywood and well-typed, *The Surprise Party* was produced by Caravel Films (NY) as the first of their West Coast program.

♦ Another Caravel production of a highly technical nature was *Inside the Flame* produced on the story of carbon black for limited distribution to the comparatively few but mighty prospects for this material. *Inside the Flame* is noteworthy for its excellent camera treatment and

TEXACO'S SELLING STORY IS PUT ACROSS WITH PUNCH IN THE company's new sound motion picture *The Surprise Party*.
Caravel



for the very simple and understandable way in which it delivers the product story.

♦ FULLER & SMITH & ROSS, Inc., advertising agency, has signed with Audio Productions, Inc., to produce a feature motion picture in Technicolor, *The Middleton Family At The New York World's Fair* for their clients, the Westinghouse Electric & Manufacturing Company. Production is being carried on at the Long Island Studios and on location at the New York World's Fair.

The new picture will be the third to be produced for the motion picture department of Fuller & Smith & Ross, for Westinghouse, by Audio. Preparation of the shooting script will be supervised by G. R. Hunter, Vice-President of Fuller & Smith & Ross, with Reed Drummond, of the New York agency staff. The film is to be directed by Robert R. Snoddy, of Audio Productions. Technicolor-In-The-East will provide color for both standard and 16-millimeter release prints, as desired. George Gladden, color-director, and William Steiner, color-cameraman, will superintend the Technicolor photography.

The Middleton Family have been featured in a series of color-pages in leading weekly magazines advertising the Westinghouse exhibit at the New York Fair. The family is described as "a family of folks you know — friends who live around the corner" and since doing the Fair is what everybody hopes to be doing this summer, the film is planned to take back this thrill to those unfortunate ones who won't be able to reach New York. The diverting adventures of Babs and Bud, their father and mother, and Grandma, will be shown in conjunction with a fascinating story of electricity's marvels, against a background of the World's Fair and the Westinghouse Building. The film is to be ready for exhibition with the mid-summer World's Fair season.

♦ London, April, 1939.—The acceptability of advertising films is shown by the fact that they have been exhibited in 4,300 of the 5,309 motion picture theatres in Great Britain and Ireland. Harold B. Seward of Seward, Baker & Co., Ltd., said in a speech here at the Regent Advertising Club. Mr. Seward said he thought there was much room for improvement in most advertising films. —The New York Times

Let's SELL it in PICTURES

★ Visual-minded businessmen, recognizing the surge toward pictorial journalism, the movies and all forms of visual advertising, are awakening to hitherto unexplored fields of usage in which the motion picture and slidefilm are to play an important part during this decade.

The phrase, "Let's sell it in pictures" will be heard more frequently this year and yet the basic understanding of films apparently needs much improvement. What happens once the idea of films is accepted in the average business organization and an appreciation of the factors of cost and personnel involved may be derived from this extensive panorama of the business film producer's plant at work. The pictures do not tell one single film story; they represent the activities of many recognized and able business studios from California to New York.

Here, step-by-step, is the story of your next picture in the making:

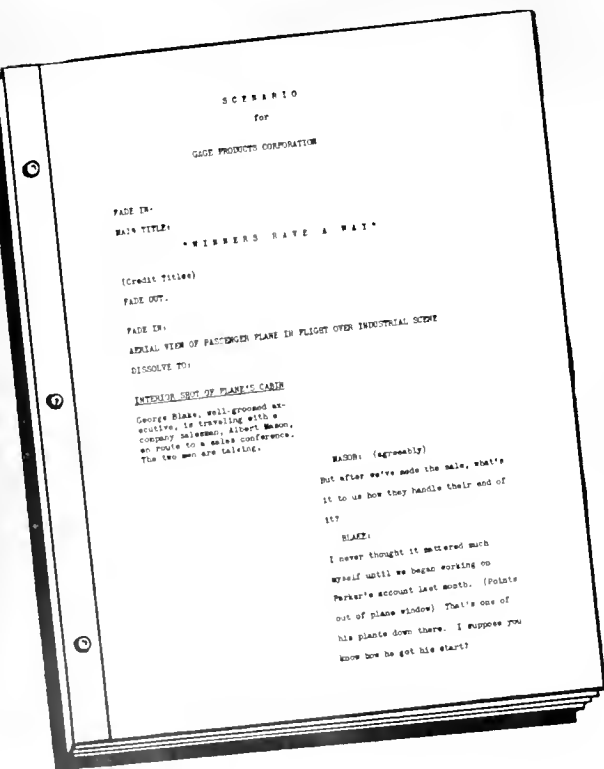

1. The Scenario

Most good business films begin with an idea; then the first organizing step is taken with the writing of the scenario and "shooting" script. Here, on paper in typing (and in pencil of the artist's scene sketches), are begun the work of creative planning and preparation.

2. The designer plans . . .

and accurate architectural drawings bring realistic proportions to hasty preliminary scene sketches for your sets. Here materials, labor and time are carefully estimated to fit a pre-determined budget. "Flats" or standard background panels; props and possibly your own equipment must be planned and placed to tell the selling story . . . all with a careful eye toward economy and effect . . .



5. Studio stages are vast

and necessarily so, for the building of large sets, sometimes multiple units requires plenty of floor space and lots of ceiling height. Above the sets are catwalks and gridirons from which lights, background flats and eye cameras are worked. The all-important camera angle is the first consideration.

8. Casting the players

is a job you've envied but which isn't as simple as it looks. No glamorous "stars" but able, experienced character players will put over your screen story. Realism demands the utmost care in portraying business types if the story calls for a dramatic technique. Company employees and executives may appear . . . but it takes professional talent to deliver dramatic dialogue that really sells . . .



11. Recording the sound

microphones, on stage, gather dialogue and incidental sound while the scene is being photographed—the sound is carried to the "monitor" who controls volume and the relation of the impulses and clears it to the recording room where, via a beam of light, the pulsating electric current becomes a permanent picture of sound on celluloid.

14. Animation helps explain

a difficult mechanical process or a technical point; whatever can be told by illustration can be skillfully depicted in sequences drawn by artists. Mechanical or technical animation helps put over the idea just that much better and is a frequently used tool. In color or black and white, the animator explains in simple, easily understood terms the inner workings of a machine or process . . .



17. Screening the Answer

For the first time, the customer sees and hears what he has bought. The Answer Print might be compared to a proof of an advertisement with its typesetting and engraving proofs pasted in. He discusses suggestions and editing notes are discussed and the film is ready for duplicating in extra prints for the field . . .



3. Sets are constructed...

A studio carpenter shops by experienced "old-timers" who bring their years of skill into the building of props and sets. The modern commercial film producer has equipment and facilities the equal of any in the world... but he has also learned the important secret of efficient economy necessary in the business film field.



4. Some props are big

as illustrated by this giant-sized automobile wheel which a sponsor used to put across an important mechanical advantage possessed by his product. But whether the "prop" is the customer's actual product, his own equipment or the realistic "dummy" constructed for film purposes — its place in the "story" is important...

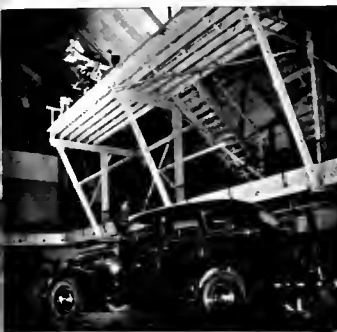

6. The right camera angle

sometimes makes it necessary to perch the crew on platforms high above the set. Technical skill in dramatizing your product brings out the important "sales" advantages: "hidden values" you hardly realized existed are put forward in unequalled interest for the benefit of future audiences: your prospects in the field!



7. The juicer is ready

with the battery of high-powered "lars" which illuminate the sets. Here, again, the commercial producers expensive and thorough studio equipment helps make successful the salesmanship of your film. One scene may require more light than the average house uses in a year. Many types of lamps must be available to get the proper lighting for color and the best black and white photography...

8. Scenes are rehearsed

Actors and the director assemble on the set preliminary to actual filming. The scene is discussed from the all-important plotting script. Commercial film direction isn't of the temperamental variety. The client's story and the budget rule out anything except skill; getting the best out of the story and talent is the job of the hand...



10. Quiet-e-et! Camera!

and a top-notch cameraman with his crew performs for the director as the actual "shooting" begins. Creative work continues through this vital step in production and the director may change scenes, add some, improve camera angles, lighting, sets just so he gives the client more for his money without increasing the budget.



12. For "off-screen" voice

sometimes sound effects and a commentator's dialogue are added to scenes previously filmed as illustrated in this study of the light images formed by the voice of Lowell Thomas. As the narrator views the finished scenes, his voiced comments are recorded and synchronized for the sound.



13. Camera on location

and if the story demands, up in the air to get an ore-derrick's view of an important scene. Portable camera and sound equipment take the mountains to Mohammed when the occasion demands. Into mines or mills; at sea or in the air — they follow the script! The camera is the world's best interpreter of the modern industrial scene.

5. Studio technique

To aid the punctuation or sequence of the picture, the powerful photomontage (right) or simple "wipes" and "dissolves" bring smoothness and heighten the interest in the picture. The film editor's task is simplified by the ingenious "optical printer". The smooth flow of a well-edited film heightens audience interest.



16. In the cutting room

the term "cutting" tends to minimize the importance of film editing. Here a picture can be "made" or "broken." A good film editor can make a masterpiece of a production which might otherwise be just another picture. Deleting overly long sequences is only one of the necessary tasks; there are many other "tricks" in the cutter's trade.



18. The audience approves

with a heart-warming burst of applause as the final scene fades from the screen. The shadows which the client bought are now impressions on the minds of his customers and if the picture has accomplished that purpose he has made a good investment.



19. and sales mount up!

as groups of prospective customers in a hundred cities — and a thousand are convinced by the realistic power of the screen image, salesmen and dealers hear the applause that counts — the magic symbol that spells orders on the books — dollars in the till.

PICTORIAL CREDITS
1, 5, 7, 14, 15: Courtesy Audio Productions, Inc.
8: Caravel Films, Inc. (NY)
4, 6, 16, 17, 18: The Jam Handy Picture Service
11, 12: Eastman Kodak
13: Roland Reed
3, 19: West Coast Sound Studios (NY)

SPEAK YOUR AUDIENCE'S LANGUAGE

IT'S NOT YOUR OPINIONS BUT THOSE OF THE PUBLIC THAT COUNT—by J. W. GAFILL

• A script writer recently spent several weeks in the dead of winter riding with the salesman-driver of a rural oil supply truck, calling on farmers. He learned the fuel requirements of the farmers, the sales methods of the driver, and gave an attentive ear to the talk of both.

Back in the office he wrote a motion picture based on the approved sales procedure of the oil company, and rendered it human and interesting by his first hand knowledge of the subject. The film was a successful stimulant of sales. Its success was attributed to the fact it spoke the language of the group of men it was aimed at. These salesman-drivers recognized themselves and their problems in the film, and were therefore open to its teaching.

This and many other important films have proven the success of the medium depends to a large extent upon knowing the audience and discovering the film patterns that please and move them to take the desired action.

This problem of fitting the film to the audience is simplified by the fact that audiences may be grouped. That they may be grouped as housewives, salesmen, merchants, farmers, debutantes. That they may be grouped by occupation, sex, age, and nationality; by the periodicals they read and the neighborhoods they live in. And being grouped may be known more intimately, and more easily sold. Therefore we establish the central fact that customer audiences go by groups, may be sold by groups, and that the successful film should talk the language of the group.

But group interests change with time and place. A film selling cosmetics to housewives is out of place at a meeting of women voters. While at a department store it is well received by the same group, produces results. Doctors are glad to look at a film selling sterilizing equipment in their hospital or office. They resent having the same film shown them at a fraternal meeting.

So we find that when it is aimed at the group buyer, talks his language, and is given a timely showing, the business film offers a streamlined selling medium. A medium from which waste circulation has been eliminated. A medium which gives a deeper penetration of the prospect, reaching him where his interests lie. We don't butter the whole loaf of bread when it's only a slice we're eating. And we don't pay for general exhibition when it's only women buyers we're selling. Thus with group showings, picture circulation can be controlled and its results checked.

Narrowing our audience allows us to know them better. We can avoid their foibles, study their habits. From our salesmen, dealers, and the customer himself we can gather a world

of intimate information for use in our films. The smaller the group the more personal the approach. A film made to sell one man could do a correspondingly better job than if it had to meet the potential interests of a thousand possible buyers. With group pictures business puts back the personal element into selling.

FILMS NEED A PATTERN

♦ To crash audience inertia the film must have a pattern, a design. The simplest sequence of scenes must have a beginning, middle, and a conclusion.

That is simply showmanship. Shakespeare, Barnum and Billy Sunday held their big stuff for the last act. Often it was the build-up that made it appear big. Barnum brought on his elephants, ponies, and trained seals a few at a time until all the rings were whirlpools of action. In short, these top salesmen maintained suspense, planned surprises, and kept the audience guessing.

Today the salesfilm is learning these ABC's of showmanship.

The advertiser is learning that even if his film is only a traveling show-case for the product it should open with interesting scenes giving a general over-all of the action, then move into closer views in sequence. The concluding scenes should show a finished product or operation.

The camel is a handy shape to check the movie against. It has an interesting beginning that says 'stop, look, and listen'. Then the camel obliges us with a nice hump, indicating a minor climax. Then the back line falls away only to rise to another climax, which should be slightly higher than the first. And finally we are presented with a surprise(?) conclusion.

When planning a sales picture it sometimes helps to keep in mind the advice of the old negro preacher, "Tell 'em what you're going to tell 'em; then tell 'em; then tell 'em what you told 'em."

If properly planned, when the room goes dark and the picture flashes on the screen it commands attention. It becomes a train with the buyer on board, and gains momentum as it goes, carrying the buyer's mind from where it is to where we want it to be. It hauls the sales freight because it has pattern, because the pattern fits the audience, and because it is given a timely showing.

So much for the importance of planning the film. What specific patterns have sold group audiences?

TELL, DON'T SELL, IN SCHOOLS

♦ Young people, school age, influence the buying of motorcars and are themselves potential buyers. They constitute a group audience.

School, where educational subjects are up-

permost, offers a splendid place to exhibit to this group. Therefore an educational film is devised which gains admittance to the school because it is acceptable to the authorities. This pattern has been called high pressure education, low pressure selling. Here it is:

Hydraulic brakes, the construction of the frame of a motorcar, its sound-proofed body are fit subjects for educational films. Proceeding from general laws of physics, chemistry, hydraulics, the educational film gives specific examples of the correct application of these laws. It uses brakes, the valve-in-head engine, the sound-proofed body, for illustrations.

To achieve its visual explanation the film uses mechanical animation, miniature models, and often a lecturer. It treats the subject in the manner of a popular science story, frequently ending with a thrilling demonstration of how the part correctly constructed will stop the car, eliminate sound, or enable it to travel over a rough road at high speed.

Another pattern used successfully for "educational" is the "let's you and I build it together" pattern. Here the narrator, in effect, asks the audience to join with him in constructing a machine. First he describes the conditions the machine must meet. Then step by step, on the screen, by means of mechanical animation, is added each part necessary to fulfill those conditions. Here the unspoken consent of the audience is gained by giving logical reasons for the special construction used. When the machine is completed the audience feels as if they had built it themselves and thoroughly approve of all parts of its construction.

WHAT DO FARMERS LIKE?

♦ So much for telling youth in public schools. And now how about the buyer who has more than a third of the national cash income jingling in his pockets? Is there a film pattern that will please and sell the farmer. Says he: "I like drama. Homely, salty, down-to-earth situations. We don't get the movie habit, and during the winter we've more leisure to get interested in folks."

Sales films most successful in selling farm audiences have been dramatic. *Back To The Old Farm*, the first dramatic sales film, proved the value of drama for this group. Then for several years there was a detour into films

(Please turn to page 36)

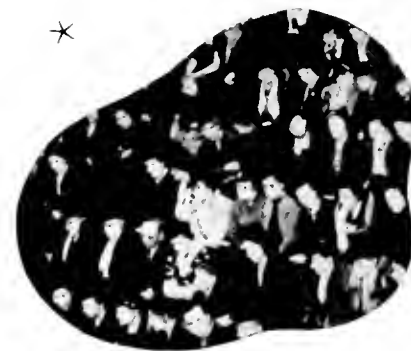

WINGS FOR THE WORLD

A Screenplay for a film that will show the development
of American aviation through the years
the Better Business Bureau has been

Business Screen Magazine
EDITORIAL MEMO:

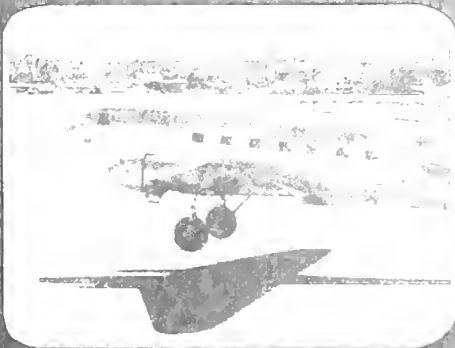
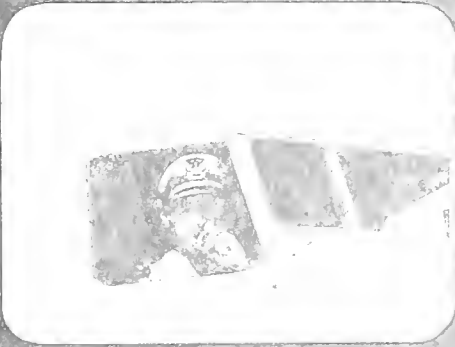

*America
builds and flies
the world's best
planes - let the
public know it!*

THE EDITORS OF BUSINESS SCREEN PRESENT AN ORIGINAL INDUSTRIAL FILM IDEA

The First Aviation Industry Film

— to be sponsored by America's leading aircraft manufacturers and the air transport companies

★ American transport planes fly the equatorial trade routes of Africa — span the barren wastes of the Canadian Northwest — cross the untracked wastes of the Tibetan desert. Year after year they fly a multi-million miles on regular transport schedules carrying their passengers and cargoes with an unheralded record of safety far more dependable than other forms of transportation — each year improving this record that today is marred only occasionally by the emphasis which newspapers give to its accident stories.

Behind the prowess of American aviation stand the great names of its builders and pioneers . . . Wright, Curtiss, Sperry, Douglas, Boeing, Lockheed, Northrop, Rickenbacker, Martin, and a hundred others who have brought us the respect of the world. America stands first, along the principal air-routes of the world, as a builder of transports for peace.

To our public here and in the countries of our friendly neighbors of Latin-America and Canada, we need to bring home the realization of the importance of our Civil Aviation industry, of the research and technical advancement which made possible its present leadership and which now make its travel the safest in the world. To the National Advisory Committee for Aeronautics, to the Air Transport Association and to the principal manufacturers of American aircraft, the editors of *Business Screen* address this suggestion:

Produce a motion picture, without advertising intent, to bring the public the "inside" story of Civil Aviation. If, as most of us realize, the existence of a great Civil Aviation industry is a reassurance of National Defense, then let us know and understand the real greatness of our planes, their builders and the dependability of their daily performance both here and abroad. There has been too much emphasis on the airplane as a weapon for war; those of us who know it as an instrument for world peace believe that story needs telling.

Well-known members of the air transport industry have been identified as sponsors of pictures advertising the scenic beauties to be glimpsed along their respective routes. The Pan-American Airways System has recently produced another scenic masterpiece, in glorious color, of travel on "The Lindbergh Trail" and has sponsored other excellent pictures of the same type. American Airlines is just completing, in Hollywood, a 20-minute subject with a dramatic background. This film, edited for group showings in cities along the American route, and another for theatrical distribution, are intended wholly for travel sales purposes. The excellent films of the United Airlines and of the Western Air Express are of a similar nature.

But what is very evidently lacking are films with a horizon of interest in the future as wide as that of the industry itself. A natural opportunity, based on the deep interest of the public in the state of our National Air Defense might well be translated into patriotic enthu-

siasm for what we already have. No small benefit would be derived from foreign showings as well. In the words of Captain Eddie V. Rickenbacker, writing in a recent issue of *Collier's*, "I believe to make us safe in the air, we should at once begin a volume production of airplanes. I mean airplanes essentially for peacetime use, that will step up our business by carrying all the first-class mail and as much of the express and light freight as possible.

"My estimate of a real beginning is fifty thousand planes. We need an airplane manufacturing industry that will stand up to punishing requirements if war should come. Very well, let us get it by building the planes now that will give that industry a real existence."

A series of films produced for the Imperial Airways and photographed along the British Empire air-routes suggests one typical approach to this subject. These pictures were shown to school and adult audiences throughout Great Britain. *Air Outpost* (1936-37) produced by Paul Rotha and directed by John Taylor and Ralph Keene is one of this series. The only "industrial" film recently produced here is a 16mm. production for the Curtiss Aeroplane Division of the Curtiss-Wright Corporation, Buffalo, New York. Certainly there is a great job of selling and telling to be done by the builders and instrument makers and films are the logical medium.

As a concrete suggestion and to bring in a final important thought, *Business Screen* suggests that three natural divisions of interest typify the film stories to be produced. In the first place, there is a "documentary" story to be told to the general public both here and abroad. In one reel, for theatrical distribution and otherwise, this picture *Wings for the World* would tell the story of the manufacturing industry and of the world routes which are flown successfully by American ships. A second film, perhaps made by adding a reel to the theatrical short, would bring a domestic story on air travel in America to club groups and other prospect audiences and thus return a dividend of general advertising to all the transport companies. This could be used jointly by all the airlines, shown by their sales agents or a projection service and thus promote air travel business.

Of final importance is the drastic need for vocational guidance in the high schools and colleges, particularly for youths hopeful of a future in Aviation. No good pictures of this character exist today and yet the need for personnel is tremendous and pressing. With only 500 of our 26,000 high schools with any aviation activities at all, an excellent vocational guidance film, perhaps made by adding a reel to the previous two, would be extremely valuable to the future course of American aviation.

"To you . . . we throw the torch . . . be yours to hold it high!"

BRIEF SYNOPSIS OF THE SCENES

I. "Wings for the World"

A Short Subject for Theatrical Release to the General Public

★ From an ancestry of bold pioneers, American aviation has inherited an unquenchable desire for perfection . . . a thirst for adventurous blazing of new trails. In the huge plants of its world renowned builders are assembled the transports which will carry passengers and cargoes over the 33,000 miles of American airways over other thousands of foreign routes. With mechanical excellence in performance its principal asset, the American transport airplane has an unequalled record of safety. Lockheeds fly in French Equatorial Africa . . . Douglas' in Siam . . . Boeings over Arctic wastes . . . unflinching . . . dependability the wide world over . . .

II. "Skyways of America"

Scenic Reels for Group Showing to Prospects for Air Travel

★ Board a plane in the early morning dawn and you're away into the rising sun for a safe, comfortable journey over the scenic airtrails of America. Down to Mexico City . . . across the Caribbean to the West Indies . . . over the Canadian forests or anywhere in the U. S. go the world's safest planes! Behind the scenes is the constant vigilance of modern science . . . the radio beam . . . automatic pilot . . . precision built instruments. The stewardess attends your personal comfort . . . the calm even flight of a superbly-powered passenger ship brings you to your destination without delay, meanwhile affords you what is truly a "birds-eye" view of the scenic wonderland which lies below.

III. "Your Future in Aviation"

A Special Vocational Edition for Showing to Schools, etc.

★ What about your future, aviation asks the youth of America in high schools and colleges . . . do you know how to get started? What kind of preliminary education is most valuable for the boy who wants to be an aeronautical engineer . . . for the girl who aspires to be a stewardess? What air schools can I attend? What are the duties of a flight engineer? How do pilots get their training . . . what are the physical qualifications of a good pilot? Aviation needs good men, will need plenty more and the schools ought to be prepared to send them. Here's a film telling the how and why of the vocations

A TYPICAL ALL-PURPOSE MOTION PICTURE

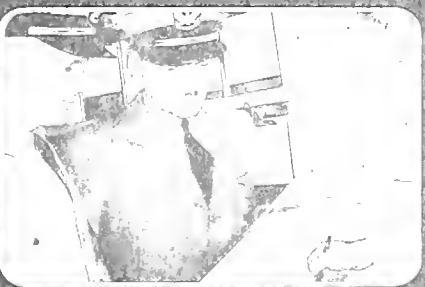
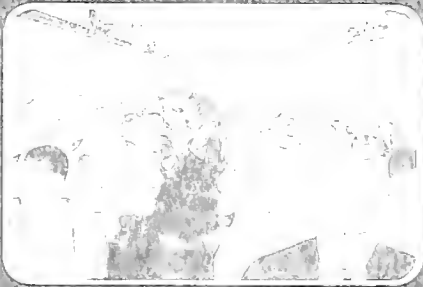
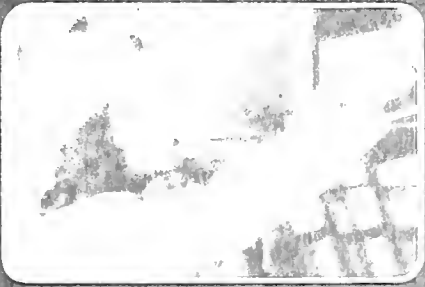
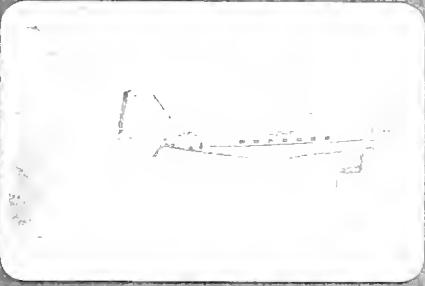

WHAT AUDIENCES SHOULD IT REACH?

I. THE GENERAL PUBLIC

In theatres, at conventions and other mass audiences . . .

* A one-reel short subject, perhaps filmed in color, should be made available to all principal exchanges or distributed by one of the commercial film theater services. Without direct advertising because its purpose is wholly patriotic, this "short" might well be jointly sponsored by the National Advisory Committee for Aeronautics, the Air Transport Association and the principal aircraft manufacturers. Its acceptance on all theatre screens is unquestioned. An additional version with Spanish sound-track, etc. might be given extensive circulation in Latin-American countries as a friendly gesture.

II. TRAVEL PROSPECTS

Exclusively by group showings of scenic subjects along the routes

* An added reel, which also might well be made in color because of the scenic advantages, could be carefully edited into the theatrical short or an entirely different film made under joint sponsorship of the members of the Air Transport Association on the subject of Air Travel alone. The subjects of safety and comfort would be of foremost importance in this picture. It might also be used as the second of a series for theatrical distribution if properly edited without any particular emphasis on advertising. For group showings on 35mm and 16mm projectors also.

III. THE SCHOOLS

Filling a Long-felt Need Vocational Guidance on Jobs in Aviation

* A special 16mm. motion picture dealing entirely with the jobs to be filled in the aviation industry would fill a real need for both the industry and the schools. Color would not be necessary in such a picture. 16mm. prints could be distributed by a projection service organization or placed in the visual department libraries of the state universities and vocational extension services. In large public schools systems such as in the case of Chicago, New York, Detroit, etc. prints will be circulated by the film departments of the schools at a minimum of expense.

1 reel short for theatres

2 reel version for group showings

3 reels (complete for schools)



Leading THE FIELD

... WITH EDITORIAL FORESIGHT... THE
FILM USER'S MOST DEPENDABLE GUIDE

★ Not only the sole consistent source of accurate news and authoritative opinion on the use and progress of the film medium, Business Screen makes its bid for leadership through research and its regular original contributions in new fields of film usefulness. Now completing its first year of successful publication, Business Screen announces two important features: The First Annual Equipment Review Section (to be contained in the forthcoming Issue Eight); and the Distribution Number (Issue Nine). Annual Film Selections made during recent months will be published in Issue Nine. More than 8,000 top-flight executives now read Business Screen; over 500 national corporations and advertising agencies have sent in reservations for issues up to 1941.

Business Screen Magazine

THE MAGAZINE OF COMMERCIAL & EDUCATIONAL FILMS

* FIRST ANNUAL SELECTIONS *

of Noteworthy Commercial Motion Pictures and Slidefilms of 1938
to be Announced in Issue Nine of Business Screen

● Having already seen several hundred film productions being considered for publication in the First Annual Selections issue of Business Screen, the Editors announce that this number will be an extremely helpful guide to film users, bringing for the first time a detailed explanation of the circulation and production of outstanding film successes of 1938. No prize awards will be made since the matter of budgets might unduly influence such selections but a review of the entire field with emphasis on fields of usefulness rather than mere production will be the keynote. Thus the simplest film, if it has been successful in merchandising its product or in putting over its idea, will get its share of attention.

SEND IN YOUR SELECTIONS

◆ The Selections Committee has agreed to give last-minute consideration to the productions of any business film sponsor (motion pictures or slidefilms, sound or silent)

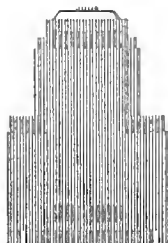

Address Review Requests to
BUSINESS SCREEN MAGAZINE

submitted up to June 15th, 1939. Although the extension will require extra labors on the part of the Committee and the Editors, the value of having participation from otherwise unknown sources is felt worthwhile. Just send in a letter telling about your picture and full review blanks will be sent by return mail.

Don't delay! A letter or card addressed to the Selections Committee will bring full details. There is not the slightest obligation, of course.

OTHER FORTHCOMING FEATURES:

◆ The Equipment Review Section to be included with Issue Eight of Business Screen will contain a complete manual of all projection and distribution equipment now useful in the commercial field. Also the usual stories and technical notes on the latest developments in the use of the motion picture and slidefilm; reviews of the new films, etc. Reserve extra copies now.

the Selections Committee
20 N. WACKER DRIVE, CHICAGO



No event is of greater importance in the annual life of a Caterpillar dealer than the well-known Diesel show which features educational displays as well as the new Company films.

THE TRACTOR DEALER TELLS 'EM WITH MOTION PICTURES

A Brief Case-History of the Caterpillar Tractor Company's Twenty Year Film Program

● For more than twenty years Caterpillar Tractor has been a consistent user of motion pictures in its sales and advertising programs. During this time more than 200 different subjects have been produced — most of them one-reel pictures devoted to a specific type of work. Naturally the first films were silent, because this pioneer producer of industrial pictures entered the field more than ten years before the advent of sound. But shortly after the sound movie swept the country "Caterpillar" followed suit with talking films of its own. For the first three years they were sound-on-disc and created such favorable comment at the annual dealers' shows held throughout the country, that the company took the next step and started producing sound-on-film subjects as soon as portable projectors were perfected for films of this type. All told, eighty sound pictures have been released by the organization since 1930 — an average of about twelve new films a year.

With a program such as this, carried on for a period of more than twenty years, it is evident that Caterpillar Tractor is a firm believer in the effectiveness of the commercial motion picture in promoting sales. But before we go into the results obtained from the pictures, let's see how they are produced. The great majority of all the films are outlined, written and compiled in the company's advertising department. Much of the negative is taken by staff photographers, who are equipped with the best professional cameras, a camera car and a full complement of lights, reflectors, etc. Since the Company enjoys a world-wide distribution of its products, consisting of track-type tractors, Diesel engines and road machinery, it cannot depend entirely on its own photographers for the negative that will tell a well rounded story of the performance of its machines. Throughout the fifty odd years of its existence, it has developed world-wide sources of supply for still and motion pictures. Many of these are commercial photographers, others are the com-

pany's field representatives who are supplied with cameras and have become very proficient in taking the type of pictures that have long been identified with the advertising of the organization. Since sound photography is not necessary in most instances, the pictures are made in silent cameras and sound is added in the studio.

When the negative is on hand for a given picture, it is edited to conform to the scenario, a work print is made and a narrative is prepared to match the picture. The recording is done in an outside studio and music and sound effects are added to provide realism.

When the recording is completed, sound prints are made for distribution through four principal channels. Primary distribution is secured through the Diesel shows, held annually by dealers in the United States and Canada in their various places of business. Owners, operators, prospects and friends of the dealer are invited to these shows and they spend the day as his guests inspecting the large amount of show material that is provided by the factory for this occasion. Seven large trucks travel over a scheduled route during the winter and spring months to put on these shows. In addition to complete motion picture projection equipment and a library of films, they carry a large cargo of cut-aways, animated signs, exhibits illustrating manufacturing processes, plus banners and display material to decorate the room in which the show is held. Two factory-trained men travel with each truck and put on the show with the cooperation of the dealer and his salesmen. A continuous motion picture program is generally run in connection with the exhibit at which the dealer's organization, his owners and prospects get a preview of the new films.

After the dealer's Diesel show prints of the new pictures are supplied to him without charge if he is equipped with a projector. Over 80 percent of domestic dealers and some 50 percent of foreign dealers have their own pro-

jectors. Silent versions of pictures that lend themselves to this kind of editing are prepared for dealers with silent projectors, but in recent years there has been such a marked trend to 16mm. sound projectors that the continued need for these silent editions seems doubtful.

The company also maintains a commodious theatre in connection with its large display room at the factory and here the sound films are shown to factory visitors and company guests. Many field representatives are supplied with projectors and films and the movies have also proved a great sales asset at the company's New York, Washington, D. C. and London offices. *(Please turn to next page)*

The production of industrial films for Caterpillar Tractor moves on in good weather and bad — just as its machines.



WHAT THE PICTURES DO

The majority of the films are designed to tell the story of the performance of the Company's products on a certain class of work. For example, there are pictures on such subjects as farming, fruit growing, road building, road maintenance, earthmoving, logging, snow removal, erosion control and industrial applications. From these films the dealer can select the one that deals with the type of work in which the prospect is interested and thus give him a demonstration right in the office, the prospect's home or his place of business. With the aid of motion pictures he can sell snowplows in July. He can take a contractor to an outstanding earthmoving operation on the other side of the continent or he can show a busy industrialist how a competitor is gaining an advantage by the use of new methods or equipment.

These movies are frequently the first means of interesting the prospect in the product and the final means of closing the sale. They play a part in every stage of selling "Caterpillar" machines because they furnish incontrovertible proof of performance, and that is what the prospective buyer always wants. In addition to this, they provide a means of broadcasting new methods — of developing markets for new equipment and of decreasing the cost of selling and increasing the speed with which the deals are closed.

TYPICAL CATERPILLAR FILMS

- BUILT FOR THE WESTERN RANCH — agricultural on the Pacific slope.
- LET'S GO DIESEL — the application of "Caterpillar" Diesel Engines to various power problems.
- GREATER GRADERS — road building with the No. 66 power-controlled blade grader.
- OUT OF THE WOODS — the use of Diesel tractors and power units in the logging and lumber industries in the western portion of the United States.
- PICKING THE WINNER — conquering adverse conditions of dust, mud, rocks, etc., with "Caterpillar" Diesel Tractors.
- ON FAR FRONTIERS — "Caterpillar" Diesels operating in the foreign field under extremes of temperature.
- MANPOWER AND HORSEPOWER — a film devoted to the "Caterpillar" factory and the folks who work there.

A TYPICAL CATERPILLAR "FAMILY" AUDIENCE



PROMOTING THE PROGRAM-II

Publicity for Your Films

• It has been pointed out in these pages before that a film, once produced, has most of its life ahead of it. Any point-of-view that accepts the distribution of a picture as a matter-of-course is in serious error.

True enough, the insatiable demand for "movies" among all types of groups can give your organization picture widespread audiences but true selectiveness is the first objective and to obtain that you'll have to use all the tricks of the trade; use 'em thoroughly and use 'em well.

The first of these is closest to home. The lowly house-organ, now risen in some business organizations to high estate because of its proven value and interest, will be a first and best bet for the opening of your publicity campaign. That's No. 1 on your checklist.

No. 2 is the local newspaper. If a public showing is possible (for that type of picture) then by all means study the feasibility of advertising and announcing your picture through the daily press. A well-produced picture often performs some phase of public service; study its useful angles and point your publicity accordingly.

One interesting campaign came to the attention of the editors recently. The Consumer's Power Company of Michigan, promoting the showings of its excellent film *All In A Day* used the following steps in building local interest:

A. The picture was released for general theatrical distribution throughout the area served by the company. In the matter of theatrical bookings, the company cooperated with theatre owners by supplying a limited amount of newspaper advertising together with window cards. As a direct tie-in the company installs a special window display where theatrical bookings are in a town in which a company store is located.

B. Request cards are sent to customers of the company so that club and group distribution may be requested. Confirmation forms are sent when a request is received and accepted.

The house-organ is naturally most valuable in the case of dealer and other types of organization films. As described elsewhere in a re-

printed piece from the *Esso Marketer* (see opposite page) the company journal keeps the dealer informed of the successful adaptation of the picture in other territories and builds his own interest higher. But the house-organ also serves to keep employees informed about pictures being seen by the public and aids that type of distribution as well.

Newspaper releases can be standardized and in a few cases very successful "syndicated" forms have been offered to local dealers for the guidance of local papers. Since he is usually an advertiser, the dealer can best "sponsor" the local showing and in the same vein, its attendant publicity. Standard Oil of Indiana, International Harvester and a few others have taken a leaf or two out of Hollywood's familiar "press-book" technique in this direction.

A final note would emphasize the importance of understanding the eventual distribution of the film as a unified plan. Then all forms of publicity, promotional printing and possible advertising can be synchronized to hit the exact places where they will do the most good.

Not only printed matter but the personal appearance of a representative of the sponsor at the time of the showing is to be thought of as an integral part of the film publicity campaign. Then, too, such personal attention helps assure more perfect showings.

HERE IS THE WINDOW DISPLAY ARRANGED BY CONSUMER'S POWER COMPANY in connection with local showings of *All In A Day* in Michigan cities served by the Company.



• One of the major advertising and sales promotional methods the Esso Marketers use for the benefit of Esso Dealers is the production and showing of motion pictures. All dealers are familiar with these, for they have seen them at dealer meetings, but most persons do not realize the tremendous audience of consumers to which these films are shown. In 1938 there were 1,285 consumer showings of Esso Marketers pictures to a total audience of 335,251 persons.

Safari on Wheels led in popularity among the Esso Marketers films last year, for in 998 showings it was seen by 236,031 persons. *News in the Air*, which was produced late in the year, also proved popular, for in only three months of 1938 it was seen by 30,075 persons at 84 showings.

Design for Power, the semi-technical film on gasoline performance which was released in May, 1938, reached 98,459 persons in 259 showings, and the older Esso Marketers films, *The Bigger They Come*, *The Magic of Oil*, and *Wings Over the Highway*, reached a total of 103,104 persons.

All this means two things: increased good will for Esso Dealers everywhere and increased consumer acceptance for the Esso Marketers products they sell.

The educational value of many of these films has permitted their showing before groups where out-and-out advertising films never would be permitted. It is for this reason that the Esso Marketers have been careful to keep

Esso Marketer Films

—show to 335,251 Persons in '38

advertising in the films at a minimum, feeling that in most cases the subjects covered in the films are sufficient advertising in themselves. For example, *Design for Power*, dealing with the qualities and performances of gasolines, demonstrates that the Esso Marketers know how to make gasoline to produce power, mileage, and smooth performance, and the natural conclusion in the minds of those who see this picture is that therefore Esso Marketers motor fuels are the best. The same is true of *The Magic of Oil*, which by its content tells the audiences that Esso Motor Oil is unexcelled.

The Esso Marketers have arranged three channels for the distribution of their films. Their own division organizations have projectors and operators, they have arranged with a regular film service to hold showings of their films, and they have arranged with the Y.M.C.A. motion picture bureau to lend their films to groups equipped with sound projectors.

Although the popularity of Esso Marketers films has been great, the present trend indicates that it still is growing, and 1939 should see more showings to a greater audience than any previous year.

Many Esso Dealers have arranged with their Esso Marketers representatives for showings in



"SULPHUR & MOLASSES" WAS ONE OF THE SUCCESSFUL DEALER-training Esso films released to service station agents in the East.

their neighborhoods. In such instances the Esso Marketers furnish the projection equipment and operator free of charge, and the only cost to the dealer is arranging for a hall for the showing and advertising it in advance. Dealers who have arranged to show the films in their towns have had amazing results in increased sales and good will. Other dealers have suggested to local groups such as the Kiwanis, Rotary, and other civic clubs that they request the Esso Marketers to show some of their films. This also costs the dealers nothing and results in good will and increased sales.

Production of the majority of the Esso films is by John W. Bransby; *Safari on Wheels* was filmed in Africa by Lawrence Thaw.

— *The Esso Marketer*

More than a MACHINE...

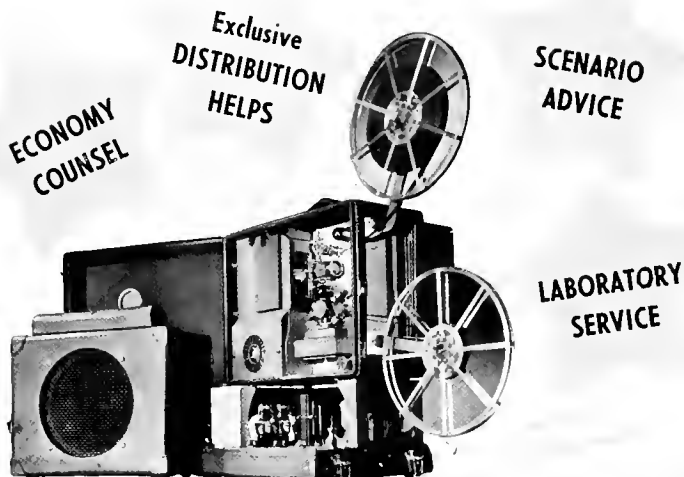

The New DeVRY *Interpreter*...represents a 16mm. sound projector value that sets new standards for clarity of pictures and fidelity of tone. Among its many advantages are: Synchronomatic Threading, Dual Sound Stabilizer, and new "Film-glide" that adds years of life to your film. Easy to carry, easy to operate, easy to buy.



DEVRY CORPORATION

(Estab. 1913)
Factory and Main Offices

1111 ARMITAGE AVE., CHICAGO, ILLINOIS

NEW YORK

HOLLYWOOD

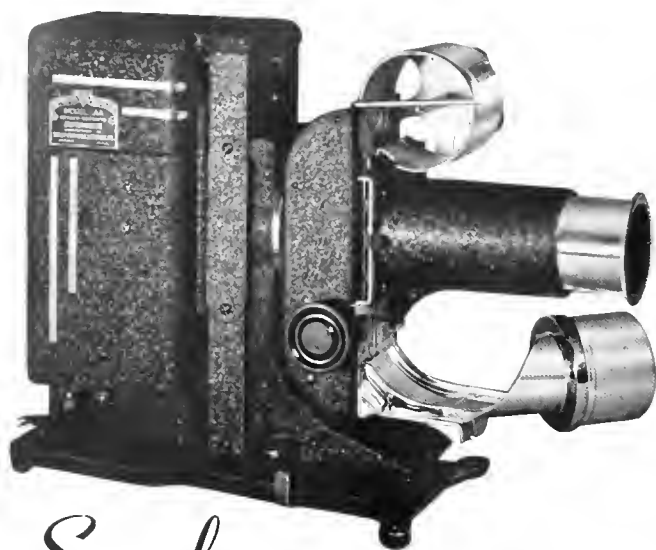

Specify
S.V.E. SLIDEFILM PROJECTORS

1. For Clearer Pictures

Made by the originators of slidefilm stereopticons, S.V.E. projectors have many advanced features that make for more brilliant projection and sharply focused screen images. S.V.E. projectors are available in several styles with 50 watt, 100 watt, 200 watt, or 300 watt lamps, for use in offices, or auditoriums.

2. Better Film Protection

A patented heat-absorbing filter between the lamp and the film safeguards its emulsion. A special releasing mechanism moves the rear aperture glass back automatically so that it will not touch the film when changing from one frame to the next. As further protection, the 300 watt models have as standard equipment the new S.V.E. rewind take-up which rewinds the film in the proper sequence as it is being shown.

3. Greater Convenience

All S.V.E. projectors are light in weight and of compact proportions for easy carrying. They can be quickly threaded, focused and adjusted in height for the proper position for showing pictures.

Send for "More Brilliant Stills"!

Everyone who uses or plans to use slidefilms, silent or sound, should read "More Brilliant Stills." Mail the coupon for a copy now!



SOCIETY FOR VISUAL EDUCATION, Inc.
 Dept. 7B, 100 East Ohio Street, Chicago, Ill.

Without obligation to us, send "More Brilliant Stills" full details regarding S. V. E. slidefilm projectors the name of the nearest producer-dealer.

Name

Address

THE COMMERCIAL NEWSREEL

• Taking another important step forward in the color field, Cinecolor this month announced the perfection of their own method of processing 16mm. films in color.

Cinecolor's president, A. L. McCormick, revealed that his company is currently building \$40,000 worth of printing and processing equipment of their own design and development, which, when installed, will give the Burbank plant a volume capacity of 600,000 feet of film a week. Price range, according to McCormick, will be extremely low.

No secret that the advent of a practical, low cost, 16mm. color process will increase the distribution of industrial pictures a hundred fold, it is the Company's expressed belief that the potential 16mm. color market will run into millions of feet of film a month.

Currently, Cinecolor is rushing completion of new, specially-designed equipment to handle innovation. Though any brand of single-coated stock can be used, both machinery and method of processing are developments of Cinecolor's own Research Department.

First great benefit to the trade, according to A. L. McCormick, Cinecolor's president, will be to allow Cinecolor to make a substantial price reduction for processing color prints.

Other features will include the elimination of many annoying difficulties now prevalent in the handling of duplitzed film. Single-coated film, for example, will require no change of focus on part of projectionists. Also, as present projection machines were originally designed to accommodate single-coated stock, danger of scratching will be minimized. Splicing will be as simple as with black and white, and as color images will be within one layer of emulsion, film will yield a sharper image. Finally, because 1,000 foot roll will be same size as standard black and white, projectionists will find the new film easy to handle.

THE VICTOR CONTINUOUS PROJECTOR OFFERED BY the Victor Animatograph projector company for use in exhibits and displays requiring this type of projection.



SCENE FROM THE NEW AND UNUSUAL CARAVEL-produced industrial film *Inside the Flame* which tells the technical story of carbon black.

New Yorker Magazine Film

♦ Mr. Marc Connelly and Mr. Franklin P. Adams, those celebrated raconteurs, bon vivants and jacks-of-all-trades, are making their first motion picture, at the Astoria studios. Co-starring in a cast of two, the Messrs. Adams and Connelly demonstrate for the films a vivid episode in the life of an advertising salesman and his mate, the space-buyer. The document is planned by and for the *New Yorker Magazine*, with the aid and assistance of Audio Productions, Inc.

The plot concerns itself with an attempt on the part of Mr. Connelly, who has a one-track mind if there ever was one, to sell Mr. Adams a bill of goods (and very good goods, too) in which process he underestimates Mr. Adams, as he would have known if he had studied his script. So, in enduring celluloid, is recorded, for the benefit of *The New Yorker* and posterity, what happens in the advertising business when an irresistible force is mowed down by an immovable object, as played by Mr. Adams.

American Oil Releases

♦ American Oil Co. has released two new sound motion pictures on the story of Amoco gasoline and lubricating products. Each is a two-reel subject and will be available to the general public as well as being shown during May and June at dealer meetings. Camera Inc., Chicago, is the producer.

Your Money and Mine

♦ *Your Money and Mine*, produced for the Wisconsin Bankers Association, by Ray-Bell Films, is the first successful attempt of American banks and bankers to tell the story of what banks and bankers do. It is primarily an educational story designed to increase public confidence and knowledge of banks and bank services.



SLIDEFILMS

Digest-Reviews of New Business Programs Sound & Silent



WILDING PIC. PROD.

● The best selling plan ever produced will bring results only *if the idea is put across*. The men who are to use that selling plan must first of all *understand it and want to use it*. However good an idea is, it must be sold first!

When The Pure Oil Company developed the plans for its "Balanced Selling" program recently, it was faced with just this problem. Before "Balanced Selling" could be put into effect, thousands of Pure Oil dealers and their employees had to be educated. Although the carefully thought-out system would help the dealer to set objectives for reasonable quotas, keep track of accomplishment from day to day and thus raise his earnings, it was a deviation from his usual loose ways of handling his business, so he actually had to be sold on the idea.

Because of Pure Oil's decentralized marketing system, dealers could not be grouped in gatherings large enough to justify the use of a motion picture. Therefore, it was decided by Sales Promotion Manager W. P. Marquam that the story should be told by a dramatized sound slidefilm, supported by printed media.

(It is quite important to mention here that Pure Oil although an extensive motion picture user, has used sound slidefilms only during the past year so the choice of this medium to present the story of one of the company's most important merchandising plans is significant of the results derived from the past year's productions.)

The picture, *Raise Your Sights*, is a 30-minute dramatized film of 274 frames. About twenty frames at the beginning and the end are devoted to an introduction and a summary, both of which are recorded on a separate record.

RESULTS BEING REPORTED

◆ To date the picture has performed its purpose to the extent that the "Balanced Selling" plan is under way in almost all territories now and there is "every indication that it will be the biggest selling factor yet devised in raising dealers' earnings." Phenomenal results are being reported from all quarters, according to Mr. Marquam, who has just returned from meetings in the field around Birmingham, Memphis and Atlanta. Here is an example of increases in one area as reported by a Mississippi company:

Commodities sold in addition to gasoline.		
Month of March, 1938		
(Before BALANCED SELLING)		
Motor Oil	Greases	Tires
23,160 gals.	21,200 lbs.	\$ 8,136.
Month of March, 1939		
(After BALANCED SELLING)		
Motor Oil	Greases	Tires
28,563 gals.	24,685 lbs.	\$10,037.

The Sales Promotion department of The Pure Oil Company has become thoroughly sold on the many uses of the sound slidefilm and feels this medium to be "more flexible than any other for the Pure Oil purpose, since it is easy to handle and to show to relatively small groups.

Since first employing screen methods of educating and training dealers, Pure Oil has used seven sound slidefilms and two talking pictures — nine productions in all. Another slidefilm, now in production, will soon be released to introduce a new product to Pure Oil salesmen and their dealers. Almost every phase of service station work has been covered in these films. The following are the order of the slidefilms and the purpose for which each was made:

1. Dealer-training film instructing men in the "Island Service routine."
2. A sales promotion film selling dealers on starting a flat rate "bumper to bumper" service.

3. A technical dealer-training film on batteries and their construction.

4. "Go Under the Hood"—training dealers on checking the oil.

5. Humorous 14 minute film "selling" dealers on clean rest rooms.

6. A color film selling the dealer on Pure Oil advertising and ways of using it.

SYNOPSIS OF STORY

◆ In the dramatic story of *Raise Your Sights*, two filling station owners decide that business is so slow they might as well go hunting. At the last moment they each lose use of their car (to the wives) and they have to take along Phil, the lazy, younger brother, in order to get his car. On the drive to their destination they drive in several service stations for gas and are sold nothing else. Later, they admitted that with balanced selling they would have made ten other well-needed purchases. These dealers on vacation then begin to wonder if they really are suffering because of too much competition. From what they have seen on this trip there isn't any selling that could be called competition!

The "Balanced Selling" program is based on the principle that every gallon of motor fuel represents an average of 15 miles of travel. Every mile of travel creates a "market" for the sale of oil, lubrication service, tires, tubes, batteries and accessories. Driving into service stations every day, the folks who make up this market make Pure Oil outlets the logical place to take care of all of the car owners' ordinary needs.

With the help of the Pure Oil "Balanced Selling" chart, the Pure Oil dealer can see exactly what his potential market is in terms of the merchandise and services that the average motorist needs as compared to every gallon of motor fuel

that he sells. In addition to being able to tell at a glance the exact amount of business that his station should be doing in relation to motor fuel sold, the Pure Oil dealer can see the gross profit that should come from the sale of each type of merchandise and service, as well as the daily sales quota that must be met to enjoy a profitable business.

Promotional Booklets

◆ The unquestioned value of tying up the production of slidefilm material with the publication of the excellent handbooks and guidance material for the audience to carry away has never been better demonstrated than in three recent examples shown below.

Lucien LeLong, the Illinois Bell Telephone Company and the American Newspaper Publishers' (Continued on Page 28)



TALK-PIX

The New Low Priced
TALKING SLIDE FILM MACHINE

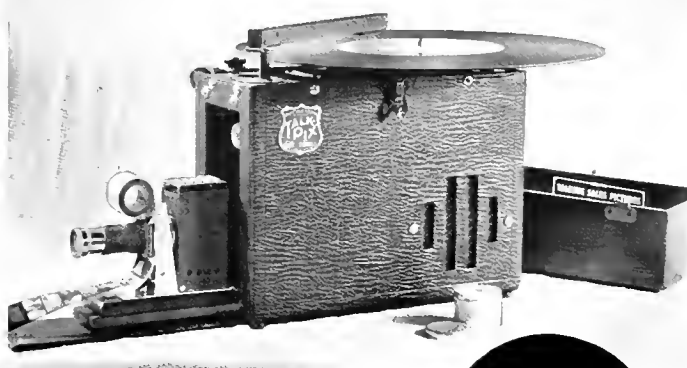

with standard
SVE projector

\$35

Distributor's profit eliminated on this new low priced machine sold to you direct by the manufacturer, one of the country's leading sound slide film producers.

TALK-PIX was developed and is now offered specifically to increase the effective utilization of slide films by our clients and other sales organizations heretofore handicapped by prohibitive prices of machines. Equip your entire sales force now at this low price.

Ready for immediate delivery. Do not delay in placing your order. Orders filled in order of receipt.

Complete facilities for production of dramatized fast moving, fast selling, sales presentations through talking slide films are available from our New York and Chicago studios.

50 Watt S.V.E. projector . . . Exceptional clarity of tone . . . Volume for 1 to 75 persons . . . Weighs only 11 pounds . . . Plays 12 or 16 inch records . . . Case holds 12 in. record and small screen . . . Price includes screen — 100 Watt S. V. E. projector with remote control; also AC-DC motor both optional at slight extra cost.

TALKING SALES PICTURES, INC.

Chicago • 510 No. Michigan Ave.
New York • 480 Lexington Ave.

Assn. (Bureau of Advertising) share honors of the month. In the main these booklets repeat the story of the slidefilm in pictures and text.

LeLong Trains Clerks

♦ Lucien LeLong, concerned with selling the entire line rather than just perfume alone, had a sales manual made for their retail clerks and are now selling the use of the manual to the sales people through a thirty-minute sound slidefilm, *Scents Make Dollars*.

Earle Ludgin, Inc., the agency in charge of production, did a remarkable job with this production. This film is entertaining but does not neglect to drive home its eight distinct sales points for the sponsor:

1. Adopting a personal sales plan for the individual customer.
2. The rule of three — trying the customer on three differently priced sizes to determine the limit customer plans to pay.
3. A demonstration of the negative ways that many clerks have.
4. Presenting the booklet showing "Seventeen Ways to Make More Sales".
5. Presentation of Lucien LeLong himself, selling his French personality.
6. The positive ways that good clerks put the manual points into practice.
7. How to sell associated LeLong products with each purchase.
8. How to suggest occasions for gifts to customers.

The use of the LeLong slidefilms in other departments of large retail stores has also been evidenced. The exchange of value satisfies both the sponsor and the store for the former gets an additional audience of customers and the stores get a top-notch sales training subject.

THE DALITE MODEL B TABLE MODEL SCREEN IS useful for desk projection of the slidefilm. See Page 34 for details.



TWO VIEWS OF THE CHICAGO RECORDING STUDIOS of RCA-Victor, frequently used by producers and users of slidefilms for recording, is a model installation.

Clinton Carpet Film

♦ The Clinton Carpet Company faced with the problem of price competition for their Ozite rug cushions, produced a thirty-minute sound slidefilm for the sales and technical training of retail rug salesmen.

This production, *Sales Lost and Found*, was produced under the direction of the Earle Ludgin advertising agency. The dramatized story revolves about the experiences of two typical floor covering salesmen. While centering primarily on the best methods of selling Ozite cushions, the film is loaded with other educational material on retail selling which applies equally to all types of furniture and house furnishings. The film is valuable for general sales training. Consequently, there has been a large demand among department stores for store-wide showings to sales people from all departments.

The principal theme of this picture is that one should not be concerned with just making sales — but with making customers. This film carries a powerful message as it improves sales promotion of Ozite products in the retail outlets.

* * * * *

♦ What's this we hear about a new projector that uses black and white film and projects colored pictures? It seems that it focuses three slidefilm frames at a time, each of a different density, and the combination produces color.

* * *

♦ See the first annual Equipment Review Number of *Business Screen* for details on all types of projectors.

Behind the Screen . . .

• Wonder what alibi the salesman can think up now to keep from using a "machine gun" on the firing line? His old kick about *weight* has been answered by manufacturers of sound slidefilm projectors who have announced new equipment weighing only 11 pounds! . . . Considering the combined weight of projector, turn-table, motor and case, it's hard to see how they can get out a unit much under the old light weight of 20 pounds . . . But with well-built, 11-pound units selling for less than 40 dollars we can expect to see a formidable army of salesmen take sound slidefilms into the field with them as direct selling aids this fall . . . The slidefilm has proved its effectiveness in technical education, sales training and dealer training but a powerful application and the one bringing the greatest immediate returns is direct selling . . . And users are adopting the medium more and more for this purpose. In 1933 hardly more than a dozen companies were using sound slidefilms and there were less than 500 machines in the field. However, the excellent results those organizations obtained through the use of the medium were so conspicuous that in three years, by 1936, over 200 of the largest national organizations were using the medium and there were more than 20,000 units in the field. It is estimated that today these figures have grown to nearly a thousand users with over 35,000 machines.

What Price Secrecy?

♦ Wish some firms wouldn't get the idea that all slidefilm activity must be kept confidential for fear their competition may use it for the same purposes. One large mail order house might be startled to know that their greatest competitor (from whom each production is kept a dark secret) is leading them two to one in the use of the medium.

To Point the Uses

♦ With the man on the street: Only about one layman out of a hundred knows what sound slidefilm is or how it's used. A producer once released a slidefilm (with sound) that was designed to explain and sell the medium. More educational work is needed and we're going through the entire matter again in a separate article

—listing all the uses found for slidefilms by some 200 leading firms from whom we have had correspondence.

How to Crash Gates

♦ Wonder why more sales managers don't realize the worth of slidefilm equipment for gate-crashing and for getting the complete presentation before tough prospects. Remember crashing a gate on my fifth trial once by telling the girl to send in word that I was out there with a commercial machine gun. She smiled, looked at the curious machine I was carrying and did as she was told. Got in all right and never had a more interested audience — the boss invited all the department heads in to see the show.

♦ SALES PROMOTION HONORS FOR THE MONTH: To R. M. McFarland, who represents several equipment manufacturers in the Chicago territory, for setting up an additional service to supply slidefilm users with the small but vital accessories such as needles, remote control cords, fuses, projection lamps, and even new rubber legs for the machine case. Small wonder that busy slidefilm users in the midwest are adopting the slogan "call McFarland!"

♦ THE PATRON SAINT OF SLIDEFILM: The Chinese sage who first uttered the time-worn phrase, "One picture is worth a thousand words." . . . A six-month's subscription to *Business Screen* to the person who first sends us his name.

Dean Towner

YOUR COMPANY'S VOICE: THE VOCALFILM ON telephone courtesy has been adapted for use in the Illinois Bell Telephone territory after its Eastern success.



ADD + A + UNIT ¹⁶MM ANIMATOPHONE

. . . The First and Only
MULTIPLE - VARIATION
MULTIPLE - USE
Motion Picture Projector
and Sound System

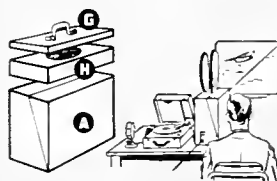

A COMPLETE but COMPACT
SMALL ROOM OUTFIT



ADD an AMPLIFIER and SPEAKER

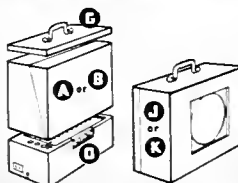

FOR LARGE AUDITORIUM
PROJECTION or
PUBLIC ADDRESS



VICTOR
ANIMATOGRAPH
CORP.
DAVENPORT, IOWA
CHICAGO · LOS ANGELES
SAN FRANCISCO · NEW YORK

ADD CENTRAL RADIO P.A.
SOUND SYSTEM

For relaying broadcasts,
recordings and
announcements

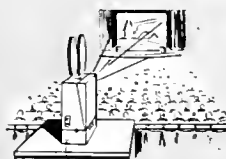

. . . to as many
rooms as desired.

Above are only 3 of Many Possible Combinations

TELL YOUR BUSINESS STORY THIS NEW, EASY WAY ★ ★ ★

★ PROJECT YOUR OWN MINIATURE
SLIDES, WHILE YOU'RE SPEAKING, BY

REMOTE
CONTROL

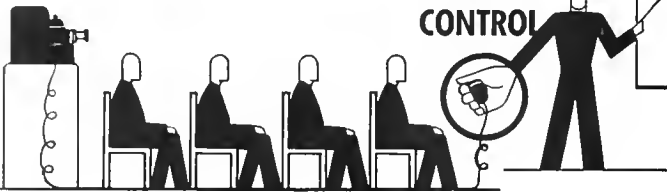

THE SELECTROSLIDE IS VITAL TO EVERY BUSINESS MAN:

- SALES MANAGERS
- LECTURERS
- ARCHITECTS
- PROFESSORS
- ENGINEERS
- ADVERTISING MEN



ONE press of the Selectroslide's remote control button, and whether you're talking to one man in an office ... or a thousand in an auditorium ... the slide automatically changes while you're speaking. The Selectroslide projects your own natural color or black and white 35 mm. film to any size. For display purposes the Selectroslide runs fully automatic, changing slides at set intervals. Interchangeable magazines, each holding 48 slides can easily be changed within a few seconds to show any number of pictures you desire.

WRITE TODAY FOR PAMPHLET!

Manufactured in San Francisco

NEW! The SELECTROSLIDE is also available in a streamlined cabinet approx. 5 ft. high and 20 in. square for point-of-sale display.

THE SELECTROSLIDE ★ SPINDLER AND SAUPPE, INC.

86 Third Street, San Francisco · With Branch Offices at 811 West 7th Street, Los Angeles



Let us Produce your Technical Films

With intelligent planning ... careful preparation ... alert, competent technicians and operators ... ENGINEERING and TECHNICAL STAFF experts available for work on your problems.

Complete films from \$1000.00 up

We have produced unsurpassed scientific motion pictures in silent, sound, and color for leading manufacturers and pharmaceutical laboratories.

Write on your letterhead for booklet "A" describing our guaranteed distribution service.

CONSULTATION INVITED

JOSEPH P. HACKEL'S

PHOTOGRAPHIC ARTISTS

PRODUCERS · DISTRIBUTORS · EQUIPMENT — A COMPLETE SERVICE
144 East 57th St. NEW YORK, N. Y. Wickersham 2-9742

Color in Slidefilms

♦ Effective combination of different techniques in color photography have been employed by the Dowling and Brownell organization in Hollywood, for production of a color slide film for General Petroleum Corporation.

The use of both original colored art copy and of action scenes made in color still photography is often necessary in the making of business film subjects.

A large number of commercial advertisers' copy generally has to do with reproduction of such material as billboards, magazine advertisements, window cards, signs, handbills and many other forms of advertising and dealer helps. In order to reproduce this kind of material on color slide films, the problem is usually to prepare it in a form suitable for re-photographing on to 35mm. color film. It is practical to transfer this type of material directly to the color strips when the original material is suitably mounted so that it can be photographed in screen frame proportion.

However, most business pictures involve the staging of scenes with living characters and with this type of scenes, it has been found more satisfactory to cast the stories, scene by scene, and photograph the action or poses with color still negatives, preferably with 3 1/4 x 4 1/4 or 4 x 5 color negative. From these color transparencies, the reproduction is then made on the 35mm. color film.

By combining these two methods the advertiser is able to present not only the dramatized part of his selling story but also certain advertising copy and charts and other necessary inserts in their original colors.

Produce in Series

♦ Judging by the film activities of eight or ten companies, it seems that many sound slidefilm users are developing a set procedure of producing slidefilm productions in series rather than singly.

Brobnck, Inc. did a series of

THE DEPENDABLE CONTINUOUS SLIDEFILM projector unit developed by the Society for Visual Education has found favor with exhibitors who use this type of equipment.

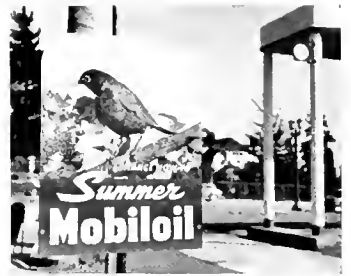
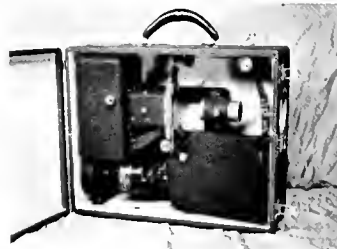

SCENE FROM THE COLOR SLIDEFILM PRODUCED BY Dowling & Brownell for General Petroleum and described in an adjoining column.

eighteen films last year for Plymouth, all devoted to sales problems. The Chrysler Corporation also has a similar series on sales and product. The producers are now engaged in the completion of a series of sales and technical training films for Firestone, The Packard Motor Co., and B. F. Goodrich and Co.

Among other companies producing films in series are: The Delaware-Lackawanna & Western Coal Co., Nash-Kelvinator Corp., Ford Motor Co., Household Finance Corp. and J. I. Case Company.

Pioneers' Equipment

♦ Sound Projects, Chicago manufacturers of sound slidefilm equipment and other sound units, note an enthusiastic reception among producers and sponsors of the new K102 Junior Model which the Company pioneered a few months ago.

Not only because of its light weight (approximately twelve pounds), but also because of its reasonable cost, the K102 has attracted new classes of slidefilm business heretofore not discovered. The Company also manufactures a complete line of sound transcription equipment for advertising agency-radio usage and because of the uniformly high quality of the sound, numerous installations have been effected in that field as well.

Chooses Selectroslide

♦ Not only the display departments of large national advertisers interested in the continuous slide projection for exhibit purposes but international users of visual media have been attracted to the Selectroslide unit manufactured by Spindler and Sauppe, San Francisco. A Selectroslide will accompany Mr. A. G. Roberts, Australian advertising executive, who was a recent visitor to America, in search of advertising materials for use on that continent.

This equipment is also being used in industrial exhibits with Kodachrome technical subjects.

THE USES FOR SLIDEFILMS

IN THE COMMERCIAL FIELD:

1. Technical and sales training for manufacturers' salesmen
2. Institutional prestige films for sales promotion to jobbers, dealers and consumers
3. Company and product dramatized in inspirational form to recruit new salesmen for house to house selling
4. Sales training films for the improvement of jobbers' and dealers' salesmen
5. Films of direct selling value for securing new dealers and retailers
6. Films for dealers' use in direct selling — for showing to the public in store or home
7. For retail training in merchandising, methods, displays, advertising, demonstrations, servicing, etc.
8. Technical and sales training films introducing new products

9. Training office and factory workers in employee relations
10. Training retail clerks in customer relations
11. For association and industrial relations messages; also convention keynotes or aids to program
12. Outlining new merchandising campaigns to all retail outlets
13. Bringing messages to public in good-will campaigns to improve public relations
14. As a medium for top executives to reach all company branches in personal address
15. As sales promotion in training department store clerks or specialty salesmen to sell the complete line

IN THE INDUSTRIAL MARKET

1. Direct selling to individual executives or boards of directors
2. Safety training for factory workers
3. Institutional good-will films for employee relations
4. Sales promotional and educational films for

production heads

5. Technical training films for branch and subsidiary organizations
6. Advertising films on product items
7. Sales recruiting and sales training films for showing in colleges and technical schools
8. Industrial good-will films for national associations
9. Good-will educational films for employee showings
10. For the solicitation of new dealers and foreign representatives.

SUMMARY

♦ It is perhaps the simplicity of the medium and equipment that is the foundation of the commercial success already attained by sound slidefilms. Some of the reasons for the wide and universal acceptance are, briefly:

1. The effectiveness of the medium as a visual-auditory force and high learning potential
2. The simplicity and low cost of sound slide-

(Continued on Page 37)

SLIDEFILM EQUIPMENT TO SUIT EVERY BUSINESS NEED

• There's a high-quality Sound Projects sound slidefilm projector for every kind of business use. Whether your audience numbers one or a thousand, you'll find the model and the quality you've been looking for.

Naturally, the price is right. As manufacturers who specialize in fine sound equipment, we're building a reputation for fairness as well as technical excellence. Inquiries promptly answered; service to any part of the world.

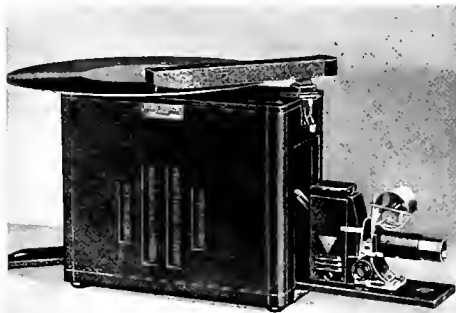

MODEL K103 FOR AC OPERATION

General utility machine for audiences up to 100 persons.

Equipped with 100 watt projector. (Model L103 for AC-DC operation, slightly higher). Self-contained record compartment and screen, priced at **\$67.50**. Here is the universally approved machine, recommended by all producers and users alike for general sales usage. Every possible advantage to assure a perfect showing under average conditions. Plays 10, 12 and 16 inch records.

Buy direct from the manufacturer — we cooperate with all responsible and recognized business film producers. Pioneers in low-cost — high quality sound slidefilm equipment for every business use. Agency transcription equipment specialists. Full technical information, prices and quantity discounts, etc. sent free on request.

Ask Your Local Producer for Details or Address Inquiries to

SOUND PROJECTS COMPANY

3140 WALTON STREET • CHICAGO • TELEPHONE: NEVADA 6261



K102 JUNIOR

FOR AC OPERATION

The new streamlined light-weight portable sound slidefilm projector just announced! Weighs only twelve pounds. Carries standard SVE 50 watt projector; plays up to 16" record. Priced at only **\$37.50**

Model K1102 Junior is priced low enough so that largest field sales organizations can be equipped at tremendous savings over previous equipment available. AC only. Model L102, equipped for AC-DC operation, slightly higher.

Consider These Advantages:

LIGHTER IN WEIGHT MORE COMPACT
SETS UP IN A MINUTE
EASY TO CARRY

MODEL K106

FOR AC OPERATION

The deluxe equipment of the sound slidefilm field; equipped with 300 watt SVE projection; highest quality true-tone amplification suitable for showings to 500 persons. Plays 16" records; priced at only **\$106.50**

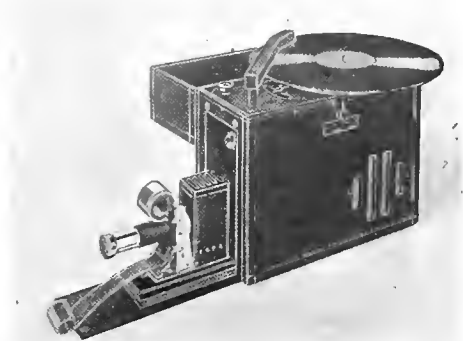
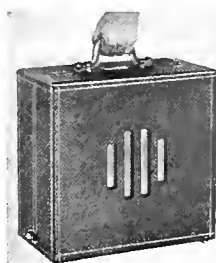

Below: for larger audiences, at conventions, etc. Models K106 and L106 are ideally suited. Brilliant 300 watt projection with amplification for audiences of 500 and over. K106 sells at only \$106.50; Model L106, equipped for AC-DC operation, priced slightly higher.



CLEAN FILM *Means* SPARKLING PROJECTION!

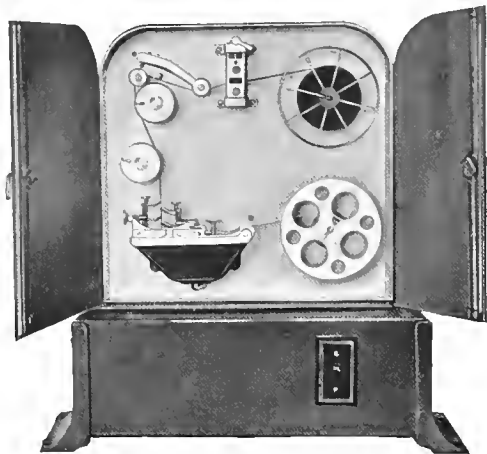

NEWLY DEVELOPED—"NEUVATOR"—AUTOMATICALLY
CLEANS · CONDITIONS · POLISHES · REWINDS

A clean polished film is the main factor in perfect unblemished projection — does away with the ruin of spots and streaks which spoil screen presentations.

"NEUVATOR" puts new life in old films, prolonging their service — keeps new films fresh. Particularly effective for sound film — keeps sound track clean and free from extraneous noises insuring perfect tones.

MODEL CL-4 (400 ft. reels of 16mm) \$175.00
Also Available—Larger 16mm Model and Models for 35mm

Complete line of quality film equipment.
CABINETS-REWINDERS-MEASURING MACHINES-SHIPPING CASES-ETC.
SEND FOR CATALOGUE NO. 16 — JUST ISSUED.

Neumade Products Corp.

429 WEST 42nd ST.

NEW YORK, N. Y.

AIR SHIPMENTS SPEED DISTRIBUTION

• The all time high for films air expressed to and from New York in one month was scored in December, 1938, when 4,092 shipments were handled, according to Railway Express Agency, Inc.

Commercial film users and their distributors have found it profitable to use Air Express' "3-mile-a-minute" delivery to get an increased number of showings out of each print while their slidefilms and motion pictures are the most timely. This high speed service to 220 airport cities includes special pickup and delivery with receipts at both ends and insurance up to \$50. additional insurance may be had at 10c per \$100.

This service is a division of Rail-

way Express and thus extends points of distribution by co-ordination with 23,000 railway express offices in off-airline cities and towns throughout the country. As an example of the rates, 1200 feet of 16mm. film in metal container, which weighs 5 pounds, can be dispatched 1,000 miles by air express for \$2.40; a slidefilm, with record and film-can packed in fibre container, weighs about 3½ pounds and can be sent 600 miles in three hours and twenty minutes for \$1.46. Deliveries of 2500 miles are made overnight.

The table below charts the actual flying time between airports of twelve federal reserve bank cities:

Airport to Airport	Atlanta	Boston	Chicago	Cleveland	Dallas	Kansas City	Minneapolis	New York	Philadelphia	Richmond	St. Louis	San Francisco
Atlanta		8¼	4¼	7½	7	12	7½	5½	5¼	4	6¼	18¼
Boston	7¾		6¼	4¼	11	13¼	10½	1½	2¼	4½	9½	19¼
Chicago	4¼	6		1¾	6½	2¼	2¼	4	3½	5¼	1¼	12½
Cleveland	5¼	4¼	2¼		8½	6	6	2¼	2¼	3¼	5½	15¼
Dallas	6	11¼	6¼	9		3½	10½	8¼	9	15¼	4¼	12
Kansas City	9	9¼	2¼	4¼	4		6¼	7¼	9½	12	4¼	12
Minneapolis	7½	10¼	2	4¼	9¼	3¼		6½	9½	11½	4½	16
New York	5¼	1¼	4¼	2¼	9¼	8	8		½	2½	6¼	17½
Philadelphia	5¼	2½	5¼	2¼	9¼	9	8¼	½		1¼	9¼	19¼
Richmond	3½	3¼	7¼	4¼	10	11¼	11	2½	2		9	22½
St. Louis	6¼	9¼	1½	4½	3¼	6½	6	6¼	7¼	10½		17½
San Francisco	18½	18½	11	14	10	11½	14½	15½	16¼	21	13¼	

VISUAL ADVERTISING

in the graphic arts as in fine business motion pictures depends on the excellence of equipment, the skill of long experience and the constant ambition for higher quality . . .

NOW IN LARGER QUARTERS AT 732 SHERMAN ST.

NU-ERA
PHOTO ENGRAVERS, INC.

*... makers of fine
printing plates and
electrotypes for
all advertising ...*

IN CHICAGO

♦ Five hundred films are featured in the theatres of the New York World's Fair. The widespread use of the medium there tells the story of its usefulness to modern business.

Gutlohn Courtesy

♦ Are you planning to visit the World's Fair? The Gutlohn organization has offered their facilities for the screening of 16mm. sound pictures for which they are international distributors and will be glad to assist in an advisory capacity to those who have film problems to solve.

Many educators and industrial film users are making their summer headquarters at Walter O. Gutlohn Inc. whose address is 35 West 45th Street, New York.

Opens in New York

♦ James Matthews who has been connected with the 16mm. field for the past 10 years has recently opened new headquarters under the name of Action Motion Picture Service at 358 West 44th Street, New York City.

Cole's Fair Service

♦ King Cole Sound Service will have an office at the World's Fair to render emergency service for projection equipment; also to supply the necessary union help for operation and maintenance. They will also lease and maintain a repair and replacement service. With well over 13,000 hours of machine operation ahead, the need for such a service is apparent. The King Cole Sound Service has been awarded a service contract to maintain and operate the projection equipment directly under the control of the World's Fair 1939 Corporation.

THE NEW DEVRV 16MM THEATRE PROJECTOR IS now being demonstrated to industrial film theatre prospects.



THE MODEL T103 PRESTO RECORDER UNIT

Hackel Screens Weekly

♦ Photographie Fair, Ltd., under the able direction of Joseph P. Hackel, has inaugurated a new service for business executives contemplating the use of business films. Each Wednesday evening at 5:30, a special screening of low-cost productions is shown to interested business men who wish to see what can be produced on modest budgets.

To date this plan has brought advance bookings for three weeks as the little theatre has a limited seating capacity. The greatest promise is held forth to the industry by this sincere interest on the part of smaller businesses as evidenced by the time which their owners and officers are willing to spend on this new type of sales promotion.

♦ With price reductions in effect, the cost of the finest 16mm. sound projector is about one-half of its 1937 price; the number in use has trebled!

Neuvator Useful

♦ Many users of business films are building small service departments within their own organizations and a welcome addition is the "neuvator". This unit is most helpful in cleaning film.

The film is first subjected to a bath and then it passes between three double sets of squeegees which remove all excessive liquid along with all foreign matter; then across two polishing rolls, one for each side which also absorb the slight amount of moisture which may remain. It is then wound up on reel.

No sprocket teeth are used so that sprockets are not torn or damaged. A mercury switch controlled by an idling arm stops all operations immediately when roll is finished or stops automatically if rethreading is needed. The "neuvator" is manufactured in sizes for 35mm. and 16mm. film, and specially designed bases are also available.

This is a development of the Neumade Products Corporation.

Dear Friend:

Salesmen who are winners find it pays to look that way. Not overdressed, of course, but neat and well-groomed.

Film salesmen are just as important but is that vital sales argument lost in streaky and scratched scenes? Films get a lot of use, are often handled by inexperienced projectionists in distant towns. Even new prints may become scratched after one showing. How do you keep your travelling "salesmen" neat?

Recono suggests that you make them "scratchless" through its exclusive "rejuvenation" process. The cost of this clean-up and scratch removal service is economical, more so because it puts "used-up" films back in circulation just as good as new!

Finally, we suggest that you let RECONO offer a laboratory analysis of your film and distribution problems without charge or obligation. Our background of experience will be helpful to you. Call or drop us a line.

Cordially yours,

Michael Freedman

AMERICAN RECONO, INC. • 245 West 55th Street • New York, N. Y.



SURE She's Pretty-

... BUT YOU SHOULD SEE HOW MUCH MORE "OOMPH" SHE HAS IN THE COLOR FILM!



And — like this Hollywood model — the magazine ads, posters, service stations, cars and other characters all take on added eye-appeal and selling punch in General Petroleum's color slide film.

We can reproduce your advertising material and stage the scenes required to tell your story, using the best of Hollywood professional talent for both voice and picture.

Let us send you detail on these striking color productions — for slide films or for motion pictures.

DOWLING and BROWNELL

6625 Romaine Street

Hollywood, California



"CRITICAL MOMENTS"

A great railroad had to clear its tracks. An entire train and train crew had to be enlisted, scenes shot at night, voices and natural sounds recorded on location — when the National Carbon Company decided to re-enact for the screen one of its thrilling "true experience" Eveready Flashlight Battery ads.

To meet these problems, National Carbon relied upon the technical skill, resourcefulness and facilities of West Coast Sound Studios. West Coast has made notable contributions to national screen advertising with this and other productions in the "Critical Moments" series.

Producing effective Screen-ads is a highly specialized art. Let us place our facilities and technical skill at your service when you consider Screen Advertising.

STUDIOS RCA EQUIPPED
WEST COAST SOUND STUDIOS, Inc.
 510-22 West Fifty-Seventh Street
 New York Circle 7-2062 N. Y.
 Nat. Sales Rep: SCREEN BROADCAST CORPORATION

Everything for INDUSTRIAL PRODUCERS

WE SUPPLY on rental all or any equipment necessary to make a Feature — Short or Commercial.

SOUND — SILENT — COLOR — SLOW MOTION

- Latest Mitchell Cameras
- Blimps — Dollies — Accessories
- Latest Type Lighting Equipment
- Variable Area Location Sound Truck
- Portable Recording Equipment
- Single System News Reel Type Cameras
- Moviola Editing Equipment

SALES — SERVICE — RENTALS

EXCLUSIVE EASTERN REPRESENTATIVES
 MITCHELL CAMERA CORPORATION

MOTION PICTURE CAMERA SUPPLY, Inc.

723 Seventh Ave • New York, N. Y.
 Phone BRyant 9-7754 Cable — CINECAMERA

♦ The first annual equipment review number of *Business Screen*, in preparation for several months, promises to be a most useful tool for the industrial film user. Watch for it!

Bowes Amateurs in 16mm Reels

♦ MAJOR BOWES' AMATEURS are now available in 16mm. sound-on-film according to an announcement made by H. Threlkeld Edwards, President of Commonwealth Pictures Corp., 729 Seventh Avenue, New York City. This company, which specializes in the sale and lease of 16mm. sound subjects, has just acquired the exclusive sub-standard distribution rights to six two and six one-reel releases featuring these nationally known amateurs. A partial list of titles includes *Variety Revue*, *Melody Makers*, *Musical Varieties*, *Radio Revels*, *Hit Parade* and *Harmony Broadcast*.

Major Bowes appears in each of these releases and with his inimitable "all right — all right — all right" guides these talented youngsters in their screen debut. He has developed a public numbering in the millions for a new and irresistible source of human interest by introducing a heretofore unknown flood of talent. Every performer has gained an opportunity for recognition by being presented on these sympathetic and immensely popular programs. An outstanding program of the air becomes the leading short subject of the screen and is ideally suited for rounding out commercial presentations.

With an infinite variety of melody, singing, and wholesome amusement and a universal appeal, they constitute an outstanding addition to the 16mm. sound field. Commonwealth Pictures Corp. also have available for purchase or lease over 175 feature pictures as well as a wide assortment of short subjects including musical comedy shorts with Donald Novis and Bing Crosby, cartoons, travelogues, and novelty reels.

Spencer Lens Elects Officers

♦ Following the Annual Stockholders' Meeting of Spencer Lens Company, Scientific Instrument Division of the American Optical Company, on March 17, 1939, the following officers were elected:

H. N. Ott — Chairman of the Board of Directors; B. H. Witherspoon — President & General Manager; H. D. Rhynedance — Vice-President and General Sales Manager; B. Glenny — Treasurer; C. W. Barton — Secretary and Manager of Research & Development.

Mr. B. H. Witherspoon, who has had broad experience in sales, engineering, and research and development work, has been active in the management of Spencer Lens Company since 1935, serving as a member of the Executive Committee, and Vice-President and General Manager, from which position he now assumes the Presidency of the Company.

RCA Advances E. C. Cahill

♦ Announcements from RCA Photophone confirm the advancement of E. C. Cahill to the post of Manager of the Photophone Division, a position which he will fill in addition to his duties as Director of the General Service activi-

ties of the company. Harry Sommerer, former Division manager, has been made assistant to the executive vice-president. Homer Snook is director of Sales for the Photophone Division.

New DaLite Catalogs Ready

♦ The Da-Lite Screen Company has just published a new and larger catalog that is more than just a listing of Da-Lite Screens.

This 48-page book contains technical information on the brightness characteristics of various types of screen surfaces, charts of picture sizes which facilitate the selection of the right size of screen for use with various kinds of still and motion picture projectors, practical suggestions regarding the selection of the right type of mounting for each user's requirements and recommendations on the care of screens to obtain maximum service from them.

The data would be helpful to anyone considering the selection of a screen, regardless of the make.

One chart is particularly interesting to those who have given consideration to ways of minimizing distortion. Many claims have been made for projection screens to the effect that certain types of surfaces are beneficial in reducing distortion. The chart and explanation of it in the Da-Lite catalog show clearly that it is not the function of the screen to eliminate distortion and that distortion is a phenomena of perspective — that the screen cannot cause it, and cannot control it. It shows that regardless of the type of surface of the screen, people seated far to either side of it will always see a picture which is distorted by perspective, in which the figures always appear narrower and taller than normal. The solution, of course, is through seating the audience within viewing angles which will minimize this effect of perspective.

Da-Lite makes all types of surfaces but recommends the glass-beaded as the most efficient for average projection requirements. The Da-Lite glass-beaded surface reflects the maximum of light yet it is so constructed that there is no glare or sparkling. Its greater brilliance is especially appreciated in color pictures because the density of color film cuts down the light from the projector. Da-Lite also makes white and silver screens for the installations where these types of surfaces are best fitted.

THE AMPRO VOLTAGE REGULATOR IS A VALUABLE ADDITION TO THE industrial film department where varied current conditions are encountered in field projection.



Personalities in the News

♦ Off the beaten track of news is the announcement of Leo Nejedski's new book "The Camera Eye" shortly due from the publishers. Mr. Nejedski, aside from his post of vantage as advertising director for Swift and Company, knows the camera as a friend and companion. His prints have appeared in salons all over the world. "The Camera Eye" contains a brief introduction by Valentino Sarra, internationally known photographic illustrator.

Chicago Changes:

♦ Announcements are expected shortly from two Midwestern "majors" in the commercial production field. In the agency field, the principal news concerns the Chicago arrival of J. C. Cornelius as vice-president in charge of the Western offices of Batten, Barton, Durstine and Osborn.

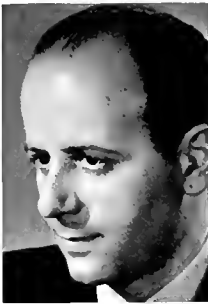

Aldo Ermini

♦ Aldo Ermini, color photography expert formerly with the Technicolor Corporation of Hollywood and London, was appointed April 1st to the staff of Dufaycolor Company, Inc., where he will have charge of the development and introduction of the new Dufaycolor process in the motion picture field. In announcing the appointment, P. M. Hamilton, President of Dufaycolor, said:

"We consider ourselves fortunate in securing the services of one with Mr. Ermini's experience in the color motion picture field.

"After more than seven years in experimental work in still and motion picture color photography, Mr. Ermini joined the Technicolor Company in Hollywood. When Technicolor, Limited, was formed in England he was sent over to train others in the technique of Technicolor Photography. He is perhaps best known for his work as Director of Technicolor Photography on Alexander Korda's feature, "Drums".

♦ Mervin W. Palmer, a well known figure in the motion picture industry for nearly thirty years, has been appointed Service Manager of the Bell & Howell Company, New York branch.

Mr. Palmer was connected with the old Biograph Studios in New York from 1912 to 1920. For the next two years he was Chief Engineer for the Paramount Studios at Astoria, Long Island. His more recent connections have been with Motion Picture Lighting & Equipment Corporation and International Projector Corporation. Mr. Palmer also is well known for his activities in the Society of Motion Picture Engineers.

Appoint Art Director

♦ Appointment of Fredrik W. Deuker as art director of Associated Sales Company, producers of sound slidefilms, as a part of the company's program of expansion, has been announced by Donald S. Benedict, vice president.

Prior to joining the staff of Associated Sales Company, Mr. Deuker was in charge of sample development and production planning for W. L. Stensgaard and Associates, Inc., of Chicago. He also served Jam Handy as art director, and for a time was with LaSalle Extension University, illustrating sales training courses.

Mr. Deuker is well known in Chicago for his exhibits of fine art and satirical design.

Argus on the Air

♦ The International Research Corporation, manufacturers of the Argus camera and accessories have announced a new series of transcribed radio programs featuring Karl A. Barleben, educational director.

The series, entitled "Today's Candid Story" is one of the first camera program series to be sponsored by a manufacturer in the photographic field.

Argus also announces that Roy Walker is now directing Sales in the absence of V. A. Searles, recently resigned because of ill health.



Karl A. Barleben

Producing the Winners!

"BASEBALL"

The 1939 National League Film . . . Another Successful Burton Holmes Production.

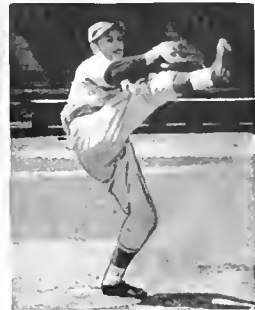

• Winning good will is of paramount importance to every organization whether in the field of business or sports. "Baseball", a Burton Holmes Film production for the National League of Professional Baseball Clubs, is now showing to over a quarter of a million people a month — winning good will for the sponsor and promoting a greater interest in the national game.

In the business world institutional films are creating better employee and public relations, winning good will and building customers for scores of organizations. The Burton Holmes organization has been producing motion pictures for general public showings for more than forty years, longer than any other American film producer.

Address Business Films Department

NOW AVAILABLE FOR FREE LOAN

"Baseball" is an inspirational film treating of the origin, history and technique of ball playing as a profession and a pastime. Of interest to every type of organization, juvenile and adult.

Available on application in 35mm. and 16mm. sound film. Running time 41 minutes.

Burton Holmes Films, Inc.
7510 North Ashland Avenue • Chicago, Illinois
PRODUCERS • DISTRIBUTORS • LABORATORY SERVICE



SHOWMANSHIP SHORTS

direct from the deluxe theatre screens to your own sponsored programs



16MM SOUND

one and two reels

The perfect short subject to pep-up your commercial programs . . . featuring Maj. Bowes and his famous prize-winning amateurs.

R. C. A. High Fidelity Recording

COMMONWEALTH PICTURES
729 Seventh Avenue • New York

Bing Crosby musicals and a large variety of other shorts available



GUARANTEED MOVIE CIRCULATION

IN 16MM.
TO 500,000 RURAL AUDIENCE

★

NOW — guaranteed and controlled distribution based on seven years' research. Our plan will circulate your minute trailer or 1, 2, or 3 reel subject to ½ million farmers in only four months' time!

Introductory rates for summer of 1939 are lowest ever available in the history of advertising film distribution.

Write for descriptive folder and rate card

FILMS INCORPORATED

Industrial Division
64 E. Lake Street
CHICAGO

NEW YORK PORTLAND, ORE.

Ballard Film Service

-:- NEW LOCATION -:-

42nd Floor Civic Opera Building

+

- EDITORIAL SERVICE
- PRODUCTION SUPERVISION
- SALES CONVENTIONS
- INDUSTRIAL PLAYS
- SALES PRESENTATIONS

We do NOT produce films. We write the scripts and act as counsel to your purchasing agent in getting your money's worth!

CENtral 2743

The Audience's Language—

(Continued from Page 18)

showing farm machines in action, films addressed more to the manufacturer than to the farmer. Today the tide turns back to drama with such film successes as *Under The 4 H Flag*, *Aces of Action* (responsible for 360 direct sales, and 10,000 prospects) and *Writing Your Own Ticket*.

"I like drama," says the farmer, "because I can see the people in the film are up against the same things I am. If machines make the job easier for them, I can see how they might do the same for me."

WHAT DO WOMEN LIKE?

The next biggest national buyer is the Mrs. What does she say about sales films?

"I can see good dramatic pictures at our regular movies, so I like to see pictures that tell me how to do something, that give me some good suggestions on how to make my work easier. Take that program on how to buy meat. I never did know whether I was buying a good cut or not until I saw that movie at our Eastern Star meeting. And the one on 'make-up' they had down at Jones store certainly sold me that cleansing cream."

It seems that whatever women *want*, they want to know more about. And the manufacturer who tells them that, *sells* them. Back-fence gossip today isn't informed on the fine points of fabrics, the composition of cosmetics, the features of cook stoves. But the business film can give the low-down on all these things. It's just as nosy, and more revealing than the greatest gossip that ever grew by a fence post. So at least one movie pattern for the Mrs. is a talkie that tells her *all* about it.

But how about the items for everyone? What films have successfully sold John Q. Public? Of course there's no easy answer to that question. One thing does stand out in the theatrical sales films. Generally speaking, the more varied the audience, the higher powered entertainment required to impress them. Here are a few of the movie techniques and patterns used in "minute movies", 'playlets', 'trailers' and for a few longer theatrical releases.

Chevrolet (animated cartoons, color, playlets); Westinghouse (color); Alka Seltzer (playlets); Coca Cola (local newsreel); Brown and Williamson (screen vaudeville in auto-movie); Chrysler (thriller and travelogue in longer theatricals).

Most of these films apply the pattern of printed advertising. An attention-getter lead-in to the product. Not always but frequently, the closer the tie-in the better the film. You will notice, too, that the longer the commercial theatrical motion picture the farther into the background the product is pushed. Many of these films are like a kiss in the dark — sweet — but whose lips? That's the question.

NEW TECHNICAL FILMS

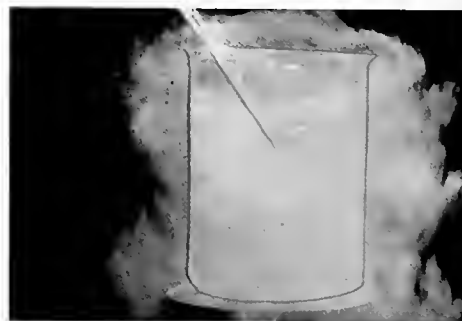

UFA FILMS, NEW YORK CITY, TO WHOM CREDIT IS DUE FOR THE unusual X-Ray films presented in these pages last month are distributing the film *Liquid Air* here illustrated.



LIQUID OXYGEN IS MAGNETIC. HERE IT IS BEING DRAWN BETWEEN poles of this powerful electro-magnet where it forms a bridge between the pale faces.

♦ Most successful films, irrespective of the audience, have a liberal allowance of IMAGINATION. All groups react to it. It is the life blood of salesmanship and showmanship. The question, "If I had it what would it be like?" precedes desire and possession. The net answer to that question once we get it, is, "Imagine it would be like this" and then we mention some concrete thing *with which he is familiar*.

When an advertiser shows his candy resting in a bed of mint with dew drops glistening on its leaves he is selling the flavor of the candy

PROJECTION SERVICE

A COMPLETE

MOTION PICTURE DISTRIBUTION SERVICE

In all phases for Theatrical and non-theatrical pictures. The non-theatrical service includes supplying projectors, screens, operators, etc., and transportation.

King Cole's Sound Service, Inc.

203 East 26th Street, N. Y. C. Lexington 2-9850

Local operating points in upper N. Y.—N. J. and Conn.

16mm.

ACTION

35mm.

Motion Picture Service

358 West 44th Street New York City
Completely equipped for servicing all makes of 35mm. or 16mm. sound or silent equipment.

Equipment

Operators

ON LIQUID AIR . . .



LIQUID OXYGEN "FREEZES" ORDINARY FLEXIBLE RUBBER WHICH becomes hard and brittle. When it reaches room temperature again, it regains its elasticity.



LIQUID HYDROGEN BOILING AT MINUS 253 DEGREES ROOM AIR condenses on the metal ball and runs off it like so much water until the temperature rises to 190 degrees below Centigrade. From Liquid Air, released through UFA films, New York City.

by appeal to our taste imagination. When the bible says the kingdom of heaven is like yeast that leavens the loaf it is stirring our imagination by appeal to the common experience of eating risen bread.

Easily pictured comparisons that make clear hidden values, Analogy, comparison, animation (mechanical and comic) color, music, speech, sound effects, miniature models, are all film tools for stirring the imagination and the desire for the real values of a product. None of these tools should be overlooked when planning a sales film for a group audience.

FILM LIBRARIES

**PLANNED 16mm. MOVIE PROGRAMS
FOR ALL ORGANIZATIONS**

NATIONAL FILM PROGRAMS

INCORPORATED
342 Madison Avenue New York City

—presenting—

"SOPHIE TUCKER"

in a musical filled with swing and rhythm
1 reel . . . 16mm. sound

PICTORIAL FILM LIBRARY, Inc.

130 West 46th St. New York City

Films at the Fair

• Of the seven Focal Exhibits of the New York World's Fair, the commercial film user and producer will find most interesting those dealing with Production and Distribution, and with Community Interests.

In the Consumers Building, where the Production and Distribution show is located, seven synchronized motion picture projectors throw the eight-minute drama (produced by Wilding under the direction of Egmont Arens) on the widest movie screen ever built. The 10-foot high screen, on an arc 100 feet wide, is in the form of a soffit, or hanging wall. The interdependence and interrelationship of men and women in all walks of life is the theme of the show, which will have the effect of a vast animated cyclorama.

In the movie auditorium of the Science and Education Building is shown a City Planning film made possible by a grant of \$50,000 from the Carnegie Corporation. After reviewing the history of American building, to show what has brought about slum areas, the picture will present the best of recent large scale American housing developments and show what is possible for the tools of today.

The three dimensional movies in the Chrysler Motors exhibit at the World's Fair offer the only opportunity at the Fair to see this new and interesting development in photography. A special screen has been installed for the showing of these pictures.

The Petroleum Industry exhibit presents a musical talking picture in Technicolor acted entirely by animated puppets capable of greater body and facial mobility than humans and entirely free of strings or other mechanical controls.

THE USES OF SLIDEFILMS

(Continued from Page 31)

- film productions
3. The comparatively short time required to produce a complete show
 4. The low cost of duplicates, (records and filmstrips), which can be distributed at an average cost of a few dollars per set
 5. The low cost of equipment, making wide field distribution possible
 6. The portability of the equipment and the simplicity of operation and handling by salesmen in the field
 7. The easily understood outlining of ideas made possible by the step-by-step operation principle.

Projectors for Sale

FOR SALE: Bargain. Two 35mm. Sound Movie Projectors. 1000 Watt Projector Lamp, Photo Cell Lamp, 1000 Foot Film Magazine. 110 To 125 Volt. Write For Details Box 18, Business Screen Magazine, 20 North Wacker Drive, Chicago.

PERSEUS
FILM TREATMENT
VAPORATE

YOUR FILM PERFORMANCE

deserves the improvements VAPORATE protection assures.

YOUR FILM BUDGET

deserves the economy VAPORATE protection provides.

**REFUSE CHEAPER SUBSTITUTES
INSIST ON PRINTS**

VAPORATED

for better screening and longer useful life.

VAPORATE protects over five hundred million feet of theatrical, industrial, educational, rental and personal motion picture, slide and continuous display films annually, against damage from climate, scratches, wear, oil, dirt and finger marks.

CONVENIENT—ECONOMICAL

VAPORATE Service is available, through producers, dealers and laboratories in the United States, England, France and Italy.

NEW YORK Vaporate Co., Inc. 130 W. 48th St. 1801 Larchmont Ave.
CHICAGO Bell & Howell Bell & Howell Co. 716 No. LaSalle Ave.
HOLLYWOOD Bell & Howell Bell & Howell Co. 716 No. LaSalle Ave.

. . . the
**MOTION PICTURE
LABORATORY**

*with a national
reputation*

★
16mm & 8mm
PROFESSIONAL PRINTS

CINELAB, INC.

33 West 60th Street

New York City New York

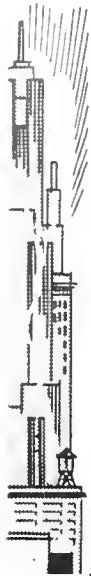

The First Step In Producing a Business Film That Does a Job

Through the mind of the man contemplating using a Business Film runs a stream of questions similar to:

- Now much will a Business Film Cost?
- How do I know it will pay out?
- Shall I use a silent film—or a sound film?
- What about a color sound film?
- Who will prepare a top-notch scenario?
- Where is a reliable film producing organization?

NEW 1939 PRODUCTION GUIDE FREE

Let us give you the answers to these and many other questions. Our experience in producing outstanding business films enables us to give you free of charge or obligation our valuable Production Guide. It will answer all your questions about adapting a film to YOUR PARTICULAR BUSINESS clearly and simply. Send for our New 1939 Production Guide today.

NORMAN WILLETS CO.

316 W. Washington Blvd., Chicago, Ill.

Dear Sirs: BS39-2
Send your helpful Production Analysis. No obligation, of course.

Name

Company

Address

City State

Studio Facilities 42nd Floor, Civic Opera Bldg.
Norman Willets Sound Productions, 20 N. Wacker, Chicago



An ultra-modern
hostelry in the
heart of Chicago



Bismarck
HOTEL *chicago.*

Advertising

has to be good to be effective on today's competitive printed pages. The best way to make advertising command attention and invite reading is to call in a qualified **a** specialist in Advertising Typography.

ADVERTISING TYPOGRAPHERS, Inc.
341 EAST OHIO STREET • CHICAGO, ILLINOIS

Checklist of British Industrial Films

Prepared for Business Screen by arrangement with the British Film Institute and presented in two installments. Next month:
16mm. sound and silent films

35MM. SOUND

AUSTIN MOTOR CO. LTD., Longbridge Works, Birmingham. Automobile Manufacture, and travel.

AUSTRIAN STATE TRAVEL BUREAU, 159 Regent Street, London, W. 1. Travel.

BOOTS THE CHEMISTS, 219 Piccadilly, London, W. 1. Colored cartoons, health propaganda.

BOY SCOUTS ASSOCIATION, 25 Buckingham Palace Road, London, S.W.1. Social activities.

BRITISH COMMERCIAL GAS ASSOCIATION, 1 Grosvenor Place, London, S.W.1. and GAS LIGHT and COKE COMPANY, Horseferry Road, London, S.W.1. Industrial and Social Welfare.

BRITISH ROAD TAR ASSOCIATION, 17 Grosvenor Gardens, London, S.W.1. Industrial. Communications.

BRITISH ELECTRICAL DEVELOPMENT ASSOCIATION, 2 Savoy Hill, London, W.C.2. History, generation, distribution and uses of electricity.

BRITISH SOCIAL HYGIENE COUNCIL, Tavistock House (South) Tavistock Square, London, W. C.1. Public Health and Hygiene.

BRITISH ROAD TAR ASSOCIATION, 17 Grosvenor Gardens, London, S.W.1. Industrial films—coal and its products.

CADBURY BROS., Bourneville Production of cocoa and manufacture of chocolate. Salesmanship.

COMMONWEALTH OF AUSTRALIA, Australia House, W. C. 2. Agriculture and Geography.

CUNARD WHITE STAR, LTD., Liverpool. Engineering and travel.

DUNLOP RUBBER CO., St. James's House, St. James's Street, London, S.W.1. History of the wheel. Manufacture and uses of rubber.

EDUCATIONAL FILMS BUREAU, 24 Denmark Street, London, W.C. 2. Geography and travel and industrial processes.

EMPIRE FILM LIBRARY, and G.P.O. FILM LIBRARY, Imperial Institute, London, S.W. 7. Geography and industries and peoples of the Empire; engineering, and civics.

FORD MOTOR CO. LTD., Dagenham, Essex. Automobile manufacture and travel.

FRY & SONS, LTD., J. S., Somerdale, Bristol. Production of cocoa and manufacture of chocolate.

GIRL GUIDES ASSOCIATION, 17-19 Buckingham Palace Road, London, S.W.1. Social activities.

HEALTH AND CLEANLINESS COUNCIL, 5 Tavistock Square, London, W.C.1. Public health and hygiene.

HODGES PRODUCTIONS, LTD., C. E., 1 Montague Street, London, W. C.1. Geography and travel.

HORLICK'S MALTED MILK CO. LTD., Slough, Bucks. Industrial and colored cartoon.

MINISTRY OF AGRICULTURE AND FISHERIES, 10 Whitehall Place, London, S. W. 1. Agriculture and distribution.

MINISTRY OF LABOUR, Montague House, Whitehall, London, S.W. 1. Vocational guidance and propaganda for unemployed training camps.

MORRIS MOTORS, LTD., Cowley, Oxford. Automobile manufacture.

NATIONAL ASSOCIATION FOR THE PREVENTION OF TUBERCULOSIS, Tavistock House North, Tavistock Square, London, W.C.1.

NATIONAL BABY WEEK COUNCIL, 117 Piccadilly, London, W.1. Child welfare.

NATIONAL BOOK COUNCIL, 3 Henrietta Street, London, W.C. Printing and book production.

NATIONAL MILK PUBLICITY COUNCIL, 33 Gordon Square, London, W.C.1. Public health and hygiene.

NATIONAL OPHTHALMIC BOARD, 1 High Street, Marylebone, London, W.1. Physiology.

NATIONAL SAFETY FIRST ASSOCIATION, 52 Grosvenor Gardens, London, W.1. Public safety.

PEARL ASSURANCE CO. LTD., High Holborn, London, W.C.1. Road safety films.

R.S.P.C.A., 105 Jermyn Street, London, S.W.1. Natural history and social activities.

SHELL MARKETING FILM UNIT, Shell Mex House, Victoria Embankment, London, W.C.2. Industrial processes; civics; and colored cartoon.

UNION OF SOUTH AFRICA, South Africa House, Trafalgar Square, London, W.C.2. Travel.

VACUUM OIL CO., Carlton House, London, S.W.1. Industrial.

WATNEY COMBE REID & CO. LTD., Stay Brewery, London, S.W.1. Industrial.

35MM. SILENT

ACETYLENE AND WELDING CONSULTATIVE BUREAU, 637 Grand Buildings, Trafalgar Square, London, W.C.2. Technical.

AUSTIN MOTOR CO. LTD., (see 35mm. Sound)

AUSTRIAN STATE TRAVEL BUREAU, (see 35mm. Sound).

BOY SCOUT'S ASSOCIATION, (see 35mm. Sound).

BRITISH ELECTRICAL DEVELOPMENT ASSOCIATION, 2 Savoy Hill, London, W.C.2. (see 35mm. sound)

BRITISH RED CROSS SOCIETY, 14 Grosvenor Crescent, London, S.

W.1. Public Health and Hygiene, Physiology, Medicine.

BRITISH ROAD TAR ASSOCIATION, (see 35mm. Sound).

BRITISH SOCIAL HYGIENE COUNCIL, (see 35mm. Sound).

CADBURY BROS., Bourneville. (see 35mm. Sound).

CANADA, DOMINION OF, Canada House, Trafalgar Square, London. Agriculture and Geography.

CENTRAL ASSOCIATION FOR MENTAL WELFARE, 24 Buckingham Palace Road, London, S.W.1. Public health.

CENTRAL COUNCIL FOR THE CARE OF CRIPPLES, 117 Piccadilly, London, W.1. Public health.

CENTRAL COUNCIL FOR HEALTH EDUCATION, 1 Thornhaugh Street, Russell Square, London, W.C.1. Public Health.

CHILD EMIGRATION SOCIETY, Savoy House, Strand, London, W. C.2. Vocational Guidance.

CUNARD WHITE STAR LINE, Liverpool. (see 35mm. Sound).

DENTAL BOARD OF THE UNITED KINGDOM, 44 Hallam Street, London, W.1. Dental.

EDUCATIONAL FILMS BUREAU, (see 35mm. Sound).

EMPIRE FILM LIBRARY, and G.P.O. LIBRARY, (see 35mm. Sound).

EUGENICS SOCIETY, 69 Eccleston Square, London, S.W.1. Eugenics.

FOOD EDUCATION SOCIETY, 29 Gordon Square, London, W.C.1. Dietetics.

GIRBS, LTD., D. & W., City Soap Works, Wapping, E.1. Dental.

GIRL GUIDES' ASSOCIATION, (see 35mm. Sound).

HEALTH AND CLEANLINESS COUNCIL, (see 35mm. Sound).

HODGES PRODUCTIONS, LTD., C. E. (see 35mm. Sound).

LYONS & CO. LTD., J., Publicity Dept., 61 Fleet Street, London, E.C.4. Vocational training.

MABIE, TODD & CO. LTD., 133 Oxford Street, London, W.1. Industrial.

MINISTRY OF AGRICULTURE AND FISHERIES, (see 35mm. Sound).

NATIONAL ASSOCIATION FOR THE PREVENTION OF TUBERCULOSIS, (see 35mm. Sound).

NATIONAL BABY WEEK COUNCIL, (see 35mm. Sound).

NATIONAL MILK PUBLICITY COUNCIL, (see 35mm. Sound).

NATIONAL SAFETY FIRST ASSOCIATION, (see 35mm. Sound).

PEOPLE'S LEAGUE OF HEALTH, 52 Stratford Place, London, W.1. Health and Hygiene.

R.S.P.C.A. (see 35mm. Sound).

SUNLIGHT LEAGUE, 29 Gordon Square, London, W.C.1. Health and Hygiene.

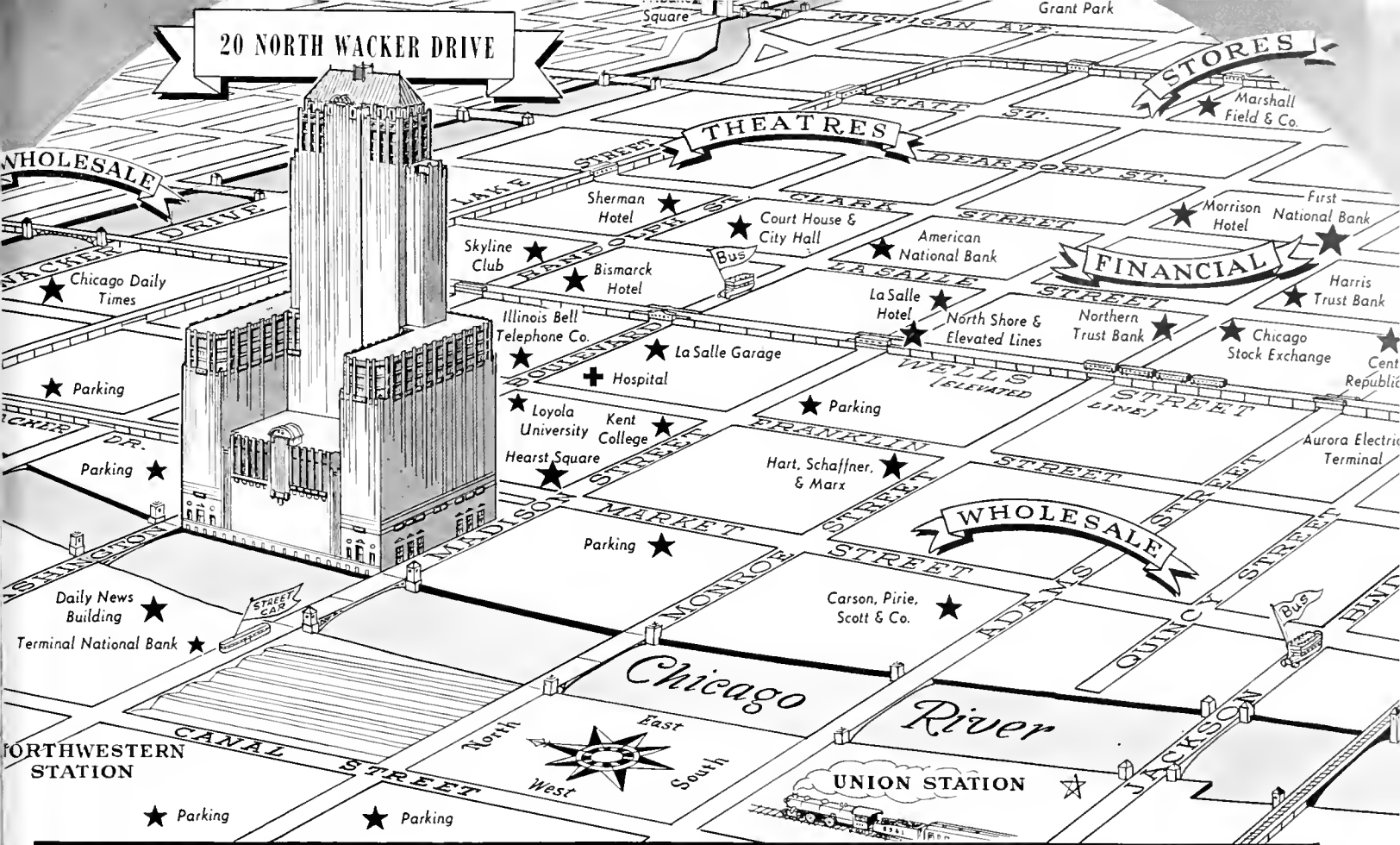

Chicago's Business Center

WITH UNEQUALLED FACILITIES FOR YOUR CONVENIENCE . . .

AVAILABLE ONLY IN THE CIVIC OPERA BUILDING:

PREVIEW THEATRES — two acoustically perfect studio theatres for film, or radio previews, 42nd Floor.

SOUND RECORDING STUDIOS — available for voice and music recording for business or personal use.

CIVIC THEATRE — ideal for radio broadcasts, lectures or sales meetings. One of the finest small theatres in the world. *Air Conditioned.*

CIVIC OPERA HOUSE — annually

featuring Chicago's famous opera company. Available out of season for business audiences. *Air Conditioned.*

CLUB & MEETING ROOMS — convenient meeting rooms for large or small groups. Food service at most economical rates.

RESTAURANTS — breakfast, luncheon, or dinner service in several fine restaurants and private dining rooms in the building.

SAFE DEPOSIT VAULTS — Chicago's finest vault facilities at economical rates for the convenience of tenants.

THE LIGHTING INSTITUTE — this modern museum of lighting offers daily illustrated lectures, attracting thousands of visitors.

CONVENIENT SHOPS — Deluxe barber shop and valet. The Opera Buffet, candy shop, and cigar store near at hand on the ground floor.

OFFICES WITH UNOBSTRUCTED LIGHT AND VENTILATION — centrally located, the building looms high above all surroundings, providing unparalleled advantages to the occupants of the efficiently serviced ultra-modern office suites.

Just across the river from two of Chicago's foremost railroad terminals, the Northwestern and Union Stations. Twenty North Wacker Drive is also within a few minutes walking distance of the LaSalle Street Station. Not only rail transportation is universally convenient but also the wholesale, financial and shopping areas are at our doorstep.

For the convenience of employees and executives, every principal elevated train, motor coach and surface earline is just a few steps away. Parking is convenient, too, and most economical just outside the Loop parking zone.

That is why leading national business organizations choose Twenty North Wacker Drive as their headquarters.

ADDRESS INQUIRIES TO THE OFFICE OF THE PRESIDENT, J. C. THOMPSON

20 NORTH WACKER DRIVE

THE · CIVIC · OPERA · BUILDING

Color Harmony

See what goes on in
your own eyes and
behind them

Have you wondered how and why your eyes see? Would you like to know why colors harmonize and your eyes manage to know it?

The amazing new talking picture "Color Harmony" will give you the scientific answers to all such questions and a definite conception of color vision.

In full technicolor, "Color Harmony" is the first and only picture in the world using color to explain color.

Authoritative from the viewpoint of the greatest experts on color, authentic from the standpoint of leading ophthalmologists, "Color Harmony" combines all the latest findings of color science and color psychologists, cinema technicians and biochemists.

This extraordinary picture shows all the essentials of color vision without the use of any technical terms whatsoever.

"Color Harmony" is accomplishing the objectives for which it was designed and produced.

Every up-to-the-minute advertising manager and salesman should see this picture . . . Say when! .

The **JAM HANDY** *Organization*

Slidefilms · Talking Pictures · Sales Conventions · Playlets

New York, 19 West 44th Street, V^Anderbilt 6-5290 Detroit, 2900 East Grand Boulevard, M^Adison 2450
Chicago, 35 East Wacker Drive, S^TAte 6758 Hollywood, 7046 Hollywood Boulevard, H^Empstead 5809

B

Business Surveys

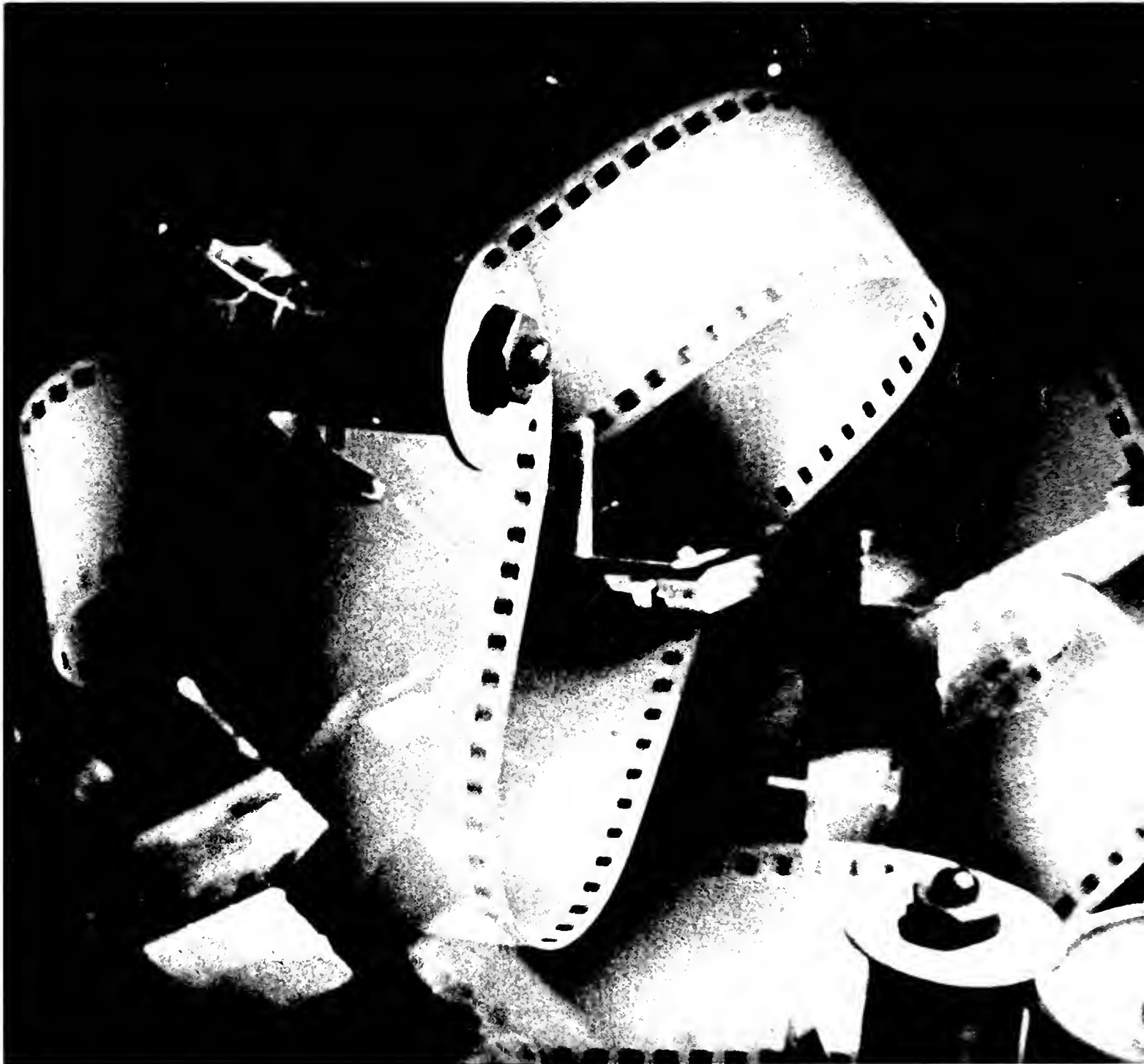

108

IN THIS ISSUE: ANNUAL EQUIPMENT REVIEW
NEW FILM SUCCESSES: SURVEYING THE FAIRS - I

To All Executives Who Appreciate GOOD SELLING

PROOF

If you want proof that Caravel
Pictures get results, check with

American Can Company
Atlantic Refining Company, Inc.
Wallace Barnes Company
The Bates Manufacturing Company
Beck, Koller & Company
Bethlehem Steel Company
Black & Decker Manufacturing Company
Godfrey L. Cabot, Inc.
Calco Chemical Company, Inc.
S. H. Camp & Company
Cluett, Peabody & Company, Inc.
Congoleum-Nairn, Inc.
Davis & Geck, Inc.
Dictaphone Sales Corporation
Eastman Kodak Company
The B. F. Goodrich Company
Hart Schaffner & Marx
Jenkins Bros.
Johns-Manville Corporation
Kenwood Mills
National Biscuit Company
National Distillers Products Corporation
National Lead Company
Premier-Pabst Corporation
Raybestos-Manhattan, Inc.
Socony-Vacuum Oil Company, Inc.
E. R. Squibb & Sons
Talon, Inc.
The Texas Company
U. S. Industrial Alcohol Company

OR ANY OTHER CARAVEL CLIENT

WE invite you to see a Caravel picture and investigate results.

Why? Because Caravel pictures are designed for only one purpose—to increase sales. And that's exactly what they do.

For example: Six thousand new and desirable dealers. An order stepped up from 250 to 350 units (an increase of approximately \$20,000). Purchases by one of America's largest stores built up from ten to fifty thousand dollars.

True, your business is "different."

But—selling is selling, whether it's blankets or biscuits, collars or corsets, paint or pipe, dyes or Dictaphones!

Among the pictures we have made—to meet repeatedly a wide variety of selling problems—there's a picture that will suggest for your company a highly profitable motion picture program.

You owe it to yourself to see that picture, either in our local projection rooms or at your own headquarters.

CARAVEL FILMS

INCORPORATED

New York • 730 Fifth Avenue • Tel. Circle 7-6112

Chicago • Tribune Tower • Tel. SUPerior 3422





You wouldn't show your product in a **PUSHCART!**

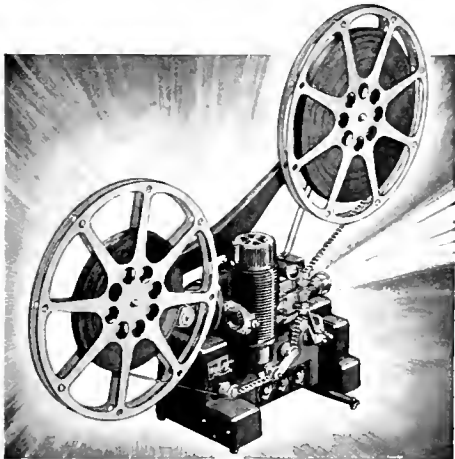

Designed Especially for Business Film Use. Filmosound "Commercial" includes only those features essential for business use. Hence, it is lower in price and easier to transport and use. Capacity serves offices, showrooms, and moderate-sized auditoriums. There are other Filmosound models for every need, including the Filmoarç, which provides arc illumination for presenting 16 mm. sound films before large auditorium audiences.

WHEN you spend thousands in research and equipment to produce a good product, you're not going to show it in a pushcart. For no matter how good your product may be, its sale depends on *how good prospects think it is!*

Today, many products are made irresistibly attractive to buyers by the use of commercial talking pictures. This modern selling vehicle commands *undivided* attention while the *complete* sales story is told and absorbed. It tells the prospect what your product will do for him—with a finality not approached by any other medium. For business films prove every sales point by demonstrating it!

Showmen of business, like Chrysler, Ford, General Motors, Frosted Foods, National Dairy, Sun Oil, and *hundreds* of others present their sound movie films with Filmosound Pro-

jectors. They prefer Filmosounds for theater-like presentations—sparkling pictures and faithful tone quality. Compact, easy to operate, lastingly dependable, Filmosounds are built by the makers of preferred professional Hollywood equipment. Bell & Howell Company, Chicago; New York; Hollywood; London. *Established 1907.*

HOW TO DRAMATIZE YOUR PRODUCT and solve sales and public relations problems with business films is told concisely in this 36-page illustrated booklet, *SHOWMANSHIP, Today's Formula for Selling*. Send coupon for your copy.

Let Your Secretary Mail Coupon



BELL & HOWELL COMPANY
1808 Larchmont Avenue
Chicago, Illinois BS 6-33
Send booklet, *Showmanship*. Include () details on Filmosound Projectors for business use.

Name.....
Company.....
Address.....
City.....State.....

PRECISION-MADE BY

BELL & HOWELL

**THERE'S MORE
THAN
SHOOTING and SHOUTING**

... when it comes to producing a motion picture.

Naturally, Industrial Pictures offers production facilities capable of meeting any and all demands — studios designed expressly for producing business sound films — a sound stage developed in collaboration with RCA engineers for maximum utility in meeting the exacting requirements of commercial pictures.

And besides the most advanced equipment available, you will find here a staff of skilled technicians, whose experienced expertness is assurance of maximum economy, commensurate with the high quality of production which is their creed. But, while technical skill plays a vital part in every successful production, it would be a valueless asset without the guidance of trained creative minds.

For, long before the cameras start to grind, your problem must be understood and analyzed ... an idea born ... a story conceived and written. And into that process must go the knowledge of your problem and of human nature, the creative power and showmanship, of a staff trained to transform prosaic problems into dramatic presentations of sight, sound and motion. That's why we say there's more than "shooting and shouting" when it comes to producing a commercial motion picture that "clicks."* It's an *organization job*, and its effectiveness will be a reflection of the proficiency of every department — contact, research, creative, production and executive.

Industrial Pictures invites your most careful consideration of this organization and its ability to serve you in this highly specialized field.

* A case in point is the recent Deleo Battery Picture produced by Industrial Pictures for United Motors Service. We would appreciate the opportunity to show you this film and present proof of its effectiveness in the field.

INDUSTRIAL PICTURES INC.
4925 CADIEUX ROAD • DETROIT
MOTION PICTURES
ILLUSTRATIVE
PHOTOGRAPHY
SLIDE FILMS

FACILITIES IN NEW YORK • DETROIT • HOLLYWOOD

BUSINESS SCREEN

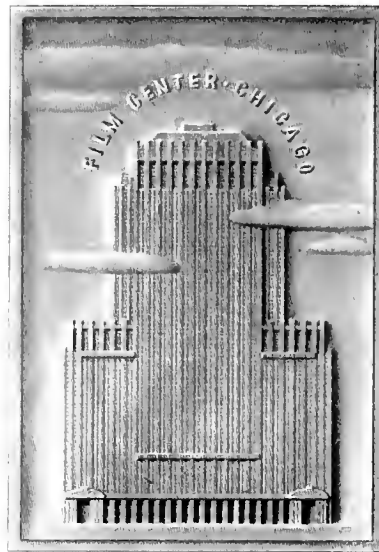

**VOLUME
ONE**

**NUMBER
EIGHT**

The Magazine of Commercial & Educational Films

Contents

*Cover Subject: from "Highlights & Shadows"
Courtesy Eastman Kodak*

Camera Eye 12
 Right Off the Reel 15
 Television, A Retail Store Development 16
 The World Fairs' Best Salesman 17
 Westinghouse Films the Fair in Technicolor 17
 Ten Minutes of Chrysler Selling 18
 The New Films, A Page of Reviews 19
 Were These the First Advertising Films? 20
 For Men Only ... But Wives are Welcome 21
 Terminex: A Case Story of Film Selling 22

and THE 1939 EQUIPMENT REVIEW

♦ Business Screen Magazine, issued by Business Screen Magazines, Inc., Twenty North Wacker Drive, Chicago, Illinois on August 1, 1939. Editorial Director, O. H. Coelln, Jr.; Managing Editor, R. C. Danielson. New York Offices: 122 East 42nd Street, Phone Murray Hill E-1054. Eastern Advertising Manager, Jack Bain; Eastern Editorial Representative, Robert Seymour. *Acceptance under the Act of June 5, 1934, authorized February 20, 1939.* Issued 8 times annually plus 4 *Visual Education Numbers* (not circulated in the business field). Subscription price: Domestic \$2.00 for eight numbers (of Business Screen), 50¢ the copy. Foreign, \$3.00. Publishers are not responsible for the return of unsolicited m.s. unless accompanied by stamped, self-addressed return envelope. Entire contents copyright, 1939, by Business Screen Magazines, Inc. Trademark Reg. U. S. Patent Office.

ILLUSTRAVOX *The* MASTER SALESMAN

USED BY: Bethlehem Steel • Coca-Cola • Ford • General Electric • DuPont • Nehi • Lever Bros. • Goodyear • Bendix • Sinclair • Johns-Manville • Lucien LeLong • Celotex • Packard • Dodge • Kratt-Phenix •

ILLUSTRAVOX is the *accepted* modern sales training and selling tool . . . proved by more than 200 leading firms who are using over 30,000 machines. ILLUSTRAVOX will make better salesmen faster and at lower cost than old methods of training . . . will actually sell more merchandise for you . . . and will do it now!



★ THE NEWEST MODEL

Designed for small group showings and individual sales solicitations, the Model 108 is small and light in weight . . . as convenient to carry as a brief case. Though low in cost, there is no sacrifice of quality, utility or performance: sturdy construction—plays both 12" and 16" records—large film magazine—carrying compartment for records and small screen—remote control for convenient operation. A powerful sales tool out of all proportion to its small size and low cost.

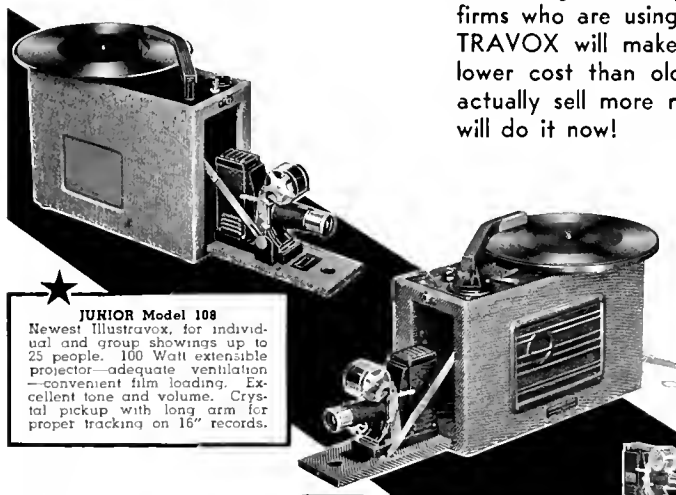

★ JUNIOR Model 108

Newest Illustravox, for individual and group showings up to 25 people. 100 Watt extensible projector—adequate ventilation—convenient film loading. Excellent tone and volume. Crystal pickup with long arm for proper tracking on 16" records.

JUNIOR Model 101 H

A popular all-purpose machine. 100 Watt projector shows brilliant 6 foot pictures or can be used with small desk screen. Excellent tone quality and ample volume for any size group up to 150 persons. Plays 12" or 16" records.

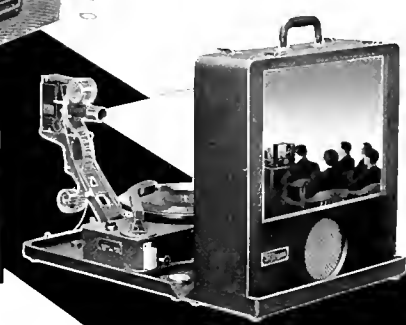

THE SALESMAKER

A complete portable theatre in a single case. Put it on desk or table, unfold, plug-in and your sales message goes into action. Projector shows pictures on translucent screen in front of case, providing unrestricted vision for moderate groups.

YOUR perfected sales story recorded on 12" or 16" records is simultaneously illustrated with graphic still pictures, projected thru 35mm non-inflammable films. Your sales message will be more dramatic, powerful and convincing and will be repeated *every time* exactly the same way.

ILLUSTRAVOX is the *most economical* medium. The equipment cost is so low as to make widespread distribution practical. The expense of duplicate films and records is so little (*only a few dollars per set*) they can be widely circulated . . . with frequent changes to fresh material. The machines are so simple that they can be set up for operation instantly . . . and operated by any inexperienced person anywhere. MADE by the oldest manufacturer of sound equipment, engineered to assure *perfect* performance *every time*, they have been *time and field tested* by thousands of users. BETTER salesmen and more forceful sales methods are paramount in modern merchandising. ILLUSTRAVOX gives you both—at low cost. Write for full particulars!

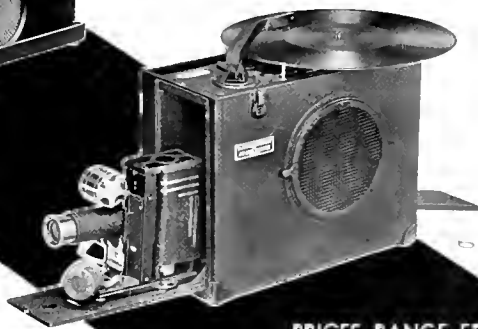

THE SENIOR

A deluxe machine. Features new 300 Watt projector with automatic film take-up and remote control. Projects brilliant 10' pictures. Powerful four tube amplifier and extensible 8" speaker with baffle provide ample sound for groups up to 1000 persons.

PRICES RANGE FROM

\$34.90 TO \$115.00

DEPENDENT ON MODEL AND QUANTITY

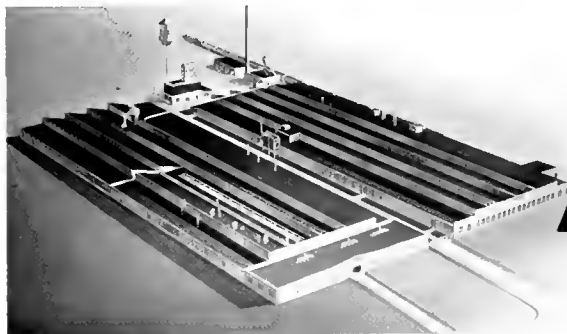

Illustravox machines are made under patents 2121910, 2056921, 2067835, 1448279, 1643670, 2056784, 2078121, 2070226, 2139152 and 2144565 owned by The Magnavox Company, Inc.

Electro - Acoustic Products Division of MAGNAVOX

• PIONEERS IN SOUND SINCE 1911 •

FORT WAYNE, INDIANA, U.S.A.

"All of Our Operations Out of 57 Cities Use **DA-LITE** Screens"



REG. U.S. PAT. OFF.

J. H. Arlinghaus
PRESIDENT

**MODERN TALKING
PICTURE SERVICE, Inc.**

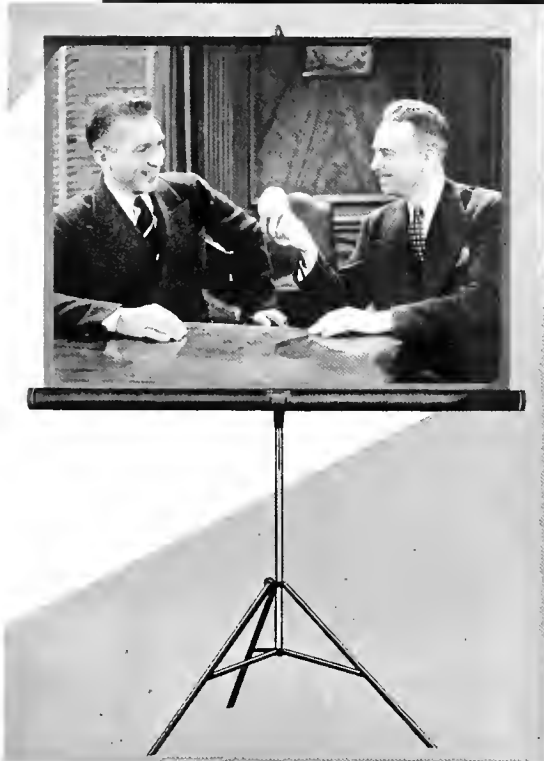

Scene from "HOW TO MAKE YOUR SALES STORY SELL"

This and other popular syndicated sales-training pictures featuring the practical instruction of Richard C. Borden and Alvin C. Busse have been shown on Da-Lite Screens by Modern Talking Picture Service, Inc. to the salesmen of scores of prominent companies including Aetna Casualty and Surety Company; Bell Telephone Company of New Jersey; Coca Cola Company, Graybar Electric Company and Libby, McNeill & Libby.

Many of these showings were made on the Da-Lite Challenger Screen illustrated above which can be set up anywhere in 15 seconds, yet folds compactly for easy carrying and storing.

"BRILLIANT and reliable salesmanship has been demonstrated to hundreds of thousands of the nation's salesmen on Da-Lite Screens," writes Mr. Arlinghaus. "We selected Da-Lite screens years ago because of their superior advantages in picture quality, convenience and reliability. All of our operations out of 57 cities use Da-Lite Screens for showing all of our own syndicated sales training pictures and the films which we distribute for our clients. When clients ask us about screens for the projection of their own films, our men are glad to recommend Da-Lite equipment."

To users of business films, this statement by the head of one of the leading organizations of professional projectionists is further assurance of the high quality and value of Da-Lite equipment. Da-Lite Screens are available with White, Silver or Glass Beaded surfaces in all types of mountings. Prices have recently been reduced. The 30" x40" Challenger (shown here) is now only \$12.50 (slightly higher in Pacific Coast States). Other styles as low as \$2.00.

NEW CATALOG

48 pages—packed with information on surfaces, mountings, sizes and other factors which should be considered in the selection of projection screens. Mail the coupon for your copy now.



**NEW
LOW PRICES!**

Mail Coupon Now!

DA-LITE SCREEN COMPANY, INC.
Dept. 88, 2723 N. Crawford Ave., Chicago, Ill.

Without obligation to us please send your new 48 page catalog, containing valuable data on screens and the new low prices on Da-Lite equipment. Also send the name and address of the nearest Da-Lite distributor.

Name

Firm Name

Address

DA-LITE SCREENS

*-First Choice of Leading Producers, Distributors
and Users of Business Films*

Victor marks a new era IN SOUND PROJECTOR UTILITY



THE NEW VICTOR Series 40 Animatophone contains all the industry has strived to achieve since the event of the 16mm sound film. Its Add + A + Unit features make available a multiplicity of uses heretofore requiring several different types and sizes of projectors. These features make it economically adaptable to public address service, phono-record reproduction, radio amplification, and sound recording — and only the Victor Animatophone provides all these Add + A + Unit features. Truly the motion picture projector of today and tomorrow.

This 16mm Sound Motion Picture Projector is so compact, so easily portable, and so brilliant in performance that it is destined to become the standard of comparison.

Likewise, new standards of performance have been achieved with unsurpassed quality of sound and simplicity of operation. Your request will bring complete catalog information.

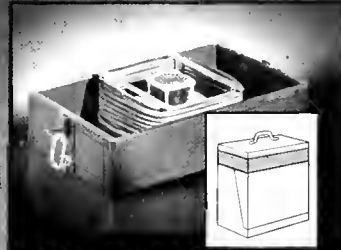

+ ADD AN INTEGRAL SPEAKER

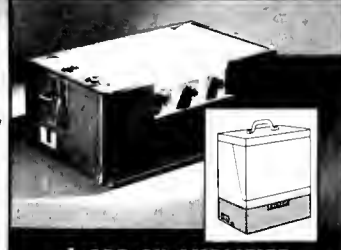

+ ADD AN AMPLIFIER

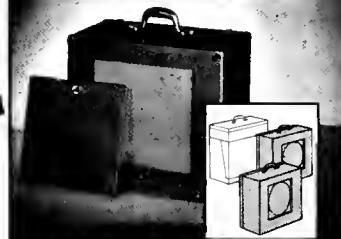

+ ADD MULTIPLE SPEAKERS



+ ADD A PUBLIC ADDRESS SYSTEM



+ ADD A RECORDING UNIT

A recording unit suitable for making clear, full toned and inexpensive transcriptions, is available as a part of Victor Add + A + Unit equipment. Details on application.

VICTOR ANIMATOGRAPH CORPORATION

DAVENPORT, IOWA, U.S.A.
CHICAGO • LOS ANGELES • NEW YORK

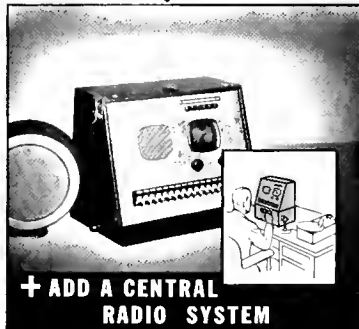

+ ADD A CENTRAL RADIO SYSTEM

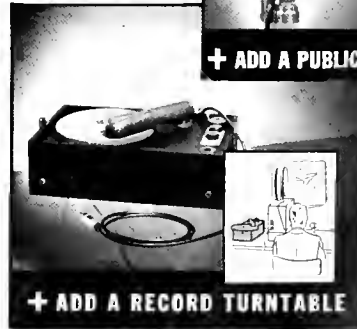

+ ADD A RECORD TURNTABLE



INSIDE THE *Flame*

A blue-ribbon industrial motion picture and its accompanying brochure tell the highly technical story of carbon black to the equally-shared benefit of science, the product's users and the sponsor . . .

THE service which commercial film producers extend to their clients is necessarily broad and inclusive. Well-acquainted to painstaking research and lengthy merchandising surveys, the producer's staff acts as guide and interpreter to the user of the medium as well as fulfilling the actual production assignment. The turning of the camera is often just a short final step carefully taken in a direction marked after a year and more of finding the right way.

Such an assignment was undertaken in the production of a film for Godfrey L. Cabot, supplier of carbon black, a pigment used in a wide variety of paints, lacquers and plastics, in quick-drying inks for modern high-speed presses and as a reinforcing agent which triples the strength and wearing quality

of rubber — "saving a nation on wheels more than fifty million dollars a year in costs alone".

The story of carbon black is highly technical. It involves the physical determination and control of tiny particles too small to be seen even through the most powerful microscope. The customary way to tell such a story to technical men is by means of a scientific paper. This method has obvious limitations.

In view of the considerable amount of illustrative material required to present this story comprehensively and vividly, and in view of the need to show flames in action, Godfrey L. Cabot, Inc. decided to blaze a new trail in the exposition of a scientific subject. The result is *Inside the Flame* — a scientific paper presented

through the medium of sound motion pictures and produced by Caravel Films, Inc., New York City.

The story itself is fully told in an accompanying brochure. But its translation into motion pictures took more than a year of painstaking study and experimentation by Caravel technicians.

In order to obtain the shots of the flames in the hot-houses, a number of hoppers had to be cut away (thereby creating new problems in ventilation), flood-lights had to be placed underneath the framework, and the moving pictures had to be shot through Pyrex glass inserted in the walls of the hot-house.

This problem became immensely complicated when a close-up of the scraper (pictured under the Fore-

word in the booklet) was attempted. The camera had to be placed in a narrow alley between two hot-houses, and the camera man had to endure a temperature of about 300 degrees while he captured this particular action picture. The tripod was badly blistered. The smell of ether gave warning that the emulsion on the film was in danger of melting and evaporating. And the blistering remarks from the camera man conveyed an unmistakable urgency for speed!

♦ The foreword to the beautifully illustrated brochure (which F. Burnham MacLeary of the Caravel staff wrote) is by the sponsor. Its summary sets an example for any business: "*we present 'Inside the Flame' . . . to be seen by all that may be benefited thereby.*"

To Buyers Of Slide Films:

SARRA, INC. PRODUCES AT ALL TIMES COLOR OR BLACK & WHITE SLIDE FILMS OF THE SAME QUALITY AS THEY ESTABLISHED IN THE PHOTOGRAPHIC ILLUSTRATION FIELD. NO PRODUCTION TOO BIG OR TOO DIFFICULT FOR US TO HANDLE . . .

photoSound
DIVISION OF SARRA, INC.

16 East Ontario Street : CHICAGO

Business you never had before now can be yours with

EXPLAINETTE



The Small, Light-Weight, Low Cost
Sound Slidefilm Unit that
Opens Up an Entire New Field . . . the
CONSUMER FIELD

EXPLAINETTE is the machine you have been asking for. **LIGHT** in weight. **LOW** in price. **SMALL** in size. **STURDY** in construction. **FINE** in appearance. It makes available for *all* your salesmen a powerful selling tool for direct sales to *individual consumers*. It *now* opens that great field for you.

The **EXPLAINETTE** weighs just a little over 14 pounds including projector . . . measures only 10 $\frac{1}{2}$ " high, 11" long, and 5 $\frac{3}{4}$ " wide. It can be carried as easily as a brief case . . . so light you can lift it with your little finger. Simple to operate as turning on a radio. It can be purchased for as little as \$29.00 and up, depending on quantity, size of projector and current.

Here, then, is a machine that your salesmen will take to enthusiastically. It will open more doors for them. It gives your product a drama that words or pictures alone can not convey. It makes certain your salesmen present your product as it should be presented. It is a great new selling technique that will pay large rewards to those who utilize it in direct *individual consumer* selling.

Films and recordings are available from producers at prices in harmony with the low cost of **EXPLAINETTE**.

Your present productions also can be used with this machine . . . for it will take up to 16-inch records, 100 watt projection, and can be used with large sized wall screens. Its newly designed amplifier with matched speaker produces a clarity of tone unsurpassed and the volume is comparable to hundred watt projector units that have been available in the past.

What you get in **EXPLAINETTE**

Sound Slidefilm Projector Unit

Standard equipment includes either SVE Projector Model "Q" 100 watt or Model "M" 50 watt or Model "Jr" 50 watt. Unit also includes built-in screen; phonograph turntable for 10, 12 or 16 inch records; Operadio heavy duty 5-inch Permanent Magnet Dynamic Speaker and 2-tube amplifier . . . matched for clear natural tone and controlled volume. Easily serviced. Sturdy all-steel construction. Stowage for four 10-inch records, four film cups, needles, 10-foot power cord. Operates on 110 volt 60-cycle A.C. or A.C.-D.C. current, \$29.00 and up depending on quantity, size of projector and current.

Note the *ease* with which your sales story can be presented to the individual consumer. The screen is in the top cover of the unit. No fuss . . . no bother. **EXPLAINETTE** requires little space on executive's desk.



FOUR GROUPS OF MEN TOLD US WHAT THEY WANTED

● **The Producer Said:** Give us a low priced unit that will let us put on a good show for the *individual consumer*. Make it small, light-weight, efficient. Be sure it projects brilliant pictures. Make the sound clear and natural. Make it easy to operate. Build it strong and rugged so it will stand all kinds of abuse. Give us that kind of a machine, and we can go out and sell our productions to a field we hardly touched before . . . the great *individual consumer* field. Producers tell us **EXPLAINETTE** meets those specifications.

● **The Advertising Agency Said:** Give us a machine that our clients can use in direct contact with the *consumer*. If you can get up a sound slidefilm unit that is so inexpensive and so easy to carry and operate that every salesman selling the *consumer* can and *will* use it, then you will literally revolutionize direct *consumer selling*. **EXPLAINETTE** meets those requirements, too.

● **The Sales Manager Said:** I'm for anything that will help my men on the firing line get more orders, but I've got to keep the selling expense down. Sound slidefilm selling is fine . . . but to date it's too expensive for me to use, and too cumbersome for my salesmen to carry. Make it low in price, light in weight, and simple to use. That kind of a machine will up *consumer sales* tremendously. Mr. Sales Manager has his machine in **EXPLAINETTE**.

● **The Salesman Said:** I was sold on my *own* product through sound slidefilms . . . and if they sold me, they will sell the public. But I'm a *salesman* and don't want to be a *peddler*. Give me a small, light-weight, good looking job . . . not much bigger than a brief case. It's got to be low in cost, too. Give me that kind of a machine and I'll have no trouble selling *Mr. Consumer*. **EXPLAINETTE** fills the bill.

EXPLAINETTE is the result of intensive research by Operadio . . . an organization long known as pioneers . . . one of the oldest firms in the Sound Industry . . . the world's largest loud speaker manufacturer. In **EXPLAINETTE** you have a

quality sound slidefilm unit for consumer selling . . . backed by the reputation which has distinguished every Operadio product. It is sold through all accredited Sound Slidefilm producers. (Patents Pending)

**WRITE or write your Sound Slidefilm PRODUCER
for full particulars, or communicate with**



OPERADIO

All Operadio Systems are Licensed by Electrical Research Products, Inc., under U. S. patents of American Telephone and Telegraph Company and Western Electric Company, Inc.

MANUFACTURING COMPANY

Pioneers in Sound

Also makers of **EXPLAINITONE**, the larger sound slidefilm unit for group selling

Dept. BS7 St. Charles, Illinois

Export Division: 145 West 45th Street, New York City

Hundreds of Thousands
Have Been Thrilled by the
Year's Top-Ranking Film—

"IN TUNE WITH TOMORROW"

Showing at the
CHRYSLER CORPORATION
NEW YORK WORLD'S FAIR EXHIBIT

George Ritchie, New York Sun:

The Critics Rave!

It makes the usually dull mechanical story of the assembly of a Plymouth car into a fifteen minute reel in a comfortable little theater that packs more laughs and imagination and ingenuity than a Walt Disney classic.

The Chrysler film, 35mm., sound, is perhaps the biggest movie hit at the Fair. Its title, "In Tune with Tomorrow," is an appropriate one, for doubtless few visitors at the Fair have ever seen a movie of its type: A dimensional film.

Sales Management — July 1, 1939

The Ross Federal Interviewers report that the Chrysler-Plymouth three-dimensional movie has a clear lead in popularity among the Fair visitors.

(Producer's Name on Request)

BEHIND the SCREEN

EDITORIAL NOTES & COMMENTS;
NEWS OF THE FILM INDUSTRY



★ CLOSER to realization than ever before is *Business Screen's* proposal for the industry's first annual *equipment show*. Such an exhibition, held on a small scale in Chicago or New York with daily demonstrations of modern sound equipment, would draw a large attendance from commercial and educational users.

By simply including examples of the finest work produced by our commercial film "majors" and the offering of discussion and lecture programs by qualified authorities available from all sides of the field, we will accomplish a great deal in making the film medium more accessible to many groups of users. *Business Screen* has gone a long way in acquainting many business executives of the potential uses of the medium but it will help clinch the argument to put on a well-staged performance of what films can do to sell themselves.

♦ We expect to have to issue a wholesale round of apologies to the manufacturers whose lines we were unable to properly display in *Business Screen's* first annual Equipment Review contained on the latter pages of this issue. No attempt was made in this section to judge or classify the equipment according to merit, etc. To one and all we

simply say that we thought there ought to be a *first* pioneering attempt to build such a feature; that we dared to venture into it knowing full well its difficulties. Because 16mm. sound projectors are widely used in the field, they are listed first and somewhat extensively; next in importance because of widespread use came the soundslide projection equipment.

♦ *Business Screen* does offer one real service. In the "Buyer's Guide" listings on Equipment Section Page XVII we offer a most convenient way to obtain complete literature on certain lines without obligation. Merely send in your request with your card or business letterhead and we'll see that your order is filled completely and promptly.

♦ One firm who used to offer sound slidefilm equipment in these pages recently contested comments we made editorially regarding the "pioneering" of low-priced projection units by another firm. For their benefit and yours, we'll explain that these comments didn't refer to the national origin of this equipment, etc. but merely to its appearance in that particular firm's own advertised line . . . because the only pioneers officially recognized are those with *registered patents*. Unfor-

tunately there aren't any registered patents, to our knowledge, on the *size* or *price* of sound slidefilm projectors. There are a *good many* on various other features of the equipment. *But that's another story*. So today we are going "pioneering" into the Wisconsin woods . . . if can we raise the price of gasoline for our car.

Establishes Equipment Supply Department

♦ Nu-Art Films Inc., New York, has established an equipment and supply department in addition to a large variety of 16mm. and 8mm. Sound and Silent Films, now sold and released exclusively — offering to dealers, roadshowmen and home users, "Compact" portable screens of every type and size. Also a solution to clean films, as well as a light box for viewing motion pictures, and a unique optical method to eliminate all unnecessary reflection and annoying glare. New specialties will be added from time to time to meet an ever increasing demand.

Official New York Fair Producers

♦ In the terms of the Official Motion Picture Photographers of the New York World's Fair who have the exclusive rights to make industrial motion pictures, stock shots, and home movies, Mr. Whalen's spectacle is the world's largest and most elaborate studio for the production of industrial films.

With field headquarters in the Communications Building, with Leslie Winik, Executive Producer and Edward Ruby in charge of Fair Production, the Official Motion Picture Photographers have set up within the Fair Grounds, complete facilities for producing any type of motion picture, in sound, color, and black and white.



HEADLINES OF PROGRESS

In Motion Picture Production!

- 1910 — Company incorporated to do National business.
- 1922 — Used more new Panchromatic negative than all Hollywood.
- 1929 — First Commercial producer to use Cinecolor.
- 1931 — Changed completely from silent to sound technique.
- 1935 — New and larger studio, sound stage and laboratory completed.
- 1936 — RCA Recording System installed throughout studio and plant.
- 1938 — Greatest business year in history of company.
- 1939 — Automatic developing machine control for film processing installed in laboratory. Perfected Kodachrome technique for commercial use.

SINCE 1910 — *The Oldest Commercial Film Producer*

RAY-BELL FILMS, INC.

Saint Paul, Minnesota

Only One Projector Offers All These Features

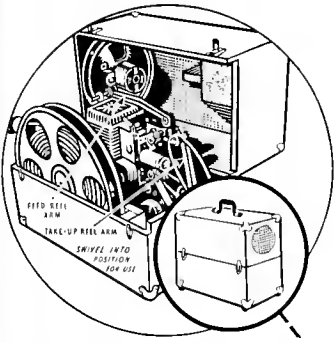

PERMANENTLY ATTACHED REEL ARMS FOR QUICK SETUP Reel Arms permanently attached; merely swivel into position for instant use. Accompanying belts, always attached, swing directly into position.

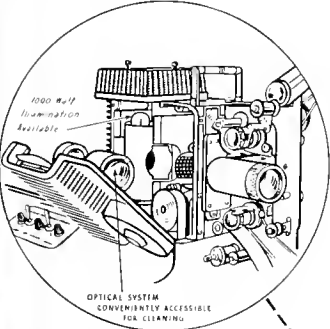

1000 WATT ILLUMINATION PROVIDED Amprosound Models X and Y are approved by the Underwriters' Laboratories for 1000 Watt Lamps. A 750 Watt Lamp is normally furnished as standard equipment but can be interchanged with 1000 Watt Lamps. Reflector and Condenser lenses are mounted on front cover for quick cleaning.

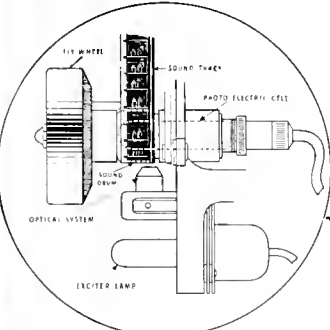

SOUND OPTICAL SYSTEM The light from the exciter lamp is projected directly and optically onto the photo cell without the losses or distortions normally encountered when mirror, prism, or mechanical slit is used.

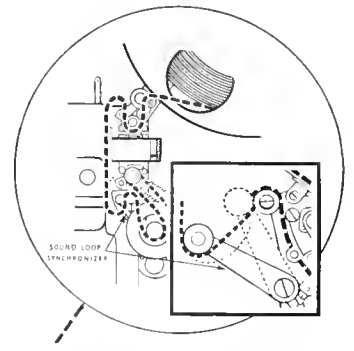

SOUND LOOP SYNCHRONIZER Permits perfect synchronization of picture and sound by the exact forming of sound loop. Guesswork is eliminated. Resetting of sound loop accomplished without stopping projector when loop is lost through faulty film and without damage to the film.

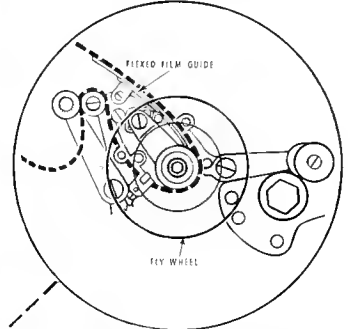

SMOOTH SOUND ENTIRELY FREE FROM WAVER The Ampro "SOUND" is free from "WAVER AND DISTORTION" due to its finely balanced fly-wheel, mounted on airplane type grease sealed ball bearings, and Ampro's patented film guides, curved film guides placed before and after the sound drum and sound-sprocket prevent the film from flapping.

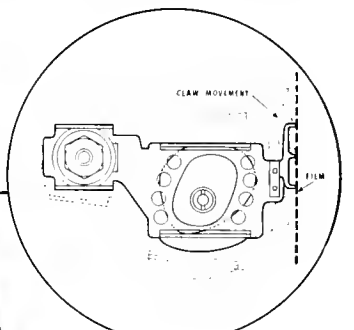

FILM PROTECTION—TRIPLE CLAW ACTION FOR MOVING FILM A triple claw is used for moving film, engaging three sprocket holes simultaneously. Film with two adjacent torn holes can be successfully used. Ampro patented "kick-back" movement lifts the claws from the sprocket holes before withdrawing, eliminating film wear. Take-up compensator prevents starting strain. The light pressures applied to the film at the aperture gate and sound head greatly increases film life.

OTHER AMPRO FEATURES

The new Amprosound Models "X" and "Y" which list at \$275 and \$295 respectively also offer you: Convenient operation with *all controls* centralized on one illuminated panel; such extreme quietness that a sound-proof case is not required; threading as simple as on a silent projector; and the fastest of automatic rewinding without the slightest damage to film. Send coupon for full details.

AMPRO

PRECISION CINE EQUIPMENT

Ampro Corp., 2839 N. Western Ave., Chicago, Ill.

Please send me the new 1939 Ampro Catalog. I am particularly interested in:

- New Amprosound Models "X" and "Y".
- Ampro 16mm. Silent and Convertible to Sound Projectors.
- All Ampro 16mm. Sound Projectors, including Ampro-Arc.
- Ampro 16mm. Continuous Projectors (for Displays—World's Fair and Convention Exhibits).

Name

Address

City

* Quite a few commercial studios have produced a series of general training films for new salesmen. They teach "from the ground up". Why doesn't someone develop a film which will be devoted to re-inspiring the discouraged salesman?

* * *

For example: how about "What's The Use?" for the theme? The introduction would frankly admit that salesmen do become discouraged. However, this very discouragement symbol can become the open sesame to rejuvenation. Before approaching any prospect, ask yourself, "What's The Use . . . to which this man can profitably or economically put my product?" Answer that question thoroughly . . . become enthusiastic about the answer . . . and go in and sell it to him!

* * *

Somewhere we read: "There never was a time when it mattered less whether a person could read and write. The writer who puts ideas before words can rejoice that his potential audience has risen from thousands to millions." That means us, doesn't it?

* * *

A sound engineer (shy fellow — he wants his name withheld!) writes in to inquire why the Orson



CAMERA EYE

NEWS AND COMMENT

ON BUSINESS FILMS

Welles' "First person — singular" technique, with its "confidential-on-mike-voice" hasn't been employed in commercials. With all the stories we have that combine off-screen narration and lip-synk episodes, there's certainly room for the device!

* * *

Word for the man who resigns because of salary differences: "income-patibility".

* * *

If a product competes with many other brands within the same general class — why not a film based on a performance contest between that product and a hypothetical opponent which will embody every "exclusive and outstanding" feature of all the competitors?

* * *

The Bible and its pungent quotations are a powerful force in American life. Odd that commer-

cial movies and slide films have used such quotes so little. A select series of them could well form the basis for a most effective sales training film.

* * *

Apt slogan for any merchandising-creative writer to have on his desk:

"Would you—if it were your money?"

* * *

♦ As the editors of *Business Screen* scanned the month's pictures, one stand-out production earned particular attention, not only for the film itself, but because of a thoroughness in planning and promotion which is readily apparent. The film, somewhat laboriously titled *Reflecting our Confidence in the Future of America*, was produced for *Anheuser-Busch, Inc.*, by The Jam Handy Organization. An excerpt from an explanatory release to dealers tells the "inside story"

in the sponsor's own words:

♦ An enormous amount of thought and labor has been put into a new Anheuser-Busch sound-motion picture that we know is going to do much good for you, your organization and the product and institution which you represent.

We, who have labored over and thought about this sound-motion picture, came out of the experience with the clear-cut conviction that its presentation to you provides an opportunity for us all to take a good, square, profitable look at ourselves and ask:

(1) Who am I?

(2) Who is Anheuser-Busch?

Answering the first question: you are not only an individual, but a part of Anheuser-Busch, which is a farflung organization and not just a name on a letterhead or a lot of buildings far away from you.

Answering the second question: Anheuser-Busch is a definite part of the economic entity which we proudly call America. The customers who buy our product are as much a part of the Anheuser-Busch segment of America's economy as are the malt house, the bottling plant or the adding machines.

The good-will of those tens of thousands of Americans who are



Among those for whom we have produced WORLD'S FAIR INDUSTRIAL FILMS are

National Cash Register Co.
International Business Machines Inc.
Ford Motor Car Co.
British Gas Utilities
Swedish Government
Turkish Government
Japanese Government

How about having your FILM FAIR CONDITIONED?

1,250 acres and \$155,000,000 in sets — the most elaborate motion picture "studio" ever available — is now at your disposal through The Official Motion Picture Producers of the New York World's Fair. The whole Fair with its unique backgrounds, buildings and scenes offers a once-in-a-lifetime opportunity to raise your film far above the plane of ordinary industrial pictures.

To World's Fair Exhibitors

Make your exhibit pay additional dividends by showing it at sales conventions, dealer meetings, and using it for other promotional purposes, as well as for your own permanent records. Such a film will have a value that far outweighs its modest cost.

To Non-Exhibitors

The World's Fair undoubtedly offers innumerable opportunities to show applications of your product or service. Let us tell you how these can be ingeniously capitalized at moderate cost.

An Exclusive Service at Low Cost

We have within the Fair Grounds complete facilities for producing any type of motion picture, in sound, color, or black and white. Our mobile apparatus, lighting equipment, and crews of technicians constitute a complete production studio with the broad industrial experience and highly specialized knowledge necessary to show the Fair at its best.

A library of 100,000 feet of 35 mm film of every worthwhile Fair shot — day and night, is also available on a footage basis.

We, as Official Motion Picture Photographers have the exclusive rights to industrial productions, stock shots, and home movies at the New York World's Fair. Because of these diverse activities and our concentration of staff and equipment, we are able to make pictures at low cost — quickly.

Address all inquiries to

OFFICIAL MOTION PICTURE PRODUCERS • N.Y. WORLD'S FAIR

1441 BROADWAY, NEW YORK, N. Y.

FIELD OFFICES
COMMUNICATIONS BLDG.
NEW YORK WORLD'S FAIR

PRODUCTION OFFICES
729 SEVENTH AVE.
NEW YORK, N. Y.

LABORATORY
441 W. 55TH ST.
NEW YORK, N. Y.

our customer family is essential to the financial health of Anheuser-Busch, which means you and me. If we help build up their moral, physical and economic confidence — we have done them a service, ourselves a service, and America a service.

That brings us to the new sound-motion picture *Reflecting Our Confidence In America*. If you think that this picture will or was intended to jolt people into suddenly scurrying around buying *Budweiser*, you are going to be thoroughly disappointed. This motion picture was not designed as a tool for immediate sales. This picture was designed deliberately and carefully to be a business foundation builder — using confidence for stones and good-will for mortar.

Have you ever asked yourself why a man goes into business — any business at all? Surely, it isn't because he wants to eat today. His friends would feed him for a day, for a week or longer. He goes into business because he thinks of the future and his *continued* stability through *every day* of the future. And the future is not some vague thing on a dim horizon. It is on you in the next moment — before you can blink an eye.

Definition of a Sale

Your new motion picture is advertising, yes — part of *Business's* steady, long-haul, drop-on-the-rock advertising . . . advertising that is calculated to *stay* with people, not wow them. Every wow in the history of advertising has ended in a poof.

The man who thinks a sale is the mere exchange of a product for money is no salesman.

A sale is really something with a slow and vague beginning — and it has no end. It is slow and vague in beginning because consumer acceptance always begins that way. The consumer reads about a product in an advertisement. If it is not purely a bargain-price advertisement, he gets an impression about the product. Subsequent advertisements expand that impression and shape it.

Eventually he buys. Either he is pleased by the product or he isn't. If he isn't pleased, all the whooping and shouting that the advertising continues to do will not keep him sold on the product. If he is pleased, subsequent advertisements remind him of the wisdom of his choice, keep him sold on the product and keep *repeat sales clicking along*.

Budweiser's advertising — whether on posters, in magazines,

or newspapers or in motion pictures thinks always in terms of *repeat sales*, not a sale. Some advertisers are content to get their products on the dealers' shelves. We want to get ours on-and-off the shelves — repeatedly.

Dealers are more interested in selling beer than in selling a brand. In order to build sales for *Budweiser* we, and not the dealer, have to work on the consuming public.

An Implement of Goodwill

Your new sound-motion picture is one of our implements for working on that public . . . gaining their confidence and good-will . . . making them partners of the Anheuser-Busch buying and selling machinery.

In your own interest, you should not judge the new picture by comparing it with our earlier production *Something More Than Beer*. These two films were intended to do entirely different jobs with entirely different groups of people.

There is a definite contrast in concept between our two pictures and their spheres of usefulness. We know that a trip through our plant has a very favorable effect upon distributors and retailers. Our first picture was designed specifically to take those distributors and retailers through the plant via a picture — distributors and retailers who could not visit the plant in person. It is a "plant" and "product" picture, of primary interest to those in the beer business and of lesser educational interest to the public at large. In our "plant" picture we talk of ourselves, our age, our size, our facilities, our skill, and our choice of ingredients and we reveal facts of self-interest to the beer dealer audience for whom the picture was primarily designed . . .

Pointing to Re-Employment

Your new picture was designed to lead other business men to imitate us and thus develop concerted action to reverse the attitude of defeatism and turn the direction of American thinking back to the road of employment. Thus, it was designed to meet the self-interest of a wide-spread public audience, treating as it does with a subject that is closer to the heart of each individual in America than any hobby or incidental or sectional interest. As far as the public is concerned, this is our purpose . . .

This second picture, *Reflecting Our Confidence in America* is designed to reach the public, — your public, — the people whose good-will you depend upon for your future sales and stability.



For Audiences
Of Any Size

S.V.E. SLIDEFILM PROJECTORS

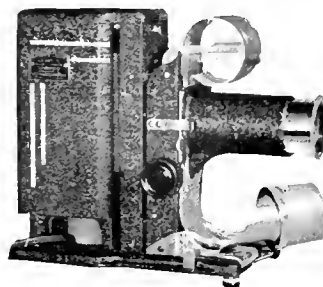

S.V.E. Model G, 300 Watts

Are Available
In Many Styles

When you specify S.V.E. equipment in your sound slidefilm units or for silent projection, no compromise is necessary on brilliance of pictures, film protection, or convenience of operation.

S.V.E. slidefilm projectors offer a broad selection in style of model, light capacity, lenses and other accessories, ranging from 50 watt units for contact salesmen to 300 watt projectors for showings to the largest audiences. Each model (even the lowest in price) has a patented heat-absorbing filter to reduce the heat on the film and a releasing rear aperture glass to protect the slidefilm from scratches.

You may choose equipment for slidefilms only or the versatile Tri-Purpose which shows single or double frame slide films and 2" x 2" glass slides.

Send for "More Brilliant Stills"!

Users of slidefilms, silent or sound, will find valuable data on efficient projection in this interesting folder. Mail the coupon for your free copy now.



SOCIETY FOR VISUAL EDUCATION, Inc.
Dept. 8B, 100 East Ohio Street, Chicago, Ill.

Without obligation to us, send "More Brilliant Stills" and full details on S.V.E. projectors including the name of the nearest producer-dealer.

Name _____
Firm Name _____
Address _____

Thousands for Good Films but How Much for Good Projectors?

Like Catalogs that are Never Distributed . . . Sound Slide Films are Valueless Unless They are Shown to ALL the Audiences!

WEBSTER ELECTRIC
Cinaudio
REG. U.S. PAT. OFFICE

is Quality Equipment at a Less-than-Quality Price



Thousands of business concerns own one or more Sound Slide Films, competently produced and of proven worth in sales and advertising programs — which do not receive maximum effectiveness because an insufficient number of projectors is available to show the films to the large number of audiences responsive to a showing.

Good Sound Slide Films, like your catalogs, are worthy of their hire, but, like your catalogs, the results are dependent upon the number of prospects they reach.

Good projector equipment costs money, but — in the long run — cheap ones cost more than good ones! And you can buy a large number of good ones for less than you pay to have the average film produced. Particularly if you buy the Webster Electric Cinaudio, for here is a quality projector at a less-than-quality price.

The Webster Electric Cinaudio is available in two models (illustrated at the right). The Cinaudio "Cub" is now being used in large quantities by well known national advertisers.

Because this company specializes in the manufacture of a broad line of sound equipment devices, it stands to reason that it is better equipped to manufacture good Sound Slide Film Projector Equipment.

Note the details of both models as set forth to the right and then write for complete details and prices.

Licensed by Electrical Research Products, Inc. under U. S. Patents of American Telephone and Telegraph Company and Western Electric Company, Incorporated

WEBSTER ELECTRIC COMPANY • RACINE, WISCONSIN, U. S. A.
 Export Dept.: 100 Varick St., New York. Cable Address: "ARLAB," New York

THE "CUB" CINAUDIO

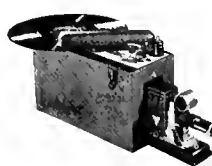

Plays 16" records at 33 $\frac{1}{3}$ RPM . . . has high quality crystal phonograph Pick-up . . . 6 feet of cord and plug for 110 volts A. C. . . . 50 watt lamp separate switch



. . . combined volume control and power switch . . . double convex condensing lens, heat absorbing meniscus double aperture plates . . . speaker in cover with 10



feet of extension cord . . . uses 35MM film strip . . . projects picture 2 $\frac{3}{4}$ x 3 $\frac{1}{2}$ feet . . . dimensions 6" x 10" x 14" . . . weight only 13 pounds

THE STANDARD CINAUDIO

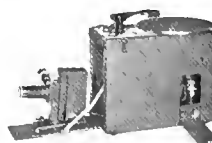

Plays up to 16" records at 33 $\frac{1}{3}$ RPM . . . high fidelity crystal reproducing unit . . . 100 watt lamp for 110 volt 60 cycle A. C. or A. C.-D. C. operation . . . separate volume and tone controls . . .



emergency motor board light to facilitate changing records, needles, or making adjustments . . . uses 35MM strip, movement of which may be operated by remote control . . . speaker housed



in cover of case with generous length of extension cord and fool-proof polarized plugs . . . high quality power amplifier which reproduces entire audible range.

Webster



Electric

"Where Quality is a Responsibility and Fair Dealing an Obligation"

★ NOW THAT the figures for the first six months of 1939 are in, a report to executives on the progress of the commercial film medium offers plenty of encouraging data:

◆ Distribution figures show wide extension of facilities throughout the country; actual case records (reported elsewhere in this issue) report theatrical bookings for one sponsor in the neighborhood of nine thousand; another showed a sponsor's film to a total of 21,753 audiences with a total of 7,178,490 persons in attendance. Equally fine records are being attained by professional projectionist organizations and by sponsors themselves where equipment is carried by representatives in the field. Since distribution is the key to film success, it would seem that the doors are opening wide for even wider use of films next fall.

◆ Reception of frankly commercial film subjects such as *Union Pacific*, and *Wells-Fargo* by enthusiastic movie fans from coast-to-coast furnishes illuminating evidence against the prejudices of a few self-interested and self-appointed Hollywood oracles.

◆ Announcement of improved projection equipment at lower prices by all sound motion picture projector manufacturers and increasing spread of equipment in the field was another noteworthy trend indicating increasing film use.

◆ The addition to our advertising pages in this number of outstanding sound slidefilm projector manufacturers may also be noted for the benefit of sponsors. The national reputations which these firms bear, their extensive manufacturing facilities and years of experience in the sound field augur well for the future of this type of equipment. The makings of a great national drive for production and use of the sound slidefilm are present and as first announcement of the part which *Business Screen* can play in pointing out extended use of the medium, we bring you the news of an *entire section* of our October publication to be devoted to the sound slidefilm. Reports from executives and particularly interesting articles on the checking of effects and the results of the medium among sales organizations will be included with the extensive discussion and charts on the uses of slidefilms in the field of business.

◆ The progress of color has been cumulative with the report now showing that *quality* rather than *economy* still rank first in the commercial user's ratings. Noteworthy productions in color for the period are the Technicolor films for National Biscuit and Westinghouse; a series of "minute movies" and the Cinecolor production for Hills Brothers Coffee now showing at the San Francisco Fair.

◆ The usefulness of the "documentary" type of production continues to be recognized though the popularity of this type of factual film reporting will be diminished by the activities of propaganda organizations loudly sponsoring such films. The communistic bugaboo is more pitiful than important but the use of the stamp has undoubtedly influenced its popularity.

RIGHT OFF THE REEL

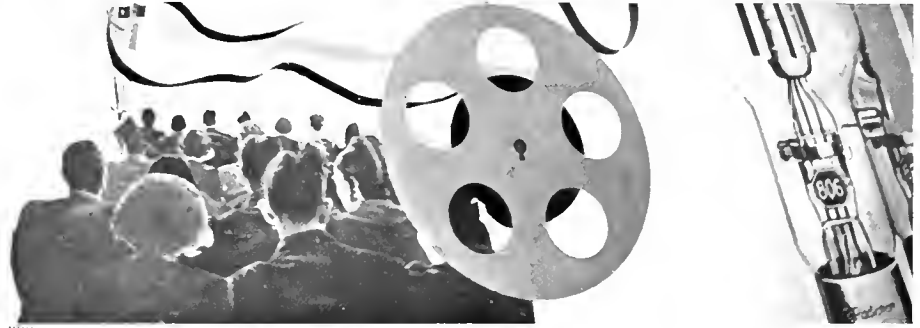

IN the clothing business they call 'em *schlagers*.

Gyps, in the furniture business, turn out *borax*.

But in the commercial film industry we haven't got a name for the guy who calls himself a producer because he once pointed a news camera at Garbo.

But when he says he'll make your next picture for only \$792.23 (*look, he has the figures!*) because the film in his camera is smaller and takes twice as many pictures and because his overhead is very, very low, etc., etc., the wise business executive who appreciates the power and usefulness of the successfully applied film medium ought to have a tag for this kind of bird.

In Hollywood they call 'em *fly-by-nights* and a hastily dished up mess of their so-called entertainment is a *quickie*.

You can't call 'em amateurs and you can't blame the equipment they use. No well-informed amateur would attempt to produce the kind of big-league motion pictures and slidefilms it takes to achieve success and results today. Professional producers use all kinds of equipment but *they know and smart buyers know that it isn't what you put in the camera that affects the majority of picture costs but what you put before it*. That means adequate talent, expertly written scripts, sets, props and the like. It wouldn't cost a hundredth less to shoot the average production in sixteen millimeter stock but even if it did, professional studio equipment, professional sound and image results today demand theatre-quality technique earned through years of experience.

So put some kind of tag on the guy who says he can do it *cheaper* and *kick him downstairs*. It will save you a lot of money in the long run and put you that much closer to the kind of real results we spend most of our time telling about in these pages.

Ott Coelln
EDITOR

July 25, 1939



A DEPARTMENT STORE EXPERIMENT OPENS A POTENTIAL FILM FIELD

• A television network of department stores which will utilize the "tele-sales" sight-and-sound merchandising system to show shoppers the wares of national advertisers, is planned by the American Television Corporation, who recently demonstrated the system successfully at Bloomingdale's in New York.

Tests last month elicited the statement of Ira A. Hirschmann, vice president and sales director of Bloomingdale's, that "tele-sales" is the most important new merchandising medium offered to department stores in many years, remarking further that "the clarity and incisiveness with which merchandise is televised from our own studio and seen by customers on all floors simultaneously make the new medium a 'must' among selling methods".

The plan provides specifically that leading stores will be equipped with "tele-sales", the apparatus including cameras that scan filmed as well as living subjects. A filmed continuity promoting the products of several national advertisers will be shown hourly in

each store so equipped, rates for such advertising to be determined by clocked audits of customer circulation and the number of stores in the network. Besides the equipment, the American Television Corporation will provide each suitable store with two engineers to operate the studio and receiving equipment.

"Controlled television", according to its sponsors, permits the advertiser to make his appeal at the very point where the sale can be rung up. If the customer is motivated to buy, he is not at home where he can postpone his purchase. He is in the store, where he may have come to buy one item but remains to examine others because he is attracted by the miracle of television. Besides creating multiple purchasers, the merchant offers his patrons the opportunity to shop by television, and if there is no regular broadcasting in his vicinity, he is in the position of being the first to introduce the new art to his community.

The first film expressly made for these telecasts was being produced by Audio Productions last month.

BLOOMINGDALE CUSTOMERS WATCH A TELECAST PROGRAM ON ONE OF THE KINETES LOCATED ON A lower floor and connected to a central studio (shown right and above) by coaxial cable, thus escaping the difficulties of outside interference, etc. and assuring dependably good performances at all times.



THE NEED FOR AVIATION FILMS

*A stimulating letter offers
further impetus to Aviation
film progress*

—by H. Canfield Cook—

• One evening this past winter I addressed a large audience on the subject of air transportation. I told of the progress that has been made since the world war when I was actively associated with aviation. Of the speed and comforts afforded by the modern leviathans of the skies. Of the vast network of airways that link the cities of our nation and the capitals of the world. How this speeding up of communications is shrinking the earth's time size and profoundly influencing the conduct of international affairs. At the conclusion of my discourse, many questions bearing on the subject matter, were asked by the audience. Just as questions began to lag and the chairman was about to close the discussion period, a little girl of possibly nine years, piped out shrilly from one of the front row seats — "Mister, what makes 'em stay up".

What makes 'em stay up, indeed? How many oldsters but would like to ask that question if they did not think it too elementary? How many other questions along the same line remain unanswered in their minds? If the public knew more of the answers, would it help the air industry? I think it would. I believe it would be the shortest route to converting that vast majority who do not fly because they are afraid of what they do not understand.

Thousands have been spent in films that tell an entertaining story of flight. That reveal glorious vistas (mountains usually excepted) from the air. That dramatize the linking of widely separated communities. That give glamour to life above the clouds. But has anyone shown John Public why he won't be dizzy when he looks earthward from a speeding plane, but possibly would be if his vantage point were the observation deck of the Empire State Building. My experiences with audiences of various ages and sizes, in metropolitan and rural communities from one coast to the other, convinces me that where aviation is concerned people want facts and more facts. They are thirsting for knowledge on this new and revolutionary form of transportation.

Never was a time more ripe for films with a background of solid reality, telling a straightforward story of achievement, unattended by an aura of artificial glamour.

The air industry is going to need "Young America" to build and operate the air liners of the future and — buy the tickets that will keep them filled. Show these young people without fanfare, what they must do to plan their careers in aviation and they can be depended upon to "sell" air transportation to those upon whom the industry must now depend. Although today millions are unemployed the air industry does offer definite, withal limited, opportunities for youth. The industry seeks personnel, qualified through proper training. This need will increase in proportion to expansion and a healthy expansion depends on the availability of skilled help. And even now on occasion there is a dearth of skilled mechanics. A few months ago, at a time when the wheels were scarcely moving in some aircraft plants, I was told by the personnel director of a more fortunate establishment, that over four hundred needed men could not be found among applicants presenting themselves for employment on that particular day. Their training was inadequate. What an opportunity this would have presented to those properly equipped through an advance knowledge of the industry's requirements.

Publicity values change in these swift moving times. There was a day not so many weeks ago, when the departures and arrivals of trans-oceanic airliners rated prominent space on the front pages of our newspapers. One must search for these items now. They've been relegated to the inside pages along with "steamship movements". This is a high price to pay for achievement but it indicates a goal hard won. Air transportation has become an integral part of the world's communication services. Flying is a casual business so far as news reports go. But flying is still far from being a casual business in the eyes of the public. It has to be sold. Not with an aura of glamour but with facts. The publicity ceiling is still unlimited. Whether the approach be through to-day's prospective ticket holders or through those ticket holders of the future, for whose hopes the sky is literally the limit, but who depend on sound, fundamental public relations programs, to safely chart their course.

WESTINGHOUSE Films the Fair in TECHNICOLOR



Business Screen's own camera reports the waiting lines at the Chrysler, Coca-Cola; other Fair theatres

The World Fairs' BEST SALESMAN!

It isn't the urbane Mr. Whalen who does the best job of selling now that the New York Fair is hitting its mid-summer stride. Grover takes a back seat to the several hundred-odd films and moving visual displays that are stopping the throngs and making them come back for more. From Aetna to Zellerbach, the pictures are packing 'em in at New York and San Francisco.

Since, as *Business Screen* has always argued, a good commercial film is, in itself, a veritable World's Fair, it isn't any wonder that the theatres of Coty, Macfadden, National Biscuit, General Motors, Johns-Manville, Household Finance, Chrysler and Metropolitan Life are "naturals" where the exhibitor and his public meet on the most excellent basis possible. For the visitor gets restful air-conditioned comfort and a well-presented sales story which reasons with

the intellect the while it entertains with humor and variety. The exhibitor may be quite satisfied with the knowledge that a potential customer has listened to an institutional presentation of his business for a lengthy period and with maximum receptiveness.

That all sounds pretty fanciful but the preliminaries of *Business Screen's* authoritative survey of the New York World's Fair reveal that an average of 11 minutes is spent in each commercial movie theatre by visitors attending these showings and a great majority of the films presented have a direct selling appeal. Straight selling reaches its zenith in such pictures as Chrysler-Plymouth's *In Tune With Tomorrow* where audiences watch with unabated interest the assembling of a Plymouth automobile for almost ten minutes. (See next page)

The animated color film *Pete-*

Roleum and His Cousins presented as the feature attraction of the Petroleum Industry exhibition is typical of a number of public relations pictures, wherein entertainment carries the subtle theme of the sponsor. In this case, however, the animating technique is too obvious and the sponsor's message apparently subordinated to experiments with stop-motion photography, novel puppets and color technique.

In contrast to this, however, the first Walt Disney all-color "commercial" brings out Mickey Mouse as a National Biscuit patron and an accompanying Technicolor short subject introduces Walter O'Keefe in *Around the Clock With the Cues*. The entertaining antics of the familiar Mickey make an ideal combination with the almost-straight selling of the O'Keefe short. Comfortable theatres at
(Please turn to the next page)

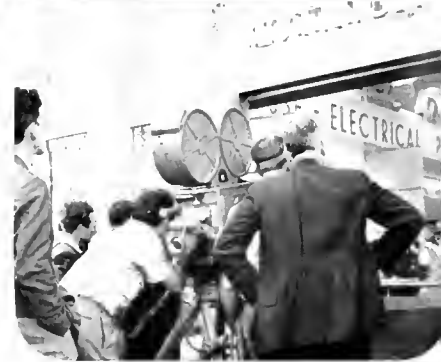

The Middleton Family in the Movies

★ When "Bud" Middleton and his fellow conspirator, Grandma Harrison, at last manage the unmasking of Nick Makaroff for their beloved "Babs", it is a safe bet that the story of the Middleton Family will have a pretty tight hold on the hearts of audiences from Nantucket to San Diego. Just now the "Middletons" are faces on the cutting room floor at Audio Production's Long Island studio and in the Technicolor lab. By mid-August they will be ready for formal introduction by Westinghouse and Fuller & Smith & Ross executives who supervised the \$70,000 Technicolor film production, *The Middleton Family at the New York Fair*.

By way of preview, the story embraces the adventures of the Middleton Family (advertised in full color pages by Westinghouse in national ads these past weeks) at the New York World's Fair. Most of the action centers around the Westinghouse building with its thousand and one electrical miracles. Production in Technicolor by Audio Productions, Inc., was directed by Robert R. Snody, with Reed Drummond, film executive of Fuller & Smith & Ross, in charge for the client. George Lewis, Marjorie Lord, Jimmy Lydon, and Harry Sherman are in the cast of well-known players which also includes radio actor Ray Perkins.



TEN MINUTES of Chrysler Selling and they love it!



(ABOVE): PRODUCER-DIRECTOR JACK NORLING SUPERVISES PRODUCTION OF THE THREE-DIMENSIONAL CHRYSLER FILM, *In Tune With Tomorrow* and (below) A diagram illustrating the projection technique employed for this picture. (Illustration courtesy of Photo-Technique Magazine)

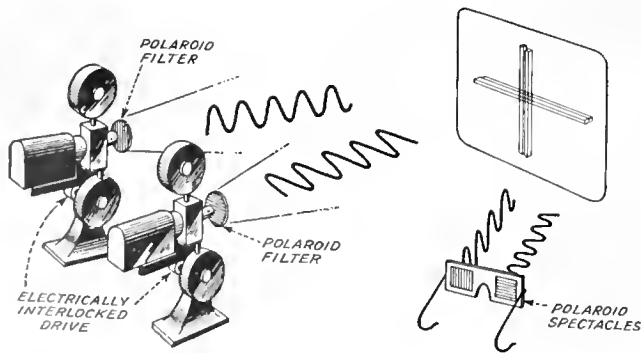

(Continued from previous Page)
both the New York and San Francisco Fairs earn National Biscuit the accolade for superb showmanship and what will undoubtedly prove to be among the outstanding selling accomplishments of the World's Fair year.

Animation certainly has its day at the Fairs. General Motors, Metropolitan Life, Aetna, Planters Peanut, Addressograph, Bromo-Seltzer, Paraffine and the California Prune-Growers are among the sponsors of animated subjects. The prize-winning *Once Upon a Time*, Metropolitan Life's humorous fairy-tale of safety education, is present at both Fairs. The Bromo-Seltzer exhibit brings a newcomer, young Douglas Leigh, into the producing realm with an animated cartoon talkie embodying the same technique for which his two animated cartoon signs on Broadway in New York are famous. A weekly audience of over 125,000 persons is said to be recorded regularly before the six-by-eight foot screen which is the label of a huge bottle of Bromo Seltzer.

♦ From this point on the Fair films seem to divide into two distinct classifications with a possible third for comparison. First there is the public relations film without direct bearing on the company's business such as Macfadden's *I'll Tell the World* and the Household Finance Company's feature attraction, *Happily Ever After* with its accompanying straight-entertainment subject, *An Evening with Edgar A. Guest*. The second group would include only those straight selling industrial presentations such as Yale & Towne's *Hundred Horsepower Hands* and *Home Defence*; Coty's *Symphonies in Fragrance* and *Air-Spun Flattery for Your Face*; Johns-Manville's

NEXT ISSUE: THE
COMPLETE WORLD'S
FAIR SURVEYS—II
and the
1938-39 SELECTION
of FILM SUCCESSES

series of industrial-educational films showing uses for J-M products and Hills Brothers Cinecolor feature, *The Story of Coffee*. The possible third group would embrace showings such as General Electric's *Excursions in Science*, Du Pont's *Wonder World of Chemistry* and the familiar United States Steel color subject *Men Make Steel*. It is difficult though to separate these groups from this point on for all selling is comparatively "indirect" although the fruits of the showing may directly benefit the sponsor's business. Safety education benefits the insurance companies, improved public understanding helps the loan company, the steel corporation, and so on.

It is also hard to find any fault with the many film showings. If any exist it is in the failure of a few to take full advantage of the medium's educational and entertainment force. This is one of the visible hazards of an over-artistic animated subject, of a tedious unrelieved industrial of the "factory run-around" type. Fortunately there are few of these since the majority of subjects were entrusted to skillful, experienced producers. Hollywood "entertainment" producers have nothing of consequence on exhibition; practically every movie and slidefilm is the work of a recognized commercial "major" and the results, in attendance and interest, seem to prove

that the client and producer both knew their business and how to tell other folks about it.

♦ While most of the film subjects at the World Fairs are acceptable entertainment (with a few notable examples to be discussed later), the New York Fair grounds offer some of the finest examples of mechanical stupidity of operation and all-around bad showmanship to be found anywhere. The editor of *Business Screen* visited most of the well-publicized showings and interviewed many of the projectionists. As a member of these audiences, seeing excellent films prepared for entertainment, he was as sadly disappointed as they must have been at the careless operating technique. These findings have been borne out strongly in the careful survey and complete film now being concluded.

Exhibitors accepted full union supervision and rates and are obviously finding that professional projectionists supplied them are less qualified to operate the average 16mm. equipment than school-children. Careless supervision of sound is the most obvious failing. Although excellent equipment is available, apparently little attempt is made to check the reception of the picture and sound, within the auditorium when each day's showings are begun. These failings in operating technique should be checked for the audiences cannot otherwise fail to carry away a bad impression of the whole performance.

♦ A vote of thanks goes to National Biscuit for helpful cooperation accorded *Business Screen's* fair representative. From the Simplex projector to the DaLite Screen to the Frick Air Conditioning to the 262 American seats, the National Biscuit show is a shining example of co-ordinated planning.

Three-Dimensions with Polaroid Make the Assembling of a Plymouth a Dramatic Hit

★ Playing to capacity at every show, the Loucks and Norling-produced three-dimensional movie *In Tune With Tomorrow* is one of the outstanding hits of the New York World's Fair. Presented in the Chrysler building theatre, the "stereo" film introduces Major Bowes as commentator and proceeds to show the assembling of a Plymouth car. Parts appear to hang in mid-air; are thrust forward as if floating above the heads of the audience and then magically assemble themselves into the finished automobile.

On a "shooting script" based on the breakdown of the Plymouth car, producer-director Jack Norling painstakingly developed the unusual sequences which are set to specially written music. George Steiner and Phillip Sheib wrote the score for the musical "action." For example the musical visualization of a squad of bowlegged Scots on parade illustrates the situation where tires roll in, wobbly. Every foot of the animation was taken by stop-motion. Other "firsts" for this producer include the first use of dialogue shown in stereo and the first use of stereo color.

• Previewed last month in New York was National Carbon's new fall promotional program for "Eveready" "Prestone", anti-freeze product. For completeness, ranging all the way from a straight-entertainment Mickey Mouse to a dramatic feature, few film promotional programs had this one beat.

The entire production, which is handled in the form of *An Evening At The Movies*, was supervised by Wilfred S. King, director of industrial motion pictures for J. M. Mathes, Inc. He has been assisted in this department by Lawrence A. Weaver, Jr., on production, and Paul Gangelin, scenarist. These gentlemen worked constantly in the closest cooperation with Henry A. MacMullan of National Carbon.

Mickey Mouse at a Filling Station, which is part of the "Eveready" "Prestone" program, had already been seen nationally as an entertainment feature.

March of Time's first industrial picture tells the laboratory story of "Eveready" "Prestone". Under the title of *Anti-freeze — A Story of Scientific Research*, the development of automobile protection is traced from its beginnings to its present perfected form, in which it is responsible for some of the outstanding trends in present automobile construction. All shots for this picture were made in the "Eveready" "Prestone" laboratory. This picture was produced by Thomas Chalmers, with Beverly Jones directing, voice by Van Voorhees, and camera by Charles Gilson, Frank Follette and Richard Maedler.

Coming Attractions was produced by the West Coast Sound Studios (New York City). This feature treats "Eveready" "Prestone's" merchandising plan for 1939 after the fashion of a motion picture house's sales talk on schedule features. The voice is by Dell Sharbuth.

Rip Van Winkle, Jr., the "Eveready" "Prestone" feature, was also produced by West Coast. In charge of productions was H.

NEW YORK STATE TROOPERS QUIZ RIP IN AN AMUSING scene from the new Eveready Prestone feature *Rip Van Winkle*.

WEST COAST (N.Y.)



G. Christensen, directed by Martin Henry, with Johnny Graham as assistant director. The scenario is by Paul Gangelin, of J. M. Mathes, Inc., voice by Jean Paul King, and music by Jack Silkret. A cast of twenty is headed by James Kirkwood, ace star of the silent movies, later a director, who recently completed a two-year run as Jeeter Lester in *Tobacco Road*. Mr. Kirkwood plays Rip Van Winkle, and the role of Rip Van Winkle, Jr. is taken by Wilfred Lytell, brother of Bert Lytell.



WILDING

STORE DISTRIBUTION OF FAMILY CIRCLE MAGAZINE is shown in the publication's new film *What Is This Power Over Women*.

Within the "Family Circle"

♦ Latest in the rising number of magazine promotional subjects is a straightforward film presentation of its readership, based on surveys, by Family Circle Magazine. Produced by Wilding, *What Is This Power Over Women*, presents reader studies by L. M. Clark, Inc.; Facts, Consolidated, and Ross-Federal.

* * *

♦ Kolynos, through the Chicago Film Laboratory, have just produced *Styles In Smiles* for distribution here and abroad.

* * *

♦ RECENT RELEASES: *Everybody's Business* for the Tea Bureau by Wilding; *Miracles of Modernization* for Federal Housing by Pathe Commercial; *Reflecting our Confidence in the Future of America* for Anheuser-Busch, Inc., by the Jam Handy Organization; *Modeled for Distinction* for Chevrolet by the Jam Handy Organization (theatrical).

For Scientific Presentation

♦ One of the most unusual technical presentations yet created in motion pictures has been completed by Audio Productions, Inc., for Ciba Pharmaceutical Products, Inc., to describe the new drug "Coramine" for the medical profession. The Picture, in four reels, is completely documentary in the evidence of reactions and characteristics of "Coramine" in the practice of medicine.

The film has been in production through the past four months. Contracts were signed last Spring with A. D. Brewer advertising manager of Ciba Products by A. J. Wilson, Vice-President of Audio, in charge of commercial film activities. The Audio staff, long established in the production of technical films collaborated with Dr. E. Oppenheimer, of the Ciba organization, in preparation of the script and presentation of the special material on the screen. Herman Roessle directed production. The film has been planned for circulation to the medical profession and interested audiences.

is expected to improve demonstrations by jobber's salesmen.

Of the film, a recent note acent its use says in part:

"Our film was made to be used in connection with a general sales promotion program in an effort to induce jobber's salesmen to demonstrate our products more efficiently to retailers.

"So far we have no reliable information as to just how much good it has done because the real gun selling season has not as yet gotten under way for the fall trade period. We are hoping, however, to have many more meetings with jobber groups before the fall season gets under way and so by the end of November we hope to have a much better idea of the success of our first film venture."

The Fisk Tire Program

♦ To H. R. Hurd, advertising manager for The Fisk Tire Company, the *New Films* editor owes a vote of thanks for this very complete statement on the Fisk program. A letter from Mr. Hurd states:

"This film is really the third reel of what eventually will be a three reel picture. The first two reels will deal with manufacturing processes, whereas the third reel is the demonstration of what our Safti- (Please turn to the next page)



A Beich Candy Co. ad film is "hot" by Ray-Bell

♦ Theatre screens will soon carry the "minute-movie" subject being filmed above for the Beich Candy Company by Ray Bell, Minneapolis producer, in the Chicago Columbia Broadcasting Studios. The girl is singer Evelyn Lyne.

Remington Awaits Fall Season

♦ Soon to get under way is the fall gun selling season. In the meantime, the Remington Arms Company, through Hugh Sharp, Jr., reports that the Company's new film

New Soundslide Film Trains Oil Dealers

♦ Soon to be available for a fraction of its production cost, is a new 22 min. syndicated soundslide film *Yours for the Taking*, based on the popular "Balanced Selling" theme for service station dealers. Burton Holmes Films, Chicago.



WERE THESE THE FIRST ADVERTISING FILMS?

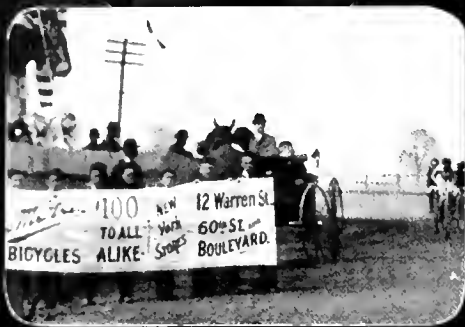

Can you help Business Screen name the first commercially sponsored advertising film? In 1895, Dewar's Scotch (top, left) appeared as sponsor of an "entertaining" motion picture screened for passers-by along Broadway. The same year saw Columbia Bicycle's (below, left) sporting adventure opus on the screen, and a few years after, a drama was sponsored by Maillard's Chocolate. (above) Weary operators hand-cranked the flickering images — pioneers of an era.

ALL PHOTOS FROM THE DOROTHY STONE LIBRARY

(Continued from previous page)

Flight tire will do — in other words, it shows the result of the factory processes.

"The Fisk Safti-Flight tire was brought out in June 1937. Its tread construction is so radically different from anything the car owner had known up to that time that the problem of explaining it so that the ordinary driver could understand it was not simple.

"We could not get it over in the magazines because it has been demonstrated over and over again that the public is not greatly interested in tire advertisements and will not read long technical descriptions. To explain the Safti-Flight construction and the reasons for it meant a long story. We then decided to try to do the job with motion pictures and turned the matter over to Wilding Picture Productions. As it would have taken some time to make the three-reels complete, we decided to go ahead with the third reel in order to have the picture available for dealer meetings this Spring. I may say that we had first tried to have a demonstration picture made here in Chicopee Falls by another motion picture outfit, but the experiment was not a success and it was finally decided to have the job

done in Hollywood under the supervision of our factory manager.

"Wilding did a very excellent job for us and after seeing the film we purchased thirty (30) 16mm. projectors and thirty (30) prints, equipping each branch with a machine and a print and keeping one here at the factory. During the last three months the picture has been shown to over 50 groups in and around this immediate area, and as each one of our branches is also keeping it busy before clubs and other organizations, we feel that we have gotten the story over to a very large number of people.

"It is likely that we will start production of the other two reels in the very near future."

(Please turn to Page 32)

OUTBOUND PILOTS CHECK MAPS AND WEATHER reports in a scene from *The American Way*, new production for American Airlines. (See Page 32)



WISCONSIN'S CONSERVATION FILMS

By Dorothy Ferguson, Photographic Section

♦ Looking back into Wisconsin's history, we find that in the year 1872, a forest fire which started in the vicinity of Peshtigo, swept over one million acres of both virgin timber and farm lands and took toll of 1500 human lives. This fire was one of the most calamitous ever to occur in America and perhaps the worst single disaster that has ever occurred in the state of Wisconsin. However, that was not a singular incident — all during the years from that time down to the present — fires, large, medium and small, have taken their toll of human lives, timber, farm lands and towns.

Realizing that 98% of the forest fires are caused by human carelessness, it has been the hope and earnest desire of the Wisconsin Conservation Department to place an appeal where it could most effectively reach the public. Considerable time was spent in the preparation of a three reel silent subject covering the causes, destruction and appeal for prevention of forest fires. The reel was entitled *Firemen of the Forest* and was distributed through the cen-

tral library at Madison, Wisconsin and through the forest rangers in the field who carry on a very effective educational program during the winter months. Since its completion in 1937, the film has been shown to at least 2000 groups, and if it is responsible for the prevention of even one serious forest fire, it has more than proven its value.

However, the Conservation Department felt that its film was not being brought to the attention of enough people who comprise the touring public of the country, and it was decided to prepare a one reel sound film suitable for theatrical distribution. The three reel subject was condensed, a sound track added to it, entitled *Siren*, and it has been placed with Burton Holmes Films for theatre use. Both 16mm. and 35mm. prints are obtainable from the distributor and the main office of the Conservation Department at Madison, Wisconsin without charge, the only expense being transportation both ways. Over 150 report cards have been received on the reception of the new film in the various theatres.

For Men Only . . .

BUT THE WIVES ARE WELCOME

• Hart Schaffner & Marx salesmen who carried prints of the Company's new film *A Personal Investment* into the dealer field for a recent series of "advance previews" presented for retail clothing store executives and their employees can tell you quite a story about the results to be obtained from a really workmanlike job of sound motion picture production.

A Personal Investment combines a dramatic story of the ambitions and romance of a typical young officer worker with an "industrial" sequence (presented through the informed eyes of a retail clerk) of the Hart Schaffner & Marx tailoring shops. According to E. R. Richer, the Company's advertising manager, the picture is really proving out its title in no uncertain terms and if sales results are any criterion, you can add the words, *gilt-edged* to the *Investment!*

But suppose we let the "boys" in the field take it from here with a few interesting remarks from their reports:

Says A—M—"the talking movie is really something . . . everyone who has seen it is very enthusiastic . . ."

P—A—writes: "we had local theatre managers sit through the entire program. The manager in A—who operates four houses made this remark: "if your dealer could show this to a group of 200 men . . . 50 would buy your clothing . . . it's the most convincing piece of sales promotion I have ever seen."

Jack E—bulletins: "thought you should know that everyone we show the picture to just about

gasps with amazement at the wonder of our fine plant. It makes me feel proud to show the film and I would like to show it to every person I know just to let them see what a truly great organization I work for."

J—W—(a retailer) writes: "we had all our employees see the picture . . . a natural and I'm sure it will help all of us in the clothing business . . . thanks to you."

From all over the selling field, company representatives found the film winning new friends among retailers. Sociable after-hours meetings brought clerks, store executives and salesman into closer cooperation. The realization that a great deal of effort and money had been expended to give him the benefit of truly unusual sales technique seemed to spur the retailer on to real enthusiasm. "You've got something there" is the watchword wherever *A Personal Investment* hits the screen.

Similar comments and increased orders in the field have been received almost daily during the period of advance dealer showings. Salesmen sent in the report form (illustrated on this page) for hundreds of request showings to be held under the auspices of local retailers this fall. The Company is also showing the picture in the theatre of the "Man-His Clothes, His Sports" building at the New York World's Fair.

But the best line in this brief yarn belongs to an ace Hart Schaffner and Marx field salesman who tagged his report to Advertising Manager Richer . . .

"Yours for more pictures . . ."



ROMANCE BLOOMS IN *A PERSONAL INVESTMENT* AND (below) the tailor's skillful fingers at work.

PRODUCED BY CARAVEL FILMS, INC. NEW YORK

Recent Honors Won by Commercial Films

1. "for the best institutional motion picture on the subject of traffic safety"
—as established by the C. I. T. Safety Foundation

1938 AWARD

"KNIGHTS OF THE HIGHWAY" Produced for the Chevrolet Motor Division of the General Motors Corp. by The Jam Handy Organization.

2. "for the best example of advertising by public utility operating companies . . . during 1938.

The Premier Award by the Public Utilities Advertising Association Dept. of the Advertising Federation of America.

"THE STORY OF A HOUSE" Produced for the Public Service Electric and Gas Company of New Jersey, by Audio Productions, Inc.

STORE NAME.....

- Showed the movie to the dealer.
- Showed the movie to the dealer and his salesmen.
- Am coming back at a later date to show picture to his salesmen.
- This is one of my major accounts (has 15 salesmen or more); would suggest the house arrange to show this picture to entire group of salesmen at special meeting next fall.
- Dealer wants film for consumer showing at later date. Please contact him when film is ready.

SALESMAN.....

• EVERY TIME a Terminix salesman gets a name on the dotted line two separate and distinct sales have been closed. The first (and often the most difficult) is selling the property owner on okaying a free inspection of his home or building for termites. The second — when termites are found — is selling the prospect on his need for Terminix Insulation (chemical protection of a structure against termites). To further complicate the salesman's job there is the widespread lack of knowledge on the part of the public about the termite problem, the activities of a multitude of "racketeers" in the termite control field, and the extreme intangibility of the service to be sold.

It is obvious that the Terminix salesman needs all the sales aids he can get. The most effective one we have yet found is a two reel 16mm. sound motion picture, *Hidden Enemies*. This picture, narrated by Lowell Thomas, depicts the life and habits of termites, has microscopic shots of the insects in their nests in the ground, gaining access to the wood in buildings, and damaging it beyond repair. The part that Terminix and its scientific control methods play in the fight against these destructive insects is graphically portrayed. The thoroughness of the Terminix method of control is strikingly presented in some detail, and to maintain interest and continuity there is a coherent plot throughout.

Some idea of the organization of the Terminix system is necessary to get a clear conception of what our problems were in the use of this motion picture. The nationwide Terminix Organization is composed of 56 independently owned companies which are licensed to apply the termite control chemical Terminix. These Licensees are located throughout the 36 states where termites are a serious problem. The Licensor of the Terminix Organization and manufacturer of Terminix is E. L. Bruce Co., better known as the world's largest maker of hardwood floorings. The Terminix Division of Bruce derives its income from the sales of the chemical, Terminix, to its exclusive Licensees. Bruce maintains a corps of field representatives to supervise the treating work of the Licensees. Bruce's advertising department is at the service of the Terminix Licensees, and the advertising and sales program of the organization is mapped out by Bruce. However, Bruce does not attempt to dictate to Licensees what types of advertising they should use, but develops and prepares ideas and sales helps and then "sells" the Licensees on their use. From this particular angle our situation is similar to that of a manufacturer having independently owned and managed dealers.

With this set-up in mind you can see that our direction of the use of a new motion picture (produced for us in 1936) was going to be a difficult problem — especially since none of us had the slightest experience with industrial movies. However, we sold about two-thirds of our Licensees on the possibilities of *Hidden Enemies*, furnished them prints (each paid a



By Harvey Creech

share of the production costs), arranged for projectors for them, gave them a few suggestions, and sat back to await further developments.

We also furnished Licensees a supply of "Record of Showings" cards, requesting them to fill in these cards in duplicate for each showing made, keeping a copy and sending us one. The cards, filled out, gave us a complete record of each showing — along with some information later found to be not particularly relevant. The card asked for the date and time, name of group seeing picture, city where it was shown, how showing was obtained, number in audience, number each of men, women and children, reaction, and names of operator and salesman. The back of the card left plenty of white space under the heading "Remarks", with the suggestion, however, that such information as what literature was distributed, number of inspections received, etc., be given.

As these cards were returned by the various Licensees, often with supplementary letters, we began to assemble valuable information about the methods of showing the picture, methods of obtaining showings, the literature that tied in best, the types of audiences that were most productive of inspection requests, the use of contests and prizes and scores of other ideas, good, bad and indifferent.

To broadcast these ideas, along with suggestions of our own, to our 56 Licensees, and to maintain enthusiasm in the use of *Hidden Enemies*, we created a special bulletin form "Terminix Movie Bulletin", sending it out at frequent intervals. In addition to practical ideas, in connection with obtaining showings, making the showing, etc., this bulletin carried inspirational messages, such as details of exceptionally good results obtained by some Licensee, suggested publicity stories, news of our special promotional work on the picture (such as a mailing to all garden club presidents and the featuring of our film in a Bell & Howell national magazine ad), suggestions for better use of equipment — in brief, anything pertaining to *Hidden Enemies*.

For about a year and a half "Terminix Movie Bulletins" went out on the average of every ten days. Since then we have slowed down on sending them out but still use them whenever we have a real message to tell about the film. We

found this regular bulletin invaluable in stimulating our Licensees to more and better use of the picture. In addition to passing on to them ideas of real merit it served as a constant reminder to each of them that the picture was going strong as a lead and sales producer for other Licensees and encouraged all to use the film more intensively. Every user of industrial movies can use a similar promotional bulletin to his organization with profit. Our experience has been that much more value is received from a standardized, special bulletin dealing with movie promotion only than simply including this information in regular sales bulletins. Ours is a simple letterhead size, one page mimeograph job, the writing and production of which require only an hour or so a week.

Naturally, at the beginning our Licensees made most of their showings of *Hidden Enemies* before groups that were most easily reached. Consequently, most of the early showings were made before schools, luncheon and civic clubs, women's organizations and other similar groups. While these showings provided mass audiences at a very low cost and undoubtedly were most effective from a purely publicity standpoint, they produced little in the way of immediate tangible results. Most luncheon clubs and organizations of a social or civic nature do not allow "commercialism" at their meetings, and therefore the Licensees were not able to explain their free inspection service and ask members of the audience for permission to inspect their properties. However, they were usually able to get a list of the people present, which they used very effectively in direct mail and personal follow ups. Solicitation of these names, incidentally, produces above ordinary cold canvassing far in excess of the cost of making the showings, and compares favorably with actual leads obtained from other sources. The school showings were purely for the purpose of education and fostering good will, of course, and little attempt to secure sales from them was made. However, a surprising number of sales did originate indirectly from this source; some jobs being sold later for treating the schools, others coming from teachers who had attended the showings, and still others coming from home owners whose children had unknowingly done a selling job on their parents on the dangers of termite infestation and the need for an inspection, as a result of seeing the picture.

Showings of this kind must be regarded as purely promotional in nature, and any attempt to measure in dollars and cents the results obtained from them is apt to be discouraging where most types of products are concerned. In our business, however, we have found that this type of showing is definitely worth while; one job sold will pay for the cost of ten or more such showings. Incidentally, sales have been made which could be traced directly back to the prospect seeing our picture more than a year before.

Large group showings are still an important part of our motion (Please turn to Page 31)

Successful

FILM SALESMANSHIP

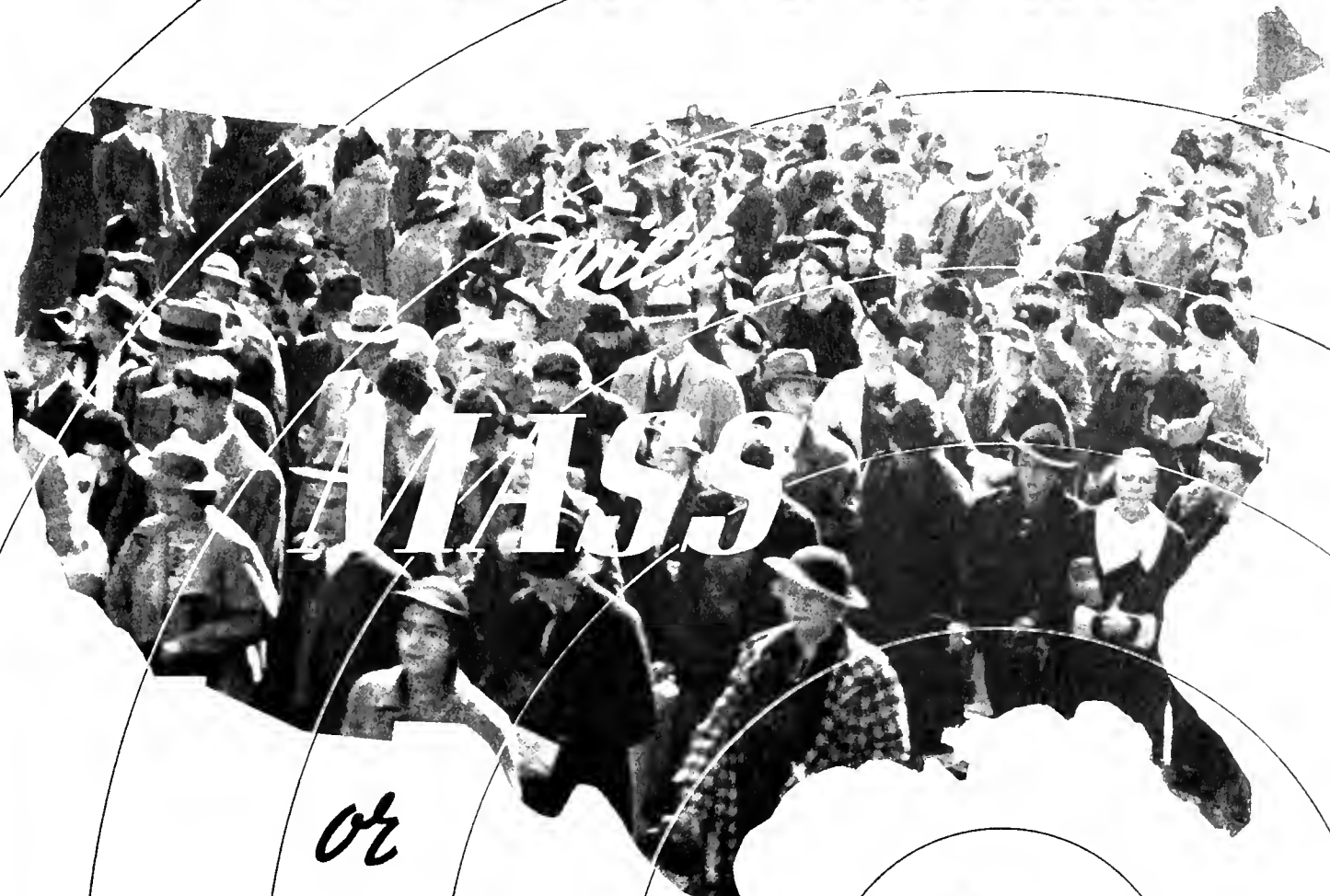

or

SELECTIVE



NATIONAL DISTRIBUTION



MODERN TALKING PICTURE SERVICE, INC.
9 ROCKEFELLER PLAZA (An Independent Organization) NEW YORK CITY

Local or National Service from 73 Cities



The Perfect Medium

DESERVES PERFECT PRESENTATION

The talking motion picture permits your message to be checked and rechecked for perfection, so that it is without flaws or omissions, and the variations of the human element to which every salesman is subject.

Your film, perfectly edited for tempo and purpose, deserves a perfect showing which involves three factors:

- ✔ **GOOD AUDIENCE**
- ✔ **GOOD EQUIPMENT**
- ✔ **GOOD OPERATOR**

Modern provides perfect showings by providing these three factors.

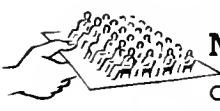

MODERN'S AUDIENCES are hand-picked from past experience. Modern's bookers solicit only those audiences which meet the client's best interests.



MODERN'S EQUIPMENT is new and up-to-date, most of it especially designed. It arrives at the showing in excellent mechanical condition always complete with spare lamps, tubes and other consumable items.



MODERN'S OPERATORS are courteous and well-mannered, with years of technical skill and experience. They are familiar with the auditoriums in their areas, they arrive promptly and anticipate unusual conditions requiring special equipment or extra set-up time.

Ordering a "Modern" film performance is assurance of a perfect presentation of your film message. Modern is as well organized and equipped to render perfect service in film distribution as you are to produce your product or to render your service in your field of activity.

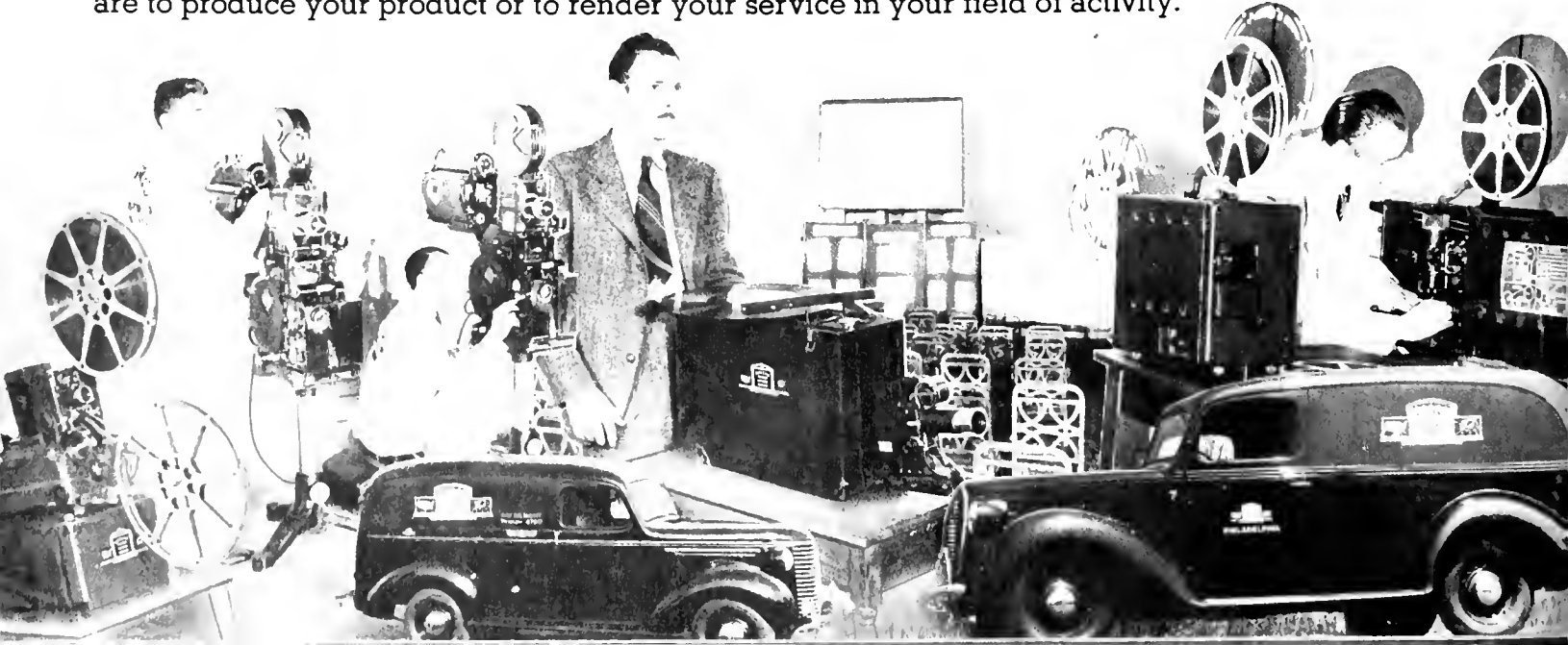

Four Primary Channels of Distribution for Sponsored Motion Pictures

WHEN AN advertiser applies the forcefulness of commercial motion pictures, he usually has in mind the improvement of public relations, the creation of consumer acceptance for his product or services, the education of users in the proper use of the product or the training of dealers, salesmen, or trade groups.

In order to assure results, the finished film must be seen by "prospects" for the advertiser's products or ideas. The right audiences are reached by predetermined selection from the four primary channels of sponsored film distribution which are:

- | | |
|-----------------------------|---------------------------|
| 1. Club Showings | 3. Theatrical Circulation |
| 2. Dealer Training Showings | 4. School Circulation |

Modern Talking Picture Service throughout the nation provides uniformly economical efficient facilities for all four channels of sponsored film distribution. These are described in detail below and on following pages.

1 Club Showings . .

THIS TYPE of distribution is subject to a high degree of control because you select your own circulation, city by city, class by class, or by age or sex, or all of them combined. The showings are made to those Service Clubs, Parent-Teacher Associations, Church Auxiliaries, Women's Clubs, Commercial and Fraternal Organizations, High Schools and Colleges, or whatever audiences you have specified. These people represent the leaders in thought and opinion in their respective communities. They are the Joneses that others strive to keep up with.

For reaching these audiences Modern provides established booking contacts, projection equipment, screens and operators in each of the 73 principal market areas shown on the map on the next page.

THIS TABLE INDICATES THE COVERAGE MODERN CAN SECURE WITH CLUB SHOW DISTRIBUTION

Modern is geared to give you the same control and keep you as well informed as if it were a department of your own company. In addition, Modern prepares all exploitation and publicity material including art and copy. From its wide experience Modern knows what approach in exploitation will give your picture the maximum acceptance. Modern provides advance notice to your home office and to your field organization of all showings, and obtains complete signed reports classified by sex and age which are combined into certifications listing all shows and giving complete breakdown of audience figures. Modern gives you this higher quality circulation and more effective showings at lower cost.

On a Modern club showing you are well represented by trained men who arrive on time, are courteous in the distribution of any tie-up literature or samples and experienced in proper assembly and operation of the up-to-date 16mm. projection equipment and 6 x 8 ft. or larger screen, which Modern uses. Good showmen make your film a real experience to your audiences.

The proper film length for club shows averages 45 minutes on the screen (for shorter messages Modern sells ten, twenty, or thirty minutes with non-competitive sponsors). Direct advertising is permissible.

NON-THEATRICAL CIRCULATION

IN THE 732 cities and towns of over 5,000 in which it operates club showings, Modern has listed 46,230 available audiences with national affiliations. These are summarized by types in the following table:

General Women's Groups

Parent-Teacher Associations	5,655
Federated Clubs	2,842
Order of Eastern Star	1,867
Rebekah Lodges	992
Total Women's Groups	11,356

Churches

(Women's Groups and Men's Groups)

Catholic	4,193
Episcopal	1,871
Lutheran	2,561
Methodist	2,257
Presbyterian	1,760
Synagogues	1,398
Total Number of Churches	14,040

General Men's Groups

Masons	2,738
Elks	367
Knights of Columbus	549
American Legion	1,002
Total Men's Groups	4,656

Service and Commercial Groups

Rotary	385
Lions	284
Kiwanis	439
Chambers of Commerce, Boards of Trade, etc.	1,030
Total Number of Service & Commercial Groups	2,138

Total Number of Outlets . . . 32,190

ADULT WOMEN'S AUDIENCES	25,396
ADULT MEN'S AUDIENCES	20,834
TOTAL POSSIBLE AUDIENCES	46,230

• The above figures are summarized from Modern's copyrighted survey, copies of which are available to interested sponsors upon request.

Projection Service Keyed to the

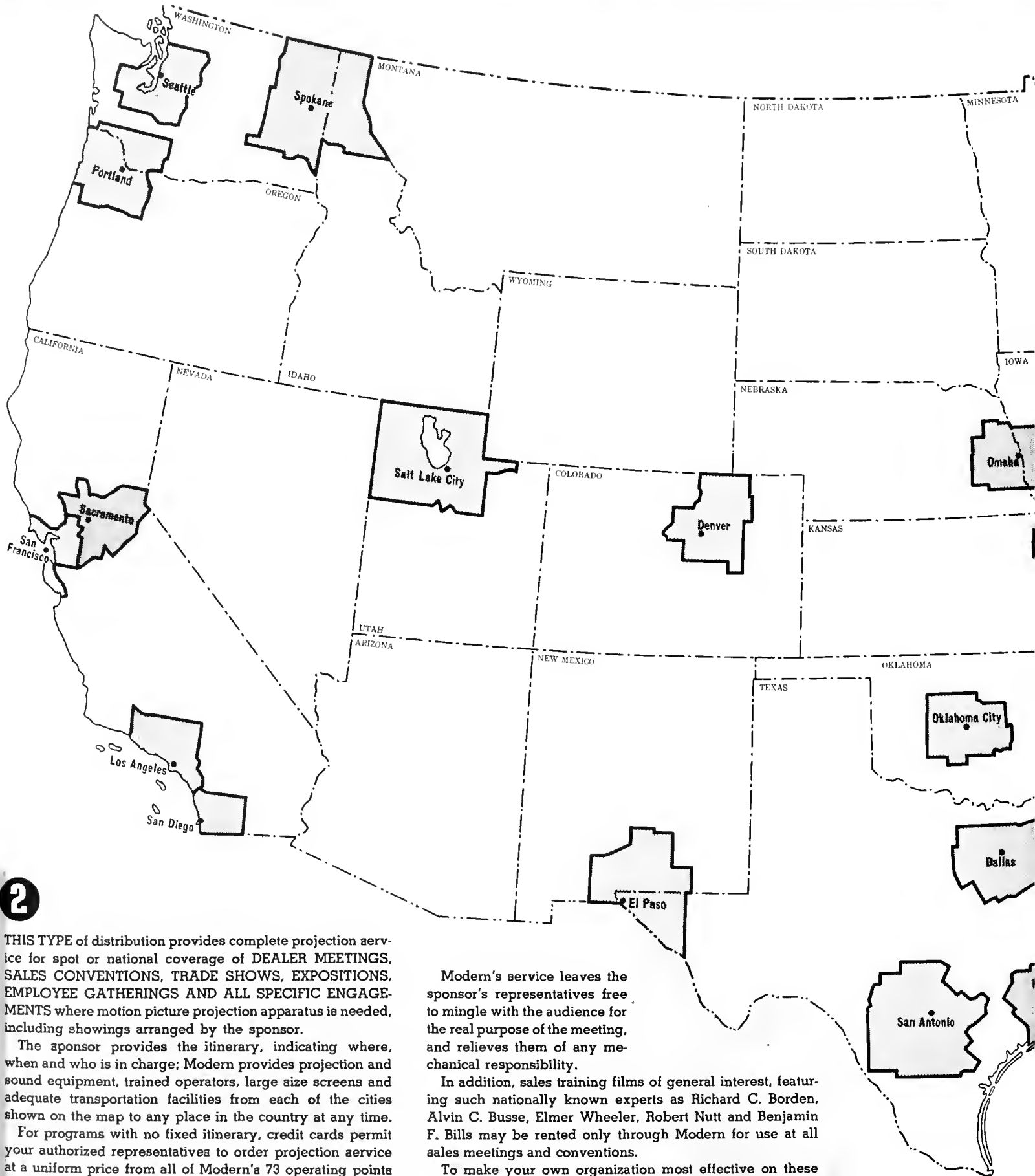

2

THIS TYPE of distribution provides complete projection service for spot or national coverage of DEALER MEETINGS, SALES CONVENTIONS, TRADE SHOWS, EXPOSITIONS, EMPLOYEE GATHERINGS AND ALL SPECIFIC ENGAGEMENTS where motion picture projection apparatus is needed, including showings arranged by the sponsor.

The sponsor provides the itinerary, indicating where, when and who is in charge; Modern provides projection and sound equipment, trained operators, large size screens and adequate transportation facilities from each of the cities shown on the map to any place in the country at any time.

For programs with no fixed itinerary, credit cards permit your authorized representatives to order projection service at a uniform price from all of Modern's 73 operating points as required.

Modern's service leaves the sponsor's representatives free to mingle with the audience for the real purpose of the meeting, and relieves them of any mechanical responsibility.

In addition, sales training films of general interest, featuring such nationally known experts as Richard C. Borden, Alvin C. Busse, Elmer Wheeler, Robert Nutt and Benjamin F. Bills may be rented only through Modern for use at all sales meetings and conventions.

To make your own organization most effective on these occasions, GO MODERN for unflinching projection satisfaction.

ation's Most Prosperous Areas.



Scale of Miles
0 50 100 150 200
Copyright American Map Co., Inc., N. Y. - 1939

PRINCIPAL RETAIL MARKET AREAS

56% of all retail sales in the United States are made in 2,329 of all United States counties (73 counties of 3,671). In the table below, taken from Rand McNally's Commercial Atlas, these 73 counties are listed in five classes. Each class represents 10% of the total retail sales of the country. Opposite the name of each county is listed the city from which Modern provides service. The table shows how Modern completely blankets this more profitable half of all American Retail Sales.

Class	County	Operating City
1.	Cook, Ill.	Chicago
	New York, N. Y.	New York
	Los Angeles, Calif.	Los Angeles
	Suffolk, Mass.	Boston
	Wayne, Mich.	Detroit
2.	Kings, N. Y.	New York
	Philadelphia, Pa.	Philadelphia
	San Francisco, Calif.	San Francisco
	Baltimore City, Md.	Baltimore
	Jackson, Mo.	Kansas City
3.	St. Louis City, Mo.	St. Louis
	Essex, N. J.	Newark
	Queens, N. Y.	New York
	Cuyahoga, Ohio	Cleveland
	Allegheny, Pa.	Pittsburgh
4.	Alameda, Calif.	San Francisco
	Denver, Colo.	Denver
	Fairfield, Conn.	New Haven
	Hartford, Conn.	Hartford
	New Haven, Conn.	New Haven
5.	District of Columbia	Washington
	Essex, Mass.	Boston
	Middlesex, Mass.	Boston
	Worcester, Mass.	Worcester
	Hennepin, Minn.	Minneapolis
Butler, Pa.	Newark	
Montgomery, N. Y.	Rochester	
Westchester, N. Y.	New York	
Hamilton, Ohio	Cincinnati	
Multnomah, Ore.	Portland	
Providence, R. I.	Providence	
Harris, Tex.	Houston	
King, Wash.	Seattle	
Jefferson, Ala.	Birmingham	
San Diego, Calif.	San Diego	
Fulton, Ga.	Atlanta	
Lake, Ind.	Chicago	
Jefferson, Ky.	Louisville	
Orleans, La.	New Orleans	
Providence, R. I.	Providence	
Bristol, Mass.	Springfield	
Hampden, Mass.	Springfield	
Franklin, Mass.	Springfield	
Franklin, Mich.	Grand Rapids	
Genesee, Mich.	Detroit	
Ramsey, Minn.	Minneapolis	
Tougal, Neb.	Omaha	
Bergen, N. J.	Newark	
Passaic, N. J.	Newark	
Union, N. J.	Newark	
Albany, N. Y.	Albany	
Nassau, N. Y.	New York	
Cattaraugus, N. Y.	Syracuse	
Franklin, Ohio	Columbus	
Lucas, Ohio	Toledo	
Madison, Ohio	Youngstown	
Stark, Ohio	Canton	
Summit, Ohio	Cleveland	
Oklahoma, Okla.	Oklahoma City	
Tulsa, Okla.	Tulsa	
Berks, Pa.	Reading	
Lackawanna, Pa.	Scranton	
Lawrence, Pa.	Scranton	
Shelby, Tenn.	Memphis	
Brazos, Tex.	San Antonio	
Falls, Tex.	Texas	
Tarrant, Tex.	Ft. Worth	
Salt Lake, Utah	Salt Lake City	
Henrico, Va.	Richmond	

▲ Map Showing the 73 Areas in Which Modern's Circulation of Sponsored Films will be Conducted During the 1939-40 Season. Within 25 miles of these 73 operating centers there are 732 cities of over 5,000 population. Within 50 miles of these 73 operating centers there are 1108 cities of over 5,000 population.

Operations in cities in parenthesis () are not yet established.
It should be noted that Modern provides complete service in 25 additional market areas not included in the above analysis. (from the Supplemental "Distribution of U. S. Pop. & Retail Sales", City Year Book, Mc-Nally & Co., Commercial Atlas & Marketing Guide, Key Subjects & License Number 2225.)

3

Theatrical Circulation

THE MOTION picture theatre imposes strict requirements upon the sponsored film and offers in return large general circulation at very low cost. This circulation may be either national or regional. In the theatre, sponsored films must compete with Hollywood's best shorts in entertainment and interest value, and must contain no direct advertising. The best industrial producers have the finesse to create films which meet these requirements while actively generating good public relations and consumer acceptance for the sponsor. Modern has the facilities for effectively placing these films in good theatres.

Modern, in supplying broadsides and exploitation materials and in providing advance notice of play dates, per-

mits the sponsor to obtain the greatest merchandising value for his outlets. This is a complete Modern service, including the preparation of copy, art work, press showings and previews for chain bookers. Publicity and exploitation is also carried on through the trade papers. Modern has booking and distribution facilities in the recognized film exchange cities.

All theatrical films are 35mm. Ten minutes is the best length, although longer and shorter films can be handled.

Modern has proven its leadership by distributing those sponsored pictures which have reached the broadest theatrical circulation and is fully experienced and qualified to handle your distribution.

4

School Circulation

5,000 SCHOOLS are now equipped to show 16mm. sound films, according to the best estimates. Of these, 3,500 have registered with Modern to receive educational industrial films. The best acceptance is accorded those films which contain genuine educational value.

Modern supplies all exploitation material including art and copy. Modern arranges editorial cooperation in educational periodicals. Modern makes the bookings and provides the sponsor with advance notices. Modern also takes care of shipping and inspection and obtains signed

reports from which it prepares consolidated certifications listing each booking and the size of each audience.

The sponsor may control the age groups by selection from grade schools, high schools and colleges. The sponsor may also specify whether his bookings are to be made nationally or only in selected regions.

Modern's complete school booking service permits the industrial sponsor to reach this vast, rapidly maturing audience with maximum effectiveness and minimum cost.

SOME TYPICAL EXAMPLES of ACTUAL DISTRIBUTION PLANS



● Household Finance Corporation sponsored "A New Adventure" (Sam Handy) and "An Evening With Edgar Guest" (Sam Handy) to women's audiences exclusively over a period of four years. Modern has given 2,752 of these showings.



● Weyerhaeuser Sales Company sponsored "Trees and Men" (Dowling & Brownell) in a ten minute version to 3,000 theatres, average audience of 1,900, and in a 45 minute version to 1,200 club audiences averaging 217 each. After the club showings, the 45 minute prints were booked in 1,050 high schools, having their own equipment.



● National Association of Manufacturers sponsored "America, Yesterday, Today & Tomorrow" (Audio), "Men and Machines" (Audio), "Frontiers of The Future" (Audio) and "America Marching On" (Audio) in 13,709 theatrical showings to a total audience of 22,981,500 people. All four films are black and white and run 10 minutes each.



● Hiram Walker, Inc., sponsored "Keeping Nature On Its Course" (Wilding Picture Productions) to 3,000 adult male audiences, 4,000 of which have been staged. This program was released to predetermined outlets in selected markets.

MODERN'S CIRCULATION CONTROLS

MODERN HANDLES routines so smoothly that no time is lost in keeping you and your field offices informed of bookings as they are made, and of all figures after the showings occur.

Advance Notices

Modern uses a separate notice for each show so that distribution to field men is easy. Copies are distributed according to your instructions for each area.

Date, time, show location, organization and person in charge are given for club showings; location and play dates for theatrical and educational film bookings.

Show Reports

Signature of organization chairman, theatre manager, or school director certifies as to showing and audience size. On club shows, Modern's operator also certifies count and breakdown of audience by men, women, boys and girls.

Certification of Showings

Certifications summarize and tabulate the individual show reports so that showings or bookings may be analyzed with a minimum of effort. Certifications are rendered monthly or by numerical groups of shows as ordered by sponsors.

PROMOTION MATERIAL DISTRIBUTED TO BUILD AUDIENCES

MODERN DESIGNS and produces literature to assist in booking sponsored films at no extra cost. This literature is extremely high-grade and attractive two-color printing. It reflects credit to the sponsor and aids in securing larger audiences and local publicity notices.

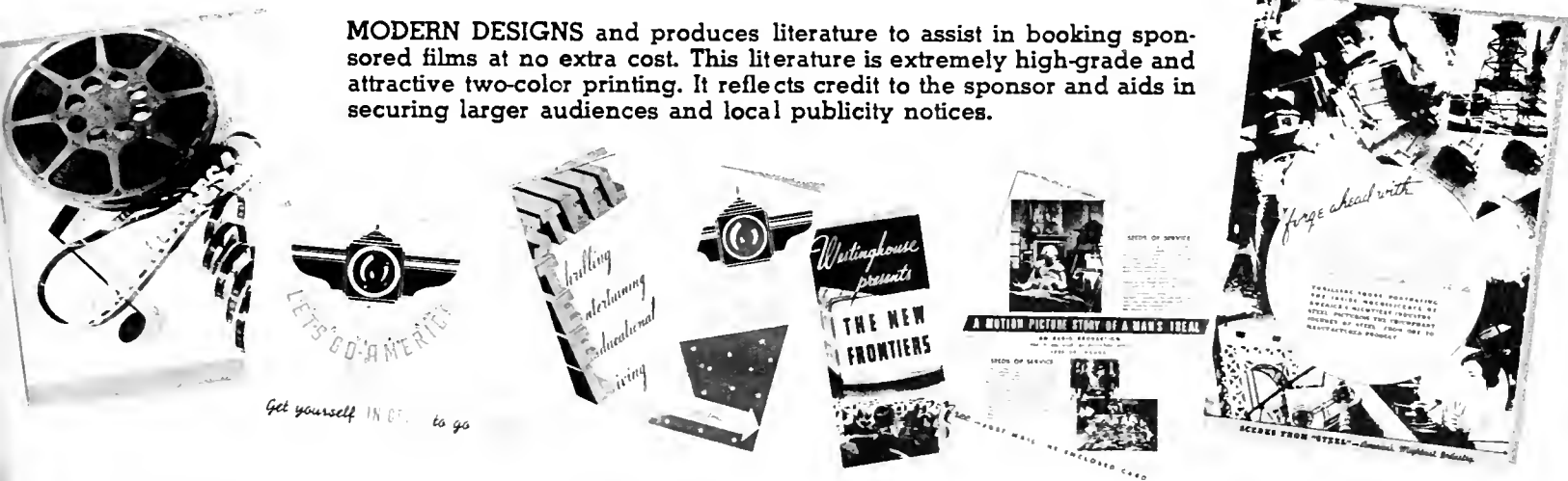

IF YOU HAVE A TALKING PICTURE

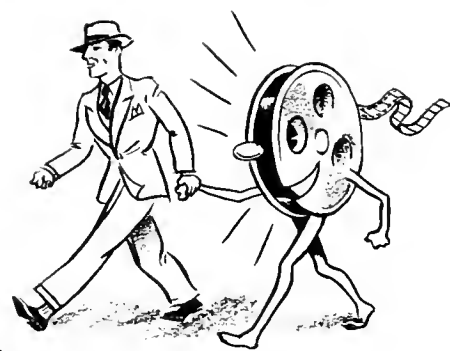

IF YOU ARE CONSIDERING



A TALKING PICTURE



IF YOU



**HAVE A PRODUCT IN SEARCH
OF A BIGGER MARKET**

IF YOU ARE AN ADVERTISING AGENT

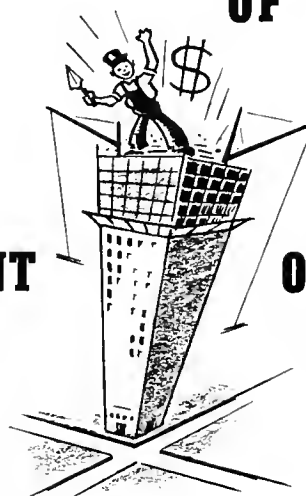

**OUT TO BUILD
SALES FOR CLIENTS**

**THEN YOU NEED INFORMATION ON HOW MODERN'S FILM DISTRIBUTION
ADAPTS ITSELF TO YOUR SPECIFIC PROGRAM. WE WILL BE GLAD TO CONFER
WITH INTERESTED ADVERTISERS, THEIR PRODUCERS OR THEIR AGENTS**

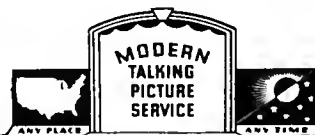

TRADE-MARK REG. U. S. PAT. OFF.

MODERN TALKING PICTURE SERVICE, INC.

9 ROCKEFELLER PLAZA (An Independent Organization) NEW YORK CITY

Local or National Service from 73 Cities

TERMINIX

(Continued from Page 22)

picture program. They are inexpensive and easy to make and there is no denying their ultimate results. Our Licensees no longer have to go after such showings now as they did in the early days of our use of *Hidden Enemies*. Most of them are usually sought out for as many such showings as they are able to or care to make, without any effort on their own part. Our most successful results from *Hidden Enemies* have been, however, from two totally different methods of presenting the picture. While they are particularly effective for us because of the nature of our business they can likely be adapted to most other businesses which can profitably use motion pictures in consumer promotion work.

The first of these plans is basically: the showing of our picture before hand picked audiences to obtain immediate requests for inspection of homes for termites. The plan, as it is carried out by most Licensees, works this way: The Licensee contacts the leader of a Sunday School class, missionary society, or other church group which is continually faced with the necessity of raising money for its treasury. He offers the group a small amount of money — usually \$5.00 for arranging a showing of *Hidden Enemies* at which there will be present a specified number of home owners. Licensees differ in the number they ask for, but the minimum is 15 and the maximum never more than 30. The group leader is required to handle all the details of arranging the showing: providing the place, contacting those he wants to be present, etc. So after contacting the group leader the Licensee can forget all about the showing until the time comes.

On the night of the showing the Licensee arrives at the appointed place early and sets up his equipment. After his audience has assembled he starts the program by making a brief educational talk in which he explains what termites are, the damage they do, and the position his company and E. L. Bruce Co. hold in the field of termite control. Then he shows the picture. At the end of the picture he again makes a brief talk, building up the value of a Terminix inspection. To conclude his talk he announces that his company will be glad to inspect the homes of all those present for termites, and that one of his men will call the next

week to make the inspection. Notice this angle — he doesn't ask that all who want their properties inspected raise their hands, or see him later or sign cards; he calmly announces that one of his men will be around the next week to give them a free inspection. And so well does *Hidden Enemies* sell the audience on the menace of termites and the benefits of finding out in time whether or not their properties are infested that when the inspectors go around the next week they are granted permission to make inspections of the homes of five out of six of the property owners attending the showing.

The percentage of termite infestation varies in different parts of the country, so it is impossible to say what is the average number of "hot prospects" (homes which are termite infested) out of the inspections received from one of these showings. One Licensee, however, closes an average of one and one-half sales from each such showing — within a week or so. Since his unit of sale ranges from \$100 all the way up to \$500 his \$5 investment certainly pays dividends.

It is interesting to note that this presentation plan has evolved from a number of ideas used by various Licensees and passed on to the whole organization through the "Terminix Movie Bulletin."

The third standard method of using *Hidden Enemies* is the plan of using it in direct selling. After a salesman has obtained permission to make an inspection, has made it, and has found termites, his real selling job begins. Although he has already sold his prospect on the danger of termite damage and the urgent need of doing something about it, his prospect is still quite hazy about the destructive way in which termites work and the complete and complicated steps that are necessary to control them. He is apt to regard them in the light of other household pests such as roaches, flies, etc., and therefore can't understand why the job of insulating his house against them should cost possibly several hundred dollars. He is particularly shocked by the price when he recalls that his neighbor down the street had his termites "eradicated" for \$20 by the local jack-of-all-trades, equipped with a couple buckets of creosote and a garden spray gun.

So at this point our salesman calls upon *Hidden Enemies* to give his prospect a visual idea of how termites attack his house and what

(Please turn to next Page)



This New DeVRY
LOW-PRICED
PROJECTOR
Has Everything!

MODEL "Q"
SINGLE CASE
SILENT OR SOUND
PROJECTOR
Ready for Operation

DeVry engineering ingenuity comes to the fore once again with this revolutionary new LOW PRICED

MODEL "Q" SINGLE CASE
16 mm. SOUND PROJECTOR

The Model "Q" combines into a smaller space EVERYTHING that's BEST of the costlier DeVry models to give YOU PROFESSIONAL SPARKLE in pictures and sound ANYWHERE, ANYTIME and at a MOMENT'S NOTICE. EVERYTHING to make it easier for YOU to profitably employ the most powerful of all sales tools . . . "Talking" Pictures or silent films, black and white or colored, at much LOWER COST.

THIS IS IMPORTANT — The Model "Q" is not just another ordinary projector "built down to a price", but like all other DeVry products a Quality, precision projector.

The Model "Q" affords you the utmost in mechanical and optical perfection; brilliant, flickerless, sharp, detailed pictures, pleasant, natural clarity of tone with ample volume for 500 people or less, (booster amplifier available for larger groups) simplicity and economy of operation in addition to lightness, compactness and LOW PRICE.

May we offer you, too, the full benefits of a time tested line of projection equipment supplemented by free consultation and advice.

MODEL "Q" PROJECTOR comes complete with built-in amplifier, dynamic speaker, motor, 1600 ft. capacity reel, necessary accessories and cords . . . ALL IN ONE CASE weighing less than 50 lbs., — at the extremely low price of \$310.00

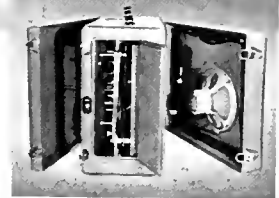

ABOVE, the Model "Q" with its easily detachable self-contained speaker. EASY to set up — a child can do it.

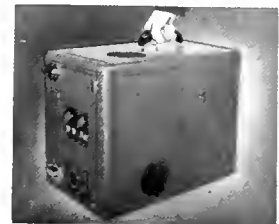

ABOVE, the Model "Q" all packed away in its compact, lightweight, easily portable, yet sturdy case. Note accessible control panels.

COMBINATION UNITS

DeVry Projectors Have ALWAYS been Decided For the Addition of COMBINATION UNITS.



A MICROPHONE may be placed in to provide loud speaker facilities.

A PHONOGRAPH TURNTABLE also adds in to furnish music for silent films, etc.

ADDITIONAL AMPLIFIER may also be placed in to provide volume for larger auditoriums.



Write Now: DeVRY CORP.
2111 Armitage Ave.
Chicago, Illinois
for complete information without obligation on the new DeVry Model "Q" Single Case 16mm. Sound Projector.

Name _____
Company _____
Address _____
City _____ State _____

(Established 1913)

DEVRY CORPORATION

Factory and
1111 ARMITAGE AVENUE
New York



Main Office
CHICAGO, ILLINOIS
Hollywood

Cable: HERMDEVRY

SIREN!

A Burton Holmes Theater
"Short" produced for the
Wisconsin Conservation
Department

• Forest fires, caused by human carelessness, destroy thousands of valuable timber lands every year. Lives are lost, farms are burned and wild life made homeless.

Recognizing public education as the best means of prevention, the Wisconsin Conservation Department now employs motion pictures as an important part of its educational program. A Burton Holmes "Short"; SIREN has been widely circulated throughout Wisconsin theaters.

Not only general public relations but also the training of salesmen, jobbers, dealers and servicemen are now being improved for large and small business sponsors by Burton Holmes motion pictures and slide-films.

Address Business Films Department:



YOUR NEXT FILM

Whether your next motion picture or slidefilm has an educational, training, or selling message, Burton Holmes experience and facilities are at your service. Years of experience in the field of commercial film production, with many outstanding successes, are yours to employ in raising sales or increasing employee efficiency.

Burton Holmes Films, Inc.

7510 North Ashland Avenue • Chicago, Illinois
PRODUCERS • DISTRIBUTORS • LABORATORY SERVICE

PACK 'EM IN WITH

★
**BING
CROSBY**
★

★
AT YOUR
SPONSORED SHOWS
★

Build Attendance by
Adding Star Value to
your Programs



3 Famous Groups of "Showmanship Shorts"
starring

MAJOR BOWES ★ BING CROSBY

★ **DONALD NOVIS** ★

ALL IN 16mm SOUND

Play them with your commercial pictures and watch the attendance grow! Preview prints sent on request.



COMMONWEALTH PICTURES

729 Seventh Avenue • New York

TERMINIX

(Continued from Page 31)

must be done if they are to be stopped. Here is the way he usually goes about it: He makes an evening appointment at the home of the prospect at a time when both husband and wife can be present. He tactfully suggests that neighbors be barred, because he does not want this showing of the picture to be regarded as entertainment. Arriving at the prospect's home he sets up his equipment then launches into his sales talk. Much of the details can be omitted, however, because they will be brought out much more forcibly in the picture a few minutes later. Then he turns out the light and shows the picture. Immediately after the showing is over he asks for the order, answers objections, asks for the order again—and gets it more times than not.

The method of using our picture for straight selling is becoming more and more popular with our Licensees, and with their salesmen. Many of the Licensees have bought extra projectors for the use of their men, and some salesmen who are particularly enthused about this sales tool now own their own equipment.

There is one other angle that should be covered in a description of our use of this motion picture. That is publicity—both the publicity we have obtained for *Hidden Enemies* and the publicity it has obtained for us. Through the aid of the producer and other sources we now have *Hidden Enemies* listed in a number of film catalogues going to schools and other groups. Since we are not particularly interested in mass distribution we have not deposited our film with any professional booking agencies, although we have listings and prints on file with several school visual aid bureaus and college extension agencies. We have also been able to place our film on the approved list of such organizations as the Junior Chamber of Commerce and the Garden Clubs sponsored by *Better Homes and Gardens Magazine*, and have had listings in bulletins issued by these organizations. Also we have obtained and used freely testimonial letters from both national and local officers of such organizations as Rotary, Kiwanis, and Civitan. "Plugs" in our two house organs, one of which goes to members of the building industry, the other to Terminix customers and prospects, have been responsible for many

showings of the picture.

The unusual subject matter of our picture has also been responsible for much publicity. Particularly in small towns, the showing of *Hidden Enemies* before some local organization earns big space news stories, giving us valuable general publicity as well as promoting additional showings of the picture. From time to time we have furnished our organization publicity stories on the movie, and they have placed them in local newspapers with success.

Excluding direct sales showings, on which we rarely get reports, our organization has made more than 2000 showings of *Hidden Enemies* before a total audience of approximately 180,000. We roughly estimate sales resulting directly from this source at more than \$750,000. How many hundreds of thousands of dollars worth of sales have been influenced by this invaluable advertising and sales medium we do not even attempt to guess.

The NEW FILMS

(Continued from Page 19)

♦ A new medium for selling mass air travel is now on view in *The American Way*, motion picture produced for American Airlines, Inc., by Wilding. The film was introduced as the finale of the airline's annual sales convention at Chicago's Palmer House in June and shown at other sales meetings throughout the country.

To introduce *The American Way* to the audience, which consisted of travel agents, editors, publishers, customers and guests from other air lines, a short preliminary motion picture was used.

This short pictured C. R. Smith, president of American Airlines, Inc., who introduced other executives of the company. The narration in the picture is by Charles A. Rheinstrom, Vice President and General Sales Manager, who explained the purpose of *The American Way*.

The picture's purpose is to help those who sell air transportation and those who are buying it. It shows clearly how air transportation is purchased and all details of actual flight in one of the airline's flagships. The handling of tickets, baggage, food service, life aboard a Skysleeper, all are woven into the theme of the picture. The characters are typical of the thousands who daily use air transportation. The central character is a little old lady making her first flight.

BUSINESS SCREEN

PRESENTS THE

1939 EQUIPMENT REVIEW

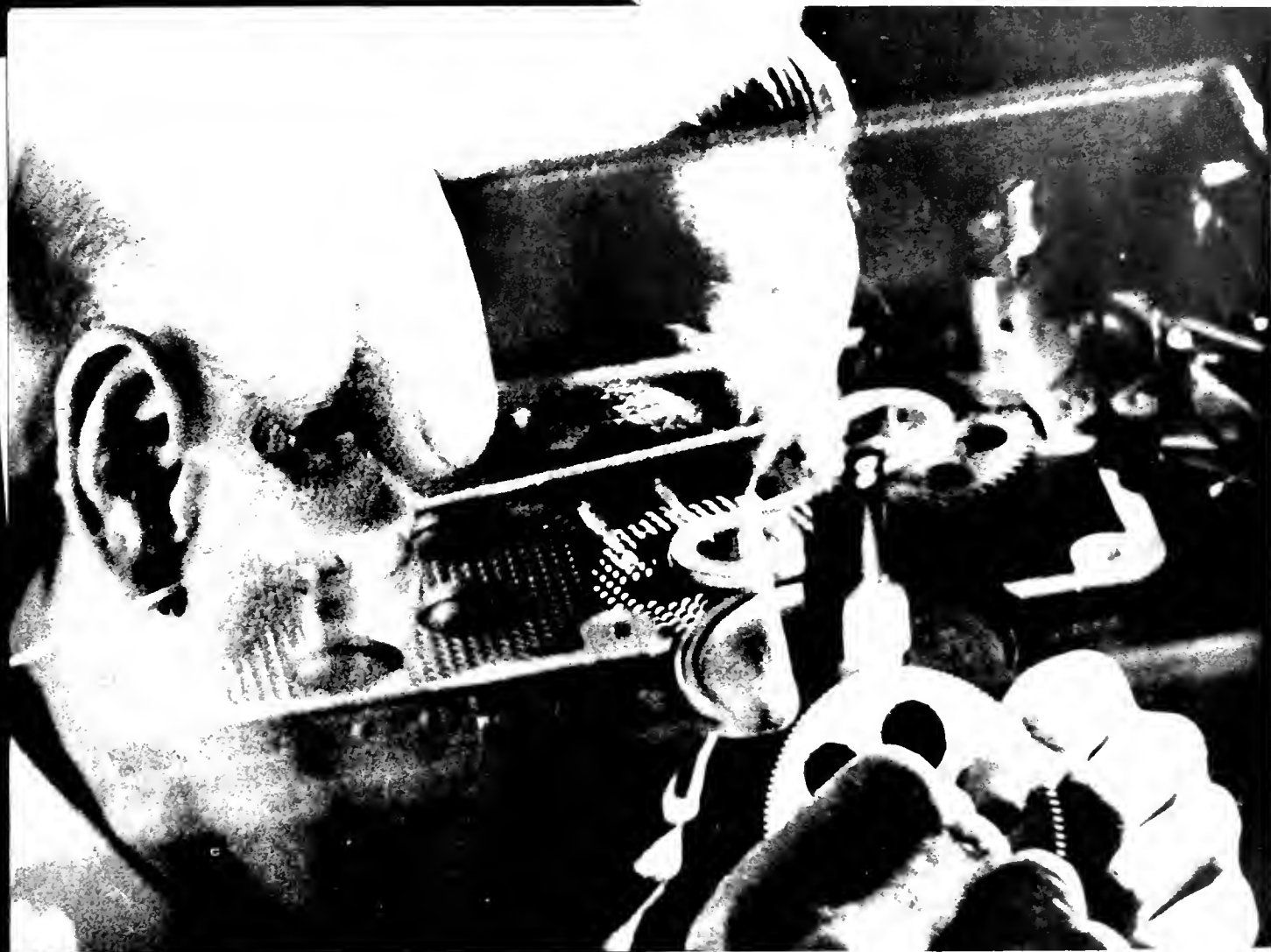

**THE COMMERCIAL & EDUCATIONAL FILM USER'S
FIRST ANNUAL GUIDE TO EQUIPMENT & ACCESSORIES**

SOUND PROJECTION

16mm. Motion Pictures

AMPRO CORPORATION

2339 North Western Avenue

Chicago, Illinois

★ Precision workmanship and simple excellence of design have distinguished the 16mm. Sound-on-Film and Silent Projectors manufactured by The Ampro Corporation. Industrial school and organization may choose a full line of models constructed to meet the special needs of various kinds of users. An unconditional guarantee against defective material and workmanship is offered. (The guaranty for lenses, lamps and tubes is set by manufacturers of these items.) All models are complete with operating accessories.

◀ Amprosound Model "X" & "Y"

Model X capacity, 1600 feet sound film only. Permanently attached reel arms . . . Equipped with A.C. motor and 8-inch dynamic speaker with permanent magnet field, complete in one case . . . Operates on 100-120 volts, 60 cycles A.C. Use with 300 watt converter equipped with constant speed governor on D.C. current . . . Model Y capacity, 1600 feet sound or silent film. Permanently attached reel arms . . . Equipped with Universal motor and 12-inch dynamic speaker with permanent magnet field, complete in two cases. Also available in one case with 8-inch speaker . . . Operates on all cycles A.C. Use with 150 watt converter or amplifier only for D.C. current . . . Both models have 2-inch focal length F1.65 objective lens. Additional charge for F1.65 lens. Other sizes from 1-inch to 4-inches . . . Operates with standard pre-focused base . . . 750-1000 watt projection lamp . . . Centralized and illuminated control panel . . . Automatic rewind. Pilot light. Automatic fire shutter. Centrifugal fan cooling system. Tilting device . . . Sound drum and filter mounted on precision ball-bearings. Pre-focused exciter lamp . . . Amplifier has 7 1/2 watts undistorted output . . . Microphone and phonograph receptacle . . . Model YS with reverse and still picture button available . . . Approved by Underwriters' Laboratories . . . Licensed under Western Electric and R.C.A. patents . . . Listed under Fair Trade Agreement . . .

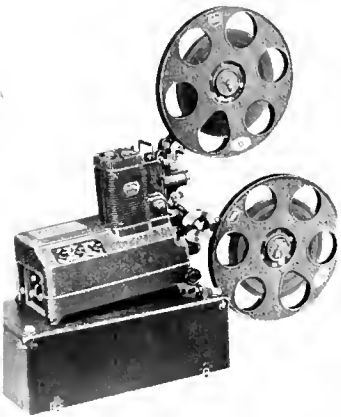

◀ Amprosound Model "U"

Capacity, 1600 feet sound or silent film . . . Permanently attached reel arms . . . Standard 750 watt or under projection lamp . . . Projector operates without converter on D.C. or 25 to 60 cycles A.C. . . . Amplifier operates on 50-60 cycles A.C. current only. For D.C. use 150 watt converter . . . 2-inch focal length F1.65 objective lens. Interchangeable with 1-inch to 4-inch lenses . . . Button control for "still" projection with automatic safety shutter. Reverse switch. Automatic rewind. Speed control knob. Motor has grease sealed ball-bearings. Pilot light is operated by switch. Centralized control panel. Adequate cooling system. Projector tilting device . . . Sound drum and filter mounted on precision ball-bearings. Pre-focused exciter lamp . . . Amplifier has 15 watts undistorted output; ample power for seatings up to 1500. Speech tone control with speaker-hiss eliminator. 12-inch auditorium speaker with extra jack for multiple speaker operation. Acoustical adaptation . . . Microphone and phonograph receptacle. Microphone switch for silent films . . . A two case unit . . . Approved by the Underwriters' Laboratories . . . Licensed under Western Electric and R.C.A. patents . . . All projector features listed for silent models are included in the Amprosound Model "U" . . .

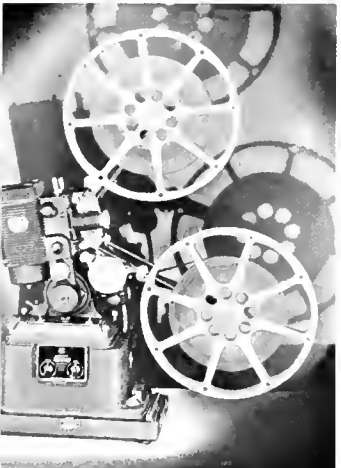

◀ Amprosound Model "UB"

Same as Model "U". Includes sound proofed "blimp" case for extreme quietness of operation . . . Capacity, 1600 feet sound or silent film. Permanently attached reel arms . . . Standard 750 watt or under projection lamp . . . Projector operates without converter on D.C. or 25 to 60 cycles A.C. . . . Amplifier operates on 50-60 cycles A.C. current only. For D.C. use 150 watt converter . . . 2-inch focal length F1.65 objective lens. Interchangeable with 1-inch to 4-inch lenses . . . Button control for "still" projection with automatic safety shutter. Reverse switch for both silent and sound film. Automatic rewind. Speed control knob. Motor has grease sealed ball-bearings. Pilot light is operated by switch. Centralized control panel. Adequate cooling system. Projector tilting device . . . Sound drum and filter mounted on precision ball-bearings. Pre-focused exciter lamp . . . Amplifier has 15 watts undistorted output; ample power for seatings up to 1500. Speech tone control with speaker-hiss eliminator. 12-inch auditorium speaker with extra jack for multiple speaker operation. Acoustical adaptation . . . Microphone and phonograph receptacle. Microphone switch for silent films . . . A two case unit . . . Approved by the Underwriters' Laboratories . . . Licensed under Western Electric and R.C.A. patents . . . All projector features listed for silent models are included in the Amprosound Model "UB" . . .

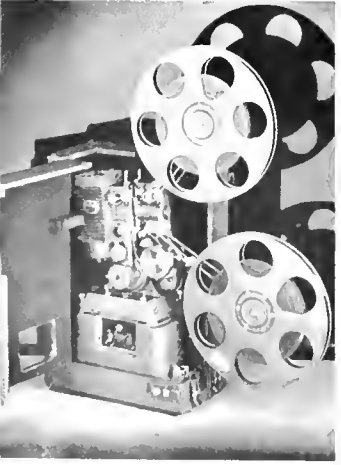

◀ Amprosound Model "N"

Capacity, 1600 feet sound or silent film . . . Standard 750 watt or under projection lamp . . . Projector and amplifier operate without converter on both D.C. or 25 to 60 cycles A.C. . . . 2-inch focal length F1.65 objective lens. Interchangeable with 1-inch to 4-inch lenses . . . Button control for "still" projection with automatic safety shutter. Reverse switch for both silent and sound film. Automatic rewind . . . Speed control knob . . . Motor has grease sealed ball-bearings. Pilot light is operated by switch. Centralized control panel. Blower type cooling system. Projector tilting device . . . Sound drum and filter mounted on precision ball-bearings. Pre-focused exciter lamp . . . Amplifier has 10 watts undistorted output; ample power for seatings up to 1000. Speech tone control. Acoustical adaptation. 12-inch auditorium speaker with extra jack for multiple speaker operation . . . Microphone and phonograph receptacle. Microphone switch for silent films . . . A two case unit . . . Approved by the Underwriters' Laboratories . . . Licensed under Western Electric and R.C.A. patents . . . Listed under Fair Trade Agreement . . . All projector features listed for silent models are included in the Amprosound Model "N" . . .

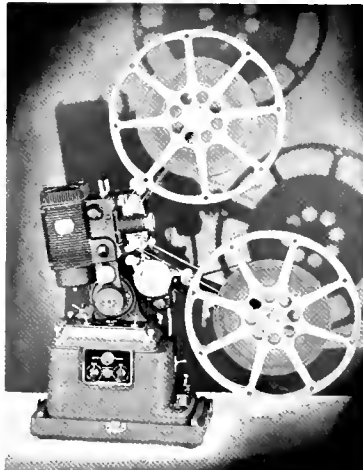

◀ Amprosound Model "NB"

Same as Model "N". Includes sound proofed "blimp" case for extreme quietness of operation . . . Capacity, 1600 feet sound or silent film . . . Standard 750 watt or under projection lamp . . . Projector and amplifier operate without converter on both D.C. or 25 to 60 cycles A.C. . . . 2-inch focal length F1.65 objective lens. Interchangeable with 1-inch to 4-inch lenses . . . Button control for "still" projection with automatic safety shutter. Reverse switch for both silent and sound film. Automatic rewind . . . Speed control knob . . . Motor has grease sealed ball-bearings. Pilot light is operated by switch. Centralized control panel. Adequate cooling system. Projector tilting device . . . Sound drum and filter mounted on precision ball-bearings. Pre-focused exciter lamp . . . Amplifier has 10 watts undistorted output; ample power for seatings up to 1000. Speech tone control. Acoustical adaptation. 12-inch auditorium speaker with extra jack for multiple speaker operation . . . Microphone and phonograph receptacle. Microphone switch for silent films . . . A two case unit . . . Approved by the Underwriters' Laboratories . . . Licensed under Western Electric and R.C.A. patents . . . Listed under Fair Trade Agreement . . . All projector features listed for silent models are included in the Amprosound Model "NB" . . .

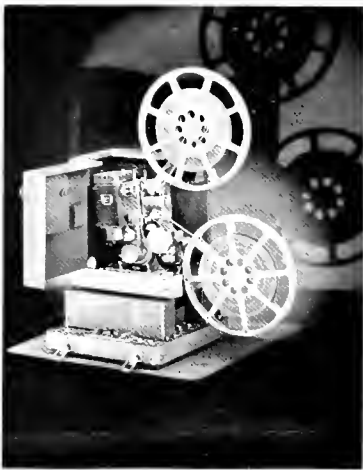

◀ Amprosound Model "L"

Capacity, 1600 feet sound or silent film . . . Standard 750 watt or under projection lamp . . . Projector operates without converter on D.C. or 25 to 60 cycles A.C. . . . Amplifier operates on 50-60 cycles A.C. only. 125 cycles available. For D.C. use 150 watt converter . . . 2-inch focal length F1.65 objective lens. Interchangeable with 1-inch to 4-inch lenses . . . Button control for "still" projection with automatic safety shutter. Reverse switch for both silent and sound film . . . Automatic rewind . . . Speed control knob. Motor has grease sealed ball-bearings. Pilot light is operated by switch. Centralized control panel. Adequate cooling system. Projector tilting device . . . Sound drum and filter mounted on precision ball-bearings. Pre-focused exciter lamp . . . Amplifier has 10 watts undistorted output with two speakers; 20 watts with single speaker. Ample volume for seatings up to 3000. 12-inch auditorium speaker with extra jack for multiple speaker operation . . . Microphone and phonograph receptacle, with complete mixing for sound from film, microphone and phonograph. While projector is in use for silent film, amplifier and speaker can be used separately for microphone talk . . . A two case unit . . . Approved by the Underwriters' Laboratories . . . Licensed under Western Electric and R.C.A. patents . . . Listed under Fair Trade Agreement.

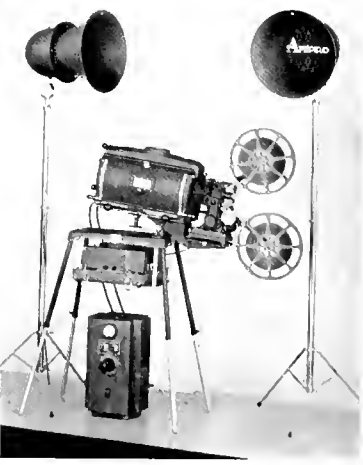

◀ Ampro-Arc Model "AA"

Capacity, 1600 feet sound or silent film. Permanently attached swivel reel arms . . . High intensity type lamp house. Carbons have minimum capacity of 30 amperes at 28 volts. Screen illumination, 650 lumens (minimum). Motor driven carbon feed. Automatic safety device to disconnect arc when lamp house door is open. Full wave rectifier . . . Projector and amplifier operate on 100-125 volts, 50-60 cycles A.C. . . . Standard 3-inch F2 lens. Other sizes available . . . Triple claw movement. Automatic safety shutter. Pilot light. Automatic rewind. Motor has grease sealed ball bearings. Manually operated rheostat for variable speeds 16 to 24 frames per second. Forced-air cooling . . . Projector stand has swivel attachment and tilting device. Collapsible . . . Sound drum and filter mounted on aeroplane type ball-bearings. Pre-focused exciter lamp . . . Amplifier has 10 watts undistorted output with two speakers. Maximum output of 50 watts. Separate volume controls for sound film, microphone and tone . . . Two steel torpedo permanent magnet type speakers. Mounted on tripods . . . Microphone and phonograph receptacle, with complete mixing for sound from film, microphone and phonograph . . . Designed to conform with the requirements of the Underwriters' Laboratories . . . Licensed under Western Electric and R.C.A. patents . . .

BELL & HOWELL COMPANY

1801-15 Larchmont Avenue
New York Hollywood

Chicago, Illinois
London (B & H Co., Ltd.)

★ Since 1907 Bell & Howell's leadership in the manufacture of precision equipment for the studios of Hollywood and the world has been unquestioned. The Company's famed 16mm. Filmosounds are equally well known in the industrial and educational fields. Highest qualities of showmanship are obtained through uniformly brilliant pictures and high fidelity sound. In addition to its complete line of accessories and silent and sound projector models for every use, the famous Bell & Howell Filmosound Library is available with a wide selection of sound and silent film subjects.

◀ Filmosound "Commercial"

Capacity, 1600 feet of sound film . . . 750 watt projection lamp . . . 2-inch f2 lens. Two speed focusing. Other sizes available as optional equipment . . . Operates at 24 frames per second. Governor controlled, constant within 2% of rated speed. Motor powered, self-monitored rewind. Flexomatic sprocket guards. Metered lubrication. Helical gear drive. Forced-air cooling system . . . Film-protecting snubber . . . Side tension springs for film control at aperture . . . Amplifier with frequency range to 7000 cycles, removable as a unit. Noiseless hum-free type exciter lamp. Built-in oscillator. "Photo-hiss reducing" volume control. Full range tone control. Sound filter system with balanced rotary stabilizer. Electro-dynamic speaker, protected by metal grill and dustproof fabric . . . One-hand type tilt, with rack and pinion; four point suspension . . . Microphone input system . . . Operates on 100 to 125 volt, 60 cycle A.C. . . 25 to 60 cycle A.C. units available. Amplifier requires converter for D.C. current . . . Single case unit. Weight, 51 pounds . . . Finished in gray damaskene. Case finished in black fabricoid . . . Fully approved by Underwriters' Laboratories . . .

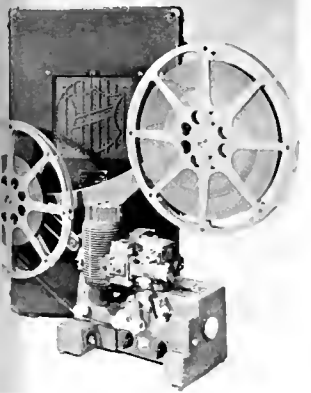

◀ Filmosound "Academy"

Capacity, 1600 feet sound or silent film . . . 750 watt projection lamp . . . 2-inch f2 lens. Lens lock. Other sizes available . . . Operates at 24 and 16 frames per second. Governor controlled . . . Motor powered rewind. Metered lubrication. Helical gear drive. Aerodual cooling . . . Amplifier with frequency range to 7000 cycles. Noiseless exciter lamp. Built-in oscillator. "Photo-hiss reducing" volume control. Rotary sound filter system. Electro-dynamic speaker . . . One-hand tilt, with rack and pinion; four point suspension . . . Microphone and phonograph input system . . . Operates on 100 to 125 volt, 60 cycle A.C. 25 to 60 cycle A.C. units available . . . In two cases. Sound-absorbing "blimp" case holds projector and amplifying unit. Combined weight, 64 pounds . . . Finished in gray damaskene. Cases in gray fabricoid . . . Approved by Underwriters' Laboratories . . .

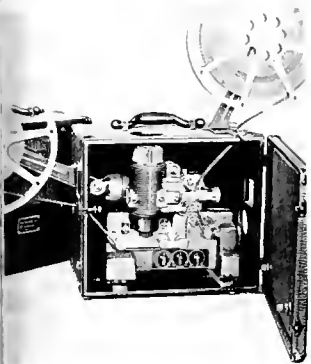

◀ Filmosound "Utility"

Capacity, 1600 feet sound or silent film . . . 750 watt projection lamp. Magnalite condenser . . . Fully corrected 2-inch f1.6 lens. Other sizes available . . . Operates at 24 and 16 frames per second. Governor controlled. Clutch for "still" projection. Reverse gear shift. Motor powered rewind. Metered lubrication. Helical gear drive. Aerodual cooling system . . . Amplifier with frequency range to 7000 cycles. Noiseless exciter lamp. Built-in oscillator. "Photo-hiss reducing" type volume control. Sound filter system. 12-inch electro-dynamic speaker . . . One-hand tilt, rack and pinion; four point suspension . . . Microphone and phonograph input system . . . Operates on 100 to 125 volts, 60 cycle A.C. 25 to 60 cycle A.C. available . . . In two cases. Sound-absorbing "blimp" case holds projector and amplifying unit. Combined weight, 70 pounds . . . Finished in gray damaskene. Cases in gray fabricoid . . . Approved by Underwriters' Laboratories . . .

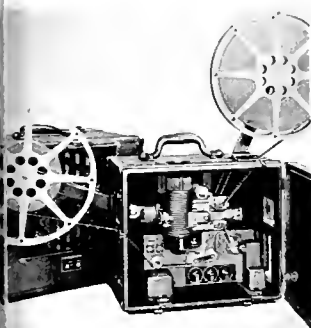

◀ Filmosound "Master"

Capacity, 1600 feet sound or silent film . . . 750 watt projection lamp. Magnalite condenser . . . Fully corrected 2-inch f1.6 lens . . . Operates at 24 and 16 frames per second. Governor controlled . . . Clutch for "still" projection. Reverse gear shift. Motor rewind. Metered lubrication. Helical gear drive. Aerodual cooling. Side-tension film movement . . . Amplifier has three audio stages. Noiseless exciter lamp. "Photo-hiss reducing" type volume control. Sound filter system. 12-inch electro-dynamic speaker . . . One-hand tilt, rack and pinion; four point suspension . . . Microphone input system . . . Operates on 100 to 125 volts, 60 cycles A.C. 25 to 60 cycle A.C. units available . . . Amplifier requires converter for D.C. . . . Adjustable optical slit assembly for reverse emulsion film . . . In two cases. Sound-absorbing "blimp" case holds projector and amplifying unit. Combined weight, 91 pounds . . . Approved by Underwriters' Laboratories . . .

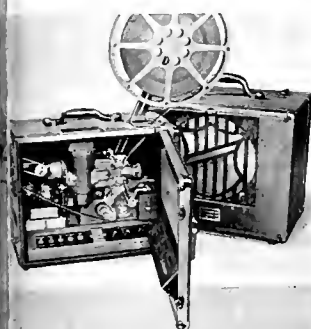

◀ Filmosound "Auditorium"

Synchronized change-over of reels

Capacity, 1600 feet sound or silent film . . . Provision for two projectors with instantaneous single-control change-over . . . 1200 watt projection lamp . . . Fast 2-inch f1.6 lens. Other sizes available . . . Operates at 16 to 24 frames per second. Separate motor for film take-up and rewind. Sealed motor lubrication. Built-in voltmeter. Variable resistance. Gear drive. Pilot light. Aerodual cooling and humidifier . . . Amplifier with 50 watt output for two speakers, 30 watts for single. Clutch for "still" projection. Permanent-magnet speakers . . . Two-way tilting device . . . Microphone and phonograph input circuit . . . Operates on 100 to 125 volt, 60 cycle A.C. . . Converter for amplifier required for D.C. . . . In three cases for semi-permanent installation. Unit can be had with one speaker and two projectors; two speakers and two projectors; one speaker and one projector and two speakers and one projector . . . Approved by Underwriters' Laboratories . . .

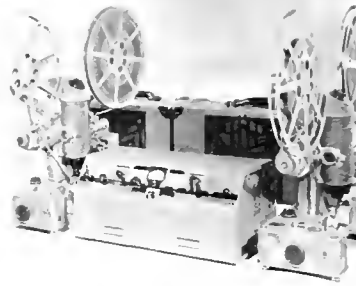

◀ Filmosound 16mm. "Arc"

Where theatre-brilliance is needed

Familiar Filmosound Projector features which appear again in the Filmosound include the B&H intermittent mechanism with its 9-to-1 ratio, the side tension method of registering film at the aperture, "floating film" protection, metered lubrication, and "Flexomatic" sprocket guards. Simplicity of operation and care have been skillfully provided for by the engineers. Both sound and silent (24 and 16) film speeds are provided, so that either type of film may be shown at the proper operating speed. Film reels as large as 1600-foot are accommodated. Film rewinding is done by a secondary electric motor, and without operating projector mechanism, projector motor, or arc lamp. Two Filmosound models are offered. One provides a roll-away stand which supports projector, amplifier, and rectifier. The other, more compact when packed for transportation, mounts the projector upon a stand having adjustable legs, while the amplifier rests upon a smaller stand directly beneath . . .

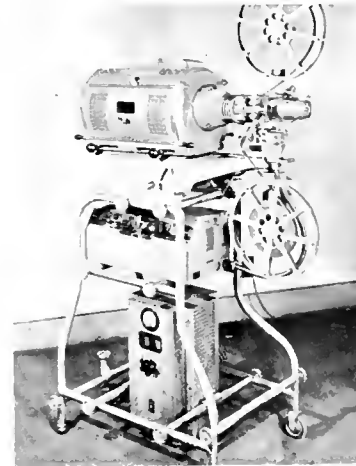

CLASSROOM LABORATORIES

100 East Ohio Street

Chicago, Illinois

★ A combination projector-amplifier-speaker unit is offered by this well-known educational supplier under the trade-name "The Soundmaster". Although a newcomer to the field of 16mm. sound projection, The Soundmaster is said to have been developed over a long period of careful research. Interested users are invited by the manufacturer to request a demonstration, particularly where acoustical problems exist.

◀ 16mm. Sound Projector—I

An all-purpose projector for audiences from 1 to 1,500. Incorporating modern refinements plus bright flickerless pictures and superior sound that are essentials to be considered in evaluating a sound projector. Very simple to operate due to development of every possible safety precaution, an easy tilting device, error-proof connections, progressive threading, the elimination of film crossovers, and the use of only two sprockets. 750 or 1,000 watt lamp, large barrel f1.6 super projection lens, 1,600 ft. film capacity. Built entirely from the ground up for sound, equipped from the first with dual sound stabilizers and automatic film adjuster . . .

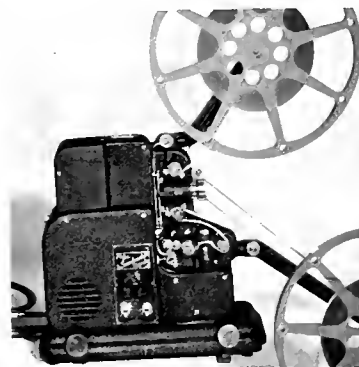

◀ Speaker and Amplifier—II

15 watt amplifier, 12 inch speaker, hiss eliminator, connection for microphone and phonograph. The amplifier unit is separate and when not in use fits into the speaker case, thus providing a public address unit in one case . . .



EDITOR'S NOTE

Because of changes in price, etc. it has been considered more practical to supply separate price sheet keyed to this section. Sent without obligation, simply address The Screen Service Bureau, Business Screen Magazine, 20 N. Wacker Drive, Chicago.

The DEVRY CORPORATION

1111 Armitage Avenue New York Chicago, Illinois
New York Hollywood

★ The name DeVry has been prominently identified with motion picture equipment manufacture for 26 years. Today, the Corporation is still under the leadership of its pioneer president, Herman A. DeVry and offers both 16mm. and 35mm. equipment for school, business and theatrical use. While the Company's name has always been synonymous with quality, prices are well in range with sound and silent models of similar capacities. The Sprocket Intermittent is a featured addition to recent 16mm. Sound Projector models. All accessories are available, as well as Public Address Systems, Sound and Silent Cameras and other Visual-Auditory products developed by the Corporation and Mr. DeVry.

◀ DeVry Model "Q"

The new low-priced sound projector

Model Q is a "single-case" projector with amplifier, dynamic speaker and projection equipment in one case, all weighing approximately 18 pounds. 1600 feet sound film capacity; folding reel arms for portability. The speaker is detachable. Mechanical equipment features synchronous threading . . . automatic film adjustment . . . filmslide operation . . . removable aperture plates and shockproof cushioned mechanism. Dual sound stabilizers and provisions for additional microphone and phonograph attachments are also available.

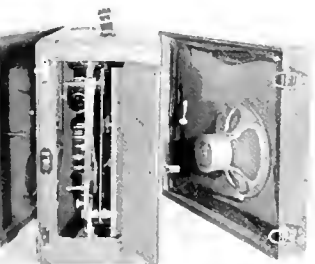
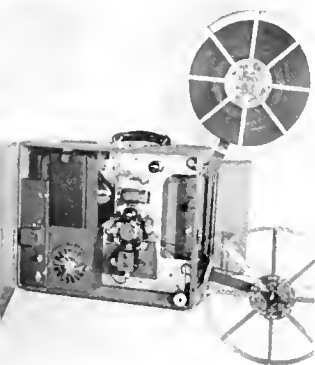

◀ Model "Q" (Front)

Compactness of the single case equipment is illustrated by the front view picture at left. "Model Q" offers ample volume for 500 people or less, simplicity of operation . . . economy, lightness and compactness. Additional amplifier and speaker supplied for larger auditoriums at nominal cost. Model "Q" projects both silent and sound films.

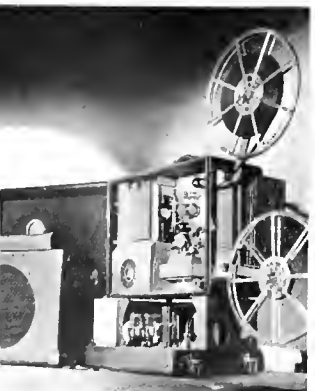

◀ DeVry "Interpreter"

Capacity: 1600 feet sound or silent film. Folding non-detachable reel arms. Speaker and amplifier in separate sound-proofed blimp case. Gray enameled finish. Weight: Projector and case, 14 pounds; amplifier, 36 pounds. 12 inch permanent magnet type speaker. Standard DeVry features: automatic (synchronous) threading of picture and sound; automatic film adjustment; filmslide operation; removable aperture plates and shockproof-cushioned mechanism. Standard equipment: 750 watt projection lamp. Interchangeable with 1000 and 1200 watt. 2-inch focal length F1.6 lens, interchangeable with 1 1/2 inch to 6 inch sizes. Governor controlled constant speed motor, speed control knob, centralized oiling, pilot light operated by switch, roller bearing type sprocket idlers. Centralized and illuminated control panel; built-in silent-sound switch with adjustable silent speed, tilting device. Amplifier has 20 watt output. Double exciter lamp socket, microphone and phonograph input system; tone and volume controls. Public address microphone jack equipped.

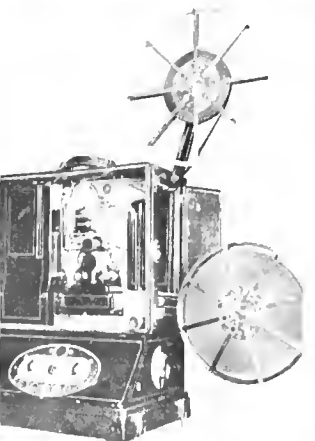

◀ DeVry Model "DeLuxe"

Capacity, 1600 feet, sound or silent film. The two-case "sprocket intermittent" deluxe 16mm. portable model of the DeVry line. Utilizes a "rotary-movement" for carrying film track, an exclusive DeVry feature. Illuminated control dials on amplifier; governor controlled (constant speed) motor. 750 watt illumination, forced type ventilation. Projection movement features roller idlers, continuous operation in oil, removable aperture plates with easy accessibility to all working parts and threading. Shockproof cushioned mechanism . . . simplified one shot oiling system. Reel arms fold into case, hook in door for extra reel. Total weight 99 pounds about equally divided-projector weight, 46 pounds; amplifier and speaker, 53 pounds. Regular amplifier, 20 watt output; facilities for public address microphone and phonograph attachment.

◀ DeVry 16mm. "Arc"

For "long-throw" and large audiences

The new DeVry 16mm. arc lamp sound projector is especially designed for auditoriums and business theatre use where length of the projection "throw", large audiences and auditoriums demand added theatre brilliance. Principal features include heavy duty "sprocket intermittent" movement, 1,000 feet film capacity . . . high intensity carbon arc capable of providing a 24 ft. image with a throw of 125 feet or more. Separate ventilating system and insulated discs between carbon and aperture eliminating heat resistance glass thereby increasing the intensity of the light on the screen. This gives DeVry Arc projector sufficient light for standard theatre projection.

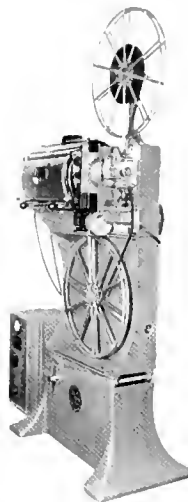

EASTMAN KODAK COMPANY

Rochester, New York

in all principal cities

Eastman Kodak Stores.

★ Only one 16mm. sound projector is manufactured by Eastman Kodak. However, the Sound Kodascope achieves new and higher standards of excellence as a reproducer of sound and motion pictures for home, industrial or educational use. Although priced higher than all standard makes now in general use, the Sound Kodascope undoubtedly meets the requirements of the user to whom price is no criterion. Wide range, great subtlety and realism were achieved by Kodak engineers who were instructed to produce the finest possible 16mm. sound projector, regardless of cost. Custom built, the Special may be adapted to meet specific requirements.

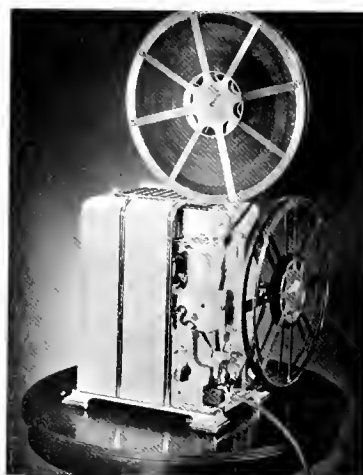

◀ Sound Kodascope Special

Capacity, 1600 feet sound or silent film. 750-watt biplane filament projection lamp (pre-focus base lamps may be used). Reflector, condenser and projection lenses designed to obtain highest efficiency. Ventilator fan mounted directly on motor shaft. Supplied with 2-inch, f1.6 lens. (For long throws, 1-inch, f1.6 lens available). Controls include: control lever which also actuates automatic loop formers . . . trial switch . . . focusing knob, tone control, speed shift button, sound optics shifting knob, volume control, framing screw, elevating knob, microphone (or phonograph pickup) jack and rewind lever. Rewind controlled by separate motor. Sound optics include variable focus for reversal or duplicate films . . . modulated beam flows to photoelectric cell through optical conductor . . . pre-amplifier with two tubes in projector . . . ruby signal window.



◀ Sound Kodascope-Case

With case closed, Kodascope Special measures sixteen inches high; eleven inches front to back and eight inches wide. Compactness aided by off-setting take-up reel which revolves parallel to front of projector. On rewinding controlled by separate motor, upper reel rotated into line with lower. Projector operates on 100-125 volt, 60-cycle A.C. current; D.C. operation with converter. Entire mechanism enclosed in cast aluminum case, rubber lacquer finish, chromium bands. Case may be entirely removed for inspection of the mechanism. Supplied complete with suitcase type carrying case, incidental accessories and 1600-foot reel.

VICTOR ANIMATOGRAPH CORP.

General Offices and Plant

Davenport, Iowa

★ For more than a quarter-century, the name Victor has been associated with great achievement in the non-theatrical motion picture industry. In 1939, pioneer Alexander F. Victor, president of the Victor Animatograph Corporation, presents an entirely new projector . . . the New Series 40 Projector, destined to be among the leaders when quality 16mm. sound equipment is judged.

Intense illumination, high sound qualities and compact portability are among the outstanding features of the Series 40. The new Add-a-Unit principal offers a full line of accessory equipment especially designed to match Series 40 Models. Cameras, lenses, stereopticons as well as specially adapted models of both sound and silent projectors are offered. Usual full guarantees apply.

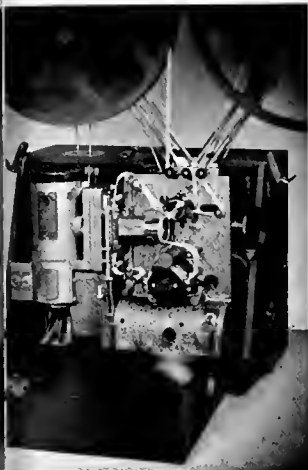

◀ Series 40 Animatophone

The newly-developed sound projector

Projector — Operating Speeds: Governed, 16-frame silent and 24-frame sound, on all models unless otherwise noted. Still Pictures: Safety shutter and shutter control knob provide for stopping film and projecting "tills" from single frames. Optical System: Victor High Efficiency Conza Condensing Lens System, and indestructible metal reflector permanently focused and precision aligned on optical axis. Projection Lens: 2" high-speed K1.6 standard equipment. Other focal lengths — 1 1/2" to 4" — interchangeable. Lamps: Standard pre-focused base . . . obtainable anywhere. Standard equipment: 750 watt, 1000 watt, and lower wattage lamps interchangeable. Switch provides for operating motor with lamp off. Cooling System: Victor "Spira-Draft" ventilation (see feature descriptions) provides perfect cooling of lamp house and prolongs lamp life. Motor: (Reversible) Universal AC-DC, VICTOR-G.E., with switch-operated, 2-speed governor. Take-up: Positive belt-drive, with film tension equalizer to prevent film damage. Gently but firmly winds film onto all size reels — 100 to 1600 feet. Rewind: Rapid, motor-driven (projector mechanism not in operation during rewinding) No shifting of reels necessary before rewinding.

◀ Animatophone-Case

Shown closed, ready for transportation

SOUND UNIT — Sound Lens: Special formula — highly corrected — with precision light slit. Unusual depth of focus insures maximum quality with Kodachrome as well as black-and-white. Microscopically set and sealed for correct, permanent adjustment. Photo Cell: Special, in pre-focused base, mounted in vibrationless rubber. Adjustable voltage control insures peak performance at all times and on all voltages (90 to 125). Exciter Lamp: Pre-focused G.E. T-8, 5 volt, 6 1/2 Ampere VICTOR Special. Filament construction and exceptional beam-intensity of this exciter are important assets to high quality reproduction . . .



Case — "Blimp." Leatherette-covered. Sturdy, rust-proof hardware. Unit entirely ENCLOSED during operation. Amplifier — Basic amplifier (5.8 or 15 watts output, depending on model) is built into case with projector. Any output of up to 55 watts may be obtained by selecting Add-a-Unit equipment to give power desired . . .

+ Integral Speaker

By the simple addition of an integral speaker, the basic Victor Animatophone Projector becomes a complete, compact sound projection outfit adequate for class rooms, homes, sales meetings, etc. UNIT B (recommended only for small room use with the basic Model 10A Projector. Separate 12" or 15" speakers should be used with greater amplification in larger rooms). Unit H affords unusual compactness and great convenience in portability as it makes an "all-in-one" sound unit. Permanent magnet type, equipped with 50 ft. attachment cord. Case is protected by mesh grille with special Duyston finish. Size: 3 3/8" x 9 1/2" x 15 1/4". Weight 6 1/2 pounds . . .

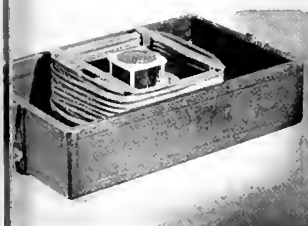

+ Amplifier

The addition of an amplifier to the basic Victor Animatophone Projector provides an outfit with maximum output power suitable for largest auditoriums or outdoor applications. AMPLIFIERS are assembled in attractively finished sheet metal housings and are enclosed in sturdy leatherette-covered cases with grille covers. Snaps onto bottom of projector case. Lid Top may be added for carrying Amplifier separately. Frequency Range: 10 to 10,000 cycles. Overall Gain: 120db. Safety Fuse: 3-Ampere, radio type. Control: Volume, Tone, Microphone-Phono mixer. Speaker Sockets: For 12" or 15" speakers. Power Sockets: A.C. input supplies power to amplifier and projector, and A.C. output socket provides power for turntable or other electrical accessories. Attachment Jacks: See specifications on different models. When amplifier is used as separate P.A. system, photo-cell jack may be used to accommodate turntable.

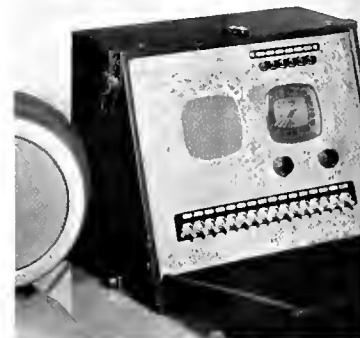
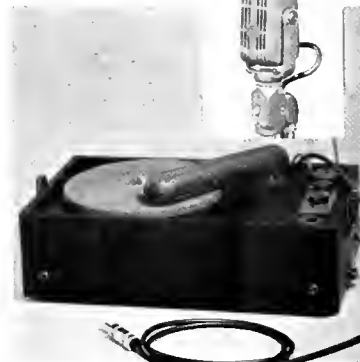

+ Multiple Speaker

By the addition of one or more speakers the basic Victor Animatophone Projector becomes a convenient, small, light weight, sturdy sound projector outfit adequate for auditorium use or public address system. Separate Add-a-Unit speakers 12" and 15" may be used with 40A or 10B Animatophones, with or without extra amplification. Type: Special high fidelity permanent magnet with impedance transformer and matching switch with settings for 1, 2, 3, and 4 speaker operation. Case: Acoustically treated, leatherette-covered, affords maximum baffle, 1600' reel compartment, and attachment cord rack. Speaker cone protected by grille. Attachment Cord — 100 feet, 2-wire cable with two male plugs . . .

+ Public Address System

When desired the Victor Animatophone Sound Projector outfit may be converted into a public address system by the addition of a microphone . . .

+ Record Turntable

The addition of a record turntable adapts the Victor Animatophone for teaching music appreciation, voice, speech, language or dancing, or when used with other Add-a-Unit equipment furnishes music for large assemblages indoors or on outdoor locations . . .

+ Central Radio System

When desired a central radio public address sound system may be added to the basic Victor Projector and other Add-a-Unit equipment to provide a complete central sound system adequate for relaying radio broadcasts, phonograph record reproduction, and microphone announcements to as many individual rooms as desired . . .

A recording unit suitable for making clear, full-toned and inexpensive transcriptions, is available as a part of Victor Add-a-Unit equipment. Details on application . . .

Other Animatograph Models: Especially adapted to various types of commercial and educational showings. Information will be furnished on request by the Company.

OTHER LINES of EQUIPMENT:

Manufacturers of portable 16mm. Sound Projection Equipment not represented in the above pictures are included herein:

HOLMES PROJECTOR COMPANY, 1813 Orchard Street, Chicago, Illinois offers the Holmes 16mm. Sprocket Sound-on-Film Projector. This new low-priced four-in-one equipment includes the sound projector, a public address system; silent projection and an electric turntable addition. The complete equipment for this model weighs but 58 pounds. A special Holmes rear picture shutter, adjustable aperture gate; decimittent sprocket movement, straight sound aperture, high fidelity sound lens and 10 watt amplifier are specified. The manufacturer enjoys a national reputation for projector excellence. Standard theatre projectors (35mm.) are also manufactured.

UNIVERSAL SOUND PROJECTORS are manufactured by the Sentry Safety Control Corporation, 1921 Oxford Street, Philadelphia, Pa. A showroom is maintained at 1600 Broadway in New York City where a full line of Universal 16mm. Sound-on-Film Projectors is displayed. A new all-purpose model, precision built and completely flexible to the varied demands of business and classroom use is now offered.

OTHER SOUND MANUFACTURERS and Service Agencies include Andre DeLrie, Inc., 115 West 15th Street, New York City; Paent Engineering Corporation, 79 Madison Avenue, New York City; S. O. S. Cinema Supply Corp., 636 Eleventh Avenue, New York City, and the Weber Machine Corporation, 59 Rutter Street, Rochester, New York.

SOUND PROJECTION

35mm. Motion Pictures

The DeVRY CORPORATION

1111 Armitage Avenue New York Chicago, Illinois Hollywood

★ DeVry Theatre Projectors and the useful DeVry field 35mm. portable are widely used where 35mm. projection is at all possible. Particularly is this true in the headquarters theatre-auditorium such as many business concerns now have and in the projection of films before large audiences such as conventions.

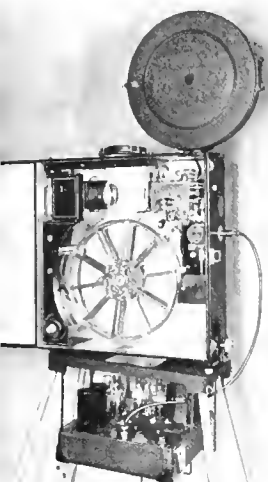

◀ DeVry 35mm. "Portable"

Field showings on theatre-size film

For road-showings or for business and educational auditorium projection of 35mm. (theatre-size) films where a conveniently-portable projector is necessary, the redesigned and improved DeVry Model ESF with a 2,000 foot capacity magazine is widely used. Features Geneva movement for film track . . . automatic tension . . . double, self-locking idlers . . . steel head, rubber-insulated . . . perfectly aligned optical system . . . forced ventilation . . . automatic takeup. Projection lens, 5" (interchangeable with other focal length lenses). Soundhead: with exciter lamp, photo-cell, factory-matched to a 20-watt Model "D" amplifier; furnished complete with tubes, speaker, cord, pilot lamp and plugs. Built in two sturdy cases with weight distributed for easier carriage. 1,000 foot capacity magazine optional.

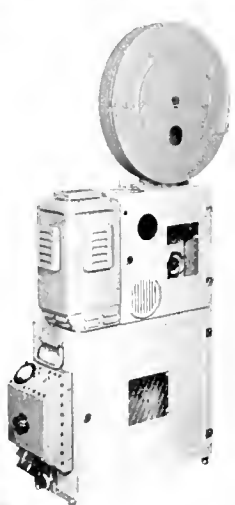

◀ DeVry 35mm. "Semi-Portable"

Featuring the silent chain drive

The DeVry semi-portable theatre projector with 2,000 foot magazine capacity features the regular DeVry theatre projector mechanism (with 1000-watt lamp illumination) but is obtainable without the solid base or legs so that it can be moved easily and can be set on any firm table or stand. The DeVry theatre projection features: silent chain drive, rear fan barrel shutter (no meshed gears), extra webbing to protect the Geneva movement and the DeVry "Brillante" lens, are included in the Semi-Portable model system. Heavy duty construction on all mechanical parts such as tilting devices, case, handles, movement supporters, etc. New lamphouse equipped with independent motor and fan. 1000-watt illumination, biplane bi-post prefocus lamp. (Thus replaces are lamp units in business and educational theatre setups of moderate size.) Any size DeVry amplifier and speaker used without mechanical wiring change. Net weight, 125 pounds. Gross, 225 pounds.

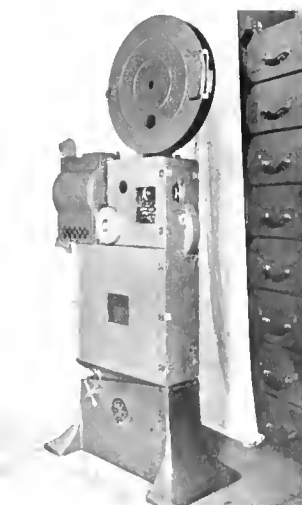

◀ Standard 35mm. DeVry

Suitable for the business theatre

The DeVry theatre projector is standard equipment in numerous entertainment theatres both here and abroad so the "Standard" model is aptly named. For the permanent installation in business or educational theatres, the "Standard" offers professional theatre-quality utility. Projection features include the silent chain drive (no meshed gears) — double V belt from motor to mechanism . . . powerful arc lamps or choice of three incandescent combinations of 1,000 watts, 110 volts; 1,500-watts, 110 volts; and 2,100-watts, 60 volts with transformer, each one capable of two size lamps without mechanical change. Rear fan barrel shutter, extra webbing of intermittent movement (Geneva cross type) and streamlined dust-proof case. The "Brillante" lens, adopted in many theatres, is standard equipment. 2,000 or 1,000 foot magazine capacity optional.

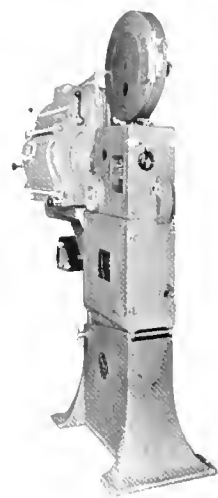

◀ "Super" 35mm. DeVry

The finest of DeVry's theatre line

The latest developments from the design and engineering departments of the DeVry Chicago factory are embodied in the Super DeVry 35mm. theatre projector. Its handsome streamlined case contains the perfected projection movement, finest "Brillante" lens equipment, and the "Super" arc equipment especially suitable for the largest auditoriums and the presentation of brilliant images with highest quality sound reproduction on the theatre-size screen. Principal additions to previous DeVry models concern arc equipment. Complete details, installation suggestions, etc. furnished to interested users upon request by factory representative. The exclusive DeVry silent chain drive feature is standard on the "Super" as on all other DeVry theatre models.

INTERNATIONAL PROJECTOR CORP.

92 Gold Street

New York, N.Y.

◀ Simplex Type SP—"Mazda"

Simplex sound projectors, used where quality 35mm. sound and picture reproduction is demanded, are practically synonymous with Hollywood. Two variations of the more portable SP models are shown. The top illustration shows the SP Model with Mazda illumination and the lower view shows the same model with arc equipment. Simplex installations at the New York World's Fair include the theatres of the National Biscuit Company, Chrysler, etc. The Model SP is particularly adapted to use in the business and educational field because of its portability. The pedestal illustrated or a demountable metal stand are optional. The column shown permits left or right rotation and tilting from horizontal to 30 degree position. Equipment includes modern type electro-dynamic loud speaker with mounted in 41 inch non-directional baffle, matched to NP-20 or NP-25 (20 or 25 watts) amplifiers. Arc equipment is low intensity reflector type arc lamp with carbons fed continuously and automatically; arc-image-device permits easy adjustment. Mazda lamp equipment with motor-driven fan cooling system permits use of either 1,000 or 1,500-watt pre-focused lamp.

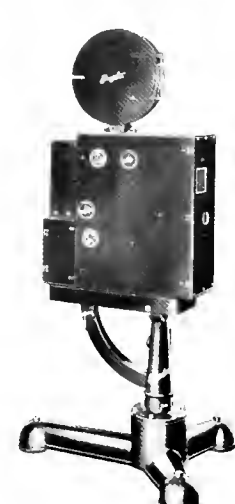

◀ Simplex Type SP—"Arc"

Projector Type SP — Drive: only gears used. Intermittent: hardened and ground star wheel and cam running in oil bath. Lens Mount: accommodates "Series I" and "Series II" lens. Lens: 5" "Series I" B & L furnished; any size lens optional. Sound Optic: Bausch & Lomb, scanning beam .0008" wide. Excitation, AC: 10 volt, 7.5 amp, lamp is standard. DC Excitation: 10 volt, 5 amps, lamp is optional. Phototube: RCA 918 furnished. Motor: 115 volt, 60 cycle AC is standard, optional 115 volt, 50 cycle AC or universal governor type motor 105-120 volts AC-DC with or without external variable speed control. Case: top, rear and base cast aluminum; panels of laminated polished black bakelite. Overall dimensions: height 26 1/2", length 27 1/4", width 10 1/4". Weight: 90 pounds. Magazines — 2,000 foot reel capacity. Takeup Magazine enclosed within projector case. Feed Magazine externally mounted.

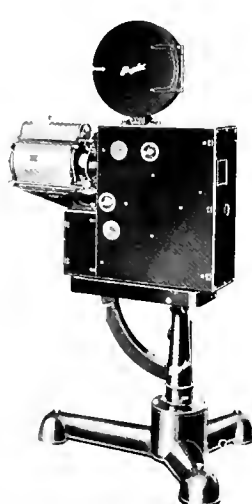

Other "Simplex" theatre model projectors are available but not shown on this page because of space limitations. Address the manufacturer for full information.

OTHER LINES OF EQUIPMENT

RCA sound head equipment is featured with Simplex and other leading types of 35mm. theatre projectors. For literature and complete technical details address the RCA Photophone Division, RCA Manufacturing Company, Camden, New Jersey. Complete specifications will be forwarded to prospective users of 35mm. sound equipment in

either the business or educational fields.

Holmes Projector Company, 1813 Orchard Street, Chicago, Illinois manufactures a highly-recommended line of theatre projection equipment. New Holmes models were recently announced (too late for publication in this number) but full technical specifications and other data will be furnished on your written request addressed to the manufacturer.

SILENT PROJECTION

16mm Motion Pictures

As in the theatrical phase, the era of commercial and educational motion pictures turned from silent to sound projection a decade ago. With the increased demand and production of sound projectors bringing lower prices, and a corresponding rise in the number of sound projectors available in the distribution field, the silent projector retains a more and more limited sphere of usefulness. Its special uses in places where sound is impractical are accepted, however, and the user may find this general listing helpful. It should be understood that the projectors shown, some of which are convertible to sound, are of a "professional" quality, not to be confused with amateur equipment or toys.



Ampro Model "NC"

A product of The Ampro Corporation
By adding sound head and amplifier, this model without alteration can be converted into the Ampro-sound Models N, NB, F, UB, or L, at a minimum of expense. Capacity, 100 feet silent film, 1600 feet optional. Standard 750 watt or under projection lamp. Operates on 25 to 60 cycles A.C. or D.C. current. Standard 2-inch focal length F1.65 objective lens. Interchangeable with 1-inch to 1 1/2-inch standard lenses. Motor and belt drive. Centralized lubrication. Motor has grease sealed ball-bearings. Button for "still" projection. Automatic safety shutter prevents blistering or burning film. Reverse film switch. Automatic rewind. No transferring of reels or belts. Easy threading. Flickerless pictures at speeds as low as 13 frames per second. Triple claw movement. Control knob for speed. Micrometric lamp adjustment. Framing button. Pilot light operates with switch. Centralized control panel. Adequate cooling system. Two-way tilting control knob. Bi-convex condenser lens. Reel locking device for all 1600 foot reel arms. Aluminum casting throughout for portability. Finished in Ampro brown, crinkle-baked enamel with chromium plated and stainless steel fittings. Approved by the Underwriters' Laboratories. Listed under Fair Trade Agreement.



Ampro Model "KD"

A product of The Ampro Corporation
Capacity, 100 feet of silent film, 1600 feet optional. Sound film can be used on silent models. Standard 750 watt or under projection lamp. Operates on 25 to 60 cycles A.C. or D.C. current. Standard 2-inch focal length F1.65 objective lens. Interchangeable with 1-inch to 1 1/2-inch lenses. Centralized lubrication. Motor has grease sealed ball-bearings. Button for "still" projection. Automatic safety shutter prevents blistering or burning film. Reverse film switch. Automatic rewind. No transferring of reels or belts. Easy threading. Flickerless pictures at speeds as low as 13 frames per second. Triple claw movement. Control knob for speed regulation. Micrometric lamp adjustment. Framing button. Automatic pilot light. Centralized control panel. Adequate cooling system. Two-way tilting control knob. Bi-convex condenser lens. Reel locking device for all 1600 foot reel arms. Aluminum castings throughout for portability. Finished in Ampro brown, crinkle-baked enamel with chromium plated and stainless steel fittings. 32-volt operation is available only for Model "KD". Approved by the Underwriters' Laboratories. Listed under Fair Trade Agreement.

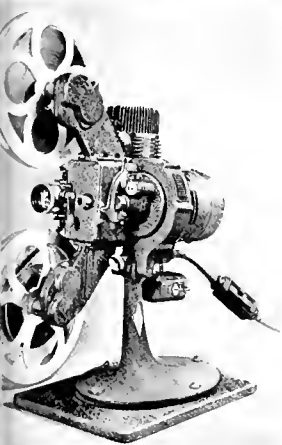

Filmo "Master"

Manufactured by Bell & Howell
Capacity, 100 feet film. 750 watt, line-voltage projection lamp. Also 300, 400 and 500 watt line-voltage lamps may be used. Magnilite condenser. Fast 2-inch F1.6 lens. Other lenses available from 5/8-inch to 1 1/2-inches. Entirely gear driven. No belts nor chains, inside or out. Gears enclosed by aluminum-alloy die castings for silent operation. Automatic motor rewind. Lamp switch for turning off lamp during film rewinding. Lever for reverse film action. Sealed motor lubrication. Clutch for "still" projection with safety shutter for the protection of stationary film from heat. No-glare pilot light. Two-way tilting device. Finished in dark brown crinkle-baked enamel. Fittings are of brown bakelite and polished nickel plate. Carrying case with drop front, permitting easy removal of ready-erect projector. Compartments for two 100-foot films, take-up reel, extra lamp, oil can, etc. Rich brown covering. Also model for 32 volt lines. Comes equipped with 100 watt, 32 volt lamp and 32 volt motor. Weight, 11 pounds. Approved by Underwriters' Laboratories.



Filmo "Showmaster"

Manufactured by Bell & Howell
Capacity, 1600 feet silent film. 750 watt, 100-125 volt projection lamp. Also 100 and 500 watt, 100 volt lamp may be used. Resistance lever to give lamp fast normal 100 volt load on 100-125 volt lines. Magnilite condenser. Fast 2-inch F1.6 lens. Two-speed focusing with lens lock. Other lenses available from 5/8-inch to 1 1/2-inches. metered lubrication. Automatic motor rewind. Lamp switch. Reels placed "fore and aft" for reverse action. Clutch for "still" projection. Safety shutter. Built-in variable resistance and voltmeter. Pilot light. Two-way tilting device. Carrying case accommodates projector, two 1600-foot reels, two 400-foot reels and extra lenses and lamps. Finished in brown fabric leather. Weight, 16 pounds. Also model for 32 volt lines. Comes equipped with 100 watt, 32 volt lamp and 32 volt motor. Approved by Underwriters' Laboratories.

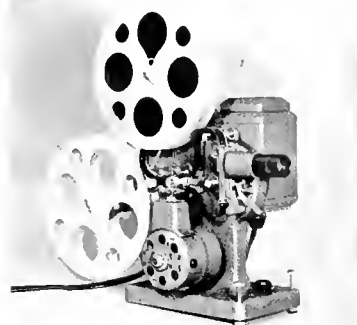

DeVry Model "G"

Mfrd. by The DeVry Corporation
The familiar DeVry silent model G projector with motor drive is now equipped with a reverse switch, automatic rewind and stop-on-film feature. The new model weighs less than ten pounds and has been widely accepted by business organizations and schools. Die-cast housing. Simple operation. Accommodates for 100-100 foot reels and an especial low price considering its high-wattage brilliance (200-watt) are the advertised features of Model G. The projector also features an efficient frame and positive tilting device as well as added portability because of its removable reel arm. Manufactured by The DeVry Corporation, Chicago, Illinois.



Eastman Kodascope

From Eastman Kodak Co., Rochester
Special features of Kodascope 6, Series 13 include: "Tailor-Made" Projection, with five lenses and three lamps available to form the perfect combination for you. Concentration of controls. Four of the major operating functions, for example, are controlled by a single switch. A threading light, illuminating the film path so that the operator can carry out the few necessary threading adjustments in an otherwise darkened room without delay or fumbling. This light automatically goes off as projection begins, and may be relighted during rewinding. Projection of any single "frame" of your movies, as a "still" with full, automatic protection of the arrested film. Exact alignment of lamp filament, in relation to reflector and condenser, controlled by set-screw on side of lamp housing. Simplified film threading. A hinged film gate, permanently positioned, opens wide, affording ample finger room; the film slips into proper place accurately and easily. Variable projection speed. The image area of the film never touches metal, a factor in film life and freedom from abrasion marks. Adaptability to either D.C. or A.C. 25- to 60-cycle, 100- to 125-volt lines.

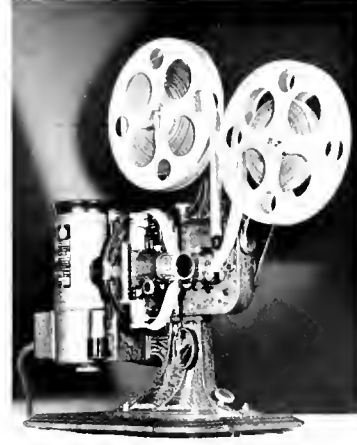

Victor Model "11"

By Victor Animatograph, Danversport
In small rooms or large auditoriums, large or small pictures, long or short throws, this Victor projector insures professional results. It embodies all the outstanding projection features that have made Victor the world's favorite. Its weight is only 13 pounds. Victor features include four point film protection—super Hi Power illumination—super efficient cooling that saves lamps—Four-in-one control for easy operation—permanent freedom from "jumpy" pictures—pilot light—lamp and motor switches—full range tilt—two-way rapid rewind. Model 22 is identical to Model 11, except that it operates in closed case and accommodates 1600 ft. reels.

OTHER SILENT PROJECTION EQUIPMENT
AMERICAN BOLEX Company, 155 E. 14th St., New York City, offers three 16mm. silent projectors which provide motor rewinding, full ac-

cessories and operate on A.C.-D.C. current.
KEYSTONE MFG. Co., Boston, Massachusetts, produces a line of inexpensive 16mm. silent projectors as well as slide projection and film editing devices.

CONTINUOUS MOTION PICTURE PROJECTION

★ The equipment reviewed represents a majority of the "continuous" sound and silent motion picture and slide projection apparatus offered for advertising displays at conventions and exhibits, etc. A frank understanding of the limitations of almost every type of continuous projector is important to the user. In the case of motion pictures, mechanical mechanisms must carry delicate film in continual motion and subject to varying degrees of temperature and humidity. With these conditions anticipated, however, the user may derive both service and satisfaction. Established sales agencies and manufacturers service equipment and surprising records of uninterrupted operation have been achieved.

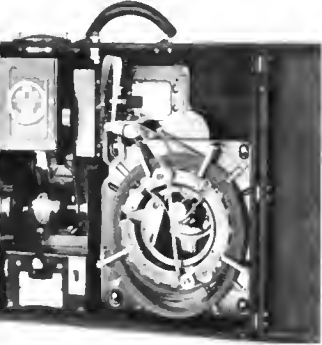

◀ Automotion

An automatic, self-winding 10mm. projector, showing in day or electric light. Automotion was designed for heavy duty continuous projection. *Continuous Action*, derived from our patented belt conveyor, *Intermittent Film*, is mechanically accurate and flexible in zooming cuts which are oiled automatically. Rock-steadiness of pictures is attained without the usual heavy pressure springs, which tear the film. *The Optical System*, gives the utmost efficiency from lamps. Automotion Projectors equipped with 500 watt lamps are equivalent to 750 watt bulbs in other projectors. The aluminum reflector is heat proof. *The Lamp House*, is four inches in diameter through which cold air is drawn by a suction fan revolving at 5000 revolutions P.M. *The Motor*, specially designed by Robbins & Myers is powerful, vibrationless, long-lived, and vastly superior to ordinary home projector motors. *Electrical parts* are made by General Electric and Ward Leonard Electric Co. *The Mercury Switch*, instantly cuts off the current in case operation is interrupted. Available from *Advertising Projectors, Inc., 111 W. 33rd St., New York City.*

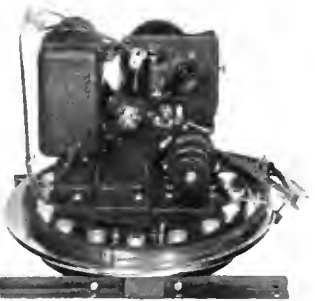

◀ Advitagraph

Several years of intensive research preceded the announcement of the Advitagraph Projector by its Louisville, Kentucky manufacturer. Within recent months the company has begun offering its product to advertisers and dealers and the important tests of actual field usage has apparently been passed. Advitagraph features a simplified antidrag film feed system (noted in the accompanying illustration) and an individual mirror-shuttle type of projection. Specially designed display cabinets are used with the projector unit. Prospective users may contact the Advitagraph Corp., Louisville, Kentucky, for adequate demonstrations, guarantees of service, etc.



◀ A-L Merchandiser

The A-L Merchandiser, developed in the Akvel Camera Laboratories, has been recently placed on the continuous advertising film projector market. This motion picture projector automatically repeats a merchandising message as a movie within a store, store window or show room day or night. In the *Merchandiser*, a simple piece of optical glass stops the image as the film reel smoothly and unhesitatingly along. There are no shocks or jerks. The use of this simple optical system reduces the normal multiplicity of gears and class to two simple spur gears, and the use of oil-less and ball bearings eliminate the need of lubricating the machine. A major cost item, other than that incurred through the necessity to service intermittent projectors, is the lamp cost. The lamp used in the *Merchandiser* is an ordinary 75 Watt, 100 hour lamp. Another unique feature is the removable magazine on which the film is received already to be inserted in the machine. There are two types of these magazines, one of which consists of simple wooden rollers which is so low in cost that the entire magazine, together with the worn-out film may be thrown away at the end of the run. *Manufactured by the Akvel Camera Company, 175 Lorick Street, New York City.*

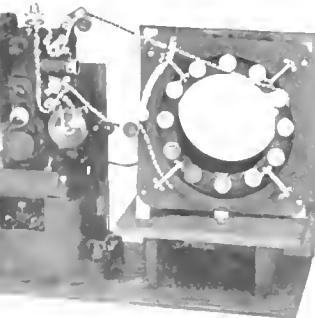

◀ Ampro "Continuous"

Seven Different Models Featured

Seven continuous projector models are included in the Ampro line. Four of these are continuous units for silent film, three feature sound. The model pictured is CS7. From the large cabinet model which shows 100" of continuous talking pictures on a screen 15" by 20". The projector is the Amprosound Model F. Other sound units are suitcase models of 100" and 800" capacity installed in portable sound-proofed suitcases with a 10" speaker in a separate carrying case. 750 illumination is general. Sound models operate on A.C. (110" on 150 watt converter), silent models on either A.C. or D.C. *A product of The Ampro Corporation, Chicago, Illinois.*

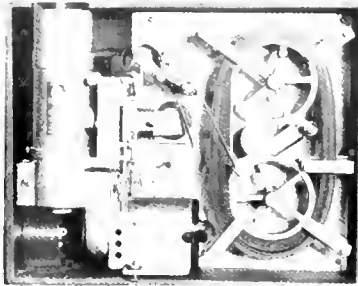
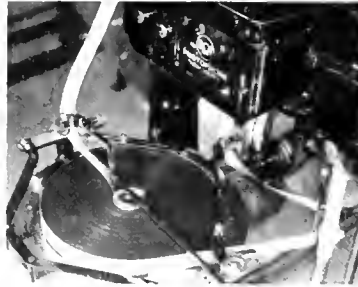
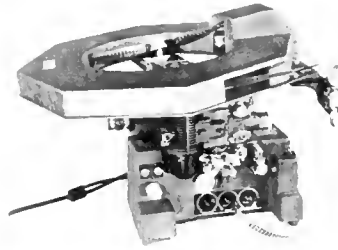

◀ Bell & Howell "Continuous"

An 800 ft. continuous attachment of unique design is offered by Bell & Howell for use with Filmo and Filmosound Projectors; shown mounted on a Filmosound model 138. The attachment is for use with 16mm. films, either sound or silent. Eight hundred feet of sound film, at 21 frames per second, provides a 22 minute showing; silent film at 16 frames per second provides a 33 minute showing, before repeating. Showings of these extra lengths are very much desired by those exhibiting at fairs, conventions, etc. The continuous attachment is now supplied for Filmo silent projector models 57 and 129, and for Filmosound models 120, 138 and 142 with the exception of the variable resistance models. *A product of Bell & Howell, 1801 Fairmount Avenue, Chicago.*

◀ Contimovie

The Contimovie is a continuous film rewind-attachment manufactured under International patents. All parts are made of either chromium plated, stainless or rolled steel. It is designed on a totally new principle that causes no tension or abrasion upon the film and insures against break-downs. The device is a horizontal turntable resembling the turntable of a phonograph. The Contimovie is a series of independent concentric discs. The center disc is driven by means of a shaft which derives its power from the motor of the projector by means of a flexible shaft or chain drive. All the other discs are frictionally driven and the speed of these discs varies according to the weight of the film on each disc. The apparatus can be attached to any existing projector by means of flexible shaft or otherwise. *Address: Contimovie Sales Corp., 52 Funderhill Ave., New York City.*

◀ Victor "Continuous"

The Victor portable continuous projector provides complete silent or sound pictures at the turn of a switch. According to the manufacturer, it eliminates operating "head-aches" and high upkeep costs previously associated with continuous motion picture projection. A patented "advance-feed" principle that provides positive regulation of the amount of film fed from the magazine to the projector intermittently, does away with strain on the film, prevents binding and breakage, and minimizes surface wear. Film in the magazine remains almost entirely in a "free", air-cushioned state and projection stops instantly and automatically in the event of any emergency. In addition to flickerless projection, it provides safer, more efficient ventilation and longer lamp life. The capacity of film magazine is 500 ft. — greater capacities to order. It has the built-in, collapsible rear-projection screen. *A product of the Victor Animatograph Corp., Davenport.*

CONTINUOUS SLIDE PROJECTION

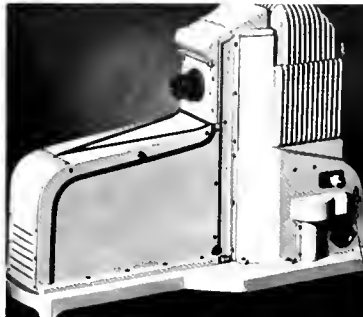

◀ Color Illustrations

Designed especially for two inch Kodachrome transparencies, Color Illustration projector apparatus reveals unique construction features: (1) Continuous automatic projection for the color transparencies. (2) Air conditioning scientifically utilized to prevent fading of the delicate color film. The lamp chamber is thoroughly air-cooled by twin fans while at the same time blasts of cool air are kept circulating in the magazine chamber. A definite guarantee that even the most subtle tones of the color transparency will not be affected after countless hours of continuous projection is offered. (3) Screen brilliance in daylight is made possible by using a 1000 Watt lamp for projection. (4) Flexibility is demonstrated in the ability of the apparatus to accommodate from 3 to 18 slides. Each slide is projected for 7 seconds and the changing period is one second during which time a synchronous shutter blacks out the screen image. (5) The optical system designed as to allow for maximum screen brilliance. *Mfd. by Color Illustrations, Inc., 152 W. 12nd St., New York City.*

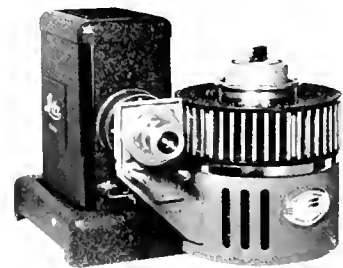

◀ Selectroslide

For automatic slide projection, the magazine of the Selectroslide will hold 16 — 2 x 2" slides made from the 35mm. motion picture film used in modern miniature cameras. It operates by set automatic control over a long period of time, with no attention required. . . . or by remote "push-button" control, which conveniently eliminates the need of a special operator. Regardless of the distance you are standing from the machine, just press the remote control button in your hand, and the slide will change. Sound equipment may be attached without any change whatsoever. At the present time the Selectroslide is being successfully used in advertising and sales promotion, and has evidenced a great number of exhibits at both World Fairs. *Manufactured by Spindler & Sappig, 36 Third Street, San Francisco, Calif.*

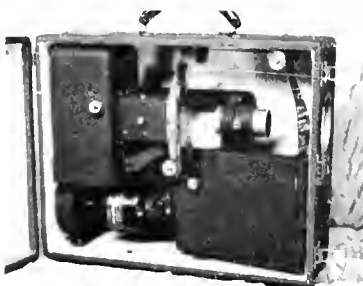

◀ S.V.E. Continuous

S.V.E. 250-watt Automatic Pictorial Projector for projecting slidefilms continuously and automatically. Recommended for window display, convention booths and general advertising. Specifications include:

1. 200 frames or pictures can be shown in each strip
2. 250 Mazda pre-focused lamp
3. S.V.E. releasing mechanism, assuring prevention of rubbing or marring film emulsion
4. Equipped as standard with 2 1/2" objective lens
5. Patented heat absorbing, heat resisting filter

A product of the Society for Visual Education, Inc., 100 East Ohio Street, Chicago.

ELECTRO ACOUSTIC PRODUCTS DIVISION

of The Magnavox Company, Incorporated

General Offices and Plant

Fort Wayne, Indiana

★ The advertised slogan of The Magnavox Company, "Pioneers in Sound Since 1911" is a fitting introduction to a review of the widely-used sound slidefilm projectors manufactured by the Electro-Acoustic Products Division of the Company. The 30,000 Illustravox projector units reported in use range in price from \$34.90 to \$115.00. Newest arrival in the Illustravox line is the Junior Model 108, suitable for individual and group showings only up to 25 people. Represented in Chicago by R. M. McFarland Associates, 520 North Michigan Ave., or write direct to Fort Wayne, Indiana for further particulars.

◀ Junior Model "108"

The newest of the Illustravox line

The unit for individual consumer, dealer or other sales interviews, etc. before smaller groups. Full 100-watt extensible projection with the Magnavox opening feature. Compact: actual dimensions — 11" x 13" x 6" closed. Weight 16 pounds. Largest-size film magazine; remote control picture advance. Full-sized crystal pickup for tracking on records up to 16". Space for two 12" records, extra films within case. AC operation; AC-DC may be specified. Natural tone reproduction for individual presentations and especially suitable for showings to small groups not to exceed 25 persons.

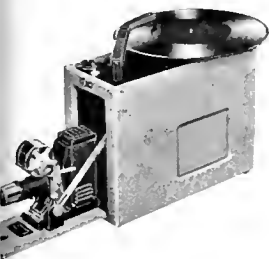

◀ Junior Model "101H"

Suitable for audiences of 100 persons or more — with regulated high-fidelity sound to provide volume for audiences of two or three up to a small auditorium. 100-watt projection; projector mounted on front door in patented Magnavox feature to drop into position when door opens. Dimensions: 13" x 15½" x 6¾". Weight, slightly over 20 pounds. Small desk-type screen furnished as standard accessory. Latest type Magnavox 6¼" speaker; constant speed motor for AC operation, requires no adjustment, very little tilting. Carries three 12" records, 3 films, inside case. Carrying case covered in gray striped airplane fabric. AC operation, AC-DC may be specified.



◀ Illustravox "Senior"

For the larger group showing

The deluxe large-audience Illustravox featuring 300-watt projection, rewind takeup and amplification suitable for audiences up to seven or eight hundred people. Illumination for best color and black and white projection results on large screen. Four-tube amplification, eight-inch Magnavox electro-dynamic speaker with curvilinear cone. Removable loud speaker . . . standard accessory equipment includes baffle and extension cord. Dimensions: 18½" x 17½" x 7½". Weight, 38 pounds. Carries four 12" or 16" records; three films. All controls, including separate switches for projector, turntable and amplifier volume mounted on rear panel of carrying case. Note: all four Illustravox models are standard for operation on 60 cycle, 110 volt alternating current; available for operation on direct and alternating current when specified at a slight increase in price.

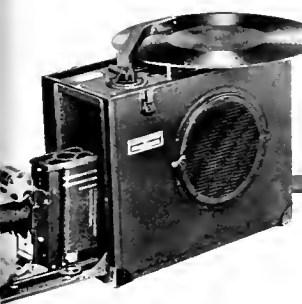

◀ The Salesmaker

A portable theatre in a single case. Built-in translucent parchment screen and loud speaker just below screen permits instant showing by moving record tray from the front of the case; projector mounted in rear. For larger audiences, speaker detaches for projection on wall or tripod base screen. Dimensions: 18" x 18" x 7". Four 12" or 16" records, two films may be carried within case. Weight 29 pounds. Achieves unusual illusion of synchronized sound and picture presentation. AC operation, AC-DC may be specified.



SOUND SLIDEFILM PROJECTORS

OPERADIO MANUFACTURING CO.

General Offices and Plant

St. Charles, Illinois

Export Division: 145 West 45th Street, New York City

★ The Operadio Manufacturing Company St. Charles, Illinois, sound, public address system and loud speaker manufacturer for many years and famed for its leadership in these fields, features two sound slide projector models: The *Explainitone*, a larger group selling unit, and *Explainette*, a small light-weight low-cost unit, recently developed after months of intensive research among producers and users of the slidefilm medium. All models feature all-metal construction with wear-resisting baked finish.

◀ Explainette-Open

Operadio's new low-priced unit

Operadio's new low priced unit *Explainette* . . . is intended primarily for direct sales to individual consumers. However, its design is such that it can also be used for larger group meetings which would normally require a 100 watt projector. It incorporates built-in screen, Operadio heavy duty 5" Permanent Magnet Dynamic Speaker, two tube amplifier; factory matched tone and volume. Available with either 50 or 100 watt projectors as specified. All-steel construction with durable baked finish. Turntable accommodates 10", 12" or 16" records. Crystal type pickup. Storage for four 10" records, four film cups and needles. Ten foot power cord. Dimensions 10½" x 11" x 5¾". Weight 14 pounds. Available for either 110 volt AC or DC as specified.



◀ Explainette-Closed

The small dimensions, light weight and enclosed screen within the top cover of the unit make the *Explainette* the ideal unit to meet the user's specifications for field use in individual consumer and small group interviews. However, it has sufficient volume of sound so that when used with a 100 watt projector and a wall type screen, it can take care of relatively large group meetings . . . All controls directly beneath the projector including combination on-off switch and volume control for amplifier, on-off switch for projector lamp, and on-off switch for motor. Loud speaker located behind decorative grille on opposite side of case from controls. All-steel cabinet finished in a durable baked gray stipple finish which cannot be torn or easily marred.



◀ Explainitone-Open

The projector for group showings

The unit for group showings . . . *Explainitone* . . . Operadio's larger "deluxe" model sound slide film unit, is intended for showings before larger audiences. The *Explainitone* is available with 100, 200 or 300 watt projectors. Standard equipment includes 8" heavy duty Permanent Magnet Dynamic Speaker and latest type amplifier, factory matched for volume and tone. Storage for six 16" records, six film cups, and spare projector lamps, all within the case. Available in either 110 volt AC, or AC-DC models as specified. Case dimensions 18" x 11¾" x 9¼", exclusive of record compartment top. Weight AT Model — 33 lbs. 12 oz.; AC-DC Model — 32 lbs. 12 oz.



◀ Explainitone-Closed

All models feature all-steel construction without appreciable increase in weight. *Explainitone* case finished in durable baked black stipple. The loud speaker is mounted in the detachable top which permits speaker to be located along side of screen. Extension speaker cable furnished. Provision for neat storage of speaker extension cable and power cable. All controls conveniently located on the same side of unit as projector. They include volume and tone controls with individual power control for amplifier, phono-graph motor, and projector lamp. Remote control for projector and S&V automatic film/slide take-up supplied at light additional cost.



Sound Slide Film Projection... contd.



Public Address Systems

Useful in convention, display or business meetings where public speaking, announcements etc., demand amplified volume

Such portable public address units as the Operadio model "Ballyhoo" shown at left have a useful place in business when window display, meeting discussion, etc., requires sound amplification. Microphone included. Amplifier and two speakers in one small case 11 1/2" x 9" x 5". Weight, when window displays, meeting discussions, etc., require 15 lbs. Complete details concerning other models will be furnished on request by writing the manufacturer.

Public address systems are manufactured on a high-quality basis by principal sound-slide equipment manufacturers whose products are pictured in these pages and by sound motion picture projection firms featured earlier in this section. For special uses in business in connection with meetings, exhibits, etc., address Sales or Engineering Departments of these firms for full technical particulars. For obvious reasons such descriptions are not included in these pages.

SOUND PROJECTS COMPANY

3140 W. Walton Street

Chicago, Illinois

★ Although one of the smaller organizations in this field, Sound Projects have consistently endeavored to manufacture a uniformly excellent line of sound equipment. Three models are offered to serve varying sizes of audience groups with prices well in range with those of other manufacturers.

Model K102 Junior

For individual sales presentation

A lightweight portable projector with self-contained dynamic speaker for showings before very small groups. Model K102, standard equipment AC only, 50 watt extension projection. One tube amplification; plays up to 16" record. Dimensions: 13" x 13" x 6". Weight, slightly over 12 pounds. Storage space for additional records, film cups. Model L102, equipped for AC-DC operation, slightly higher. 100-watt projection also optional equipment. Volume and motor speed control, lamps, needle cup, small screen, and cord included.

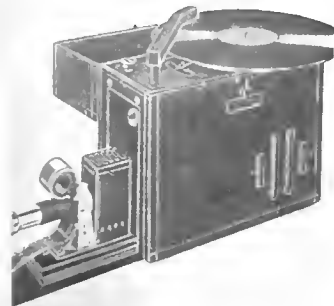

Model K103

For medium-sized audience shows

The projector medium-sized audience groups of 100 persons or more. Equipped with 100 watt projector, self-contained record compartment and screen. Increased volume with added amplification power. Plays 10, 12 and 16-inch records. Storage capacity for records and film cups. Model K103 for AC operation only; Model L103 equipped for AC-DC operation, slightly higher.

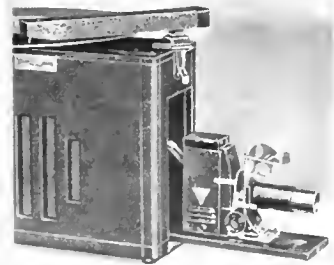

Model K106

For showing to larger groups

For showing sound slidefilm programs before larger audiences. Deluxe type 300-watt projection, self-contained record compartment and screen. Dynamic speaker detachable with extension cord furnished. Volume suitable for audiences up to 500 persons or more. Plays all film-slide records up to 16-inch. Model K106 equipped for AC operation only; Model L106 for AC-DC operation, slightly higher.



WEBSTER ELECTRIC COMPANY

General Offices and Plant

Racine, Wisconsin

Export Department: 100 Varick Street, New York City

★ Webster of Racine is another nationally-known sound and electrical appliance equipment manufacturer. The "Cinaudio" line of sound slidefilm projectors which Webster produces under its trade slogan "Where quality is a responsibility and fair dealing an obligation" include two principal models: The Cinaudio "Standard" and the low-cost Cinaudio "Cub". The former model is intended for larger group showings and the "Cub" for individual presentation and before small gatherings.

The "Cub" Cinaudio

Webster's low-cost, high-quality unit

Especially useful in presenting sound-slide films before a few executives or for direct consumer selling interviews, etc., the Cinaudio "Cub" model offers 50-watt extension-slide projection (100-watt optional). A net weight of 13 1/4 lbs. facilitates carrying in the field. Case dimensions: 13 3/4" x 10 1/2" x 5 7/8". Projection has standard elevating mechanism, simple framing device; double convex condensing lens, heat absorbing meniscus, double aperture plates. Turntable accommodates up to 16" records at single 33-1/3 RPM speed; crystal pickup.

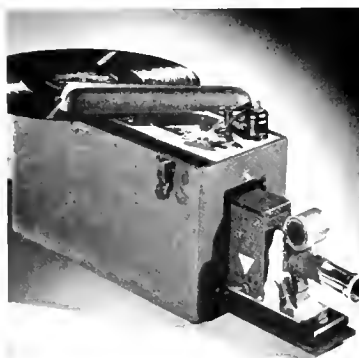

"Cub" Cinaudio-Case

Detachable cover contains speaker unit

The detachable cover of the "Cub" provides a separate speaker which is supplied with a 10-foot extension cord so that the speaker may be placed in close proximity to the screen. At ten feet, a projection size of 2 1/4 x 3 1/2 feet is afforded. Power Supply: 110-120 volts, 60-cycle AC; AC-DC when specified slightly higher. Tubes include one 6U5 and one 25A7, furnished. Durable case construction and covering, sturdy handle at top for carrying.



"Standard" Cinaudio

For use before bigger groups

The larger group-selling model offered by Webster of Racine is the Cinaudio "Standard" equipped with 200-watt projection (100 or 300-watts optional). Detachable speaker in cover with adequate extension cord supplied. Features an exclusive emergency motor board light to facilitate changing records, etc. Separate volume and tone controls, on-off switches for projector, amplifier and phonograph motor. Plays 10, 12, 16-inch records. Built in power amplifier and crystal reproducing pickup.

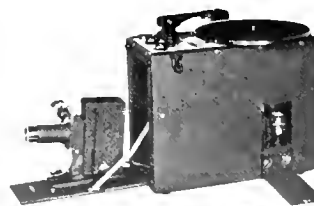

"Standard" Case Views

The detachable speaker is shown as in use

Model 2-C8-2 of the "Standard" series features 100-watt projection for AC operation. Model 2-C8-1, 100-watts, AC-DC operation. These projectors accommodate audiences of 25 or more people. Cinaudio Model L-CM-2 is the 200-watt unit for AC operation; Model L-CM-1 includes AC-DC operation. These projectors accommodate audiences up to 250 people. 300-watt projection with AC and AC-DC also obtainable, when specified. All models are covered with Spanish blue leatherette with modern hardware and are contained in a single case, with room for record and film storage. Foolproof polarized plugs with extension cords; latest type electronic tubes.



SILENT SLIDEFILM PROJECTORS

SOCIETY for VISUAL EDUCATION, Inc.
100 East Ohio Street Chicago, Illinois

★ In two decades of pioneering effort on behalf of educational and commercial use of visual media, the names of The Society for Visual Education, Inc. and its talented chief executive, Marie Witham, have been synonymous with progress and development. Today, the Society's slidefilm projectors are used in the sound slidefilm equipments of every leading manufacturer. Its libraries of stillfilm subjects under the trade name "Picturals" are in thousands of school systems throughout the world. In the business field, wherever silent slidefilm projection is useful, S.V.E. projectors offer a model suitable to the need. Double-frame projection equipment and, in fact, every type of still projector necessary for either single or double frame projection, Kodachrome transparencies, etc., may be selected from the extensive S.V.E. line. A continuous silent slidefilm model is also offered and a wide variety of accessories, including the popular take-up attachment for slidefilm projection, are listed.

◀ S. V. E. Model "Junior"

50-watt projection — small groups

50-watt Single Frame Pictorial Projector the smallest and lowest priced standard equipment available. Recommended for showing slidefilms to very small groups. Simple, neat, and noiseless elevating device. Furnished complete with carrying case.

1. Patented heat absorbing, heat resisting element
2. Double convex condensing lens
3. Metal reflector
1. Special Junior 2 3/4" e. l. projection lens



◀ S. V. E. Model "K"

50-watts, complete with case

50-watt Single Frame Pictorial Projector the most popular 50-watt unit in use today for salesmen. Projects pictures brilliant enough to serve the average group of prospects or salesmen, even in a partially darkened room. Mounted in a metal folding case which acts as a carrying case when the projector is not in use, and as a base or stand when the machine is in use.

1. Patented heat absorbing, heat resisting element
2. Ground and polished reflector; two plano condensing lenses
3. Self-enclosed metal case
1. Weight 3 lbs. — 7 3/4" long, 1 1/2" high, 2 1/4" wide when closed
5. 3" Series "00" projection lens

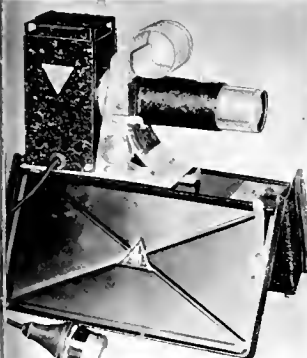

◀ S. V. E. Model "Q"

100-watt projection; medium groups

100-watt Single Frame Pictorial Projector. This projector has long met a need for an equipment to take care of intermediate groups where the 50-watt equipments do not give quite enough illumination, and where the throw is not long enough to necessarily indicate the use of the 200-watt units.

1. Patented heat absorbing, heat resisting filter
2. Chrome plated film magazine and rack
3. Well ventilated lamp house and separate housing for condensers
1. Double aperture plates with releasing feature
5. Specially designed case for holding two extra lamps and four cans of film
6. 3" Series "00" projection lens



◀ S. V. E. Model "CC"

100-watt, Tri-Purpose Projector

100-watt Tri-Purpose Projector. The original Tri-Purpose unit, proved efficient through years of use. The highly efficient optical system, including 100-watt lamp and 5 inch focal length objective lens, produces screen images of amazing brilliance and sharp focus.

1. 7" high; 8" long; 3" wide; weight — 3 1/2 lbs.
2. Mazda projection lamp; 100-watt 115 volt, bayonet base, single contact, T-8 bulb
3. Two biconvex lenses ground and polished optical glass; one patented heat absorbing, heat resisting lens, one meniscus condenser
4. Objective lens — S.V.E. Series "0A" — 5" focal length Model shown has head swiveled for showing horizontal double-frame pictures.

◀ S. V. E. Model "F"

200-watt Single-Frame Projector

200-watt Single Frame Pictorial Projector. This projector was the first manually operated projector having a rear aperture glass releasing mechanism — a patented S.V.E. feature. The large film magazine will accommodate up to 100 frames of film. The illumination is superior to that of any other 200-watt projector in this field.

1. Glass silvered mirror reflector and two plano condensing lenses
2. Well ventilated lamp house and separate housing for condensers
4. Rubber covered cord and toggle switch; novel elevating device
1. 1" Series "0" objective lens
5. Prefocused base, 200-watt, 110-120 volt T-10 projection lamp



◀ S. V. E. Model "G"

300-watt, Single-Frame Projector

300-watt Single Frame Pictorial Projector for showing only single frame strips where maximum brilliancy is required. Complete with lamp, 1" Series "0" projection lens, S.V.E. Rewind-Take-Up, and carrying case.

1. Patented heat absorbing, heat resisting filter
2. Glass silvered mirror reflector and two plano condensing lenses
3. Well ventilated lamp house and separate housing for condensers
1. Double aperture plates with releasing feature
5. Crystal black frame with modernistic chrome trim



◀ S. V. E. Model "AA"

300-watt, Tri-Purpose Projector

300-watt Tri-Purpose Projector for showing either single or double frame filmstrips and individual frames mounted between 2" x 2" glass slides. This model gives more brilliancy to all color, and black and white projection at all distances.

1. 11 1/2" long; 3 1/2" wide; 8 1/4" high — weight, 6 pounds, 2 ounces
2. Mazda projection, 300-watt, 115 volt medium prefocus base, T-10 projection lamp
3. Patented heat resisting filter of highest visible light transmission and greatest heat absorption
4. Extra size film magazine equipped with retaining arm
5. Pictures can be framed on-screen, easily changed from single to double frame

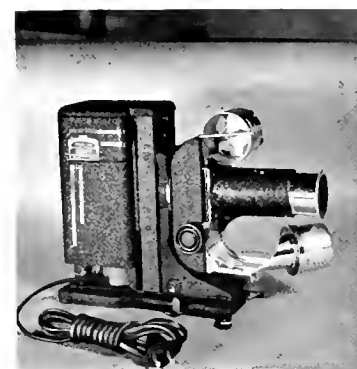

◀ S. V. E. Model "DD"

150-watt, Tri-Purpose Projector

150-watt Tri-Purpose Projector. The newest Tri-Purpose model especially outstanding because of its several new features including special anastigmat lens, as standard equipment, new semi-automatic slide changer, and combination mask.

1. 10 1/4" long; 7 1/4" high; 4" wide—weight, 4 3/4 pounds, without case
2. Mazda projection, 150-watt, 115 volt, bayonet base single contact, T-8 bulb
3. S.V.E. Anastigmat Series "0A" 5" focus lens — fully corrected
1. Semi-automatic slide changer operated entirely from top, cutting off light when slide is changing
5. New and original combination single and double frame masks providing micrometer side adjustment for centering picture on the screen

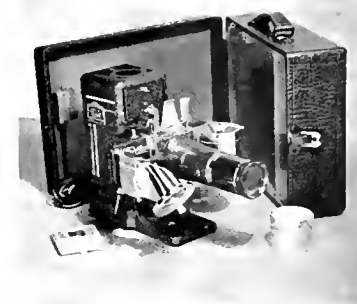

Stillfilm Projection . . . contd.

Useful silent slidefilm projection equipment offered by other manufacturers and firms specializing in visual products:

◀ Spencer Model "O"

100-watt Single-Frame Projection

Model O Filmslide Projector provides the utmost that can be secured with safety when using single frame 35mm. film with a 100 watt lamp. The optical system includes two plano convex condensers, heat absorbing glass, two pressure plates and a four lens objective of 3" focal length. The definition and flatness of field are excellent. Film threading is simple and quick. A snap of the clip on the magazine keeps large rolls of film from spilling out, a lift of the gate catch and both the catch and gate swing clear out of the way. Vertical guides above and below the aperture secure exact "tracking" of film and allow its placing of film in position. The projector is 2½" x 5¾" x 6½". Weight 3 lbs. Mfd. by Spencer Lens Co., Buffalo, N. Y.

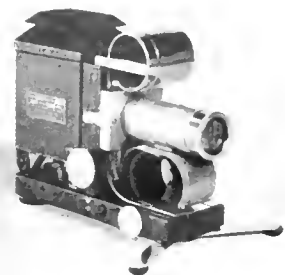

◀ Spencer Model "I-F"

200-watts; enclosed film mechanism

When maximum illumination is desired in using the 35mm. single frame film, the Model IF is selected. Brilliant illumination and clear definition are produced by 200 watts of illumination, a Spencer formulated optical system, using a triple condensing system (one meniscus and two plano convex condensers), a heat absorbing glass, two pressure plates to hold film flat during projection and a four lens achromatic objective of 1⅝" diameter, 4" focal length. Film life is protected by a large upper magazine which eliminates re-rolling film into a smaller spool. The entire film track is recessed so film emulsion does not rub and scratch. Whenever film is being moved, the rear pressure glass is retracted and held clear of emulsion. The heat absorbing glass absorbs a high percentage of the infra red rays from the lamp and protects film from damage by heat. Projector size 2½" x 8½" x 10¾". Weight 4¼ lbs. Mfd. by Spencer Lens Co., Buffalo, N. Y. . . .

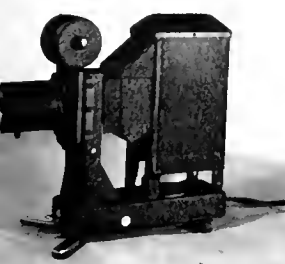

◀ Spencer "Pocket" Model

Useful in the selling field

The Spencer Pocket Filmslide Projector was designed primarily for the traveling salesman. However, its compactness, light weight and simplicity, make it extremely attractive to other travelers who prefer film presentation. It is frequently carried in the coat pocket and no carrying case used. All parts are enclosed and protected by a beautiful polished case of black molded Bakelite. The material was especially developed for this purpose by the Bakelite Company. The illumination is ample for direct sales presentation, and the definition and flatness of field are remarkably good. The objective is 2.5" focal length, giving a desirably short working distance. It projects a 1" picture at 30", or, in a darkened room, a 5" picture at 15". It is supplied with a carrying case, housing a spare lamp, and one film. The projector itself, houses three films. Projector size is 1¾" x 3¾" x 5¾". Weight 16 ozs. A 50 watt bulb is used. Mfd. by Spencer Lens Co., Buffalo, N. Y. . . .

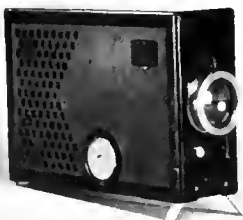

◀ Diafant Model "VIa"

by Intercontinental Mktg., New York

Diafant model VIa is a specially designed projector for 2½ x 2½" transparencies (6 x 6 cm) . . . same construction as model I but larger condensers and Omnar lens F 3.5, 120mm., giving even illumination over all parts of the transparencies . . . accessories for showing 35mm. negatives also fit model VIa.

Interchangeable lens tubes with lenses of various focal length available for Diafant Models I and VI . . . For full particulars address Intercontinental Mktg. Corp., 10 E. 10th St., New York City.

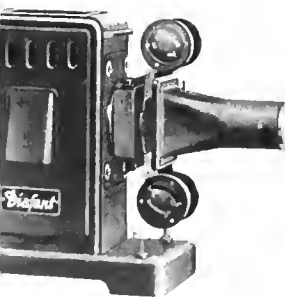

◀ Argus Model "B"

by International Industries, Ann Arbor, Mich.

The Argus Model B is a powerful projector of improved design utilizing a triple condensing system consisting of one meniscus and two biconvex condensing lenses made of ground and polished crown optical glass. The well ventilated double-walled lamp house with ground and polished silvered mirror reflector and patented heat absorbing filter permits the use of either glass slides or strip film. Film magazine capacity 500 single frames or 250 (Argus) double frames. Automatic rear aperture glass release, simultaneously relieves all pressure with advance of film, eliminating film scratches or damage to emulsion. Projector head swivels in either direction for horizontal, vertical or upside-down frames.

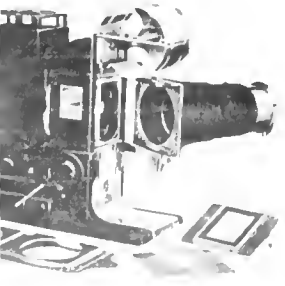

STILL PROJECTION Mounted Transparencies, etc.

◀ Arguslide Model "CP"

by International Industries, Ann Arbor, Mich.

Model CP is a powerful slide projector with highest quality, color corrected, four-inch focal length lens of type S.V.E. Special series 00. The Arguslide Projector is of moulded bakelite, chrome trim — equipped with a special 100 watt bulb, plug-in extension cord and slide carrier. A sturdy leatherette covered combination carrying case with hinged lower indexed compartment accommodating 75 slides is also available for this projector . . .



◀ Kodaslide Model "2"

Equipped with the Ready-Mount Changer

The Kodaslide Model 2 Projector pictured is equipped with the new Kodaslide Ready-Mount Changer intended for showing groups of Kodachrome still transparencies or black-and-white film positives in the Kodak Ready-Mounts. The projector is one of the standard Kodaslide Models. The Ready-Mount attachment accommodates up to 50 slides and the shifting mechanism is operated by a flexible 30-inch plunger which moves a slide into position, etc. Obtainable in Eastman Kodak stores or your regular camera supply dealer . . .



◀ S. V. E. Model "EK"

100 watt — for transparencies, etc.

100-watt Miniature Projector for 35mm. Kodachrome transparencies or black and white film mounted between 2" x 2" cover glass. For pictures taken with Argus, Coontax, Leica, Kodak Bantam, Eastman Retina, Welta, and other miniature cameras.

1. 5" projection lens
2. T-8 single contact bayonet base 100-watt, 110 volt Mazda projection lamp
3. Special patented heat absorbing filter

1. Convenient film viewer
Mfd. by The Society for Visual Education, Inc., 100 E. Ohio St., Chicago



◀ S. V. E. Model "AK"

300 watt, shows only 2" x 2" slides

300-watt Miniature Projector for showing only 2" x 2" glass slides. Gives more brilliancy to Kodachrome, black and white, and all color projection at all distances.

1. Patented heat absorbing, heat resisting filter
2. Well ventilated lamp house and separate housing for condensers
3. Double aperture plates with releasing feature

1. Mazda projection, 300-watt, 115 volt medium prefocus base T-10 projection lamp

5. Crystal black frame with modernistic chrome trim
Mfd. by The Society for Visual Education, Inc., 100 E. Ohio St., Chicago.



◀ Spencer Model "MK"

An all-purpose slide and film unit

The Spencer Model MK Delineascope offers quality and efficiency, combined with compact size and moderate price, according to the manufacturer. Its optical system projects images of a uniform brilliance and clarity, heretofore possible only with higher priced projectors. The design of this projector provides for the addition of attachments for projecting roll film and for viewing strip film before making slides. Ideal for classroom, home or club. Film protection is assured. A large well ventilated lamp house keeps the equipment cool enough to handle at all times. Very sharp definition is secured by the well corrected Spencer projection lens of 5" focal length. The electrical system includes 10' of rubber covered cord with switch. The projection lamp is of 100 watt capacity. The lens is of 5" focus and an aperture of f:3.6. Height 7½". Width 4¼". Length 11½". Weight 5 lbs. A product of Spencer Lens Co., Buffalo, New York . . .



◀ DaLite "Junior"

Made in all standard Da-Lite sizes from 13" x 18" up to and including 30" x 40". Gross weight of 13" x 18" is 1½ lbs. Mounting: The Junior consists of our standard beaded surface mounted on a round wood roller at the top and an attractive crossed moulding as the bottom support. A spring wire upright support is included with each unit. Adaptability: The Junior can be used by hanging on the wall or the straight ends of the spring wire support can be easily inserted into the sockets provided in the base.

◀ DaLite Model "D"

Model "D" is a modern streamlined box screen. Made in all standard Da-Lite sizes from 22" x 30" to 72" x 96"; also made with square picture surface for slide projection from 10" x 10" to 52" x 52". Box: The box is covered with black leatherette and equipped with burnished hinges and clasps. Roller: Specially designed heavy duty 1¼", 1½" and 1¾" diameter rollers are used, in keeping with their sizes. These will need no further attention throughout the life of the screens. Mounting: A collapsible steel center support, equipped with a hinge bracket, is bolted to the bottom rear center of the box. The single upright, together with the non-sag tubular slat, assures positive and continuous alignment of the screen when fully erected. Surface: Da-Lite beaded surface is standard equipment. Mat white or silver surfaces are supplied upon request at same prices. Black borders are also standard.

◀ DaLite "Challenger"

The Challenger is a tripod and screen unit and can be set up anywhere in 15 seconds. Ideal for club, school and home use. Made in all standard Da-Lite sizes 30" x 40" to 52" x 72"; also made with square picture surfaces for slide projection from 10" x 10" to 60" x 60". Case: A reinforced slotted tubular metal case is pivotally attached to the tripod. End caps are steel stampings, fastened by three metal drive screws, assuring permanent fixed position for roller brackets. Tripod: Steel with center tubing and elevating rod square instead of round. Extension rod equipped with gause neck at top to receive screen and a flange on bottom to support and lift the case. This design prevents rotating of the case and is fully covered by patents. Non-Sag Tubular Slat: Used in pocket at top edge of screen surface. This together with spring roller in case provides even tension. Roller: Heavy duty 1¼", 1½" and 1¾" spring rollers. Adjustable Height: Has three fixed height positions 38", 48" and 58" from the floor to the lower edge of the screen. This is the only tripod screen which provides for making a change in height.

◀ DaLite Model "B"

Model "B" is designed to hang on a wall, or, in the larger sizes from Da-Lite Super Tripods. Made in all standard Da-Lite sizes from 22" x 30" to 63" x 84". Gross weight of 22" x 30" is 5½ pounds. Case: Slotted, tubular steel case with two hanger loops fastened to case. End caps are steel stampings and secured by three metal drive screws. This assures a permanent fixed position for the roller brackets, and keeps all torque out of the case caused by the spring tension of the roller. Roller: Specially designed heavy duty 1¼", 1½" and 1¾" rollers are used. Screen operates with the ease of a window shade. Finish: Attractive, durable, black haked crystal finish. Surface: Glass beaded surface is standard. Mat white or silver supplied upon request at same prices. Black borders are standard in all sizes.

◀ DaLite "Electrol"

Da-Lite Electrol is a motor driven screen. Made in standard sizes 6' x 8' to 15' x 20' and with square picture surface from 8' x 8' to 20' x 20'. Special sizes can be supplied on request. Motor: Special 3-wire quick reversal. Interlocking gears. Ball-bearing. No further lubrication necessary. Screen speed 16 feet a minute. A.C. 110 volts, 60 cycles is standard. D.C. is supplied at no additional cost. Limit Switch: Automatic limit switch is set at factory to drop or raise screen to desired position. Switch Control: A three-way control switch is provided. Roller: Unusually strong, 5" in diameter. Operates on ball-bearings. Finish: Prime white filler which can be easily painted to harmonize with surroundings. Surface: Beaded surface is standard equipment. Mat white supplied upon request at same price. Black borders can be supplied if desired at a small extra cost.

MOTION PICTURE SCREEN & ACCESSORIES CO., INC.
351 West 52nd Street New York City

◀ Britelite-Truvision "Tripod"

Another practical model for commercial use is the Britelite-Truvision Tripod Model Screen. It is rigid, semi-automatic and mechanically perfect. The screen is contained in a roller tube, which is pivoted onto the tripod and swings into position easily. The screen may be raised on the tripod to desired heights up to 7½ feet by the use of spring-release catches. All mechanical parts of the highest quality plated steel. The legs and screen tube are finished in black crackle. Attached is a leather handle to insure ease and comfort while carrying. Available in sizes from 30x40 inches to 42x56 inches.

SCREENS & Accessories
Motion & Stillfilm Projection



◀ DeLuxe Model "A"

Motion Picture Screen & Accessories Co., Inc., makers of Britelite-Truvision motion picture screens and accessories offer a complete line of screens to suit every type of business and industrial organization. The DeLuxe Model "A" Screen is an extremely practical box-type model which may be instantly set up anywhere. The crystal beaded fabric screen permits the showing of clear, bright, glare-free pictures. It is contained in a solid wood case, covered with fine quality leatherette, and trimmed in nickel. To open the screen, you merely lift the top of the case, and pull the screen up. It is held taut and erect by a double frame support. A making device around the screen surface greatly enhances the appearance of this model. The DeLuxe is available in sizes from 30x10 inches to 54x72 inches.

RAVEN SCREEN CORPORATION
314-16 East 35th Street New York City

Raven Screen announces one of the world's most extensive screen lines. In the industrial field, industrial film concerns find Raven Raftone suited for accurate reproduction of their pictures. The physics department of Eastman Kodak Company recently concluded that Raven Screens would be

best suited for "The Cavalcade of Color" at the World's Fair. Over 1000 square feet of Raven Screens are being used. Raven Screens are supplied in five different fabrics each supreme in its field, and each designed to be used for a specific purpose. Raven Screens are available in any one of nine different mounts, and in over thirty various sizes. In addition the Raven Master Utility Tripods fill the need for an easily available unit from which to hang screens, lamps or reflectors. Extended the tripods measure 12'6" while the carrying length is only 4'6".

FILM STORAGE CABINETS

Neumade Products Company, 429 West 42nd Street, New York

★ The complete Neumade catalog lists some thousands of film storage and handling accessories. Of these, producers and users of commercial and educational films may choose storage cabinet equipment exactly suited to individual needs, since all are especially designed for filing, storing and preservation of film. All are dustproof and protect films from fire.

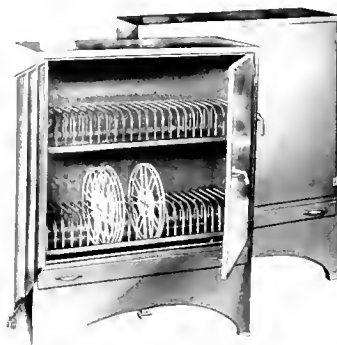

◀ Neumade Model "MM-55"

This cabinet accommodates 50-800 ft., 1200 ft., or 1600 ft. reels with or without cans, held erect in place by reel. Removable drawer equipped for humidification of cabinet or for utility purposes if desired. Double inter-rigid wire-rod separators, index card holder for each; locking doors have key lock also. Overall size 53" high, 11" wide, 16" deep.

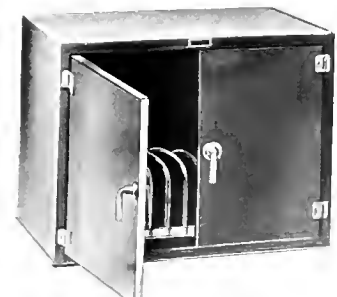

◀ Neumade Model "MM-16"

Holds 17 reels of 800 ft., 1200 ft., or 1600 ft. size; provided with double doors fitted with three point latching device or with single drop door; overall size 29" wide, 21½" high, 17" deep.

INNOVATION MODELS

Storage facilities keep growing with the library when innovation models are used. Each section is an individual cabinet complete in itself for either 800, 1200 or 1600 ft. reels with humidior trays and index cards. When additional space is needed simply obtain another unit and place it on top of the initial unit like a sectional bookcase. Either 16mm. or 35mm. (or combination) storage provided in all models.

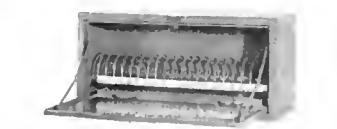

◀ Neumade Model "MM-20"

Accommodates 20-100 ft. reels with or without cans; doors may be linged at top or bottom; overall size 29" wide, 11" high, 10" deep.

Specify on order when units are to be placed on top of initial cabinet. An overlapping flange is then provided, without charge, to hold the section in place. (over)

DON'T LET

SCRATCHES

MAR YOUR FILM!

SCRATCHES CAN BE REMOVED

ONLY BY RECONO

NOW YOU CAN RESTORE YOUR
POSITIVE PRINTS AND NEGATIVES
TO ORIGINAL PERFECT QUALITY WITH

RECONO PATENTED **METHOD**

WRITE FOR FREE TRIAL OFFER!

AMERICAN RECONO, Inc.

245 West 55th Street • New York, N. Y.



"Aristocrat of Hotels"—The Drake is distinguished for the spacious luxury of its rooms, the excellence of its cuisine. Yet tariffs are always moderate.

Under the Same Management as

The Gotham
NEW YORK CITY

The Blackstone
CHICAGO

The Evanshore
EVANSTON, ILL.

The Town House
LOS ANGELES

Bellevue Biltmore
BELLEAIR, FLA.

A. S. Kirkely, Managing Director

The Drake

Lake Shore Drive • CHICAGO

FOR THE FILM DEPARTMENT



Neumade Cabinet Model DC-115 & all other models available in olive-green enamel, baked-on. Chrome hardware.

♦ LARGER STORAGE cabinet facilities for 16 and 35mm. films in the NEU-MADE line include the typical Model DC-415 (illustrated). A combination cabinet for 92-400 foot reels & 18-800, 1200 or 1600 foot reels each held in place by curved rigid wire rod separators.

PROJECTOR STANDS

♦ Sturdiness and steadiness are the two S's which are to be looked for in projection stands. AMPRO, DALITE, DEVRY, COMMERCIAL METAL and NEU-MADE are among principal manufacturers in this field. The NEU-MADE tilt table (illustrated) is of heavy gauge steel with two



Another Neumade product — the tilt-top projection table of heavy gauge steel is a convenient accessory.



Showing the Ampro Projection Stand of all-metal construction, portable type for field use.

rigid shelves for reels, projector case, etc. Top tilts to any angle up to 10° rise-by 2 sets of spiral gears controlled from one hand wheel. AMPRO (illustrated) projector stand is of collapsible telescope type to facilitate transporting, etc.

REELS, SHIPPING CASES

♦ Reels by BELL & HOWELL, DEVRY, KIN-O-LUX, NEU-MADE and COMMERCIAL METAL PRODS., etc. are of different design but all possess uniformly good construction. Sizes from 400 to 1600 feet are available in

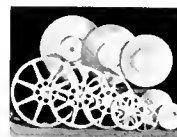

Bell & Howell reel and metal case display showing various sizes available from the line.



Large Humidor cans of Neumade type.



Metal shipping cases insure safe delivery.

16mm. reels; the 35mm. reels by DeVry range to 4,000 maximum capacity. The shipping case problem is one faced by the sponsor and producer whenever films are to be sent into the field. The two apparent choices involve the fiber shipping case (by FIBER-BILT, through NEU-MADE, BELL & HOWELL, etc.) v.s. the metal case (by NEU-MADE, KIN-O-LUX, etc.) with the metal products much more numerous



Kin-O-Lux 16mm. Reels — All Sizes

because of the primary need for extreme sturdiness in shipping large size reels subject to express handling. The metal Kin-

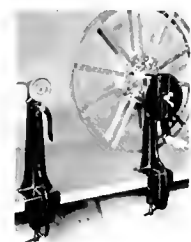

The DeVry Rewinders and a DeVry heavy-duty constructed reel. Available — all sizes.

O-Door (for 16mm. reels up to 2,000 foot capacity) offered by KIN-O-LUX has been frequently seen in shipments to *Business Screen*. So have the metal cases of NEU-MADE Products which feature a complete lining of fibre; patented ring-locking device.

REWINDERS & SPLICERS

♦ The average office-size film department where occasional films are received and reshipped may require the use of rewind and splicing equipment. Accurately geared with sturdy cast housing, special square shafts, the NEU-MADE rewinders pictured on this page are typical equipment. Most sound projector manufac-



Neumade Rewinders of sturdy construction.



Typical Kin-O-Lux Rewind Equipment



Neumade Model RWI Rewinders will take up to 1600 foot reels 2-point base holding.

turers offer and service this kind of accessory equipment. The DEVRY rewind attachments shown above, the KIN-O-LUX equipment below and similar equipment from AMPRO, BELL & HOWELL are in the

buyer's listing. Simple splicing equipment (such as the BELL & HOWELL unit illustrated) will be helpful in handling films from the field. FILM STRIP CABINETS: Slidefilm handling deserves special consideration.



Bell & Howell film editing equipment — 16mm. size.

Typical Power rewind model supplied by Neumade Products Corp. for the business or school film department.



PROJECTION LAMPS

• Few men, except those especially engaged in electrical research, appreciate the skill and patience required in the construction of projection lamps. Lamps ranging in wattage from 50 to 2100 are used in commercial film projection and a most important element in the success of any show depends on the steady clear brilliance with which the images may be viewed on the screen. To this end, a few suggestions are in order:

Look to your projector manufacturer for adequate lighting brilliance. . . . make sure that the lamps supplied meet the requirements under which a majority of your showings will be held. Insufficient wattage simply means a bad show. This applies to the soundslide showing as well as motion pictures, although the wattage required for the former will generally be a good deal less. In very few cases, however, is the 50 watt lamp (for slide-films) adequate for a commercial performance excepting under absolutely



A few of the lamps in general use for commercial projection.

ideal conditions of darkness and before a very small group of not more than several persons.

The principal sources of projection lamp manufacture, are General Electric, Westinghouse and Radiant Lamp Corporation. Research engineers in any one of these companies will advise but projection manufacturers are almost as equally well skilled. Some idea of the precision required in turning out lamps was gained recently when a technical representative of *Business Screen* visited the Radiant Lamp plant at Newark, New Jersey.

"Most of the work here," he writes, "is hand and precision work of the highest order. Every lamp is accurately centered and checked several times after various operations to see that filaments are perfectly centered."



The Neuvator, an automatic film cleaner and conditioner is available in 16 & 35mm. models from Neumade Prods. Corp., New York City.

The Business Executive's CAMERA



A Bell & Howell Filmo is popular among executives for personal use.

Some of the enthusiasm with which business executives naturally greet the commercial film medium carries over into personal affairs. Not a few advertising and sales executives have become ardent camera fans . . . which may explain the deference with which they now view the skillful lensing of their company's own commercial productions.

While a far cry from the highly-developed professional Mitchell, Bell & Howell and DeVry of the commercial production lots, the amateur's camera has been equipped with top-notch lenses and there are gadgets and attachments available for almost any kind of "trick" technique. You can "wipe" and "dissolve" with all the skill of a Birch or Steiner, even if your technique is a little ragged at the edges.

Here are a few concerns who offer catalogs and handbooks with plenty of variety in models for the better-than-average amateur:

Agfa Corp., Binghamton, New York. *Agfa Cameras and Accessories.*

Ampro Corporation, 2839 No. Western Av., Chicago. *Gumbiner Sound Motion Picture Camera.*

Bell & Howell Company, 1801-15 Larchmont Avenue, Chicago. *Filmo Motion Picture Cameras and Accessories.*

Burleigh Brooks, Inc., 127 W. 42nd St., New York City. *Rolleiflex and Rolleicord "Still" Cameras; Accessories.*



The DeVry camera is available in 16mm. or 35mm. models.

DeVry Corporation, 1111 Armitage Avenue, Chicago. *DeVry Sound & Silent Motion Picture Cameras; Recorders.*

Eastman Kodak Company, Rochester, New York. *Cine-Kodak motion picture cameras and accessories.*

International Industries, Inc., Ann Arbor, Michigan. *Argus Cameras & Accessories.*

E. Leitz, Inc. 730 Fifth Ave., New York City. *Leica Cameras and Accessories.*

Victor Animatograph Corporation, Davenport, Iowa. *Victor Motion Picture Cameras and Accessories.*

Some use of still cameras in commercial fields is being made by salesmen, research workers and others who use both miniature and reflex equipment. A nationally known florist makes Kodachrome shots of prize-winning gardens developed from his plants and shows them to garden clubs. A heavy machine salesman takes pictures of installations for his records. Hundreds of real-estate concerns regularly employ the camera for listing desirable properties.

The Otis Elevator Company has equipped representatives with projection apparatus as have many other firms.



The Rolleiflex offers "reflex" vision of the camera subject.



Rolleicord models have the same reflex viewer principle.



The Gumbiner Sound Camera (exclusively represented here by Ampro Corp., Chicago) is synchronized for sound & silent movie production.

ACTION STARTS ON OUR PICTURE NUMBER 100—



Inland waters of the Pacific Coast, Alaska and Hawaii provide the scenes for the latest Dowling and Brownell industrial picture.

100 pictures is not a big volume of production for a company specializing the last 10 years in industrial films.

But the fact that 31 of these 100 pictures were repeat jobs, for the same customers for whom we previously produced, tells a real story of achievement.

This strong indication of customer satisfaction is all the testimony necessary to prove sincerity of effort and quality of service.

DOWLING and BROWNELL*

6625 Romaine Street

Hollywood, California

*Full data on our motion picture or slide film service will be sent on request.

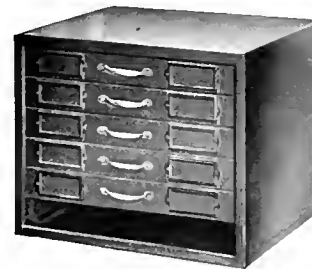

DUSTPROOF — FIREPROOF HUMIDIFIED

Specially designed for commercial and educational users — heavy gauge all steel humidified cabinet properly protects, preserves and files your slide films in the most practical, efficient way.

Model MF-6 (illustrated): all steel cabinet with six drawers for 1 1/2" film strip cans or loose rolls. Films may be filed by subject as each drawer contains six adjustable dividers — also used to provide facilities for larger cans or rolls. Concealed humidifier in base humidifies entire cabinet. Overall size 15" wide, 12" deep, 13" high.

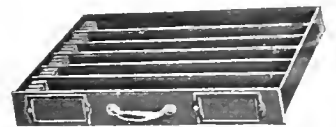

Complete line of 16m and 35m equipment

SEND FOR CATALOGS

TRADE MARK
Neumade
PRODUCTS CORP.
427 WEST 42ND STREET
NEW YORK, N.Y.

HOW BUSINESS USES . . .

PRESTO RECORDING:

● Now every salesman can own one of the world's finest recording instruments . . . bring real life into the routine of everyday sales procedure.

● Liven up your "pep" talks by substituting a Presto recording for dull correspondence. Give customers your ideas by direct transcription! Bring radio programs into the dealer . . .

● As business field representatives of the famous Presto Recording Equipment, Norman Willets now offer a Presto Recorder for as little as \$169.50!

● Full cooperation given in building sales uses including all operating instruction. Write, wire or phone for free demonstration record made on the particular model in which you are interested.

*Exclusive Photographic Distributors
of Presto Recording Equipment*

NORMAN-WILLETS CO.

316 W. Washington Blvd. Chicago, Ill.

1. TRAIN SALESMEN
2. IMPROVE SPEECH BY RECORDING TALK
3. DEALER MESSAGES
4. "LETTERS" TO SALESMEN IN FIELD
5. TRANSCRIPTS OF CONFERENCES
6. PROTECTION OF IDEAS
7. RECORDING TELEPHONE MESSAGES
8. REPLAYING RADIO PROGRAMS IN FIELD
9. PRESENTING SALES AND ADVERTISING PROGRAMS
10. INDUSTRIAL AND SCIENTIFIC RESEARCH

Sales Showmanship

● A new dimension has entered into the everyday life of the salesmanager. Affecting his contacts with salesmen in the field, it offers dramatic possibilities now being rapidly realized by a number of organizations.

By the simple device of recording home-office messages, "pep" talks and other helpful sales material, the sales executive may bring the magic of his own voice to the men outside, may thus exert far more influence in pushing certain ideas than less effectual means of letterwriting, etc. In the office, too, the portable recorder is being used for picking up important group discussions, making records of long-distance phone calls where small details and

(Continued in the next column)

VAPORATING FILMS

The Peerless Vaporate Film Treatment, used by United Artists, 20th Century-Fox, and other major Hollywood producers, is now available to movie makers throughout the country, through Bell & Howell dealers. Complete equipment for treating film by this life-prolonging process has been installed in Bell & Howell's Chicago factory. For this treatment meets the three basic requirements involved in prolonging the useful life of film.

Motion picture film is a strange commodity in that when it is ready to project it is expected to exhibit properties directly opposite to those it must have before the picture is made. Until its task of recording the image is completed, the film must, for chemical reasons, have a low melting point, it must be soft, and it must be porous. After it has been returned from the manufacturer's reversal processing laboratory (or, in the case of negative film, after it has been printed), the properties desirable for a long and useful life are a high melting point, toughness, and imperviousness.

The Vaporate Film Treatment imparts those very qualities to the finished film. The film is made tougher, yet retains its pliability. It is made impervious, yet it is lubricated externally. Its melting point is many degrees higher. It is difficult to scratch, will not absorb oil or excess water, will not retain finger marks, and will not dry out and become brittle.

Of course the Vaporate process does not remove dirt and oil from the film. It is earnestly recommended that all film which has collected dust and finger marks be cleaned before it is Vaporated.

To accomplish this cleaning efficiently and economically, special cleaning and polishing equipment has been added to the Bell & Howell film laboratory. The highly efficient Cinex machine, hitherto used only in Hollywood for the polishing of valuable negatives, has been adapted for B&H engineers to clean and polish 16mm. and 8mm. film prints. This cleaning and polishing service is available through Filmco dealers at the nominal rates which are quoted in the accompanying price list.

★

THE PRESTO Model M Dual Turntable Recorder Has Two 12" Turntables, Sells at \$550.00



specifications might otherwise have been missed, and for general training of clerks and workers in improved voice technique.

The present-day recorder such as is offered by R.C.A. Victor, Presto, Radiotone and other dependable manufacturers, is a complete unit requiring no extra processing or treatment of the record. With the addition of inexpensive "play-back" reproducers (portable phonographs adjusted for varying record speeds), the salesman, dealer or anyone else can play the records in the field. A great many organizations now bring transcriptions of radio programs into the field where salesmen can replay them for dealers.

Costs, including microphones, reproducers and a supply of uncut records, begin at about two hundred dollars for the complete outfit.



THE PRESTO MODEL J Recording Phonograph. Retail at \$169.50

VOICE REPRODUCER MANUFACTURERS:

Bell & Howell Co., 1801 Larchmont Ave., Chicago, Illinois.
Ampro Corporation, 2839 N. Western Ave., Chicago, Ill.
Del Ry Corporation, 1111 Armitage Ave., Chicago, Illinois.
RCA Victor Mfg. Co., Camden, New Jersey & Prin. Cities
and all sound slide equipment manufacturers (pages IX & X)

Equip Your Field Men with Rolleiflex* Cameras for Better Stills

ROLLEI cameras are ideal for making pictures indoors or outdoors — and for action shots of all kinds, in rapid sequence, if desired. It's easy to convert them into brilliantly sharp slides for projection, or to enlarge them for use in sales portfolios. With a Rolleiflex, you see each picture before you make it. And you get twelve in the popular, practical 2 1/4 x 2 1/4" size on a roll of 120 or B2 film.

There are now five different models in the famous Rolleiflex line, as follows:



Rolleicord Ia. with Zeiss Triotar 1/4.5 lens in Compur shutter (speeds up to 1/300) . . . \$57.50

Rolleicord II. with Zeiss Triotar 1/3.5 lens in Compur shutter (with speeds up to 1/300) \$77.50

1 x 1 cm. Rolleiflex. with Zeiss Tessar 1/2.8 lens in Compur Rapid-shutter, with case \$125.00

New Standard 6 x 6 cm. Rolleiflex. with Zeiss Tessar 1/3.5 lens and 1/3.1 finder lens, Compur Rapid shutter, with case \$128.50

New Automatic Rolleiflex. with Zeiss Tessar 1/3.5 lens and ultra-fast (1/2.8) finder lens, Compur Rapid delayed-action shutter, automatic film thread, etc., complete with case \$152.50

If your dealer cannot supply full information and literature on genuine Rolleiflex and Rolleicord cameras, write: Dept. 328

BURLEIGH BROOKS, INC.
127 WEST 42ND STREET, NEW YORK CITY

BRITELITE-TRUVISION De Luxe Model "A" Screen

Box-type model, instantly sets up anywhere, on a desk, chair, counter. Easily carried from place to place. Ideal for sales meetings, demonstrations, employee gatherings, etc. New wide angle crystal beaded screen surface shows bright, clear glare-free pictures. Contained in solid wood case, covered with fine quality leatherette. Case is nickel trimmed, and has a leather handle.



Available in sizes from 22x30 inches to 54x72 inches. Write for catalog describing the full Britelite-Truvison line.

MOTION PICTURE SCREEN & ACCESSORIES CO., INC.
351 West 52nd Street New York City

COMING ATTRACTIONS

In the next number of

BUSINESS SCREEN:

★ *Screen Advertising: Resuming the Series with Three Interviews*

★ *How a Bankers' Association Won State-wide Goodwill With a Film!*

★ *Trade Follows the Film. An Article by W. Adolphe Roberts*

To be Published in Early September Reserve Your Copies Now!

**THIS IS HARD TO READ,
IT STRAINS YOUR EYES...**

Its appearance distracts too much attention from the message—

**SCRATCHES
SPOTS
STAINS**

▼ Distract attention from the subject matter of your film. The best planned production can't do its job unless it is properly presented on the screen.

The Research Council of the Academy of Motion Picture Arts and Sciences reports, after exhaustive tests, that...

"These tests indicate that because of the fact that a film preservative contributes to the better projection as well as longer life, all release prints should be given some treatment before being placed in use."

VAPORATE
FILM TREATMENT

▼ is used for over five hundred million feet of entertainment, industrial and educational film annually... because years of experience have proved conclusively that it is the best means of assuring better projection and longer useful life.

Fraction-of-a-cent-per-foot-cost... 24 hour service... nationwide facilities... through your own dealer, producer or laboratory.

Vaporate Co., Inc. 130 W. 46th St. New York, N. Y.
Bell & Howell Co. 1801 Larchmont Ave. Chicago, Ill.
716 N. LaBrea Hollywood, California

PROJECTION SERVICE

A COMPLETE MOTION PICTURE DISTRIBUTION SERVICE

In all phases for Theatrical and non-theatrical pictures. The non-theatrical service includes supplying projectors, screens, operators, etc., and transportation.

King Cole's Sound Service, Inc.
203 East 26th Street, N. Y. C. Lexington 2-9850
Local operating points in upper N. Y.—N. J. and Conn

16mm. ACTION 35mm. Motion Picture Service

358 West 44th Street New York City
Completely equipped for servicing all makes of 35mm. or 16mm. sound or silent equipment.

Equipment Operators

FILM LIBRARIES

PLANNED 16mm. MOVIE PROGRAMS FOR ALL ORGANIZATIONS

NATIONAL FILM PROGRAMS INCORPORATED
342 Madison Avenue New York City

presenting

"SOPHIE TUCKER"

in a musical filled with swing and rhythm
1 reel... 16mm. sound

PICTORIAL FILM LIBRARY, Inc.
130 West 46th St. New York City

A BUYERS' GUIDE TO EQUIPMENT

Detailed information furnished without obligation by the Business Screen Service Bureau on all lines listed in capital letters below.

16mm. SOUND PROJECTOR MFRS.
AMPRO CORPORATION 2839 North Western Ave., Chicago
BELL & HOWELL COMPANY 1801 Larchmont Ave., Chicago
CLASSROOM LABORATORIES, INC. 100 East Ohio Street, Chicago
DEVRY CORPORATION 1111 Armitage Ave., Chicago
EASTMAN KODAK COMPANY Rochester, New York
HOLMES PROJECTOR CO. 1813 Orchard Street, Chicago
UNIVERSAL SOUND PROJECTORS 1921 Oxford Street, Philadelphia
VICTOR ANIMATOGRAPH CORPORATION Davenport, Iowa

35mm. SOUND PROJECTOR MFRS.
DEVRY CORPORATION 1111 Armitage Ave., Chicago
HOLMES PROJECTOR CO. 1813 Orchard Street, Chicago
INTERNATIONAL PROJECTOR CORP. 492 Gold Street, New York City
MOTIOGRAPH, INC. 4331 West Lake Street, Chicago

CONTINUOUS MOTION PICTURE PROJECTOR MFRS.
AMPRO CORPORATION 2839 North Western Ave., Chicago
BELL & HOWELL COMPANY 1801 Larchmont Ave., Chicago
ADVIDATGRAPH CORP. 305 West Broadway, Louisville, Ky.
ACLEY CAMERA COMPANY 175 Varick Street, New York City
ADVERTISING PROJECTORS, INC. 10 W. 33rd Street, New York City
CONTIMOVIE SALES CORP. 52 Vanderbilt Avenue, New York City
VICTOR ANIMATOGRAPH CORPORATION Davenport, Iowa

CONTINUOUS AUTOMATIC SLIDE PROJECTOR MFRS.
COLOR ILLUSTRATIONS, INC. 152 W. 42nd Street, New York City
SOCIETY FOR VISUAL EDUCATION, INC. 100 E. Ohio Street, Chicago
SPINDLER & SUTPPE, INC. (Selectroslide) 86 Third St., San Francisco, Calif.

SOUND SLIDEFILM PROJECTOR MFRS.
ELECTRO-ACOUSTICS PRODS. DIV. OF MAGNAVOX Fort Wayne, Indiana
OPERADIO MANUFACTURING COMPANY St. Charles, Illinois
SOUND PROJECTS COMPANY 3140 W. Walton Street, Chicago
TALKING SALES PICTURES, INC. 540 North Michigan Ave., Chicago
WEBSTER ELECTRIC COMPANY Racine, Wisconsin

SILENT SLIDEFILM PROJECTOR MFRS.
SOCIETY FOR VISUAL EDUCATION, INC. 100 E. Ohio Street, Chicago
SPENCER LENS COMPANY Buffalo, New York
INTERNATIONAL INDUSTRIES, INC. Ann Arbor, Michigan
INTERCONTINENTAL MARKETING CORP. 10 E. 10th St., New York City

GLASS & TRANSPARENCY SLIDE PROJECTOR MFRS.
SOCIETY FOR VISUAL EDUCATION, INC. 100 E. Ohio Street, Chicago
SPENCER LENS COMPANY Buffalo, New York
INTERNATIONAL INDUSTRIES, INC. Ann Arbor, Michigan
INTERCONTINENTAL MARKETING CORP. 10 E. 10th St., New York City
EASTMAN KODAK COMPANY Rochester, New York

SCREENS AND ACCESSORIES
DALITE SCREEN COMPANY 2723 North Pulaski Road, Chicago
HURLEY SCREEN COMPANY 24-45 43rd Ave., Long Island, N. Y.
MOTION PICTURE SCREEN & ACCESSORIES CORP. 351 W. 52nd St., New York City
RAVEN SCREEN CORPORATION 314 E. 35th St., New York City

FILM STORAGE CABINETS
COMMERCIAL METAL PRODUCTS CO. 2251-61 W. St. Paul Ave., Chicago
NEUMAIDE PRODUCTS CORPORATION 427 W. 42nd St., New York City

PROJECTION TABLES & STANDS
AMPRO CORPORATION 2839 North Western Ave., Chicago
DALITE SCREEN COMPANY 2723 North Pulaski Road, Chicago
DEVRY CORPORATION 1111 Armitage Ave., Chicago
NEUMAIDE PRODUCTS CORPORATION 427 W. 42nd St., New York City

REELS, REWINDERS, SHIPPING CASES
AMPRO CORPORATION 2839 North Western Ave., Chicago
BELL & HOWELL COMPANY 1801 Larchmont Ave., Chicago
COMMERCIAL METAL PRODUCTS CO. 2251-61 W. St. Paul Ave., Chicago
DEVRY CORPORATION 1111 Armitage Ave., Chicago
KIN-O-LIX (Reels, Cases) 105 W. 40th St., New York City
NEUMAIDE PRODUCTS CORPORATION 427 W. 42nd St., New York City
VICTOR ANIMATOGRAPH CORPORATION Davenport, Iowa

RAW FILM STOCK
EASTMAN KODAK COMPANY, Motion Picture Film Division, Rochester, New York
J. E. BRULATOUR, INC. 1500 Broadway, New York City
J. E. BRULATOUR, INC. 1727 South Indiana Ave., Chicago
J. E. BRULATOUR, INC. 6700 Santa Monica Blvd., Hollywood, California
AGFA-ANSCO CORP. Binghamton, New York
DUPONT FILM MANUFACTURING CORP. Nine Rockefeller Plaza, New York City

COLOR PROCESSES
TECHNICOLOR, INC. 823 No. Seward St., Hollywood, California
Thirty Rockefeller Plaza, New York City
CINECOLOR, INC. Burbank, California
CINEMACHROME CORP. 1108 Lillian Way, Hollywood, California
COSMOCOLOR, INC. 1010 Las Palmas Ave., Hollywood, California
DIMMING PROCESS CO. 932 N. LaBrea Ave., Hollywood, California
TELEO-CORP. 1257 N. LaBrea Ave., Hollywood, California
CONSOLIDATED FILM INDUSTRIES, INC. 959 Seward, Los Angeles, California
EASTMAN KODAK COMPANY (Kodachrome) Rochester, New York

PROFESSIONAL CAMERA EQUIPMENT
AMPRO CORPORATION (Gumbiner Camera) 2839 North Western Ave., Chicago
BELL & HOWELL COMPANY 1801 Larchmont Ave., Chicago
BERNIT-MAURER CORP. 117 E. 24th St., New York City
DEVRY CORPORATION 1111 Armitage Ave., Chicago
MITCHELL CAMERA CORP. 665 N. Robertson Blvd., West Hollywood, California
MOTION PICTURE CAMERA SUPPLY 723 Seventh Avenue, New York City
ART REEVES MOTION PICTURE EQUIPMENT, 7512 Santa Monica Blvd., Hollywood

PROJECTION LAMPS
General Electric Company, Incandescent Lamp Dept., Nela Park, Cleveland
RADIANT LAMP CORPORATION 268 Sherman Avenue, Newark, N. J.
WESTINGHOUSE LAMP COMPANY 30 Rockefeller Plaza, New York City

PHOTOELECTRIC CELLS
DEVRY CORPORATION 1111 Armitage Ave., Chicago
General Electric Company Schenectady, New York
G-M LABORATORIES, INC. 1731-35 Belmont Ave., Chicago
HYGRADE-SYLVANIA CORP. Clifton, New Jersey
RCA MANUFACTURING COMPANY, INC. 201 No. Front St., Camden, N. J.
WESTINGHOUSE ELECTRIC & MFG. CO. East Pittsburgh, Pa.

PRECISION
does make a difference
in Projection Lamps

BRILLIANT PICTURES — Filaments are located with precision equipment to align perfectly between reflector and lens.

LONG LIFE — Each lamp is accurately rated and stamped with correct wattage. Cheap inaccurately rated lamps, not so marked, are a poor buy at any price.

COMPLETE SATISFACTION — Every Radiant Lamp must be good because we dare not prejudice our only source of income by any compromise with absolute perfection.

Ask your Producer or write to:



260 SHERMAN AVENUE • NEWARK, N. J.

RAVEN BUSINESS SCREENS

... are business builders.

Don't take our word for it. Those who make film their business have checked and rechecked all screens. M.G.M. and Loew's use Raven Screens in their theatre circuits. Eastman Kodak is using Raven Screens exclusively for Kodachrome projection, at the World's Fair. These people know screens. They specify Raven Screens.

You too should specify Raven Screens. That industrial film sales help you prepared so carefully will look better on a Raven Screen. The technical division of the Raven Screen Corporation will gladly cooperate with you in selecting the one screen surface and mount best suited for your purpose. Write Department B 4 for illustrated leaflet and other information.

RAVEN SCREEN CORPORATION
314-16 East 35th Street • New York City

KODACHROME SLIDEFILMS

35mm * 16mm

Silent or Sound

Geo. W. Colburn Laboratory
1197 Merchandise Mart • Chicago



An ultra-modern
hostelry in the
heart of Chicago

KNOWN
for
GOOD
FOOD

Bismarck
HOTEL *chicago*

Emil Eitel - Karl Eitel - Roy Steffen

COMMERCIAL METAL PRODUCTS CO.

Designers and Builders of:

BUSINESS & EDUCATIONAL FILM DEPARTMENT
EQUIPMENT & ACCESSORIES FOR
EDITING, STORAGE & SHIPMENT

FILM STORAGE & HANDLING
CABINETS, BENCHES & TABLES

Designed and Built to your Specifications

METAL SHIPPING CONTAINERS

Cut Shipping Costs! Light-weight Metal Cases of Extra Sturdy,
Double-Strength Construction

COMPCO PIC-A REEL
FILM CASES

Solve the Small Film Library Storage Problem — Featuring the Individual Film Selector

PORTABLE PROJECTOR
STANDS

Made for Easy Handling and Steady Performance

YOUR EXACT NEEDS STUDIED & ESTIMATED BY METAL SPECIALISTS
WITHOUT OBLIGATION



PHONE
ARMITAGE 1123

COMMERCIAL METAL PRODUCTS CO.

2251-2261 W. ST. PAUL AVENUE • CHICAGO

REJUVENATION of FILM

The Recono Process Described

• A photographic film contains colloidal systems which tend to change as the film ages. This change develops serious symptoms: the film shrinks and tends to become dry and brittle. The mechanical strains and stresses to which dry and brittle films are subjected during use soon cause a breakdown of perforations.

The nature of the photographic emulsion, and likewise, of the base, makes it a receptive medium for accumulating moisture, oil, and dirt. The substances of which the emulsion is composed are not highly resistant to abrasion and scratches appear in a short time under normal use. These scratches become receptacles for dirt. The dirtier a scratch, the worse it appears when projected. Therefore, when a film becomes scratched during the first run, which may occur on poor equipment or on good equipment improperly operated, subsequent use of the film will make these original scratches more and more apparent. In addition, new scratches will be added constantly, and in a short time, it has acquired the "rainy" appearance which has been a source of much perturbation.

By the rejuvenation process, scratches and abrasion marks on both the emulsion and celluloid sides of negatives and positives are removed. Dry, brittle film is re-

The Ampro Voltage Regulator has been designed to aid projection where line voltage is too low or too high. Assures 115 volt output where line voltage varies from 80 to 125 volts.



stored to an elastic condition, and warped film is straightened. The removal of scratches is effected by causing a temporary swelling of the celluloid and emulsion layers, thus bringing together the walls of the scratches. After the swelling is reduced by drying, the walls of the scratches adhere. Elasticity is restored by impregnating the celluloid with material to take the place of the material that has evaporated. Neither distortion of the film nor disturbance of the relative positions of the silver grains results from this treatment.

Industrial and educational organizations have found *Recono* service of great economic value. By restoring their used prints to good screening quality, they saved the cost of buying new prints and were able to use the savings towards the purchase of new subjects.

Films that are stored away for future generations often become unusable because of chemical deterioration. Important films should be inspected periodically — merely keeping a film in a can in the vault does not insure its preservation.

SELECTED RESORTS FOR THE DISCRIMINATING BUSINESS EXECUTIVE

COME AND PLAY!

at these Cool Lakes

HOT SPRINGS

NATIONAL PARK, ARKANSAS

Rebuild your pep and restore health. Outdoor sports are bracing and invigorating, and the healing waters of 47 Government owned and supervised thermal springs give new life and happiness in America's favorite vacation land.

Lake Catherine

Lake Hamilton

New Low Rates!

MODIFIED AMERICAN PLAN

AT BOTH HOTELS YOUR ROOM & TWO MEALS FROM \$3 A DAY

ALSO EUROPEAN PLAN \$1.50 Rooms (without meals) from 1/2 A DAY

SELECT EITHER ONE OF THESE FINE HOTELS

As a guest of the Majestic or the Eastman your visit to Hot Springs is sure to be a success. Set in private parks, famous for quality service and food, both hotels operate government-supervised bath houses in connection.

Write for booklet

MAJESTIC
HOTEL APARTMENTS & BATHS
R. E. McEACHIN, MANAGER

EASTMAN
HOTEL AND BATHS
J. A. SAEGEL, MANAGER



SOUTHWEST HOTELS, Inc. H. GRADY MANNING, Pres.

Come to SEA CLIFF INN on NANTUCKET this Summer



Sankaty Head Lighthouse, a picturesque landmark on Nantucket.

Superb Swimming, Sailing, Golf, Tennis, Fishing, Riding, Cycling and other Sports

NANTUCKET, quaint old home port of whaling ships and clippers, has a charm all its own. Here you will find everything you have always hoped to find in a vacation spot — and *nothing undesirable*. 3 good golf courses, Surf and sheltered bathing, Cocktail lounge and concert music. Enjoy a perfect holiday with us — where the air is cool, the water is warm, and the people are friendly.

The SEA CLIFF INN is now under new management. Many improvements have been made, including 40 gleaming, modern tile baths, with tubs and showers. American Plan rates from \$6.00 a day single, \$11.00 a day double, up. Splendid cuisine. Rates on cottages upon request. Write for descriptive folder and rates. Reservations should be made in advance.

SEA CLIFF INN and Cottages

ARTHUR JELLS, Pres.

DEPT. 48

NANTUCKET, MASS.

Now Available to the Commercial Film Industry

THE FAMOUS SCENIC STUDIOS

of the

CHICAGO CITY OPERA COMPANY

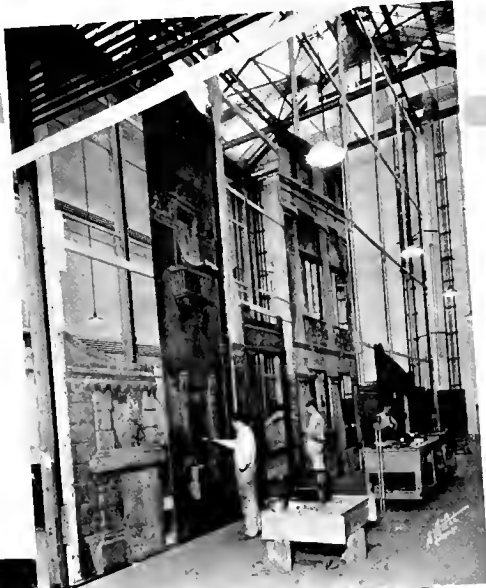
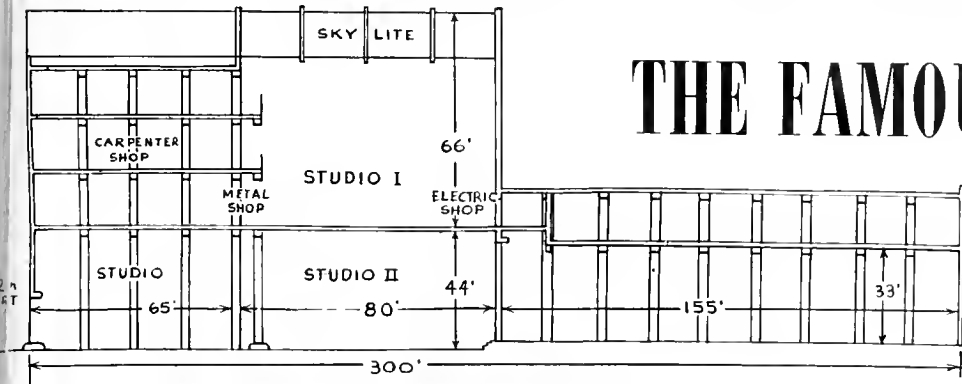

Sixty-six ft. from floor to skylight; this magnificent studio will accommodate the largest type of settings with ease. Below: A complete Chicago subway station is seen as it was recently constructed in this huge studio by local traction engineers

Here is an unusual opportunity. The world-famous scenic studios and shops of the Chicago Opera Company are now available on a rental basis to the commercial film industry. Within the walls of this specially-designed theatrical service structure are three studios, two of them of 80-foot length with ceilings at 66 and 44-foot heights, respectively. Convenient platforms, grids and skylights offer easy access to production. Extensive storage and workroom facilities and complete up-to-date mechanical facilities for costume and scenery making, include splendidly equipped woodworking, sheet metal, paint-spraying, and armor shops.

Built for handling of large theatrical properties and sets as well as construction, the Opera Studios have truck entrances on two streets, extra-size elevators and large receiving platforms. Office facilities within the building are light and modern, with convenient access to all studios and workshops. A large number of existent "flats" and stage settings may be utilized in production by arrangement.

THESE STUDIOS AND WORKROOMS ARE AVAILABLE:

Studio: 66' high x 80' long; second floor.

Studio: 44' high x 80' long; ground floor.

Studio: 44' high x 65' long; ground floor.

All have ready access to workrooms and storage as well as receiving facilities.

Costume Shop: with full sewing equipment.

Paint-Spraying: latest mechanical equipment.

Woodworking Shop: all equipment necessary for stage carpentry, scenery & set building.

Sheet Metal Shop: all modern equipment is installed here also.

Armor Shop: completely equipped for your use.

Storage Facilities: ample for sets and props, etc.

Office Facilities: modern offices available close to production studios.

And many other physical advantages for production.

Address all inquiries to the office of the President, J. C. Thompson,

20 NORTH WACKER DRIVE

THE CIVIC OPERA BUILDING • CHICAGO

(IN CONJUNCTION WITH THE CHICAGO CITY OPERA COMPANY)

A street view of the immense Opera studio building just south of Chicago's Loop Business district at 26th Street. Large truck entrances are shown.

Painters at work spraying scenery in one of the Opera studios. Mechanical equipment is of the latest type, especially adapted for set and scenery production.

Woodworking machines of every description necessary for complete set production are part of the permanent equipment of the Opera Woodworking Shop shown below.

The sheetmetal facilities in the Opera studios complete metal working shop include every useful type of equipment, thus affording unusual economies.





The more of the "right people" see your picture, the more it multiplies in value. A national organization, operating continuously and exclusively for Jam Handy distribution customers, is set up to put suitable pictures before any and every type of audience, non-theatrical or theatrical, provided your picture has been edited for theatrical appeal.

Group Selling

A total of 21,753 picture showings to 7,178,490 people in selected areas have been conducted in recent months by the Jam Handy staff of professional projectionists located in 26 strategic cities. These 21,735 audiences included: women's groups, school and college groups, luncheon and fraternal groups, war veterans, payroll groups, social and civic clubs.

Theatrical

More than 6,000 theatrical playdates were arranged and completed for the one-reel educational pictures of one customer; more than 2,000 playdates for another.

As sales representatives for General Screen Advertising, Inc., we can place "one-minute movies" in the programs of approximately 8,400 theatres.

The **JAM HANDY** *Organization*

Sales Meetings • Slidefilms • Talking Pictures • Convention Playlets

New York

110th St.
NY 10035

Hollywood

11611 Hollywood Boulevard
Hollywood 5809

Chicago

35 East Wacker Drive
Chicago 5758

Detroit

2900 East Grand Boulevard
Detroit 4240

Dayton

405 Mutual Home Building
Dayton 5208

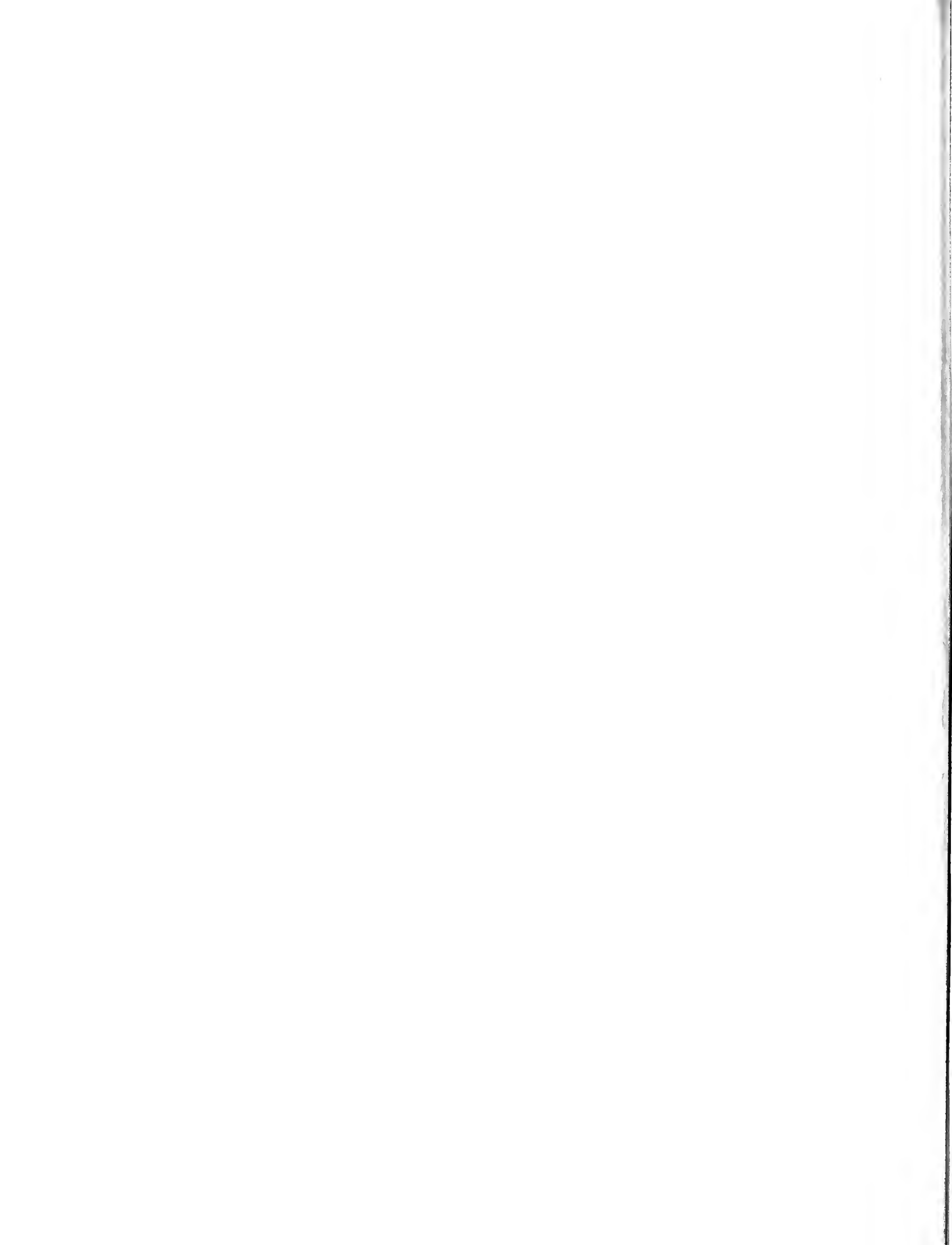

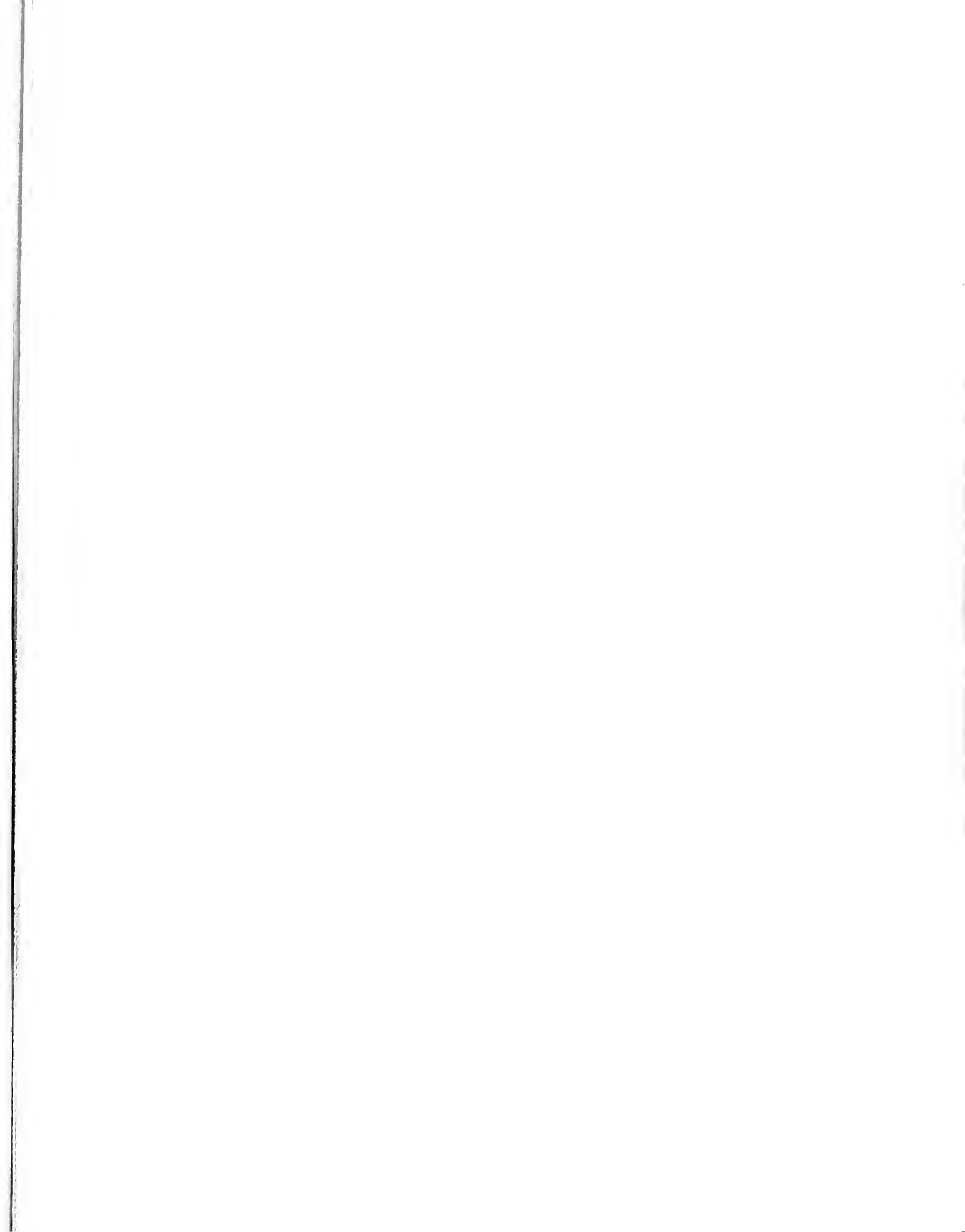

WITHDRAWN

APR 26 1983

