



673.3

Fub

MUSEUM OF VICTORIA



22174

ART OF COPPERSMITHING.

A PRACTICAL TREATISE ON WORKING SHEET
COPPER INTO ALL FORMS.

THIRD EDITION, REVISED.

SCIENCE MUSEUM

12 JAN 1982

OF VICTORIA

By

JOHN FULLER, S R.

PUBLISHED BY

DAVID WILLIAMS COMPANY,

232-238 WILLIAM ST., NEW YORK.

1904

UNIVERSITY OF MICHIGAN

THE UNIVERSITY OF MICHIGAN LIBRARY

ANN ARBOR, MICHIGAN

UNIVERSITY OF MICHIGAN
LIBRARY
ANN ARBOR, MICHIGAN

Copyrighted, 1893, by JOHN FULLER, SR.

Copyrighted, 1904, by JOHN FULLER, SR.

DEDICATED

TO THE MEMORY of my Father, to
whose early instruction much of the
following work is due: and to the Boys
of the Copper Trade, in the hope that
it may assist them to acquire pro-
ficiency in the art of Copper Work-
ing.

TO THE READER.

When a boy between the age of nine and fifteen years, struggling along with my father, trying to be what was then called a Tinman and Brazier, I was compelled by circumstances to encounter many stumbling blocks and overcome many obstacles in the way of education. It will be noticed in the opening pages of this work that the writer was but a mere child when, like thousands of other children, he commenced to handle tools, *not toys*. As my childish mind began to develop and inquire into the whys and wherefores of things about me, I also began to look for a source of information, beyond the shop, to assist me to fill the position it seemed I was destined to occupy with a hope of some degree of distinction (for most children have aspirations). My search was incessant, and not altogether in vain, because among the vast amount of chaff searched I found occasionally a golden grain, which was laid up in the storehouse of my mind.

I jotted down instinctively in my memory each practical lesson learned in the shop, which was my only record. After using every means at my command to obtain the education necessary, wrestling in the little spare time allotted to me in the evening with such books as came in my way, storing my mind indefinitely for several years with whatever seemed likely to be useful, I went to London. Here I ransacked every old book stall I could find, hoping to find some guide to the copper trade; but all in vain. I never discovered a line to

help me. I then resolved to exert every effort to acquire the necessary ability, so that when a favorable opportunity should offer I could give my experience for the benefit of boys placed in the same unfortunate position as myself.

And while the aspirations of my youth died away amid the busy turmoil of mechanical life, and smoldered for years (with an occasional burst of warmth), the thoughts were still cherished, and I began without any preparation, save my memory, to give the helpless boys of the trade reliable instruction in things they should know in starting out to acquire the "Art of Coppersmithing." I did my best to tell from my own experience, in the most lucid manner, that which is being called for in everyday life, in three separate branches of the copper trade, supposing with each lesson there was a good boy at my side. I am pleased with the result of my first effort, which was in a measure impromptu. It will not, however, make Coppersmiths of any one without effort and application, but I trust it will be a help to all who have need of assistance, and be an incentive to boys to exercise whatever talents they may possess for their own benefit and that of others less fortunate.

Before closing my few introductory remarks I desire to tender thanks to THE METAL WORKER for the opportunity afforded me for the consummation of my work.

JOHN FULLER, SR.

Seneca, Kansas.

TABLE OF CONTENTS.

	PAGE.
Historical Sketch of Copper.....	1
Braziers' Art, or Light Coppersmithing.....	6
First Year's Experience.....	14
Repairing and Tinning.....	17
The Boy's Second Year.....	22
Making Washing Coppers.....	26
Making Small Brewing Coppers.....	31
Table of Dimensions and Capacity.....	33
Making Hand Bowls.....	35
Making Frying Pans.....	42
Making Closet Pans.....	47
Making Water Balls.....	47
Mounting for Copper Goods.....	50
Glue Pots and Tea-Kettles.....	61
Oval Tea-Kettles.....	68
Beer Mullers.....	71
Funnels.....	80
Coffee Pots.....	83
Saucepans and Pudding Pots.....	87
Stewpans.....	93
Stock Pots.....	99
Fish Kettles.....	102
Brazing Pans.....	104

	PAGE.
Tea Boilers.....	107
Warming Pans.....	112
Preserving Pans.....	117
Dripping Pans.....	118
Coal Scoops and Coal Hods.....	122
Making Coal Scoops.....	128
Planishing and Smoothing.....	148
Cranes or Syphons.....	151
Pumps.....	154
Appliances of Railway and Marine Coppersmiths.....	162
Making Copper Pipe.....	171
Piecing and Joining Pipes.....	173
The Fire Pots.....	176
Fire Pot Set for Brazing Joint.....	178
Soft Soldering Large Joints.....	180
Taking Templates.....	183
Filling and Bending.....	183
Making Bends.....	186
Template Boards.....	191
Patching Pipes.....	196
Outlets.....	199
Expansion Joints.....	204
Tee Pieces.....	200
Three-Way Pieces.....	211
Cross or Four-Way Pieces.....	213
Saddle Fire.....	217
Marine Work.....	219
View of Maudsley, Sons & Field's Shop.....	221, 222
Making Large Bends.....	224

CONTENTS.

vii

	PAGE.
Making Double Bends.....	227
Brazing on Flanges.....	230
Short Bends.....	232
Air Pipes for Ships.....	234
Making Hollow Spheres.....	241
Brazing Sheet Brass.....	248
Locomotive Brass Work.....	252
Brazing the Joint of Valve Chimneys.....	258
Brass Dome Covers.....	262
Heavy Pipes for Breweries.....	269
Brewing Coppers or Kettles.....	281
Dome Coppers.....	293
Dome and Pan Coppers.....	299
Tallow Coppers.....	301
Dyers' Coppers.....	307
Sugar Tieches.....	311
Stills	312
Index	318

HISTORICAL SKETCH OF COPPER.

Copper is one of the most important of the seven metals mentioned by ancient historians. It was known probably before the time of Tubal Cain, who was well acquainted with its uses and an educator of workers in brass and iron. Grecian historians say that Cadmus discovered copper and taught its application to the wants of his countrymen. It was brought to notice on the island of Eubœa, near the city of Chalkis, and thus we may suppose the Grecians gave it the name of *chalcos*, by which name the metal was known to Homer and other ancient authors. The old Romans knew copper as *æs cyprum*, and later as *cyprum*, names apparently derived from that of the island of Cyprus, where Pliny says the art of working it was first discovered. It is certain that upon this island the Phenicians had opened copper mines at a very early period. Hence, in the mystic nomenclature of the old alchemists, copper received the name of Venus, the goddess to whom Cyprus was sacred, and among their signs it was known by the astronomical sign of that planet, ♀. The English word *copper*, the German *kupper*, the Spanish *cobre* and the French *cuivre* were probably introduced into those languages during the middle ages and seem but slight modifications of the Latin name. Copper is mentioned in the oldest records and appears to have been one of the first metals brought into use by mankind. We are led to this conclusion by the consideration of its nature and the probable manner of its occurrence. Masses of native metal, separated by water from the original beds and deposited by floods in spots where warlike people sought materials from which to make their rude weapons would, by their weight, color, luster and malleability, quickly attract attention. These qualities, in connection with the fact that pure native copper is often detached in masses of considerable size, make it more than probable that this metal was the first upon which the unskilled attempts of the primitive smiths and smelters were made. It is generally assumed, without any authentic evidence to support the assumption, that the ancient workers in copper had some particular alloy of tin and copper which they made so hard that they were

able to cut the hardest rocks, and the remains of large temples, whose columns were of porphyry and syenite, seem almost incapable of any explanation except by this supposition. Another fact in connection therewith challenging examination is that the Incas in Peru, although unable to make any use of the iron ores which lay profusely about them, were familiar with the special properties of this particular hard alloy of copper and tin and made it in proportions almost the same as those which the ancients adopted in the Old World, using it to construct the tools necessary for cutting the stones required in the building of their immense aqueducts and temples. Whether the Phenicians, who carried tin from Britain, acquired the knowledge of making bronze there is not certain; but it may probably be assumed that the weapons and tools of bronze found in the graves of some ancient race in various European lands, and which are known to be Celtic remains, were taken by wandering tribes from that region of Britain where at the present day the descendants of the same Celts have been and are possibly to day among the largest copper refiners on the globe; and there the richest, and until recently the only known, tin region within thousands of miles occurs

USES OF COPPER.

In the construction as well as the beautifying of public buildings copper, bronze and brass have all played an important part, the roof being covered with copper, the monuments dedicated to the honored dead being of bronze and the decoration of their walls artistically executed in brass. The invention of gunpowder and the introduction of bronze cannon, which were used in the fourteenth and fifteenth centuries, added greatly to the increasing value and stimulated the production of copper, and as civilization advanced the desire for a metal similar in its properties and beauty to gold and silver rapidly increased until there is scarcely a branch of human industry where copper is not an important factor in the means of arriving at or securing greater perfection. It is employed in nearly all kinds of machinery, either pure or as a compound. We see it in the hands of the musician, in the construction of mathematical instruments and instruments for the astronomer, adding to the security of sailing ships and contributing its share in the internal construction of ocean steamers that ply between the Old and the New World, besides furnishing a path for the electric current in its journey from continent to continent in

the service and extension of civilization. It supplies a reagent for the chemist and gives the physician a remedy against disease. The electro-metallurgist uses it to catch and make prominent the evanescent forms of nature and art. The dyer, the cook, the brewer and distiller, use it, and in many other important industries it is in constant consumption, while almost every advance in science adds to the number of its applications.

COPPER MINES.

At Newlands, near Reswick, in Cumberland, England, some rich mines of copper were worked as early as 1250, and it seems that in 1470 this place was still famous for the amount of metal it produced. Ecton Hill, in Staffordshire, was another place where copper was obtained in abundance before the era of copper-mining in Cornwall. It is somewhat interesting and amusing, in the light of passing events when searching into the history and development of the mineral resources of England, to meet with acts of Parliament passed in the reigns of Henry VIII and Edward VI for the purpose of preventing the export of copper and brass, "lest there should not be metal enough in the kingdom fit for making guns and other engines of war and for household utensils;" and then down to so late a date as 1708 we find a memorial presented to the House of Commons by the workers in brass, stating that "England by reason of the inexhaustible plenty of calamine might become the staple of brass manufacture for itself and foreign parts, and that the continuing the brass works of England would occasion plenty of rough copper to be brought in."

At this time nearly all the copper used in England came from the Continent, principally from Hungary, and not till 1717 do we read of English pennies being made from English copper. About the close of the seventeenth century the attention of Cornish tin-miners was drawn to the more valuable cupreous deposits around them; previous to that time copper ore had been of little value, and was sold under the name of *poder*, but this was produced from mines originally opened and worked for tin. The yellow pyrites of copper was the first ore recognized as valuable by the miner; the richer black oxide of copper was considered as worthless, and tons of it were thrown into the sea or left in the lodes to reward the later and wiser explorers. Deposits began gradually to be opened for the copper they contained about the beginning of the last century, and from that time to the present the

produce of the ore has steadily increased, as well as the consumption of the metal taken from it. The discovery of the rich mines in Anglesea in 1768 was followed by the addition of Devonshire and Ireland to the number of copper-producing regions, and later on immense quantities of ore were imported from Cuba, Chili and the Pacific islands.

THE SMELTING OF COPPER.

The advantage of sending ores to be smelted in the rich coal districts of Wales was very early perceived, and even in 1586, according to Carew, copper ore was shipped there from Cornwall. In 1765 several furnaces were in existence near Bristol—still famous for its brass—and several others along the coast westward. The various processes then in use appear to have been almost the same as that practiced as late as 1865 and known as the English method of smelting copper; and considering the complex nature of the many operations which it includes and the remarkable difference that exists between those practiced at that time in all other refining countries, we cannot help admiring the ingenuity and judgment of those old metallurgists who, aided only by their own observation, worked a system which, while so well adapted to all the circumstances of the locality, can be used in the treatment of every known variety of ore and has withstood, with scarce a change, the keenest research of modern science.

AMERICAN COPPER MINES.

In America copper in paying quantities has been found in nearly every State through which run the Appalachian chain of mountains. The oldest incorporated mining company appears to have been one for the purpose of reducing ores in Connecticut, the date of whose charter is 1709. But all other deposits sufficiently developed to assure a definite knowledge of their value are exceeded by those which within the last 25 years have been opened in California, Arizona, New Mexico and in particular in Montana and upon the shores of Lake Superior. That this wonderful lake region was occupied by a race which existed at a time prior to the earliest authentic aboriginal history is evident from the remains which still exist of gangways, tools, and other proofs of skill which the races occupying the country at the time of its discovery nowhere make manifest. The Indians met by the first travelers were quite ignorant of the methods of working that had been practiced by the former race; they could give no accounts to explain

the numerous excavations, and what copper they possessed was gathered from the surface stones. The first record of the deposits is found in the missionary report of the Society of Jesus for 1659-60. The natives had then rude utensils made from this metal, and large blocks of it were erected and worshiped among their gods. In 1768 an Englishman named Henry, a practical man, carefully examined the old works at great risk, on account of the native hostility, and in 1771 established works which were operated a short time only and then abandoned. The later and more successful mining era begins about the year 1844. The careful inspection of competent scientific men made those regions gradually known to the world, and practical miners who were drawn thither by the reports of mineral wealth soon discovered large blocks of copper permeated with silver. A great excitement was caused among adventurers and capitalists, who formed companies in various parts of the world to work in localities of which not even a survey had been made. In 1847, however, the crisis came, and of the then hundreds of nominally existing companies only six were found actually engaged in mining. The results of these early disasters have gradually disappeared. Since then the progress of this region has been healthy and profitable.

THE BRAZIER'S ART, OR LIGHT COPPERSMITHING.

The brazier's art, or the working of light sheet-copper into vessels for cooking and articles for ornamental purposes, must have engaged the attention of man from the earliest periods of his civilization, for among the ancient art treasures in the British Museum in London may be seen many very fine and interesting specimens of Oriental work, illustrating vividly to a practical eye the skill and ingenuity which had been exercised by the primitive craftsmen in the production of armor, cooking utensils, lamps, vases and a great variety of articles for personal adornment taken from the tombs of ancient Egypt, Babylon and various parts of India and other places. Judging from their preservation and the beautiful work displayed on them they must have played an important part in illustrating the exalted positions held by their prehistoric owners, as well as the social standing of the artist. It would seem that for thousands of years this ancient handicraft has been handed down from father to son, and even to-day many of the arts connected with special branches of brazing are as jealously guarded and kept secret with the craft as they were at the very dawn of its development. One of the most imperative injunctions received by the writer from his father was to faithfully guard his patrimony from the scrutiny of prying eyes, it having descended to him through a long line of ancestors for many generations, who had plied their craft with various degrees of proficiency, thus maintaining their respectability and independence to an honorable old age, in evidence of which in Canterbury, England, four years ago one of his kinsfolk could yet be seen working at the brazier's bench at the advanced age of 87 years. But having been imbued with more liberal ideas by coming in contact with and feeling my indebtedness to many other men from whom we are compelled to borrow more or less, I have concluded to waive the injunction received in childhood for the benefit of those who are most interested. I will now try to describe a brazier's shop in an old country town, together with the tools used therein, and give such lessons in the art of brazieri as I can recall to memory to assist as far as practicable the learner to become proficient.

AN OLD-FASHIONED SHOP.

In the beautiful little town of Dorking, in the county of Surrey, England, could be seen an old-fashioned iron-monger's shop, with the usual stock of copper goods, comprising stew-pans, saucepans, preserving-pans, frying-pans, omelet-pans, cutlet-pans, dripping-pans, warming-pans, tea-kettles, fish-kettles, turbot-kettles, coffee-pots, pudding-pots, stock-pots, tea-boilers, tankards, spirit-measures, coal-scoops, coal-hods, beer-mullers, washing-coppers, hand-bowls and a variety of goods displayed in a tasteful manner in a spacious show-room window. In the rear of this iron-monger's shop (hardware store) was once a busy hive of some 25 or 30 men and boys engaged as blacksmiths, whitesmiths, tinsmiths, gunsmiths, coppersmiths and braziers, each department separate and distinct in itself. We will now visit this old brazier's shop, with which we have the more special interest, look about it, and endeavor to describe the interior as it was some 40 years ago and as it probably is to-day, or at least as it was in 1884, hoping it may benefit and interest the younger members of the craft. As shown in the plan view, Fig. 1, the door is facing east, and the room is some 25 feet square, with an east-window light; on the north side is a brick forge, Fig. 2, about 4 feet 6 inches square, the chimney of which is built in the shape of a square pyramid and covers the whole hearth; the fire-place or fire-hole is about 12 inches square and some 6 inches deep, and set about 2 feet from the front of the hearth and the same distance from the wall that carries the west side of the cone of the chimney; on the west side of this wall the bellows are hung, and at the back of the bellows are placed three covered pickle-tubs containing severally sulphuric acid, muriatic acid and salt pickles. Along the south wall and under the east window are the benches, Fig. 3, with vises attached; on the east side of the forge is the scouring-sink, which is some 3 feet long, and placed there so the fumes of the various acids in daily use may be carried off by the draft of the chimney; there should be a good supply of water at hand for rinsing purposes, which is carried off by the drain-pipe running to the sewers. At the back of the sink are a few shelves to hold spelter-boxes, mortar and pestle, and a few covered jars containing sal ammoniac and borax. In the chimney-wall are driven a number of square hoops upon which are hung ladles, sal ammoniac wads of various sizes and the different kinds and sizes of tongs. The rocking-shaft of the bellows is supplied with

ART OF COPPERSMITHING.

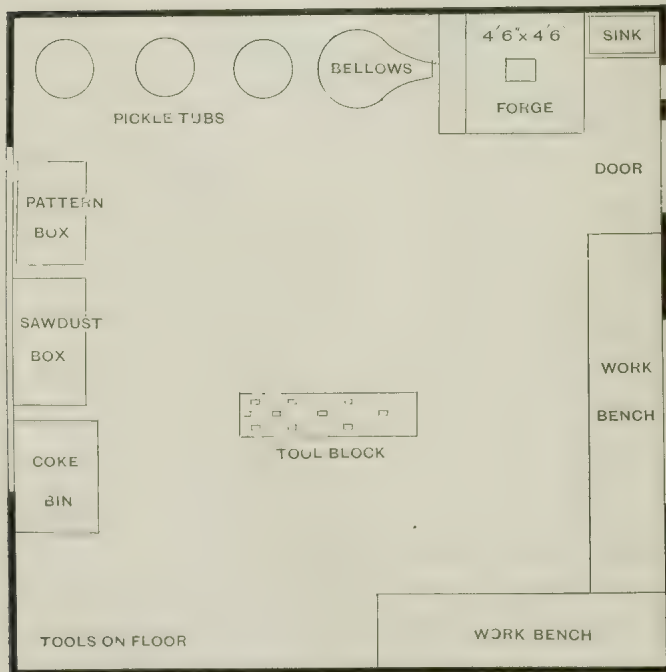

Fig. 1.—Ground Plan of Old Shop.

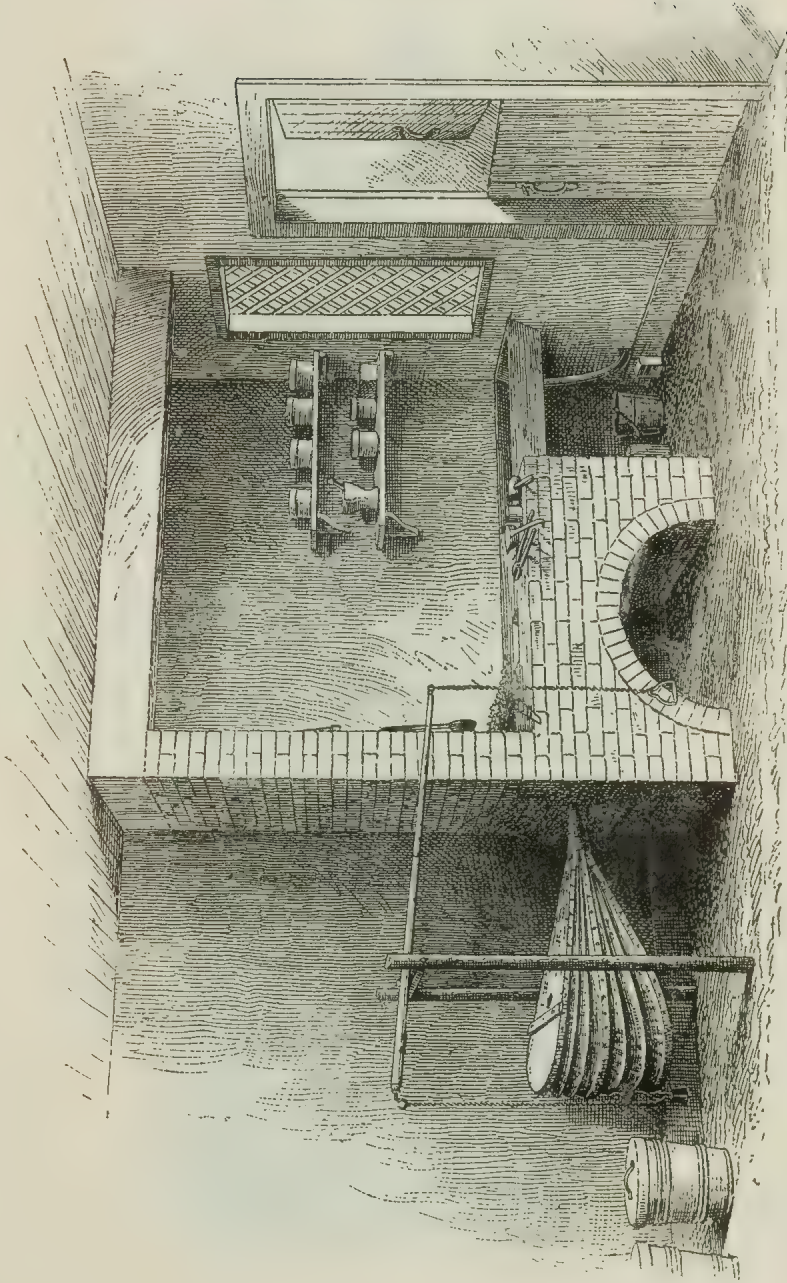

Fig. 2.—North Side of Shop, Showing Forge and Scouring Sink.

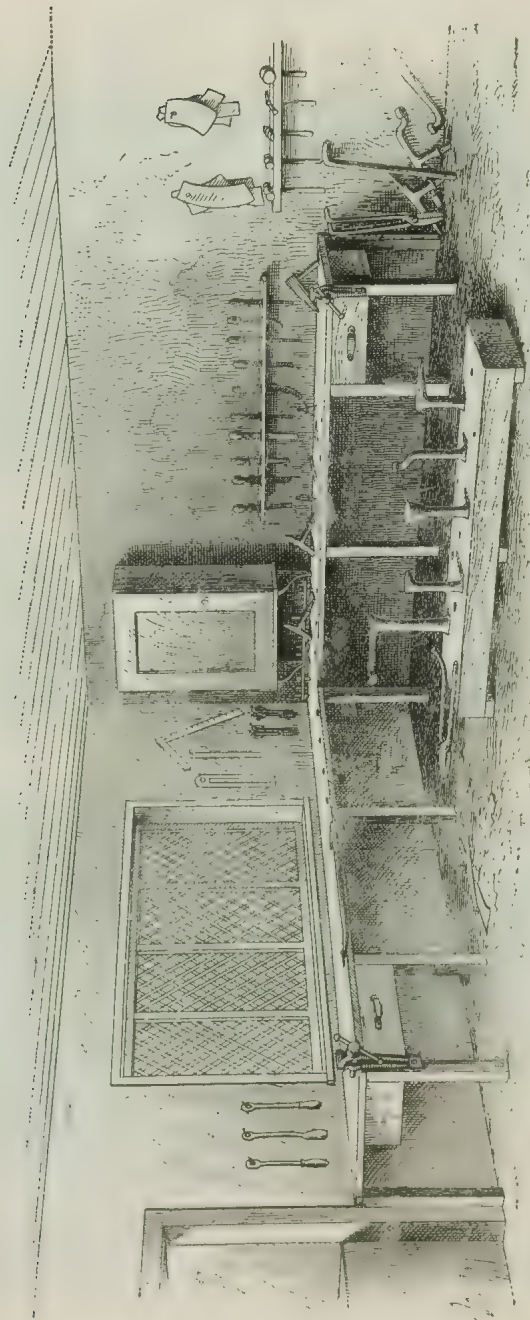

Fig. 3.—East and South Sides of Shop, Showing Floor-Block and Tools.

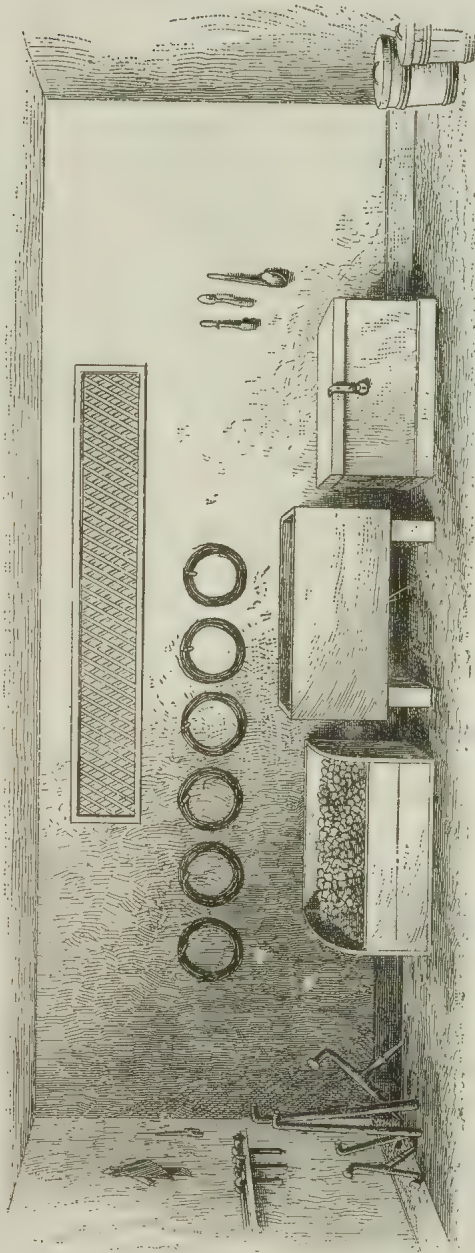

Fig. 4.—West Side of Shop, Showing Coke-Bin, Sawdust and Pattern Boxes.

a chain and stirrup so that the workman may easily work the bellows with his left foot, leaving his hands free for his work at the fire. On the east side of the shop is the main work-bench, upon which is fastened an old contrivance for turning stove and other pipe which I think may claim to be the parent of the rollers now in use in the modern tin-shop. This primitive contrivance is a round bar having the ends turned square about 5 inches, flattened and then bolted to the bench, leaving a space between it and the edge of the bench wide enough to get the sheet iron or copper between, the workman forming the pipe by bending the sheet over the bar with the leverage of the metal. On the south end of this bench and on the south wall is a cupboard with several shelves, in which is kept the bright-heads, dry spelter, borax, rosin, flax and hemp tow, block and grain tin, solder and other little necessities, so that they may always be in store and be kept clean and always ready for use. The east bench is continued along the south wall about half way and the remaining part taken up by the heavy tools, such as beak-horns, shanks and side-stakes, along the wall. Over this part of the bench is a file-rack and further on is a long hammer-rack, the other space being variously taken up by hanging patterns on hooks in the wall. On the west side Fig. 4 is the coke-bin, and a large box, about two-thirds full of sawdust, used to wipe off or dry work in after it has been scoured clean. The next is a large box containing a full and complete stock of patterns, kept together on rings in the same manner as they are in the shops of the present day. In the middle of the floor is the heavy tool-block which is about 16 inches wide by 6 or 8 inches thick and some 6 or 8 feet long, usually of beech wood, and having pieces of wood nailed to it to answer as feet to keep the block off the floor and the holes which receive the tools free from dirt and chips, so that no impediment be in the way of tools placed therein. This stock of tools is comprised in and named as follows: Large and small round bottom-stakes, tea-kettle-bottom stake, tea-kettle shank with heads, sauce-pan-belly stake with single and double end, bent and upright bullet-stakes, side-stakes, large and small; funnel-stake, hatchet-stake, beak-irons, crease-irons, anvil and heavy and light stock-shears. These are all of the heavy and most costly tools; the bottom stakes and the various kinds of heads have bright faces and must be kept greased. The bottom-stakes have lead covers to protect them from the action of the acids constantly in use. The various kinds of hammers used can better be described as

we proceed and come to the work for which they are adapted and used by the workman. In the most convenient corner of the bench are kept with the shears several round and square mandrels, from 4 to 5 feet long, of suitable sizes, having their ends turned down square and made to fit the holes in the bench, the same as the other tools. The small tools on the shelf over the south bench consist of hollow punches, chisels, flat punches, rivet-sets, groovers, &c. The other small tools are plyers, nippers, hand-shears, snips, compasses, squares and straight-edges, a good assortment of rough and smooth files and two burnishers. Having now described as vividly as possible the interior of this old brazier's shop, together with all its appurtenances, we will next follow an apprentice through his seven years of service, from his first two years of drudgery on and up until he shall have gained sufficient proficiency to take his place as a journeyman.

FIRST YEAR'S EXPERIENCE.

On Monday, February 7, 1842, in the town of Dorking, at 6 o'clock in the morning, could have been seen a little boy, fairly intelligent and rather larger in stature than his tender years would seem to indicate, who lacked just 46 days to complete his ninth year. This little fellow was trudging along by the side of his father toward an old brazier's shop to take his initial step amid life's busy turmoil. Having arrived there in due time and admission gained, a light was the first thing in order, which was obtained from an old tinder-box with a brimstone match, the light being transferred to an old-fashioned whale-oil lamp (Fig. 5), which burned after being lit with a reddish-yellow flame. On looking around the boy saw that about everything seemed black and forbidding, cold and cheerless; the soot of half a century previous was still clinging to those dreary-looking walls. The next anxiety was to get a fire, which was made from a pile of cinders at hand in the corner of the forge. This fire seemed to offer a ray of hope to the little fellow, who clung to the chain of the bellows and kept the cinders bright enough to be able to see just where he was. After two and one-half long, weary hours the bell rang and the boy trudged home to get his breakfast; and what a release it seemed to get away, if but for 30 minutes, from this gloomy-looking place and revel in the sunshine while walking home and back! As the hour of 9 approached he was wending his way thither again, and from 9 until 1 o'clock blew the fire, ran errands and helped his father, when the joyful bell rang for dinner, for which an hour was allowed, returning at 2 o'clock and working until 5, then going to tea for half an hour and back to work again until 7 o'clock, at which time the most welcome sound of the whole day said, "Leave until 6 the next morning." Never did child go to bed more cheerfully or sleep more soundly than did that little hero of nine summers, and never did the time seem to fly more swiftly as the gentle word summoned him to his duties each succeeding morning.

The first week was at length finished, and on Saturday we left off work an hour earlier; but the last employed were the last paid, and

thus the boy was the last to be paid, which was done with as much ceremony as if he were the most important man. After paying him his 3 shillings wages the good man seemed moved by pity, for he spoke the only kind word that had seemed to greet the boy's ear (excepting from his father) during the week, and so the first week of the infant's toil closed. Peter L. Saubergue always proved a good and kind master, and our boy learned to love him as time went on. Here let us pause a moment to consider if it ought to have been then or is now necessary for the welfare of the race that little children of such tender years should be made captive and brought to labor while thousands of able-bodied men are idle around them waiting for work.

At the end of six months this boy had got to be quite handy and was kept busily engaged breaking coke, sal ammoniac and borax, charging joints and drying them ready for the fire, thinning edges and other little jobs. Then as each batch of cooking utensils was brought to be repaired and retinned he was taught to burn off the

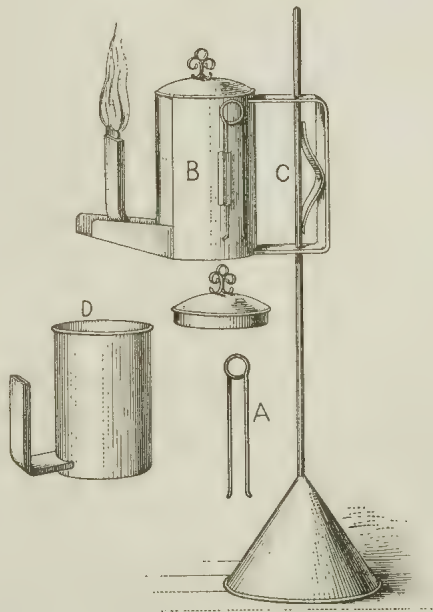

Fig. 5.—Old-Fashioned Whale Oil Lamp.

REPAIRING AND TINNING.

At the close of each year, before the Christmas holidays commence and the prominent families leave city resorts for country homes, all the kitchen furniture has to be overhauled, tinned and repaired, and all of these goods are sent to the brazier's shop for this purpose. We will now take a batch and proceed to repair them and then go on and describe the process of retinning as it would be done, giving the boy his share in the job. There would be stew-pans, saucepans, frying-pans, fish-kettles, stock-pots, ladles, spoons, gravy-strainers, fish-slices and a host of other things required for a complete kitchen outfit. Fig. 6 shows a copper saucepan with curved sides. The first thing necessary is to burn off the grease which accumulates under the flap of the handle and around the wire of saucepans and other vessels, and this is to be done carefully, so that the articles are not softened. They are made hot enough so the gases evolved by the heat will just ignite and no more, each piece going through the fire in succession, when they are brushed off and examined. If any of the handles are loose the old rivets are taken out and new ones put in, the rivet-holes being cleaned and tinned and the handle then replaced with new tinned copper rivets. It often happens that a hole is worn through the lag of a saucepan or stew-pan by the constant rubbing on the kitchen hot-plate or scullery-sink. The damage done by this wear is repaired in three ways, according to the time available, the ability or inclination of the workman, or the affluence and dignity of the owner.

At one time it was the fashion to finish all utensils up with a sharp lag (Fig. 7), and often careless workmen have half cut the lag through before completing them when new. When they are in need of repairing and it must be done in as short a time as possible, and the slit is not too long, say over 2 inches in length, then at the extremities of the slit punch two small holes and slightly open it; now take a thin piece of sheet copper of sufficient length and double it, as in Fig. 8, then slip the two leaves through the slit, as in Fig. 9 or 11, and lay the leaves back each way, as in Fig. 10; then close the whole up close

grease, apply the acids and scour them ready for the process of re-tinning. Then, again, all the hammers were required to be kept clean and bright, also all other polished tools, all of them being carefully greased with raw goose-grease, which duty had to be performed every day before leaving work, because if a hammer should get cloudy it entailed much labor repolishing on the buff-board to restore it suitable for use. The boy labored along at this seeming drudgery, which many boys are apt to shun and exert every effort to evade, to their own detriment, for wrapped up in this so-called drudgery are some of the most important features of every trade.

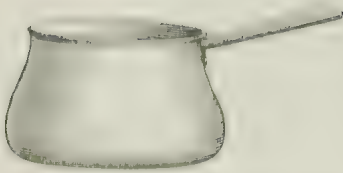

Fig. 6. Bellied Saucepan.

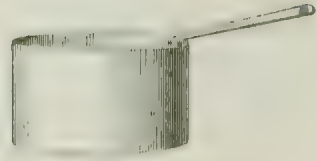

Fig. 7. Sleapan.



Fig. 8. Showing Piece Doubled.

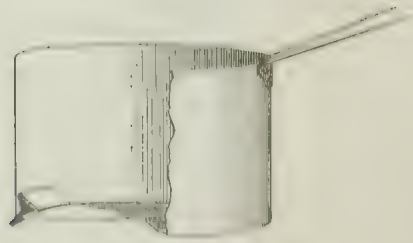

Fig. 9. The Way Piece is Put In.

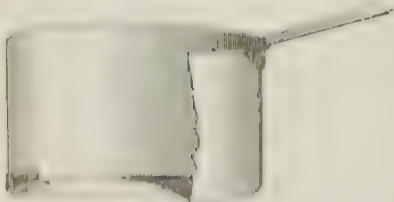

Fig. 10. Piece Put Through Outside.

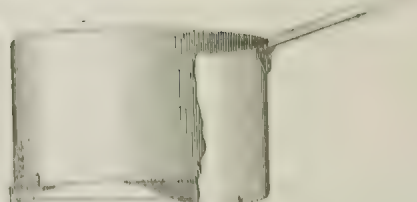
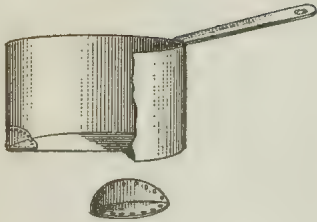

Fig. 11. The Piece Put Through Inside.



Showing Shell Piece.

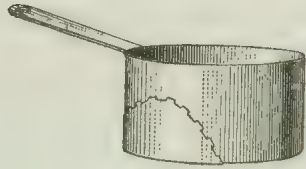

Fig. 13.—Showing Piece Cramped and Brazed In.

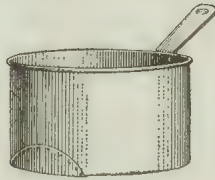

Fig. 12.—Showing Piece and How Put In.

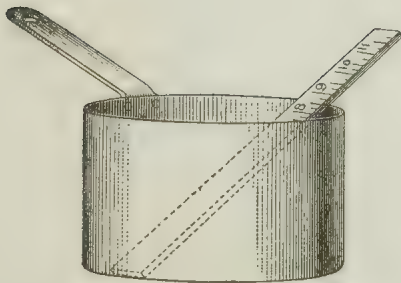

Fig. 15.—Manner of Measuring to Determine Price.



Fig. 14.—Sal Ammoniac Wad for Tinning.

with a mallet, letting the double part, if inside, go one-half up the side and the other half out into the bottom, as in Fig. 10; it may now be soldered with spelter or soft solder. The article can be repaired by making a shell piece and riveting it to its place, as in Fig. 12; this kind of piece may be of any length, but the best job is to cut the damaged part out and cramp and braze a new piece, as in Fig. 13, which may be done by an expert hand in as short a time as the other two methods, excepting, however, the cleaning off and replanishing. New bottoms may be cramped and brazed in or double-seamed, as may be considered expedient.

When all the repairing is complete and the bruises taken out and the bottoms of the stew-pans and saucepans and the like are laid flat or made level the preparation for retinning properly begins. We commence with the application of a coat of pure commercial muriatic acid to eat off or remove the dirt and the portions of the old or previous tinning. When the vessels have stood a sufficient time they are thoroughly scoured inside with good sharp sand, with the addition of some common salt, and then washed clean, care being taken that all of the old tin is off when burnt and that nothing greasy gets inside. Then while the vessel is yet damp a coat of finely-powdered sal ammoniac is sprinkled over the inside and a coat of wet salt carefully put on the outside to guard against the effects of the different gases from the fire.

Now take a quantity of block or ingot tin and slowly melt it in a ladle, being careful not to allow any part of it to become too hot or get burnt. When the tin is melted and ready, then warm and dry the vessel to be tinned and pour a sufficient quantity of tin into it. Next take a sal ammoniac wad, Fig. 14, and with it rub and agitate the liquid tin over the entire inside surface of the vessel until every part is well covered, and then pour out the bulk of the liquid tin. After heating the vessel to a uniform heat all over, take a wisp of clean, soft flax-tow, the hand first being protected by means of a glove which has had the tips of the fingers cut off as far as the first joint, and whisk it in a pan of powdered sal ammoniac; then with a light hand and a few quick motions, first around the left side and then the right, and then across the bottom, wipe out the residue of the tin, leaving only a clear bright coat on the surface of the vessel. Only by constant practice can this operation be accomplished or excellent results secured. Being a few months out of practice will seriously affect a man's efficiency

in the sense of touch and cause him many unpleasant and annoying failures. While the tinning process is going on the boy is busily scouring and preparing other vessels and keeping his weather-eye open to what is going on. The tinning process being over, the next in order is to scour each article with clean white sand on the outside to remove the salt and inside any sal ammoniac that might be left. This scouring must be carefully done, and it is best to have a separate place for each operation, so that when the outside is cleaned off the inside can be scoured without fear of contamination from the salt; because if the outside scouring wisp should by mistake get on the inside the work would be spoiled and can scarcely ever be restored again, so it is best to keep the wisps far enough apart to insure them from being taken up and used by mistake. After the sal ammoniac has been scoured off and the surface outside and inside is clean and bright, the articles are rinsed in fresh, clean water and dried in clean pine sawdust kept in a large box and then stood around a large forge-fire to be dried more thoroughly. Next brush off the sawdust and with a clean, soft linen or cotton rag and clean whiting polish the inside; then with another rag and a little crocus polish the outside and the job is complete.

Tinning has always been paid for extra in all country shops at the rate of a shilling a day in excess of the ordinary pay on account of the disagreeable nature of the work. The manner of measuring and paying for the work is by the inch, as shown in Fig. 15. The rule is laid obliquely from lag to brim, so that the longest measure may be obtained, and the price varies from 1 to 2 pence an inch according to the nature of the work.

THE BOY'S SECOND YEAR.

The first year of drudgery glides slowly away, and as the end of the second year approaches the long, weary, damp and chilly nights of October and November come with it; the heating-stoves of those who are compelled to use them are called into service, and with them comes a demand for stove-pipe, both iron and copper. Now, at the time of which we are writing there were no squaring-shears with which to cut the sheets into suitable pieces, so all the work had to be cut out with hand-shears or the stock-shears. Then there was no folder with which to fold the edges for grooving; the locks were all folded over a hatchet stake and closed down on a straight edge. The men usually cut out the pipe, and if it was not too large the boy was put to work folding edges and then closing them down over a straight-edge on a square mandrel laid across the bench (Fig. 16). If copper stove-pipe is to be made it is usually browned and planished. Here, then, is one of the boy's first lessons in the manipulation of a planishing-hammer. While he is engaged at this many a "half-moon" intrudes itself on the surface of his work to enlighten him that he must be careful and attend to his task.

COPPER STOVE-PIPE.

Let us now describe the making of two joints of copper stove-pipe. We will suppose the pieces are cut the proper width and of sufficient taper that the small end of one joint will when formed fit snugly into the large end of the other. The pieces are first clipped at the end as in Fig. 17, about 2 inches from the end and as far in on each side as the locks will take up; then, with a tow wisp, some dry Spanish brown is rubbed all over one surface of each piece, and the sheets are fastened together with four dogs, as shown in Fig. 18, or secured in whatever way seems best. The browned surfaces being outside the sheets are then taken to the large bottom-stake (Fig. 19), and with a suitable hammer, called a bottom-hammer, which has one face a little fuller in the center than the other, the pieces are planished—that is, the grain of the copper is closed. There is only one way to do this part of the work successfully and in a perfect manner, and there is a

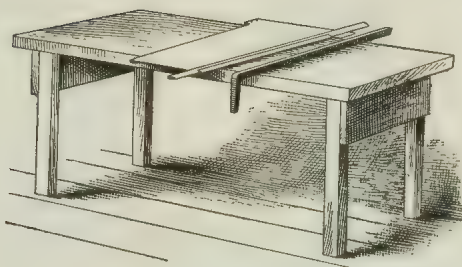

Fig. 16.—Folding Edges on Bench.

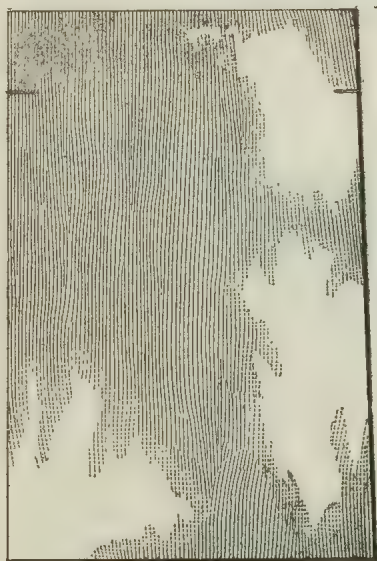

Fig. 17.—Pattern Clipped Ready for Folding.

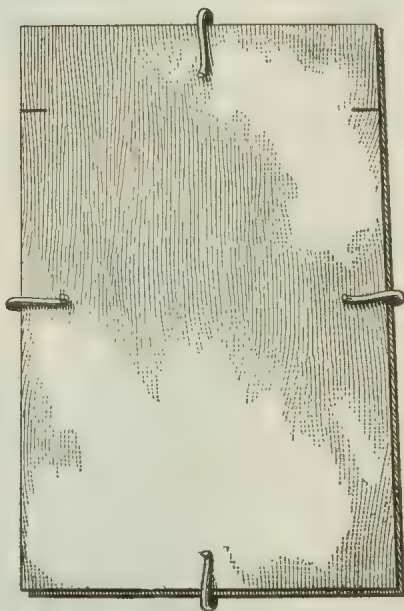

Fig. 18.—Two Pieces Dogged Together.



Fig. 19.—Planishing at the Block.



Fig. 20.—Showing the Blows Arranged.



Fig. 21.—Folded for Turning.



Fig. 24.—Bench Hook for Holding Mandrel.

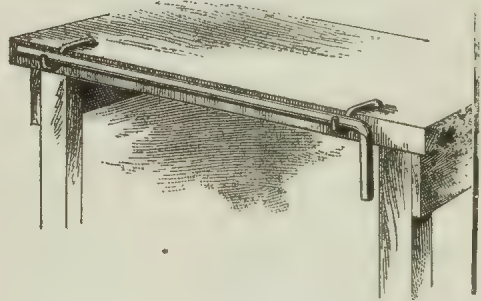

Fig. 25.—Mandrel in Position.

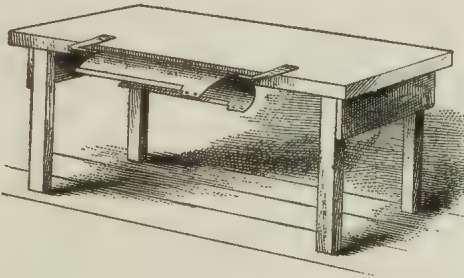

Fig. 22.—Old Fashioned Bending Bar.



Fig. 26.—Loose Bar and Pipe.

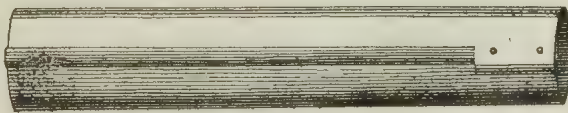

Fig. 23.—Pipe Finished and Riveted at End.

little knack in it which boys are a good while learning, particularly if they are, unfortunately, counted as unwelcome intruders in the shop. The secret of success is to keep the blows regular. The best results are obtained by striking each succeeding blow in as near a direct line with the previous one as possible, and then filling in between as each line is completed, as in Fig. 20. When the surface has been planished all over the sheets are taken apart and made to lay level; this done they are ready for folding and forming. They are then taken to the hatchet stake and folded, the edges being closed down, as in Fig. 21, and next they are taken to the bending-bar (Fig. 22) and bent round by placing one edge between the bar and the bench, and bending a little at a time until the locks will meet each other, and after grooving, rounded up and smoothed with a mallet, making finished pipe as in Fig. 23.

That old bar (used in the shop we are writing of), judging from the wear of the bench and itself, must have served as a former for many a boy before, and perhaps is used yet, for it was still clinging to its place in 1884. An improvement was introduced by my father in bending-bars by making two hooks of $\frac{1}{2}$ -inch rod (Fig. 24) and placing them in the bench, so a mandrel or bar could lay in them close to the bench (Fig. 25) and permit of one end being raised so that the pipe could be slipped off readily (Fig. 26). One day there was some pipe of different sizes to make, and after finishing the smallest, while at work forming up the larger sizes one of the smaller pipes was placed on the bar and the larger pipes formed over it. During this simple operation it was noticed that the pipe was formed without any ribs appearing, as had been the case when the naked bar was used. By this method the pipe can be made smooth and much work saved in rounding up. This method has been used to advantage when no rollers were at hand, and as good work can be turned out by this means as by the use of the rollers, though of course not so rapidly.

MAKING WASHING-COPPERS.

The next lesson in the use of the hammer would be "spotting" coppers, or, more properly, making coppers complete. In the South of England scarcely a house could be found without a washing-copper in or near it; hence there was always plenty of this kind of work for a boy in any brazier's shop. The capacity of these coppers runs from 8 to 25 gallons or more, according to the size of the house, and they

are much more economical as regards fuel and would seem much better adapted for washing purposes than a wash-boiler on a cook stove. Some of these boilers are made to serve for both washing and brewing. A copper to be used for brewing is made a little different from a washing-copper, although the greater part of their construction is the same. Let us proceed with a washing-copper to hold about 20 gallons and a brewing-copper of a little larger capacity. Now, in nearly all cases the sides are all cut out and furnished ready to be put together, and the bottoms also, which are already raised up at the edge some 3 or 4 inches, and therefore few boys or men trouble themselves as to the dimensions they ought to be, their only care being to put them together into shape as quickly as possible, which they proceed to do in the following manner: The sides are first examined and made true, if necessary. As shown in Fig. 27, one piece is laid half-way on the other and a line drawn along the edge of the top piece; it is then turned over and the end of the same edge placed at the end of the line drawn on the other piece. If the edge coincide with the line drawn and the curved edges also coincide, it will be considered true. If the end edges do not coincide, divide the difference at one end and pare it until the edge and line coincide with each other. Next, the holes are punched along the side and bottom edge, as shown in Fig. 28, in such a way that the distance between the center of the holes will be equal to the diameters of the head and shank of rivet added together. Thus if the head be 1 inch and the shank $\frac{1}{4}$ inch, then the distance between the centers of the holes will be $1\frac{1}{4}$ inches. The rivets in the bottom must be at least one size larger, sometimes two sizes, according to the strength of the bottom, which is always much stronger than the sides.

Now form the sides and put three rivets in each seam, as in Fig. 29, and knock them down half-way temporarily, and put a small tack in the middle of the part which will form the brim at top; then with a racer (Fig. 30) or a pair of compasses mark off the width of the brim as in Fig. 29. Now take the copper and put it on a suitable head, which is placed in the square shank (Fig. 31) and run a course around with a hammer on the bottom side of the line that marks the width of the brim, to harden the metal, after which proceed to lay off the brim with a mallet, being careful to get it down true. Next smooth it down on an anvil, with a full-faced hammer, this being done carefully so as to preserve the roundness. The sides are now stiff

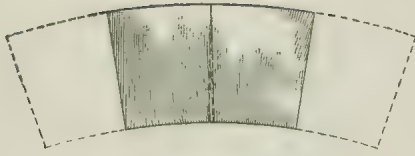

Fig. 27. — Making Sides True.

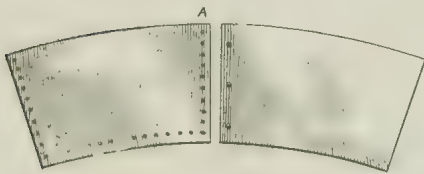

Fig. 28. — Sides Prepared and Punched.

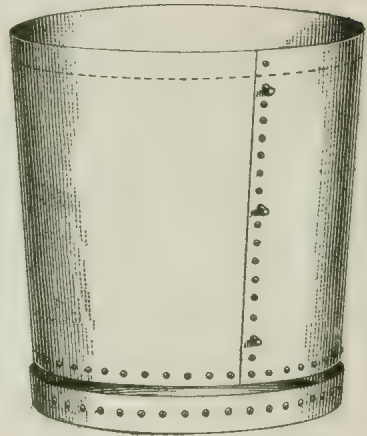

Fig. 29. — Sides Formed.



Fig. 30. — A Racer.

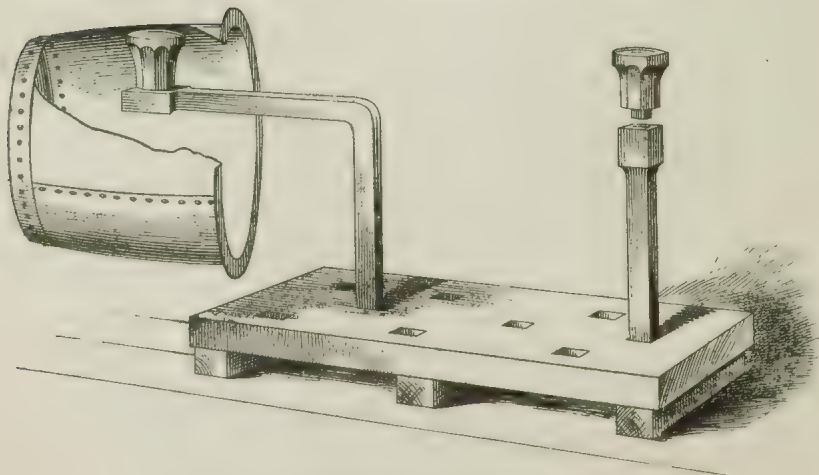

Fig. 31. — Riveting and Planishing.

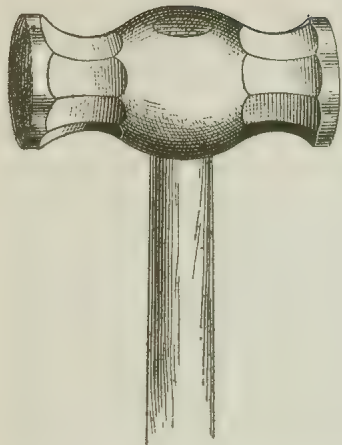

Fig. 32.—Planishing Hammer.

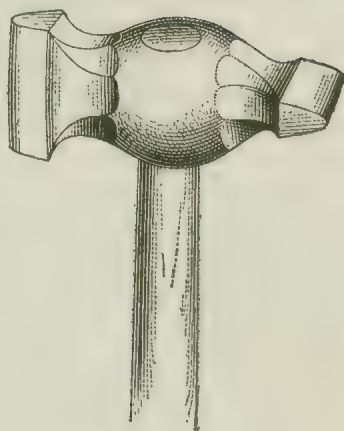

Fig. 35.—Scrubbing Hammer.

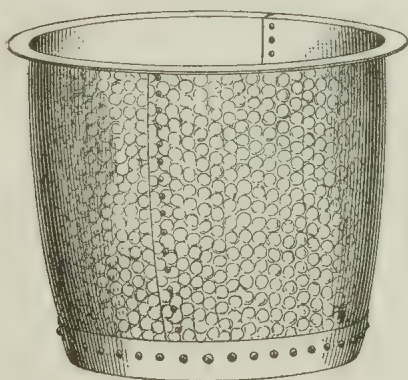

Fig. 33.—Spotting Copper.

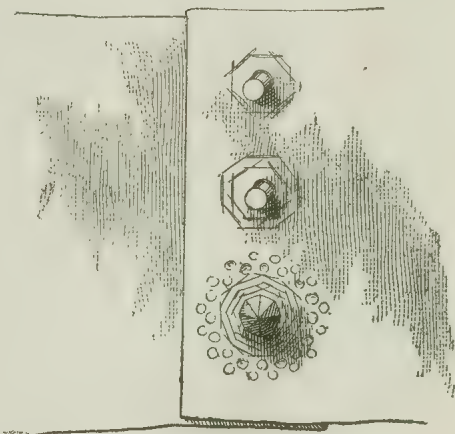

Fig. 36.—Way to Scrub Rivets.

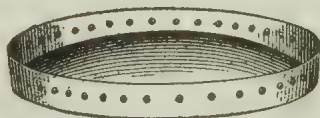

Fig. 34.—Bottom Punched.

enough to handle, and we proceed to draw in the bottom ends to fit the bottom, as in Fig. 29, making them small enough to go into the raise of the bottom, and the bottom to lap up the side about $\frac{3}{4}$ inch more than the diameter of the rivet-head. When these are fitted, shape up the sides true and smooth them with a mallet on the head in the square shank (Fig. 31). Now take a wispful of Spanish brown and rub it all over the outside surface, and with another wisp rub a little dry black-lead over the inside. We are now ready to commence the spotting, which is done as follows: Take the bottom of the slides in the left hand, and with a double-faced planishing-hammer (Fig. 32) begin by striking several blows in succession around each other until the spot formed is from $\frac{3}{4}$ to 1 inch in diameter; then repeat, making each spot regular and in line and about $\frac{1}{4}$ inch apart, or so that the spots are clearly defined, and cover the whole surface as shown in Fig. 33. As this proceeds and each course comes to a rivet, scrub it enough to set the sides down to the head to draw up the head of the rivet, or the whole joint may be partly scrubbed before spotting begins. When the spotting is complete finish the scrubbing and draw up the rivets with the set. Clean the end of the rivet-shank with a file and knock down the rivet, finishing it in a pyramid form, as near octagon as possible. Now take the bottom (Fig. 34) to the head in an upright shank as shown at the right in Fig. 31, and with the bottom in both hands, hit it on the head enough to make the outside convex; then smooth it, brown it and planish it all over. This could be done on the head (shown at the left in Fig. 31) if more convenient, and only one is engaged on the work. Put the sides into the raise of the bottom and mark four holes (being careful that the sides set true before marking the holes) opposite each other and punch them in the bottom; then place the sides into the bottom again, and put in four rivets and knock them half-down temporarily, and punch the rest of the holes through the bottom from the inside. Next put in all the rivets, knocking them half-down in the same way, and when they are all in take a suitable cross-piened hammer (Fig. 35) and begin to scrub up the bottom rivets, after which draw them up with the set and head them up eight square to the form of a pyramid. If the scrubbing is properly done there will be no need of any cement being used to secure the joint against leaking; all that is required is good workmanship. What is called scrubbing is to hammer the part all around the

rivet down close to the head, making the surface on the inside perfectly smooth, the rivet-head being, as it were, in a countersink when the scrubbing is completed. To do this we first use the pane of the hammer between the rivets; then on each side; then across the four corners made by the previous blows, as shown in Fig. 36.

MAKING BREWING-COPPERS.

We will now finish the brewing-copper (Fig. 37), the sides of which have been made the same as those described for a washing-copper. We next take the bottom (Fig. 34) in both hands and hit it on a head in an upright shank (Fig. 31) enough to make it concave on the outside, as shown in Fig. 37. Then brown and planish it from the inside, after making the crown nearly level with the raise of the bottom. This is done so that all liquor will run out clean through the pipe. The rivets are now put in the bottom the same way as described for the washing copper, except that enough rivet holes are left where the pipe is to go. A pipe is seldom put in a brewing-copper by a boy until he has been at the trade for a considerable time; but we will work it in, and, in doing so, let us suppose the pipe is 3 inches in diameter at the large end and $1\frac{1}{2}$ inches at the small, so as to fit the socket of the cock. The pattern (Fig. 38) should be extra heavy copper, thick enough to allow a flange to be worked on it from 2 to 3 inches wide, which is commenced while the pattern is flat, using in the operation a cross-piened hammer, and, as the flange is being laid off, the pattern or pipe is made to curl with each blow as the work is being done (Fig. 40). The bottom of the pipe flange (Fig. 39), or that part which spreads over the bottom, requires a little more work than the part of the flange intended to go up the side, to make it fit to its place and secure a good job. When the flange is laid off enough and the seam of the pipe is soldered down, the hole for the pipe is cut in the side of the copper, close to the bottom, where the rivets have been left out for that purpose, and in the middle of one of the sides or sections of the body, the hole being cut small enough so that about a quarter inch can be turned out to let the pipe and its flange go up to its place easily and form a narrow collar around the pipe, the seam of the pipe being on the bottom, as shown in Fig. 39. Now turn the copper on its side as in Fig. 42 and with a suitable piece of rope, passed down through the pipe, sling the head A, and pass a strong wooden bar through the loop B, so that it will hang in the right position, and a boy can hold it



Fig. 37.—Brewing Copper, Showing Bottom.

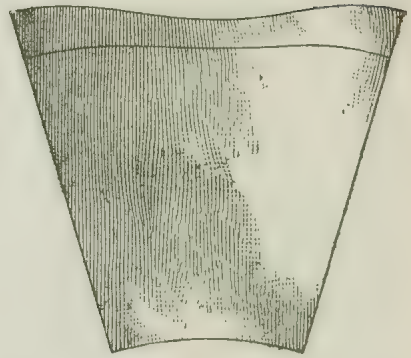

Fig. 38.—Pipe Pattern.

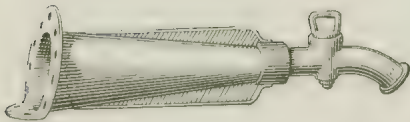

Fig. 39.—The Way to Fit Pipe, Cock and Boss.

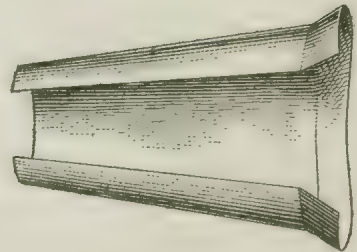

Fig. 40.—Pipe Pattern Half Worked.



Fig. 41.—Showing Boss Ready.

steady while the rivets are worked in which hold the flange to the bottom. When the rivets are all in scrub them and the edge of the flange until both are smooth with the surface of the side and bottom, and close down the narrow collar tight around the pipe (Fig. 37).

The cock is then made to fit tight on the pipe (Fig. 39), and a case of light copper (Fig. 41) made to fit tight around the large end of the pipe and outside of the socket of the cock, with a collar, as shown. When it is fitted, a hole is cut in the case and a lip turned back, as in Fig 41. The case is now put on the pipe and the end of the pipe driven tight into the socket of the cock, and then the pipe rammed full of damp sand from the inside of the copper and some clay rubbed in around the collar of the case and a little rosin in the case. When all is ready the case is filled with old, rough solder, burnt tin or any other suitable metal which cannot be used with advantage for anything else. When cool enough, the lip is closed down and a nail driven in to keep it close while it is being soldered

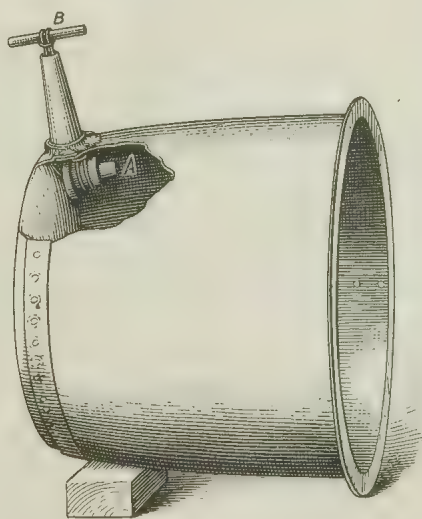

Fig. 42.—Riveting Bottom of Flange.

The table below gives the dimensions of coppers, with their capacity and approximate weight up to 100 gallons. Small country shops seldom make anything larger, not having room or the conveniences for building them. The work was paid for by the pound—that is, the weight when finished—at a rate of from 3 to 5 cents per pound.

Inside diameter at top, in inches.	Diameter of bottom at lag, in inches.	Depth of sides, in inches.	Diagonal length from lag to brim, in inches.	Contents in gallons.	Approximate weight, in pounds.
13 $\frac{1}{4}$	11 $\frac{1}{2}$	11	16	6	8
15 $\frac{1}{4}$	13 $\frac{1}{2}$	12	19 $\frac{1}{2}$	8	10 $\frac{3}{4}$
17	14 $\frac{1}{2}$	13	21	10	13 $\frac{1}{4}$
18 $\frac{1}{4}$	15 $\frac{1}{2}$	13 $\frac{1}{2}$	22 $\frac{1}{2}$	12	16
20	17	15	24 $\frac{1}{2}$	16	21 $\frac{1}{4}$
22	18 $\frac{1}{2}$	16 $\frac{1}{2}$	27	21 $\frac{1}{4}$	28 $\frac{1}{4}$
23 $\frac{1}{2}$	20	17 $\frac{1}{2}$	28 $\frac{3}{4}$	25 $\frac{1}{2}$	34
25	21 $\frac{1}{2}$	18 $\frac{1}{2}$	30 $\frac{1}{2}$	31	41 $\frac{1}{2}$
26	22 $\frac{1}{2}$	19	31 $\frac{1}{2}$	35	46 $\frac{1}{2}$
27	23	20	33	41 $\frac{1}{2}$	55 $\frac{1}{4}$
28	24	20 $\frac{1}{2}$	34	44 $\frac{3}{4}$	59 $\frac{1}{2}$
29	25 $\frac{1}{2}$	22	36	49 $\frac{1}{2}$	66
30 $\frac{1}{2}$	27	22 $\frac{3}{4}$	37 $\frac{1}{2}$	55 $\frac{3}{4}$	74
31 $\frac{1}{2}$	27 $\frac{1}{2}$	23 $\frac{1}{2}$	38 $\frac{1}{2}$	60	80
32 $\frac{1}{2}$	28 $\frac{1}{4}$	23 $\frac{3}{4}$	39 $\frac{1}{2}$	66	88
34	29 $\frac{1}{2}$	24 $\frac{1}{2}$	42	75	107
34 $\frac{1}{2}$	30 $\frac{1}{2}$	25	43	83	121 $\frac{1}{2}$
35	31	26	43 $\frac{1}{2}$	87	128
37	32 $\frac{1}{2}$	27	44 $\frac{1}{2}$	93	137
38	33 $\frac{1}{2}$	28	46	106	159

Table Showing Dimensions, Capacity and Weight of Coppers.

MAKING HAND-BOWLS.

If a boy has made himself useful during his first two years he has gained much valuable information for future application. He has been kept busy, and thus secured efficient training for the eye and hand by having many little jobs given him to try his skill upon, by which he has assisted his tutor and partly repaid him for the care and attention received while watching over him and directing his initial work. If, on the other hand, he has been negligent and afraid he would do too much, his progress is likely to have been a little slow, for few men care to help a boy who shows a desire to shirk his duty. After the writer was made to understand why he had been placed in that old shop, he was usually the first to arrive and the last out, and became much attached to the trade; particularly after having seen the first half-dozen bright copper tea-kettles finished and cleaned ready for the show-room, he looked forward to the time when he could imitate them.

When the tinning season is past and no more stove-pipe is likely to be wanted, and jobbing work is slack, the stock is reviewed, and usually about the first things that are wanted are hand-bowls, which supply the work for advancing the boy a step further. Copper hand-bowls furnish an excellent initial lesson, because while the work to be executed in making them may not necessarily call for the finest finish, yet a boy who is interested in his work may display his best skill here and make preparation for the better work which is to follow. Then again, if the bowls are to be tinned inside an opportunity is offered to try his hand at the tinning process, seeing that this also does not have to be done as carefully as in the case of cooking utensils. Copper hand-bowls were made in three sizes, and called small, middle and large. The small size when finished was 8 inches in diameter, the middle size $8\frac{1}{2}$ inches and the large 9 inches. The bodies were cut the following dimensions :

	Length.	Width.	Diameter of bottom
Small.....	24	$3\frac{1}{2}$	$5\frac{1}{2}$
Middle.....	26	$3\frac{3}{4}$	6
Large	28	4	$6\frac{1}{2}$

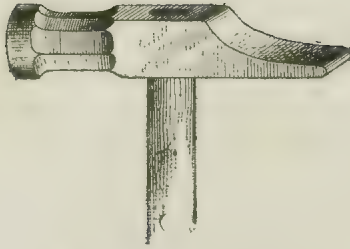

Fig. 44.—Riveting Hammer.



Fig. 45.—Side Stake.

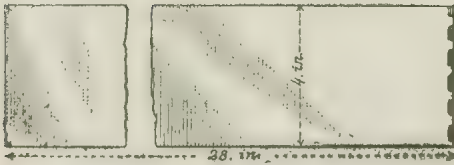

Fig. 46.—Sides of Hand Bowl.

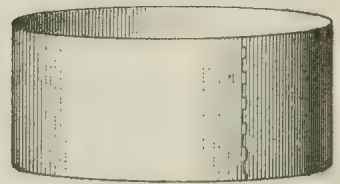

Fig. 47.—Sides Brazed Together.

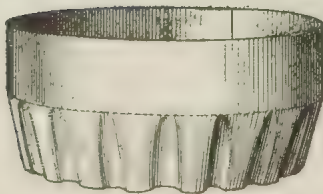

Fig. 48.—Sides Wrinkled for First Course.

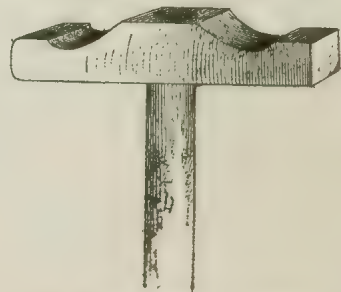

Fig. 49.—Razing Hammer.

The strength of the material may be governed by the price at which it is desired to sell the finished articles, but the usual weight was 8, 9 and 10 pound plate for the sides of each size respectively and 10, 11 and 12 pound for the bottoms. This difference would seem due to a desire to make the bottom stronger, but is really on account of the thickness of the body, which is increased in the thickness while razing it in to suit the size of bottom.

We will now proceed with the work and finish up a 9-inch bowl. The side is cut, according to the above table, 28 inches long and 4 inches wide. Smooth the burrs off with a file and then thin the end edges with a hammer (Fig. 44) on a side-stake (Fig. 45) in the floor-block. After thinning clean the edges if necessary with sand-paper; now cramp it with the snips at one end as far as the scarf made with the hammer, which should be about 3-16 inch (Fig. 46). Form it round as in Fig. 47, then close the cramps down and jar a little borax and water through the joint and charge it with fine spelter, following the zigzag line of the cramps. (It is well to wash and mix the solder with borax and water a few days before.) Next dry it slowly over the fire, after which, holding it with a suitable pair of tongs, make it hot enough at the back to annul any spring and to assist to heat the copper; then turn the seam to the fire, and with a brisk blast from the bellows run the solder down the joint. When cool, see that the seam is full and perfect. Now file up and trim the joint on the outside and inside, taking off any sharp corners or knobs of spelter. When smooth take it to a side-stake (Fig. 45) and knock down the seam, making it the same thickness as the other part of the sheet, and then anneal. Now take a racer and mark around the middle of the body, and wrinkle it at one end as far as the middle (Fig. 48). Then take it to the block, and on a long head in a tea-kettle shank or on the point of the side-stake raze in a course with a mallet or light razing hammer (Fig. 49) until the diameter of the body at the end is reduced to within about five-eighths of the size of the bottom. Next "stag" it in, as shown in Fig. 50, a shade smaller than the bottom. Thin the edge of the part turned on a suitable bullet-stake (Fig. 51), also the edge of the bottom and cramp it, as in Fig. 50, then lift each alternate cramp and put the bottom in from the inside. Close down the cramps on a bottom-stake with a hammer, and popple the bottom (which is done by a few blows of a hammer on a bottom-stake in the center to draw it a little), and then spring the bottom in and out to

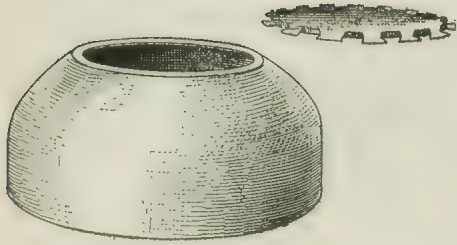

Fig. 50.—Body and Bottom Prepared to Put In.



Fig. 52.—Bowl Ready for Wiring.



Fig. 51.—Bullet Stake.

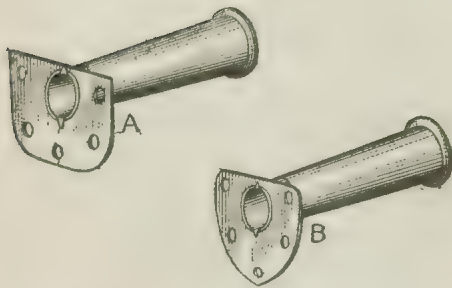

Fig. 54.—Way to Put the Flaps On.

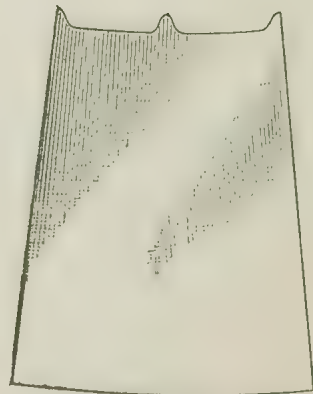

Fig. 53.—Pattern for Handle.

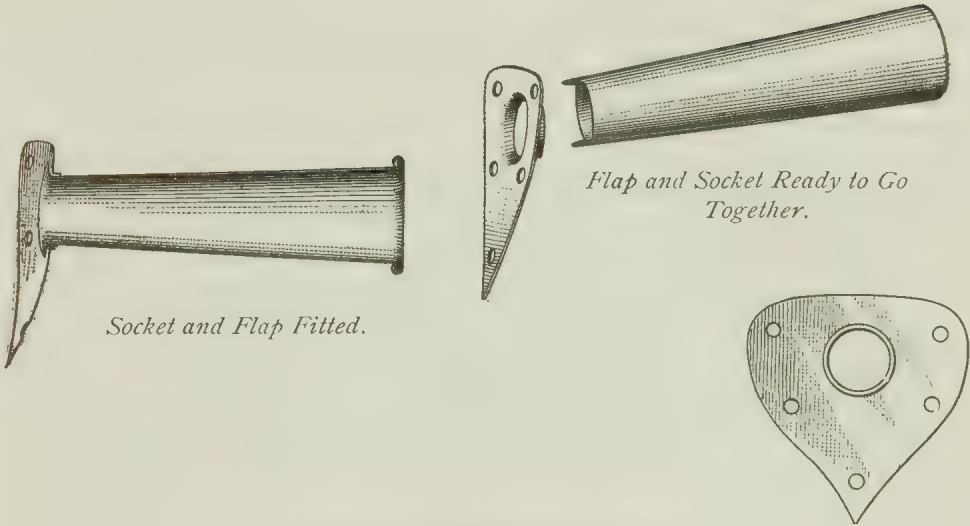

Fig. 55.—Making the Handle.



Fig. 56.—Duck-Bill Tongs.

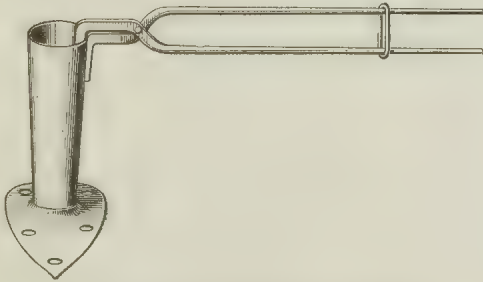

Fig. 57.—Tongs Holding Socket.

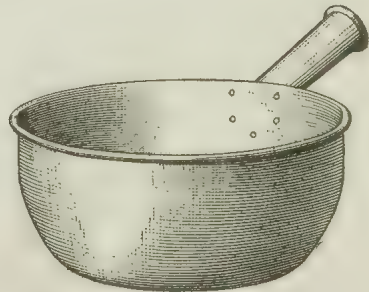

Fig. 58.—The Bowl Finished Complete.

loosen the joint enough to receive the spelter freely into the seam when being run at the fire. Jar some borax and water through the joint and charge it with spelter, following the cramps in their zigzag path around the bottom, then take it to the fire and dry slowly. Heat the sides until the borax is all down, run the joint around, and when cool clean off the joint outside and knock it down on a bullet-stake and anneal. Next take it to a small bottom-stake and flatten the bottom with a mallet, and with a pair of compasses mark the size the bottom is to be when the bowl is in its finished shape, which will be $5\frac{1}{2}$ inches. Break the bottom up the side from the outside of the circle made by the compasses, which will increase the depth a good $\frac{1}{2}$ inch. After the bowl is shaped, turn the edge on the back of the side stake for a No. 8 wire, as shown in Fig. 52. If the inside is to be tinned it is now ready, and the work may be done in the manner already described.

We will now make the handle, which is a socket-handle, about $1\frac{1}{2}$ inches inside at the wire and 1 inch in diameter at the flap and $5\frac{1}{2}$ inches long. The pattern of the socket would be $4\frac{5}{8}$ inches at one end and $3\frac{3}{8}$ inches at the other. When cutting the pattern leave a little V-piece in the middle of the flap-end and a point at the seam, as shown in Fig. 53, to hold the flap on while it is being brazed. The pattern being cut, thin the edges and turn it, then charge it and braze it down, clean off the joint and knock it down on a beak-iron. Next cut out the flap (Fig. 54, A B) and make the hole for the socket small enough so that a collar may be worked out as shown in Fig. 55, to go a little way up the socket. When the collar is fitted, put the socket through the hole and turn back the V-piece and also the little points left on at the seam, which should hold the flap firmly in place. Charge it with spelter and dry, and holding it with a pair of duck-bill tongs (Fig. 56), warm first gently and then heat it until the borax is down, or run, then turn the flap down to the fire as in Fig. 57 and run the solder around the edge of the socket and flap, and when the joint is cleaned off wire the end of socket.

If the bowl (Fig. 58) has been tinned and scoured clean, it may now be planished so that it is bright or brown. To planish articles of this kind with ease and comfort it is necessary to sit at the foot-block, and in such a position that the operator's thigh may lie in a horizontal line with the knee, and the shank and head at such a height that the fore-arm and hand may lie, when at rest, level with the ham-

mer-handle when the face of the hammer is at rest on the face of the head, or as near to this as it is practicable to get, the knee acting as a gauge, rest and guide during the operation. We may now proceed with the planishing. If the article is to be brown it is rubbed on the outside with some Spanish brown, care being taken that none gets on the inside. Wipe the inside with a clean rag; next flatten the bottom, smoothing it first with a mallet, and make a faint mark with the compass showing the size of bottom. On a clean, bright bottom-stake planish the bottom with a small bottom-hammer, after which, on a clean, bright head, commence at the bottom and take each course around the body until the wiring edge is reached, then with a concave smoothing-hammer smooth as much as is needed. Now put in the wire, and after planishing the flap of the handle and chamfering the edge of it with a hammer, rivet on the handle and finish the article by cleaning.

FRYING-PANS.

Frying-pans, closet-pans and water-balls afford means for the next step and initiate the boy into the art of raising. It may be necessary to explain here for the benefit of the beginner the difference between the terms raising, hollowing and razing, which are often confounded one with another. Thus we say a closet-pan is raised up. When we made the body of the hand-bowl smaller we razed the body in or down to the required size. Hollowing is performed with a hammer (Fig. 59) similar to a bullet-hammer, the difference being that the hollowing-hammer face is half an oblate spheroid, while the face of a bullet-hammer is half a sphere. A hammer used for raising up or razing down has a rectangular face and is nearly flat, as already illustrated in Fig. 49. Hollowing is done by sinking the pattern into a hollow in a hollowing-block, and the work that can be done in this way is quite limited, while with a raising-hammer any desired height or depth may be obtained.

Frying-pans have their sides raised up from a flat disk and are usually made from 9 to 15 inches in diameter at the rim and from 2 to 3 inches deep when finished. They are sometimes made larger, but not often. We will now describe the making of a pan 12 inches in diameter at the brim and to receive a $\frac{5}{16}$ -inch wire. Frying-pans are made flaring in the ratio of about 2 to 1—that is, if the side be 2 inches deep, then the flare on the side will be 1 inch, or in other words, if such a pan be 12 inches at the top the bottom will be 10 inches. Let our example be 12 inches at top and 10 at bottom, the slant height 2 inches and the wire $\frac{5}{16}$. Now, to make this we require a disk of metal equal to the surface of the pan, the strength of which may range from 14 to 18 pound plate. The disk then would be equal to the bottom + sides + half the covering of wire, which, allowing 1 inch for the circumference of the wire, would make the sides before turning the edge for wire $2\frac{1}{2}$ inches deep, and the top diameter $12\frac{1}{2}$ inches. Then

$$\sqrt{10^2 + \left(\frac{10 + 12.5}{2} \times 3.1416 \times 2.5 \div .7854\right)} = \sqrt{100 + 112.5} = 14.57$$

equals diameter of disk; adding the thickness of the metal



Fig. 59.—Hollowing Hammer.

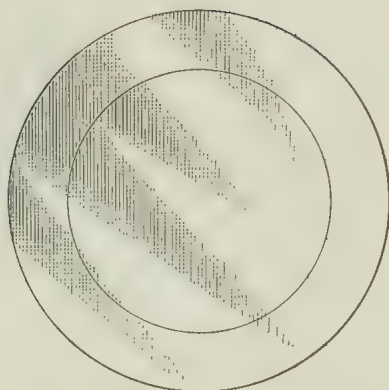

Fig. 60.—Pattern of Frying Pan.

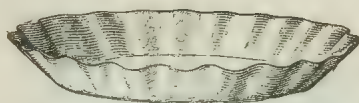

Fig. 61.—Disk Wrinkled.

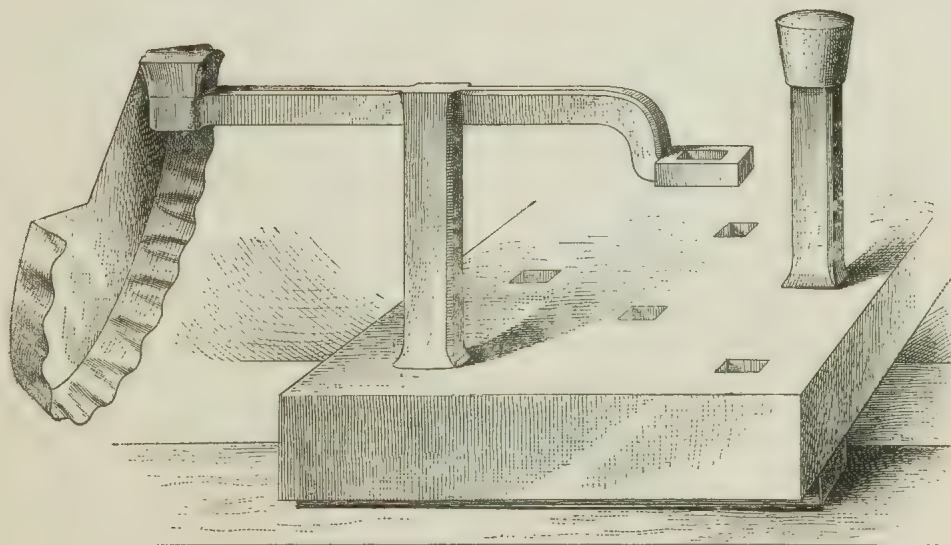

Fig. 62.—Razing Pattern on Tea-Kettle Shank.

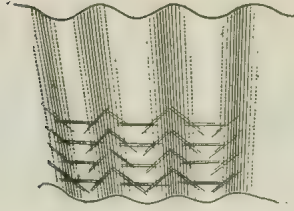

Fig. 63.—How Wrinkles are Razed Down.

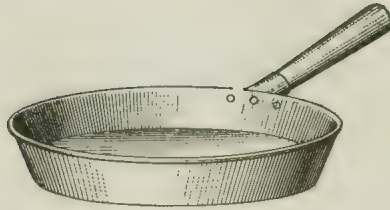

Fig. 64.—Handle Riveted on Frying-Pan.

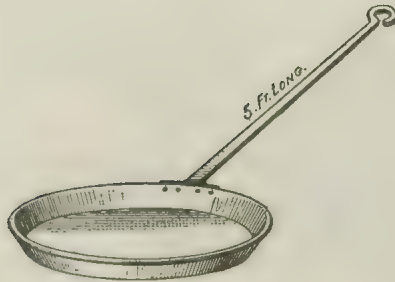

Fig. 65.—Ancient Frying-Pan.

to this we have about 14.6 the size of the disk required for our pan. Now describe with the compasses the size of the bottom on the pattern (Fig. 60), and wrinkle the edge regularly all around as shown in Fig. 61; then take it to the floor-block and on a long head in a tea-kettle shank (Fig. 62), or on the point of a side-stake (previously shown in Fig. 45), commence to raze down the wrinkles, bringing the razing-hammer down first in front, then on each side of every wrinkle in succession, as in Fig. 63, beating down at each blow from $\frac{1}{8}$ to $\frac{1}{4}$ inch. Follow up each course until the brim is reached; then anneal by making it a bright cherry-red in the shade. Now wrinkle again as before, only with this difference, that the wrinkle which was exposed to the hammer before shall be in the hollow in the next course, thus making all of the sides to feel the hammer equally. The third course should bring the sides up sufficiently, and may be done with a mallet. The last course should bring the sides up enough so that when the pan is being planished the expansion caused by hammering will just bring it to its proper size. Finally, smooth out the marks made by the razing-hammer with any smooth-faced hammer up to where the wiring edge is to be turned, and partially turn the edge over. It is now ready for tinning, after which it is scoured clean and planished—first the bottom on a bottom-stake (Fig. 62), and then the side on a bright head; when this is done it is wired. The handle, which is a socket-handle made of iron, as shown in Fig. 64, is now riveted on and the whole cleaned ready for the store-room.

It was stated that frying-pans were sometimes made larger than 15 inches. It may interest the reader to learn that in the old farm-houses of England, where the fire is made on dog-irons on the hearth under an open chimney, the frying-pans used (Fig. 65) were seldom less than 18 inches in diameter, with a wire $\frac{1}{2}$ inch thick and a handle from 5 to 6 feet long, so that the cook should stand a good distance from the fire without scorching. It would seem they were very unpleasant utensils to use, for this long handle was merely a piece of bar-iron, with sharp corners about $\frac{5}{16}$ inch thick, tapering from $1\frac{1}{2}$ inches at the flap to 1 inch at the ring by which it was hung in the chimney corner when not in use.



Fig. 66. -Pan for Water-Closet.

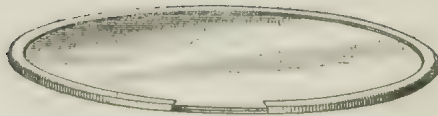

Fig. 67. Blanks Fastened Together for Raising.

CLOSET-PANS.

Copper pans for water-closets are made in a similar way to frying-pans, but are of lighter material, scarcely ever stronger than 10-pound plates, usually of 8, and are raised from flat disks three at a time. Their dimensions are about 4 inches at the bottom, 9 at top and 4 deep and wired with a No. 9 wire. Let us make three pans similar to the one shown in Fig. 66 and let their dimensions be 4 inches at the bottom, 9 at top and the sides 4 inches high. Then proceeding by the rule already given to find the size of a disk equal in surface to a given pan and one-half of the circumference of the wire we have:

$$\sqrt{4^2 + \left(4 + \frac{9.3}{2} \times 3.1416 \times 4.25 \div .7854\right)^2} = \sqrt{16 + 113.05} = 11.364,$$

the diameter of a disk required to make the pan. Now cut two disks 11.364 inches in diameter and one $\frac{1}{2}$ inch larger, upon which turn up an edge $\frac{1}{4}$ inch deep (Fig. 67) and lay the other two in it and close the edge down on them; they may now be worked up as one pan. Wrinkle the side regularly with the edge that holds them together on the inside and proceed to work on the point of a side-stake in the block with a raising-hammer. At the completion of each course anneal and wrinkle again, making the outside wrinkle the inside one in the next course. When the pan is up enough smooth down the hammer marks with a smoothing-hammer and separate the blanks. After turning the edges for the wire they are ready for tinning. After tinning and scouring they are planished in the grain, made bright on the inside and brown outside; when planished wire and clean.

WATER-BALLS.

Water-balls are a kind of float used for the purpose of regulating the water-supply in tanks and reservoirs, so that they may always be kept full. These spherical floats have a long strig or lever made of copper soldered to them, having a square hole in it to fit on the square of the plug of a cock, as shown in Fig. 68, so that as the cistern or reservoir is emptied the float falling with the water opens the cock,

and as it gradually fills again the float rises and shuts off the supply. These balls are made in various sizes from 4 to 12 inches in diameter. They are made of light material, from 6 to 8 pound plate, according to size, and, like closet-pans, are raised up three at a time. Let us raise up three pair of halves for three 8-inch balls. As the convex surface of a sphere is equal to the curved surface of its circumscribed cylinder, we have $\frac{8 \times 3.1416 \times 8}{2} = 100.5312$, the convex surface of one-half a sphere 8 inches in diameter. Converting this into a disk we get $\sqrt{\frac{100.5312}{.7854}} = 11.313$, the diameter of a disk equal to the convex surface of one-half of an 8-inch ball. But we must have a $\frac{1}{4}$ -inch lap on one-half for the joint; therefore the convex surface of this larger half will be

$$8 \times 3.1416 \times 4.25 = 106.8144 \text{ and } \sqrt{\frac{106.8144}{.7854}} = 11.661,$$

the diameter of a disk equal to the larger half. Having the size of each half, two are to be cut the size of each and one each enough larger to allow turning an edge over to hold the other two, as previously described and shown in Fig. 67. To find the exact size of the inner circle to wrinkle from draw the semicircle A B C (Fig. 69). Space it with the radius, dividing the semicircle into three equal parts and join C H, H I and I A. Divide the versed-sine B E into two equal parts and draw the lines M F, F G and G R parallel to C H, H I and I A, then taking G F as the diameter from which to start mark the circle on the disk (Fig. 70). After having wrinkled the disk the same as in Fig. 61, start to raze down by striking with the hammer first in front and then on each side of the wrinkles, as shown in Fig. 63, until all are razed down to the brim. Next anneal and wrinkle again, razing down the wrinkles until the proper size is obtained; then take it to a bullet-head in the straight end of a tea-kettle shank and break the lag down by holding it in both hands and hitting the bottom on the head in the center to swell it out, and then with a mallet work down the lag, beginning in the middle of the side. When the lag is down, round up and smooth with a hammer, after which they may be taken apart, browned and planished. The large half is to be beaded with the hand-swage, as shown in Fig. 71. Tin the edge as far as the bead; then put the halves together and solder the seam. The strig or lever is finally soldered on and the article cleaned ready for the store-room.



Fig. 68.—Water-Ball and Lever.

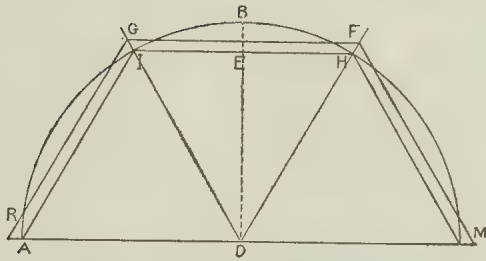

Fig. 69.—Method of Obtaining Circle.

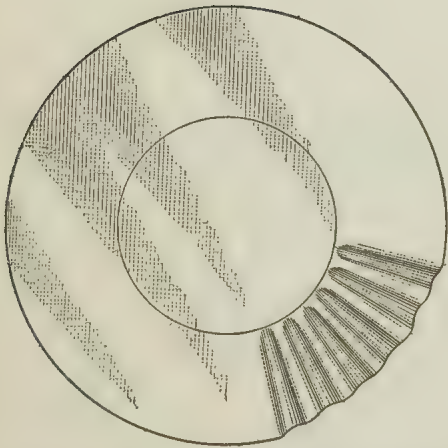

Fig. 70.—Pattern for Half of Water-Ball.

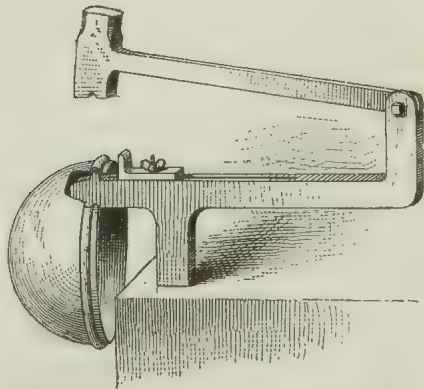

Fig. 71.—Hand-Swage.

MOUNTINGS FOR COPPER GOODS.

The preparation of mountings ; that is, spouts and handles for tea kettles, handles for sauce pans, stew pans and all the many kinds of utensils used in a kitchen is the next in order. In London, there are men who rarely do anything else, but prepare mountings for all kinds of brazier's work, but in the country shops braziers prepare the greater part of their own mountings, which affords an opportunity for a boy to learn how to make them that is very seldom open to him in a large city. Let us consider a few of the pieces among the many sets of mountings upon which a boy may display his best skill and learn how to manipulate a file and burnisher, so that when the mounting is attached to the article it is intended for it will be an ornament and add beauty to the whole fabric. Many an otherwise good piece of work has been spoiled for the want of proper symmetry in the mountings or carelessness in their finish. To file and finish mountings is tedious work. Side handles for stock pots, fish kettles, and the like ; ears for the cross handles or bails for coal scoops ; sockets for sauce pans, coffee pots and scooplets ; bails, ears and barrel handles for tea kettles, with the spouts for them and coffee pots all this work, though tedious and requiring much care to execute it well, is good to school a boy to patient labor. Common coal scoop bails ; that is, those made for plain bright coal scoops, A, Fig. 72, were usually made of $\frac{3}{4}$ -inch pipe nicely rounded up ; filled with rosin and bent, then filed and burnished. In the illustration B shows an ornamental form of ear. The handles of such vessels as stock pots, turbot kettles and preserving pans were of cast copper, Fig. 73. Tea kettle handles were made in a variety of fashions as shown in Figs. 76, 77, 78 and 79. The handle illustrated in Fig. 76 was made of three pieces, a tube, see Fig. 74, and two rods made as in Fig. 75. Sauce pan handles, Fig. 80, illustrates a coffee pot handle. Fig. 81 were of two kinds principally : one B made of wood and inserted into a copper socket, the other A, a complete iron handle. These handles were japanned when the goods were made brown ; if they were made bright, the wooden handles were oiled, while the iron ones were

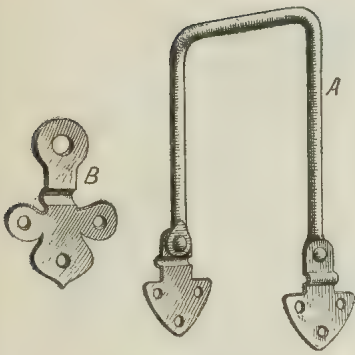

Fig. 72.—Handle for Coal Scoop.



Fig. 73.—Stock Pot Handle.



Fig. 74.—Top Piece of Tea-Kettle Handle.



Fig. 75.—Side Piece of Tea-Kettle Handle.

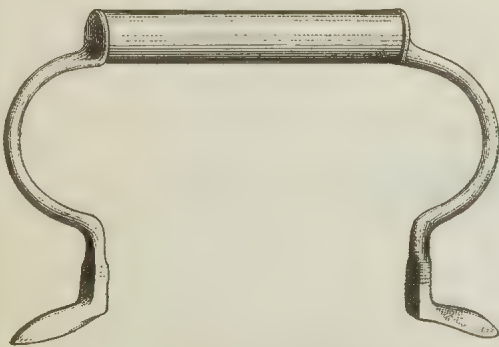

Fig. 76.—Completed Tea-Kettle Handle.

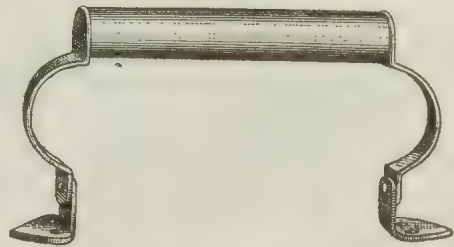

Fig. 77.—Design for Tea-Kettle Handle.

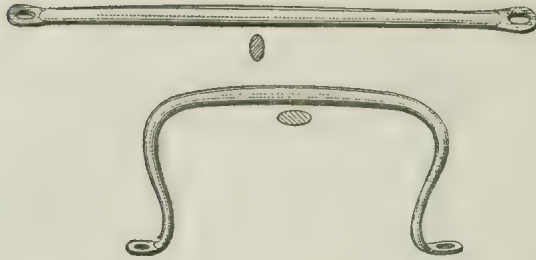

Fig. 78.—Design for Tea-Kettle Handle.

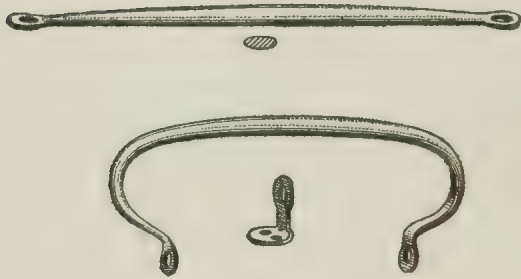

Fig. 79.—Design for Tea-Kettle Handle.

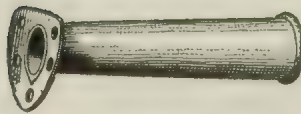

Fig. 80.—Coffee-Pot Handle.

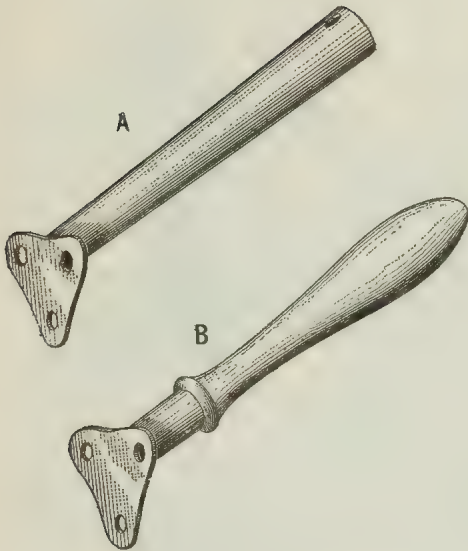

Fig. 81.—Sauce-Pan Handle.



Fig. 82.—Dimensions of Tea-Kettle Spout.

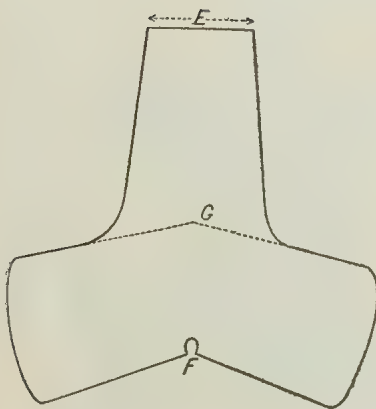

Fig. 83.—Pattern for Spout.

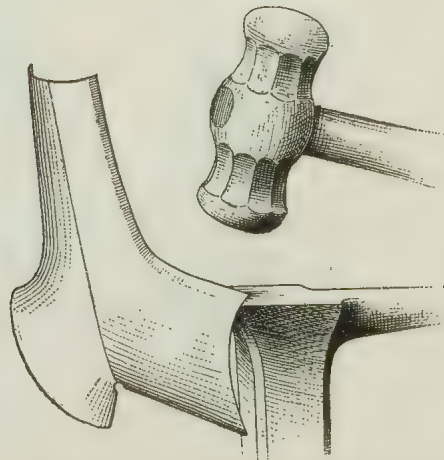

Fig. 84.—Working the Throat Down.

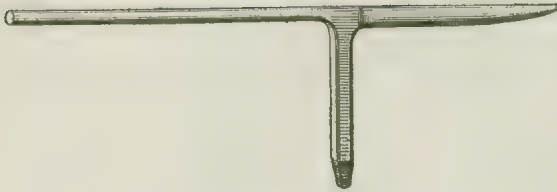

Fig. 85.—Candle-Mold Stake.



Fig. 86.—Spout Partly Formed.

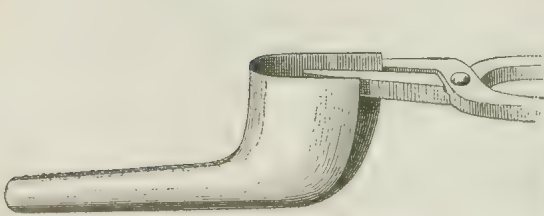

Fig. 87.—Manner of Holding Spout with Tongs.

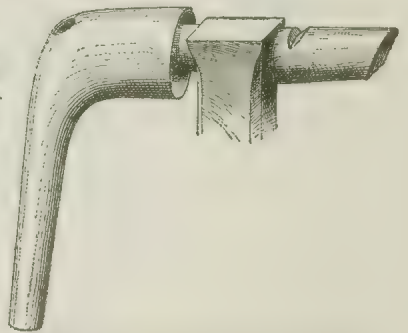

Fig. 88.—Turning Over Laps.



Fig. 89.—Spout Tool.

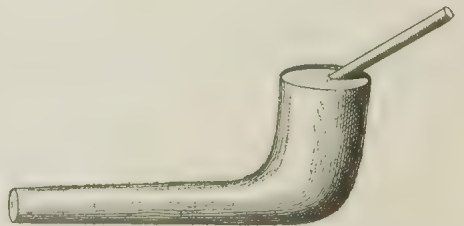

Fig. 90.—Spout Filled with Lead.

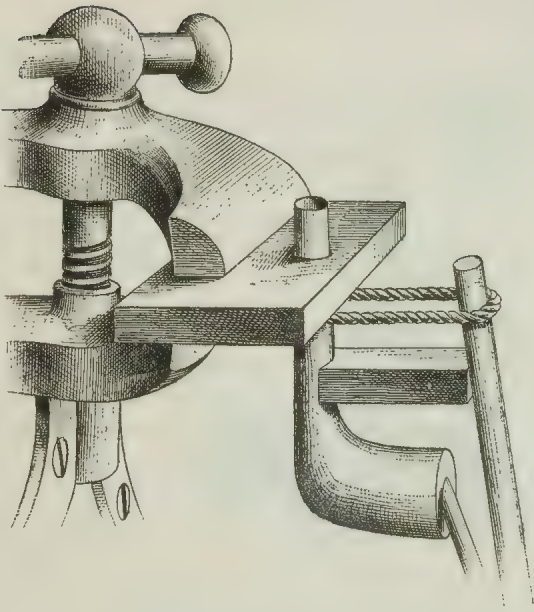

Fig. 93.—Improved Way of Bending.

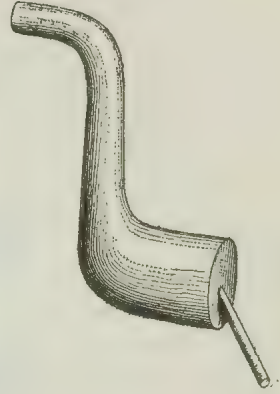

Fig. 91.—End of Spout Bent.

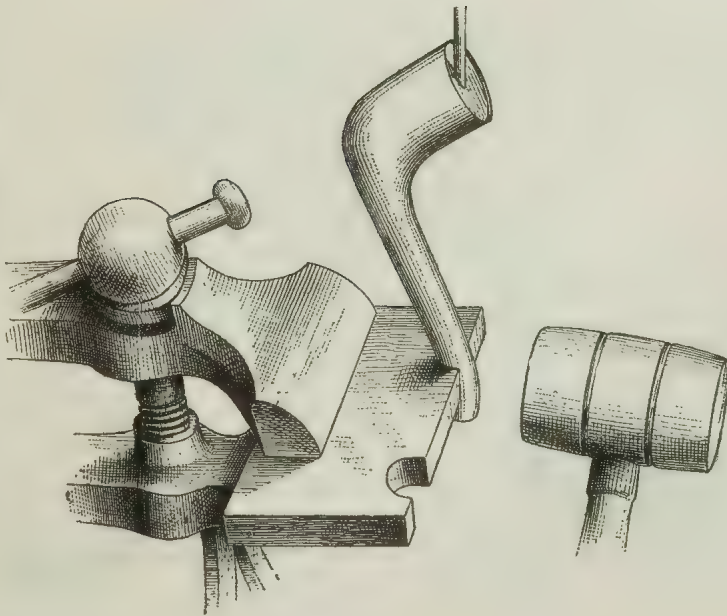

Fig. 92.—Bending Spout Over Lead Piece.

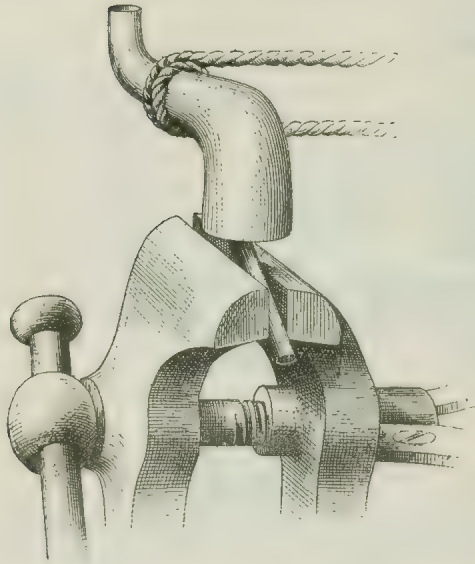

Fig. 94. Polishing Spout with Hemp Rope and Emery.



Fig. 95.—Burnisher for Finishing Spout.



Fig. 96 Spout Stake for Pitching Collars.

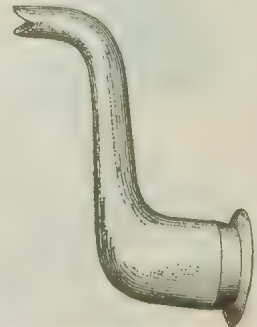

Fig. 97—Collar Pitched on Spout.

either tinned, or filed and burnished. This work atways helped to keep the boy busy.

Let us make and finish for one gallon tea kettles, a spout and the several kinds of handles. The mouth of the spout on Fig. 82 should be $1\frac{3}{4}$ inch, at the breast, C, $1\frac{1}{2}$ inch, and at the end, about $\frac{5}{8}$ inch. The pattern for spout, Fig. 83, will be 2 inches wide at E, and $2\frac{3}{4}$ inch at C, and 3 inches from F to G. Cut it off and smooth off the burrs, and on the back of a side stake, or some other suitable stake, Fig. 84, draw over each side $\frac{1}{2}$ inch and then thin the edge; then on the candle mold stake, Fig. 85, turn the stem of the spout and bring the two flaps together as in Fig. 86, and lap the seam together about $\frac{1}{8}$ inch. It is then ready for the fire. Charge the joint with spelter and gently dry at the fire, holding the spout with the tongs, Fig. 87; when the borax is down and the back is blood red, turn the spelter to the fire and run it down the joint; when cool, round up the stem and file the joint smooth. Next turn the flaps and form the mouth as in Fig. 88, and charge the joint inside and braze it down, leaving the hole at the breast open. Now put the spout tool, Fig. 89, in a vise and round up the breast, C, Fig. 82, at the same time drawing in to close up the hole left; when closed it is to be brazed; it is now ready for filling with lead. To do this wrap a piece of thick paper around the end and lay it in a box of damp sand, covering it to within $\frac{1}{2}$ inch of the mouth; then put in a piece of iron rod 5 or 6 inches long, Fig. 90, which forms a sort of handle for holding the spout when at the vise, and fill the spout with nice clean soft lead. When cool, bend the stem as shown in Fig. 91. This used to be done with a mallet over a lead piece, Fig. 92. An improved way is shown in Fig. 93, the bending being done by placing the spout through a hole in the lead pieces, and by means of a rope block and lever the spout is bent by pressing down on the lever. After the bending is done we then true the whole up, making the distance through the breast at C, Fig. 82, a little smaller than the end, so it will go with ease into its place in the kettle. It is then filed, the joint being cleaned up with a half-round file, then rough filed all over. Smooth again with a fine file, and follow with emery cloth wrapped around a stick, and finally smooth with a piece of soft hemp-rope and fine emery, taking one hitch with the rope around it, Fig. 94, and pulling it back and forth until fit for the burnisher. Now wipe it clean, and when free from all grit rub a

little sweet oil over it, and with a clean bright burnisher, Fig. 95, take a course all over it. Now wipe it off and examine it, and touch up all parts which may have escaped the burnisher, then cover all over with wet whiting, and at the fire gently run the lead out, being careful that it does not get too hot. Next fit the mouth of the spout to the side of the kettle and on a spout stake, Fig. 96, pitch the spout, leaving a collar, as shown in Fig. 97, $\frac{1}{4}$ inch wide; after which file the jaws in the small end of the spout and tin it on the inside; it is then ready for the kettle.

The handles or bails have been shown, Figs. 76 to 79, the barrel, Fig. 77, is $5\frac{3}{4}$ inches long and 1 inch in diameter; the straps are 1 inch wide, 6 inches long and about $\frac{1}{16}$ inch thick. In order to braze these straps on the barrels we had two frames, made of inch-hoop as shown in Fig. 98. The frames were made so that when the straps were wired on, the barrel would slide in tight; they are then charged with spelter and the straps brazed to the barrel. While one is cooling the other can be prepared. When cool, clean and trim off the corners around the barrel and round up the edges of the straps with a file and then burnish them; finally planish the face and bend as shown. (This kind of bail is probably the oldest in use, for the writer saw when a boy, tea-kettles having the same kind of handle, which could easily be traced back from son to father for 100 years or more.) Another kind of handle, Figs. 78 and 79, were cast straight, of a flat, oval shape, they also were filed and burnished before bending. In the barrel handle, Fig. 76, the straps were brazed to the barrel and then filed up and finished and bent on a suitable bright tool. The sockets for coffee-pot and sauce-pan handles, Figs. 80 and 81, were made of strong copper and finished with file and burnisher. The burnisher, Fig. 95, was made from an ordinary 12-inch safe edge file, with the teeth ground out and ground to the desired shape. It would appear that this trouble was taken in order to retain the original temper given the file, it being the best for this kind of tool. Handles for preserving pans and turbot kettles, Fig. 73, were filed and finished bright in the same way as spouts, the soft rope, Fig. 94, being used to assist in the operation.

Tea-kettle rings, on or in which the cover sets, were made in two ways: one was to wire a narrow strip, Figs. 99 and 100, and after putting it through the hole up close to the wire, turn the edge back on the inside. The other way was to cut a strip of copper, Fig. A, and

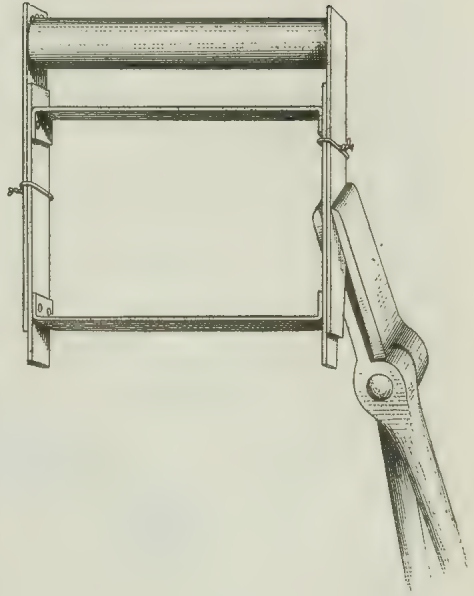

Fig. 98.—Frame for Holding Handles for Brazing.



Fig. A.—Strip for Ring.

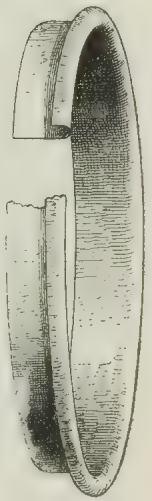

Fig. 99.—Wired Ring for Core Seat.

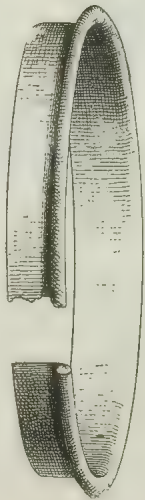

Fig. 100.—Wired Ring for Core Seat.

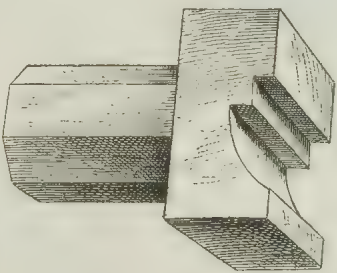

Fig. B.—Die for Making Rings.

hammer it while hot in a die, Fig. B, then form it round and solder it together. Next braze a narrow strip of copper around the middle of the ring on the under side, see Fig. C, so as to go through the hole in the kettle and turn over to hold the ring in. This makes a nice looking job. The wire ring was used for common brown kettles and glue-pots.

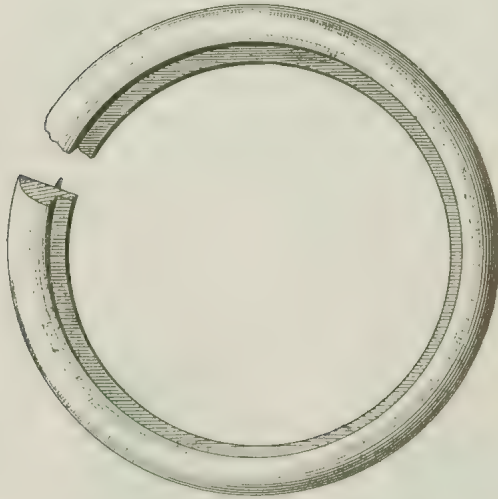
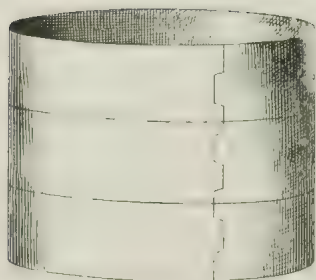

Fig. C.--Ring for Cover Support.

GLUE POTS AND TEA-KETTLES.

Glue pots may be considered as the stepping-stones to tea kettle making, as the bodies are made the same size and way, and if a boy (or man either for that matter,) will take the necessary care and interest while being instructed in the work of making glue pots, he may attain the proficiency necessary to execute the best work, such as is demanded for bright goods. Let us begin to make two round bodies, the same as for 1-gallon glue pots, and at the proper place we will branch off, finishing one a brown glue pot, and the other a bright tea kettle, following throughout the methods in vogue when the copper-smith made his own mountings. The body for a gallon glue pot or tea kettle is cut 24 inches long and 6 inches wide, and from an 8 to 12-pound sheet. Having cut the body from a 10-pound sheet smooth, cramp and put the edges together, Fig. 101, and braze the joints. After careful examination trim the corners and then knock down the joint on a side stake to make it the same thickness as the sheet. When annealed, divide the depth into three equal parts as shown in Fig. 101 and with a racer, mark distinctly, so the divisions may serve as a guide for the work about to be begun. Take the two bodies to the block, and on a head in the straight end of a tea kettle shank, Fig. 102, draw in a light course at each end of both with a mallet, keeping the wrinkles that form, in regular order as they appear, and until the course is completed; then anneal. This should bring in the bottom end enough; the other end, or that which is for the top, may now be razed down another course with a hammer; when this is completed, anneal and knock the side out even with the bulge caused by razing down the top. Take it to a bullet stake, Fig. 103, and finish razing down the top until the hole for the cover is 4 inches in diameter. Stag in the bottom, partly on the long-head, and finish it on the tea kettle bottom stake, Fig. 104; thin the edge and anneal, and it will be ready for the bottom. The bottom should be about 6 inches in diameter, and of about 13 or 14-pound plate; the hole to receive the bottom should be slightly smaller than the bottom before thinning. The bottom is to be thinned and cramped, Fig. 105, making the cramps about 1 inch long; open each alternate one and lay in the bottom



*Fig. 101. — Body of Gallon
Glue Pot or Tea-Kettle.*

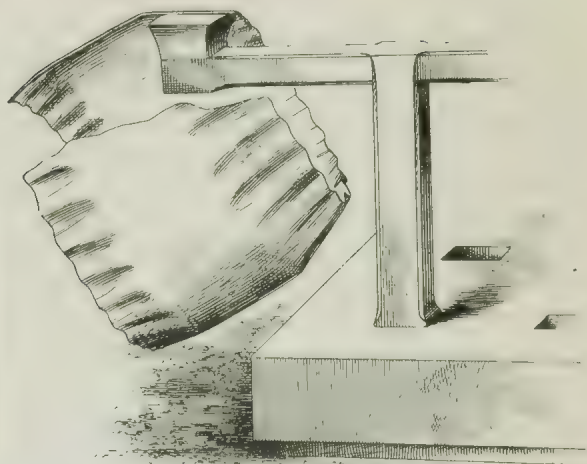
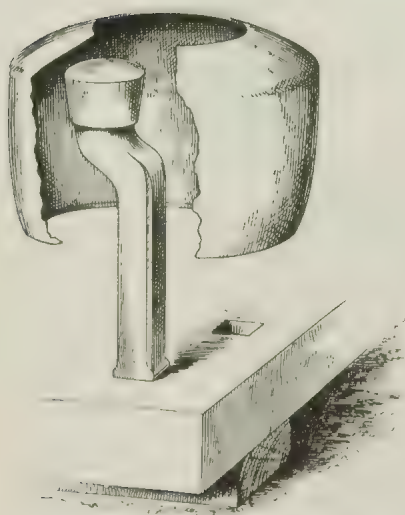

Fig. 102. — Forming Tea-Kettle Body.



*Fig. 103. — Razing Down Top on
Bullet Stake.*

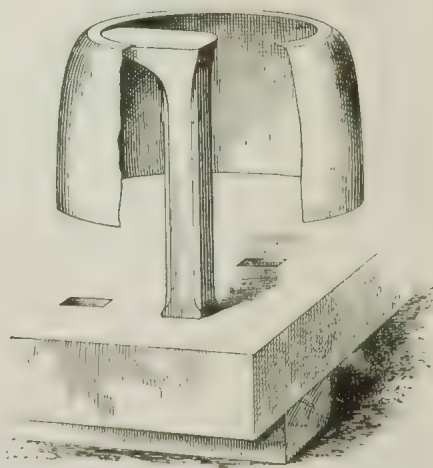

Fig. 104. — Turning Lag on Bottom Stake.

which should go in easy, but not too loose ; lay the cramps down on the bottom stake, Fig. 104, and popple the bottom, when it will be ready for brazing.

The spelter should be fine, clean, and free from dust. With a charger, Fig. 106, made from a $\frac{1}{4}$ -inch rod, having the end flattened out like a spoon, lay a little borax and water around the cramps on the outside, and jar it through the joint ; charge the joint on the inside, laying as much spelter on as will when run fill up the joint, following the zigzag line of the cramps ; when charged, dry slowly. The fire should be clean and free from coal. A nice clean coke fire is best, but if coal cinders are used by way of economy, then prevent as much as possible the coal from coming in contact with the joint. When the spelter is dry take a piece of rough but clean canvas or rag, and brush off all the borax on the outside, so that no inducement be offered to the solder to spread further than is necessary from the joint while the spelter is being run around the seam. Holding the pot with a pair of tongs, heat the sides gently until the borax is all down ; this is also done for the purpose of distributing or charging the body with heat before proceeding to run the joint ; then with a steady blast turn it around, turning the pot with two handy pokers or rods. If the joint is perfect take it to a bullet stake and pounce the bottom up enough so that the sharp corners of the cramps may be filed off easily ; clean them off, then knock the joint down. Cover the surface inside and out with a pickle of salt and water, by immersing it in the pickle tub, and while wet sprinkle a little dry salt around the seam to kill the borax. Then heat it to a bright cherry red in the shade, and thrust it into the pickle tub. If there be any borax left the pot may be put into the vitriol tub for a few hours, scoured clean, then dried in sawdust, when it is ready for planishing.

Having finished the two vessels as described, the one intended for a glue pot has a coat of Spanish brown rubbed over the outside ; the one intended for a tea-kettle is kept clean and bright. The planishing is first begun on the bottom stake, Fig. 104, and the bottom made flat and true, the lag being rounded up with a mallet, then the side is next planished on a suitable head in the shank, Fig. 107.

The workman should be seated at the side of the block so his left side is toward it, the arm of the shank extending over the end of the block, the left hand holding the pot or kettle with the fingers inside and the thumb outside ; the right knee should be used

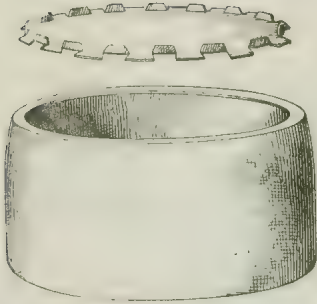

Fig. 105. Putting in Bottom.

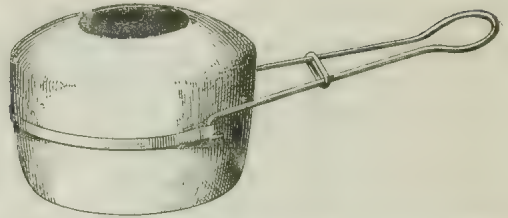

Fig. 108.—Clamp for Holding Tea-Kettle White Being Tinned.



Fig. 106. Charger.

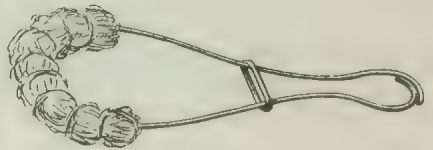

Fig. 109.—Tow-Wisp Used in Tinning.



Fig. 107.—Polishing Tea-Kettle Side.

to steady and guide the work, the body of the kettle on the under side resting on the left knee, and the lag of the kettle against the right ; when the side has been run over, the other end of the shank is used and the top planished. They are now to be tinned inside, thus : A little new muriatic acid is rubbed over the inside, which is next scoured and rinsed clean ; then some wet whiteing is rubbed on the outside to keep the fire from affecting the surface. The clamp (see Fig. 108) is fastened to the kettle by means of the link which slides down the rod and thus forms a handle. The inside of the kettle is to be rubbed over with soldering acid in which a little salamoniac has been dissolved, and the kettle heated enough to flow tin or solder, enough of which is melted and poured in so it can be rinsed out and then wiped off with a tow wisp wound around a wire, Fig. 109. After tinning, the inside is washed with clean water and the whiteing washed off ; when it is dry the outside of the kettle is scoured with a piece of flannel moistened with sweet oil and then wiped off clean. It is now ready for the smoothing course of planishing, which is done with a spring-faced hammer. The hole for the spout is now to be cut in the center of the side, the hole being made a half-inch smaller than the diameter of the mouth of the spout, to allow of a $\frac{1}{4}$ -inch collar being worked out (see Fig. 110) to fit in the pitch of the spout. Put in the cover ring, Figs. 110 and 111, and turn the edge back as described in the article on mounting ; then fit in the spout, closing the collar around the pitch with the collar-tool, Fig. 113, and soft soldering around the flange on the inside of the kettle. The handle of the kettle having been previously prepared with the ring and spout, it is now riveted on, also the ears of the glue-pot.

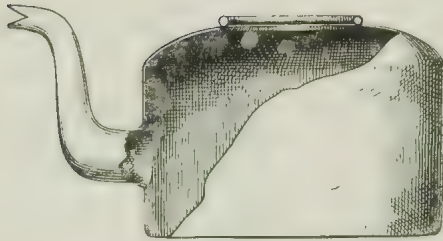

Fig. 110. Tea-Kettle, Showing Spout Attached.

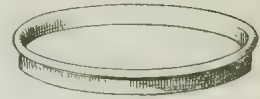

Fig. 111. -Cover Ring.

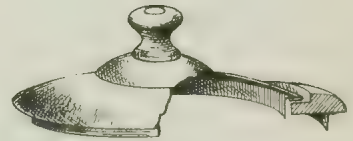

Fig. 113. -Broken View of Collar and Ring.

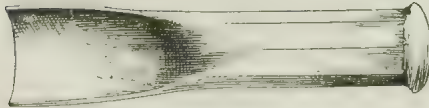

Fig. 112. -Collar Tool.

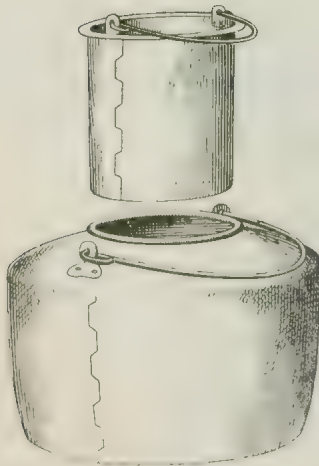

Fig. 114. -Glue Pot with Inside Cup.

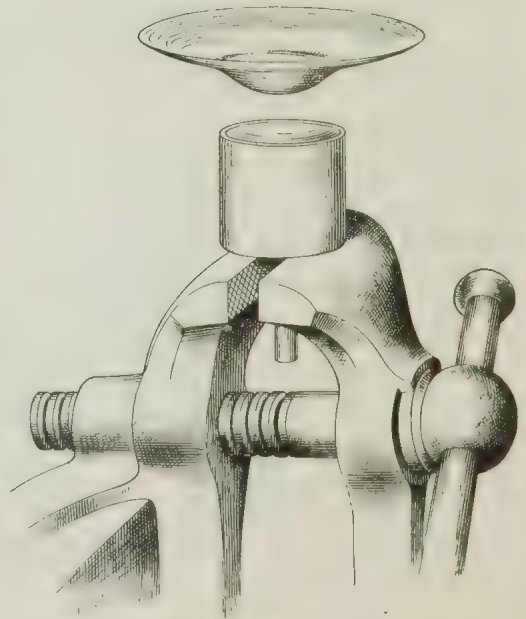

Fig. 115. -Cup for Making Boss on Cover.

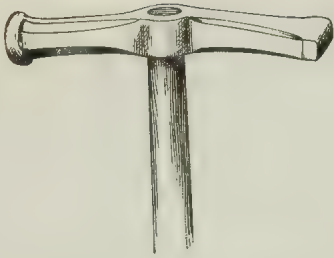

Fig. 116.—Bullet Head Hammer.

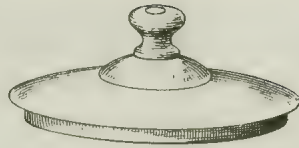

Fig. 117.—Finished Tea-Kettle Cover.



Fig. 118.—Finished Tea-Kettle.

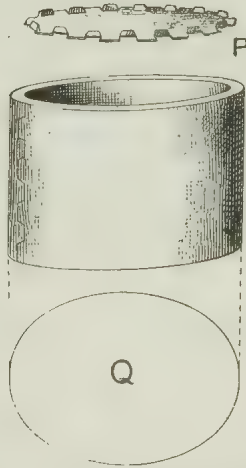

Fig. 119.—Body of Oval Tea-Kettle.

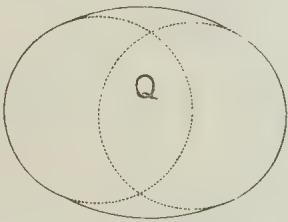

Fig. 120.—Method of Drawing Oval Bottom.

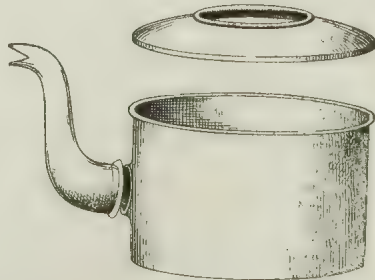

Fig. 121.—Oval Tea-Kettle, Showing Top.

The inside cup of the glue pot, see Fig. 114, is put together and the seam soldered in the same manner as the outside, and the bottom put in in the same way. The top may be wired with a large wire, or an edge laid off square, to rest on the ring of the outside boiler, the bottom of the cup when hanging in place being about an inch above the bottom of the kettle. The cover for the tea kettle is next in order: the rim is made to fit easy, and so that when the edge of the rim is in the cover and the cover paned down, the cover will set in the seat of the ring, Fig. 113. The cover is hollowed first, and then the boss is worked out in a cup, see Fig. 115, made of a ferrule of strong copper and having a strig of iron secured in it by pouring solder around a head made on the end of the strig. This cup is held in a vise, as shown in Fig. 115, and the boss worked out with a bullet-faced hammer, Fig. 116, then the cover is planished and the rim and knob put in, Fig. 117. The finished tea kettle is shown in Fig. 118. When the kettle and cover are completed they are scoured bright with a piece of flannel moistened with sweet oil, to which a little Tripoli is added,

No. of Quarts.	Length.	Depth.	Length of barrels and straps.
1½.....	20 inches.	5 inches.	4¾ inches.
2.....	21 "	5¼ "	4¾ "
3.....	22 "	5½ "	5¼ "
4.....	24 "	6 "	5¾ "
5.....	26 "	6½ "	6¼ "
6.....	28 "	7 "	6½ "
8.....	32 "	8 "	7 "

Dimensions of Round Tea-Kettle Bodies, &c.

and finally polished with dry Tripoli powder. Full directions are given in the article on mounting for the making of spouts and handles.

OVAL TEA-KETTLES.

Oval tea-kettles, Fig. 122, have usually been made differently from round ones, as the tops are generally double-seamed on, al-

though occasionally they are made with the tops razed down in the same way as are the round ones. There have been quite a number of fashions and some artistic skill displayed on oval tea-kettle covers and handles, much more than on round ones. We will make one, such as are ordinarily made for every-day use (the learner may display his artistic skill at his leisure) to hold 1 gallon, as in the case of the round kettle. The body is cut $23\frac{1}{2} \times 5\frac{1}{2}$ inches, and from a 10-pound sheet. The body is to be put together in a similar manner to the round one: After smoothing the edges, thin the ends, cramp one, solder the joint, clean it off, knock down and anneal. Then take to a head and work in a light course, beginning one-third from the bottom, after which stag in the lag $\frac{1}{2}$ inch wide, partly on the head, finishing on the bottom stake (Chap. VII., Fig. 104) and thinning the edge. Cut out the oval bottom Q, Fig. 119, making it a trifle larger than the hole of the lag. Fig. 120 shows method of drawing bottom. Thin the edge and cramp as indicated in P, Fig. 119, then lift each alternate cramp and put the bottom in from the inside, lay the cramps down close, then braze and finish, and tin as directed for the round

No. of Pints	Length of body.	Depth of body.	Weight of copper for		
			Body.	Bottom.	Spout and barrel.
2.	$16\frac{1}{4}$ inches.	$3\frac{7}{8}$ inches.	8 pounds.	10 pounds.	13 pounds.
3.	$17\frac{3}{4}$ "	$4\frac{1}{8}$ "	8 "	12 "	13 "
4.	$18\frac{1}{4}$ "	$4\frac{3}{8}$ "	9 "	12 "	14 "
5.	$20\frac{1}{4}$ "	$4\frac{5}{8}$ "	9 "	13 "	14 "
6.	$21\frac{1}{4}$ "	$4\frac{7}{8}$ "	9 "	13 "	14 "
7.	$22\frac{1}{2}$ "	$5\frac{1}{4}$ "	10 "	13 "	14 "
8.	$23\frac{1}{2}$ "	$5\frac{1}{2}$ "	10 "	14 "	15 "
10.	$25\frac{1}{2}$ "	6 "	11 "	14 "	15 "
12.	$26\frac{1}{2}$ "	$6\frac{1}{2}$ "	11 "	14 "	15 "

Dimensions of Oval Tea Kettle and Weight of Copper.

tea-kettle, truing it up to the shape Q, Fig. 119. Turn the edge for the top and make the top, Fig. 121, which is to be double seamed on

to the body. The cover (see Fig. 122) is to be made in the usual manner, the boss being sunk in an oval cup similar to the one shown in Fig. 115. The handle, having been previously made, is to be riveted on and the rivet-heads soldered on the inside. When all is completed, polish for the storeroom with Tripoli, as previously directed.



Fig. 122. - Oval Tea-Kettle with Cover and Handle Complete.

BEER MULLERS.

Copper beer mullers, or warming pots, will next engage our attention. These are nice little jobs for a boy, progressive in their character, and give, after the first three years of drudgery, some relief to the monotony of scouring, breaking coke, and other so-called boy's work, the continued repetition of which has often been the means of breaking the spirit and blighting the hopes of many a good promising lad, who has been kept dragging along, year after year, wasting precious time at work that should have been shared between man and boy, and which could have been done without loss or detriment, but rather a benefit to both. I would pause to plead for the boys of the coming generation as I have often done for those of the past, craving for them sympathy, when they have been compelled to complain (and justly, too,) of the amount of time which has been sacrificed by them in incessant and unnecessary drudgery, often times, too, with a man who was altogether inferior in perception or mechanical ability to the lad placed under his control. If a lad is once given a place in a shop to learn any trade, he should have a chance to develop at least his own natural ability, even though the kind attention he should receive be withheld.

Beer mullers are made after three general designs, peaked, open and curved. Our first job at these (and they were the first vessels we began and finished complete) was a half dozen $\frac{1}{2}$ pints, three with lips and three without. We will now describe the various operations: A $\frac{1}{2}$ pint (British standard) muller, Fig. 123, measures $2\frac{1}{4}$ inches at top, $3\frac{3}{8}$ inches deep and 3 inches at bottom. To describe the pattern: Let C D F G, Fig. 124, represent the elevation of article, which is shown $3\frac{5}{8}$ inches deep, to allow for wire at top and edge at bottom. Through the center draw the center line K B. Extend the lines F D and G C, until they meet the center line as at B. Then B C and B G are the radii of the arcs which contain the pattern. With B as a center, describe the arcs J N and H L indefinitely. Upon the arc J N measure the circumference of the bottom of article, and from these points, as J and N, draw lines to the center B. Then L H J N will be the pattern for the article shown by C D F G. Having obtained the

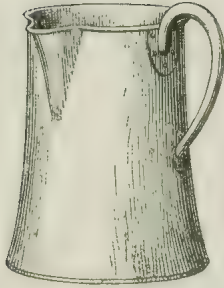

Fig. 123. - Half-Pint Beer Muller.

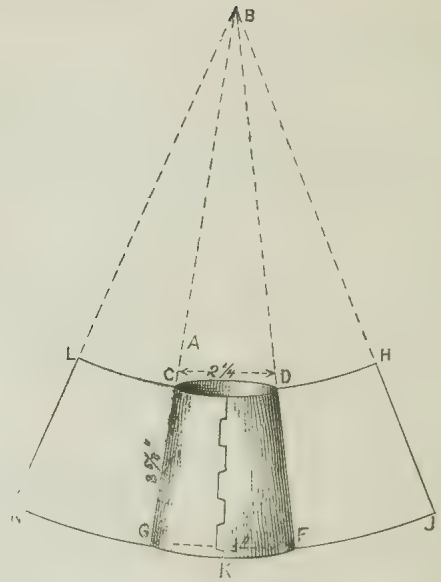

Fig. 124. - Pattern for Muller.

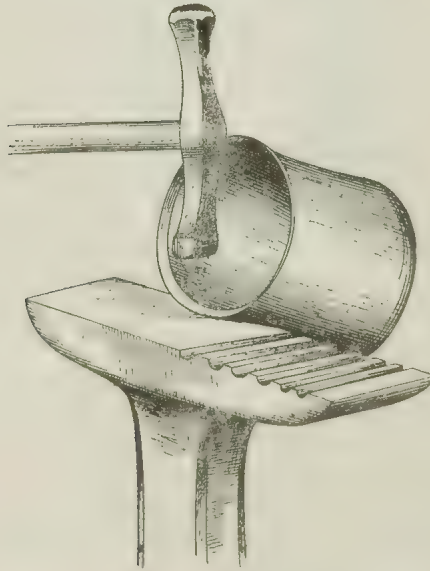

Fig. 125. - Turning Over Edge for Wire.

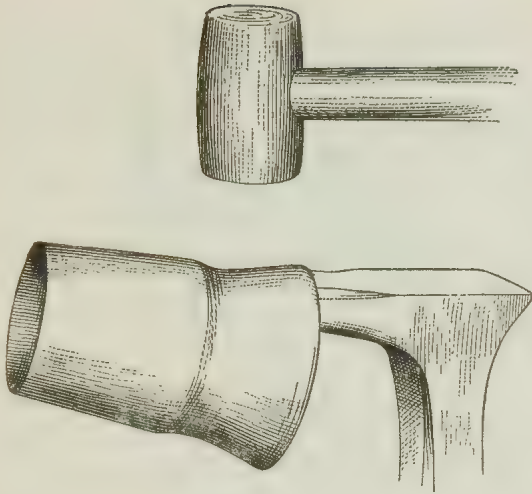

Fig. 126. Forming Concave Side of Muller.

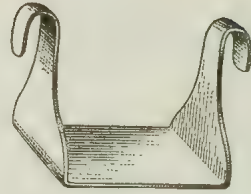

Fig. 129.—Hammer Face Formed

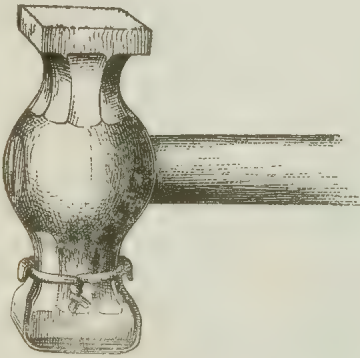

Fig. 127.—Spring-Faced Planishing Hammer.

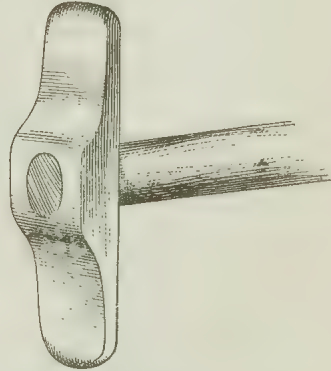

Fig. 130.—Creasing Hammer.

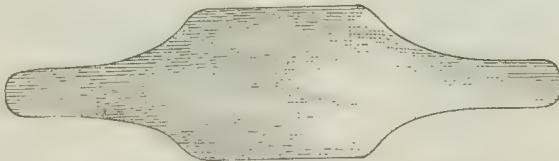

Fig. 128.—Pattern for Hammer Face.

pattern, it is to be cut out of about 6-pound plate; thin the edges cramp and form, and braze the seam; then clean off and knock down the joint, and anneal. Now turn the edge over for the wire, as shown in Fig. 125, and work in a course from the bottom to form the curve or bell at the base, as shown in Fig. 126. It is then ready for tinning inside. When tinned and scoured it is ready for planishing, which is done on a bright side stake, with a small spring-faced hammer, Fig. 127—that is, a hammer with an extra face of thin sheet steel, made and fitted as follows: A piece of sheet steel, of a suitable thickness, in this case about 20 gauge, is cut, as shown in Fig. 128, the two ends turned up as in Fig. 129, to fit the hammer-face, the lugs being placed in a line with the handle. When fitted suitably lay between the hammer-face and the spring-face two or three layers of French shalloon, which answers as a cushion; now bind the lugs with a stout piece of binding wire, and turn the points of the lugs down on the wire in such a way that they will tend to draw the spring-face close up and tight to the hammer. After polishing, it is ready for use. The job must now be cleaned inside and out with a piece of nice soft rag, then commencing close up to the wiring edge with the hammer, begin to planish and follow each course around the body until the bottom is reached, then again clean it inside and out, and planish it over again to smooth and finish it. Now put in the wire and then the bottom, which is done thus: With a creasing hammer, Fig. 130, on the creasing iron, Fig. 131, sink the edge around the bottom edge, being careful to make it regular and true. Then lift the edge enough to lay the bottom in the crease as shown in Fig. 132, the bottom having been previously tinned and planished, bring the edge down close and solder the bottom around inside, or if preferred the bottom may be soldered on the outside, keeping the soldering-iron as close to the outside edge as possible, that the work may be neatly done. When this is done form the lip on an extinguisher stake as shown in Fig. 133 by placing the cup on the beak, and with a hatchet-shaped mallet sink the wire on each side of the stake, a little at a time, until the lip is formed. Then with the wooden set, see Fig. 133, made of boxwood and smooth like the pane of a hammer, shape the V of the lip on the point of the stake, letting the point extend a third down the body, or they may be left without the V, the wiring only being bent. Make the handle, Fig. 134, 4 inches long from 30-pound plate, the edges being made round and burnished, and the surface planished smooth; after bend-

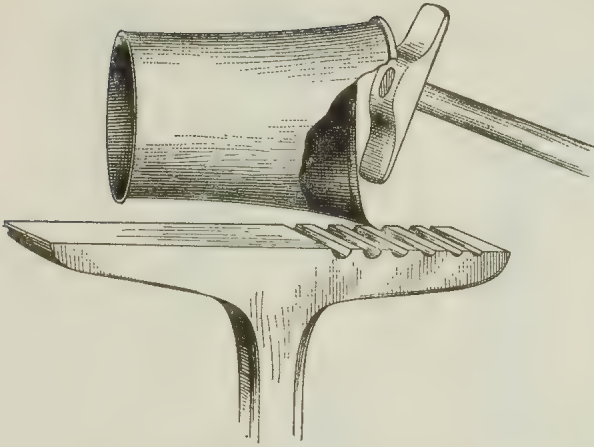

Fig. 131.—Forming Crease in Bottom.



Fig. 132.—Laying Bottom in Crease.

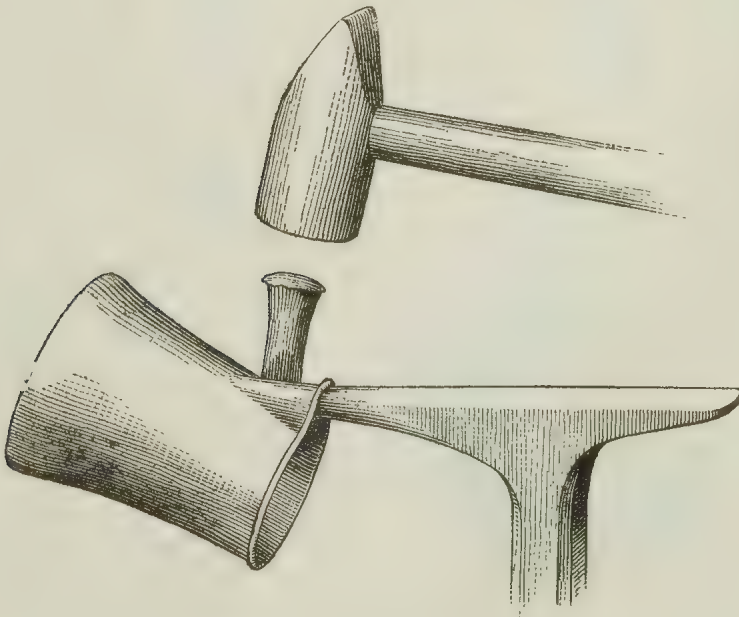

Fig. 133.—Forming Lip on Muller.

ing into shape as shown, rivet on and clean the article. Handles for the three largest sizes of mullers are made hollow and bent, having a flap brazed on as shown in Fig. 135, the small end being flattened and filed to the desired shape.

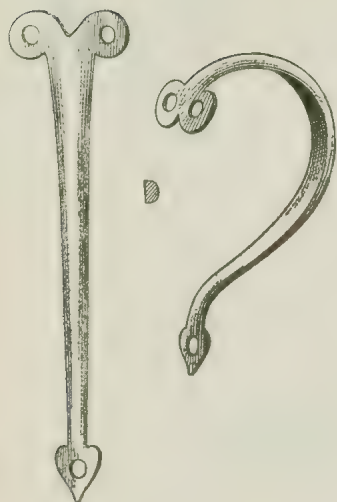

Fig. 134.—Handle for Small Muller

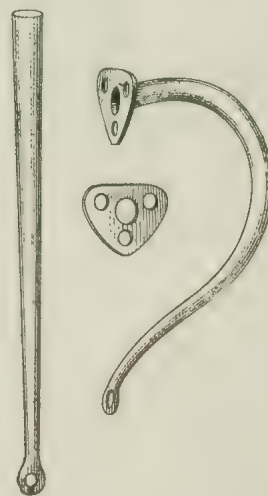

Fig. 135.—Handle for Large Muller.



Fig. 136.—Old Style of Muller.



Fig. 137.—Covered Muller.

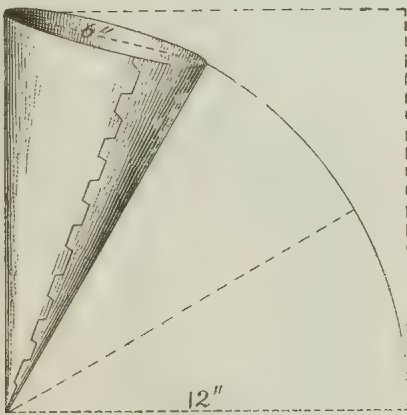

Fig. 138.—Pattern for Peaked Muller.



Fig. 139.—Pitched Cover.

The peaked Muller, Fig. 136, is an old design, and was made in two sizes—namely, pint and quart, while the covered mullers of the shape illustrated in Fig. 137 were made in five sizes, from $\frac{1}{2}$ pint to 2 quart—that is, $\frac{1}{2}$ pint, pint, quart, 3 pint and 2 quart.

The peaked muller, Fig. 136, is made in two ways; in the one the side is brazed together; in the other it is grooved; if the side is brazed the work is similar to that already described. If the side is to be grooved the pattern is tinned, planished, wired and the edges are turned, before being formed into shape, after which the point is flattened and turned over, as shown in Fig. 136. The pattern for a muller of this conical shape to hold 3 pints is shown in Fig. 138, and should measure 6 inches at the brim inside and about 11 long after the point has been flattened and curled.

The covered muller, Fig. 137, was made similar to the one shown in Fig. 123, but with a socket and wood handle, the body curving the other way, as shown, it also had a pitched cover. To pitch a cover is to raise it in the center, Fig. 139, a certain distance, which is roughly done on the block, Fig. 140, having a suitable hole cut in it for this purpose, and with the hammer like the one shown in Fig. 142, having one round face and the other oblong. With the round face sink or beat the copper into the hole in the block, allowing the edge to pucker up all around until the pitch is of sufficient depth, which takes two courses to complete, then raze down the wrinkles with a mallet and smooth with a hammer; next tin the inside of the cover and planish it, first on a small bottom stake, Fig. 141, and then on a side stake, Fig. 142, or some other suitable head, with the oblong face of the hammer, and, lastly, on a bright anvil, held in an upright shank, Fig. 143, planish the outer ring and wire the edge. The cover should be large enough, so that the wire of the body will just fit in the wiring of the cover. The joint or hinge of the cover shown in Fig. 144 is slipped through the notch left in the wiring of the body and then riveted to the cover. The bottom may be doubled seamed on or put in as has been described for open mullers. The socket for the handle is placed in the middle of the body, as shown in Fig. 137.

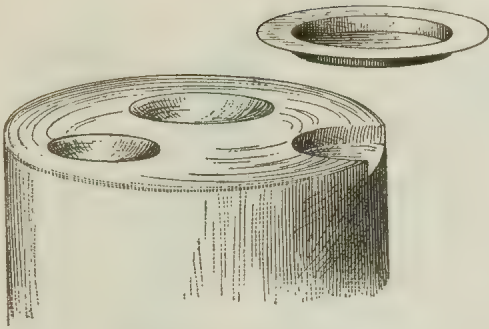

Fig. 140.—Raising Block.

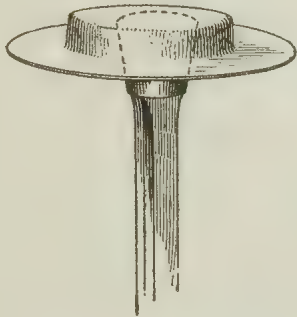

Fig. 141.—Planishing Cover on Bottom Stake.



Fig. 144.—Cover Hinge.

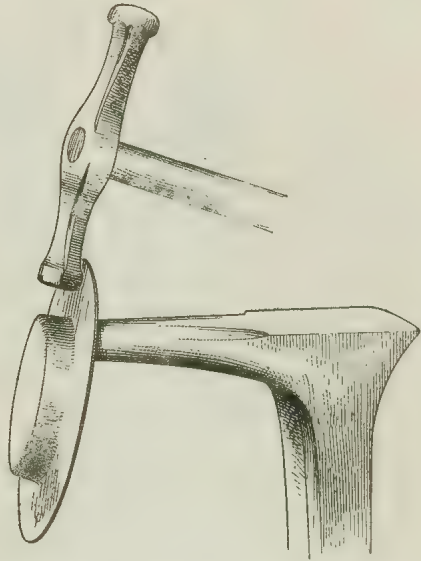

Fig. 142.—Planishing Cover on Side Stake.

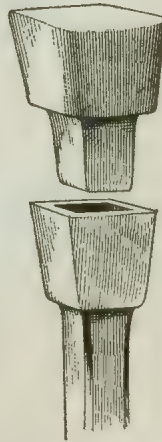

Fig. 143.—Anvil Held in Upright Shank.

FUNNELS.

Copper Funnels, Fig. 145, were generally made brown, in size from pint to gallon, namely : pint, quart, 3 pint, $\frac{1}{2}$ gallon, and gallon. Let us make one to hold a $\frac{1}{2}$ gallon ; that is, one into which a $\frac{1}{2}$ gallon of liquor may be dumped without running over. It will be found that an 8-inch cone whose slant height is equal to its diameter will hold approximately a $\frac{1}{2}$ gallon, Imperial measure. Funnels have always been made of one style, and formed of one-half a disk whose radius is equal to the diameter of the mouth of the funnel. Braziers, however, tuck in the mouth from 1 to 2 inches, according to the size. Our pattern, then, will be $\frac{1}{2}$ of a 16-inch disk, $\frac{1}{4}$ of an inch being added for wire, and the hole for the outlet being 1 and $\frac{1}{4}$ inches when finished, being cut $\frac{1}{8}$ less to allow of a narrow collar being worked out to lap on the spout. Cut out the pattern, Fig. 146, from 8-pound plate, thin, cramp, form and join as in Fig. 147, then anneal and tuck in the rim on a side stake, Fig. 148. The edge is next turned for the wire, with a crease iron and hammer, in the same manner as the edge of the beer mullers was turned. It is now ready for tinning ; when tinned and scoured, wipe the inside with a soft rag, and rub some Spanish brown over the outside, then planish on the bright head, Fig. 150 ; put in the wire, Fig. 149, and it is ready for the spout. The spout should be pitched and flanged as at H, Fig. 151, and the outlet collared as at K, so that when the spout is in, and the collar set down close, it will be held fast as at J. It is then to be soldered on the inside, being careful that no solder runs through to mar the outside ; put on the ring and clean. Bright heads, Fig. 150, are shaped in such a way that their faces form as it were a section of the funnel, with the heel made to fit the booge or rim, and are used principally for these funnels and the kind of spirit measures shown in Fig. 152.

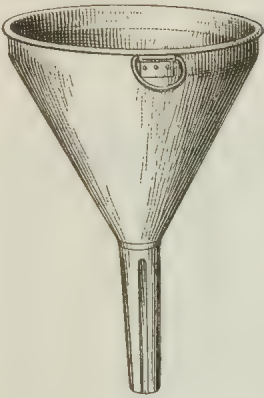

Fig. 145.—Copper Funnel.

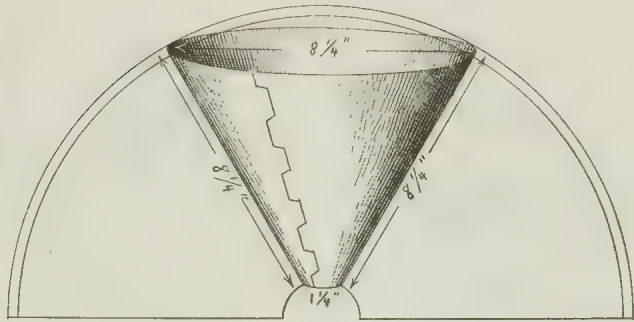

Fig. 146.—Pattern for Funnel.

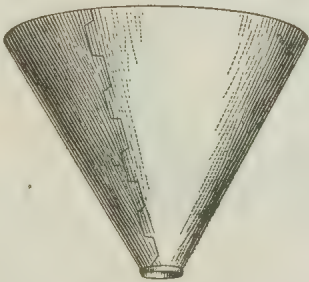

Fig. 147.—Funnel Formed and Cramped.

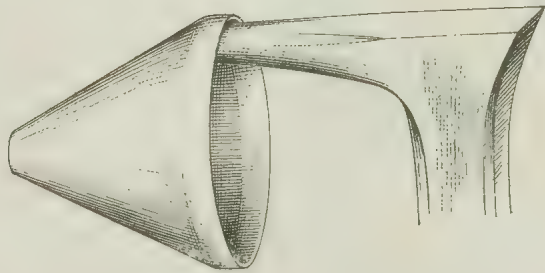
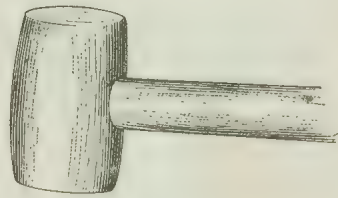

Fig. 148.—Tucking in Rim on Side Stake.

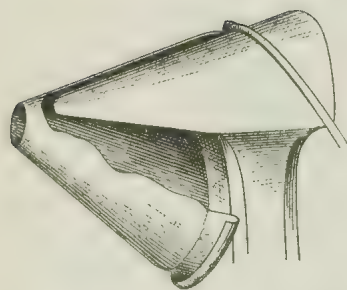

Fig. 149.—Putting in Wire.

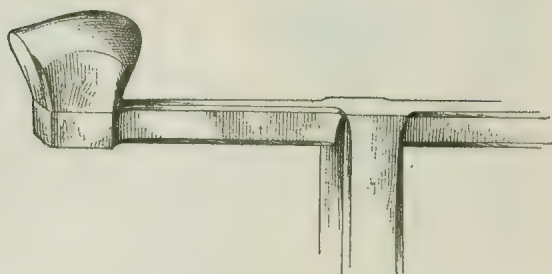

Fig. 150.—Bright Head on which Funnel is Planished.

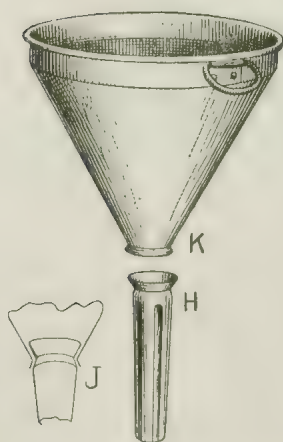

Fig. 151.—Joint Between Spout and Funnel.



Fig. 152.—One Form of Spirit Measure.

COFFEE POTS.

Coffee pots were made as shown in Fig. 153, and somewhat similar to the muller, Fig. 123, but their height was two and a half times the top diameter; that is, if the diameter at the top is 4 inches, the pot would be 10 inches deep, and the bottom one and a half times the top, or 6 inches in diameter. They were made in four sizes, namely : 3-pint, 2-quart, 3-quart and 4-quart. An imperial $\frac{1}{2}$ gallon contains 138 cubic inches, and a frustum of a cone whose dimensions are $3\frac{5}{8}$ inches at top, $5\frac{1}{2}$ inches at bottom and 9 inches deep, will hold 150 cubic inches; but when the curve is given to the side, by working in a course and smoothing, the capacity is reduced enough so that the pot will hold just about $\frac{1}{2}$ a gallon when it is finished. It is well to say here that all such vessels as these only approximate to the capacity named, most of them holding somewhat more than the given amount. The pattern is cut according to the method already shown in Fig. 124, an 8-pound plate being used for the purpose. After the seam has been made and the body annealed, take in a course on a side stake, as previously explained in Fig. 126, until the body appears straight one-third the depth from the top, and then gradually hollow out the remaining two-thirds, bell fashion, down to the bottom; smooth, true up and turn the edge over for wire, when it is ready for tinning. When this operation has been performed it is planished on a bright side stake, and the wire put in, Fig. 154. The hole for the spout is next cut, the center of the hole being one-third the depth from the bottom of the body, Fig. 155. Cut out the spout, Fig. 156, thin the edge, turn it round and braze the seam; clean off the seam and tin the spout inside; then round up and smooth with a mallet, after which take a suitable stick or a file, and with emery cloth lapped around it prepare the spout for the burnisher, and burnish it. Now pitch the spout on the under side, Fig. 157, then work out the collar of the pot, Fig. 155 D, to fit in the pitch of the spout, Fig. 157, and then put in the spout. Set down the collar close to the spout with a set shaped like a gouge, the end being square or blunt; then put in a small rivet at the end of the spout Fig. 155 D, and solder it inside. Next put in the bottom the same as was done with the open muller and solder it inside. The socket for

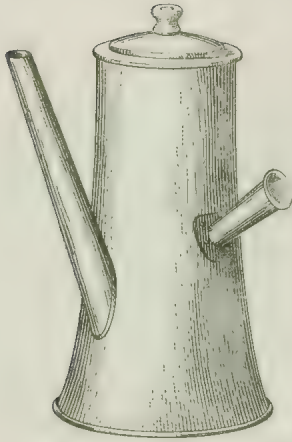

Fig. 153.—Coffee Pot.

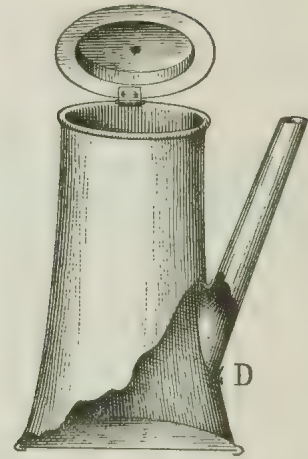

Fig. 155.—Joining Spout to Coffee Pot.

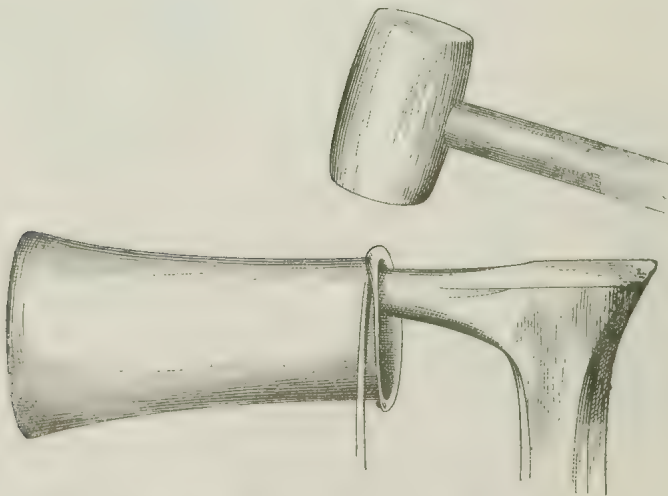

Fig. 154. Wiring Body of Coffee Pot

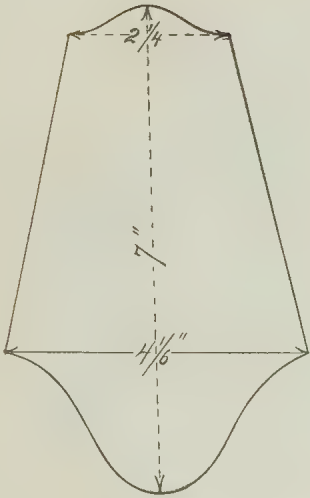

Fig. 156.—Pattern of Spout.

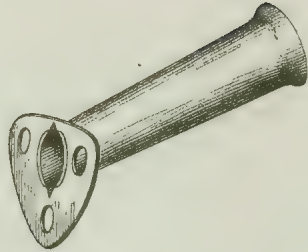

Fig. 158.—Socket for Wooden Handle.



Fig. 159.—Tools for Turning Burr on Cover.



Fig. 157.—Coffee Pot Spout.

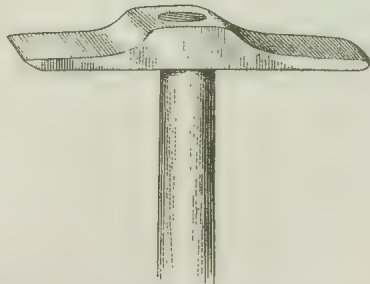

Fig. 160.—Piening Hammer for Covers.

the wooden handle, shown in Fig. 158, is made as before directed for hand bowls and the cover is pitched the same as for mullers.. The coffee pot cover, however, must have a rim about $\frac{1}{2}$ inch wide, when edged ready for the cover. In order to turn the edge on cover (as we had no burring machine), we had to use the tool shown in Fig. 159, of which there were three different sizes. They were called "taking up stakes;" that is, stakes for taking up the edges of bottoms and covers. The bottom end of the stake enlarged so as to fit the hole made for it in the bench. The edge of the cover, after the rim is in, is peined down with a hammer kept especially for the purpose, as shown in Fig. 160. Now put in the joint or hinge through the notch left of the wiring, and through a notch left in the rim of the cover and rivet on the cover, put in the wooden handle, then clean the article for the storeroom. Some coffee-pots had bent spouts, like tea kettle spouts, which made a more ornamental coffee pot than when plain spouts were used.

SAUCEPANS AND PUDDING POTS.

It is probable that among the culinary utensils made by braziers 40 years ago there were more saucepans than almost any other article; but later on the French stew-pan seemed to supercede the saucepan altogether, excepting in a few instances, such as the smaller sizes, which were made with lips and used for the preparation of little delicacies. Copper pudding pots were also in good demand before they were supplanted by those made of cast iron, which were not only tastefully designed, but were much cheaper and safer to use, where those made from copper were apt to be neglected and not kept clean and properly tinned. The progressive braziers were, however, equal to the emergency, and turned their attention to the manufacture of wrought iron goods, made in the same way and after the same fashion as the copper goods.

It may be stated here, for the benefit of the learner, that the proportions of all vessels are in ratio to one another as the cubes of their diameters; hence a boy who has the desire to become proficient and make an efficient workman, and understand the proper proportions of the work he is engaged at, should make himself conversant with solid geometry, and thus be prepared to work out any example in cubic proportion likely to be called for. Two examples will be given, showing how the dimensions of all sizes smaller and larger than one gallon may be obtained, providing the utensil is made of a straight strip. The strip for a gallon saucepan is cut 24 inches long by 7 inches wide. Let it be required to make one to hold 6 quarts. The strip of metal 24 inches long is to be formed into a cylinder thus: $24 \div 3.1416 = 7.6394$, its diameter, and as all cylinders are to each other as the cube of their diameters, and as we want a cylinder to hold one-half as much more, and in the same proportions as to height, we cube the diameter of the first cylinder—namely, $7.6394^3 = 445.8384$, and then $\frac{445.8384}{2} \times 3 = 668.7576$, and $\sqrt[3]{668.7576} = 8.78$, the diameter of a cylinder required for a 6-quart saucepan. Then, $7.6394 : 7 :: 8.78 : 8.0451$, and $8.78 \times 3.1416 = 27.5832$. Therefore the sheet for



Fig. 161. --Copper Saucepan.



Fig. 162. -Copper Pudding Pot.



Fig. 163. Pudding Pot Cover.



Fig. 164. --Braziers' way of Measuring Saucepans, etc.



Fig. 165. --Body Marked for Razing.

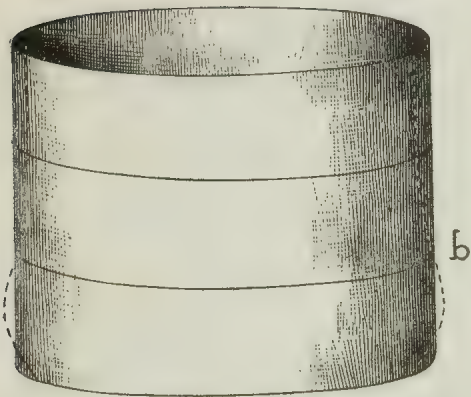

Fig. 166.—Manner for Razing Top Part of Body.



Fig. 167.—Lag Drawn in for Bottom.

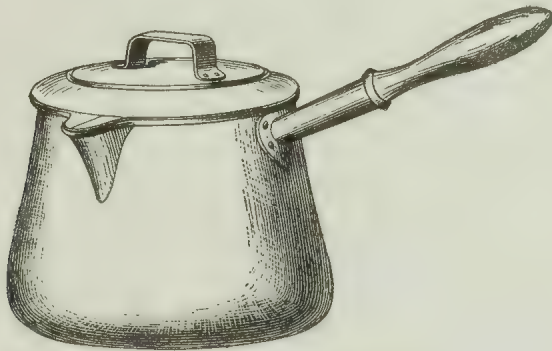

Fig. 168.—Lipped Saucepan.

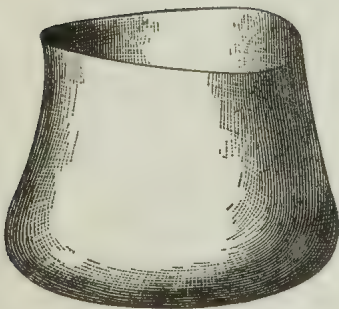

Fig. 169.—Slack Left for Forming Lip.



Fig. 170.—Oval Pudding Pot.

a 6-quart saucepan would be about $27\frac{1}{2}$ inches long and 8 inches wide—approximately—that is near enough for practical purposes. Again, let it be required to make a saucepan to hold 3 quarts. Then proceeding

similarly, as above, $\frac{3}{7.6394} = 445.8384$, and as there are 4 quarts in

a gallon, we proceed thus: $\frac{445.8384}{+} \times 3 = 334.3788$, and $\sqrt[3]{334.3788} =$

6.99, the diameter of a cylinder to hold 3 quarts. Then $6.99 \times 3.1416 = 21.9597$, the length. Now, $7.6394 : 7 :: 6.99 : 6.40$ —that is, the sheet for a 3-quart saucepan would be nearly 22 inches long and $6\frac{3}{8}$ wide.

Copper saucepans, Fig. 161, were made in sizes to hold from 1 pint to 4 gallons. Pudding pots, Fig. 162, from 3 to 6, and sometimes as large as 8 gallons. As the work of making plain saucepans and round pudding pots is the same, excepting a little variation in the shape, we will make one to hold 1 gallon; the other sizes being made in the same manner. It will be seen from an inspection of Fig. 161 that a 1 gallon saucepan is the frustrum of a cone with the base turned in, forming at that point almost one-half an oblate spheroid. The brazier's measurement of a gallon saucepan is taken from lag to brim, as shown in Fig. 164, and should measure $9\frac{3}{4}$ inches. (The writer has one made by himself in the year 1856 which was in constant use up to 1872, and is apparently as good as when new, if retinned and made fit for use. This old relic measures 7 inches in diameter at the brim, $6\frac{1}{4}$ inches deep, $7\frac{1}{2}$ inches at the lag, from lag to brim $9\frac{3}{4}$ inches, and at the swell or belly, 9 inches. It is made from 16-pound plate, with No. 6 wire.) The body for a gallon saucepan is cut 24 inches long and 7 inches deep, and may be made from 12 to 18 pound plate. The pattern is to be formed and the seam made as previously described; then divide the depth into three parts, as shown in Fig. 165, and with a mallet proceed to raze in a course a third from the end, as at *a*; now turn it end for end and raze in a course, Fig. 166, *b*, on the other side of the same line we started from before, drawing in the side until it is 7 inches at the top, and about $7\frac{1}{4}$ inches at the bottom. Then stag in the lag $\frac{1}{2}$ inch, Fig. 167, partly on head and finishing on a bottom stake, and thinning the edge on a bullet stake; cramp and put in the bottom B, braze the seam, clean it off, knock down, and anneal; then true it up on a long head, from the swell to the brim, and turn the edge for the wire. Now true

up the lag and belge on a suitable round head, and it is ready for the pickle tub and annealing, after which it is scoured bright and dried in the sawdust box. It is now to be put into its final shape and planished all over one course, beginning with the bottom, and next the sides; then tin it inside with pure tin. After being tinned and scoured clean, it is planished again, this time on a suitable bright head, and smoothed; then the wire is put in and handle riveted on. The cover is next in order; the rim of the cover is made slightly flaring, and the top pitched about $\frac{1}{2}$ inch; then tinned and planished. When the whole is complete, as in Fig. 161, it is scoured and polished with oil and tripoli.

In making lipped saucepans, Fig. 168, the work is done nearly the same, excepting that while drawing from the belge to the brim enough slack is left at the left of the seam to form the lip—that is, we work around the lip, leaving the brim, as it were, egg shaped, as in Fig. 169, until the planishing is completed and the wiring has been done; then the lip is put into final shape on an extinguisher stake. The cover is made with a projection to cover the lip, but the rim is round; the handle is of wood inserted into a socket, as shown in Fig. 168. Lipped saucepans are seldom made to hold more than 1 gallon.

Round pudding pots, Fig. 162, were made similar to saucepans, but with a bail and ears and somewhat less in depth; thus the body for a pudding pot to hold 3 gallons was cut about 34 inches long and $8\frac{1}{2}$ deep, being worked up in the same manner as a round saucepan, only having a bail and ears, as shown. The cover for pudding pot is shown in Fig. 163. Oval pudding pots, Fig. 170, were made similarly and cut the same size as the round ones; both differed a little in shape from the saucepans, the difference being in the belge or belly, which was drawn in at the top and bottom alike. Let us make an oval pot to hold 4 gallons, the body being cut from a 14-pound sheet, being $34 \times 8\frac{1}{2}$ inches. The body is to be formed and seam made in the usual manner, and the depth divided into three parts, as shown in Fig. 165, the form of oval is indicated in Fig. 171, making it 12 inches long. The sides are to be razed in at both ends until the belge has a curve of about an inch; then stag in the lag and put in the bottom, as indicated in Fig. 167; true up the body to shape and roughly planish, or run it over with a hammer. Then turn the top edge for wire and tin, after which scour and dry; then finish planishing and smooth on

a suitable head. Pitch the cover a good $\frac{1}{2}$ inch and tin, then planish it and put in the rim, which should be about $1\frac{1}{8}$ inch wide. Next put on the ears, the rivet holes of which should be countersunk enough so that the rivet heads may be drawn in and be flush and smooth with the surface inside. The bail can be tinned or japanned, as desired.

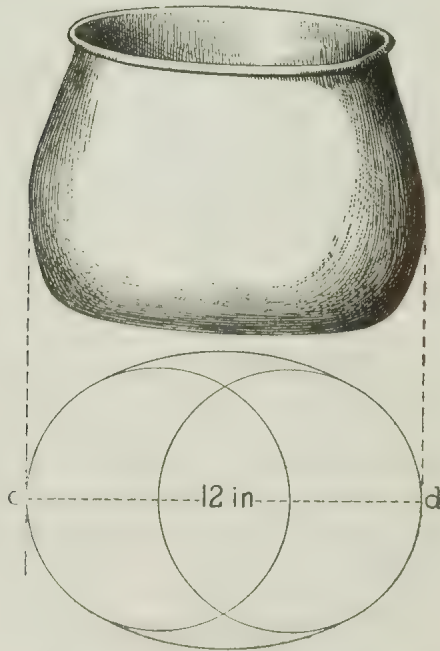

Fig. 171 — Plan of Oval Pudding Pot.

STEW PANS.

As previously stated, stewpans seemed to take the place of saucepans in a great measure after their introduction, because they were handier and more easily made; then, again, there were long and rapid strides being made in the perfecting of cooking apparatus in general, all tending to a complete revolution of culinary apparatus and methods. The general progress in education and the advances made on every hand were felt by the braziers, as well as others, and the surrounding influences compelled them, though a little reluctantly, to keep pace with the advancing tide about them and acquiesce in the demand for more tasty and shapely goods. An old-fashioned stewpan is represented in Fig. 172. At first there seemed to be but little attention paid to the symmetry of the parts; the handles were roughly made, and apparently without any particular design, so long as it was something to hold by; the flap was clumsily made, seemingly to get as much weight into it as possible. The pan proper was the best piece of work about it, and this, when compared with others of later make, was poor enough, and directly resulted from the opposition to any innovation or change from the old usages, and yet the work on the old-fashioned pan in its way really required more skill than those of a more recent date. The lag being made at first sharp or square, many an otherwise good piece of work has been spoiled in the finishing by being cut through, or nearly so, on the sharp edge of the old-fashioned bottom stake. This was at last obviated by making the lag round, thus adding beauty to the pan and at the same time overcoming all danger of failure at this point.

Let us make a stewpan after the old-fashioned method, and then show the difference between the old and new methods. At first they were made in accordance with the taste of the master, or if it happened that he was not a practical man, then the workman was relied upon to produce the best design he could; but later more attention was paid to the wants of the cook, and stewpans have been made in several styles to suit their demands—namely, shallow, medium and deep. The shallow ones were one-half their diameter in height, the medium two-thirds and the deep as high as their diameter—that is,

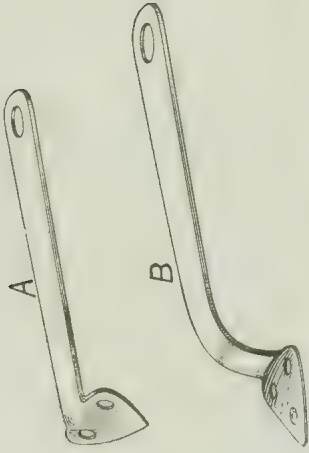

Fig. 173.—Old and New Style of Handles.

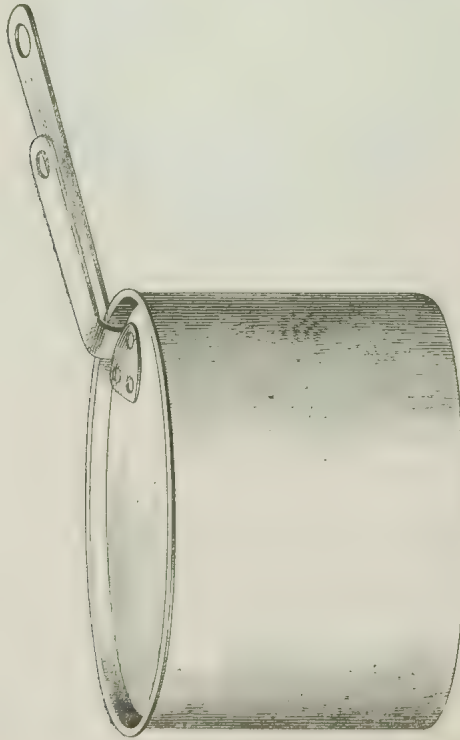

Fig. 172.—Old-Fashioned Steapen.

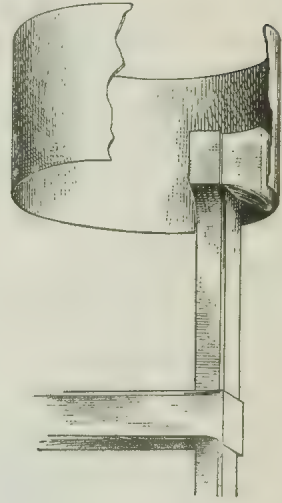

Fig. 174.—Forming Lag.

where attention was paid to the matter. There were, however, then as now many different styles, which we will leave to the investigation of the reader, the immediate object being to show him the manner and means adopted to produce the pan, or the execution of the mechanical part; so we will proceed to make one of medium hight to hold a gallon. Stewpans were made light or heavy to suit the wants of the purchaser, or to meet competition in price; generally they were made heavy. Let the example be made from a 30-pound plate, and of medium hight. The dimensions of a stewpan to hold 1 gallon are found in the following manner: A gallon of water (English) contains 277.274 cubic inches, and the pan is to be two-thirds of its diameter in hight. Then $\frac{277.274}{2} \times 3 = 415.911$, the cubical contents of a cylinder as high as its diameter. Then converting this into cylindric inches, we have $\frac{415.911}{0.7854} = 529.553$, and extracting the cube root of this we get $\sqrt[3]{529.553} = 8.089$ for the diameter, and as the pan is to be two-thirds of this, $\frac{8.089}{3} \times 2 = 5.392$, the hight of the pan inside measurement, to which add the thickness of the metal, and we have $5\frac{1}{2}$ inches for the hight, and 8 inches the diameter, approximately. Then the dimensions of a stewpan of medium hight to hold a gallon would be 8 inches in diameter, and $5\frac{1}{2}$ inches deep when finished; therefore our pattern requires to be $25\frac{1}{2}$ inches long and 6 inches deep, allowing $\frac{1}{2}$ inch for lag. Cut out the pattern cramp it with a chisel and thin. (For the benefit of the learner I will here state that it is the custom among braziers to cut their cramps in heavy metal before thinning; copper-smiths on the other hand do the thinning first, and cut the cramps after, and both ways have their advantages in particular cases which practice alone can teach and point out). Now form it and braze the seam as previously described; clean off and knock down; then stag in the lag, and thin the edge ready for the bottom; put in the bottom and braze it round; trim and knock down the seam; anneal, and true up to size. The lag being carefully formed on the heel of a suitable head, as in Fig. 174, it is now ready for the tinning. When tinned and scoured, it is first planished on a bright bottom stake, making the bottom level and true, and then the sides on a bright head in a shank, the smoothing being finished with a spring-faced hammer. The sides and bottom

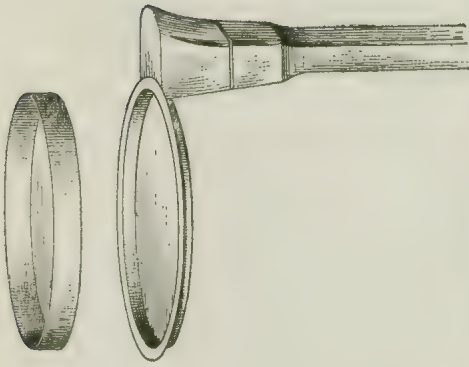

Fig. 176. — Making Cover for Steeplepan.

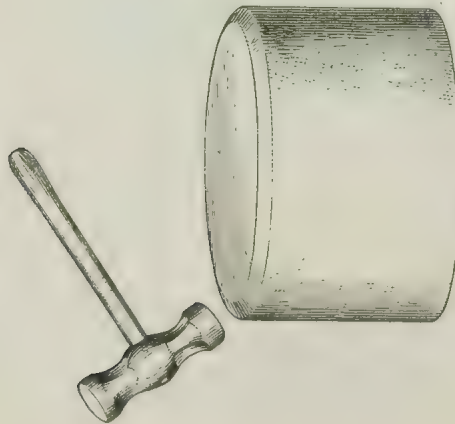

Fig. 175. — Finishing a Square Lag.

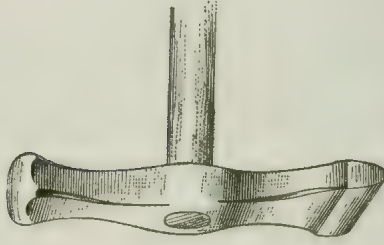

Fig. 177. — Coffee Pot Hammer.

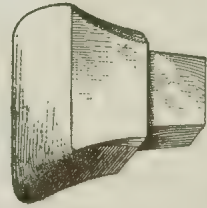

Fig. 178. — Head for Forming Round Lag.

completed, the lag was finished up square with a hammer, as shown in Fig. 175, and here is where the failure came in usually, by the lag being cut through, or nearly so, at this point. The covers were first pitched with a square corner, as shown in the top illustration, Fig. 176, the seat being turned with the long face of a coffee pot hammer, Fig. 177, and finished with a planishing hammer on the anvil, shown in Fig. 176. The work on the improved pan would be the same up to this point, the difference being in forming the lag round on the heel of the head, Fig. 178, it being made round and suitable for the purpose. This in time was superseded by a lagging machine, upon which dies or wheels (similar to a double seamer) of various sizes could be placed suitable for all kinds and sizes of pots and pans whose sides were made straight or parallel. The covers were also treated in the same way as the lag of the pan. About this time the burring machine was introduced for turning the seat of the cover and a few other purposes, and for a wonder it was received without much opposition.

The tinning of these improved pans was carried down on the outside from 1 inch to 1½ inches, according to the size of the pan, and was done as follows: The distance it was required to tin down, the side being determined, it was then marked off, and some wet whiting or black and size (plumber's soil) was carefully smeared on with a brush around and up to the mark, to prevent the tin from adhering further than the mark, and to keep it true to it. It was then immersed in a pan of liquid tin, Fig. 179; a clamp was then applied, and while the operation of tinning was being proceeded with inside the outside tinning was wiped off smooth and completed at the same time. The planishing was performed as before described, only the lag was carefully rounded with a mallet, and burnished to correspond with the other finish. The handles were lighter, more graceful, and formed so as to be placed nearly in the center of the side; the flaps were of a triangular shape and light, Fig. 173 B, which gave the article a much more finished appearance, and displayed more tasty workmanship. There seems to have been no deviation made since either in the pans or their handles, or none to my knowledge. The old style handle and flap is shown in Fig. 173 A. When the pan and cover are finished, the handle of the cover is put on first, and then the handle of the pan. This rule is observed to insure both handles being close and in a line with each other, so that the cook could grasp both handles together when necessary to move them about while in use.

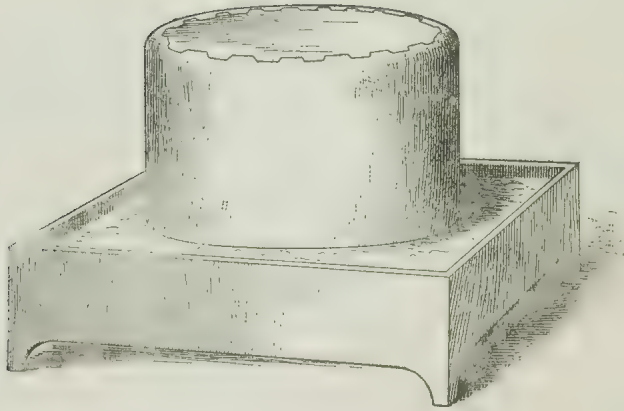

Fig. 179. — Process of Tinning Rim Outside.

STOCK POTS.

Stock pots were made in several sizes, from 9 to 20 inches in diameter. The smaller sizes were from 9 to 12 inches in diameter and the larger from 13 to 20 inches. They were fitted with pipe and inside grating when required, as shown in Figs. 180 and 181. The work of making stock pots is the same as that of large deep stew pans, excepting that the cover is made to fit on over the outside, and deep enough to be used as a cutlet pan, the pot and cover being mounted with cast copper handles as shown. Stock pots are a good job when made well, and are usually given to old and experienced hands, a young man seldom getting a chance at them. I was never called on to make one, but have noticed that the tools and appliances used in their manufacture were not adapted to the job, and it is a little surprising that such good work was produced by their use. I will describe the making of one of the stock pots of medium size, to hold 8 gallons standard or American measure, and made from 40 pound plate, and as high as its diameter. The American or United States gallon contains 231 cubic inches, and the pot is to hold 8 gallons; then $231 \times 8 = 1848$ inches, and converting these into cylindric inches we have $\frac{1848}{0.7854} = 2352.941$, and extracting the cube root we get

$\sqrt[3]{2352.941} = 13.3$, the diameter, and $13.3 \times 3.1416 = 41.7832$, the circumference, or length of the pattern, and 13.3, the depth. Add to this $\frac{3}{4}$ inch for lag and we have $13.3 + .75 = 14.05$, or a piece of copper 3 feet 6 inches by 14 inches for the pattern. Cut this out, cramp and thin; then braze the joint, trim, knock down and anneal; then put in the bottom and braze the seam.

When a boy I saw my father working on these pots occasionally and dragging them about on the forge with a pair of tongs, and have often wondered since how it was that the old braziers never adopted the plan or seemed to think of putting their heavy work in a sling; for after working some years among railway and marine work I returned to some of the old shops to work again and found that there had been but little progress made. The same old methods were still

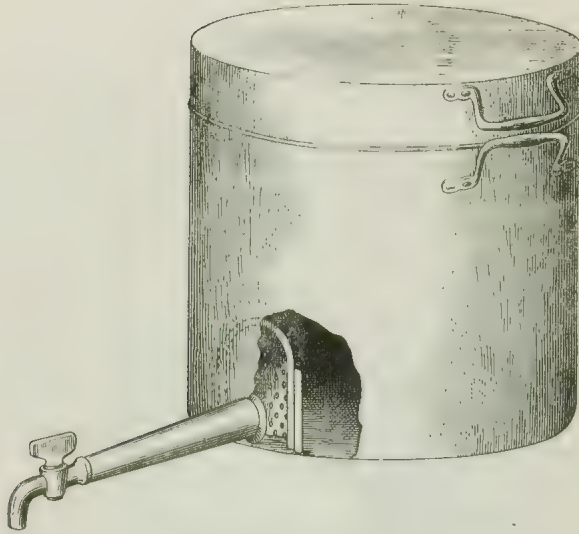

Fig. 180.—Stock Pot.

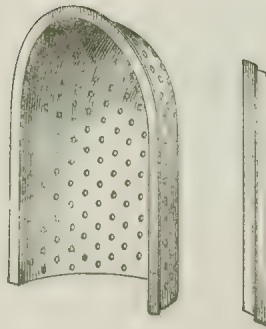

Fig. 181.—Inside Grating for Stock Pot.

in use, and to introduce any new ones was almost certain to bring one into contempt, particularly if there was any large number of men employed.

But to proceed. True the bottom on a square shank, using a suitable head and carefully keeping the turn of the lag round and as large as the head will permit; when this is completed, raise up the cover. This cover is raised from a disk, the size of which may be obtained as follows: Let the cover for this size be 2 inches deep, and its diameter $13\frac{3}{8}$ inches, so that it will fit easy; then, $13.375 \times 3.1416 \times 2 = 84.0378$, converting this into circular inches we have $84.0378 \div 0.7854 = 107$. Now square the diameter of cover, or 13.375, and adding this last result $(13.375)^2 + 107 = 285.890625$, and extracting the square root we get $\sqrt{285.890} = 16.9$ or 17. Raise up the cover to fit the pot, tin them both, planish and smooth; then put on the handles, those on the cover first, then on the pot, placing them in such a position that they will pass each other when being turned around on the pot.

FISH AND TURBOT KETTLES.

Fish and turbot kettles were made shallow and similar to stew pans. The work being of the same nature, a general description of them will avoid unnecessary repetition. There seems to have been one size for turbot kettles. They were made of light copper and of a suitable shape for the fish they were named after, they were about $5\frac{1}{2}$ inches high and wired at the brim; the handles were placed at the two furthest corners; the cover was pitched about $\frac{3}{4}$ inch, similarly to a stew pan cover, as shown in Fig. 182. The inside was supplied with a perforated fish plate, Fig. 183, having two lugs or handles with which to lift it out; the plate was tinned on both sides, planished bright, and then wired around the edge. The fish kettle, Fig. 184, was made oblong, with circular ends and straight sides, and about the same depth as the turbot kettle, and supplied with a fish plate, Fig. 185. Any workman who is skillful enough to make a good sauce pan may be trusted with the work of making either of these kettles without fear of failure.

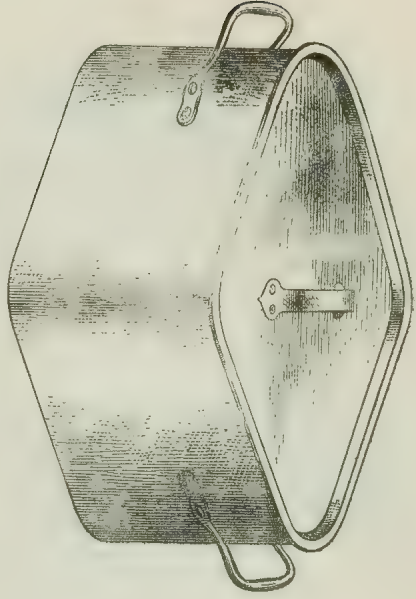

Fig. 182.—Turbot Kettle.

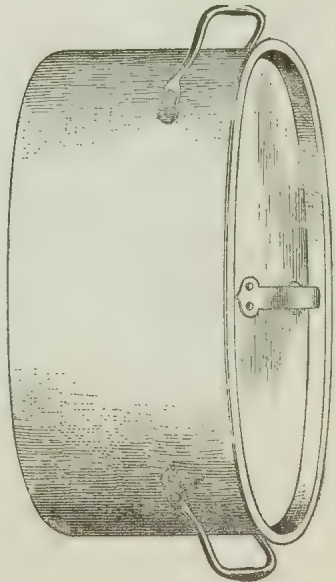

Fig. 184.—Fish Kettle.

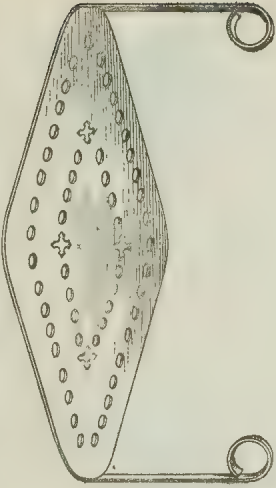

Fig. 183.—Fish Plate for Turbot Kettle.



Fig. 185.—Fish Plate.

BRAISING PANS.

The body of a braising pan, Fig. 186, is similar to a fish kettle except in shape, which is nearly a true ellipse; the pan, which is about 6 inches deep, is made strong and without wire. The cover is a difficult piece of work and requires more skill, as will be seen by referring to Fig. 187. Let us make a cover, and let the kettle measure 15 inches long and $11\frac{1}{2}$ wide; then the circumference is $\frac{11.5 + 15}{2} \times 3.1416 = 41.626$. Now, the outside case or pan of this cover at *a*, Fig. 187, is about 3 inches deep, and the wire, No. 6, would require another $\frac{1}{2}$ inch to cover it. The rim *b* which covers the kettle is 1 inch deep; add a quarter for seat and an eighth at *c* to turn on the inside to keep the cover proper in, the cover proper forming the bottom of the real braising pan. We then have for the width of the outer rim $\frac{1}{2} + 3 + \frac{1}{4} + 1 + \frac{1}{8} = 4\frac{7}{8}$. The strip, then, to form the upper pan of this cover would be $41\frac{5}{8}$ inches long and $4\frac{7}{8}$ wide. Cut it out, bend round and braze the joint; trim the seam, knock it down and anneal; take in a course on the head secured in a square shank, as shown in Fig. 188, until the size at *x z*, Fig. 187, is a good $\frac{1}{4}$ inch smaller all round than the cover *M*; now turn it up and work down the seat *d* with a mallet on an anvil, Fig. 189, and bring up the narrow rim to fit the rim of the cover *M*, Fig. 187. Next raze out the upper part or flare evenly all around until it measures $16\frac{1}{2}$ inches the long way, and turn the edge for the wire; now make the cover *M* and tin it inside and scour clean and fit the cover to the rim, planish and smooth both; then put in the wire, set the cover in the seat tight; then turn the edge of the outside rim over it, as shown at *c*, which finishes the cover or real braising pan. Finally put on the handles and clean.

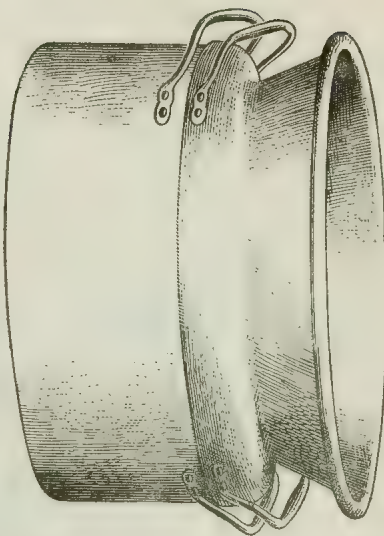

Fig. 186.—Braising Pan.

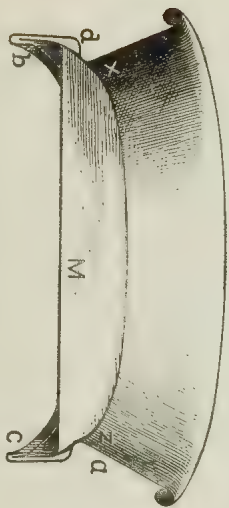

Fig. 187.—Section of Braising Pan Cover.

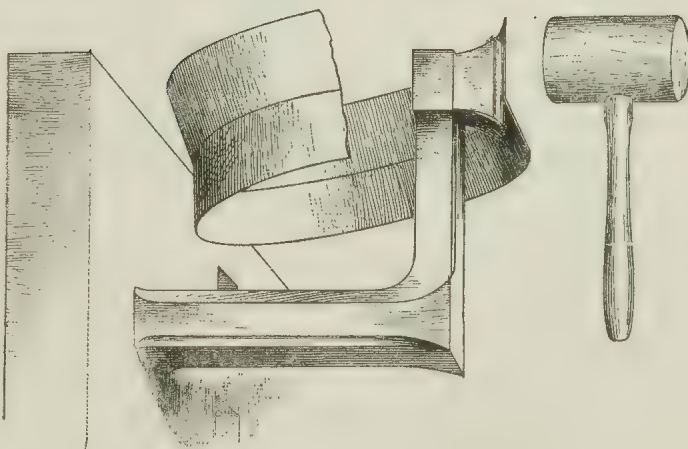

Fig. 188.—Working Cover to Shape

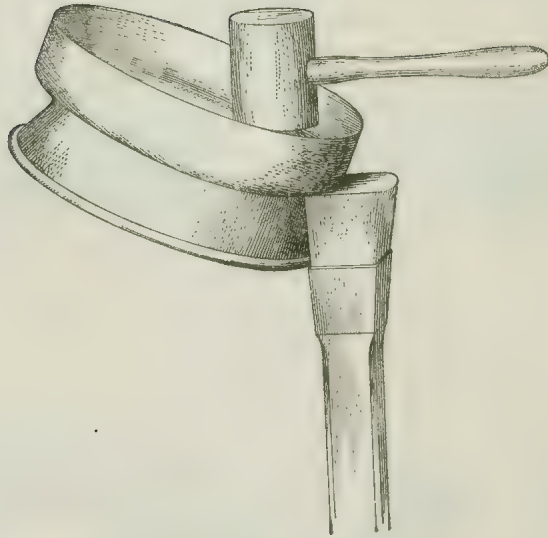

Fig. 189.—Working Down the Cover Seal.

TEA BOILERS.

Tea boilers, as shown in Fig. 190, were made 40 years ago, to furnish a reservoir of warm water, as well as to provide for boiling a larger quantity than the common sized tea kettle would hold. They generally stood on the hob of the fire place, and as close to the fire as was convenient, this gave place to the hob boiler, when the kitchen range was introduced, which cut off much of the brazier's work; but they are still made and used occasionally in the rural districts of England. The swivel in the bail served to hang it by, where there was a bar in the chimney on which to hang the pot hook and rack, Fig. 191, the loop being made to hang on the teeth of the saw shaped plate, by which to raise and lower the hook on which the boiler hung by the swivel in its bail. Tea boilers were made from about the same weight of copper as the larger tea kettles, and to hold from 2 to 8 gallons, advancing in capacity $\frac{1}{2}$ gallon with each size, making nine sizes in all. We will make one to hold 4 gallons. Tea boilers were made of a cylindric form, as shown in Fig. 190, the same depth as their diameter, hence a boiler 12 inches in diameter would be 12 inches deep. To find the size of the pattern or sheet to make a 4-gallon boiler we may proceed as follows: Four gallons (English) contains $277.274 \times 4 = 1109.096$ cubic inches, and converting these into cylindric inches we have $1109.096 \div 0.7854 = 1412.01426$, and extracting the cube root of this we get $\sqrt[3]{1412.01426} = 11.25$, or $11\frac{1}{4}$ inches. Then $11.25 \times 3.1416 = 35.343$, or $35\frac{3}{8}$ inches for the circumference. As the depth is $11\frac{1}{4}$ inches, add to this $\frac{1}{2}$ inch for the lag, and $\frac{1}{4}$ inch for edge to seam on the top; then the pattern will be $35\frac{3}{8}$ inches long by 12 inches wide, and made from 12-pound plate. Cut out the pattern, cramp, thin, form round, and tie with wire to hold while making the seam, Fig. 192, after which anneal and put in the bottom as previously directed. True to size, and run over the body with a hammer to stiffen it, and turn the edge for the top. The breast, cover and pipe are next in order. The breast has a rise or pitch of one-third, and the rim for the cover, from $\frac{3}{4}$ to $1\frac{1}{4}$ inches deep, finished, according to size—that is,

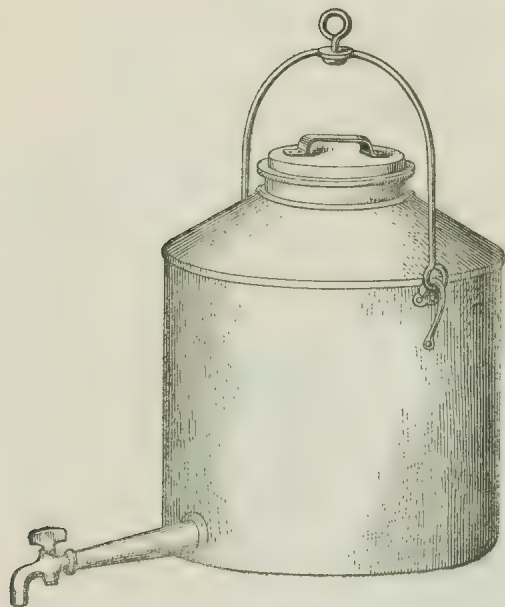

Fig. 190.—Tea Boiler.

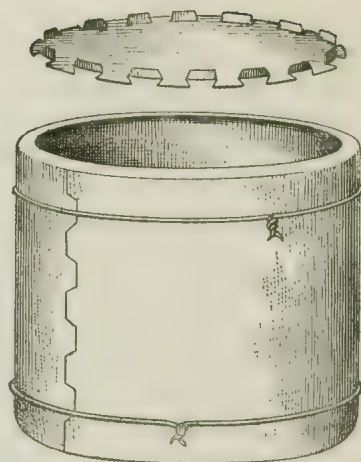

Fig. 192.—Body and Bottom of Boiler.



Fig. 191.—Pot Hook and Rack.

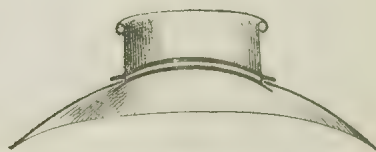

Fig. 193.—First Method of Forming Tea Boiler Breast.

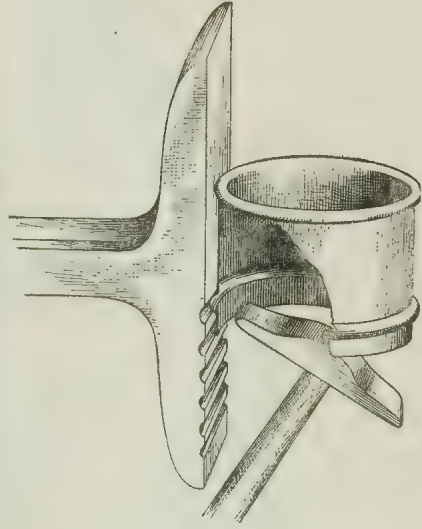

Fig. 191—Forming head on Creasing Stake.



Fig. 196.—Third Method of Forming Tea Boiler Breast.

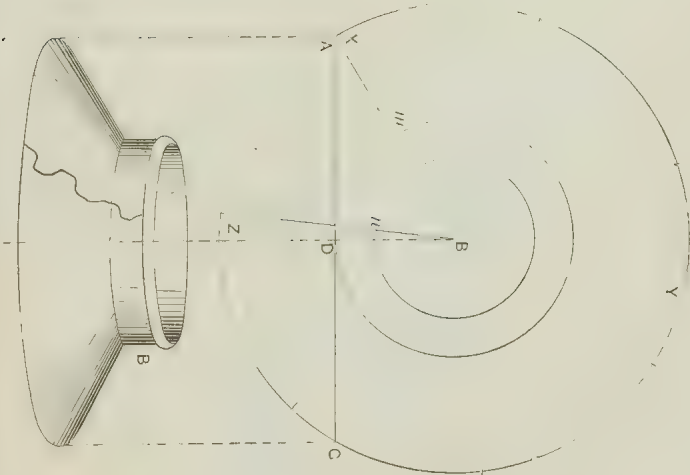

Fig. 195.—Second Method of Forming Tea Boiler Breast.

after being wired. Now, the breast or top may be made in several ways—namely, first, hollow it up and pitch the ring, as in Fig. 193, which is done in this way: After the ring is made and wired, take a creasing hammer and then sink the bead in a creasing stake, as shown in Fig. 194, and after putting the collar through the hole, as in Fig. 193, turn the edge back, and close the bead and edge down close to the top at one and the same time. Second, the top may be cut out flaring or conical, as shown in B, Fig. 195, and the ring partly formed before the seam is made. The cone is shown by A B C, and the pattern and ring by $x y z, m n$; the distance around the pattern $x y z$ being six times the radius A D of the finished cone A B C. Cut out the pattern, cramp, thin, and then work out the collar or ring on an anvil or table of the side stake; then braze the seam, finish the ring and wire. Third, cut out a disk so that its surface is equal to the breast and ring before wiring; wrinkle it, as in Fig. 196, and form the ring O P, making the opening about 5 inches in diameter and the required depth, and then work out the wrinkles; this can be done in one course, if necessary, and in as little time as either of the preceding methods, and is a much nicer job when finished; now tin, planish, and wire. The cover is made in the same manner as are those for saucepans, and which has been previously explained. The pipe for this size should be about 7 inches long, $1\frac{1}{2}$ inches in diameter at the large end and to fit the faucet at the other. Cut out the pattern and make a cramp at each end, Fig. 197, and lay the edge close, when turned ready for brazing, then braze. Tin the inside of boiler, pipe and cover, then pitch the pipe for collar, similar to a tea kettle spout, and work out the collar in the side of the boiler about an inch from the bottom, to fit the pipe, as in Fig. 198; then brown the boiler, planish and smooth it; next put in the pipe and double seam on the top; put on the ears, bail and finally clean.

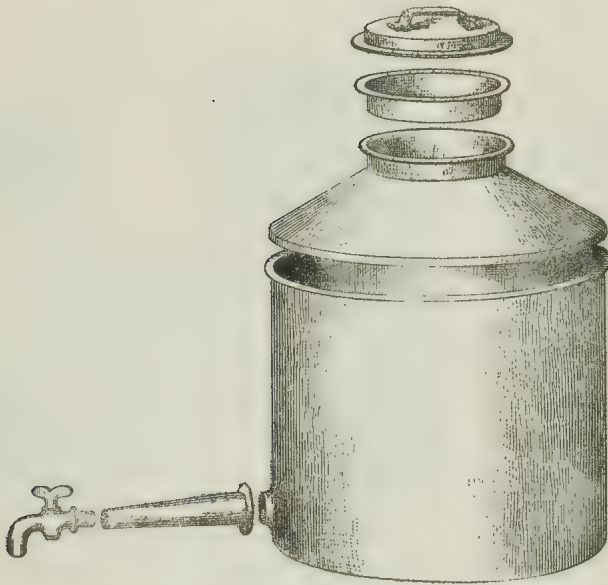

Fig. 198.—Separate Parts of Tea Boiler.

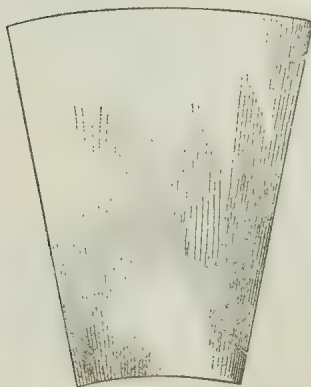

Fig. 197.—Pattern for Pipe.

WARMING PANS.

Copper warming pans were once quite largely in demand, and kept men busy at work for a considerable time during the year, as almost every household, rich or poor, possessed a warming pan, and it is presumed it would be a difficult task to-day to find a house in the rural districts of England without its warming pan, many of them having been handed down from father to son for generations. Warming pans are made or raised up and formed from a disk whose surface is equal to the surface of the pan and the cover seat, together with the covering of a 5-16 wire. They are wired as in Fig. 199, though they have been made so that the cover fitted into a $\frac{3}{8}$ rim turned up on the pan, as in Fig. 200, and left without wire, but in such a case they must be made stronger, the joint of the cover being riveted to the socket, as shown. They were made in five sizes—namely, 10, $10\frac{1}{2}$, 11, $11\frac{1}{2}$ and 12 inch. Let us make one to measure 11 inches, and from 10 pound plate (the plate or brazier's sheet, by which the strength was designated, measured 2 feet wide by 4 feet in length), and let it measure at the lag $1\frac{1}{2}$ inches less than at the brim, as in Fig. 201. Our first move is to get the size of a disk equal in surface to the pan thus represented; first the ring *a*, which is to cover the wire; then the cover seat *b*; next the sides of the pan *c*, and then the bottom of the pan *d*; these are all shown separately in Fig. 202. This is probably one of the best lessons in the trade for a boy (or man either) who desires to be familiar with the art of measuring and converting surfaces into forms suited for the work in hand. It will be seen by referring to Fig. 202 that there are four different problems involved in this calculation,—namely, the cylindric ring *a*, the disk ring *b*, the flaring ring *c*, and the disk or bottom *d*. Now we want to reduce these four problems to one form or denomination—that is, to one disk whose surface shall equal the whole of them taken together. First, the cylindric ring *a*, to cover the wire, $13\frac{1}{2}$ inches in diameter and an inch deep; then $13.5 \times 3.1416 \times 1 = 42.4116$ square inches. Next the disk ring *b*, whose outside diameter is $13\frac{1}{2}$ inches and inside diameter 11 inches; then $13.5^2 - 11^2 = 182.25 - 121 = 61.25$

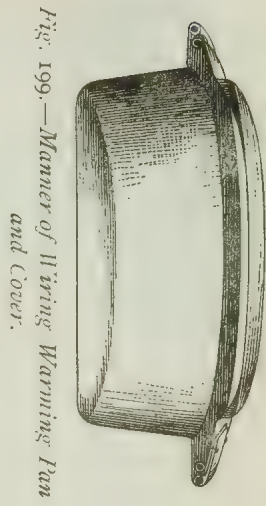

Fig. 199.—Manner of Hitting Warming Pan and Cover.

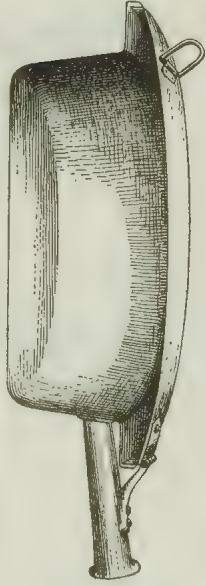

Fig. 200.—Edge Turned on Pan to Receive Cover.

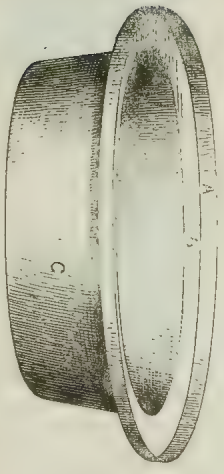

Fig. 201.—Body of Warming Pan.

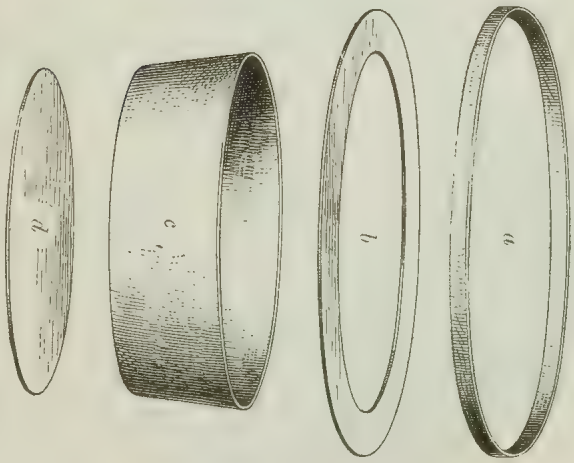

Fig. 202.—Parts of Warming Pan Body.

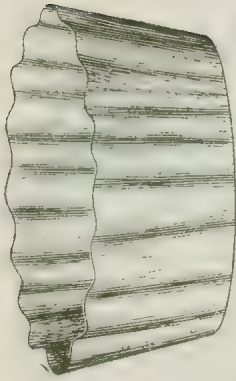

Fig. 204.—Disk wrinkled for Razing.

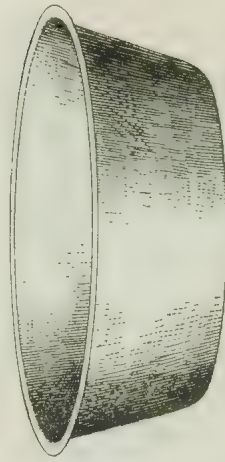

Fig. 205.—Wrinkles Worked Out of Pan.



Fig. 206.—Rim Worked Out on Pan.

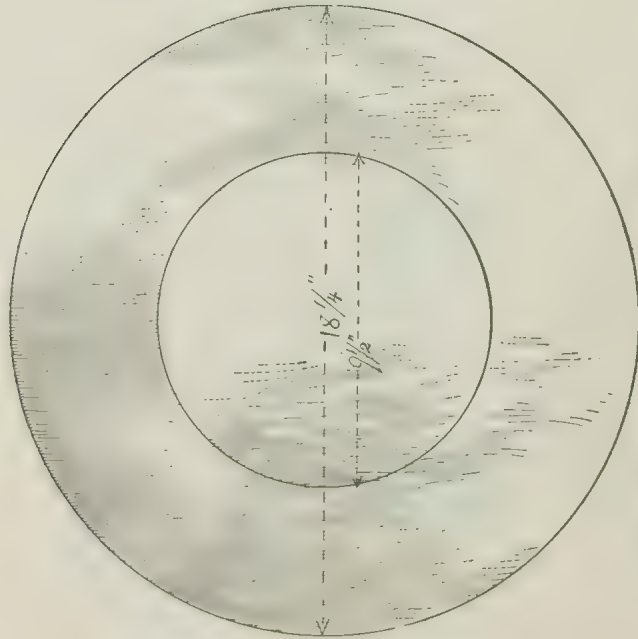

Fig. 203.—Disk Marked for Bottom.

$18\frac{1}{4}$ "
 $10\frac{1}{2}$ "

disk inches. Now, the opening of the pan *c* at the brim will equal 11 inches, and at the bottom $9\frac{1}{2}$ inches, and 3 inches deep; then $11 + 9.5 \div 2 \times 3.1416 \times 3 = 96.6042$ square inches; and last, the bottom *d*, which is $9\frac{1}{2}$ inches in diameter; then $9.5^2 = 90.25$. Now we must reduce the surface of the flaring ring *c* and the cylindric ring *a*, which are now represented in square to disk inches, and to do this we add them together and divide by 0.7854; then, $\frac{96.6042 + 42.4116}{0.7854} = 176.987$, and adding these disk inches to those of the disk ring *b* and the bottom *d* we have $176.987 + 61.25 + 90.25 = 328.487$; and then extracting the square root of this last result we get $\sqrt{328.487} = 18.124$, which will be the size of the disk for our pan. Cut it out, smooth the edges and describe the bottom *d*, as in Fig. 203, and start a course with a mallet on a suitable long head in a square shank. then take a razing hammer and raze down the wrinkles, working first on one side of the wrinkle and then on the other, then on the front of it, and continue until all the wrinkles are worked out and the rim has the measure of $13\frac{1}{2}$ inches, as in Fig. 205, annealing at the conclusion of each course. Now work it up until the pan proper is 3 inches deep, and measures 11 inches across the brim, as in Fig. 206. Then take it on an anvil, or the table of a side stake, and with a mallet raze down the cover seat or flange B, Fig. 201, leaving the edge of the wire standing, while the seat is brought down to its proper width, or $1\frac{1}{4}$ inches wide all around, then anneal. Now true it up to size and shape, then planish and put in the wire. The cover and socket are next in order; the cover is pitched about $\frac{1}{2}$ inch deep and wired on the edge, and a few small holes punched in it, as shown in Fig. 207; then planished and smoothed, leaving the cover raised or hollowed, and the bottom a little also, so that it will slide smoothly between the bed clothing. The cover joint, Fig. 208 may be hung on the wire of the pan, as in Fig. 199, or separate and riveted on the socket, as shown in Fig. 200. Now hang on the cover and rivet on the socket, Fig. 209, and put in the handle, which is usually about $1\frac{1}{2}$ inches in diameter and 5 feet long, turned from some nice looking wood and oiled; then clean with tripoli and oil, and polish with the dry powder.

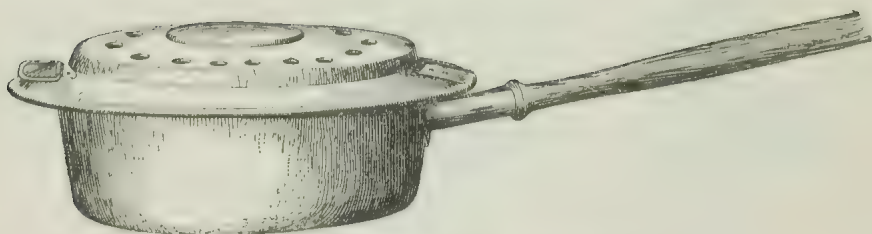

Fig. 207. - The Finished Warming Pan.

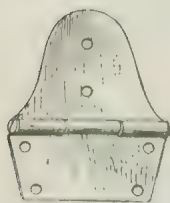

Fig. 208. - Cover Joint.



Fig. 209. - Socket for Handle.

PRESERVING PANS.

Preserving pans, Fig. 210, were made in sizes ranging from about 9 to 18 inches. These pans, like warming pans, have been kept and cherished as heirlooms, passing from one generation to another, and when made strong are very durable—with careful usage they may be in good condition at the end of a century. Preserving pans are raised up from a disk similar to warming pans, and usually wired with a heavy wire; the pan should be strong, too; therefore let our pan be made of 20-pound plate and 15 inches at the brim, 14 at bottom and $4\frac{1}{2}$ inches deep, including the wiring edge; then a disk whose surface is equal to the surface of the pan is found thus:

$\frac{14 + 15}{2} \times 3.1416 \times 4.5 = 204.9894$. Converting this into disk inches we

have $\frac{204.9894}{0.7854} = 261$, and adding this to the square of the bottom we

have $(14)^2 + 261 = 457$, and extracting the square root of this last result we get $\sqrt{457} = 21.377$, or $21\frac{3}{8}$ inches nearly, for the disk to make our pan of. Preserving pans are made in the same way as warming pans, described in the previous chapter. The first step is to mark the side of bottom on the disk and the second to form the side wrinkles for razing. When razed up to the proper height turn the edge for wire, as in Fig. 211, and then planish and smooth, being careful to have the bottom level; the sides usually belge a little from the bottom up. Finally, put in the wire and clean up with tripoli and oil and then put on the handles.



Fig. 211.—Pan Turned for Wire.



Fig. 210.—Copper Preserving Pan.

DRIPPING PAN AND LADLE.

Dripping pans, represented in Fig. 212, which we will now consider, are utensils probably as old as any in the trade, and which are in almost daily use in all the old manor houses and baronial halls of England. Their name is suggested by the use to which they are put—namely, to catch the drip from large joints of meat while they are roasted before the kitchen fire, the spit upon which the joint revolves being turned by a chain from a smokejack. These pans are considered a good job, and, like stock pots, are usually made by old and experienced hands, or men who have been some time in the employ and have gained the confidence of the employer, and are of known and tried ability; apprentices rarely have an opportunity to try their skill on these. Dripping pans have been constructed in several ways; first, with the well in the center of the pan, or in the middle of one end, as shown; sometimes with legs fastened to the pan; at other times without legs, but made to fit in a frame with legs. They are usually made in any case as large as the sheet will permit, a sheet being 2 feet wide and 4 feet long, and the sides of the pan being turned up some $3\frac{1}{2}$ inches and wired with a $\frac{5}{16}$ rod. The corners may be made square and brazed in the corner, or cut to form a round corner and brazed, or they may be wrinkled, and razed up solid, as may seem most advisable, or as the taste of the employer or the purchaser may require. We will make one to be 3 inches deep when finished, having the corners round and brazed, as shown in Fig. 212. The pan is shown bottom upward in Fig. 213. Let it be made of a common sized sheet and of 20-pound plate, and wired with a $\frac{5}{16}$ rod, the corners to be part of an 8-inch circle at the top and flaring at an angle of 120° at the lag. Now, this would make the corners what the old braziers called “funnel fashion”—that is, if all the corners were joined together in one entire circle they would be in the shape of a funnel, of 60° at the apex (see Fig. 218). Now, then, square the sheet as in Fig. 216, and mark off around the edge the depth of the pan (including the edge for the wire), $3\frac{1}{2}$ inches, drawing the inner lines parallel to sides and ends of sheet. Then draw the line AC, and with GC, $2\frac{1}{4}$ inches, as radius, describe the arc GM, which is the size of the circle of the corner

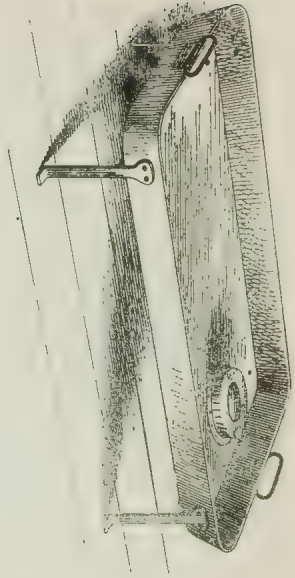

Fig. 212.—Dripping Pan.

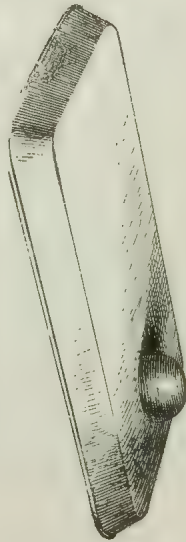

Fig. 213.—Bottom View of Pan.

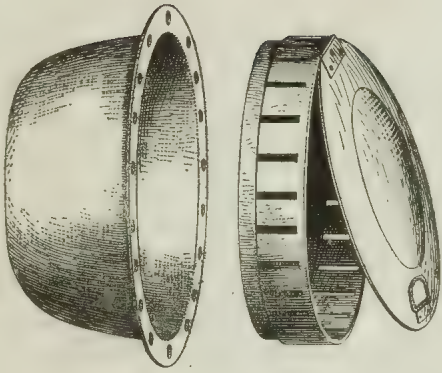

Fig. 214.—Well, Strainer Ring and Cover



Fig. 215.—Dripping Pan Ladle.

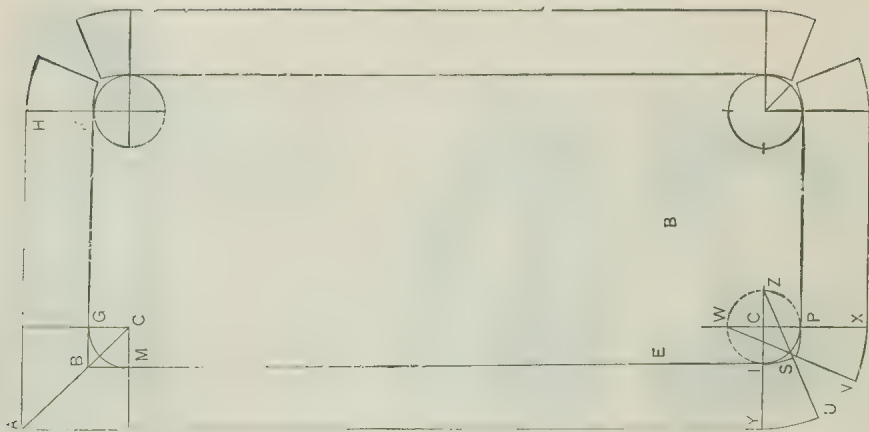

Fig. 216.—Pattern for Dripping Pan.

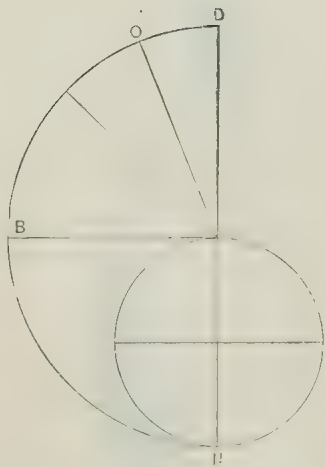

Fig. 217.—Diagram for Cutting Corners.

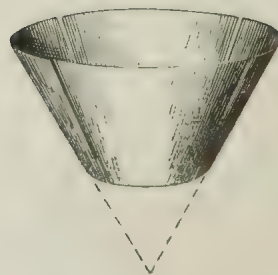

Fig. 218.—Corners Bent to Funnel Shape.

at the lag. Now look at the corner marked B. Draw the line Y C, extending it to Z, also X C to W, making the distance in each 8 inches, and describe the arcs X V and Y U. (Every boy knows that a half circle turned round and the ends joined will make a funnel.) Then the circle in Fig. 217, which is intended to represent the four corners of the pan brought together, will be 8 inches in diameter, and to make a funnel this size it is necessary to have the half of a circle with a radius of 8 inches, or 16 inches in diameter. Let the circle, Fig. 217, be 8 inches in diameter; then N B D will be the half circle with a radius of 8 inches. Divide the circumference into eight equal parts, as D O, and make the distance X V and Y U in the corner B, Fig. 216, equal to O D, and draw the lines V W and U Z and describe the arcs X V and Y U and P S and S I. Then cut out the pieces V S U and P S I, and the pattern for one corner is complete. Repeat the process at each corner. Cramp and thin; bend up the sides; bring them together and braze the seams; now trim and finish the corners and true up to size and shape, making the middle of the pan sag from 1 to 2 inches, so the drip will flow to the well. If the well be at the end then the pan may be made enough deeper at one end, or the legs enough shorter, so the drip will drain to the well at the end. Next turn the wiring edge, tin, planish and wire. The well, which is next in order, is made about 9 inches in diameter and formed like a basin, or half sphere nearly, as shown in Fig. 214, with flange $\frac{3}{4}$ inch wide to rivet to the bottom of pan. The strainer ring and cover are made to fit tight inside the well. The ring is about 2 inches deep and goes into the well about $\frac{1}{2}$ inch; there are also slits, as shown, made at intervals of about 2 inches all around, so that no cinders may find their way into the well. When the well is made and tinned inside, and the ring and cover are tinned all over and ready, put in the well and scrub the rivets so the surface is smooth; now put the ring into the well tight and soft solder to its place. The ladle, as shown in the pan, Fig. 215, always accompanies the pan; it is made about 4 inches in diameter, and with the bottom like a shallow cup, the top being full of small holes to answer for a strainer. The ladles are tinned inside and out. The handle is made of iron and from 20 inches to 2 feet long, with a hook at the end by which to hang it.

COAL SCOOPS AND COAL HODS.

Bright copper coal scoops have been considered an adornment for the parlor, as well as a necessary accompanying adjunct for the fire-side, as long probably as any article which has been wrought out from this sheet metal. There has been called out in their production as much art and painstaking care, perhaps more, as in any other thing upon which the brazier has been called to exercise his skill. They have also unconsciously furnished a stepping stone or preparatory course for the perceptive and studious beginner at the trade. In the manufacture of the various kinds of coal scoops which have been in use up to the present time, scope is given for the execution of some of the prettiest work of which the workman, under ordinary every day necessities, is called on to perform, and, furthermore, they must give much satisfaction to the zealous worker for the labor bestowed. These goods may be made by a skillful workman in any shape to suit the taste and please the fancy of the most fastidious. They furnish sometimes for boys, or young men who are approaching the end of an apprenticeship, an opportunity of becoming proficient in the use of a hammer. There is, however, little profit in coal scoops; that is, in those ordinarily in use, for they were among the goods which were paid the least for, considering the labor necessary to produce them in such a maner as the purchaser desired. On this account men sought the assistance of a good careful boy when the opportunity offered, and in this labor a pathway was opened for the boy which was closed in other instances where better wages were given for the work.

Coal scoops were made in a number of fashions, among which, besides the common hod, Fig. 219, were the round mouthed scoop, in Fig. 220; the square mouthed or flat bottom, Fig. 221; the Tudor, Fig. 222; the Florence, Fig. 223; the Nautilus, Fig. 224; the Royal, Fig. 225; the Boat, Fig. 226; and the Helmet, Fig. 227. In Fig. 228 is shown a round bottomed scoopet and in Fig. 229 a flat bottomed scoopet. Some of these names are variable, according to the factories in which they are made, while others have had the same name from the time they were first designed. The hod has always been a hod, and the common round mouth shape, as in Fig. 219, has never received any

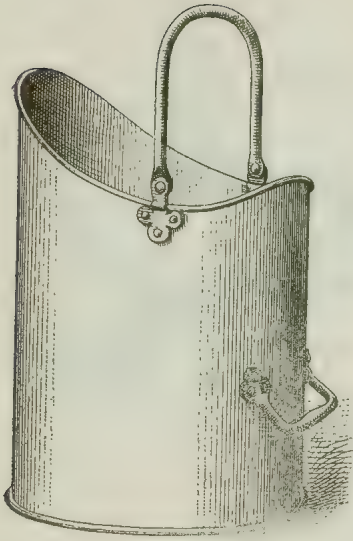

Fig. 219.—Common Coal Hod.

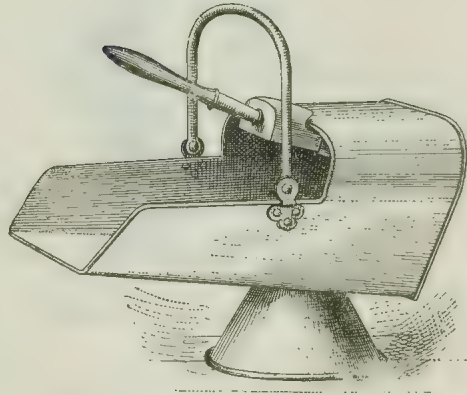

Fig. 221.—Square Mouthed or Flat Bottomed Coal Scoop.

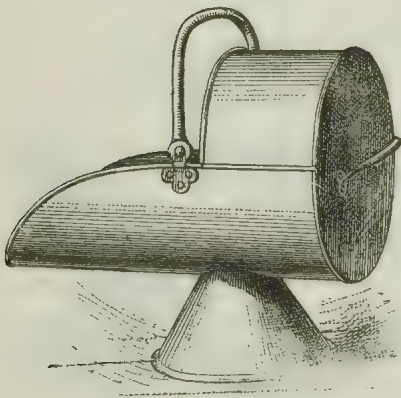

Fig. 220.—Round Mouthed Coal Scoop.

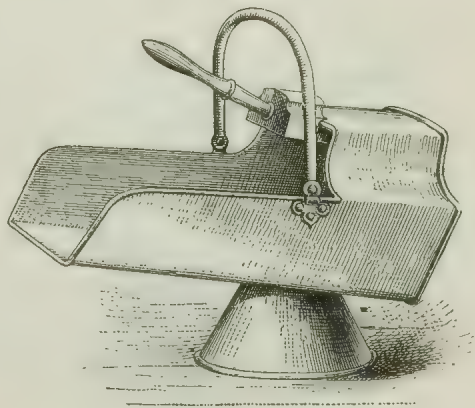

Fig. 222.—The Tudor Coal Scoop.

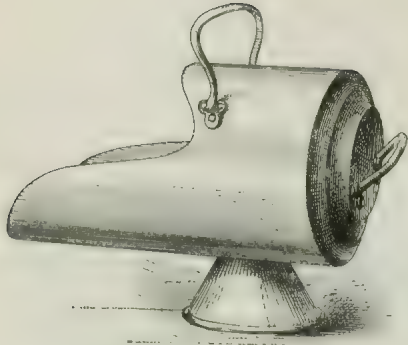

Fig. 223. The Florence Coal Scoop.

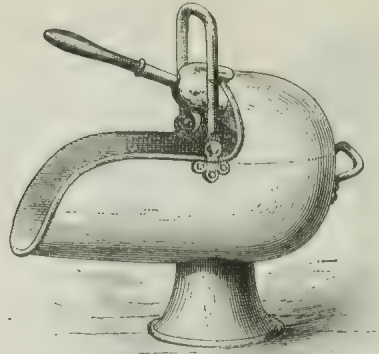

Fig. 224.—The Nautilus Coal Scoop.

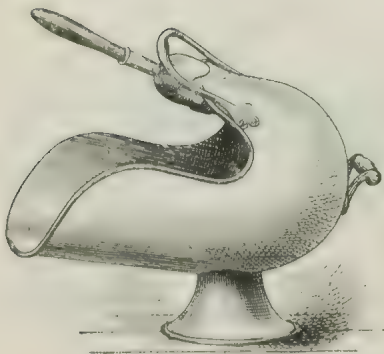

Fig. 225.—The Royal Coal Scoop.

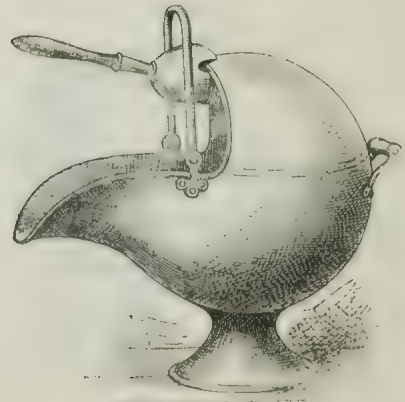

Fig. 226. The Boat Coal Scoop.

other cognomen ; the same with the helmet scoop, Fig. 227, which has always been wrought. The same and will probably continue to be, while the metal is used for this purpose.

We will now endeavor to describe the manufacture of several scoops in which we participated some forty years since, and while there have been deviations made during this long time, judging from late observations, it would seem that nothing of any marked importance has been introduced to inconvenience one from resuming work as of yore. The hod seen in Fig. 219 is of a cylindric form, the mouth being shaped in front similar to one-half an elbow as far as the ears, while the other half curves or returns up a little at the back, perhaps $1\frac{1}{2}$ inches. Let us cut out and then work two of these hods bright, and let them measure 12 inches in diameter, and from the front of the lip to the bottom, 18 inches, and $13\frac{1}{2}$ inches at the back, or let A B G L K, in Fig. 230, represent the outline of the proposed hod, of which C D F H is the plan. To describe the shape of the top of hod, from A to B would be about 56° . From the point E, which is midway between M and H, on the line A H, with E B as radius, describe the arc B G, which completes the shape of top. To outline the pattern, divide the semicircle C D F into any convenient number of equal parts, in this case six. Lay off the distance O P, equal to the circumference of the circle C D F H, which divide into twice the number of parts, as the semicircle C D F, and erect the parallel lines 1, 2, 3, &c. Place the blade of the T-square at right angles to A K, or, which is the same, parallel to the stretchout line O P, and bringing it successively against the points in A B G, cut the corresponding measuring lines, as shown. Then trace the curved line S I J through the points of intersection, which will give the form of the top or mouth of the hod. Now cut out and scour bright with sand, vitrol and water; rinse in clean water and dry in sawdust, and then remove the sawdust; clean and place two together and dog them so that they will be held fast; then with a planishing hammer weighing about 4 pounds, proceed to a bottom stake or an anvil; planish the surface in regular blows, lengthwise or crosswise as is most practical, so long as the surface is treated regularly all over and not in a promiscuous way. When the surfaces have been covered entirely, take them apart and scour the hammered side with sweet oil and tripoli, and then polish with the dry powder, being careful that all dust and oil are removed. When this has been done go carefully over each one singly again

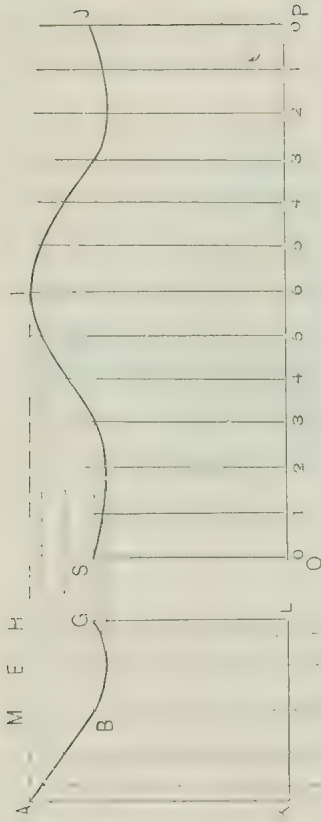

Fig. 230.—Obtaining Pattern for Common Coal Hold.

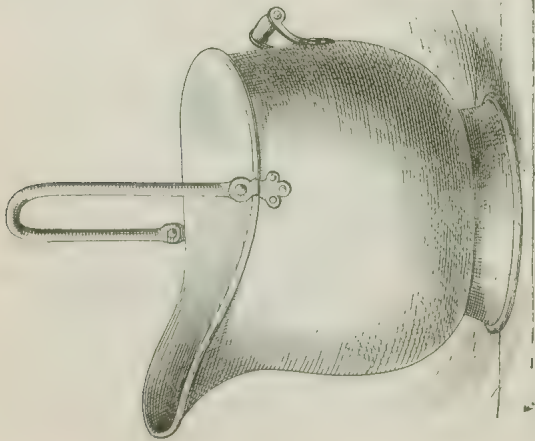

Fig. 227.—The Helmet Coal Scoop



Fig. 228.—Round Bottomed Scoop.



Fig. 229.—Flat Bottomed Scoop.

with a smoothing hammer. When this course is completed, wire, form on a former, grove together, and then bottom. The back handle is of cast copper, filed and burnished; the cross handle or bail is of $\frac{3}{4}$ -inch pipe, filled and bent, then filed and burnished. The ears may be cast or wrought, and should be made so the bail will lay on the wire at the sides, but leave room for the fingers in the loop, so that the handle may be grasped with ease. When the hod and both handles are ready give the hod its final clean up, and rivet on the handles the last thing.

MAKING COAL SCOOPS.

The plain round-mouthed coal scoop, as shown in Fig. 220, is made in four pieces, the bottom H and bridge B being shown separately in Fig. 231. The sheet and wire from which the bridge is made are shown in Fig. 232, while the foot is shown in Fig. 233. Let us work up two of these plain scoops, as shown in Fig. 220, and let them measure 15 inches when completed—that is, 15 inches from the back inside to the front of the mouth. Our rule for this particular kind of scoop was that the width should be four-fifths of its length; hence the width of our scoop across the bridge B or back (see Fig. 235) would be 12 inches from X to Z. The bridge itself was one-third the length of the scoop in width when finished, or 5 inches, and the bottom of foot C, Fig. 233, one-half the length of the scoop in diameter; therefore, the foot C would be $7\frac{1}{2}$ inches in diameter when finished.

We will first describe the pattern for the bottom or body, H, Fig. 231, as shown in Fig. 234, which from E to F, including $\frac{1}{4}$ inch for wiring edge and $\frac{1}{8}$ for back edge, is $15\frac{3}{8}$ inches, and from C to D is one-half the circumference of a 12-inch circle, with the wire edge added; that is, $CD = 0.5 + \frac{12 \times 3.1416}{2} = 0.5 + 18.8496 = 19.3496$, allowing $\frac{1}{2}$ inch for wiring; then, with the radius H C, equal to one-half of C D (9.67 inches), or $9\frac{5}{8}$ approximately, describe the semicircle C F D and extend the ends on each side parallel to each other to M N. Then draw M N so E F will measure $15\frac{3}{8}$ inches, which gives the pattern, of which two are to be cut. We next require the pattern of the back, as shown in Fig. 235. The semicircle X Y Z would be 12 inches plus the edges for seam, making $12\frac{1}{2}$ inches. The radii of arcs X O and N Z is one-third of X Z, with the edge for seam added, making $4\frac{1}{2}$ inches. The radius of the arc O N is equal to X Z, with the edge added, or $12\frac{1}{4}$ inches. With S as center, describe the semicircle X Y Z and divide the diameter X Z into three parts, as X P, P R, R Z, and, with P X as radius, describe the arc X O, and, with R Z as radius, describe the arc N Z. Then, with P M equal to 8 inches, erect the triangle P M R on P R, and, with O M as radius, describe the arc O N, and we have the pattern for the back.

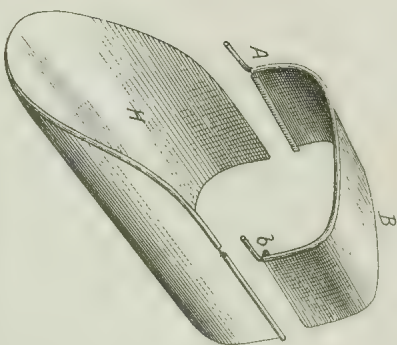

Fig. 231.—Bottom and Bridge of a Coal Scoop.

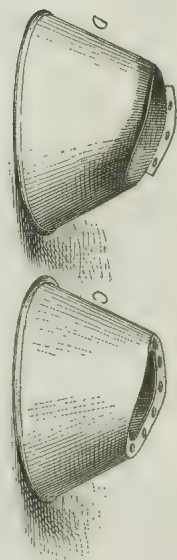

Fig. 233.—Tool for Coal Scoop.

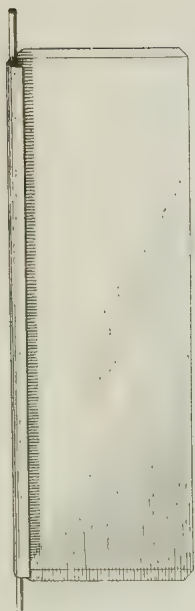

Fig. 232.—Making the Bridge.

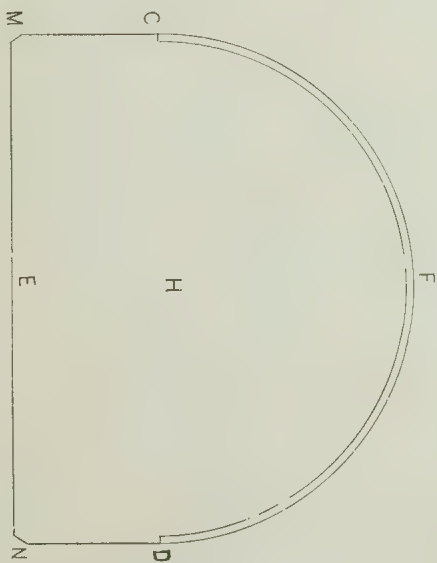

Fig. 234.—Obtaining Pattern for Bottom of Coal Scoop.

The length of the bridge (see Figs. 231 and 232) is found as follows: It will be seen that the top part of the back is half an ellipse whose transverse axis is 12 and conjugate 9 inches nearly; then the length of the bridge will equal one-half the circumference of the ellipse $9 + 12$ thus: $\frac{9 + 12}{2} = 10.5$ and $\frac{10.5 \times 3.1416}{2} = 16.4934$; to this add a $\frac{1}{2}$ -inch for groove and we have the length of the bridge, which is 17 inches nearly. Let it be 17 inches long and $5\frac{3}{8}$ wide, including edge for wire and back, and we have the desired pattern.

The foot is a part of a cone of funnel fashion and cut obliquely through the sides, as shown in Fig. 220. The scoop is set on the foot in this way to tilt it up, so that any drip from wet coal may drain toward the back rather than run out on the floor. In the foot represented at C, in Fig. 233, the riveting flange is turned inside, as shown, but in the foot D (for an iron scoop) the riveting flange is laid off on the outside, there being no flange in front or behind, and only enough flange laid off to get three rivets in each of the flaps.

In order to obtain the pattern for the foot let E F G H, in Fig. 236, represent the bottom of scoop and A B C D represent the funnel or foot adjoining the same. The part of bottom of scoop which joins the funnel, as X' L Z' is a semicircle struck from the center S'. Produce A B and D C until they meet in the point Y, thus establishing the apex of the cone. Draw the semicircle R S T, representing one half of the profile of the cone at the larger end or base. Divide R S T into any number of equal parts, as indicated by the small figure 1, 2, 3, 4, &c. From the points thus established carry lines at right angles to A D, cutting that line as indicated. From the points thus established in A D carry lines toward the apex Y, as indicated by the dotted lines in the engraving. The next step is to produce the opening of the funnel, as it would appear when viewed from a point opposite the end, or as indicated by M N in the engraving. Lay off the straight line M N parallel to the axis of the bottom, making it in length equal to A D of the elevation. Transfer to it the several points produced in A D by lines dropped from the points in the half profile R S T, and through the points thus established draw lines at right angles to M N, as indicated. Then, with the blade of the T-square placed parallel with M N and brought successively against the points in the line A D, cut corresponding lines drawn through M N. By

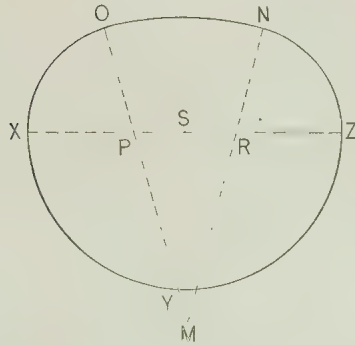

Fig. 235.—Obtaining Pattern for Back of Coal Scoop.

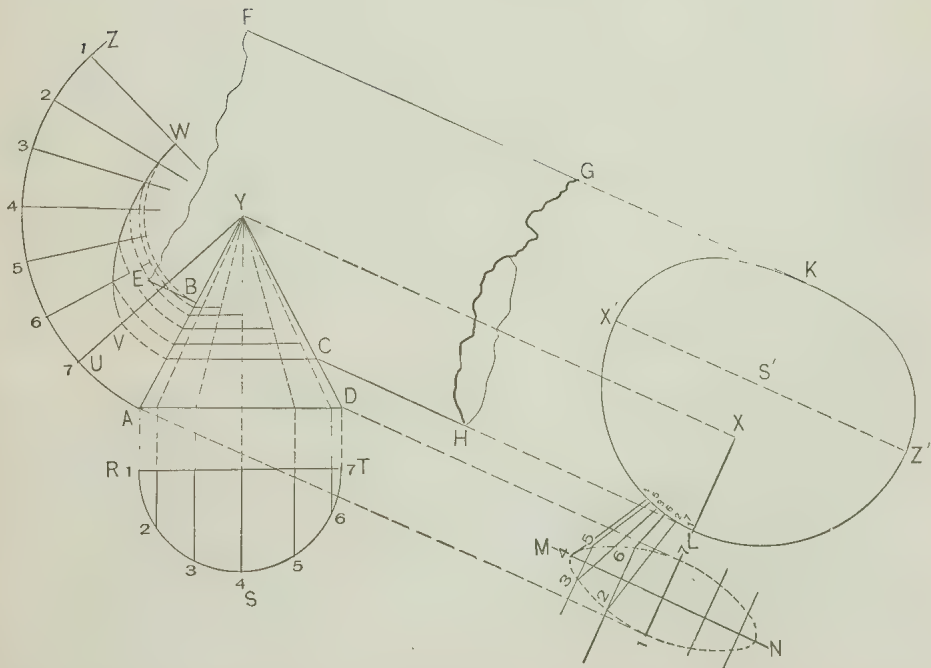

Fig. 236.—Elevation, Plan and Development of Pattern for Foot of Coal Scoop.

this means half of the profile will be obtained, and from it the other can be duplicated, giving the required shape. In the same manner bring the blade of the T-square against the apex Y in the elevation and cut the center line I 7, thus obtaining the point X. Then, with a straight edge cutting X and brought successively against the different points in the profile just established, draw lines cutting the plan of the pipe, as shown by the small figures to the left of L. Then, with the blade of the T-square parallel with the axis of the bottom, and brought successively against the points thus established in the plan, cut lines of corresponding number drawn from the points in A D to the apex Y, or as indicated from C to B. This done, we are ready to lay off the pattern. With the blade of the T-square parallel to A D draw lines from each of the points established between C and B, producing them until they cut the line A Y, as shown. From Y as center, with Y A as radius, describe an arc, as indicated by U Z, and upon it step off the stretch-out of the profile R S T, as shown, marking the points, as indicated by the small figures. From these points draw radial lines to Y, as indicated. Then, with Y as center, and with radii corresponding to the points established in A Y, as already set forth, describe arcs, producing them until they cut corresponding numbered lines drawn from the arc Y Z to the point Y. Then a line traced through the intersections thus established, as indicated by V W, will be the pattern joining the cone, as shown in the elevation from C to B. U V W X will be one-half of the pattern, and the whole pattern may be obtained by continuing the same process, or by duplicating. Allowance for joining to be made at U V, for wire on U Z and for the flange on V W.

Having the four patterns, we are now ready to proceed. Dog all the pieces together, two and two, and planish them the first course, having previously cleaned them bright; then take them apart, and with a clean flannel wisp scour with oil and tripoli and polish with the dry powder. Having carefully removed all oil and dust with a nice soft, clean rag, go over them singly again to smooth and finish. We are now ready to form and put the scoop together. First notch for wire and groove; then break the bottom on the former, Fig. 238, by bending first one way and then the other, being cautious not to rib it; proceed slow and easy, carefully avoiding sudden bends. The former should be at least one-half the

diameter of the scoop. When formed, turn the wiring edge and wire, letting the wire come within 2 inches of the notch on each side, and leave the edge open at the end on each side to receive the bridge wire. Now fold the grooving edge and wire the bridge, turning the edge on the inside and sink the wire into a creasing stake, the wire being left out 2 inches at each end of the bridge, as in Fig. 232, and bent to hook hold of the bottom (see B, Fig. 231), and complete the wiring of the bottom. The wire of the bridge should butt the wire of the bottom in the middle of the ear. When this is done, groove the bridge to the bottom and finish the wiring up to the turn of the bridge. Now double seam on the back, then make the foot, which may be grooved together or riveted, the wiring edge being turned on the inside, and the flange for riveting to be about $\frac{5}{8}$ inch, also turned on the inside. Now prepare the back handles and bails, and clean all up, putting on the handles the last thing. The loop for the scoopet should be about 2 inches wide and riveted to the bridge, in which the scoopet is placed when not in use.

The flat bottom scoop, Fig. 221, is made in nearly the same proportions as the round mouth, Fig. 220, and the work is about the same or similar in the most essential features, the difference being only in its form, shown in the back, Fig. 239, which may be made either with the sides of the bottom straight or curved to suit the taste, as in Y or Z, Fig. 240. If the sides be straight, then the mouth is generally square or angular, as in Fig. 221, but if they are curved, then from the corner of the mouth to the ear it would usually be made curved; they may, however, be made either way without offending the eye, if

Note.—In an old shop I once saw and used a simple, yet effective, substitute for a tilt hammer, which is shown in Fig. 237. A large block was made fast to the floor, and an anvil some 8 or 9 inches square on the face set in it. There were four upright timbers fastened to the floor and ceiling. The hammer, which weighed from 10 to 14 pounds, was put on a long elastic handle, made of ash and having a sufficient spring to lift the handle after the blow was struck. The shaft was bolted, as shown, to the two upright pillars, and the hammer end of the shaft raised and made to work between two others, as close to the hammer as convenient. One man or boy gave the blow while the other manipulated the work under it. The block was of such a height that a man could comfortably slide the sheet or work it about on the anvil, which weighed some 75 pounds or more. The whole contrivance was considered a good tool then, and I have done, and seen others do, some good work with it; the blow when struck covered a space as large as a half dollar. If a hammer like this were to be provided, the sheets could be planished the first course before the work is cut out.

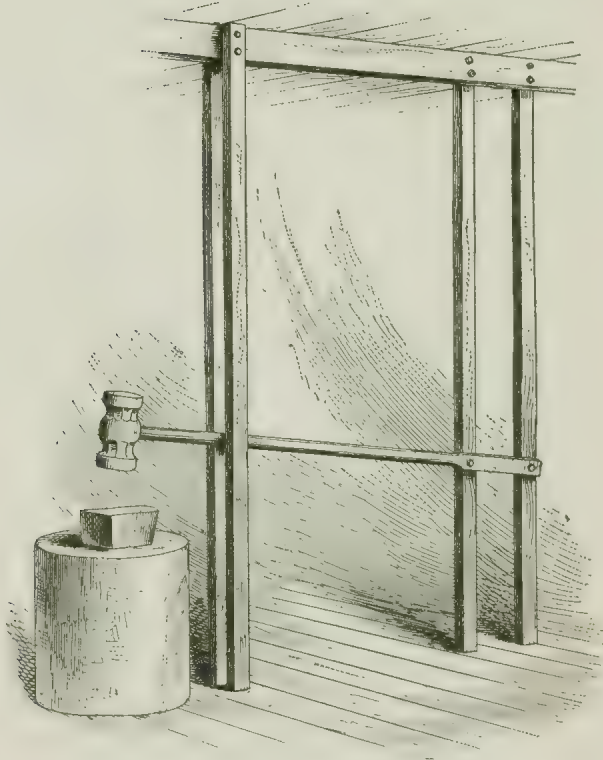

Fig. 237.—Spring Hammer for Planishing.

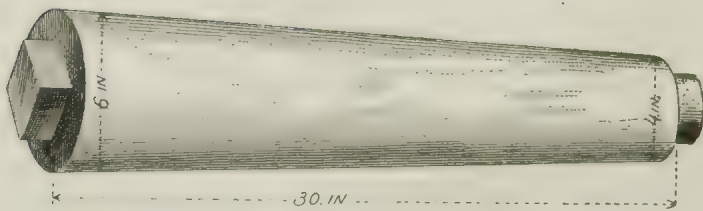

Fig. 238.—Wooden Former.

the work is done well. We will mark one out and describe the variations which may be made in this class of scoop. Let it be required that the scoop shall be 17 inches; then, as the back of a 15-inch scoop is 12 inches across at the bridge, $15 : 12 :: 17 : 13.6$; that is, 13.6, which in practice would usually be called $13\frac{1}{2}$. Now divide the distance $a b$ across the bridge into three parts, as in Fig. 239; that is, $\frac{13.5}{3} = 4.5$. Then on $c d$, with $c g$ equal to $a d$, erect the triangle $c g d$ and continue $g d$ and $g c$ to e and f ; then with $d b$ as radius describe the arcs $b f$ and $a e$, and with radius $g e$ describe arc $e f$; then draw $b l$ and $a h$ parallel to $d g$ and $c g$, and $h l$ parallel to $a b$, making $a h$ equal to $c k$ and $b l$ equal to $d k$. Then $h a e b f b l$ forms the back. If the side is to be curved, then with the radius $a b$ describe the arc $b l$, as shown by the dotted line, and the form of the back is again complete. The bottom, Fig. 241, or body of scoop from y to T is 17 inches when finished; from w to x two-thirds of 17 or $11\frac{2}{3}$ inches, from w to u 6 inches, from u to v $10\frac{1}{4}$ inches, from the notch s to w one-third of 17, or $5\frac{2}{3}$. Join $x P$ and $o n$; then $w T$ is the pattern for an angular flat bottom coal scoop. If the bottom be curved at the side, then from the point q on the line $y T$, with $q o$ as radius, describe the arcs shown by the dotted lines $o p$ and $P s$, and the pattern is indicated by the dotted lines from o to p and from P to s . The bridge finished will be $5\frac{2}{3}$ inches wide and one-half of $\frac{13.5 + 9.5}{2} \times 3.1416$, which is 18.0642, long without the grooving laps and edges. The foot, Fig. 242, may be marked out as in Fig. 243, and will very nearly fit, but not near enough. To meet this, in the absence of scientific knowledge, the foot is formed and placed in position on the scoop and marked around with a compass, and then trimmed to fit; and this means often is adopted in practice to save time, even when the knowledge is possessed by the workmen. The Tudor, represented in Fig. 222, and the back of which is shown in Fig. 244, will now be considered. By examination it may be seen that the measurements are nearly alike. If the scoop is to have straight sides, then $a h l b$ will represent the bottom or body, and $a e f b$ the bridge, taking the dotted lines on each side as the shape. If the scoop is to have the sides of the bottom or body as shown by the semicircle $a k b$, then the bridge is again shown by $a e f b$, taking the solid line area on each side as the shape. In these Tudor scoops the patterns

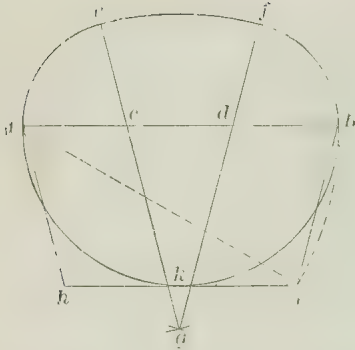

Fig. 239.—Back for Flat Bottom Scoop.

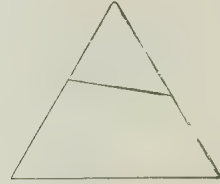

Fig. 242.—Section through Foot.



Fig. 240.—Bottoms with Straight and Curved Sides.

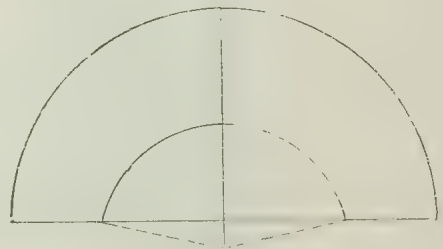

Fig. 243.—Pattern for Foot.

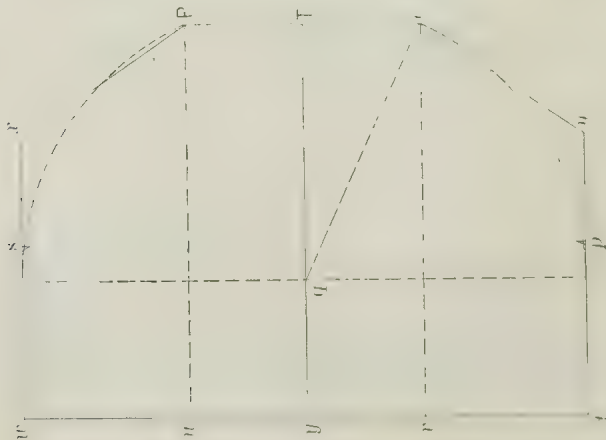

Fig. 241.—Pattern for Bottom of Scoop.

for the bottom were furnished to us ; the illustration will suggest the shape of the sides at the mouth, which is variable, according to the taste of the employer when he superintends the design. I may here say that while these different styles have been frequently made and were fashionable in their turn, I think, generally, those made easiest and with the fewest corners or angles were most popular, and generally took the best with the purchaser. The planishing is performed as described in the previous article, and the forming suggests itself. The scoopets were made similar and to correspond with the scoop, as shown ; the scoopets were usually made one-half the length of the scoop for this size, and $6\frac{1}{2}$ inches across the bridge ; that is, the scoopets were about one-eighth the size of the scoop. They were supplied with a socket and wooden handle, japanned, oiled or polished.

The Nautilus is next in rank, and is represented in Fig. 224. In this style of scoop the bridge is formed in such a manner that it supplies one-half the back, which is razed down from the end of the bridge, as it were, while the other half of the back is raised up from the bottom or body. Now, these are a good job, and require altogether another method for their construction than the preceding styles. The back when complete, it will be seen, is one-half a hollow sphere, the bridge being a little in excess in the front, to ornament or give a finished aspect to the scoop. Let us cut one out, required to measure 16 inches, and proceed to work it up. Proceeding as before, $15 : 12 :: 16 : 12.8$, or $12\frac{3}{4}$ inches we should call it in practice ; then $\frac{12.75 \times 3.1416}{2} = 20.0277$; that is, the circumference of the bottom half of the scoop is 20 inches. Let Fig. 245 represent the pattern for the bottom of our scoop, to describe which we proceed as follows : Draw ab , making it 20 inches from a to b , and erect the perpendicular cd at the middle ; now lay off the distance cd on perpendicular equal to 16 inches. Draw eb and fa parallel to cd , and fe parallel to ab ; then dividing fe into three equal spaces, fg , gh , he , and with the radius fg (that is, gl), describe the arcs gm and hn , from l and k as centers, and we have the form of the mouth indicated by $mg hn$. Now we want the back, which may be raised up solid, or cut and brazed together if time is an object. If the end is raised up solid, it will be seen in Fig. 246 that the whole back finished forms a half

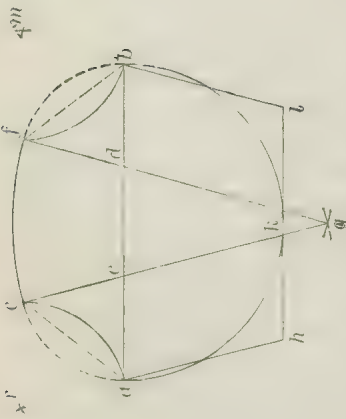

Fig. 244.—Back for Tudor Scoop.

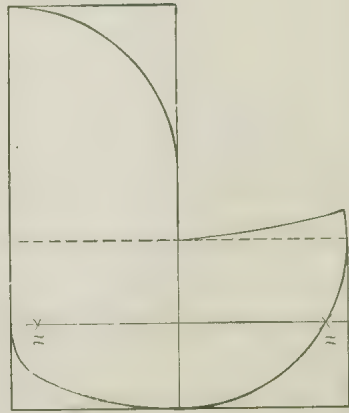

Fig. 246.—Side Elevation of Nautilus Scoop.

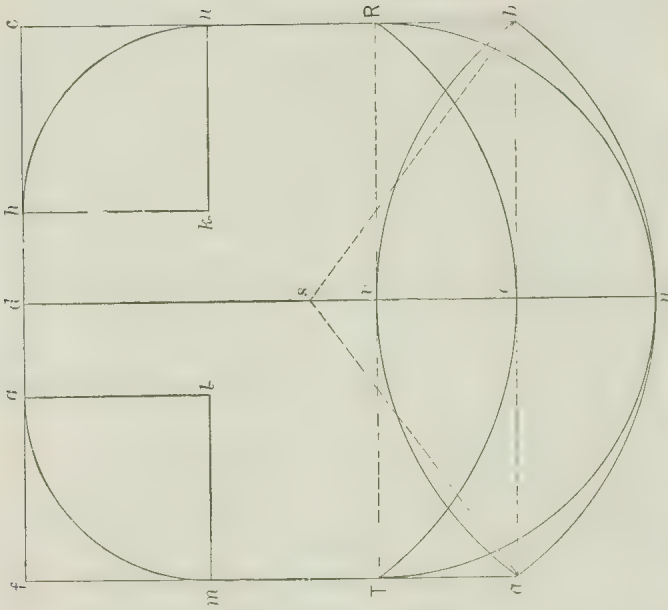

Fig. 245.—Pattern for Bottom of Nautilus Scoop.

of a hollow sphere approximately, the curve of the razed down bridge being made spherical, while the curve of the raised up back is elliptical in form when finally finished, $u u$ being the foci. The pattern, however, it would seem, was cut to suit a spherical end, the deviation being made during the process of raising, as the surface is about the same or near enough for practice. Let the pattern then be made to suit a spherical back of $12\frac{3}{4}$ inches diameter across the bridge, as above; then from a to b , Fig. 245 is 20.0277 inches, and from

a to c one-half of $a b$, or 10.01385; then $\frac{\left(\frac{a c}{u c}\right)^2 + c u}{2} = s u$; that is.

$\frac{\left(\frac{10.01385}{5.00697}\right)^2 + 5.00697}{2} = 12.5$, the radius $s b$ (that is, $s u$). Describe the

arc $a u b$, and the surface outlined by the segment $a u b c$ will be equal approximately to the back required, but the parallelogram $a T R b$ containing the segment $a v b$ is in excess of needs by the corners $v R b$ and $v T a$, and the segment is lying the wrong way. Turn it, or describe it as shown by $R c T v$, and with the radius $v R$ describe the semicircle $R u T$, forming the lune $R c T u$, and we have the pattern $T U R n h g m$ for the bottom or body completed. Now cut it out and wrinkle up the pattern around the lune, Fig. 247, forming at the same time the turn at the mouth as shown in Fig. 248, making the wrinkles small at the sides, and enlarging them in proportion to the surface to be operated on. Then take it to a suitable head, Fig. 249, in a square shank, as in Fig. 250, and proceed to work up the back until the distance across the bridge is $12\frac{3}{4}$ inches and the back is the curve required. Now mark out the bridge, using Fig. 251, and the dimensions delineated by $a v b u$, as in Fig. 245, leaving on one side enough in excess so that it may hang over in front 2 inches, as shown in Fig. 246. Extend $Y u$, Fig. 251, 2 inches to x , and form the lune $a x b y$, and the pattern of the bridge is complete, but without edges for wire or groove, which must be allowed and left on. To raise up the bridge, wrinkle the edges both sides, Fig. 252, in the same manner as the bottom, and sink the center in a hollowing block, Fig. 253, letting the wrinkles form regularly round the edge until the proper curve is reached. Then take it to the shank or bullet stake,

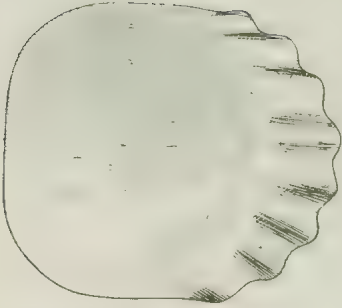

Fig. 247.—Wrinkling up the Pattern.

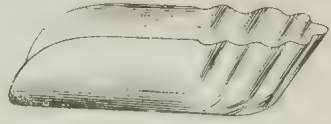

Fig. 248.—Mouth Formed on Pattern.

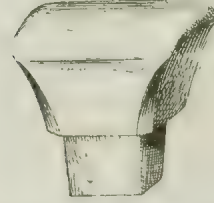

Fig. 249.—Head Used in Working up Back.

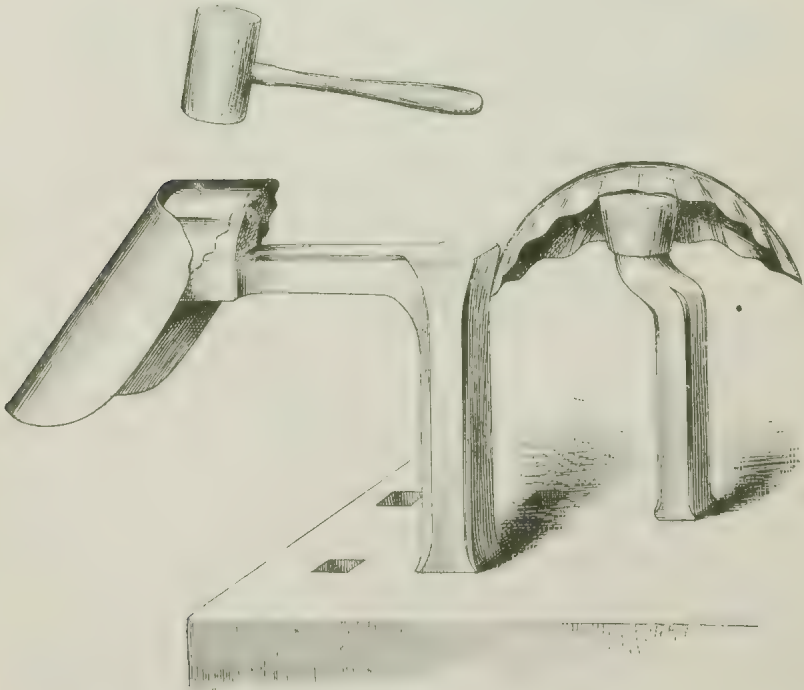

Fig. 250.—Working up Back and Bridge for Nautilus Scoop.

shown at the right in Fig. 250, and with a razing hammer raze down the wrinkles one course, and then wrinkle again until the desired curve is obtained. When this is accomplished trim the edges on each side ready for the wire and groove, then planish and smooth both bridge and body, and wire both, leaving the wire out at each end of the bridge, and turn the grooving edge inside so that it will lap over the bottom. Now lock them and groove them together, letting the end of the bridge wire butt the wire of the body in the middle of the ear of the bail. Then make the foot and prepare the bail and back handle, and clean all up, riveting the foot and handles on the last thing.

If the back of the body for a Nautilus scoop is cut to bring it near the shape required, and then brazed together, it may be formed, or the pattern may be cut as follows, see Fig. 254: (The pattern of the mouth is the same as in the last example, and has been already described.) In Fig. 255 let $A E C B$ represent the back of the scoop and $A B$ the radius of the curve. Draw $A D$ perpendicular to $A B$, and from B lay off the distance $B C$, one-fourth of the semicircle $G E C B$, and draw $B D$ through C ; then $B D$ in Fig. 255 will represent and be equal to $a R$, $u R$, $T S$ and $b s$ in Fig. 254. Divide $a b$ in Fig. 254 into four equal spaces, $a p$, $p c$, $c o$ and $o b$, and with $p c$ as radius describe the semicircle $o y p$. Now, with the radius $R a$ (that is, $D B$ in Fig. 255), describe the arc $a u$, and with $S b$, also equal to $D B$, describe the arc $T b$. Then, with $s o$ in Fig. 254 (that is, $D C$ in Fig. 255), describe the arcs $o v$ and $p x$, making them equal to $o y$ and $p y$ respectively: join $u x$ and $T v$, and the pattern is complete and ready for work. First punch two small holes at p and o and thin the edges and cramp them one side; then form and bring the edges together and braze them, as shown in Fig. 256. Clean off the joint, knock down and anneal and wrinkle the edges, as in Fig. 256, and then proceed to pounce the bottom into shape on a bullet stake, at the same time breaking down the corner or lag along the curved seam. While this is being done, the side and bottom will bulge out sufficiently to give it the required shape if it receive the proper treatment, which treatment, however, can only be learnt by practice or from a tutor on the spot. When the bottom is prepared, proceed as before to trim, planish, put together and finish.

The Royal comes next. This scoop has no bail, but is mounted with a handle similar to the back handle, as shown in Fig. 225. The

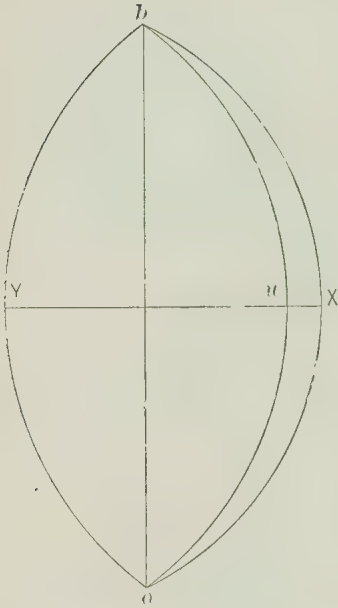

Fig. 251. *Pattern for Bridge.*

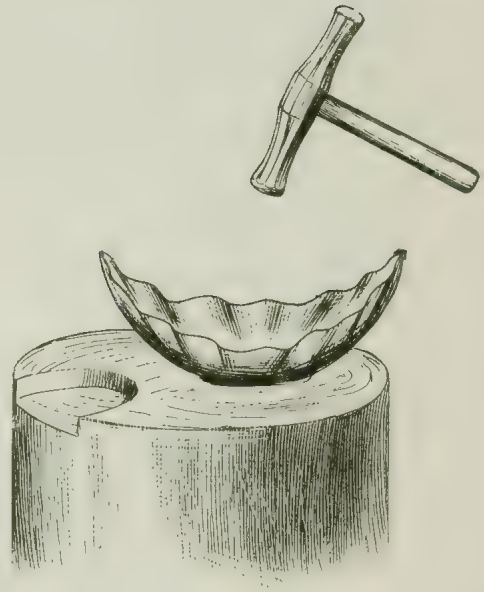

Fig. 253.—*Sinking the Center of the Bridge.*

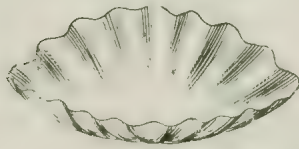

Fig. 252.—*Bridge with Edges Wrinkled.*

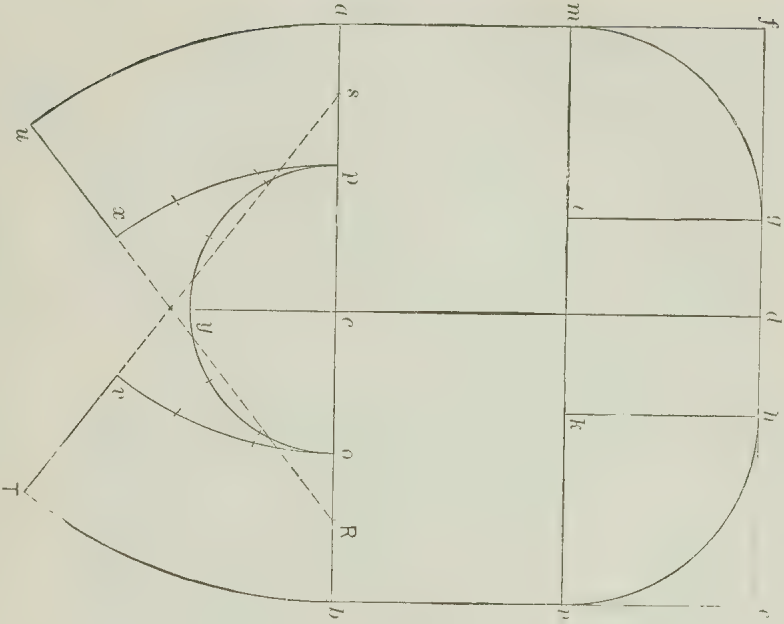

Fig. 254.—Pattern for Brazed Nautilus Scoop.

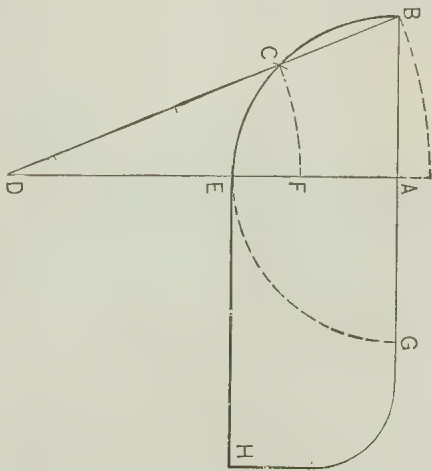

Fig. 255.—Side Elevation of Nautilus Scoop Bottom.

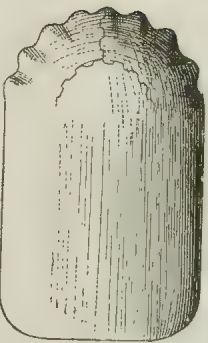

Fig. 256.—Bottom Brazed and Wrinkled.

bridge is made a little stronger and the wire about two sizes larger than usual, to strengthen the bridge enough to bear the strain of carrying when filled with coal. The pattern for the bottom may be the same as for the round-mouth scoop, or, as is sometimes done, made a little fuller, or to rise about 1 inch in the curve at the mouth, as shown in Fig. 257. When the bridge, see Fig. 258, has been brazed to the bottom, the back end is wrinkled and razed in, forming the curve, as shown in Fig. 257. After this is done the back is cramped in. The wiring is made to go completely round the scoop, commencing and finishing in the middle of the bridge. The scoopet is made to correspond with the scoop.

The Boat, Fig. 226, is next in order. It will be seen that this scoop is formed like and a little in excess of three-fourths of a sphere that is, up to and where the lip commences the back and bottom, so far as the ears are, are formed similar to the Nautilus; the other quarter, when half up, being worked out again to form the lip, similar to an earthen jug. Let it be required to make a Boat scoop of the same dimensions as the Nautilus—namely, $12\frac{3}{4}$ inches across the bridge. The bridge may be cut from the pattern already described (allowing for the extra dip in the front), and the bottom may be made thus: Conceive the bottom to be one-half a sphere, $12\frac{3}{4}$ inches in diameter, then a disk whose surface is equal to this half sphere of $12\frac{3}{4}$ inches will be:

$$\sqrt{\frac{12.75^2 \times 3.1416}{2}} = 18.0312$$

0.7854

Then draw the line A B in Fig. 259, making it 18 + inches long, and draw D C at right angles to it; then with the radius P C describe the semicircle A C B. This forms the pattern for the back of the bottom, A E B for the front, and the lune A D B E is the pattern for the lip. Then A D B C is the pattern required for the bottom of the boat scoop without wiring edge. Wrinkle up the edges and raise up the back and sides with a razing hammer on a bullet stake until the curve has reached the middle of the back, and as far as the lip in front, leaving wrinkles enough to form the lip in the second course; then proceed to work back the lip of the mouth with a round-faced mallet, which will require perhaps three courses. After the desired shape is obtained, planish and smooth; then wire both bridge

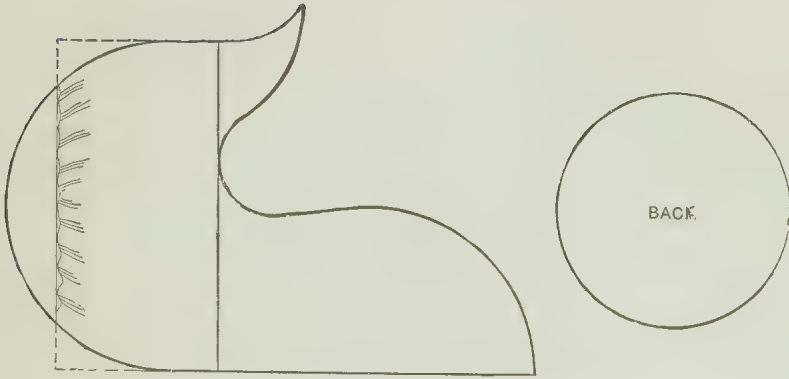

Fig. 257. —Side Elevation of Royal Scoop.

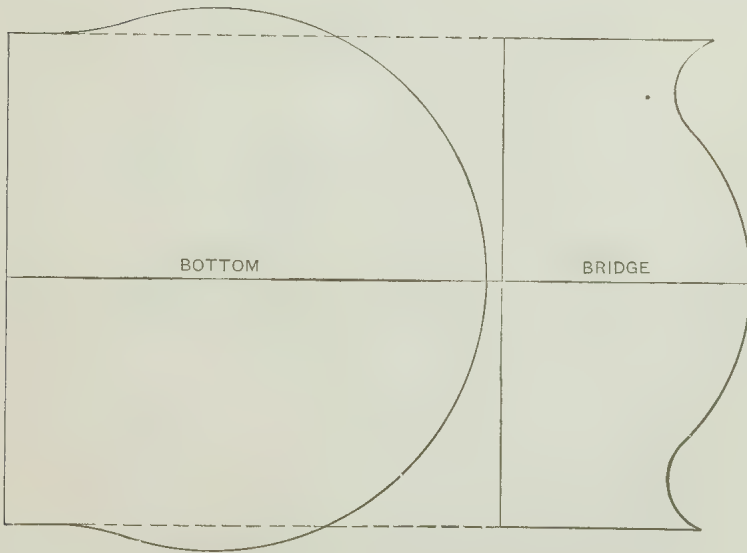

Fig. 258. —Patterns for Bottom and Bridge of Royal Scoop.

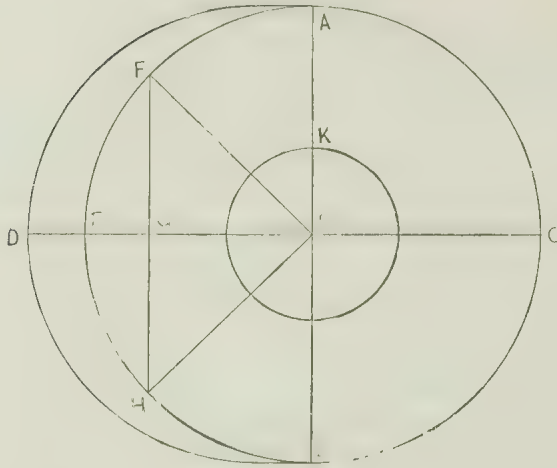

Fig. 259. - Pattern for Bottom of Boat Scoop.

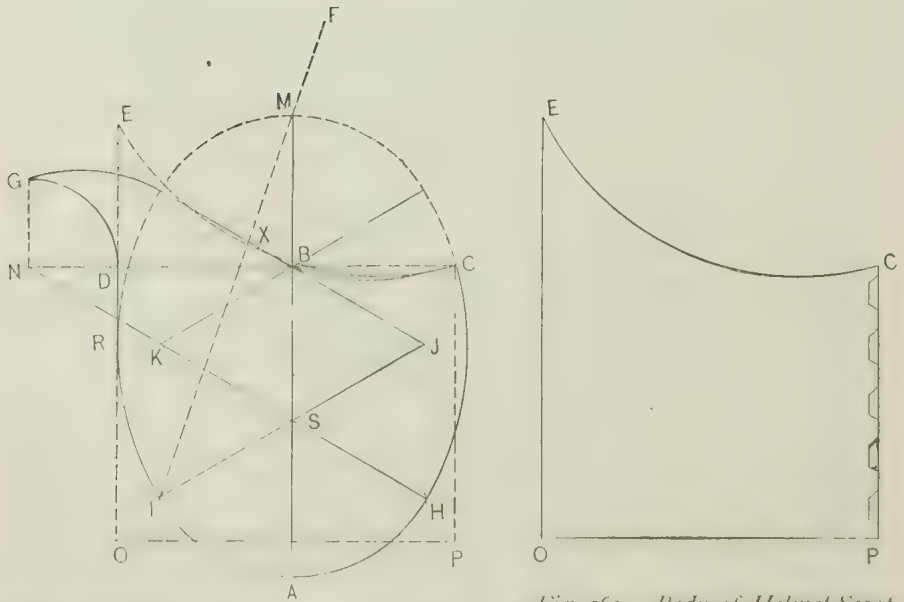

Fig. 260. Side Elevation of Helmet Scoop.

Fig. 261. - Body of Helmet Scoop Brazed Together.

and bottom as directed for the Nautilus and put them together; clean up and put on the mounting.

The Helmet scoop, Fig. 227, was considered at one time by old braziers as the summit of excellence in this line; but I think that a careful study of the subject will show that there is as much or more skill required to produce the Nautilus or the Boat as is required for the Helmet. They however, all demand proficiency and a long, careful training with much patience to acquire the skill necessary for the execution of the various steps through which they pass to completion. In my boyhood we knew nothing of buff wheels or any of the other devices which have sometimes been used to substitute this labor; our work was smooth and complete from the hammer except the final scouring to remove the hand or finger marks. While it was a tedious task to acquire this proficiency, it was a continual source of pleasure and profit to any who possessed the attainment.

We will make a Helmet scoop, and then describe the planishing and smoothing as I was taught to do it. It will be seen by reference to Fig. 260 that the scoop, if made true by a workman, is two-thirds of an ellipse, with the lip added, as shown by the outlines G D A C. The foci of the ellipse are B and S, which are obtained thus, and form the foundation of the work. Draw B A equal to the depth of the scoop, and D C at right angles to it; divide B A in two equal parts at S, and with S A as radius, describe the arc I H; then with S A lay off from A each way the distances A I and A H, and through S draw the line H N, cutting the line N B C at N. Now, with K H describe the arc H C, and with J I describe the arc I R, and draw R D at right angles to N D; with N D as radius describe the arc G D, and G D A C forms the outline of the body required. Continue I M through M to F, and with B A or K H describe the arc X B C, and join G X, giving the curve of the mouth when finished. To fashion this we must prepare a cylinder, indicated by the dotted lines running through E B C P O in Fig. 260, and more clearly shown in Fig. 261. The envelope or pattern for Fig. 261 may be drawn similar to that described for a coal hod in a former chapter. The pattern then being given cramp, put together and braze, trim the joint, knock down and anneal, then wrinkle at O P, and on a head in the square shank raze in the end so that the seam of the bottom may be covered by the edge of the foot when riveted on. When the proper size, stag in the edge to stiffen, and proceed to work out the lip, after which put in the bottom and true up to shape and make the foot ready.

PLANISHING AND SMOOTHING.

Planishing as understood by braziers is the art of first molding smoothly or shaping the metal when first formed; second, hardening or closing the grain, and third, by the aid of the hammer giving it a gloss or a kind of case-hardening sufficient to receive the final polish with tripoli, which is a very fine powder having a purple hue. To planish the goods under consideration, it is necessary to have the heads as near their curves as possible, and the square shank of the head should be taper enough to make it fit tight into the tools which receive it; the convex curves of the round heads may run from 4 inches to 2 feet or more, the long heads the same, the long heads being about twice their width in length. It is also necessary to have a few saddle heads for such work as requires them, and though we had no bright mandrels then, later experience has taught me that they would have been better adapted to our use for many things than the little short heads we had. Our hammers were various, some with round and some with square flat faces, see Fig. 262, or commonly called so, and ranged from 10 ounces to 3 or more pounds. The concave hammers, Fig. 263—that is, those whose faces are hollow—ranged from a circle of 4 or 5 inches to 15 inches, and were used for spherical or ball-shaped work. The saddle hammers, Fig. 264, and those with long faces were used for such work as helmet scoop lip; we also had a number of bright bullet or convex hammers for special purposes.

Now, let us suppose we have heads and hammers suitable for the Royal scoop, and that the scoop has been scoured clean and bright. We first take it to a long head, and commence by smoothing down all the irregularities with a clean, smooth-face mallet. Take then a suitable flat-faced hammer weighing, say, about 1 pound, and commence with blows from back to front in the middle of the bottom, and in regular succession until the edge is reached, making each line of blows lap a little at their edges; now work up the other side and over the bridge. Then proceed with the back in circles on a bullet stake, or a head in an upright shank, the same way until the

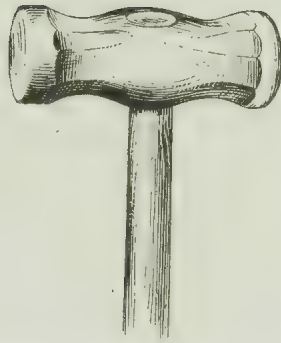

Fig. 262.—Round-Face Hammer.

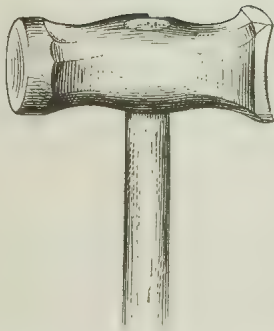

Fig. 263.—Concave-Face Hammer.

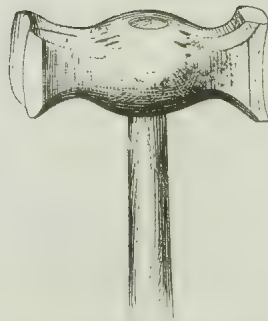

Fig. 264.—Saddle-Face Hammer.

first course is completed. Next give it a good rubbing down with a clean rag, so that the blows of the next course, which is done with a spring-faced hammer, may be readily seen. When this course is finished the scoop should be in good shape. With a flannel wisp scour with sweet oil and tripoli, and clean off carefully all oil and dust. Look over and examine to find omitted spots and touch them up. Then muffle the head with a piece of shalloon or a piece of skin parchment drawn tight over it, and go over the work lightly to finish. The spring face may be changed from hammer to head, according to the ingenuity of the workman and to suit the work in hand. The shalloon supplies the place of a spring face, as also does the skin, their purpose being to take off or counteract the effect of the impact of the hammer, the impinging of which on a naked head causes a sharp ridge all around the blow, and this can only be obviated by the muffler inside or by the spring face outside. The concave and all other hammers may be fitted with false or spring faces, according to the work for which they are to be used.

The parts of the Nautilus may be treated in the same manner as directed for the Royal. The Boat and Helmet scoops will call into requisition both flat and concave, as well as long and saddle-faced hammers. In working around the lip of these scoops it should be stated that the lips should be bright and smoothed on the inside as far as the eye catches them at first sight; the rest is left dead—that is, as the skin or shalloon leaves it, clean but dull, not bright.

The planishing described in the foregoing is for the best kind of bright work. The next grade is for common brown work, which is finished in two courses. The brown used is good Spanish brown, put on dry with a tow wisp, well rubbed into the grain and applied so that plenty hangs on, but uniformly all over; it is then hammered into the grain in the first course, and then smoothed in the second. Another style of planishing is executed in a way that every blow may be seen distinctly and in regular succession, and is adopted in that kind of goods where closing the grain or hardening is the principal object in view, as in washing coppers and some other work; while for many rough kinds of brazery, such as carboys, sugar molds, pump heads, air vessels and various kinds of boilers, the hammering is done in a promiscuous way, so long as the surface is covered and the work hardened sufficient to maintain its shape.

CRANES OR SYPHONS.

Cranes or syphons may be said to possess or perform the functions of a self-acting pump, but their operation, in reality, is only the effect of destroying the equilibrium of the liquor by the unequal lengths of the legs or ends of the bent tube through which the liquor passes. The liquor acts as if it were a rope hanging or passing over a nicely adjusted pulley wheel, Fig. 265, the excess of weight on the one side pulling the lighter or shorter end over; or, as the perpendicular height of the column A C, Fig. 266, is greater than that of B D, and the pressure of the atmosphere the same at both orifices, the pressure or weight of water at C is greater than at D, and therefore the weight at A, Fig. 267, overbalances that at B, and draws the liquor over the bend. In the meantime the atmospheric pressure at the end B is forcing the liquor up through the orifice at B, and it continues to flow from A until the liquor in the vessel falls to the level of the orifice B. These simple machines were made for, and are principally used by, brewers and wine and spirit merchants to draw off the contents of casks of various kinds, where it is not desirable to insert a faucet. They are usually formed of a copper tube about $1\frac{1}{4}$ inches inside, and with a cock at the longer end, as shown in Fig. 268, for the purpose and convenience of stopping the flow when necessary. They are also supplied with a small tube, E, running along the side, by which the liquor is made to flow when the air has been exhausted through it by the mouth, the long end of the syphon being stopped with a cork or by the hand covering the orifice, or the syphon may be charged through a stopcock with funnel at the crown G when the liquor to be drawn off is of an offensive nature, as is sometimes the case. The inside of the bend H is reinforced with a saddle piece from A to B to protect the bend from the hoops of barrels being emptied. The stopcock was soldered to its place and the end lengthened out with two plumbers' joints, D and F, and the ends strengthened as at C, to shield it from contact with the ground while moving it about when in use. A pipe of 25 to 30 pound plate was considered fairly strong.

We will make one, and let be $1\frac{1}{4}$ inches inside (the thickness of the

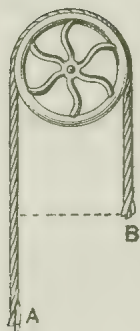

Fig. 265.—Rope and Pulley Illustrating Siphon.

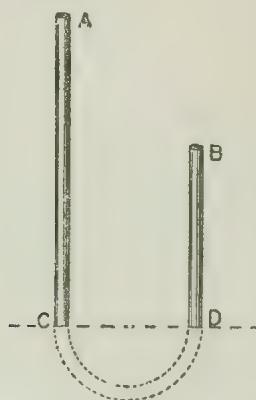

Fig. 266.—Water Columns in Siphon.

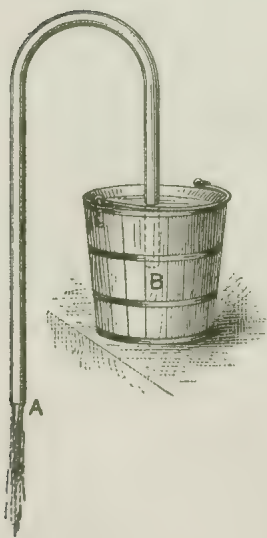

Fig. 267.—Siphon in Operation.

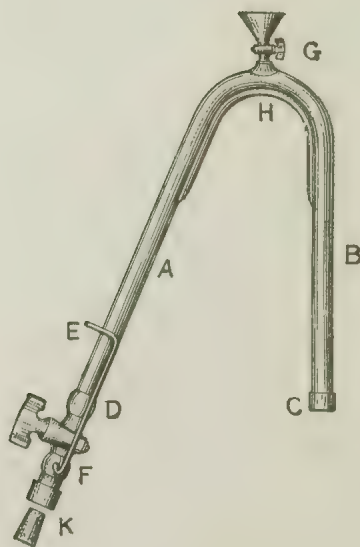

Fig. 268.—Copper Siphon.

metal will be about 1-16 inch); then to make a pipe 1-16 inch thick and $1\frac{1}{4}$ inches inside diameter we have $0.0625 + 1.25 \times 3.1416 = 4.1233$, or $4\frac{1}{8}$ inches wide, and some 7 feet long.* Now thin the edges on opposite sides and trim and smooth them with a file and anneal; when cool scour clean and take it to a vise and with a razing hammer, sink it between the jaws of the vise or some other suitable tool, such as a blacksmiths' swedge block (if handy). When half turned finish it on 1 inch steel bar, closing the edge uniformly down the whole length. Now jar some borax and water through the joint and charge it with solder, which may be done on the outside or inside, as preferred by the operator, although it is the best job when charged inside. Dry carefully, and when the borax is all down run the solder down the joint with a moderately brisk but clean fire. When cool examine and repair any deficiency; then trim the joint and swage on the bar; then anneal, and fill with rosin, and in the absence of any other convenience it may be bent in a well-worn hole in the edge of the bench. Before bending see that the edge of the seam is perpendicularly in the center of the pipe and that it laps toward the inside of the bend, because if it is bent with the seam lapping toward the outside there is a tendency to break. Be careful that no cinders or other foreign matter gets into the pipe; and have the rosin clean and solid when cool. When bent and the resin has been taken out solder in the saddle piece, A B, put on the rings, C and K, and fasten in the cock; next put on the air tube, F, below the cock, clean off all the soft solder practicable and finish up clean.

* *Note.*—The first syphon I saw when a boy was made in three pieces—that is, the bend and two legs soft soldered together. The reason for this was, our sheets were only 4 feet long; and again, our forge was not adapted for this kind of work. The next one was made in two pieces, and brazed together and bent after. The last one was in one piece of solid drawn tube with the cock and the air tube brazed on.

PUMPS.

Copper pumps, or rather pump heads with cylinder, have been and are now made in several different styles and shapes to be used for various purposes; among which are those made for brewers and bargemen, tanners, oilmen and others. The pump illustrated in Fig. 269 is the simplest kind made, so far as the brazier is concerned. It consists of a straight piece of pipe of the desired length, usually from 8 to 10 feet long, with a flange at each end, the head being made large enough to hold about two strokes—that is, to have room enough so that it may not overflow while in operation. The head is a straight cylinder, Fig. 270, having the bottom turned in far enough to take the bolts so that it may be bolted to the flange, as shown, the bolt heads being on the inside; the spout, Fig. 271, is flanged and riveted to the side of the head near the bottom. The iron ring and double eye, Fig. 272, in which the handle works, is then riveted to the top edge and the copper turned over evenly all round the rim.

We will make one 10 feet long from bottom to spout, and let it be 1-16 inch thick and $2\frac{1}{2}$ inches in diameter inside; then we have $0.0625 + 2.5 \times 3.1416 = 8.0503$, or 8 inches; cut the strip and trim the edges, anneal and scour clean. Now lay it in a trough, Fig. 273, made by a 10 x 2-inch oak plank, having two other pieces 2 inches thick fastened to its sides, making a trough about 5 inches wide. With a mallet sink the sheet in the trough; then turn it over on the mandrel and finish the turning, being careful to keep the seam straight and closed down evenly (I have sometimes put a cramp at each end and one in the middle to keep the joint close). Now jar some borax and water through the seam and with a reed, Fig. 274 (that is, a strip of light copper about 1 inch wide turned half round), filled with solder, charge the seam by sliding the full reed through the length of the pipe, and, turning it over on the joint, jar the solder out of the reed and remove it. Take the tube to the fire and dry it; then gradually make it hot all along, and when the solder is all down, run it down the seam on a moderately brisk fire. When cool examine and repair all faulty places, if there are any; clean off the joint and planish on a smooth mandrel as near the size as you have at hand, and then braze on the

Fig. 269.—Lift Pump.

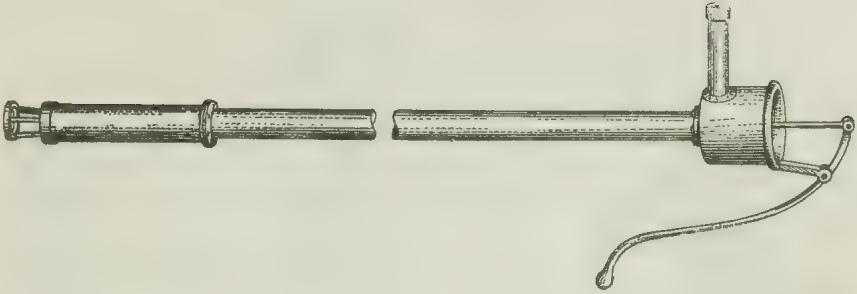

Fig. 272.—Ring and Double Eye.



Fig. 271.—Spout.



Fig. 270. Head.

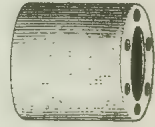

Fig. 273.—Trough and Turning bar.

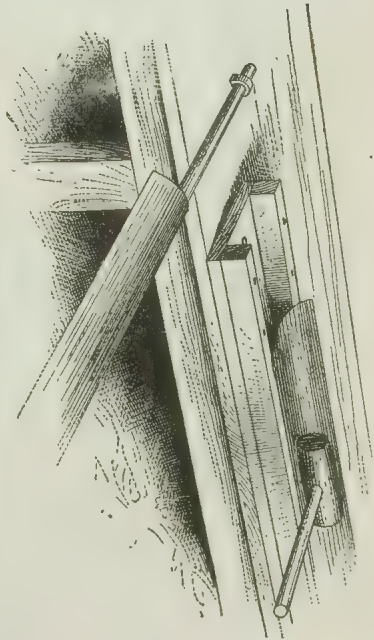

Fig. 274.—Soldering Reed.



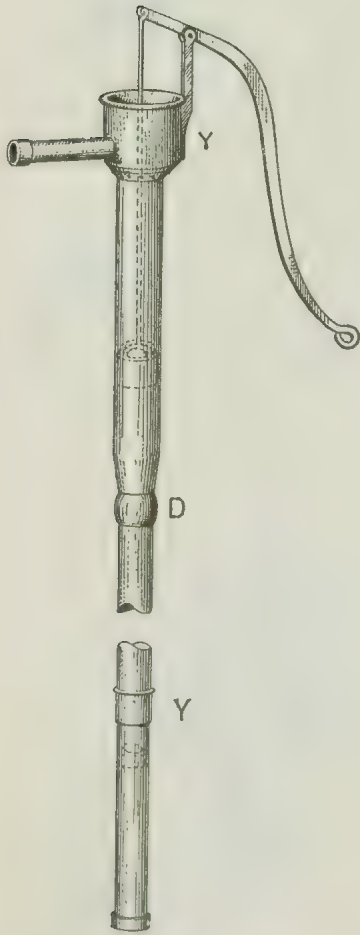

Fig. 275.--Barge or Tanners' Pump.



Fig. 276. Head and Cylinder.



Fig. 278.--Pump Barrel.

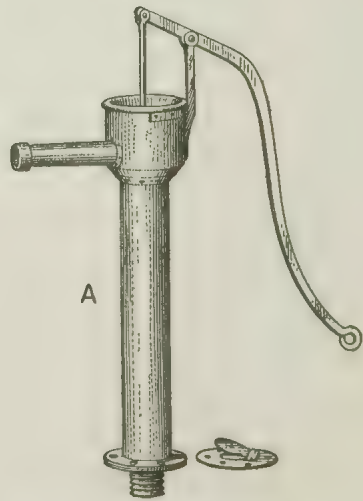

Fig. 277.--Pump for Pipe or Hose Connection.

flanges. Make the head to hold, say, 1 gallon. A strip of copper 24 inches long and 6 inches wide would make 1 gallon head, but there must be in addition 1 inch to turn in for bolts and $\frac{1}{2}$ inch to turn over the iron ring, making the width, therefore, $7\frac{1}{2}$ inches. Cut it out and work it up, and make the spout 2 inches in diameter, flange it, fit it and rivet it on, and then bolt the head to the flange and clean up. The cylinder for this pump is made of gun metal and the clacks are all ground in the pump, as it is used principally for hot work.

The next pump, Fig. 275, is used by bargemen, tanners and others to pump liquids from barges and tan pits, wells, cellars, foundations, &c. This pump is somewhat similar to Fig. 269, but is usually furnished with a wooden bucket and leather clack; the bottom clack is also of leather, although it may be, and often is, fitted with brass bucket and clacks when made for brewers. The pump, when complete, is usually 10 feet from bottom to the delivery spout, but they are made whatever size is required, so that any number of men may be used to work them. It will be seen that the cylinder of this pump, in which the bucket or plunger works, is enlarged, and forms part of the pump, and is drawn in small enough to suit the suction pipe, which is invariably the same size as the bucket clack, so that the full column or capacity of the suction pipe may be thrown from the delivery spout. When this pump is correctly made the barrel is perfectly cylindrical, and is a good job when completed. Let us make one and suppose the cylinder to be 4 inches in diameter inside and 2 feet long, and let it be $\frac{1}{16}$ inch thick; then $0.0625 + 4 \times 3.1416 = 12.75$, the circumference or width of the sheet required. Cut it out and trim off the burrs and trim; cramp, making the cramps about 2 inches long, turn and bind with wire, and close down the joint carefully, so that the inside is smooth; that is, after the joint has been laid with a hammer. Then take a mallet and with a few smart blows bring the joint down to the spindle, which should not be less than 3 inches in diameter; next charge the joint and let the solder follow the zigzag course of the edges of the cramps; dry and heat the back of the pipe to take off any spring, and then turn the joint to the fire, and run it down, care being taken that the fire is clean. The suction pipe is made in a similar way, but need not be cramped. Flange the cylinder G, Fig. 276, and draw in the end, making a collar, say, $1\frac{1}{2}$ inches wide, and fit the suction pipe to it and tin both parts of the joint. Make the head Y, Fig. 275, about 8 inches in diameter and the same in depth to

the turn of the bottom. To do this there is required a strip 10 inches wide, together with $\frac{1}{2}$ inch to turn over the ring and double eye, making a strip $10\frac{1}{2}$ wide by $25\frac{1}{4}$ inches long. Cut it out and form and raze in the bottom end of G, so that the hole is 4 inches. The barrel, or cylinder, may now be riveted to its place and the suction pipe joined to it by a plumber's joint, D, Fig. 275, or it may have a socket joint, Y, also soft soldered. Solder the length of pipe together, making the whole, when complete, 10 feet from bottom to delivery spout. Now put in the lower clack about 12 inches from the bottom, then the bucket and clean up. The next pump, Fig. 277, is made in every way similar to the last, excepting that it has a flange brazed at the bottom of the barrel, Fig. 278, while the additional coupling flange is attached to a piece of iron pipe and screw threaded, for iron pipe or a leather hose.

The pump, Fig. 279, is used by oilmen and others to lift oil out of barrels and is a good job for a young man approaching the end of his apprenticeship. The head is made spherical, and the spout after being bent extends from the pump about 2 feet. The pump from clack to delivery spout is usually from 4 to 5 feet long and 2 inches in diameter. The spout is tapering from $1\frac{1}{2}$ inches at the bend to 2 at the flange. This head may be formed from a strip of metal the required size, as shown in Fig. 280, the two ends being razed in similar to a round tea kettle body, leaving the wiring edge as the work proceeds. When the bottom end is razed in sufficiently the short flange pipe or flanged collar is cramped in as shown and brazed; the head is then planished brown and wired and the collar tinned. The flange of the spout, Fig. 281, is worked out so that it will fit on the underside of the head to empty it and the operation of flanging is performed during the turning; that is, it is begun while flat, and as the work proceeds the spout curls round the seam, being on the underside. When flanged and the seam soldered, fill with rosin or lead and bend the end. Now make the pipe, Fig. 282, and let it be 2 inches inside diameter. Cut out the strip, thin, sink in trough, Fig. 273, and finish, turning on the bar and making the joint straight. Solder it downward, clean off and put it on the bar, Fig. 283, then with a swage and a sledge hammer smooth the pipe, making it cylindrical and smooth, so that a brass plunger or bucket will work uniformly through it. Next swell out the end to receive the collar of the head, Fig. 284, which must be the same size as internal diameter of the pipe, so that

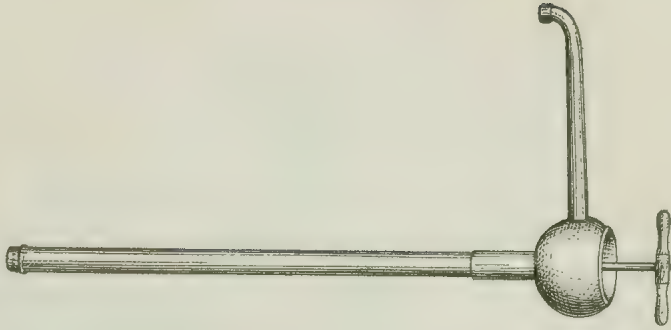

Fig. 279.—Oil Pump.

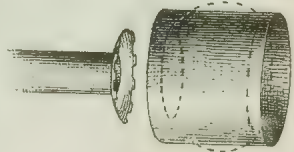

Fig. 280.—Forming Head.



Fig. 281.—Spout and Flange.

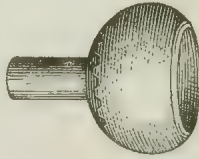

Fig. 284.—Finished Head.

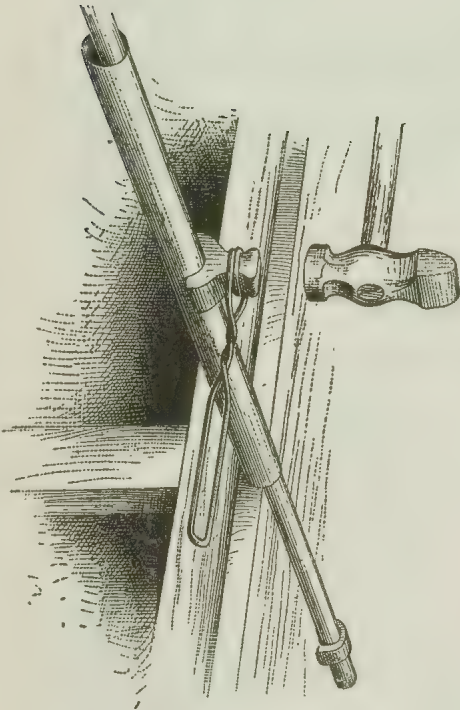

Fig. 283.—Bar with Savage and Hammer.

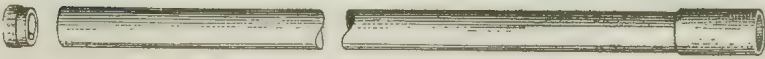

Fig. 282.—Pump Pipe.

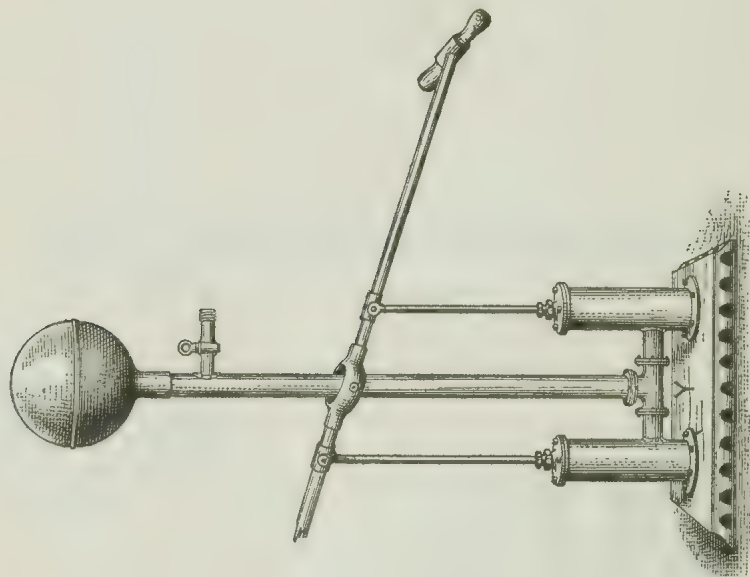

Fig. 286.—Double-jigger Pump.

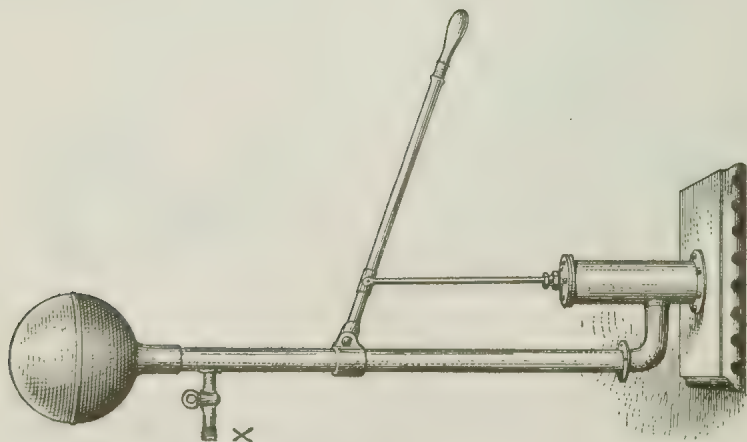

Fig. 285.—Single-jigger Pump.

the joint may be smooth inside. Rivet on the spout, solder in the head, fit in the clack and the bucket, put in the handle and clean all up.

The next pump, Fig. 285, is called a single jigger. This pump is mounted on a heavy cast-iron plate with avenues or water courses on the underside. The cylinder and first bend with flange is cast of gun metal, and the stand or upright pipe and air vessel are made of copper. The outlet or discharge pipe may be either soft soldered or plain, or it may be riveted and soldered, or brazed on. The air vessel may fit on the inside or end of the pipe, or be swelled out to receive it. The handle, or jigger, is fastened to the stand pipe with a clamp and bolt, which is made to form the double eye for the jigger which is suggested by the sketch.

The last or double-jigger pump is shown in Fig. 286, and as far as the brazier is concerned, is the same as the pump, Fig. 285, with the addition only of the T piece at Y, the cast-iron plate also being made larger to conform to the needs of the two cylinders forming the double-action pump.

And now in closing my recollections of light sheet copper working or brazery, from early childhood to manhood, if I have been fortunate enough to have supplied the means of helping some struggling, earnest boy on the road to success, the purpose of these articles is accomplished. At the same time, it is hoped by the writer that they may be read with a degree of pleasure and profit by some of the elders of the craft.

RAILWAY AND MARINE

COPPERSMITHS AND THEIR APPLIANCES

Men skilled in the art of working sheet copper are usually divided into three classes, which may almost be designated as three separate trades. The first and most ancient have been known for centuries as braziers. These men were employed in the manufacture of all kinds of cooking utensils, transmitting their craft from father to son for many generations, and have guarded their patrimony with a jealous eye. The next division was turned in the direction of larger and heavier vessels, such as brewing coppers, tallow coppers, dyers' coppers, stills of various kinds and vacuum pans for refining sugar, worms and coils, pumps, and many other heavy articles and vessels. These men are called coppersmiths, and properly so, because a majority of their work has no need of soldering or brazing, and as a rule they are poor brazers. With the advent of the steam engine another and third branch was called into existence. These men are employed about locomotive and marine engines, and seldom seek employment in any other line. Their work principally consists in making pipes of various sizes, forming bends, tee-pieces, cross-pieces, and, in fact, twisting a copper pipe into any conceivable shape required to fit the position it is intended to occupy. We shall for the present engage the attention of the reader to this last class of coppersmiths, and endeavor to describe a well-appointed shop for this kind of work. The first and most essential thing for a healthy coppersmiths' shop is a lofty, spacious room; if possible, not less than 20 feet high, with a floor 50 x 60 feet; the light should, if practicable, come from the roof through opaque glass; the roof should be furnished with dormers having movable slats, which may be raised and lowered as occasion requires to let out the fumes and gases that arise from the fuel in the forges and from the metal which is being worked, for they are often of a most repugnant and almost suffocating nature. The room having been obtained and provision made for the easy exit of the poisonous gases, benches for the accommodation of from six to ten men may be erected and fixed firmly against the wall on one side of the shop to suit convenience, as shown in Fig. 287. The benches should not be less than 3 feet wide and 3 inches thick, of some hard wood. They should

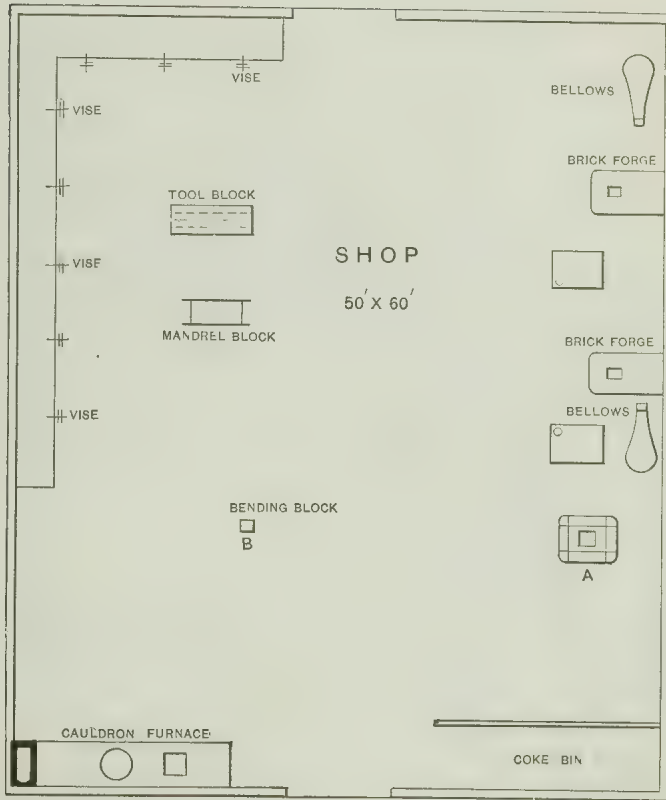

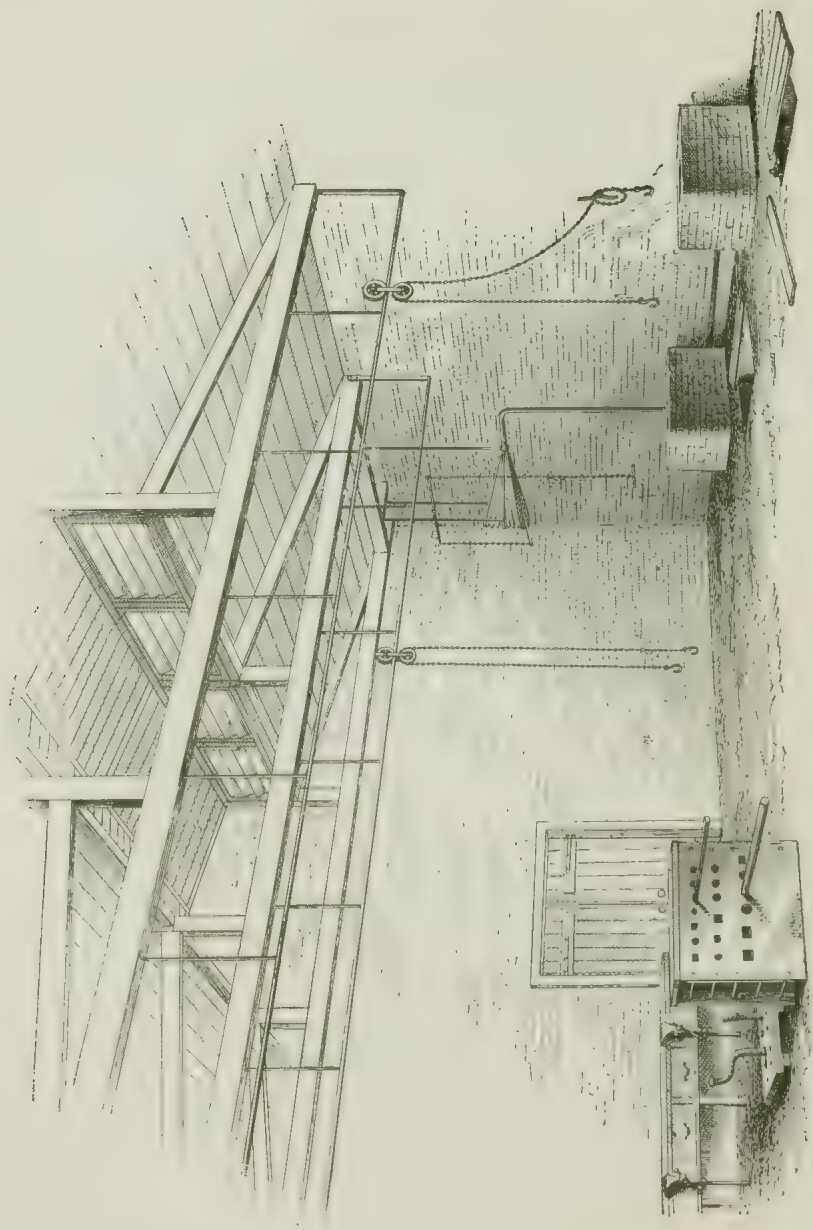

Fig. 288.—Interior View of Front End of Shop.

be provided with capacious drawers for the tools of each man, with a vise at each drawer, Fig. 288, the vises being not less than 8 feet apart. The bench may reach as far as necessary along the side of the shop, and may turn at the end as far as the door. The doors should be in the middle of each end, and large enough to allow such work to pass through as is likely to be done, and admit a current of air readily when necessary. On the opposite side of the shop three forges may be placed, two made of brick, and one, A, of iron. The two of brick, Fig. 288, should be about 3 feet high and 3 feet wide, and reach 5 or 6 feet from the wall. In the center of the top is the fire hole, which is about 10 inches wide and 12 long and from 8 to 10 deep. The blast can be supplied in the most convenient way, either from a fan or a large bellows; if from bellows, they should be hung overhead out of the way, so as to be convenient for the two outside forges, pipes being laid so the blast can be carried from one fire to the other, and to all if necessary. The iron forge, Fig. 289, should be made of $\frac{3}{8}$ -inch boiler iron, and so constructed that the side leaves can be taken off easily when necessary.

In the spaces between the three fires should be two pits of convenient depth to receive from 8 to 10 feet of pipe. These pits are about 3 x 4 feet and 6 deep, and covered with a lid of 2-inch oak plank; one plank of the lid or cover being left loose, to give access to the pit. In one of the outer corners of the pits a blast pipe is fixed for work which must be done over or near a pit. On the same side of the shop is a bin to hold coke, Figs 287 and 289, and which is placed close to the door. On the opposite side and in the space from door to wall a furnace is erected having a cast-iron caldron for the purpose of melting lead, also a fire to melt the rosin used to fill pipes for bending. Above each of these fires and forges is a kind of tramway for wheels to run on, the lower wheel carrying a chain, as shown in the cuts. The chain should be large enough so that a hook at each end of it can be readily caught in the links. The chain is used to hoist up and sling the work that it may be easily manipulated over the fire and at the mandrel block. To the wall is fixed a hitching hook for the purpose of tying the fall end of the chain when work is slung over the fire. The tramways are conveniently placed so that work may be easily carried from one place to another and to and from the fire; also to hold the work balanced while being operated on at the mandrel block or bench. The mandrel block is made of cast-iron plates some

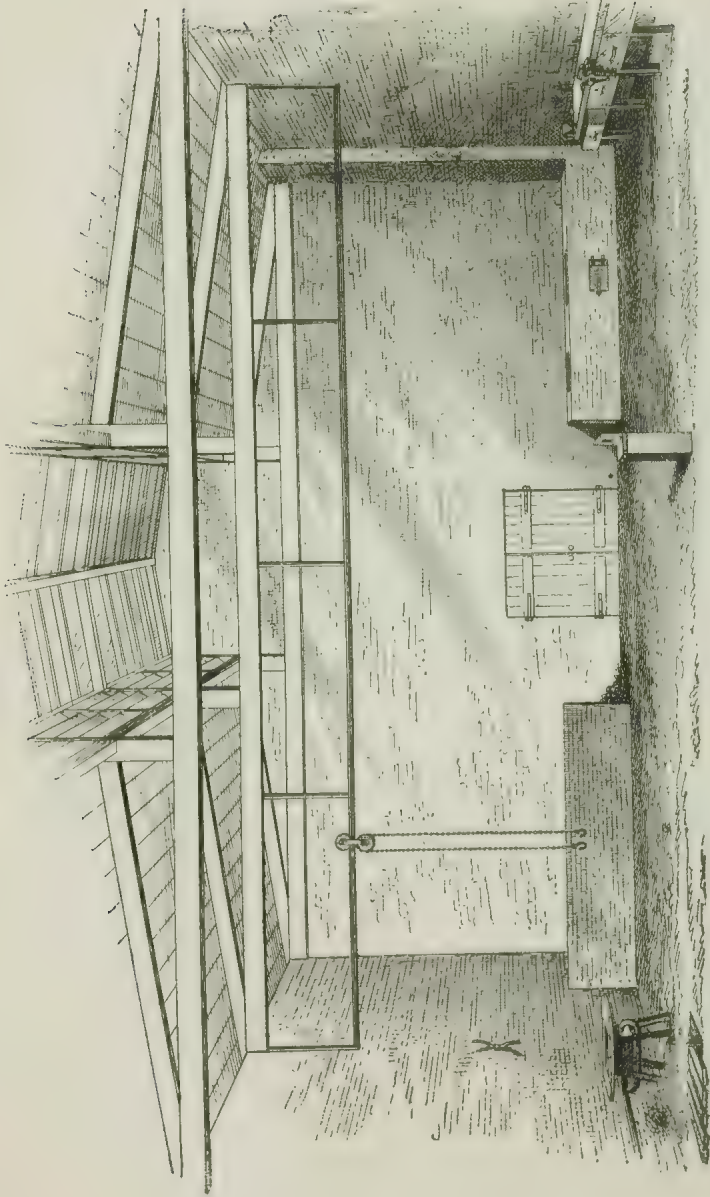

Fig. 289.—Interior View of Back End of Shop.

2 inches thick, and about 5 feet long and 4 feet wide, stood on edge, 2 feet apart. The plates, which are firmly fixed opposite each other, have holes in them both round and square to receive round and square mandrels, which go through both plates, so that the mandrels may be securely wedged and held fast in their places. Some 20 feet from the back or furnace end of shop floor is fixed a cast-iron post, B, from 12 to 14 inches square. This post is for the purpose of bending pipe, and is called a bending block. It should be placed as near the middle of the shop as convenient, and must be firmly set in the ground with a good broad foot at the bottom, as it requires considerable power to bend 5-inch pipe filled with lead, and if the block is not solid the power used in bending would loosen it. The top of the block has a ledge 4 inches deep for a strap to rest upon, the strap holding the lead-piece. The strap is of iron, 1 inch thick and 3 inches wide, made like a square staple with the ends drawn down so that a $1\frac{1}{4}$ -inch thread can be cut on them. Another piece of iron with holes in each end is made to go over the threaded ends of the strap. This strap is to hold a thick lead-piece on top of the block, the lead having a hole in it large enough to take the pipe in easily which may be required to be bent.

Since this article was prepared I have been favored by Mr. Moreton, one of the workmen in the coppersmiths' shop of the London and Southwestern Railway of London, England, with two views of the interior of a new and larger shop than the one above described, the arrangement of which is a little different from the old shop. In these two illustrations of the new shop, Figs 290 and 291, I notice the old brick forge has been discarded and the position of all the forges has been changed. The new ones are apparently placed in the middle of the shop, which has probably been found more convenient. The first object in the picture, Fig. 290, is the floor block, with a bottom stake standing in it. A little to the right of this is an anvil, used to work down the saddles of bends which are made in two halves. (One of these bends is lying on the end of the mandrel block in Fig. 291.)

On a table near are two brass valve covers, the crowns of which have just been brazed in. The next thing beyond these covers is a forge, in which there was a fire when the picture was taken. Other prominent objects are three brass dome covers, the making of which will be described later.

The next thing we notice is a coping, which is made of sheet



Fig. 299—London—South-eastern Railway Coppersmith Shop.



FIG. 29.—Ladle in Southern British Coppersmith Shop.

iron and screws as a finish to the lagging of the back end of the fire box. Under the left-hand end of this coping is a pit with a blast pipe at the southeast corner of it. Hanging on the wall is another kind of coping for the front end of the fire box, and which connects the lagging of the fire box with that of the boiler. The traveler chains used for slinging work are all clearly shown hanging at different points in the shop. In the other picture, Fig. 291, taken from another point, the benches are shown. The principal object on the bench is another iron coping finished ready for fitting, and in the corner are two long boiler steam pipes 6 inches in diameter, which are the largest pipes usually made in a locomotive shop. The next thing is the mandrel block, upon which are lying four cods, six small heads of different shapes and three large long heads: In the end hole at the left hand of the mandrel block is a wooden bar made to receive the shank of the large heads, the end of the bar being shoed with an iron strap to keep the head in and form the hole for the head shank. The shop, it will be noticed, is illuminated by electric light, two lamps being shown. In the left-hand corner of the mandrel block, and securely fastened, is a 3-inch round iron bar about 7 feet long, upon which are two cast-iron blocks that slide up and down the bar as required. These blocks have holes in them to receive mandrels, and are made fast by a suitable set screw at the back, which holds the block at any required height when the main mandrel block is too low for the work in hand. A little to the left of this bar is a screw jack, used to hold up one end of a pipe at the fire or for other purposes. On the wall may be seen various wire templates of delivery and other pipes. Altogether these pictures afford an interesting peep into a London railway coppersmiths' shop.

MAKING COPPER PIPE.

Copper pipes until recently were made by hand in 10 and 12 foot lengths, and from $\frac{1}{2}$ inch in diameter to any required size, and so great was the demand with the advent of the steam engine that many men, who were called pipe makers, were employed exclusively in making copper pipes and brass tubes. The marine coppersmith is now supplied with all sizes of straight pipes ready to his hand, but formerly he made them all. There have been rapid strides made in this art, and, like all other arts, that of the coppersmith has had to succumb to the march of scientific and practical research. Copper pipes are now drawn and made without seam, yet it often happens that the coppersmith is called on to make a few lengths in an emergency, and the most efficient method of doing this by hand will now be described. If the sheet of which the pipe is to be made is heavy the edges are thinned on the opposite sides of the strip; it is then turned and lapped only. If, on the other hand, the sheet is light, the edges must be cramped before thinning. If the pipe to be made is more than 6 feet long, we use a trough, Fig. 292, made of two long planks about 2 inches thick, placed in crossed pieces similar to a sawbuck, and lying at right angles to each other. The sheet is laid in the trough and a straight bar is dropped on the sheet metal, which yields to the falling bar, and the first form is thus given to the sheet. It is then further rounded by placing it the other side up over one of the edges of the trough and bringing it together with a mallet. When brought together sufficiently the joint is laid even on a long steel bar fastened at one end in the mandrel block. If the pipe is to be made of thin sheet metal, then the joint should be cramped together. This is done by cutting the edge on one side about every 2 or 3 inches with a chisel held slanting so that the cramp will form a lap where cut, as shown in Fig. 293. The edge is now suitably thinned, after which the sheet is turned round. The outside cramps are then lifted so as to admit the other edge, which is not cut, and which is put between the cramps, one going inside and the other outside.

The pipe, Fig. 294, is then bound together with pieces of binding wire placed about 2 feet apart and pulled up tight, the cramps are closed down and the joint laid evenly with a hammer or mallet to suit

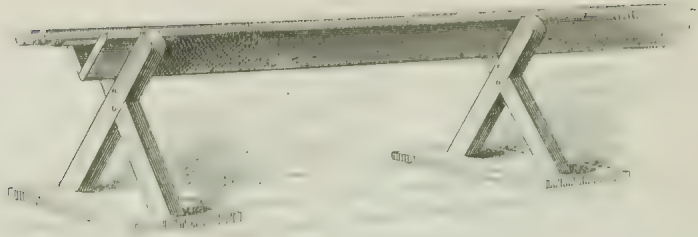

Fig. 292.—Trough for forming Copper Pipe.



Fig. 293.—Edge of Sheet Clamped.



Fig. 294.—Pipe Ready for Brazing.



Fig. 295.—Reed for Placing Spelter on Seam.

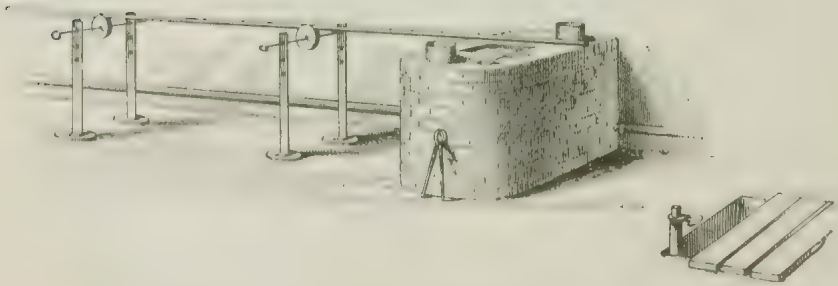

Fig. 296.—Portable Supports for Holding Pipes while Brazing.

the joint required. The joint must now be made to chatter—that is, jarred to loosen it enough so that the spelter may have room to flow freely through the joint when it is being brazed. All the foregoing directions having been followed successively, we now proceed to charge the joint with spelter. The spelter is mixed with clean water and borax, equal amounts of spelter and borax by measure being used. The best results follow if the mixture is made ready two or three days before wanted. To charge the joint take a strip of metal and form it into a V-shaped reed, Fig. 295, the length of the pipe and large enough to hold a sufficient quantity of spelter for the joint. Fill the reed evenly with spelter, and then slide it carefully through the pipe, laying it evenly on one side of the seam. Then turn the reed over on the seam, jar the spelter out of it and carefully remove the reed. The pipe is then ready for the fire. The fire must be clean and made of clean coke, care being taken that no lead or soft solder is on the forge or in the fire. The pipe is laid on the supports, Fig. 296, which are made of angle iron and bolted to a heavy foot so as to stand firm. The angle irons have holes punched about 1 inch apart, and a $\frac{1}{2}$ -inch rod run through with a wheel between the standards having a groove in it large enough to lay the pipe in so that as the joint is brazed it can easily be drawn through the fire without any unnecessary friction. During the process of soldering a pan of powdered borax must be at hand in case at some point the spelter should need more to flux it. After the pipe is cooled the seam is cleaned off by a sharp file and taken to the mandrel, and with a bright top swage it is rounded up and smoothed ready for use.

PIECING AND JOINING PIPES.

There are two ways of piecing or joining copper pipes—namely, a flush joint and a socket joint, soft soldering and hard soldering or brazing being employed. The manner of making a flush joint for soft soldering is shown in A and B, Fig. 297. A represents a flush joint prepared and ready for soft soldering. B represents a socket joint prepared for soft soldering. C a flush joint for hard solder, and D a socket joint for hard solder. The socket joint is adopted when it is necessary to preserve the full bore of the pipe; the flush joint when it is necessary to retain the exact size outside, as in the case of a gland, or where a screw nut has to pass over the joint.

In Fig. 297, A, it will be noticed that one piece has been reduced, or swaged down; this may be done with a top and bottom swage used

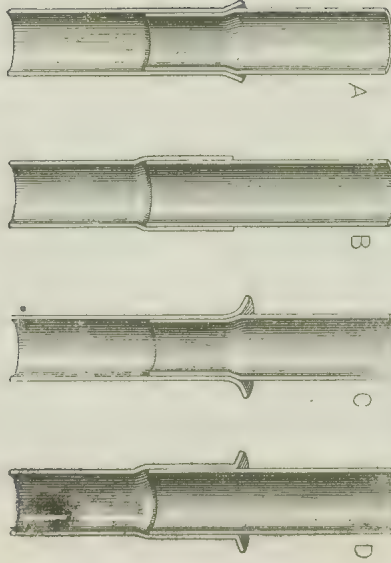

Fig. 297. Ways of Joining Copper Pipes.

by blacksmiths, if proper care be exercised, and the part operated on kept soft, or it may be reduced with a raising hammer. The inner piece should be carefully fitted, and, where reduced, of sufficient length to allow of its being kept cool at the end, so that it will retain the solder when the fire is applied to the joint. The female or outside piece should be thinned at the end, and the male or inside piece carefully hammered (not filed) to fit the scarf of the female end, which should project from the side sufficiently so that a suitable stick or bar of solder, when the joint is made hot enough to melt solder, can be drawn around the joint without any of it running down the outside, or when being filled from a ladle of solder, as is often done. Sometimes it is best and most convenient to wipe a plumber's joint, as it often happens that a fire cannot be applied or used in the work, either from its situation or because it would be unsafe to apply a fire.

The socket joint, Fig. 297, should be carefully fitted as in the case of A, the projection of the edge of the socket answering the purpose of the projection as in the flush joint A—namely, to insert or run the solder into the joint.

The flush joint C should have the same care given to it as in the case of A and B, but with this addition: On the female end a collar or flange must be laid off of the desired width, as shown, to form a channel or receptacle to hold enough spelter or hard solder when melted to fill the joint full.

The socket joint D is prepared the same as B. These sockets are made or enlarged on a suitable mandrel or steel stake by hammering until expanded to the proper size; the flange or collar is then laid off and the two ends are fitted easy, so the male end will go snugly into the socket without binding, but with sufficient room for the solder to flow freely about it and fill the joint full and make it solid. If the foregoing instructions are closely followed we are now well on with the work to be accomplished. We must now tin the joint (coat the ends with tin), both male and female, if for the joints shown by A and B; but the male end should be tinned only to within $\frac{1}{4}$ or $\frac{1}{2}$ inch of the end. On this spare space a little plumber's soil is applied to prevent the solder flowing down too far while the joint is being made. To clean the joints for soldering cover the parts with a strong solution of common salt and water, heat them in a clean coke fire to a cherry-red heat, and then plunge into water; next scour with a clean tow wad and sand and water, and finally dry. The pipes are now ready to place in position for the fire.

Having secured a suitable position, the application of the fire is next in order. In Fig. 298 is shown my first fire pot, which subsequently went through some two or three transformations, but was only improved to a limited extent by being cast in halves to suit some purposes, and in three sections for work of larger proportions. The first, however, was a ring of No. 20 sheet iron, about $3\frac{1}{2}$ inches deep, and perforated with holes, which, in the aggregate, were equal to or a little in excess of the capacity of the supply pipe. Around this iron ring was placed a hollow half-round ring made of copper, to receive and confine a blast from a fan, or wind from a bellows. The copper was inclosed as shown by section in the flanges of the iron ring, which was closed down close to the hollow half-round copper ring top and bottom. The supply pipe was flanged and riveted to the hollow copper ring as shown, the supply pipe being about 2 inches in diameter. The holes in iron ring were burred toward the inside, projecting enough to assist in holding a coat of fire clay to protect the iron from the action of the fire and keep the ring from burning. This answered for a time, and was fairly successful, but many little difficulties, and sometimes great ones, attended its use. The next pot, Fig. 299, was constructed in a similar way; but the iron ring was of boiler plate, about $\frac{1}{4}$ inch thick. This obviated the use of a fire-clay lining, and was a partial success until we got a job for which it was not applicable, in consequence of its being a complete ring. This compelled or suggested that the pot should be made in two parts, which was done in the best way that would answer the purpose. This one finally gave way to one of cast iron, a little different in shape, but the same in principle.

Fig. 300 shows the shape of the last pattern, which was of cast iron. It will be seen that the cavity for the blast was easily provided in this form, and the inside wall was made thick enough to render the lining unnecessary. With this pot the bottom of a joint could be more successfully kept cool, so as to check the molten spelter from running down too far, or leaking through the joint at the bottom. For general purposes this was the best, and we are not aware that it has ever

been improved. Fig. 300 also shows a sectional view of this pot cut through the feed pipe. For large work it is necessary to have the blast let in on both sides, and sometimes in three directions, the pot being then made in sections, with a feed pipe in each section, care being taken that none of the inner holes are opposite the inlet or last pipe.

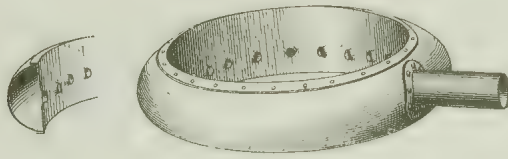

Fig. 298.—First Form of Fire Pot.

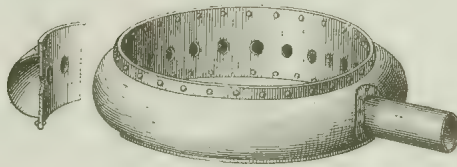

Fig. 299.—Second Form of Fire Pot.

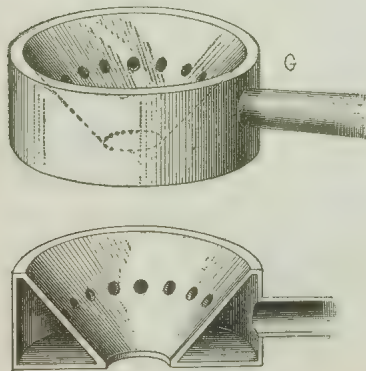

Fig. 300.—Cast-Iron Fire Pot.

FIRE POT SET FOR BRAZING JOINT.

We shall now proceed to make use of the fire pot, and describe the process of hard soldering or brazing by its aid. The pipe having been placed into position, care is taken that the socket is level across the brim, perhaps secured in the pit, or fastened to the forge or other suitable and convenient place, so that the roller and chain overhead is handy if necessary to the job. By referring to the engraving, Fig. 301, the clamp to hold up the pot is seen, which is made of $2\frac{1}{2} \times \frac{1}{4}$ inch iron, the arms being formed so that they will clasp the pipe, and are held there by two bolts, as shown. There may be space between them, so that they could be used for different sized pipe. These clamps are fastened up under the bottom of the socket, then the plates which form the fire-pot bottom are laid on, as shown in Fig. 302. Now spread a thin coat of moist fire clay over the plates, and hollow it up the socket from 1 inch to $1\frac{1}{2}$ inches. This is to keep the joint cool at the bottom, so that as the spelter melts it will not run down through—that is, not lower than the clay. Now place the fire pot in position, as shown in Fig. 303. This is the most critical and important feature of the work. Care must be taken to have the pot level with the socket flange which is to hold the solder. The pot would be better rather below than above, for if the spelter be too far out of the pot the blast will be too low down, and if it be too low in the pot there is danger of running out the seam in the upper pipe. Then, again, the joint cannot be skimmed off handily or so well attended to. When the pot is in position draw the clay around the bottom of it on the outside, so that the flame will not escape between the pot and bottom plates; then apply the blast pipe. If the joint be less than 6 or 7 inches in diameter one blast pipe will be enough, if the blast is of sufficient strength, but if the pipe to be joined be larger than 7 or 8 inches, then there should be two entries, as in Fig. 303. The joint is now filled with clean mixed spelter and borax. If the joint to be made is on brazed pipe, then spread a little of the moist fire clay over the seam up to the rim of the socket. Fasten the two screw clamps, Fig. 304, opposite each other on the top end of the pipe, and pass the chain through them and hook in a link or hook around the chain.

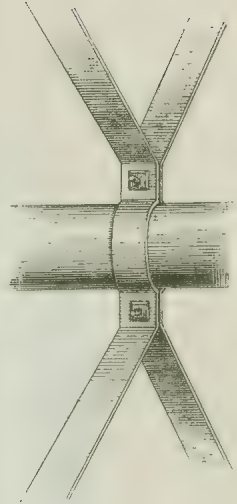

Fig. 301.—Clamp for Holding Pipe and Plates.

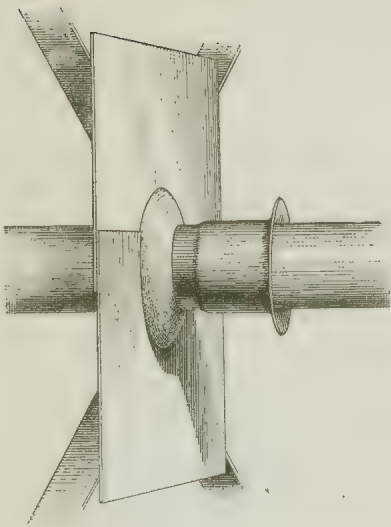

Fig. 302.—Plates in Position and Fire Clay Applied.

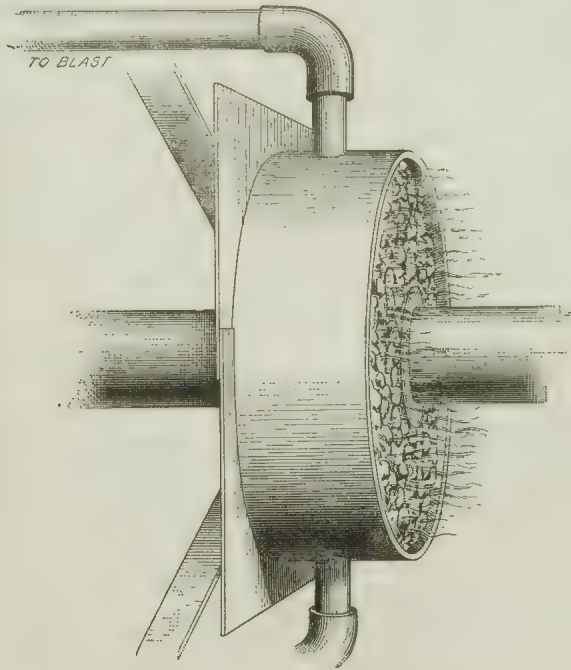

Fig. 303.—Fire Pot in Position for Brazing Joint.

On the other end of the chain a counterbalance weight is attached, nearly equal in weight to the male part of the job, or upper piece, or the chain may be fastened to the hitching hook on the wall in such a way that it will take the weight of the top piece of pipe while the joint is hot.

We are now ready for the fire. First, place a little dead charcoal on the wet clay, then put in a layer of live hot pieces, and cover them with a few more dead ones, and fill up with nice clean coke of the size of a walnut, covering the spelter some 2 inches; that is, pile the coke up around the pipe in a conical form from the edge of the pot. Then let in the blast slowly and be patient until the joint is just red-hot right through. While this is going on slowly, touch down the coke into a compact mass. When the joint is red-hot take the coke back a little from the pipe and dust a little freshly-powdered borax on the spelter; by this time the fire should be in good condition. Draw the coke up to the pipe again and replenish the fire and let in the blast at a brisk rate, keeping a watchful eye on the spelter and the blast slide. When the spelter has run and the joint is full and well fluxed, skim it off with a hot iron poker or a rod, Fig 305, flattened at the end, and stop the blast; take off the pipes and lift the pot, then throw a little common salt on the joint to kill the borax, which is hard on a new file. In all cases the draft through the pipe should be stopped, as the cold air going through tends to keep the joint cold, and in the larger pipes greatly retards progress. The directions above given are intended especially for learners, although old hands would save themselves some time, and often trouble, were they in the majority of cases to follow them out. The practice in many shops is to make a large fire on the brick forge, and then take a shovel full of hot coke and fill the pot with it; and a failure is often the result. But practice will partly balance the chances, because a man *must* make himself acquainted with the "ropes" (customs) of the shop in which he gets employment, no matter how absurd they are. Advance or innovation is seldom countenanced by workmen without trouble. I never failed when the fire was started with charcoal as above directed.

SOFT SOLDERING THE JOINT.

To make a soft solder joint, the fire pot is placed in position in the same manner as for brazing, and charcoal is used in preference to coke entirely. The solder is run from a suitable stick or from a

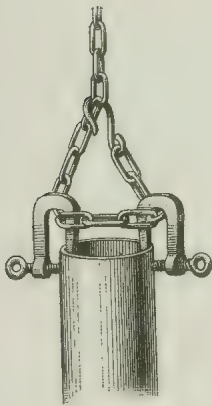

Fig. 304.—Screw Clamps for Holding Pipe.



Fig. 306.—Charcoal Fire Pot Within a Pipe.



Fig. 305.—Skimming Rod.

ladle. Joints in small pipes may be made with the aid of a pair of round tongs made hot. Joints in large pipes are sometimes more conveniently made by a pot of burning charcoal, Fig. 306, applied on the inside, held by and lowered into the pipe with the chain, care being taken to keep the lower end of the joint cool, and sizing the male part with size made of lampblack or ivory black and gold size, or any other pigment that will answer to prevent the solder from running through the joint. The fire pot for large soft solder joints is made to fit easily, and to hold a sufficient quantity of charcoal to do the work required. The bottom end of the pipe in this case is kept open if possible, so as to permit the draft, which in the other case it is necessary to stop. It will be seen that the bottom of the socket must be kept cool enough to stop the solder from running through, or the possibility of a leak may be prevented by rubbing into the inside some moist clay, if one can get to it to do so.

TEMPLATES.

Taking templates for bends is an important feature as an adjunct to the successful performance of the operation of bending ; for if the template be taken without a proper knowledge, trouble often ensues. Many a good piece of work has been mutilated and valuable time consumed by ignorance on the part of the maker of the bend, or the maker of the template, or perhaps it should have been said, from the want of a mutual understanding between them, when it happens that the coppersmith does not take the template himself. Templates for use at the bending block are usually made from an iron rod, which is stiff enough to retain its form without fear of alteration while being handled. It should be formed so that it will run through the center of the pipe after it is bent. Templates for large work are usually made by a pattern maker, showing the exact curve by cutting boards, and nailing the flanges to them in the position desired. When the position the pipe is to occupy affords sufficient space, due regard, care and attention should be exercised so that the pipe when finished will hang perpendicular, and lie horizontal, and the bends occupy as near as practicable the center of the space through which the bends run—that is, neither cramped nor straggling, but filling the space with a flowing ease. Having the templates in proper shape, we will now proceed to filling and bending.

FILLING AND BENDING.

All copper pipes and brass tubes should be carefully annealed before bending—that is, that part which is to be bent ; the other ought to be left hard. The part to be softened should when hot be a cherry red in a clear north light (not sunshine); when cold the part to be bent is filled with either lead or rosin, whichever is the more suitable to the particular bend it is required to make. If the desired bend is short—that is, part of a small circle—lead is the best for the purpose, new soft lead without any foreign substance mingled with it. If, on the other hand, an easy, flowing bend is desired, then rosin is the best adapted to the purpose. If the bend is to be made at the end of a long pipe it is not necessary to fill it the whole length. We

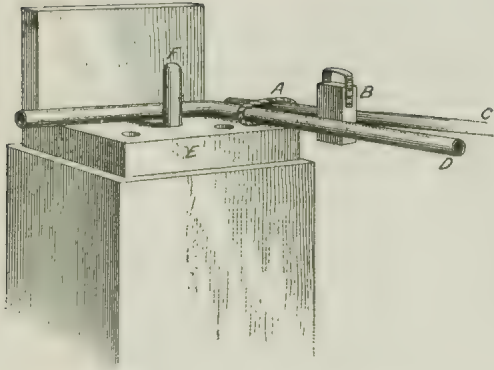

Fig. 307.—Bending Block Arranged for Use with Back Plate and Center Pin.

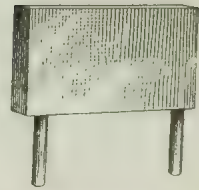

Fig. 308.—Back Plate for Bending Block.

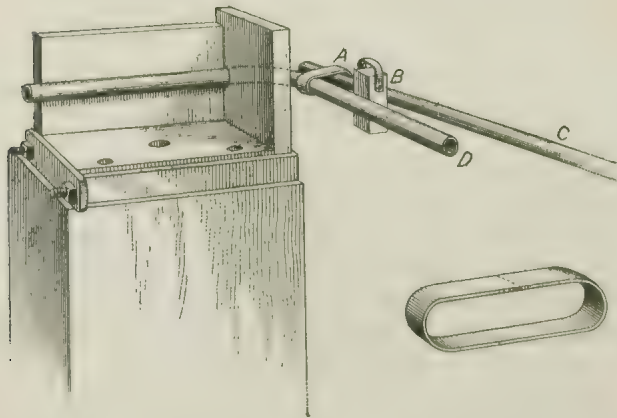

Fig. 309.—Bending Block Arranged for Use with Lead Piece and Back Plate.

usually roll up hard a ball of waste or paper and ram it in tight as far as it is necessary to fill it, and then pour in the lead or rosin as the case may be. When the work is done and the lead is out, heat the pipe blood red and the wadding will fall out, or it may be blown out by applying the blast pipe to it. We now proceed to the bending block. The center pin is used when from the nature of the work nothing will answer in its place. It is adapted to a great many forms of bending which practice alone can teach the learner. It will be noticed in Fig. 308 that the back plate is a piece of iron, usually about $1\frac{1}{2}$ inches thick, with two legs, the top of the bending block having four holes an equal distance apart at each corner to receive the two legs on any side, so that with the center pin the bending may be done on whichever side of the block is most convenient to the operator.

Fig. 307 shows the block ready for bending. A, loop; B, packing C, lever; D, pipe to be bent; E, center pin, and F, back plate in position. The pipe is first marked by laying the straight part of the template on the pipe and running the curved part along until the straight part at the other end of the template lies level on the pipe again, and marking with chalk where the bend begins and terminates on the pipe. It is then laid between the pin and back plate, Fig. 307, or put through the hole in the lead piece, as shown in Fig. 309. Between the plate and pipe is put a soft piece of wood or lead, and between the pin and pipe a piece of thick sheet lead; these are to save the pipe from being marked by the pressure exerted against the pin and back plate in the operation of bending. (It is always necessary to have a helper at the block when bending.) Now put the loop A on the pipe and slip the lever C through it, which may be of iron or wood—in some cases a wooden lever is the best, in others an iron one. Then put a block of soft wood, B, between the lever and pipe. After the loop is on one mark and the other mark behind the pin, or just inside the hole in the lead piece, then apply the necessary pressure to bend it to the required curve. The rope loop A, Fig. 307, is made of one strand of rope and formed like a sailor's grommet. The copper loop shown at the side in Fig. 309 is made of a strong piece of sheet copper. Sometimes the rope is the best adapted to the job in hand, at other times the copper loop; experience must dictate this. With the apparatus described, pipes up to 5 inches in diameter may be bent. If anything larger is needed, a hydraulic press must be provided.

MADE BENDS.

Bends that are not filed and bent are made in two ways principally and in halves ; one way the seams are on the side, the other the seams are in the throat and back. When the seams are on the side the inner piece is called the saddle and the outer piece the back. To make a bend saddle and back, take two strips of copper, each one-half the circumference of the pipe in width ; let the saddle piece be nearly the diameter of the pipe shorter than the back piece ; file the edges of each piece up carefully, half round, so that there are no rough burrs or small cracks left made by the shears in cutting the strips. Bend each to the working template. It will be found that the saddle, as the edges are being turned over on a mandrel, has a tendency to open out straight ; this may be obviated by bending the saddle piece a third smaller than the bend is required to be when finished, as shown in Fig. 310 ; that is, if a mallet is used in making the saddle. If the saddle is made with a hammer and drawn over on an anvil, the hammer will curl it around enough to the template, because the edges will be drawn longer. When the work is performed with a mallet the center is upset nearly as much as the edges of the strips are drawn, and a more equalized thickness is obtained and therefore a better bend. The back is turned similarly, under the same conditions, to the saddle, and the edges are puckered or wrinkled at regular intervals and then brought round to the template by hollowing in the center of the back in a hollowing block, Fig. 311, allowing the wrinkles to come up regularly until the back has curled round about a third less circle than the template. Gradually work out the wrinkles, first a little on one side and then on the other, over a T-stake, as shown in Fig. 312, until they are worked down and the edges are smooth and fit the edges of the saddle half. Then thin the edges with a double paned hammer on the inside of the two halves, saddle and back, and file the edges true along them. They will now be ready for softening and cleaning, which is done at one and the same time by covering the parts with strong brine of salt and water and heating to a cherry red (out of the sunshine), and quenching in a vessel or trough of clear water, and scouring with a clean tow wad and clean sand and water. It is now ready for cramping, as shown in Fig. 310. When cramped, open the cramps and bring the back to it ; let one go inside and one outside ; pull them up together in a vise and wire them together, as shown at D in Fig. 313. Dress down the cramps and hammer them

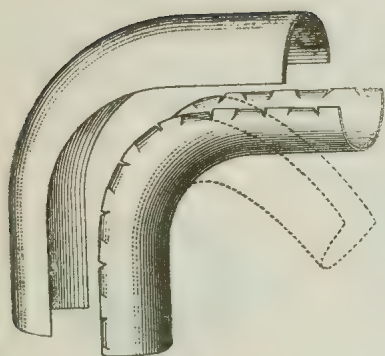

Fig. 310.—Made Bends.—Seams on Sides.

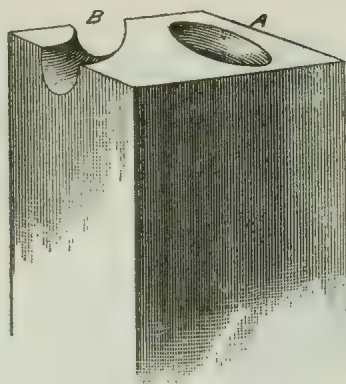

Fig. 311.—Hollowing Block for Forming Made Bends.

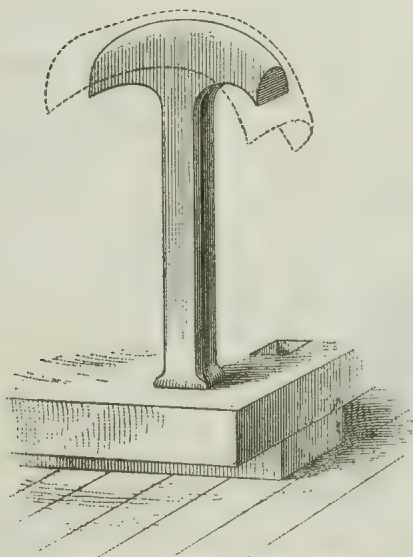

Fig. 312.—Half Bend Being Worked Over T-Stake.

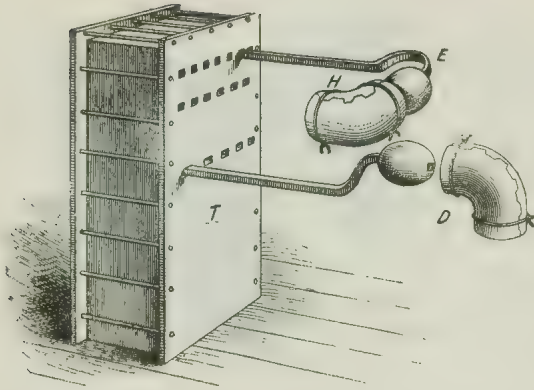

Fig. 313.—Mandrel Block. -Cods keyed to Bent Mandrels.

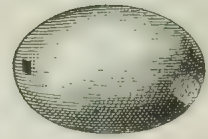

Fig. 314.—A Cod.

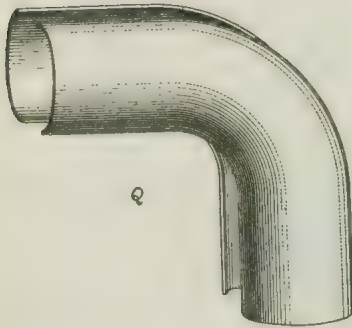

Fig. 315.—Made Bends. - Seams on Throat and Back.

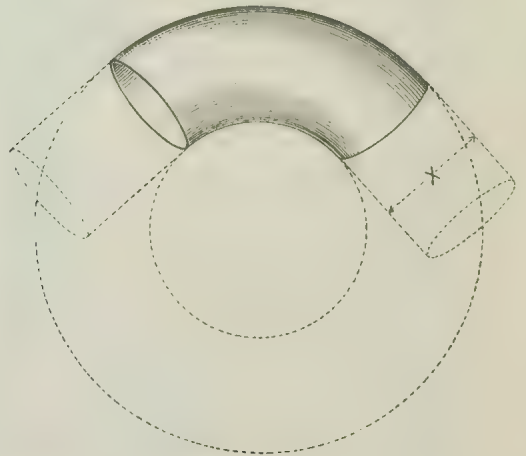

Fig. 316.—Diagram Showing Size of Bend.

close and even on a bent mandrel and a cod to fit. A cod is an egg-shaped casting, Fig. 314, having a square hole through its transverse axis, so that it can be keyed on the end of a bent square mandrel, as at D and E, one end of which is fastened in the mandrel block T, Fig. 313. After the cramps are hammered down smooth, chatter the joint, when it is ready for charging with spelter and the fire.

SEAM IN THROAT AND BACK.

We will now work on the other two halves, top and bottom, Fig. 315. In working these two halves into shape, the method usually adopted by workmen is to draw the throat down on an anvil, and then hollow up the back in a block; but this is not satisfactory nor can a real good job be done in this way, because the throat is drawn thin too much by the hammering and there is difficulty in keeping the work to the template; then, again, there is an excess of stuff in the back; yet this method is still in use. While engaged at this kind of work the writer discovered a very much better way by which the throat is scarcely touched; and when the bend is finally shaped, the throat is practically the same thickness as the sheet from which it was cut. This method has never been taught to any one but one apprentice boy, and it is given to the public now for the first time; that is, the formula. All bends are in the abstract but sections of a hollow cylindrical ring, and a square bend is one-fourth of a hollow ring, having the straight part, if any, joined to it or left unbent. A little mathematical knowledge is now required to be able to fully understand the ground work or the theoretical part. Referring to Fig. 316, let the inner dotted diameter of the diagram be equal to 9, and the diameter of pipe X equal 6; then the outside diameter of the diagram will be 21. Now we want to unroll the outside edge of one-half of this hollow ring, see Fig. 317, when cut horizontally, yy' , and form it into the frustum of a cone, E. To do this we proceed thus: First find the convex surface of the whole ring. Here the inner diameter of the ring is 9, and the diameter of the thickness or size of pipe is 6; then $(9 + 6) \times 6 = 15 \times 6 = 90$, and $90 \times (3.1416)^2 = 90 \times 9.8696 = 888.2685$, the convex surface of the whole ring; then $\frac{888.2685}{2} = 444.1342$, one-half surface, and $\frac{444.1342}{7854} = 565.488+$. Now add the square of 9, the inner diameter of the bend or ring, to this last result, and $565.488 + 81 = 646.488$. Extracting the

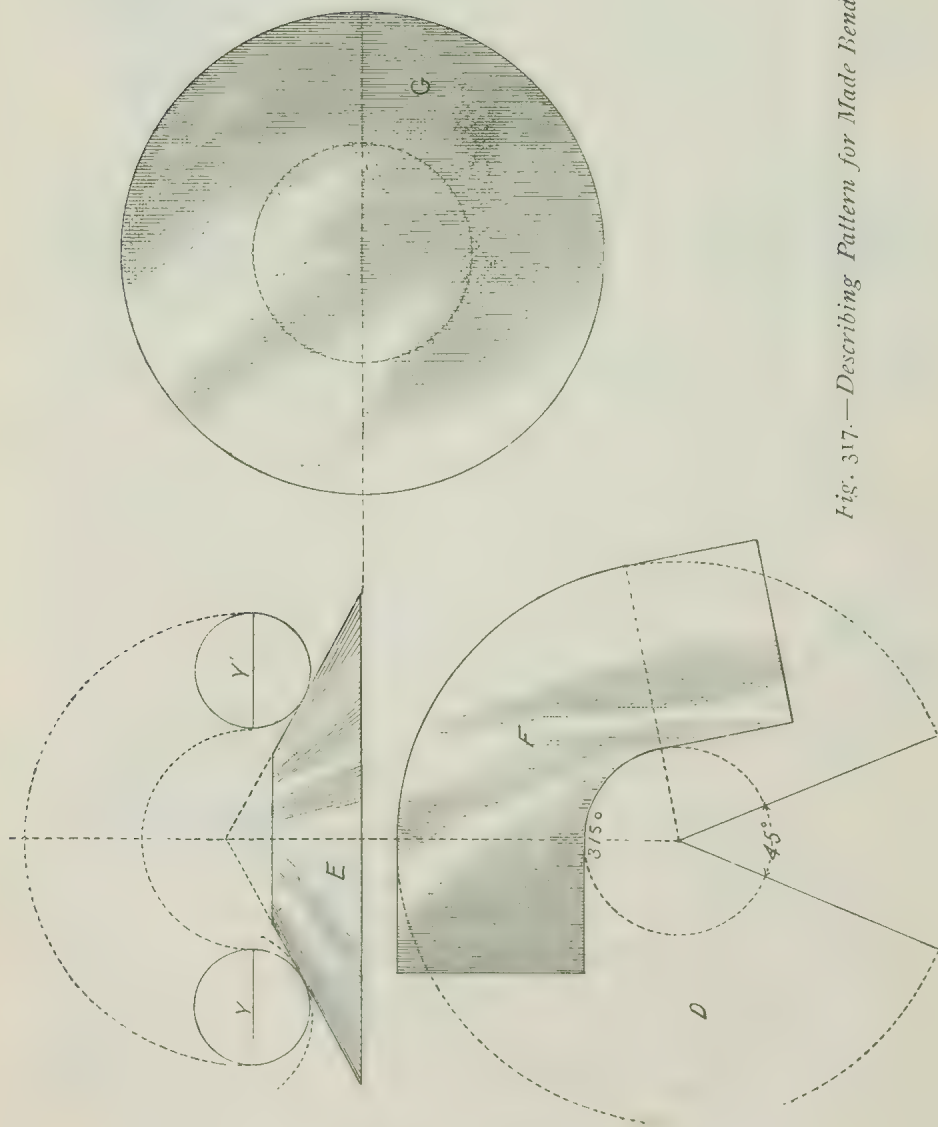

Fig. 317.—Describing Pattern for Made Bend.

square root of this last sum gives us 25.4262, the outside diameter of the circular disk G, Fig. 317. Now we want to transform this flat disk ring G into a frustum of a cone, E, whose convex surface is equal to the flat disk ring G. Practice has shown that a frustum of a cone formed of 315° of a circular ring is the best pitch it can have to obtain the result required with the least work. To raise this disk to a frustum of a cone proceed thus: $\frac{25.4262 \times 3}{5.25} = 14.5292$, the radius or slant height of the complete cone of which the frustum E is a part. Now take for a square bend one-fourth of 315° of circle D, or 78.75° , F, and add to it whatever is required for the straight part at either end, if any; then round up the edges with a file (as before directed), smooth, and it is ready for forming up into a half bend, proceeding as follows: Take two pieces of copper, F, and curl them round, a third smaller in diameter, Fig. 318, in the throat than they are required to be, the circular part forming one-fourth of the cone E, and turn them right and left in opposite directions, forming one-fourth of a cone with the part intended to form the bend. Now turn the throat in to begin the forming, A, Fig. 318; then turn the outer edge up and pucker or wrinkle the edge at regular intervals, as shown in B, Fig. 318; then take it to the hollowing block, Fig. 311, and sink it in the hollow in the corner, letting the wrinkles come in regularly all alike, until it is curled up enough, Fig. 319; now work out the wrinkles, partly in the block on the inside and part on a cod outside, until the edge is smooth and the two edges of the halves fit each other, Fig. 320. Then thin the edges, file them true, cramp one-half and bring the other to it and wire; dress down the cramps and chatter the joint; it is now ready for charging with solder and the fire.

TEMPLATE BOARDS.

The template boards are a very useful and convenient contrivance, made for the purpose of substituting the position in which pipes are intended to be coupled or occupy on an engine or tender or in a ship's hold. The single board is shown in Fig. 321. This board, or rather two boards, are hinged together at A and provided with two wings, B, about 1 inch wide, similar to that of a pair of compasses. These wings are fastened to the bottom leaf of the board, and slide through a loop which is fastened to the side of the other leaf. The loop is provided with a thumb screw, which holds the upright leaf in any position the flanges of a pipe may require. The double board, Fig.

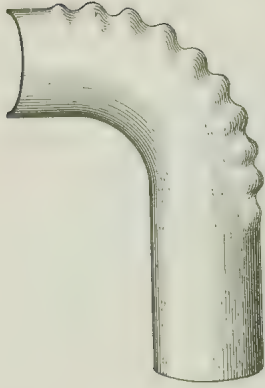

Fig. 319.—Piece with Outer Edge Wrinkled.

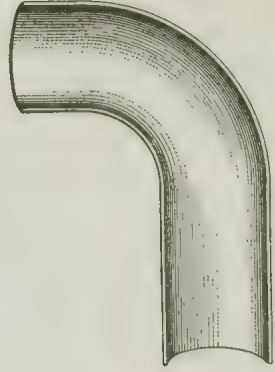

Fig. 320.—Piece with Wrinkles Worked Out.

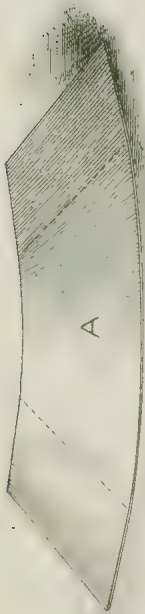

Fig. 318.A.—First Curve Given to F Pattern.



Fig. 318.B.—Piece with Outer Edge Wrinkled.

322, is similar to the single board, but has two leaves. This board is to take the set of S bends, which are set at right angles to each other, as shown by the pipe standing on the double board, Fig. 322. Here is an example of its practical use. It often happens in the case of steam pipes, feed pipes and suction pipes that the pipe breaks off close at the back of the flange A, Fig. 323, and the flange is not damaged or the pipe either further than the flange being broken off, and it is necessary to put the flange back on the pipe again without piecing, and to have the bolt holes in the exact position after the pipe is repaired as they were before the pipe was broken. Suppose the pipe is broken at the bottom flange C, Fig. 321. First match the fracture and take a template of it on the board by making the board fit the flanges, as shown. When they are in their true position, as they were before the pipe broke, mark the flanges around with a pencil on the board and all the bolt holes; then make a chisel mark on the edge of the flange, and at this point mark it on the board. Now all is ready to proceed with the repairing. Anneal and clean the end of the pipe inside and outside, and make a short thimble 2 inches long, D, Fig. 326, of light copper and fit it tight into the end of the pipe, and place it so that when the flange is put on over it the thimble will come through the flange E, Fig. 323, $\frac{1}{4}$ inch. Braze the ferrule in the pipe on two sides inside, and run off all the old solder from the flange A, and when cool fit it to its place again, being careful to match the fracture exactly and the holes and chisel mark on the template board. Then turn the end of the ferrule over the flange, forming a rivet, and draw the flange close to its place. Make a collar of a strip of thick copper, B, Fig. 324, and scarf the ends, and after bending, C, Fig. 325, put it around the fracture F, Fig. 327, making it wide enough to cover the break $\frac{1}{4}$ inch. Then wire it on tight, and after carefully charging it with solder around the top edge of the collar, sling it over the fire and run the solder. When the solder is set the wire may be taken off, while it is yet hot, quite easily. If the instruction here given be carefully followed, a strong, substantial job will always result.

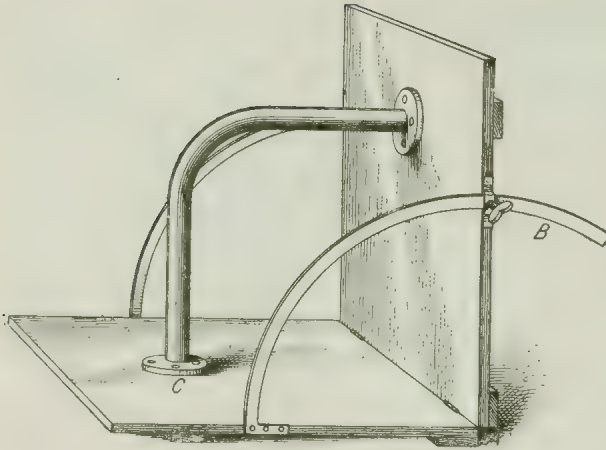

Fig. 321.—Single Template Board.

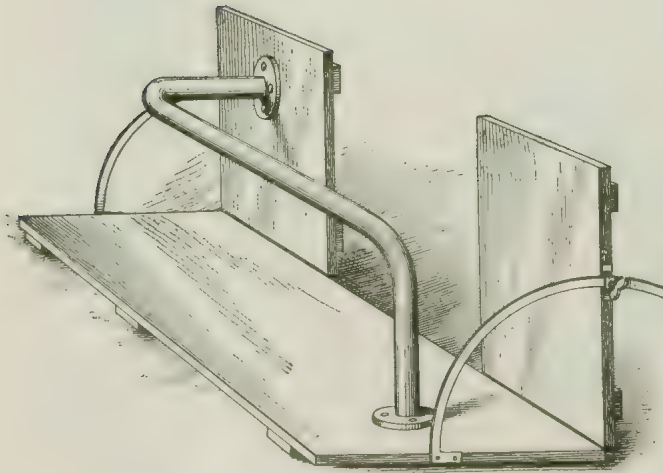

Fig. 322. Double Template Board.



Fig. 323.—Broken Pipe.



Fig. 324.—Copper Strip.



Fig. 325.—Collar.



Fig. 326.—Thimble

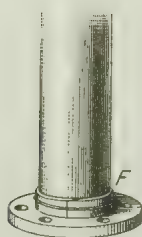

Fig. 327.—Method of Mending Fracture.

PATCHING PIPES.

Patching copper pipes, like most other branches of the copper-smith's art, requires perception first, and then skill, with patient, persevering ingenuity. Pipes are liable to so many different kinds of fractures and breakages that one can hardly prescribe beforehand a remedy suitable for all the many contingencies that may arise. We will, therefore, mention a few occurrences that are happening frequently, and let them act as stepping stones to the performance of others that may call for the attention of the operator. It often happens that pipes burst at the seam; this may arise from one of several causes—namely, from imperfect brazing, such as overheating while at the fire, or not enough heat to fuse the spelter so that it firmly adheres, or from freezing, continual jar, overpressure from force pump or flaws in the metal. If a fracture should occur from overheating—that is, if the part has been burnt—it is best to cut it out, as it can never be successfully repaired.

If ever so good a job be done it is all to no purpose, seeing the foundation of the work has been made rotten, and it is useless, except in cases of extreme emergency, to waste time or material on it. If the fracture arises from the want of heat, or the spelter has not been run enough to adhere to the joint, then open the joint and properly clean it; then close it down and give it a coat of warm borax and water, the borax having been previously dissolved in water; jar this through the joint, then charge it with spelter, either inside or outside, as seems best. If outside, the addition of a little spelter inside will do no harm if care is taken to see that it is completely run. If from freezing, the fracture may be anywhere as well as at the seam; then the metal will be parted as if cut through with a knife. If this be the case, file it down at the fracture, as at C in Fig. 328, so that where the split is the edge is thin, making a scarf similar to those at the seam, and clean the split carefully on the edges. Make the patch *a*, thinning the edges down to a suitable thickness, *b*, and so that the edge of the patch will just cover the outside edge of the scarf on the pipe at *c*. When the patch is properly fitted, anneal it with some salt previously put



Fig. 328.—Pipe and Patch Prepared.

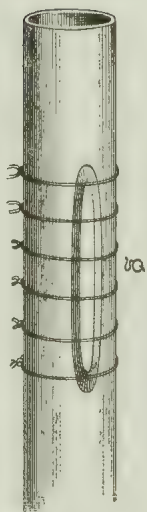

Fig. 329.—Patch Ready for Brazing.



Fig. 330.—Collar Used in Repairing Break.

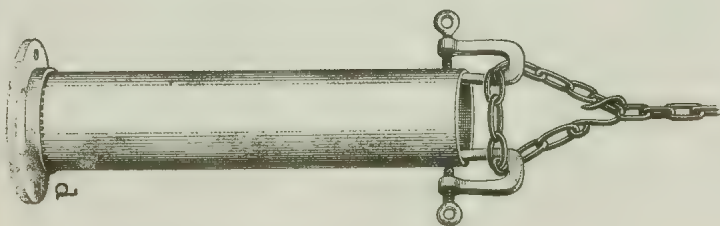

Fig. 331.—Break at Flange Ready for Brazing.

over it; when scoured clean cover it with a thin coat of fine spelter and run it smooth at the fire, throwing off all that will leave it while hot (this is to answer the same purpose as tinning). Wire the patch to the pipe, as shown in Fig. 329, the wires being sufficiently close to keep it from bagging when hot; charge it with spelter, one-half on the pipe and the other on the patch, then make the pipe red hot all around at the back of the patch and along the length of it, preventing oxidation of the spelter by a supply of borax. When sufficiently hot gradually turn it over and offer the spelter to a brisk fire. It should run easily, and if carefully performed, a good, sound and durable job will be insured. The cleaning off of the patch is next in order, which may be done as tastily as the job will admit of, to make it look as if the work had been performed by a mechanic. If a fracture is caused by continual jar or overpressure by a force pump, it will in all probability be like that caused by freezing, and may be treated the same. Flaws in the metal are from many causes, and their particular condition must govern the measures to be taken to remedy the defects. If in large work the flaws may be cut out and a piece cramped in or riveted, and then brazed. It often happens that continual jar produces a lateral fracture at right angles to the length or around the flange, immediately above the spelter. To repair this a collar *c*, Fig. 330, from $\frac{1}{2}$ to $\frac{3}{4}$ inch wide, is prepared of about the same thickness as the pipe. The pipe is cleaned as far up as necessary, then the collar is prepared to suit and covered with spelter as before directed, then coiled around the pipe and wired close, as at *d*, Fig. 331, the wire being placed on the upper edge of the collar to form additional room to lay the solder, care being taken that the collar fits tight up to the pipe. If the work is on a small pipe it is left open so that the heat may readily run up through the pipe to assist in the running of the spelter laid about the upper edge of the collar *d*. If it be a large pipe on which the work is being performed, then the end is stopped with a piece of sheet iron, clipped and bent at the edges, which is placed about a foot up the pipe, instead of 3 or 4 inches, as when brazing on flanges, as previously described.

OUTLETS.

Outlets are made in two ways principally, and may be soft soldered to their places, riveted and soft soldered, or brazed after being fixed in their positions, as the circumstances of the case may require. In many kinds of work where outlets are necessary they are more often soft soldered in place than brazed, but in marine work all are brazed, excepting when they are worked out from the main pipe, and can be of any size to suit the requirements of the work in hand. We will suppose that in the example before us the pipe, Fig. 332, is 6 inches in diameter, and an outlet 3 inches in diameter is required at the point V. A short piece of pipe to form the outlet, of the length required, is cut to fit the pipe, the outlet being drawn a little tapering at the bottom; then the edges are rounded up smooth and free from cracks, and a flange from $\frac{1}{2}$ to $\frac{3}{4}$ inch wide is laid off from the edge, the flange being next fitted close to the main pipe. The hole in the main pipe is cut out about $\frac{1}{2}$ inch smaller than the hole is required to be when finished, and a bur is worked out from the main pipe, as shown at T, and made to stand up $\frac{1}{4}$ inch inside the outlet when it is placed on the pipe. Let the bur fit close and snug on the inside of the outlet, and the outlet flange fit nicely down on the main pipe. When the flange on the outside is fitted, clean the place it is to occupy by the heating process, using the salt and water pickle before making hot; also clean the outlet the same way. When this is done spread an even coat of fine spelter on the flange of the outlet on the inside, Fig. 333, letting it extend as far into the outlet as the bur of the main pipe is likely to reach. Now take it to the fire, and run the solder smooth all around the flange, giving it a coat of spelter all around evenly. (This is to answer the same purpose that tinning does when making soft-solder joints.) Cool it in clear water, when the face of the flange should look like a piece of clean sheet brass. Place it in position and wire it fast to the main pipe. It may now be brazed on the brick forge, Fig. 334, by laying solder $\frac{1}{2}$ inch wide, more or less, around the joint, one-half of which should be on the outlet flange, the other on the

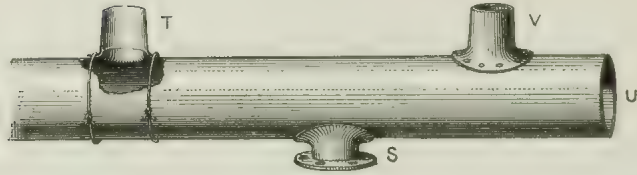

Fig. 332.—Manner of Attaching T-joint to Pipe.

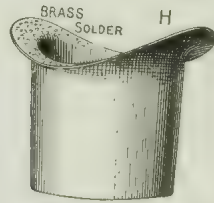

Fig. 333.—Outlet with Flange Covered with Spelter.

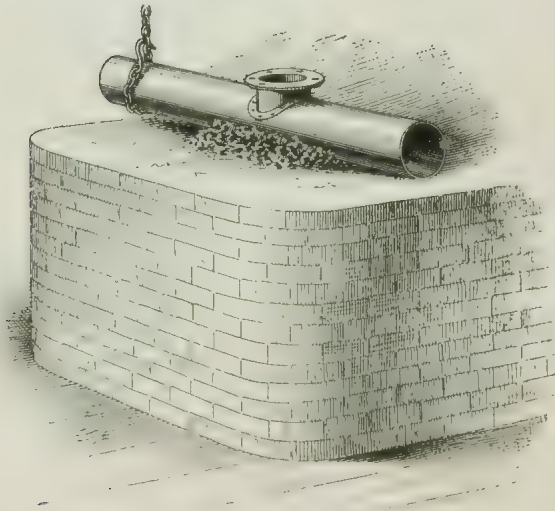

Fig. 334.—Brick Forge Used in Brazing.

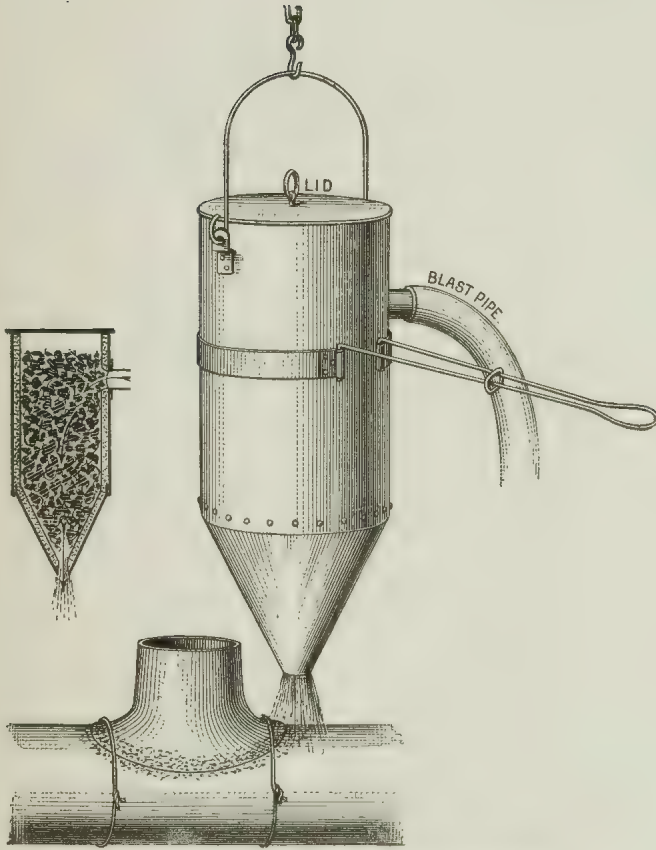

Fig. 335. —Balloon Fire Pot Used in Brazing.



Fig. 337.—Burring Fin.

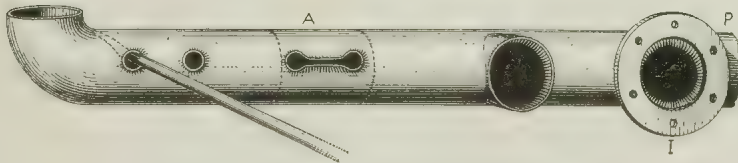

Fig. 336.—Working Outlets from Pipe.

main pipe ; heat the main pipe slowly until it is blood red in the shade ; by this time the borax and spelter on the joint should have the appearance as if varnish was among the spelter, caused by the melting of the borax. Now offer the spelter to a brisk fire so it will flow with ease and fill the joint right through to the edge of the bur inside. If, however, it is inconvenient to handle the job by reason of its size and weight, or some other contingency, a balloon fire may be brought into service with advantage, and, as stated in a previous article, the fire may be taken to the work, as in Fig. 335. This fire pot is called a balloon fire pot from its similarity to a balloon. It is made of boiler iron, and usually from 10 to 12 inches in diameter and 12 to 14 long, with a conical point at the bottom, at the end of which is an opening about 2 inches in diameter, through which the flame is driven by the blast, which is conveyed from the supply pipe to the pot by means of a hose. The cover is a flat piece of heavy boiler plate. Before using this fire pot it should be lined on the inside with about $\frac{1}{2}$ inch of fire clay. The work is first made ready for this fire by heating it, as near as can practically be done, to a red heat, so that the pot may not have to supply too much heat to the parts surrounding the joint, but that all its power or intensity may be concentrated on the point where it is required and most necessary ; when this instruction has been carried out the work is ready. The pot having previously been hung in position, it is now filled with live hot coke, which is made to lie compact in the pot, when it is then brought to the joint and a brisk blast thrown on the spelter, which will quickly run if it has been properly handled and kept in condition with a sufficiency of borax, and the parts adjacent to the joint have been kept hot.

Outlets intended to be soft soldered should be fitted with the same care as are those for brazing, and may be riveted as at V, in Fig. 332, in addition ; in some cases this is quite necessary and should not be omitted. To work outlets from the main pipe we proceed as follows : On the pipe, Fig. 336, at the point where the outlet is to be, measure off the distance equal to one-half the circumference of the outlet required ; from the two extremities of this half circumference, and between them, measure each way a distance equal to the turn to be made for the flange I. Now drill two small holes, and with a file round up the edges of the holes smooth ; then insert the bar, Fig. 337, and with the end jar or drive out the collar while the pipe is hot ;

when it is out as far as necessary, slit it down between the holes as at A, Fig. 336, and open it out until completed as shown. Care must be taken to file the edges of the outlet up round and keep them that way, so that no rough burs are left on. With ordinary mechanical ability an outlet can be worked out from the main pipe long enough to get on a flange, I, Fig. 336, by which to make connections with other pipes.

EXPANSION JOINTS.

Expansion joints are used in places where a long length of pipe is necessary to conduct steam or hot water from the boiler to its destination. These joints are made of any required size to suit the particular case, and are a means whereby the expansion caused by the heat may be taken up, and when the contraction takes place on cooling the deficiency may be supplied. Fig. 338 represents a broken view of an expansion joint in its finished state. Now we desire the easiest way to form this, so that the outer edge of the part intended to supply the elasticity may be about one-half the thickness of the original sheet from which it was cut, and give the required flexibility to the joint. First represent one-half the joint in outline, as in Fig. 339, $b d c e$; divide the diameter $c d$ into six equal parts; second, divide the diameter $b e$ into four equal parts, and through the points f and h draw the lines $f g$ and $h g$, passing through the points p and s ; then, with the length of the curved lines $s, b d$ and $c e$, measure off a distance equal to them on the lines $s h$ and $p f$ extended, and with the radius $g v$ and $g s$ describe the arcs $x y$ and $z n$. Now develop or unfold the convex surface of the frustum, Fig. 340, along the curved line $x y$, making the line $x y$ equal to the circumference of the truncated cone, Fig. 340. Draw lines $x z y n$; then the pattern $x y n z$ will, when turned round, form the envelope of the surface of the truncated cone, shown in Fig. 340. Having the pattern, two pieces are to be cut from a sheet of copper of the required thickness. Then the edges, cramp them and make the joints by brazing; when this has been done, clean them off and knock them down; then anneal. Mark off with a gauge or racer, Fig. 341, the distance of the straight part in Fig. 338, as further shown in $O M$, Fig. 342, and with a bullet hammer inside, or a hammer pein outside, draw or stretch the edge one course out; now turn the big end up, and take a course around that on the mandrel, Fig. 343, expanding or stretching the edge in each course as indicated by the dotted lines in Fig. 342, annealing at the end of each spell. When by these stretching courses the outer edges are of the required size, turn it back again and with it hanging on the mandrel, take in successive courses with a mallet until the straight

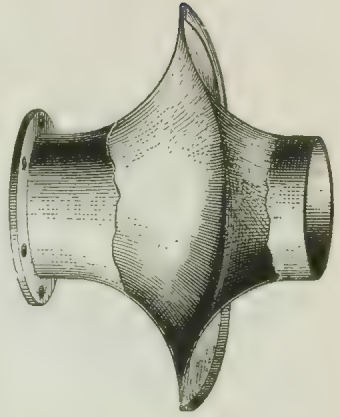

Fig. 338. — Broken View of Expansion Joint.

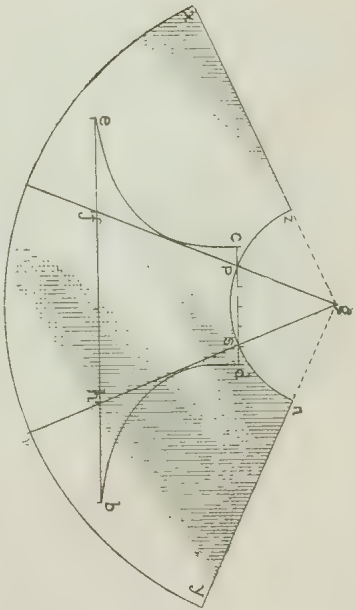

Fig. 339. Method of Obtaining Pattern for Expansion Joint.

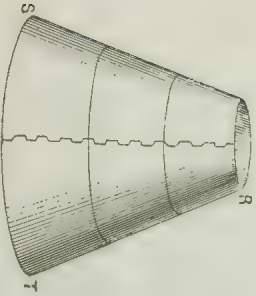

Fig. 340. Pattern formed and Seam Brazed.



Fig. 341. — Gauge or Ruler.

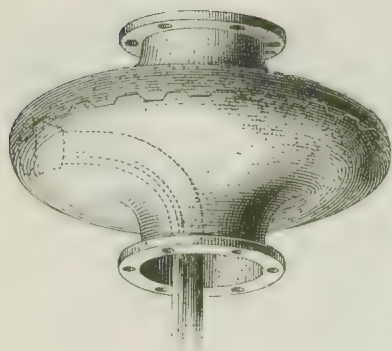

Fig. 344.—Expansion Joint with Round Edges

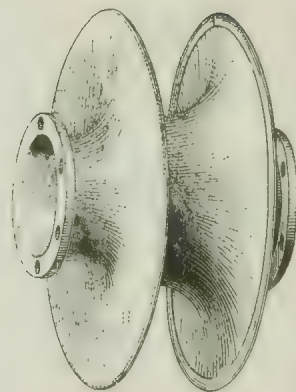

Fig. 345.—Double Expansion Joint.

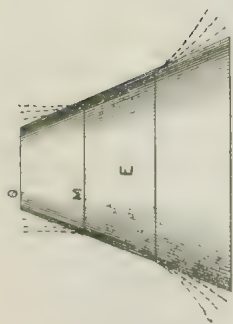

Fig. 342.—Manner of Drawing Out Edges.

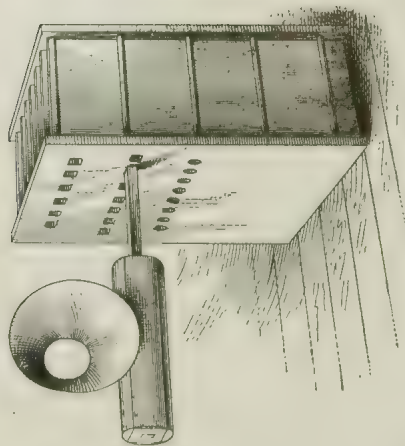

Fig. 343.—Shaping the Edge on a Mandrel.

part remaining is of the curve desired. True the job up, smooth and planish on a suitable mandrel; then turn up the bottom edge all around, as shown in Fig. 338, and bring the other side to it and place it inside this edge and close it down. Charge with spelter and braze it round, then clean off the joint and braze on the flanges.

The foregoing specimen may be changed in form—that is to say, instead of the outer edge being put together sharp, we sometimes find it more suitable to make the edge round, as shown in Fig. 344. The process of making this joint is similar to the last example up to the point of preparing for putting together, when in this case the edges should be worked up in an easy curve, so that when they are brought together they would make a half circle, and form the outline of a body like an oblate spheroid or a skittle ball. The edges are then cramped together, as shown, and after the seam has been properly closed down on the head and bent shank, as represented in Fig. 344, the work should be slung over the fire for brazing, and have enough solder placed inside to flow around the seam. If carefully charged, however, it may be soldered from the outside, being slung at the fire in the same way.

Fig. 345 is similar also to the first pattern, Fig. 338, but made double. The middle section in this one is made like the inside half of a cylindrical ring or the outside rim of a pulley wheel. The two outside pieces are made nearly like the single joint first described, with the addition of the circular or saddle piece between them, as shown in Figs. 345 and 346. Fig. 345 shows the joint put together; Fig. 346 shows them separated for closer inspection. This is called a double joint, and will be readily understood from the engraving. Fig. 347 is another form of expansion joint, which is frequently used where there is plenty of room for it, and is a good device for the purpose for which it is intended. The engraving fully explains itself.

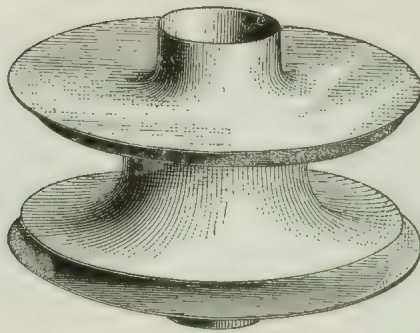

Fig. 346.—Joint with Parts Separated.



Fig. 347.—Bent Pipe Expansion Joint.

TEE PIECES.

Tee pieces are made in several ways, but there are only two in common use as a general rule. These are, when the three passages are all of one size, as in Fig. 348, and when the inlet is equal to the two outlets or the reverse, as in Figs. 349 and 350. The first is formed by making two saddle pieces, a cap or bottom piece, and gusset, A, as in Fig. 348. This piece of work would look better without a gusset, as in Fig. 351, which can be done by leaving the corners on the two saddle pieces and squaring them up before putting together; but there is the advantage of economy in favor of the gusset, as there is always a good supply of pieces available in all shops. The tee in Fig. 349 is formed of two taper pieces, the large end being equal to one-half the circumference of the inlet at one end and half of the circumference of the outlet at the other. This can be made with or without a gusset, as desired. The large end or stem should be kept the same thickness or diameter right through to the bottom or cap, and the other two taper off as if two frustums of cones were joined together at the base, the small ends having a short distance of them parallel from the end for a flange to fit on, to make connections with other pipes. I have made small tees from one piece cut from the sheet, as in Fig. 352, by working down the throats into shape with a razing hammer and forming the two outlets by bending the pattern in the middle and bringing the two edges together. The stem is thus in two halves, while the part forming the two outlets is one continuous piece, having the seam in the two throats, as in Fig. 352. There is no reason why a large one could not be made the same way with economy in labor, but I never made one nor saw one made



Fig. 348.—Tee with Gusset Piece.

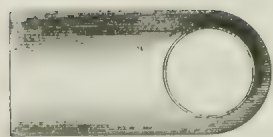

Fig. 350.—End View of Large Inlet Tee.

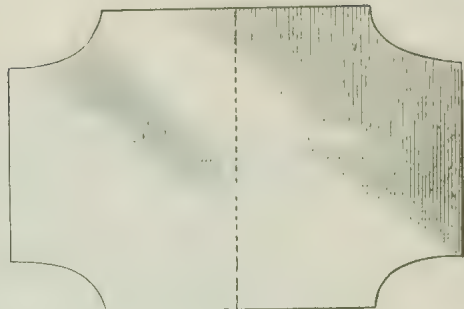

Fig. 352.—Tee Made from One Piece and Pattern for Same.

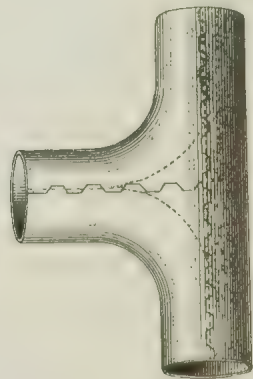

Fig. 351.—Tee Made without Gusset Piece.

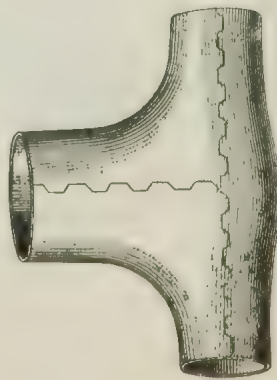

Fig. 349.—Tee with Large Inlet.

THREE-WAY PIECES.

Three-way pieces, Fig. 353, are made by putting together three saddle pieces and a gusset, the outlet pipes being an equal distance apart and usually of one size. They sometimes require one outlet equal to the other two in area. If the two inlets are made to approach nearer to each other than in the three-way piece, and the outlet equal in area to these two, as in Fig. 354, it is called a britch piece, and is made of pieces similar to those described for Fig. 349, excepting the crotch piece at the bend or turn is cut a third through on each side, as shown, and a gusset, A, cramped in and brazed; then the other two side pieces are brought together and wired, the seam dressed down and then brazed.

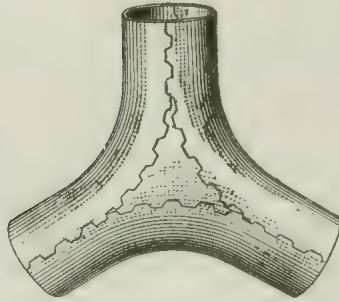

Fig. 353.—Three-Way Piece.

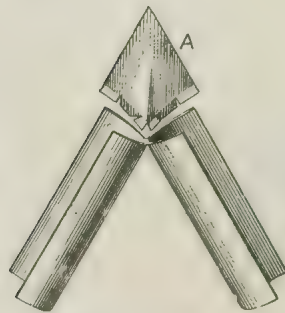
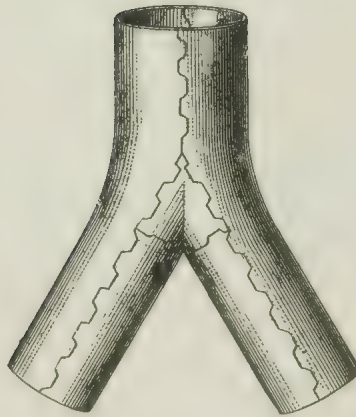

Fig. 354.—Britch-Piece with Large Inlet.

CROSS, OR FOUR-WAY, PIECES.

Small four-way pieces are made similar to three-way by joining four saddle pieces together with a gusset, unless some special purpose calls for another method. In large work two ways are adopted. The first by cutting out two pieces as shown in Fig. 355, and razing down the throats and making the four joints by cramping the pieces together in the four throats or saddles, and brazing. The other by making it in two halves with the seam on the side and cramping together, as shown in Fig. 356. To do this with the least amount of labor, we must reduce the surface of one-half of the piece to a flat sheet of metal, as in Fig. 357, proceeding as follows: From the point A, Fig. 358, with the radius A B, describe the arc B C; divide the arc B C into three equal parts; through the two points B and D draw the line G E; on the opposite side of the figure draw E H, similar to G E; then B I H G will represent a frustum of a cone. Now find the convex surface of the frustum which is thus represented. Let B I H G, Fig. 358, be a frustum of a cone, and let I B = 3 and H I = 4, and H G = 5. Then the convex surface of the frustum = $\frac{3 + 5 \times 3.1416 \times 4}{2} = 50.2656$, and converting this into circular

or disk inches we have $\frac{50.2656}{0.7854} = 64$. Now add the square of the di-

ameter B I $3^2 = 9$; then $64 + 9 = 73$, the convex surface of B I H G in circular inches; extracting the square root we have $\sqrt{73} = 8.544$, or a disk of sheet metal 8 544 inches in diameter, as in Fig. 357. Draw the line through the center O, and from the points P and G draw the lines N P M and S G V at right angles with the diameter P G, and measure off from the points P and G one-fourth of the circumference of I B, Fig. 358, making the lines M N and V S join R M and U N, which are tangent to the circle. Then the pattern V S M N, Fig. 357, will equal approximately the convex surface of E, Fig. 357.

Having cut two pieces of copper like the pattern in Fig. 357, they are ready for forming after the edges have been rounded smooth. Begin this process by wrinkling or puckering, as in Fig. 359, then with the razing hammer, Fig. 360, raze the wrinkles down on a suitable

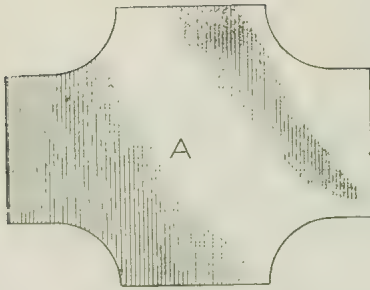

Fig. 355.—Pattern for One-Half of Four-Way Piece.

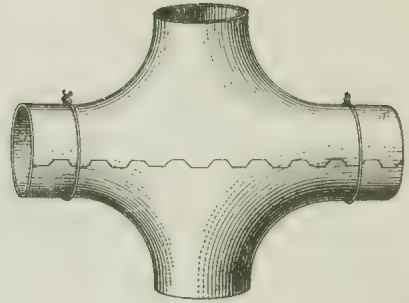

Fig. 356.—Four-Way Piece Made of Two Pieces, Seams on Side.

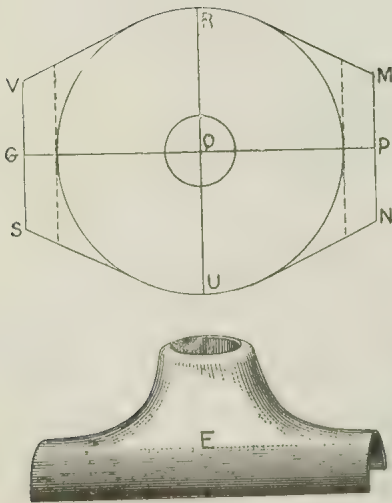

Fig. 357.—Method of Obtaining Pattern for One-Half of Four-Way Piece E.

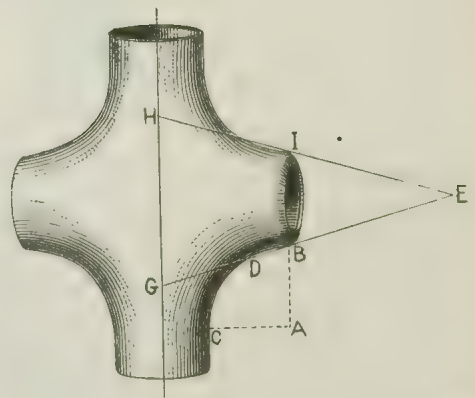

Fig. 358.—Diagram for Obtaining Pattern for One-Half of Four-Way Piece.

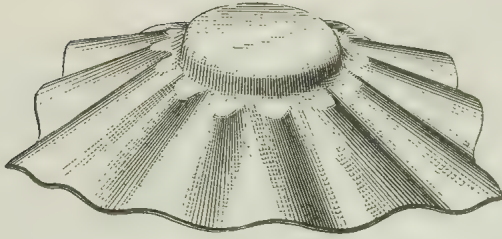

Fig. 359.—Method of Forming E, Fig. 357.

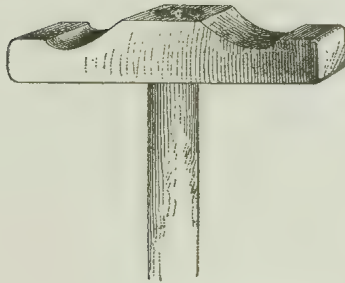

Fig. 360.—Razing Hammer.

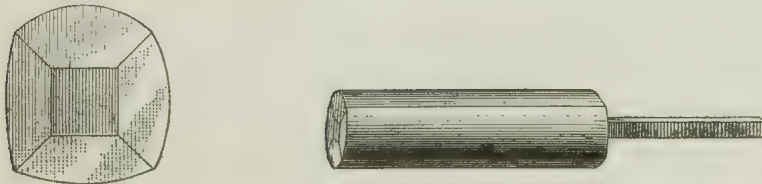

Fig. 361.—Mandrel for Working Out Four-Way Pieces.

mandrel, Fig. 361 (secured in the mandrel block or bench strap), to form the frustum, and when it is of a sufficient length turn the two ends to form the cross way.

Practice and experience only can supply the place of an instructor when making this bend. Care must be taken during the work not to press it too severely or work the metal when it is too hard, but anneal it at the close of every course; when properly formed, the edges can be trimmed off and thinned from the inside. Now take the crown of the cone, about $\frac{1}{2}$ inch from the edge, round up the edge free from rags and chisel marks, and then turn out the edge level with and forming a part of the outlet, thus extending its length that much further. It is next covered with salt and water, made blood red and quenched in clean water, scoured and dried. The halves, after one has been cramped, are now brought together and wired; the seam dressed down and brazed, the work being slung in the traveler chain from overhead if necessary. When the seams are cleaned off and the work again scoured clean, it is put in shape and final symmetry on a cod. The seam is knocked down and the piece planished over to smooth and harden it. The mandrel, Fig. 361, is a piece of cast iron or steel some 6 inches in diameter having a 2-inch square hole in the center, so that it will slide on a square bar; the four sides are planed, turned or cast from a pattern so they are segments of four circles from 9 to 20 inches in diameter, to suit the different sizes of pipes or cylinders. The mandrel is about 3 feet in length. It is necessary to have several of these mandrels of different sizes and lengths to suit different work.

THE SADDLE FIRE.

Bends made with the seams on the side are brazed on the brick forge ; but those with the seam in the throat and back must have a fire for the purpose, and made narrow enough to suit the curve of the throat seam. This fire is very useful for a great many special purposes besides the one under consideration. It is made of pieces of $\frac{1}{2}$ -inch boiler iron, Fig. 362, with four legs made of angle iron ; the height of the fire being the same as the brick forge. This fire is about 6 inches wide, 18 inches at the bottom where the blast pipe lies, and 24 inches at the top, and 10 or 12 inches deep. It is coated with an inch of fire clay, and left to dry hard ; it is then fit for use. It could be lined with fire tiles inside, made to fit, which would be better, if they are obtainable ; if not, then fire clay must be used. The blast pipe, Fig. 363, at the bottom of the forge, is perforated with holes, whose aggregate area is equal to about twice the area of the conveying blast pipes, because when necessary the wind is let in at both ends. There should be two fires of this kind, one hollowed out, as it were, to fit the pipe nearly, Fig. 362 ; the other straight across, Fig. 364, as they are often very convenient.



Fig. 363.—The Blast Pipe.

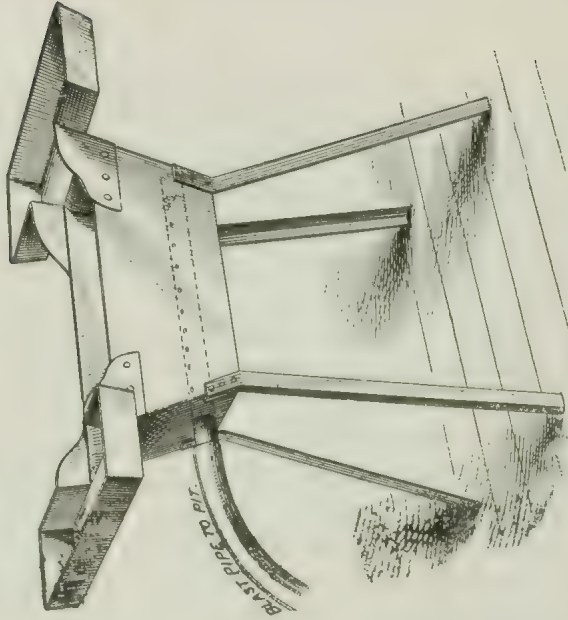

Fig. 364.—Saddle Forge with Straight Sides.

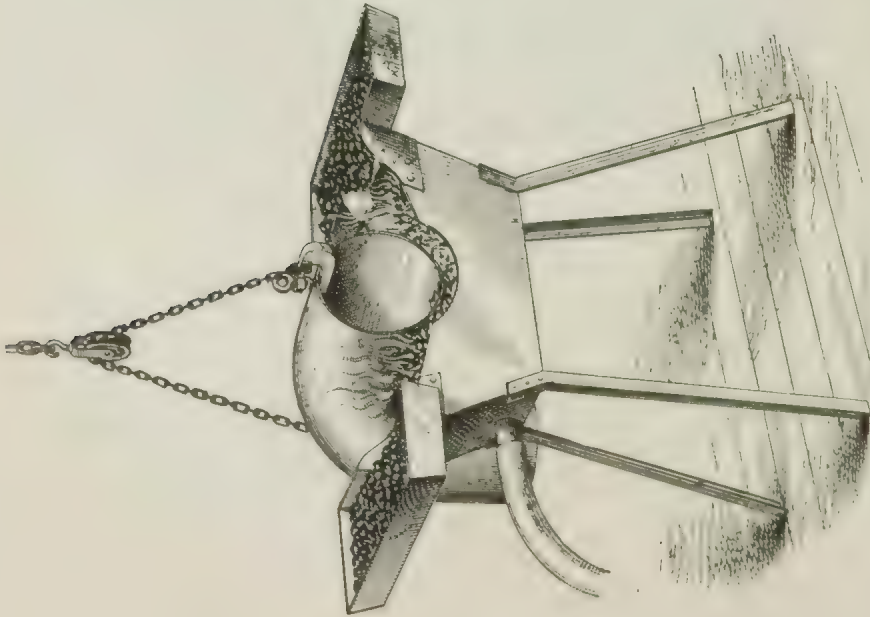

Fig. 362.—Saddle Forge for Brazing Seams.

MARINE WORK.

In the preceding chapter we have been speaking of small bends of from 4 to 5 inches inside diameter, which is the largest size usually made in locomotive works or railway shops. Marine work for war ships or ocean steamers is very much larger, requiring heavier tools and appliances, and we shall now describe some of the means employed in the working up or making of pipes and bends from 6 to 15 inches in diameter and upward. By a careful study of the engravings, Figs. 365 and 366, which we here present, * the reader can get a better idea of what marine work is than by the best written description without their aid. These large pipes and bends here represented in Fig. 365, judging by the bench vise, the jaws of which usually measure from 5 to 6 inches wide, are about 15 inches in diameter, and, as will be noticed, the bends are made saddle and back, which is the usual way of making them when the bend required is of a reasonably long curve. A specimen may be seen in the middle of the two pipes, one of which is slung over a fire, the back being slung to the traveler by suitable hooks and in position for annealing. The large pipe slung on the right-hand side of this back has just had a flange brazed on; the one on the left hand, it will be seen, is in position, and has a fire pot placed around it, for brazing a round joint, or joining this bend to another pipe. Carefully notice the standards upon which the bottom or floor of the fire pot is arranged. The pot appears to have two inlets for the blast, one on each side of the pot, so that the fire may be regulated in such a manner that all the solder will be run at the same moment of time, and the joint skimmed off all round instantly when ready. A little at one side of this pipe is an open hearth under a chimney, where the coke is prepared and made hot for the fire pot, a pan of coke being at hand. The apparatus opposite the hearth is for straightening and rounding up the pipe after the seam is made. The bend, which is slung and balanced at the vise

* These engravings are from photographic views of the interior of the coppersmiths' shop of Messrs. Maudsley, Sons & Field, one of the oldest and largest marine engine builders of London, England, and kindly furnished by them especially for this work.

bench, is in position for truing up and planishing on a cod. The next object is a wooden template for a pipe with two short bends in it, and showing the position of the flanges; further on are two breech pieces, which appear to have their seams recently soldered or brazed together, the seams being in the saddles or throats—that is, they are made in halves and from a sheet about a quarter inch thick. The several other pipes lying around are of minor interest, but the view, as a whole, gives a clear idea to the learner and those interested of what is necessary for a well-appointed shop. In the other plate, Fig. 366, the first object on the left hand is an old bending apparatus, which no doubt is still found to be very handy. The next is a large bend, apparently about 20 inches in diameter. The main object is a hydraulic bending table, the whole machine being clearly shown, with a pipe about 8 inches in diameter in position for bending, and having one bend already completed. Carefully examine this machine. The hydraulic cylinder and piston are placed in an immovable position at the table, and before it in a groove in the table is a large screw, to which is attached the handle on the right hand of the table. The two upright pillars on which the concave blocks revolve are drawn together or spread apart by a left and right thread, the link placed over the pillars being to regulate and hold the pillars securely to the place required. These concave blocks revolve to suit the condition of the pipe as the power of the piston is exerted to bend the pipe between them. The workman's chalk mark is plainly visible, showing where the bending is to be, or the power applied to effect the bending. The link which helps to hold the pillars in position is provided with a screw and sliding block so that it may be lengthened or shortened to suit the distance the pillars are required to stand apart. Another and longer link is lying on the floor to be used for longer bends. The next prominent object is a pipe with a double bend. These bends have been soldered together just where the workman's file is lying, and the joint has been made with a round fire such as we have described in a previous chapter. Behind this pipe is the back of a bend in course of construction. The block on which it is being worked is cubical and made of cast iron or some hard wood. The holes or hollows are plainly shown in the block, and each face has a different size and hollow to suit different sized pipe. Notice the travelers at each mandrel loop along the bench and at other parts of the shop which show how the work may

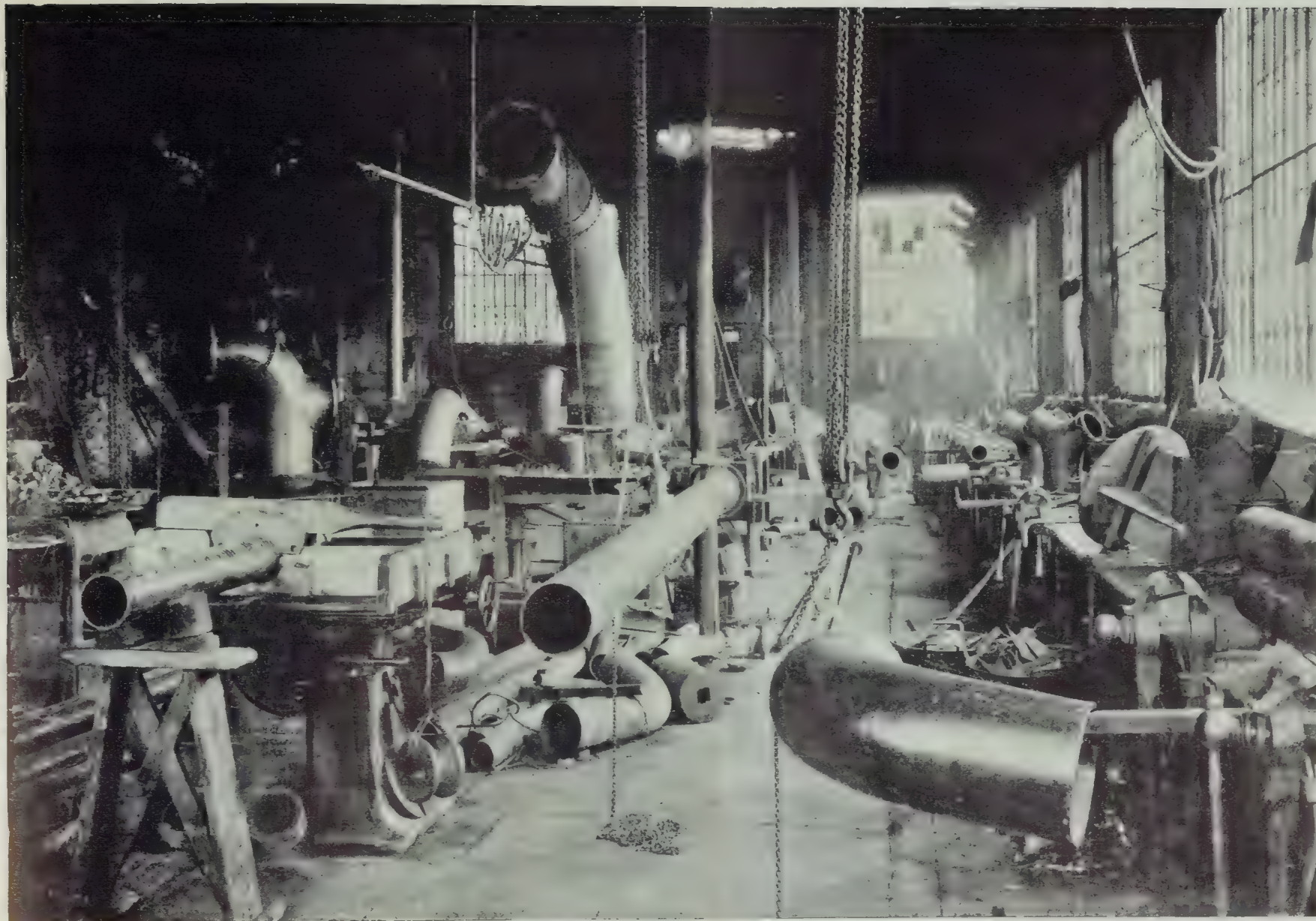

Fig. 365.—Interior View of Coppersmith Shop of Maudsley, Sons & Field.



be slung and manipulated with as much ease as possible. These views were taken from opposite corners of the shop, so that all the most important appliances could be clearly shown. The other objects are of minor interest.* As I have said before, these larger bends can be and are made saddle and back, according to the capacity of the workman or the desire of the employer ; but much better results may be obtained by competent workmen when the seam is in the throat and back, especially if the inside curve of the bend is short or of small diameter.

* These photographs have only been recently obtained. When the articles were written they were entirely from memory, and after 20 years' absence from a coppersmith's shop I notice by them there has been no material advance.

MAKING LARGE BENDS.

The large bends, Fig. 367, cannot be brought together after being formed by a vise ; it is therefore necessary to use a chain and lugs, A, and pull the halves together with a bolt. Neither can they be dragged along on the fire, owing to their weight, which would crush the coke and break down the fire, besides exposing the joint to probable injury while hot. They must be slung as shown in the illustration, so that the joint will lie level when on the side, and so that it can be brought to the fire continuously and with ease. When the slinging chains are properly adjusted, the sling is hooked to the traveler chain overhead, and the work may then be handled over the fire with ease. In the case of the joints being in the throat and back, as in Fig. 368, the halves are brought together with the chain and lugs as before directed, and then wired ; then two screw clamps N and U are fastened at each end, through which chain M is passed loosely. A hook and pulley, O, are now applied, the loose chain running through the clamps over the pulley wheel and the hook hooked to the traveler chain P from overhead, as before. By this means the throat seam may be easily handled, as also the back one, reversing the screw clamps to suit, as in Fig. 369, and guiding the work with the tongs K. A good fire is to be kindled in the forge, Fig. 362, with a supply of coke in the pans or hoppers on each side. The back of the bend is usually brazed first on the brick forge, and then the throat on the portable forge, Fig. 362. It sometimes happens that a job cannot be got at even with this narrow forge fire, or there is no convenience by which it can be used to advantage. When this is the case we carry the fire to the job, instead of the job to the fire, and charge the joint with spelter outside, carrying the fire inside with a pot having a hose pipe attached to it, Fig. 370, and slinging the fire on the traveler chain from overhead. The fire pot for this operation is made similar to those used for the joining of pipes, but with a bottom fixed to it. The work to be done governs the size and shape ; it may need to be of an oval shape in some cases.

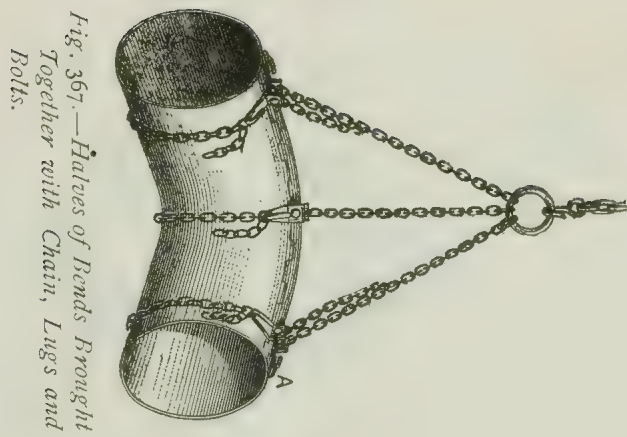

Fig. 367.—Halves of Bends Brought Together with Chain, Lugs and Bolts.

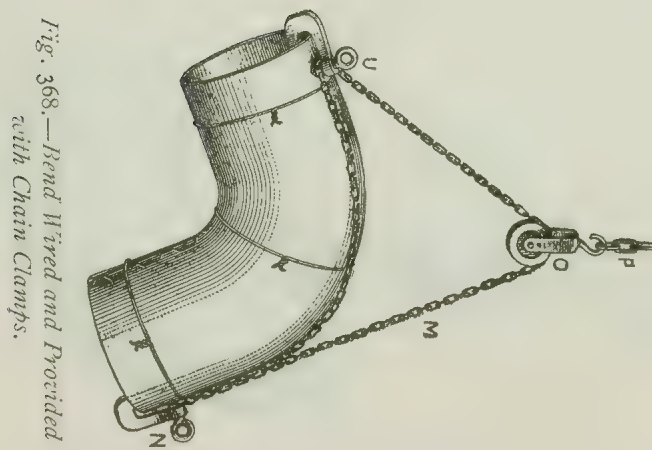

Fig. 368.—Bend Wired and Provided with Chain Clamps.

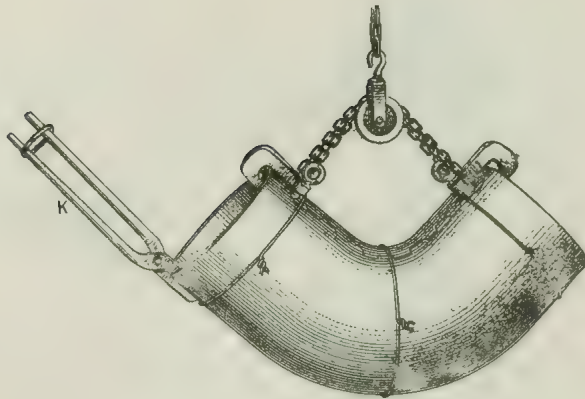

Fig. 369.—Bend Reversed and with Tongs for Guiding.

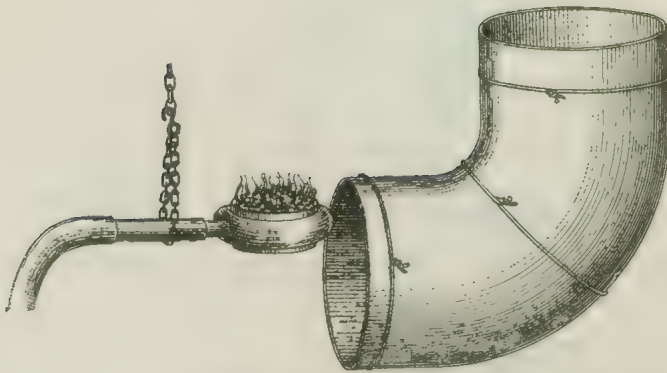

Fig. 370.—Portable Fire Pot to go Inside of Bends.

DOUBLE BENDS.

In large work we have only noticed so far single bends. We now come to double ones, which are, as occasion requires, twisted from a flat S-bend to any angle required. When bends require to be twisted they are made single and then joined and brazed together, as in Fig. 371. The operation is the same in principle as that described for joining straight pipe, the difference being only in the size of the fire pot and the manner of application, which is shown in Fig. 372. Four upright standards, with holes in them, are placed in position near the pipes, and the bottom plates laid on the two rods, which are put through the holes in the standards at the proper height. The bottom bend is held in position so that the socket is level and securely fastened there, the top bend held in position and balanced with the traveler chain and then lowered into the socket. The pot is then placed around the joint as before directed, Fig. 373, which may be in two or three sections, see Fig. 374, so the blast can be applied by two or three supply pipes, as is most convenient or may be desired to suit the work in hand. After the seams of each bend have been dressed off clean and are in proper shape, they are cleaned with a pickle made of vitriol and water, about one part vitriol and two parts water, which may be varied to suit the requirements of the job. When it is thoroughly scoured and all the acid washed off in clean water and dried, it is usual to rub some dry Spanish brown all over, so that in hammering the hammer marks can be more plainly seen. It is then taken to the mandrel block, where it is planished true and into its final shape on a cod, and hardened by closing the grain of the metal with a hammer at the same time that it is planished.

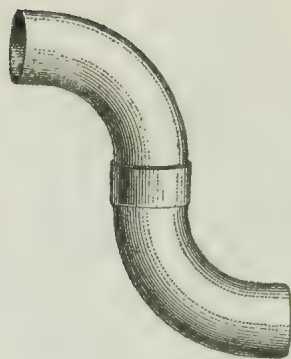

Fig. 371.—S-Bends Made by Joining

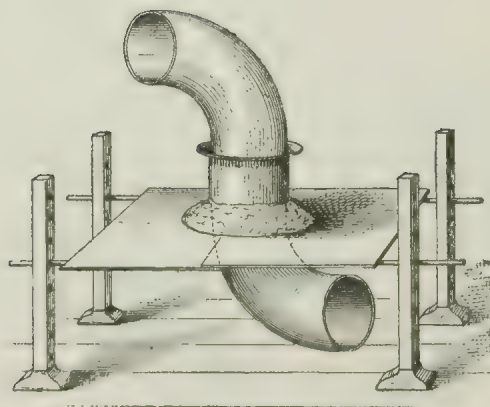

Fig. 372.—Bends at Right Angles Arranged for Brazing.

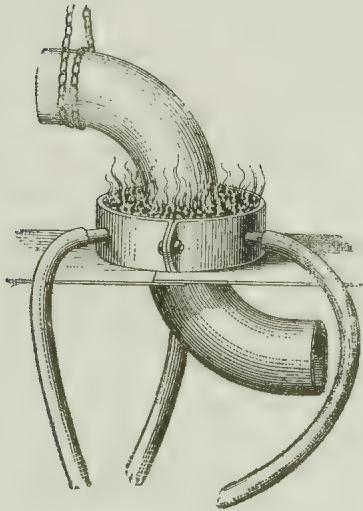

Fig. 373.—Fire Pot in Position for Brazing.

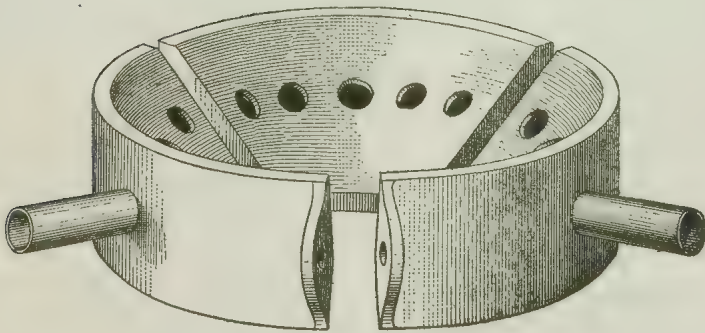

Fig. 374.—View of Fire Pot.

BRAZING ON FLANGES.

The brazing on of flanges, large and small, has caused as much or more objectionable language to be uttered than almost any other operation usually performed in a coppersmith's shop, owing principally to a want of a little knowledge, or the possession of an inquiring mind; sometimes, too, owing to the greed of a manufacturer who will palm off a flange for pure copper that will not bear enough heat to run the spelter. This entails much trouble and annoyance to the workman, and not a little loss to themselves, because the extra time spent and liability of failure more than balances the advantage sought to be gained by the use of spurious metal. In speaking thus I do not wish it understood that pure copper is the best material from which flanges can be made, for the best flanges the writer ever operated on were cast from a mixture composed of 1 pound of old copper and 1 pound of brass tubes, which reduced to its elements would make the flange about 16 parts copper and 3 of zinc; this makes the flange stiff and close grained, and much better for general purposes than pure copper. Having a good flange provided, the next thing is to have it properly prepared while at the lathe; the only thing, however, that concerns the coppersmith is the hole into which the pipe is to fit. This should be tapered $\frac{1}{8}$ inch so that it will drive on tight, the end of the pipe being reduced that much. On the face side an eighth countersink should extend into the hole one-fourth of its thickness. When the flange is eased on the end of the pipe and the pipe is through a short distance, drive it back into the countersink, turning it over a little toward the face of the flange. It is now ready so far for brazing, but before taking it to the fire, if the pipe is small, it is sufficient to stop the opposite end of the pipe with a ball of waste or a wooden plug, so that the heat cannot run up through the pipe. Around the countersink of the pipe, which is through the flange, rub some soft fire clay, and a little up the seam if it be brazed pipe. It is now ready for charging and the fire. Flanges for large pipes are bored the same as small ones, but it is necessary to take a little more precaution in preparing for the fire, so that the heat does not run up through the

pipe. In this case take a disk of light sheet iron about 3 or 4 inches larger than the diameter of the pipe and clip this disk all around with the shears at intervals of about 1 inch ; now turn the edges up, forming a kind of pan, the places clipped acting as a spring. This pan is crowded into the end of the pipe about 4 or 5 inches from the end, and some soft fire clay is plastered in the cracks of the pan all around the edge, and also around the edge of the countersink of the flange. The edge of the fire clay should be an inch or two above the flange, or above the thickness of the flange, and so that no flame goes up the pipe. See that the joint of the pipe is well covered with clay a little beyond the top of the flange where the solder is to lay. Sling the pipe so that it will hang level, and it is ready for charging and the fire. If the flanges are of doubtful metal, try their quality before putting on the pipe by trying to run a small portion of the spelter on the flange first. If it is suspected that the spelter will not run on the flange, it should be rerun—that is, remade—to do which take 1 pound of the spelter and melt it and add 1 ounce of zinc while it is in a state of fusion, and when cool enough to just char a hazel stick, place it in an iron mortar previously made warm, and break it up again. Then try it on the flange. If it still takes too much heat, or more than it is thought the flange will bear, lower it again with zinc until it runs at a low enough temperature to preserve the flange and there will be no danger of failure. Never use what is called black solder or spelter ; it is only used by those wanting a sufficient knowledge concerning spelters suitable for their work ; neither be tempted to add tin under any circumstances.

SHORT BENDS.

Another bend of a special kind is sometimes needed to be worked on the end of pipes when it is required to get the shortest possible turn that can be made so that a flange will set right down close on the straight part of the pipe, as in Fig. 375. To turn this bend we proceed as follows: First measure along the pipe a length equal to one-half the circumference of the pipe on which it is required to make the turn, Fig. 376. At the point B make a small hole, and with a round file round up the edge all around the hole carefully. Now take the steel bar, Fig. 377, having the point bent as shown, make the pipe red hot about the hole, insert the point of the steel bar and jar it out with a hammer, as shown in Fig. 378, until there is a burr or turn, C, as high as the flange is thick on the long part. Then cut the pipe from the hole to the end, as in Fig. 379, and run out the seam at the back if it is a brazed pipe. If it is drawn pipe make a hole at the back or opposite side (without burring), and cut the pipe down as far as this hole and open it out, as in Fig. 380. Flatten out the flaps. Then with the radius of a circle whose circumference would be equal to one-half of the circumference of the pipe describe the curve shown in Fig. 380, E, and from the line where the burr or bend turns take 78.75° of the circle (as shown in a former chapter), of which the section X is a part. Now thin the back edges of the flaps of the turn, Fig. 381, and work them over on a cod or some suitable bullet stake, and if large enough cramp it; then close the seam, and finish by brazing, Fig. 382. This is a method of making a short turn which it is often necessary to adopt in steam-boat work, and when it happens that workmen do not know how to make this turn a casting has to take its place at a much greater cost.

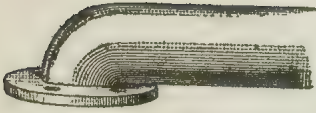

Fig. 375.—Short Bend.



Fig. 379.—Manner of Cutting Pipe.



Fig. 376.—Pipe Measured for Bend.



Fig. 380.—Pipe Opened Out.



Fig. 377.—Burring Bar, for Enlarging Hole for Bend.



Fig. 381.—Edges Thinned.

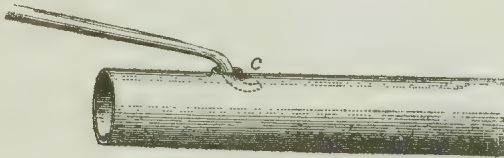

Fig. 378.—Enlarging Hole with Bar.



Fig. 382.—The Finished Bend.

AIR PIPES.

Air pipes are used by ocean and other steamers for conveying fresh air from the upper to the lower decks and are somewhat similar in form to the bowl of a tobacco pipe, Fig. 383. They are frequently made of copper, the mouth being of any size required to catch and convey a sufficient quantity of air to the lower decks and cabins. When made of copper, the easiest and most economical way is to make the bend of three pieces or sections, as shown in Fig. 384. After the pattern has been cut out, the pieces, *b* and *c*, Fig. 385, are thinned at each end and cramped; they are then bent, as in Fig. 386, and held together with dogs, *d* or *f*, Figs. 387 and 388, at each side, as shown.

Now wrap a chain around the section, as in Fig. 386, and sling it to the traveler so that it hangs level. Take a little warm borax and water, the borax having been previously dissolved, and jar the joint so that some of the liquid may penetrate through and all around and under the cramps in the joint, then charge it, laying the spelter on first with a short reed. Move the spelter over the edge of each cramp in a zigzag form, then slowly dry it; when dry, slowly heat it, first on one side and then on the other, until the part is red hot and the spelter is all down on the joint; next bring it over a brisk flame and run down the seam. The directions given may be followed for the other two sections. When the seams are cleaned off and knocked down and the sections annealed, open them and round them up on the mandrel block for the next step, which will be to draw the edges in at the back part extending to one-fourth of the circumference from the center of the back each way. This is done on a suitable head, Fig. 390, secured on a bent bar fastened in the mandrel block B, the part drawn in forming part of the regular curve and some 2 or 3 inches wide. When this is done sufficiently, pare the edges true, and see that the two parts which are to be joined together are exactly the same size in diameter, or as near so as possible; then thin them with a hammer, which may need to be done with the pane if the copper is heavy, or with the face if it is light. When the edges are thinned and the ragged edges, if any,

Fig. 383. —Air Pipe.

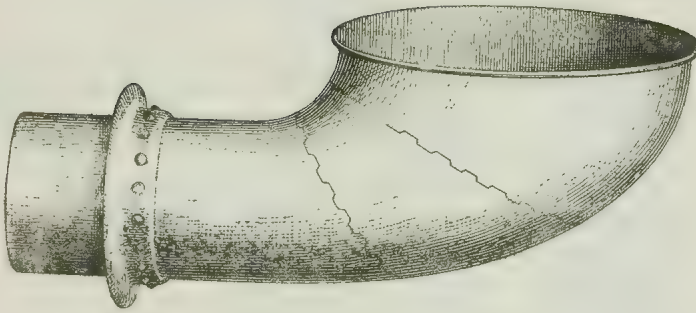

*Fig. 384. —Air Pipe Made in
Three Sections.*

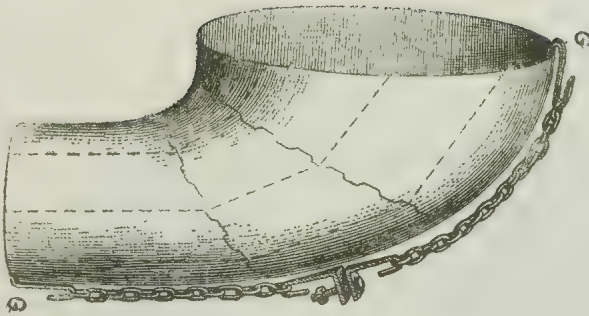

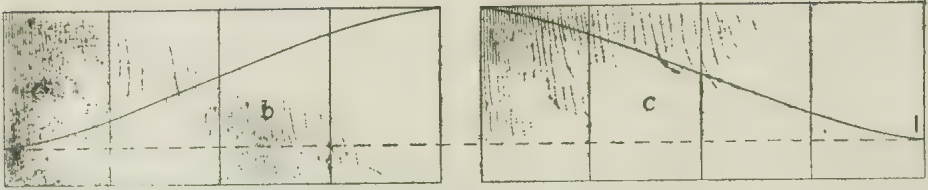

Fig. 385. — Pattern of Air Pipe Section.

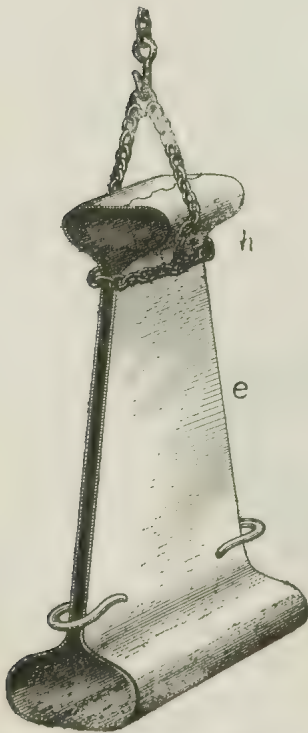

Fig. 386. — Section of Air Pipe Ready for Brazing Seam.

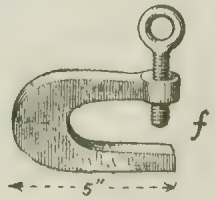
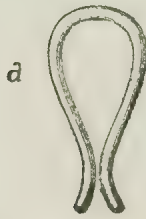

Fig. 387. — Spring Dog. Fig. 388. — Screw Dog.

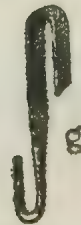

Fig. 389. — Chain Hook.

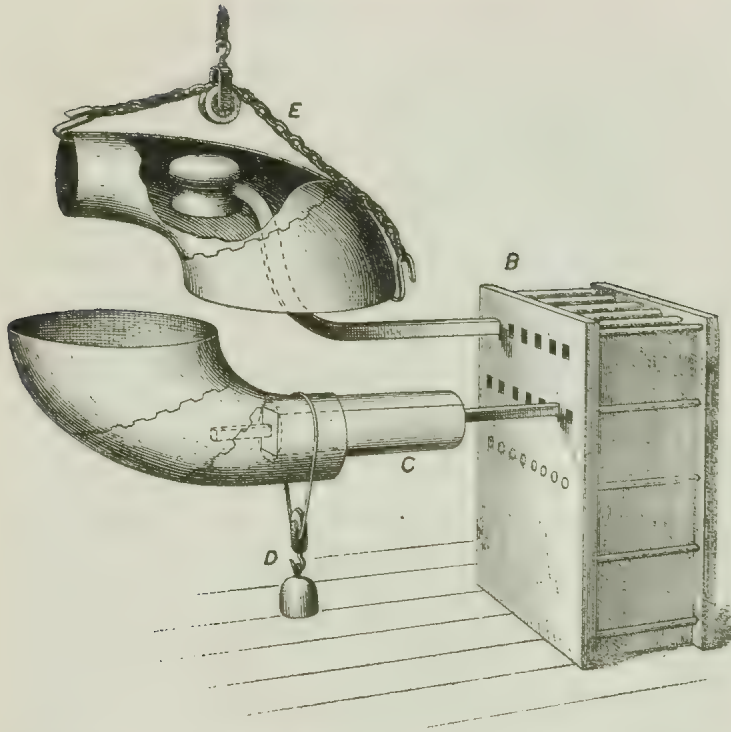

Fig. 390.—Planishing the Air Pipe on Head and Mandrel.

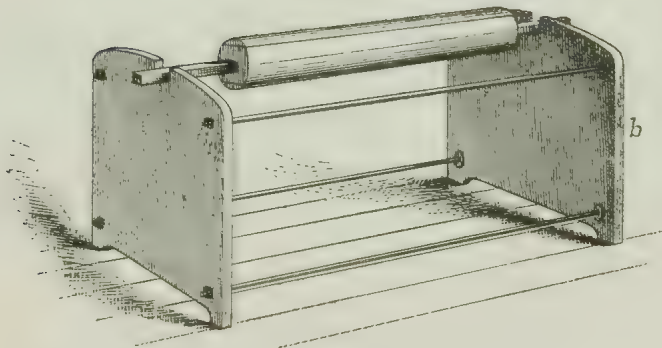

Fig. 391.—Mandrel on Trestle Frame.

filed smooth cramp one side, making the cramps which will be on the inside one-half longer than those on the outside. Bring them together and secure with the lugs and chain, as in Fig. 384, the hooks *g*, Fig. 389, being made to hook on the ends of the pipe. When the seam is closed down true make a suitable cradle with wire and sling it, and proceed to charge the cramps, following them in their zigzag path so that the spelter covers the edges of the cramps, not forgetting to jar through it previously a solution of borax. Dry the spelter and heat the joint slowly. When hot enough show it to a medium brisk fire and run the joint around. After the circular joints are made, knocked down and annealed, scour it clean with vitriol and water and rinse off clean and dry it. When dry rub it over with Spanish brown. Now shape it up true and planish on the double-faced head, Fig. 390, at the mandrel block, finishing the small end on the mandrel *C*. The endless rope and small pulley *D* has a weight hung to it sufficiently heavy to counterbalance the weight at the large end. The chain and pulley *E* and sling hooked to the traveler chain assists the operator by balancing the work and giving him power to manipulate it with ease.

The straight conductor pipe to convey the air to its destination is usually of light copper and made in lengths of from 6 to 8 feet long. Straight steam pipes may be made from material from $\frac{1}{8}$ to $\frac{1}{4}$ inch thick and from 6 to 8 feet long. To planish these pipes after being made and properly cleaned a mandrel is placed on a trestle frame, Fig. 391, which supports the bar at both ends, or one end may be secured in the mandrel block and a screw crutch, *A*, Fig. 392, placed under it at the other end to support it. The mandrel should run through the entire length of the pipe, or as nearly so as is practicable.

The planishing should begin in the middle and finish at the ends; that is, about 2 feet at a time, beginning with the first 2 feet in the middle of the pipe, then finishing up at the joint after the planishing of the whole length has previously been completed. The planishing is done with a bright double-faced hammer, No. 3, Fig. 393, of sufficient weight, a number of which form the necessary equipments of a shop, and vary in size and weight from 8 ounces to 3 pounds or more, having square and round, flat and bullet faces, others having two panes for razing down, and bullet faces for hollowing up. These hammers are carefully looked after, and kept bright by being cleaned on a buff-board before being put away in the rack, and greasing with

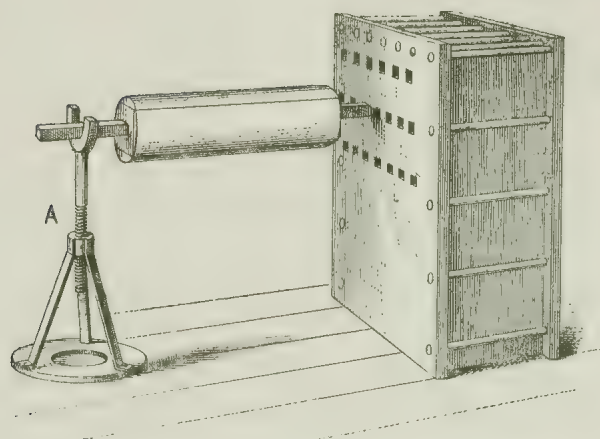

Fig. 392.—Mandrel for Planishing Long Pipes.

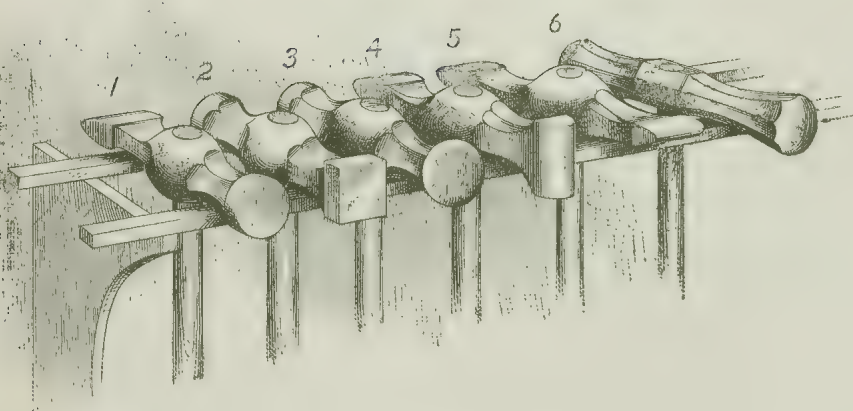

Fig. 393.—Hammer Rack.

pure goose grease to protect them from the various gases and acid vapors which always occupy a coppersmith's shop more or less. The hammers shown in the rack, Fig. 393, are No. 1 round face and pane; No. 2 round and square face; No. 3 two round faces; No. 4 cross paned; No. 5 two flat paned; No. 6 bullet or hollowing.

HOLLOW SPHERES.

The forming of spheres or balls has taxed the ingenuity of the youthful metal worker, it is presumed, in all ages; the coppersmiths of my youth have, and those at present engaged in the craft will continue an ineffectual wrestle with this problem until there is a more universal application of the system of industrial or technical education so happily inaugurated now in some of the large cities. How strange it is that our public educators scarcely ever seem to venture from the beaten paths of school book routine for the purpose of assisting the student to grasp a subject or shed a little light by which a pupil can mark out his course prior to an apprenticeship. The properties of circles, squares, cubes and spheres are all Greek to the majority of boys sent into a shop ostensibly to learn a trade, and particularly does this happen in country places, as in the writer's case, where among all the men he was brought in contact with it is not remembered that one could measure the superficial area or solid contents of a single vessel they were working at in a mathematical way; it seemed one continual grope in the dark, guessing, or working by rule of thumb. It is hoped that this chapter may be so clear that any one who will exert an effort to make himself familiar with any ordinary work on mensuration will be able to form a hollow sphere of any metal ductile enough to bear the different operations necessary to its formation. The greatest stumbling block has been a want of knowledge as to the exact size of patterns necessary to cover the surface. It is a well known property to those versed in geometry that the convex surface of a sphere is equal to its circumscribed cylinder, or the surface of a sphere is equal to four times its generating circle; that is, the surface of a sphere is equal in area to that of four disks whose diameter is the same as that of the sphere. Then the surface of one-half a sphere would be equal to two disks the same diameter as the given sphere. Now, as hollow spheres, or balls, are usually raised up in halves, therefore to make a ball we must first start with two disks of metal, the surface of each being equal in area to the sum of two others whose diameters are the same

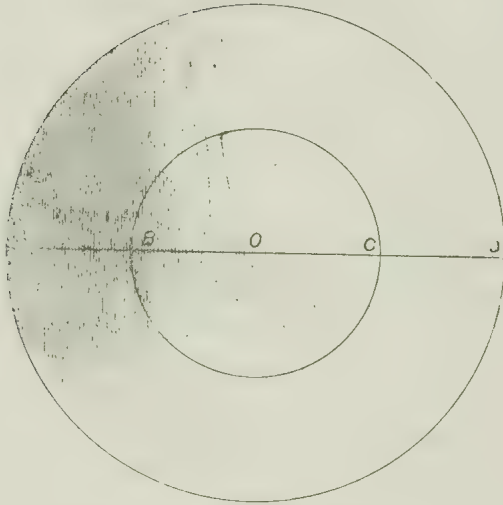

Fig. 394. Disk for Half Ball.

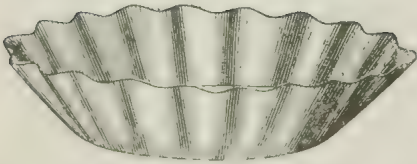

Fig. 395. —Disk Wrinkled for Forming.

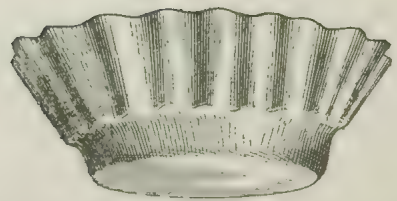

Fig. 396. —Disk with Wrinkles Partly Drawn Out.

as the diameter of the hollow sphere required; that is, the two taken together shall equal four times the surface of a circle whose diameter is equal to the diameter of the ball required.

Let it be required to make a hollow sphere, or ball, 9 inches in diameter; then $9 \times 9 \times 2 = 162$, the number of circular inches in the convex surface of one-half a sphere 9 inches in diameter; therefore,

$\sqrt{9 \times 9 \times 2} = 12.729$, the diameter of a disk of metal required to make one-half a hollow sphere, or ball, 9 inches in diameter, no allowance being made for the thickness of metal or for joining together. Let us add these now, and suppose the metal to be $\frac{1}{8}$ inch thick, and that the joint requires $\frac{1}{2}$ -inch lap, which will be a quarter on each half; then the area of this $\frac{1}{2}$ -inch band for lap or joint will equal $9.125 \times 3.1416 \times .5 = 14.3335$. Converting this into circular inches we

have $\frac{14.3335}{.7854} = 18.25$. Dividing this by 2 and giving one-half to

each disk we have $\frac{18.25}{2} = 9.125$. Therefore, the whole value of one disk for one-half of a 9-inch hollow sphere $\frac{1}{8}$ inch thick, and $\frac{1}{4}$ inch for lap will be $(9.125)^2 \times 2 + \frac{(9.125 \times 3.1416 \times 5 \div .7854)}{2} = 175.6562$

and extracting the square root of this last result we have 13.2535, the size of a disk required for one-half the ball.

We will now proceed to raise these halves to the spherical form. First, divide the diameter A D, Fig. 394, into four parts, as shown by A B C D, and with the radius B O describe the circle B C, which will be about $6\frac{3}{8}$ inches in diameter. Wrinkle the disks in spaces of about 2 inches apart at the outer edge, forming a pan, as shown in Fig. 395; now take it to the floor block, Fig. 397, and on a suitable bullet head in the shank S take in the first course, draw out the wrinkles, working first on one side of each one, as in Fig. 396, and then on the other until they are all worked out and are smoothed down. Now smooth it some with the face of a hammer. This will conclude the first spell. Anneal it by heating to a cherry red, cool in water and wrinkle again, making the wrinkles which were the lower ones in the first spell the upper ones in the second, and continue the process with the razing hammer until the last course. This is brought up to the size without wrinkling. It should be a little under size, because smoothing and planishing will expand or draw it some, there-

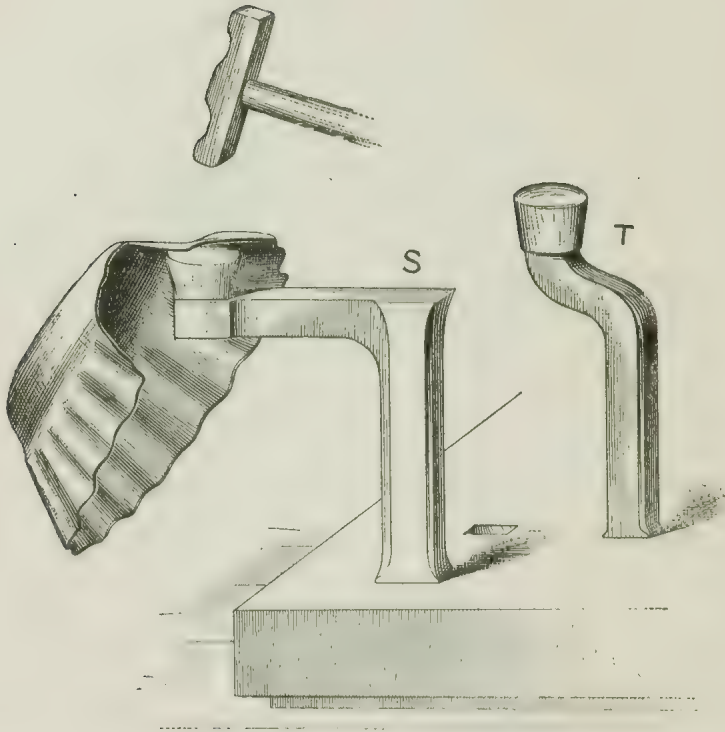

Fig. 397.—Floor Block with Stakes and Head for Forming Half Balls.

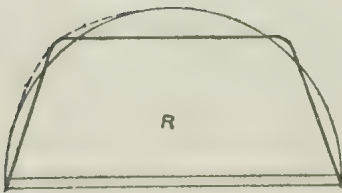

Fig. 398. Section Showing How Half Ball is Formed.

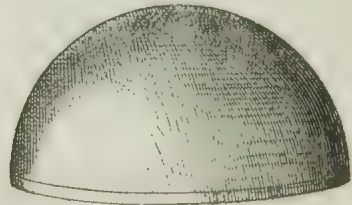

Fig. 399.—Finished Half Ball.

fore it may be about $8\frac{1}{2}$ inches in diameter when finishing the last course before smoothing. We now are supposed to have two pans as shown at R in Fig. 398, that are about 6 inches at the bottom, and $4\frac{1}{2}$ inches at the side. These are to be taken to the block and on a suitable bullet head, S, or bullet stake, T, Fig. 397, break down the lag or corner of each pan with a mallet. As this is being done, the curve will be bulged out, part in the bottom and part in the side, as indicated by the dotted lines in Fig. 398. It is now easy to smooth them down true to the size required, after which anneal, clean and planish, as in Fig. 399. They are then ready to put together and finish the sphere.

The directions in the foregoing are for metallic balls raised or formed of two solid pieces or halves—that is, with the middle seam only. It often happens, however, that time is an object in the construction, as also sheet metal of a sufficient size or convenient shape from which to make a ball in two solid parts. When this is the case, it may be made in this way: Let it be required to construct a ball 10 inches in diameter; then proceed as follows to get out the pattern for one of the halves: In Fig. 400 on the line A B describe the semicircle B C A, 10 inches in diameter, and with the radius A E divide the circumference of the semicircle into three equal parts, as shown by B H, H G, G A. Divide the versed sine C D into two equal parts, and through the center of it draw the line Y X and similar lines V Y and X O parallel to B H, H G and G A; then the convex surface of a truncated cone, Fig. 401, represented by the lines V Y, Y X, X O, Fig. 400, will equal approximately the convex surface of one-half of a sphere, which is represented by the semicircle B C A. Extend V Y and O X to K; then with K as center describe the arc O N S and with the distance V O space off three spaces on the arc O N S, as shown. With the radius K X describe the arc X M Z and join S K; then O N S X M Z will be the pattern for the frustum of a cone, Fig. 401. File and round up the edges to rid them of all rough burrs, cracks or flaws, and thin the edges O X and Z S. Cramp one side; then double up the pattern, as shown in Fig. 402, and braze the seam as directed for section of air pipe. Clean off the seam and knock it down—that is, hammer it down so that the joint is the same thickness as the rest of the sheet; then round it up true, producing the sides of an inverted pan without a bottom, shown in Fig. 401. The next step is to prepare the pan for the bottom. 1. Commence to form

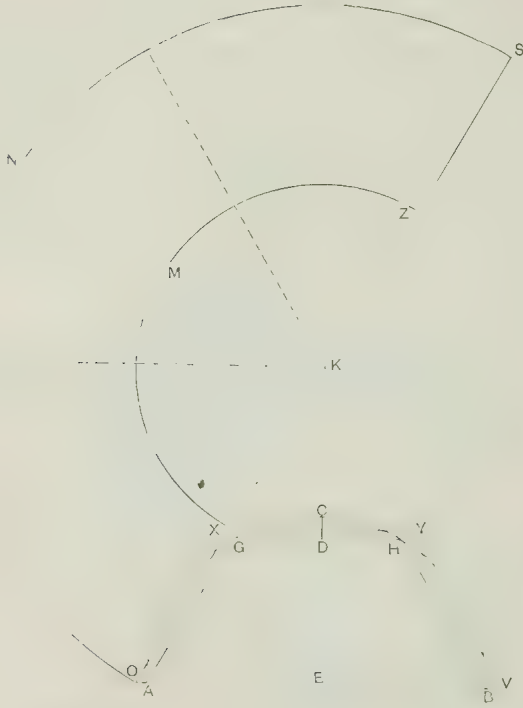

Fig. 400. Method of Describing Pattern for Half Ball.



Fig. 402.—Showing Pattern Doubled Up.

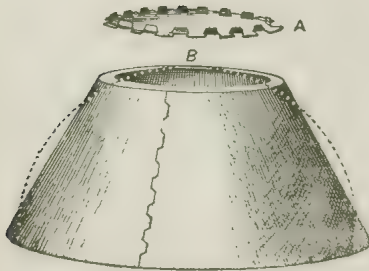

Fig. 401.—Pattern Formed with Seam Brazed and Lag Raised.

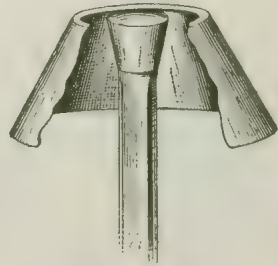

Fig. 403.—Raising Down the Lag for Bottom.

the lag by a course around the small end about $\frac{3}{4}$ inch wide on the end of a mandrel of suitable size ; then anneal on the brick forge, cool and take to the floor block, and on a bottom stake, Fig. 403, finish razing down the lag for the bottom. Next cut out the bottom, which may be the exact size of the hole or a trifle larger, and thin the edges both of the bottom and the part forming the lag, after which cramp the bottom with a chisel if it is of heavy copper, and with the snips or shears if of light. Open the cramps far enough so that the bottom may be put in from the under side, or inside, each alternate cramp going through the hole ; that is, one inside and one outside. Place it on the bottom stake and smooth down the seam and "popp" the bottom by a few blows in the center, then spring it in and out a few times — this will loosen the joint and answer the same purpose as chattering straight seams, to give room for the borax and spelter ; it is now ready for the fire. Charge the seam with spelter as previously described, following the cramps in their zigzag path around it ; then take it to the fire, and when the borax and solder are thoroughly dry roll the sides of the pan around on the fire, using a pair of duck-bill tongs for the purpose, until the fire can just be seen through it. Show the seam to the fire, turning the pan while the spelter is running ; then cool, clean off the joint and knock it down smooth, and afterward anneal it. Take the pan to a suitable bullet head and raze a course at the brim, enough to make it about $9\frac{7}{8}$ inches in diameter ; then break the lag down, round up smooth and planish. To one who is apt and quick at perception the outlines suggested above will give the cue for many similar pieces of work which offer themselves occasionally to the practical coppersmith or sheet-metal worker, who is called on sometimes for something out of the common run of every day work. One of the uses to which an article of this kind may be and often is put to when suitably perforated is a strainer to keep out rubbish that might interfere with the working of bilge pumps on ships, or it may be used wherever it is necessary to have a strainer with capacity largely in excess of the pipe leading to the pump.

BRAZING SHEET BRASS.

In both marine and locomotive work there is sometimes considerable ornamental brass work of various kinds, such as edging for splashers, coping, hand rails, domes and a variety of moldings, and I have often witnessed a good deal of annoyance and disappointment among workmen (myself included) on account of their want of knowledge in relation to the law of expansion and contraction while attempting to braze joints necessary to the completion of their work. Then, again, the many different kinds and qualities of brass made and sold often lead men into trouble, partly through the deception of the dealer or manufacturer, but mainly through their own ignorance of the nature of the material they are expected to work up.

There are so many mixtures called brass that unless the workman is quite familiar with them, or on the alert and wary, he may encounter a failure when least expected. After much unpleasant experience in this direction it has been learned that when working on sheet brass of an unknown quality which it is required to join and solder together, before the work is begun, it is best to take a small corner and try its merits with such spelter as may be at hand; if it can be made to run with ease on the scrap being tested, there will be no further trouble, but if it will not run on it, then it is desirable and necessary that some should be procured that will. After the work is cut out there are usually some scraps that cannot be used for anything to advantage; take a portion of these scraps, if there are any (if not, take a part of the sheet) say 1 pound, and having provided a small crucible, melt the scraps with some borax, and in the mean time have 1 ounce of zinc melted in a ladle; when they are both in a liquid state, mix in the zinc and stir with a stick, then pour it out, and when cool enough to only char a hazel rod, break it up in an iron mortar and try its merits on another scrap of the brass. If this new composition, now to be used as spelter, is found to require too much heat, melt it again and add a little more zinc, so it will run with safety to the work in hand—that is, without fear of burning the parts adjacent to the joint

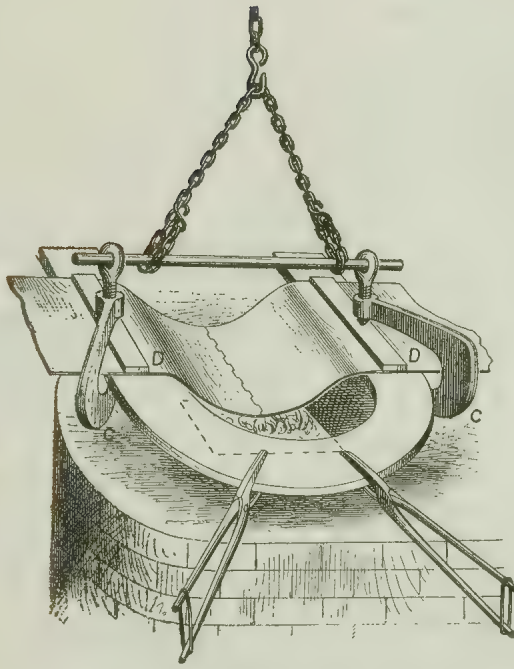

Fig. 404.—Brazing Seam in Sheet Brass.

or having the cramps fall off from excessive heat. Brass made to have a silvery hue when polished is always difficult to work, and requires the utmost vigilance while being brazed, as well as in the preparation for that operation. In some instances it is necessary to add a little silver to the spelter in addition to the zinc, which will reduce the heat necessary to run it, and add to its malleability; the quantity required, however, will necessarily depend on the kind of brass, and must be left to the scrutiny of the operator. Having procured a spelter suited to the brass, we will suppose the work requires a strip of brass 12 inches wide to be joined and brazed together; then trim the edges of both ends and thin them, and cramp one. The next step is to prepare a frame from a piece of $\frac{1}{2}$ -inch boiler plate, Fig. 404, in the shape of a horseshoe, some 4 or 5 inches wide, and about 15 inches long, also two screw clamps C, and two pieces of bar iron D, strong enough to hold the brass fast on the horseshoe plate when the screw clamps are applied. Bend the sheet in the form shown, so that when the joint is brought together within the horseshoe frame it will hang in a curve or bag between the legs of the frame. Now bring them together, open the cramps and let them receive the end of the other piece, and screw it fast to the plate with the clamps. Put an iron rod through the screw clamps and sling it to the chain. Remove it to an anvil and close down the joints, care being taken that all the spring is taken out of the parts about the joint before going to the fire. When at the forge, jar some liquid borax through the joint, charge it, and sling it so that it will balance and hang level; then with a slow fire heat the parts within the frame gradually until the solder is all down; then with a gentle fire the joint may be easily and successfully run down.

The strongest spelter used by coppersmiths for heavy work is composed of three parts copper to one of zinc. Another is made of eight parts of old tubes or Bristol brass and one of zinc. Another, for copper of medium strength, is composed of 16 parts copper and 12 of zinc; for the better kinds of brass, 16 ounces of copper and the same amount of zinc. It may be well to notice here some of the many alloys called brass. The following have been collected in a promiscuous way, as opportunity has offered, and are presented for the benefit of those interested:

	Copper. Ounces.	Zinc. Ounces.
Bristol brass	16	6
Muntz metal	16	10 $\frac{2}{3}$
Pale yellow brass	16	12
Muntz sheathing	16	16
Mosaic gold	16	17

	Copper. Parts.	Zinc. Parts.
Brass, reddish yellow	86.6	11.4
Princess metal	83.0	17.0
Rolled brass	79.6	20.4
English brass	74.6	25.4
German brass	66.2	33.8
Watchmakers' brass	49.5	50.5
Pinchbeck	88.0	11.0
Tombec	44.5	15.5
Mannheim gold	70.0	30.0
Button brass (white)	30.4	69.6
Bath metal	32.0	9.0

Cymbal metal, 80 copper, 20 tin.

Gilding bronze, 82.3 copper, 17.5 zinc, 0.24 tin. 0.02 lead.

Button metal, 32 brass, 4 zinc, 2 tin.

Tutenag, 45.7 copper, 36.9 zinc, 17.4 nickel.

Chinese white copper, 40.4 copper, 25.4 zinc, 31.6 nickel, 2.6 iron.

It will be seen that the workman who is ignorant of the many alloys commonly called brass, and incapable of forming an opinion as to their quality or the spelter necessary for the particular kind he may have to work up, can very easily and innocently fall into an error and be placed in a very unpleasant position. I have found but little charity shown toward workingmen, or by them, when innocent failures of this kind have happened, and I have had my share. It is hoped the tables above given may be the means of assisting the young workmen, and old ones who are willing to learn, to avoid the chances of failure likely to occur in the working of any of the poorer kinds of brass, if called on to do so.

LOCOMOTIVE BRASS WORK.

Among the various kinds of metals and their alloys which have been brought into use and wrought from the sheet into many forms of ornamental work, there is none excepting the two precious metals that has or can give to the zealous workman as great delight and satisfaction for the labor bestowed as sheet brass; it matters little what hue or tint may be the most prominent, there is always a pleasant satisfaction after the work is finished, cleaned and polished. Especially is this the case when the work is finished complete from the hammer. The thought ever present in the mind of the careful workman, that the result of his efforts is destined to be brought under the scrutiny of the public eye, as well as of his fellow workmen, is an incentive to greater caution and care on his part, that the work shall be carefully and well performed. While there is work executed in copper which requires much greater skill on the average than is called for ordinarily in working sheet brass, it is almost always from the nature of things carried out of sight and covered up. Most workmen like to work brass after they have become familiar with its properties, and have learned by experience the best method of treating it during the operation of shaping to the form desired. In this article, closing the description of a coppersmith's shop adapted to marine and locomotive work, I will describe three pieces of ornamental brass work for a locomotive, at the same time showing the necessary appliances and their application, so that the young mechanic may, by using ordinary intelligence, successfully perform that which has been and is now under some conditions regarded as a leading or first-class piece of work in the coppersmith's art, and which will serve as a guide to others of a similar nature, although they may be required for an entirely different purpose. The best brass—that is, the safest for the beginner—is Bristol brass (see tables in a previous chapter), which, being composed of 8 parts of copper to 3 of zinc, leaves a good margin for the spelter, which is of equal parts copper and zinc, and will run readily on brass as low as 6 of copper and 3 of zinc with safety.

Now, it would seem there are fashions in dress even among locomotives, for at one time they were covered with ornamental brass work and were very attractive. Among these ornaments was a chimney to take steam from the safety valve, while another was a cover for the regulator dome. These were of many different kinds and shapes, and as the three I shall now consider will answer as a guide to all the rest, I will try to give the details as fully as possible, so that they may be easily understood by those interested and seeking such information. Let Fig. 405 represent the covering for a safety valve, and also to answer the purpose of a chimney to convey the steam escaping from the valve, above the head of the engineer. These chimneys were about 2 feet 6 inches in height, and some 18 inches in diameter at the base, the foot of which was razed out and given an easy graceful flow over the boiler. The chimney proper, as will be seen by *a b c* of Fig. 406, was made in three pieces, which with the base, or foot *d*, made four. Thus the cover at the outset was in four pieces, three of which, *a b c*, were brazed together after being formed into shape, and the fourth, which was the base or foot, slipped into a bead formed on the lower end of the chimney and soft-soldered in place. I will now give directions for forming it, and for the different stages through which it will pass until finished, together with the tools used. Let it be required that the bell *a*, Fig. 406, at the top, measures 12 inches, the straight part *b* measures 7 inches at the top and 8 inches at the bottom, and the bell *c* 18 inches at the bottom. First prepare the top, the outer edge of which must be enough larger than 12 inches to cover a $\frac{1}{4}$ inch wire, say, about $\frac{1}{2}$ inch each side; then the bell at the top before wiring would be 13 inches in diameter. The curve or flow of the bell is most pleasing to the eye when it is an elliptic curve, as shown in Fig. 407, all the lines of which are given as a guide. Let *a y d b* of Fig. 408 represent the top bell of Fig. 407 before wiring—that is, with the edge flat and measuring 13 inches in diameter, the bottom next the pipe or straight part being 7 inches. Draw the line *a b* of Fig. 408 from the point *a* $\frac{1}{2}$ inch from the outer edge through the points *a* and *b*, and divide the versed sine of the arc or curve into three equal parts. From the point *b* on the line *b d* mark off a distance equal to one-third the length of the versed sine, and from the point *a* on the line *a y* mark off a distance equal to two-thirds of the length of the versed sine. Draw the line *m c* and con-

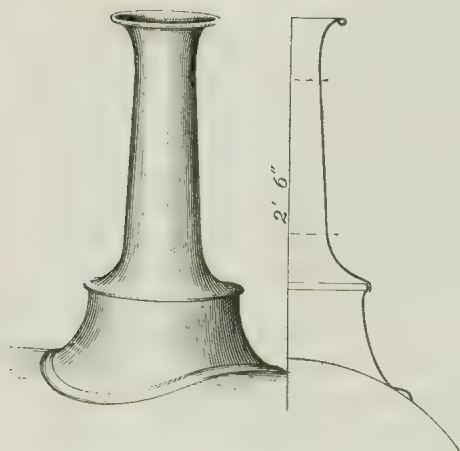

Fig. 405.—Valve Chimney.

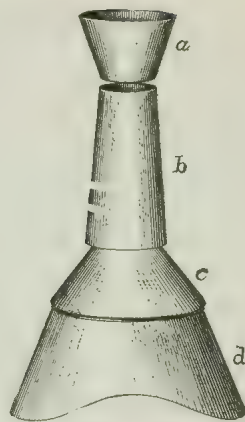

Fig. 406.—Parts of Valve Chimney.

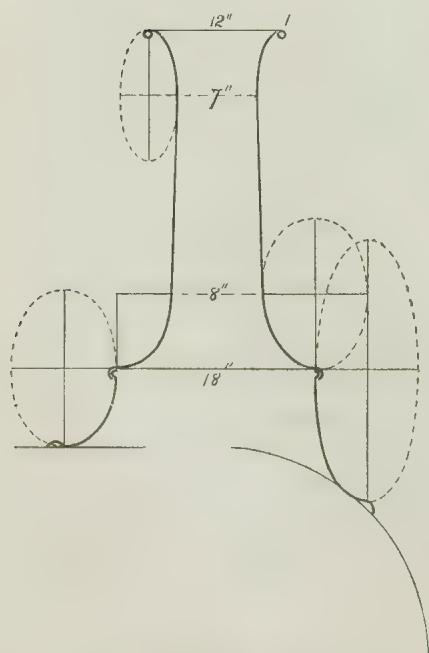

Fig. 407.—Manner of Obtaining Curves for Valve Chimney.

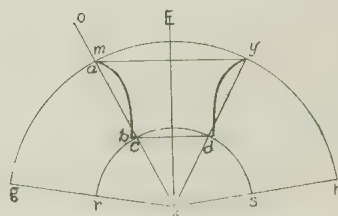

Fig. 408.—Manner of Obtaining Pattern for Bell.



Fig. 409.—Bell Folded and Suspended by Chain Ready for Brazing.

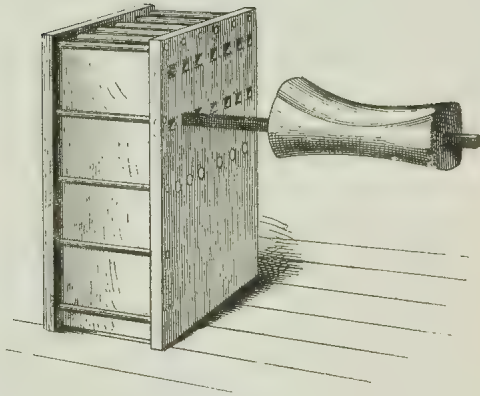

Fig. 411.—Mandrel for Planishing Bell.

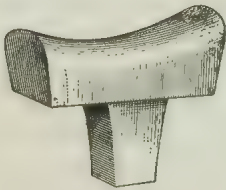

Fig. 410.—Saddle Head for Planishing Bell.

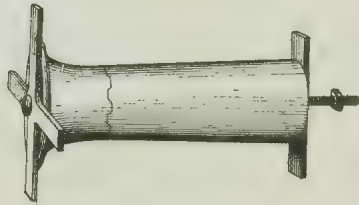

Fig. 412.—Bell and Straight Part Cramped Together.

tinue it to x . Draw xy . From the points c and d on the lines xo and xy , lay off the length of the curved line of the bell; then, with the radius xy thus obtained, describe the arc $g a y h$, and with the radius xs describe the arc $r c d s$. Then the surface of the truncated cone $c d m y$ will equal approximately the surface of the bell of which $g a y h s r$ is the pattern. The pattern for the bottom bell may be obtained in a similar manner. File up round the outside and inside edges, after which thin the two ends and anneal and cramp them. Then fold it up as shown in Fig 409, being careful that the two edges lie snugly together, and that all the spring is taken out after the joint is laid and ready for the fire. To assist in this, let the pattern be held together by four dogs, two on each side, as shown. Jar a little borax and water through the joint, and charge it. Now sling, and with a clean fire slowly heat it, first on one side and then the other, until the borax is all down; then with a gentle fire the joint may be easily run down. When cool, the joint can be cleaned, care being taken to see that all cramps are well filled. If any are deficient, open the cramp and carefully clean it on the under or inside, then close it down and lay a little fresh spelter on the outside and inside, and run it afresh, keeping the solder outside from oxidizing by applying powdered borax. After the seam has been cleaned off outside and inside it may be rounded up into shape. A hammer should be used as little as possible in dressing the joint. If an oven of a proper heat is at hand, the annealing can be better performed in it than in any other way. If there be none, place it over a clean coke fire, and gradually make it blood red. When cool take it to a suitable sized mandrel, and with a ball-faced mallet work out from the inside a light course at the small end, then turn it up and work out a course at the large end, also from the inside. Now hang it on the mandrel and work in a course each way from the outside, being careful that the blows are regular, so that all parts receive an equal amount of working strain. If this is not properly attended to it may crack when the annealing begins, as brass is very brittle when hot, hence it is necessary that the work should be performed regularly and uniformly all around in each course. When by continued courses, first inside and then outside, the desired curve is obtained, the edges at the small ends of bell and pipe may be thinned and annealed and the pieces planished, leaving

enough of the outer edge of the bell soft to cover the wire at the top end and to form the bead to receive the foot at the bottom. The planishing is best performed on a saddle head, Fig. 410, if one is at hand ; if not a mandrel, Fig. 411, may be cast to suit the curve and slide on a bar fastened in the mandrel block or in a loop in the bench. When the planishing of the two bells and the straight piece is completed and all the edges are thinned, annealed and scraped or filed clean, cramp the straight part and bring the bell to it, as indicated in Fig. 412, and with a bolt and two pieces of stiff iron draw them together, passing the rod through them and pulling them together, as shown. Smooth down the cramps, and the work is ready for the fire.*

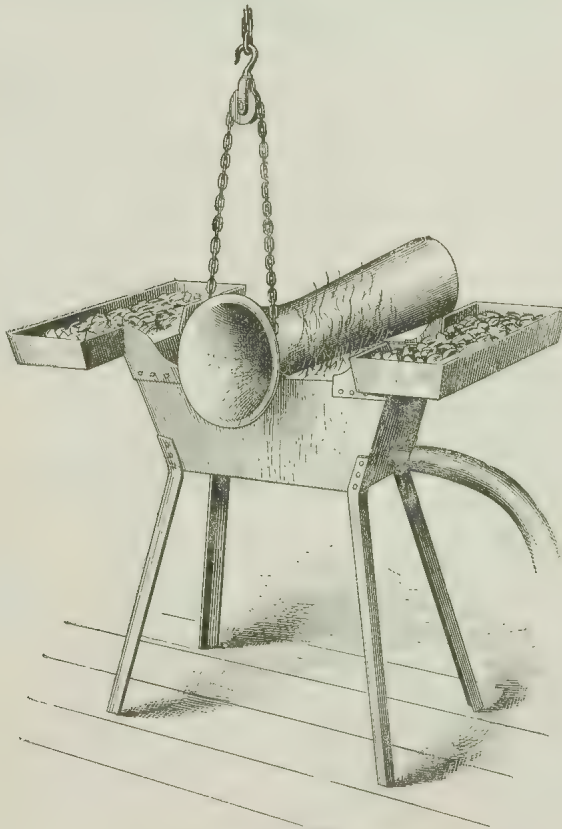

Fig. 413.—Saddle Forge.

* When the writer first began making these chimneys a number of failures resulted, partly from ignorance of the laws of expansion by heat, but mainly from the fear that if the irons and rod were taken off the joint would separate; but one day, by accident, the joints not being in line, the bolt was taken out to adjust them, when it was found to be quite a job to pull the joint apart; so after the adjustment an attempt was made to braze the joint without the bolt to hold it together, with complete success. The work was much better than ever it had been done before.

BRAZING THE JOINT.

Now take the straight saddle forge, Fig. 413, place in position and make a clean fire in it; jar some borax through the joint and charge it slowly all around on the inside, and sling it in an endless chain running over a pulley. Hook it to the chain overhead, holding the end with a suitable pair of tongs. Now heat it slowly; then tack it by running the spelter in two opposite places, slowly making it hot enough to bring the borax down, then with a gentle fire run it around, one cramp at a time, always having command of the blast slide so as to stop it immediately if necessary. The lower bell may be brazed on in the same way. When both joints are cleaned off and the parts planished about them, it is then ready for polishing, which is usually done on a lathe. The foot, by reason of its size, is usually made in halves in order to economize the sheet. After the pattern is cut (which will be described further on), the seams made and the foot rounded up, an iron band or hoop, Fig. 414, about 1 inch wide and $\frac{1}{4}$ inch thick is put on the level end, and the brass partly turned over in some six or seven places. This is to keep the foot in proper shape while working out the flow—which is done after the same fashion as the bell—in light courses with a mallet. The valve cover, Fig. 415, has no straight part. The two bells *ef* of Fig 416 are put together at the small ends; the top or upper end of the foot *g* of Fig 416 and *A* of Fig. 417 being razed over enough so that the lower bell may be cramped in with ease and readily brazed on the narrow fire, being slung as in Fig 418. After the joint is brazed and cleaned off and the planishing is completed, it is put in a lathe and polished.

We will now turn to Fig. 414 and cut out the pattern for this foot. Let the crown of the firebox *A B C*, Fig. 414*a*, upon which the foot is to stand, have a radius of 2 feet, and the foot of our valve cover *D e f G* have a diameter of 18 inches at the top *ef*, and a flow of 4 inches, over the crown on each side, as shown at *e D* and *f G*, and the flow an elliptic curve, as indicated by the ellipse on each side. Divide one-half the conjugate axis of the two ellipses which form the curves into four equal parts, and through the points of division *n* and *m* draw the line *D n* and *P m* parallel to the two transverse axis *E b* and *G a*, cutting the crown *A B C* in *D* and *P*, making the line *D P* 24 inches. Draw *H B O*. Through *P f* and *D e* draw *P f O*

and $D e O$, and let them meet in O . Describe the arc $Z Y X$ with the radius $O D$ and make it three times $D P$; now divide the arc $Z Y X$ into eight equal parts as shown. On the lines $Z O$, $Y O$ and $X O$, from the points Z , Y , X , lay off the distances $Z I$, $Y N$, $X J$ equal to $D E$. Through the points $N g$ and $N h$ draw the lines $N V$, $N U$, and through the points $I d$ and $J t$ draw the lines $I V$, $J U$, letting them meet in V and U . Now, with $N Y$ as radius, and from the points I , N and J , describe the arcs $Z R$, $T Y R'$, and $T' X$. Then, with $U R'$ or $V T$ as radius, from the points U and V , describe the arcs $R T$ and $R' T'$. From the point S , on $O K$, lay off $S r$, the length of the curve flow $f G$, and with $O r$ as radius from the point O , describe the arc $x y z$; then $Z Y X . x y z$ is the pattern for the foot which is represented in Fig. 414.

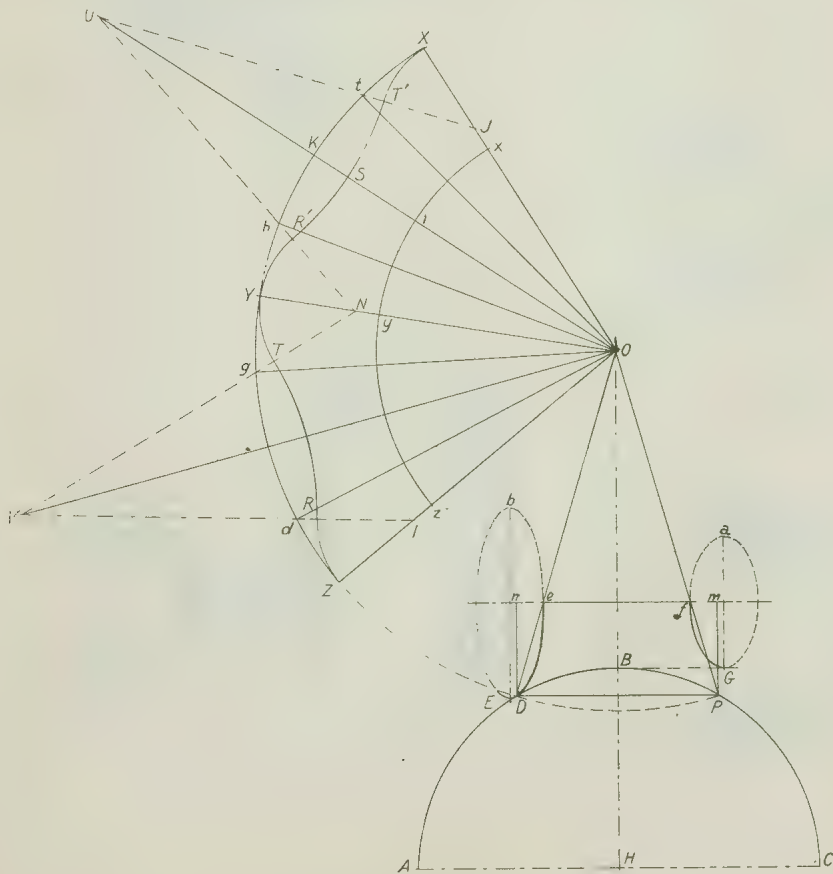

Fig. 414a.—Pattern for Valve Cover Foot.

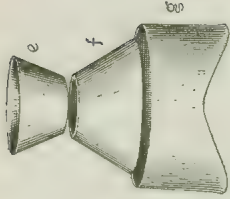

Fig. 416. -- Parts of Valve Cover.



Fig. 415. -- Valve Cover.



Fig. 414. -- Band Placed on Lower Part While Being Worked.

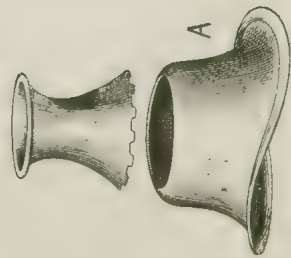

Fig. 417. -- Bell Cramped for Joining.

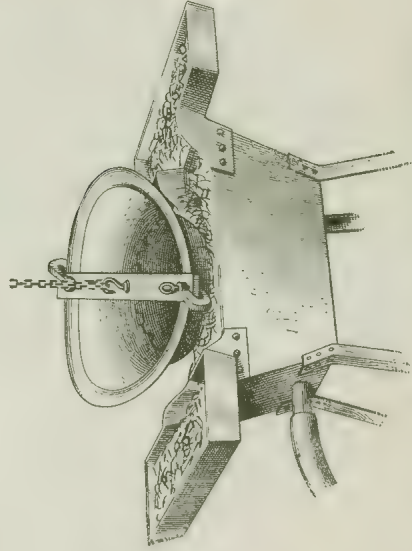

Fig. 418. -- Valve Cover Suspended for Brazing.

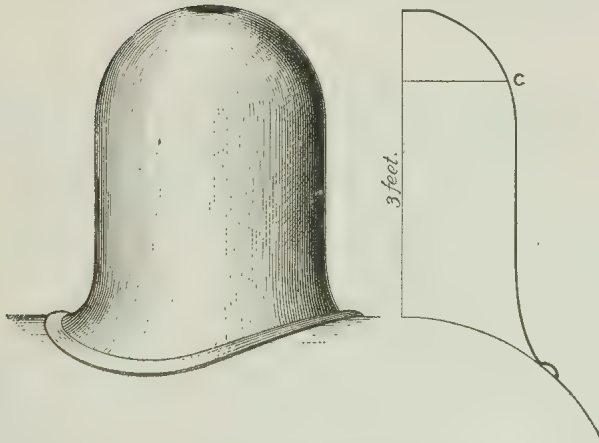

Fig. 419.—Cover for Regulator Dome.

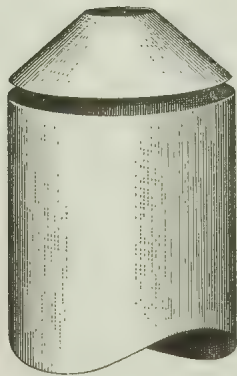

Fig. 420.—Parts of Dome.

BRASS COVER FOR REGULATOR DOME.

The cover for a regular dome, Fig. 419, is about 2 feet 3 inches in diameter and 3 feet high, made from brass of No. 12 wire gauge in thickness. To mark out the curve which will fit the boiler when the sheet is turned round, as in Fig. 420, proceed as follows: Let ab of Fig. 421 equal the diameter of the boiler, and cd equal the diameter of the dome cover. With the radius cd describe the circle $cbdg$, and divide the circle into sixteen equal parts; then on the line hi lay off a distance equal to the circumference of the circle $cbdg$ and divide hi into sixteen equal parts. Draw the lines parallel with hk to in , then from the points 1 2 3 4 of the circle ab draw the lines 1 1, 2 2, 3 3, and 4 4, parallel to hi . Through the points of intersection draw the curved line $hopi$, which will fit the boiler when formed into a cylinder. Round up the edges and thin the ends; cramp them and double the sheet, being careful, as before directed, that all spring caused by doubling is taken out before going to the fire: then sling it; jar some borax through the joint, and with a reed, charge it, laying the spelter in a zigzag line, following the edge of the cramps, which should not exceed an inch in length. Now, be patient, and slowly heat the sheet, each side, on a clean fire, being careful that there is no lead, salt, or any foreign matter in it (the coke should be clean and about an inch square). When the borax is all down, with a gentle blast slowly run the joint down, and when cool, clean off and round up on a suitable mandrel. In working out the foot, as previously observed, the most pleasing curve is that of the ellipse, which may be made of any length desired.

Having the pattern of the curve, which will be one-fourth of an ellipse, commence razing out the foot or flow by a light course with a ball faced mallet, represented by F in Fig. 422, using a thick wooden block E hollowed out to nearly fit the circle of the cylinder, and sloped off at one end, being rounded nearly to the curve it is desired the foot should be. The block is dogged to the bench G as shown. Let each course taken to raze the foot out be light and the blows regular, annealing at the conclusion of each course. The top, or crown, of Fig. 420 may be worked with the foot in alternate spells as they

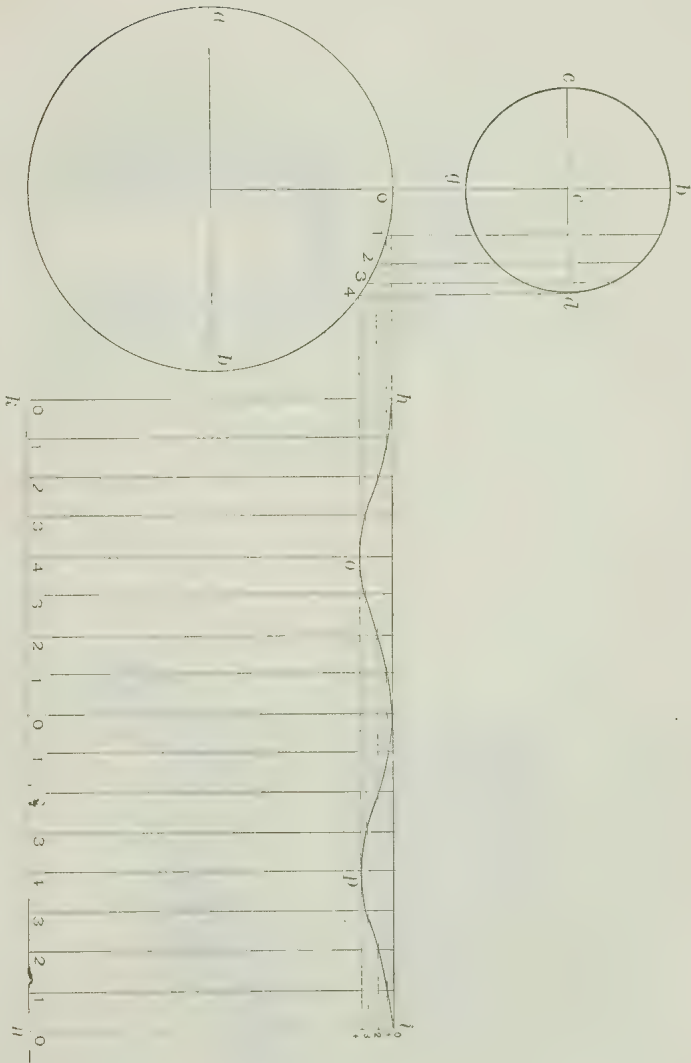

Fig. 421.—Manner of Obtaining Pattern for Foot of Dome.

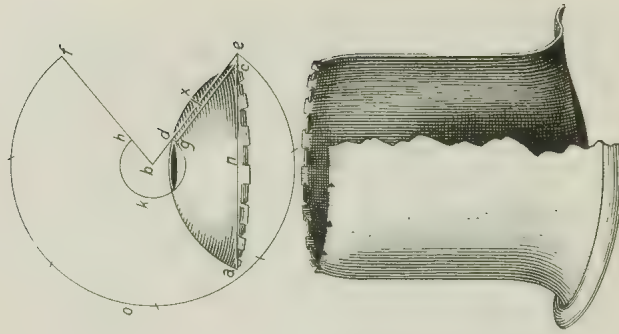

Fig. 423.—Pattern for Crown.

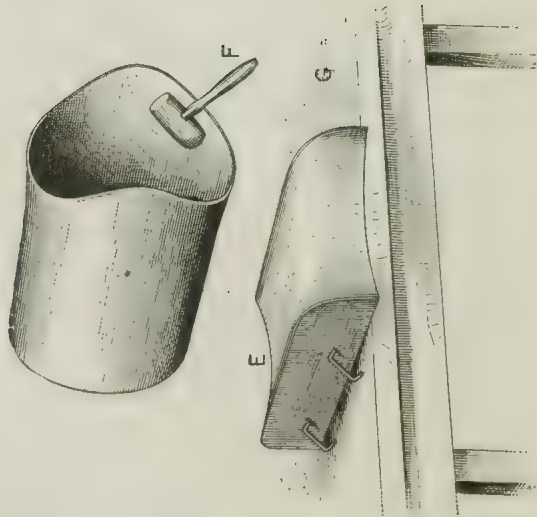

Fig. 422.—Block and Mallet for Shaping Dome Foot.

are cooling, and thus economize time. When the writer first began to make these covers the crown was made an exact half-sphere, but while in the act of drawing the outlines it was noticed much time could be saved by taking a wider sheet and tucking in the top end, making the crown smaller, which method was adopted, the work being much easier performed with less time spent at the fire. The difference is illustrated at C in Fig. 419, where it is shown that two-sixths of the circle is taken for the crown and the other sixth left on the cylinder, which lessened the labor and made the work required much easier than when the crown was one-half a sphere.

I will now form the top or crown, first cutting the pattern and forming it, and then complete the job. Let agc , Fig. 423, represent the crown for the dome-cover, which is two-thirds of one-half of a hollow sphere whose diameter is the same as the cylindrical part of the dome-cover. Draw the line gc from the edge of the hole g to c ; then draw the versed sine x and divide it in the center; through the center of x draw the line be parallel to gc and meeting ac at e . With the radius be describe the arc $eaof$ and measure off on its circumference six times the radius nc , and draw bf . With db as radius, describe the arc dkh , then $eaofdkh$ will be the pattern for the segment of the hollow sphere agc , or the crown of the dome-cover. Now make the joint and braze it; round up into shape and anneal, when it is ready for the first course. Crimp the edge at the bottom and take it to the mandrel block, Fig. 424. With a mallet, on the head take in a course, beginning one-third the distance up the side; then the same at the top, and anneal. The next course should be enough to bring in the edge at the bottom and also at the top; then take a course in the middle from the inside, which should complete the curve. It may now be smoothed up true, after which the crown is ready to be put in. Before proceeding to do this, see that the edges are true across their diameter, then thin them with a paned hammer, after which anneal and clean either by scraping or filing. Cramp the base part, then open the outside cramps, bringing the crown to it, and with a cross-piece, or two pieces laid across each other, pass a rod through them and through the crown, upon which lay another short piece, the bolt passing through it also. Now screw it up tight, tapping the joint occasionally all around to assist the bolt in bringing the joint up close. Turn it with the foot up, and at four opposite places close down four cramps and drill four holes, putting in four small brass

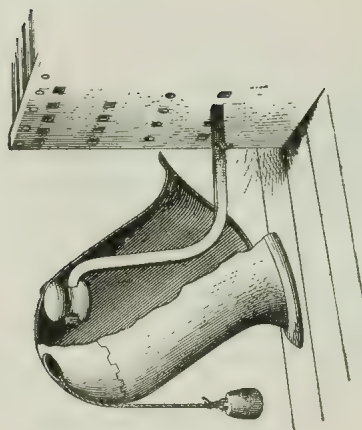

Fig. 425.—Closing Down Seam on Head.

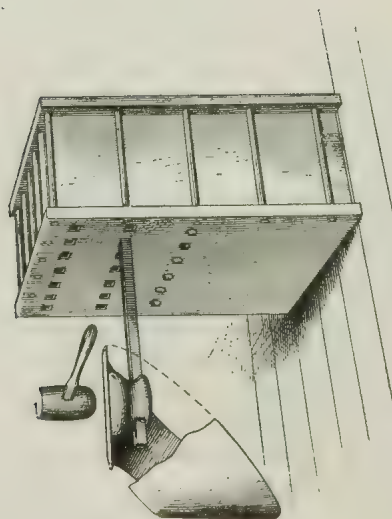

Fig. 424.—Drawing in Top of Dome.

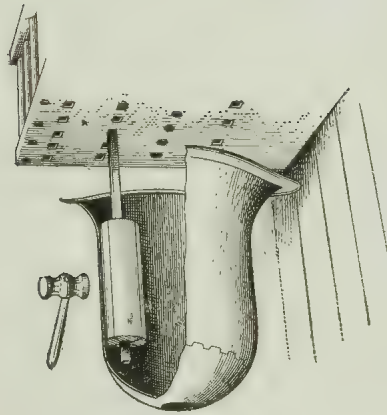

Fig. 427.—Planishing the Body of Dome Cover on Mandrel.

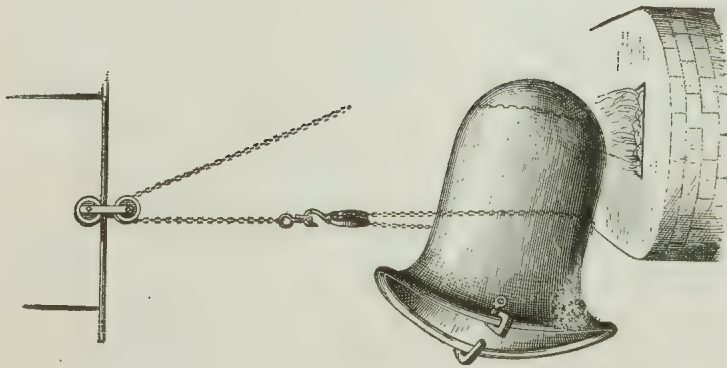
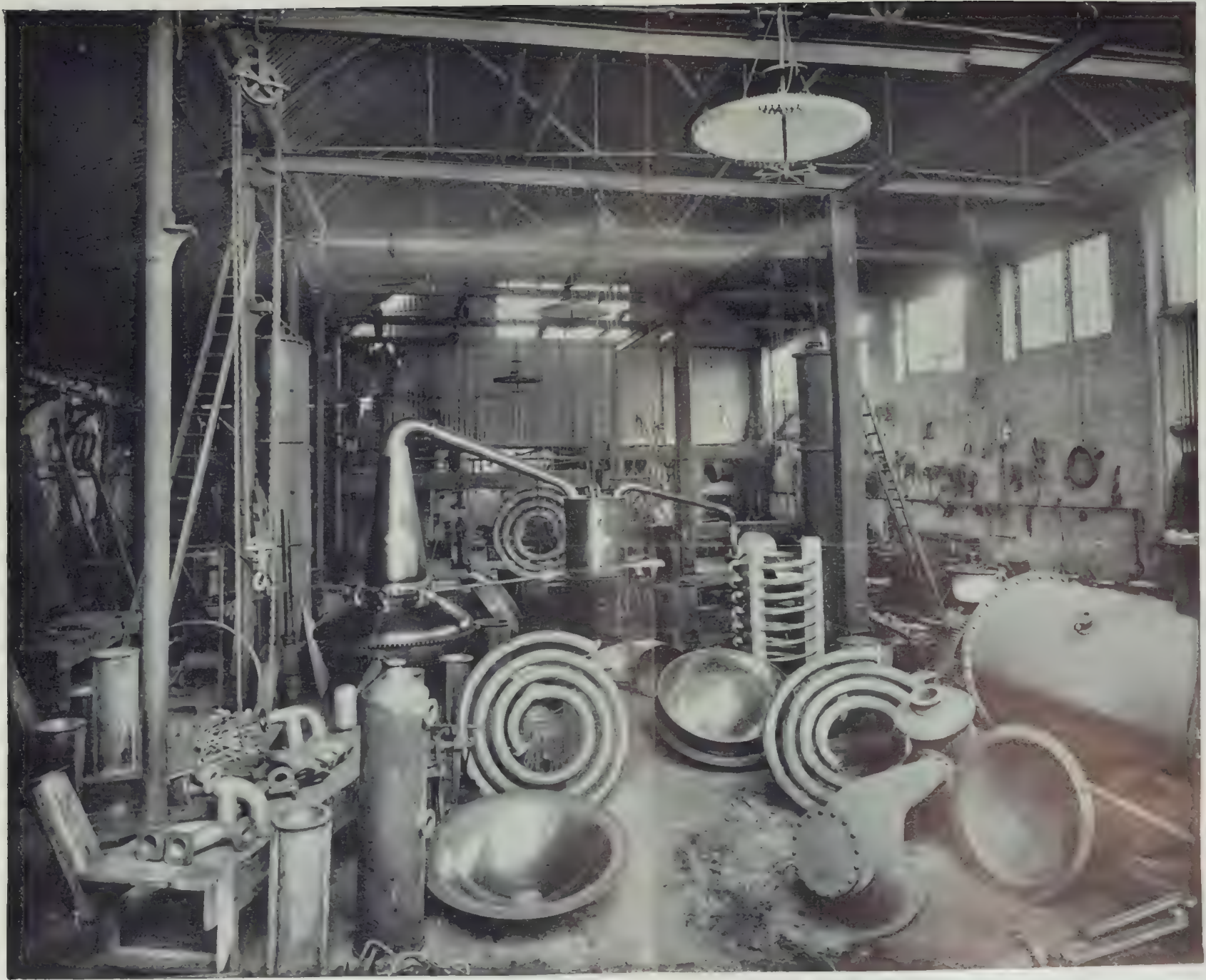

Fig. 426.—Dome Cover Hung for Brazing.

rivets, enough to hold it while the joint is being closed down smooth—which may be done by a helper holding a head inside or by putting it on the head as in Fig. 425 and balancing it with a weight, as shown. When the joint is ready, take to the fire and sling it in an endless chain with pulley wheel, Fig. 426, hooking it to the traveler overhead. Jar some liquid borax through the joint, and sprinkle some powdered borax outside; then charge it with spelter all around, warming it gradually, and then tack it in four places between the rivets. By this time it will be fairly hot. Go once more around slowly, and when at the place of starting begin to run the joint with a gentle fire, one cramp at a time. A little help is now necessary to attend to the blast and sprinkle borax on the joint as required. As a hand-hold to use while at the fire, two screw-clamps are fastened to the points of the foot, as shown. When the joint is run and has had time to cool, it may be cleaned if found to be perfect. The whole job is now trued to shape and planished; first the body, as in Fig. 427, the mandrel curve being rather smaller than that of the dome cover; and then the crown, as in Fig. 425. The cleaning and polishing can be done in a lathe.



[A268]

Fig. 428. Interior View of Coppersmith Shop, Showing Pipe Coils and Brewery P



HEAVY PIPES FOR BREWERY WORK.

The earlier pages were principally devoted to a description of the working of light sheet copper in the manufacture of cooking utensils or small articles generally, and known better as the braziers' art. This was followed by the work for the locomotive and marine engine, which, it will have been seen, in the main comprises the making of copper pipes, large and small, bending and twisting them into any shape to suit the position desired or exigent circumstances, and is known as light coppersmithing. From this point an endeavor will be made to interest the reader with some examples of heavy work, such as he may occasionally encounter in his way (as has happened with the writer) while moving from shop to shop, either from choice or necessity. To keep as nearly in a progressive line as possible, the subject of pipes will be resumed and considered in their various forms in large and heavy work for application in breweries, sugar and still houses.

In breweries the principal uses for pipes are for refrigerators and attemperators, and these consist of coils of pipe of various forms which are made to fit the coolers or fermenting vats for the purpose of raising or lowering the temperature of the liquor by the aid of a current of water or steam passing through the pipes.

In Fig. 428 is presented a view of the interior of a shop engaged in this kind of work, which gives the reader a good idea of the conveniences that are necessary to perform it successfully. The photograph from which the cut was made was kindly furnished by G. Hendry & Co. of London, England, especially for this work, with a view of giving the reader a more faithful illustration than can be done by a pen description. The picture is so complete that it would seem to need no further explanation.

In Fig. 429 is represented a cooler having a group of pipes made to fit it, and so arranged that the pipes may be raised or lowered in a convenient way when necessary to do so for cleaning. This grouping of the pipes is perhaps among the oldest contrivances used for cooling purposes in the manufacture of beer. It consists of a number of pipes of equal length, grouped together with horseshoe bends to form a con-

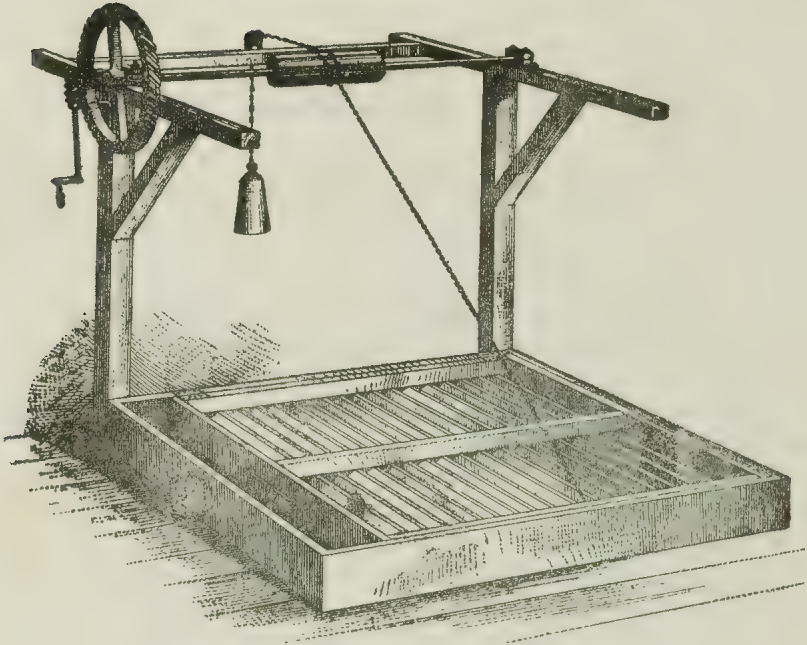

Fig. 429.—Cooler with Movable Pipes.

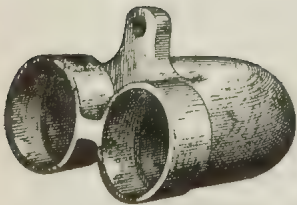

Fig. 430.—Horseshoe Bend.

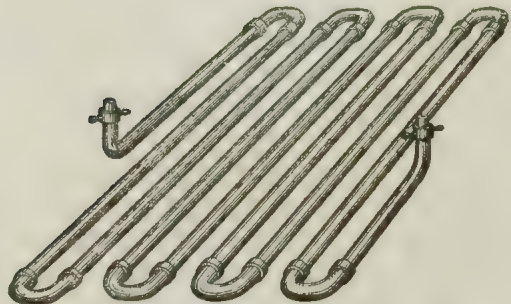

Fig. 431.—Set of Pipes for Small Cooler.

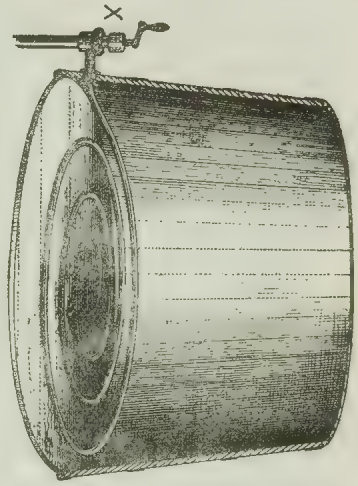

Fig. 432.—A Boiling Round or Vat.

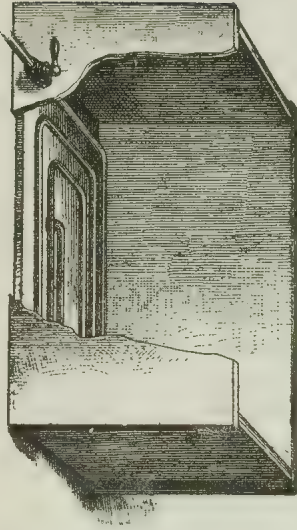

Fig. 433.—A Lignor Vat.

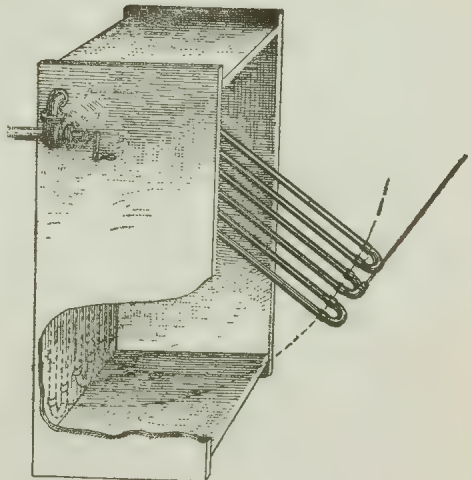

Fig. 434.—Lignor Back with Movable Pipes.

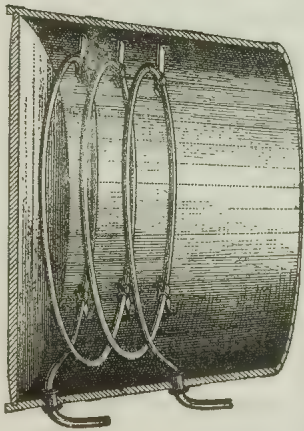

Fig. 435.—Attenuator Fitted to Fermenting Round.

tinuous run of piping sufficient to fill up the space on the bottom of a cooler, as shown. The horseshoe bend is shown in Fig. 430, and is made of brass or gun metal. The pipes are separated from each other by boards called channel boards. The two end pipes are left open and are provided with hose unions for connection with the water supply, which is made to run along inside the pipes in the opposite direction to the wort in the cooler. Fig. 431 shows a set of pipes for a small cooler without the lifting appliance shown in Fig. 429. For large coolers two and three sets of pipes may be and often are connected together, each working independently of the other, but all bolted on the same frame by means of the lugs on the bend. By this arrangement smaller pipes can be used and the cooling surface increased, while the consumption of water is proportionately diminished. The pipes are usually soft soldered into the bends. The foregoing apparatus is designed and used for cooling purposes, but the conditions are sometimes changed, and similar pipes are used for warming, which are called attemperators, and others are used for boiling coils. In Fig. 432 is represented a boiling round—that is, a round vat or tub, supplied with a coil of copper pipe lying on the bottom, which is set with a gradual fall toward the center so that the condensed steam or water is drained off through the bottom, the condensed steam keeping the live steam at the full pressure, thus making the liquor boil quicker, and preventing a waste of steam, which must occur if it was allowed to blow off into the air. The steam is turned into the coil by a valve fastened to the side of the round, as shown at X, Fig. 432. Fig. 433 is the same in principle, but made to suit an oblong vessel. This vessel is called a back, on account of its shape, so that it may be easily distinguished from a round vat. Another form of liquor back is shown in Fig. 434. The set of pipes is furnished with either ball joints or gland and stuffing box, so that it can be raised or lowered at will for cleaning, or to get it out of the way when necessary to do so. It is therefore much better and more convenient than the kind with fixed coil. Vats and backs are also fitted with spiral coils, as shown in Fig. 435 and Fig. 436. When they are fitted with coils in this way they are used principally for fermentation, thus distributing the temperature evenly through the mass of liquor.

Let us make one of these coils, and let the pipe of which it is made be 3 inches in diameter and the coil consist of four rings, Fig. 437, the outside ring being 6 feet in diameter from center to center, and the in-

side ring 2 feet. The first thing is to find the length of the coil, which we do by marking out the coil in Fig. 437, as follows: Draw the line Z Y, making it 6 feet, and bisect it in V, and with V as center and V X as radius, equal to 1 foot, describe the semicircle X U W; then divide X Z and W Y into three equal spaces, X a, a b, b Z; W c, c d, d Y, and from V on V Z lay off V e, equal to one of the spaces X a, and divide V e at T; then from the point T as center, with T W as radius, describe the semicircle W S a, changing the centers V and T for each semicircle in succession until the coil is complete. Now, we have seven semicircles, the center one, X U W, 2 feet in diameter, the next, W S a, $2\frac{2}{3}$, the third, a R c, $3\frac{1}{3}$, the fourth, c Q b, 4 feet; the fifth, b P d, $4\frac{2}{3}$, the sixth, d O Z, $5\frac{1}{3}$, and the seventh, Z N Y, 6 feet. Now adding these all together and dividing by 2 we have $\frac{2}{2} + \frac{2\frac{2}{3}}{2} + \frac{3\frac{1}{3}}{2} + 4 + \frac{4\frac{2}{3}}{2} + \frac{5\frac{1}{3}}{2} + \frac{6}{2} = 14$, or a cir-

cle of 14 feet equal to coil; and multiplying this by 3.1416 we get $14 \times 3.1416 = 43.9824$, the length of the coil. Hence we want 44 feet of pipe (exclusive of that required to make the joints) to make the coil. The pipes may be made, fitted and bent and joined together with socket joints.

Copper pipe used in the making of coils of various kinds has usually been made in lengths varying from 10 to 14 feet, therefore all coils of any considerable size must be made in sections and joined or brazed together. To do this brazing in the most convenient and expeditious way it is necessary to provide a wheel and axle, as shown in Fig. 438, upon which the coil may be fastened with a strap, A, and held in position for manipulation as each section of pipe is added to the coil and the process of brazing together is being executed. The wheel and axle are fastened to a suitable post and over a pit, the axle being placed about 3 feet from the floor, so that the socket when level will be on a line with the center of the axle, and can easily be attended to when the coil exceeds 6 feet in diameter. The accompanying illustration, Fig. 438, sufficiently explains itself.

The method given above for describing a flat coil is perhaps the simplest that can be used. For those who desire to make a coil nearer the truth, it is necessary to resort to what is called an eye—that is, a group of points situated in regular polygon form for centers, which may begin with a triangle, as in Fig. 439, or with any other number of points, as in Fig. 440. I will explain these two methods, and leave the learner

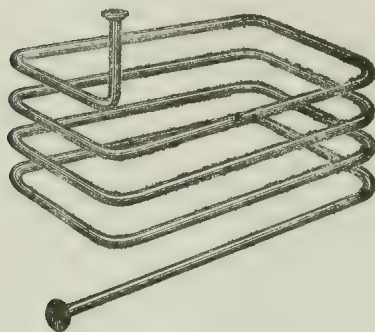

Fig. 436.—Attemperator Suitable for Fermenting Back.

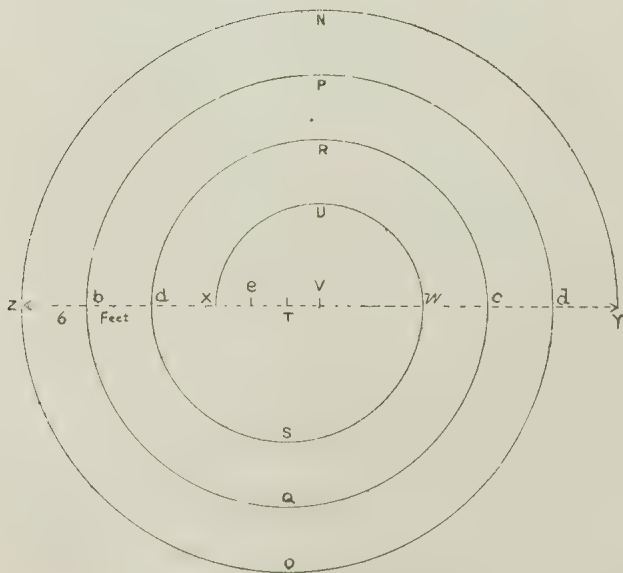

Fig. 437.—Diagram for Coil.

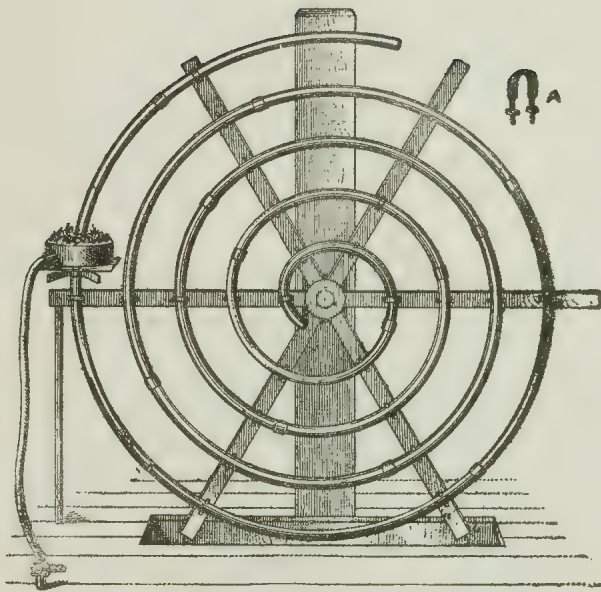

Fig. 438.—Wheel and Axle for Brazing Pipe.

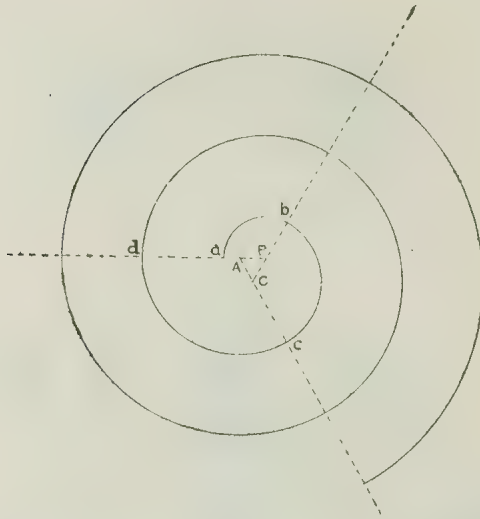

Fig. 439.—Laying Out Coil with Triangle for Center.

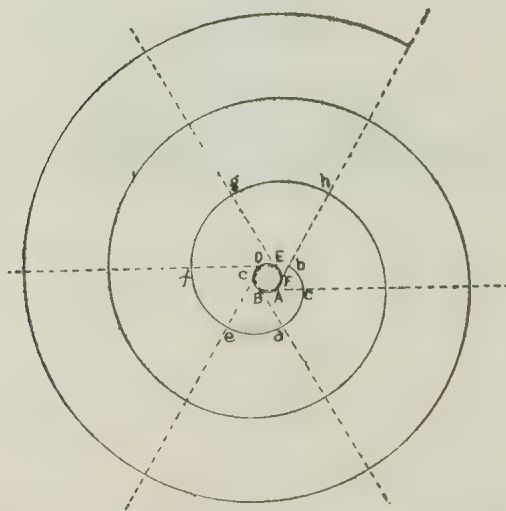

Fig. 440.—Laying Out Coil with Hexagon for Center.

to pursue the further study of the subject as he may desire. In Fig. 439, the eye of the coil which governs the distance between the rings is an equilateral triangle. Now let it be required to make a coil 6 inches apart from center to center of the rings, then we divide the 6 inches into three and erect a triangle, $A B C$, making the sides equal to 2 inches; then with B as center and $B a$ as radius, describe the arc $a b$; and with C as center and $C b$ as radius, describe the arc $b c$, and with A as center and $A c$ as radius, describe the arc $c d$, and repeat the process until the size of the coil is reached. In Fig. 440 the eye of the coil is a hexagon. Now let the distance apart be the same as in the last example. Then 6 inches divided into six parts gives us 1 inch for one side of a polygon of six sides. Draw a hexagon, $A B C D E F$, Fig. 440, and make the sides equal to 1 inch; then from A as center and $A b$ as radius, describe the arc $b c$, and with B as center and $B c$ as radius, describe the arc $c d$, and repeat the process around the polygon, taking each corner in succession, until the coil has been completed the required size.

The length of these coils may be obtained in a similar way to that already given—that is, by adding together the diameters of all the circles which compose the coil and multiplying by 3.1416 and dividing the product by the number of points in the eye of the coil.

Fig. 441 shows a portable coil and the manner of using. The three supporting stays are iron, bolted together and provided with eye bolts for suspending rods by which the coil may be hung in a vat or tun at any height desired. The ends of the coil are supplied with unions for connecting leather or rubber hose. These portable coils are quite handy, as they may be removed readily with pulley blocks out of a tun when not required. Portable coils may be made any other shape desired.

It sometimes happens that it is better and more convenient to have the two ends of an attemperator—that is, the outlet and inlet—lying side by side or close together in preference to having one end cross the coil, as in Fig. 441. In this case we resort to another plan, which is shown in Fig. 442. When it happens that the workman does not possess the skill necessary to perform the operation of brazing the sectional joints of the coil, flanges may be employed for joining the sections together, as shown in Fig. 443, the flanges being made just wide enough to get bolts in, and of sufficient strength to make the joint se-

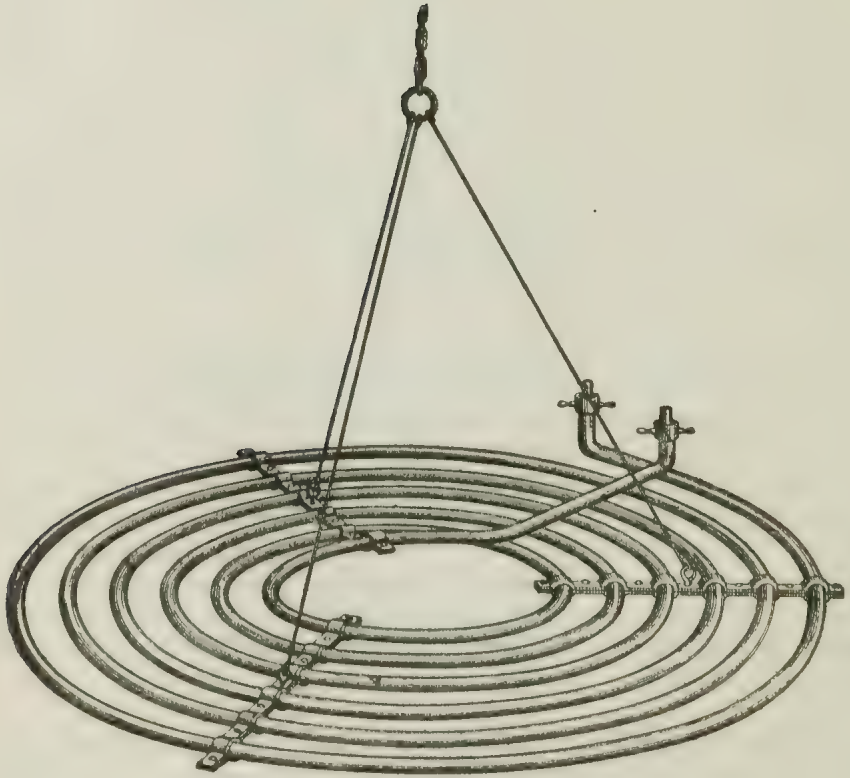

Fig. 441. — Portable Coil.

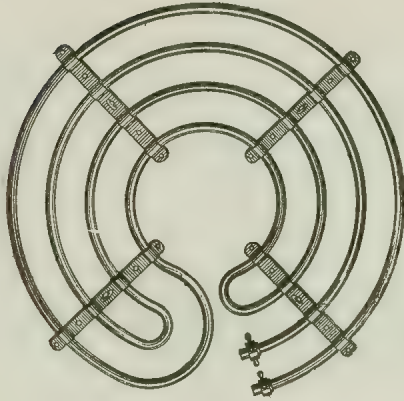

Fig. 442.—Coil with Openings Together.

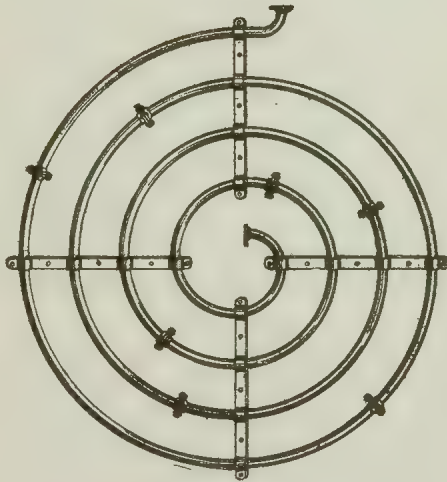

Fig. 443.—Coil with Flanged Joints.

cure. It may sometimes be better to put them together in this way, so that any section may be taken out for repairing when necessary.

To find the length of a spiral coil, as in Fig. 435, whose diameter is 6 feet from center to center of pipe and having three rings, with a rise of 1 foot to each ring, it will be seen that as each ring rises 1 foot the length of pipe required for the three rings of the coil would be the hypotenuse of a right-angled triangle whose base is equal to the circumference of three flat rings as the base and the foot rise of each of the three rings of the coil as a perpendicular. Then the length of the coil is

$$\sqrt{(6 \times 3.1416 \times 3)^2 + (1 \times 3)^2} = 56.619 \text{ or } 56 \text{ feet } 7.42 \text{ inches};$$

therefore to make a spiral coil, as in Fig. 435, we require 56 feet 7 inches of pipe, which is made of convenient lengths and put together with socket joints as before directed.

BREWING COPPERS OR KETTLES.

Large brewing coppers are made in several different ways; the accompanying illustrations give three of the styles most in use, and will, I think, be sufficient for our purpose.

Fig. 444 is an open copper with a light course; that is, an addition to the copper proper, to enlarge its capacity and lessen the cost, the light course being made of lighter material than the copper proper, and yet of sufficient strength, as it is usually supported by brick work built around the course nearly or up to the brim. Let us build one of these large coppers with a light course, and let it hold, say, 50 barrels in each course; that is, the copper proper to hold 50 and the light course to hold 50 barrels also. The coppers may be made in any proportions to suit the place they are to occupy; that is, they can be tall or squat, as the room can be spared, because the copper, in consequence of its bulk, together with the brick work necessary for the furnace, takes up considerable room, and therefore is usually placed in some convenient position, as much out of the way as possible.

In an early chapter it was shown that the usual proportion for a copper to hold 106 gallons is, top 38, bottom $33\frac{1}{2}$ and depth 28, so we will make our proposed 50-barrel kettle in the same proportion, and then add the light course to it. Now, all vessels of capacity are in the triplicate ratio; that is, comprise length, breadth and thickness, or their capacity is found by multiplying these three dimensions together.

Therefore we will take the diameter at the top as the basis by which to obtain the dimensions required for the sides and bottom. Then the top diameter of a 106-gallon kettle measures 38 inches, and $\frac{3}{38} = 54,872$ inches, and as a barrel (English) contains 36 gallons, therefore 50 barrels contain 1800 gallons, and $1800 \div 106 = 16.981$, or the number of times 106 gallons is contained in 50 barrels. We now multiply the cube of 38, or 54,872, by 16.981, the number of times 1800 gallons contain 106 gallons, which gives us 930,781.432, and then extracting the cube root of this last result we get 97.63, or the top diameter of a copper to hold 50 barrels, which, in practice, we should call 8 feet 2 inches. Here then we

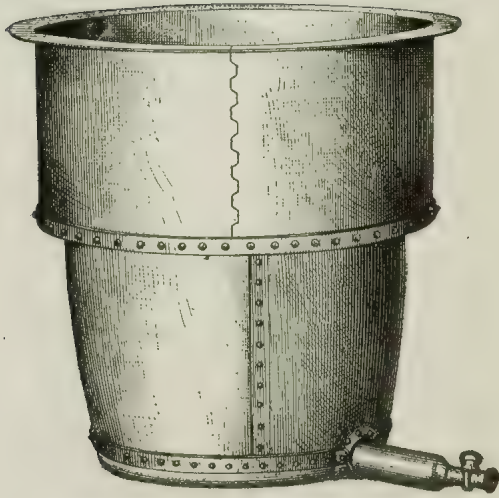

Fig. 444.—Open Copper, with Light Course.

have the first dimension of our proposed copper, 8 feet 2 inches. We will now proceed to obtain the other two dimensions by proportion, thus: Taking the dimensions of our 106-gallon vessel, as stated, top 38, bottom 33.5, and depth 28 inches; then $38 : 33.5 :: 97.63 : 86$. Again, $38 : 28 :: 97.63 : 71.938$. From this, then, we find the three dimensions of a 50-barrel copper to be: Top, 97.63; bottom, 86.068, and depth, 71.938, which we should call 8 feet 2 inches top, 7 feet 2 inches bottom and 6 feet deep. We must now have the pattern for the sides, which we will proceed to get. By referring to Fig. 445, it will be seen that a copper is a part of the middle zone of a circular spindle; that is to say, the body of which it is a part is generated by the revolution of the segment of a circle, and the versed sine of the segment is one-half the diameter of the copper at the brim. Without a knowledge of the properties of the circular spindle, we can at best only make a good guess at what the pattern should be.

The illustration here given shows two coppers with their brims placed together, and then the outline of the spindle completed. This when carefully and intelligently performed gives the key for cutting the sides of all bellied vessels which are built up of a number of pieces, as in the case of large coppers. Then as stated: The depth of the copper is one-half the chord of the arc A B, and is 71.938 inches, and the versed sine of the arc A B is one-half the difference between the diameter of the top and bottom, which is $\frac{11.57}{2}$ or 5.785.

$$\frac{71.938^2 + 5.785^2}{2} = 450.176$$
, the radius E I, Fig. 446, of the circle of which the curve of the spindle (that is, the sides of the coppers from top to bottom, or from A to B) E A B F is a part. The diameter G H at the center of the spindle is 97.63; then one-half G H, or $\frac{97.63}{2} = 48.815$, or the versed sine G J of the arc E G F, Fig. 446, and $450.176 \times 2 - 48.815 = 851.538$; then $\frac{2}{4} 851.538 \times 48.815 = 203.611$, or E J, which is one-half the length of the spindle, and $\sqrt[2]{851.538 \times 48.815 + 48.815^2} = 209.586$, or G F.

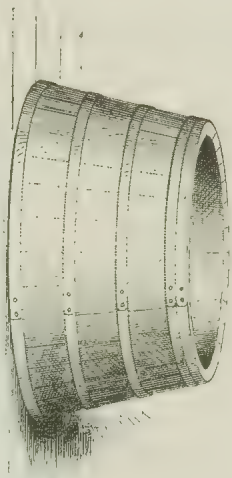

Fig. 447.—Hollowing Tub.

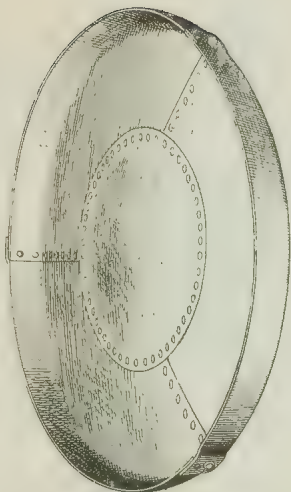

Fig. 448.—Four-Piece Bottom.

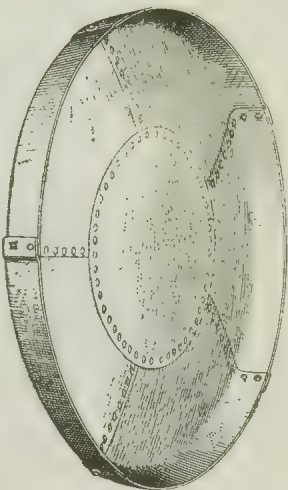

Fig. 449.—Six-Piece Bottom.



Fig. 450.—Sectional View of the Bottom Crown,
Shaped Ready for Sides.

But $GF = GK$, therefore $\sqrt{851.538 \times \frac{48.815}{2} + 48.815^2} = 144.91$, or

KN , the radius of the circle $M G K$; whence KM is 144.91×2 , or 289.82 ; that is, 24.15 feet is the radius of the curve at the brim edge of the pattern, and $289.82 - 71.93 = 217.89$, or 18.157 feet, is the radius for the arc ST at the bottom edge. Again: $\frac{97.63 \times 3.1416}{6} = 51.1424$,

or the versed sine of the arc of the circle of which curve the side edges must be cut before hollowing in the hollowing tub, Fig. 447, ready for placing in position for riveting—that is, when the sides are in three

pieces. Then $\frac{203.611}{51.1424} + 51.1424 = 812.78$, or the diameter in inches of the circle of which the curve of the two edges are a part or must be cut before hollowing.

Therefore $\frac{812.78}{2} = 406.39$, or 33.8658 feet, for the radius of the two side edges of the pattern. Here, then, we have three pieces or sides in the small sketch, Fig. 446, 102.2383 from O to P , 71.93 from M' to R , and 90.059 from S to T , with a radius of 33.8658 feet for the curve of the side seam edges, and a radius of 24.15 feet for the curve at brim, and 18.157 the radius of the curve at the bottom.

These dimensions are, of course, all bare—that is, nothing allowed for the seams or the brim, which must be left on to suit the rivets which are to be used in the side seams and the width of the brim required for the light course, a part of which would be taken from the depth, as the side would not reach the lag of the bottom by some 2 or 3 inches, for which allowance must also be made. We now come to the bottom. To-day they may be had already milled up in one piece of any size or strength up to 15 feet in diameter. But when I was a boy there was no machinery then in existence of such capacity; hence it was necessary to make large bottoms by hand in four, five and sometimes more pieces, Figs. 448 and 449. But we will suppose that we have the bottom supplied to use in one piece, and let it be 7 inches deep. Now, the first thing is to put the bottom in shape for planishing—that is, form the crown, as shown in Fig. 450, by hollowing in the hollowing tub. This hollowing tub, Fig. 447, as we call it, is a

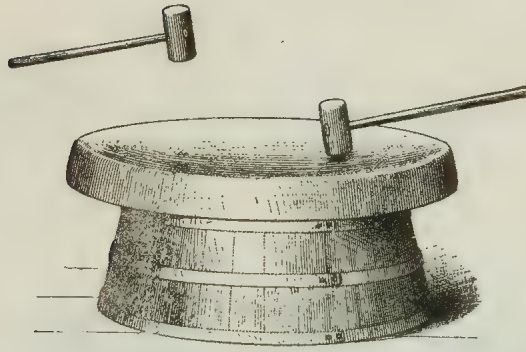

Fig. 451.—Crowning Bottom in Hollowing Tub.

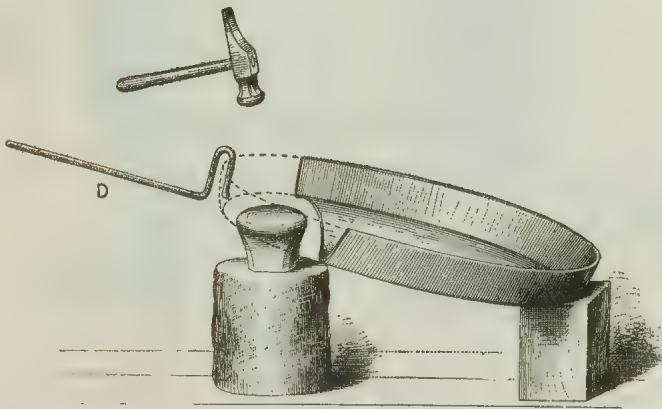

Fig. 452.—Planishing Bottom.

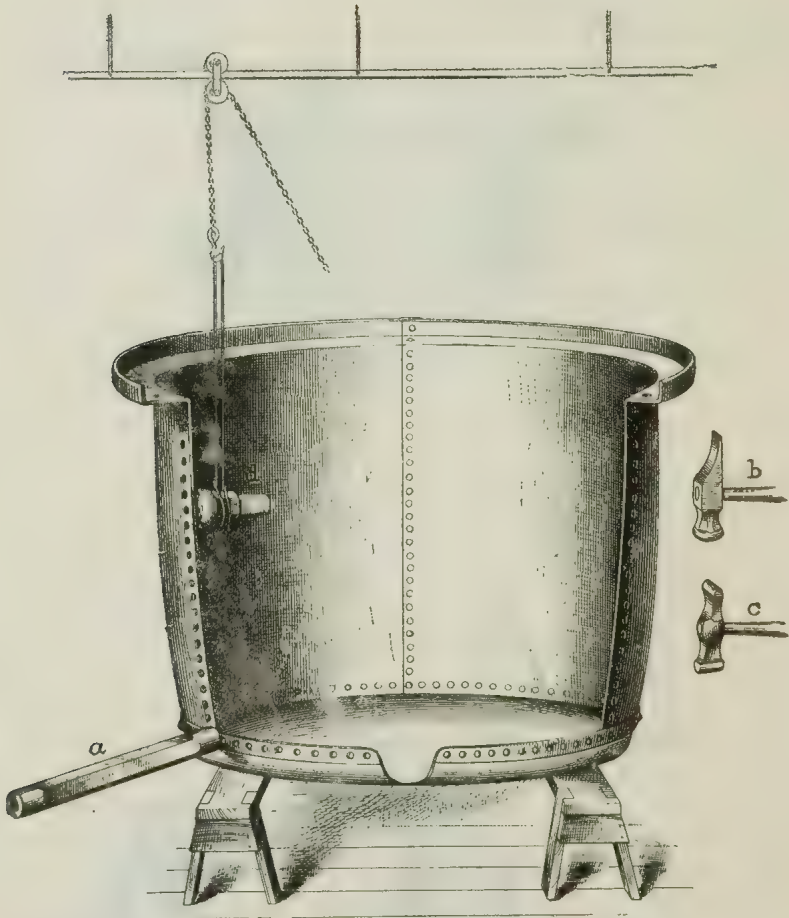

Fig. 453.—Copper on Trestles, Ready for Working.

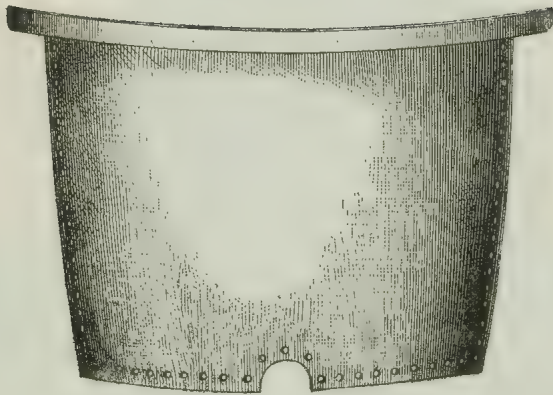

Fig. 454.—Side Ready for Riveting.

wooden ring like a washtub without a bottom, made of oak staves about $2\frac{1}{2}$ inches thick, about 2 feet high and from 3 to 4 feet in diameter, taper, and supported by three stout hoops, which are bolted to their places after the wood has shrunk sufficiently. The bottom is laid over the tub bottom side up, Fig. 451, and two men with large mauls or hammers sink the bottom in the tub, while another man guides the bottom on the tub with the iron dog D, shown in Fig. 452. When the bottom fits the template it is turned the right side up and the planishing is begun, which is done as shown in Fig. 452. A suitable large head is placed in a block and the bottom is then smeared all over on the outside with wet plumbago, also the surface of the block on which the bottom rests, so that the bottom will slide about with ease while the planishing is going on. The inside is rubbed all over with either wet or dry Spanish brown, so that the blows may be plainly seen. When the planishing has been completed, the bottom is placed on two or more suitable trestles, Fig. 453, and after marking the holes the proper distance apart, the rivet holes are punched in the bottom with a punch placed in a chisel rod and the hammer *b*, while a man holds a bolster, *a*, on the outside (the bolster *a* explains itself). Then all three sides, which have been previously prepared—that is, bellied or hollowed and planished, Fig. 454—are placed in position and secured with bolts. Then the head is taken out of the block and put into a sling, *d*, Fig. 453, and one man holds the head in position inside while two others, opposite each other outside, work in the rivets, first with long-handled cross-peined hammers, *c*, and finishing with hammer *b*. The light course is now prepared, the sides of which may be brazed or riveted together, as desired, when, after planishing, the holes are punched in the bottom edge, and then the course is set in its place on the copper brim and the rivet holes punched through the riveting edge into a small bolster and the rivets worked in with short-handle hand hammers. The pipe or outlet is next worked in and all finished up complete.

The same methods which are here described may be used for building a vessel of any number of pieces in the side or of any shape. In Fig. 455 is shown a large open copper, with a light course, completed ready for use, and about to be set in its future resting place. This vessel was built in 1891 by Messrs. Shears & Co. of Bank-side, London, and is said to be the largest copper ever built in England. It has a capacity of 36,000 English gallons. This large vessel was built

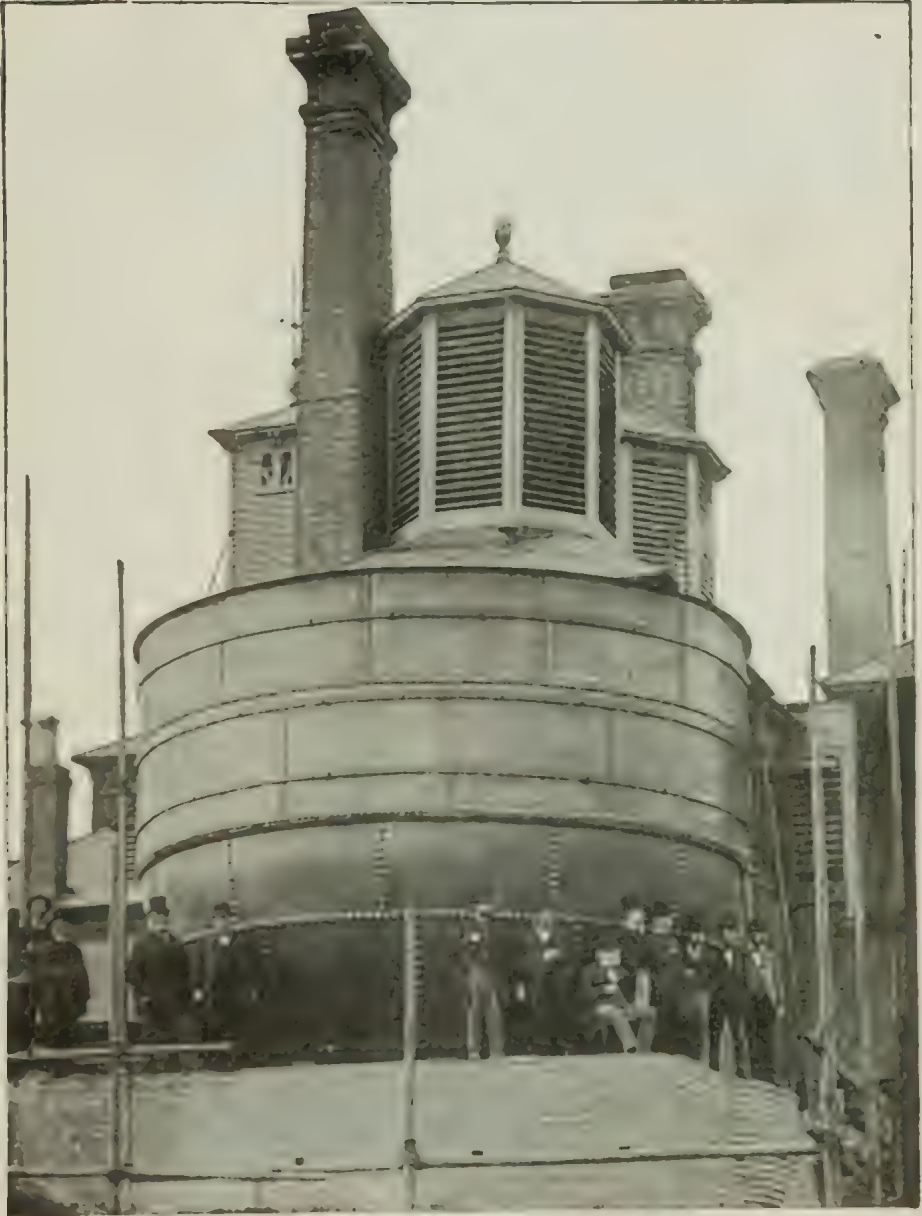

Fig. 455 — Large Open Copper with Light Course

for Ind, Coope & Co. The reader can get an excellent idea of its construction, as well as its immense size. The size of the rivets should be noticed, the proportion of the copper proper to the light course, and then the three iron bands placed around the light course to strengthen it; also that the wall at the end of the building has been taken down to let it into its place. This is a very interesting and instructive illustration for these engaged in this kind of work.

DOME COPPERS.

Dome coppers, as will be seen, Fig 456, are made similar to open ones, the dome being substituted for the light course. Let us suppose we have a copper ready for a dome, and it is required to make a dome and work it on to the copper. As I have said before, a dome may now be had in one piece, but were this not the case, as in years gone by, then it must be made in pieces, and these must conform to the size of the sheets at hand. Now, let the size at the brim be as in the last example, namely: 97.63 inches in diameter, and the brim or dome seat $3\frac{1}{2}$ inches wide, with a riveting edge turned up 2 inches deep, and the dome a half sphere, made in four pieces. To obtain the pattern for this we proceed as follows: The diameter inside the turned-up dome seat or riveting edge A B, Fig. 457, will be $97.63 + 3.5 \times 2$ or 104.63. Then $\frac{104.63}{2} = 52.31$, and $\sqrt{52.31^2 \times 2} = 73.97$ or C B; that is to say, it equals the side of the inscribed square of a circle A B, whose diameter is 104.63 inches, or the diameter inside the riveting edge, representing the circle D C A N B. Now $\frac{73.97}{2} = 36.98$ or one-half the cord C B of the arc C D B, or F B, and one-half the diameter D E — F E = D F; that is to say, $51.31 - 36.98 = 15.33$, and $F B^2 + D F^2 = D B^2$, or $36.98^2 + 15.33^2 = 40.30$; that is, it equals the cord D B of half the arc C D B; but D G equals D B and $D B^2 - \text{one-half of } D F^2$ (that is, D H) equals $\overline{H G}^2$, or $D G^2 - \overline{D H}^2 = \overline{H G}^2$, which is $40.30^2 - 7.66^2 = 39.29$. Then $\frac{H G}{D H} + D H = D N \times 2$, or $\frac{39.29}{7.66} + 7.66 = 209.20$, or the diameter of a circle of which the curve of each side of the pattern is a part. Now construct the triangle on K G (that is, on O P, Fig. 458, which is equal to K G), and with D N or 104.60 or $\frac{209.20}{2}$ (that is, the diameter of the dome seat) as a radius

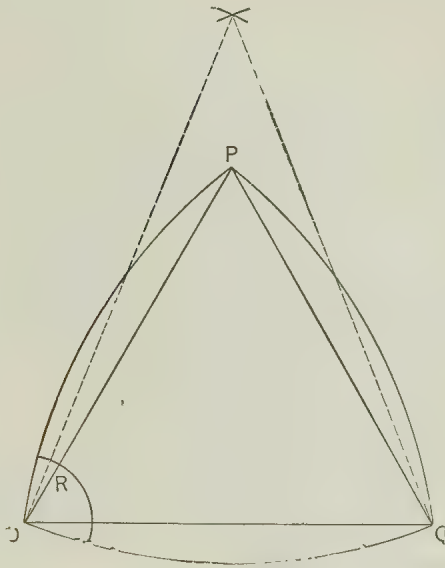

Fig. 458.—Pattern for Quarter of Dome.

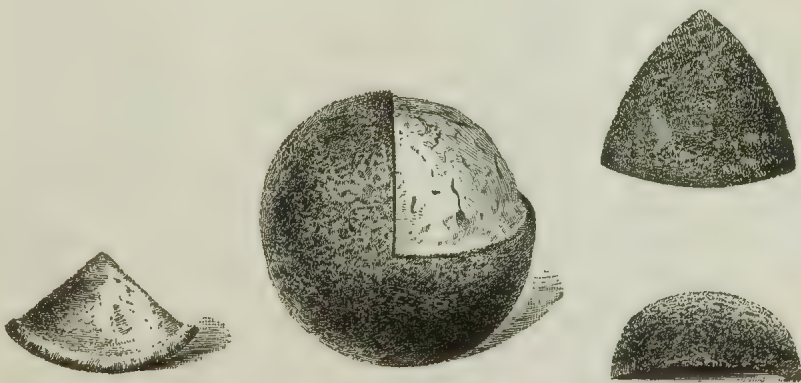

Fig. 459.—Illustrated Lesson by an Orange.

describe the arcs about the triangle O P Q, as shown in Fig. 458. Then at one corner, O, of the pattern, with a radius, O R, equal to one-half the diameter of the crown pipe, mark out the hole for it, making the hole so that when complete it will be about 20 inches in diameter, which will then complete the pattern required of one of the four sections of the dome. Now, having the pattern and the four pieces cut out by it, bend an iron template to the curve of a radius of 48.81 inches, and take the sections to the hollowing tub and hollow them until they fit the template every way, after which planish them in a promiscuous way on a suitable head placed in a solid block. Then punch them and place them in position in the seat, remembering to have the crown pipe also in position before the last quarter of the dome is put finally into its place. Next bolt them together in succession. The manhole may be prepared and fixed to the last quarter before placing, or it may be worked on after, at the discretion of the workman or employer. Put three or four temporary rivets in each seam of the dome and in the seat at each seam, and one or two between. We are now ready to work in the rivets, which may be done in a similar manner to that described and illustrated for an open copper with a light course.

I wish here to make a suggestion for the benefit of the boy who may have occasion to peruse these pages in the hope of finding the assistance he is in search of, because I think this is one of the most appropriate places which has suggested itself, where we can take a practical lesson from nature. Fig. 459 is the picture of an orange with the rind peeled off from three-fourths of the upper half of it, one-fourth being left on to illustrate a part of our lesson. Lying apart from the orange are the three-fourths of the rind which have been taken off. One piece is lying with the concave or flesh side of the skin upward and one with the concave side down and one lying perfectly flat. Now let us carefully consider these three pieces of rind in relation to the lesson under consideration. Let the upper half of the rind of this orange represent the dome of the copper in the next example, and let the dome be made in four pieces, as before. It will be readily seen that the four pieces of orange rind, after being removed from the orange, show in miniature: 1, the exact shape of the pattern; 2, the exact shape it should be when hollowed and planished, and, 3, the position of the first piece when it is placed in the riveting edge on the copper brim. Now,

if we conceive the edges for riveting to have been left on at two sides of the pattern, then the rivet holes of the seam would come down the line of division where the rind of the orange has been cut. With a little study this should be plainly understood. We will now proceed to find the shape and size of this pattern, as suggested to us by the orange rind. Let the diameter CM of a spherical dome or an orange, Fig. 457, be 88 inches in the present example. Describe the circle $ACBM$ to some easy scale that would represent a large-sized orange, say $\frac{3}{4}$ inch to a foot, and divide its circumference into four equal parts, AC , CB , BM and MA ; then the diameter of the circle CM is $1\frac{1}{8}$ inch, or $5\frac{1}{2}$ inches. Now draw the diameters AB and CM , and join CB ; then the arc $CD B$ represents the bend of either side of the section when hollowed to fit the surface of the orange. Draw DB , which represents the chord of half the arc $CD B$. Now divide DF in two equal parts at H , and through H draw KHG , parallel to CFB ; then with DB as radius and D as center describe the arcs BG and CK , cutting KHG in K and G ; then KG represents the true length of the side of a triangle, OP , Fig. 460; that is, from point to point, when the section is lying flat the same as the orange rind in the picture, the line DB having remained the same as it was before the section was flattened and made a plane by being pressed down level. Here, then, we have the length KG of one side of a triangle lying within the pattern OP , Fig. 460, and we find by actual measurement that the line KG is full $4\frac{1}{8}$ inches, which, being multiplied by 16, is 66 inches (or more correctly, 66.1). Now bisect PQ in S , and through S draw OS and continue it to T , making ST equal to DI , Fig. 457, or one-half of DF ; and draw the lines, or chords, TF and TQ ; and bisect these chords perpendicularly with lines meeting in U . Then from the point of intersection of these lines at U , with the distance UQ , UT or UP (which is 5.5 inches, and this multiplied by 16 gives 88; the first, the diameter of the orange, and the second, that of the dome), describe the arcs OP , PQ , QO . Now, with OR as radius, describe the arc WV for the crown pipe hole, and $WPQV$ is the pattern of one section of the dome, as before, but without riveting edge, which must be left on the two sides WP and QV .

There are very many useful lessons that may be learned in a similar way to that suggested here by the rind of an orange, if the student is apt and is of an inquiring turn of mind.

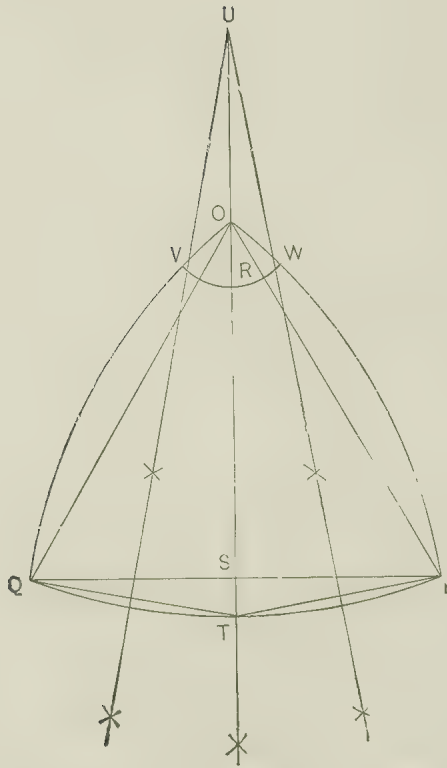

Fig. 460.—Second Method of Obtaining Tattern.

DOME AND PAN COPPERS.

Dome and pan coppers are a combination of the other two coppers we have been treating of, combined in one apparatus, with some few additions, such as the valves at the top of the chimney and the two side pipes to convey the overflow into the pan should the liquor in the copper tend to boil over; also to convey the steam generated in the copper into the liquor which may have been placed in the pan to be heated. It will be seen that the pan bottom is made separate, and when formed ready the inner edge is fitted to the sides, with the edge of the dome crown (except when the dome is in one piece, when the pan would be worked on the dome, as shown in Fig. 461), and then all three are riveted secure, and the rivets scrubbed up so that the heads are all smooth and even with the inner side. The inlet pipes are made of a suitable size, as in N, and connected by flanges with the pan bottom and the side of the copper. At the upper end of the inlet pipes and on the inside of the pan bottom is bolted a screw valve, Fig. 462, which is secured to its place by the same bolts that hold the pipe flange to the pan bottom. When the pan bottom and crown (if the dome is made in pieces) have been worked in the manhole H, Fig. 461, and the inlet pipes also completed, then the sides of the pan may be put up into position and the rivets worked in. The screw valves are now applied with a rod and T-handle with which to open and close them, the rod being held in position by a bracket, B, bolted to the side of the pan. Any good workman who has made a large open or dome copper should be competent, after studying the preceding pages and the accompanying illustrations, to build a dome and pan successfully. I shall therefore let the directions given for the building of the other two styles suffice for that of a dome and pan, and thus avoid repetition as much as possible.

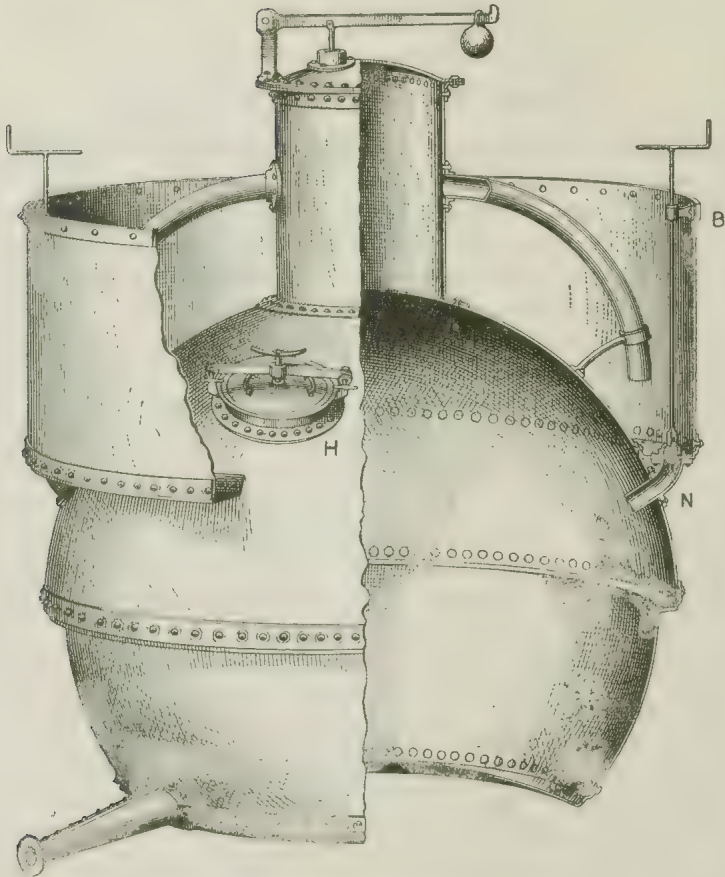

Fig. 461.—Dome and Pan Copper.

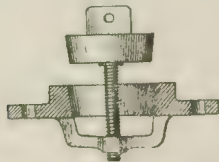

Fig. 462.—Screw Valve.

TALLOW COPPERS.

In Fig. 463 is shown a tallow copper. These vessels were made for and used by tallow chandlers, whose principal use for them at one time was in manufacturing tallow candles. Tallow coppers are an extra good job, because of the greater care necessary to make them sound—that is to say, perfectly tight and not liable to leak. These coppers were at one time in great demand, when all England burned candles much more so than now. But there is yet an occasional demand for one, because tallow is still used for many other purposes besides that of making candles, and the shape of this copper is better adapted for the use of rendering out tallow than any other, as the curve or spherical shape of the sides tends to throw the fat that boils up the sides toward the center, which partially accounts for its peculiar shape, as compared with coppers for some other purposes. This copper has a wide brim, so that any slopping or drainings may be conveyed back into the copper

NOTE.—In this connection some piece work prices for copper-smith's work paid in London will be of interest :

- Brewing coppers, $3\frac{1}{2}$ cents per pound for men ; one-half the price for boys.
- Tieches for planishing general, 2 cents for men ; one-half the price for boys.
- Four-inch worms, 4 cents per pound for man and boy.
- Retorts, 6 cents per pound for man and boy.
- Stills, $3\frac{1}{2}$ cents per pound, metal as well.
- Middle pieces, 4 cents per pound for brazed seams.
- Four-inch tee-pieces, \$1 each for men ; 50 cents for boys.
- Three-inch tee-pieces, 75 cents each for men ; $37\frac{1}{2}$ cents for boys.
- Four-inch bend complete, 83 cents each for men ; $41\frac{1}{2}$ cents for boys.
- Three and one-half-inch bend complete, 64 cents each for men ; 32 cents for boys.
- Three-inch bend complete, 50 cents each for men, 25 cents for boys.
- Two-inch bend complete, $37\frac{1}{2}$ cents each for men ; 18 cents for boys.
- Worms, when two men work at them, 8 cents ; when a man and boy work at them, 6 cents.
- The time usually consumed putting up sides into bottom of a 300-barrel copper by two men, inside and three outside, two and one-half days. Punching holes, in bout, three men inside and two outside, one and one-half days each.
- Setting-to 105 holes, two men one day. Setting-to 20 holes in seam and working in 20 No. 2 nails, with one man inside and two outside, three hours.
- Working one seam of 20 nails, three men, one day. Working one bout of 15 nails No. 1, three men, one day.
- Time consumed taking off old bottom from a dyer's copper and putting on new one, the new bottom weighing 140 pounds, 33 inches in diameter and 9 inches deep. Cutting out old bottom and annealing sides and planishing, ten hours. Planishing new bottom, seven hours. Putting up block, punching holes, bolting together and working in 40 No. 4 nails, nine hours. Scrubbing up new bottom, eight hours. Total time for job, three days four hours.



Fig. 463. Broad-Brim Tallow Copper.

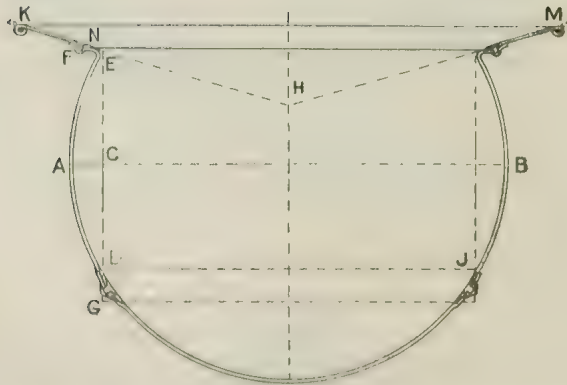

Fig. 464.—Section Through Broad-Brim Tallow Copper.

by it. They are made sometimes with narrow brims, in which case the broad brim is substituted by one made of lead, covering the whole of the brick work on its top surface about the brim, and turning down over it on the inside of the copper from 2 to 3 inches, which, in some cases, is preferable, because, then, none of the tallow can penetrate the brick work from the top.

Let us make one of these broad-brimmed tallow coppers, and let the sides be made from a sheet of, say, 35-pound plate, or about 1-16 inch in thickness, to hold 200 gallons, and let its sides be in three pieces and the bottom in one. It will be noticed that this vessel, Fig. 463, is spherical in form, the body being made up of the middle zone and the bottom segment, the other or top segment being absent to form the brim or copper mouth. Now, the first thing we must do is to find the size of a vessel of this shape that will hold 200 gallons, which we will now proceed to do as follows: It is well known that a spherical inch is represented by 0.5236, but the copper is a sphere with a segment cut off equal in height to one quarter of the diameter of the sphere (see Fig. 464), and the value of this segment cut off is 0.08181; therefore, $0.5236 - 0.08181 = 0.4417$. Now, there are 277.274 inches in a gallon (English measure), therefore, $277.274 \times 200 = 55,454.80$ cubic inches, and $\frac{55,454.80}{0.4417} = 125,548$; when, extracting the cube root of 125,548, we get 50 inches as the diameter A B of the middle zone of the copper when ready for the bottom. If Fig. 464 be drawn to a scale of $\frac{3}{4}$ inch to a foot, it will be found that from C to B is 47 inches, from D to E is 25, from F to E is 4 inches, and from D to G 3 inches. Adding these last three dimensions together, we have $25 + 4 + 3 = 32$ inches for the depth of the sides before working, and the diameter C B 47 inches, when $47 \times 3.1416 = 147.6552$, and 147.6552 divided by 3, the number of sides to be used, we have 49.2184, or $49\frac{1}{4}$ inches. To this we add 2 inches to each piece for seams, when we get $51\frac{1}{4}$ inches for the length of each side, including edges, and 32 inches deep, including brim and lap for the bottom seam. Now we find the size the disk should be for the bottom before hollowing, as follows: It was stated in a former chapter that the surface of a sphere is equal to its circumscribed cylinder, and therefore the surface of any segment of a sphere is equal to the diameter of the sphere multiplied by the height of the segment, multiplied by 3.1416; or the surface of a sphere is equal to four disks whose diameter is equal to

the diameter of the sphere. From which we get $50 \times 12.5 \times 4 = 2500$, and extracting the square root we get 50 inches for the diameter of the disk to form the bottom before hollowing, or $4 \sqrt{50 \times 12.5 \times 4}$. Now we have the sides and bottom, and require the broad brim, which is obtained as follows. The brim when completed with a $\frac{3}{4}$ inch wire in the outer edge should measure 10 inches, or thereabouts from E to K, Fig. 464. Now the wiring edge at K will take $1\frac{1}{2}$ inches, and will reach and lap at N 2 inches, which will make the brim before working $10\frac{1}{2}$ inches wide. Then the diameter of the brim from K to M when complete before wiring is 66 inches, and forms a frustum of a cone, the slant height of which is H M, or 34.5; that is, \sqrt{r} , Fig. 465. With the radius r a from r as center describe the circle $y w x u s$, making the distance around it from y to y equal to the circumference of a circle whose diameter is K M, or 66 inches. Now $66 \div 3.1416 = 207.315$ and $69 \div 3.1416 = 216.77$ and $216.77 - 207.315 = 9.42$, or $9\frac{1}{2}$ inches nearly; that is to say, the segment $y r x$ from y to x , which would be taken out, is equal to $9\frac{1}{2}$ inches nearly. The brim may be put on in any number of pieces. In this case let there be four; then $y u a b$ is one section of the brim bare. Adding 2 inches on for riveting edge, the pattern is complete and will measure from u to d 33.83, and from a to e 38.06, and from e to d 10.5 inches. Here we have all the patterns and will now begin to put them in shape. First, the bottom, by taking it to a hollowing tub, and with suitable maul, sink it in the tub until it is hollowed enough; that is, until it measures across it 46 inches. Then mark the rivet holes for about No. 1 or No. 2 wrought copper rivets, and space the holes so that the edges of the rivet heads are about $\frac{1}{2}$ inch apart. The sides are next in order. These will be put together with No. 3 or No. 4 rivets, and the heads about $\frac{3}{4}$ inch apart and reaching to within $\frac{1}{4}$ inch of the lap edge. When the sides have been punched bend them into shape and put in a few temporary rivets; take a racer and divide the depth into three spaces and proceed to raze in both ends; the bottom end right out to the end, the top end to within 4 inches, making the lower end fit into the bottom about $\frac{3}{4}$ inches, and drawing the top end out until it measures 43 inches at 4 inches from the end, when the brim is thrown back for the additional wide brim. While the two ends are being worked in the sides are put on the tub at the end of each course, and hollowed out to complete the spherical curve of the body. Now we form the brim by putting the four pieces together and wiring the edges with a $\frac{3}{4}$ inch

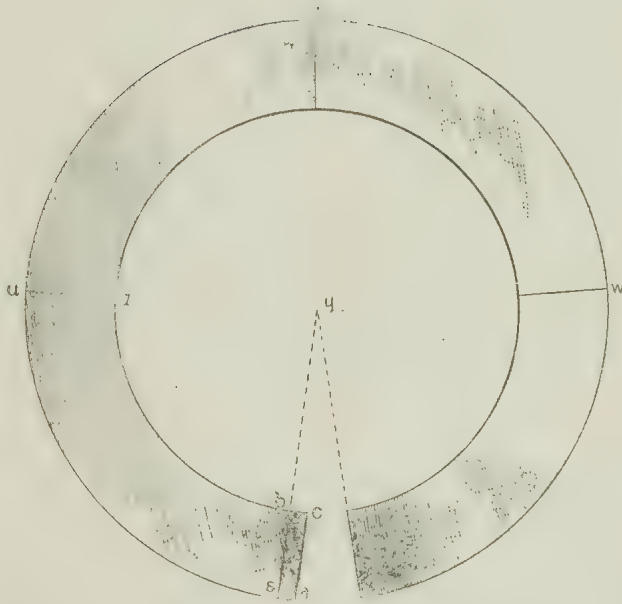

Fig. 465.--Pattern of Brim.

iron ring. The workmen may now select which is more convenient to him, and first put on the brim or the bottom. If the brim is first put on, carefully scrub the rivets and make the surface smooth about the rivet heads, and work the seam edge carefully down close, then the same with the bottom. It is usual to rub the seam well with white lead and oil on the inside after the job is finished

DYERS' COPPERS.

Dyers' coppers, as compared with some others, are not a difficult job, which will be readily seen by referring to Fig. 466. A dyers' copper is made with a cylindrical body and a segment of a sphere for a bottom. The sides are usually made in two pieces, and the bottom in one. These coppers may be made with a broad or narrow brim, similar to that of a tallow copper; or they may be supplied with a lead apron to catch and convey the drip and slopping, which is always a contingent circumstance in the dyers' art. Let us make a dyers' copper to hold 150 gallons American standard. Now, we have learned by experience that the easiest way to build this vessel is to make the bottom one-fourth the depth and the sides three-fourths, without the brim, although this, like all others, may be made any style or shape to suit the taste or convenience of the purchaser. But we will suppose the sides needed are three-fourths the depth and the bottom one-fourth. An American gallon equals 231 cubic inches, and $231 \times 150 = 34,650$, or the number of inches in 150 gallons, and we have 0.7854, which represents a cylindrical inch; then $\frac{0.7854}{4} \times 3 = 0.58905$, or $\frac{3}{4}$ cylindrical inch. The value of a segment of a sphere whose height is one-fourth its diameter is 0.08181, and adding this to the value of $\frac{3}{4}$ cylindrical inch we have $0.58905 + 0.08181 = 0.67086$, the value of the figure which represents a dyers' copper. Then $34,650 \div 0.67068 = 51,663.982$, and extracting the cube root of this last result we have 37.2 as the diameter, or $\sqrt[3]{\frac{34,650}{0.67068}} = 37.2$; that is to say, $37\frac{2}{10}$ inches is the diameter of the sides, and $\frac{37.2}{4} \times 3 = 27.9$, or 28 inches nearly, is the depth, without seams, and $\frac{37.2 \times 3.1416}{2} = 58.4337$, the length of one side. Add to each side about $2\frac{1}{2}$ for seams and we have the full length represented by $58.4337 + 2.5$, or 60.9337, which we should call in practice 61 inches. Now we must add 3 inches for the brim, and we have $27.9 + 3 = 30.9$,

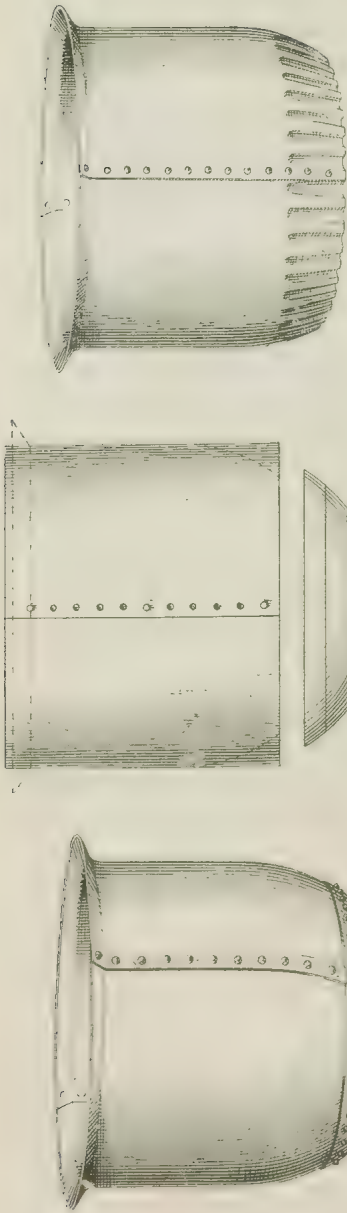

Fig. 469.—Drawing in the Sides to Fit Bottom.

Fig. 468.—Preparing to Turn the Brim.

Fig. 466.—Dyers' Copper.

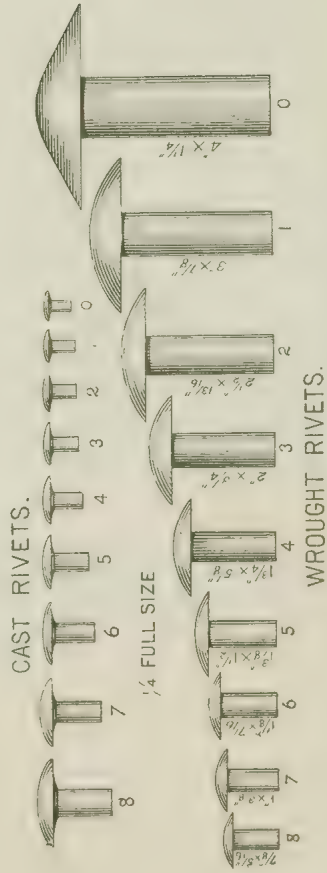

Fig. 467.—Size and Shape of Copper Rivets, One-Quarter Size.

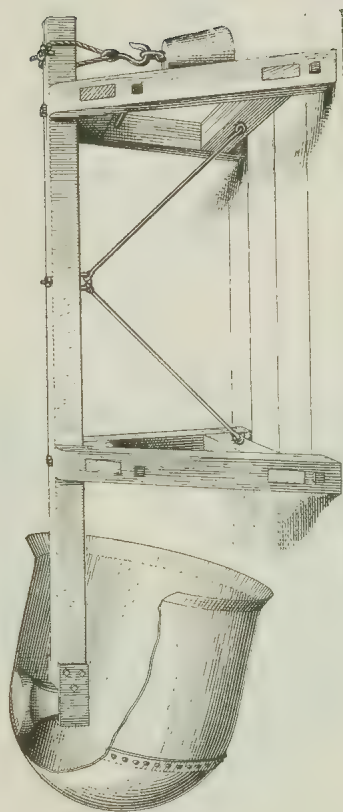

Fig. 470.- Planishing Dyers' Copper.

or 31 inches nearly. Let the sides be 60 inches long and 31 inches deep. The bottom is obtained as follows: $\sqrt{6.975 + 3 \times 4 \times 37.2}$
 $= 38.52$; that is to say, one-fourth of the height of the copper, or 6.975, with 3 inches added for bottom seam, making 9.975, multiplied by 4, and then by 37.2, the diameter of the copper, and the square root of this last result is 38.52, or $38\frac{1}{2}$ inches, which is the diameter of the bottom before hollowing.

We are now ready to hollow the bottom, mark and punch it, also to prepare the sides for putting together in the same way. In the building of this copper we may use cast or wrought rivets; let us use cast. I should here state that the sizes of cast rivets are designated the opposite way to that of wrought—that is, No. 0 is the largest size in wrought rivets, which run from 0 to 8, while 8 is the largest cast rivet, which run from 8 to 0. Fig. 467 shows the shape and sizes of both wrought and cast. (We usually call the wrought ones nails to distinguish them from cast rivets.) Take the bottom and wrinkle it regularly around the edge; then sink it in the hollowing tub, and work out the wrinkles carefully until the diameter is the size required; smooth up and planish. Now work and punch the sides and bend them to shape, and put three temporary rivets into each seam; then with a racer mark off the depth of the brim and run around it with a hammer, Fig. 468, to harden it at the turn, and then lay off the brim. Draw in the other end at the sides to fit the bottom, Fig. 469, and planish the sides on the horse as shown in Fig. 470, and work in the seam rivets. Scrub and finish the seam, making the surface of the seam inside smooth. Mark and punch the holes for the bottom seam, after which set the sides into the bottom evenly all round, and mark the holes in the bottom by the sides, and punch the bottom. Put the sides back in the same place, and put into the bottom seam a few temporary rivets. Now work them in all round the bottom seam, performing the work on the horse. When they are all in, scrub them up tight until the inside is smooth, after which head up the rivets outside and finish.

TIECHES.

Sugar tieches were made the same as a tallow copper, excepting that heavier material was used, and the brim usually made narrow, as shown in Fig. 471. They can now be made in one piece, but where this is not possible the same rules and directions given for tallow coppers may be used, and will be found as useful for tieches and all other vessels of this shape as for tallow coppers, due allowance always being made for seams, as suggested in the directions given.



Fig. 471.—Sugar Tiech.

STILLS.

Copper stills are and have been in continual demand for many years and are likely to be, seeing that there are so many uses to which they may be put in the manufacture of the many commercial commodities which depend upon the process of distillation. Stills are made from 1000 to 5000 gallons capacity, according to the uses for which they are required. The largest, however, are used for the purpose of distilling spirits, such as gin, rum and brandy. These large stills will occupy our attention. In Fig. 472 is shown a squat or fire still with head and worm. This apparatus is usually made in three sections—that is to say, the still boiler, the head, and then the worm, which together complete the still proper. But they are often supplemented with retorts of various designs, the most common of which is shown in Fig. 472. These retorts are used for rectifying purposes, and there are sometimes several interposed between the still and the worm, according to the degree of rectification required. As all large stills are made nearly the same pattern, we will make one as an example or guide for ascertaining the dimensions and pattern of those most in use and then consider their construction. Let our example be required to hold 500 gallons. It will be seen by reference to Fig. 472 that the outline or design of the body of the still boiler is that of an oblate spheroid—that is, down to the lag of the bottom, when the bottom is reversed or pressed upward to form the bottom crown, in the same way as that of a brewing copper. Here, in the case of a still, as in a brewing copper, the quantity displaced by the crown of the bottom is quite an item in the capacity and must, therefore, be taken into account, although it was ignored in the case of large brewing coppers. Our body, then (that is, the boiler), is to hold 500 English gallons. Now, we find the solid contents of a spheroid by multiplying the square of the revolving axis by the fixed axis and this product by 0.5236. Here, then, we have the key to the solution of the various problems involved in the sizes or dimensions we should make the still boiler, and we will proceed to find the diameter and height of a still boiler to hold 500 gallons (English meas-

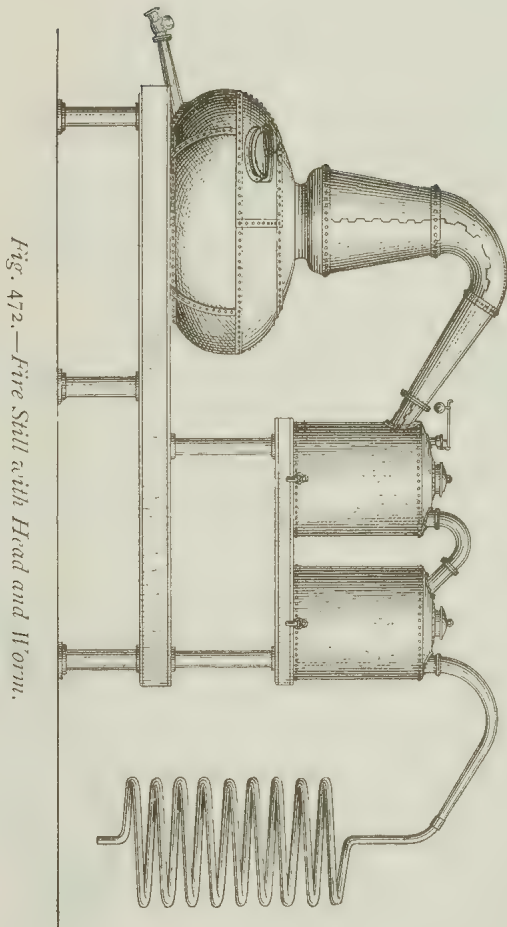

Fig. 472.—Fire Still with Head and Worm.

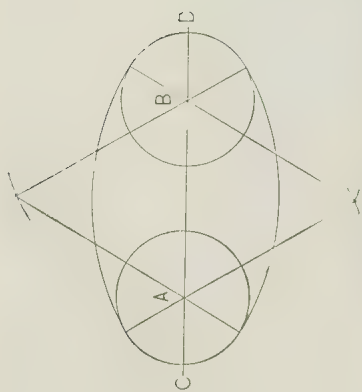

Fig. 473. Method of Drawing Oblate Spheroid.

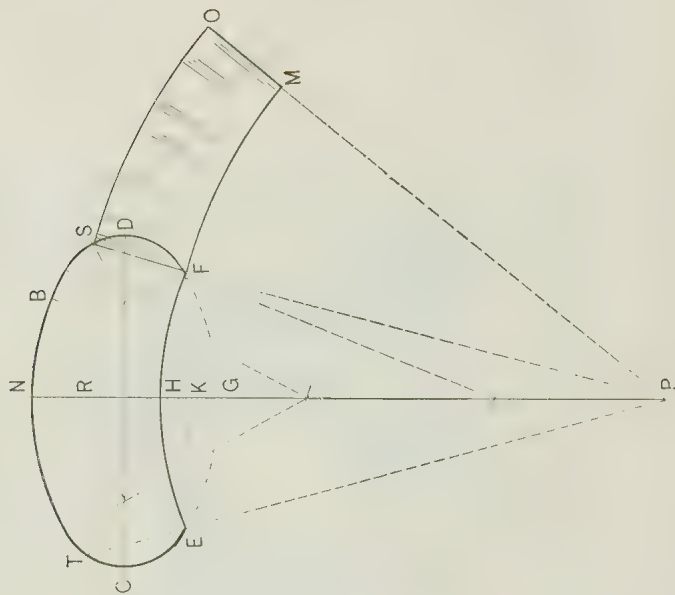

Fig. 474.—Pattern for Sides of Boiler.

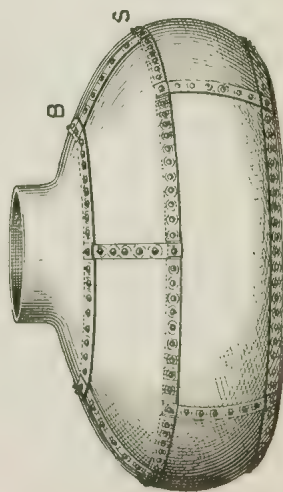

Fig. 475.—Elevation of Boiler.

ure), to be used as a rule to find any or all others. An English gallon contains 277.274 cubic inches, therefore $500 \times 277.274 = 138,637$. Again, in an oblate spheroid whose dimensions are fixed in the proportions shown in Fig. 473—namely, two and a half diameters of the focal circles A and B as the measure of the transverse axis of the ellipse which forms the outline for or boundaries of the spheroid, and whose axis is C D, or is 1—the value of its solidity is found by the rule given to be 0.29362. The spheroid, however, is made concave on the under side to form the lag and crown of the boiler bottom, therefore this value must be reduced by the value of the spherical segment E G F, Fig. 474, which vanishes, together with the segment E H F, which forms the bottom crown. Now,

$\overline{E K}^2 \times 3 + \overline{G K}^2 \times G K \times 0.5236 = 9.02758$, the solid content of the seg-

ment H E F, and $\overline{E K}^2 \times 3 + \overline{H K}^2 \times H K \times 0.5236 = 0.02128$, the solid content of the segment E H F, or the segment which forms the crown of the boiler bottom; then subtracting the value of these two segments from the whole spheroid we have $0.29362 - (0.02758 + 0.02128) = 0.24476$, or the value of solid figures whose dimensions are similar to or like that of a still boiler. To proceed: the solid content of 500 English gallons is shown to be 138.637 cubic inches; then $138.637 \div 0.24476 = 566,420.168$ boiler inches, and extracting the cube root of this last result we have 82.73 as the diameter C D of a still boiler to hold 500 gallons. Now, we want the depth, H N, Fig. 474, which we find by multiplying the transverse axis C D, or 82.73, the diameter of the boiler, by 0.3701; that is to say, C D by H N, or $82.73 \times 0.3701 = 30.618$. We thus have the diameter of the boiler 82.73 inches, or 6 feet 10 $\frac{5}{8}$ inches, and the depth from the bottom crown to the head collar 30.618 inches, or 2 feet 6 $\frac{5}{8}$ inches nearly. For the pattern proceed as follows: Through S F and T E, Fig. 474, draw the lines S P and T P, and with P F as radius describe the arc F M, and with P S as radius describe the arc S O, making the distance from F to S equal to 26.028; that is, 82.85 multiplied by one-fourth of the circumference of the focal circle. The length of each one of the sides from F to M may be any convenient length, according to the size of the sheet; but for the symmetry and beauty of the work the sides should be all alike; that is to say, either three, or four, or any other suitable number, so long as they

are all alike or can be got out of the sheets at hand without waste. Now take sides enough so that when they are put together they will measure 83 inches in diameter at the points C and D after the top and bottom have been tucked in to form the bulge or curves of the sides, and let the sides, when ready for the bottom, go into the raise of the bottom within about $2\frac{1}{2}$ inches of the bottom lag. The first section of the crown from S to B, Fig. 475, may be made in the same number of pieces as the sides if it cannot be supplied in one piece with the bottom, but the crown pieces are usually supplied. Having then the sides, bottom and crown, the workman may proceed to put them together in a similar manner to that described for the building of large brewing coppers. I should here say, it is sometimes better to cover the trestles with boards of a suitable thickness (if at hand), which will add firmness to the trestles and make the stage more complete. The illustration, Fig. 472, fully explains itself as to the construction of the still head and worm, while the processes or methods used to make them have been explained in a former chapter and need not be repeated.

INDEX.

	Page.
American Copper Mines.....	4
Ancient Light Coppersmithing.....	6
An Old-Fashioned Shop.....	7, 13
An Ancient Frying-Pan.....	44
Attaching Outlets.....	200, 201
Apparatus for Brazing Brass Seams.....	249
Attemperator, Round, with Coil.....	271
Attemperator For Fermenting Back.....	274
Braziers' Art Treasures.....	6
Bellied Saucepan.....	18
Benches with Forming Bars in Position.....	10, 25
Boss for Outlet Pipe and Bock of Copper.....	32
Bottom Prepared for Putting into Hand Bowl.....	38
Blanks Fastened Together for Raising.....	46
Brazing Barrels to Straps for Handles.....	59
Bossing Covers.....	66
Bullet Hammer.....	67
Beer Mullers.....	71
Brazing Pans.....	104
Boiler Hook and Rack.....	108
Boat Coal Scoop.....	124
Barge Pump.....	156
Bending Block and Lever.....	184
Block and Stake for Working Bends.....	187
Bend Making.....	186 to 193
Balloon Firepot in Position for Use.....	201
Burring Pin, and How to Use It.....	201, 202, 232
Broken View of Expansion Joint.....	205
Bent Expansion Joint.....	208
Bringing Halves of Pipe Together.....	186, 225
Bend Wired and Slung for Fire.....	225, 226
Bends, S.....	228
Bends, S, to Stand at Right Angles.....	228
Bends Placed in Position for Brazing.....	228
Brazing on Flanges.....	230
Bends, Shortest, How to Make Them.....	232

Brazing Sheet Brass	248
Brass Covers for Safety Valves.....	254
Brazing Round Joints.....	258
Brass Dome Covers	261
Brazing in Dome Crown.....	267
Boiling, Round (Vat) and Coil	272
Brewing Coppers.....	281 to 300
Copper and Its Uses.....	2
Copper Mines.....	3
Copper Stove Pipe, How to Make It.....	22 to 25
Coal Scoop Handle.....	51
Coffee Pot Handle.....	52
Collar Pitched on Spout	56
Clamp for Tinning Tea-Kettles	64
Charger or Solder Spoon	64
Cup for Bossing Covers.....	64
Collar Set.....	66
Creasing Hammer	73
Covered Muller.....	77
Coffee Pots.....	83
Coffee Pot Spout	85
Coal Hod	123
Coal Scoop, Plain	123
Coal Scoops	124
Coal Scoop Making.....	128 to 150
Coppersmiths' Appliances.....	162
Cutting Cramps	171, 172
Clamps to Hold Fire Pots in Position	179
Cod and Its Uses.....	189
Cross Pieces	213, 214
Chain, Hook, and Dogs Applied.....	236
Copper with Light Course.....	282
Crowning a Copper Bottom	287
Copper Sides in Position for Building	288
Dimensions of Hand Bowls.....	35
Duckbill Tongs.....	39
Die for Making Tea-Kettle Rings.....	59
Dimensions and Weight of Copper Tea-Kettles.....	69
Dripping Pan and Ladle	118
Diagram of Bend	188
Describing Pattern for a Bend	190
Double Expansion Joint	206
Double Bends	227
Dogs for Securing Sheet.....	236

Diagram for a Flat Coil.....	274
Diagram for Calculating Curve of Sides.....	283
Dome Coppers.....	294
Dome and Pan Coppers.....	300
Dyers' Coppers.....	307
Drawing in Sides to Fit Copper Bottom.....	308
East Side of an Old Shop.....	10
Ears for Coal Scoop Handles.....	51
Expansion Joints.....	204
Expansion Joint with Round Edge.....	206
End View of Large Tee.....	210
Enlarging Hole with Burring Bar.....	233
Elevation of Still Boiler.....	314
First Year's Experience.....	14
Folding Edges.....	23
Filing and Finishing Spouts and Handles.....	57, 58
Forming Beer Muller Body.....	73
Forming Lips of Mullers.....	75
Funnels.....	80
Forming Funnel Body.....	81
Finishing a Square Lag.....	96, 97
Fish Kettles.....	102
Fish Plates.....	103
Forming Breast of Tea Boilers.....	109
Flat Bottom Coal Scoop.....	123
Florence Coal Scoop.....	124
Flange Broken Off, How to Put It On.....	193, 194
Four Types of Tee Pieces.....	209, 210
Fire Pots.....	177, 179, 181, 201, 226, 229
Glue Pot Making.....	61
Glue Pot and Cup Finished.....	66
Grommet for Bending Pipe.....	184, 185
Gauge for Marking.....	205
Gusseting Tee Pieces.....	210
Gusseting Britch Piece.....	212
Historical Sketch of Copper.....	1
How to Arrange the Planishing Blows.....	24, 26
Hammers, Cross Piened.....	29
Hand Bowl Making.....	35
Hammers, Riveting.....	36
Hammers, Razing.....	36
Hand Bowl, Finished.....	39
Hollowing Hammer.....	43
How Wrinkles Are Razed Down.....	44

Hand Swage for Water-Balls.....	49
Hammers, Bullet.....	67
Hammers, Creasing.....	73
Hammers, Spring Faced.....	73
Handle for Large and Small Mullers.....	76, 77
Head and Shank for Planishing.....	82
Hammers, Piening.....	85
Hammers, Coffee Pot.....	96
Head for Working Round Lag.....	96
How to Raise Preserving Pans.....	117
How to Mend a Fracture or Split.....	194
How to Prepare Patches.....	197
How to Sling Large Bends.....	225
Hammers and Rack.....	239
Hollow Spheres.....	241 to 247
Heavy Pipes for Breweries.....	269 to 280
Horse-Shoe Bend.....	270
Hollowing Tub.....	285
Horse for Planishing Coppers.....	309
Interior View of Front End of Railway Shop.....	164
Interior View of Back End of Railway Shop.....	166
Interior Views of New Shop.....	168, 169
Interior Views of Marine Shop.....	221, 222
Interior View of Shop for Still and Brewery Work.....	A268
Instructive Lesson with an Orange.....	295, 296
Joining Spout to Coffee Pot.....	84
Joint for Warming Pan Cover.....	116
Jigger Pumps.....	160
Joining Pipes.....	173, 175, 228, 276
Kettle (Tea) Handles.....	51
Kettle Spouts.....	53 to 56
Kettle Rings or Cover Seat.....	59
Kettles, Oval, Top Seamed On.....	67
Kettles, Oval, Top Razed Down.....	67
Kettle, Dimensions and Weight of Copper.....	70
Kettles, Fish.....	102
Kettles, Turbot.....	103
Kettles, Brewing.....	281
Light Coppersmithing.....	6
Lipped Mullers.....	75
Lipped Muller, Old Style.....	77
Lipped Saucepans.....	89
Ladle and Dripping Pan.....	119
Lift Pump and Fittings.....	155

Liquor Backs with Attemperator Pipes	271
Laying Out Coils	276
Laying Off Brim of Copper	27, 308, 310
Measuring Tinning and Retinning	19
Making Stove Pipe	22
Making Washing Coppers	26
Making Copper Sides True	28
Making Brewery Coppers (Small)	31, 33
Making Hand Bowls	35
Making Socket Handles	38
Making Frying Pans	42 to 45
Making Closet Pans	46
Making Water-Balls	47, 49
Making Mounting for Copper Goods	50
Making Tea-Kettle Spouts	53 to 58
Making Rings for Cover Seat	58, 59
Making Glue Pots	61
Making Tea-Kettles	62, 67
Making Beer Mullers	71 to 79
Making Funnels	80
Making Coffee Pots	83 to 85
Making Saucepans	87
Making Round and Oval Pudding Pots	88 to 92
Making Stewpans	93 to 98
Making Stockpots	99
Making Fish Kettles	102
Making Fish Plates	103
Making Brazing Pans	104
Making Tea Boilers	107 to 111
Making Warming Pans	112 to 116
Making Preserving Pans	117
Making Dripping Pans	118, 121
Making Coal Hods	122, 123
Making Scoopets	125, 126
Making Coal Scoops	128 to 147
Making Cranes or Syphons	151, 153
Making Lift Pump	155
Making Barge Pump	156
Making Oil Pump	159
Making Jigger Pumps	160, 161
Making Copper Pipe	171, 172
Making Templates	183
Making Bends	186 to 190
Making Outlets	199, 201

Making Expansion Joints.....	204 to 207
Making Tee Pieces.....	209
Making Three-Way Pieces.....	211
Making Cross or Four-Way Pieces.....	213, 214
Making Large Bends.....	224
Making Double Bends.....	227, 228
Making Shortest Bends.....	232, 233
Making Air Pipes.....	234, 237
Making Hollow Spheres.....	241 to 247
Making Valve Chimneys.....	254, 255
Making Valve Covers.....	260
Making Dome Covers.....	262 to 267
Making Square and Round Coils.....	269 to 280
Making Large Open Brewing Coppers.....	281 to 292
Making Dome Coppers.....	293
Making Dome and Pan Coppers.....	299, 300
Making Tallow Coppers.....	301
Making Dyers' Coppers.....	307
Making Sugar Tieshes.....	311
Making Stills.....	312 to 316
North Side of Old Shop.....	9
Nautilus Scoop, Brazed and Wrinkled.....	143
New Locomotive Coppersmiths' Shop.....	167
New Way of Making Bends.....	189
Old-Fashioned Whale Oil Lamp.....	15
Oval Tea-Kettle, Top Seamed On.....	67
Oval Tea-Kettle, Top Razed Down.....	67
Oval Tea-Kettle, Dimensions.....	69
Old-Style Muller.....	77
Oval Pudding Pot.....	89, 92
Old-Fashioned Stewpan.....	94
Oil Pumps.....	159
Outlets.....	199
Piece Doubled for Mending Split.....	18
Piece Put Through from Inside of Pan.....	18
Piece Put In from Outside.....	18
Piece Riveted In.....	19
Piece Cramped and Brazed In.....	19
Pieces Dogged Together for Planishing.....	23
Planishing at the Block.....	24
Punching Holes in Sides.....	28, 288
Punching Holes in Bottom.....	29, 288
Pipe Pattern.....	32
Pattern for Socket Handle.....	38

Pattern for Frying Pan	43
Pattern for Half Ball	49
Pattern for Tea-Kettle Spout	53
Pitching Spout Collars	56, 58
Position to Sit While Planishing	64
Pattern for Oval Tea-Kettle Bottom	67
Pattern for Muller	72
Pattern for Old-Style Muller	77
Pattern for Funnel	81
Pattern Coffee-Pot Spout	85
Pattern for Warming-Pan Body	114
Pattern for Dripping Pan	120
Pattern for Coal Hod	126
Pattern for Coal Scoop Bridge and Body	129
Pattern for Back and Foot of Coal Scoop	131
Pattern for Flat-Bottom Scoop	136
Pattern for Back of Tudor Scoop	138
Pattern for Raised Nautilus Scoop	138
Pattern for Nautilus Scoop Bridge	142
Pattern for Nautilus Scoop, Cut and Brazed	143
Pattern for Royal Scoop	145
Pattern for Bottom of Boat Scoop	146
Pattern for a Made Bend	190
Pattern for Expansion Joint	205
Pattern for Tee Piece	210
Pattern for Three-Way Piece	212
Pattern for Cross or Four-Way Piece	214
Pattern for Shortest Bends	233
Pattern for Air Pipe or Ship Ventilator	236
Pattern for Half Ball or Hollow Sphere	246
Pattern for Valve Chimney Bell	254
Pattern for Valve Chimney Foot	259
Pattern for Dome Cover Foot	263
Pattern for Dome Crown	264
Pattern for Quarter of Copper Side	283, 284
Pattern for Quarter of Copper Dome	295, 296
Pattern for Tallow Copper Brim	305
Pattern for Still Boiler	314
Putting in Muller Bottom	75
Pitched Cover for Muller	77
Planishing Muller Cover	79
Piening Hammer	85
Pudding Pot and Cover	88
Pattern Wrinkled for Raising	114

Preserving Pans, How to Raise Them	117
Planishing and Smoothing	148
Planishing Hammers	149
Photographs of Railway Shop Inside	168, 169
Planishing Bends	188, 227
Patching Pipes	196, 197
Photographs of Maudsley, Sons & Fields' Coppersmiths' Shop in London, England	221, 222
Portable Fire and Its Uses	226
Planishing Pipe	237, 239
Photograph of Hendry & Co.'s Shop in London	269
Planishing Copper Bottom	287
Preparing to Turn Brim of Dyers' Copper	308
Repairing and Tinning	17
Riveting Together Sides of Copper	28, 288
Raising Hammer	36
Riveting Hammer	36
Raising Up Side of Frying Pans on Shank	43
Razing Down Wrinkles	44, 45
Raising Up Water-Balls	48, 49
Razing Down Tea-Kettle Tops	62
Razing Down Pudding-Pot Bodies	88
Raising Up Warming-Pan Bodies	114
Raising Up Preserving Pans	117
Raising Up Back and Bridge of Scoop	140
Rope Grommet for Bending	184, 185
Raising Up Half of Cross Piece	213, 215
Raising Hammer	215
Raising Up Hollow Spheres	242, 244
Razing Out Bell Tops for Valve Covers and Chimneys	256
Razing Out Valve Cover Foot	258
Razing Out Dome Cover Foot	264
Rivet Card Complete	308
Smelting Copper	4
South Side of Old Shop	10
Stewpan Repairing	18
Shell Pieces, Making of	19
Sal Ammoniac Wad	19
Shell Piece Riveted In	19
Shell Piece Brazed In	19
Sides of Copper Formed	28, 288, 289
Sides with Holes Punched for Rivets	28, 288, 289
Spotting Coppers	29
Scrubbing Rivets	29

Showing How Bottom of Brewing Copper is Crowned.....	32
Side Stake	36
Side of Hand Bowl.....	36
Sides of Bowl Working to Shape	37
Socket Made Ready for Flap.....	39
Stock-Pot Handle	51
Spout Tools	54
Spout Making	53, 54
Spout Filling and Bending	55
Spout Bending, Old Way.....	57
Spout Bending, New Way	57
Solid Copper Tea-Kettle Ring	60
Showing Kettle Cover in Seat of Ring.....	66
Spring Faced Planishing Hammer	73
Spring Face Detached from Hammer	73
Spirit Measure.....	82
Spout Pattern for Coffee Pot.....	85
Saucepan Cover	88
Saucepan Handles	88, 89
Stewpans	93
Stewpan Handles	94
Stockpots, Way to Get Sizes	99
Stockpot, Showing Strainer and How Put In.....	100
Section of Brazing Pan Cover.....	105
Separate Parts of Tea Boilers.....	111
Socket Handle for Warming Pan	116
Spring Hammer for Planishing	134
Syphons.....	151
Solder Reed for Charging Seams	155
Swaging and Smoothing Pipe	159
Single and Double Jigger Pumps	160
Standards for Holding Up Pipe.....	172
Soft Soldering Large Joints.....	180
Skimming Rod.....	181
Seaming Bends in Throat and Back	189
Single and Double Template Boards	191 to 194
Shaping Expansion Joints	206
Saddle Forges	218, 259
Slinging Bends for Brazing	225
Solder, Black (Never Use It).....	231
Showing First Form of Half Ball.....	242, 244
Sides of Copper Ready for Riveting	28, 289
Screw Valve for Dome and Pan Copper.....	300
Sectional View of Tallow Copper	302

Still with Head and Worm Complete.....	313
Tinning Kitchen Utensils.....	20
Truing Up Sides of Copper.....	28
Table of Dimensions, Capacity and Weight of Coppers.....	34
Tea-Kettle Handles.....	51
Tinning Stewpan Rims Outside.....	98
Trough and Bar for Turning Pipe.....	155
Tanners' Pump.....	156
Taking Templates.....	183
Tee Pieces.....	209
Three-Way Pieces.....	211
Three-Section Firepot.....	229
Trestle and Mandrel for Planishing.....	237
Tools for Raising Up Half Balls.....	244
Thousand Barrel Copper.....	291
Tallow Coppers.....	301
Time Consumed Repairing Some Copper Jobs.....	301
Tieches (Sugar).....	311
Uses of Copper.....	2
Valve Chimneys.....	254
Valve Covers.....	260
Valve Cover in Parts.....	260
Valve Cover Slung at Fire for Brazing Seam.....	260
Washing Coppers.....	26
Way to Fit in Pipe and Cock.....	32
Way to Put Flaps on Handles.....	38
Way to Hold Socket to Fire.....	39
Water Balls.....	47
Working Throat of Tea-Kettle Spout.....	53
Wisp Used for Tinning.....	64
Wiring Funnels.....	82
Working Cover of Brazing Pan.....	105
Well, Strainer and Cover of Dripping Pan.....	119
Wooden Former.....	134
Working Up Back and Bridge of Scoop.....	140
Way to Prepare Patches for Pipe Splits.....	197
Wiring Bend Together for Brazing.....	225
Working Out Dome Foot.....	264
Working Up Dome Crown.....	265, 266
Wheel and Axle for Brazing Coil Joints.....	275
Working Rivets and Time Consumed.....	288, 301, 310

~~1911~~

S. 7167
6733
966

