

Historic, Archive Document

Do not assume content reflects current scientific knowledge, policies, or practices.

6261

Spring, 1895.

DESCRIPTIVE CATALOGUE

OF SEEDS - PLANTS -
AND BULBS



WEEBER & DON,
SEED MERCHANTS AND GROWERS,
114 CHAMBERS ST.
NEW YORK.

OF

VEGETABLE AND FLOWER SEEDS,



Garden Tools, Fertilizers,

Plants, Bulbs, Trees and Shrubs.

NEW YORK, JANUARY, 1895.

In submitting our Catalogue for 1895, we take this opportunity of again thanking our numerous friends and customers for their liberal support and recommendations. From those who have not hitherto favored us with their orders, we would respectfully solicit a trial, which we believe will lead to increased confidence and an extension of business. We assure them that all orders intrusted to our care, either large or small, will receive our prompt and personal attention.

To meet the growing demand for our reliable seeds, we have had to still further increase our facilities for filling orders, and we are now in a position to fill all orders same day as received. As heretofore, we have been able to secure our supply of Vegetable and Flower Seeds from the most reliable growers, and, to still further guard against the possibility of failure, we have the Germination of our seeds carefully tested before sending them out.

ABOUT WARRANTING SEEDS.

While we exercise the greatest care to have all seeds pure and reliable, we do not give any warranty, express or implied. If the purchaser does not accept the seeds on these terms and conditions, they must be returned at once; and the money that has been paid for same will be refunded.

OUR REGISTER OF GARDENERS AND FARMERS.

We have at all times upon our Register the names of several competent men, qualified either to fill the situation of Head Gardener, Under Gardener or Farm Manager. Ladies and gentlemen requiring help in the above capacity will please send particulars, when we will be pleased to make selections for the different requirements and answer all correspondents.

HORTICULTURAL BOOKS.

FOR THE GARDEN AND FARM.

		PRICE.
American Dairying.....	Arnold.....	\$1 50
An Egg Farm.....	Stoddard.....	75
Book of the Farm.....	Waring.....	2 00
Designs for Flower Beds.....	Solly.....	3 00
Farm Implements and Machinery.....	Thomas.....	1 50
Farming for Profit.....	Read.....	3 00
Fruit and Fruit Trees of America.....	Downing.....	5 00
Fruit Culture.....	Strong.....	1 00
Fruit Garden.....	Barry.....	2 00
Garden and Farm Topics.....	Henderson.....	1 50
Gardening for Pleasure.....	Henderson.....	2 00
Gardening for Profit.....	Henderson.....	2 00
Grape Culturist.....	Fuller.....	1 50
Grape Growers' Guide.....	Chorlton.....	75
Hand-Book of Plants.....	Henderson.....	4 00
How the Farm Pays.....	Henderson & Crozier.....	2 50

FOR THE GARDEN AND FARM.

		PRICE.
Insects of the Farm and Garden ..	Treat.....	\$2 00
Landscape Gardening.....	Kemp.....	2 50
Lilies, and their Culture.....	Dr. Wallace.....	1 65
Mushrooms, How to Grow Them.....	Wm. Falconer.....	1 50
Ornamental Gardening.....	Long.....	2 00
Peach Culture.....	Fulton.....	1 50
Pear Culture.....	Quinn.....	1 00
Play and Profit in My Garden.....	E. P. Roe.....	2 00
Practical Floriculture.....	Henderson.....	1 50
Practical Poultry.....	S. Fuller.....	1 50
Practical Poultry Keeper.....	Wright.....	2 00
Success in Market Gardening.....	W. W. Rawson.....	1 00
Small Fruits.....	Hills.....	1 00
Your Plants, and How to Grow Them.....	Sheehan.....	40
American Gardening. 1 Year; 24 numbers.....		1 00

WEEBER & DON,

Seed Merchants and Growers,

114 CHAMBERS STREET, NEW YORK.

NOVELTIES AND SPECIALTIES

— IN —

VEGETABLE SEEDS



The Chelsea Pea.

CHELSEA PEA.

This fine new dwarf pea grows one foot in height, and is of compact habit. It is as early as "American Wonder," and gives a much larger crop than that sort, bearing in pairs from the bottom to the top an abundance of handsome pods, which are half as long again as those of any other first early dwarf kind.

Per pt., 20 cts.; qt., 35 cts.; peck, \$2.50.

THE DON PEA.

This is a deep green, wrinkled sort, produces an abundant crop of large, square-ended, well-filled pods. These are literally crowded with fine, large peas of delicious flavor. It grows about four feet high and comes into bearing between the second early and main crop.

Per pt., 20 cts.; qt., 35 cts.; peck, \$2.50.

NOTT'S EXCELSIOR PEA.

We consider this Dwarf Extra Early variety one of the best of recent introduction. Vines are larger and more vigorous than the American Wonder, earlier and more prolific than the Premium Gem. Pods are always well filled with peas, which in sweetness and quality are far superior to any of the other extra early varieties. The stock which we offer is from the originator, and can be depended upon as being the true sort.

Per pt., 40 cts.; qt., 75 cts.; peck, \$5.00.

DWARF

CHAMPION OF ENGLAND PEA.

Medium late and best adapted for second crop. The vines are vigorous, growing two and a half feet high, bearing abundantly large pods, filled with rich, marrow peas, superior in quality and much larger than the well-known Champion of England.

Per pt., 15 cts.; qt., 25 cts.; peck, \$2.00.

NEW YORK MARKET PEA.

The Earliest Pea in Cultivation.

This is the finest round white Extra Early Pea that has yet been introduced. For size of pod and regularity of growth it has no equal, and the quality is of the finest. The pods are of a dark green color and are produced in immense quantities. Hardy and robust.

Per pt., 15 cts.; qt., 25 cts.; peck, \$1.25.

THE QUEEN PEA.

This new variety is one of the few really fine peas that resist the long droughts and stands well under the scorching rays of the sun, and it is not subject to mildew. It is a green, wrinkled, main crop variety, growing to about two or two and one-half feet in height. The pods are very large, slightly curved, produced mostly in pairs, and all over the vine from bottom to top. They are so packed in the pods that when opened it would almost seem impossible that they could be contained in the pod. The vines are very sturdy, and being of a branching habit, this variety can be sown more thinly than most varieties. Its season is just right to succeed "The Don," as it comes into bearing when that variety is about finished.

Per pt., 25 cts.; qt., 50 cts.; peck, \$3.00.



HEROINE PEAS.

This is a medium early, green, wrinkled Pea, and grows uniformly two to two and a half feet high, coming in between Advancer and Champion of England, and bears a profusion of large, long, slightly curved, pointed pods, containing from nine to ten large Peas of finest quality. Immense cropper.

Per pt., 20 cts.; qt., 35 cts.; peck, \$2.50.

New Dwarf Wrinkled Sugar Pea. (EDIBLE PODDED.)

This new dwarf wrinkled variety is far superior to the old round seeded sorts. The pods are large, remarkably tender, and of delicious flavor. It grows to about the height of two feet, and requires very little brushing. The large, well-filled pods are produced in great profusion; they are stringless and can be cooked the same way as string beans. Without doubt the finest Sugar Pea yet introduced.

Per pt., 20 cts.; qt., 35 cts.; peck, \$2.50.

All new varieties of Peas not enumerated in this List can be supplied at advertised prices.

PARAGON PEA.

This grand new Pea grows from 2½ to 3 feet high. It is a double podded medium early variety, with long, straight pods, eight or nine Peas in each pod. Stubbed, stocky vines with luxuriant foliage; pods light green. Quality superb, not excelled by any pea, and an abundant cropper. Per pt., 20 cts.; qt., 35 cts.; peck \$2.50.

NEW PEA, "JUNO."

This Pea differs from the Heroine in that it has a more robust vine, and has stout, straight pods, usually borne in pairs. It is noticeable that the pods are very thick, broad-backed all the way up, and filled from the stem to the tips with seven to nine sweet, delicious dark green Peas of immense size. Its height is two feet, and its season from medium early to main crop. Altogether, we are satisfied it is a Pea that is destined to become a standard variety, and we strongly advise all to try it. Per pt., 20 cts.; qt., 35 cts.; peck, \$2.50.



Juno Pea.



Burpee's Bush Lima Beans.

Burpee's Bush Lima Beans.

The bushes grow eighteen to twenty inches high, of stout growth and always erect, yet branching so vigorously that each plant develops into a magnificent circular bush from two to three feet in diameter. The leaves are of large size and great substance. The bush character is thoroughly established, not one plant in a thousand showing any disposition to "run." It is an immense yielder, each bush bearing from fifty to two hundred of the handsome large pods, well filled with very large beans, which are identical in size and luscious flavor to the well-known large pole Limas.

Per pkt., 10 cts.; pt., 30 cts.; qt., 60 cts.; peck, \$4.00.

Currie's Rust-Proof Dwarf Black Wax Beans.

The Currie's Rust-Proof Bean having been tested side by side with the other varieties of Wax Beans, we have found them to be nearest to perfection of them all. For earliness they are at the head of the Wax Bean family. Habit upright and robust, holding their pods well from the ground. Foliage remarkably vigorous and healthy. Pods, long, flat and straight, of a beautiful golden color; quality not surpassed, and for productiveness unequalled.

Per pkt., 10 cts.; pt., 20 cts.; qt., 40 cts.; peck \$2.50.

New Pink Plume Celery.

This Celery is a strong, healthy, compact grower, with no tendency to rust; stems very solid and crisp, extra early and a long keeper, remaining when properly trenched in perfect condition away into the spring. The variegation on the tops does not show quite as early as the "White Plume," but the celery blanches and matures really a little earlier. It is a self-blanching variety in the same sense that "White Plume" and Golden Self Blanching are; that is, it requires but a slight earthing-up or banking to prepare this variety for the table.

Per pkt., 20 cts.

Dreer's Bush Lima Beans.

This valuable Bush Bean possesses all the good qualities of the Dreer's Improved Lima. It is of vigorous bushy habit, growing from 1½ to 2 feet high, and producing pods in great abundance. The beans grow close together in the pods, producing 3 or 4, and sometimes 5 in a pod, and are very thick, sweet and succulent.

Per pkt., 10 cts.; pt., 30 cts.; qt., 60 cts.; peck, \$4.00.

Henderson's Bush Lima Beans.

Enormously productive, bearing continuously throughout the summer until killed by the frost. Its greatest merit lies in the fact that it is a true bush variety, requiring no support from stakes or poles.

Per pkt., 10 cts.; pt., 20 cts.; qt., 40 cts.

Improved Golden Wax Bean.

We cannot speak too highly of the good qualities of this Bean. We find it to be free from rust, larger in pod and more prolific than the old variety. It is also handsome and robust, and shows no string even when past its best.

Per pkt., 10 cts.; qt., 40 cts.; peck, \$2.00.

Extra Early Refugee Wax Bean.

This is a perfect Refugee with wax pods that are long, round and of a golden yellow color. It is suitable for early or late sowing, and for a wet or dry season. The earliest Bean grown.

Per pkt., 10 cts.; pt., 15 cts.; qt., 30 cts.;

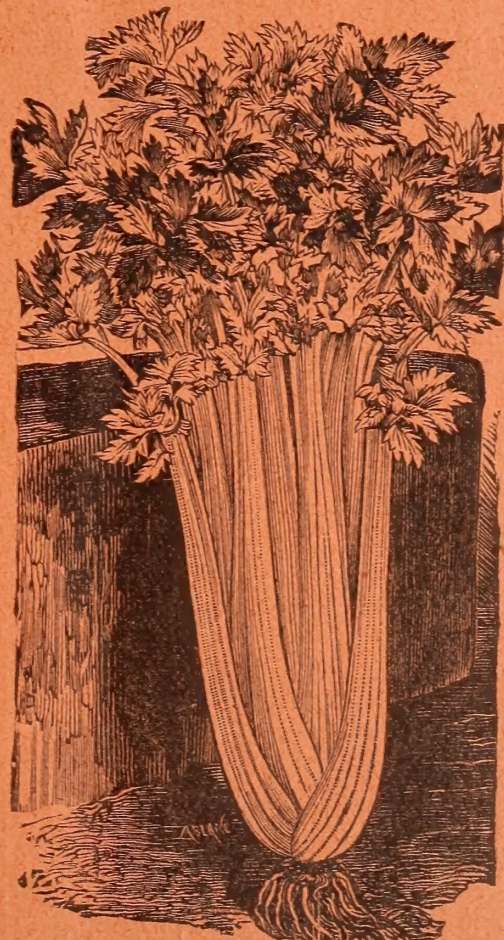

New Pink Plume Celery.



Early Jersey Wakefield Cabbage.

W. & D.'s Extra Selected Stock.

A standard, very early variety of medium size, pyramidal shape with a rounded peak; being very hardy, is well fitted to winter in coldframes; permits of close planting; reliable to head. Per pkt., 5 cts.; oz., 30 cts.; $\frac{1}{4}$ lb., \$1.00; lb., \$3.00.



NEWARK EARLY FLAT DUTCH CABBAGE.

W. & D.'s Extra Selected Stock.

The finest strain of Second Early Cabbage in cultivation, large solid heads, very popular as a market variety. Per pkt., 5 cts.; oz., 30 cts.; $\frac{1}{4}$ lb., \$1.00; lb., \$3.00.



Mammoth Rock Red Cabbage.

This is by far the best, largest and surest heading red cabbage ever introduced. The plant is large, with numerous spreading leaves. The head is large, round, very solid, and of a deep red color. The best red cabbage in the market. Per pkt., 10 cts.; oz., 30 cts.; $\frac{1}{4}$ lb., \$1.00; lb., \$3.00.

Excelsior Flat Dutch Cabbage.

The best strain of this popular variety in the country. The heads are large and solid, with few outer leaves, thus adapting it for close planting. We can recommend it highly, as it stands the heat better than any other of the large sorts. Per pkt., 5 cts.; oz., 30 cts.; $\frac{1}{4}$ lb., \$1.00; lb., \$3.00.

First and Best Cauliflower.

The Surest Header and Best for Forcing.

This splendid Cauliflower is without doubt the finest variety for forcing or general use that has yet been introduced. The plant is of a dwarf and compact habit, with short stem and small leaves. In earliness it is a week ahead of the Snowball, and its firm snow-white heads are larger than any other variety. Per pkt., 50 cts.; $\frac{1}{4}$ oz., \$3.00; oz., \$10.00.



First and Best Cauliflower.

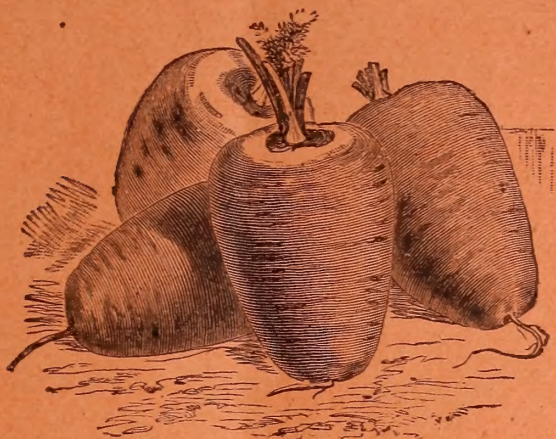

Guerande, or Ox-Heart Carrot.

Guerande, or Ox-Heart Carrot

A very desirable new carrot. In length intermediate between Short Horn and Chantenay; much thicker than either, and carries its thickness well down towards the bottom. In color as dark as Chantenay; is an immense cropper, early harvested, requiring no digging, while its handsome appearance and excellent table qualities make it valuable for either the market or home garden. Pkt., 5 cts.; oz., 10 cts.; $\frac{1}{4}$ lb., 30 cts.; lb., \$1.00.

Upland Cress

This new vegetable gives us a garden substitute for the English Water Cress. Crisp, tender, perfectly hardy, and has the peculiar specific flavor of Water Cress. Per pkt., 5 cts.; oz., 50 cts.

Early Mammoth Sweet Corn

A valuable variety, at least ten days earlier than the Mammoth. Ears twelve-rowed, straight, and handsome. It is remarkable for its delicious sweetness. Per pkt., 10 cts.; qt., 20 cts.; peck, \$1.25.

Country Gentleman Sweet Corn

The sweetest and most tender of all sweet corn. The ears are short, the cob is small, and the kernels pearly white and irregularly crowded together on the cob. Per pt., 15 cts.; qt., 25 cts.; peck, \$1.50.

EVERGREEN

White Spine Cucumber.

This valuable variety differs from the ordinary White Spine, in the fact of always remaining of a deep green color in all stages of growth. It is a very hardy sort, and will not turn yellow after being picked from the vine. Per pkt., 5 cts.; oz., 10 cts.; $\frac{1}{4}$ lb., 25 cts.; lb., 75 cts.

Bennett's White Spine Cucumber

W. & D.'S ORIGINAL STOCK.

This strain grows from seven to ten inches long, proportionately thick throughout, being as full at both ends as in the centre. It is a week earlier than the variety known as "Improved White Spine," but retains its glossy dark-green color much longer on the vine. Per pkt., 5 cts.; oz., 10 cts.; $\frac{1}{4}$ lb., 30 cts.; lb., \$1.00.

CHANTENAY

Half Long Scarlet Carrot

A stump-rooted variety, somewhat resembling the well-known Nantes Carrot. Much more productive. Per pkt., 5 cts.; oz., 10 cts.; $\frac{1}{4}$ lb., 30 cts.; lb., \$1.25.

Golden Self-Blanching Celery

A self-blanching variety, of the "White Plume" order, but far superior for either market gardeners' or private use. It requires earthing up, although but little more than the "White Plume." It is very crisp, tender and of fine flavor, keeps well throughout the season, and is the earliest variety grown. Per pkt., 10 cts.; oz., 50 cts.; $\frac{1}{4}$ lb., \$1.50; lb., \$5.00.

Japanese Climbing Cucumber

This new Cucumber is a strong and vigorous grower, the vines attaining nearly twice the length of common varieties. The young plants are bushy, but as soon as they become well established they begin to climb, and may be grown on fences, poles or trellises, thus saving much valuable space in small gardens. The fruits are ten to twelve inches in length, of a fine green color; the flesh is thick and firm; never bitter, and fine for pickling as well as slicing. Per pkt., 10 cts.; oz., 25 cts.; $\frac{1}{4}$ lb., 75 cts.; lb. \$2.50.



New Cucumber, Cool and Crisp.

This Cucumber is inclined to taper off at the stem end, and is generally a little pointed at the other end also. This is the most desirable shape for pickles. At the pickling stage, the Cucumbers are straight, long, even and slim, and until they reach their full size they are of a very dark green color, so dark that it might be almost called "black." This variety is the *earliest and most prolific of all pickling Cucumbers*, and is certain to become a standard sort. While primarily a pickling variety, it is also most useful for slicing, the Cucumbers, when fully matured, being of good size and exceedingly tender and crisp. Per pkt., 10 cts.; oz., 25 cts.; $\frac{1}{4}$ lb., 75 cts.; lb., \$2.50.



Cool and Crisp
Cucumber.

New Forcing Lettuce. "GOLDEN QUEEN."

A very desirable small, early variety, of a most pleasing golden yellow color, it forms all solid heads, with little or no waste, so that there is really more to it, than in many Lettuce double the size. It is very crisp, tender and juicy, and of particularly delicate flavor, resembling in its tender quality the Boston Market Lettuce when that variety is forced with artificial heat under glass. Per pkt., 5 cts.; per oz., 15 cts.; per $\frac{1}{4}$ lb., 40 cts.; per lb., \$1.25.

Prize Taker Onion.

This is the large beautiful Onion that is seen every fall offered for sale at the fruit stores in New York and other large cities. They are a rich straw color and of enormous size, averaging 12 to 14 inches in circumference. Although of such great size, it is very hard and an excellent keeper. Per pkt., 5 cts.; oz., 25 cts.; $\frac{1}{4}$ lb., \$1.00; lb., \$3.00.

Mammoth Silver King Onion.

Single onions of this variety, grown from seed the first season, have weighed as much as 3 lbs. It matures early, is a white-skinned and a white-fleshed variety, flat shape, and of a mild and delicate flavor. Per pkt., 5 cts.; oz., 25 cts.; $\frac{1}{4}$ lb., 75 cts.; lb., \$2.50.



Evergreen Parsley.

Evergreen Parsley.

A distinct variety, with dark glossy green leaves, beautifully curled; it retains its dark green color throughout the winter, which makes it valuable alike for garnishing and market purposes. Per pkt., 5 cts.; oz., 15 cts.; $\frac{1}{4}$ lb., 30 cts.; lb., \$1.00.

Everbearing Cucumber.

This is an entirely new and unique variety. It is of small size, very early, enormously productive, and valuable as a green pickler. Its peculiar merit is that the vines continue to flower and produce fruit until killed by frost. Per pkt., 5 cts.; oz., 10 cts.; $\frac{1}{4}$ lb., 25 cts.; lb., 75 cts.

Yellow Seeded Butter Lettuce.

This withstands summer heat well, and remains in head long before running to seed. It is a very distinct sort, making a large, dense yellow head, of a very handsome appearance, very crisp and tender, and excellent in flavor. Per pkt., 5 cts.; oz., 15 cts.; $\frac{1}{4}$ lb., 40 cts.; lb., \$1.25.

American Hollow Crown Parsnip.

The superior qualities of our improved strain of Parsnip are now so well established that it would be superfluous for us to further extol its merits. The roots are the largest that are brought to the New York market, long, smooth and milky white. It is without doubt the finest stock of Parsnip in this country. Per pkt., 5 cts.; oz., 10 cts.; $\frac{1}{4}$ lb., 25 cts.; lb., 65 cts.



American
Hollow Crown
Parsnip.



Golden Yellow Olive-Shaped Radish.

GOLDEN YELLOW Olive-Shaped Radish.

This is a fine new German radish, equally well adapted as an early forcing or summer radish. It is of very rapid growth and fine quality; flesh white, tender, crisp and brittle. The outside skin is a bright, fresh yellow, and has a very small top. Per pkt., 5 cts.; oz., 10 cts.; $\frac{1}{4}$ lb., 30 cts.; lb., \$1.00.

Earliest Carmine Forcing Radish.

The smallest topped and earliest Forcing Radish in cultivation. Roots small, round, deep rich red, with very crisp, tender white flesh. This is the best variety for forcing, as it will mature in eighteen to twenty-one days, and the tops are so small that a large number can be grown in a single bed. Per pkt., 5 cts.; oz., 10 cts.; $\frac{1}{4}$ lb., 30 cts.; lb., \$1.00.

Thorburn's Long-Keeper Tomato.

Bright purplish red, early, very productive, and the longest keeper of all Tomatoes. Per pkt., 5 cts.; oz., 20 cts.; $\frac{1}{4}$ lb., 60 cts.; lb., \$2.00.

New Stone Tomato.

This is a large, very smooth, bright scarlet Tomato, ripening evenly to the stem without cracking. The flesh is firm, solid and of excellent quality; one of the best for shipping. Per pkt., 5 cts.; oz., 20 cts.; $\frac{1}{4}$ lb., 60 cts.; lb., \$2.00.

Ponderosa Tomato.

This Tomato is claimed to be the largest that has yet been introduced. It is of a bright red color, rather flat, but in flavor and solidity it is unequalled. A grand variety for canning purposes. Per pkt., 10 cts.; oz., 50 cts.; $\frac{1}{4}$ lb., \$2.00; lb., \$8.00.



Dwarf Aristocrat Tomato.

Dwarf Aristocrat Tomato.

This fine new variety in habit of growth and foliage resembles the "DWARF CHAMPION" very much, and might be taken for that popular variety if it were not for the color of its beautiful rich, glossy, red fruit, so much preferred in many localities to the purple or rose-colored varieties. The size, solidity, productiveness, smoothness, flavor of its fruit, etc., are up to the present day standard of excellence. It will be found especially desirable for forcing under glass and growing outside for early market purposes. Per pkt., 5 cts.; oz., 20 cts.; $\frac{1}{4}$ lb., 60 cts.; lb., \$2.00.

The Lorillard Tomato.

This "Tomato" possesses extra good forcing qualities, ripens very uniform over the whole surface; very solid, smooth, and well-flavored; early, productive, handsome; also a splendid variety for general crop. Per pkt., 10 cts.; oz., 20 cts.; $\frac{1}{4}$ lb., 70 cts.; lb., \$2.50.

Improved White Bush Squash.

W. & D.'S Extra Selected Stock.

We have been supplying this Improved strain of White Bush Squash for several years to our Market Garden trade on Long Island. It is a decided improvement on the old variety, being very much thicker in the centre, and, with a little or no rim, a splendid market sort. Per pkt., 5 cts.; oz., 15 cents; $\frac{1}{4}$ lb., 40 cts.; lb., \$1.25.



Improved White Bush Squash.

WEEBER & DON'S

SURE CROP MUSHROOM SPAWN

GERMAN—Champignon. FRENCH—Champignon. SPANISH—Seta.
10 Pounds will Spawn 10 Feet Square.



Mushrooms in Greenhouse.



A Few Directions for Forming Mushroom Beds.

The Mushroom is one of the most profitable crops grown, especially in the vicinity of large cities, where the demand, at all seasons, is far in excess of the supply.

The best time for making Mushroom beds is in August and September, as in the fall months the natural heat is sufficient to cause the spawn to germinate freely, and the beds made then ought to bear freely before and up to Christmas. Mushrooms can be grown in sheds, cellars, caves, under benches in greenhouses, and in regular Mushroom houses.

In preparing the materials, collect sufficient fresh horse droppings to form the desired size of bed, spreading them out in an airy shed to dry, and turning them frequently. When in a proper state as to dryness, which will soon be learned by experience, make these into a bed from nine inches to one foot thick, beating them firmly together. If the droppings have been properly prepared, gentle fermentation will soon commence, and when the temperature of the bed is from 75° to 80°, with no danger of it rising higher, put in the spawn. This is done by making shallow holes about nine inches apart, inserting pieces of spawn about the size of a hen's egg and covering with the dung, pressing this closely about the spawn. It is of the greatest importance that the temperature of the bed should not decline below 75°, nor rise above 80° for a month after spawning. Within a fortnight after putting in the spawn, cover the bed about two inches thick with good mellow moist soil, making this firm; and if under this a covering one or two inches thick of cow dung, in about the same state as to moisture as the soil, can be afforded, this will cause the bed to last longer, and also to produce a larger crop than if covered with soil only. The most suitable temperature for beds in bearing is 50° to 55°, and as a high temperature causes the Mushrooms to come small, this should be avoided. Watering beds in bearing often causes the small Mushrooms to damp off; therefore, water only when the bed ceases to be productive, and then use the water about the same temperature as the bed.

Be sure that the *Mushroom Spawn* you buy is good. Half of the failures can be traced to the use of *cheap, worthless spawn*.

ENGLISH MUSHROOM SPAWN (in bricks), the finest quality.

Per lb., 15 cts.; 8 lbs. for \$1.00.

FRENCH MUSHROOM SPAWN, more bulky than the English, being packed loosely in boxes.

In 2-lb. boxes, 75 cts. each. In bulk, 35 cts. per lb.

MUSHROOM CULTURE.

BY WILLIAM FALCONER.

How to grow them in "Cellars," "Mushroom Houses," "Greenhouses," and "Sheds," "Preparing the Beds," "Watering" and "Cooking," etc.

CLOTH, ILLUSTRATED, \$1.50 EACH.

GENERAL LIST

OF

VEGETABLE SEEDS

While we exercise the greatest care to have all seeds pure and reliable, we do not give any warranty, express or implied. If the purchaser does not accept the seeds on these terms and conditions, they must be returned at once, and the money that has been paid for same will be refunded—W. & D.

When seeds are ordered by mail **Postage** must be added to catalogue prices at the rate of 8 cents per pound for **Seeds**, 15 cents per quart for **Peas** and **Beans**, and 10 cents per quart for **Corn**.

ARTICHOKE, Globe.

German, *Artischoke*.—French, *Artichaut*.—Spanish, *Alcachofa*.

One ounce will produce 500 plants.

Sow in light, rich, and rather moist soil, in drills eight or ten inches apart; when the plants are well up, transplant, four or five inches deep, in rows four feet apart, and two feet apart in the rows. Hoe often and water freely during the warm season. Cover with straw during winter.

Large Globe. Fine large heads. Per pkt., 10 cts.; oz., 30 cts.

ARTICHOKE, Jerusalem.

Grown for its tubers, which resemble potatoes, and are cultivated in a similar manner, only the rows should be at least four feet apart when grown in rich soils.

Large tubers. Per qt., 25 cts.; peck, \$1.25; bush., \$4.00.

ASPARAGUS.

German, *Spargel*.—French, *Asperge*.—Spanish, *Esparrago*.

One ounce will sow about 50 feet of drill.

Sow in autumn or in spring, as soon as the soil is in good working condition. The seed bed should be thoroughly spaded over, the surface leveled and raked smooth, and the seeds sown, not very thickly, in drills twelve or fourteen inches apart, and about an inch deep. When the plants are well up, thin them to three inches apart. Cultivate during summer, and give the plants a light covering of stable-litter during winter. At one or two years, transplant to permanent beds. The soil should be trenched two feet deep, and highly manured.



PALMETTO ASPARAGUS.

THE PALMETTO. The merits of this new variety consist in its earliness, productiveness and shipping qualities. In these points it surpasses any other sort grown. Per pkt., 10 cts.; oz., 20 cts.; $\frac{1}{4}$ lb., 60 cts.; 1 lb., \$2.00.

Conover's Colossal. The largest and most prolific; very tender. Per pkt., 5 cts.; oz., 10 cts.; $\frac{1}{4}$ lb., 20 cts.; lb., 50 cts.

ASPARAGUS ROOTS.

11,000 Roots will plant one acre; distance, 4 feet in drill, 1 foot in row.

A saving of one to two years is effected by planting roots. Those offered below are strong two-year-old roots. For private use or for marketing on a small scale, beds should be formed five feet wide with three rows planted in each, one in the middle and one on each side a foot from the edge; distance between the plants in the rows, nine inches.

THE PALMETTO. Strong two-year-old roots, per 100, \$1.25; per 1,000 \$10.00.

Colossal. Strong two-year-old roots, per 100, \$1.00; per 1,000, \$7.00.

BEANS.

ENGLISH OR BROAD.

German, *Gartenbohne*.—French, *Fève de Marais*.—Spanish, *Haba*.

One quart will plant 100 feet of drill.

Plant four inches apart and two inches deep, in drills four feet apart, as early in spring as the ground can be worked. To insure well-filled pods, pinch off the tops as soon as the lower pods begin to set.

Early Mazagan. Very early, hardy, and bears freely. Per pkt., 10 cts.; qt., 40 cts.

Early Long Pod. The earliest and most prolific. Per pkt., 10 cts.; qt., 40 cts.

Broad Windsor. The largest variety grown; very tender and delicious. Per pkt., 10 cts.; qt., 40 cts.

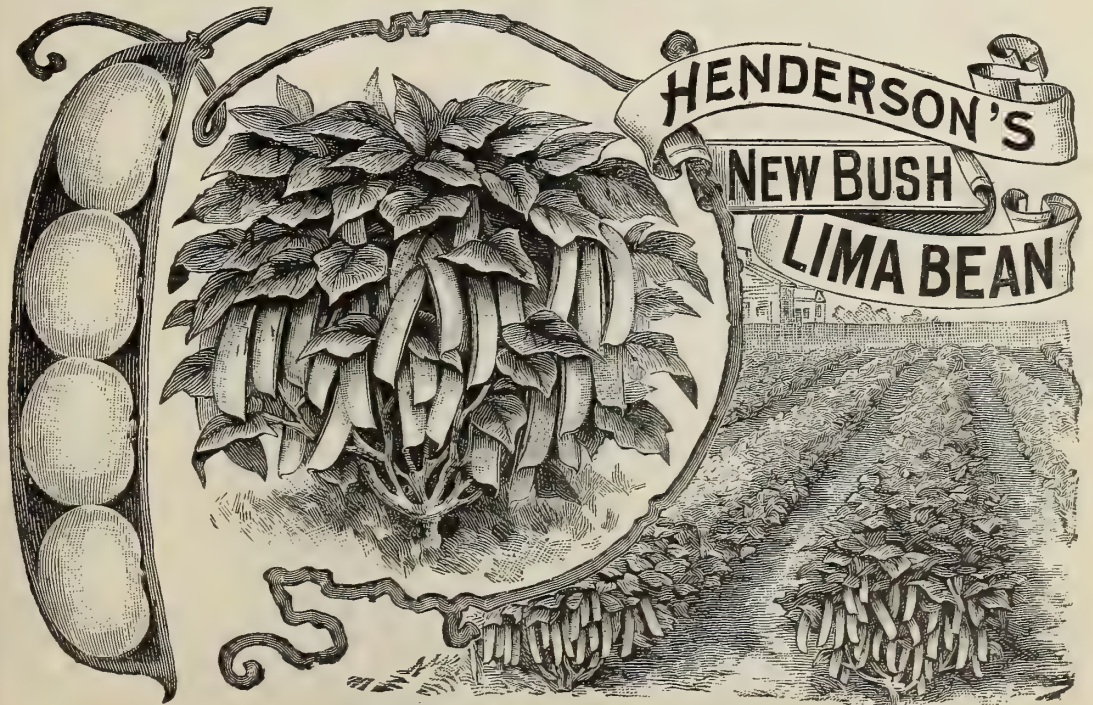

New Bush Lima. Enormously productive, bearing continuously throughout the summer until killed by the frost. Its greatest merit lies in the fact that it is a true bush variety, requiring no support from stakes or poles, but, at the same time, the experience of all who have grown it has been that it excels as well in quality, quantity and earliness. Per pkt., 10 cts.; pt., 20 cts.; qt., 40 cts.

BEANS, Dwarf or Bush.

GREEN POD VARIETIES.

German, *Busch-Bohnen*.—French, *Haricots nains*.—Spanish, *Frijoles*.

One quart will plant 100 feet of drill.

Bush Beans may be had in fine condition throughout the season, by planting at intervals of two weeks, from the beginning of May until the middle of August; they should be planted in drills three feet apart and one inch deep.

Early Mohawk. Long, straight, flat pods, good for string; early, hardy, productive. Per pkt., 10 cts.; qt., 25 cts.; peck, \$1.25.

EARLIEST RED VALENTINE. This variety is at least 10 days earlier than the Early Red Valentine, and is usually ready to pick in 35 days from time of planting. Per pkt., 10 cts.; qt., 30 cts.; peck, \$2.00.

Early Valentine. Round green pods; early and tender, good for string or picking. Per pkt., 10 cts.; qt., 25 cts.; peck, \$1.25.

Long Yellow Six Weeks. Very early and productive; full flat pods. Per pkt., 10 cts.; qt., 25 cts.; peck, \$1.25.

Early China. Early, prolific, good for string or shell. Per pkt., 10 cts.; qt., 25 cts.; peck, \$1.25.

Improved Dwarf Horticultural. Large, early, excellent for market and shelling. Per pkt., 10 cts.; qt., 25 cts.; peck, \$1.25.

REFUGEE, OR THOUSAND TO ONE. Very tender and productive; the best variety for pickling. Per pkt., 10 cts.; qt., 25 cts.; peck, \$1.25.

EXTRA EARLY REFUGEE. Large, productive, hardy, tender, fleshy pods, a great improvement on the old Refugee. Per pkt., 10 cts.; qt., 25 cts.; peck, \$1.25.

Wonder of France. Long, straight, bright green pods; retains its beautiful green color even when cooked; early, productive. Per pkt., 10 cts.; qt., 30 cts.; peck, \$2.00.

White Marrow. One of the best for use in a dry state in winter; fine bearer, excellent quality. Per pkt., 10 cts.; qt., 25 cts.; peck, \$1.25.

White Kidney. Excellent shell bean, green or ripe. Per pkt., 10 cts.; qt., 25 cts.; peck, \$1.25.

WAX POD VARIETIES.

WARDWELL'S DWARF KIDNEY WAX. This variety is distinct from all other wax varieties, the bean being of a perfect kidney shape. It produces a heavy crop of wax pods, which are long, flat, showy, and not liable to rust. Per pkt., 10 cts.; qt., 35 cts.; peck, \$2.00.

Improved Golden Wax. We cannot speak too highly of the good qualities of this bean. We find it to be free from rust, larger in pod and more prolific than the old variety. It is also handsome and robust, and shows no string even when past its best. Per pkt., 10 cts.; qt., 35 cts.; peck, \$2.00.



EARLY MOHAWK BEAN.

Golden-eyed Wax. This is an early and vigorous growing variety, yielding a great profusion of tender pods of a beautiful waxy appearance. It is free from blight and rust; the pods flat and larger than the Golden Wax. Per pkt., 10 cts.; qt., 30 cts.; peck, \$2.00.

Golden Wax. Round golden waxy pods; early, prolific, stringless, the finest wax bean. Per pkt., 10 cts.; qt., 30 cts.; peck, \$1.75.

IMPROVED BLACK WAX. This is an improved stock of Black Wax, superior to the ordinary strains; it is earlier with perfectly round pods, and of a rich golden color; very productive. Per pkt., 10 cts.; qt., 35 cts.; peck, \$2.00.

Black Wax. Round wax pod; early, stringless, excellent. Per pkt., 10 cts.; qt., 30 cts.; peck, \$1.75.

Flageolet Wax. An improved variety of the dwarf Flageolet beans, unsurpassed in flavor. Per pkt., 10 cts.; qt., 40 cts.; peck, \$2.00.

EXTRA EARLY REFUGEE WAX. This is a valuable sort for early and late sowing. If sown in spring it will give seed in time for a second crop in fall; long, round yellow wax pods. Per pkt., 10 cts.; qt., 15 cts.; peck, \$2.00.

Ivory Pod Wax. Half transparent waxy pods; delicate, early, stringless. Per pkt., 10 cts.; qt., 40 cts.; peck, \$2.00.

Detroit Wax (Rust-proof). Grown side by side with other varieties of wax beans that were completely ruined with rust, this bean was entirely free from it. In earliness it is a little ahead of the Golden Wax, retaining its crisp and tender qualities all through the season. Per pkt., 10 cts.; qt., 30 cts.; peck, \$2.00.

White Wax. Waxy pods; flat, stringless, prolific. Per pkt., 10 cts.; qt., 30 cts.; peck, \$2.00.

Yosemite Mammoth Wax. The pods frequently attain a length of eight to ten inches, with the thickness of a man's finger. The pods are a rich golden color, and are absolutely stringless, cooking tender and delicious. Per pkt., 10 cts.; qt., 20 cts.; peck, \$2.00.



WARDWELL'S KIDNEY WAX BEAN.



REFUGEE WAX BEAN.

BEANS, Pole or Running.

German, *Stangen-Bohnen*.—French, *Haricots a Rames*.—Spanish, *Frij de Bijuco*.

One quart will plant 100 hills.

Plant in hills three to four feet apart each way, and two inches deep, allowing six seeds to each hill. When the plants are well established they should be thinned out to four. They are more sensitive to cold than the Bush Beans, and should not be planted before the middle of May.

FORD'S MAMMOTH. This is the largest of all the Limas, the pods are of enormous size and containing from five to eight beans. Per pkt., 10 cts.; pt., 30 cts.; qt., 50 cts.

LARGE WHITE LIMA. One of the best shell beans grown; matures in ninety days, very popular. Our seeds of this variety are extra selected, large and fine. Per pkt., 10 cts.; pt., 25 cts.; qt., 40 cts.; peck, \$2.75.

Extra Early Jersey Lima. This variety is ten days earlier than the ordinary variety, while it is equal in flavor and productiveness. Per pkt., 10 cts.; pt., 25 cts.; qt., 50 cts.; peck, \$3.50.

Dreer's Improved Lima. A great improvement upon the Large Lima, being more productive and of better quality. Per pkt., 10 cts.; pt., 25 cts.; qt., 35 cts.; peck, \$2.25.

Scarlet Runner. A great favorite, both ornamental and useful. Bright scarlet flowers. Used both as a string and shelled bean. Per pkt., 10 cts.; pt., 20 cts.; qt., 35 cts.; peck, \$2.00.

Early Dutch Case Knife. Very early and prolific; fine shelled, green or dry. Per pkt., 10 cts.; qt., 40 cts.; peck, \$2.25.

Horticultural Cranberry. One of the best for family use. The pods are tender, and of fine quality. Per pkt., 10 cts.; qt., 35 cts.; peck, \$2.00.

EXTRA EARLY GOLDEN CLUSTER WAX. Long golden-yellow pods borne in clusters; extra early, stringless, snaps easily, vigorous, prolific, tender. Per pkt., 10 cts.; pt., 25 cts.; qt., 40 cts.

Indian Chief. German Butter. Very prolific; pods succulent, tender and of rich flavor. Per pkt., 10 cts.; qt., 35 cts.; peck, \$2.00.

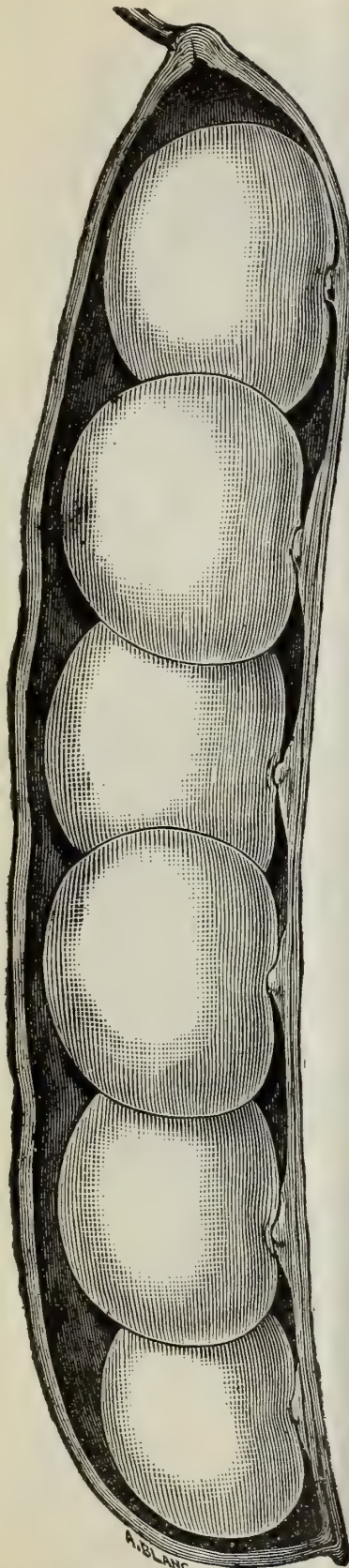

FORD'S MAMMOTH BEAN.

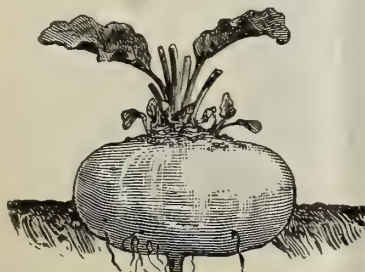

EGYPTIAN BEET.

BEET.

German, *Rothe Ruben*.—French, *Betterave*.—Spanish, *Remolacha*.

One ounce will sow 100 feet of drill.

A deep, rich and rather light soil, which has been well manured previously, is most suitable for beet culture. For early supply, sow as soon as the ground is in working order, in drills one foot apart and two inches deep. For main crop, sow the second week in May, and for winter use sow in June. When the plants are well forward, thin out to about nine inches apart.

LENTZ EXTRA EARLY. Round, smooth, dark red, tender and sweet; larger than the Egyptian, fully as early and better quality; small top and fine keeper. Per pkt., 5 cts.; oz., 10 cts.; ¼ lb., 20 cts.; lb., 50 cts.

EDMAND'S EARLY BLOOD TURNIP. This beet is *deep blood-red* in color, and *exceedingly sweet and tender* in quality; round and smooth in shape; of good marketable size; highly recommended as second early. Per pkt., 5 cts.; oz., 10 cts.; ¼ lb., 20 cts.; lb., 60 cts.

Egyptian. Flat turnip shaped, extra early, deep red, tender and sweet. Per pkt., 5 cts.; oz., 10 cts.; ¼ lb., 20 cts.; lb., 50 cts.

Early Blood Turnip. Good form, dark red, well flavored; a favorite for summer and winter use. Per pkt., 5 cts.; oz., 10 cts.; ¼ lb., 20 cts.; lb., 50 cts.

Early Flat Bassano. Early, flat, light color. A standard variety. Per pkt., 5 cts.; oz., 10 cts.; ¼ lb., 20 cts.; lb., 50 cts.

Bastian's Early Blood Turnip. This valuable variety is larger than Dark Red Egyptian, tender and sweet, and retains its blood-red color after cooking. Per pkt., 5 cts.; oz., 10 cts.; ¼ lb., 20 cts.; lb., 50 cts.



WEEBER & DON'S
New York Market Pea
 Is the
 Earliest and Most Prolific
 Variety that is grown.

BEET—Continued.

ECLIPSE. Earlier than the Egyptian, of finer form, being globular, and it grows exceedingly smooth with small top. Flesh deep blood-red, firm and sweet. Per pkt., 5 cts.; oz., 10 cts.; $\frac{1}{4}$ lb., 20 cts.; lb., 50 cts.

Dewing's Improved Blood Turnip. Of fine form and flavor, and deep blood-red; a desirable variety. Per pkt., 5 cts.; oz., 10 cts.; $\frac{1}{4}$ lb., 20 cts.; lb., 50 cts.

Long Smooth Blood. Large, late, deep blood-red; best for winter. Per pkt., 5 cts.; oz., 10 cts.; $\frac{1}{4}$ lb., 20 cts.; lb., 50 cts.

Swiss Chard. The leaves of this variety are used as spinach, and the mid-rib of the leaf, cooked and served up like asparagus, is delicious. Per pkt., 5 cts.; oz., 10 cts.; $\frac{1}{4}$ lb., 20 cts.; lb., 50 cts.

Brazilian Variegated. Used for garnishing and flower-garden decoration, the stems and veins being colored crimson, yellow and white. Per pkt., 5 cts.; oz., 10 cts.; $\frac{1}{4}$ lb., 20 cts.; lb., 50 cts.

BEET, Sugar, and Mangel Wurzel.

See Farm Seed Department, page 36.



SWISS CHARD.

BROCCOLI.

German, *Spargel Kohl*.—French, *Chou Broccoli*.—Spanish, *Brocoli*.

Sow the first week in May, in drills three or four inches apart, covering the seeds lightly. When the leaves are about three inches broad, transplant to prepared beds, two feet apart each way.

Walcheren. A fine variety, closely resembling a cauliflower, but of a hardier nature. Per pkt., 10 cts.; oz., 60 cts.; $\frac{1}{4}$ lb., \$2.00.

White Cape. A hardy and vigorous variety, heads large and firm. Per pkt., 10 cts.; oz., 60 cts.; $\frac{1}{4}$ lb., \$2.00.

BORECOLE, or Kale.

German, *Blatter Kohl*.—French, *Chou Vert Frise*.—Spanish, *Col*.

One ounce will produce 3,000 plants.

To grow this valuable winter vegetable successfully, it is important that the soil should be deep, well worked, and liberally manured. Sow about the middle of April in prepared beds, covering thinly and evenly; plant out in June, following the directions recommended for cultivating cabbage.

DWARF GREEN CURLED SCOTCH. One of the best; very hardy, and improved by a moderate frost. Per pkt., 5 cts.; oz., 10 cts.; $\frac{1}{4}$ lb., 30 cts.; lb., \$1.00.

Siberian Kale or Sprouts. Sown in September, in drills one foot apart, and treated like spinach; it is fit to cut early in spring. Per pkt., 5 cts.; oz., 10 cts.; $\frac{1}{4}$ lb., 20 cts.; lb., 60 cts.

Dwarf Brown Kale. A beautifully curled variety, with spreading foliage; very productive, hardy, and of fine flavor. Per pkt., 5 cts.; oz., 10 cts.; $\frac{1}{4}$ lb., 30 cts.; lb., \$1.00.

Tall Green Curled Scotch. One of the best for winter, very hardy. Per pkt., 5 cts.; oz., 10 cts.; $\frac{1}{4}$ lb., 35 cts.; lb., \$1.00.



TALL GREEN CURLED SCOTCH KALE.

CARDOON.

German, *Cardon*.—French, *Cardoon*.—Spanish, *Cardo*.

One ounce will produce 300 plants.

The mid-ribs of the leaves are used in salads, soups and stews. Sow early in spring and thin out, when large enough, to one foot apart in the rows. When full grown, tie up with matting, and earth up like celery.

Large Solid. Grows nearly four feet in height. Per pkt., 10 cts.; oz., 40 cts.; $\frac{1}{4}$ lb., \$1.25; lb., \$4.00.

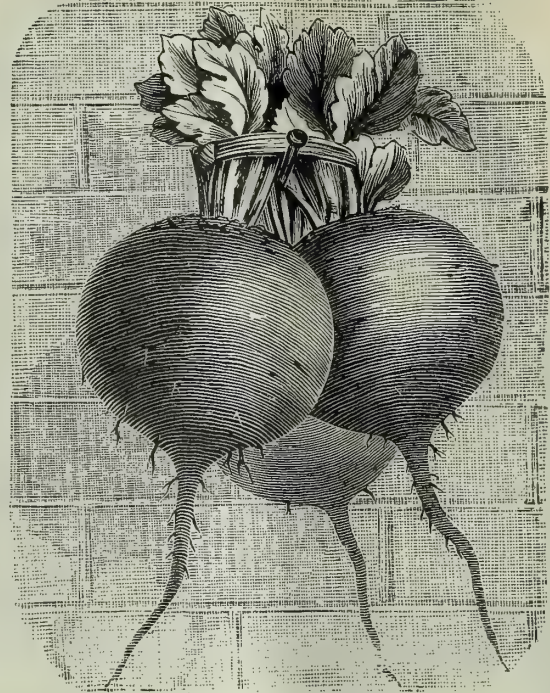

ECLIPSE BEET.

BRUSSELS SPROUTS.

German, *Rosen Kohl*.—French, *Chou de Bruxelles*.—Spanish, *Berza de Brusels*.

One ounce will produce 3,000 plants.

This is a delicious vegetable, superior to either borecole or spinach. The small, cabbage-like heads which grow upon the stem are much improved by a moderate frost. Sow in hot-beds in March or April, and in the open ground in May; cultivate same as broccoli.

Tall Brussels Sprouts. Compact heads of best quality. Per pkt., 5 cts.; oz., 20 cts.; $\frac{1}{4}$ lb., 60 cts.; lb., \$2.00.

Improved Dwarf. A dwarf variety, earlier than the preceding, producing numerous heads, which are very tender and of fine flavor. Per pkt., 5 cts.; oz., 20 cts.; $\frac{1}{4}$ lb., 75 cts.; lb., \$2.50.



BRUSSELS SPROUTS.

CABBAGE.

German, *Kohl*.—French, *Chou*.—Spanish, *Beza de Repollo*.

One ounce will produce 3,000 plants.

The cabbage, to be well grown, requires a deep, rich, loamy soil. For early use, sow the seed in hot-beds in February or March, or it may be sown about the middle of September, and the plants wintered over in cold frames. Transplant in spring, as soon as the ground can be worked, in rows two feet apart, and the plants eighteen inches apart in the rows. For late or winter use, the seed should be sown in May, and the plants set out in July, two and a half by three feet.

IMPROVED EARLY JERSEY WAKEFIELD. The standard early variety; conical in shape; medium-sized heads; very solid; few outside leaves. Per pkt., 5 cts.; oz., 30 cts.; $\frac{1}{4}$ lb., \$1.00; lb., \$3.00.

Large Early York. A fine early sort. The heads are solid and of good size. It endures the heat well, seldom fails to head. Per pkt., 5 cts.; oz., 20 cts.; $\frac{1}{4}$ lb., 60 cts.; lb., \$2.00.

Winningstadt. Somewhat resembling the Sugar Loaf, but larger and more solid; one of the best for general use. Per pkt., 5 cts.; oz., 25 cts.; $\frac{1}{4}$ lb., 75 cts.; lb., \$2.00.

Early French Oxheart. An early sort of good quality. The heads are firm and close; stems rather short, with very few loose leaves. Per pkt., 5 cts.; oz., 20 cts.; $\frac{1}{4}$ lb., 60 cts.; lb., \$2.00.

NEWARK EARLY FLAT DUTCH. The finest strain of second early cabbage in cultivation; large solid heads; very popular among Long Island farmers. Per pkt., 5 cts.; oz., 30 cts.; $\frac{1}{4}$ lb., \$1.00; lb., \$3.00.

Improved Early Summer. Resembling the Newark Early Flat Dutch; heads smaller and about one week later. Per pkt., 5 cts.; oz., 25 cts.; $\frac{1}{4}$ lb., 80 cts.; lb., \$3.00.



IMPROVED JERSEY WAKEFIELD CABBAGE.

Autumn King. We believe this to be one of the finest strains of late cabbage ever offered. It produces regular, even heads of enormous size; a magnificent cropper. Per pkt., 5 cts.; oz., 30 cts.; $\frac{1}{4}$ lb., \$1.00; lb., \$3.00.

Large Late American Drumhead. One of the largest, most solid and best keeping late varieties; seldom fails to head, and is of good quality. Per pkt., 5 cts.; oz., 20 cts.; $\frac{1}{4}$ lb., 60 cts.; lb., \$2.00.

Marblehead Mammoth Drumhead. This is the largest variety of the cabbage family grown. One of the best varieties for the South. Per pkt., 5 cts.; oz., 20 cts.; $\frac{1}{4}$ lb., 60 cts.; lb., \$2.00.

Early Blood-red Erfurt. A very early, intense blood-red variety. The leaves are smaller and spread less than those of the common varieties of red cabbage. Per pkt., 5 cts.; oz., 25 cts.; $\frac{1}{4}$ lb., 75 cts.; lb., \$2.50.

Large Red Drumhead Cabbage. This is a great improvement on the Red Dutch, being earlier, larger and a better header; heads round, solid and deep blood-red in color. Per pkt., 5 cts.; oz., 25 cts.; $\frac{1}{4}$ lb., 75 cts.; lb., \$2.50.

SAVOY CABBAGE.

Early Dwarf Ulm Savoy. A very early and superior dwarf variety of fine quality. Per pkt., 5 cts.; oz., 20 cts.; $\frac{1}{4}$ lb., 60 cts.; lb., \$2.00.

American Drumhead Savoy. For winter use this variety is unsurpassed; heads large, solid, tender and of excellent flavor. Per pkt., 5 cts.; oz., 25 cts.; $\frac{1}{4}$ lb., 75 cts.; lb., \$2.50.

PERFECTION DRUMHEAD SAVOY. This selection is certainly the finest we have seen, and largely grown on Long Island for the New York market. Per pkt., 5 cts.; oz., 30 cts.; $\frac{1}{4}$ lb., \$1.00; lb., \$3.00.



EXCELSIOR FLAT DUTCH CABBAGE.

Filderkraut. Larger than Winningstadt; more conical and has few outside leaves. Per pkt., 5 cts.; oz., 20 cts.; $\frac{1}{4}$ lb., 60 cts.; lb., \$2.00.

Fotter's Improved Brunswick. An early Drumhead variety, producing solid heads, weighing from twenty to thirty pounds each. Per pkt., 5 cts.; oz., 20 cts.; $\frac{1}{4}$ lb., 60 cts.; lb., \$2.00.

All Seasons. A variety which is becoming very popular as a second early. The heads are large, solid and keep well in winter; ready to cut as soon as early summer. Per pkt., 5 cts.; oz., 20 cts.; $\frac{1}{4}$ lb., 80 cts.; lb., \$3.00.

SUCCESSION. The Succession is about one week later than the Early Summer, but is double the size, and is so finely bred that in a field of ten acres every head was a magnificent, perfect specimen, fit for exhibition purposes; handsome, large and a sure header. Per pkt., 5 cts.; oz., 25 cts.; $\frac{1}{4}$ lb., \$1.00; lb., \$3.00.

Premium Flat Dutch. A popular and highly esteemed late variety; its keeping qualities are unsurpassed. For market and family use this variety is more extensively cultivated than any other. Per pkt., 5 cts.; oz., 20 cts.; $\frac{1}{4}$ lb., 60 cts.; lb., \$2.00.

EXCELSIOR FLAT DUTCH. The heads are large and solid, with few outer leaves, thus adapting it for close planting. We can recommend it highly for the South, as it stands the heat better than any other of the large sorts. Per pkt., 5 cts.; oz., 30 cts.; $\frac{1}{4}$ lb., \$1.00; lb., \$3.00.

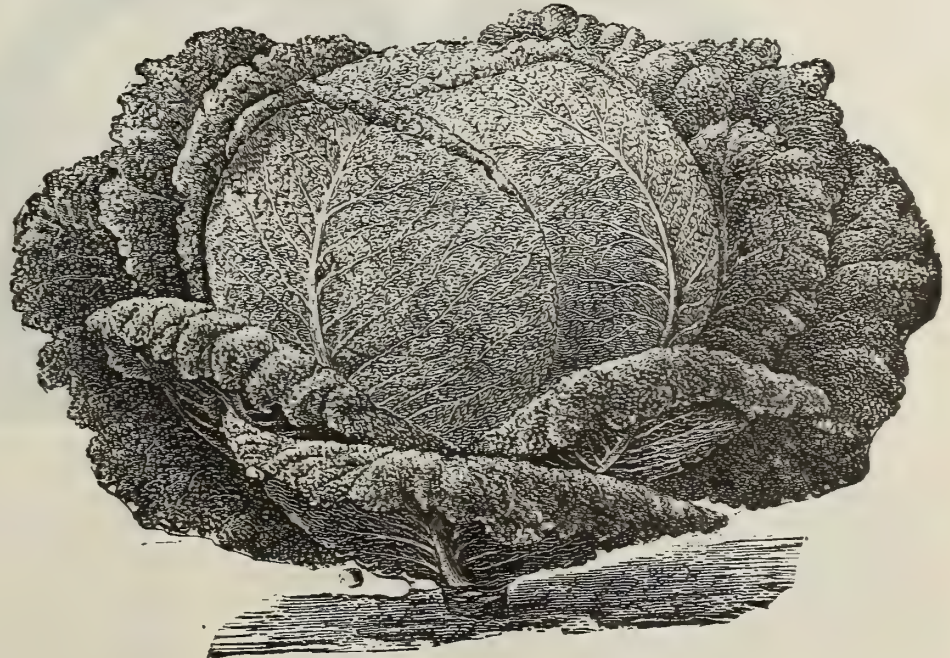

PERFECTION DRUMHEAD SAVOY.

CARROT.

German, *Möhren*.—French, *Carotte*.—Spanish, *Zanahoria*.

One ounce will sow 100 feet of drill.



EARLY FRENCH FORCING
CARROT.

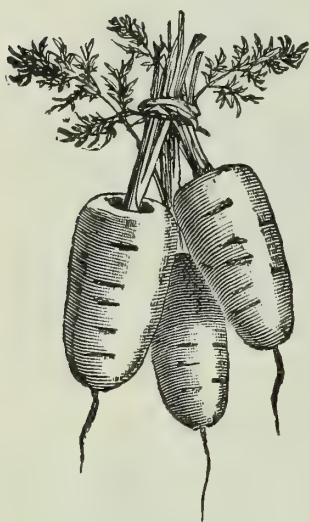

EARLY HORN CARROT.

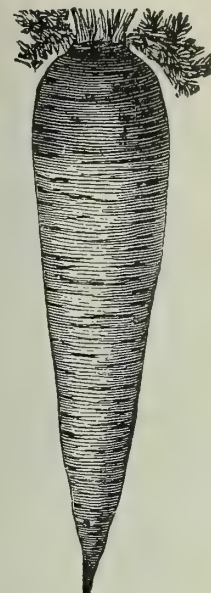

IMPROVED LONG
ORANGE CARROT.



IMPROVED DANVERS
CARROT.

Avoid sowing on newly manured ground, which has a tendency to produce forked roots; the land should, therefore, be manured the previous season. For early crops sow as soon as the ground can be worked, and for later crops, from the beginning until the end of May, in rows fifteen inches apart and half an inch deep. Thin out the young plants to five inches, and keep the surface open by a frequent use of the hoe.

Early French Forcing. The earliest variety grown; roots very small and exceedingly mild flavored. Per pkt., 5 cts.; oz., 15 cts.; $\frac{1}{4}$ lb., 40 cts.; lb., \$1.25.

Early Scarlet Horn. A very old and highly esteemed variety; medium size, fine grained and agreeably flavored. Per pkt., 5 cts.; oz., 10 cts.; $\frac{1}{4}$ lb., 30 cts.; lb., \$1.00.

Half Long Scarlet, Stump Rooted. A variety intermediate in size and period of maturity between the preceding and Long Orange. Per pkt., 5 cts.; oz., 10 cts.; $\frac{1}{4}$ lb., 30 cts.; lb., 90 cts.

NEW INTERMEDIATE OR ST. VALERY. Smooth; handsome; 10 to 12 inches long; tapers from shoulder to tip; fine quality; very productive. Per pkt., 5 cts.; oz., 10 cts.; $\frac{1}{4}$ lb., 30 cts.; lb., \$1.25.

CHANTENAY HALF LONG SCARLET. A stump-rooted variety, somewhat resembling the well-known Nantes Carrot; much more productive. Per pkt., 5 cts.; oz., 10 cts.; $\frac{1}{4}$ lb., 30 cts.; lb., \$1.25.

DANVERS HALF LONG. This variety is now very extensively cultivated, both for market and family use. Per pkt., 5 cts.; oz., 10 cts.; $\frac{1}{4}$ lb., 25 cts.; lb., 80 cts.

LONG ORANGE, IMPROVED. For garden and field crops this is the best and most profitable variety grown. Per pkt., 5 cts.; oz., 10 cts.; $\frac{1}{4}$ lb., 25 cts.; lb., 75 cts.

White Belgian. Extensively grown for feeding horses and cattle, for which purpose it is highly valued. Per pkt., 5 cts.; oz., 10 cts.; $\frac{1}{4}$ lb., 20 cts.; lb., 60 cts.

CAULIFLOWER.

German, *Blumen-Kohl*.—French, *Chou Fleur*.—Spanish, *Coliflor*.

One ounce will produce 3,000 plants.

A good, rich soil is essential for the successful cultivation of this delicious vegetable; our most experienced cultivators, however, acknowledge the advantage of a cool, moist season. Pursue the same general directions as recommended for growing Cabbage, watering liberally during dry weather. An occasional application of liquid manure is beneficial.

FIRST AND BEST (New). This splendid Cauliflower produces large, beautifully formed and fine-grained heads of snowy whiteness, while the flavor is extremely delicate. It is, without question, the earliest, surest and most solid heading variety grown in this country; fit to cut early in June, a few days ahead of the "Snowball," differing from that variety in being more dwarf and robust. The leaves completely envelop the head, thus protecting it from the sun. Per pkt., 50 cts.; $\frac{1}{4}$ oz., \$3.00; oz., \$10.00

Carrara Rock. This variety has proved a great acquisition. It is one of the earliest, producing perfectly formed, compact and almost snow-white heads of the finest quality. Per pkt., 50 cts.; $\frac{1}{4}$ oz., \$3.00; oz., \$10.00.

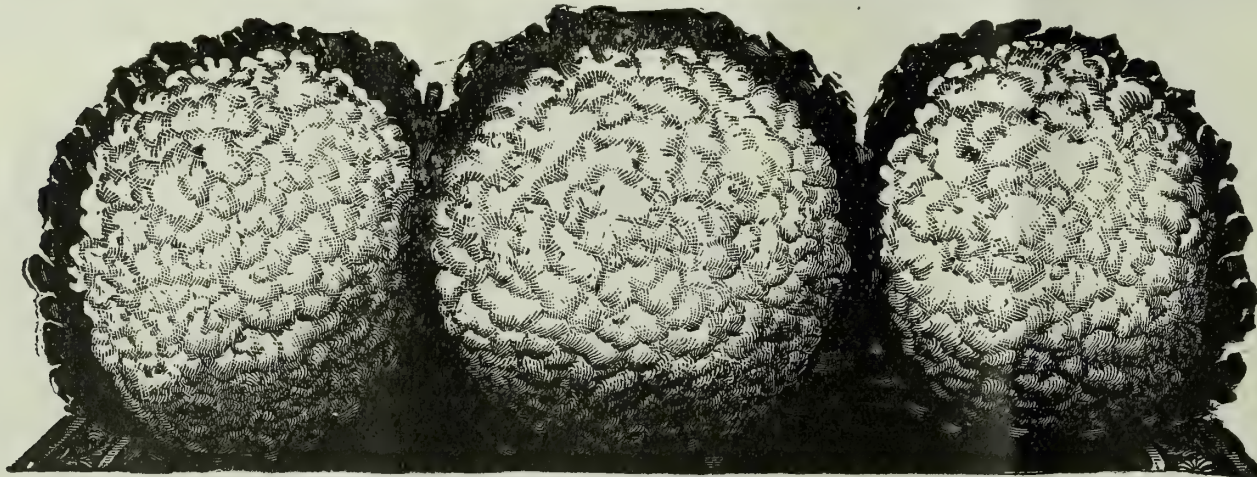

EARLY SNOWBALL CAULIFLOWER.

ERFURT EARLIEST DWARF. One of the earliest and most desirable varieties; almost certain to head. Per pkt., 50 cts.; $\frac{1}{4}$ oz., \$3.00; oz., \$10.00.

EARLY SNOWBALL. One of the earliest and most reliable sorts. It is dwarf, and being of compact form may be planted 20 inches apart each way. Per pkt., 25 cts.; oz., \$3.50.

Early Dwarf Erfurt. A favorite early market variety, producing large compact heads of fine quality. Per pkt., 15 cts.; oz., \$2.00.

Early Paris. A well-known variety, excellent for market or family use. Per pkt., 5 cts.; oz., 75 cts.; $\frac{1}{4}$ lb., \$2.50; lb., \$8.00.

Half Early Paris, or Nonpariel. One of the most popular varieties grown; good for early or late crops. Per pkt., 5 cts.; oz., 60 cts.; $\frac{1}{4}$ lb., \$2.00; lb., \$7.00.

Lenormand's Short Stemmed. An excellent late variety, with large heads of superior quality. Per pkt., 5 cts.; oz., 60 cts.; $\frac{1}{4}$ lb., \$2.00; lb., \$7.00.

Algiers. A late market variety, producing immense heads of excellent quality. Per pkt., 10 cts.; oz., 75 cts.; $\frac{1}{4}$ lb., \$2.00; lb., \$7.00.

Walcheren. An old and favorite sort. Per pkt., 10 cts.; oz., 60 cts.; $\frac{1}{4}$ lb., \$2.00; lb., \$6.00.

CAULIFLOWER PLANTS.—See page 33.

CELERY.

German, *Sellerie*.—French, *Celeri*.—Spanish, *Apio*.

One ounce will produce 5,000 plants.

The seed may be sown in the open border as soon in April as the ground can be worked. When the plants are three inches high, transplant four inches apart, into temporary beds of soft rich soil, where they will soon acquire sufficient strength for planting out in beds. Plant in rows three feet apart, and set six inches apart in rows. If the weather is dry at the time of planting, care should be taken that the roots are firm in the ground. After the planting is completed, nothing further is necessary for six or seven weeks, except running through between the rows with the cultivator or hoe and freeing the plants from weeds. About the middle of August earthing up is necessary for blanching and whitening of that which is wanted for early use. After the soil has been drawn up against the plant with the hoe, it is further pressed close around each plant by the hand, firm enough to keep the leaves in an upright position and prevent them from spreading, using care to prevent the soil falling into the heart of the plant.

GOLDEN SELF-BLANCHING. A self-blanching variety of the "White Plume" order, but far superior for either market gardeners' or private use. It requires earthing up a little more than the "White Plume." It is of a rich golden-yellow color, crisp, tender and of fine flavor; keeps well throughout the season; and is the earliest variety grown. Per pkt., 10 cts.; oz., 40 cts.; ¼ lb., \$1.25; 1 lb., \$4.00.

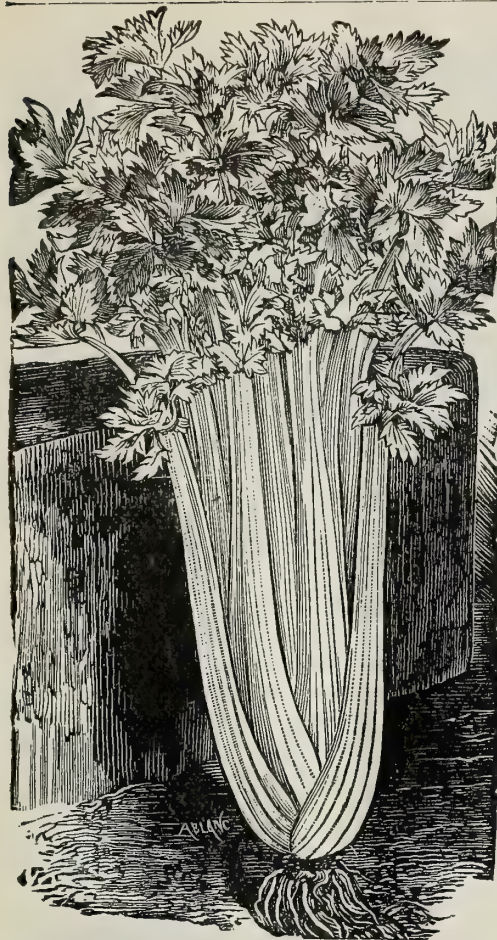

GOLDEN SELF-BLANCHING CELERY.

GIANT PASCAL. This splendid variety is a sport from the well-known "Golden Self-blanching," carefully selected. It partakes of the fine nutty flavor of that variety without being stringy. The stalks are thick, solid and crisp, golden-yellow heart. Per pkt., 10 cts.; oz., 30 cts.; ¼ lb., \$1.00; lb., \$3.00.

PERFECTION HEARTWELL. It is of medium height, the stalks being long and thick, while its compact structure makes it easily worked. It blanches well up in the leaves, and its crisp tenderness, distinct and delicious flavor are unequalled. Per pkt., 5 cts.; oz., 25 cts.; ¼ lb., 75 cts.; lb., \$2.50.

Giant White Solid. A favorite strong growing variety; hardy, solid and crisp. Per pkt., 5 cts.; oz., 25 cts.; ¼ lb., 75 cts.; lb., \$2.50.

New Rose Celery. The finest of its class. The color is a beautiful shade of rose, of fine flavor, solid, crisp, and entirely free from stringiness. A splendid variety for late use. Per pkt., 5 cts.; oz., 30 cts.; ¼ lb., \$1.00; lb., \$3.00.

MAJOR CLARKE'S PINK. In this variety we have a desirable acquisition. It is of medium growth, stiff close habit, large heart, remarkably solid and crisp, and of fine walnut flavor. Per pkt., 5 cts.; oz., 25 cts.; ¼ lb., 75 cts.; lb., \$2.50.

London Red. The largest variety grown, and one of the best in quality. Per pkt., 5 cts.; oz., 25 cts.; ¼ lb., 75 cts.; lb., \$2.50.

White Plume. A valuable early and exceedingly ornamental variety, requires very little labor in blanching, one of the best for early use. Per pkt., 5 cts.; oz., 30 cts.; ¼ lb., \$1.00; lb., \$2.50.

GOLDEN DWARF. A distinct variety; when blanched the heart develops a beautiful golden yellow; crisp, solid, fine flavor. Per pkt., 5 cts.; oz., 25 cts.; ¼ lb., 75 cts.; lb., \$2.50.

Improved Dwarf White. The best dwarf variety grown; of close habit, crisp and juicy. Per pkt., 5 cts.; oz., 25 cts.; ¼ lb., 75 cts.; lb., \$2.50.

Sandringham Dwarf White. The dwarfiest white variety, solid and crisp. Per pkt., 5 cts.; oz., 25 cts.; ¼ lb., 75 cts.; lb., \$2.50.

Improved Half Dwarf. A superior white variety of intermediate size, possessing a delicious nutty flavor. One of the best for market or family use. Per pkt., 5 cts.; oz., 20 cts.; ¼ lb., 60 cts.; lb., \$2.00.

Boston Market. Of dwarf-branching habit, solid, crisp and fine flavor. Per pkt., 5 cts.; oz., 25 cts.; ¼ lb., 75 cts.; lb., \$2.50.

White Walnut. A half-dwarf white variety, having uncommonly large and solid leaf stalks of fine walnut flavor. Per pkt., 5 cts.; oz., 25 cts.; ¼ lb., 75 cts.; lb., \$2.50.

Celery Seed. For flavoring soups. Per lb., 30 cents.



GOLDEN DWARF CELERY.

CELERIAC, or Turnip-Rooted Celery.

French, *Celeri-rave*.—German, *Knob Sellerie*.—Spanish, *Apio raiz de Nabo*.

A variety of celery with turnip-shaped roots which are white-fleshed, comparatively tender, and have the flavor of celery-stalks. The seed may be sown in the open ground in April, and the young plants nursed in the same way as Celery; but in planting out, the ground is manured and dug, not trenched, and the plants set in shallow drills 12 inches apart, watering freely. As the growth advances, draw the earth to the plants, by which the knotty roots will be blanched, and made delicate and tender.

LARGE ERFURT. A standard variety, producing turnip-shaped roots. Per pkt., 5 cts.; oz., 25 cts.; ¼ lb., 75 cts.; lb., \$2.50.

Apple-Shaped. A variety with small foliage and tubers almost round in shape. Per pkt., 5 cts.; oz., 25 cts.; ¼ lb., 75 cts.; lb., \$2.50.

Large Smooth Prague. The finest variety yet introduced. Per pkt., 5 cts.; oz., 30 cts.; ¼ lb., \$1.00; lb., \$3.00.



LARGE PRAGUE CELERIAC.

CHERVIL.

German, *Kerbel*.—French, *Cerfeuil*.—Spanish, *Perifollo*.

The Curled Chervil is cultivated like Parsley, and used for garnishing and flavoring soups and salads. The seed of the Tuberous Rooted is sown in August, and treated like the Carrot.

Curled Chervil. The young leaves are used for flavoring soups and salads. Per pkt., 5 cts.; oz., 20 cts.; $\frac{1}{4}$ lb., 60 cts.; lb., \$2.00

Tuberous Rooted. Prepared for the table like Carrots, this is one of the most delicious vegetables grown. Per pkt., 10 cts.; oz., 30 cts.; $\frac{1}{4}$ lb., \$1.00; lb., \$3.00.

CHICORY.

German, *Chicorie*.—French, *Chicoree*.—Spanish, *Achivoria a Cafe*.

Chicory is cultivated chiefly for its roots, which are dried, and used as a substitute or flavoring ingredient for coffee. The leaves, when blanched, are also esteemed as an excellent salad. Cultivate as recommended for Carrots.

Large Rooted. Per pkt., 5 cts.; oz., 10 cts.; $\frac{1}{4}$ lb., 30 cts.; lb., \$1.00.

WITLOOF. Sow in June and transplant the roots in October in rows eight inches apart, in trenches one foot deep; cut off the leaves. Cover the roots with well sifted soil eight inches thick, adding a good layer of manure two to three feet thick. The Witloof will be ready for use in about three weeks. Valuable as a salad as well as a vegetable. Per pkt., 5 cts.; oz., 15 cts.; $\frac{1}{4}$ lb., 50 cts.; lb., \$1.50.



CORN SALAD.

CRESS, or Peppergrass.

German, *Kresse*.—French, *Cresson*.—Spanish, *Mastuerzo*.

One ounce will sow 150 feet of drill.

A popular salad, which should be sown early in spring—very thickly in shallow drills—and at short intervals, for succession, as it soon runs to seed.

UPLAND CRESS. This new vegetable gives us a garden substitute for the English Water Cress. Crisp, tender, perfectly hardy, easily raised in any garden, and has the peculiar spicy flavor of water cress. Per pkt., 10 cts.; oz., 50 cts.

Extra Curled. The best variety grown; leaves are beautifully cut and curled; highly prized for garnishing. Per pkt., 5 cts.; oz., 10 cts.; $\frac{1}{4}$ lb., 20 cts.; lb., 60 cts.

Australian. Fine, piquant flavor. Per pkt., 5 cts.; oz., 10 cts.; $\frac{1}{4}$ lb., 30 cts.; lb., \$1.00.

American, or Land. Eaten as Water Cress in winter. Per pkt., 5 cts.; oz., 10 cts.; $\frac{1}{4}$ lb., 30 cts.; lb., \$1.00.

WATER-CRESS.

German, *Brunnenkresse*.—French, *Cresson de Fontaine*.—Spanish, *Berro*.

This wholesome salad may be grown in any moist situation, but more successfully by the edge of a running brook. The seed may be sown in May, on the ground where it is intended to be grown, and the thinnings transplanted. The plants should be set not less than a foot apart. The cress will be fit for gathering the second year.

The Common Variety. Per pkt., 10 cts.; oz., 30 cts.; $\frac{1}{4}$ lb., \$1.50; lb., \$5.00.

True Erfurt. More highly esteemed than the ordinary variety, being less pungent and of a more agreeable flavor. Per pkt., 15 cts.; oz., 75 cts.; $\frac{1}{4}$ lb., \$2.50.



CURLED CHERVIL.

CORN SALAD or Fetticus.

German, *Ackersalat*.—French, *Mache*.—Spanish, *Macha Valerianilla*.

One ounce will sow 150 feet of drill.

This excellent salad may be had the year round. Sow in September, in drills eight inches apart, covering the seeds lightly and protect from frost by a light covering of hay or litter. The seed may also be sown in spring.

LARGE-SEEDED. The most popular variety grown. Per pkt., 5 cts.; oz., 10 cts.; $\frac{1}{4}$ lb., 25 cts.; lb., 75 cts.

COLLARDS, or Colewort.

German, *Blatterkohl*.—French, *Chou*.—Spanish, *Cabu*.

One ounce will produce 3,000 plants.

Sow the seeds at intervals from June to August, in drills one foot apart. They are ready for use when one month old, but may be transplanted six or eight inches apart to prolong the season.

True Georgia. Pkt., 5 cts.; oz., 10 cts.; $\frac{1}{4}$ lb., 30 cts.; lb., \$1.00.



COLLARDS.



UPLAND CRESS.

DANDELION.

German, *Pardeblum*.—French, *Pisse-en-lit*.—Spanish, *Amargon*.

One ounce will sow 100 feet of drill.

In spring, the blanched leaves of this plant make a most delicately-flavored and wholesome salad. The seed may be sown in May or June, in drills half an inch deep, and twelve inches apart; thin out the plants to six inches; cultivate during summer, and the following spring the leaves will be fit to cut. The quality is improved very much by blanching, which can be easily done by covering over the plants with boards.

French (Common). Per pkt., 10 cts.; oz., 25 cts.; $\frac{1}{4}$ lb., 75 cts.; lb., \$2.50.

Improved Large Leaved. A thick-leaved variety, of great productiveness and fine flavor. Per pkt., 10 cts.; oz., 50 cts.; $\frac{1}{4}$ lb., \$1.50.

CORN, Sweet.

German, *Welschkorn*.—French, *Mais*.—Spanish, *Maiz*.

One quart will plant 200 hills.

Plant in hills three feet apart each way, dropping five or six kernels in each hill, or planted in rows three to four feet apart, and the plants thinned out to eight or nine inches in the row. From the beginning of May until the middle of July a succession planting can be made every two or three weeks, and by properly selecting the varieties a continued supply can be had until frost kills the plants.



MOORE'S CONCORD.



MAMMOTH SUGAR CORN

EXTRA EARLY CORY. This variety is of great value for its extreme earliness. It is ten days earlier than any other sort. The ears are of good size and of first-rate quality. Per pt., 10 cts.; qt., 20 cts.; peck, \$1.25.

Extra Early Tom Thumb. A very early eight-rowed variety. Kernels of fair size, white and sweet; stalks about three feet high. Per pt., 10 cts.; qt., 20 cts.; peck, \$1.25.

Early Minnesota. One of the earliest varieties grown; dwarf; ears small, but of fine quality. Per pt., 10 cts.; qt., 20 cts.; peck, \$1.25.

STABLER'S EARLY. Ready a few days after the Minnesota. Very productive and of superior richness; profitable for either market or canning. Per pt., 10 cts.; qt., 20 cts.; peck, \$1.25.

Early Marblehead. This is an eight-rowed, flesh-colored, very early variety. The plant is of dwarf habit; ears of medium size. Per pt., 10 cts.; qt., 20 cts.; peck, \$1.25.

EARLY MAMMOTH. A valuable variety, at least ten days earlier than the Mammoth. Ears twelve-rowed, straight and handsome. It is remarkable for its delicious sweetness. Per pt., 10 cts.; qt., 20 cts.; peck, \$1.25.

Perry's Hybrid. A large variety, following the Crosby. The kernels are large, sweet and tender. Per pt., 10 cts.; qt., 20 cts.; peck, \$1.25.

Squantum. A second early sort, very sweet and luscious, produces four or five ears to the stalk. Per pt., 10 cts.; qt., 20 cts.; peck, \$1.25.

Crosby's Early. One of the standard early sorts; ears of medium size. Per pt., 10 cts.; qt., 20 cts.; peck, \$1.25.

Moore's Early Concord. A standard variety for market or family use; ears large, of superior quality. Per pt., 10 cts.; qt., 20 cts.; peck, \$1.25.

NE PLUS ULTRA or SHOE PEG. The sweetest and most tender of all sweet corn. The ears are short and the cob is small, the kernels pearly white and irregularly crowded together on the cob. Per pt., 15 cts.; qt., 25 cts.; peck, \$1.50.

Roslyn Hybrid. A large growing variety which ripens ten or twelve days later than Stabler's Early, and the quality is equal to Stowell's Evergreen. Per pt., 10 cts.; qt., 20 cts.; peck, \$1.25.

Large Early Eight-rowed. Ears large and handsome; quality excellent. Per pt., 10 cts.; qt., 20 cts.; peck, \$1.25.

Hickox Improved. Of medium earliness; valuable for market or family garden; ears twelve-rowed; quality of the best. Per pt., 10 cts.; qt., 20 cts.; peck, \$1.25.

Egyptian. Vigorous and productive; ears large and uniform, tender and sweet. Per pt., 10 cts.; qt., 20 cts.; peck, \$1.25.

STOWELL'S EVERGREEN. The most popular variety grown; late; ears large; very sweet, and retain their juicy tenderness longer than any other sort. Per pt., 10 cts.; qt., 20 cts.; peck, \$1.25.

MAMMOTH. The largest late variety grown; very productive and fine flavored. Per pt., 10 cts.; qt., 20 cts.; peck, \$1.25.

Black Sugar. The sweetest and most delicious variety grown. Per pt., 15 cts.; qt., 25 cts.; peck, \$1.25.

White Pop-corn. Per lb., 10 cts.; 100 lbs., \$8.00.



EARLY MAMMOTH.



STOWELL'S EVERGREEN

CUCUMBER.

German, *Gurken*.—French, *Concombre*.—Spanish, *Pepino*.

One ounce will plant 50 hills.

Cucumbers succeed best in warm, moist, rich, loamy ground. They should not be planted in the open air until there is a prospect of settled, warm weather. Plant in hills about four feet apart each way. The hills should be previously prepared, by mixing thoroughly with the soil, in each, a shovelful of well-rotted manure. When all danger from insects is passed, thin out the plants, leaving three or four of the strongest to each hill.

Early Russian. The earliest in cultivation; fruit produced in pairs; very hardy and prolific. Per pkt., 5 cts.; oz., 10 cts.; ¼ lb., 25 cts.; lb., 75 cts.

Early Cluster. A very early and highly esteemed variety, bearing in clusters; very productive. Per pkt., 5 cts.; oz., 10 cts.; ¼ lb., 25 cts.; lb., 75 cts.

Early Frame or Short Green. A standard sort for table or pickling; of medium size, straight and handsome. Per pkt., 5 cts.; oz., 10 cts.; ¼ lb., 25 cts.; lb., 75 cts.

New Everbearing. This variety is of small size, very early, enormously productive and valuable as a green pickler. Its peculiar merit is that the vines continue to flower and produce fruit until killed by frost. Per pkt., 5 cts.; oz., 10 cts.; ¼ lb., 25 cts.; lb., 75 cts.

Improved Long Green. A fine bearer; fruit long, of superior quality. Per pkt., 5 cts.; oz., 10 cts.; ¼ lb., 25 cts.; lb., 75 cts.

West India Gherkin. Used only for pickling. Per pkt., 5 cts.; oz., 15 cts.; ¼ lb., 25 cts.; lb., \$1.25.

English Frame or Forcing Varieties.

Sow in small pots from middle of January, in hot-bed or hot-house. When grown to three leaves, plant out in a previously prepared hill of loose, rich soil, in the centre of the sash. Keep a temperature of 65 degrees at night, to 75 or 80 degrees with sun-heat. The following selection includes some of the leading English varieties:

Blue Gown,
Lord Kenyon's Favorite,

Telegraph,
Marquis of Lorne,

Duke of Edinburgh,
Cuthill's Black Spine.

Per pkt., 25 cts.

WEST INDIA GHERKIN.



IMPROVED WHITE SPINE.

BENNETT'S WHITE SPINE. This strain grows from seven to ten inches long, proportionately thick throughout, being as full at both ends as in the centre. It is a week earlier than the variety known as "Improved White Spine," but retains its glossy dark-green color much longer on the vine. Per pkt., 5 cts.; oz., 10 cts.; ¼ lb., 30 cts.; lb., \$1.00.

Improved Early White Spine. A favorite market variety, of medium size, deep-green, flesh crisp and of fine flavor. Per pkt., 5 cts.; oz., 10 cts.; ¼ lb., 25 cts.; lb., 75 cts.

Green Prolific Pickling. Besides combining all the valuable features of a superior pickle, this is by far the most productive variety grown. Per pkt., 5 cts.; oz., 10 cts.; ¼ lb., 25 cts.; lb., 75 cts.

Tailby's Hybrid. An excellent variety for general use. Per pkt., 5 cts.; oz., 10 cts.; ¼ lb., 25 cts.; lb., 75 cts.

EXTRA EARLY GREEN PROLIFIC. Same as Green Prolific Cucumber, but from ten days to two weeks earlier. Those who wish an early strain of the Green Prolific will find in this something that they have long desired. Per pkt., 5 cts.; oz., 10 cts.; ¼ lb., 25 cts.; lb., 75 cts.

Nichol's Medium Green. Valuable either for forcing, pickling or table use. It is of medium size, dark-green and very productive. Per pkt., 5 cts.; oz., 10 cts.; ¼ lb., 25 cts.; lb., 75 cts.



TELEGRAPH CUCUMBER.



EGG PLANT.

German, *Eierpflanze*.—French, *Aubergine*.—Spanish, *Berengena*.

One ounce will produce 1,000 plants.

The Egg Plant will thrive well in any good garden soil, but will repay good treatment. The seed should be sown in hot-beds the first week in April, care being taken to protect the young plants from cold at night. Plant out about June 1st, about two and a half feet apart. If no hot-bed is at hand, sufficient plants may be raised for a small garden by sowing a few seeds in common flower-pots or boxes in the house.

Early Long Purple. A very early, hardy and productive variety of good quality. Per pkt., 5 cts.; oz., 25 cts.; $\frac{1}{4}$ lb., 75 cts.; lb., \$2.00.

Black Pekin. A highly-esteemed variety, producing very handsome, jet-black fruit of superior quality. Per pkt., 5 cts.; oz., 40 cts.; $\frac{1}{4}$ lb., \$1.25; lb., \$4.00.

NEW YORK IMPROVED PURPLE. This variety is extensively cultivated for both market and private use; it grows to a large size, very prolific and fine flavored. Per pkt., 5 cts.; oz., 40 cts.; $\frac{1}{4}$ lb., \$1.25; lb., \$4.50.

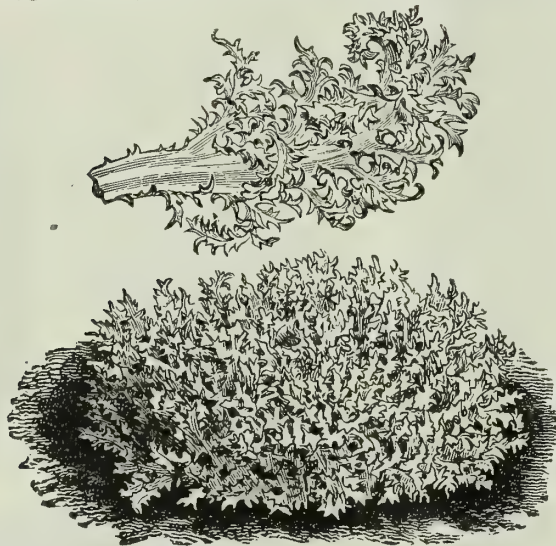

GREEN CURLED ENDIVE.

ENDIVE.

German, *Endivien*.—French, *Chicoree*.—Spanish, *Endivia*.

One ounce will sow 200 feet of drill.

A highly-esteemed winter salad. For first crop sow about the middle of May, and for succession in June and July. When the plants are two or three inches high, thin them out or transplant into moderately rich and rather light soil, one foot apart. When nearly full grown, and before they are fit for the table, they should be blanched, by tying the leaves loosely together, or by covering with boards or flower-pots.

GREEN CURLED. The hardiest variety grown; beautifully curled, tender and crisp. Per pkt., 5 cts.; oz., 15 cts.; $\frac{1}{4}$ lb., 40 cts.; lb., \$1.50.

White Curled. Very tender when cut young; blanches readily. Per pkt., 5 cts.; oz., 15 cts.; $\frac{1}{4}$ lb., 40 cts.; lb., \$1.50.

Moss Curled. More finely curled, heavier and a more dense plant than green curled. Per pkt., 5 cts.; oz., 15 cts.; $\frac{1}{4}$ lb., 40 cts.; lb., \$1.50.

Broad-Leaved Batavian. (*Escarrolle*.) This variety is chiefly used in soups and stews; requires to be tied up for blanching. Per pkt., 5 cts.; oz., 15 cts.; $\frac{1}{4}$ lb., 40 cts.; lb., \$1.50.

GARLIC.

German, *Knoblauch*.—French, *Ail*.—Spanish, *Ajo*.

One pound will plant 10 feet of drill.

Garlic is used for a variety of flavoring purposes. Plant the sets six inches apart in rows one foot apart. As soon as the leaves have turned, the crop is matured, and may be harvested like the onion.

Garlic Sets. Per lb., 30 cts.

MARTYNIA.

One ounce will plant 200 hills.

A strong growing annual plant bearing curiously shaped seed pods, which, when young and tender, make excellent pickles. Sow in the open ground in May, and thin out the plants to two or three feet apart, or a few seeds may be sown in a hot-bed and afterwards transplanted.

Proboscidea. Per pkt., 10 cts.; oz., 30 cts.; $\frac{1}{4}$ lb., \$1.00; lb., \$3.00.

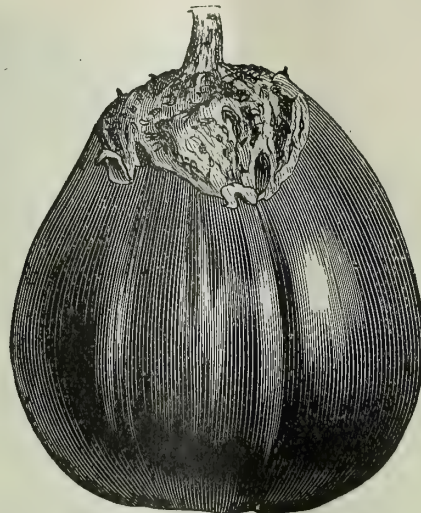

NEW YORK IMPROVED EGG PLANT.

KOHL-RABI.

German, *Kohl-Rabi*.—French, *Chou-Rave*.—Spanish, *Col de nabo*.

One ounce will sow 200 feet of drill.

This vegetable, the popularity of which is rapidly increasing, combines the virtues of the turnip and cabbage, but excels both in nutritive, hardy and productive qualities. The seed may be sown in June, in rows eighteen inches apart, and the plants thinned out to eight or ten inches.

EARLY SHORT-LEAVED WHITE VIENNA. The earliest and best table or market variety. Per pkt., 10 cts.; oz., 30 cts.; $\frac{1}{4}$ lb., \$1.00; lb., \$3.00.

Early Short-Leaved Purple Vienna. Similar to the preceding, except in color, which is of a bluish purple. Per pkt., 10 cts.; oz., 30 cts.; $\frac{1}{4}$ lb., 75 cts.; lb., \$3.00.

LEEK.

German, *Lauch*.—French, *Poireau*.—Spanish, *Puerro*.

One ounce will sow 200 feet of drill.

The Leek is very hardy, and easily cultivated; it succeeds best in a light but well-enriched soil. Sow as early in spring as practicable, in drills one inch deep and one foot apart. When six or eight inches high, transplant in rows ten inches apart each way, as deep as possible, that the neck, being covered, may be blanched.

LARGE AMERICAN FLAG. The most desirable for market or family use. Per pkt., 5 cts.; oz., 25 cts.; $\frac{1}{4}$ lb., 75 cts.; lb., \$2.25.

Musselburgh. A very large variety of superior quality. Per pkt., 10 cts.; oz., 25 cts.; $\frac{1}{4}$ lb., 75 cts.; lb., \$2.50.



AMERICAN FLAG LEEK.



Hanson. Heads large, from two to three pounds each; hearts quickly, and stands the summer well; quality excellent. Per pkt., 5 cts.; oz., 15 cts.; $\frac{1}{4}$ lb., 40 cts.; lb., \$1.25.

Early Prize Head. Forms a mammoth plant, in which the outer leaves are crisp and tender, and remain so throughout the season. Per pkt., 5 cts.; oz., 15 cts.; $\frac{1}{4}$ lb., 40 cts.; lb., \$1.25.

New York. This variety branches itself naturally, is crisp, tender and of excellent flavor, and always free from bitterness. The outside color is distinct, being a clear, deep apple green, while on the inside the color is yellowish white. Per pkt., 5 cts.; oz., 15 cts.; $\frac{1}{4}$ lb., 40 cts.; lb., \$1.25.

BLONDE BLOCKHEAD OR SUNSET. This is a large growing Head Lettuce, resisting the heat for a long time before running to seed. The heads are large, solid and crisp, of a golden-yellow color. Per pkt., 5 cts.; oz., 15 cts.; $\frac{1}{4}$ lb., 40 cts.; lb., \$1.25.

Large India. Immense heads; brittle and of fine flavor. This variety is prized for enduring the summer heat. Per pkt., 5 cts.; oz., 15 cts.; $\frac{1}{4}$ lb., 40 cts.; lb., \$1.25.

SALAMANDER. An excellent summer variety, forming large sized heads that stand the drought and heat without injury longer than any other sort. Per pkt., 5 cts.; oz., 15 cts.; $\frac{1}{4}$ lb., 40 cts.; lb., \$1.25.

Deacon. A splendid variety for standing the summer heat; large solid heads, tender, crisp and sweet. Per pkt., 5 cts.; oz., 15 cts.; $\frac{1}{4}$ lb., 40 cts.; lb., \$1.25.

Defiance Summer. One of the best summer lettuces for family use, remaining crisp and tender for a long time; heads light green and large. Per pkt., 5 cts.; oz., 15 cts.; $\frac{1}{4}$ lb., 40 cts.; lb., \$1.25.

Drumhead or Malta. One of the largest and best summer Lettuces; branches naturally; tender and crisp. Per pkt., 5 cts.; oz., 10 cts.; $\frac{1}{4}$ lb., 30 cts.; lb., \$1.00.

Hardy Green Hammersmith. One of the hardiest and best for winter. Per pkt., 5 cts.; oz., 15 cts.; $\frac{1}{4}$ lb., 40 cts.; lb., \$1.25.



LETTUCE.

German, *Salat*.—French, *Laitue*.—Spanish, *Lechuga*.

One ounce will sow 200 feet of drill.

For early crop, the seed may be sown in the open ground about the middle of September, and transplanted to cold frames as soon as large enough to handle, being wintered over in the same manner as early Cabbage. In dry, sheltered spots, by covering up with leaves or litter late in the season, Lettuce plants may be saved over winter without glass covering. The plants for setting out in spring are also sown in cold frames in February, and in hot-beds in March, and by careful covering up at night make plants to set out in April.

Early Curled Simpson. One of the earliest and best for market. Per pkt., 5 cts.; oz., 15 cts.; $\frac{1}{4}$ lb., 40 cts.; lb., \$1.25.

Black-seeded Simpson. Nearly double the size of the ordinary Curled Simpson; stands the summer well. Per pkt., 5 cts.; oz., 15 cts.; $\frac{1}{4}$ lb., 40 cts.; lb., \$1.25.

Green Fringed or California Curled. A delicate shade of green, the inner parts of the leaves white, with edges beautifully cut and fringed. Per pkt., 5 cts.; oz., 15 cts.; $\frac{1}{4}$ lb., 40 cts.; lb., \$1.25.

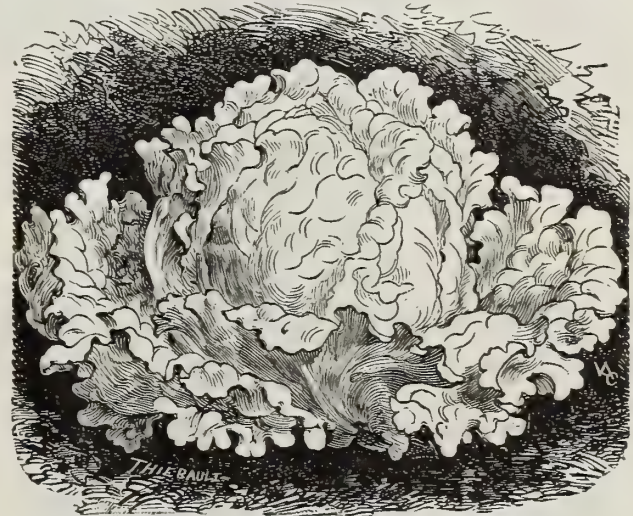

BLONDE BLOCKHEAD LETTUCE.

Boston Market. Solid, crisp, and compact; one of the best for forcing. Per pkt., 5 cts.; oz., 15 cts.; $\frac{1}{4}$ lb., 40 cts.; lb., \$1.25.

Tennis Ball. This variety forms a very compact head with few outer leaves; fine for forcing. Per pkt., 5 cts.; oz., 15 cts.; $\frac{1}{4}$ lb., 40 cts.; lb., \$1.25.

Early Butter Salad. (*Black Seeded*.) A very tender and crisp variety of delicate flavor. Per pkt., 5 cts.; oz., 15 cts.; $\frac{1}{4}$ lb., 40 cts.; lb., \$1.25.

White Summer Cabbage. A fine summer variety; heads of good size, close and well formed. Per pkt., 5 cts.; oz., 15 cts.; $\frac{1}{4}$ lb., 40 cts.; lb., \$1.25.

All the Year Round. A very hardy, compact variety, white, solid and crisp; for summer and forcing this variety is unsurpassed. Per pkt., 5 cts.; oz., 15 cts.; $\frac{1}{4}$ lb., 40 cts.; lb., \$1.25.

BIG BOSTON. This variety is the same in color, shape and general appearance as the Boston Market, but *double the size*. It is about one week later in maturing, but its solidity and greater size of head will make it a most valuable sort. Per pkt., 5 cts.; oz., 15 cts.; $\frac{1}{4}$ lb., 40 cts.; lb., \$1.25.

Golden Stonehead. Small, solid; very handsome; splendid forcer; stands the summer well. Per pkt., 5 cts.; oz., 15 cts.; $\frac{1}{4}$ lb., 40 cts.; lb., \$1.25.

DENVER MARKET. The heads are large, solid, light green, beautifully curled like a Savoy cabbage, very crisp and tender. The heads are a little after the style of the Hanson, but more oblong. Delicate, tender, and very superior. Per pkt., 5 cts.; oz., 15 cts.; $\frac{1}{4}$ lb., 40 cts.; lb., \$1.25.

TRIANON COS. The long, narrow leaves, which form solid heads, almost like a Wakefield Cabbage, bleach and quickly become snowy white. They excel all other Lettuces in quality, having a taste and crispness unequalled. Per pkt., 5 cts.; oz., 15 cts.; $\frac{1}{4}$ lb., 40 cts.; lb., \$1.50.

Brown Dutch. One of the best winter varieties; very hardy crisp and sweet. Per pkt., 5 cts.; oz., 15 cts.; $\frac{1}{4}$ lb., 40 cts.; lb., \$1.25.

Paris White Cos. (*Romaine*.) One of the finest varieties for summer use; the long, narrow leaves should be tied up for a few days to facilitate blanching. Per pkt., 5 cts.; oz., 15 cts.; $\frac{1}{4}$ lb., 40 cts.; lb., \$1.25.

FOR FORCING

—USE—
Boston Market Lettuce, First and Best Cauliflower, Earliest Carmine Radish, The Lorillard Tomato.

MUSK MELON.

German, *Melone*.—French, *Melon*.—Spanish, *Melon Muscatel*.

One ounce will plant 75 hills.

Cultivate in hills, which should be five to six feet apart each way, and composed of light, moderately rich soil. The hills should be dug about two feet square, eighteen inches deep, and half filled with well-rotted manure, which must be thoroughly incorporated with the soil. Plant in May, ten seeds to the hill, and when the plants are well up, thin out to three. Cultivate until the vines cover the ground, and pinch the ends of the growing shoots to induce early fruiting.

NETTED GEM. One of the earliest and most prolific small melons, Globe-shaped, uniform in size, weighing from $\frac{1}{4}$ to $\frac{1}{2}$ lbs. each. Flesh light green and of fine flavor. Per pkt., 5 cts.; oz., 10 cts.; $\frac{1}{4}$ lb., 25 cts.; lb., 75 cts.

"The Delmonico." This variety is one of the most delicious flavored Musk Melons ever introduced. It is an oval-shaped melon of large size, finely netted, and has beautiful orange-pink flesh. Per pkt., 5 cts.; oz., 10 cts.; $\frac{1}{4}$ lb., 25 cts.; lb., 75 cts.

Skillman's Netted. A small, early and prolific, rough netted variety; flesh green, thick, and of fine flavor. Per pkt., 5 cts.; oz., 10 cts.; $\frac{1}{4}$ lb., 25 cts.; lb., 75 cts.

Nutmeg. Fruit globular in form, finely netted and scented; flesh greenish-yellow and of superior quality. Per pkt., 5 cts.; oz., 10 cts.; $\frac{1}{4}$ lb., 25 cts.; lb., 75 cts.

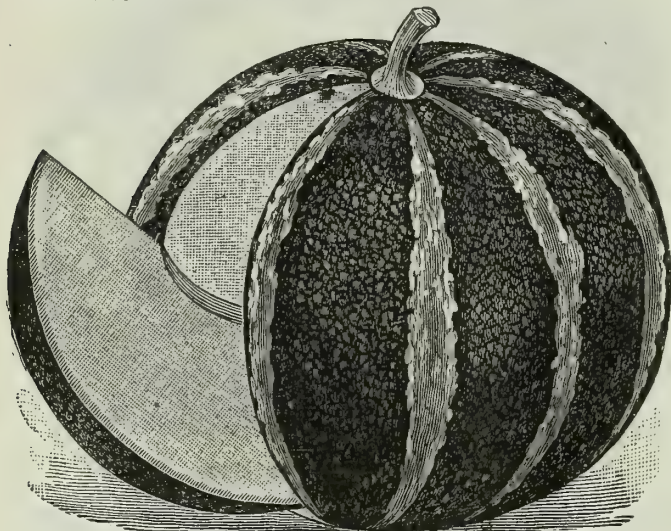

EMERALD GEM MUSK MELON.

Improved Christiana. Preferred in the extreme North to any other variety, being the earliest grown; flesh yellow, and of excellent quality. Per pkt., 5 cts.; oz., 10 cts.; $\frac{1}{4}$ lb., 25 cts.; lb., 75 cts.

Surprise. A very early sort of a similar type to the Nutmeg. The flesh is thick, of a deep salmon and exquisite flavor. Per pkt., 5 cts.; oz., 10 cts.; $\frac{1}{4}$ lb., 25 cts.; lb., 75 cts.

Green Citron. Fruit round, of good size and deeply netted; flesh green, thick and delicious. Per pkt., 5 cts.; oz., 10 cts.; $\frac{1}{4}$ lb., 25 cts.; lb., 75 cts.

Large Yellow Cantaloupe. Fruit nearly round, of good size and early; flesh reddish-orange, thick, and of musky flavor. Per pkt., 5 cts.; oz., 10 cts.; $\frac{1}{4}$ lb., 25 cts.; lb., 75 cts.

Ward's Nectar. A green fleshed variety of fine quality, exceedingly sweet and delicious. Per pkt., 5 cts.; oz., 10 cts.; $\frac{1}{4}$ lb., 25 cts.; lb., 75 cts.

EARLY HACKENSACK. This strain is the result of careful selection of old variety by the same name, but is much larger, ten days earlier and of superior quality. Flesh light green and of delicious flavor. Per pkt., 5 cts.; oz., 10 cts.; $\frac{1}{4}$ lb., 25 cts.; lb., 75 cts.

THE EMERALD GEM. Fruit of medium size, skin smooth, of a deep emerald green color. The flesh is of a suffused salmon color, and ripens thoroughly to the extremely thin green edge; delicious flavor. Per pkt., 5 cts.; oz., 10 cts.; $\frac{1}{4}$ lb., 25 cts.; lb., 75 cts.

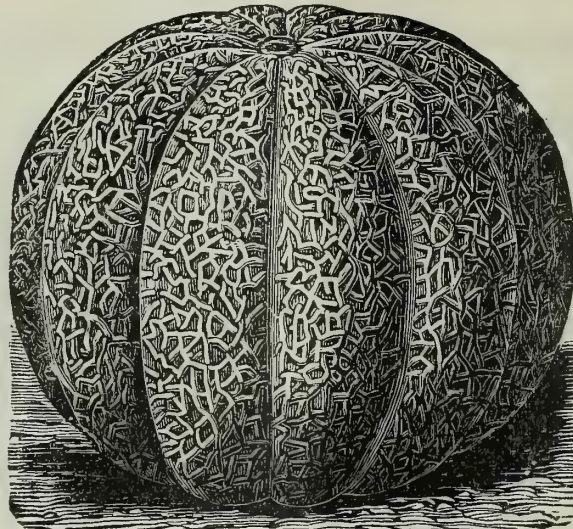

EARLY HACKENSACK MUSK MELON.

Jenny Lind. A popular sort; fruit small, medium early and of good quality. Per pkt., 5 cts.; oz., 10 cts.; $\frac{1}{4}$ lb., 25 cts.; lb., 75 cts.

Japan Coral-flesh. An exquisite variety, of average size, round form, regularly ribbed and densely netted. The most delicious and economical musk melon in cultivation. Per pkt., 5 cts.; oz., 10 cts.; $\frac{1}{4}$ lb., 25 cts.; lb., 75 cts.

MONTREAL MARKET. This variety is a decided improvement upon the old form of nutmeg, being twice the size and greatly superior in flavor. Per pkt., 5 cts.; oz., 10 cts.; $\frac{1}{4}$ lb., 25 cts.; lb., 75 cts.

Hackensack. This variety resembles the Green Citron in most respects, but is generally preferred, especially for market purposes. Per pkt., 5 cts.; oz., 10 cts.; $\frac{1}{4}$ lb., 25 cts.; lb., 75 cts.

THE BANQUET. "The Banquet" is a medium sized melon, flat at both ends and more beautifully netted than any known variety. In quality it has no equal, the flesh is uniformly deep and of that granulated character that always indicates a good melon; the color is a dark rich salmon. Per pkt., 5 cts.; oz., 10 cts.; $\frac{1}{4}$ lb., 25 cts.; lb., 75 cts.



MONTREAL MARKET MUSK MELON.

Baltimore. A green fleshed, productive and excellent shipping variety of oblong form. Per pkt., 5 cts.; oz., 10 cts.; $\frac{1}{4}$ lb., 25 cts.; lb., 75 cts.

Miller's Cream. Most delicious. The flesh is a rich salmon color, very thick, sweet and rich; rind very thin and finely netted; very productive. Per pkt., 5 cts.; oz., 10 cts.; $\frac{1}{4}$ lb., 25 cts.; lb., 75 cts.

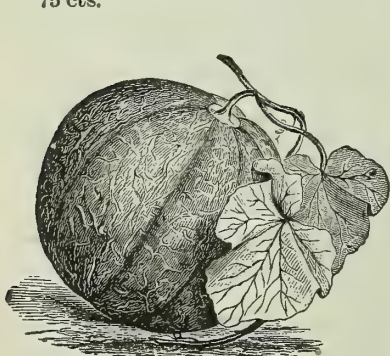

SURPRISE MUSK MELON.

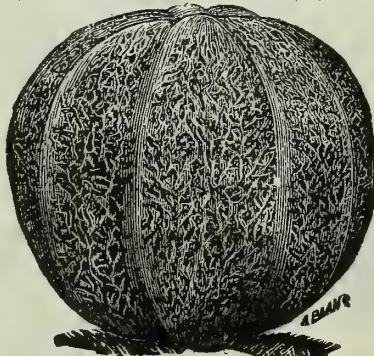

NUTMEG MUSK MELON.

FOR GENERAL CROP

USE OUR

Early Mammoth Sweet Corn,
Bennett's White Spine Cucumber,
Dwarf Champion Pea,
American Hollow Crown Parsnip.

WATER MELONS.

German, *Wassermelonen*.—French, *Melon d'Eau*.—Spanish, *Zandiu*.

One ounce will plant 50 hills.

Water Melons are cultivated in hills, which should be six to eight feet apart each way, and composed of light, moderately rich soil. The hills should be dug about two feet square, eighteen inches deep, and half filled with well-rotted manure, which must be thoroughly incorporated with the soil. Plant in May, ten seeds to a hill, and when the plants are well up, thin out to three. Cultivate until the vines cover the ground, and pinch the ends of the growing shoots to induce early fruiting.

Mountain Sweet. The most popular variety grown; fruit of oblong shape; flesh red, firm and sweet. Per pkt., 5 cts.; oz., 10 cts.; $\frac{1}{4}$ lb., 20 cts.; lb., 60 cts.

KOLB'S GEM. Largely grown, particularly in the South, for shipment to Northern markets. As a shipping melon it has hardly an equal. The fruit is nearly round; rind dark green, somewhat marbled with lighter shades. Per pkt., 5 cts.; oz., 10 cts.; $\frac{1}{4}$ lb., 20 cts.; lb., 60 cts.

PHINNEY'S EARLY. Very early and sweet; flesh, deep red. Per pkt., 5 cts.; oz., 10 cts.; $\frac{1}{4}$ lb., 20 cts.; lb., 60 cts.

Florida Favorite. Oblong, green and white stripes; flesh light crimson, crisp and deliciously sweet. Very early; one of the finest table melons grown; not a good shipper, owing to its thinness of rind. Per pkt., 5 cts.; oz., 10 cts.; $\frac{1}{4}$ lb., 20 cts.; lb., 60 cts.

PRIDE OF GEORGIA. It is dark green in color, almost oval in shape. It is an excellent shipping variety, of large size. Flesh crisp and sweet. Per pkt., 5 cts.; oz., 10 cts.; $\frac{1}{4}$ lb., 20 cts.; lb., 60 cts.

Black Spanish. A sweet and delicious variety; fruit round, of large size; skin blackish green; scarlet flesh. Per pkt., 5 cts.; oz., 10 cts.; $\frac{1}{4}$ lb., 20 cts.; lb., 60 cts.

The Volga. A Russian variety, of perfect globe shape, small size and weighing 10 to 15 pounds. The flesh is bright crimson, and in crispness and delicacy of flavor is unsurpassed. Per pkt., 5 cts.; oz., 10 cts.; $\frac{1}{4}$ lb., 20 cts.; lb., 60 cts.

Scaly Bark. The rind is very thin, and yet so tough and strong that it will bear any amount of handling before bursting or cracking open. Flesh light crimson and of excellent quality. Per pkt., 5 cts.; oz., 10 cts.; $\frac{1}{4}$ lb., 20 cts.; lb., 60 cts.

NEW SEMINOLE. It is extra early, enormously productive, very large and of splendid flavor. The seed will often produce gray and green melons on one vine, but the number of the former predominates. Per pkt., 5 cts.; oz., 10 cts.; $\frac{1}{4}$ lb., 20 cts.; lb., 60 cts.

GREEN AND GOLD. The flesh is a beautiful golden orange color, and in flavor is said to surpass any of the red-fleshed sorts. The melons are of good size, ranging from 25 to 45 pounds in weight, and ripen very early. Per pkt., 5 cts.; oz., 10 cts.; $\frac{1}{4}$ lb., 20 cts.; lb., 60 cts.

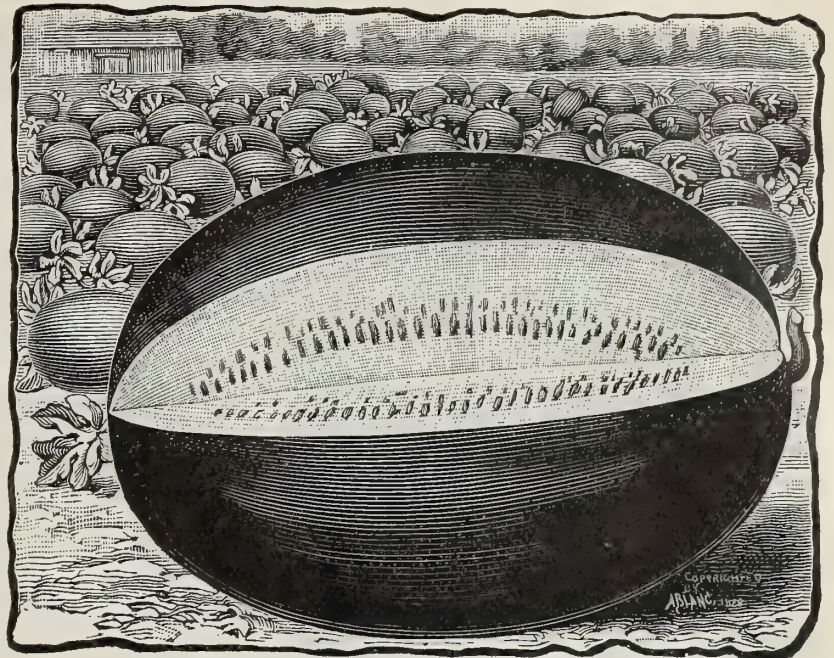

GREEN AND GOLD.

Ice Cream. (*White Seeded*.) Fruit round, of medium size; skin pale green; flesh scarlet, crisp and delicious. Per pkt., 5 cts.; oz., 10 cts.; $\frac{1}{4}$ lb., 20 cts.; lb., 60 cts.

Cubau Queen. Beautifully striped, dark and light green; vigorous in growth; flesh bright red, solid, luscious, crisp and sugary. Per pkt., 5 cts.; oz., 10 cts.; $\frac{1}{4}$ lb., 20 cts.; lb., 60 cts.

MAMMOTH IRONCLAD. Excellent; of large size and weight, averaging nearly 50 pounds each. The flesh is deep red and of a delicious rich flavor. Unsurpassed for shipping. Per pkt., 5 cts.; oz., 10 cts.; $\frac{1}{4}$ lb., 20 cts.; lb., 60 cts.

Gipsy, or Rattlesnake. A large striped variety of oblong shape; flesh scarlet and of superior quality. Per pkt., 5 cts.; oz., 10 cts.; $\frac{1}{4}$ lb., 20 cts.; lb., 60 cts.

Hungarian Honey. This variety ripens early. The flesh is a very brilliant red color, and of a very rich honey flavor; color of skin medium dark green; uniformly of medium size. Per pkt., 5 cts.; oz., 10 cts.; $\frac{1}{4}$ lb., 20 cts.; lb., 60 cts.

Mountain Sprout. A large, long variety; striped skin; flesh red, of superior quality. Per pkt., 5 cts.; oz., 10 cts.; $\frac{1}{4}$ lb., 20 cts.; lb., 60 cts.

California, or Improved Odella. One of the best sorts for shipping purposes. Per pkt., 5 cts.; oz., 10 cts.; $\frac{1}{4}$ lb., 20 cts.; lb., 60 cts.

Citron. For Preserving. Handsome round fruit of small size, highly esteemed as a table preserve. Per pkt., 5 cts.; oz., 10 cts.; $\frac{1}{4}$ lb., 20 cts.; lb., 60 cts.

Ruby Gold. One of the juiciest and finest flavored Water Melons ever raised. Averages 40 to 50 lbs. in weight. Per pkt., 5 cts.; oz., 10 cts.; $\frac{1}{4}$ lb., 20 cts.; lb., 60 cts.

The Dixie. A new melon of excellent quality, extremely sweet, juicy and tender. Very early, hardy and productive. Per pkt., 5 cts.; oz., 10 cts.; $\frac{1}{4}$ lb., 20 cts.; lb., 60 cts.

The "Boss." Oblong in shape; skin dark green; flesh deep scarlet and of rich flavor. Early, heavy, productive, and a good shipper. Per pkt., 5 cts.; oz., 10 cts.; $\frac{1}{4}$ lb., 20 cts.; lb., 60 cts.

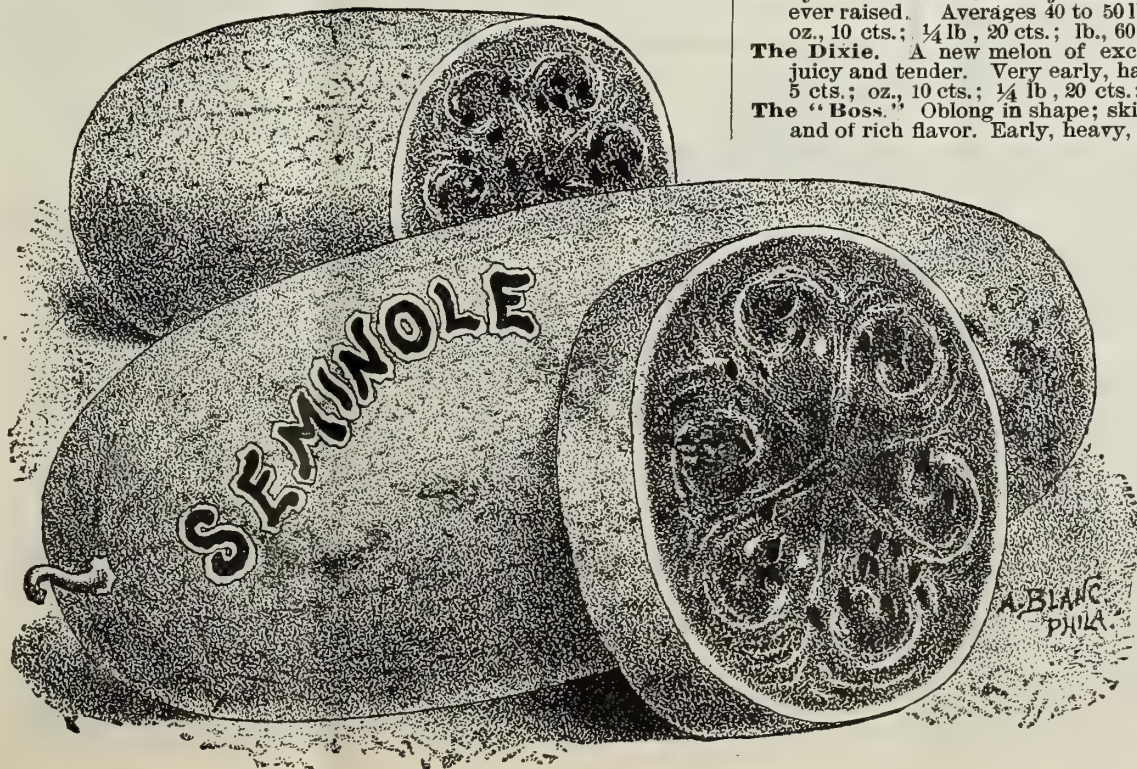

DWARF LIMA BEANS,
 SHOULD BE
 Grown in every Garden.
NO STAKING,
NO TROUBLE.
 Several weeks earlier
 than the Pole
 varieties.

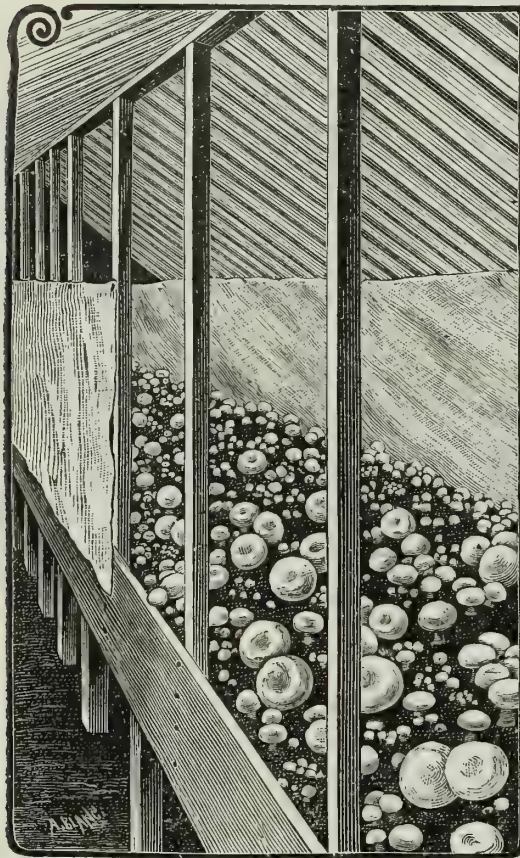

MUSHROOMS IN GREENHOUSE.

MUSHROOM SPAWN.

German, *Champignon*. — French, *Champignon*. — Spanish, *Seta*.
Ten pounds will spawn 10 feet square.

The Mushroom is one of the most profitable crops grown, especially in the vicinity of large cities, where the demand, at all seasons, is far in excess of the supply. Its cultivation may be carried on successfully in a cellar or shed during winter, or in the open air in summer.

CULTURAL DIRECTIONS:—Collect sufficient fresh horse droppings to form the desired size of bed, spreading them out in an airy shed to dry, and turning them frequently. When in a proper state as to dryness, which will soon be learnt by experience, make these into a bed from nine inches to one foot thick, beating them firmly together. If the droppings have been properly prepared, gentle fermentation will soon commence, and when the temperature of the bed is from 75° to 80°, with no danger of its rising higher, put in the spawn. This is done by making shallow holes about nine inches apart, inserting pieces of spawn about the size of a hen's egg and covering with the dung, pressing this closely about the spawn. It is of the greatest importance that the temperature of the bed should not decline below 75°, nor rise above 80° for a month after spawning. Within a fortnight after putting in the spawn, cover the bed about two inches thick with good mellow moist soil, making this firm; and if under this a covering one or two inches thick of cow dung, in about the same state as to moisture as the soil, can be afforded, this will cause the bed to last longer, and also to produce a larger crop than if covered with soil only. The most suitable temperature for beds in bearing is 50° to 55° and as a high temperature causes the mushrooms to come small, this should be avoided. Watering beds in bearing often causes the small mushrooms to damp off; therefore, water only when the bed ceases to be productive, and then use the water about the same temperature as the bed.

ENGLISH SPAWN. (*In Bricks*.) Superior quality. Per lb., 15 cts.; 8 lbs., \$1.00.
French Spawn. More bulky than the English, being packed loosely in boxes. In 2-lb. boxes, 75 cts. each. In bulk, 35 cts. per lb.

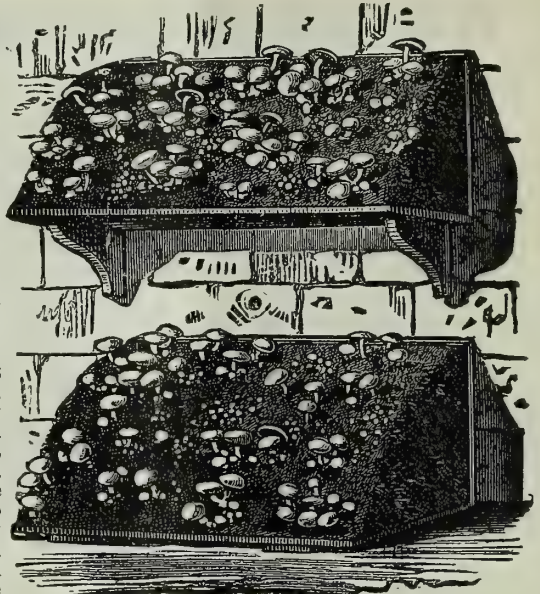

MUSHROOMS ON SHELVES.

MUSTARD.

German, *Senf*. — French, *Moutarde*. — Spanish, *Mostaza*.

One ounce will sow 75 feet of drill.

As an ingredient, the green Mustard imparts a delightfully pungent flavor to the various forms of prepared salads. For early crops the seed may be sown in a hot-bed in March, and for general crop at frequent intervals through the spring, in drills from eight to twelve inches apart.

White London. The best variety for salads; the seed is also used medicinally, and as a seasoning for pickles. Per oz., 5 cts.; ¼ lb., 15 cts.; lb., 40 cts.

Black or Brown. An esteemed sort for culinary use. Per oz., 5 cts.; ¼ lb., 15 cts.; lb., 40 cts.

NEW CHINESE. Leaves twice the size of the ordinary white Mustard; stems more succulent, of deeper green; flavor pleasantly sweet and pungent. Per pkt., 5 cts.; oz., 10 cts.; ¼ lb., 30 cts.; lb., \$1.00.

OKRA, or Gumbo.

German, *Safran*. — French, *Gombo*. — Spanish, *Quimbombo*.

One ounce will plant 100 hills.

This plant is extensively cultivated for its green pods, which are used in soups and stews, and are very wholesome and nutritious. Sow about the middle of May, in drills three feet apart, and thin out the plants to one foot apart.

Improved Dwarf Green. Very early; smooth pods. Per pkt., 5 cts.; oz., 10 cts.; ¼ lb., 20 cts.; lb., 60 cts.

Long Green. Long ribbed pods; very productive. Per pkt., 5 cts.; oz., 10 cts.; ¼ lb., 20 cts.; lb., 60 cts.

WHITE VELVET. This Okra takes its name from the smoothness of its pods, which are round, differing in this respect from the old sort. Per pkt., 5 cts.; oz., 10 cts.; ¼ lb., 25 cts.; lb., 75 cts.



OKRA.

MUSHROOM CULTURE.

BY WILLIAM FALCONER.

How to grow them in "Cellars," "Mushroom Houses," "Green Houses" and "Sheds," "Preparing the Beds," "Watering" and "Cooking," &c.

Cloth, Illustrated, \$1.50 ea.

NASTURTIUM, or Indian Cress.

German, *Nasturtium*. — French, *Capucine*. — Spanish, *Moranuella*.

One ounce will sow 20 feet of drill.

The Nasturtium is both ornamental and useful, the tall variety forming a showy and graceful climber, and the dwarf an exceedingly beautiful and attractive border flower, while the young seeds of either, when pickled, furnish an excellent substitute for capers. Sow the seeds in drills one inch deep; the tall should be grown by the side of a fence or supported by a trellis.

Tall Mixed. Per pkt., 5 cts.; oz., 15 cts.; ¼ lb., 35 cts.; lb., \$1.25.

Dwarf Mixed. Per pkt., 5 cts.; oz., 15 cts.; ¼ lb., 40 cts.; lb., \$1.25.



ONION SEED.

German, *Zwiebel*.—French, *Oignon*.—Spanish, *Cebolla*.

One ounce will sow 100 feet of drill.

For onion culture the ground should be prepared the previous autumn by ploughing or spading deeply, using plenty of well-rotted barn-yard manure. A rather strong, deep, rich, loamy soil is considered most suitable, although we have seen splendid crops raised upon a stiff clay soil, which was well under-drained. Sow the seed as early in spring as practicable, in shallow drills one foot apart, covering with fine soil, which should be pressed down by the use of a light roller or the back of a spade. When the young plants are strong enough thin out to four inches apart. Keep the surface of the ground open and free from weeds by hoeing frequently.

Extra Early Flat Red. A trifle smaller, but fully ten days earlier than the large Red Wethersfield; of mild flavor, and a good keeper. Per pkt., 5cts.; oz., 15cts.; ¼ lb., 40cts.; lb., \$1.40.
LARGE RED WETHERSFIELD. A well known sort, grows to a large size, very productive, and an excellent keeper. Per pkt., 5 cts.; oz., 20 cts.; ¼ lb., 60 cts.; lb., \$2.00.



RED WETHERSFIELD ONION.

Southport Red Globe. A large, handsome variety of globular form, very productive and of fine quality. Per pkt., 5 cts.; oz., 20 cts.; ¼ lb., 60 cts.; lb., \$2.00.

WHITE PORTUGAL, OR SILVER SKIN. A mild flavored variety grown extensively for pickling. Per pkt., 5 cts.; oz., 30 cts.; ¼ lb., \$1.00; lb., \$3.00.

PRIZE TAKER. This is the large beautiful Onion that is seen every fall offered for sale at the fruit stores in New York and other large cities. They are a rich straw color and of enormous size, averaging 12 to 14 inches in circumference. Although of such great size, it is very hard and an excellent keeper. Per pkt., 5 cts.; oz., 25 cts.; ¼ lb., 75 cts.; lb., \$2.50.

Southport White Globe. Handsome Globular Onion, of mild flavor; good keeper. One of the best. Per pkt., 5 cts.; oz., 30 cts.; ¼ lb., \$1.00; lb., \$3.00.

Yellow Globe Danvers. Early, round, very small neck, fine-grained, mild flavor, immensely productive and an excellent keeper. Per pkt., 5 cts.; oz., 15 cts.; ¼ lb., 50 cts.; lb., \$1.50.

Yellow Dutch. A very old variety, somewhat flatter in form than "Danvers Yellow," of mild flavor, and keeps well. Per pkt., 5 cts.; oz., 15 cts.; ¼ lb., 50 cts.; lb., \$1.50.

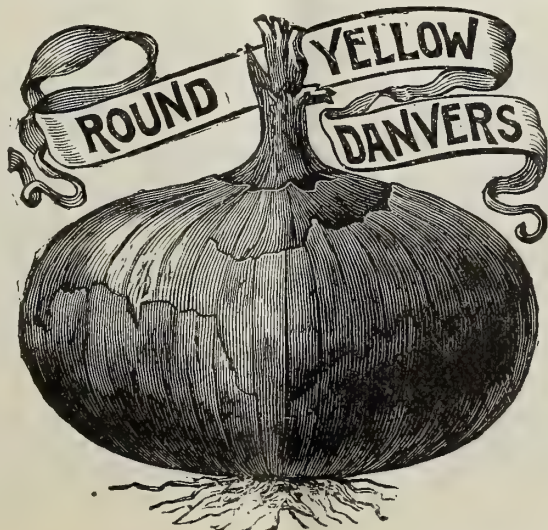

BERMUDA ONION SEED.

PALE RED. Per pkt., 5 cts.; oz., 20 cts.; ¼ lb., 70 cts.; lb., \$2.25.
WHITE. Per pkt., 5 cts.; oz., 20 cts.; ¼ lb., 70 cts.; lb., \$2.25.

ITALIAN ONION SEED.

The following are Italian Varieties, and specially suited for cultivation in the Southern States:

ADRIATIC BARLETTA. A very early, small, pure white variety, having a very delicate silver skin, flesh firm and mild in flavor. Its great merit over all others is its extreme earliness. For pickling purposes it is unequaled. Per pkt., 5 cts.; oz., 25 cts.; ¼ lb., 75 cts.; lb., \$2.50.

The Queen. A handsome silver-skinned variety; esteemed for its rapid growth, mild flavor and fine keeping qualities. Per pkt., 5 cts.; oz., 20 cts.; ¼ lb., 60 cts.; lb., \$2.00.

Large White Italian Tripoli. An excellent variety, of quick growth and mild flavor. Per pkt., 5 cts.; oz., 20 cts.; ¼ lb., 50 cts.; lb., \$1.75.

Large Red Italian Tripoli. When well grown, this is a beautiful onion, of immense size and delicate flavor. Per pkt., 5 cts.; oz., 20 cts.; ¼ lb., 50 cts.; lb., \$1.75.

Giant Rocca. A splendid variety, of exceedingly mild flavor, large globular shape and light brown skin. Per pkt., 5 cts.; oz., 20 cts.; ¼ lb., 60 cts.; lb., \$2.00.

MAMMOTH SILVER KING OR GIANT WHITE GARGANUS. Single onions of this variety, grown from seed the first season, have weighed as much as 3 lbs. It matures early, is a white skinned and a white-fleshed variety, flat shape and of a mild and delicate flavor. Per pkt., 5 cts.; oz., 20 cts.; ¼ lb., 70 cts.; lb., \$2.25.

MAMMOTH POMPEII OR GIANT RED GARGANUS. This fine Italian variety has produced Onions weighing 4 to 5 lbs. each. The skin is a delicate red, flesh close grained, nearly white, and of a very mild flavor. Per pkt., 5 cts.; oz., 20 cts.; ¼ lb., 60 cts.; lb., \$2.25.

ONION SETS.

Onion sets require the same kind of soil as recommended for "Onion." They should be planted early in spring in rows 12 inches apart, placing the sets four inches apart in the row. When raised from sets, the onions can be used in the green state in June, or they will be matured by July.

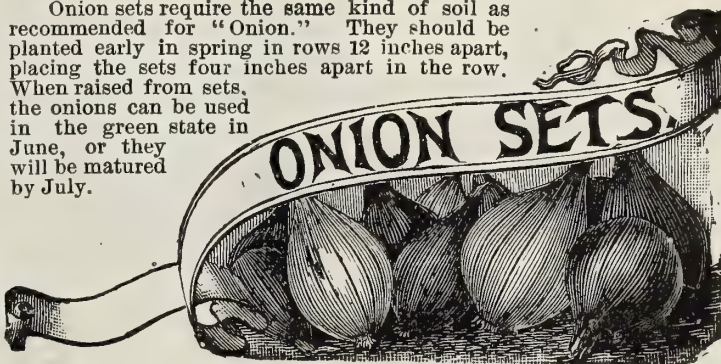

White Onion Sets; Yellow Onion Sets; Red Onion Sets; Potato Onions, or Multipliers; Top, or Button Onions; Shallots. Per qt., 30 cts.
White Multiplier. " 30 cts.

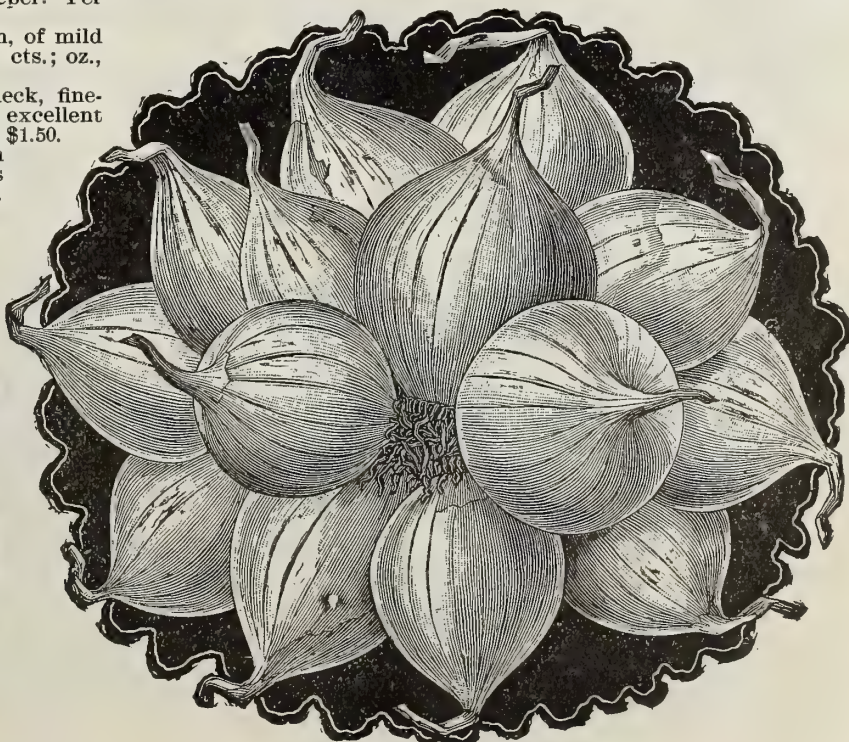

WHITE MULTIPLIER ONION.

PARSNIP.

German, *Pastinake*.—French, *Panais*.—Spanish, *Chirivía*.

One ounce will sow 200 feet of drill.

Sow Parsnip seed as early in spring as the weather will permit, in drills fifteen to eighteen inches apart, covering with fine soil to the depth of half an inch. The soil should be rich and deep, manured, if possible, the previous autumn. Thin out the young plants to about six inches apart and keep the surface of the ground open, and free from weeds. It is perfectly hardy, and may remain in the ground through the winter; indeed, the fine sugary flavor is only perfected by a severe frost.

AMERICAN HOLLOW CROWN. The roots are long, smooth and milky-white, without doubt the finest stock of Parsnip in this country. Per pkt., 5 cts.; oz., 10 cts.; $\frac{1}{4}$ lb., 25 cts.; lb., 60 cts.

The Student. A fine-flavored variety, recommended for small gardens. Per pkt., 5 cts.; oz., 10 cts.; $\frac{1}{4}$ lb., 20 cts.; lb., 50 cts.

Early Round. Adapted to shallow soils; very early and of good flavor. Per pkt., 5 cts.; oz., 10 cts.; $\frac{1}{4}$ lb., 20 cts.; lb., 60 cts.

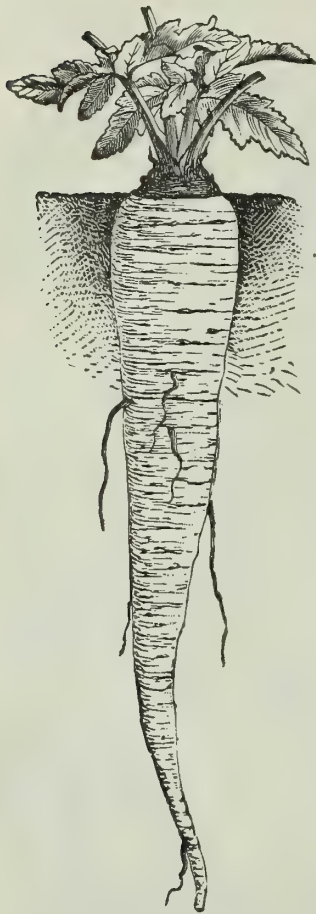

AMERICAN HOLLOW CROWN
PARSNIP.



EXTRA DOUBLE CURLED PARSLEY.

PARSLEY.

German, *Petersilie*.—French, *Persil*.—Spanish, *Perijil*.

One ounce will sow 150 feet of drill.

To grow Parsley to perfection, it requires a rich, mellow and rather deep soil. Sow early in spring, in drills one foot apart and half an inch deep, previously soaking the seeds a few hours in tepid water, to facilitate germination. Thin out the young plants to four inches. Hamburg Parsley is cultivated for its roots, and treated in the same manner as Carrots.

EXTRA DOUBLE CURLED. A beautifully curled, dwarf variety, highly esteemed for garnishing. Per pkt., 5 cts.; oz., 10 cts.; $\frac{1}{4}$ lb., 25 cts.; lb., 75 cts.

Extra Moss Curled. A handsome and distinct variety; beautifully crimped and curled. Per pkt., 5 cts.; oz., 10 cts.; $\frac{1}{4}$ lb., 30 cts.; lb., \$1.00.

Fern-leaved. The most superb garnishing variety ever introduced. Per pkt., 5 cts.; oz., 10 cts.; $\frac{1}{4}$ lb., 25 cts.; lb., 80 cts.

Plain. A plain-leaved variety, fine for flavoring. Per pkt., 5 cts.; oz., 10 cts.; $\frac{1}{4}$ lb., 25 cts.; lb., 75 cts.

Hamburg or Rooted. Extensively grown for its roots, which are used in flavoring soups. Per pkt., 5 cts.; oz., 10 cts.; $\frac{1}{4}$ lb., 30 cts.; lb., \$1.00.

PEPPER.

German, *Pfeffer*.—French, *Piment*.—Spanish, *Pimiento*.

One ounce will produce 2,000 plants.

Sow early in April in a hot-bed, in shallow drills, six inches apart, and transplant to the open ground as soon as the weather is warm and settled. Set the plants in mellow soil, in rows sixteen inches apart, and the same distance apart in the rows. The seed may also be sown in the open ground, but not until all danger of frost is past.

CARDINAL. A distinct variety, growing from five to six inches in length, being about an inch broad at the top and tapering to a point, of a glossy bright red color. Very sweet and thick fleshed. Per pkt., 5 cts.; oz., 30 cts.; $\frac{1}{4}$ lb., \$1.00.



SWEET MOUNTAIN PEPPER.

Sweet Spanish. One of the largest and earliest; flesh sweet, mild and pleasant. Per pkt., 5 cts.; oz., 25 cts.; $\frac{1}{4}$ lb., 75 cts.; lb., \$2.50.

Japan Cluster. A desirable Pepper, bearing its fruit in bunches. For ribboning it will be found very useful, as its brilliant scarlet fruit makes a charming contrast with its deep green leaves. Per pkt., 5 cts.; oz., 30 cts.; $\frac{1}{4}$ lb., \$1.00; lb., \$3.00.

LARGE BELL OR BULL NOSE. A large, early variety, of pleasant flavor. Per pkt., 5 cts.; oz., 25 cts.; $\frac{1}{4}$ lb., 75 cts.; lb., \$2.50.

Celestial. This variety forms a pretty decorative plant. The pods which are conical, are borne upright, changing from creamy-white to brilliant scarlet. Per pkt., 5 cts.; oz., 25 cts.; $\frac{1}{4}$ lb., 75 cts.; lb., \$2.50.

Sweet Mountain, or Mammoth. Similar to the "Bull Nose," but larger, sweeter, and of milder flavor; extensively used for mangoes. Per pkt., 5 cts.; oz., 25 cts.; $\frac{1}{4}$ lb., 75 cts.; lb., \$2.50.

RUBY KING. The fruit, when ripe, is bright ruby-red. The flavor is so mild and pleasant that it can be sliced and eaten with pepper and vinegar, like cucumbers or tomatoes. Per pkt., 5 cts.; oz., 30 cts.; $\frac{1}{4}$ lb., \$1.00; lb., \$3.00.

Golden Dawn. In color this is a bright golden yellow, and in productiveness is said to surpass any other variety. Per pkt., 5 cts.; oz., 25 cts.; $\frac{1}{4}$ lb., 75 cts.; lb., \$2.50.

Cayenne (True). Small pods, very piquant; fine for making pepper sauce. Per pkt., 5 cts.; oz., 40 cts.

Long Red Cayenne. Fruit three to four inches long, conical in form, of a bright red color and very productive. Per pkt., 5 cts.; oz., 25 cts.; $\frac{1}{4}$ lb., 75 cts.; lb., \$2.50.

Cherry Red. Small round fruit, of a rich glossy scarlet color, and extremely piquant. Per pkt., 5 cts.; oz., 25 cts.; $\frac{1}{4}$ lb., 75 cts.; lb., \$2.50.

Chili (True). Very piquant and prolific; small, slim fruits, generally used for making pepper sauce. Per pkt., 5 cts.; oz., 25 cts.; $\frac{1}{4}$ lb., 75 cts.; lb., \$2.50.

PEAS.

German, *Erbisen*.—French, *Pois*.
—Spanish, *Guisantes*.

One quart will plant 125 feet of drill.

For first early crop sow in March or April, according as the ground can be worked, and at intervals of two weeks for succession.

Sow in single or double rows two inches deep and from three to four feet apart, according to the height of the variety and strength of the soil, supporting the taller varieties with brush.

After the end of May sowing should be discontinued until beginning of August, when a profitable crop may be secured by planting the extra early varieties.

EXTRA EARLY PEAS, MEDIUM HEIGHT.

NEW YORK MARKET

PEA. This is the finest round white Extra Early Pea that has yet been introduced. For size of pod, regularity of growth, it has no equal and the quality is of the finest. The pods are of a dark green color and are produced in immense quantities. For earliness it is a week ahead of all that class of peas, and as the pods fill very evenly, the whole crop can be cleared off at two pickings. For market garden trade it is undoubtedly the best; 2½ ft. Per pt., 15 cts.; qt., 25 cts.; peck, \$1.25

Improved Daniel O'Rourke. One of the most popular market varieties; 2½ ft. Per pt., 15 cts.; qt., 25 cts.; peck, \$1.15.

Philadelphia Extra Early. A favorite variety; extensively grown in the South; 2½ ft. Per pt., 15 cts.; qt., 25 cts.; peck, \$1.15.

First and Best. One of the earliest fine market sort; 3 ft. Per pt., 15 cts.; qt., 25 cts.; peck, \$1.15.

Laxton's Alpha. A very early wrinkled marrow, very productive; large, well-filled pods of superior quality; 3 ft. Per pt., 15 cts.; qt., 30 cts.; peck, \$2.00.

Alaska. The earliest blue pea, very uniform in growth. The dark green color of the pods makes it extremely desirable; 2 ft. Per pt., 15 cts.; qt., 25 cts.; peck, \$1.15.

DWARF EXTRA EARLY PEAS.

CHELSEA. The Chelsea grows one foot in height, and is of compact habit; it is as early as American Wonder and gives a much larger crop, bearing in pairs from the bottom to the top an abundance of handsome pods, which are half as long again as those of any other first early dwarf kind; 1 ft. Per pt., 20 cts.; qt., 35 cts.

American Wonder. One of the best and most desirable varieties grown, being a cross between Champion and Little Gem is sufficient guarantee of its superior qualities; 1 ft. Per pt., 15 cts.; qt., 30 cts.; peck, \$2.00.

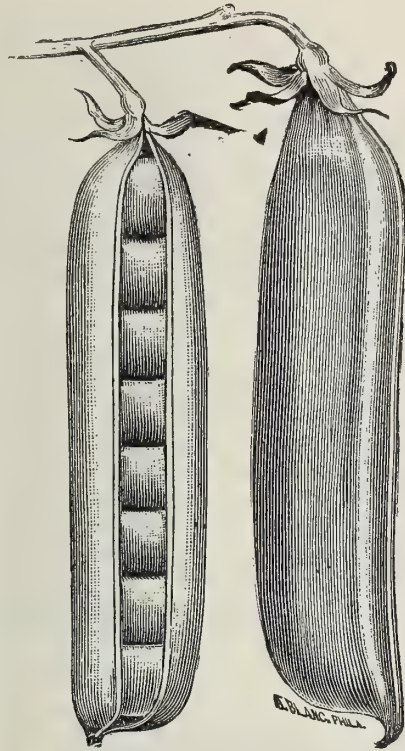

NEW YORK MARKET PEA.



EXTRA EARLY PREMIUM GEM PEAS.

DWARF EXTRA EARLY PEAS—Continued.

McLean's Little Gem. One of the best dwarf wrinkled marrows grown; very productive and of fine flavor; 1½ ft. Per pt., 15 cts.; qt., 30 cts.; peck, \$1.60.

Extra Early Premium Gem. Of the Little Gem order, but a decided improvement in quality and productiveness; 1¼ ft. Per pt., 15 cts.; qt., 30 cts.; peck, \$1.75.

Blue Peter. A first early blue-seeded Tom Thumb; pods large and well filled; 1 ft. Per pt., 15 cts.; qt., 30 cts.; peck, \$1.75.

Tom Thumb. Very dwarf and early, of fine quality and very prolific; 1 ft. Per pt., 15 cts., qt., 30 cts.; peck, \$1.75.

SECOND EARLY PEAS.

McLean's Advancer. An early green wrinkled variety; long pods well filled; quality excellent; 2½ ft. Per pt., 15 cts.; qt., 25 cts.; peck, \$1.25.

Laxton's Prolific Long Pod. One of the best and most productive; pods large; 3 ft. Per pt., 15 cts.; qt., 25 cts.; peck, \$1.25.

HORSFORD'S MARKET GARDEN. A wrinkled variety, coming in between Little Gem and Advancer. It is a prolific bearer, and has yielded more per acre than any other American variety. The pods are of medium size, well filled with peas of a delicious flavor; 2 ft. Per pt., 15 cts.; qt., 25 cts.; peck, \$1.50.

Bliss's Abundance. Pods 3 to 3½ inches long, roundish and well filled, containing six to eight large wrinkled peas of excellent quality; 2 ft. Per pt., 15 cts.; qt., 25 cts.; peck, \$1.50.

Fillbasket. A large podded blue pea, of dwarf habit, very productive and fine quality; 3 ft. Per pt., 15 cts.; qt., 25 cts.; peck, \$1.75.

THE HEROINE. This is a medium early, and grows uniformly two to two and a half feet high. It comes in between Advancer and Champion of England, and bears a profusion of large, long, slightly curled pointed pods, containing from nine to ten large peas of finest quality. Per pkt., 10 cts.; pt., 20 cts.; qt., 35 cts.

THE DON. This is a deep green wrinkled sort, producing an abundant crop of large, square-ended, well-filled pods. These are literally crowded with fine, large peas of delicious flavor. It grows about four feet high and comes into bearing between the second early and main crop. Per pt., 20 cts.; qt., 35 cts.

SMALL EARLY FRENCH. (Petit Pois.) A medium early variety, with long slender pods, containing from eight to ten small peas of delicious quality. It is a robust grower, of branching habit, attaining a height of from three to four feet. Extensively used in France for canning. Per pt., 15 cts.; qt., 25 cts.; peck, \$1.25.



AMERICAN WONDER PEA.

PEAS—Continued.

LATE OR MAIN CROP PEAS.

- Bliss's Ever-bearing.** A continuous bearing variety, which gives it especial value for late summer and autumn use. Pods, three to four inches long, producing six to eight large wrinkled peas, quality unsurpassed; 2 ft. Per pt., 15 cts.; qt., 25 cts.; peck, \$1.50.
- Champion of England.** The most popular variety grown, fine flavored and an abundant cropper; 4 ft. Per pt., 10 cts.; qt., 20 cts.; peck, \$1.25.
- Yorkshire Hero.** A large-podded, delicious marrow pea, of branching habit and a prolific bearer; 2½ ft. Per pt., 15 cts.; qt., 25 cts.; peck, \$1.25.
- STRATAGEM.** A dwarf wrinkled blue marrow, heavy cropper, with large, remarkably well-filled pods; 2 ft. Per pt., 20 cts.; qt., 30 cts.; peck, \$2.00.
- Telephone.** An extraordinary cropper, bearing immense semi-double pods, full of large peas of exquisite flavor; 4 ft. Per pt., 15 cts.; qt., 30 cts.; peck, \$2.00.
- Veitch's Perfection.** A delicious marrow pea, producing large, well-filled pods; very productive; 3 ft. Per pt., 15 cts.; qt., 25 cts.; peck, \$1.50.
- PRIDE OF THE MARKET.** This grand pea grows from eighteen inches to two feet high, and bears grand pods, well-filled with large and finely flavored peas, from top to bottom of the haulm. Per pt., 20 cts.; qt., 30 cts.; peck, \$1.75.
- Blue Imperial.** A productive variety of good flavor; 3 feet. Per pt., 15 cts.; qt., 25 cts.; peck, \$1.25.
- British Queen.** A very tall, vigorous and productive variety; one of the sweetest wrinkled peas grown; 5 ft. Per pt., 15 cts.; qt., 25 cts.; peck, \$1.25.
- DWARF CHAMPION OF ENGLAND.** Medium late and best adapted for second crop. The vines are vigorous, growing two and a half feet high, bearing abundantly large pods filled with rich, marrow peas, superior in quality and much larger than the well-known Champion of England. Per pt., 15 cts.; qt., 25 cts.; peck, \$2.00.
- AMERICAN CHAMPION.** We consider this one of the very best late peas sent out in years. It is one of the largest of all peas, enormously productive, and its flavor and quality closely approach that of the well-known Champion of England. Each pod contains from nine to twelve large, fine peas; 4½ ft. Per pt., 20 cts.; qt., 35 cts.; peck, \$2.25.
- Black-eyed Marrowfat.** A popular variety, highly esteemed both for garden and field culture; 4 ft. Per pt., 10 cts.; qt., 20 cts.; peck, \$1.00.
- Large White Marrowfat.** A tall late variety with large broad pods, freely produced; quality excellent; 5 ft. Per pt., 10 cts.; qt., 20 cts.; peck, \$1.00.

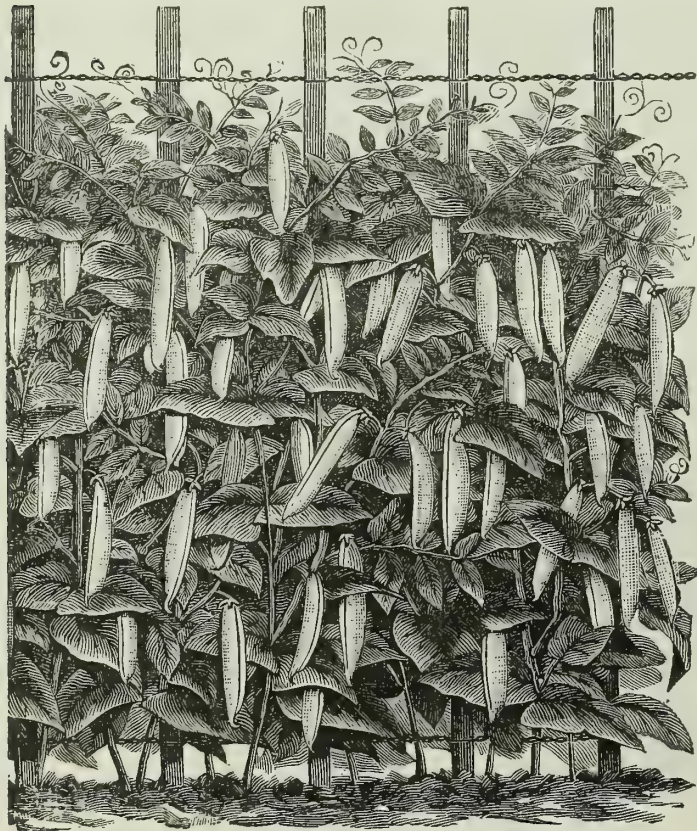

AMERICAN CHAMPION PEA.



DWARF CHAMPION PEA.

EDIBLE PODDED OR SUGAR PEAS.

The varieties of this class are cultivated for their pods, which are remarkably tender and succulent; in flavor equal to the best string beans. They are gathered young and boiled whole.

NEW DWARF WRINKLED SUGAR. This new dwarf wrinkled variety is far superior to the old round seeded sorts. Pods are large, remarkably tender and of delicious flavor; without doubt the finest Sugar Pea yet introduced; 2 ft. Per pkt., 10 cts.; pt., 20 cts.; qt., 35 cts.

Dwarf Sugar (Round seeded). A prolific variety of fine quality; 2½ ft. Per pt., 20 cts.; qt., 35 cts.; peck, \$2.25.

Tall Sugar (Round seeded). Similar to the preceding, but taller; 4 ft. Per pt., 20 cts.; qt., 35 cts.; peck, \$2.25.

PUMPKIN.

German, *Kurbis*.—French, *Potiron*.—Spanish, *Calabaza*.

One ounce will plant 50 hills.

The common practice is to drop two or three seeds in every second or third hill in the cornfield, but if cultivated on a large scale the seed may be sown in hills, eight feet apart each way, four plants to each hill, and otherwise treated in the same manner as Melons or Cucumbers.

LARGE CHEESE. The best for cooking purposes. Per pkt., 5 cts.; oz., 10 cts.; ¼ lb., 20 cts.; lb., 60 cts.

Sugar. Smaller than the Large Cheese, one of the best for the table or feeding to stock. Per pkt., 5 cts.; oz., 10 cts.; ¼ lb., 20 cts.; lb., 50 cts.

Nantucket. One of the sweetest Pumpkins in the market. Per pkt., 5 cts.; oz., 10 cts.; ¼ lb., 20 cts.; lb., 50 cts.

Jumbo. The largest variety grown, often attaining a weight of 200 pounds. Per pkt., 10 cts.; oz., 25 cts.; ¼ lb., 50 cts.; lb., \$1.50.



CHEESE PUMPKIN.

Cashaw. Resembling the Winter Crookneck Squash; color white, striped and mottled with green. Per pkt., 5 cts.; oz., 10 cts.; ¼ lb., 25 cts.; lb., 60 cts.

LARGE TOURS, OR MAMMOTH. Grows to an immense size, often weighing over 100 pounds. Per pkt., 5 cts.; oz., 10 cts.; ¼ lb., 25 cts.; lb., 60 cts.

Connecticut Field. Very productive. Per oz., 5 cts.; ¼ lb., 15 cts.; lb., 40 cts.

POTATOES.

German, *Kartoffel*.—French, *Pomme de Terre*.—Spanish, *Patata*.

Ten bushels cut tubers will plant one acre.

The Potato, like all robust-growing vegetables, can be grown with varying success on soils of all kinds, and in all conditions of fertility, but the soil best suited to it is a sandy loam. In breaking up good pasture land, the decaying sod answers sufficiently well for the first year in lieu of manure. Manure is applied either in rows or hills, or broadcast over the hills and ploughed in—the latter in most cases being preferable. In highly enriched soils the plants are more liable to disease than when grown in soil that is naturally good. Plant as early in spring as the ground can be had in fair working order, in hills or ridges, about three feet apart; covering in light soil, about four inches deep.

EARLY VARIETIES.

- Early Puritan.** An early white skinned variety; very productive. Per peck, 75 cts.; bu., \$2.00; bbl., \$5.00.
- Vanguard.** The earliest variety; same color as the Early Rose; flesh white and mealy. Per peck, 75 cts.; bu., \$2.00; bbl., \$4.00.
- Early Ohio.** A seedling of the Early Rose; tubers round; very early. Per peck, 75 cts.; bu., \$2.00; bbl., \$4.00.
- Thorburn.** A desirable early variety; very productive, and of excellent quality. Resembles the Beauty of Hebron. Per peck, 75 cts.; bu., \$2.00; bbl., \$4.00.
- PEARL OF SAVOY.** It is very early, and, considering its extreme earliness, wonderfully productive. The tubers are oblong and of large size, the flesh pearly white and mealy. Per peck, 75 cts.; bu., \$2.00; bbl., \$4.00.

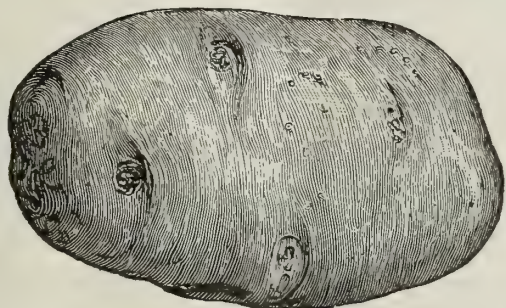

EARLY ROSE POTATO.

- EARLY ROSE.** A standard variety, early, productive and of excellent quality. Per peck, 75 cts.; bu., \$2.00; bbl., \$4.00.
- Extra Early Vermont.** An improved variety of the Early Rose; fine for market or family use. Per peck, 75 cts.; bu., \$2.00; bbl., \$4.00.
- Beauty of Hebron.** Of the Early Rose type, but decidedly more productive. Per peck, 75 cts.; bu., \$2.00; bbl., \$4.00.
- CLARKE'S No. 1.** Earlier than the Early Rose and very productive. Flavor excellent. Per peck, 75 cts.; bu., \$2.00; bbl., \$4.00.
- Early Mayflower.** Ripens at the same time as the Early Rose. Flesh white and solid. Per peck, 75 cts.; bu., \$2.00; bbl., \$4.00.

MAIN CROP VARIETIES.

- Pride of the West.** A flattish, round red-skinned variety; tubers large, of fine quality; medium late, coming in about the same time as Peerless and Jumbo. Per peck, 75 cts.; bu., \$2.00; bbl., \$5.00.

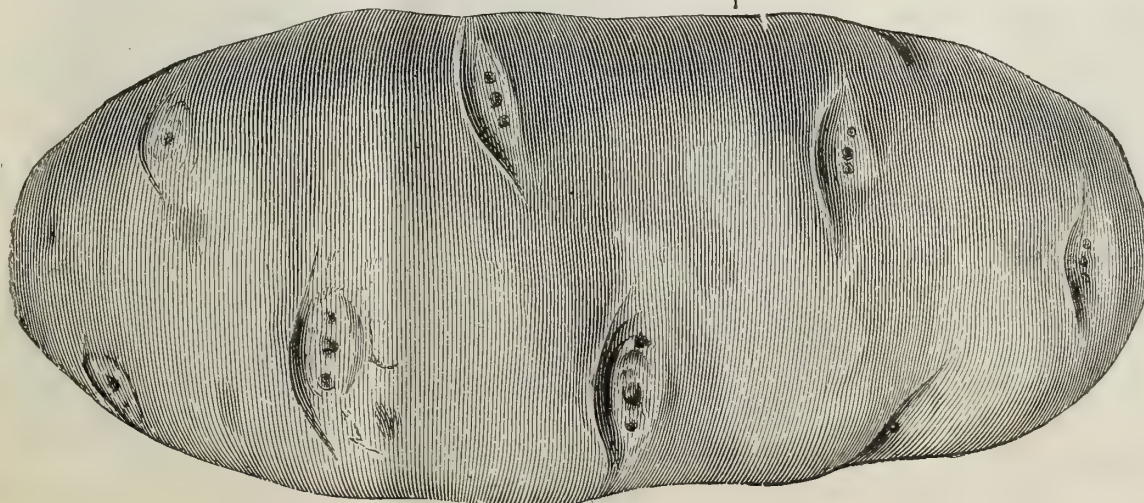

PEARL OF SAVOY POTATO.



CLARKE'S NO. 1 POTATO.

MAIN CROP POTATOES—Continued.

- Bill Nye.** A valuable white kidney variety, a cross between Beauty of Hebron and the Belle. A vigorous grower of first-class quality, and an enormous cropper. Per peck, 75 cts.; bu., \$2.00; bbl., \$4.50.
- EMPIRE STATE.** A main crop variety, very productive; the skin is white and smooth; flesh pure white; of fine flavor. Per peck, 75 cts.; bu., \$2.00; bbl., \$4.00.
- St. Patrick.** Handsome, smooth and regular; oblong in shape. It is a large yielder and of the first quality. Per peck, 75 cts.; bu., \$2.00; bbl., \$4.00.
- Jumbo.** A very heavy yielder. One of the best keepers. Per peck, 75 cts.; bu., \$2.00; bbl., \$4.00.
- White Elephant.** Late, large, good quality and very productive. Per peck, 75 cts.; bu., \$2.00; bbl., \$4.00.
- WHITE STAR.** Medium early and large cropper; a good keeper. Per peck, 75 cts.; bu., \$2.00; bbl., \$4.00.
- Late Rose.** One of the best varieties for main crop. Per peck, 75 cts.; bu., \$2.00; bbl., \$4.00.
- Burbank's Seedling.** A white-skinned medium early variety. Flesh of fine grain and of excellent flavor. Per peck, 75 cts.; bu., \$2.00; bbl., \$4.00.
- Queen of the Valley.** A medium early variety, and one of the most productive. Per peck, 75 cts.; bu., \$2.00; bbl., \$4.00.
- Rural Blush.** An excellent variety, having a blush skin, while the flesh is tinged with pink. It is of first-rate quality and cooks through dry and evenly. Per peck, 75 cts.; bu., \$2.00; bbl., \$4.00.
- Chas. Downing.** Pure white. One of the earliest sorts, of splendid quality. Per peck, 75 cts.; bu., \$2.00; bbl., \$4.00.

RHUBARB.

German, *Rhabarber*.—French, *Rhubarbe*.—Spanish, *Ruibarbo*.

One ounce will produce 1,000 plants.

Sow in April in drills eighteen inches apart, and cover the seed with fine soil, pressing it down firmly. When the plants are strong enough, thin out to six inches. In the fall or following spring, transplant the roots into deep, rich soil, three feet apart each way.

- St. Martin's.** Immensely productive; one of the earliest. Per pkt., 10 cts.; oz., 50 cts.; ¼ lb., \$2.00.
- Linnæus.** Early, large and tender. Per pkt., 5 cts.; oz., 20 cts.; ¼ lb., 50 cts.; lb., \$2.00.
- Victoria.** Very large; later than the Linnæus. Per pkt., 5 cts.; oz., 20 cts.; ¼ lb., 50 cts.; lb., \$2.00.

RHUBARB ROOTS.

(See Vegetable Plants, page 33.)

OUR POTATOES

ARE

NORTHERN

GROWN

SPECIALLY

FOR SEED.

A change of seed will improve the quality and increase the yield.

RADISH.

German, *Rettig*.—French, *Radis*.—Spanish, *Rabanos*.

One ounce will sow 100 feet of drill.

A light, rich soil, not recently manured is best suited for Radishes. For early use sow in a gentle hot bed in February, and in the open air as soon as the ground can be worked, continuing at intervals until September. Water freely during dry, hot weather, as rapidity of growth is necessary to insure tenderness and mild flavor. Sow in August and September for winter use.

EARLIEST CARMINE FORCING RADISH. The earliest variety in cultivation, deep scarlet, turnip shaped, very small top, flesh crisp and white. The most valuable for forcing or general sowing. Per pkt., 5 cts.; oz., 10 cts.; $\frac{1}{4}$ lb., 30 cts.; lb., \$1.00.

EARLY SCARLET GLOBE. A variety of distinct shape and brilliant color, short leaved. An excellent variety for forcing. Per pkt., 5 cts.; oz., 10 cts.; $\frac{1}{4}$ lb., 30 cts.; lb., \$1.00.

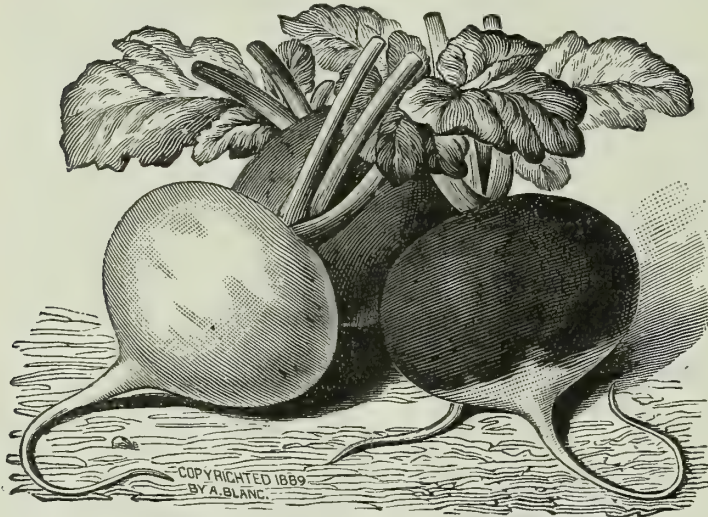

WHITE TURNIP. SCARLET TURNIP. WHITE TIPPED SCARLET TURNIP.

EARLY SCARLET TURNIP, WHITE TIPPED FORCING. New forcing sort, maturing in about twenty days. Per pkt., 5 cts.; oz., 10 cts.; $\frac{1}{4}$ lb., 30 cts.; lb., \$1.00.



Giant White Stuttgart. Very large pure white sort, firm, crisp, juicy, does not get pithy, a quick grower, and can be used at any stage of growth. Per pkt., 5 cts.; oz., 10 cts.; $\frac{1}{4}$ lb., 25 cts.; lb., 75 cts.

Celestial. A distinct variety from China. The flesh is firm, solid and pure white, skin creamy white and very attractive in appearance. Per pkt., 5 cts.; oz., 10 cts.; $\frac{1}{4}$ lb., 30 cts.; lb., \$1.00.

Long Scarlet Short Top. Very long and crisp, valuable for forcing or open ground. Per pkt., 5 cts.; oz., 10 cts.; $\frac{1}{4}$ lb., 25 cts.; lb., 65 cts.

CHARTIER. Distinct from any other radish in cultivation, the color at the top being crimson, running into pink about the middle, and from thence downward it is a pure waxy white. Per pkt., 5 cts.; oz., 10 cts.; $\frac{1}{4}$ lb., 25 cts.; lb., 75 cts.

WINTER RADISHES.

THE SANDWICH. So called because it is largely used by the French and Germans for slicing for sandwiches. This variety is of a pure snow-white color, similar to the White Strasburg in shape, but rather more stump rooted. Per pkt., 5 cts.; oz., 10 cts.; $\frac{1}{4}$ lb., 30 cts.; lb., \$1.00.

Rose China Winter. Bright rose color, flesh firm and piquant, fine for winter use. Per pkt., 5 cts.; oz., 10 cts.; $\frac{1}{4}$ lb., 25 cts.; lb., 75 cts.

Long Black Spanish. One of the hardiest and best for winter use. Per pkt., 5 cts.; oz., 10 cts.; $\frac{1}{4}$ lb., 25 cts.; lb., 75c.

Round Black Spanish. Per pkt., 5 cts.; oz., 10 cts.; $\frac{1}{4}$ lb., 25 cts.; lb., 75 cts.

California Mammoth White Winter. A white-fleshed radish of excellent quality. Per pkt., 5 cts.; oz., 10 cts.; $\frac{1}{4}$ lb., 30 cts.; lb., \$1.00.

IMPROVED LONG BLACK SPANISH. A fine market-gardeners' strain. Flesh white and crisp; fit to use early in the fall. Per pkt., 5 cts.; oz., 10 cts.; $\frac{1}{4}$ lb., 30 cts.; lb., \$1.00.

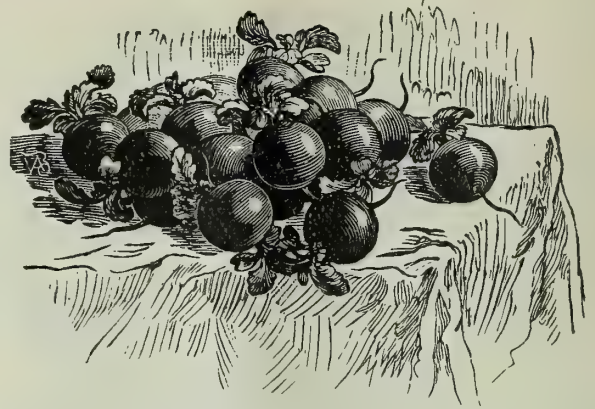

EARLIEST CARMINE FORCING RADISH.

RADISHES—Continued.

Early Scarlet Turnip. A well-known and highly esteemed variety, extensively grown for market. Per pkt., 5 cts.; oz., 10 cts.; $\frac{1}{4}$ lb., 25 cts.; lb., 65 cts.

White Tipped Scarlet Turnip. Size medium; early and of delicate flavor; one of the best. Per pkt., 5 cts.; oz., 10 cts.; $\frac{1}{4}$ lb., 25 cts.; lb., 75 cts.

Early Round Dark Red. Same shape as the Scarlet Turnip, darker in color and makes smaller tops. This variety is grown largely for early market. Per pkt., 5 cts.; oz., 10 cts.; $\frac{1}{4}$ lb., 25 cts.; lb., 75 cts.

Early White Turnip. A quick growing variety, pure white, fine for early use. Per pkt., 5 cts.; oz., 10 cts.; $\frac{1}{4}$ lb., 25 cts.; lb., 75 cts.

Olive-Shaped Scarlet. A very handsome, quick growing variety, of excellent quality. Per pkt., 5 cts.; oz., 10 cts.; $\frac{1}{4}$ lb., 25 cts.; lb., 75 cts.

French Breakfast. Scarlet, with white tip, shape nearly oval, good for forcing or summer sowing. Per pkt., 5 cts.; oz., 10 cts.; $\frac{1}{4}$ lb., 25 cts.; lb., 75 cts.

Early Purple Turnip. Similar to the preceding, except in color. Per pkt., 5 cts.; oz., 10 cts.; $\frac{1}{4}$ lb., 25 cts.; lb., 75 cts.

White Summer Turnip. Excellent for summer use. Per pkt., 5 cts.; oz., 10 cts.; $\frac{1}{4}$ lb., 25 cts.; lb., 75 cts.

Yellow Turnip. A splendid summer variety, remarkable for its endurance of heat and drought. Per pkt., 5 cts.; oz., 10 cts.; $\frac{1}{4}$ lb., 25 cts.; lb., 75 cts.

Gray Turnip. One of the best summer radishes; a fine market sort. Per pkt., 5 cts.; oz., 10 cts.; $\frac{1}{4}$ lb., 25 cts.; lb., 75 cts.



CHARTIER RADISH.



LONG STANDING SPINACH.

In drills two feet apart, thin out to six inches, and the next spring plant in hills three feet apart.

Sea-Kale Seed. (For Plants, see Vegetable Plants.) Per pkt., 10 cts.; oz., 30 cts.; ¼ lb., \$1.00; lb., \$3.50.

SALSIFY, or Oyster Plant.

German, *Haferwurzel*.—French, *Salsifis*.—Spanish, *Ostion Begetal*.

One ounce will sow 50 feet of drill.

A very delicate and nutritious esculent, especially esteemed for its peculiar oyster flavor. Sow the seed early in spring, in drills twelve inches apart and one inch deep, thinning out the young plants to six inches. The roots will be ready for use in October, when a supply should be taken up and stored like carrots. Those remaining will suffer no injury by being left in the ground till spring.

MAMMOTH SANDWICH ISLAND. Tender and delicious, very superior. Per pkt., 5 cts.; oz., 20 cts.; ¼ lb., 40 cts.; lb., \$1.50.
Long White French. Per pkt., 5 cts.; oz., 10 cts.; ¼ lb., 30 cts.; lb., \$1.00.

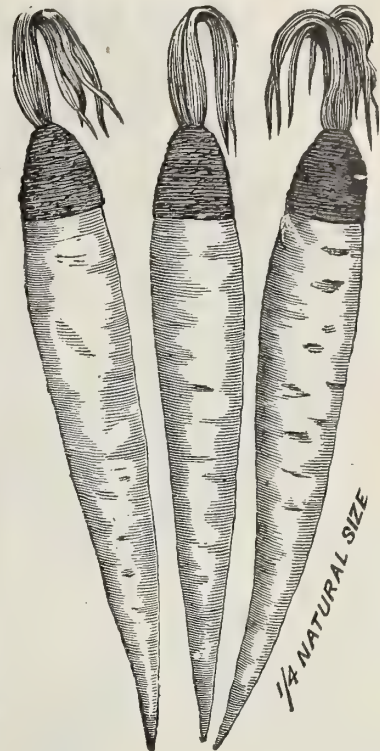

MAMMOTH SALSIFY.

¼ NATURAL SIZE

SEA-KALE.

German, *Meerkohl*.—French, *Chou*.—Spanish, *Marm*.

One ounce will produce 300 plants.

Cultivated for its blanched shoots, which are cooked as asparagus. A supply may be had all winter by planting the roots closely in a warm cellar before frost. Sow one inch deep, in hills three feet apart.

SPINACH—Continued.

Large Thick-Leaved. One of the best market sorts. It produces a large, thick leaf and stands a long time before running to seed. Per pkt., 5 cts.; oz., 10 cts.; ¼ lb., 15 cts.; lb., 35 cts.

Round Leaved. One of the best for market or family gardens; good for fall or spring sowing. Per pkt., 5 cts.; oz., 10 cts.; ¼ lb., 15 cts.; lb., 35 cts.

LARGE THICK-LEAVED VIROFLAY. A fine selection of the old lettuce-leaved Spinach; for summer use it is excellent. Per pkt., 5 cts.; oz., 10 cts.; ¼ lb., 15 cts.; lb., 35 cts.

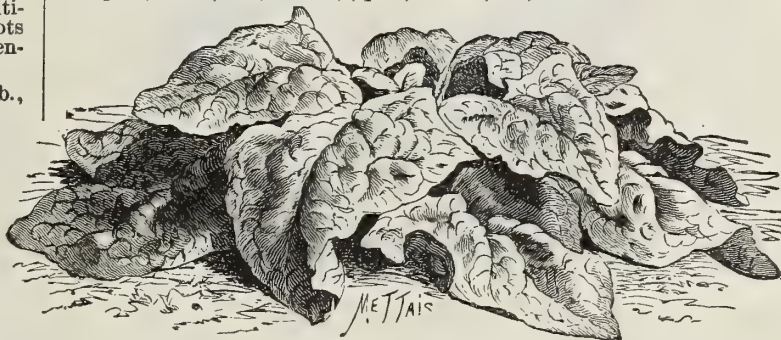

LARGE THICK-LEAVED SPINACH.

Long Standing. A distinct variety, standing from two to three weeks longer than any of the other sorts without going to seed in this climate. Per pkt., 5 cts.; oz., 10 cts.; ¼ lb., 15 cts.; lb., 35 cts.

Prickly. An exceedingly hardy and productive variety, adapted for fall sowing. Per pkt., 5 cts.; oz., 10 cts.; ¼ lb., 15 cts.; lb., 35 cts.

New Zealand. A very desirable and distinct variety. It should be transplanted two by three feet. Per pkt., 5 cts.; oz., 10 cts.; ¼ lb., 30 cts.; lb., \$1.00.

Spinach Beet or Swiss Chard—See p. 12.

SCORZONERA, or Black Oyster Plant.

German, *Schwarzwurzel*.—French, *Scorzonera*.—Spanish, *Escorzonera*.

One ounce will sow 50 feet of drill.

A very wholesome and agreeable vegetable, cultivated like salsify, which it closely resembles. The roots should not be scraped, but simply washed, boiled tender, then peeled and served like asparagus.

Scorzonera. Per pkt., 5 cts.; oz., 20 cts.; ¼ lb., 60 cts.; lb., \$2.00.



SCORZONERA.

SPINACH.

German, *Spinat*.—French, *Epinard*.—Spanish, *Espinaca*.

One ounce will sow 100 feet of drill.

Spinach is more productive and of better quality if grown in rich soil. The main crop is sown in September for spring use, and although extremely hardy, requires to be occasionally protected by light covering of hay during winter. For summer use sow from April to August, in drills twelve inches apart, thinning out the plants to three inches.

BLOOMSDALE SAVOY-LEAVED. A valuable variety with wrinkled leaves, resembling the Savoy cabbage; it is very hardy and prolific. Per pkt., 5 cts.; oz., 10 cts.; ¼ lb., 20 cts.; lb., 40 cts.



BLOOMSDALE SAVOY-LEAVED SPINACH.

SORREL.

German, *Sauerampfer*.—French, *Oseille*.—Spanish, *Acedera*.

One ounce will sow 150 feet of drill.

This plant is considered valuable for its acid properties; mixed with salads, it imparts an agreeable and refreshing flavor. Sow in shallow drills twelve inches apart, and thin out the young plants to six inches.

Large-Leaved French. Per pkt., 5 cts.; oz., 15 cts.; ¼ lb., 40 cts.; lb., \$1.25.

TOBACCO SEED.

One ounce will produce plants for one acre.

Connecticut Seed Leaf. Per pkt., 10 cts.; oz., 30 cts.; ¼ lb., \$1.00; lb., \$3.50.

Imported Havana. Per pkt., 10 cts.; oz., 30 cts.; ¼ lb., \$1.00; lb., \$3.50.

SQUASH.

German, *Kurbiss*.—French, *Courge*.—Spanish, *Calabaza*.

One ounce Early will plant 50 hills, one ounce Marrow 25 hills.

The Squash is best cultivated in good rich soil. Being a tender vine, and very sensitive to cold, the seed should not be sown before the 15th of May. Sow in hills as recommended for cucumbers, thinning the plants to three or four to a hill.

WHITE BUSH SCALLOPED. A very early and excellent market variety. Per pkt., 5 cts.; oz., 10 cts.; $\frac{1}{4}$ lb., 20 cts.; lb., 60 cts.

Yellow Bush Scalloped. Similar to the preceding, except in color. Per pkt., 5 cts.; oz., 10 cts.; $\frac{1}{4}$ lb., 20 cts.; lb., 60 cts.

Bush Summer Crookneck. A very fine summer variety, yellow fruit, early and productive. Per pkt., 5 cts.; oz., 10 cts.; $\frac{1}{4}$ lb., 20 cts.; lb., 60 cts.

Essex Hybrid. It is one of the richest flavored, finest grained, sweetest and best winter keeping varieties known. Per pkt., 5 cts.; oz., 10 cts.; $\frac{1}{4}$ lb., 20 cts.; lb., 60 cts.

Boston Marrow. A well known and highly popular winter variety; quality unexcelled. Per pkt., 5 cts.; oz., 10 cts.; $\frac{1}{4}$ lb., 20 cts.; lb., 60 cts.

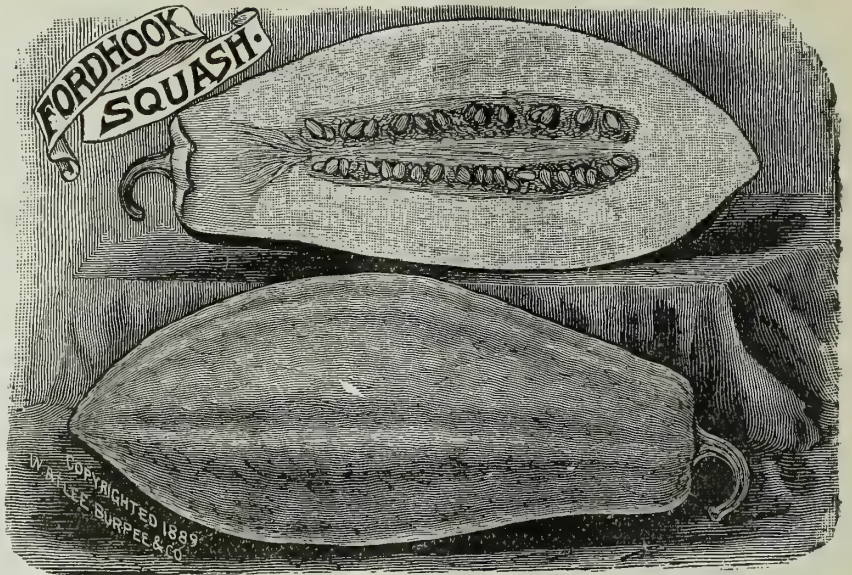

SQUASH—Continued.

FORDHOOK. Bright yellow skin, flesh straw-yellow, dry and sweet, and the best in quality of all Winter Squashes. It matures early and is everywhere a sure cropper, being earlier in ripening than any other Winter Squash; immensely productive. Per pkt., 5 cts.; oz., 10 cts.; $\frac{1}{4}$ lb., 20 cts.; lb., 60 cts.

HUBBARD. A large, very hard shelled variety of the first quality; keeps longer than the Marrows. Per pkt., 5 cts.; oz., 10 cts.; $\frac{1}{4}$ lb., 20 cts.; lb., 60 cts.

EARLY PROLIFIC MARROW. An improvement on the Boston Marrow, being earlier and more productive, brilliant orange-red color and fine keeping. Per pkt., 5 cts.; oz., 10 cts.; $\frac{1}{4}$ lb., 20 cts.; lb., 60 cts.

PERFECT GEM. Desirable as a summer or winter squash. Creamy white, with thin, smooth shell, slightly ribbed. Per pkt., 5 cts.; oz., 10 cts.; $\frac{1}{4}$ lb., 20 cts.; lb., 60 cts.

Pine Apple. The skin and flesh are of a pure, creamy white color, flesh very fine grained, and of excellent quality. Per pkt., 5 cts.; oz., 10 cts.; $\frac{1}{4}$ lb., 20 cts.; lb., 60 cts.

Bay State. Fine and dry flesh, of sweet flavor, bright golden yellow, very handsome, an excellent keeper. Per pkt., 5 cts.; oz., 15 cts.; $\frac{1}{4}$ lb., 20 cts.; lb., 60 cts.

Vegetable Marrow. Skin greenish yellow; flesh white, soft, and of rich flavor; quite distinct. Per pkt., 5 cts.; oz., 10 cts.; $\frac{1}{4}$ lb., 30 cts.; lb., \$1.00.

Mammoth Chili. Grows to an immense size, often weighing two hundred pounds. Per pkt., 5 cts.; oz., 15 cts.; $\frac{1}{4}$ lb., 40 cts.; lb., \$1.25.

Winter Crookneck. Excellent for winter; flesh close-grained, sweet, and of fine flavor. Per pkt., 5 cts.; oz., 10 cts.; $\frac{1}{4}$ lb., 20 cts.; lb., 60 cts.



LONG WHITE BUSH VEGETABLE MARROW.

LONG WHITE BUSH VEGETABLE MARROW. A decided improvement on the old trailing Vegetable Marrow. The fruit is larger, handsomer, more ribbed or fluted, and of strictly bush form. Per pkt., 5 cts.; oz., 15 cts.; $\frac{1}{4}$ lb., 30 cts.; lb., \$1.00.

Marblehead. A variety resembling the Hubbard, but generally acknowledged to be superior. Per pkt., 5 cts.; oz., 10 cts.; $\frac{1}{4}$ lb., 20 cts.; lb., 60 cts.

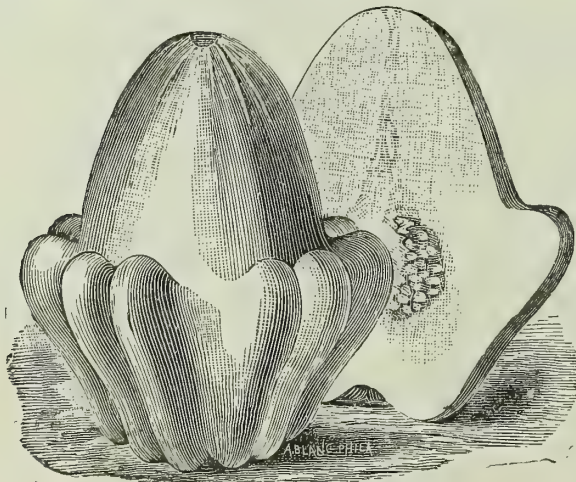

PINE APPLE SQUASH.



BAY STATE SQUASH.

TOMATO.

German, *Liebesapfel*.—French, *Tomato*.—Spanish, *Tomates*.

One ounce will produce 1,500 plants.

This delicious vegetable is one of the most important of all garden products. The seed should be sown in a hot-bed about the first week in March, in drills five inches apart, and half an inch deep. When the plants are about two inches high, they should be set out four or five inches apart in another hot-bed, or removed into small pots, allowing a single plant to a pot. About the middle of May the plants may be set out in the open ground; they are planted for early crops on light, sandy soil, at a distance of three feet apart, in hills in which a good shovelful of rotted manure should be mixed. On heavy soil, which is not suited for an early crop, they should be planted four feet apart. Water freely at the time of transplanting, and shelter from the sun for a few days until the plants are established. Sufficient plants for a small garden may be started by sowing a few seeds in a shallow box or flower-pot, and placing it in a sunny window of the room or kitchen.



MATCHLESS TOMATO.

Extra Early Advance. We consider this variety to be the earliest really good tomato grown. The fruits are large, bright-red, very solid and without green core. Per pkt., 5 cts.; oz., 20 cts.; $\frac{1}{4}$ lb., 60 cts.; lb., \$2.00.

EARLY RUBY. This variety had a very wide distribution last year, and has given the best satisfaction. It is the earliest of all large tomatoes and of distinct and handsome appearance. Per pkt., 5 cts.; oz., 25 cts.; $\frac{1}{4}$ lb., \$1.00; lb., \$3.00.

Perfection. An early variety of blood-red color; perfectly smooth, ripens uniformly and bears abundantly until frost. Per pkt., 5 cts.; oz., 20 cts.; $\frac{1}{4}$ lb., 60 cts.; lb., \$2.00.

Cardinal. Bright, glossy red, smooth and solid. Valuable for general crop. Per pkt., 5 cts.; oz., 20 cts.; $\frac{1}{4}$ lb., 60 cts.; lb., \$2.00.

Favorite. This variety is of a bright-red color, ripens evenly and well up to the stem; of good size. Its shape is globular, slightly flattened, and generally grows very smooth. Per pkt., 5 cts.; oz., 20 cts.; $\frac{1}{4}$ lb., 60 cts.; lb., \$2.00.

Acme. Rich glossy crimson, tinged with purple; perfectly smooth; one of the earliest. Per pkt., 5 cts.; oz., 20 cts.; $\frac{1}{4}$ lb., 60 cts.; lb., \$2.00.

Beauty. Another sort of great merit; round, smooth, glossy; crimson, tinged with purple. Excellent quality; solid and free from core. Early, vigorous. Per pkt., 5 cts.; oz., 20 cts.; $\frac{1}{4}$ lb., 60 cts.; lb., \$2.00.

MATCHLESS. A distinct variety. It is early, of beautiful and uniform shape and good size; very dark red, and possesses extraordinary keeping qualities. Per pkt., 5 cts.; oz., 25 cts.; $\frac{1}{4}$ lb., 75 cts.; lb., \$2.50.

Dwarf Champion. The foliage is very marked, of a dark-green color, leaves thick and different from other sorts. Fruit smooth, medium in size and similar in color to the Acme. Per pkt., 5 cts.; oz., 25 cts.; $\frac{1}{4}$ lb., 75 cts.; lb., \$2.50.



PERFECTION TOMATO.

LORILLARD FORCING. Possesses extra good forcing qualities, ripens very uniform over the whole surface; very solid, smooth, and well flavored, early, productive, handsome; a splendid variety for open air as well as for forcing. Per pkt., 5 cts.; oz., 20 cts.; $\frac{1}{4}$ lb., 70 cts.; lb., \$2.50.

IGNOTUM. A large, solid, deep-red variety, prolific and of good quality. Per pkt., 5 cts.; oz., 20 cts.; $\frac{1}{4}$ lb., 70 cts.; lb., \$2.50.

Volunteer. The color is bright red; smooth, solid and handsome shape. Good main crop variety. Per pkt., 5 cts.; oz., 20 cts.; $\frac{1}{4}$ lb., 70 cts.; lb., \$2.50.

Table Queen. This tomato is said to be the largest and heaviest smooth tomato ever offered. The color is a rich shade of crimson and of a most agreeable acid flavor. Per pkt., 5 cts.; oz., 20 cts.; $\frac{1}{4}$ lb., 70 cts.; lb., \$2.50.

CHEMIN. Of fine flavor, the tomatoes are very solid, without hard core; they are borne early and continuously throughout the season. Per pkt., 5 cts.; oz., 20 cts.; $\frac{1}{4}$ lb., 70 cts.; lb., \$2.50.

Trophy, Extra Selected. A very large, smooth and solid variety, of fine flavor, and immensely productive. The best for general and late crop. Per pkt., 5 cts.; oz., 20 cts.; $\frac{1}{4}$ lb., 70 cts.; lb., \$2.50.

Peach. It resembles a medium-sized peach in size, form and color, with a firm, fleshy texture. The entire fruit is tender, free from core around the stem, and of very superior quality. Per pkt., 5 cts.; oz., 20 cts.; $\frac{1}{4}$ lb., 70 cts.; lb., \$2.50.

MIKADO. Very large, fairly smooth, solid and fine quality; color purplish red, foliage distinct. Per pkt., 5 cts.; oz., 20 cts.; $\frac{1}{4}$ lb., 70 cts.; lb., \$2.50.

Yellow Plum. Shape uniformly oval and perfectly smooth, color lemon yellow; used for preserves. Per pkt., 5 cts.; oz., 20 cts.; $\frac{1}{4}$ lb., 70 cts.; lb., \$2.50.

Large Yellow. About the size and shape of the Perfection; color bright yellow. Per pkt., 5 cts.; oz., 20 cts.; $\frac{1}{4}$ lb., 70 cts.; lb., \$2.50.

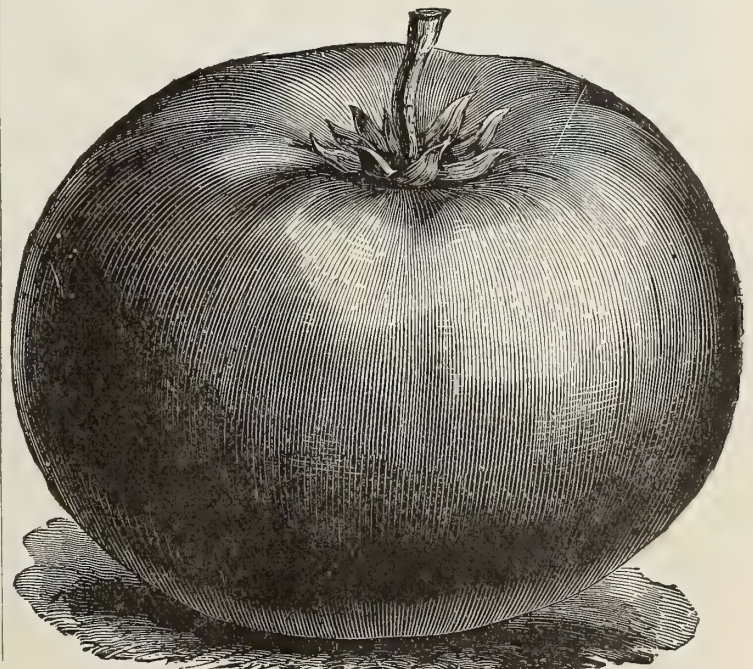

EXTRA SELECTED TROPHY TOMATO.

TURNIP.

German, *Rueben*.—French, *Navet*.—Spanish, *Nabo*.

One ounce will sow 150 feet of drill.

Turnips do best on highly-enriched, light, sandy or gravelly soil; commence sowing the earliest varieties in April, in drills, from twelve to fifteen inches apart, and thin out early to six or nine inches in the rows. For a succession, sow at intervals of two weeks, until the middle of August.



EXTRA EARLY MILAN TURNIP.

EARLY SNOWBALL. Small, solid, sweet and crisp, one of the best for table use. Per pkt., 5 cts.; oz., 10 cts.; $\frac{1}{4}$ lb., 20 cts.; lb., 50 cts.

White Egg. Its shape is nearly oval, flesh very firm, thin and perfectly smooth white skin, flavor of the best, mild and sweet. Per pkt., 5 cts.; oz., 10 cts.; $\frac{1}{4}$ lb., 20 cts.; lb., 50 cts.

Yellow Stone. An excellent variety for early or late sowing; a good cropper and fine keeper, valuable for table use. Per pkt., 5 cts.; oz., 10 cts.; $\frac{1}{4}$ lb., 20 cts.; lb., 50 cts.

Yellow Malta. An early variety of fine flavor. Per pkt., 5 cts.; oz., 10 cts.; $\frac{1}{4}$ lb., 20 cts.; lb., 50 cts.

YELLOW MONTMAGNY. It is semi-globular in form, smooth, shiny skin, with violet-red top, delicately blending with its bright, yellow base, sweet and tender. Per pkt., 5 cts.; oz., 10 cts.; $\frac{1}{4}$ lb., 20 cts.; lb., 50 cts.

GOLDEN BALL. Bulb of fine form and bright yellow color; a fine keeper; unsurpassed for table use. Per pkt., 5 cts.; oz., 10 cts.; $\frac{1}{4}$ lb., 20 cts.; lb., 50 cts.

Purple Top White Globe. A very handsome globe-shaped variety, valuable for market purposes. Per pkt., 5 cts.; oz., 10 cts.; $\frac{1}{4}$ lb., 20 cts.; lb., 50 cts.

Yellow Aberdeen Purple Top. A very hardy and productive variety of fine form and excellent quality; good for either table or stock. Per pkt., 5 cts.; oz., 10 cts.; $\frac{1}{4}$ lb., 20 cts.; lb., 50 cts.

Long White or Cowhorn. A quick-growing, long shaped variety; flesh fine grained and sweet; an excellent sort for table use. Per pkt., 5 cts.; oz., 10 cts.; $\frac{1}{4}$ lb., 20 cts.; lb., 50 cts.

Large White Norfolk. A very large growing variety; one of the best early sorts for feeding stock. Per pkt., 5 cts.; oz., 10 cts.; $\frac{1}{4}$ lb., 20 cts.; lb., 50 cts.

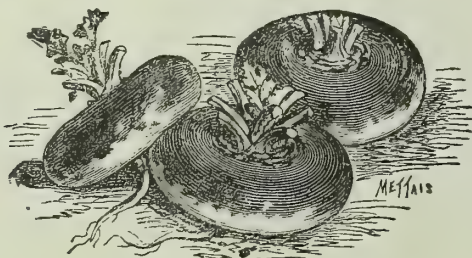

RED TOP STRAP LEAF TURNIP.

RED TOP STRAP LEAF.

A well known variety, extensively grown both for table and for stock. Per pkt., 5 cts.; oz., 10 cts.; $\frac{1}{4}$ lb., 20 cts.; lb., 50 cts.

Early White Strap Leaf.

The best white table or market variety. Per pkt., 5 cts.; oz., 10 cts.; $\frac{1}{4}$ lb., 20 cts.; lb., 50 cts.

Extra Early Milan.

The bulbs are white, with a purple top, round, flattened and solid, flesh pure white, sweet and crisp. Per pkt., 5 cts.; oz., 10 cts.; $\frac{1}{4}$ lb., 30 cts.; lb., \$1.00.

Early Flat Dutch.

A very quick-growing white variety, adapted for spring sowing. Per pkt., 5 cts.; oz., 10 cts.; $\frac{1}{4}$ lb., 20 cts.; lb., 50 cts.

YELLOW GLOBE.

The best yellow variety for general crop. It keeps well until late in the spring and is excellent for table use. Per pkt., 5 cts.; oz., 10 cts.; $\frac{1}{4}$ lb., 20 cts.; lb., 50 cts.



EARLY WHITE STRAP LEAF TURNIP.

RUTA BAGA, or Swede Turnip.

The Ruta Baga, Russian, or Swedish Turnip is extensively grown for table use; the roots are close grained, very hard and will endure a considerable degree of cold without injury. The roots are best preserved in a pit or cellar during winter, and are excellent for the table early in spring. Sow from 20th June to the middle of July, in drills, two feet apart, and thin out to eight or ten inches.

CHAMPION SWEDE. (New.) A handsome globe-shaped and short-necked variety, surpassing all the other varieties for size and richness. Per pkt., 5 cts.; oz., 10 cts.; $\frac{1}{4}$ lb., 25 cts.; lb., 75 cts.

Improved American. A yellow-fleshed, purple top variety grown for stock or table. Per pkt., 5 cts.; oz., 10 cts.; $\frac{1}{4}$ lb., 20 cts.; lb., 50 cts.

Skirving's Purple Top. A very heavy cropper; one of the best for field culture. Per pkt., 5 cts.; oz., 10 cts.; $\frac{1}{4}$ lb., 20 cts.; lb., 50 cts.

Sweet German. A superior variety for table or stock; flesh firm, sweet and juicy. Per pkt., 5 cts.; oz., 10 cts.; $\frac{1}{4}$ lb., 20 cts.; lb., 50 cts.

Long White French. A delicate flavored variety, an excellent keeper and fine for table. Per pkt., 5 cts.; oz., 10 cts.; $\frac{1}{4}$ lb., 20 cts.; lb., 50 cts.



IMPROVED AMERICAN RUTA BAGA.

—SOW OUR—

CENTRAL PARK LAWN GRASS

AND YOU WILL HAVE

A Perfect Lawn the First Season.

ALSO USE OUR LAWN INVIGORATOR.

HERBS—SWEET, POT AND MEDICINAL.



SWEET BASIL.



SWEET MARJORAM.

The seeds should be sown in spring, in shallow drills, twelve inches apart, and the young plants thinned out or transplanted to about four inches. They should be harvested on a dry day, just before the blossom develops, dried quickly and bottled, or closely packed in dry boxes with the air entirely excluded.

- Anise** (*Pimpinella anisum*).—Biennial. Per pkt., 5 cts.; oz., 20 cts.
- Balm** (*Melissa officinalis*).—Perennial. Per pkt., 5 cts.; oz., 20 cts.
- Basil, Sweet** (*Ocimum basilicum*).—Annual. Per pkt., 5 cts.; oz., 20 cts.
- Bene** (*Sesamum orientale*).—Annual. Per pkt., 5 cts.; oz., 20 cts.
- Borage** (*Borago officinalis*).—Annual. Per pkt., 5 cts.; oz., 15 cts.
- Caraway** (*Carum carai*).—Perennial. Per pkt., 5 cts.; oz., 20 cts.
- Castor Oil Plant** (*Ricinus communis*).—Annual. Per pkt., 5 cts.; oz., 20 cts.
- Coriander** (*Coriandrum sativum*).—Annual. Per pkt., 5 cts.; oz., 20 cts.
- Catnip** (*Nepeta cataria*).—Perennial. Per pkt., 10 cts.; oz., 30 cts.
- Dill** (*Anethum graveolens*).—Biennial. Per pkt., 5 cts.; oz., 10 cts.; lb., 75 cts.
- Fennel** (*Anethum feniculum*).—Perennial. Per pkt., 5 cts.; oz., 15 cts.



SAGE.



BROAD-LEAVED THYME.

- Horehound** (*Marubium vulgare*).—Perennial. Per pkt., 5 cts.; oz., 30 cts.
- Hyssop** (*Hyssopus officinalis*).—Perennial. Per pkt., 5 cts.; oz., 20 cts.
- Lavender** (*Lavendula spica*).—Perennial. Per pkt., 5 cts.; oz., 20 cts.
- Marjoram, Sweet** (*Origanum marjorana*).—Annual. Per pkt., 5 cts.; oz., 2) cts.
- Marjoram, Pot** (*Origanum onites*).—Perennial. Per pkt., 5 cts.; oz., 20 cts.
- Opium Poppy** (*Papaver somniferum*).—Annual. Per pkt., 5 cts.; oz., 20 cts.
- Rosemary** (*Rosmarinus officinalis*).—Perennial. Per pkt., 5 cts.; oz., 20 cts.
- Rue** (*Ruta graveolens*).—Perennial. Per pkt., 10 cts.; oz., 30 cts.
- Saffron** (*Carthamus tinctorius*).—Annual. Per pkt., 5 cts.; oz., 20 cts.
- Sage** (*Salvia officinalis*).—Annual. Per pkt., 5 cts.; oz., 20 cts.; lb., \$2.00.
- Summer Savory** (*Satureia hortensis*).—Annual. Per pkt., 5 cts.; oz., 20 cts.
- Sorrel, Broad-leaved** (*Rumex acetosa*).—Perennial. Per pkt., 5 cts.; oz., 15 cts.; lb., \$1.25.
- Tansy** (*Tanacetum vulgare*).—Perennial. Per pkt., 5 cts.; oz., 20 cts.
- Thyme, Broad-leaved** (*Thymus vulgaris*).—Perennial. Per pkt., 5 cts.; oz., 40 cts.; lb., \$4.00.
- Wormwood** (*Artemisia absinthium*).—Perennial. Per pkt., 5 cts.; oz., 35 cts.

BIRD SEEDS, ETC.

Canary.....	Per lb., 10 cts.
Canary Seed, Mixed.....	“ 10 “
Hemp.....	“ 10 “
Lettuce Seed.....	per oz., 5 cts., “ 40 “
Maw, Blue Poppy ..	“ 20 “

Millet, American.....	Per lb., 10 cts.
Rape, German.....	“ 10 “
Rough Rice. (<i>Oryza sativa</i>).....	“ 25 “
Sunflower Seed for Parrots.....	“ 15 “



HORSE RADISH.

ESCULENT ROOTS AND PLANTS.

- Asparagus Roots.** (See page 9.)
- Chive Plants.** Per bunch, 25 cts.
- Globe Artichoke Clumps.** Extra large. Each, 20 cts.; per doz., \$2 00.
- Horse-Radish Roots.** Per doz., 25 cts.; per 100, 75 cts.
- Hop Roots.** Each, 20 cts.; per doz., \$2.00.

- Jerusalem Artichoke.** (See page 9.)
- Mint.** Each, 20 cts.; per doz., \$2.00.
- Rhubarb Roots.** Each, 20 cts.; per doz., \$2.00.
- Sea Kale Roots.** Each, 20 cts.; per doz., \$2.00.
- Tarragon Roots.** (*Estragon*) Each, 35 cts.; per doz., \$3.50; extra large, each, 75 cts.

VEGETABLE PLANTS.

CAULIFLOWER AND CABBAGE.

These plants have been wintered over in cold frames, and can be planted out any time after the first of April.

Cauliflower. First and Best, and Early Snowball. Per 100, \$2.00; per 1,000, \$15.00.

Cabbage. Improved Early Summer and Improved Jersey Wakefield. Per 100, \$1.00; per 1,000, \$9.00.

Hot-bed plants of the above ready May 10, at half these prices.

EGG PLANTS, Pot Grown.

New York Improved. Per doz., \$1.00; per 100, \$3 00.

LETTUCE PLANTS.

Boston Market, Salamander and Curled Simpson. Per 100, \$1.00; per 1,000, \$7.50.

PEPPER PLANTS, Pot Grown.

Large Bell or Bull Nose, Long Red Cayenne, and Sweet Mountain. Per doz., \$1.00; per 100, \$6.00.

TOMATO PLANTS.

(READY MAY 1.)

Acme, Perfection, The Trophy, The Mikado, and Lorraine. Per doz., 30 cts.; per 100, \$2.50.

CELERY PLANTS.

(READY ABOUT JUNE 10.)

LAWN GRASS SEED.



WEEBER & DON'S CENTRAL PARK LAWN GRASS.

(Weight, 20 lbs. per bushel.)

This lawn mixture is composed entirely of the finest quality of fine-leaved dwarf (evergreen) growing grasses, in such proportions as will enable it to withstand the extreme heat of our summer. We give special attention to the RE-CLEANING of our grass seeds, removing all obnoxious weeds and foreign substances, thus insuring a perfect and clean lawn.

We recommend **four bushels of seed to the acre**; the thicker the seed is sown the sooner a smooth, velvety lawn will be obtained. One quart of seed will sow 15 x 20 feet.

Price, per quart, 25 cts.; per peck, \$1.25; per bushel (20 lbs.), \$4.50; per 100 lbs., \$20.00.

WEEBER & DON'S LAWN GRASS.

For Terraces.

Price, per qt., 30 cts.; peck, \$1.75; bu. (20 lbs.), \$6.00.

WEEBER & DON'S LAWN TENNIS MIXTURE.

Price, per qt., 25 cts.; peck, \$1.25; bu. (20 lbs.), \$4.50.

WEEBER & DON'S LAWN GRASS.

For Shady Places and Under Trees.

Price, per qt., 30 cts.; peck, \$2.00; bu. (20 lbs.), \$7.00.

FRENCH LAWN GRASS.

Good Mixture.

Price, per qt., 25 cts.; peck, \$1.00; bu. (15 lbs.), \$3.50.

Full Directions for Making a Lawn Printed on Each Box.

WEEBER & DON'S LAWN INVIGORATOR.

This **odorless fertilizer** is especially prepared for use on LAWNS, MEADOWS and PASTURE LANDS as a top dressing. It contains, in proper proportions, the ingredients required to supply the wants of the various grasses. Its application will induce a luxuriant growth and impart a beautiful dark green color without the aid of any other manure, and land on which it is used will increase in fertility from year to year. Use from 600 to 1,000 pounds per acre when seeding down, and from 400 to 600 pounds per acre as a top dressing. A 10-pound package is sufficient for a plot of 15 x 20 feet.

Price, 5 lbs., 30 cts.; 10 lbs., 50 cts.; 25 lbs., \$1.00; 50 lbs., \$2.00; 100 lbs., \$3.75; 200 lbs., \$7.00; ton of 2,000 lbs., \$60.00.



ORCHARD GRASS.

FARM SEEDS.

WEEBER & DON'S

SPECIAL MIXTURE OF

Grasses and Clovers

FOR

HAY AND PERMANENT PASTURE.



MEADOW FESCUE.



HARD FESCUE.



RED TOP GRASS.

The selections of seeds in our mixture, being entirely composed of the true permanent species, are somewhat more expensive than mixtures of seeds which contain a considerable proportion of Rye-grass and Timothy, but it is admitted that the laying down of land to grass with such mixtures as it was customary to use a few years ago has often proved very unsatisfactory, and even when most successful the success has only been attained by the application of expensive manures and after years of waiting; whereas selections of such seeds as are given in this mixture will produce profitable pastures the first year after they have been laid down, and will increase in profitableness year by year if ordinary care be given them.

This special mixture may be sown either in the spring or fall, using **three bushels of seed** to one acre, with an additional **ten pounds of mixed clover**, sown in the spring.

Special mixture, per bush. (14 lbs.), \$2.50. **Mixed clover**, per lb., 20 cts. Special quotations for large quantities.

GENERAL LIST OF GRASSES AND CLOVERS.

Prices Subject to Change.

RED TOP (*Agrostis Vulgaris*). Valuable for either pastures or lawns. Per bush. (14 lbs.), \$1.50; bag (50 lbs.), \$5.00.

Fancy Red Top. Clean seed, free from chaff. Per lb., 25 cts.; bush. (30 lbs.), \$6.50.

Kentucky Blue Grass (*Poa Pratensis*). Well known and extensively grown in all parts of the country; thrives well in a variety of soils and endures the hottest summers. Per bush. (14 lbs.), \$2.50.

Bermuda (*Cynodon Dactylon*). Per lb., \$2.00.

ORCHARD GRASS (*Dactylis Glomerata*). A valuable pasture grass, relished by stocks of all kinds, particularly adapted for growing in shady moist places, under trees, etc. Per bush. (14 lbs.), \$3.00.

TIMOTHY or HERD GRASS (*Phleum Pratense*). A variety well known and highly appreciated, producing a profitable hay crop in almost any soil. $\frac{1}{2}$ bushel per acre. Per bush. (45 lbs.), about \$3.50.

Meadow Foxtail (*Alopecurus Pratensis*). One of the earliest and best pasture grasses, grows rapidly when cut or eaten down by stock. Per lb., 40 cts.

Sainfoin (*Onobrychis Sativa*). Per lb., 15 cts; 100 lbs., \$10.00.

Sweet Vernal Grass (*Anthoxanthum Odoratum*). Prized more for its early growth than nutritive value. It should be sown in connection with other grasses. Per lb., 40 cts.

TALL OAT GRASS (*Avena Elatior*). Producing an early and luxuriant growth; this is a valuable variety for pastures. Per bush. (10 lbs.), \$2.50.

Johnson Grass (*Sorghum Halapense*). Per lb., 20 cts.; bush. (25 lbs.), \$4.00.

Rhode Island Bent (*Agrostis Var*). Excellent for lawns or pastures. Per bush. (14 lbs.), \$3.00.

CRESTED DOGSTAIL (*Cynosurus Cristatus*). An excellent grass for hard, dry soils, valuable for pastures and lawns. Per lb., 40 cts.

HARD FESCUE (*Festuca Duriuscula*). One of the most desirable dwarf grasses, excellent for dry soils. Per lb., 25 cts.

MEADOW FESCUE (*Festuca Pratensis*). A valuable grass for permanent pastures, very productive and nutritious. Per lb., 20 cts.

SHEEP FESCUE (*Festuca Ovina*). An excellent grass for sheep pastures. Per lb., 25 cts.

English Rye Grass (*Lolium Perenne*). A very nutritious, rapid-growing variety, valuable for meadows and pastures. Per bush. (24 lbs.), \$2.50.

Italian Rye Grass (*Lolium Italicum*). A valuable European variety, adapted to any climate, and produces large and nutritive crops. Per bush. (18 lbs.), \$2.00.

Rough Stalked Meadow Grass (*Poa Trivialis*). Produces an abundant crop of highly nutritious herbage, valuable for either moist or dry soils. Per lb., 40 cts.

Wood Meadow Grass (*Poa Nemoralis*). A very productive and nutritive grass, adapted for lawns or pastures. Thrives well under trees. Per lb., 40 cts.

HUNGARIAN GRASS (*Panicum Germanicum*). This is a species of millet, growing less rank, with smaller stalks, often yielding two or three tons of hay per acre. 1 bushel per acre. Per bush. (48 lbs.), \$1.75.

Yarrow or Milfoil. Used for sheep pasture. Per lb., \$1.50.

CLOVERS.

Alfalfa or Lucerne (*California grown*). A deep, rich soil is best adapted to the cultivation of this plant; in such, several crops are produced in a season. 15 lbs. sown an acre. Per lb., 20 cts.

ALSIKE (*Trifolium Hybridum*). Per lb., 30 cts.

WHITE (*Trifolium Repens*). Per lb., 30 cts.

TREFOIL (*Medicago Lupulina*). Excellent for sheep pasture. Per lb., 20 cts.

LARGE RED or PEA VINE. Per lb., 20 cts.

MEDIUM RED (*Trifolium Pratense*). Per lb., 15 cts.

JAPAN CLOVER (*Lespedeza Striata*). Per lb., 30 cts.

FARM SEEDS—Continued.

ROOT CROPS FOR FEEDING STOCK.

MANGEL-WURZEL.

Six pounds will sow one acre.

LEVIATHAN LONG RED. One of the largest and most profitable varieties grown for agricultural purposes. Per $\frac{1}{4}$ lb., 15 cts.; lb., 35 cts.

Long Red. An excellent variety for feeding stock; a heavy cropper in deep soil. Per $\frac{1}{4}$ lb., 10 cts.; lb., 25 cts.

CHAMPION YELLOW GLOBE. The finest globe variety ever introduced; the bulb is of handsome form, clean single-tap root, and small foliage. Per $\frac{1}{4}$ lb., 15 cts.; lb., 35 cts.

Yellow Globe. A globular-shaped variety, adapted for growing in shallow soils. Per $\frac{1}{4}$ lb., 10 cts.; lb., 25 cts.

GOLDEN TANKARD. Flesh bright golden-yellow, and in this respect differs from all other varieties. Per $\frac{1}{4}$ lb., 15 cts.; lb., 35 cts.

SUGAR BEET.

White Sugar Beet. A very heavy cropper, highly recommended for feeding purposes. Per $\frac{1}{4}$ lb., 15 cts.; lb., 35 cts.

Lane's Imperial Sugar Beet. One of the best and most nutritious varieties for feeding cattle. Per $\frac{1}{4}$ lb., 15 cts.; lb., 35 cts.

CARROT.

Three pounds will sow one acre.

Danver's Half Long Orange. This variety is now very extensively cultivated, both for market and agricultural purposes. Per $\frac{1}{4}$ lb., 25 cts.; lb., 80 cts.



LONG ORANGE CARROT.

Improved Long Orange. For garden or field crops this is the best and most profitable variety grown. Per $\frac{1}{4}$ lb., 25 cts.; lb., 75 cts.

White Belgian. Very extensively grown for feeding horses and cattle, for which purpose it is highly valued. Per $\frac{1}{4}$ lb., 20 cts.; lb., 60 cts.

PARSNIP.

Six pounds will sow one acre.

American Hollow Crown. Long, smooth and milky white; the largest and most profitable for feeding stock. Per lb., 60 cts.

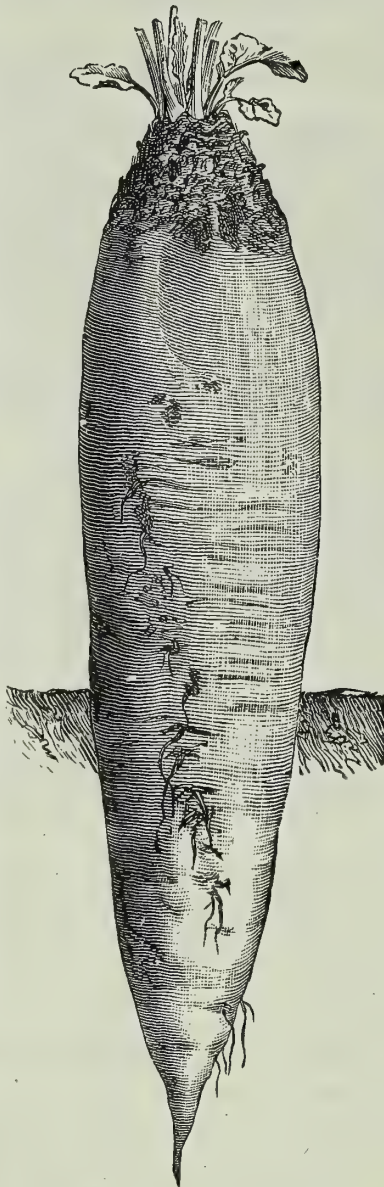

LEVIATHAN MANGEL-WURZEL.

TURNIP.

Two pounds will sow one acre.

PURPLE TOP WHITE GLOBE. A very handsome globe-shaped variety; valuable for feeding stock. Per $\frac{1}{4}$ lb., 20 cts.; lb., 50 cts.

Pomeranian White Globe. Grows to a large size; one of the best for field culture. Per $\frac{1}{4}$ lb., 20 cts.; lb., 50 cts.

Large White Norfolk. A very large growing variety; one of the best early sorts for feeding stock. Per $\frac{1}{4}$ lb., 20 cts.; lb., 50 cts.

Long White or Cowhorn. A quick-growing, long shaped variety; flesh fine grained and sweet; an excellent sort for table use. Per $\frac{1}{4}$ lb., 20 cts.; lb., 50 cts.

YELLOW ABERDEEN PURPLE TOP. A very hardy and productive variety of fine form and excellent quality; good for either table or stock. $\frac{1}{4}$ lb., 20 cts.; lb., 60 cts.

Large Yellow Globe. The best yellow variety for general crop. It keeps well until late in the spring, and is excellent for stock. Per $\frac{1}{4}$ lb., 20 cts.; lb., 50 cts.

RUTA BAGA, Russian or Swedish Turnip.

Two pounds will sow one acre.

CHAMPION SWEDE (New). A handsome globe-shaped, short-leaved variety, surpassing all the other varieties for size and richness; heavy cropper, the best for stock. Per $\frac{1}{4}$ lb., 25 cts.; lb., 75 cts.

Improved American. A yellow-fleshed, purple top variety grown for stock. Per $\frac{1}{4}$ lb., 20 cts.; lb., 50 cts.

Skirving's Purple Top. A very heavy cropper; one of the best for field culture. Per $\frac{1}{4}$ lb., 20 cts.; lb., 50 cts.

Long White French. A fine flavored variety; an excellent keeper and fine for stock. Per $\frac{1}{4}$ lb., 20 cts.; lb., 50 cts.

Sweet German. A superior variety for stock; flesh firm, sweet and juicy. Per $\frac{1}{4}$ lb., 20 cts.; lb., 50 cts.

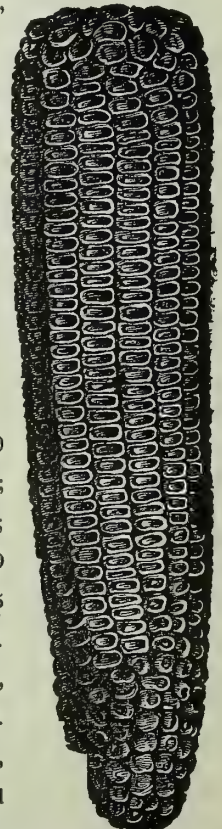

GOLDEN BEAUTY.

FIELD CORN.

Eight quarts will plant one acre in hills; three bushels will sow one acre broadcast or half that quantity in drills.

Self-husking. Per qt., 15 cts.; peck, 60 cts.; bush., \$2.00.

GOLDEN BEAUTY. Surpasses all in size, appearance and productiveness. Per qt., 15 cts.; peck, 60 cts.; bush., \$2.00.

Leaming. Ears of good size, cob small, large grain of bright yellow. Per qt., 15 cts.; peck, 60 cts.; bush., \$2.00.

Farmer's Favorite. Ripens early, and succeeds in the North. Per qt., 15 cts.; peck, 60 cts.; bush., \$2.00.

Chester County Mammoth. One of the largest varieties of field corn. Per qt., 15 cts.; peck, 60 cts.; bush., \$2.00.

QUEEN OF THE PRAIRIE. In this latitude it has matured a crop in ninety days. Per qt., 15 cts.; peck, 60 cts.; bush., \$2.00.

Golden Dew Drop. One of the best for Northern planting, as it grows quickly and matures early. Per qt., 15 cts.; peck, 60 cts.; bush., \$2.00.

King Philip. Very early; matures three months after planting. Per qt., 15 cts.; peck, 60 cts.; bush., \$2.00.

Early Yellow Canada. A very early, small-eared variety. Per qt., 15 cts.; peck, 60 cts.; bush., \$2.00.

Longfellow. Well adapted for Northern States. Per qt., 15 cts.; peck, 60 cts.; bush., \$2.00.

Large Yellow Flint. Very productive and of good quality. Per qt., 15 cts.; peck, 60 cts.; bush., \$2.00.

RURAL THOROUGHbred WHITE FLINT. Of spreading habit; not more than one kernel should be grown in a hill; for ensilage purposes it is most valuable. Per peck, 75 cts.; bush., \$2.50.

Sweet Fodder. Per peck, 50 cts.; bush., \$1.75.

Southern Horsetooth. For Fodder. Per peck, 50 cts.; bush., \$1.50.



DANVER'S CARROT.

MISCELLANEOUS FARM SEEDS.



BUCKWHEAT.

One-half bushel will sow one acre.

NEW JAPANESE BUCKWHEAT. This variety has proven itself to be a decided acquisition. It is a splendid yielder, being superior in this respect to the Silver Hull. In addition to its great productiveness, it is, at least, from seven to ten days earlier, and makes better flour than any other kind of buckwheat. Per lb., 20 cts.; bush., \$1.50.

Silver Hull. This variety is superior in every respect to the common kind. Per bush., \$1.30.

Common or American. Per bush., \$1.25.

BARLEY.

Two bushels will sow one acre broadcast.

Vermont Champion. Two-rowed, early, hardy and prolific. Per peck, 60 cts.; bush., \$2.00.

Hulless. An important acquisition. Per peck, 75 cts.; bush., \$2.50.

Two-Rowed. Per peck, 50 cts.; bush., \$1.75.

OATS.

Two bushels will sow one acre broadcast.

Clydesdale. An early variety of White Oats; heavy cropper, early and productive. Per peck, 50 cts.; bush. (32 lbs.), \$1.50.

Welcome. Heavy white grain; very productive. Per peck, 35 cts.; bush. (32 lbs.), \$1.25.

Surprise. A superior variety; heavy and productive, and produces long, stiff straw. Per bush. (32 lbs.), \$1.25.

Probsteier. One of the most valuable varieties. It is very productive and heavy. Per bush. (32 lbs.), \$1.00.

RYE.

One and one-half bushels will sow one acre broadcast.

Excelsior Winter. A variety from Vermont; heavy cropper. Per bush., \$2.00.

Winter. Hardy and prolific. Per bush., \$1.50.

Spring. Splendid yielder. Per bush., \$2.00.

WHEAT.

One and one-half bushels will sow one acre broadcast.

Saskatchewan Fife (Spring). Unequaled for earliness, yield and vigor. Per bush., \$2.00.

Early Red Clawson (Winter). Very productive. Per bush., \$2.00.

Hybrid Mediterranean (Winter). One of the best; hardy and prolific. Per bush., \$2.00.

Fultz (Winter.) A standard sort; very reliable. Per bush., \$2.00.

MAMMOTH RUSSIAN SUNFLOWER.

Five quarts will plant one acre.

This gigantic variety of sunflower will produce double the crop of any other variety. It is one of the most profitable crops; the seeds being used for poultry feed, and for this purpose are the best egg-producers. Besides this, they are good for horses, and yield a considerable quantity of oil. The leaves make excellent fodder, being relished by all kinds of stock. Per qt., 15 cts.; bush. (25 lbs.), \$2.50.

MILLETS.

One bushel will sow one acre.

Common (*Panicum Miliaceum*). Per bush., \$1.75.

German or Golden (*Panicum Miliaceum Aureum*). Medium early; height, three to five feet; heads closely condensed; spikes very numerous. Per bush., \$2.00.

Hungarian (*Panicum Germanicum*). Early; height, two to three feet; abundant foliage, and slender head; withstands drought, and yields well on light soils. Per bush., \$1.75.

SUNDRY FARM SEEDS.

Sorghum, Early Amber Sugar Cane. Its distinctive features are its earliness and great yield of both sugar and syrup. Culture the same as for Corn. Per qt., 20 cts.; bush., \$3.00. If by mail add 15 cts. per qt. for postage.

Sorghum, Early Orange Sugar Cane. A little later than the Amber. It does not succeed well north of latitude 43 degrees. Per qt., 20 cts.; bush., \$3.00. If by mail add 15 cts. per qt. for postage.

Sorghum, Halapense (*Johnson Grass*). Per lb., 20 cts.; bush. (25 lbs.), \$4.00.

Broom Corn, Evergreen. Per qt., 20 cts.; bush., \$3.00.

Canada Field Peas, White. Per peck, 50 cts.; bush., \$1.85.

Cotton, Sea Island. Per lb., 15 cts.

Flax Seed. Per qt., 25 cts.; bush., \$4.00.

Hop Seed. Per pkt., 10 cts.; oz., \$1.00.

Honey Locust. Per lb., 40 cts.

Yellow Locust. Per lb., 40 cts.

Osage Orange. Per lb., 50 cts.; bush., \$8.00.

Serradella. Per lb., 25 cts.

Spring Vetches. Per qt., 15 cts.; bush., \$3.50.

Teosinte (*Reana luxurians*). Per lb., \$1.50.

Wild Rice (*Zizania Aquatica*). Much sought after by water fowl. Per lb., 25 cts.

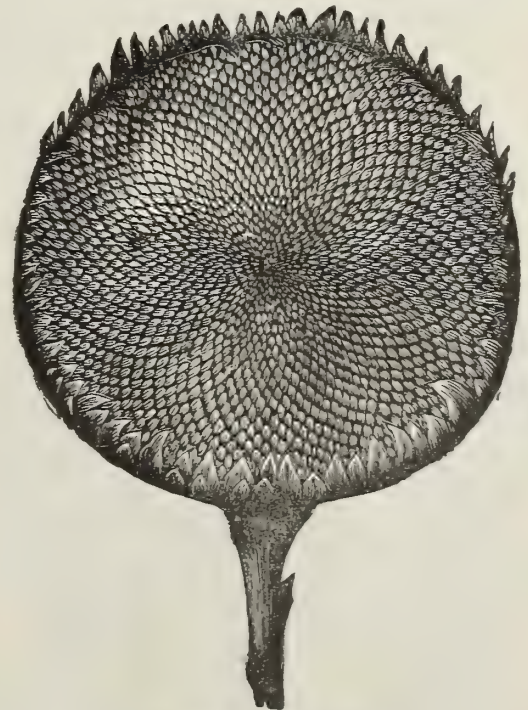

MAMMOTH SUNFLOWER.

Seeds of Deciduous Trees, Shrubs, Evergreen Trees, Hedge Plant, Fruit, and Grape Vines. Prices on application.

NOVELTIES AND SPECIALTIES

— IN —

FLOWER SEED.

Double Flowering Morning Glory.

IPOMEEA PURPUREA FL. PLENO.

This is the first Double Flowering Morning Glory yet introduced. It is of rapid growth and produces its double flowers very freely. They are white, with a slight spot of red or blue at the base of the larger petals. About 80% of the seedlings will reproduce themselves true from seed; the remainder will flower semi-double or single. Per packet, 50 cts.

TECOMA SMITHI.

Valuable addition to our autumn and early winter flowering greenhouse plants. The handsome pinnate leaves, surmounted by the large terminal corymbiferous heads of orange colored blossoms are most charming and effective. The individual flowers are tubular and about two inches long. Especially recommended on account of its easy growth and its floriferousness. Per packet, 50 cts.

Ten Weeks Stock, "Princess May."

"Princess May" produces fine trusses of very large double flowers of excellent shape and of the purest yellow. The individual flowers when fully expanded have attained the extraordinary size of two inches across or six inches in circumference.

It is early flowering, and will prove exceedingly popular both in private gardens and as a market pot plant. Per packet, 25 cts.

White Perfection Balsam.

The seed we offer has been saved from a magnificent strain of dwarf Double Pure White Balsams. The individual flowers are of perfect form, pure white and produced in great profusion; very useful for cutting. Per packet, 10 cts.



White Perfection Balsam.



Cosmos Hybridus.

Mammoth Perfection Cosmos.

The flowers are double the size of the old large-flowering Cosmos, measuring 12 to 15 inches in circumference; the petals are broader and overlapping, forming a perfectly round flower, deeply ribbed and of splendid substance. For cutting for bouquets and vases this is one of the finest flowers grown, lasting in water for two weeks; the long stems and feathery foliage lend themselves to graceful arrangements.

Large Flowering White.....Per packet, 10 cts.
 Large Flowering Pink....." " 10 "
 Large Flowering, Choice Mixed....." " 10 "

DATURA CORNUCOPIA.

PURPLE AND WHITE.

A magnificent variety, of striking beauty. The flowers average 8 inches long by 5 inches across the mouth, are formed of two to three flowers, growing one within the other, the interiors being glistening French white, contrasting beautifully with the mottled royal purple exteriors, very fragrant. Seeds started early in the house will produce plants that will flower from early summer until frost. Per packet, 25 cts.

DATURA CORNUCOPIA.

YELLOW.

Every one that is acquainted with the Datura cornucopia can imagine a plant of the same general appearance, with flowers the same size, form, and shape, differing only in color, which is a beautiful shade of yellow. Per packet, 25 cts.

NEW SALVIA, CLARA BEDMAN.

This is the finest Salvia for bedding yet introduced. The plants grow into compact oval bushes, about 2½ feet high, producing long spikes of brilliant scarlet flowers. The spikes stand out stiff and erect; over 200 spikes to a plant are not unusual, and the spikes bear from 20 to 30 flowers each. Per packet, 15 cts.



SWEET PEAS.

The Cream of Eckford's New Varieties.

	PER PKT.
Adonis. Carmine rose, very showy.....	\$0 05
Alba Magnifica. Pure white, very fine..	10
Apple Blossom. Bright rose; wings apple blossom.....	10
Boreatton. Standards rich maroon, wings purplish maroon, rich and velvety	10
Butterfly. Pure white, delicately laced with lavender....	5
Crown Princess of Prussia. Bright blush, large and showy.....	5
Duchess of Edinburgh. Light scarlet, flushed crimson, splashed at the edge with white; wings deep rose	10
Emily Henderson. Absolutely pure white, as clear as alabaster and as lustrous as satin. The best white for forcing under glass.....	10
Grand Blue. Bright blue, mauve and violet.....	10
Indigo King. Rich indigo blue.....	5
Miss Blanche Ferry. Deep pink and white. The best pink for forcing under glass.....	5
Mrs. Gladstone. Pink standard, blush wings; singularly delicate and pretty.	10
Mrs. Sankey (black seeded). Large, bold flower, pure white, excepting standards, which are faintly flushed.....	10
Painted Lady. Rose and white.....	5
Princess Beatrice. Bright rose.....	5
Princess of Wales. Shaded and striped mauve on white ground.....	10
Queen of England. Yellowish white, large flower.....	10
The Queen. Light rosy pink standard, wings light mauve.....	10
Violet Queen. Colors varying from deep mauve to light violet.....	5
White. The old fashioned pure white. Fine for cutting....	5
Choice named varieties, separate colors, per oz., 25 cts.; ¼ lb., 75 cts.; lb.....	\$2.50
Choice mixed varieties, per oz., 20 cts.; ¼ lb., 50 cts.; lb.....	1.50
Common mixed Sweet Peas, per oz., 10 cts.; lb.....	.75

Collection of six named varieties, 40 cts.; twelve varieties, 75 cts.

COPYRIGHTED 1888 BY A. BLANC

CARNATION, GOLDEN BEAUTY.

Of a bright yellow color, producing a large proportion of double flowers from seed. Strong, robust habit; large flowers. Per pkt., 25 cts.

CARDINAL POPPY.

This variety differs from all other Poppies through its particularly sturdy, dwarf and compact habit. It is about eighteen inches high, with deeply indented foliage of a very bright green, and bearing ten or twelve enormous and extremely double flowers of a glowing scarlet on white ground. Per pkt., 10 cts.

DWARF FRENCH CANNA, MADAM CROZY.

The immense flower heads of deepest vermilion, gold bordered, are double the diameter of a Gladiolus spike, and these flower spikes or heads follow each other so rapidly that the plant is always in bloom. Seed sown in a hot-bed or green-house in January will produce flowering plants in July. Per pkt., 15 cts.

GIANT WHITE DAISY.

(PYRETHRUM ULIGINOSUM.)

If sown early in spring will bloom the first year. Its large, pure, white flowers are produced in the greatest abundance, and being borne on long stems, are of the greatest value for cutting. Our engraving gives a very good idea of the habit of the plant and the form of the flowers. As a flower for summer cutting, for commercial use, or any other purpose, this grand plant should be freely grown, and will give the greatest satisfaction. Per pkt., 10 cts.



**GIANT
WHITE DAISY**



American Flag Poppy.

GRAND DOUBLE POPPY, "AMERICAN FLAG."

The plants are robust growers—about 2 feet high—well branched, bearing freely large flowers, 3 to 4 inches across. Very double and charmingly colored; a pure white ground, margined dark orange scarlet. Unlike most Double Poppies, with two colors, one which is obscure, in this variety the ground color is plainly displayed, making an unusually effective combination. Per pkt., 10 cts.

DWARF FRENCH MIGNONETTE.

New dwarf, compact variety of this universal favorite, with dark red flower spikes; especially adapted for borders and pot culture. The plants are of a robust, pyramidal habit; fine, healthy growers. They throw up very large reddish tinted spikes of delicious fragrance. Per pkt., 10 cts.; oz., \$2.00.

TOM THUMB AGERATUM. LARGE FLOWERING ROSE.

This beautiful variety forms bushy, compact plants about twelve inches high, bearing large tresses of rose-colored flowers in such abundance as to almost cover the plant. For beds in the flower garden, it is very effective, and is equally as desirable for pot culture, or as a basket or vase plant. Per pkt., 10 cts.

PHLOX DRUMMONDI.

Dwarf Varieties for Pots or Bedding.

Sanguinea (Fireball). Brilliant Fire Scarlet; splendid for massing and edging. Per pkt., 10 cts.

Nana Compacta (Snowball). Compact, bushy form, six to eight inches high, with pure white flowers. Per pkt., 10 cts.

Star of Quedlinburgh. Of dwarf habit, with pretty star-like flowers, varying in color from violet blue to deep purple margined with white. Per pkt., 10 cts.

Finest Dwarf Varieties, Mixed. Per pkt., 5 cts.

Double Scarlet. Large double bright scarlet flowers, produced in great profusion, which last much longer than the single varieties. Per pkt., 15 cts.

Double White. The plants produce a profusion of charming, densely double white flowers. Per pkt., 15 cts.

AMERICAN SHOW PANSY.

A Grand Exhibition Pansy.

This strain of Pansy for size and colors has not yet been surpassed. They comprise a wide range of gorgeous colors and markings, with flowers twice the size of the ordinary sorts. Price per pkt., 25 cts.

HUMULUS JAPONICUS FOL. VARIEGATIS.

Variegated Japanese Hop.

A very attractive variety of the Japanese Hop, with beautifully silver-white variegated or blotched leaves. It is as hardy and of the same vigorous growth as the green leaved species, and will prove to be an admirable and decorative climbing plant, well suited for covering fences, rustic arches, etc. Eighty per cent. of the seedlings will come true from seed. Per pkt., 15 cts.



Curled and Crested Zinnias.

CURLED and CRESTED ZINNIAS.

The flowers of Curled and Crested Zinnias are of perfect form—large, round, full and double, the petals being twisted, curled and crested, rendering them entirely free from the stiffness which was heretofore the characteristic of this family. They comprise a wide range of color, embracing all the shades of red, pink, yellow, white, and striped. Per pkt., 10 cts.

GIANT CALIFORNIA PETUNIAS.

These grand strain Petunias are very deep throated. Most of the flowers are exquisitely ruffled or fringed on the edges, and are of enormous dimensions, often 5 inches across, but their great merits lie in the innumerable varieties of colors, many of them intense; with markings, veinings, blotchings and stripings, in the most grotesque and beautiful combinations.

Petunia, Giant of California, AURORA.

A particularly lovely shade of rosy pink, with a distinct red band around the deep exquisitely penciled white throat. Per pkt., 25 cts.

Petunia, Giant of California, MIDNIGHT.

The coloring of this variety is dark claret crimson, with a surface bloom like that of a purple plum. In the sunlight it looks like crumpled velvet. Per pkt., 25 cts.

Petunia, Giant of California, SNOWSTORM.

Of the purest glistening white, with ruffled or fringed edges, deep, yellow throat. Per pkt., 25 cts.

Petunias, Giants of California, CHOICE MIXED

Including all the above colors. Per pkt., 25 cts.



Giant California Petunias.

COPYRIGHTED 1891 BY
PETER HENDERSON & CO.

WEEBER & DON'S GENERAL LIST OF FLOWER SEEDS.

The following **ABBREVIATIONS** are used throughout the **FLOWER SEED** portion of our Catalogue :

H. A.....Hardy Annuals. H. H. A.....Half Hardy Annuals. T. A.....Tender Annuals.	H. P.....Hardy Perennials. H. H. P.....Half Hardy Perennials. H. B.....Hardy Biennials.	H. H. B....Half Hardy Biennials. H. C.....Hardy Climber. G. S.....Greenhouse Shrub.
--	---	---

Full Directions for Sowing FLOWER SEEDS printed on each packet.

FLOWER SEEDS in packets free by mail.

ABOBRA.

Viridiflora. An elegant and rapid-growing climbing plant, with glossy dark green foliage, and bright scarlet fruit. H. H. P. 10

ABRONIA.

Beautiful trailing plants, with pretty Verbena-like clusters of sweet-scented flowers; valuable for hanging-baskets or vases. H. H. A., ½ ft.
Umbellata. Deliciously fragrant rosy-lilac flowers..... 5
Fragrans. Sweet-scented, waxy yellow flowers..... 10

ACACIA.

Elegant winter and spring flowering plants, remarkable for their graceful and varied foliage. G. S. Finest mixed varieties..... 10

ACROCLINIUM.

Beautiful border plants, with pretty everlasting flowers; fine for winter bouquets. H. H. A., 1 ft.
Album. Pure white..... 5
Roseum. Bright rose..... 5
Finest Mixed Colors...... 5

ADLUMIA.

A beautiful hardy climbing plant of graceful habit. H. A.
Cirrhusa (Mountain Fringe). White, 15 ft. 10

AGERATUM.

A very showy plant, blooming throughout the summer, and if taken out of the ground in fall and potted, will keep up a succession of flowers during winter. H. H. A., 1 ft.
Mexicanum. Fine for bedding or pot culture, blue..... 5
Album. A beautiful white variety..... 5
Tom Thumb, Blue. A floriferous variety of robust form; blue, ½ ft..... 5



AGERATUM, TOM THUMB.

ALYSSUM.



SWEET ALYSSUM.

This is a very much admired and pretty little plant, alike valuable for beds, edgings and rock-work. Blooms nearly the whole summer. H. A.

Odoratum (Sweet Alyssum). White flowers, sweet-scented, ½ ft. Per oz., 50 cts..... 5

Little Gem. Dwarf and compact, never more than three or four inches high, and each covers a diameter of fifteen to twenty inches. They begin to flower when quite young, and remain a full mass of white bloom all the season..... 10

Saxatile. A pretty yellow flowered variety; dwarf, early spring flowering. H. P., ¾ ft..... 5

AMARANTHUS.

Ornamental foliage plants of an extremely graceful and interesting character, producing a striking effect either in the conservatory or flower-garden. H. H. A.

- Atropurpureus.** Red foliage, drooping spikes, 2 ft..... 5
- Bicolor Ruber.** Foliage green and dark red with golden tip, 3 ft. 5
- Caudatus (Love Lies Bleeding).** Dark drooping spikes, 3 ft..... 5
- Cruentus (Prince's Feather).** Erect scarlet flowers, 2 ft..... 5
- Melancholicus Ruber.** Foliage blood red, 2 ft..... 5
- Salicifolius (Fountain Plant).** Distinct variety, with gracefully drooping willow-shaped leaves, marked with orange, carmine and bronze, 4 to 6 ft..... 15
- Tricolor (Joseph's Coat).** Leaves scarlet, yellow and green, 2 ft. per oz., 50 cts..... 5



AMARANTHUS CAUDATUS.

AMPELOPSIS.

A slender growing variety of the Virginia creeper; the young growth during summer is a dark purplish green, changing in fall to the brightest tints of scarlet, crimson and orange. It clings to stone-work, trees, etc., and is a splendid plant for covering unsightly objects. H. P. 50 ft.

- Veitchii (or Boston Ivy).** Per oz., 50 cts..... 10
- Roylii.** Similar to "Veitchii," but with larger foliage and of more rapid growth, and foliage more highly colored in autumn..... 15

ANEMONE.

These are exceedingly beautiful early spring flowering plants. H. P.
Coronaria (Poppy Anemone). Mixed colors. 1 ft..... 5

AQUILEGIA—Columbine.

- Handsome early blooming plants, with flowers of curious form and attractive colors. H. P.
- Single.** Mixed superb colors, 1½ ft..... 5
- Double.** Mixed superb colors, 1½ ft..... 5

**ANTIRRHINUM,
or Snap-Dragon.**

PER PKT.
Handsome free-flowering border plants, with flowers of interesting form, striped and spotted in many rich colors. H. H. P.

Tall Choice Mixed. From the choicest varieties, 2 ft. 5
Tom Thumb. Mixed colors, beautifully spotted, 1 ft. 5

**ARISTOLO-
CHIA, or
Dutchman's
Pipe.**

A very attractive and highly ornamental climber with flowers resembling the Pitcher Plant. H. P., 30 ft.

Sipho. Yellowish brown 10

ARABIS.

An early spring flowering plant. Excellent for borders or rock-work. H. P., ½ ft.

Alpina. Pure white... 10



DWARF CHRYSANTHEMUM-FLOWERED ASTER.



ANTIRRHINUM.

ARNEBIA CORNUTA—Arabian Primrose.

PER PKT.
The blossoms are of a brilliant yellow color with five large black spots. The latter change into a coffee-brown shade on the second day, and disappear altogether on the third day of its bloom, so that pure yellow and spotted flowers are on the same flowering branch. H. A., 2 ft. 25

ASPARAGUS PLUMOSUS NANA.

Graceful and feathery bright green foliage, extensively grown by florists for cutting purposes, the lace-like leaves being used for bouquets, baskets and other decorations. 25

ASTERS.

These are among the prettiest annuals in their season, blooming profusely, and producing, in great diversity of color, flowers of the most perfect and beautiful form. H. H. A.

Dwarf Pyramidal Bouquet. When well grown the plants are completely covered with flowers. Mixed colors, 15 in. 10

Dwarf Chrysanthemum-flowered. A splendid variety, of compact habit. Mixed colors, 10 in. Per oz., \$3.00. 10

VICTORIA. In elegance of habit surpasses all other varieties, being that of a beautifully formed pyramid, bearing ten to twenty flowers, which are perfectly double, imbricated, globular and larger than the peony-flowered variety, 1½ ft.

PER PKT.	PER PKT.
Crimson and White..... 10	Sky Blue..... 10
Dazzling Scarlet..... 10	Peach Blossom Pink..... 10

Victoria White. Flowers large and double; very unique and beautiful; remarkably free flowering, 1½ ft. 10

Mixed Victoria. All colors. Per oz., \$3.00. 10

WHITE PRINCESS OR SNOWBALL. This class resembles in height and habit the Mignon Aster. Each plant produces thirty or more pure white flowers, which keep fresh for a longer period than those of any other kind. 15

Deep Scarlet Triumph. A rich brilliant scarlet; each plant bears at least thirty to forty flowers of great beauty. 15

Harlequin. A variety with spotted and striped double flowers of various colors; dwarf and novel. 10

Betteridge's Quilled. Flowers composed of tube or quill-shaped petals; very large, double and beautiful colors, 2 ft. Finest mixed. Per oz., \$2.00. 5

Mignon. A beautiful pure-white variety, like the Victoria in form and habit, but a more profuse bloomer. 15

BOLZE'S DWARF BOUQUET. One of the finest dwarf asters; very profuse bloomer. Mixed colors. 10

COMET. A beautiful class, forming fine, regular pyramids twelve to fifteen inches high and covered with large double flowers. The color is a lovely delicate pink bordered with white. 15

GOLIATH. Immense flowers, very double. Mixed colors. 10

QUEEN ASTER. A large flowering class of very fine dwarf habit, not exceeding nine or ten inches in height and bearing profusely full, double imbricated flowers of extraordinary size; excellent for growing in pots for market. Mixed colors. 15

ASTERS—Continued.

PER PKT.
CROWN OR COCARDEAU. A very handsome variety, with large flowers, the centres of which are pure white, bordered with scarlet, violet and many other colors, 2 ft. Finest mixed. 10

PEONY-FLOWERED PERFECTION. The finest variety in cultivation; flowers very large and double, the petals beautifully curved, 1½ ft. Finest mixed colors. Per oz., \$3.00. 10

PEONY-FLOWERED PERFECTION, PURE WHITE. Very beautiful. 10

PEONY-FLOWERED PERFECTION, BRIGHT SCARLET. Brilliant. 10

PEONY-FLOWERED PERFECTION, SKY BLUE. Very effective. 10

Rose-Flowered. A splendid variety of beautiful pyramidal habit; the flowers are large and double. Choice mixed, 2 ft. 10

China. Fine mixed varieties. Per oz., \$1.00. 5

Imported Collections.

Pæony-Flowered Perfection. In twelve separate colors, 75 cts.

Bettridge's Quilled German. In twelve separate colors, 50 cts.

Dwarf Chrysanthemum-Flowered. In six separate colors, 40 cts.

Crown, or Cocardeau. In six separate colors, 40 cts.

Victoria. In six separate colors, 50 cts.; in twelve, 85 cts.



WHITE PRINCESS ASTER.



TRIUMPH ASTER.

AURICULA.

Of this beautiful little plant we have a very fine strain of English-saved seed. The flowers, which resemble the Primrose somewhat, are of various shades of crimson, yellow, maroon, etc. H. H. P.
Finest Mixed Colors.....25

BALSAM—Lady's Slippers.

Magnificent, either for conservatory or out-door decoration, producing, in gorgeous profusion, flowers of the most beautiful and varied colors. H. H. P., 2 ft.

Double Lavender.....10
Double Pink.....10
Double Scarlet, Mottled White.....10
Double White, Striped Red and Purple.....10
Double Pure White. The finest strain.....10
Solferino, Double. Beautifully marked, with scarlet and lilac stripes on satin-white ground10
Camellia-Flowered, Double. From a magnificent collection of double varieties. Mixed colors.....10
Rose-Flowered. Very double choice varieties, mixed.....10
Double Mixed Colors. Per oz., 50 cts..... 5

Imported Collections.

Double Dwarf Camellia-flowered. In six separate colors. .50

BRACHYCOME—Swan River Daisy.

A charming dwarf plant of easy culture, covered with a beautiful mass of *Cineraria-like* flowers. H. H. A.



DOUBLE BALSAM.

Iberidifolia.
 Blue and white, 1/2 ft. . . 5

BROW-ALLIA.

Very handsome, profuse blooming plants, growing freely in any rich soil, H.H.A., 1 1/2 ft.

Cerviakovskii. Blue with white centre, beautiful..... 5
Elata Grandiflora. Sky blue, large and handsome.....10

BALLOON VINE.
 (Cardiospermum.)

A rapid growing, handsome and interesting climber, with small white flowers, which are followed by seed pods formed like balloons. H. H. A.
Cardiospermum Halicababum. White..... 5

BELLIS.

Double Daisy.

One of the most charming of spring flowers, suitable for edgings or pot culture. H. H. P., 1/4 ft.

Perennis, fl. pl., Double White.....10
Longfellow. Double dark rose flowers, which are of unusual size and doubleness.....10
Perennis, fl. pl. Double mixed.....10

BEGONIAS, TUBEROUS-ROOTED.

Magnificent Plants for Bedding.

It is only recently that it has been known what splendid bedding plants the Tuberous-rooted Begonias make, and how beautifully they flower in the open garden under our hot summer sun. The dry tubers can be planted out any time in the spring when the ground is warm, and will produce a wealth of beauty and profusion of bloom all the summer and fall months. The bulbs can be taken up after frost and kept over winter in a dry, warm place. The beautiful foliage consists of shapely, glistening leaves, gracefully disposed, the plants forming dense oval pyramids crowned with unsurpassed sprays of the most brilliant flowers, some small and others of such immense size as to measure from four to six inches across a single flower. Our mixed seeds are all from varieties with splendid flowers, of fine form and substance, of dwarf growth, well adapted for bedding. (See next page.)



DOUBLE AND SINGLE TUBEROUS-ROOTED BEGONIAS.

TUBEROUS BECONIAS.

Griffin's American Strain.

This magnificent strain of double and single begonias, which we now offer for the first time, surpasses all the European introductions. The mammoth flowers comprise the most gorgeous colors, ranging from deep blood crimson through all the shades of scarlet, yellow and white. They are easily forced, and for cut flowers the double has no equal. H. H. P., 1 ft.

EXTRA CHOICE, DOUBLE. Tuberous rooted.....25
EXTRA CHOICE, SINGLE. Tuberous rooted.....15

BEGONIA BULBS—See page 76.

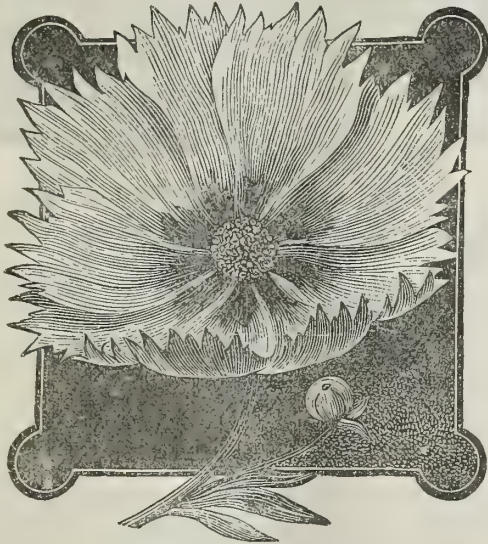

CALLIOPSIS OR COREOPSIS.

CALLIOPSIS, or Coreopsis.

These very profuse blooming plants rank among our best hardy annuals. The flowers are bordered yellow, orange and reddish brown, with dark purple centre. Fine for cut flowers, 2 ft.

Finest Mixed Varieties. Per oz., 50 cts..... 5

Imported collection of ten separate colors, 50 cts.

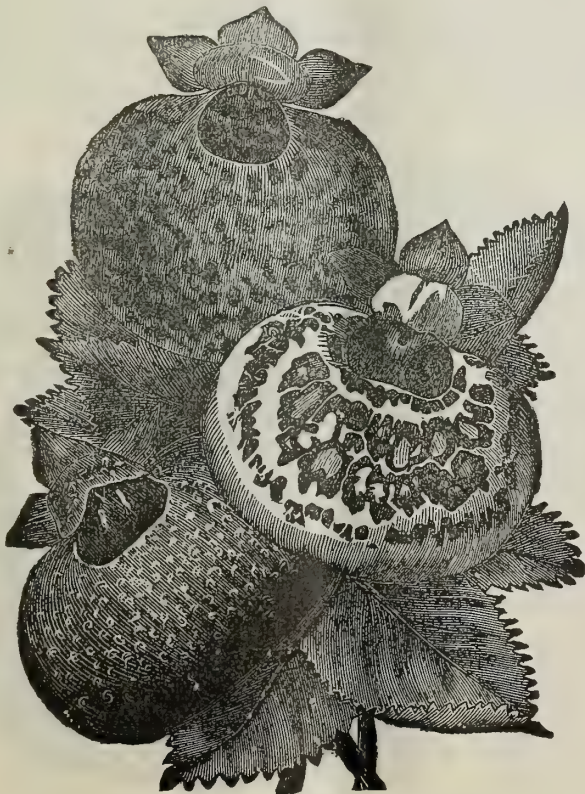

CALCEOLARIA HYBRIDA SUPERBA.

CALCEOLARIA.

PER PKT.

Plants of a highly decorative character, forming in spring dense masses of pocket-shaped flowers, indispensable for the greenhouse or the flower-garden. H. H. P.

HYBRIDA SUPERBA. Saved from the finest formed and most beautiful marked varieties35
Shrubby. Choice dwarf bedding varieties, mixed colors.....35

CACALIA—Tassel Flower.

A very beautiful and profuse flowering plant, with tassel-shaped flowers. H. A.

Coccinea. Orange-scarlet, flowering in clusters; pretty, 1½ ft.... 5

CALANDRINIA.

Beautiful free-flowering plants, adapted for rockwork and dry, hot situations. H. A.

Splendid Mixed Colors. 1 ft..... 5

CALLIRHOE.

Dwarf, free-flowering plants, coming into bloom when small, and continuing during the entire summer. The rich, purple-crimson glow of their salver-shaped flowers is very effective.

Pedata. Rich violet purple with white eye; excellent for beds or masses. H. A., 1 ft..... 5

Involucrata. A pretty trailer with rich crimson-purple flowers, a fine hardy perennial rock-plant 5



CALENDULA "METEOR."

CALENDULA—Cape Marigold.

For effective and persistent blooming in beds and groups, the newer varieties of the common marigold have no superiors, their beautiful flowers being produced from early spring until late in the fall. H. A., 1 ft.

Meteor. Large double yellow flowers, striped with orange..... 5

Prince of Orange. Similar to "Meteor," but much darker..... 5

CATCHFLY—Silene Armeria.

A showy, free-flowering hardy annual, rendered interesting by a gummy secretion on the leaves, which entraps small flies.

Mixed. Red, white and flesh colors. 1½ ft..... 5

CLARKIA.

This beautiful and attractive annual has been much improved since its introduction. The flowers are twice the original size, and this, combined with its brilliant colors, profusion of bloom and fine habit makes it one of the most indispensable of garden favorites. H. A., 1½ ft.

Finest Mixed. Double and single varieties..... 5

CENTRANTHUS.

Free-blooming, compact, very delicate, yet effective in beds or edgings. H. A.

Macrosiphon. Mixed colors, 1½ ft..... 5

CAMPANULA.

Well-known handsome hardy biennials, bearing large bell and saucer shaped flowers in profusion; well adapted for borders. H. P.

- Carpatica.** A dwarf-growing plant, producing a fine mass of salver-shaped blossoms. Blue, 1 ft. 5
Carpatica, Alba. Pure white, 1 ft. 5
Grandiflora. Deep purple, 2 ft. 5
Loreii. A pretty hardy annual, with purple-lilac flowers, 1 ft. 5

Canterbury Bells—Medium.

As single specimens these are unrivaled border plants, and also very effective when grown in large pots. H. B., 2 ft.

- CALYCANTHEMA** (*Cup and Saucer*). A comparatively new race of "Canterbury Bells." The flowers are large, of a beautiful shade, resembling somewhat a cup and saucer. Mixed blue, white, lilac, etc., 1½ ft. 5
Finest Double Mixed 5
Finest Single Mixed 5

CANDYTUFT.

Very pretty, profuse blooming plants, adapted for ribbons and flower beds. Cultivated in pots, they form neat and pretty plants for the conservatory during the winter. H. A., 1 ft.

- Fragrant.** Pure white. 5
Lilac. Compact dwarf. 5
Purple. Very fine. 5
Dunnett's Crimson. Very dark. 5
White Rocket. White, large trusses. Per oz., 30 cts. 5
White. Very robust. 5
Splendid Mixed. All colors. Per oz., 25 cts. 5
Empress. A beautiful variety, producing large trusses of pure white pyramidal-shaped flowers; very effective. 10
Snow Queen. The flowers are pure white, produced in handsome clusters, and in such great abundance that at a distance the plants resemble a ball of snow. 10
Perennial (*Iberis Sempervirens*). Pure white. 10

CANNA—Indian Shot.

Beautiful large-leaved foliage plants, suitable for forming groups on lawns or centres of mixed flower beds. The flowers of many of the varieties are very handsome.

- Anneii.** Crimson, very ornamental, 3 ft. 15
Bonetti. Red and yellow, handsome, 7 ft. 15
Discolor Floribunda. Scarlet, foliage maroon tinted, 3 ft. 15
Marechal Vaillant. Orange, foliage green, purple band, 4 to 6 ft. 5
Warszewiczii. Brilliant red, foliage striped, 3 ft. 15
Zebrina. Beautiful zebra-striped foliage, 5 ft. 15
Choice Mixed Varieties. Per oz., 50 cts. 5



CUP AND SAUCER CANTERBURY BELL.

Large Flowering Dwarf French Canna.

A new class of Cannas, dwarf in habit, averaging not over three to four feet in height. Their great merit lies in the large size and brilliant hues of the flowers, ranging through all shades of yellow and orange to the richest crimson, scarlet and vermilion. Seed sown in a hot-bed or green-house from January to April will produce flowering plants in July. H. H. P.

Mixed Colors. Including many new varieties. 10
 Imported collections in six separate varieties, 25 cts.

CARNATIONS AND PICOTEES.

These well-known charming plants are highly prized for the delicious perfume of their flowers. They are invaluable for Pot culture, or bedding out in the summer. H. H. P.

- Bizarres.** Choicest mixed, fancy and selfs, very double, including crimson, rose, white, yellow, purple and striped. 35
Grenadin. Brilliant double scarlet flowers, dwarf and early. 15
Grenadin. Snow white. 25
Hermine. Pure white. 25
Perpetual, or Tree. Of upright growth and branching habit, flowering several times during the season. Choice mixed. 35

CARNATIONS—Continued.

- PER PKT.**
Double Early Flowering. A very early blooming and distinct variety of dwarf and robust habit. 25
Choice Mixed. Saved from one of the finest collections. 25
Fine Mixed. Splendid colors, for the border. 10
 Imported collection of six finest double, separate sorts, 50 cts., or twelve for \$1.00.

- PICOTEE.** Choice varieties, mixed. 50
Fine Mixed, Garden. 10

MARGUERITE CARNATIONS.

Dianthus Caryophyllus, fl., pl. These perpetual flowering Carnations produce a large proportion of double flowers from seed. They bloom in about four months from the time of sowing. The flowers are of magnificent colors, ranging through many shades of pink, red, white and variegated. 10

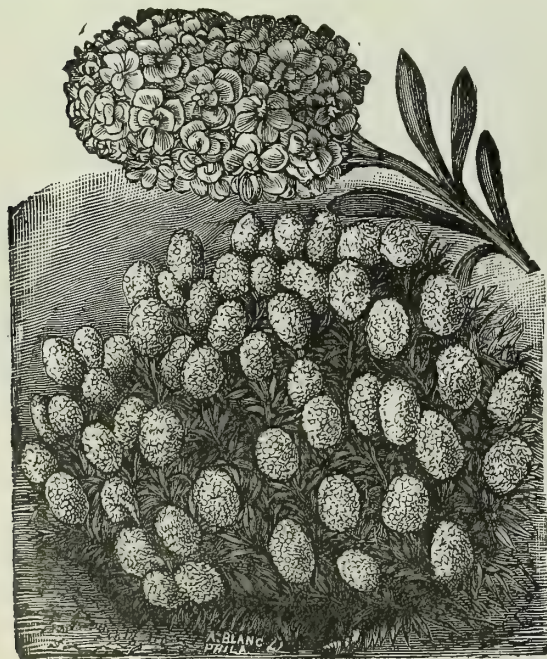

CANDYTUFT, SNOW QUEEN.



MARGUERITE CARNATIONS.



CELOSIA PYRAMIDALIS AUREA.

CELOSIA,
or Feathered Cockscomb.

PER PKT.

Very attractive and showy plants, producing magnificent spikes of beautiful, feathery looking flowers. They succeed well in the garden, if planted out in June. H. H. A.

- Aurea Pyramidalis.** Golden yellow plumes, very handsome, 3 ft. 10
- Scarlet.** Bright and graceful, 3 ft. 10
- Japonica.** Pyramidal plant, composed of crimson branches, each bearing a comb of the same color and finely ruffled. 5
- Fine Mixed Colors.** Many colors. 5

COCKSCOMB.

- Cristata.** From selected Cockscombs, velvety crimson, 1 ft. 5
- Golden Beauty.** Golden yellow combs, 1 ft. 5
- Empress.** This Cockscomb produces combs of colossal proportions. The color is bright crimson, with a rich velvet-like appearance, double and well formed. 10
- Glasgow Prize.** Very dwarf; immense crimson combs, 1 ft. 10
- Queen of Dwarfs.** The finest Cockscomb of all. It grows but six inches high, with beautiful dark rose-colored combs. For bordering or massing it cannot be surpassed. 10
- Fine Dwarf Mixed.** Various colors. 5

Imported collection of six dwarf varieties, 30 cts.



CENTAUREA GYMNOCARPA.



COCKSCOMB, QUEEN OF DWARFS.

CENTAUREA.
Dusty Miller.

PER PKT.

Beautiful silvery-foliaged bedding plants, extensively used for bordering. H. H. P.

- Candidissima.** The most desirable silvery variety for bedding, vases, baskets, etc., 1 ft. Per 1,000 seeds, \$1.50. 10
- Clementi.** Very handsome and ornamental; the leaves, are deeply cut and fringed, and covered with a silvery-white down, 1 1/4 ft. 10
- Gymnocarpa.** A graceful, silvery variety, valuable for bedding, 1 1/2 ft. Per oz., \$2.00. 10

CORN FLOWER—See Cyanus.

CHRYSANTHEMUMS.

The following varieties, when well grown, are among the most beautiful and showy of summer blooming plants. Very attractive. H. A., 1 1/4 ft.

Single Annual Varieties.

- Burridgeanum.** White centre, crimson band, beautiful. 5
- Eclipse.** Golden yellow, scarlet ring; centre rich brown. 5
- Gladstone.** Brilliant rich crimson. 5
- Lord Beaconsfield.** Crimson, maroon edged and striped gold, brown eye. 5
- The Sultan.** Crimson maroon, centre a wide gold rim. 5
- Tricolor.** White, with yellow band, very pretty. 5
- Venustum.** Crimson centre, white band; handsome. 5
- Fine Mixed Varieties,** including new hybrids. Per oz., 50 cts. 5
- Chrysanthemum Latifolium** (*Giant White Moon-Penny Daisy*). This is one of the finest, forming bushy plants about two feet high, which are literally covered with large, pure white flowers, three inches across. Very effective for garden decorations. 10

Double Annual Varieties.

- Coronarium, Double Yellow.** Handsome border plant, 2 ft. 5
- Double Scarlet.** Very effective, 2 ft. 10
- Double White.** Very showy, 2 ft. 5

PER PKT.

- Inodorum Plenissimum.** Small double white flowers. Fine for cutting. 10
- Fine Mixed Varieties,** including new sorts. 5
- Porcupine** (*Coronarium imbricatum, fl. pl.*). The flowers are extremely double and of a golden yellow color; plants bushy, 1 ft. 15

Imported collection of 6 separate sorts, 25 cts.

- New Perennial Varieties.** The seed we offer has been saved from a superb collection, and includes all the best named show varieties. EXTRA CHOICE MIXTURE. 50

Paris Daisies.

- Chrysanthemum Frutescens Grandiflorum** ("Marguerites"). White, dark eye, fine for cut flowers. 10



CHRYSANTHEMUM ECLIPSE.



CINERARIA, EXTRA SELECT LARGE FLOWERING.

CINERARIA.

PER PKT.

A well-known greenhouse plant, having a range and brightness of color scarcely surpassed. It may be had in bloom through the greater portion of the year. G. P.

LARGE FLOWERING EXTRA SELECT. The plants are of dwarf habit, flowers beautifully marked; brilliant colors, 1½ ft. .50

Finest Mixed Varieties. Comprising showy and striking colors, 1½ ft. .25

New Pyramidal. Of a beautiful pyramidal form; the flowers are borne in immense heads and run through all the various combinations of colors. Very desirable. .50

Double Flowering. This is unquestionably one of the finest florists' flowers. The colors represent all the finest tints of this class. .50

Maritima. An exceedingly pretty silvery-leaved variety, adapted for bedding, 1½ ft. 5

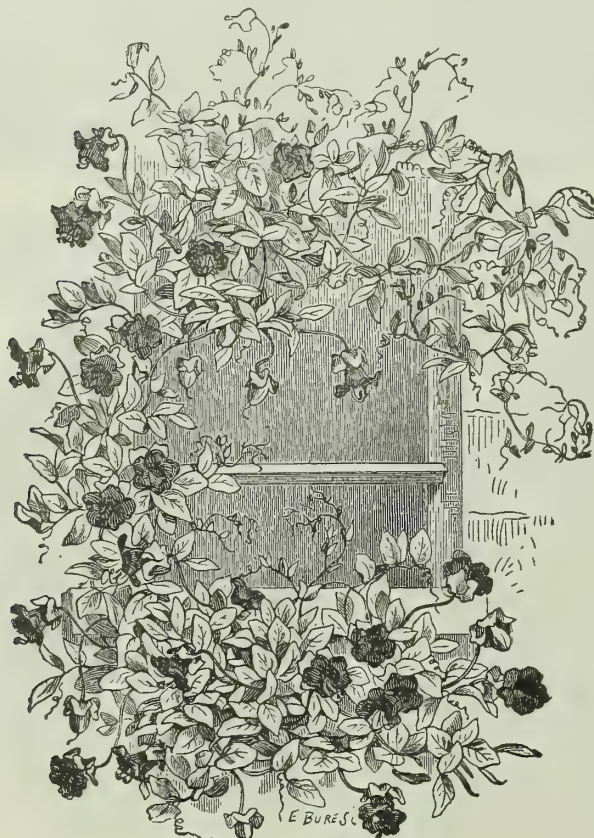

COBÆA SCANDENS.

CLEMATIS.

PER PKT.

Very rapid growers and free bloomers, adapted for arbors, fences, etc. H. P., 10 ft.

Cirrrosa. An elegant climber, producing a great profusion of sweet-scented white flowers. 10

Flammula. A beautiful white fragrant variety. 5

Paniculata. Covered with pure white, fragrant flowers, completely hiding the foliage. In September the flowers are followed by seed pods of bronzy red. Perfectly hardy. 15

Jackmanni Varieties. Mixed shades. Flowers three to four inches across. 15

CLIANTHUS.

One of the most beautiful plants in cultivation, about three feet in height with neat compound leaves, and drooping clusters of large, rich scarlet, long petaled, pea-shaped flowers, three inches in length, each flower beautifully marked with a large, black, cloud-like blotch in front. F. S.

Dampierii (Australian Glory Pea). Scarlet and black flowers. . . 10

Punicus (New Zealand Parrot's Bill). Scarlet and white flowers. 10

COBÆA.

Handsome half-hardy perennial climber, with purple-lilac bell-shaped flowers. Valuable for the conservatory; may be planted out of doors in June.

Scandens. Blue. 10

COCCINEA INDICA.

This is a pretty climber, ivy-like foliage, bright and luxuriant, admirably adapted for trellises. The small flowers are followed by numerous fruits two inches long, which turn to brilliant scarlet, spotted with white. H. H. P., 10 ft.

Scarlet Fruited Ivy Leaved Climber. 10

COLEUS.

One of the most popular ornamental foliage plants. It is very decorative in the flower border, and easily grown from seed. H. H. P.

Finest Mixed Hybrids. 25

Finest Large Leaved Varieties, Mixed. 35

COLLINSIA.

An exceedingly pretty, free-flowering annual, remarkably attractive in beds, or ribbons. H. A.

Finest Mixed Varieties. 1 ft. 5

CONVOLVULUS, or Morning Glory.

Beautiful, free-flowering, and remarkably showy plants, with exceedingly handsome, rich-colored flowers, producing in beds and mixed borders an unusually brilliant effect. H. A.

Dwarf Bedding Varieties.

Tricolor Minor. Rich violet-purple, with white centre; trailer. H. A., 1 ft. 5

Crimson Violet. Rich crimson violet, white throat, yellow eye. 5

Roseus. Rose with white throat, fringed purple, golden eye. 5

Finest Mixed Varieties. Per oz., 25 cts. 5

Climbing Varieties.

PER PKT.

Blue. 5

Striped. 5

Blood Red. 5

White. 5

Violet. 5

Finest Mixed Colors. 20 ft. Per oz., 15 cts. 5

Mauritanicus. A beautiful creeping variety, porcelain blue, very floriferous; a charming plant for baskets, vases, etc. H. P., 3 ft. 10



MORNING GLORY.



COSMOS HYBRIDUS.

COSMOS.

PER PKT.

A charming autumn flowering plant, with flowers borne profusely in loose clusters of variegated colors.

- Hybridus Pearl. Beautiful snow white.....10
- Hybridus Mixed. Purple, rose, white.....10

COWSLIP.

A favorite free-flowering-plant, which should be extensively grown for filling the beds and borders of the spring flower-garden. H. P.

- Finest Mixed Colors. 3/4 ft..... 5

CUCUMIS—Ornamental Cucumber.

Remarkable for the ornamental and picturesque character of its fruit and foliage. The rapidity and luxuriance of growth make it one of the most useful vines cultivated.

- Flexuosus (Snake Cucumber). 3 ft..... 5
- Fine Mixed Varieties. Including the most useful and ornamental 5



CYCLAMEN.

CYCLAMEN.

One of the handsomest greenhouse or parlor plants with beautifully mottled foliage. The seed will produce flowering bulbs the second season. G. P.

Persicum. Foliage beautifully variegated; flowers crimson, rose, magenta, scarlet, lilac and spotted, very large and fragrant.....15

Persicum Giganteum. This superb variety is a greatly improved type, having very broad, beautifully mottled coriaceous leaves and stout flower stalks, throwing the flowers well above the foliage.....35

CYPRESS VINE.

Among the most beautiful climbing plants which adorn the flower-garden. The dark green, very graceful fern-like foliage, thickly studded with brilliant starry flowers, is very effective. H. H. A., 15 ft.

- Crimson. Very brilliant..... 5
- White. Beautiful and graceful..... 5
- Rose. Handsome and delicate..... 5
- Ivy Leaved. Pretty scarlet flowers..... 5
- Finest Mixed Colors. Per oz., 50 cts..... 5

CYANUS—Corn Flower.

Ragged Sailor or Blue Bottle.

A very ornamental and easily cultivated flower, exceedingly beautiful in mixed borders, and much prized for table bouquets. H. A., 1 1/2 ft.

- Americana. Large and showy for borders or backgrounds; purplish red; 3 ft..... 5
- Blue..... 5
- White..... 5

CYANUS—Continued.

PER PKT.

Flore Pleno. The flowers may, to a certain extent, be compared to those of Gaillardia Lorenziana. For garden decoration and cutting these pretty double Corn Flowers will be found very useful. Mixed colors. 10

Splendid Mixed Colors. Purple, sky-blue, rose, striped..... 5



CORN FLOWER.

PER PKT.

Extra Choice Mixed Double. From a splendid collection..... 25

Fine Mixed Double. Saved from standard sorts..... 10

Choice Mixed, Single. These single Dahlias are among our most showy late summer and fall blooming plants, and for bouquets they are exceedingly graceful and bright..... 30

DAHLIA.

The seed offered has been saved from a large collection of new and beautiful seedlings comprising the richest shades of crimson, white, orange and maroon. H. H. P., 4 ft.

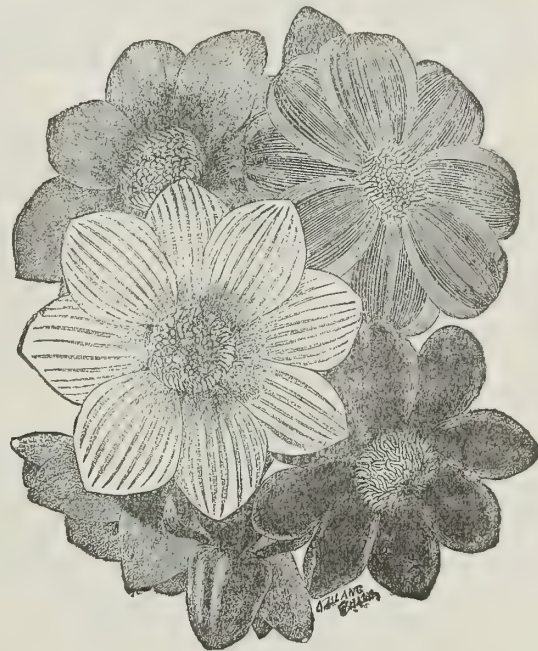

SINGLE DAHLIAS.

DELPHINIUM—Perennial Larkspur.

Magnificent border plants with gorgeous spikes of bloom, varying in shade from the most delicate white to the richest blue. If the seed is sown early, they will flower the first season. H. P.

Brunonianum (Musk-scented Larkspur). Flowers large, one to two inches across; light blue, shading to purple with a black centre; they emit musky odor, 8 to 10 in. Per pkt., 15

Elatum (Bee Larkspur). Blue, 5 ft.... 5

Formosum. Rich dark blue, white centre, 2 ft.. 5

Nudicaule. Spikes of orange-scarlet bloom, 1 1/2 ft.....Per pkt., 5

Zalil (Hardy Yellow Larkspur). Pure sulphur yellow, of branching habit, 4 ft.10

Grandiflorum Flore Pleno. Colors ranging through shades of blue, porcelain and white to dark violet. 15

Finest Mixed Colors, 2 ft. 5



DELPHINIUM FORMOSUM.



SINGLE FRINGED DIANTHUS.

DIANTHUS, or Pinks.

A beautiful genus, which embraces the most brilliant and rich variety of colors. They have a delicate perfume which makes them valuable for cutting. H. A., 1 ft. PER PKT.

Single Annual Varieties.

- Chinensis** (*China or Indian Pink*). Brilliant colors mixed, $\frac{1}{2}$ ft. 5
Laciniatus. A splendid fringed variety, with large flowers of magnificent colors. 5
LITTLE GEM. This is one of the finest of this class. Plants only six inches high, which are almost covered with red and rose margined white flowers. 10
Snowflake. Pure snow white. 10
The Bride. Large flowers of perfect form, marked with velvety dark violet, surrounded with snowy white. 10
Finest Mixed, Single. Superb colors. Per oz., 40 cts. 5

Double Annual Varieties.

- Chinensis Alba, fl. pl.** Double white. 5
Chinensis, Double Crimson. Bright color. 5
Diadematis, fl. pl. One of the finest varieties. The flowers are large and double, comprising beautiful and striking colors. 5
FIRE BALL (*Sinensis, fl. pl.*). This brilliant double Chinese Pink is densely double and of a glowing velvety red color; fine for cutting 10
Heddewigii, fl. pl. (*Double Japan Pink*). Mixed colors. 5
Imperialis, fl. pl. (*Double Imperial Pink*). An extremely pretty variety, beautifully variegated; colors mixed. 5
Laciniatus, fl. pl. A double fringed variety with handsome flowers, brilliant colors mixed. 5
Mourning Cloak, or White Frill. Violet, black and maroon flowers, bordered white. 10



DIANTHUS DIADEMATICUS, FL. PL.

DIANTHUS, DOUBLE ANNUAL VARIETIES—Continued.

- SNOWFLAKE**. Purest white; flowers of large size, very double and delicately fringed. 10
Finest Double Mixed. Containing a fine assortment of exquisite colors. Per oz., 50 cts. 5
Imported collection of eight distinct varieties, 60 cts.

Hardy Double Perennial Varieties.

The Garden Pink is highly admired for its beautifully laced and delightfully fragrant flowers, and is esteemed above all others for decoration and bouquets. It is of easy culture and accommodating habit, growing freely and flowering profusely, either in the greenhouse or open borders. H. P.

- Florists' or Paisley Pink**. Saved from the finest double flowers. 1 ft. 25
Gardnerianus, fl. pl. A beautifully fringed variety, with fragrant double flowers; various colors, $1\frac{1}{2}$ ft. 5
Semperflorens Hybridus, fl. pl. Double "Mule Pink" 25
Finest Mixed, Double. Splendid colors. 5
Finest Mixed, Single. Various colors. 5

GIANT AMERICAN COWSLIP.

Dodecatheon Clevelandi. This beautiful perennial throws up stems of flowers fully one foot high, each surmounted by beautiful Cyclamen-like flowers of violet blue, with yellow and black centre. Perfectly hardy. 15

DIGITALIS—Foxglove.

Handsome plants of stately growth, specially adapted for shrubberies. H. P., 3 ft.

- Purpurea**. Rich purple, spotted. 5
Alba. Pure white, very showy. 5
Gloxinioides. Beautifully spotted, large, Gloxinia-shaped flowers. 5
Finest Mixed Colors. Splendid for mixed borders. 5



DIANTHUS HEDDEWIGII, FL. PL.

DOLICHOS—Hyacinth Bean.

A very ornamental and rapid growing climber, with dense foliage and handsome purple and white flowers. T. A.

- Lablab, Purple, White, Mixed**. Very handsome. Each. 5

ECHEVERIA.

A showy, thick-leaved plant, easy of cultivation in the house, or when used for rockeries, carpet or ribbon beds. T. P.

- Metallica**. Large pinkish leaves, flowers yellow and red, 1 ft. 25
Secunda Glauca. Small bluish white fleshy leaves, flowers yellow and red, $\frac{1}{4}$ ft. 25

EDELWEISS—Gnaphalium.

Leontopodium Alpinum. This is the true variety from the Alps, where it grows in almost inaccessible places among the rocks. The flowers are of downy texture, pure white and star-shaped. 15

EUCALYPTUS.

Ornamental tree, used for sub-tropical gardening; while young it has a powerful influence in destroying the malarious agency which is supposed to cause fever in marshy districts.

- Globulus** (*Blue Gum Tree of Australia*). Per oz., 50 cts. 10

EVENING PRIMROSE—*Oenothera Biennis*.

A beautiful hardy perennial, opening its large yellow flowers in the evening and early morning. 5

ESCHSCHOLTZIA.

California Poppy.

- Remarkable alike for their profusion of bloom and beautiful bright colors. H. A., 1 ft. PER PKT.
- Alba. Creamy white. 5
 - Giant Californian. These have been produced by careful selection and culture for several years, and the mixture contains several beautiful colors. 10
 - Californica. Bright yellow, rich orange centre. 5
 - Mandarin. Large flowers of a bright scarlet; inner side rich orange. 5
 - Rose Cardinal. Beautiful rose color. 5
 - Finest Mixed Varieties. 5

Double Varieties.

- Double White. 5
- Double Yellow. 5
- Double Mixed. 5

EUPHORBIA.

White, foliage nicely veined and margined with white; a showy plant for the border or pot culture. H. H. A.

- Variegata. PER PKT. 5
- HETEROPHYLLA** (*The Annual Poinsettia*). "Mexican Fire Plant." An annual of the easiest culture, forming bushy plants three to four feet high, with glossy green leaves, which form at the ends of the branches into large whorls and bracts, which in summer and autumn become blazed with a darker fiery scarlet so that only a tip of green is left. This is also valuable as a pot plant for house culture. 10

FENZLIA DIANTHIFLORA ROSEA.

A charming hardy annual from California, forming compact, tuft-like plants, two to three inches high, bearing large flowers of a lovely rose color. A desirable edging plant. 10

FERNS.

The seed offered is saved from a large collection of very elegant, new and interesting varieties. Graceful foliage plants.

Greenhouse Varieties, Mixed. Graceful conservatory or window plants. T. P., 6 in. to 2 ft. 15

GLOBE AMARANTH.

Bachelor's Buttons.

Very showy annuals, with extremely pretty everlasting flowers, which are usually cut and preserved for winter bouquets. H. A., 2 ft.

- | | | | |
|----------------------|----------|-------|----------|
| | PER PKT. | | PER PKT. |
| Orange | 5 | Red | 5 |
| Purple | 5 | White | 5 |
| Finest Mixed Colors. | 5 | | |
| Per oz., 50 cts | | | |

GAILLARDIA.

This is one of the most valuable annuals lately introduced. For general decorative purposes as well as for bouquets it is invaluable, its gay-colored double flowers being abundantly produced without intermission, from July until frost sets in.

- Picta Lorenziana.** 5
- Collection of seven grand Hybrid Gaillardias, 60 cts.



EUPHORBIA VARIEGATA.



GLOBE AMARANTHUS.

GERANIUM.

Gorgeous shades of color, borne continuously, render this the most popular plant grown, either for pot culture in winter or for bedding out in summer. Sown early they flower the first season. H. H. P., 1½ ft. PER PKT.



GAILLARDIA LORENZIANA.

- White. 1½ ft. 5
- Mixed. White, lilac and purple, ¾ ft. 5

- Fancy Varieties (Pelargonium).**
- Mixed. 25
 - Extra Choice. Mixed, from prize varieties. 25
 - Scarlet. Fine mixed. 10
 - Fine Mixed. All colors. 10

GILIA.

These well-known and much admired dwarf plants are highly prized for their earliness, and are very effective in masses and rockwork. H. A.

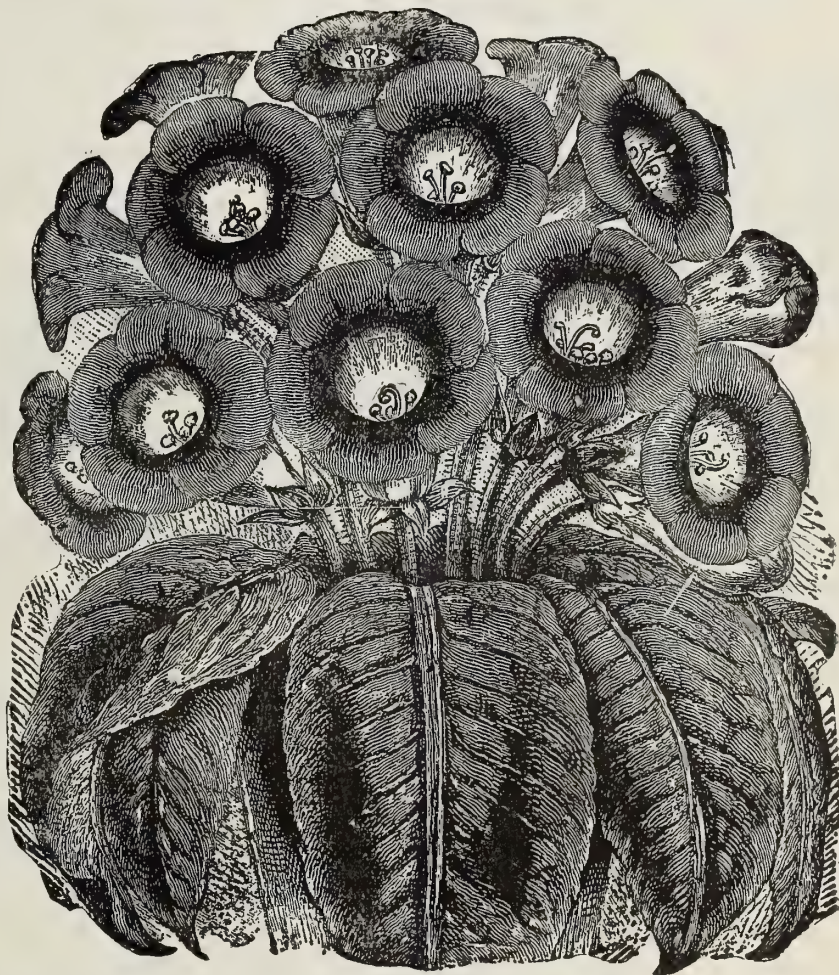

GLOXINIA—LARGE-FLOWERED.

GLOXINIA.

Magnificent strains saved from the very finest flowers in existence, embracing an endless variety of beautiful shades and color.

- Erect Flowering. 35
- Pendulous Flowering. 35
- Erect and Pendulous Flowered. Mixed. 35

GYPSOPHILA.

Pretty, free-flowering little plants. Will do well in any garden soil. The flowers are valuable for bouquet making, either fresh or dried. H. A.

- Elegans. A very graceful plant, with beautiful white and pink flowers, fine for table bouquets, 1½ ft. 5
- Muralis. A charming plant, covered with pretty little red flowers, which contrast beautifully with its very graceful foliage; unsurpassed for small beds, rockwork and baskets, ¾ ft. 5



HUMEA ELEGANS.



HELIANTHUS GLOBOSUS FISTULOSUS.

CODETIA.

Very attractive and exceedingly beautiful annuals embracing a great variety of rich colors; effective in beds, masses and mixed borders. H. A., 1 ft.

- Apple Blossom. Silvery white, spotted crimson and pink..... 10
- Bijou. Milk white with crimson spots..... 5
- Duchess of Albany. A beautiful glossy satin white color..... 5
- Fairy Queen. White flowers passing into blush and large carmine spots at the base of each petal. 10
- Lady Albemarle. Crimson and carmine, suffused lilac..... 5
- The Bride. White, with crimson centre..... 5
- Finest Mixed Colors..... 5

GOURDS—Mock Orange.

A highly interesting genus, of rapid growth, with luxuriant and ornamental foliage, and bearing fruit of the most varied and fantastic forms; very desirable for trellis-work. T. A.

- Chinese Loofa, Sponge or Dish Rag. Large yellow flowers followed by long green fruits, which form inside a tough fibrous mass, which is used for bathing, being superior to a sponge..... 5
- Hercules Club..... 5
- White Nest Egg..... 5
- Finest Mixed Varieties..... 5

Imported Collections in twelve separate varieties, 50 cts.

HELIOTROPE.

Deliciously fragrant plants, equally prized in the conservatory and flower-garden. Plants raised from seed bloom the first season. H. H. P., 1½ ft.

- Finest Mixed Varieties..... 10



JOB'S TEARS.

Within the past few years these grasses have gained in popularity for the numerous forms of winter decoration. Some are curious-looking plants, others exceedingly graceful; some neat and compact, others stately and majestic. The more slender and graceful varieties are very decorative. H. A.

- Agrostis Nebulosa. A very graceful and pretty grass, 1½ ft.... 5
- Avena Sterillis (Animated Oats). Drooping, very graceful, 2 ft. 5
- Briza Maxima (Quaking Grass). Very pretty, 1¼ ft..... 5
- Gracilis (Small Quaking Grass). Very delicate and graceful, 1 ft. 5
- Bromus Brizaeformis. An elegant Briza-like grass, 1 ft..... 5
- Chrysurus aureus. Golden spiked, ½ ft. 5
- Coix Lachrymæ (Job's Tears). 2 ft..... 5
- Erianthus Ravennæ. Resembling the Pampas, with silvery-white plumes. H. H. P., 7 ft..... 5
- Gynerium Argenteum (Pampas Grass). P., 10 ft..... 10
- Hordeum Jubatum (Squirrel Tail). Elegant for bouquets, 2 ft.. 5
- Lagurus Ovatus (Hare's Tail). Small white plumes, 1 ft..... 5
- Panicum Colonom. Very graceful and curious, 1½ ft..... 5
- Setaria Macrocheta. Large drooping plumes, 2 ft..... 5
- Stipa Pennata (Feather Grass). One of the prettiest. P., 2 ft.. 10
- Tricholæna Rosea. A beautiful rose-tinted grass. P., 2 ft.... 5



QUAKING GRASS.

HELIANTHUS

SUNFLOWER.

The following varieties are remarkable for their majestic growth and fine bold outline, admirably adapted for shrubberies; very effective. H. A.

Single Varieties.

- Macrophyllus Giganteus. A tall variety with large yellow flowers, 10 ft..... 5
- Miniature Sunflower. Of dwarf branching habit, bearing many small flowers. Orange with black centre, 3 ft..... 5

- Oscar Wilde. Orange and black, six inches across..... 5

- Russian Mammoth. Immense flowers; very showy, 6 ft..... 5

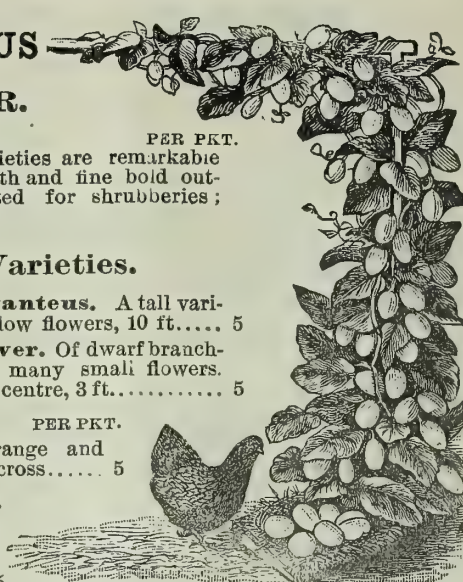

NEST EGG GOURD.

- Silver Leaved. Silvery foliage; flowers yellow and black..... 5
- Sulphur Gem. A delicate primrose or sulphur yellow color with a black centre. Very desirable, 5 ft..... 10

Double Varieties.

- Californicus. Very large double orange flowers, 5 ft..... 5
- Globosus Fistulosus. One of the finest varieties. Flowers one foot in diameter, of bright rich saffron color, 5 ft..... 5
- Grandiflorus Plenissimus. Large double golden-yellow flowers, forming a magnificent ball, 5 ft..... 5
- Peruvianus. Double orange flowers, striped with black..... 10

HELIPTERUM.

- Sanfordi. Pretty annual, producing large clusters of yellow flowers. An "Everlasting" for winter bouquets. T. A., ¾ ft.. 5

HONEYSUCKLE.

Hedysarum Coronarium.

- French. A free-growing border plant of easy culture. Flowers red and white. H. P., 3 ft..... 5

HUMEA.

An elegant and picturesque plant, remarkable for its graceful feathery panicles, and fragrant foliage. H. H. B.

- Elegans. Ruby red, pink and crimson, 6 ft..... 10

GRASSES, ORNAMENTAL.



DOUBLE HOLLYHOCK.

HELICHRYSUM.

PER PKT.
Exceedingly pretty and effective border plants, the dried flowers of which are highly prized for winter bouquets. H. A.
Fireball. Large, dark red, double flowers..... 5
Double Mixed Varieties. Comprising all colors..... 5
Imported collection of 10 separate sorts, 50 cts.



HELICHRYSUM.

HUMULUS.

Japanese Hop.

Ornamental and fast growing annual climbing plant. The very dense foliage of a vivid green hue resembles that of the common hop. The advantage of this climber is that the seeds may be sown in the open ground, where the plants attain gigantic dimensions in a very short time, retaining its fresh and lively green color until late in the autumn. H. A., 25 ft.

Japonicus10

HOLLYHOCK.

The distinctive character and massive beauty of the Hollyhocks render them unrivaled as a picturesque relief to the dark background of evergreen shrubs. For distant effect in large groups they are matchless; they also form a showy and effective outline in flower-gardens and borders, and an admirable boundary line for extensive avenues in park scenery. The seed offered has been saved from exhibition flowers and cannot fail to produce superb varieties. H. P., 6 ft.

- PER PKT.
Double Canary Yellow10
Double Crimson10
Japanese "Tokio," Double15
Double Maroon10
Double Pink10
Double White. The best white variety grown.10
Extra Choice Double Mixed15
Fine Mixed. From good flowers10

Imported collection of six separate sorts, 50 cts.

ICE PLANT.

A pretty little trailing plant of dwarf habit, suitable for rockwork and flower borders. The leaves are covered with crystal-like icy globules extensively employed in garnishing. H. H. A.
Mesembryanthemum crystallinum ... 5



ICE PLANT.

IMPATIENS SULTANA.

One of the most beautiful of decorative plants. It thrives in stove, green-house, and open border during summer. The flowers are of a brilliant rosy-scarlet, 1½ inches in diameter.
Perennial Balsam.....15

JACOBEE—Senecio.

For large beds and mixed borders the Jacobee is very effective. It is a continuous bloomer, and with its rich array of colors, produces a splendid effect. H. A., 1 ft.
Finest Mixed Colors..... 5



LINUM GRANDIFLORUM COCCINEUM.

IPOMŒA.

PER PKT.
Quick growing summer climbers. For covering arbors, walls, trellises, etc., they are unsurpassed. H. A.

- Coccinea** (*Star Ipomœa*). Small scarlet flower, blooming in dense profusion, 8 ft. 5
Grandiflora Marmorata (*Variegated Morning Glory*). Green and white foliage, with various colored flowers.....10
Hookeri. White, lake red and blue.....10
Learii (*Blue Dawn Flower*). Intensely bright blue. Splendid25
Finest Mixed..... 5

LANTANA.

Splendid bedding plant, also beautiful in pots. No plant presents a greater variety of colors and changing hues. H. H. P.
Hybrida. Finest mixed varieties, 1 ft.10

LAVENDULA—Lavender.

This favorite plant is much prized for the delicious fragrance of its violet flowers. H. P., 2ft.
Spica, Lilac..... 5

LARKSPUR.

Elegant and ornamental plants, producing in great variety of form and color some of the most beautiful flowers in cultivation. H. A., 1 ft.

Double Dwarf Rocket Varieties.

- White, Azure Blue, Apple Blossom Pink.** Each..... 5
Emperor. Magnificent; remarkably floriferous; rich colors..... 5
Finest Mixed Colors..... 5

Various Double Varieties.

- Tall Rocket.** Finest double mixed, 2½ ft. 5
Tricolor Elegans. Very handsome spikes of rose, white, and blue, 2½ ft. 5

LARKSPUR DOUBLE

—Continued.

- PER PKT.
Giant Scarlet Californian.
The flowers are a brilliant scarlet, the petals distinctly yellow, 3 ft.10
Rosy Scarlet. Bright rosy scarlet; very double flowers.....10
Lustrous Carmine. Brilliant, fiery carmine, 2 ft.10
Imported collection in eight separate sorts, Dwarf Rocket, 40 cts.

LINUM.

One of the handsomest annuals ever introduced; for brilliancy of color and duration of bloom it is unsurpassed. H. A., 1 ft.
Grandiflorum Coccineum.
Brilliant scarlet..... 5
Flavum. Beautiful golden yellow 5

LOPHOSPERMUM.

Rapid growing and handsome climber, with beautiful large Gloxinia-like flowers. H. A.
Scandens. Dark rose, 10 ft.10



LARKSPUR.

LOBELIA.

A charming dwarf plant, admirably adapted for beds, edgings and rock-work. Their delicate, drooping foliage, and pretty little blue and white flowers render them very attractive in pots or hanging baskets. H.H.A., ½ ft.



LOBELIA, CRYSTAL PALACE COMPACTA.

Erinus Varieties.

- PER PKT.
Duplex. Double blue, distinct. 10
Erinus. A very profuse blooming variety, with pretty, deep blue flowers. 5
Gracilis. Pale blue; spreading habit; very effective in pots. 5
Paxtoniana. Pure white, with blue belt; fine for bedding. 5
Speciosa. Deep blue; fine for bedding. 5

Compacta Varieties.

- Blue King.** Dark blue; white centre. 10
Compacta Alba. Pure white. 5
CRYSTAL PALACE COMPACTA. Intense blue. 10
Finest Mixed Varieties. 5
Littoralis. An attractive species of trailing habit, covering the pot completely like a carpet, and forming with its long, trailing branches a splendid plant for hanging-baskets. The pure white flowers, appearing in large numbers on upright flower stems, are followed by berry-like seed pods. 15



AFRICAN MARIGOLD.

LUPINUS.

A splendid genus of handsome and ornamental garden plants, with long, graceful flower spikes of rich and varied colors

- Annual Varieties.** Mixed colors. 5
Perennial Varieties. Mixed colors. 5



MARVEL OF PERU.

MALOPE.

A handsome plant of branching habit, producing beautiful large crimson flowers in great profusion. H. A., 2 ft.

- Grandiflora.** Purple and white. 5

MARVEL OF PERU.

Four O'Clocks.

Handsome border plants, remarkable for their compact growth, rich glossy leaves, profusion of bloom, and diversity of color in flower and foliage. H. A., 2 ft.

- Finest Mixed.** Brilliant colors. Per oz., 20. 5



FRENCH MARIGOLD.

MARIGOLD.

Magnificent mixed border plants, with elegant and graceful foliage, covered with handsome double flowers of rich and beautiful colors. H. H. A., 1 ft.

- El Dorado.** The colors run through all shades of yellow, from very light primrose to the deepest orange. Very double. 10
Double African Mixed, 2 ft. Per oz., 50. 5
French Dwarf Gold-striped. Large flowers, regularly striped with chestnut-brown on a bright yellow ground. This is one of the best for bedding. 10
Nana Faviflora Brunea. Orange and ruby maroon, 1 ft. 10
Double French Mixed. Per oz., 50. 5

*Imported collection of French, six separate colors, 25 cts.
 Imported collection of African, six separate colors, 25 cts.*

MATHIOLA—Night Scented Stock.

The delicious rich perfume emitted by the flowers of this plant in the afternoon and evening, is delightful. H. A.

- Bicornis.** Pink and lilac, 1 ft. 5

MAURANDYA.

These charming climbers cannot be too highly praised for their beautiful flowers and foliage. From their graceful, slender growth they are admirably adapted for hanging-baskets, vases and trellis-work. H. H. P.

- Barclayana.** Deep violet, 10 ft. 10
Alba. A pretty white variety, 10 ft. 10
Luceyana. Rose; very showy, 10 ft. 10
Finest Mixed Colors. 10

MESEMBRYANTHEMUM.

Dwarf spreading plants, growing in sunny positions and producing freely large wax-like flowers of various colors. H. H. A., ½ ft.

- Tricolor.** Mixed colors. 5

MIMULUS.

Monkey Flower.

Handsome, profuse blooming plants, with flowers of singular form and brilliant colors, rich and beautifully marked. H. H. P.

- Cardinalis.** Scarlet; very striking, 1 ft. 10
Duplex Mixed. Flowers are borne in pairs. 15
New Emperor. Rich colors; mottled and figured. 15
Finest Mixed Varieties. 5



MIMULUS CARDINALIS.



LEVIATHAN MIGNONETTE.

MIGNONETTE.

PER PKT.

- The mignonette is universally esteemed for its delicate perfume, and singularly pretty spikes of bloom. If well thinned out at an early stage, the growth of flower and foliage will be greatly facilitated. H. A.
- Golden Queen.** A distinct variety of Mignonette, with spikes of golden yellow blossoms, which, with the bright green foliage of the plant, forms a pleasing contrast. 5
 - Large-flowered Pyramidal.** A distinct and improved variety, of robust, pyramidal growth and large flowers. Per oz., 50 cts. . . 5
 - LEVIATHAN.** This is without doubt the largest, most compact and odoriferous mignonette yet introduced; splendid for forcing. The seed we offer was saved from selected spikes measuring from 15 to 20 inches. Per oz., \$1.50. 15
 - MATCHET.** Dwarf and vigorous plants of pyramidal growth and thick green leaves with long and broad spikes of deliciously-scented red flowers. Per oz., \$1.00. 10
 - Miles' Hybrid Spiral.** Dwarf and branching with spikes often attaining a length of from 8 to 10 inches. Per oz., 50 cts. 5
 - Parsons' White.** A distinct variety, with very long spikes; nearly white and very fragrant. 5
 - Large Flowering Sweet-scented.** ½ ft.; per oz., 15 cts. . . . 5

MOMORDICA.

- Trailing plants, with curious and ornamental foliage, and remarkable fruit. H. H. A.
- Balsamina (Balsam Apple).** Orange fruit, 10 ft. 5
 - Charantia (Balsam Pear).** Copper-colored scarlet fruit, 10 ft. . . . 5
 - Involucrata (Red Balsam Apple).** Vivid green deeply cut foliage. The flowers are very large; some are creamy white dotted with black, and the males pure white with red pistils. Sulphur-yellow fruits, which change to rich carmine-scarlet. . . . 10



MUSA ENSETE.

MINA LOBATA.

PER PKT.

One of the most beautiful climbers. Flowers bright red in the bud, later on yellowish white and nearly one inch long. After the first flowers have faded, new ones appear on the top of the panicles, so that the plant, when fully developed, appears perfectly covered. T. A. 10

MOONFLOWER.

This well-known plant is certainly one of the most beautiful and rapid growing climbers now cultivated. At night and during dull days the plant is covered with large, pure white fragrant flowers, five to six inches in diameter. H. A., 20 ft.

IPOMEA NOCTIFLORA 16

MORNING GLORY—See *Convolvulus Major*.

MUSA—Abyssinian Banana.

A magnificent sub-tropical plant; very effective in masses or when planted singly. The seed will produce large plants first season if sown early. T. P., 6 to 20 ft.

ENSETE 25

MUSK PLANT—*Mimulus*.

A well-known little plant, thickly studded with pretty yellow blossoms, highly valued for their delicious perfume. H. H. P.

Moschatus. Valuable for pots and window-boxes, ½ ft. 10



MEMOPHILA ENSIGNIS.

MYOSOTIS.

Forget-me-not.

These beautiful little plants are too well known to need recommendation. H. P.

- Alpestris Alba.** White, a very attractive variety, ½ ft. 5
- Alpestris, Blue.** 1 ft. 5
- Azorca.** Blue, shaded purple, a very robust variety, 1 ft. 10
- Cœlestina.** Sky-blue, very floriferous, 1 ft. 10
- Dissitiflora.** Large, sky-blue flowers; very early, 6 to 12 in. . . . 10
- Palustris.** Blue, adapted for moist situations, ½ ft. 5
- Semperflorens.** Perpetual-flowering. Flower from early spring to autumn, 6 in. 10
- Victoria.** Azure blue, remaining in bloom a long time, 6 in. . . . 10
- Finest Mixed Varieties.** 5

NEMOPHILA.

PER PKT.

A genus of exceedingly beautiful dwarf growing plants. Their height and habit of growing being so uniform, and the colors so varied and striking, they never fail to produce a pleasing effect. H. A.

- Insignis.** Clear, bright blue, white centre, ½ ft. 5
- Alba.** Pure white, ½ ft. 5
- Maculata.** White, violet blotches, very pretty. 5
- Fine Mixed.** All colors. Per oz., 25 cts. 5

NICOTIANA.

Sweet scented, pure white, star-shaped flowers, three inches across, blooming continually in the green-house in winter or bedded out in summer. H. H. A., 2 to 3 ft.

Nicotiana Affinis 10



NICOTIANA AFFINIS.

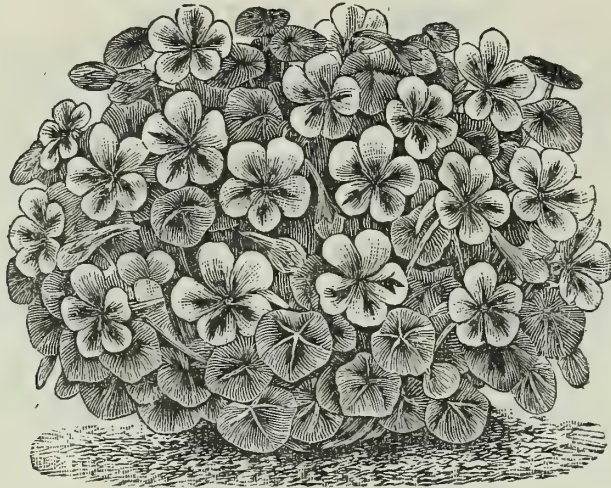

TOM THUMB NASTURTIUM.

NASTURTIUM.

When planted in beds or masses, the brilliant effect of these splendid flowers is scarcely surpassed by any of our finest bedding plants. H. A.

Tom Thumb Varieties.

- AURORA.** A beautiful pink variety, very effective for bedding purposes..... 5
- Brilliant Scarlet.** Very effective in beds, 1 ft..... 5
- Beauty.** Yellow, flushed vermilion, 1 ft..... 5
- Cloth of Gold.** Golden yellow foliage, scarlet flowers..... 5
- Crystal Palace Gem.** Sulphur color, maroon spots, 1 ft..... 5
- EMPRESS OF INDIA.** Brilliant crimson; dwarf, compact habit, with dark tinted foliage. Per oz., 25 cts..... 5
- King Theodore.** Dark green foliage, flowers nearly black, 1 ft.. 5
- King of Tom Thumb.** Intense scarlet, 1 ft..... 5
- Lady Bird.** Orange yellow, red spots..... 5
- Pearl.** Creamy white, very pretty, 1 ft..... 5
- Rose.** New color, splendid acquisition, 1 ft..... 5
- Finest Mixed Tom Thumb Varieties.** Per oz., 15 cts..... 5

Imported collection of twelve Tom Thumb varieties, 50 cts.

Tall or Climbing Varieties.

A well-known and exceedingly ornamental genus of very handsome, profuse flowering plants, which are admirably adapted for rock-work, banks, covering trellises or rustic work; the seeds, if pickled young, are an excellent substitute for capers. H. A., 10 ft.

- Crimson.** Bright and showy..... 5
- Orange.** Very effective..... 5



TALL OR CLIMBING NASTURTIUMS.

NASTURTIUM—TALL VARIETIES—Continued.

- Pearl.** White..... 5
- Purple, Scarlet.**..... Each 5
- Scarlet and Gold.** Bright yellow..... 5
- Yellow, Spotted Crimson.**..... 5
- Finest Mixed.** Per oz., 15 cts..... 5

Imported collection of twelve climbing varieties, 50 cts.

NIGELLA.

Love in a Mist.

Beautiful border plants, with prettily cut foliage and curiously formed flowers.

- H. A.
- Finest Mixed, Double.** Various colors, 1 1/4 ft.... 5



NIGELLA—LOVE IN A MIST.

GENOTHERA—Evening Primrose.

Beautiful, free-blooming plants of majestic habit, with large, silvery-white, golden-yellow and crimson-spotted flowers. H. A.

- Finest Mixed Varieties**..... 5

OXALIS.

A splendid class of plants, with brilliantly colored flowers and dark foliage; suitable either for greenhouse decoration, rock-work or rustic baskets out of doors. H. H. P.

- Rosea.** Delicate rose, forming a pretty plant when in bloom, 1/2 ft. 10
- Tropaeoloides.** Deep yellow, with fine, compact, brown foliage, 1/2 ft..... 10
- Valdiviana.** Fragrant yellow..... 10



OXALIS ROSEA.

PASSION FLOWER—Passiflora.

Magnificent twiners of unrivaled elegance and commanding beauty. The foliage is graceful and attractive, and the flowers truly gorgeous. H. H. A.

- Cœrulea.** A beautiful variety producing rich green foliage and sky-blue flowers, followed in the autumn by a profusion of golden fruit. 20 ft..... 10
- Constance Elliott.** Pure ivory white, flowering profusely..... 20
- Gracilis.** A pure white variety, which grows rapidly..... 10
- Maliformis.** Large blue, white and red flowers..... 20

PENTSTEMON.

These are plants of a highly ornamental character, graceful in habit, and remarkable for the abundance as well as individual beauty of their tubular blossoms; they possess charms which claim for them a first place in the flower garden. H. H. P.

- Finest Varieties Mixed**..... 10



AMERICAN SHOW PANSY.

PANSY.

Viola Tricolor.

This lovely flower, a favorite with every one, is too well known to need any description. Nothing can be more effective, whether grown in beds, ribbons, groups, or interspersed among other plants in the border. It is also admirably adapted for pot-culture, for the decoration of the conservatory during the winter and spring months.

AMERICAN SHOW. No strain of this favorite flower ever enjoyed such popularity, or gave such general satisfaction, as this has done. It embraces all the most striking and beautiful colors. Choice mixed.....25

- Beaconsfield.** Violet, shading to lavender and white.....10
- Emperor Wm.** Dark blue, very fine.....10
- English.** Finest mixed, comprising many beautiful and handsome varieties.....25
- Faust, or King of the Blacks.** Intensely black; very effective in groups.....10
- Fire Dragon.** Fiery orange and bronze, purple eye.....10
- French.** Finest blotched colors.....10
- Mahogany Color.** Peculiar shade.....10
- Mammoth Butterfly.** Mixed colors, beautiful varieties.....25
- Odier, or Five-spotted.** Blotched petals; colors numerous and beautiful.....10
- Rex.** Deep purple, very effective.....10
- TRIMARDEAU.** A distinct and beautiful race; the flowers stand well above the foliage and are generally marked with three large blotches or spots.....20
- White.** Suitable for cemetery planting.....10
- Yellow.** Golden, fine for bedding.....10
- Finest Mixed Varieties.** Per oz., \$1.50.....5

Imported collection of German Pansies, six varieties, 40 cts.; twelve varieties, 75 cts.

SWEET PEAS.

Lathyrus Odoratus.

Beautiful, fragrant and free-flowering climbing plants, continuing in bloom all summer. For trailing over fences and other similar purposes, they are invaluable. Fragrant. H. A., 5 ft.

- Adonis.** Carmine rose, very showy.....5
- Butterfly.** Pure white, delicately laced with lavender.....5
- Crown Princess of Prussia.** Bright blush.....5
- Indigo King.** Rich indigo blue.....5
- Miss Blanche Ferry.** Deep pink and white.....5
- Painted Lady.** Rose and white.....5
- Princess Beatrice.** Rose.....5
- Purple Striped**.....5
- Scarlet Invincible.** Brilliant scarlet.....5
- Violet Queen.** Colors varying from deep mauve to light violet..5

SWEET PEAS—Continued.

- White.** Fine for cutting..... PER PKT 5
- Finest Mixed.** All colors, per oz., 10 cts.; lb., 75 cts.... 5
- Separate Colors, Named Varieties.** Per oz., 15 cts.; lb., \$1.50.

Imported collections in ten separate varieties, 50 cts.

Eckford's New Large Flowering Hybrid.

- Apple Blossom.** Bright rose; wings apple blossom.....10
- Duchess of Edinburgh.** Light scarlet, flushed crimson, splashed at the edge with white; wings deep rose.....10
- Grand Blue.** Bright blue, mauve and violet.....10
- Mrs. Gladstone.** Pink standard, blush wings; singularly delicate and pretty.....10
- Princess of Wales.** Shaded and striped mauve on white ground.10
- The Queen.** Light rosy pink standard, wings light mauve.....10
- CHOICE MIXED VARIETIES.** Per oz., 20 cts.; lb., \$1.50...10

Collections of six named varieties, 40 cts.; twelve varieties, 75 cts.

EVERLASTING PEAS.

Lathyrus Latifolius.

A very ornamental climber; useful for covering trellises, old stumps, etc. The flowers are extremely beautiful, and highly prized for bouquets. H. P., 5 ft.

- Splendens.** "The Pride of California." Brilliant rosy red.....10
- Finest Mixed Colors**.....5

CULTURE OF SWEET PEAS.

Sweet Peas should be sown in drills, as early as possible in spring, in rich, friable soil. Prepare the bed by thoroughly working in a large quantity of well rotted manure. Make a trench six inches deep. In this sow the seed and cover two inches deep. As soon as the plants begin to show through, fill in the trench. This will secure a deep planting without the bad effect of deep covering of the seed at first, and so enable the plant to bloom continually through the heat of summer. As fast as the flowers come into full bloom or fade, they should be cut off, for if the pods are allowed to form, the plants will stop blooming.

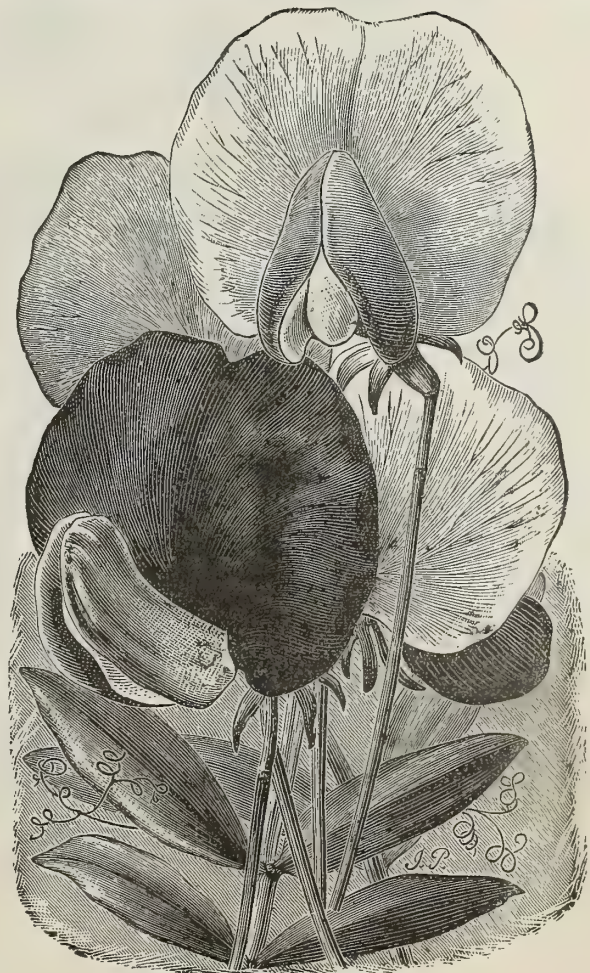

SWEET PEAS.

PETUNIA.

PER PKT.
A highly ornamental and profuse flowering garden favorite, equally effective for the decoration of the greenhouse and sitting-room window, or planted out in beds or borders. The brilliancy of its colors, combined with the duration of its blooming period, render it invaluable. H. H. P.

Single Large Flowering Varieties.

- Striped and Blotched.** Marbled, fringed and variegated, finest mixed..... 10
- Hybrida Nana Compacta.** Its little bushy plants, 5 to 8 inches in height, studded with their regularly striped flowers, are exceedingly effective in masses or pots. Mixed colors..... 25
- Yellow Throated.** Deep throats, with veins of yellow; very handsome. Finest mixed..... 50
- Grandiflora Fringed.** Beautifully fringed, mixed colors..... 25
- Fine Mixed.** Many beautiful and fancy colors..... 5

Large Flowering Double Varieties.

- Double Dwarf.** Inimitable, 6 in. high; small cherry and white flowers..... 35
 - Dwarf Double Lilliput.** Pretty, small double flowers of the most charming shades of color; the flowers are in part spotted, in part striped, and also self-colored..... 50
 - Fringed Double.** Choice mixed colors, one of the finest..... 50
 - Hybrida Grandiflora Pleno.** The finest double variety grown, superb colors..... 25
- Imported collections, single, six separate large flowering varieties, 60cts.; double, six separate large flowering varieties, 75 cts.*



DOUBLE AND SINGLE PETUNIAS.

PHLOX DRUMMONDI.

PER PKT.
For brilliant effect and continuous blooming in the flower garden the Phlox cannot be surpassed. As a plant of simple culture and robust habit, it is not excelled by any annual in cultivation. H. A., 1 ft.

Large Flowering Varieties.

- Alba.** Pure white..... 5
- Coccinea.** Fine deep scarlet..... 5
- Rosea.** Splendid bright rose..... 5
- Purpurea.** Fine deep purple..... 5
- Grandiflora Splendens.** Bright scarlet flowers, with pure white centre..... 10
- Finest Varieties, Mixed.** Per oz., 75 cts..... 5

Imported collection of six separate varieties, 50 cts.

Dwarf Varieties.

- Nana Compacta (Snowball).** Compact, bushy form, six to eight inches high, producing pure white flowers in great profusion..... 10
- Star of Quedlinburgh.** Of dwarf habit, with pretty star-like flowers, varying in color from violet blue to deep purple margined with white, fringed..... 10
- Finest Varieties, Mixed**..... 10
- Double Scarlet.** Large, double bright scarlet flowers, produced in great profusion, which last much longer than the single varieties..... 15
- Double White.** The plants produce a profusion of charming, densely double white flowers..... 15

PERENNIAL PHLOX.

- Elegant heavy border plant, bearing large trusses of brilliant colored flowers. One of the most beautiful plants for beds or mixed borders. H. P.
- Decussata.** Finest mixed, saved from choice named varieties, 2 ft..... 10
- New Dwarf.** Dwarf habit, producing large trusses of beautiful flowers, including many rich colors, 1 ft..... 25

PERILLA.

- Its habit of growth is neat and shrubby, while its dark bronze foliage forms a beautiful and striking contrast, especially to plants of the silvery-leaved order. H. H. A.
- Laciniata.** Edges of the leaves are finely cut or fringed, 1½ ft..... 5

PER PKT.

- Nankinensis.** Foliage black..... 5

POLYANTHUS.

Primula Elatior Polyantha.

- A spring flowering plant, suitable either for out-door or pot culture, producing a profusion of bloom in many rich colors. H. P.
- Gold Laced Mixed.** Early blooming dwarf plant for spring flower beds, with large round flowers on stalks 8 in..... 25
- Finest Mixed.** From finest laced flowers, ¾ ft..... 10



PERILLA NANKINENSIS.



PHLOX GRANDIFLORA SPLENDENS.

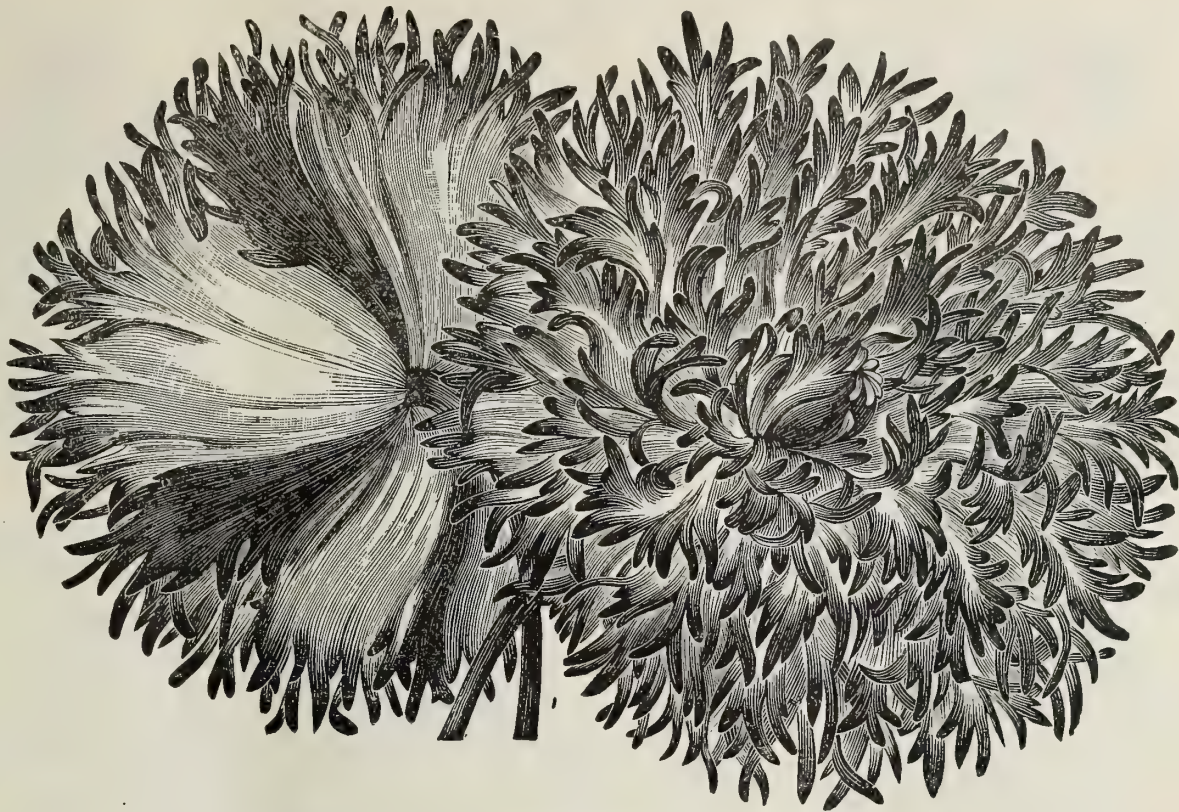

MIKADO POPPY.

POPPIES.

Extremely showy, free flowering plants, which by their stately form, brilliant and effective colors, are admirably adapted to enliven shrubbery and mixed borders. H. A.

Single Annual Poppies.

- Danebrog.** Large flowers of a brilliant scarlet, with a silver spot on each of the petals..... 5
- Flag of Truce.** Large satiny white flowers, three to four inches across; extremely handsome, 2 ft.....10
- Fire Dragon.** Flowers four inches across, of brilliant deep scarlet, with black spots margined white, 2 ft.....10
- Lævigatum.** Flowers four inches in diameter, brilliant deep scarlet with black spots, surrounded by a white margin, at the base of each petal.....10
- Peacock.** Flowers vivid scarlet and cherry crimson, with black zone.....10
- Umbrosum.** Rich vermilion, with a shining black spot on each petal..... 5
- Fine Mixed.** Brilliant colors..... 5

Double Carnation-Flowered Poppies.

A splendid class; flowers round, very double and with finely fringed petals.

- Brilliant Scarlet**..... 5
- Silver Gray**..... 5
- Rose**..... 5
- Pure White**..... 5
- Scarlet and Yellow**..... 5
- White Tipped Crimson**..... 5
- Double Dwarf Chinese.** Not exceeding two feet in height, with magnificent double flowers, very ornamental.....10
- The Mikado.** The petals are cut and fringed; the color, pure white at the back, while the fringed edges are of a brilliant crimson scarlet..... 10
- Fairy Blush.** Large double fringed flowers, white tipped with rose.....10
- Marseilles.** Double white and red, 2 ft. 5
- Poppy, Carnation.** Double mixed, from many varieties, 2 ft ... 5

Imported collection of eight separate varieties, 30 cts.

- Pæoniflorum, fl. pl.** White with scarlet stripes. The broad scarlet stripes on the satiny white ground produce a striking effect.....10
- Pæony-Flowered.** Finest mixed, double, 2 ft..... 5
- French or Ranunculus.** Choice mixed, double, 2 ft..... 5

POPPIES—Continued.

- NEW SHIRLEY POPPIES.** Finest mixed colors..... 10
- Iceland Poppies** (*Papaver nudicaule*). Finest mixed colors.... 10

Hardy Perennial Poppies.

For permanent beds, these elegant large flowering hardy Poppies are unequalled; the flowers average from four to six inches across. Finest mixed, many brilliant varieties, 2½ ft..... 10

Great White California Poppy.

Romneya Coulteri. This fine perennial is of supreme and stately beauty, flowering from July until November. The flowers are pure white, with a fine bunch of yellow stamens, 6 ft..... 10
Imported collection of Double French Poppies in six separate varieties, 25 cts.

PLATYCODON.

The large flowered Chinese Bell Flower; showy hardy perennial bearing large, broad, bell-shaped white, blue or pink flowers. H. P., 6 to 12 in.

- Large Flowering.** Mixed Shades.....10

POLYGONUM—Variegated Leaved.

Orientalis Foliis Variegatis. The red flowers are borne in spikes seven to eight inches long, in great numbers; the foliage is variegated with white, 8 ft..... 10

PORTULACA.

For brilliancy, delicacy, diversity, and beauty of color the Portulaca surpasses all other out-door plants. For small beds, edgings, rockwork, or hanging baskets, it is unrivaled. H. A., ½ ft.

- Alba.** Beautiful pure white..... 5
- Alba Striata.** White, striped crimson..... 5
- Thorburnii.** Deep orange..... 5
- Rosea.** Beautiful bright rose..... 5
- Thellusonii.** Splendid scarlet..... 5
- Fine Mixed.** Single, all colors. Per oz., 40 cts..... 5

Double Varieties, Large Flowering.

- Sulphur**.....15
- White**.....15
- Grandiflora, Double.** Finest mixed; selected from large double flowers, brilliant colors.....10

Imported collections, eight separate varieties, 75 cts.



PRIMULA SINENSIS FIMBRIATA.

PRIMULA.

Chinese Primrose.

For winter decoration, the Primula is one of the most important greenhouse plants. The seed offered has been saved from the finest types, the flowers being large, rich in color, and of great substance, while the habit of the plant is robust, and the flowers stand well above the foliage. G. P., ¾ ft.

Single Large Flowering Fringed Varieties.

- ALBA MAGNIFICA.** Pure white, with large yellow eye and beautifully fringed..... 50
- Chiswick Red.** Brilliant crimson scarlet, beautifully fringed, of robust habit, foliage finely cut 35
- Sinensis Fimbriata, Alba.** Choice pure white, ¾ ft..... 35
- Sinensis Fimbriata, Rubra.** Choice red, ¾ ft..... 35
- Sinensis Fimbriata, Striped.** Effective..... 35
- Sinensis Fimbriata.** Extra choice mixed 35



PYRETHRUM, GOLDEN FEATHER.

PRIMULA—Continued.
Double Large Flowering Fringed Varieties.

- PER PKT.**
- Extra Choice, Double Red.....** 50
- Extra Choice, Double White.....** 50
- Extra Choice, Double Striped.....** 50
- Extra Choice, Double Mixed.....** 50

Primula Obconica (Ever Blooming Primrose). A pretty Primula, with flowers of a soft lilac shade of color, beautifully fringed, flowering continuously from spring till autumn, rendering it one of the most useful of Primulas for pot culture 15

Primula Floribunda. Foliage deep green, stems of both leaves and flowers red, bright yellow flowers, which in color and appearance remind one of the yellow Jasmine..... 20



RICINUS—CASTOR OIL PLANT.

PYRETHRUM.

Very beautiful, and exceedingly ornamental dwarf growing plant, with yellow foliage for edgings and ribbon beds. H. P.

- Pyrethrum Aureum (Golden Feather).** Bright yellow foliage, fine for bedding, 1 ft. Per oz., \$1.50..... 5
- Parthenium, fl. pl. (Double Feverfew).** Double White 10

ROCKET—Sweet.

A very interesting, useful and free-flowering plant. Blooming early, it remains beautiful for a long time in beds, ribbons, etc., and is much admired for the delicious fragrance of its flowers. H. P.

- Finest Mixed.** Various colors, 1½ ft..... 5

RHODANTHE.

A charming everlasting of great beauty, producing a beautiful effect in beds or ribbons, while its silvery, rose-tinted flowers are in great demand for winter decoration. H. H. A.

- Manglesii.** A beautiful and floriferous variety, with semi-double, daisy-like blossoms of bright rose, 1 ft. 5

RICINUS.

Castor Oil Bean.

These plants are cultivated for the stately and highly ornamental character of their growth and foliage. From seed they quickly attain gigantic proportions, and are ornamental till destroyed by frost. H. A.

- Borboniensis Arboreus.** Large and handsome green foliage, 15 ft..... 5
- Communis (Castor Oil Plant).** Large green foliage, 6 ft..... 5
- Gibsonii.** Dark purplish red foliage, 6 feet..... 5
- Obermanii.** Light red foliage; red fruit, 8 ft..... 5
- Sanguineus Tricolor.** Red spotted fruit in clusters; red foliage, 10 ft..... 5
- Finest Mixed Varieties.** Per oz., 20 cts..... 5

RUDBECKIA—Texas Cone Flowers.

These robust growing plants are becoming very popular for border decoration. They are of very easy culture and produce showy flowers during summer and autumn.

Bicolor. An annual variety, bright yellow with black-purple centre. 1½ ft..... 10

Newmanii. Perennial; grows 2 ft.; large golden yellow flowers with velvety maroon centre cone. 10



SALPIGLOSSIS.

SALPIGLOSSIS.

Handsome funnel-shaped flowers of a peculiar velvety softness; very effective in beds, etc.; useful for filling vases and table bouquets. H. H. A.

- Large Flowering.** Finest mixed varieties, including scarlet, sky-blue, yellow and black, 1½ ft..... 5

SALVIA.



SANVITALIA PROCUMBENS.

Magnificent bedding plants of the most brilliant and effective character. Laden with gorgeous scarlet spikes, a bed of *Salvia Splendens* forms a beautiful and highly attractive object. H. H. P., 2 ft.
Coccinea. Scarlet, free-flowering. H. H. A. 10
Patens. Rich deep blue, fragrant. 20
Splendens. Bright scarlet, spikes varying from sixteen to twenty-four inches in length. Per oz., \$3.00. 10
Splendens Compacta Nana. More dwarf and compact in growth than the ordinary sort; rich glowing scarlet color, 1½ ft. 10

SANVITALIA.

Very effective, compact growing plants, admirably adapted for small beds or rock work. H. A.
Procumbens, fl. pl. A beautiful variety of compact form, densely covered with golden-yellow double flowers. 5

SCABIOSA, or Sweet Scabious.

A very showy, free-flowering plant, producing a great profusion of beautiful and richly colored flowers. H. A.



SCABIOSA—MOURNING BRIDE.

SCABIOSA—Continued.

Dwarf Double. Many colors, mixed, 1 ft. 5
Tall Double. Very showy. Mixed colors, 2 ft. 5
Dwarf, Mixed. 1 ft. 5

Imported collection of six separate sorts, 30 cts.

SEDUM—Stone Crop.

A very interesting genus of pretty little plants, which develop a great profusion of brilliant star-shaped flowers. Admirably adapted for rock-work, hanging baskets or vases. H. P., ¼ ft.
Ceruleum. Bright blue flowers, fine for rock-work. 10
Finest Mixed. Recommended for rock-work. 10

SENSITIVE PLANT.

One of the most remarkable and interesting plants in cultivation; so sensitive that the leaves, when touched, instantly fold up.
Mimosa Pudica. H. H. A., 1 ft. 5

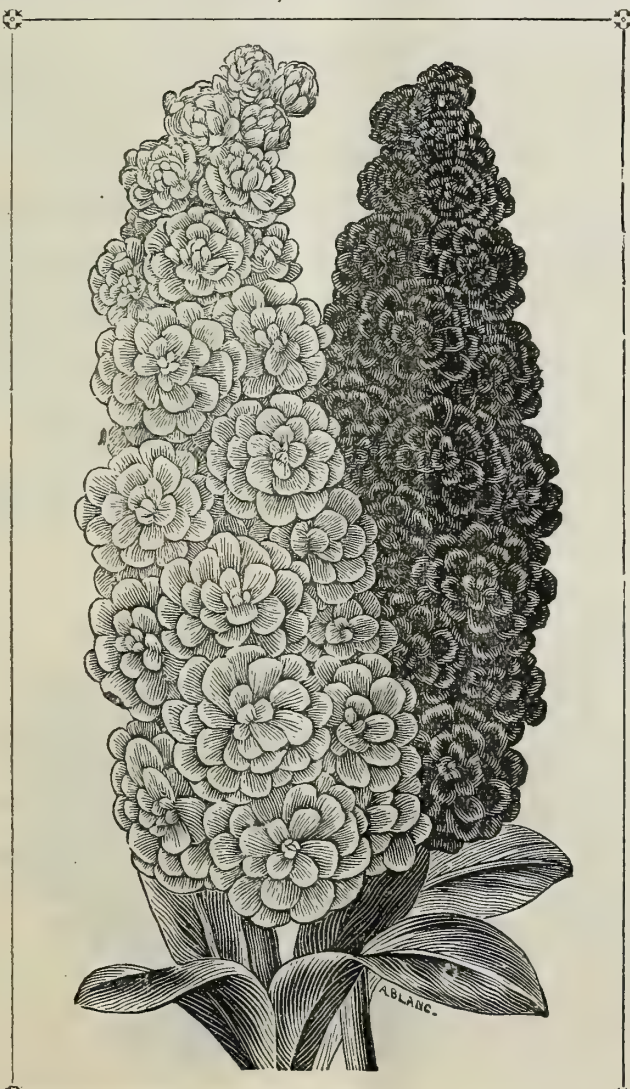

PERPETUAL FLOWERING STOCK.

SMILAX.

The Smilax is the most useful and one of the most graceful climbers which adorn the greenhouse or conservatory; for bouquets and floral decorations it is indispensable. T. P., 6 ft.
Myrsiphyllum Asparagoides. Per oz., \$2.00. 10



SENSITIVE PLANT.

SOLANUM.

A highly ornamental and interesting genus of fruit-bearing plants; singularly grotesque in fruit and foliage. H. H. P.

Capsicastrum (Jerusalem Cherry). Covered with scarlet fruit during winter, 1½ ft. 5

Ciliatum. The fruit resembling a plum, of a rich soft orange-scarlet, 2 ft. 10

Warszewiczoides. It attains a height of six feet and the leaves often measure sixteen inches in length. 10

STOCKS, TEN-WEEKS.

Large Flowering Double Dwarf.

The Stock is one of the most popular, beautiful and important of our garden favorites; and whether for bedding, massing, edging, ribboning or pot culture, it is unsurpassed, either for brilliancy and diversity of color, or profusion and duration of bloom; fragrant. H. H. A., 1¼ ft.

Canary Yellow; Bright Crimson; Blood Red; Sky Blue; Pure White, each. 10
Large Flowering Dwarf. Finest variety grown; mixed. 10
Large-Flowering Dwarf Pyramidal. Spikes eighteen inches long; very handsome. Colors mixed. 10
Wallflower-leaved. Finest colors mixed. 10
Dwarf Snowflake. Double snow-white flowers; very early. 10

Perpetual Flowering Stocks.

PRINCESS ALICE OR SNOW WHITE. The finest perpetual-blooming stock. The individual flowers are very large, perfectly double, and of the purest white; very fragrant. 10
FINEST MIXED TEN-WEEKS. All colors mixed. Per oz., \$2.00. 5
Cut and Come Again. Pure white, beautifully shaped double flowers; a splendid Stock for cutting. 10

Intermediate, or Autumn-Flowering Stock.

The Intermediate Stocks are valuable on account of their flowering late in autumn, also as pot plants for spring blooming. H. H. B., 1 ft.
Scarlet, White, Colors Mixed, each. 10

Brompton and Emperor Stocks.

They may be treated in the same manner as the Intermediate; frequently they last several years, if protected from the frost. The Brompton is a biennial of branching habit.
Brompton or Winter. Splendid mixed, 2 ft. 10
Emperor or Perpetual. Brilliant varieties, 1½ ft. 10

IMPORTED COLLECTIONS OF STOCKS.

Large-Flowering German Ten-Weeks. In twelve separate colors. 75
Dwarf German Ten-Weeks. In twelve separate colors. 75
Dwarf Pyramidal. In six separate colors. 50
Emperor. In six separate colors. 50
Intermediate. In six separate colors. 50



SWEET WILLIAM.

SWEET WILLIAM.
(*Dianthus barbatus.*)

A well-known, free-flowering favorite, exceedingly beautiful and showy. For richness and variety of color they are unsurpassed; very fragrant. H. A., 1 ft.

Single Varieties.

	PER PKT.
Auricula-Flowered. A handsome variety, producing immense trusses of bloom.....	5
Scarlet. Fine.....	5
Pure White.	5
Fine Mixed, Single. All colors. Per oz., 40 cts.....	5

Double Sorts.

Double White	10
Double Crimson	10
Finest Mixed, Double. Beautiful colors mixed.....	5

Imported collection of twelve separate sorts, 75 cts.

SWEET SULTAN—Centauria.

A free-flowering, very effective hardy border plant. The flowers have a delicate honey perfume, and are highly prized for bouquets. H. A., 1½ ft.

Finest Mixed Colors	5
----------------------------------	---



THUNBERGIA.

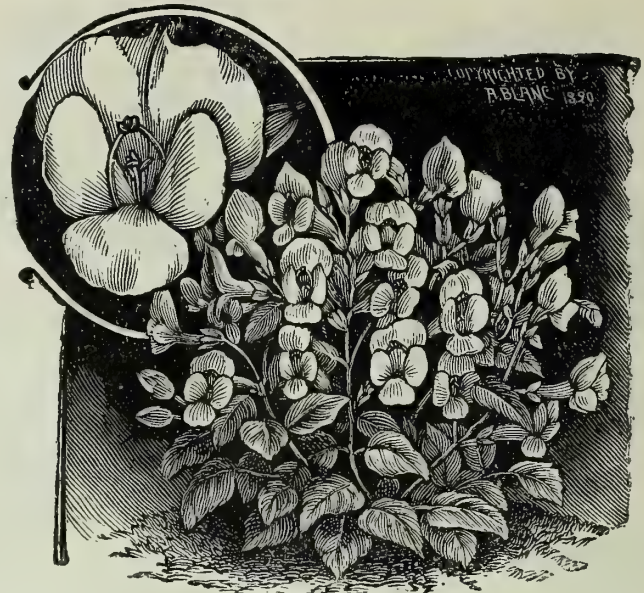

TORENIA, WHITE WINGS.

TAGETES.

A beautiful and delicate fern-leaved plant, forming a compact bush, covered with bright yellow blossoms, with a reddish-brown stripe through the centre of each petal. H. H. A., 1 ft.

Signata Pumila	10
-----------------------------	----

THUNBERGIA.

A slender and rapid-growing climber, with extremely pretty and much-admired flowers, which are freely produced, either in the greenhouse or in a warm situation out of doors. H. H. A., 4 ft.

Alata. Orange, rich brown eye.....	5
Alba. White, dark eye.....	5
Aurantiaca. Bright orange, dark eye.....	5
Bakerii. Pure white.....	5
Finest Mixed Colors. Per oz., 40 cts.....	5

TORENIA.

Beautiful plants for vases, baskets, etc.; they bloom continually during the summer in the open ground, and also in the winter in the greenhouse.

Fournieri. Porcelain blue and rich violet; throat, bright yellow; very free flowering, 6 inches.....	10
White Wings. This variety is very attractive, pure white, with rose at the throat.....	15

TROPÆOLUM—Canary Bird Flower.

Very elegant and beautiful climbers, flowering most profusely; admirably adapted for greenhouse or conservatory decorations, especially during the winter months; very useful for covering verandas, trellis and rustic work out of doors. H. H. A.

Peregrinum (<i>Canary Bird Flower</i>). This variety, with its beautifully fringed, rich yellow flowers and pretty foliage, is universally known and admired.....	5
Finest Mixed Varieties. Per oz., 50 cts.....	5

VINCA.

A genus of beautiful greenhouse shrubs; if sown early in heat, and transplanted to a warm situation in the garden, about May or June, they will flower beautifully in the autumn, and may be potted for the house before frost. T. P., 1½ ft.

	PER PKT.
Rosea. Rose, very pretty.....	5
Alba. White, with crimson eye.....	5
Finest Mixed Colors. Per oz., \$1.50.....	5

VIOLET—Viola.

Well-known plants, suitable for edgings, groups, or mixed borders. *V. odorata* is highly prized for its fragrance. *V. cornuta* is a highly effective garden plant, admired for its rich blue flowers. H. P., ½ ft.

Odorata Semperflorens (<i>Sweet-scented Violet</i>).....	10
Cornuta. Delicate blue.....	10



VINCA ROSEA.



DOUBLE WALLFLOWER.

VERBENAS.

Unrivaled in the splendor of its dazzling brilliancy, the Verbena is the most effective bedding plant in cultivation. Verbenas bloom from seed the first season. H. H. P., 1 ft.

- Bright Scarlet**.....10
- White.** A splendid acquisition.....10
- Hybrida.** Striped varieties.....10
- HYBRIDA, EXTRA CHOICE MIXED.** Saved from a splendid collection of magnificent named varieties.....20
- Mammoth, Choice Mixed.** Flowers of this variety are very large, of dazzling colors and large distinct eyes.....25
- Tom Thumb.** Dwarf and compact, not exceeding six inches in height; flowers well formed, of various beautiful colors; finest mixed.....20
- Fine Mixed Varieties.** Per oz., \$2.00.....5

LEMON-SCENTED VERBENAS.

This is the well-known Lemon Verbena, and is chiefly cultivated for its pleasing fragrant foliage; easily grown, it is in consequence a popular favorite. H. H. A., 2 ft.

- Aloysia Citriodora.** Lemon-scented.....10

VIRGINIAN STOCK.

Charming dwarf free flowering plants, extremely effective in small beds, baskets, or as edgings. H. A., 1/2 ft.

- Finest Mixed.** Red and white.....5

VISCARIA.

Brilliant and effective plants, attractive in ribbons or mixed borders; colors very showy. H. A., 1 ft.

- Large Flowering, Mixed.** Splendid.....5

WALLFLOWER.

Wallflowers are highly prized for their delicious fragrance. In the spring they are indispensable for beds, groups and ribbons. The large, massive, conspicuous spikes of the double German varieties have a charming effect; while the more bushy, compact growth and profuse blooming of the single varieties render them exceedingly attractive. H. P., 2 ft.

Single Large Flowering Varieties.

- Blood Red**.....10
- Golden Yellow**.....10
- Fine Single Mixed**.....5

Double Large Flowering Varieties.

- Canary Yellow**.....15
- Purple**.....15
- Finest Double Mixed.** 1 1/2 ft.....10

Imported collection of six separate sorts, 50 cts.

WHITLAVIA.

A beautiful free-flowering plant with rich bell-shaped blossoms, very effective for bedding or mixed border. H. A., 1 ft.

- Whitlavia Grandiflora.** Violet-blue, 1 ft.....5

XERANTHEMUM.

Very showy and pretty everlastings, valuable to cut for summer and winter bouquets. H. A., 2 ft.

- Alba, fl. pl.** Double white.....5
- Cerulea, fl. pl.** Double purple.....5
- Finest Mixed Colors**.....5

ZEA—Striped Japanese Maize.

A very graceful and attractive foliage plant, unrivaled in the beauty of its variegation. Its broad stripes of alternate white and green present a matchless effect in lawns and shrubberies. H. H. A., 6 ft.

- Japonica**.....5

ZINNIAS.

The flowers are large, beautifully formed and exceedingly handsome. Few plants in the flower border are more effective; and scarcely any flower, when cut, is more suitable for table bouquets. H. H. A., 1 1/2 ft.

- Large Flowering Dazzling Scarlet**.....5
- Large Flowering Canary Yellow**.....5
- Large Flowering Pure White.** Beautiful.....5
- Haageana, fl. pl.** Compact, bushy habit, producing magnificent double yellow flowers.....10
- Zebra, Double Striped.** A splendid strain of large double flowers, beautifully striped and marked.....10
- Tom Thumb.** This miniature class of Zinnias forms charmingly compact, round bushes of six to twelve inches in height, and eight to fifteen inches in diameter. The flowers are very double, and comprise every shade of color.....10
- Finest Double Varieties Mixed.** Per oz., 50 cts.....5

Imported collection of six separate varieties, 25 cts.



ZINNIA ELEGANS, LARGE FLOWERED, DOUBLE.

GARDEN TOOLS and REQUISITES.



- Asparagus Knife.** (Fig. 23.) Very useful..... \$1 25
- Aphis Brush.** For cleaning plants..... 60
- Bellows, Improved.** (Fig. 15.) These bellows are the best for distributing powder for the destruction of insects in the garden or orchard. Small size, each, \$1.25; large size... 1 50
- Bill Hooks.** (Fig. 17.) Light, \$1.25; Heavy..... 1 50
- Brush or Briar Hook.** Can be used for pruning, clearing weeds from potato crops, hedge fences, briars, bushes, etc. Handles, 5½ feet..... 1 75
- Dibbers.** Medium or large..... 40
- Edging Knives, English.** (Fig. 20.) Handles 15 cts. extra. 8 in., \$1.25; 9 in., \$1.50; 10 in..... 1 75
- Floral Tools.** Set of 4. Small, 50 cts.; long handled set.... 1 00
- Forks, Digging.** Best make. 4 prongs, 75 cts.; 5 prongs... 90
- Forks, Manure.** Best Cast Steel. 4 prongs, 75 cts.; 5 prongs... 85
- Forks, Weeding.** (Fig. 21.) 75 cts.; with short handles... 50
- Fumigator, The Eureka.** (Fig. 19.) For fumigating greenhouses, conservatories, pits, frames, poultry-houses, etc.:
 - No. 1. Height, 12 inches; ½ peck of stems..... 1 50
 - No. 2. " " 16 " " 1 85
 - No. 3. " " 20 " " 2 25
 - No. 4. " " 24 " " 3 00
- Flower Pot Scrubbers or Brushes.** Strong and durable. Each, 15 cts.; per dozen..... 1 50
- Gardeners' Gloves.** For handling thorny plants... 85 cts. and 1 00
- Glazier's Points, Van Reyper's.** (Fig. 16.) The only durable and reliable points. Made of steel wire and galvanized.....per box (1,000), 60
- Pincers** for applying same..... 50

- Grafting Wax.** For grafting, cuts and bruises on trees, which causes them to heal up rapidly. Per pkge., each, 10 cts., 15 cts., and..... \$0 25
- Grass Hooks.** (Fig. 22.) English. 3 sizes, 50 cts., 60 cts. and 70
- Hoes, Draw.** With handles, cast steel polished, 5 in., 30 cts.; 6 in., 35 cts.; 7 in., 40 cts.; 8 in..... 45
- Hoes, Scuffle or Dutch.** (Fig. 18.) Handles, 15 cts. extra. 5 in., 55 cts.; 6 in., 60 cts.; 7 in., 65 cts.; 8 in., 70 cts.; 9 in., 75 cts.; 10 in., 80 cts.; 12 in..... 90
- Hose, Rubber.** In 25 and 50 foot lengths. Best quality, per foot, ¾ in., 15 cts.; 1 in..... 20
- Good quality, per foot, ¾ in., 12 cts.; 1 in..... 15
- Hose, Armored Rubber.** First quality, 3-ply, size, ¾ in., per foot..... 20
- Second quality, 3-ply, size, ¾ in., per foot..... 13
- Couplings, 50 cts.; Nozzles, each..... 75
- Hose Mender.** The best mender. ¾ in., each, 15 cts.; per doz. 1 50
- Hose Reels.** Small, \$1.50; large..... 2 00
- Hose Nozzle.** Brass, with spray tip, ¾ in., 75 cts.; 1 in..... 1 00
- Horse Radish Grater, Box Pattern.** Grates 15 lbs. an hour..... 6 50
- Horse Radish Grater, on legs.** Grates 20 lbs. an hour... 10 00
- Hydronette Pump.** Throws water 40 feet..... 5 00
- Knives, Budding.** Finest imported. Fig. 1, \$1.25; 2, \$1.25; 3, \$1.25; 4, \$1.25; 5, \$1.00; 6..... 1 25
- Knives, Pruning.** Finest imported. Fig. 7, \$1.00; 8, \$1.00; 9, \$1.25; 10, \$1.00; 11, \$1.00; 12, \$1.50; 13, \$1.2; 14..... 1 25
- Lawn Sprinkler, "California."** A splendid, small, 4-arm sprinkler..... 2 00

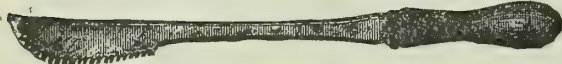

No. 23. ASPARAGUS KNIFE.



No. 21. WEEDING FORK.

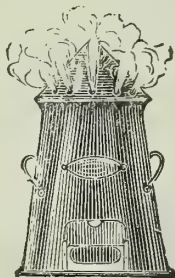

No. 19. FUMIGATOR.



No. 20. EDGING KNIFE.



No. 15. POWDER BELLOWS.



No. 22. GRASS HOOK.

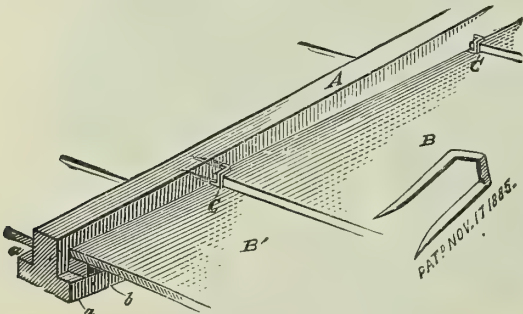

No. 16. GLAZIER'S POINTS

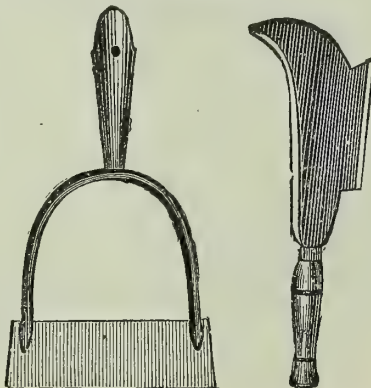

No. 18. SCUFFLE HOE.



No. 17. BILL HOOK.

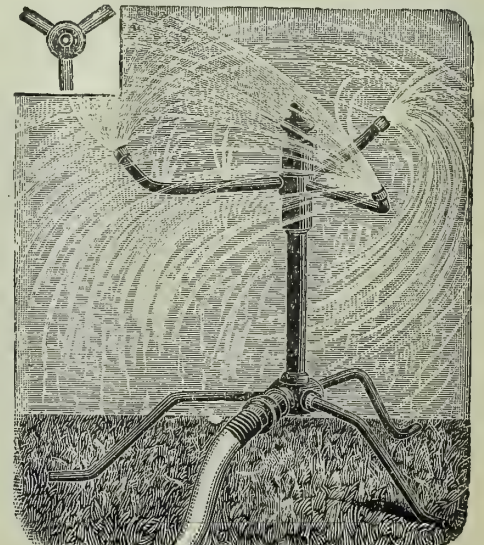

No. 24. CALIFORNIA LAWN SPRINKLER.

GARDEN TOOLS AND REQUISITES—Continued.



No. 25.

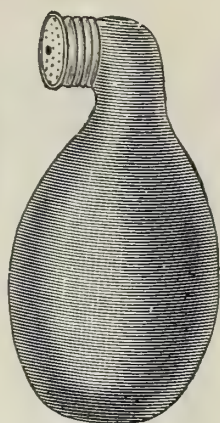

No. 26. PLANT SPRINKLER.

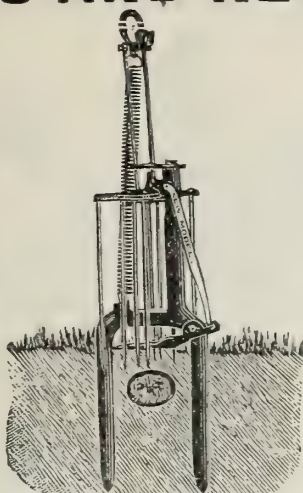

No. 27. NEW MODEL MOLE TRAP.



No. 28. POWDER DISTRIBUTER.

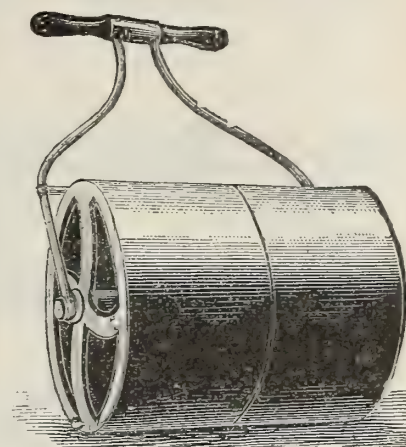

No. 29. GARDEN ROLLER.

- Lines, Braided Garden.** The best garden line made, very durable. 75 feet, 50 cts.; 100 feet, 75 cts.; 150 feet, \$1.00; 200 feet, \$1.50
- Mats, Archangel.** These are extensively used for covering sashes and protecting tender out-door plants during winter... 75
- Mats, Straw.** For covering hot-bed sashes, etc.; 6 x 6 feet... 1 50
- Mole Traps, New Model.** (Fig. 27.) This is the only mole trap that can be set under a hot-bed frame, as the trap, when set, is only 11½ inches over all... 1 50
- Pencils, Indelible.** Black. For marking on wood labels for garden purposes... 15
- Plant Sprinklers, Rubber.** (Fig. 26.) For sprinkling cut flowers and seedlings. Small, 75 cts.; large size... 1 00
- Powder Distributors, Rubber.** (Fig. 28.) For applying hellebore, sulphur and other powders to plants in greenhouses... 1 25
- Powder Gun.** For applying powders to house plants... 20
- Protecting Cloth.** Valuable for protecting early plants from frosts, covering hot-beds and frames in spring, in lieu of glass, and for throwing over bedding plants at night in fall; for Chrysanthemum houses, etc. at one-tenth the cost of glass. Pieces contain from 40 to 60 yards.
- Heavy Grade,** per yard, 12 cts.; by piece, per yard... 11
- Medium Grade,** for general purposes, per yard, 10 cts.; by piece, per yard... 9
- Light Grade,** mostly used in South for tobacco plants, per yard, 6 cts.; by piece, per yard... 5
- Pruner, Eagle Tree.** (Fig. 30½.) The knife and guard of this tool are so shaped as to allow the limb to rest on the joint, so that in cutting it cannot injure the bark or the wood. It cuts easier than any other in use... 1 25
- Pruners, Waters' Tree.** (Fig. 25.) 4 feet, 85 cts.; 6 feet, \$1.00; 8 feet, \$1.15; 10 feet... 1 25
- Putty Bulb, Rubber.** Excellent for glazing. Makes tight and neat joint. Does not daub the glass nor stick to the hands... 1 00
- Raphia.** The best material for tying plants. Per lb... 25
- Rakes, Steel Garden.** 6 teeth, 30 cts.; 8 teeth, 35 cts.; 10 teeth, 40 cts.; 12 teeth, 45 cts.; 14 teeth, 50 cts.; 16 teeth... 55
- Rakes, steel, Short Tooth.** 12 teeth, 50 cts.; 14 teeth, 55 cts.; 16 teeth... 60
- Rakes, Wooden Hay.** 3 bow, 12 teeth... 35
- Rakes, Wooden Lawn.** 22 teeth... 40

- Reels, Garden.** (Fig. 37.) Small size, 50 cts.; medium size, 85 cts.; large size... \$1 00
- Rifles, Emory (Strickles).** For sharpening. Small, 15 cts.; large... 25
- Rollers, Iron Garden and Lawn.** (Fig. 29.) Our rollers have weights attached to the central shaft and can be unhooked and removed when lighter weight is desirable. These weights keep the handle up from the ground.
- | Sizes. | Width of section. | Height. | Weight. | |
|-------------------|-------------------|----------|----------|-------|
| No. 1. 2 section, | 7½ inch. | 15 inch. | 125 lbs. | 6 50 |
| " 2. 1 " | 20 " | 20 " | 220 " | 11 00 |
| " 3. 2 " | 12 " | 20 " | 300 " | 14 00 |
| " 4. 3 " | 12 " | 20 " | 450 " | 20 00 |
| " 5. 2 " | 12 " | 24 " | 400 " | 17 00 |
| " 6. 2 " | 12 " | 28 " | 500 " | 20 00 |
- Rustic Hanging Baskets.** 8 inch, \$1.00; 10 inch, \$1.25; 12 inch... 1 50
- Saws, Pruning.** (Fig. 32.) Double edge. 16 inch, 60 cts.; 18 inch, 70 cts.; 20 inch... 80
- Sash, Hot Bed, Unglazed.** Size, 3 x 6 feet, using 6 x 8 inch glass, each, \$1.00; per doz... 11 00
- Scythes, Lawn.** English. (Fig. 33.) Broad blades, 30 to 40 inches... 1 50
- Scythes, Grass.** American. 30 to 40 inches... 85
- Scythe Snaths (or handle).** Patent fastening... 80
- Scythe Stones.** (Fig. 35.) English round Talacre, 15 cts.; flat... 10
- Scissors, Flower Gatherers.** (Fig. 40.) Best quality. 6 inch, \$1.00; 7 inch... 1 25
- Scissors, Propagating.** (Fig. 39.) For making small soft wood cuttings... 1 00
- Scissors, Vine.** (Fig. 38.) Finest imported. 6 inch, \$1.00; 7 inch \$2.75; 10 inch... 3 00
- Shears, Hedge.** (Fig. 31.) English manufacture. 8 inch, \$2.00; 9 inches, \$2.25; 10 inch... 2 50
- Shears, Hedge, Ladies.** (Fig. 34.) Small and light... 1 50
- Shears, Sheep.** (Fig. 36.) Used for trimming grass borders. 1 00
- Wiss' Hand-Pruning Shears.** (Fig. 41.) Very useful in the graperies and for pruning small fruit, vines, etc. 7 inch, \$1.25; 7½ inch, \$1.50; 8¼ inch, \$1.75; 9 inch... 2 00

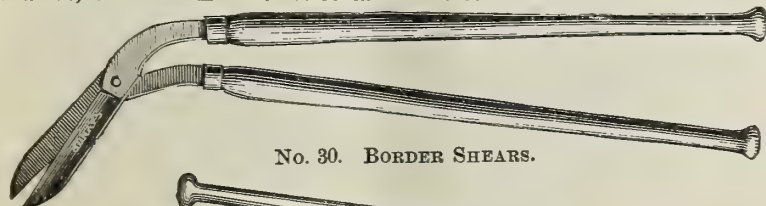

No. 30. BORDER SHEARS.



No. 34. HEDGE SHEARS (LADIES).

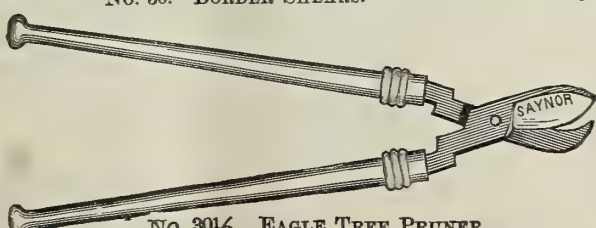

No. 30½. EAGLE TREE PRUNER.

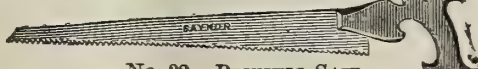

No. 32. PRUNING SAW.



No. 33. SCYTHE BLADE.



No. 38. VINE SCISSORS.



No. 36. SHEEP SHEARS.

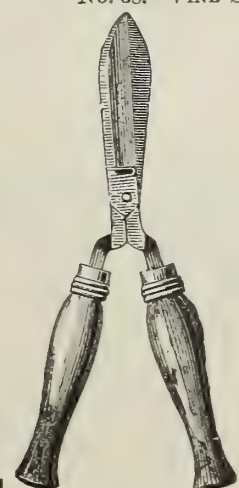

No. 31. HEDGE SHEARS.



No. 37. GARDEN REEL.



No. 39. PROP. SCISSORS.



No. 40. FLOWER GATHERERS.

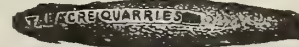

No. 35. SCYTHE STONE.



No. 41. WISS' HAND-PRUNING SHEARS.

GARDEN TOOLS AND REQUISITES—Continued.

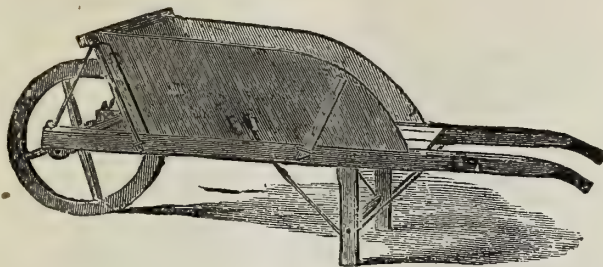

No. 51. GARDEN WHEELBARROW.

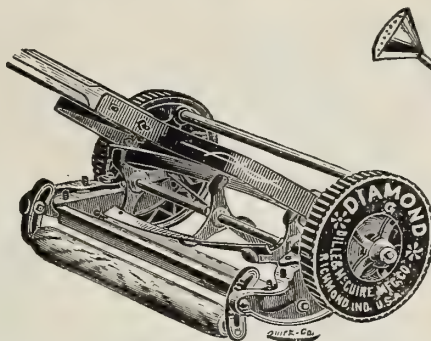

No. 52. DIAMOND LAWN MOWER.

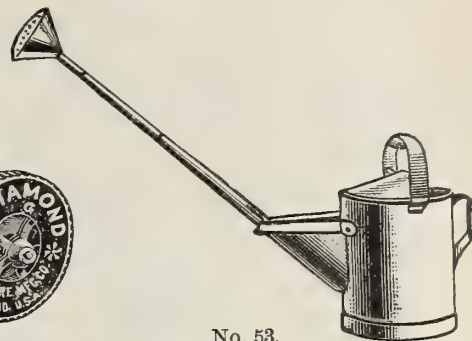

No. 53.

PHILADELPHIA PATTERN WATER POT.

Garden Wheelbarrow.	No. 1. Boys' size.....	\$4 00
	" 2. Small.....	5 00
	" 3. Medium.....	6 00
	" 4. Large.....	7 00

TINNED STONE WIRE. For Stemming.

No. 23. Coarse or camellia, per lb., 25 cts.; per stone (12 lbs).....	2 50
" 26. " " " 30 " " ".....	3 00
" 34. Fine hair, " 35 " " ".....	3 50
" 36. " " " 40 " " ".....	4 00

PATENT ANNEALED TINNED WIRE.

On Spools.

No. 23. Coarse, ¼ lb., 15 cts.; ½ lb., 25 cts.; 1 lb.....	35
" 26. " " " 15 " " ".....	40
" 34. Fine hair, " 20 " " 35 " " ".....	50
" 36. " " " 25 " " 40 " " ".....	75

Wooden Labels. 4 inch, plain, per 100, 10 cts.; per 1,000....	50
5 " " " 15 " " ".....	70
6 " " " 20 " " ".....	90
7 " " " 30 " " ".....	2 00
8 " " " 35 " " ".....	3 00
12 " " " 45 " " ".....	3 50
4 inch, painted, " 15 " " ".....	70
5 " " " 20 " " ".....	85
6 " " " 25 " " ".....	1 25

Tree Labels. Notched.....	" 10 " " ".....	50
----------------------------------	-----------------	----



No. 54. DAISY GRUBBER.



No. 54½. LANG'S WEEDER.

Weeders. Excelsior.....	each	15
Daisy Grubbers (fig. 54).....	"	1 00
Lang's (fig. 54½).....	"	25

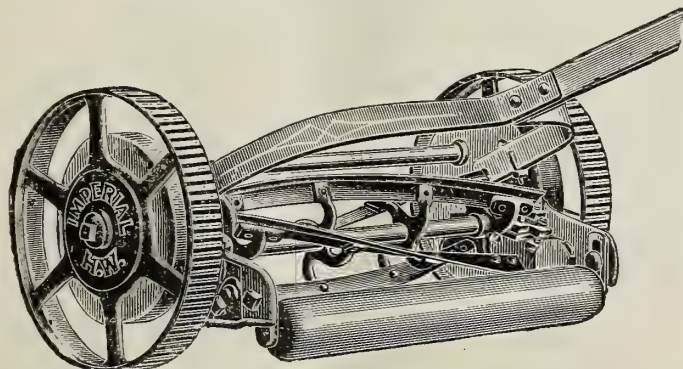

"IMPERIAL" HIGH WHEEL LAWN MOWERS.

The principal feature of this machine is that the bottom knife-bar is bolted to the sides, thus making the frame perfectly rigid, while by a new patent hanger the revolving cutter is adjusted to the bottom knife. This is the reverse of the adjustment in all other mowers. When the knives are properly adjusted, a lock screw secures them in position.

List price 14-inch.....	\$20 00	net price.....	\$7 00
" 16-inch.....	22 00	".....	8 00
" 18-inch.....	24 00	".....	9 00
" 20-inch.....	26 00	".....	10 00

WATERING POTS.

Watering Pots. Galvanized iron, 6 qts., 75 cts.; 8 qts., 85 cts.; 10 qts., \$1.00; 12 qts., \$1.25; 16 qts.....	\$1 50
Watering Pots. French, with long spout and bow handle, 6 qts., \$1.25; 8 qts.....	1 50
Watering Pots. Philadelphia pattern, with two copper-faced roses. (See cut.) 4 qts., \$1.65; 6 qts., \$1.80; 8 qts., \$1.90; 10 qts., \$2.00; 12 qts.....	2 25
Watering Pots. Strawberry (Japan Tin). 3 qts.....	2 00

YEAT'S ZINC GARDEN LABELS.

PRICE, per 100, No. 1, \$2.00; No. 2, \$1.75; No. 5, \$1.75; No. 6, \$1.50; No. 13, \$1.50; No. 14, \$1.00; No. 15, \$1.00.

YEAT'S INDELIBLE INK. For zinc labels. 25 cts. per bottle.

THOMSON'S STYPTIC. For preventing the bleeding of vines. \$1.00 per bottle.

LITTLE'S ANTIPEST. Price, qts., \$1.25; 2 qts., \$1.75; gallon, \$3.25.

THE FARMER'S FAVORITE POTATO-BUG EXTERMINATOR. For dusting Paris green on potato vines. Price, \$1.50 each.

Coldwell's "Improved" HORSE LAWN MOWER.

We believe this to be the best Horse Lawn Mower ever made. It has side draft attachment to enable the horse to walk on the cut grass only, and caster rollers which will not mark the lawn. We secure evenness of cut by an adjustment which raises or lowers the two sides at the same time by means of a simple lever movement; the same lever serves the purpose of raising the knives from the ground when driving over gravel walks or roads. The mowers are fitted up with steel shafting and composition split bushings, same as the hand mowers, and the same care is taken to have the workmanship perfect.

NET PRICES—	
25 inch, without seat or shafts.....	\$37 00
25 inch, with seat and shafts.....	45 00
30 inch, " " ".....	60 00
35 inch, " " ".....	75 00
40 inch, " " ".....	90 00

Horse Boots. Set of four, \$9 00.

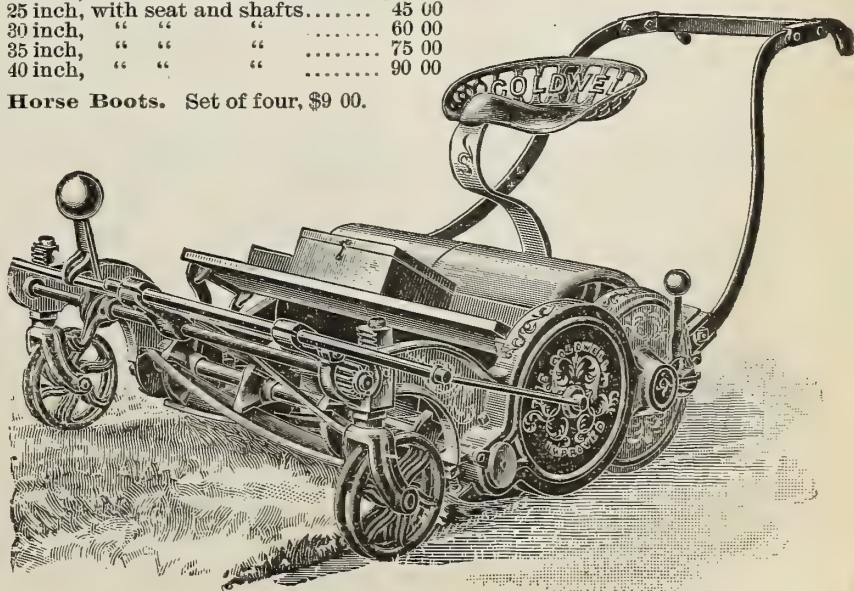

FERTILIZERS AND INSECTICIDES.

FIR TREE OIL.

For destroying all insects and parasites that infest fruit trees and plants, such as Mealy Bugs, American Blight, Red Spider, Green and Black Fly, Caterpillars, Worms, Lice, etc. $\frac{1}{2}$ pt., 50 cts.; 1 pt., 75 cts.; qt., \$1.50; $\frac{1}{2}$ gal., \$2.75; gal., \$5.00.

GISHURST COMPOUND.

A preparation highly recommended for preventing and destroying Red Spider, Mealy Bug, Thrip, Green and Brown Fly, etc. Per box, 50 cts.

WHITE HELLEBORE POWDER.

For destroying the Currant Worm, Rose Slug, etc. Dust on while the foliage is moist. Per lb., 25 cts.

NITRATE OF SODA.

This is valuable solely for the nitrogen it contains, equal to twenty per cent. of ammonia. It is very quick in action, and hastens the maturity of crops fully two weeks. It is valuable for grain, corn, beets, potatoes, grasses, peas, beans, clover, etc.

QUANTITY REQUIRED.—Being extremely soluble, it should not be applied until the plants are above ground, using 100 to 500 pounds per acre, mixed with wood ashes or land plaster.

PRICE, 5-lb. package, 30 cts.; 10-lb. package, 50 cts.; 25-lb. bag, \$1.25; 50-lb. bag, \$2.00; 100-lb. bag, \$3.50; 300-lb. bag, \$9.00; \$55.00 per ton.

HAMMOND'S SLUG SHOT.

An Insecticide and Fertilizer Guaranteed to Destroy Potato Bugs,

and those on Tomato and Egg Plants, Currant Worms, Cabbage Lice and Worms, and Striped Bugs on Melons, Squash, Turnips, Beets, Onions, etc. Per lb., 10 cts.; 5-lb. package, 25 cts.; 10-lb. package, 45 cts.

HAMMOND'S GRAPE DUST.

A powder especially prepared to kill grape rot and mildew on Grapes, Gooseberries, Rose Bushes, etc. Apply with a powder bellows. 5-lb. package, 30 cts.; 100-lb. keg, \$5.00.

FLOUR OF SULPHUR.

A preventive and cure for mildew on Grape Vines, Rose Bushes, etc., in or out doors, and for the destruction of insects on plants. Per lb., 10 cts.; 10-lb. lots, 60 cts.

PARIS GREEN.

Unexcelled for the destruction of Potato Bugs and other insects that eat foliage. Per lb., 25 cts.

WHALE OIL SOAP.

Excellent for destroying and preventing insects on plants, vines, etc. Per lb., 15 cts.; 3-lb. boxes, 40 cts.

TOBACCO SOAP.

The most convenient and cheap specific for the destruction of Insects, Parasites and their Eggs. Per lb., 35 cts.

ANT DESTROYER.

A non-poisonous powder which will destroy or drive away black ants from lawns, trees, plants, houses or other affected locality. Price, $\frac{3}{4}$ lb. can, 50c.

BOWKER'S FOOD FOR FLOWERS.

An excellent fertilizer for house plants. Easily applied by dissolving in water. Clean to handle, without odor, produces rich green growth and profusion of flowers.

PRICE, small package, 15 cts.; large package, 25 cts.

TOBACCO DUST.

This can be used instead of tobacco stems for fumigating greenhouses, and being made from the leaves and not from the stems, it is much more powerful than snuff made from the stems and refuse. Per lb., 10 cts.; 10-lb. packages, 65 cts.; per bbl., \$3.00.

TOBACCO STEMS.

For fumigating plants, to destroy insects in hothouses, hotbeds, etc. In bales of 100 lbs., \$1.75; 300 lbs., \$4.50.

NEW JERSEY PEAT.

Of great value for hothouse and greenhouse plants, and especially for orchids. Per bbl., \$2.25.

SPHAGNUM MOSS.

Very useful for mixing in soil for potting, also for mulching, packing, etc. Per bbl., \$2.00.

PERUVIAN GUANO.

Free from adulteration. 1 lb. package, 10 cts.; 25 lbs. for \$1.50; per bag of about 200 lbs., \$10.00.

PURE BONE MEAL.

This is a very pure, finely pulverized form of ground bone, especially prepared for rose culture, top dressing for lawns and for potted plants. Per lb., 10 cts.; 10 lbs., 50 cts.; per 100, \$3.50; bbl. (200 lbs.), \$6.00; ton, \$45.00.

PURE CRUSHED BONE.

A coarse grade, well adapted for grape vine borders. Per bbl. (200 lbs.), \$5.50; per ton, \$45.00.

PULVERIZED SHEEP MANURE.

Mixed with soil or used as a liquid, it has no equal as a plant invigorator. It differs from guano in effect, as it does not overstimulate nor cause an unhealthy reaction. Per bag (100 lbs.), \$3.50; per ton, \$45.00; in packages, 25 and 50 cts. each.

WEEBER & DON'S

LAWN INVIGORATOR.

This fertilizer is especially prepared for use on lawns, meadows and pasture lands as a top dressing. It contains, in proper proportions, the ingredients required to supply the wants of the various grasses. Its application will induce a luxuriant growth and impart a beautiful dark green color without the aid of any other manure, and land on which it is used will increase in fertility from year to year. Use from 600 to 1,000 pounds per acre when seeding down, and from 400 to 600 pounds per acre as a top dressing. 5 lbs., 30 cts.; 10 lbs., 50 cts.; 25 lbs., \$1.00; 50 lbs., \$2.00; 100 lbs., \$3.75; 200 lbs., \$7.00; ton of 2,000 lbs., \$60.00.

COMPLETE POTATO MANURE.

This fertilizer, although prepared expressly to nourish the potato plant and produce a large yield of perfect tubers, will enrich the land on which it is used for other crops to follow. It contains a high percentage of available phosphoric acid, nitrogen and potash; 600 to 800 pounds per acre is the quantity usually employed. Per bag of 200 lbs., \$5.50; per ton of 2,000 lbs., \$50.00.

COMPLETE MANURE FOR VEGETABLES AND GENERAL CROPS.

A plant food of the most nutritious character, containing, in a highly concentrated form, all the virtues of fertility found in stable manure—600 to 800 pounds per acre. Per bag of 200 lbs., \$5.50; per ton of 2,000 lbs., \$50.00.

The Planet Jr. Hand Garden Implements.

The Planet Jr. No. 2 Seed Drill.

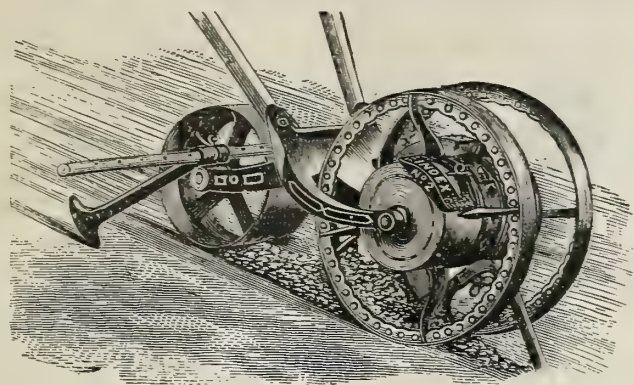

This is a simple and most accurate drill, and has been the standard machine for years. It holds two and one-half quarts. It sows all garden seeds accurately at any desired thickness or depth; it opens, drops, covers, rolls down and marks the next row, all at one passage, in the most perfect manner. *List Price, \$9.00; Net Price, \$7.50.*

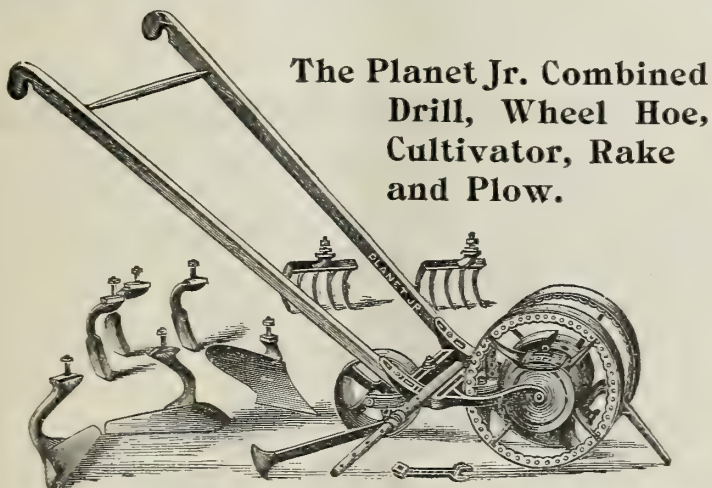

The Planet Jr. Combined Drill, Wheel Hoe, Cultivator, Rake and Plow.

This is unquestionably the most popular and perfect machine of its kind made. As a seed drill it is the same as the No. 1, except in size; it holds one quart. It has all the tools shown in cut. All blades are steel, tempered and polished. *List Price, \$12.00; Net Price, \$10.00.*

The Planet Jr. Grass Edger.

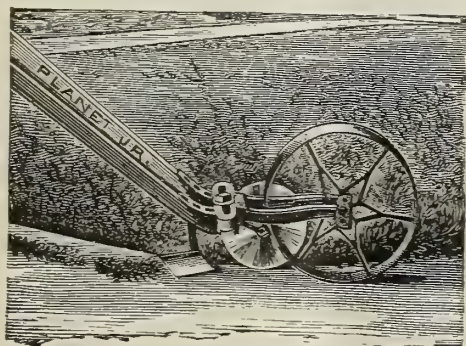

A cheap, handy and effective Grass Edger is a treasure, and here it is; one with which you can in an hour edge beautifully the walks and the flower and shrub beds of an ordinary half-acre lawn. Think of it! Why, in the usual way it would take a day. This perfect little tool does either straight or curved work most accurately, edging at the desired angle and at the speed of a mile an hour. It will give more genuine pleasure and satisfaction for its moderate cost and the little time expended in its use than the lawn mower. *Price, \$3.50; Extra Heavy, \$5.00.*

The Planet Jr. Double Wheel Hoe, Cultivator, Rake and Plow.

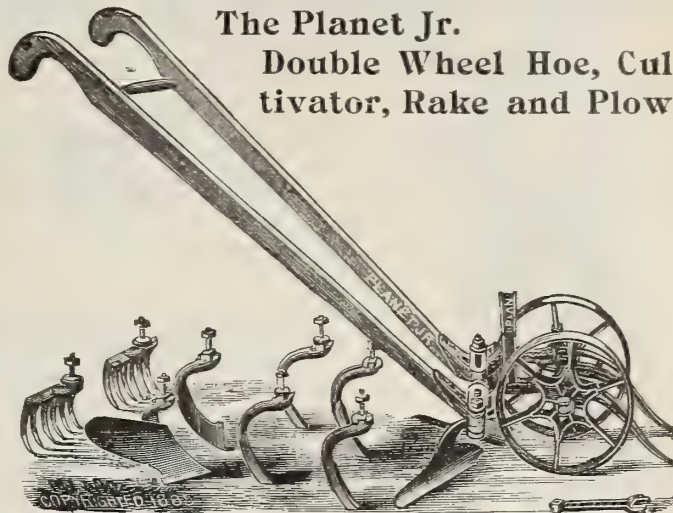

This tool is the best for all who raise onions or garden vegetables on an extensive scale. It does the work of six to ten men with ordinary hand hoes. It can be used to straddle the row, or between rows, as desired. *List Price, \$8.00; Net Price, \$6.75.*

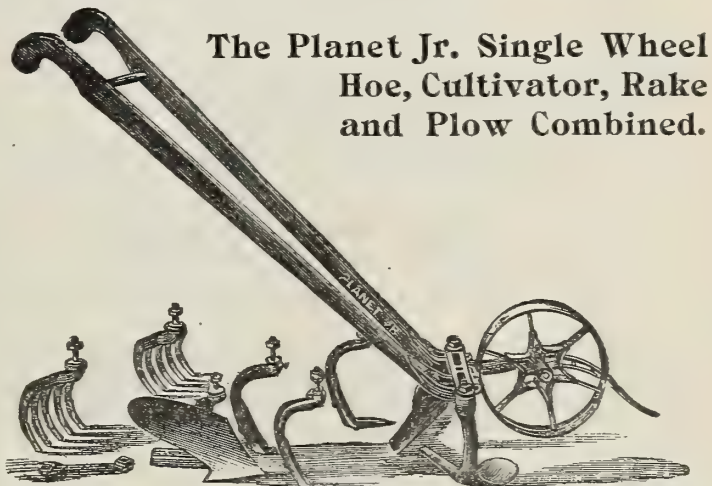

The Planet Jr. Single Wheel Hoe, Cultivator, Rake and Plow Combined.

This tool combines lightness, great strength, variety and adjustability of tools. It has all the tools shown in the cut. It is pronounced by practical men without an equal in design and finish, ease of operation, variety of adjustment and perfection of work. *List Price, \$6.00; Net Price, \$5.00.*

The "Fire-Fly" Wheel Garden Plow.

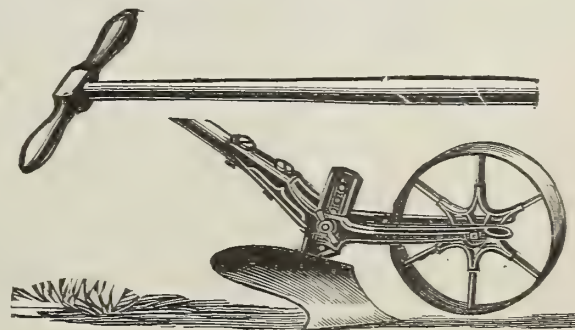

This tool is intended for those who have but small gardens and a moderate amount of time to spend in them. The moldboard is tempered and polished steel. The depth may be changed as desired very quickly. The low price brings it within reach of all. *List Price, \$2.50; Net Price, \$2.15.*



ROSES.

A GRAND NEW ROSE.

MRS. PIERPONT MORGAN. We do not hesitate to say that this is one of the very finest Roses ever introduced in America. It is a sport from Madam Cusin, and is in every way very much superior to that variety, being a much more robust grower. The flowers are very much larger and very double. Many of the flowers measure four and a half inches through when in perfection, with much larger foliage than its parent. It is also much more prolific. The petals are broad and massive; the color is intensely bright cerise, or rose pink. It has received special certificates of merit wherever exhibited. Dean Hole, of Rochester, England, the king of Rosarians, says, "It is the finest and most perfect Tea Rose he has ever seen." Mr. Thorley, the leading New York Florist, says, "It is the most beautiful Rose in form and color and fragrance I have ever seen."

Strong, vigorous plants, ready April 15th. Price, \$1.50 each; \$15.00 per doz.

Mrs. W. C. WHITNEY. (*Hybrid Tea*). New American seedling of 1893, and one of the most desirable varieties ever introduced; color clear, deep pink, long pointed buds, very sweet scented, fine handsome foliage, long stems.

Strong plants: first size, 60 cts. each; \$6.00 per doz.; \$40.00 per 100
 " " second " 50 " " 5.00 " 35.00 "

10 BEST TEA ROSES,

SUITABLE FOR GREENHOUSE CULTURE.

- Bridesmaid.** Clear, bright pink, and a very handsome flower.
- Catherine Mermet.** Soft pink, very large and fine form.
- Madam Hoste.** Fine, large flower, lemon yellow, very free.
- Madam Cusin.** Deep shaded pink, exquisite form.
- Madam De Watteville.** Large, graceful form, very free.
- Niphetos.** Pure white, very free and desirable.
- Papa Gontier.** Deep red, very fine and free.
- Perle des Jardins.** Clear yellow, large and fine.
- Safrano.** Apricot yellow, very sweet.
- The Bride.** The finest white yet introduced.

Strong plants: first size, \$3.50 per doz.; \$25.00 per 100.
 " " second " 2.50 " 15.00 "

6 BEST HYBRID TEA ROSES,

SUITABLE FOR FORCING.

American Belle. A Pink sport from American Beauty, very distinct in color, fragrance and foliage, and a very beautiful rose.
 Strong plants: first size, \$5.00 per dozen; \$35.00 per 100.
 " " second " 4.00 " 30.00 "

American Beauty. Too well known to need any description.
 Strong plants: first size, \$5.00 per doz.; \$35.00 per 100.
 " " second " 3.50 " 25.00 "

Empress Augusta Victoria. A very fine variety, white delicately shaded with lemon, very free and sweet.
 Strong plants: first size, \$3.50 per doz.; \$25.00 per 100.
 " " second " 2.50 " 18.00 "

La France. Soft pink, extra fine variety.
 Strong plants: first size, \$3.50 per doz.; \$25.00 per 100.
 " " second " 2.50 " 18.00 "

Madam Caroline Testout. The most beautiful pink rose of all; very large.
 Strong plants: first size, \$4.00 per doz.; \$30.00 per 100.
 " " second " 3.00 " 20.00 "

Meteor. Color of General Jacqueminot, very large and fine.
 Strong plants: first size, \$3.50 per doz.; \$25.00 per 100.
 " " second " 2.50 " 18.00 "

12 Best Hybrid Perpetual Roses, SUITABLE FOR WINTER FORCING.

- Anna de Diesbach.** Bright rose, very large.
- Baroness Rothschild.** Delicate pink, extra good.
- General Jacqueminot.** Deep crimson, one of the best.
- Gloire de Margottin.** Clear scarlet crimson.
- Mabel Morrison.** Pure white, extra fine.
- Madam Gabriel Luizet.** Satin-like pink, extra.
- Magna Charta.** Deep rose, very early bloomer.
- Merveille De Lyon.** White, margined with delicate pink.
- Mrs. John Laing.** Very free, clear pink, extra fine, early bloomer.

- Prince Arthur.** Deep crimson, very free.
- Prince Camille De Rohan, or Black Prince.**
- Ulrich Brunner.** Bright, clear crimson; one of the best.

Strong plants: first size, \$4.50 per doz.; \$35.00 per 100.
 " " second " 3.00 " 25.00 "

12 BEST MONTHLY ROSES,

FOR BEDDING PURPOSES.

These are really the best bedding Roses for the amateur, as they produce a continuous supply of flowers till frost. They are of very easy culture, and if given liberal treatment cannot fail to please. Many of the varieties produce flowers nearly as large, and equally as fine colored as the Hybrid Perpetuals.

- Agrippina.** Deep crimson.
- Clothilde Soupert.** White, delicately tinted with pink, extra fine.
- Duchess of Albany.** Deep, clear pink, very sweet.
- Duchess de Brabant.** Soft, delicate pink, very free.
- Etoile de Lyon.** Clear yellow.
- La France.** Light pink, very sweet.
- Madam Joseph Schwartz.** A beautiful tinted white, very free.
- Malmaison.** Flesh pink, one of the best.
- Marie Guillot.** Pure white.
- Meteor.** Bright crimson, extra.
- Mrs. DeGraw.** Bright rose, very free.
- Papa Gontier.** Bright red, very free.

Strong plants, first size, \$4.00 per doz.; \$30.00 per 100.
 " " second " 3.00 " 20.00 "

GREENHOUSE CLIMBING ROSES.

- Gloire de Dijon.** Salmon, tipped with pink, very sweet scented.
- Lamarque.** White.
- Marechal Niel.** Brilliant yellow.

Extra strong plants, 50 cts. to \$1.00 each. \$5.00 to \$9.00 per doz., according to size.

CHRYSANTHEMUMS

TWELVE GRAND NEW VARIETIES

The Cream of the List, now offered for the first time.

Dean Hole. White, beautifully flushed with pink, immense in size, and exquisite form.

J. E. Lager. Very bright, clear yellow; fine bold flower; very early.

J. H. Troy. Large, massive, white, fine form and build; very early.

Miss Louise D. Black. An improvement on "Mrs. L. C. Madeira." Deep, rich yellow, with good, stout stem and foliage.

Miss M. M. Johnson. Incurved Japanese, yellow; very early, and really a very desirable variety.

New York. Very fine, bold, white, almost a perfect globe in shape; a very fine thing.

Philadelphia. White, beautifully tinted with pale yellow, ideal in form and build.

Mrs. J. M. Parker, Jr. Large massive built flower; pleasing shade of pink, and one of the very earliest.

Nemesis. Color of "Daybreak" carnation; bold, round flower, with broad petals, and one of the very best of the season; very early.

Olympus. One of the very largest, pearly white, tipped and flushed with delicate pink; a magnificent flower, almost round, measuring $7\frac{1}{2}$ inches through, and 7 inches deep.

Sunrise. Very large, bold, handsome flower; bright terra cotta inside; reverse, old gold; with handsome oak-like foliage. The finest red of the season; very early.

Trilby. A very fine, clear white, and a great improvement on Niveus, both in substance and general build.

PRICE, \$1.00 each; \$9.00 the set of 12.
All the other new varieties at advertised rates.

CHRYSANTHEMUMS OF 1894.

THE PICK OF THE LOT.

Mrs. E. G. Hill. The earliest pink; fine, large flower.

Yellow Queen. The very best, early yellow; large, handsome flower.

Major Bonnaffon. The best second early yellow; very compact.

May Flower. The finest midseason variety in cultivation; white.

Lady Playfair. An extra fine pink.

Georgienne Bramhall. Very fine, lemon yellow.

Mrs. H. McK. Twombly. Very fine, large white.

Mrs. Geo. A. Magee. Large, massive flower; soft, shaded pink.

Eugene Dailedouze. Very large, bold, massive yellow, of exquisite shade.

Inter Ocean. A very delicate colored "Vivian Morel."

Mrs. J. Geo. Ills. An immense flower; clear white, and very beautiful form.

Oriana. Soft, delicate pink, of exquisite form and size; late.

Price, 35 cents each; \$3.00 the set of 12.



CHRYSANTHEMUMS.—Continued.

SEEDLINGS OF MERIT.

Of Recent Introduction.

Gettysburgh. The outer petals are broad and drooping, and have a lustrous sheen in the sunlight. The form is flat with drooping outer petals, which gives it a very graceful appearance. Splendid crimson color.

Good Gracious. Color unique, being a delicate shade of peach pink throughout. The form is remarkable; the petals are incurved and twisted, overlapping each other in irregular fashion, and resembling talons. Of all the splendid varieties introduced from Japan this is perhaps the most remarkable for size, form and color.

G. W. Childs. One of the best varieties of last year's introductions; color deep velvety crimson. Large flat flower with drooping outer petals.

El Dorado. Clear golden yellow, very dwarf and compact growth. An early flowering variety and very valuable for cut flowers.

Harry May. Deep old gold, with occasional veins of red; petals very broad and thick, spoon-shaped.

Miss Ada McVicker. A plant of strong habit, producing immense creamy white flowers with broad, thick, reflexed petals. A grand variety, and one of the best for all purposes.

Mr. Hicks Arnold. Large, full double flowers of an old gold color, lighting up wonderfully by artificial light.

Miss Annie Manda. Flower perfectly double, incurved, of the purest white. The petals are studded with a soft feathery growth like Mrs. Alpheus Hardy.

Mrs. E. D. Adams. Flower very large; petals of medium width, very long, twisted, the outer ones whirled; color pure white.

O. P. Bassett. A grand crimson variety, lighted up with scarlet, large solid flower; one of the very largest in its class.

Roslyn. A superb, clear, Mermet rose pink, petals thick and heavy, cup-shaped, solid to the centre, immense in size, having been exhibited eleven inches across, habit the best, stems stiff and erect, foliage luxuriant, the best pink in commerce.

Vice-President Hardy. Flower exceptionally large, brilliant yellowish gold, bordered with rosy crimson violet.

Price, 25 cts. each; set of 12 for \$2.50.

"FIRST PREMIUM" COLLECTION. EXHIBITION VARIETIES.

Golden Wedding. A remarkable flower in color, form and size. In color the clearest yellow, in form perfection itself, in size ranking with the very largest. Has won first honors wherever exhibited.

H. L. Sunderbruch. Another grand yellow, even surpassing "Golden Wedding" in size and form, and equal in color.

Maud Dean. Clear, bright pink, of the very largest size and a superb incurved flower. A 1 in every way.

M. B. Spaulding. Clear, soft yellow and a very fine flower; a rather late variety.

Miss Kate Brown. The earliest white yet introduced, the flowers being in perfection by the 12th of October. Will open well in open ground.

Miss F. Thorley. The largest and very much the finest variety of the ostrich plume family, clear white, rather late.

Mrs. Bayard Cutting. A grand reflex, massive flower; color, deep rose, reverse of petals silvery pink.

Niveus. Clear white, and a most remarkable flower, very large, with straight, broad petals, forming a perfect round ball. A great acquisition.

Parthenia. Bright, clear white, reflexed, and a very graceful flower.

Portia. A very large, clear, soft pink, incurved, with broad, massive petals, forming a very handsome flower. Early.

Temptation. White, with delicate pink tips, straight petals, forming a round ball, and a wonderful keeper on the plant or after it is cut. Extra fine stem and foliage.

The Queen. The purest of all whites; a bold, massive, incurved flower. This variety has taken more premiums for best white than any other variety known.

Price, 25 cents each, or \$2.50 for the set of 12.

EXHIBITION COLLECTION.

Autocrat. Deep yellow, fine globular form, large flowers. A strong grower, with stiff stems. Early, and promises to be very valuable for cut flowers.

David Rose. Rosy claret, edged with silvery white, large handsome blooms. Awarded a certificate of merit at Philadelphia.

ELLA MAY. Primrose yellow, apricot centre, extra large and fine. Awarded a silver medal at Philadelphia, (See cut.)

Evening Glow. A strikingly beautiful variety, deep yellow in the centre, with rich bronze red shadings toward the ends of the petals, very like the rich coloring of a brilliant sunset.

Faultless. Deep golden yellow, extra large and full, quilled petals. In color and form it is unequaled; some of the flowers measured over eleven inches in diameter.

Goldfinch. In this variety we have a richness of color rarely seen, a deep intense crimson on the upper surface of the petals—the reverse being a light bronze, making a pleasing contrast.

Grenadier. Deep brilliant red, reverse of petals old gold, large globular flower with reflexed outer petals.

Harry E. Widener. Large, grand yellow; one of the finest for exhibition purposes.

Indian Chief. In sharp contrast to the above is this variety; here the coloring is a vivid, strong crimson; the flower is equally large, but stronger and bolder, loosely incurved and decidedly Japanese in outline.

Ivory. Pure white; a splendid free-flowering variety. It is doubtful if any other Chrysanthemum unites in such marked degree the many excellent qualities of Ivory. Size, habit, color and growth are superb.

Jessica. Splendid, white, large flat flower; very early.

Lilian B. Bird. Beautiful light pink; extra fine.

L. Canning. Clear white; large flat flower.

Majesty. Deep glowing red; in form it is similar to Cullingfordii, but larger and finer; the coloring is even more intense than that fine sort.

Mark Twain. Chrome yellow and cinnabar red, a striking combination of colors.

Mermaid. Large; soft pink; a grand exhibition variety.

Mrs I. Forsterman. A magnificent extra large, snowy white variety of the Japanese incurved type. A superb grower and free bloomer.

Mrs F. Schuchardt. A charming variety, which, like all in this collection, is of the largest size. The coloring is exquisite; the centre of the flowers is creamy white, the ends of the petals tinted delicate rose, a pronounced improvement on this type.

Nankin. Sulphur yellow, shading to creamy white at the margin of the flower. The petals are long and silky. A unique and attractive variety.

Polo. A very curious variety, long petals with crooked ends, like a polo stick.

Popularity. A delicate shade of flesh pink, of fine incurved form, large and handsome. The ends of the petals are cut so as to resemble a stag's antlers in outline.

Robert Bottomley. Large, pure white, irregularly twisted and incurved; splendid for exhibition purposes.

Surprise. A unique shade of bronze red, bold, handsome flowers of the largest size and fine globular form. A variety which is sure to find numerous admirers.

Sun God. One of the largest varieties yet offered. Flowers of the largest size, with broad, bold petals. Color deep yellow, slightly marked with rich bronze.

The Tiger. A grand incurved variety, old gold and deep red.

Price, 20c. each; set of 25 Exhibition Varieties for \$3.75.

BEDDING PLANTS.

The following are all well known varieties of the leading plants that are used for "carpet bedding," "massing," "ribbon line" planting or general bedding. Parties desiring large quantities will do well to write us, and we will make special prices.

ALTERNANTHERA.

Paronychoides Major. The "Rainbow Plant."...Per 100, \$6 00
Aurea Nana. The finest yellow... " 6 00

AGERATUM.

Mexicanum. Best blue... " 4 00
White Cap. Best white... " 4 00
Cope's Gem. Dwarf blue... " 4 00

ASPARAGUS TENUISSIMUS.

Very fine, filmy foliage. A handsome climbing plant for the window, and a very useful pot plant. Each, 15 cts.; per doz., \$1.50.

ASTERS.

Finest Colors. Per 100, \$5.00.

AMPELOPSIS VEITCHII.

Boston Ivy, or Japan Ivy.

First size, extra strong pot grown, 2 to 3 feet. Each, 50 cts.; per doz., \$4.50.

Second size, extra strong pot grown, 1 to 2 feet. Each, 30 cts.; per doz., \$3.00.

Third size, extra strong pot grown, 6 to 9 inches. Each, 15 cts.; per doz., \$1.50.

BALSAM.

Choice Double. Magnificent colors. Per 100, \$5.00.

CALENDULA.

Splendid Bedding Plant. Per 100, \$2.50.

CARNATIONS.

New and Choice Varieties.

No garden of flowering plants is complete without a collection of these. In the varieties named and described, we offer the best and most distinct of the sorts of recent introduction, being careful to select such as combine beauty of form, most distinct and brilliant colors, with vigor of growth and free flowering qualities.

Daybreak. A beautiful shade of flesh pink, the finest pink Carnation yet introduced; very free bloomer.

Wm. Scott. Quick and healthy grower, the freest bloomer of any pink carnation we have ever seen. The blooms are large, magnificent color, and first-class stems. flowers on long stems, clear red.

Fred. Creighton. Flowers large, of good substance, beautifully fringed, very double, rich fragrance and very lasting after being cut; color a soft shade of pink.

Golden Gate. Clear golden yellow, free bloomer, strong grower.

Lizzie McGowan. Large pure white flowers, very fragrant, long stems; one of the best yet introduced.

Madame Diaz Albertini. The queen of pink carnations. Strong, healthy grower, producing immense bloom of exquisite clove fragrance.

L. L. Lamborn. We consider this the finest white Carnation in cultivation; the flowers are very large and pure white; it is of dwarf habit, free bloomer, and keeps a long time after being cut.

New Jersey. Bright scarlet; the flowers often measure three inches in diameter; free bloomer.

Portia. The most intense bright scarlet, strong, robust grower, and a very free bloomer.

Silver Spray. Of bushy, compact growth, unusually free bloomer. flowers produced on long stems, large and of perfect form, color pure white, beautifully fringed.

Tidal Wave. Flowers very large, bright rosy pink, changing to carmine pink with salmon shadings; dwarf habit, healthy and very free bloomer.

Each, 15 cts.; set of twelve for \$1.50.

CENTAUREA GYMNOCARPA.

White Leaved. Per 100, \$6.00.

CLEMATIS JACKMANII.

The best known and most valued variety of this popular family. A perfect mass of bloom when in full flower. Color, dark, rich, royal purple. A superb Clematis.

First size, each, \$1.00; per doz., \$7.50.

Second size, each, 75 cts.; per doz., \$4.50.

FANCY COLEUS.

Our stock of Fancy Coleus is unsurpassed. 12 distinct varieties, each, 10 cts.; per doz., \$1.00.

Verschaffelti. Crimson. Per 100, \$5.00.

Golden Bedder. Yellow. Per 100, \$5.00.

Hero. Black. Per 100, \$5.00.

Kirkpatrick. Yellow and green, Per 100, \$5.00.

DAISIES.

Finest Mixed. Each, 10 cts.; per 100, \$8.00.

ECHEVERIA.

Extensa Globosa. Per 100, \$12.00.

Secunda, Californica. Retusa, etc. Per 100, \$8.00.

FORGET-ME-NOT.

Per doz., 75 cts.; per 100, \$5.00.

FUCHSIAS.

We name below the very finest of the old varieties, embracing all the various shades of color to be found in this popular class of plants.

Speciosa. Corolla orange-scarlet, sepals white.

Storm King. Corolla pure white; very free.

Black Prince. Tube and sepals waxy carmine.

Mrs. Marshall. Corolla carmine, sepals white.

Le Negre. Violet corolla, sepals crimson.

Brilliant. Corolla carmine, sepals white.

Wave of Life. Violet corolla, crimson sepals.

Snow Fairy. White corolla, crimson sepals.
Each, 10 cts.; per doz., \$1.00.

GERANIUMS.

Gen. Grant. Best single scarlet. Each, 10 cts.; per 100, \$8.00.

Double Gen. Grant. Best double scarlet, Each, 10 cts.; per 100, \$8.00.

Naomi. Best double pink. Each, 10 cts.; per 100, \$8.00.

Queen Olga. Best single pink. Each, 10 cts.; per 100, \$8.00.

Cand. Plena. Best double white. Each, 10 cts.; per 100, \$8.00.

Albion. Best single white. Each, 10 cts.; per 100, \$8.00.

Mt. of Snow. Best silver-leaved. Each, 10 cts.; per 100, \$8.00.

Ivy-leaved. Excellent for trellis or baskets. Each, 10 cts.; per 100, \$8.00.

HELIANTHUS MULTIFLORUS, fl. pl.

Double Dwarf Sunflower.

A double perennial "Sunflower." Its dark golden yellow color is both fashionable and beautiful for cut flowers; grows from 3 to 5 feet in height; never fails to flower the first season of planting; hardy perennial, coming up every year. Each, 25 cts.; per doz., \$2.50.

HONEYSUCKLES.

Yellow, coral or scarlet, white, pink, evergreen and golden leaved.
Strong plants. Each, 25 cts.; per doz., \$2.50.

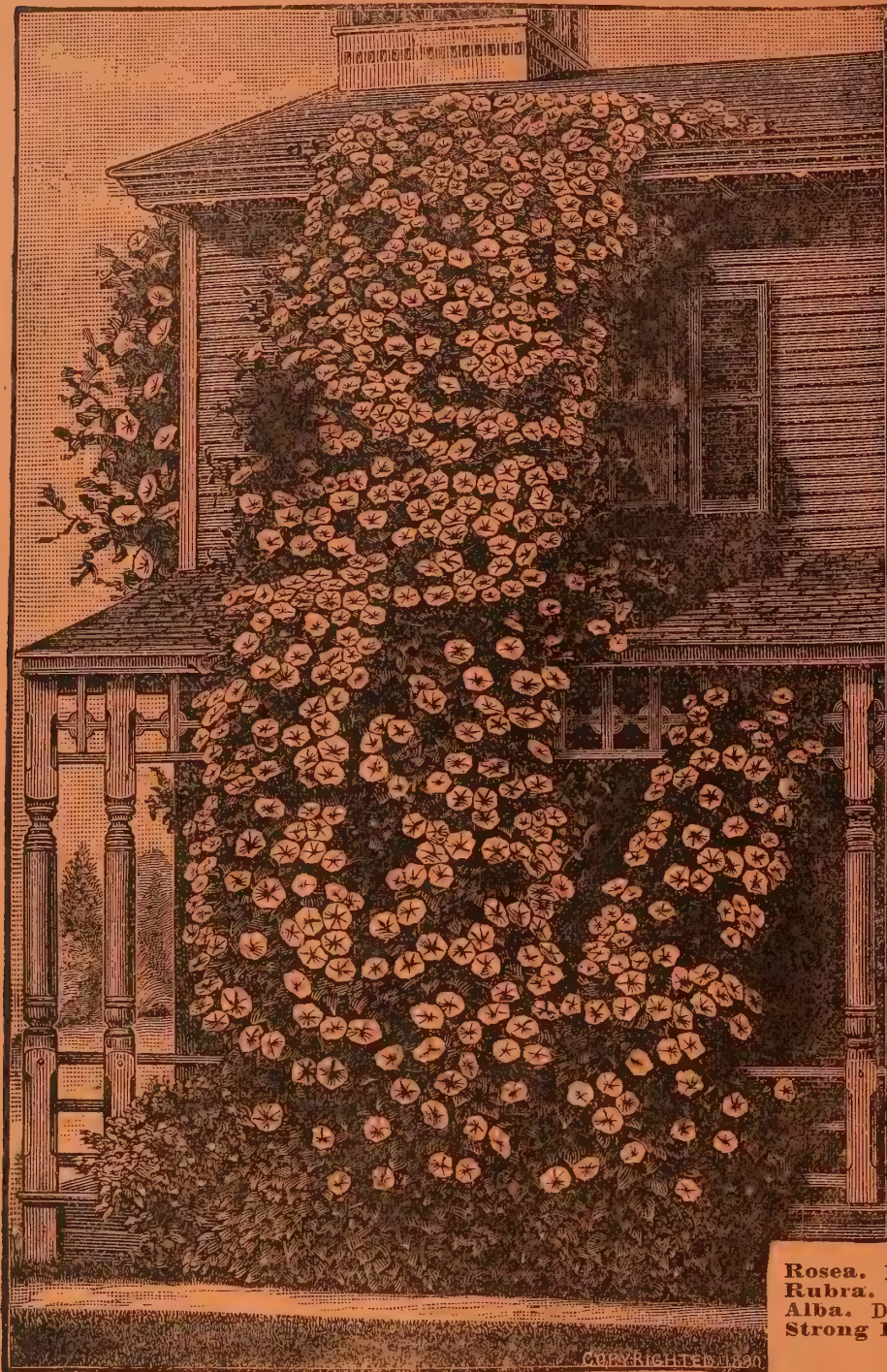

THE MOON FLOWER.

HELIOTROPES.

Colors all shades of purple, violet, etc. Each, 10 cts.; per 100, \$8.00.

HOLLYHOCKS.**New Double Strain.**

These varieties are remarkable for their perfect double flowers, large size, brilliancy and variety of colors. We offer in the following shades, which are the leading colors grown, double white, double yellow, double lavender, double pink, double crimson. Each, 20 cts.; per doz., \$2.00.

DOUBLE PINK HYDRANGEA.**H. Stellata Rubra Plena.**

The flowers are double and similar in appearance to a Polyantha Rose. It attains a height and width of three to four feet, and when in bloom is covered with its rosy red double blossoms. Price for large plants, each, \$2.00. Strong plants from four-inch pots, each, 50 cts.; per doz., \$5.00. Fine plants from three-inch pots, each, 30 cts.; per doz., \$3.00. Plants from two-inch pots, each, 20 cts.; per doz., \$2.00.

LOBELIAS.

Best Dwarf. Blue. Per doz., \$4.00.

HARDY MOON FLOWER.***Ipomœa Pandurata.***

The foliage is large and handsome, giving a dense shade. The flowers are truly magnificent, measuring from three and a half to six inches across, pure white shading to pink and purple in the throat. Unlike the tender Moon Flower, this species opens its flowers during the day-time and remains open all day, which makes it doubly valuable. Strong Northern grown roots. Each, 25 cts.; per doz. \$2.50.

THE MOON FLOWER.***Ipomœa (or Calonyction) Grandiflora.***

It is called Moon Flower from its rare peculiarity of blooming best at night, although it also expands its flowers in dull days; the flowers are of pure white, from five to six inches in diameter, emitting a rich, Jessamine-like odor at night. Each, 15 cts.; per doz., \$1.50.

BLUE DAWN FLOWER.***Ipomœa Learii.***

The flowers are the most intense violet-blue, with reddish-purple rays, and are six inches across. There is nothing of its color that exceeds in richness the flowers of *Ipomœa Learii*. Each, 15 cts.; per doz., \$1.50.

MANETTIA VINE.***Manettia Bicolor.***

The coloring of these flowers is gorgeous in the extreme, being a flame color tipped with bright yellow, the contrast with the vivid green, glossy foliage is startling, making the plant an object of rare beauty. Six to ten feet. Each, 15 cts.; per doz., \$1.50.

DOUBLE GOLDEN MARGUERITE.***Anthemis Coronaria, fl. pl.***

This plant might well be called the Shower of Gold, as it is a perfect mass of rich golden yellow flowers the whole year round, being equally useful in winter as in summer. Each, 20 cts.; per doz., \$2.00.

HERBACEOUS PÆONIAS.

Magnificent hardy plants, almost rivaling the Rose in brilliancy of color and perfection of bloom. Some of the varieties are very fragrant. They are perfectly hardy, require little or no care, and produce large and fine blooms when well established.

Maxima. Double red changing to blush.

Rosea. Double crimson, changing to rose, fragrant.

Rubra. Double crimson, large and fragrant.

Alba. Double large white.

Strong Flowering Roots; each, 50 cts.

PETUNIAS.

Double. Per 100, \$10.00.

Single. Per 100, \$5.00.



DOUBLE PETUNIA.

PANSIES.

Grown from selected seed and offered as unequalled for size, form and color. Pansies are now largely used for bedding purposes, vases, etc., and these grand varieties will greatly increase their popularity. Each, 10 cts.; per doz., 75 cts.; per 100, \$6.00.

HARDY PINKS.

Embracing white, pink, crimson, etc. Each, 15 cts.; per doz., \$1.50.

SALVIAS.

Scarlet, White, Maroon and Striped. Each, 10 cts.; per doz., 75 cts.; per 100, \$6.00.

SWEET WILLIAM.

Mixed Colors. Per doz., \$1.00; per 100, \$6.00.

MAMMOTH VERBENAS.

Many kinds in richness of color and large white centre resemble *Auriculas*.

Named Varieties. Each, 10 cts.; per doz., 75 cts.; per 100, \$6.00.

VIOLETS.

Marie Louise. The well known double purple variety. Its exquisite fragrance and beautiful color make it always in demand. Each, 10 cts.; per doz., \$1.00.

Swanley White. Same as preceding, but pure white. Each, 10 cts.; per doz., \$1.00.

ZINNIA.

Elegans. Mixed colors, per doz., 30 cts.; per 100, \$2.50.



AMERICAN SHOW PANSY.

Greenhouse and Summer Flowering Bulbs.

AMARYLLIS.

- Aulica (Lily of the Palace).** Crimson shaded with green. Each, \$1.50.
- Belladonna Major (Belladonna Lily).** Silvery white. Each, 40 cts.
- Formosissima (Jacobean Lily).** Dark scarlet. Each, 25 cts.
- Fine Mixed Hybrid.** Brilliant colors. Each, 60 cts.



SINGLE BEGONIA.

TUBEROUS BECONIAS.

Griffin's American Strain.

The engraving shows these grand Bedding Begonias. The kinds we offer were specially grown for us and are a comparatively new section of this beautiful tribe. They are now largely grown as bedding plants and no doubt will be almost universally planted in the very near future. The colors are far more varied and brilliant than Geraniums, the single flowers measuring from three to five inches across, ranging through all the shades of crimson, scarlet, rose, orange, etc. They are easily forced, and for cut flowers the double has no equal.

Named Varieties, Double and Single.

- Extra Large Bulbs.** Each, 40 cts.; per doz., \$4.00.
 - Mixed Shades.** Colors separate. Each, 20 cts.; per doz., \$2.00.
 - Choice Mixed.** Each, 15 cts.; per doz., \$1.50.
- Seed of this superb strain, per pkt., 15 and 25 cents.

CALADIUM.

Caladium Esculentum. A very effective plant and suitable for either a single plant on the lawn, masses in beds or margins of water. Watering in dry seasons will help develop large leaves. Extra large bulbs, ea., 25 cts.; per doz., \$2.00. Second size, ea., 15 cts.; per doz., \$1.50.

CINNAMON VINE.

Dioscorea Batatas. Beautiful summer climber; glossy foliage and fragrant flowers; stem dies down in winter, but the root is hardy. Large roots, each, 10 cts.; per doz., \$1.00.



CALADIUM.

LILIES—Lilium.

Among hardy plants the lily is matchless in beauty, in variety of color and in chasteness of form.

AURATUM (*Golden Japan Lily*). Delicate white, thickly studded with crimson spots, and through the centre of each petal is a bright gold band, large and fragrant. Strong bulbs. Each, 15 cts.; per doz., \$1.50.

Lancifolium (*Speciosum*). The varieties of *Lancifolium* are perhaps the most popular lilies grown, being easy of cultivation; very showy and fragrant.

Lancifolium Album. Pure white; very fragrant. Each, 30 cts.; per doz., \$3.00.

Lancifolium Monstrosum Album. Distinct variety; pure white flowers; very floriferous. Each, 20 cts.; per doz., \$2.00.

Lancifolium Roseum. White spotted with rose. Each 15 cts.; per doz., \$1.50.

Lancifolium Rubrum. Rose, spotted with crimson. Each, 15 cts.; per doz., \$1.50.

Tigrinum (*Tiger Lily*). Orange Salmon. Each, 10 cts.; per doz., \$1.00.

Tigrinum Flore Plena (*Double Tiger Lily*). Each, 10 cts.; per doz., \$1.00.

MADEIRA VINE.

A rapid-growing, graceful vine, with smooth, glossy leaves, bearing racemes of tiny, white, fragrant flowers. Each, 5 cts.; per doz., 50 cts.; per 100, \$3.00.

TIGRIDIA.

Grandiflora Alba. Flowers are large, pearly-white, marked at the base of each division with large spots of reddish brown. Each, 10 cts.; per doz., \$1.00.



LILIUM AURATUM.

Conchiflora. Deep yellow, red spots. Each, 5 cts.; per doz., 30 cts.

Grandiflora. Deep crimson-scarlet, of large size. Each, 10 cts.; per doz., \$1.00.

TUBEROSES.

Tall Double. Spike four feet and upwards; flowers not so large or heavy as Pearl; large bulbs. Each, 5 cts.; per doz., 50 cts.; per 100, \$3.00.

Double Pearl. Large size bulbs. Each, 5 cts.; doz. 50 cts.; 100, \$3.50.

Variogated. The leaves of this variety are bordered with creamy white; flowers single, very fragrant. Each, 15 cts.; doz., \$1.50; 100, \$10.00.

NEW TUBEROSE, "ALBINO."

The flower spikes are very large and evenly filled; flowers in July and August, throwing from two to five flower stems from a single bulb, and these again are often branched; it is entirely free from the brown tint common to the old sort, being of the purest waxy white. Each, 10 cts.; doz., \$1.00; 100, \$6.00.

Small Fruits, Vines, Etc.

BLACKBERRIES.

Erie. Large size, excellent quality, hardy, very early, the finest blackberry.

Wilson, Jr. Second only to the above; a first-class berry.

Kittatiny. Very large and of excellent flavor.

Minnewaski. An early blackberry, valuable for market and the home garden. Fruit is large and of good quality.

Early King. An extra early, hardy blackberry, one of the best for the home garden. Per doz., 60 cts.; per 100, \$4.00.

CURRENTS.

Fay's Prolific. As compared with the "Cherry Currant" it is equal in size, better in flavor, with much less acid and five times as prolific. Red.

Lee's Prolific. Earlier than Black Naples, and of superior quality; larger, longer clusters and more productive.

Cherry. Fruit of the largest size, bunches short, berries deep red and rather acid; valuable for market.

White Grape. This is the best white variety, large and delicious, not as acid as the other varieties; productive.



KITTATINY BLACKBERRY.

WATER LILIES.

NYPHÆA ALBA CANDIDISSIMA.

The large flowering variety of the English water-lily; flower six inches in diameter; pure white, with broad petals; the earliest flowering variety, and continuous until frost. Price, \$1.00 each.

NYPHÆA MARLIACEA CHROMATELLA.

A charming variety. The leaves are mottled with brown when in a young state, and its large, fragrant flowers, which are a beautiful clear yellow, with bright, orange stamens, are produced from early Spring until destroyed by frost. Price, 75 cts. each.

NYPHÆA ODORATA.

The well-known, fragrant pond lily. Its lovely, pure white flowers, so common in some locations, are worthy of a place among the choicest varieties where cultivated. It can be successfully grown in tubs and wintered in a cool cellar. Price, 25 cts. each.; \$2.50 per doz.

NYPHÆA ODORATA ROSEA.

This is the famous Pink water lily of Cape Cod. It possesses all the desirable qualities of *N. Odorata*. The flowers are of large size, cup-shaped; a lovely deep pink in color; delicious fragrance and free bloomer. Price, 75 cts. each.

THE WATER POPPY.

(*Limnocharis Humboldtii*.)

A charming and easily cultivated floating water plant, with bright lemon yellow poppy-shaped flowers, 2 inches across. It is easily grown in a tub, tank or pond. Price, 25 cts. each; \$2.50 per doz.

THE WATER HYACINTH.

(*Eichhornia [Pontederia] Crassipes Major*.)

The flowers are as large as a silver dollar, resembling hyacinths, and are as handsome as an orchid, of a beautiful, sparkling, rosy lilac color. It can be grown in the summer in the water-lily tub or pond. In the winter it is beautiful and effective when grown in a glass vessel of some sort. Price, 25 cts. each; \$2.50 per doz.

WATER LILY SEEDS.

All the best varieties, 25 cts. per packet.

CURRENTS—Continued.

Victoria. The best late red variety; exceedingly productive, and splendid for table use.

Two-year-old bushes of any of the above varieties of Currants, each, 15 cts.; per doz., \$1.00; per 100, \$6.00.

DEWBERRIES.

The Dewberry has thus far not been cultivated to any great extent, on account, perhaps, of the few varieties that are worth growing. There is no reason, however, why people should not enjoy this wholesome fruit, especially as it comes between the raspberries and blackberries. The best mode of culture is to treat it somewhat like the strawberry, and plant it in rows six feet apart with the plants three feet distant in the rows, or setting the plants four feet by four. Keep the soil mellow and clean. Owing to its trailing habit it will be necessary to mulch the ground well, as with the strawberry, to keep the fruit from becoming soiled and gritty.

Lucretia. Decidedly the best of all Dewberries. As early or earlier than Early Harvest Blackberry, and larger than Erie. It is a superb fruit; large and handsome, of a shining jet black, melting, and of a delicious quality. The plant is entirely hardy everywhere, a healthy, strong grower, and exceedingly productive. We can confidently recommend the Lucretia as being a fine acquisition to the family garden, and a delightful introduction to the blackberry season. Strong plants. Per doz., \$1.00; per 100, \$6.00.

FOREIGN GRAPE VINES.

For Graperies.

We have a large assortment of well ripened canes, including the following well-known standard sorts: Black Hamboro, Lady Down's, Muscat Hamburg, Royal Ascot, Gros Colman, Muscat of Alexandria, etc., etc.

Strong One year Old Canes, each, \$1.25; per doz., \$12.00.
Strong Two Year Old Canes, each, \$2.50; per doz., \$25.00.

HARDY GRAPE VINES.

Agawam. Maroon, bunches and berries large, aromatic.
Brighton. One of the very best red grapes; early.
Concord. Black, the hardiest and best grape for general cultivation.
Delaware. Red, compact bunch, berries small, very sweet and delicious.
Duchess. Greenish white, splendid quality.
Moore's Early. Black, very early.
Lady. Light yellowish-green, early; berries large, sweet and rich.
Wilder. (Rogers' No. 4.) Dark purple, juicy, rich and sweet.
Worden. Black, very juicy; large size, early.
Strong Two Year Old Canes, each, 25 cts.; per doz., \$2.50.

GOOSEBERRIES.

Industry. The berries are exceedingly large, of a dark cherry color, of delicious flavor; immense cropper and succeeds well under trees.
 Two year old bushes, each, 25 cts.; per doz., \$2.50.
Downing. Pale green berries, vigorous, hardy and prolific.
 Two year old bushes, each, 15 cts.; per doz., \$1.00.
Hughton. Berries small, pale red; sweet and good, vigorous and productive.
 Two year old bushes, each, 15 cts.; per doz., \$1.00.



RASPBERRIES.

Marlboro. Very dark, exquisite spicy flavor.
Cuthbert. The leading market variety for late fruiting.
Thompson's Early Prolific. Remarkable for its early season of ripening; prolific, hardy, large, firm and of the best quality.
The Gregg. A Black Raspberry or Blackcap of the largest size; enormously productive and excellent flavor.
Golden Queen. The best Yellow Raspberry yet introduced. Of large size, hardy and productive.
Palmer. An early Blackcap fruit, medium size, fine flavor; productive.
Strong Canes of any of the above, per doz., 75 cts.; per 100, \$5.00.

STRAWBERRIES.

Our stock of Strawberry plants is the finest in the country; we can supply all the new and leading varieties.

STANDARD SORTS.

Early Varieties.

Crescent (P). Very prolific; succeeds on all soils. Per doz., 50 cts.; per 50, 75 cts.; per 100, \$1.00; per 1,000 \$5.00.



GOOSEBERRY.

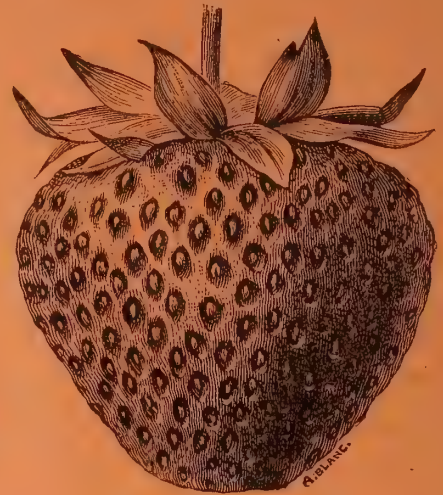

STRAWBERRY.

STRAWBERRIES—Continued.

Warren. Fruit large, remarkable firm, and exceedingly sweet and rich. It is early, and cannot fail to rank among the best for home and market use. Per doz., 50 cts.; per 50, 75 cts.; per 100, \$1.00.

Medium Varieties.

Chas. Downing. Very prolific; best for general cultivation. Per doz., 50 cts.; per 50, 75 cts.; per 100, \$1.00; per 1,000, \$5.00.
Wilson. The old standard, but is generally superseded by better varieties. Per doz., 50 cts.; per 50, 75 cts.; per 100, \$1.00; per 1,000, \$5.00.
Seth Boyden. Very large and of excellent flavor; desirable. Per doz., 50 cts.; per 50, 75 cts.; per 100, \$1.00; per 1,000, \$6.00.
The Manchester (P). For family use, as well as for market, it ranks high. It is a strong grower, does not rust, is wonderfully productive, bearing large fruit, of a bright, glossy scarlet; in quality good. Per doz., 50 cts.; per 100, \$1.00; per 1,000, \$6.00.
Monarch of the West. Very handsome, large and excellent. Per doz., 50 cts.; per 50, 75 cts.; per 100, \$1.00; per 1,000, \$5.00.
Cumberland Triumph. Largest size, exceedingly handsome and luxuriant. Per doz., 50 cts.; per 50, 75 cts.; per 100, \$1.00; per 1,000, \$5.00.
Bidwell. Berries very large, bright glossy crimson, of very good quality; is a strong grower, healthy, and bears immense crops when fair cultivation is given; one of the best. Per doz., 50 cts.; per 50, 75 cts.; per 100, \$1.00.

Late Varieties.

Sharpless. A grand variety in every respect, monstrous in size, most berries of good shape, though some are compressed or coxcomb shaped; flesh solid, sweet, rich and juicy, and of a luscious flavor; plant hardy, very large and vigorous. Per doz., 50 cts.; per 50, 75 cts.; per 100, \$1.00; per 1,000, \$6.00.
Golden Defiance (P). A very strong-growing, prolific, late variety; a most desirable sort for home use. Per doz., 50 cts.; per 50, 75 cts.; per 100, \$1.00; per 1,000, \$5.00.
Kentucky. Very late and vigorous; best for light soil. Per doz., 50 cts.; per 50, 75 cts.; per 100, \$1.00; per 1,000, \$5.00.

GREAT JAPANESE WINEBERRY.

The canes of this interesting plant are large, robust and perfectly hardy; they are thickly covered with purplish-red hairs, which extend along the stem to its extremity. The leaves are large, tough, dark green above and silvery gray beneath. Each berry is at first tightly enveloped by the large calyx, forming a sort of burr, which is also covered with purplish-red hairs so thickly as to present the appearance of moss rose buds. These gradually open and turn back, exposing the fruit in all its beauty. The berries are of medium size, but of a beautiful, translucent appearance, running through all the shades of amber to crimson as they ripen. In quality it is good, with a rich and sprightly flavor, but decidedly brisk sub-acid. When cooked it is simply grand; surpassing by far when canned the Huckleberry and all other small fruits.

Strong Plants, each, \$1.00; per doz., \$10.00.

WHITE CEDAR TUBS.

No. 1.	15 1/2 in. diameter,	13 in. high	each	\$1 75
" 2.	16 1/2 "	14 "	"	2 00
" 3.	18 1/2 "	15 "	"	2 50
" 4.	20 "	16 "	"	3 00
" 5.	22 "	17 "	"	3 50
" 6.	24 "	18 1/2 "	"	4 50
" 7.	26 "	20 "	"	4 75
" 8.	28 "	22 "	"	5 50

Outside measurement.

Fruit and Ornamental Trees, Shrubs, etc.

We commence shipping in Spring about April 1, and in Fall about November 1.

We enumerate only a few of the standard sorts, all other sorts can be supplied at advertised prices. See our Tree Catalogue. Free on application.

Apples.

Baldwin, Newtown Pippin,
 Fall Pippin, Northern Spy,
 Golden Russet, Spitzenberg.
 Price—Choice Standards, 6 to 7 ft., each, 50 cts.

Cherries.

Bigarreau (Yellow Spanish), Early Whiteheart,
 Black Heart, Mayduke,
 Black Tartarian, Morello.
 Price—Standard or Dwarf, each, 50 cts.

Peaches.

Crawford's Early, Mountain Rose,
 Early York, Morris White,
 George IV., Susquehanna,
 Hale's Early, Yellow Rarripe.
 Price—Each, 30 cts.

Pears.

Bartlett, Madeleine,
 Brandywine, Seckel,
 Flemish Beauty, Winter Nelis.
 Price—Standards, each, 75 cts.; Dwarfs, each, 50 cts.

Plums.

Coe's Golden Drop, Green Gage (Reine Claude),
 Damson, Imperial Gage.
 Price—Each, 50 cts.

Flowering Shrubs.

	EACH.		EACH.
Almond, Double Flowering	\$0 50	Rose of Sharon	\$0 25
Burning Bush	35	Snowball, Common	35
Dogwood, Red	35	Spireas, Assorted	35
Hydrangea Grandiflora	50	Syringa (Mock Orange)	35
Lilacs, Several Sorts	35	Tree Pæonies	2 00

Shade and Ornamental Trees.

	EACH.		EACH.
Ash, White	\$0 50	Maple, Sugar	\$0 75
Beech, Purple-leaved	1 00	Mountain Ash	75
Beech, American	50	Oak, Royal	75
Chestnut, American	75	Oak, Purple	1 00
Chestnut, Horse	75	Poplar, Carolina	50
Elm, American	75	Tulip Tree	75
Elm, Purple	1 00	Willow Laurifolia	50
Maple, Norway	75		

Evergreens.

	EACH.		EACH.
Arbor Vitæ (Specimen)	\$0 75	Pine, Austrian	\$0 75
Fir, Nobilis	2 00	Pine, Scotch	75
Fir, Siberian	1 50	Spruce, Dwarf	1 00
Hemlocks (Specimen)	75	Spruce, Norway (Specimen)	75

Ivy—Hedera.

	EACH.
Arborescens Regneriana. Hardy, heart-shaped, thick leaves	\$0 50
Hibernica (Irish Ivy). Large leaves	40
Daurica (Russian Ivy). Small leaves	40
Maculata Major (Spotted Ivy)	50

Hedge Plants.

	PER DOZ.	PER 100.
Arbor Vitæ, American, 1½ to 2 ft.	\$2 50	\$15 00
Arbor Vitæ, American, 2 to 2½ ft.	3 00	18 00
Hemlock, 2 to 3 ft.	4 50	30 00
California Privet, 2 years	2 50	15 00
Evergreen Thorn, 2 years	2 50	15 00

EXCELSIOR STANDARD FLOWER POTS.

These Pots are all "Standard" Shapes and Sizes, the same as adopted and recommended by the Society of American Florists, and are far superior to any other Flower Pots.

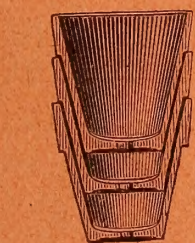

SIZES.	PRICE PER DOZ.	PRICE PER 100.	PRICE PER 1,000.
2 inch Height and Width Inside	\$0 12	\$0 75	\$6 00
2½ "	15	90	8 00
3 "	20	1 25	9 50
3½ "	25	1 75	14 00
4 "	35	2 00	18 00
4½ "	40	2 50	23 00
5 "	45	2 75	30 00
6 "	75	4 25	40 00
7 "	1 25	6 50	58 00
8 "	1 50	9 00	75 00
9 "	2 50	16 00	140 00
10 "	3 00	18 00	160 00
11 "	3 50	25 00	225 00
12 "	4 00	27 00	300 00
14 "	6 00	45 00	400 00



SEED PANS.

	HEIGHT. Inches.	WIDTH. Inches.	PER DOZ.		HEIGHT. Inches.	WIDTH. Inches.	PER DOZ.
Round Seed Pans	4	8	\$1 50	Square Seed Pans	6	6	\$2 00
"	6	12	2 00	"	8	8	2 50
"	8	16	2 50	"	10	10	3 00

FLOWER POT SAUCERS OR STANDS.

Per dozen	Size, 4 in.	6 in.	7 in.	8 in.	9 in.	10 in.	12 in.	14 in.
	\$0 25	\$0 35	\$0 40	\$0 50	\$0 85	\$1 00	\$1 50	\$1 75



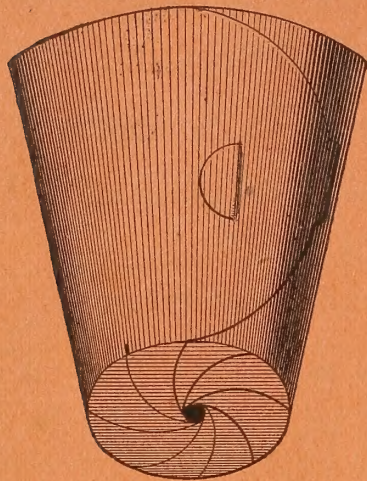

Neponset Paper Flower Pots.

FROM THE CELEBRATED NEPONSET WATERPROOF FABRICS.

For shipping of plants in pots, with intact root balls, they have no equal. For a pot cover in decorations, they are unsurpassed in cheapness. Bulbs, and all soft-wooded plants which do not shun water, agree well with this pot. Cabbage, Tomato and Strawberry plants have been grown with success in these pots. Paper pots retain the moisture in the soil longer than Earthen pots. **The Neponset Pots** are manufactured of waterproof paper, are unbreakable, handsome, light, cheap and terra cotta color.

STANDARD POT MEASURE.—PACKED IN CRATES.

Less quantities than full crates at one hundred rates.

Size	Packed in Crates of	Gross Weight per 1000 pots	Per 100	Per 1000	Size	Packed in Crates of	Gross Weight per 1000 pots	Per 100	Per 1000		
2 1/4 inch.	1,000	about 20 lbs.	\$0 50	\$4 00	5 inch.	500	about 100 lbs.	\$1 80	\$15 00		
2 1/2 "	1,000	" 23 "	60	4 50	6 "	500	" 150 "	3 00	20 00		
3 "	1,000	" 24 "	70	5 50	SAMPLE DOZENS, POSTAGE PAID, BY MAIL.						
3 1/2 "	1,000	" 45 "	1 00	8 00	2 1/4	2 1/2	3	3 1/2	4	5	6 inch pots.
4 "	500	" 76 "	1 20	10 00	For 15c.	18c.	20c.	25c.	35c.	55c.	75c. per Dozen.

ONLY FULL DOZENS OF ONE SIZE SENT AT ABOVE PRICES.

All Who Cultivate

FRUITS

FLOWERS

VEGETABLES

FOR
PLEASURE
OR
PROFIT

Should see that the Journal they subscribe to is the best and most reliable authority obtainable.

AMERICAN GARDENING

Stands Foremost in the List

It deals practically with Flowers, Fruits and Vegetables, Trees and Shrubs, and covers the field of horticulture systematically and thoroughly.

It illustrates and describes methods of cultivation, improved varieties and labor-saving devices. Among the many striking departments are those devoted to the Flower, Fruit and Vegetable Garden, with the *Current Work* in each written specially for the amateur; The Orchard; Small Fruits; Spraying Mixtures and Devices; Ornamental Gardening; and Woman's Realm, a special feature for the ladies. The Question Box is open to all, free to all, and as broad as necessity. It is, without doubt,

The Paper for the People!

\$1.00 a Year (24 numbers).

Sample Copy on application.

ADDRESS YOUR ORDERS TO

WEEBER & DON, 114 CHAMBERS ST., NEW YORK.

I N D E X.

VEGETABLE SEEDS.

	PAGE
Artichoke.....	9
Asparagus.....	9
" Roots.....	9
Beans, English.....	9
" Dwarf.....	10
" Lima.....	9
" Pole.....	11
Beet.....	11, 12
" Mangel-Wurzel.....	36
" Sugar.....	36
Bird Seeds.....	33
Borecole or Kale.....	12
Broccoli.....	12
Brussels Sprouts.....	12
Cabbage.....	13
" Plants.....	33
Cardoon.....	12
Carrot.....	14, 36
Cauliflower.....	14
" Plants.....	33
Celery.....	15
Celeryiac.....	15
Chervil.....	16
Chicory.....	16
Collards.....	16
Collections, Vegetable	
Seeds.....	8
Corn, Field.....	36
" Pop.....	17
" Sugar.....	17
" Sweet Fodder.....	36
" Salad or Feticus.....	16
Cress.....	16
Cucumber.....	17
Dandelion.....	16
Egg Plant.....	18
Endive.....	18
Fruit Seeds.....	37
Garlic.....	18
Herbs.....	33
Kale or Borecole.....	12
Kohl Rabi.....	18
Leek.....	18
Lettuce.....	19
Mangel-Wurzel.....	36
Martynia.....	18
Melon, Musk.....	20
" Water.....	21
Mushroom Spawn.....	22
Mustard.....	22
Nasturtium.....	22
New Vegetable Seeds.....	1-8
Okra or Gumbo.....	22
Onion.....	23
" Sets.....	23
Parsley.....	24
Parsnip.....	24
Peas.....	25, 36
" Field.....	36
Pepper.....	24
Potatoes.....	27
Pumpkin.....	26
Radish.....	28
Rhubarb.....	27
Ruta Baga.....	32, 36
Salsify or Oyster Plant.....	29
Savoy Cabbage.....	13
Scorzonera.....	29
Sea Kale.....	29
Sorrel.....	29
Spinach.....	29
Squash.....	30
Tobacco.....	29
Tomato.....	31
Turnip.....	32, 36
" Ruta Baga.....	32, 36
Vegetable Plants and	
Roots.....	33
Vegetable Seed Collec-	
tions.....	8

LAWN GRASS.....34

FARM AND SUNDRY SEEDS.

	PAGE
Barley.....	37
Broom Corn.....	37
Buckwheat.....	37
Carrot.....	36
Clover Seed.....	35
Cotton.....	37
Field Corn.....	36
Flax Seed.....	37
Grass Seed.....	35
Hop.....	37
Locust.....	37
Millet.....	37
Mangel-Wurzel.....	36
Oats.....	37
Osage Orange.....	37
Parsnip.....	36
Peas.....	37
Ruta Baga.....	36
Rye.....	37
Serradella.....	37
Sorghum.....	37
Sugar Beet.....	36
Sunflower.....	37
Teosinte.....	37
Turnip.....	36
Vetches.....	37
Wheat.....	37
Wild Rice.....	37

FLOWER SEEDS.

Abobra.....	42
Abronia.....	42
Acacia.....	42
Acroclinium.....	42
Adlumia.....	42
Ageratum.....	42
Alyssum.....	42
Amaranthus.....	42
Ampelopsis.....	42
Anemone.....	42
Antirrhinum.....	43
Aquilegia.....	42
Arabis.....	43
Arcebia.....	43
Aristolochia.....	43
Asparagus.....	43
Asters.....	43
Auricula.....	44
Balloon Vine.....	44
Balsam.....	44
Begonia.....	45
Bellis.....	44
Brachycome.....	44
Browallia.....	44
Cacalia.....	45
Calandrinia.....	45
Calceolaria.....	45
Calendula.....	45
Calliopsis.....	45
Campanula.....	46
Canary Bird Vine.....	63
Candytuft.....	46
Canna.....	46
Canterbury Bell.....	46
Carnation.....	46
Catchfly.....	45
Celosia.....	47
Centaurea.....	47
Centranthus.....	45
Chrysanthemum.....	47
Cineraria.....	48
Clarkia.....	45
Clematis.....	48
Clianthus.....	48
Cobaea.....	48
Coccinea.....	48
Cockscomb.....	47
Coleus.....	48
Collinsia.....	48

	PAGE
Convolvulus.....	48
Cornflower.....	49
Cosmos.....	49
Cowslip.....	49
Cucumis.....	49
Cyclamen.....	49
Cyanus.....	49
Cypress Vine.....	49
Dahlia.....	49
Daisies (see Bellis).....	44
Delphinium.....	49
Dianthus.....	50
Digitalis.....	50
Dodecatheon.....	49
Dolichos.....	50
Echeveria.....	50
Edelweiss.....	50
Eschscholtzia.....	51
Euphorbia.....	51
Eucalyptus.....	50
Evening Primrose.....	50
Fenzlia.....	51
Ferns.....	51
French Honeysuckle.....	52
Gaillardia.....	51
Geranium.....	51
Gilia.....	51
Gladiolus Bulbs.....	76
Globe Amaranth.....	51
Gloxinia.....	51
Gnaphalium.....	50
Godetia.....	52
Gourds, Ornamental.....	52
Grasses, Ornamental.....	52
Gypsophila.....	51
Helianthus.....	52
Heliotrope.....	52
Helichrysum.....	53
Helipterum.....	52
Hollyhock.....	53
Honeysuckle.....	52
Humea.....	52
Humulus.....	53
Hyacinthus.....	76
Ice Plant.....	53
Impatiens.....	53
Ipomoea.....	53
Jacoea.....	53
Lantana.....	53
Larkspur.....	53
Lathyrus.....	57
Lavender.....	53
Linum.....	53
Lobelia.....	54
Lophospermum.....	53
Lupinus.....	54
Malope.....	54
Marigold.....	54
Martynia.....	18
Marvel of Peru.....	54
Mathiola.....	54
Maurandia.....	54
Mesembryanthemum.....	54
Mignonette.....	55
Mimulus.....	54
Mimosa.....	61
Mina.....	55
Moon Flower.....	55
Momordica.....	55
Musk.....	55
Musa.....	55
Myosotis.....	55
Nasturtium.....	56
Nemophila.....	55
Nicotiana.....	55
Nigella.....	56
Novelties in Flower	
Seeds.....	38-41
Nymphæa.....	77
Oenothera.....	50, 56
Oxalis.....	56
Pansy.....	57
Peonia.....	75
Papaver.....	59
Passion Flower.....	56

	PAGE
Pentstemon.....	56
Perilla.....	58
Petunia.....	58
Phlox.....	58
Pinks.....	50
Platycodon.....	59
Polyanthus.....	58
Polygonum.....	59
Poppy.....	59
Portulaca.....	59
Primula.....	60
Primroses.....	60
Pyrethrum.....	60
Rhodanthe.....	60
Ricinus.....	60
Rocket.....	60
Romneya.....	59
Rudbeckia.....	60
Salpiglossis.....	61
Salvia.....	61
Sanvitalia.....	61
Scabiosa.....	61
Sedum.....	61
Sensitive Plant.....	61
Smilax.....	61
Solanum.....	61
Stocks.....	61
Sweet Peas.....	57
Sweet Sultan.....	62
Sweet William.....	62
Sunflower.....	52
Tagetes.....	62
Thunbergia.....	62
Torenia.....	62
Tropæolum.....	62
Verbena.....	65
Vinca.....	62
Violet.....	62
Virginian Stock.....	63
Viscaria.....	63
Wallflower.....	63
Water Lilies.....	77
Whitlavia.....	63
Xeranthemum.....	63
Zea.....	63
Zinnias.....	63

SUMMER FLOWER-ING BULBS.

Amaryllis.....	75
Begonias.....	75
Caladium.....	75
Cannas.....	76
Cinnamon Vine.....	75
Dahlias.....	76
Gladiolus.....	76
Gloxinias.....	76
Hyacinthus.....	76
Iris.....	76
Lilies.....	77
Madeira Vine.....	77
Specialties in Bulbs.....	41
Tigridias.....	77
Tuberoses.....	77
Water Lilies.....	77

PLANTS.

Ageratum.....	73
Alternanthera.....	73
Amaryllis.....	75
Ampelopsis.....	73
Anthemis.....	74
Asparagus.....	73
Asters.....	73
Balsam.....	73
Begonias.....	75
Bellis.....	73
Blackberries.....	77
Blue Dawn Flower.....	74
Bulbs.....	75-77

	PAGE
Cabbage Plants.....	33
Caladium.....	73
Cannas.....	76
Carnations.....	73
Cauliflower Plants.....	33
Centaureas.....	73
Chrysanthemums.....	71-72
Clematis.....	73
Coleus.....	73
Currants.....	77
Dahlias.....	76
Daisy.....	73
Dew Berries.....	77
Double Golden Margue-	
rite.....	74
Echeverias.....	73
Egg Plants.....	33
Evergreens.....	79
Forget-me-not.....	73
Fruit Trees.....	79
Fuchsias.....	73
Geraniums.....	73
Gladiolus.....	76
Gloxinias.....	77
Gooseberries.....	78
Grape Vines.....	78
Hardy Moonflower.....	74
" Shrubs.....	79
Helianthus.....	73
Heliotrope.....	74
Hollyhock.....	74
Honeysuckle.....	73
Hydrangeas.....	74
Ipomoea.....	74
Iris.....	75
Ivy.....	79
Japan Snowball.....	79
Lettuce Plants.....	33
Lilac.....	79
Lobelias.....	74
Manettia.....	74
Moon Flower.....	74
Myosotis.....	73
Ornamental Trees.....	79
Pæonies.....	75
Pansies.....	76
Pepper Plants.....	33
Petunias.....	75
Pinks.....	76
Privet.....	80
Raspberries.....	79
Rhubarb.....	33
Roses.....	70
Salvias.....	75
Strawberries.....	78
Shrubs.....	79
Sunflower.....	73
Sweet William.....	75
Tomato Plants.....	33
Tuberous Begonias.....	75
Vegetable Plants.....	33
Verbenas.....	75
Violets.....	75
Wine Berry.....	78
Zinnia.....	75

SMALL FRUITS.....77-78

MISCELLANEOUS.

Books on Gardening,	
Second page cover.....	
Fertilizers.....	68
Flower Pots.....	79
Lawn Invigorator.....	34
Garden Tools and Re-	
quisites.....	64-70
Insecticides.....	68
Lawn Mowers.....	67
Protecting Cloth.....	65
Requisites, Garden.....	64-70
Tubs, Tree.....	78

1895

CATALOGUE

1895

— OF —

VEGETABLE, FLOWER, & FARM

SEEDS

Plants

Horticultural Tools

Bulbs

and Requisites.

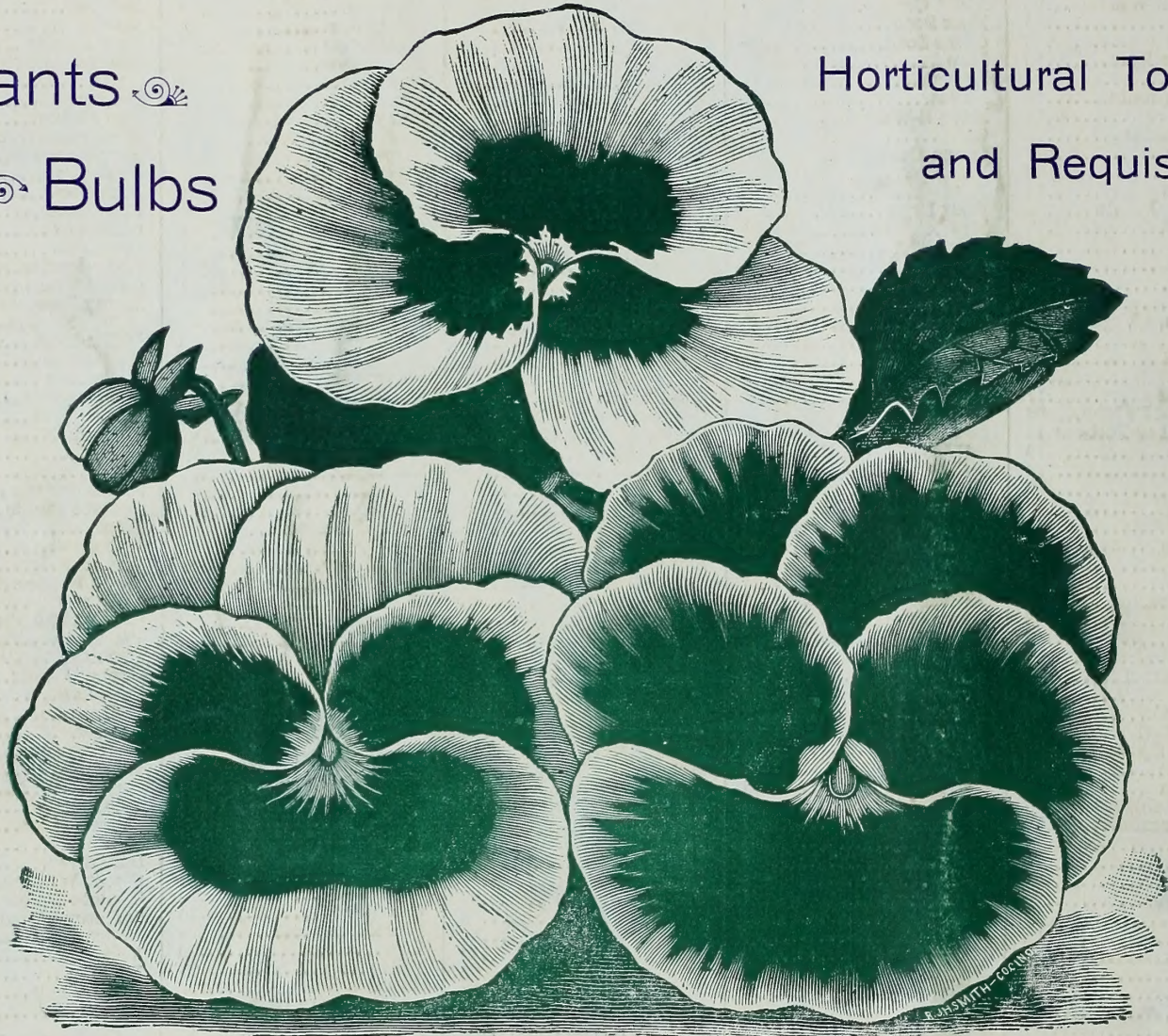

AMERICAN SHOW PANSY.

WEEBER & DON,

SEED MERCHANTS AND GROWERS,

114 Chambers St., New York.