

Historic, Archive Document

Do not assume content reflects current scientific knowledge, policies, or practices.

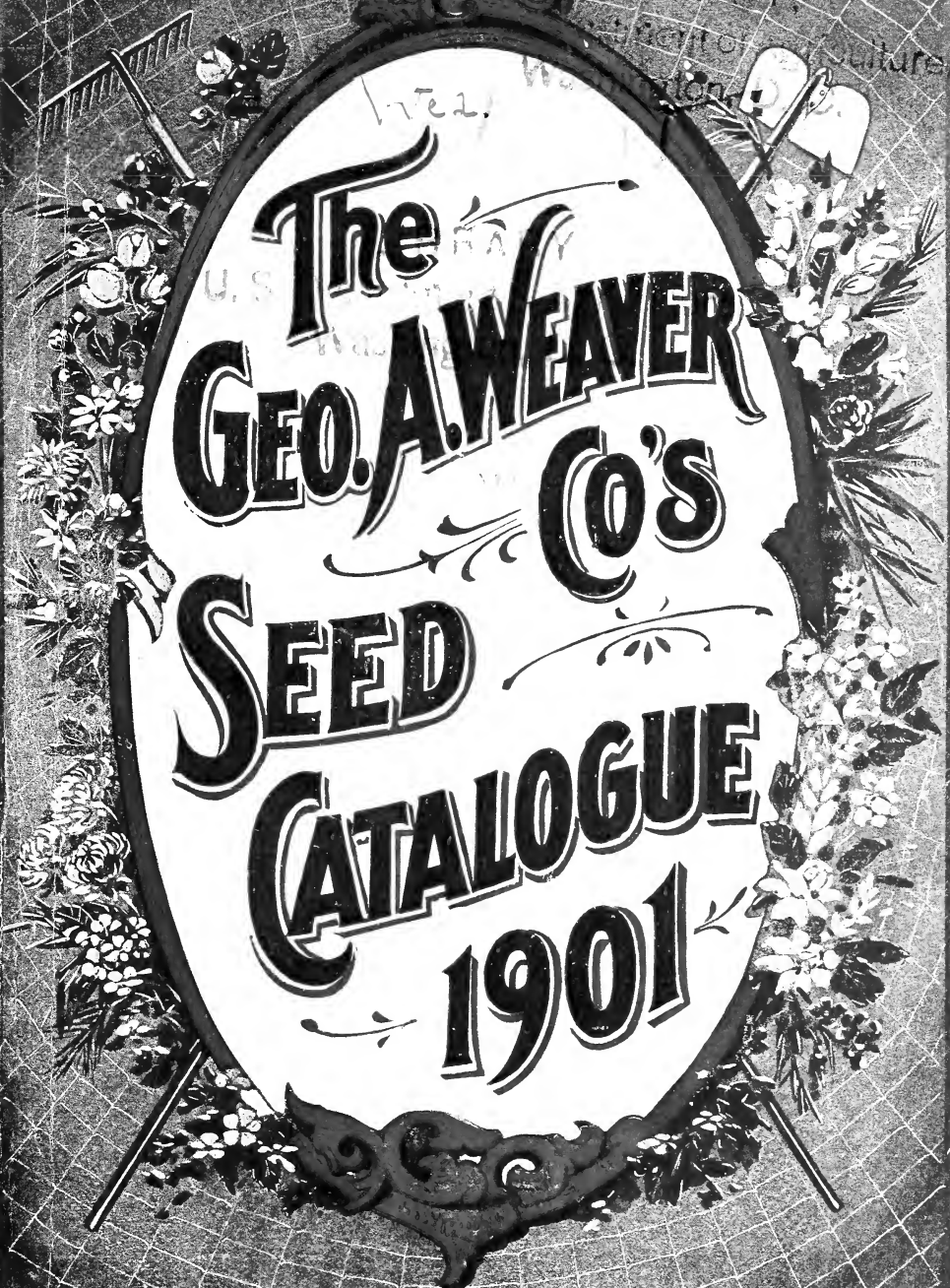

The
GEO. A. WEAVER
Co's
SEED
CATALOGUE
1901



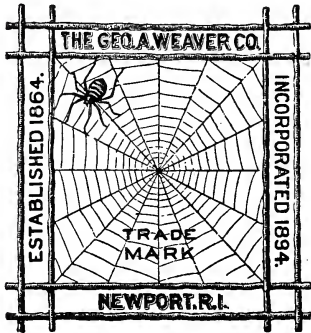

TO OUR FRIENDS— AND ... PATRONS



WEN PRESENTING our Annual Seed Catalogue, we thank you for your liberal patronage in the past, and by careful and personal attention, solicit a generous share in the future. We spare no pains and expense to secure the very best Seeds from reliable growers. We have omitted prices because we compete with any Seed House, and give you the benefit of fluctuations in the market.

Our Cash Coupon System is greatly appreciated by our patrons, it being a 5% cash discount. Our prices of merchandise are fixed to meet competition. Our stock is large and well assorted, so that you can select what you like with the coupons as you could with cash. With every cash purchase to the amount of ten cents we give one-half cent coupon. When accumulated to the amount of one dollar, or when you have purchased twenty dollars worth of us, they are good in trade with us, as cash.

OUR WARRANT.—That seeds shall be fresh and true to name, so far as we hold ourselves responsible. If they prove defective in this respect, in any way, we will fill the order anew for the same amount gratis. We warrant everything but the crop, for which we assume no responsibility. If purchaser does not accept the Seeds on these terms they must be returned at once.

TEST. — To assure you of the germinating quality of our Seeds, we show proof of our tests of everything we sell and welcome your inspection.

NOVELTIES. — Our selections are made with great care, all being new and worthy of a trial.

SEEDS BY MAIL are prepaid by us at ounce and packet prices, all heavy Seeds, including Peas, Beans, Corn, etc., we do not send free, as these are quoted at net prices at store. Purchasers are requested to remit an additional amount sufficient to cover the postage at the rate of eight cents a pound.

ORDERS.—All orders will be attended to with greatest care and prompt delivery.

Very respectfully yours,

THE GEO. A. WEAVER CO.,
Geo. A. Weaver, Manager

F. L. ZIEGLER,
Managing Seedsman

Nos. 19-23 Broadway, Newport, R. I.

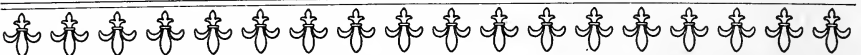

Floral Novelties,

1901.

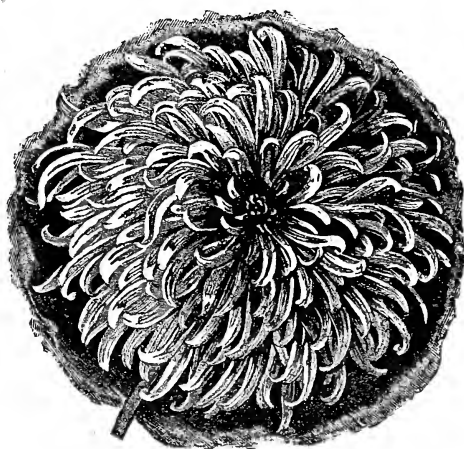

ASTER—KING HUMBERT—WHITE.

Aster, King Humbert, Pure White. — Compact, 12 inches high growing bushes, bear magnificent globular pure white flowers of the long petalled Comet type, but of extraordinary large size, 5 ins. in diameter. Pkt. 25cts.

Aster, Dwarf Princess. White, Carmine Rose, Crimson. The plants grow 10 inches high, branching out just above the soil and produce freely elegant stalks with flowers of middle size. Pkt. 25cts.

Aster, Dwarf Victoria. White passing to lilac. A new color of this variety of Asters. Pkt. 25cts.

Aster, Dwarf-Comet-Perfection, Rose.
Aster, Dwarf-Comet-Perfection, Pure White. } These two introductions
are the Perfection of the
new Comet Aster. The plants are 8 inches high, of vigorous upward growth; the flowers attain a diameter of 5 ins., are exceedingly double with long, well curled petals; bloom very early. Pkt. 15cts.

FLORAL NOVELTIES, 1901.



ASTER — MIDSUMMER TRIUMPH.

Aster, Midsummer Triumph. Dark Scarlet. Very early and perfect in the form of the flower blooms from June to August, the bushy little plants producing beautiful deep scarlet red flowers of the most perfect incurved shape. Pkt. 30c.

Aster, Dwarf Ostrichfeather. The Bride. White changing to rose. This variety resembles a Japanese Chrysanthemum and is becoming a general favorite, producing good form and beautiful colored flowers, grows into dwarf bushes 8 ins. high. Pkt. 25cts.

Aster, Dwarf Ostrichfeather.— Pure white. Pkt. 25cts.

Aster, Ostrichfeather. Rose, and white changing to rose. Pkt. 25cts.

Aster, Princess. Crimson. This color will greatly enrich the existing assortments of the Princess Aster. The form and arrangements of the petals are perfect, has a straight habit of growth, 16 to 18 ins. high and is a profuse bloomer, valuable for cutting. Pkt. 25cts.

FLORAL NOVELTIES, 1901.

Ageratum grandiflorum album. A very large flowering pure white novelty with luxuriant fresh green foliage and apple perfume, very useful for cutting during Summer until frost. Pkt. 25cts.

Ageratum, Princess Victoria Louise. Beautiful light blue with white centre, dwarf and compact, very useful for edgings and beddings, grows 3 1-2 ins. high. Pkt. 20cts.

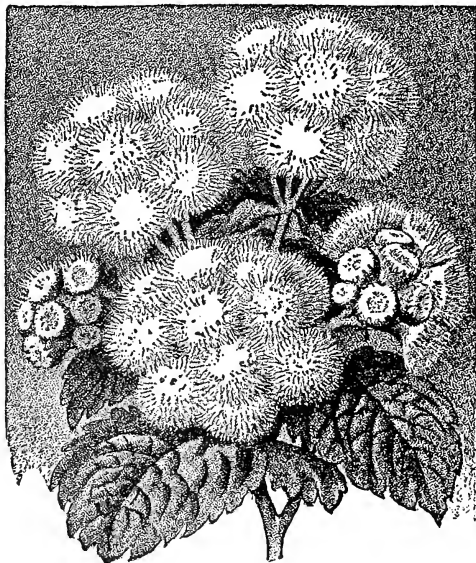

AGERATUM GRANDIFLORUM ALBUM.



CELOSIA.

Aguilegia Chrysantha flore pleno. A splendid new double-flowering Columbine. The seed produces robust plants about 2 1-2 feet high with pretty foliage and double and semi-double golden yellow flowers.

Celosia, cristata nana Ardour. Dwarf Celosia of greatest perfection, beautiful scarlet giant comb with fine light green foliage. Pkt. 25cts.

Gaillardia grandiflora foliis aurea variegatis. Pkt. 25cts.

FLORAL NOVELTIES, 1901.

Gloxinia Brilliant. The flowers are graceful brilliant carmine scarlet, shading off to somewhat lighter; often produces 18 flowers at one time. Pkt. 50cts.

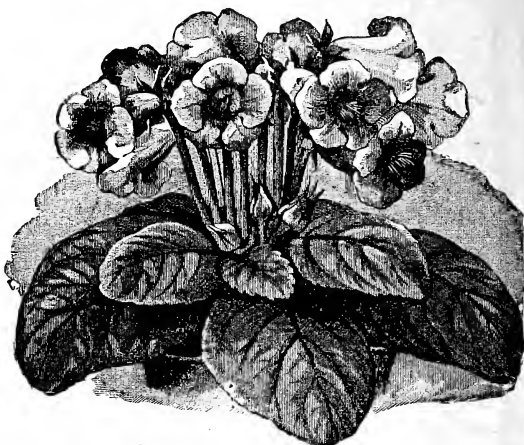

GLOXIANA BRILLIANT.

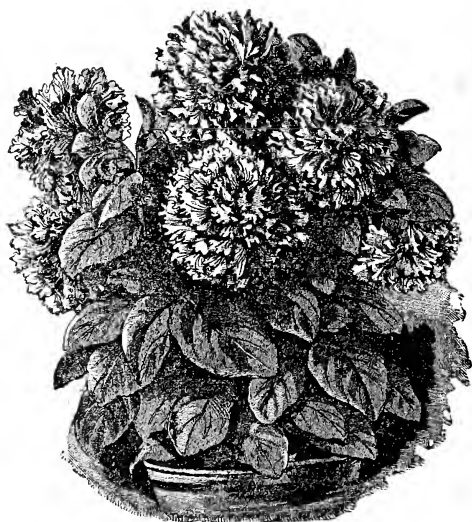

PETUNIA—DOUBLE ROSEA PERFECTA.

Petunia, double, rosea perfecta. A beautiful dwarf double fringed variety, bearing brilliant rose double flowers and develop into neat bushes 4 to 6 inches high; bloom all summer. Pkt. 50cts.

FLORAL NOVELTIES, 1901.

Mignonette, Bismark. The largest and most pyramidal shape of any Mignonette; indispensable for bouquets.

Mignonette, Orange Queen.

Mignonette, Nineteen hundred. The plant forms a bush measuring 24 ins. in diameter and often bears 300 to 400 golden yellow flowers. Pkt. 15cts.



POPPY—DWARF SHIRLEY.

Poppy, Dwarf Shirley. Charming dwarf varieties of the universally esteemed Shirley Poppy, which is admittedly one of our best annuals. The seedlings grow into bushy plants 18 ins. high with bright green foliage, and innumerable fine flowers of rose, chamois, scarlet and salmon. Pkt. 25cts.

FLORAL NOVELTIES, 1901.

Poppy, Single Pæony-flowered, Miss Sherwood. Plants grow 2 1-2 feet high, bear in profusion large single flowers of a shining satiny white, the upper half of the corolla being a silky chamois rose; desirable for cut flowers. Pkt. 25cts.

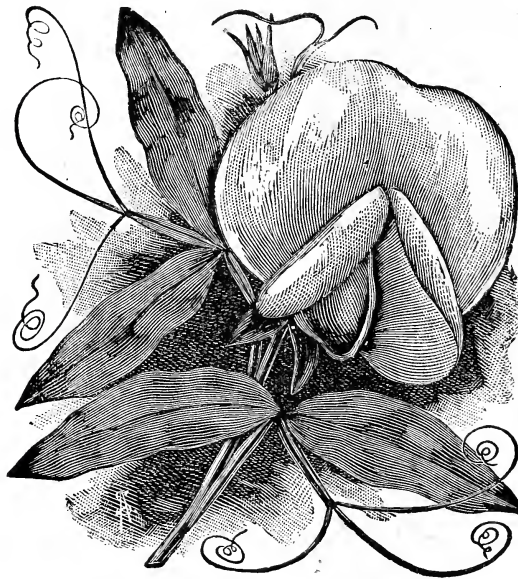

SWEET PEAS—MONTBLANC.

Sweet Peas, Montblanc. Pure White. The earliest and most graceful Sweet Pea in the market of pyramidal growth; a very showy novelty. Pkt. 25cts.

Papaver, alpinum facinatum, Alpine Poppies. White, salmon, rose or orange. Pkt. 20cts.

FLORAL NOVELTIES, 1901.

Pyrethrum roseum hybridum grandiflorum. Are well known for the use of cutting during all the summer; this new variety bears large flowers often reaching 4 ins. diameter, which presents great variations of color between rose and deep carmine.

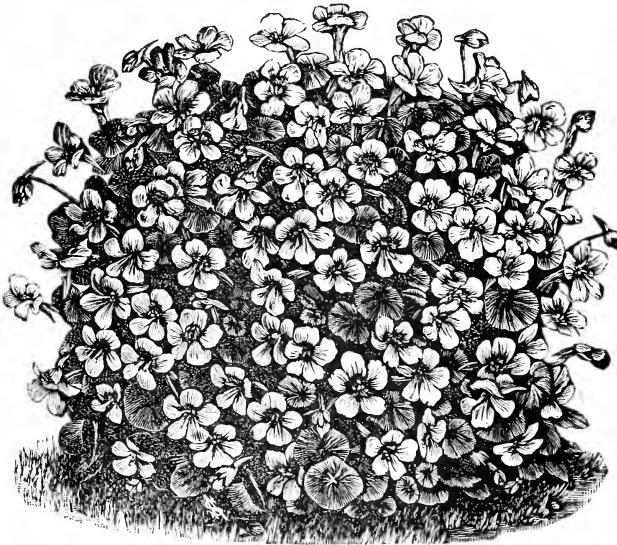

TROPÆOLUM LOBBIANUM LILLIPUT.

Tropæolum Lobbianum Lilliput, Dark Crimson, Scarlet, Spotted. Produce a great profusion of dainty little flowers with beautiful dark green foliage. Pkt. 25cts.

Verbena erinoides alba. The plants are about 8 ins. high, with very finely cut dark green foliage; they branch freely and produce fine trusses of dazzling white flowers. Pkt. 25cts.

Verbena hybrida compacta, Purple-Cloak. Dark velvety purple with white star. Pkt. 25cts.

VEGETABLE NOVELTIES, 1901.

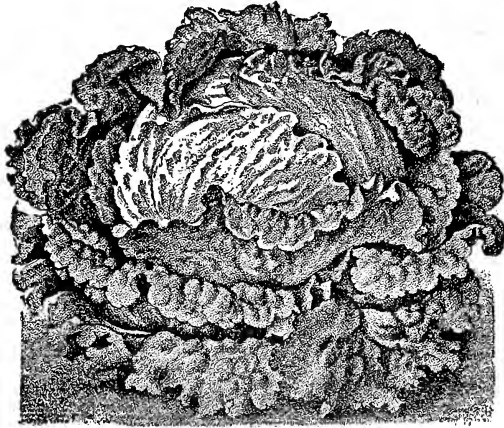

LETTUCE.

Lettuce, Giant Crystal Head. This variety excells all others in size, firmness, weight and keeping qualities. The inside is crystal white with a yellowish heart, exceedingly crisp and tender ; is also a very early variety. Pkt. 25cts.

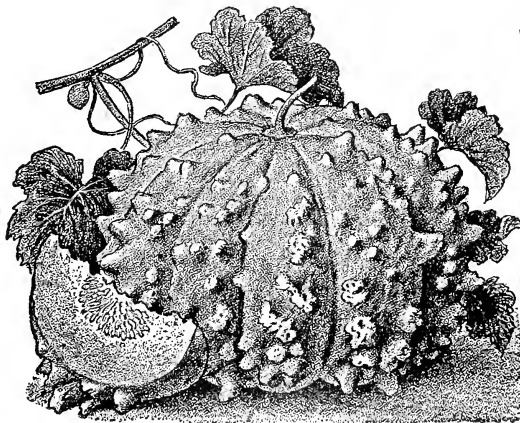

MELON.

Melon (Cantaloup) Coral Reef. The skin of this melon is full of knobs of whitish or yellowish color. Very early and prolific fruit, weighing about 15 pounds. Pkt. 25cts.

THE GEO. A. WEAVER CO.'S



New and
Choice

VEGETABLE SEEDS Of Special Merit

Carefully Selected and Tested Varieties.

ARTICHOKE.

✓ Large Green Globe. Best for general culture.

✓ Jerusalem. For pickling and feeding stock. Strong tubers. Qt. 20 cts. (by mail, 40 cts.), pk. \$1.

ASPARAGUS.

Sow in early Spring in rows a foot apart. The soil should be thoroughly manured and kept clean from weeds. One ounce sows sixty feet of drill.

✓ Columbian Mammoth White. Large.
✓ Conover's Colossal. Large and productive.

✓ Palmetto. Very large and fine.

ASPARAGUS ROOTS.

✓ Conover's Colossal. 2 years old.
✓ Columbian Mammoth. White. 2 yrs. old.
✓ Palmetto. 2 years old.

BRUSSELS SPROUTS.

The seed should be sown and cultivated like cabbage. This is one of the most delicious vegetables.

✓ Dwarf Improved. A standard variety and rich flavor.

✓ Giant Imported. Best market variety.

RUNNER BEAN.

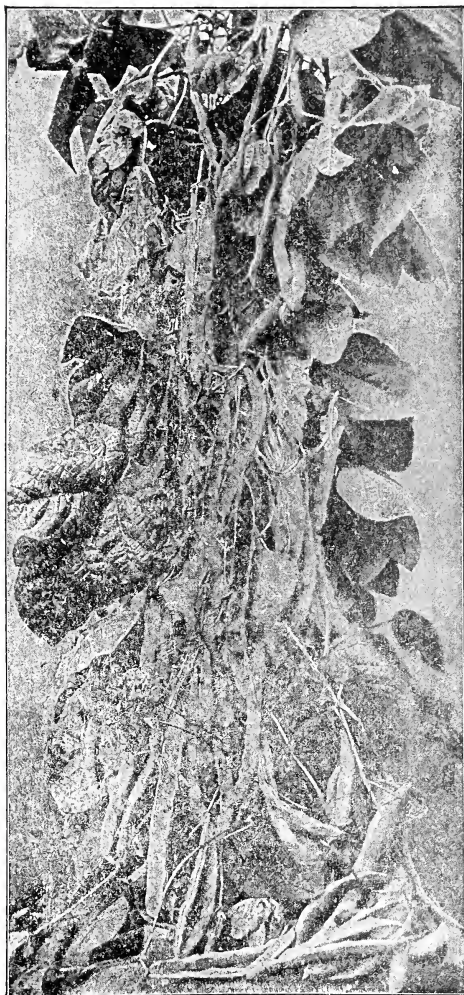

RUNNER BEAN.

Earliest ten week.

BEANS—English.

✓ **Broad Windsor.** The largest and best of the class of English Dwarf Beans for main crop.

BEANS—Dwarf or Bush.

These succeed well in almost any well-worked soil. Plant when the weather has become warm, in drills 2 or 3 feet

apart, according to the richness of the soil; cover the seed about 2 inches. For succession, plant every two weeks from the first of May till August. Hoe often, but never when the vines are wet, as the pods would discolor.

DWARF GREEN PODDED VARIETIES

✓ **Burpee's Bush Lima.** Best Dwarf Lima in cultivation, large and delicious.

✓ **Henderson's Dwarf Lima.** Earliest Lima Beans, small, exquisite flavor; very productive. A true Bush Variety.

✓ **Dreer's Bush Lima.** Pods and Beans very thick. Standard sort.

✓ **Extra Early Red Valentine.** The earliest and most profitable variety for private use or market.

✓ **Early Mohawk.** Excellent for string or shell; flat pods; very early.

✓ **Extra Early Refugee.** Large, productive, improvement on the old Refugee.

✓ **Early Yellows, six weeks.** Early, very productive and of excellent quality. Pods often eight inches long.

✓ **Dwarf Horticultural.** The best shell Bean. Good for private use.

✓ **Boston Favorite.** Fine shell Bean; plant thinly.

✓ **Refugee.** Late or 1000-to-1.

Burpee's Stringless Green Pod.

✓ **White Marrow.** One of the best for use in a dry state in winter; fine bearer; excellent.

✓ **White Kidney.** Fine shell Bean; green or ripe.

✓ **Wonder of France.** Green Flageolet. Standard sort.

WAX-PODDED VARIETIES.

✓ **Refugee Wax.** Earliest Wax Bean in cultivation; long, round, yellow pods; immense yielder.

✓ **Currie's Improved Rust-Proof Wax.** A new, distinct and most valuable variety of excellent flavor; pods tender and free from rust.

✓ **Wardwell's Kidney.** One of the best Wax Beans. Long pods, waxen yellow, entirely stringless and brittle; of fine flavor; a heavy yielder.

✓ **Improved Golden-Wax.** Pods tender and free from rust or spots.

✓ **Golden-eyed Wax.** Early, hardy and prolific.

✓ **New Davis Kidney Wax.** The best Wax Bean for the market-gardener. A large, handsome pod, containing pure white, kidney-shaped Beans.

✓ **Valentine Wax.** Earliest Wax Bean in use.

✓ **Black Wax, or Butter.** Round pod, very tender.

✓ **White Wax.** Flat pods and white seeds.

BEANS—Pole or Running.

One quart will plant 100 to 150 hills.

✓ **Early Jersey Lima.** Earlier than large Lima.

✓ **Large White Lima.** Largely grown and highly esteemed. Beans large and rich flavored.

✓ **King of the Garden Lima.** Large and of rich flavor.

✓ **Dreer's Improved Lima.** Superior early variety of excellent quality ; heavy yielder.

✓ **Small Lima, or Sieva.** Earliest of the Lima's. Prolific ; Beans small but good quality.

✓ **Black Wax, or Butter.** Round pod, transparent.

✓ **Horticultural, or Speckled Cranberry.** Good as snap or shell Bean.

✓ **Worcester Pole.** The largest Bean, brightest pod, longest keeper.

✓ **White Dutch Case-knife.** Early, productive.

✓ **White Runner.** Climber for arbors and trellises.

✓ **Scarlet Runner.** A popular English Pole Bean ; very ornamental.

BROCCOLI.

One ounce of seed produces about 2000 plants.

✓ **White Cape.** Heads white, close and compact. Most certain to head.

BEETS.

One ounce will sow 50 feet of drill ; 5 or 6 pounds are required for an acre.

A light soil, well enriched, is best suited to the cultivation of the various Beets.

✓ **Grosby's Egyptian.** A very early and carefully selected strain of the original Egyptian. Good table variety.

✓ **Arlington, Favorite Blood.** A dark-leaved early blood Beet closely following Eclipse in maturing, but of much darker color and superior in quality.

✓ **Detroit Dark Red Beet.** An ideal early market Beet.

✓ **Dewing's Blood Turnip.** Color blood red.

✓ **Eclipse.** Very early and of extra fine quality ; perfectly smooth and round ; skin and flesh intense red.

✓ **Egyptian Turnip.** Early ; tender ; excellent.

✓ **Edmand's Ea, Blood Turnip.** Good size.

✓ **Bastian's early.** Good market var.

✓ **Long Smooth Blood.** Excellent late sort.

✓ **Swiss Chard, or Silver Sea-Kale Beet.** Used as greens ; the ribs of leaves served as Asparagus.

Sugar Beets and Mangel Wurzels.

Sown in April or May, using 5 to 6 pounds to the acre.

✓ **Improved Imperial White Sugar.** An improved variety of Sugar Beets ; harder and containing a greater percentage of sugar.

✓ **Mammoth Long Red Mangel.** It produces large roots partly above the ground. Fine quality. Selected strain.

✓ **Yellow Globe Mangel.** An excellent keeping, solid variety, adopted for shallow soils. Very productive.

✓ **Golden Tankard.** Flesh, bright, golden, yellow.

✓ **Red Globe Mangel.** Larger than the yellow.

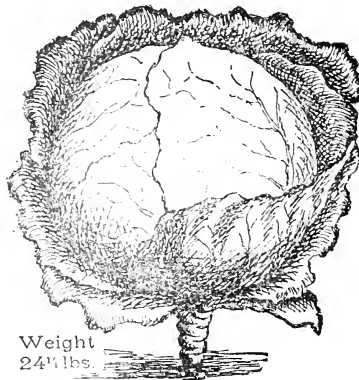

CABBAGE.

One ounce of seed produces about 2000 plants.

For very early use, sow in January or February, in hotbeds. Prick out when the plants are strong enough into other hotbeds ; or sow in cold frames in March.

✓ **Early Jersey Wakefield.** A fine early variety for home use or market ; size medium, shape pyramidal ; solid and sure heading.

New Large, or Charleston Wakefield. About five days later than Early Jersey Wakefield, with heads fully one-half larger; shape globular, flattened.

Burdee's Surehead. For a main crop is unsurpassed. Large, round, flattened heads, and is sure-heading; sweet-flavored, of fine texture and generally weighs from 10 to 15 pounds.

Large Early York. Old standard; early.

SECOND EARLY CABBAGE.

Henderson's Early Summer. 10 days later than Ea. Jersey Wakefield, but twice its size, the best second early cabbage.

Winnigstadt. Medium early, very solid.

Fottler's Improved Brunswick. An excellent early Drumhead; stem short and small; sure-heading; fine quality.

Henderson's Succession. A second-early sort, with large, solid heads; valuable also for a late crop.

Stone Mason Drumhead. Standard variety. A large, solid, tender and excellent winter Cabbage.

Danish Ballhead. Good Winter variety.

Autumn King. Superior of all Winter Cabbage.

Premium Flat Dutch. Flattened heads; finest strain. Early Fall sort.

Early Red Dutch Erfurt. Earliest Red.

Dark Red Drumhead. Large handsome heads; a favorite for pickling.

Mammoth Rock Red. The largest and most solid red variety.

Perfection Drumhead Savoy. Short stalk, compact grower and an excellent keeper. Size of the Drumhead, with the curled leaves and fine flavor of the Savoy.

Globe Curled Savoy. Finely curled leaves.

Filderkraut. Best for Sauerkraut.

CAULIFLOWER.

One ounce of seed produces about 2,000 plants.

Weaver's Earliest Dwarf Erfurt. Extra choice strain, 100 seeds, 25 cts. The most expensive seed in the market.

Weaver's Early Snowball. An extremely early dwarf variety, producing magnificent white heads of fine quality. Packet, 15 cts.

Gilt Edge. Large heavy sort maturing immediately after our Snowball. The best and surest header.

Early Paris, or Nonpareil. Medium early. Packet, 10 cts.

Lenormand's Short Stem. A large, late variety. Packet, 10 cts.

Veitch's Autumn Giant. One of the finest late varieties; of robust habit; heads large, compact. Packet, 10 cts.

CARROTS.

One ounce to 100 feet of drill; 3 lbs. to an acre.

For an early crop sow as soon as the ground is in working order; for a late crop sow in June and July.

Early French Forcing Scarlet. The earliest variety; small turnip-shaped roots.

New Rubicon Half-long. It is the best in shape, and its deep red-orange colored flesh is the finest in quality of all. It is earlier than the Danvers.

Scarlet Horn. Early and excellent sort; fine grained; medium size; grown for bunching.

Danver's Half-long. Most desirable variety for main crop; very productive and keeps well.

Chantenay. A choice variety; longer than the Scarlet Horn, and broader at the top.

Guerande, or Oxheart. Intermediate between the Half-long and Short Horn. Excellent.

Long Orange. Much used for main crop; the best late var.; good keeper.

Large White Belgian. Used for feeding stock.

CHICORY.

One ounce of seed to 100 feet of drill.

The young leaves when blanched are used for salads.

Large-rooted Chicory.

Common or wild.

CELERY.

One ounce will produce about 4000 plants.

Sow seeds in March or April in a hot-bed or cold-frame. As soon as the plants are 3 inches high, transplant into a prepared border, setting them 4 inches apart. When grown 6 inches, and fine, stocky plants, shear the tops and set in richly manured, deep soil, in rows 4 feet apart, and about seven inches from plant to plant.

Boston Market. A short, bushy, white, excellent-flavored market variety.

Henderson's White Plume. The stalk and portions of the inner leaves and heart are naturally white.

Paris Golden Self-blanching. One of the finest in cultivation ; very early, very solid ; crisp, with fine, nutty flavor. Imported originator's seed.

Giant Pascal. A superior keeping sort. The stalks are very large, thick, solid, crisp, of a rich flavor.

Kalamazoo. Perfectly solid, white, of a fine, sweet flavor, and of extra good keeping quality.

Dwarf-Golden Heart. When blanched the heart, which is large and full, is of a waxy, golden yellow.

Perfection Heartwell.

Roseribbed Paris. Delicious flavor.

Celeriac, or Turnip-rooted. The round, solid roots of this variety are used.

Soup, or Flavoring Celery (old seed). Used for flavoring pickles, sauces, etc.

CHERVIL.

One ounce of seed to 100 feet of drill.

The young leaves are used for flavoring stews, soups, salads, etc. Sow the seed in May.

CHIVES.

Seeds and Roots.

CRESS or PEPPERGRASS.

One ounce to 60 feet of drill.

Sow the seed thickly in shallow drills, 10 inches apart. For succession sow every two weeks.

Extra Curled. Fine pungent flavor.

Water Cress. Hardy aquatic perennial, growing readily on the banks of streams or ponds.

Corn Salad or Feticcus.

One ounce will sow 100 feet of drill.

Round-leaved. Used as a salad.

CORN—Sweet or Sugar.

One quart plants about 200 hills.
Ten quarts to the acre.

Select a warm soil, if possible, especially for the earlier sorts, which should not be planted before the middle of May. Successive plantings should be made every two weeks until July. Plant in hills 3 or 4 feet apart, in thoroughly manured soil.

Early Crosby. Twelve-rowed ; the finest for main early crop.

Early Concord. Ears longer than Crosby.

Early Cory. One of the earliest varieties, 8-rowed, with large red kernels ; fair quality.

White Cory. Similar to the preceding, except the kernels are white.

Burbank's Early Maine. The earliest Sweet Corn in cultivation ; has a pure white cob, with a rich cream-white kernel.

Perry's Hybrid. An early 12-rowed variety, growing 5 to 6 feet high ; large ears, set low on the stalk.

Stowell's Evergreen. A general favorite ; the ears are large, with grains deep ; tender and sugary.

Potters Excelsior, or Squantum Sugar. Twelve-rowed ; one of the finest and sweetest main crop. Very productive.

Country Gentleman. Cob small, kernels deep, very sweet and delicate ; medium early and very productive.

Black Mexican. A black-grained variety ; sweet and tender.

Mammoth Sugar. The largest late sort ; productive ; of fine flavor ; 12 to 16-rowed.

Sweet Fodder Corn. For green fodder ; 3 bushels per acre, broadcast, or 1 1-2 bushels in drills.

Rice. An early variety ; kernels pointed.



CUCUMBERS.

One ounce for about 50 hills ; 2 pounds to the acre.

For very early use, seed may be started in heat and the plants set out in May.

Improved White Spine. Very productive ; of medium length ; dark green color.

Arlington White Spine. A remarkably fine strain; is especially recommended to market-gardeners.

Evergreen White Spine. Very early; differs from the ordinary White Spine in holding its deep green color much longer.

Green Prolific Pickling. Dark green; medium length; very free bearer.

Early Cluster. Prolific tender, crisp.

Long Green. Fruit about 12 in. long.

Short Green, or Gherkin. Good for pickling.

Early Russian. One of the earliest; the fruit is small and produced in pairs.

Everbearing. The vines continue to flower and produce fruits in every stage of growth until killed by frost.

Rollisons Telegraph. Produce very large cucumbers used mostly for Forcing.

Tailby's Hybrid. A hybrid between White Spine and English Prize, retaining the beauty of the English and hardness of the White.

Cool and Crisp. Extra early, prolific.

Boston Pickling. The best for pickling.

West India Gherkin. Use only for pickling.

Japanese Climbing. Can be grown on trellises, fences, etc.

DANDELION.

One ounce for 200 feet of drill. One pound for an acre.

Improved Large-leaved. The finest variety.

EGG-PLANT.

One ounce will produce about 1,000 plants.

New York Improved Spineless. The leading market variety. Very large, oval, heavy fruit.

Perfection Thornless. A great improvement over the New York.

Early Long Purple. Fruit longer and smaller than the New York. Early, productive.

Black Pekin. An excellent globe-shaped variety.

ENDIVE.

Green Curled. Useful as a salad, and highly ornamental, from its delicately cut and colored leaves.

White Curled. Handsome variety.

Broad-leaved Batavian (Escarolle). A looser-growing sort, sometimes used in soups.

KALE, or BORECOLE.

One ounce will sow about 200 feet of drill.

Green Curled Scotch. Beautifully curled, bright green.

Brown German. Curled, very hardy.

Siberian. This variety is extensively grown as winter greens; sown in September.

KOHL RABI.

One ounce sow about 100 feet of drill.

Early Purple Vienna. Greenish purple outside, with white flesh.

Early White Vienna. Fine variety.

LEEKS.

One ounce will sow about 100 feet of drill.

Leeks require a very rich soil and a liberal dressing, sow in April.

Large American Flag. A favorite variety with the market-gardeners; strong and vigorous.

London Flag. It is hardy and of good quality.

Musselburg. Strong flavor.

Monstrous Carentan. Large variety.

LETTUCE.

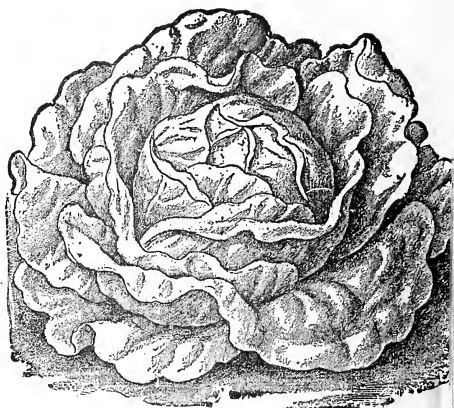

SALAMANDER.

LETTUCE.

One ounce will produce about 3,000 plants.

Boston Market. For forcing. Forms fine perfect heads; very crisp and tender. The true strain, on which growers for Boston market rely extensively for heading under glass.

Big Boston. Identical in color, shape and general appearance with the above, but is double the size and about one week later in maturing.

Henderson's New York. Of unusual size and solidity; center white; crisp and tender.

Black-seeded Tennisball. Most popular for open air culture; forms a handsome compact head.

Grand Rapids Forcing. Leaves crimped and frilled; heads of fair size, crisp.

Deacon. Heads large, compact, leaf is tender; stands our hot sun well.

Salamander. One of the best for summer use; good-sized, compact head; light green outside and white inside.

Paris White Cos, or Romaine. Of upright growth, standard variety.

Trianon Self-closing Cos. The finest of the Cos varieties; leaves long, narrow; heads upright; crisp and tender.

All the Year-Round, Buttercup Hanson, Early Curled Simpson. Drumhead.

MELON.

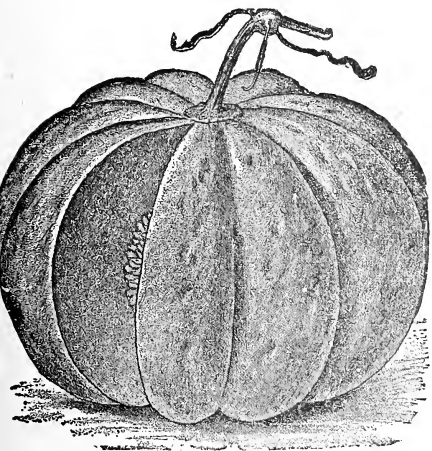

MUSKMELONS.

One ounce to about 50 hills; 2 pounds to an acre.

Melons thrive best in a light, rich soil. Plant early in May, when the ground has become warm and dry.

Roky Ford. A sweet and luscious Melon that has become world famous for its captivating flavor.

New Green-fleshed Osage. Very sweet and fine.

Jersey Belle. The largest of all the first-early sorts. Green flesh, fine flavor, heavily netted.

Extra Early Hackensack. Large, round, deeply ribbed and netted; flesh green, of delicious flavor.

Burpee's Melrose. Hardy, strong, and a vigorous grower; shape oval; the flesh is thick and solid.

Delmonico. The Flesh is deep rich orange yellow color, has a delicate and delightful flavor.

Improved Christiania. Rich flavor, flesh deep and solid.

Paul Rose or Petoskey. Salmon flesh, very sweet, gray netting. Good variety for market gardeners.

The Newport. The Banquet. Miller's Cream, or Orange. Surprise. Jenny Lind, Green Citron, Montreal Nutmeg.

WATERMELONS.

One ounce to about 30 hills; 4 pounds to an acre.

Vick's Early. Oblong, dark green skin.

Ice Cream. Of medium size, nearly round, pale green with thin rind; flesh solid, scarlet, crisp, of delicious flavor, and very sweet.

Kolb Gem. Very large, nearly round, delicious, sugary flavor; red flesh.

Mammoth Ironclad. Of large size and great weight; flesh deep red.

Black Spanish. Round, dark green; flesh scarlet, delicious.

Long Light-Icing. Nearly twice as heavy as the Round Icing, and fully equal to it in quality.

Dark Icing.

Citron. Used only for preserves.

Cuban Queen. Phinneys early, Dark Icing.

MUSTARD.

One ounce will sow 60 feet of drill.

Sow thickly in rows, and cut when about 2 inches high; for use during winter it may be sown in boxes in the greenhouse or in frame.

Black, or Brown. Most pungent in flavor.

White London. Best for salads.

MUSHROOM.

One pound will spawn about 10 square feet.

Best English Milltrack Spawn.

French Spawn produces Mushrooms of very delicate flavor.

WE OMITTED PRICES BECAUSE WE SELL AT COMPETITION PRICES.

MARTYNIA.

One ounce will plant about 100 hills.

Martynia proboscidea. The best for pickles.

ORKA, or GUMBO.

One ounce will sow 40 feet of drill.

Perkins' Mammoth Long Podded. The pods shoot out from the stalk within 3 inches of the ground. The whole plant is covered with them, are intense green, 9 to 10 inches long, very slim,

ONIONS.

1 ounce to 100 feet of drill; 4 to 5 pounds to the acre.

Danver's Yellow Globe. An early, globe-shaped Onion of mild flavor and attractive color; a good keeper and very productive; a standard variety. Our seed is first-class in every respect.

Large Red Globe. Beautiful globe shape, and rich purplish crimson color.

Large Red Wethersfield. A leading variety; it grows to full size the first season from seed; is large, almost round, deep red, and keeps well.

Extra Early Red. About 10 days earlier than the Wethersfield; flat and somewhat smaller; of mild flavor; an excellent keeper.

Prize-Taker. This is the large, pale yellow Onion that is offered for sale in the fruit stores and markets.

White Portugal. Early, mild-flavored.

White Globe. Large and very handsome.

Adriatic Barletta. A very early, small, white variety, having a very delicate silver skin.

Giant White Rocco. Paris Silverskin.

ONION SETS.

Onion Sets should be planted out as early in spring as the ground is dry enough to work. Plant them in rows a foot apart, with sets 3 or 4 inches apart.

White. Quart, 25 cts.

Yellow and Red. Quart, 20 cts.

Potato Onions, Yellow. Quart, 25 cts.

Shallots. Quart, 25 cts.

Garlic. Pound, 25 cts.

White Multiplier. Of pure silvery white color, and enormously productive. Of excellent quality and size for bunching green, or can be ripened for use as pickling Onions. Their keeping qualities are remarkable; very early. Quart, 25 cts.

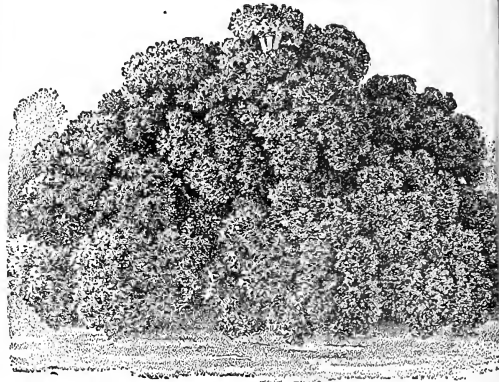
PARSLEY.

WEAVER'S DWARF PERFECTION.

PARSLEY.

One ounce will sow 100 feet of drill.

Parsley succeeds best in rich, mellow soil.

Weaver's Dwarf Perfection. Bright green, delicious flavor, compact growth, with beautiful curled leaves.

Extra-curled. Dwarf; good for table or edging. Beautifully curled.

Fern-leaved. Finely cut. Fernlike.

Moss-curled. Double curled and crimped.

Plain-leaved. Strong flavored.

Hamburg, or Rooted. The roots are used for flavoring soups or stews.

PARSNIP.

One ounce will sow 100 feet of drill; 5 to 6 pounds to the acre.

Sow in April or early in May, as Parsnips require a long season to mature.

Hollow Crown. One of the best grown.

Long Smooth White. Straight, smooth and handsome.

Student. An improved English sort; suitable for shallow soils.

PEAS.

One quart will plant 100 feet of drill; 1 to 1-4 bushels per acre.

EXTRA EARLY VARIETIES.

Alaska. One of the very earliest blue Peas; quite productive.

First and Best. Seeds round and white; one of the most profitable extra-earliest for market and private use.

Daniel O'Rourke Improved. Extra early; favorite market gardeners sort.

Gradus. The finest extra-early Pea yet introduced; it is in condition to pick about four days after our extra early First and Best. The Pods are very large, and well-filled with large wrinkled deep green Peas of the very finest quality.

DWARF EARLY VARIETIES.

Nott's Excelsior. Robust and vigorous in growth. Very prolific.

Chelsea. Grows about 15 inches high, and is of compact, short-jointed habit, requiring no brush; very productive.

American Wonder. A remarkably fine dwarf; early variety.

McLean's Little Gem. A green wrinkled Pea of delicious, rich, sugary flavor; very early; 1 foot; straight pods.

Premium Gem. Somewhat more robust in habit than Little Gem; very sweet; 1 foot high. Well filled. Standard.

Duke of York. Very large, long full pods, and Peas of the finest flavor, very early and productive; one of the finest Peas grown.

MEDIUM EARLY PEAS.

McLean's Advancer. A dwarf green, wrinkled marrow Pea, with numerous long, well-filled pods.

Abundance. Dwarf, bushy habit; pods large, full and numerous; sow thin; height 18 inches.

Everbearing. Fine wrinkled marrow; pods 3 to 4 inches long, well filled with large Peas; quality unsurpassed in sweetness; 2 feet.

Heroine. A green wrinkled Pea, growing uniformly 2 to 2 1-2 feet high, coming in between Advancer and Champion of England.

Horsfords Market Garden. Early, very fine flavor and remarkably productive; 2 feet.

Shropshire Hero. Improvement on Yorkshire Hero, bearing in greater abundance large pods filled with Peas of fine flavor; height 2 1-2 feet.

LATE VARIETIES.

Champion of England. One of the best and most popular wrinkled varieties in cultivation; of delicious flavor and a profuse bearer; height 5 feet

Improved Stratagem. The pods are of immense size and very uniformly filled with very large, dark green Peas of the finest quality.

Stratagem. A green, wrinkled marrow, producing numerous pods of large Peas of excellent quality.

Junco. Pods are thick and filled from stem to tip.

Melting Sugar. Edible pod.

Telephone. Immensely productive; of the finest quality and sugary flavor.

Marrowfat, Dwarf White. An old standard.

Marrowfat, Black-eyed. Excellent for garden or field culture; large, well-filled pods; 4 feet.

Canada Field Peas.

PEPPERS.

One ounce will produce about 2,000 plants.

Sow in hotbed early in March or April, and transplant to the open ground when the weather is favorable.

Large Bell, or Bull-nose. Very large; mild flavor; bright red.

Golden Dawn. A magnificent yellow Pepper of the Bell class; mild and sweet.

Long Red Cayenne. From 3 to 4 inches long; bright red; very productive and pungent. Slender pots.

Small Chili. Red conical pods about 2 inches long; very hot and prolific.

Ruby King. Crimson-scarlet; large, bell-shaped pods; a good variety for pickling.

Sweet Mountain. Large size; regular handsome shape; mild flavor; very early.

POTATOES.

Eight bushels of cut tubers are sufficient to plant one acre.

Special quotations on large lots. Prices subject to variations of the market.

The soil best suited to growing Potatoes is a sandy loam. In breaking up good pasture land the decaying sod answers sufficiently well for the first year in lieu of manure.

EARLY VARIETIES.

Early Rose. We offer select eastern-grown seed of this leading variety, for earliness, quality and productiveness.

White Rose. Early and productive.

Early Norther. In shape it resembles the Early Rose, but is a little longer and earlier, also a strong, vigorous grower; the eyes are few and shallow.

Early Thoroughbred. An extra early Potato of the Rose type. Of the handsomest appearance, of superb quality and an enormous yielder.

Queen. Closely resembles Beauty of Hebron, but is much earlier and heavier yielding.

Beauty of Hebron. A little earlier than Early Rose; productive; fine quality; a good keeper.

LATE CROP VARIETIES.

Carman, No. 1. Second-early, enormous yielder, white skin.

State of Maine. Medium early; excellent flavor; cooks dry; a good keeper and productive.

White Elephant. Very productive and of excellent flavor; pure white; excellent keeper; yielded last year 127 barrels to an acre on one of our customer's farm.

PUMPKINS.

One ounce will plant 25 hills.

Sweet, or Sugar. Excellent for baking or pies.

Cheese. Very productive; for stock or cooking.

Connecticut Field. The large yellow Pumpkin; excellent for stock; very heavy cropper.

Mammoth. Often weighing over 100 pounds.



ICICLE.

RADISHES.

One ounce will sow 100 feet of drill.

These require a light, loamy soil, made moderately fertile. It should be dug a full spade deep, and well pulverized.

Non Plus Ultra Turnip. Quite invaluable for first crops.

Early Scarlet Globe. An excellent forcing variety. Brilliant scarlet, of fine globe-shape, with small top.

French Breakfast. Form oval; scarlet-tipped with white; quick-growing, of excellent flavor.

Icicle. Last years novelty; medium long, of exquisite taste.

Scarlet Turnip, White-tipped. Round, of most attractive appearance; quality unsurpassed; early.

Early Scarlet Turnip. Round, scarlet; small, short top, mild and crisp. One of the best for successive sowings in open ground.

White Turnip. Suitable for summer use or for forcing.

Golden-Yellow, Olive-Shaped. A new very early yellow Radish, for forcing or open ground.

White Olive-shaped. Good keeper.

Arlington Long Scarlet. This is the variety so extensively grown in the vicinity of Boston for market.

Scarlet China. One of the best fall and winter varieties. Rose color; flesh white, fine quality.

Long Black Spanish. One of the hardest and best for winter use.

Round Black Spanish.

Giant White Stuttgart Winter. Finest white.

Rosy Gem. Fine flavor.

RHUBARB.

Sow in April in drills a foot apart. When 3 or 4 inches high thin out in the rows to 10 inches apart and transplant the ensuing autumn or spring to any desired situation, in a deep, rich soil.

Victoria. Very large; the finest for cooking.

Roots.

SALSIFY.

One ounce will sow 50 feet of drill.

Commonly called Vegetable Oyster. Used stewed, boiled or fried; when cooked has an oyster flavor.

Long White French.

Mammoth Sandwich Island. This variety will average nearly double the size of the White French, of excellent quality; best variety for market-gardeners' use.

SPINACH.

One ounce to 50 feet of drill;
15 to 16 pounds an acre.

This is an important market-gardeners' crop of easy culture. The ground cannot be too rich.

New Victoria. The foliage is heavy, the broad, dark green leaves being of the finest quality.

Curled-leaved Savoy or Bloomsdale. Large curled and wrinkled leaves; tender, and of the finest flavor.

Round Thick-leaved. One of the best for early spring or fall sowing; leaves large and succulent.

Long-standing. Except in standing a longer time before running to seed, this variety in other respects closely approaches the well-known Round-leaved.

Prickly-seeded Viroflay.

New Zealand Summer Distinct. Grows well during hot summer weather when the ordinary Spinach cannot be had.

SQUASHES.

One ounce of the bush varieties will plant 30 hills; of the running varieties 15 hills; 4 pounds per acre.

All varieties are somewhat tender, and should not be planted till all danger of frost is past in the spring.

EARLY VARIETIES.

Early Summer Crookneck. Golden-yellow, long; warty variety; excellent flavor.

New Giant, Summer Crookneck. This new Squash is not only earlier than the common variety, but grows uniformly to twice the size.

New Mammoth White Bush Scallop. An improved strain of the well-known White Bush, growing much larger; ripens early; skin handsome white.

White Bush Scallop. This and the Yellow Bush are grown almost exclusively for first crop.

Yellow Bush Scallop. Differs only in color.

Vegetable Marrow. A delicious English sort. Skin greenish white; flesh white, soft and of a rich flavor. A heavy cropper; quite distinct.

Boston Marrow. Oval, bright orange, flesh yellow and fine.

Early Prolific Orange Marrow. This variety is much earlier than the Boston Marrow.

Hubbard. A general favorite and one of the best late table varieties. Of large size; flesh fine-grained, dry and of excellent flavor.

TOMATO.

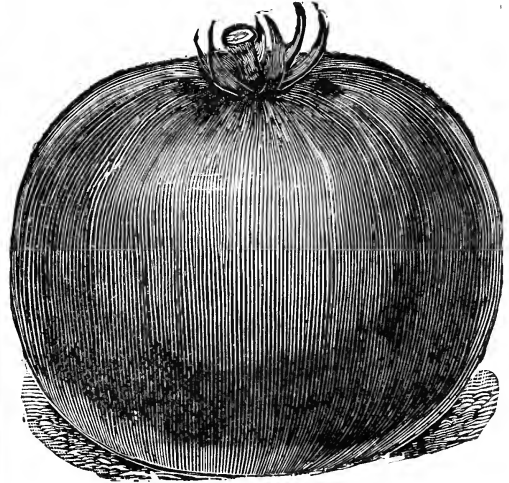

MAGNUS.

TOMATOES.

One ounce will produce about 1500 plants.

For early plants sow in hotbeds early in March, in drills 5 inches apart and half an inch deep.

Early Ruby. A real early variety.

Atlantic Prize. Very early, bright red, solid, smooth and very productive.

Dwarf Champion. Foliage dark; stems strong; fruit crimson, smooth and solid.

Golden Queen. Color light yellow; good.

Livingston's Beauty. Rich, glossy crimson; the fruit grows in clusters; large size, and smooth.

Livingston's Favorite. Large; ripens evenly and early; prolific, good flavor; solid, bright red.

Livingston's Perfection. Larger than Acme; as early; perfectly smooth, solid, almost round; deep red.

Livingston's Royal Red. A first-class main crop variety for market and private gardener.

Livingston's Honor Bright. Its qualities are excellent. Its color first is light green, then an attractive waxy white, then lemon, changing to bright red.

Magnus. Produces large fruit, perfect form, firm flesh.

The Mikado. Perfectly solid; generally smooth, sometimes irregular; color purplish red.

Trophy, Paragon, Acme.

Stone. Royal Red.

Ponderosa. Solid, perfect in form, delicious flavor.

Crimson Chusion. Good size, smooth.

TURNIPS.

One ounce will sow 150 feet of drill; 2 pounds to an acre in drills; 1 pound to an acre broadcast.

Turnips do best in highly enriched, light, sandy or gravelly soil.

Extra Early White Milan. A splendid extra early Turnip, in which the extreme earliness, small top and tap-root of the Purple-top Milan is united with clear white skin and flesh.

White-top Strap Leaf. Standard white variety of fine quality. Excellent for table use.

Purple-top Strap Leaf. The principal sort for early spring and fall use; the top is red or purple above ground; flesh white, fine-grained, mild flavor.

Purple-top White Globe. Excellent for early spring and fall use; improvement on above flesh; fine-grained, mild flavor; a good keeper.

Early Snowball. Small, and of rapid growth, pure white.

Early White Flat Dutch. Early, white fleshed, mild flavor and excellent quality.

Cow Horn, or Long White. Fine grained, sweet; keeps well. Roots are shaped like a cow horn.

Yellow Aberdeen. Yellow-fleshed; excellent sort. Round, smooth and fine in appearance.

Yellow Stone, or Globe. One of the best; fine for table or stock. Fine-grained and sweet.

Golden Ball or Orange Jelly. Its beautiful color and fine flesh have earned for it the synonym of "Orange Jelly."

White Egg. Smooth; medium large; egg-shaped; fine quality; excellent fall variety.

RUTA-BAGA OR SWEDISH TURNIPS.

The Swedish or Ruta-baga varieties, should be sown in drills 18 to 24 inches apart, at any time from the first of June to the middle of July, using about one pound of seed per acre.

Budlong Swede. A choice strain. White. Fine grained; of medium size, quick-growing, tender and sweet; is fine for winter and spring use.

White French. Solid, mild, sweet; of large size; later than Budlong.

Sweet German. More globe-shaped than White French; coarser; white-fleshed; excellent flavor.

Skirvings Purple-top. Large, good keeper.

Long Island Improved. Good variety.

MEDICINAL HERBS.

Herbs in general delight in a rich, mellow soil.

Those marked with a (*) are perennial and when once established in a garden may be preserved for years with a little attention.

Anise, Balm, Sweet Basil, Bene, Borage, *Caraway, Catnip, Coriander, Dill, Sweet, *Fennel, *Horehound, Lavender, Lovage, Sweet Marjoram, *Rosemary, Rue, Sage, Savory, Summer, Sorrel, Broad-leaved, French, *Tarragon, Thyme, Broad-leaved English, *Thyme French Summer, Wormwood.

VEGETABLE PLANTS.

The best early and late sorts.

Cabbage, Cauliflower, Celery, Chive, Horse Radish, *Egg-plant, N. Y. Imp., Lettuce, Parsley, Pepper, Tarragon, Tomato.

Bird Seed, Mocking Bird and Parrot Food.

Market Prices.

Sicily Canary, Hemp, Rape, German Millet, French Millet, Flax, Maw, Gold Fish Food, Parrot Food, Sunflower Seed, Mocking Bird Food, Paddy or Unhulled Rice, Kaffir Corn, Peas for Pigeonfood, Canadien Vetches, Cuttle-Fish Bone, Bird Gravel, Bird Mannia, Song Restorer, Feed Cups, Breeding Nests, Perches, Bath Cups, Bird Lice Destroyer, Cage Hooks.

FERTILIZERS.

Prices Subject to Variations.

Special Quotations on Large Quantities.

Bone Fertilizers.

Contain forty to fifty per cent. phosphate of lime, and nitrogen equal to about four per cent. of ammonia. Decompose slowly in the soil and, therefore, form excellent permanent improvement, being less likely than almost any other kind of manure to waste in rainy seasons, particularly on sandy soils. There is no danger of burning the plants, whether applied as top-dressing or directly to the roots. Excellent for top-dressing lawns and grass lands, for garden and field crops.

Quantity required. *For permanent pasture and mowing lands, $\frac{1}{2}$ to 1 ton per acre. For trees and vines, 2 to 4 quarts each. For top-dressing, 1,000 to 1,500 lbs. per acre. For field and garden crops, $\frac{3}{4}$ to 1 ton broadcasted and harrowed in. For rose beds, pot plants, etc., 1 part to about fifty of soil.*

Raw Bone Meal. This is ground very fine, decomposes more rapidly in the soil than the coarser grades, and is, therefore, more quickly beneficial.

Raw Ground Bone. This is moderately fine and particularly adapted for general fertilizing; the finer particles are immediately beneficial, the coarse keeping up the supply of plant food for a long period.

Raw Crushed Bone. Slow but permanent in action, indispensable in the preparation of grapevine borders—for fruit trees, small fruits, etc.—where a lasting fertilizer is required.

Grape Bone. Special to prepare grapevine borders.

Bone Superphosphate.

Benefits crops quickly, readily available, promoting early maturity, affording constant nourishment during their entire season's growth. In case of rotation of crop it is nearly as valuable for the last as for the first.

Quantity required. *For garden and field crops, 500 to 600 lbs. per acre; for garden crops it is best drilled in at*

seed-sowing time. For top-dressing swift, sure, super Phosphate, special adopted and used by Farmers for Potatoes.

Blood and Bone.

A very concentrated source of nitrogen, yielding ammonia, etc., by gradual decomposition, and, in consequence, is superior for immediate as well as for prolonged results; it is of exceptional value for garden crops, root crops, corn, grain, grasses, fruit trees, small fruits, grape vines, and, in fact, all kinds of vegetation.

Quantity required. *When broadcasted and harrowed in use from $\frac{1}{2}$ to 1 ton per acre. For garden crops drill in 300 to 500 lbs. per acre.*

Nitrate of Soda.

Valuable solely for the nitrogen it contains, equal to twenty per cent. of ammonia. It is chiefly a stimulant; it is used in addition to other fertilizers. It is very quick in action and hastens the maturity of crops.

Quantity required. *Being extremely soluble it should not be applied until the plants are above ground, when 100 to 500 pounds per acre, mixed with wood ashes or land plaster, for convenience in applying are generally used.*

Muriate of Potash. A high grade Fertilizer and one of the best Orchard Fertilizers known.

Swift Sure Guano. For Tomatoes, Truck and Corn.

Peruvian Guano.

The Geo. A. Weaver Co.'s High-Grade Fertilizer. For all Crops. Special prepared for us by the factory for market gardening and highly recommended by the same. Sales are yearly increasing, last year's increase 200 tons.

Swift Sure Fertilizer. For General use.

Land Plaster. Excellent for composting, fertilizing or mixing with Guano.

Agricultural Salt. For top-dressing Asparagus beds.

Kainit, German Potash Salt. One of the most useful ingredients for making Commercial fertilizers or using alone.

Pure Pulverized Sheep Manure

A pure natural manure, and most nutritious for plants. Its effect is immediate and lasting. Excellent for mixing with the soil for greenhouse plants (one part manure and six parts soil). Strewn over and dug into the vegetable garden, or placed directly in drills or hills, it promotes a rapid, steady growth until maturity. It makes a rich, safe and quick Liquid Manure; one pound to five gallons of water can be used daily, if necessary, with safety.

Ashes.

Canada Unleached Hard Wood. Contains all fertilizing elements except nitro-

gen. They drive away insects, and are indispensable for all crops requiring potash. They are very beneficial for garden and field crops, and are of high value for cabbage, potatoes, onions, strawberries, fruit trees, corn, clover, wheat, beans, grass lands and lawns.

Quantity required. *Apply 1 to 2 tons per acre, as one heavy application will help much more than the same quantity would, applied in fractions.*

Imperial Liquid Plant Food.

Immediately available as food for plants, producing quick and lasting results, and adapted to all garden and pot plants, lawns, etc. Before using dilute with 50 times its bulk of water, and apply with watering-pot.

PRICE (*not available*), pint, 25c.; quart, 40c.; 1 gallon \$1.25; 5 gallons, \$5.00; barrel of 30 gallons, \$20.00.

Farm Seed, Grain, Etc.

Market Price.

BARLEY.

Champion Vermont.

BUCKWHEAT.

Am. Silver Hull.

Japan. Very productive, grains larger than other variety.

MILLETS.

Japan Barn-Yard. Excellent for Fodder, very productive; less harsh and woody than other Millets.

Hungarian. Most valuable soiling plant, also good for hay or green fodder.

Golden or German. Useful in the same way as the Hungarian, and for Birdseed.

OATS.

All the approved sorts furnished.

RYE.

Winter Excelsior. Spring.

WHEAT.

Winter.

SORGHUM.

Early Amber Sugar Cane, Early Orange Sugar Cane, Brown Dhoura Corn, Yellow Branching, (Yellow Millo Maize, non-saccharine) White Branching (White Millo Maize, non-saccharine).

Red Kaffir Corn. Non-saccharine. The plant is low, stalky, perfectly erect. The whole stalk as well as the blades, cures into excellent Fodder and in all stages it is available for green feed.

White Kaffir Corn.

White African Sorghum, African Millet or White Dhoura Halepense (Johnsongrass). Very valuable southern fodder plants.

Forage, Economical and Miscellaneous Seeds.

Market Price.

Common English Horse Bean.

Soja Bean. Excellent for green fodder.

Velvet Bean. Forage and Fertilizer plant.

Cow Peas. Fodderplant and gathers large amount of nitrogen from the air,

valuable for plowing under when green.

Flaxseed, Hemp, Canadian Field Peas, Rape—Dwarf Essex, English, Vetches — Spring Tares, Winter Vetches.

WE OMITTED PRICES BECAUSE WE SELL AT COMPETITION PRICES.

LAWN MIXTURES.

Bellevue Avenue Lawn Mixture.

For permanence, for beauty under all circumstances, and for value, we are confident Bellevue Avenue Lawn Mixture will meet all requirements. By a judicious use of some of the standard lawn grasses of America, we are enabled to offer to our customers a mixture which for all good staying qualities is unsurpassed. Modern lawns demand grasses that are able to stand the wear and tear consequent to lawn tennis, croquet, etc.

Bellevue Avenue Lawn Mixture.

I have for the last two years used the "Bellevue Avenue" Lawn Mixture, and can cheerfully say that I have found it very satisfactory, both for renovating and also for making a new lawn. Last season I sub-soiled the lawn at "The Elms," using for a portion of it fertilizer and seed procured from your firm, at the rate of $1\frac{1}{4}$ tons fertilizer and $6\frac{1}{2}$ bushels of "Bellevue Avenue" Lawn Mixture per acre. The seed was sown April 26, and we started mowing the first week in June. Its quality and color are excellent. Please accept my thanks. Very truly,

BRUCE BUTTERTON, Gardener for E. J. Berwind, Esq., Newport, R. I.

I have at different times used large quantities of the "Bellevue Avenue" Lawn Mixture, and find it meets all the requirements of a perfect and at all times velvety lawn. Later have used it in reconstructing the grounds of Mr. John H. Davies' handsome place on Bellevue Ave., where it has given the best results.

NILS A. KNUTSON, 541 Spring St., Newport, R. I.

Newport Golf Links Mixture. The Newport Links, sown with our mixture, have been admired and praised this season by Golfers from all over the world, who declare that it cannot be surpassed in any respect.

South Park Mixture. Composed of grasses making a quick growth, and forming a close, compact sod.

Mixture for Shady Locations. This is a mixture of such grasses as are best suited to grow in locations partially shaded, such as orchards, shrubberies, etc.

Weaver's Mixture for Permanent Pastures. Composed of grasses and clovers best suited for permanent pastures. Great care is used in the selection of the varieties composing this mixture.

Add 8 cents per pound if ordered by mail.

GRASS and CLOVER SEEDS.

PRICES VARIABLE.

If by mail, add 8 cents per pound for postage.

Governed by Market Fluctuations.

(All our Grass and Clover Seeds are of the finest quality, selected, cleaned and Tested.)

COMPETITION OR MARKET PRICES.

Timothy, or Herd's Grass. On most soils will produce a better crop than any other variety.

Red-Top. Growing in almost any soil, moist or dry, and standing our hot climate.

Red-Top, Clean Seed. Chaff and weed seeds sifted out; extra fine quality.

Rhode Island Bent. A fine, hardy, compact grass; very permanent, excellent for pastures.

Kentucky Blue. Known as June Grass. An early Grass of great value; makes a close, velvety turf, and is excellent for pastures.

Orchard. One of the earliest grasses; yields immense crops, and is excellent for pasture or hay.

Pacey's Perennial Rye Grass. An early, hardy and nutritious grass for meadows, pastures or hay crop.

Italian Rye. Thrives in any soil; excellent for pastures mixed with other grasses.

Hard Fescue. This splendid grass is found in all the best lawns and permanent pastures; invaluable for dry soils; of low, dense-growing habit.

Sheep's Fescue. Of dense growth; excellent for dry situations and sheep pastures.

WE OMITTED PRICES BECAUSE WE SELL AT COMPETITION PRICES.

Tall Fescue. Excellent for permanent pastures on moist soil, on which it yields immensely.

Meadow Fescue. Of great value in mixtures for permanent pastures.

Crested Dog's-Tail. (*Cynosurus cristatus.*) A perennial grass much valued for its dwarf habit and hardiness. Fine for lawns.

Tall Oat Grass. Succeeds well in pastures with other grasses.

Sweet Vernal. Useful to mix with other grasses for lawns; hardy, early and permanent.

Meadow Fox-tail. Very valuable in mixtures for pastures exposed to heat and drought.

Rough-Stalked Meadow. An excellent permanent grass to mix with other varieties for moist pastures. Suitable growing in shade.

Wood Meadow. Well adapted for growing under trees.

CLOVER SEED.

All carefully cleaned and selected samples. Prices-variable. Subject to market changes.

Crimson, or Scarlet Clover. A more valuable crop than this annual Clover does not exist. As an improver of the soil, or for an early summer forage or hay crop.

Lucerne, or Alfalfa. Bears heavy crops of forage; will stand cutting 3 or 4 times in a season.

Red Clover. Finest quality.

Alsike, or Swedish. Luxuriant and sweet.

White Clover. Excellent for lawns and pastures.

Millet, or Hungarian Grass.

Hungarian Grass. One of our most valuable forage plants.

Millet, Common. An excellent forage plant; very early.

Millet, German. (*Golden Millet.*) Of stronger and taller growth.

SMALL FRUITS.

BLACKBERRIES.

Child's Everbearing, or Tree. A large, spreading plant, producing berries of enormous size, ripening in July; sweeter juicy and coreless. A valuable berry for family use. \$1.25 per doz

Eldorado. This very promising Black-berry claims to have no rival in point of hardiness; productive; large size berries; excellent in flavor and keeping qualities; without core. \$1.75 per doz.

GENERAL LIST OF BLACKBERRIES.

The prices quoted are for Root-Cutting Plants.

Early King. Large, black; fine flavor; hardy, productive. Fine for home use. 50 cts. per doz.

Erie. Large, roundish; good quality; hardy, productive; popular. Second early. 50 cts. per doz.

Lawton. Large, fine quality; hardy and productive. Mid-season to late. 40 cts. per doz.

Kittatinny. Large; delicious; strong grower; productive, but tender. Mid-season. 40 cts. per doz.

Snyder. Medium to large; sweet; very hardy and exceeding productive. Early. 40 cts. per doz.

CURRANTS.

The prices named are for strong 2-year-old plants.

Black Champion. The finest black Current; bunches large. \$1 per doz.

Cherry. The largest of all the older red varieties; excellent for marketing. 75 cts. per doz.

Fay's Prolific. More prolific than Cherry; of excellent quality. Best of Currants. \$1 per doz.

Versailles. A French variety resembling the Cherry; of great beauty; large berry; very productive. 75 cts. per doz.

White Grape Very large; mild excellent flavor; fine for table or market. 75 cts. per doz.

GOOSEBERRIES.

Good strong plants.

Downing. Fruit large, whitish green; flesh tender, juicy; excellent quality. \$1 per doz.

Industry. Of great vigor and productiveness; large, oval, dark red, rich and agreeable; fruiting early; best market

GOOSEBERRIES—Continued.

variety; imported; free from disease and mildew. 25 cts. each, \$2.50 per doz.

Red Jacket. A strictly native variety, rivaling the foreign sorts in size; vigorous; free from mildew, and exceedingly productive; berries large, smooth, ruby red and of fine flavor. 1-year, each 25 cts., 3 for 60 cts., doz, \$2. 2-years, each 30 cts., 3 for 75 cts., doz, \$3.

RASPBERRIES.

All Summer. Originally from Mexico; one of the red varieties; the only ever-bearing variety; ripens its bright red fruit in July, and continues until autumn; perfectly hardy; unaffected by the heat of summer, thriving well where many other fail. A good garden variety \$1.25 per doz.

Cuthbert. The leading market variety; canes hardy; berries large, firm and extra quality, very productive. 50 cts. per doz.

Golden Queen. The best yellow Raspberry; excepting color, it has all the good qualities of the Cuthbert; berries large and of great beauty; very productive. 50 cts. per doz.

Marlboro. The largest of the early red Raspberries; very productive; thriving well in cold, exposed places; strong-growing. 50 cts. per doz.

Japanese Raspberry, or Wineberry. Fruit is borne in large clusters; it begins ripening in July, and continues in succession a long time; strong-growing, with fine growing, with fine foliage, making a fine garden ornamental. Single plants 20 cts., \$2 per doz.

STRAWBERRIES.

Bubach, No. 5. Vigorous; productive; of most excellent flavnr. \$1 per 100.

Charles Downing. Large; superior quality late. 75c. per 100.

Crescent Seedling. Medium size; sweet; early. 75 cts. per 100.

Gandy. Large; one of the best late sorts; rich soil. 75 cts. per 100.

Sharpless. Large; very fine late, \$1.00 per 100.

Wilson. Very reliable old sort; somewhat tart. 75 cts. per 100.

In addition to the above, we can furnish any of the leading varieties at reasonable prices.

GRAPES.

HARDY VARIETIES (2-YEAR-OLD VINES.) BLACK.

Concord. Large; reliable. Medium. 75 cts. per doz.

Eaton. Very large; new. Medium. \$2.00 per doz.

Moore's Early. Large; fine quality. Early. \$1 per doz.

Wilder. (Roger's No. 4.) Very large. Medium. \$1 per doz.

Worden. Large; excellent quality. Early. \$1 per doz.

RED.

Agawam. (Rogers' No. 15.) Large; fine. Medium. \$1 per doz.

Brighton. Large; best quality. Early. \$1.50 per doz.

Delaware. Small; delicious. Late. 50 cts. each. \$1.50 per doz.

WHITE.

Empire State. Tender. Medium. \$1.50 per doz.

Moore's Diamond. Large; excellent. Early. \$1.50 per doz.

Niagara. Large and productive. Medium. \$1 per doz.

Pocklington. Large and sweet. Late. \$1.50 per doz.

FOREIGN VARIETIES.

For growing under glass; 2-year-old vines. \$1.75 each.

BLACK.

Black Hamburg. The best for general use.

Gros. Colman. Very large, sweet and juicy.

Madresfield Court. Large; rich Muscat flavor.

WHITE.

Bowood. Large, with a sweet Muscat flavor.

Hamburg. Large bunches; one of the best.

Muscat of Alexandria. A delicious variety.

FLOWER SEEDS.

SOWING, TRANSPLANTING, SOIL, ETC.

SUCCESS IN THE CULTIVATION OF FLOWERS FROM SEED depends to a great extent on some of the operations, on which we venture a few suggestions. The first requisite is **RELIABLE SEEDS**; we spare no pains or expense to procure the **VERY BEST**. A trial of our seeds will do more to establish this fact than any statement by us would be likely to do. Having obtained the seeds desired for planting, procure suitable boxes or pans, in the bottom of which put pieces of broken pots for drainage, and fill with fine porous soil; level it carefully and press lightly, so that a comparatively smooth surface may be obtained. Water the surface with a fine hose, and sow the seed as evenly as possible. Cover with a light, fine soil to a depth twice the diameter of the seed. Very fine seeds require little or no covering at all, a mere pressing into the soil in many cases being sufficient. A pane of glass or piece of paper should be put over them after sowing, to retain the moisture, which will generally be sufficient to insure germination, and will prevent the soil from crusting over. If they should get dry, however, it will be better to water from the bottom, by standing the pan a few minutes in water, as top-watering is very apt to wash up the seeds and leave them uncovered on the surface. All seedlings and young plants should be kept as near the glass as possible, and as soon as they are fit to handle they should be transplanted.

General List of Choice Flower Seeds

Embracing all of the best of the Old Favorites, as well as many New Kinds.

ALL SEEDS FIVE CENTS A PACKET UNLESS OTHERWISE NOTED.

- | | |
|--|--|
| ABRONIA. <i>H. H. A.</i> Charming trailers. | Mexicanum. Lilac-blue; free bloomer 1 1-2 ft. |
| Arenaria. Yellow; very fragrant. | — Album. White; free bloomer; 1 1-2 ft. |
| Umbellata. Rosy-lilac blooms; very fragrant. | Little Dorrit. Azure-blue; 1 ft. |
| ACACIA. <i>G. P. Shrubs.</i> Elegant; finest mixed. | Blue Perfection. |
| ACROCLINIUM. <i>H. H. A.</i> Ever-lasting flowers. | AGROSTEMMA. (Rose of Heaven.) |
| Album. Flowers single white; 1 ft. | Coeli-rosa. <i>H. A.</i> Deep rose; 1 ft. |
| Roseum. Single, bright rose; 1 ft. | — Alba. <i>H. A.</i> White; 1 ft. |
| — Flore pleno. Double rose; 1 ft. | Coronaria atrosanguinea. Dark blood-red; 1 1-2 ft. |
| ADONIS. Showy and popular border flowers. | ALYSSUM. <i>H. A.</i> Dwarf plants, blooming profusely throughout the season. |
| Aestivalis. Bright scarlet. <i>H. A.</i> 1 ft. | Benthami. (Sweet Alyssum). White; fragrant. |
| Vernalis. Produces its beautiful yellow flowers in early spring. <i>H. P.</i> 1 ft. | Carpet of Snow. 2-3 in. high. |
| AGERATUM. <i>H. H. A.</i> Effective plants for bedding out. Blooms all summer. | Little Gem. Distinct and very sweet. |
| Conspicuum. White; 2 1-2 ft. | Saxatile compactum. (Golden Alyssum). Yellow. |
| Lasseauxii. Rose color; valuable for cutting. | AMARANTHUS. <i>H. H. A.</i> Ornamental foliage; striking and effective decorative plants. |
| | Caudatus. (Love-lies-bleeding.) Blood-red; drooping. |

WE OMITTED PRICES BECAUSE WE SELL AT COMPETITION PRICES.

AMARANTHUS—Continued.

- Cruentus.** Erect-flowering; bright scarlet.
- Tricolor.** Leaves red, yellow and green.
- Little Dorrit.** Azure-blue; 1 ft.
- Fine Mixed.**
- AMMOBIUM.** *H. A.* Pure White flowers; a valuable everlasting for winter bouquets.
- Alatum grandiflorum.** 2 ft.
- AMPELOPSIS.** *Hardy Climbing Plant.* This beautiful climbing vine is easily raised from seed, perfectly hardy, and adheres to stone, brick or wood.
- Veitchii.** (Japanese or Boston Ivy).
- ANTHERICUM.** *H. P.*
- Liliago.** White; fragrant.
- Liliastrum.** White, with delicate spots on each petal.
- ANTIRRHINUM.** (Snapdragon). *H. H. P.* Beautiful and useful plants, blooming profusely the first season from seed until after frost.
- Blotched varieties.** Finest mixed; 1 ft.
- Dwarf varieties.** Finest mixed; 3-4 ft.
- Striped varieties.** Finest mixed; 1 ft.
- Tall varieties.** Finest mixed; 2 ft.
- ANTIRRHINAM MAJAS.** *Romeo.* Deep rose, yellow spotted. Pkt. 10 cts.
- Antirrhinum,** (Snapdragon).
- Black Prince.** Pkt. 15 cts.
- AQUILEGIA** (Columbine). *H. P.* Blooms early, and produces beautiful, curiously formed, variously colored flowers.
- Double mixed.** Finest varieties.
- Single mixed.** Finest varieties.
- ARISTOLOCHIA.** *H. P.* Curious pipe shaped flowers.
- Sipho.** (Dutchman's Pipe). Yellowish brown. Packet 10 cts.
- Elegans.** Large, dark purple and white flowers. Packet 10 cts.
- ARGEMONE** (Prickly Poppy). *H. A.*
- Grandiflora.** Large, white, poppy-like flowers.
- ARMERIA** (Thrift, or Sea Pink.) *H. P.* fine for edgings or borders.
- Formosa Alba.** White; 1 ft.
- Maritima splendens.** Rose.
- Asperula azurea.**
- ASPARAGUS.** *Plumosus nanus.*
- Sprengere.** Favorite hanging plant.

ASTERS.

Probably no plant among all the annuals has had more care bestowed on it by professional florists than the Aster, and it has responded by breaking into numerous classes of varieties, all of which are handsome and worthy of cultivation.

Our Aster seeds are selected and grown for us by some of the best growers of Germany and France.



ASTER.

- BALL, or JEWEL ASTER.** A magnificent class, with perfectly round flowers, about 2 1-2 inches in diameter, borne on long stems; petals incurved.
- Apple Blossom, Deep Rose, Scarlet, Violet, White Mixed.** Packet 10 cts.
- BETTERIDGE'S IMPROVED QUILLED.**
- Sulphur Yellow.**
- Finest Mixed.**
- CRYSANTHEMUM - FLOWERED DWARF.** Compact growth, with large, double flowers.
- White, Peachblossom, Brilliant Rose, Crimson, Scarlet, Lilac, Light and Dark Blue Mixed.**
- COMET, or PLUME.** A distinct race, with loose petals like Japanese chrysanthemums; very double.
- Giant Victoria.** Snow white.
- Carmine.** Fine pink, bordered with white.

ASTERS—Continued.

Deep Rose, Light Blue, Light Blue with White, Peach Blossom, Finest Mixed. Packet 10 cts.

CROWN, or COCARDEAU. Large flowers. Mixed.

DWARF BOUQUET, Boltze's. Finest mixed. Packet 10 cts.

DWARF BOUQUET PYRAMIDAL. White.

DWARF COMET, Bridesmaid. White and lilac rose. Packet 5 cts.

Dwarf Mignon. Carmine, free blooming, very double imbricated flowers—Pkt. 5 cts.

Christmas Tree. Grows about 1 1-2 feet high; the lower branches spread about 2 feet. Pkt. 25 cts.

Giant Victoria. Snow-white, of enormous size. Pkt. 5 cts.

Ostrich Feather. Produces flowers 4 to 5 inches in diameter. Pkt. 5 cts.

Semples Branching Aster. Mixed.

Semples Branching Aster. White.

Semples Branching Aster. Lavender.

Semples Branching Aster. Crimson.

Semples Branching Aster. Shell pink.

Rose, Light and Dark Blue, Mixed.

GIANT EMPEROR. Each plant produces one flower of enormous size; very double and beautiful; 2 ft.

Finest Mixed. Packet 10 cts.

Imbricated Pompon. Very fine, small-flowered sort; excellent for cutting; 1 1-2 ft.

Finest Mixed.

Lady Aster. Packet 10 cts.

Mignon. Beautiful for floral arrangements.

White, Rose, Mixed. Packet 10 cts.

Needle Victoria. Finest mixed. Packet 10 cts.

Princess Rosalind. Habit like snowball. Blossoms of a charming bright rose. 10 cts. packet.

Snowball, or Princess. One of the finest white varieties; very double, a long bloomer. Packet 10 cts.

Queen of the Market. A very early, low-growing class, with handsome double flowers.

White. Finest mixed.

TRUFFAUT'S PAEONY-FLOW-ERED PERFECTION.

The strain we offer is a great improvement, the flowers being larger and fuller,

and the petals beautifully incurved like a full, double chrysanthemum, 2 ft.

Snow White, Rose, Dark Scarlet, Light and Dark Blue. Finest mixed. Packet 10 cts.

VICTORIA TALL. One of the most showy Asters; admirably adapted for beds, and unsurpassed for florists' use.

White Rose, Bright Rose, White Tipped Brilliant Crimson, Light Blue, White and Dark Blue. Packet 10 cts.

Victoria Dwarf. Finest of the dwarf. Packet 10 cts.

White, Apple Blossom, Rose, Light and Dark Blue, Scarlet. Finest mixed.

Washington. Very fine, large Aster; valuable for exhibition purposes; 2 ft. Mixed. Packet 10 cts.

BALLOON VINE. *Cardiospermum.*

BACHELOR'S BUTTON. See *Centaurea.*

BALSAM (Lady's Slipper). *T. A.* A favorite garden flower, producing beautiful brilliantly colored double flowers.

Rose-flowered. Double. Mixed.

Camellia-flowered spotted. Mixed.

Carnation Striped. Finest mixed.

Batonia. *H. A.* Very showy; 1 ft.

Aurea. Fragrant golden-yellow flowers.

BEANS. *T. A.* Popular ornamental climbers.

Scarlet Runner. Scarlet flowers.

White Runner. White flowers.

BEGONIA SEMPERFLORENS. *Hybrida.* Double. Pkt. 5 cts.

Zulu King. Leaves nearly black, flowers bright red. Pkt. 15 cts.

BEGONIA, TUBEROUS-ROOTED. *T. P.* For beds, borders, window-boxes or pots they are unsurpassed.

Single Mixed. Packet 15 cts.

Double Mixed. Packet 20 cts.

Flowering Bulbs. Each 10 to 20 cts.

Semperflorens vernon. *Semperflorens erfordi.* *Semperflorens finest mixed.*

BELLIS (Double Daisy). *H. P.* Among the most charming spring flowers.

Maxima (Giant). New sort, with extremely double flowers in red and rose. Packet 10 cts.

Snowball. Very large, double, pure white flowers on long stems. Packet 10 cts.

BELLIS—Continued.

Longfellow. Very large, dark rose flowers, long stalks. Packet 10 cts.

Finest Mixed.

BROWALLIA. *Elata grandiflora.*

Browallia. *Elata alba.* White.

Browallia. Finest mixed.

CACALIA (Tassel Flower.) *Coccinea.*

CALAMPELIS Scabra. Orange flowers. Packet 10 cts.

CALCEOLARIA. *G. P.* Our seeds are from the finest strains in cultivation; the flowers are large, rich and varied in color, of fine form and substance; 1 to 1 1-2 ft.

Crystal Palace Prize. An English strain of great merit. Packet 25 cts.

James' Giant. Extra choice; very large, finely marked flowers. Packet 25 cts.

CALENDULA. (Pot Marigold.) *H. A. grandiflora fl. pl. (Orange King).* Large double flowers of deep orange color.

Sulphurea. Double lemon-colored.

Le proust. Double, nankeen color.

Meteor. Double, orange-striped.

Prince of Orange. Double, deep-orange.

Pluvialis (cape marigold). White.

Finest Mixed.

CALLIOPSIS, or COREOPSIS. *H.* Few annuals are more useful than these; the colors are rich and striking.

HARDY ANNUAL VARIETIES.

Finest Mixed. Tall varieties.

Atrosanguinea. Blood-red, marble; 2 ft.

Bicolor marmorata. Golden-yellow, with purplish brown center; 2 ft.

Drummondii. Large yellow, red spot; 2 ft.

Golden Wave. Large, golden-yellow; 1 1-2 ft.

Nigra speciosa. Dark red; 2 ft.

Dwarf varieties mixed.

HARDY PERENNIAL VARIETIES.

Grandiflora. Very large, golden-yellow; 3 ft.

Lanceolata. The Perennial golden-coreopsis. One of the easiest to cultivate; perfectly hardy.

CAMPANULA (Bell Flower.) *H. P.*

Finest Mixed.

Carpatica. Fine blue; 1 ft.

Macrantha. Deep purple.

Pyramidalis. Large blue.

CAMPANULA MEDIA (Canterbury Bells). *H. P.* One of the most showy hardy garden plants.

Calycanthema. Finest mixed.

Double Blue. Double white.

Single Blue. Single rose. Single white.

Prize Mixture. Of all classes and colors; single, double and cupped.

CANARY-BIRD VINE. See Tropæolum.

CANDYTUFT (Iberis.) *H. A.* One of the most popular classes; excellent for cutting.

Crimson, Dunnett's. 1 ft.

Empress. Extra fine; large.

Fragrant. White, 1 ft.

Purple. 1 ft.

White Rocket.

Sempervirens. *H. P.* White; early, 1 ft.

Dwarf White. Fine, very free.

New Hybrid, Dwarf. Mixed; large flowers. Packet, 10 cts.

CANNA (Indian Shot). *T. P.* Highly ornamental plants, large and handsome foliage and flowers, 3 to 6 ft.

Crozy's Dwarf Finest Mixed. Large flowers in a great variety of colors. Packet, 10 cts.

CARNATIONS. *H. H. P.* A magnificent class of popular favorites, most of which are deliciously fragrant and with colors extremely rich and beautiful. The seed we offer is from the finest collection in Europe.

Prize Mixed, Carnation and Picotee. Packet, 25 cts.

Bizarres, Fancies, Flakes and Sells. Superb varieties; finest mixed. Pkt. 25 cts.

Picotee. Fine mixed. Packet, 20 cts.

Countess of Paris. Beautiful double canary-yellow; free bloomer. Pkt. 25 cts.

Double Earliest French (Chabaud). Combining earliest with the perfection of flowers of the perpetuals; fine colors. Packet, 10 cts.

Grenadin. Double scarlet; dwarf. Packet, 10 cts.

White. Double dwarf white; fine. Packet, 15 cts.

Gillaud. This is the finest strain of perpetual carnations, and is of nearly as rapid growth as the Marguerite class. The seed produces over 90

CARNATIONS—*Continued.*

per cent of splendid double flowers, with a large percentage of yellows. Packet, 20 cts.

MARGUERITE. A very large percentage of the flowers come double and of good size, fine form and green beauty. Packet, 10 cts.

Improved Giant. Producing large flowers. Packet, 10 cts.

Improved Giant. White; pkt., 15 cts.

Improved Giant. Yellow; pkt., 15 cts.

Rose. Packet, 10 cts.

White. Fine, double white. Pkt. 10c.

CASTOR-OIL BEAN. See Ricinus.

CELOSIA (Cockscomb). *H. A.* Highly esteemed and beautiful plants, with splendid richly colored flower heads.

Crimson.

Empress. (Giant). Bright purple combs; dark foliage.

Glasgow Prize. Dwarf sort, with dark leaves and large crimson comb.

Japonica. A beautiful scarlet.

Pyramidalis plumosa. Charming, feathery golden heads, rich crimson; 1 ft.

Thompsoni. Magnificent, with red foliage and brilliant crimson stems and flowers.

Dwarf Mixed.

Tall Mixed.

CENTAUREA, Odorata Chameleon.

Odorata Margaretæ.

Odorata Imperialis. White.

Odorata Imperialis. Pink.

Odorata Imperialis. Lilac.

Odorata Imperialis. Purple.

CENTAUREA CYANUS (Bachelor's Button or Corn Flower.) *H. A.*

Free-flowering plants, with handsome showy flowers; excellent for cutting.

Victoria. Dwarf azure-blue; 1 ft.

Emperor William. Dark blue; 2 ft.

White. 2 ft.

Rose. 2 ft.

Double Finest Mixed. 2 ft.

Finest Mixed. 2 ft.

CENTAUREA NANA (Dusty Miller.)

H. H. P. Silver-foliaged plants, extensively used for edgings, baskets, etc.

Candidissima. Very white, thick foliage; 3-4 ft. Packet, 10 cts.

Gymnocarpa. Very graceful white foliage; 1 ft. Packet 10 cts.

Americana. Packet 10 cts.

CHRYSANTHEMUM. *H. A.* Showy and effective plants for garden and house.

Burridgeannum (Lord Beconsfield).

White, with rose band and yellow centre; 1 1-2 ft.

Dunetti. Yellow.

Dunetti. White.

Eclipse.

Golden Feather. White with bright yellow and crimson bands, dark centre and yellowish foliage; 1 1-2 ft.

Nanum coccineum. Dwarf; scarlet.

Purpureum (W. E. Gladstone). Rich, purplish crimson, distinct; 1 1-2 ft.

Finest Single Mixed. 1 1-2 ft.

Finest Double Mixed. 1 1-2 ft.

Double Lemon Yellow. Excellent; 1 1-2 ft.

White. Fine; 1 1-2 ft.

CHRYSANTHEMUM. *H. H. P.* The hardy sorts are of great value in the garden, producing flowers before the autumn-flowering varieties are in bloom.

Chinese Finest Mixed. Large, autumn flowering varieties, from a choice collection. Packet 10 cts.

Delaux Early French. Early and large flowering. Seed sown in March or April will bloom in August or September, and continue up to frost. For outdoor growing this is the finest variety. Packet 10 cts.

Frutescens. (Marguerite or Paris daisy). Single white for pot-growing. Packet 10 cts.

Japanese Finest Mixed. Autumn-flowering variety, with large loose flowers. Packet 10 cts.

CONVOLVULUS MAJOR (Tall Morning-Glory). See Ipomoea

CINERARIA GRANDIFLORA. *G. P.*

This strain cannot be surpassed, either for size or beauty. Many of the blooms measure 2 1-2 in. in diameter.

Hybrida grandiflora nana. Semi-dwarf mixed. Packet 15 cts.

Grandiflora. Mixed. Packet 15 cts.

Maritima candidissima.

Maritima acantifolia.

CINNERARIA. *Hybrida Grandiflora.*

Colors pink Hydrangea. Pkt. 25 cts.

CLARKIA. *H. A.* Free-flowering plants.

Double Mixed. Fine for cutting. 1 ft.

Single Mixed. 1 ft.

Clianthus Dampieri.

CLEMATIS. (Virgin's Bower). *Hardy Climbers.* Rapid-growing climbers; fine for arbors and verandas.

Jackman's New Hybrids. Very large, star-shaped flowers; choicest mixed. Packet 10 cts.

Davidiana. A variety forming a bush 3 ft. high, with porcelain-blue flowers.

Paniculata. A vigorous grower, and is covered in the latter part of the summer with tar-like, fragrant white flowers in broad panicles; 25 ft.

COBAEA. *H. H. P.* Splendid climbers.

Scandens. Purple.

Flore albo. White. Pkt. 10c.

Macrostemma. New sort. Pkt. 15c.

CONVOLVULUS MINOR (Dwarf Morning-Glory). *H. A.* Free-flowering plants.

Mauritanicus. Charming plant for baskets, rock-work, etc.; flowers lavender.

Major Finest Mixed.

COLEUS. Benary's exhibition mixture. Pkt. 10c.

New Large Leaved Mixed. Pkt. 15c.

COSMOS. *H. A.* Perfectly lovely fall blooming annuals, with numerous large anemone-like flowers; splendid for bouquets; start early in heat.

Hybrida Grandiflora. Mixed.

Alba, Pure White. Packet 10 cts.

Rose. Large rose. Packet 10 cts.

Giant Red, Pink and White. Separate colors. Flowers of perfect form, great size and beauty. Pkt. 10 cts.

Giant Californian, mixed colors. A magnificent strain, bearing flowers of mammoth size. Packet 10 cts.

New Dwarf Early Cosmos "Dawn." This grand variety comes into full flowers in July, and continues a mass of bloom until severe frost. Pkt. 10c.

New Improved Yellow. Entirely novel and distinct, deep yellow flowers about 2 1-2 in. across. Packet 10 cts.

COWSLIP (Primula veris). Yellow. Packet 10 cts.



CYCLAMEN PAPILIO — BUTTERFLY.

CYCLAMEN. *G. P.* Bulbs. A genus of the most beautiful and elegant winter and spring blooming plants for pot culture in parlor or conservatory.

CYCLAMEN, PAPILIO. *Butterfly.* The latest and most beautiful novelty; the flowers are in a butterfly shape and of magnificent colors. Pkt. 25 cts.

Persicum giganteum. Improved type, broad, beautifully mottled leaves, bearing immense flowers of great substance. The very best mixed. Packet 20 cts.

CYPERUS. *Alternifolius.*

CYPRESS VINE. *H. H. A.* Finest mixed.

DAHLIA. *H. H. P.* The seeds of these should be started in gentle heat.

Cactus. Finest mixed.

Double Large Flowered. Packet 10c.

Single-flowering (Giant).

Small flowered. Lilliput. Pkt. 10c.

DATARA (Trumpet Flower). *H. A.*
Handsome bushy plants, covered with deliciously fragrant, trumpet-shaped flowers.

Finest Mixed Double Varieties. 3 ft.

Arborea (*Brugmansia*). *T. P.* Fine for the house or conservatory; pure white and very fragrant. Pkt. 10c.

Wrightii. White, shaded to lilac; 3 ft.

DELPHINIUM (Larkspur). Among the most showy annual and perennial plants, with curiously cut handsome foliage, and most brilliant colored flowers; excellent for bouquets and cut-flowers.

HARDY ANNUAL SORTS.

Branching, Finest Mixed. Large double.

Dwarf Candelabrum, Finest Mixed.

Dwarf Rocket, Finest Mixed. Extra double.

Tall Rocket, Finest Mixed. Large double.

HARDY PERENNIAL SORTS.

Most of the perennial sorts bloom the first season from seed.

Cashmerianum. Deep blue; 1 1-2 ft. Packet 10 cts.

Elatum. (*Bee Larkspur*). Blue, 4 ft. Packet 10 cts.

Formosum. Dark blue; 2 1-2 ft. Packet 10 cts.

Nudicaule. Dwarf scarlet. Pkt 10c.

Zalil. Sulphur-yellow; 3 1-2 ft. Pkt. 10c.

Pink. Best for cut flowers.

DIANTHUS (Pink). *H. B. or P.* A magnificent genus, embracing some of the most popular flowers in cultivation, producing in great profusion their beautiful brilliant colored flowers.

Chinensis fl. pl. (*Chinese Pink*). Finest mixed, double in great variety of colors.

Heddewigii fl. pl. (*Double Japan Pink*). Finest double mixed; large flowers; fine.

Single. Finest selected single-flowered varieties in choice colors.

Atropurpurea fl. pl. Double blood-red.

Albo marginata fl. pl. *Mourning Pink*. Double deep purple with white edge.

Brilliant (*Crimson Belle*). Beautiful dark crimson; single.

Heddewigii diadematus fl. pl. (*Double Diadem Pink*). Extra fine, double flowers in great variety of choice colors.

Eastern Queen. Immense single flowers, beautifully fringed, marked and suffused with carmine-rose, mauve and lilac.

Laciniatus fl. pl. Finest fringed, double.

Striatus. Charming double varieties.

Imperialis fl. pl. (*Double Imperial Pink*). Extra fine colors, charming varieties.

Plumarius fl. pl. (*Double Pheasant's-Eye Pink*). Finest mixed double. Packet 10 cts.

Single (*Pheasant's-Eye Pink*).

Cyclops. Large, double flowers of unapproachable beauty. Pkt. 20 cts.

DIANTHUS HEDDEWIGI. *Queen of Holland.* White; beautiful for cut flowers. Pkt. 10 cts.

DIGITALIS (Foxglove).

Gloxinaeflora. Beautiful spotted flowers.

Monstrosa. Beautiful large-flowered class.

DODECATHEON (Am. Cowslip). *H. P. Clevelandi* (*Shooting Star*). Pkt. 10c.

DOLICHOS (Hyacinth Bean). *T. A.* A beautiful, quick-growing climber.

Lablab, Mixed.

DRACAENA. Graceful, decorative foliage plants; tender.

Finest Mixed. Fine variety. Pkt. 10c.

Indivisa. Green; very graceful. Pkt. 10 cts.

Veitchii. Beautiful colored leaves. Packet 10 cts.

E C H E V E R I A. *Hybrida*, *Splendid Mixed*. Packet 10 cts.

EDELWEISS. *Leontopodium alpinum*. Packet 10 cts.

ESCHSCHOLTZIA (Cal. Poppy.) *H. A.* Profuse blooming, showy plants; remain beautiful until frost; 1 ft.

Californica. Yellow, with orange centre.

—**Maritima** (*Maltese Cross*). Yellow, with dark orange markings; splendid.

—**Rose Cardinal.** Rosy.

Mandarin. Splendid; flowers are scarlet outside, inside orange.

Crocea. Orange.

—**Flore pleno.** Double, dark orange.

Fine Mixed. All brilliant colors.

EUPATORIUM. *H. P. Fraseri.*

EUPHORBIA. *Heterophylla variegata.* White and green bracts; 2 1-2 ft.

FERNS. Greenhouse Species, Finest Mixed. Packet 10 cts.
FEVERFEW. See *Matricaria*.
FORGET-ME-NOT. See *Myosotis*.
FORGET-ME-NOT. *Oblongata Perfecta*. Longest stem and largest flower of all the Forget-Me-Nots. Pkt. 10c.
FOUR O'CLOCK. See *Mirabilis*.
FOXGLOVE. See *Digitalis*.
FUCHSIA. Single Mixed. Double Mixed. Packet 15 cts.
GAILLARDIA. Beautiful showy plants, giving a profusion of brilliant flowers.
Lorenziana, Finest Mixed, Double. A rich mixture from very double flowers; 1 1-2 ft.
 Finest Mixed, Single. Choice collections.
Grandiflora, Finest Mixed. Bicolor.

GODETIA. *H. A.* Profuse; very showy.
Duchess of Albany. Pure white.
Lady Albemarle. Large, crimson-rose,
The Bride. White, carmine centre.
 Mixed. Dwarf varieties.
GLOXINIA. Sutton's Hybrids, Finest Mixed.
Spotted and Striped. Finest. Pkt. 20c.
Grandiflora crassiflora erecta. Pkt. 20c.
Sutton's New Giant. Packet 25 cts.
Benary's New Giant. Packet 25 cts.
GOURDS, Ornamental. *T. A.*
Apple, Bottle, Dipper, Egg, Serpent, and Orange Shape.
Dish-Cloth, Gooseberry. Very small.

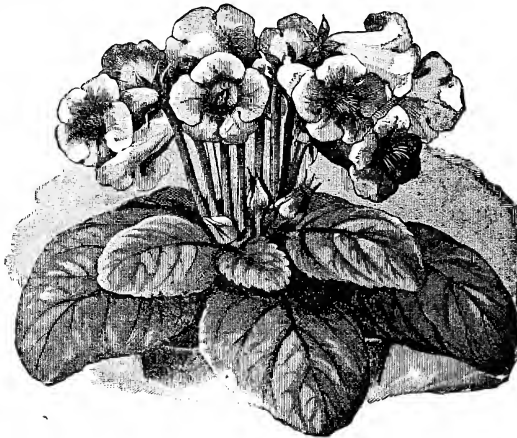

GLOXINIA.

GAILLARDIA. *Grandiflora Sulphurea Oculata*. A new perennial variety of beautiful colors. Pkt. 10 cts.
GAZANIA SPLENDENS.
GENISTA. *Canariensis*. Yellow.
GENTIANA. *Acaulis*.
GERANIUM (Pelargonium.) *G. P.* Popular plants, for bedding and house.
Apple-scented. Fragrant foliage. Pkt. 20 cts.
Ivy-leaved. Finest varieties. Pkt. 20c.
Zonale (Horseshoe). Finest Mixed. Packet 25 cts.
Show Pelargonium. Packet 25 cts.
GILIA. *H. A.* Finest Mixed.
GLOBE AMARANTH (Gomphreno). *H. H. A.* Finest Mixed.

Hercules' Club, Sugar Trough. Large and useful.
 Mixed. Great variety.
GREVILLEA. *Robusta*. (Australian Silk Oak).
GYPSOPHILA (Infant's Breath). *H. A.*
Muralis. Dwarf rose, 3-4 ft.
Elegans. White; 1 1-2 ft.
Paniculata. *H. P.* White; excellent; 2 ft., blooms first year.
HEDYSARUM. Mixed Colors.
HELIANTHUS (Sunflower). *H. A.*
 Well known genus, the small-flowering, very useful for cutting, while the larger sorts are very ornamental, and form a fine screen.
Argrophyllus. Silvery foliage, and single yellow flowers; 5 ft.

WE OMITTED PRICES BECAUSE WE SELL AT COMPETITION PRICES.

HELIANTHUS (Sunflower)—Continued.

- Californicus fl. pl. Double yellow, 7 ft.
- Cucumerifolius (Sutton's Miniature.) Small, single, yellow, floriferous; 3 ft.
- Globosus fistulosus fl. pl. Very double, deep yellow; globe-shape; 6 ft.
- Multiflorus. Very double and free; 6 ft.
- Giant Russian. Large, single, yellow; 7 ft.
- Nanus fl. pl. Dwarf double; 4 ft.
- Variegatis. Green and yellow foliage, and single yellow flowers; 4 ft.

HELICHRYSUM Everlasting flower.

- Monstrosum. Mixed double.

HELIPTERUM. Finest Mixed. All colors. Packet 10 cts.

HELIOTROPE. Fragrant plants.

- Finest mixed. All colors.
- Louise Delaux. Fine rose tint.
- Dark Sorts, Finest Mixed.

- Snowball. Beautiful white. Pkt. 10c.

HIBISCUS. Africanus.

HONESTY. (Lunnaria.) Biennis.

HOLLYHOCK. Double, Finest Mixed. Fine strain. Packet, 10 cts-

- Chater's Finest Mixed. From a splendid collection of double varieties. Packet 10 cts.

Single Mixed. Choice colors.

- Double. Yellow, crimson, pink. Pkt. 10 cts.

- Salmon White. Packet 10 cts.

HUMULUS. Japonicus. Beautiful green foliage.

- Variegatus. Handsome foliage. Pkt. 10 cts.

ICE PLANT. Mesembryanthemum. crystallinum.

IMPATIENS. (Perennial Balsam.) G. P. Sultani. Large, rich carmine. Pkt. 10 cts.

- Hybrida. New, rich-colored varieties; as free-blooming as *I. Sultani*. Pkt, 15 cts.

IPOMOEA (Convolvulus). H, A. Fine climbers, with large bright colored flowers.

- Purpurea flore pleno. New double. Packet 10 cts.

- Imperialis. (New Imperial Japanese Morning Glory). Choicest mixed. Packet 10 cts.

- Purpurea. (Morning Glory). Finest mixed.

- Coccinea. (Star Ipomoea.) Scarlet.

- Learii. Intense bright blue; 12 ft. Packet 10 cts.

- Noctiflora hybrida. (Moon Flower.) Large, fragrant, white flowers; 30 ft. Packet 10 cts.

- Setosa. (Brazilian Morning Glory.) Magnificent vine with enormous leaves 8 to 12 inches across.

KAULFUSSIA. Finest Mixed.

- LANTANA. Hybrida. New varieties, mixed.

- LARKSPUR. See Delphinium.

LATHYRUS. (Everlasting Pea.)

- Fine White. Finest Mixed.

- LAVENDULA (Lavender.) *H. P.* Grown for its delicious and lasting fragrance.

Spica vera.

LEPTOSIPHON. Finest French Hybrids.

- LINARIA. A splendid genus of plants well worthy of cultivation, easily grown.

- Alpina. (Alpine Snapdragon.) Covered all summer with deep violet flowers. Packet 10 cts.

- Cymbalaria (Kenilworth Ivy). *T. P.* Beautiful trailing plants for baskets, etc. Packet 10 cts.

LINUM (Flowering Flax).

- Grandiflorum rubrum. Flavum.

LOBELIA.

Compacta Varieties, 4 to 6 Inches.

- Crystal Palace. Dark blue; fine. Pkt. 10 cts.

- Emperor William. (Blue King.) Grand blue.

- Formosa. Most vivid scarlet-colored dwarf bedding variety ever offered. Packet 10 cts.

- Prima Donna. Velvety maroon. Pkt. 10 cts.

- White Gem. Very dwarf white. Pkt. 10 cts.

Erinus Varieties, 6 to 12 Inches.

- Trailing sorts, suitable for vases, etc.

- Gracilis. Bright blue trailer; fine var.

- Littoralis. Pretty trailing species, white flowers, followed by red seed-pods. Pkt. 10 cts.

- Paxtoniana. White, blue edge. Pkt. 10 cts.

- Mixed Trailing Sorts. For vases, baskets.

PERENNIAL VARIETIES.

- Cardinalis. (Cardinal Flower.) A beautiful hardy, scarlet variety; 2 ft. Packet 10 cts.

LOBELIA — *Continued.*

Hybrids. Flowers large; splendid shades of rose, red, lilac, purple, etc.; in bloom from July to October; 2 ft. Packet 15 cts.



Blau Roth Weiss

LOBELIA TRICOLOR—PARROT.

LOBELIA TRICOLOR. Parrot. Red, white and blue colored flowers; a great novelty, from last year.

LOVE-LIES-BLEEDING. See *Amaranthus*.

LUPINUS. Hardy. Desirable plants, having long spikes of bright-colored flowers.

Mutabilis. Sweet-scented white flowers.

Annual Varieties. In finest mixture; 3ft.

Perennial Varieties. Finest mixture.

LYCHNIS. Mixed.

MALVA or MALLOW.

Crispa. Ornamental foliage.

Moschata. *H. A.* 4 ft.

MARIGOLD. (*Tagetes*.)

African Dwarf Mxed. Double; 1 1-2 ft.

—**Mixed Double.** 1 1-2 ft.

—**Tall Mixed.** Double; 3 ft.

—**Eldorado.** Large double flowers; 3 ft.

—**Orange.** Double; orange color; 3 ft.

African Lemon Quilled. Quilled petals; 3 ft.

—**Collection Six Sorts.** Packet 25 cts.

French, nana grandiflora. New dwarf, large, double-flowered sort; fine; 1 ft.

—**Pulchra.** Golden-yellow, with velvety brown centre; dwarf; double-1 ft.

—**Striata.** Dwarf; double striped; 1 ft.

Finest Mixed, Dwarf. Very double; 1 ft.

Finest Mixed, Tall. Double; 2 1-2 ft.

Collection of Six Sorts, all Dwarf. 25 cts.

MATRICARIA (*Feverfew*). *H. A.*

Corymbosa fl. pl. Pure white, double quilled.

Capensis fl. pl.

Golden Ball. Yellow; quilled; 1 ft. Packet 10 cts.

Pyramidalis fl. pl. Very dwarf, white; 1-2 ft.

Grandiflora fl. pl. Tom Thumb. Aurea.

MAURANDIA. Finest Mixed.

MESEMBRIANTHEMUM. Tricolor. (*Wax Plant*).

MIGNONETTE (*Reseda odorata*). *H. A.* A fragrant favorite.

Allen's Defiance. New; the acme of perfection; spikes 12 to 15 inches long; deliciously fragrant. Individual florets are of remarkable size, and stand out boldly. Packet 10 cts.

Bird's Mammoth. Under proper cultivation the spikes average 12 to 15 inches long, and are exceedingly fragrant. Packet 10 cts.

Covent Garden Variety. Most fragrant of all; very free; unsurpassed for cutting. Packet 10 cts.

Elois Francois. Splendid strain; very long spikes of large, fragrant flowers. Packet 10 cts.

Excelsior. Grows 10 inches high, very thick undulated foliage, throws up extremely broad spikes of elegant form and a silvery-tinted buff color, merging in a copper-red tint to the centre. Packet 15 cts.

Gabrielle. (*Imperialis*). Large; fragrant.

Giant Pyramidal. Large, bright red flowers.

Golden Jewel. Dwarf compact growth, vigorous foliage. The color is an intense bronze-yellow, very fragrant. Packet 15 cts.

Golden Machet. Strong, compact habit, with the large crinkled leaves peculiar to Machet, and long massive spikes, crowded with golden-yellow fragrant blossoms.

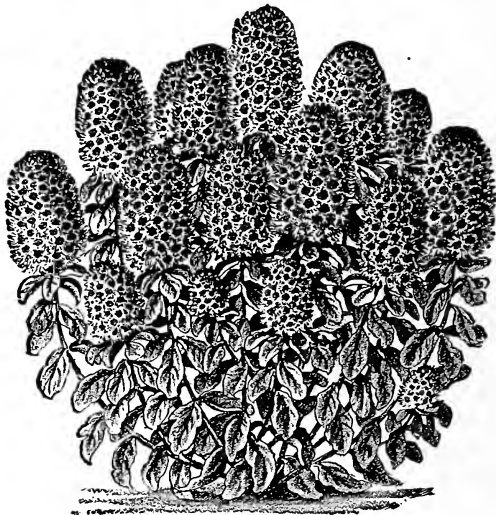

MIGNONETTE — EXCELSIOR.

MIGNONETTE — *Continued.*

- Queen.** Golden-yellow; fine.
- Grandiflora.** Large-flowered; sweet scented.
- Machet.** Very large, thick spikes, and very fragrant. One of the most attractive and beautiful Mignonettes. Packet 10 cts.
- Red Goliath.** Largest flower; often 8 ins. long. Packet 15 cts.
- Silver-flower.** Beautiful silvery flowers, of a bushy growth. Pkt. 15 cts.
- Collection of Six Best Varieties.** Packet 30 cts.
- MIMOSA.** Pudica. (Sensitive Plant).
- MIMULUS.** (Monkey Flower.)
- Cardinalis Mixed.**
- Moschatus.** (Musk Plant).
- Tigrinus grandiflorus.** Finest mixed. Packet 10 cts.
- MIRABILIS FOUR O'CLOCK.**
- Tom Thumb.**
- Finest Mixed.**
- Tom Thumb var.**
- MOMORDICA.** Ornamental climbing plants.
- Balsamina.** (Balsam Apple). 10 ft.
- Charantia.** (Balsam Pear). 10 ft.
- MOONFLOWER.** See *Ipomœa noctiflora.*
- MORNING GLORY.** See *Ipomœa.*

- MOURNING BRIDE.** See *Scabiosa.*
- MUSA.** (Abyssinian Banana.) *G. P.*
- Ensata.** Packet 15 cts.
- MUSK PLANT.** See *Mimulus.*
- MYOSOTIS (Forget-me-not).** *H. H. P.*
- Delight in a moist situation.
- Alpestris.** Blue; 1 ft.
- Alba.** White.
- Finest Mixed Varieties.** All colors.
- Azorica.** Dark blue; large, fine. Packet 10 cts.
- Alba.** White. Packet 10 cts.
- Dissitiflora.** Early. Bright sky-blue. Packet 10 cts.
- Palustris.** (True Forget-me-not.) Packet 10 cts.
- Robusta grandiflora** (Eliza Fonrobert). Very large-flowering and robust.
- Victoria.** One of the best for pots or garden; blue, double centre. Pkt. 10c.
- NASTURTIUM, DWARF (Tropaeolum).**
- Lilliput.** New class of Dwarf Nasturtiums. Packet 10 cts.
- Aurora.** Chrome-yellow; spotted and striped with deep crimson.
- Beauty.** Yellow and scarlet.
- Cloth of Cloth.** Scarlet flower and yellow foliage.
- Crystal Palace Gem.** Sulphur yellow, spotted maroon.
- Empress of India.** Dark brilliant crimson; dark foliage.

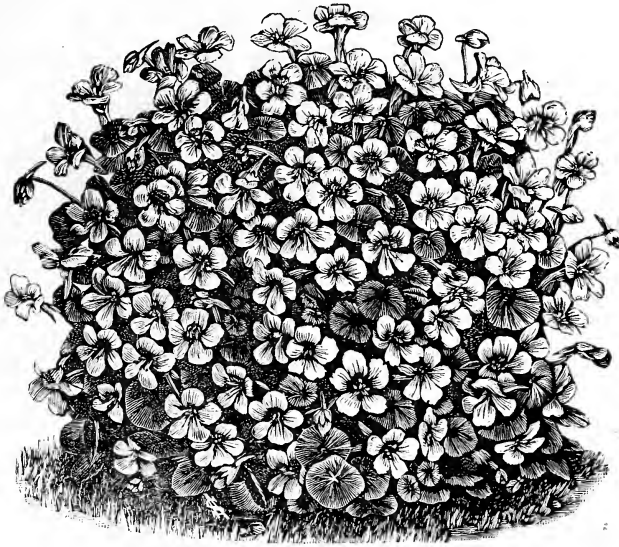

TROPAEOLUM LOBBIANUM LILLIPUT.

NASTURTIUM—Continued.

- Golden King.** Deep yellow.
- King Theodore.** Dark maroon; dark foliage.
- King of Tom Thumbs.** Crimson-scarlet, with dark foliage.
- Lady Bird.** Yellow, barred with ruby-crimson; beautiful.
- Pearl.** White.
- Rose.** Soft tint.
- Ruby King.** Wine colored.
- Yellow.** Canary-yellow.
- Mixed, Finest.**
- Collection of Eight Varieties.** 30 cts.
- Collection of Twelve Varieties.** 45 cts.

NASTURTIUM. (Tall or Climbing).
For trellises or arbors. 6 to 10 ft.

Madame Gunter's Hybrids. For richness and variety of colors these new hybrids have no equals among Nasturtiums.

- Chocolate.**
- Crimson.** Deep rich color.
- Dunnett's Orange.**
- King Theodore.** Maroon.
- Pearl.** White.
- Purple Violet.** Fine.
- Rose.** Bright.
- Scarlet.** Very brilliant.
- Straw-color Spotted.**

Yellow. Light.

Mixed, Finest.

Collection of Eight Varieties. 30 cts.

Collection of Twelve Varieties. 45 cts.

NASTURTIUM. (Lobbianum Varieties). Leaves smaller than the ordinary Tall Nasturtiums; flowers of unusual brilliancy and richness.

Asa Gray. Yellowish white; very fine.

Brilliant. Dark scarlet.

Mons. Colmet. Dark brown; handsome.

Roi des Noirs. Black-brown.

Spitfire. Bright scarlet.

Mixed, Choice.

Canariensis. (Canary-Bird Flower).
Yellow.

NEMOPHILA Mixed varieties.

NICOTIANA.

Affinis. White.

Colossea. Tall and handsome foliage plant.

NIEREMBERGIA Gracilis.

NIEREMBERGIA. Frutescens.

NIGELLA. Mixed.

OENOTHERA. Evening Primrose.

Mixed Biennis (Yellow).

OXALIS. *H. H. P.* Splendid for baskets.

—Alba. —Rosea.

—Trapaeoloides. —Veitchii.

—Valdiana. —Mixed.

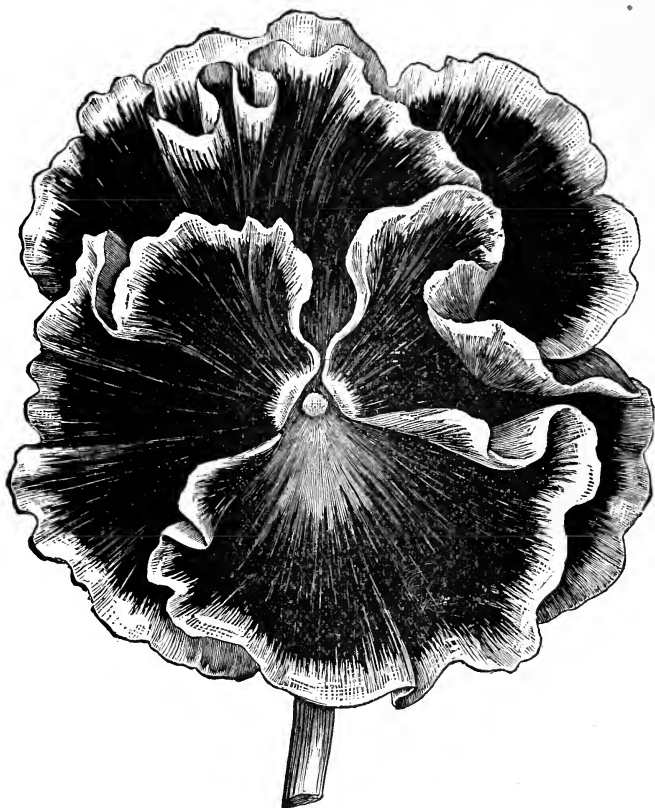

PANSIES.

H.1A. We have taken great care in the selection of our strain of this seed, obtaining it from the best of European and American growers. For size, variety of marking and brilliancy of colors we do not think our strain can be surpassed. Any six 10-cent varieties, 50 cts.

Weaver's Superb Mixture. Cannot be excelled. It is composed of the best varieties obtainable from French, German and English growers. Pkt. of over 150 seeds, 25 cts.

Bugnot's Superb Blotched. Very beautiful; extra large flowers, with broad blotches, two upper petals finely lined; great diversity of the handsomest colors. Packet 25 cts.

Cassier's Very Large-flowered Blotched. Saved exclusively from very large and beautifully blotched model flowers; a

very showy and especially rich strain. Packet 15 cts.

Ozier or Blotched, Large-stained. Superb and particularly recommendable strain of three and five blotched show Pansies, unsurpassed for shape, markings, richness of color and habit of growth. Packet 15 cts.

French Large-stained. Very beautifully marked varieties in finest mixture; from a celebrated French grower. Pkt. 15 cts.

Benary's Non Plus Ultra. A very fine mixture, containing some of the finest blotched varieties; very effective. Pkt. 15 cts.

Very Fine Mixture. Of the separate varieties; remarkably rich in color. Pkt. 10 cts.

Fine Mixture. Good strain of fine colors.

WE OMITTED PRICES BECAUSE WE SELL AT COMPETITION PRICES.

PANSIES — *Continued.*

Superb Prize. Giant Masterpiece. The richest combination of colors ever introduced. Packet 25 cts.

Quartricolor, Giant Prize. Rainbow colors. Packet 25 cts.

Maxima Variabilis. Beautiful. Pkt. 25c.

Maxima Germania. Packet 25 cts.

Maxima Trimardeau. Ruby red. Pkt. 25c.

TRIMARDEAU OR GIANT PANSIES.

The plants are of vigorous, compact growth; the flowers of good form and of enormous growth.

Extra Fine Mixed.

Azure Blue. New; very fine. Pkt. 10c.

Black Blue. Dark blue; splendid. Pkt. 10c.

Bronze Colored. Fine shades. Pkt. 10c.

***Candidissima.** (Snow Queen). Flowers of a delicate satiny white. Pkt. 10 cts.

***Emperor William.** Ultramarine-blue; true.

Fawn Color. Delicate. Packet 10 cts.

***Fire King.** Golden yellow, the upper petals purple; very fine. Packet 10 cts.

***Gold-margined.** Splendid.

Havana Brown. New shades. Pkt. 10c.

***Lord Beaconsfield.** Purple-violet, shading to a white.

Mahogany Colored. Splendid. Pkt. 10c.

Meteor. New; brown shades. Pkt. 10c.



POPPY—DWARF SHIRLEY.

Brown Red. Very fine. Packet 10 cts.

Candidissima. (Snowflake). White. Packet 10 cts.

Lord Beaconsfield. Deep purple, shading off in the top petals to white. Packet 10 cts.

Striped. Carefully selected strain. Pkt 10c.

White Giant. White purple eye. Pkt. 10c.

Yellow Giant. With black eye. Pkt. 10c.

SEPARATE SORTS OF PANSIES.

The varieties to which a star (*) is prefixed are the best for the bedding purposes.

***Azure Blue.** Very fine.

***Black or Faust.** (King of the Blacks). True.

Peacock. New; large peacock-blue flowers, with white edge. Packet 10c.

Red Shades, Mixed. Superb. Pkt. 10c.

Silver-edge. Dark purple, white edging.

Victoria. Red; very effective color.

Packet 10 cts.

***Yellow Gem.** Without eye; fine. Packet 10 cts.

POPPY.

Double Annual Varieties.

American Flag. Large, double; red and white fringed flowers; fine; 2 ft.

Cardinal. Dwarf; double; scarlet, on white ground; very striking; 1 ft.

POPPY—Continued.

- Carnation flowered.** Finest mixed; double; large, showy flowers; 2 ft.
New Fayal Poppies. Beautiful. Pkt. 10 cts.
Irresistable. New. The grandest Poppy grown; 5 ft. high. Packet 10 cts.
Mikado. Double; white fringed petals, tipped with scarlet; 2 ft.
Ranunculus-flowered. (African Rose). Finest double mixed; 2 ft.
White Swan. Dwarf, double, white; lovely.

Single Annual Varieties.

- Danebrog.** Single; scarlet, with white blotch on each petal; 1 1-2 ft.
Glaucum (Tulip Poppy). Large, scarlet.
Pavonium (Peacock). Large, scarlet, with glossy black ring and carmine centre; 2 ft.
Shirley. Most beautiful strain of single Poppies; delicate colors in great variety; 3 ft.
The Bride. Beautiful, single, white; 2 ft.
Umbrosium. Vermilion, with black spot on each petal; 1 1-2 ft.
Somniferum fl. pl. Heliotrope blue. Packet 15 cts.
Rhoeas. The Shirley. Fire-red. Pkt. 15c.
Rhoeas. The Shirley. Delicate holly-hock red. Packet 15 cts.
Dolly Varden. Beautiful flesh color.

Hardy Perennial Varieties.

- Alpinum.** Mixed, charming, 6 ins. Pkt. 10 cts.
Bracteatum. Red; 2 1-2 ft.
Naudicaule. Yellow, white, yellow, mixed.
Coccineum fl. pl. New. Double; bright orange scarlet. Packet 10 cts.
Oriental Waves. Superb scarlet flowers with dark centre; often 6 inches across; 3 ft. Packet 10 cts.
PASSIFLORA (Passion Flower.) *T. P.*
Coerulea. Sky-blue; 25 ft. Pkt. 25c.
Coccinnea. Vivid scarlet; 15 ft. Pkt. 10 cts.
PENTSTEMON. *H. P.* Mixed. Pkt. 10 cts.
PERENNIAL PEA. See Lathyrus.
PHASEOLUS. Caracalla. Pkt. 10c.
PERILLA NANKINENSIS.
PERILLA MACROPHYLLA COMPACTA.



PETUNIA — DOUBLE ROSEA PERFECTA.

- PETUNIA. H. A.** Unsurpassed as house plants or for outdoor growing.
Nana compacta multiflora. Very dwarf, with beautiful striped flowers. Packet 10 cts.
Striped and Blotched. Beautiful, large-flowered strain. Packet 10 cts.
White. Very free bloomer.
Finest Mixed. Superb strain; very rich colors and highly effective. Packet 10 cts.
Fine Mixed. Very fine quality.

PETUNIA GRANDIFLORA, or Large-Flowering Sorts. These have extremely large flowers of the richest colors, and are of fine form and substance; the quality is unsurpassed.

- Single.** An extra good mixture.
- Fimbriata.** Elegantly fringed flowers in great variety of delicate and charming colors. Packet 15 cts.
- Giants of California.** A strain of incomparable beauty, size and luxuriance, including fringed and deep-throated sorts. Flowers of great substance. Packet 15 cts.

DOUBLE-FLOWERING SORT.

Grandiflora fl. pl. Large-flowering, double. Finest varieties mixed. Packet 25 cts.

PETUNIA — *Continued.*

— **Fimbriata** fl. pl. A very large per cent. of beautiful, double-fringed flowers can be obtained from this strain. Packet 25 cts.

— **Pure White Double.** Packet 15 cts.

PHLOX DRUMMONDII. *H. A.*

Double Mixed. Beautiful colors; do best in a light, sandy soil. Pkt. 10c.

Grandiflora, Finest Mixed. A much improved strain, with very large flowers in great variety.

— **Alba.** Very large, pure white.

— **Atropurpurea.** Deep blood red.

— **Coccinea.** Brilliant scarlet.

Grandiflora rosea. Fine rose.

Cuspidata, Finest Mixed. Beautiful star-shaped flowers in showy colors.

Fimbriata, Finest Mixed. A fine strain, with beautiful fringed flowers.

Nana Compacta, Extra Fine Mixed. A dwarf, handsome class. Pkt. 10c.

— **Nivea.** (Snowball). White; a most excellent variety. Packet 10c.

Star of Ouedlinburg. Improved large flowering, star shaped. Pkt. 10c.

— **Sanguinea** (Fireball). One of the best for brilliant dwarf groups. Packet 10 cts.

PHLOX, Hardy Perennial. Perfectly hardy, immense trusses of large and beautiful flowers, in the greater variety of color; 3 ft.

Decussata. Many fine sorts. Pkt. 10c.

PORTULACA. Double, Finest Mixed. Packet 10 cts.

Single, Finest Mixed.

PRIMULA SINENSIS (Chinese Primrose). *T. P.* Is a great favorite for the house and conservatory.

— **Sinensis Alba Magnifica.** Pkt. 10c.

Fine Mixed. A splendid strain, with large, fringed flowers. Packet 15c.

Double. Extra mixed; large flowers; beautifully fringed, choice colors. Packet 25 cts.

PRIMULA. *H. H. P.* The following are useful for growing under glass or in borders.

Auricula. Finest mixed; saved exclusively from prize flowers. Pkt. 25c.

Japonica. Finest mixed; stalks 1 to 2 feet high, with whorls of large flowers. Packet 10 cts.

Obconica grandiflora. Very large flowers, varying from pure white to bright rose; largely grown for cut flowers. Packet 10 cts.

Veris (Polyanthus). Giant fancy; splendid colors; extra fine.

Duplex (Hose-in-Hose). Very beautiful varieties. Packet 10 cts.

Gold-laced. Charming varieties. Pkt. 10 cts.

Vulgaris. True yellow English Primrose.

Flowering Hardy Perennials.

PYRETHRUM.

Atrosanguineum. Fine deep red. Packet 10 cts.

Double Hybrids. Finest mixed; large double flowers of choicest colors. Packet 15 cts

Single Hybrids. Finest mixed; large, single flowers of choicest colors. Packet 10 cts.

Yellow-Leaved Half-hardy Perennials

These are usually grown and treated as annuals.

Aureum (Golden Feather). Yellow foliage.

Discoideum. Golden foliage, double yellow flowers

Roseum. *H. P.* Single.

Roseum. *H. P.* Double.

Golden Gem. Golden foliage, double white flowers

Selaganoides. Handsome, golden-yellow fern, fern-like foliage. Pkt. 10 cts.

RHODANTHE (Everlasting).

Finest Mixed. Beautiful colors; 1 ft.

RICINUS (Castor-Oil Bean.) *H. H. A.* **Borboniensis.** Tallest; 15 ft.

Cambodgensis. Of great value in border decorations and for single specimens.

Gibsoni. Dwarf, branching habit; deep foliage; 5 ft.

Sanguineus. One of the finest, with deep red foliage; 8 ft.

Zanzibarensis. The beautiful Zanzibar Castor Bean. Distinct, with gigantic leaves; the most ornamental of all.

Mixed Varieties.

SALPIGLOSSIS. Large-flowering. Mixed.

SALVIA.

Argentea. Silvery foliage and white flowers.

Carduacea. Light blue flowers with vermilion.

Patens. Beautiful species; flowers deep blue.

SALVIA — *Continued.*

Splendens. Finest scarlet; one of the best ornamental fall-blooming plants; 3 ft.

The President. Dwarf and compact, producing quantities of flower spikes of a bright red; 1 1-2 ft. Pkt. 10 cts.

SALVIA SPLENDENS. **Silverspot.** Leaves rich dark green with light sulphur or cream-colored spots. Pkt. 15 cts.

SCABIOSA (Mourning Bride). *H. A. Grandiflora.* Finest mixed; double, large-flowered, in choice variety of colors; 1 1-2 ft.

Black Purple. Very large, double.

Cherry Red. Large, double.

Rosy Carmine. Large, double-extra.

Tall Double Azure Fairy. Delicate lilac; recommendable for cut flowers and bouquets. Pkt. 15 cts.

SCHIZANTHUS. (*Butterfly Flower.*) *H. A.*

Finest Mixed.

SEDUM (Stonecrop). Finest Mixed.

SILENE, or CATCHFLY. Profuse-blooming plants, bright and attractive flowers; easy culture.

Armeria. H. A. Finest; 1 1-2 ft.

Perennial Varieties. Mixed.

SMILAX. *Myrsiphyllum asparagoides.* Packet 15 cts.

SOLANUM. *H. H. P.* Highly decorative fruit-bearing plants for greenhouses or garden.

Capscistrum. Numerous red berries.

STEVIA. *Serrata.* Pure white.

STATICE. *Sinuata.*

STOCKS (Gilliflower).

Large-flowered Double Ten-Week.

Produce a larger per centage of double flowers than any strain grown.

Bright Rose. Large-flowered. Pkt. 10c.

Sulphur-Yellow. Very double. Pkt. 10 cts.

Crimson. Large; very fine, double. Packet, 10 cts.

Carmine-Rose. Handsome. Pkt. 10c.

Finest Mixed. Brilliant colors only. Packet 10 cts.

Fine Mixed. A splendid variety.

Giant Perfection. **Finest Mixed.** Spikes of beautiful, large, double flowers. Packet 10 cts.

Dresden Perpetual. (*Princess Alice, or Cut-and-Come-Again.*) A splendid sort, with large, double, pure white flowers; continually in bloom. Pkt. 10 cts.

—**Finest Mixed.** A great variety of colors of this continuous bloomer. Packet 10 cts.

White Giant Perpetual. Enormous spikes of large, double, pure white flowers. Packet 10 cts.

SWEET PEAS.

Weaver's Newport Favorite is a mixture which has given universal satisfaction wherever planted. This year we have added many of the new varieties, and mixed by ourselves. This mixture consists of the choicest English and American large and fragrant sorts. All Packets 5 cts. unless otherwise noted.

America. Cardinal stripe on white ground.

Apple Blossom. Pink, wings white.

Blanche Ferry. Beautiful pink and white.

Blanche Ferry, Extra Early. Two weeks earlier.

Blanche Burpee. Pure white; very large. **Burpee's New Countesse.**

Blushing Beauty. Soft pink, tinged lilac.

Butterfly. White, tinted lilac.

Brilliant. Bright scarlet.

Boreaton. Dark maroon.

Captain of the Blues. Standards bright purple-blue; wings pale blue.

Captivation. Rosy purple self; finely expanded standards, shell-shaped; charming.

Cardinal. Bright scarlet. One of the most effective for bunching and decorations.

Celestial. Delicate azure-blue.

Coquette. A delicate creamy flesh, with a faint rose tinge.

Countess of Shrewsbury. A blending of pink and purple difficult to describe, wings shading to pink, faintly suffused with lilac; abundant bloomer.

Countess of Radnor. Fine, pale lavender; wings pale lilac; lovely.

Crown Jewel. (*Novelty.*) Pale standard, tinted and veined with violet-rose; wings creamy, with slight tint of rose.

Crown Princess of Prussia. Blush with salmon tint; fine.

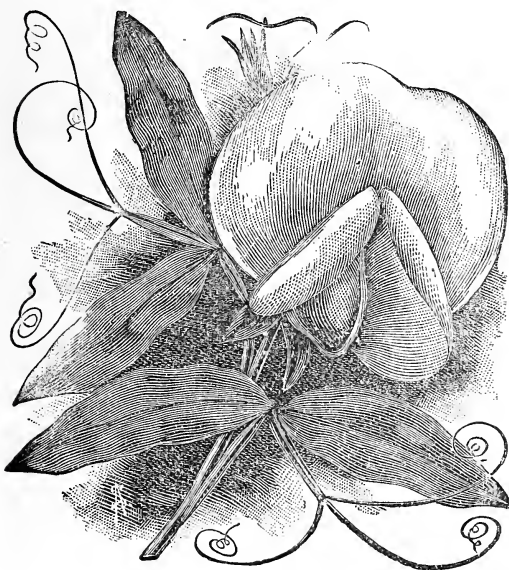

SWEET PEAS—MONTBLANC.

SWEET PEAS—Continued.

Cupid, Dwarf White. (Novelty). The first of a new race of Sweet Peas, less than one foot high; flowers pure white, very fragrant and freely produced. Packet 10 cts.

Cupid, Dwarf Pink. (Novelty). Same as preceding, except in color, which is similar to Blanche Ferry. More easily germinated and stronger in growth. Packet 10 cts.

Cupid Burpee's Beauty. Delicate Rose color, lightening to nearly white at the edges. Packet 20 cts.

Cupid, Alice Eckford. Rich creamy white, with shade of flesh pink; wings are silvery white. Packet 20 cts.

Cupid Primrose. Rich creamy tint very beautiful. Packet 20 cts.

Burpee's Bush. Grow 16 to 18 inches high. Color, watered purple on white ground. Packet 20 cts.

Earliest of All. Grows 2 ft. high. Bright rich pink wings, white. Packet 10c.

Cupid Boreatton. Very dark maroon. Packet 15 cts.

—**Countesse of Radnor.** True mauve or lavender. Packet 15 cts.

—**Firefly.** Deep, brilliant scarlet. Pkt. 15 cts.

Dorothy Tennant. Rosy mauve.
Eliza Eckford. Porcelain, suffused with reddish-mauve.

Emily Henderson. Pure white, flowers large and of great substance.

Firefly. A self-color—intense, glowing crimson; fine form, large flower.

Gray Friar. A beautiful watered-purple on white ground.

Her Majesty. Newport's favorite. Am. Beauty Rose color.

Katherine Tracy. Soft, brilliant pink.

Lady Beaconsfield. Wings primrose-yellow, with salmon pink standards.

Lady Penzance. Pale, but very bright rose.

Lottie Eckford. Rose and white, edged blue.

Lovely. Large, well-shaped flowers; wings a delicate rose, lightly suffused at the throat of standard and at base of wings.

Mars. Most intense and best formed of all the reds; a gorgeous flower of large size and perfect form. Medium early.

Meteor. Orange-salmon; wings light pink.

Mikado. Deep orange-cerise ground, striped white, of good form.

Navy Blue. True blue color.

Monarch. Bronzy crimson standards, blue wings.

Mrs. Jos. Chamberlain. White, striped and flaked heavily with bright rose.

Mrs. Eckford. Delicate, shaded primrose.

Mrs. Gladstone. Pink standards; wings blush, edged delicate pink.

Mrs. Sankey.

Orange Prince. Orange-pink, flushed with scarlet.

Peach Blossom. Salmon-pink.

Pink Friar. Carmine rose suffused on white ground.

Prima Donna. A large, perfect flower, of elegantly hooded form and finely proportioned. A rich, yet delicate blush-pink. Medium early.

Prince Edward of York. Large flower, scarlet; wings rose.

SWEET PEAS Continued.

Queen Victoria. Soft yellow, overlaid with faint purple; handsome flowers.

Ramona. Creamy white, flaked soft pink.

Royal Robe. Bright pink and blush-white.

Senator. Chocolate, on white ground.

Stanley. Deep maroon; large, fine form,

Sadie Burpee. The white sweet pea par excellence. Packet 20 cts.

Fashion. Reddish-mauve and rich carmine. Packet 10 cts.

Venus. Buff and pink.

Choice Mixed. Made up from named sorts by ourselves, and is much superior than of late years.

SWEET SULTAN (*Centaurea moschata*) *H. A.* Sweet-scented, free-flowering.

SWEET WILLIAM. (*Dianthus barbatus*) *H. B.* Old favorite, producing brilliant colored flowers.

Double, Extra Large. Finest mixed.

Single, Finest Mixed. Choice colors.

TAGETES. *Signata pumila.*

Golden Ring. Flowers pure yellow.

THUNBERGIA. Finest Mixed.

VIOLET (*Viola*). *H. P.* Well known favorites, in demand on account of their abundant and fragrant blossoms.

Odorata semperflorens. Fine blue. Packet 10 cts.

—**The Czar.** Light violet; very large. Packet 10 cts.

—**White Czar.** Very large, white. Packet 10 cts.

VERBENA. *H. H. P.* The Verbena is deservedly a universal favorite, unrivaled in the splendor of its dazzling brilliancy of flower.

Auricula-flowered. Saved from the finest sorts, with large white eyes.

Candidissima. Best pure white. Packet 10 cts.

Coerulea. Best blue shades, mixed. Packet 10 cts.

Coccinea. Bright red shades. Packet 10 cts.

Defiance. Clear, brilliant scarlet. Packet 10 cts.

Hybrida Grandiflora Atrococcinea. The richest scarlet in existence. Packet 15 cts.

Striata. Finest striped sorts. Packet 10 cts.

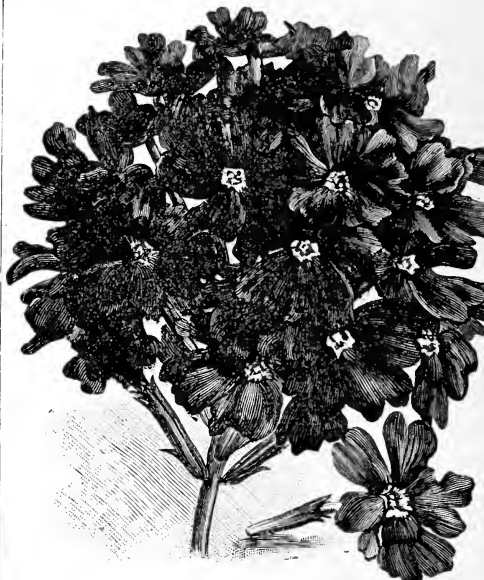

VERBENA.

Hybrida Grandiflora Atrococcinea.

Mammoth Finest Mixed. Very large and brilliant-colored flowers. Pkt. 10 cts.

Fine Mixed. An excellent strain.

Dwarf Finest Mixed. A splendid variety of dwarf, compact growth, and large, brilliant flowers. Packet 10c.

WALLFLOWER. *H. H. P.* Charming evergreen perennials, requiring but slight winter protection.

Double. Mixtures, finest colors.

Earliest Paris. New, single, fine colors, blooming first year from seed. Packet 10 cts.

XERANTHEMUM. Double Mixed.

ZEA. *H. A.* Stately plant; leaves striped green and white; 5 ft.

—**Japonica.** (Striped Maize).

ZINNIA ELEGANS. *H. A.* One of the most brilliant and showy of annuals, and a general favorite.

Double Giant "Queen Victoria." A pure white variety.

Double Minima. Packet 15 cts.

Miniature. The smallest Zinnia in existence, grows only 4 inches high, blooms in all colors. Pkt. 15 cts.

Weaver's "Non Plus Ultra" Mixture. A large variety of choice colors.

ZINNIA—Continued.

- Large Double Crimson.
- Flesh Color. Odd and pretty.
- Large Golden-Yellow. Very showy.
- Lilac.
- Purple.
- Rose.
- Scarlet. Bright and rich.
- White.

Robusta grandiflora fl. pl. (Giant Zinnia.) Grows in handsome bush; 3 ft. high; blooms 5 or 6 inches across. Mixed. Packet 10 cts.

Curled and Crested. The large, full flowers of this attractive class of Zinnias are exceedingly unique, the petals being curled and twisted in many graceful forms; the colors include orange, purple, pink, rose, yellow, etc. Finest mixed.

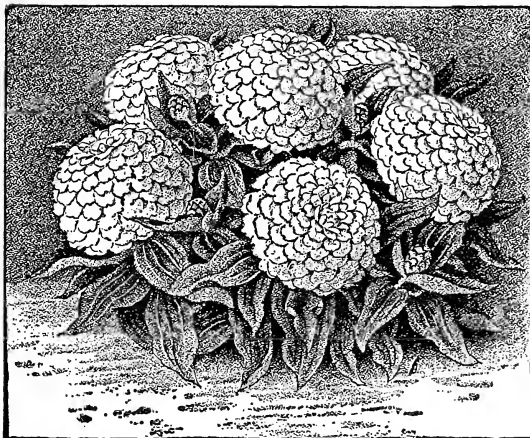

ZINNIA — LORENZ'S MINIATURE.

Grandiflora coccinea striata. Giant striped gold and scarlet; new, fine. Packet 10 cts.

ZINNIAS, Double Dwarf. Habit of the plant dwarf, not often exceeding 1 ft.

Large-flowering Crimson.

Golden-Yellow.

Purple.

Salmon. Odd and new.

Lilliput. "Golden Gem." A worthy compeer to the beautiful "Scarlet Gem" and "White Gem." Pkt. 10c.

Dbl. Lilliput, "Scarlet Gem." Thickly branched little plants, about 1 1-2 ft. high.

"White Gem." This forms a fitting companion to the "Scarlet Gem."

Scarlet.

White.

Mixed.

Dwarf Double Striped (Benary.) The seed will produce 60 to 65 per cent. of very fine Striped or Zebra Zinnias, in a great variety of very effective shades. Packet 10 cts.

Elegans Double Rose. Packet 10 cts.

Pompon. Mixed. Small; very double flowers.

PLANT DEPT.

Prices on all plants, unless noted, are for strong plants, which must go by express at purchaser's expense. We can supply mailing plants at low prices.

BEGONIAS. Gloire de Lorraine, has been the attraction at all Horticultural Exhibitions. It blooms continuous. A brilliant rose color. Plants from 25c. to \$2.00.

Rex. The best named varieties, each 25 cts. to \$1.00.

CHRYSANTHEMUMS. The best selected Japanese, Chinese, and American double large flowering varieties. Each 10 cents, \$1.00 per doz.

GERANIUMS. All colors and best market varieties, 10 to 12 cents each, \$8.00 to \$10.00 per 100.

ROSES.

Hybrid Perpetual. Abel Carrier, Alfred Colomb, Alfred K. Williams, Baron de Bonstetten, Baroness Rothschild, Captian Christy, Capt. Haywood, Countess of Roseberry, Fisher Holmes, General Jacqueminot, John Hopper, Jules Margottin, Jubilee, Louis Van Houtte, Mabel Morrison, Mad. Eugenie Verdier, Mad. Gabriel Luizet, Mad. Victor Verdier, Magna Charta, Mrs. John Laing, Paul Nerow, Prince Camille de Rohan, Reine Marie Henriette, Ulrich Brunner and many others. 35 cents each.

Hybrid Tea Roses. Bessie Brown, Caroline Testout, Germaine Trochon, Gloire

ROSES—Continued.

de Dijon, Lady Mary Fitzwilliam, La France, Mad. Abel Chantenay, Maman Cochet. Above Tea Roses are perfectly hardy and good summer bloomers. 40 cents each.

Austrian Briar. *Harrisonii*, Persian yellow.

Hybrid Rosa Rugosa. *Rosa Rugosa* alba, *Rosa Rugosa*, Madame Georges Bruant.

Rosa Polyantha. Crimson Rambler, Yellow Rambler, Pink Rambler, White Rambler.

Noisette Roses.

Hermosa Roses.

Moss Roses.

Hollyhocks. Strong plants in a grand assortment of colors to bloom the present season.

Double Hollyhocks in fall shades. White, light flesh color, pink, rose pink, scarlet, salmon, yellow, crimson.

Phlox. One of the most effective of herbaceous plants, make a grand show during the season. Price 25 cents each. \$2.50 per dozen.

Pansies. Of this popular flower we have a great variety of colors and large blooms, special grown for us from our seed which is mixed from the best foreign and home varieties. 5c. each.

CLIMBING PLANTS.

Aristolochia Siphon. Each 50 cents.

Ampelopsis, Veitchii. Each 15 cts., \$1.50 per dozen.

Ampelopsis Quinguefolia. Each 25 cts., \$2.50 per doz.

Bignonia, Trumpet Creeper. Each 25c., \$2.50 per doz.

Bignonia, Grandiflora, radicans. Each 25c., \$2.50 per doz.

Periploca graeca, 35 cents each.

SUMMER FLOWERING BULBS.

AMARYLLIS. Lily-like flowers, very beautiful, which should be found in every garden.

Belladonna major. Rosy pink; 30c ea.

Formosissima. (Jacobæan Lily). Crimson; graceful, blooming early in the summer. 20c each.

BEGONIAS, Tuberous-rooted. Among the handsomest summer-flowering bulbs. Require no more care than geraniums, and bloom continuously throughout the summer.

White, Rose, Salmon-colored, Scarlet, Yellow. 10c each, \$1 per doz.

Single. Finest mixed. 8c ea.; 80c doz.

Double. Finest mixed. 15c ea.; \$1.50

CALADIUM ESCULENTUM (Elephant's Ear). One of the most effective plants in cultivation for the flower border or for planting out upon the lawn.

Extra Large Bulbs. 20c ea.; \$2 doz.

Good Bulbs. 10c ea.; \$1 doz.

CALLAS. Extra size, large white flowers. 25c ea., \$2.50 doz.; by mail 35c ea.

CANNAS, Dwarf French. These plants have been wonderfully improved in the last few years. The contrast of their beautiful foliage and gladiolalike flowers is very striking.

Alphonse Bouvier. 5 ft. Grand sort, with numerous spikes of very large,

rich, scarlet-vermilion flowers; foliage green.

Austria. 6 ft. Large foliage; grand spikes of large canary-yellow flowers, spotted red.

Chas. Henderson. 3 1-2 ft. Rich, crimson flowers in compact trusses; fine green foliage.

Eldorado. 3 1-2 ft. The nearest to a clear yellow; very finely speckled with light red.

Flamingo. Immense trusses of superb deep crimson flowers; a gem indeed.

Florence Vaughan. 3 ft. Rich, golden-yellow, spotted bright red; foliage massive and rich green. One of the finest yellow spotted varieties.

Italia. Large foliage, deep green bordered white; large Iris-shaped flowers, bright red, bordered golden-yellow. Belongs to Orchid-flowered section.

Mme. Crozy. 4 ft. Large, brilliant crimson-scarlet, bordered with golden-yellow; foliage bright green.

Mrs. Fairman Rodgers. Color scarlet bordered with a narrow-band of yellow. The compactness of the flower-head, rich color, and the well-flowered spike, make this popular.

Paul Bruant. 4 ft. Intense orange-scarlet, with peculiar satiny surface; foliage dark green.

CANNAS—Continued.

Queen Charlotte. 3 ft. Rich, deep red, with broad, canary-yellow edge; foliage bluish-green.

Sophie Buchner. Scarlet, overlaid with orange; large, deep green; Musa-like foliage.

Named Sorts. 20c ea., \$2 doz.

Mixed Sorts. Fine varieties. Dry roots only. 10c ea., \$1 doz.

Cyclamen persicum grandiflorum. 15c ea., \$1.50 doz.; 25c ea., \$2.50 doz. Extra large bulbs, 50c ea., \$4.50 doz.

DAHLIAS. These grand, fall-blooming plants delight in a sunny situation and a rich soil.

Double Large-flowering. Finest show varieties, distinct colors, assorted. Customer's choice of flowers. 15c ea., \$1.50 doz.

New Single-flowering. A fine collection; assorted colors. 15c ea., \$1.50 doz.

By mail, add 5 cents each for postage.

GLADIOLUS. This magnificent family contains hundreds of varieties, comprising all imaginable colors, shades, and variegations, from the most gorgeous and dazzling to the softest and most delicate shades. They deserve to be grown in every garden.

Extra Fine Mixed All colors. 25c doz. \$1.75 per 100.

Scarlet and Crimson Shades. Mixed 35c doz., \$2.50 per 100.

White and Light Shades. Mixed. 50c doz., \$3 per 100.

Pink and Variegated. Mixed. 50c doz., \$3 per 100.

Yellow Shades. 50 cts. doz., \$3 per 100.

	per doz.	per 100
White. Extra fine,	40c.	\$2.50
Scarlet. First quality,	30c.	2.00
Pink. Extra fine,	30c.	2.00
Pink and Orange,	50c.	3.00
Striped and variegated,	50c.	3.00
Snowwhite,	\$1.50	
Lemoine's Hybrid Spotted,	50c.	3.50

GLOXINIAS. Choicest Stran. The bulbs we furnish are of the finest varieties in cultivation. Flowers large, finely carried above the foliage, and of the most splendid colors.

Fine Mixed Varieties. 20c ea., \$2 doz.

HYACINTHUS candicans. Perfectly hardy; producing strong flower-stalks 3 ft. high, terminating in fine

spikes of bell-shaped, pure white blossoms. 10c ea., \$1 per 100.

IRIS KAEMPFERI. Perfectly hardy, flowering for a period of five to seven weeks in June and July. These gorgeous flowers compare favorably with the finest Orchids, and are among the best of recent additions to the flower garden.

Finest Mixed. 15c ea., \$1.50 doz.

IRIS GERMANICA. Neat, robust, hardy herbaceous early-blooming plants, with large ornamental flowers of rich and elegantly blended colors, exquisitely striped with dark violet-purple or bronzed lines upon a lighter ground. Thrive best in low situations, and can be planted in marshy places or interspersed with low-glowing sedges on the margins of ponds.

Finest Mixed. 15c ea., \$1.50 doz.

LILIUM auratum (Golden Japan Lily). This superb Lily has flowers 10 to 12 in. in diameter, composed of six white petals, thickly studded with rich chocolate-crimson spots, and a bright golden band through the centre of each petal. 15c ea., \$1.50 doz.

Candidum. Pure white, very fragrant. Plant in August or September. 10c ea., \$1 doz.

LILIUM speciosum album. White Japan Lily. 20c ea., \$2.00 doz.

Speciosum rubrum. White, spotted with crimson. 15c ea., \$1.50 doz.

Superbum. A beautiful native variety; color yellowish, red spotted. 15c ea., \$1.50 doz.

Tenuifolium. (Coral Lily). One of the earliest and best. It bears in profusion medium-sized flowers of perfect form and a rich, dazzling orange-scarlet. 20c ea., \$2.00 doz.

Tigrinum (Tiger Lily). Orange-salmon spotted with black. 10c ea., \$1.50 doz.

Tigrinum fl. pl. (Double Tiger Lily). Orange red, spotted with black; double showy flowers. 15c ea., \$1.50 doz.

MADEIRA VINE. A beautiful rapid-growing climber, bearing graceful racemes of very fragrant white flowers. The vine is very pretty and useful. 5c ea., 50c doz.

MONTBRETIAS. All colors. 3 for 10c., 30c doz., \$2.25 per 100.

PAEONY, Herbaceous. The Herbaceous Pæonies are exceedingly hardy, and will succeed in any good garden

PAEONY—Continued.

soil well enriched with manure. It is well to mulch during the hot summer months.

Mixed Colors. 25c ea., \$2.50 doz.

Finest Mixed Colors. 40c ea., \$2.50 doz.

TIGRIDIA (Tiger Flower). Curious and beautiful shell-like flowers about 4 inches in diameter, flowering from July to October. The bulbs can be planted in May, and taken up in October, and kept over winter in dry sand.

Grandiflora. Very large; deep scarlet.

Grandiflora alba. Large ivory-white flowers, spotted with maroon and rosy-like in center. 8c ea., 75c doz.

TUBEROSES. These beautiful fragrant flowering bulbs are too well known to need either description or praise.

Excelsior Pearl. Dwarf habit; pure white, double flowers. 5c ea., 50c doz., \$3.00 per 100.

OUR DUTCH BULB LIST

Will Be Out in September.

We can save money for you by giving us your order early in the season. We import them direct from Holland, Europe, and can guarantee you first-class bulbs, good size at a reasonable price.

HARDY ORNAMENTAL SHRUBS.

50 cents each, except where noted.

ALTHAEAS. Double; white, rose and purple.

Variiegated-leaved. Foliage beautifully edged with white.

Almond, double-flowering. Beautiful rose color.

Double White. Elegant shrub. May.

AZALEAS. (Ghent Azaleas). Various colors; entirely hardy. Junc. 75 cts. to \$3 each.

Mollis. Japan. Large; orange or yellow. Junc. 75 cts. to \$3 each.

Cydonia Japonica. (Japan Quince). Brilliant crimson. May.

DEUTZIA, crenata alba plena. Double white; upright. June.

Crenata rosea plena. Rose; beautiful. June.

Gracilis. White, in panicles. May and June.

EUOMYMUS Americanus. (Burning Bush). Brilliant foliage.

Europaeus. (Spindle Tree.) Red berries.

Exochorda grandiflora. Beautiful white flowers.

FORSYTHIA suspensa. Drooping Golden Bell. May.

Fortunei. Bright yellow; upright. May.

Hydrangea paniculata grandiflora. Immense panicles of large, white, ray

Strong, 2 to 3 years old.

flowers; one of the best shrubs; September and October.

Hypericum Moserianum. A beautiful plant with large showy golden-yellow flowers, 2 to 2 1-2 inches across. The habit of the plant is free and graceful, producing long, slender, much-branched stems; wonderfully free-flowering; continually in bloom from July to October.

Lonicera tartarica. Tartarian Honey-suckle). Pink flowers, red berries. May.

Paeonies, Tree. Magnificent flowers. \$1 to \$2 each.

PHILADELPHUS coronarius. (Mock Orange.) Fragrant white flower. June.

Grandiflorus. Large flowers, white. July.

Rhododendrons. Among the most beautiful of all shrubs; large variety of colors. Large plant in bud, \$1 to \$5 each, according to size.

Berberis purpurea. Purple foliage and fruit.

Calycanthus floridus. (Spice Brush). Chocolate-red; fragrant. June and July.

Cornus Siberica variegata. Rugose foliage, strongly marked; silver and rose.

Chionanthus Virginica. (White Fringe.)

CRATAEGUS OXYACANTHA (Eng. Hawthorn). Beautiful; dbl. June, July.

RHUS COTINNS. Smoke Bush, or Purple Fringe.

SPIRAEA callosa. Rose colored; handsome.

Reevesii fl.pl. Double, white in clusters.

SYRINGA vulgaris. (Common Lilac). Purple.

Vulgaris alba. (White Lilac). Fragrant. May.

Symphoricarpus racemosus. (Snow-berry). Pink, with large white berries. May.

Tamarax Gallica. Pink, very pretty; foliage fine.

Viburnum plicatum. (Snowball). Globular heads of white flowers.

WEIGELA rosea. Rose colored. May.

Candida. White; beautiful. May.

Variegata. Pink, foliage variegated. May.

HEDGE PLANTS.

Arbor vitae. American. 9 to 12 inches, \$8 per 100; 12 to 18 ins., \$10 per 100.

Cydonia, or Pyrus Japonica. (Japan Quince). Glossy foliage, bright scarlet flowers. \$8 per 100.

PRIVET, California. Keeps green till Christmas; excellent. \$10 per 100.

SPRUCE, Norway. 9 to 18 ins., \$12 per 100; 12 to 18 ins., \$20 per 100.

Hemlock. A very largely used and fine hedge plant. 6 to 9 ins., \$9 per 100. 12 to 18 ins., \$30 per 100.

REMEDIES FOR INSECTS AND FUNGI.

Havana Tobacco Stems. For fumigating; valuable as a mulch for rose beds, lettuce beds, etc. Lb. 5c; 100 lbs., \$3; full bales, 2 1-2c per lb.

Tobacco Extract, "Rose Leaf." A concentrated extract of uniform strength, for use in greenhouses. It will not injure the plants if properly used, but will most effectually destroy green-fly, scale, mealy bug, and can be used by vaporising or applying on the pipes with a brush. Diluted with water it can also be applied with a syringe. One gal., \$1.50; 2 gals., \$2.75; 5 gals., \$5.

Tobacco Dust. Cheaper than snuff, and quite as effectual; a sure remedy for green-fly. Lb., 5c; 100 lbs., \$3.

Pure Powdered Hellebore. For rose-slugs, currant worms, green-fly, etc. Dust on with gun or bellows while the foliage is moist. Lb., 30c; by mail, 45c.

Paris Green. Genuine; unexcelled for potato bugs and other insects that eat foliage. Lb., 30c. Price variable.

London Purple. One of the best destroyers of insects. It is cheaper and less dangerous than Paris Green. At the rate of 1 lb. to 150 gals. water. Lb., 20c.

Persian Insect Powder. One of the best and safest insecticides for all insects. When blown on with a bellows or gun, it penetrates hidden crevices, and is invaluable to the housekeeper for flies, cockroaches, etc. Lb., 60c., by mail 75c.

Pure Flowers of Sulphur. Prevents and cures mildew on roses, grape vines, etc.

Apply with gun or bellows. Lb., 10c 15 lbs., \$1.

Gishurst's Compound. A famous English preparation for destroying red-spider, mealy bug, thrips, and scales, etc. In boxes. Each 60c; by mail 80c.

Whale-Oil Soap. Pure, fresh and of finest quality; makes an excellent wash for trees and plants; kills insects and their eggs. Lb. 15c, 2 lbs. 25c, 5 lbs. 50c.

Soluble Fire-Tree Oil. For destroying all insects that infest plants and animals, such as mealy bug, scale, red-spider, green-fly, thrips, lice, fleas, etc. Harmless to the hands of the user. Directions with each package. 1-2 pt. 50c; pt. 75c, qt. \$1.40.

Bug Death. Sure death to all Bugs on Vegetables.

Hammond's Slug Shot. One of the cheapest and best powders for destroying the cut worm, potato bug, rose slug, curculio, worms or caterpillars upon vines, currants and fruit trees. It is an excellent fertilizer, contains nothing injurious to domestic animals, and does not deteriorate by age. On low-growing plants it should be dusted with a very fine sifter; on tall shrubs and trees it should be applied with a bellows. Lb. 15c, 5 lbs. 35c, 10 lbs. 50c.

Permal Kerosene Soap.

Sulpho-Tobacco Soap. This soap is easily dissolved in warm or cold water; as a rule two ounces of soap should be taken to a gallon of water. Where the

insects are underneath the leaves, care must be taken that the liquid reaches them there. It is non poisonous; can be used on vines and small fruits without fear of poisonous infection. Cake 10 and 20 cts.

Grape Dust. A preparation for destroying mildew on grape vines. Can also be used on plants and trees affected with mold, mildew or rust mite, either in greenhouses or the open air. Its diffusibility is great. It must be applied frequently by dusting, as atoms of fungi are always spreading or floating. Apply at the first appearance of trouble. Dust on a warm, dry day. 5-lb. package 35 cts.

Little's Antipest. This preparation is a sure destroyer of all insect pests that infest plants; it is non-poisonous, and when diluted and used according to directions is perfectly harmless to vegetation. Qt. 75 cts., 2 qts. \$1.50, gal. \$2.50.

Canker Worm Exterminator. (Morrill's Tree Ink. A sure protection to trees from the ravages of grub and canker worm. Directions with each can. 2-lb. cans 30 cts., 5-lb. cans 60 cts., 10-lb. cans \$1.10, 20-lb. cans \$2, 28-lb. cans \$2.80; 125-lb. kegs, per lb. 9 cts.

Owl Brand Tree-Protector. The safest, simplest, and most effective destroyer of the canker worm, gypsy moth, curculio, caterpillar, and other fruit and shade tree pests. This preparation can be applied as easily as the tree ink in common use, but is much more lasting and beneficial in its results; retains its virtue for a long period. If applied twice in accordance with directions furnished, will last for nearly an entire year. One pound to a tree is a safe estimate. 3-lb. cans 45 cts., 5-lb. can 60 cts., 10-lb. can \$1.

Paris Green and Fungiroid. This preparation is made of pure Paris green, mixed with Fungiroid in such proportions as not only to kill the bug, but at the same time to prevent blight. Sold at the material price for Paris green.

Bordeaux Mixture in Dry Form. Recommended as a valuable and indispensable fungicide for black-rot, potato blight, potato rot, leaf blight of cherry, pear, quince, and many other fungous diseases. We have the necessary chemicals for the preparation of the Bordeaux mixtures for sale. For the convenience of those desiring to test the dry method, we offer the Fungiroid Dry Bordeaux Mixture in a fine dry powder. For most plants this powder is to be diluted with

an equal part by weight of plaster, and the mixture applied when the foliage is wet with dew or rain. Lb. 12 cts.

"BODLIME" For Canker-Worms. A cheap substitute for Tar and Printer's Ink Bands, and superior to both for preventing the wingless female moths from ascending the trees. It does not harden, and only one banding is necessary to keep the canker-worms out of the trees for a whole season. It is easily applied, and a most effectual remedy. 5 1-2 lb. can \$1.

Bowker's Insect Emulsion. For oyster shell bark lice, scale insects, worms, red spiders, green and black fly, thrips, beetles, etc., apply 1 part to 9 part of water. 9 1-2 lb. can \$1.

Bowker's Boxal. A combined Insecticide, Fungicide and Germicide, a practical remedy for Potato Beetle and Rot; Apple Scab and Fungous Diseases and all kind of leaf insects. 11 lb. can \$1.25.

Bowker's Disparene. Substitute for Paris Green and London Purple may be used in quantity without burning or scalding the foliage. 5 1-4 lb. can \$1.25.

XL All Vaporising Compound.

XL All Liquid Insecticide.

Nicoteen Aphis Punk. Kills insects on plants and flowers, especially recommended for Roses and Carnations, Palms, ferns, etc.

Nikoteen. A Liquid Insecticide specially prepared for use in greenhouses and conservatories.

"Pillar-Cattar" consists of a strip of water-proof paper, four inches wide, with a narrow row of cotton batting firmly and neatly stitched on each edge. The center strip, or paper is coated with a sticky paste, thus rendering it impossible for any crawling insect to get over. The paste is made expressly for the purpose. It will stand a high degree of heat; will not melt and run off, yet it remains sticky for months. 15 cts. per yard.

DISINFECTANTS.

Chloride of Lime, Copperas, Chlorine, Camphor and Camphor Balls, Carbolic Powder, Carbolic Acid, Crude and Crystallized Carbolated Lime, Chloro Naphtholeum, Cresyl jeyes in powder and liquid, Household disinfectant. Sulpho Napthol, Sultar Disinfectant, Magic fluid.

FORMULAS FOR SPRAYING MIXTURES.

WHEN TO SPRAY AND WHAT TO USE. The following brief directions for the spraying of fruits and vegetables have been compiled as the result of several years' experimenting with different materials and it is believed they can be followed without injury to the crops and with profit to the owner.

It will pay to spray all fruit plants early in the spring with copper sulphate solution, and the second and third applications, as given, can generally be made with profit. Never spray with arsenites while the trees are in blossom, as the bees will be poisoned; they are necessary to fertilize the flowers.

Bordeaux Mixture. Copper Sulphate, 6 pounds; quicklime, 4 pounds; water 40 gallons.

Dissolve the copper sulphate by putting it in a bag of coarse cloth, and hanging this in a vessel holding at least four gallons, so that it is just covered by the water. Use an earthen or wooden vessel; slake the lime in an equal amount of water, then mix the two and add enough water to make 40 gallons. It is then ready for immediate use. For rots, molds, mildews, and all fungous diseases.

Paris Green. Paris green, one pound; water, 250 gallons. If this mixture is to be on peach trees, one pound quicklime should be added. Repeated applications will injure most foliage, unless lime is added. Paris green and Bordeaux mixture can be applied together with perfect safety. The action of neither is weakened and the Paris green loses all caustic properties. For insects which chew.

Copper Sulphate Solution. Copper Sulphate, 1 pound; water, 25 gallons. Dissolve, then it is ready for use. This should never be applied to foliage, but must be used before the buds break. For peaches and nectarines, use 25 gallons of water. For fungous diseases.

Hellebore. Fresh white hellebore, 1 ounce; water, 5 gallons. Apply when well mixed. For insects which chew.

London Purple. This is used in the same proportions as Paris green, but as it is more caustic, it should be applied with the lime or with the Bordeaux mixture. Do not use it on peach or plum trees. For insects which chew.

Emulsion to kill Elm Beetle. (Dissolve in water and strain.) Flour 6 pounds; London purple, 1 pound; kerosene emulsion, 1 gallon; soap, 1-2 pound; water, 100 gallons.

The above preparation is recommended by the R. I. Experiment Station for the destruction of the Elm Beetle. (*Galleruca Xanthomelana*). It should be applied with a force-pump having a fine spray.

Kerosene Emulsion. Soft soap 1 quart, kerosene 1 pint, water 6 to 11 quarts. Warm the soap until it becomes liquified, remove from near the fire, add the kerosene and agitate rapidly with a force pump for five to ten minutes, until it becomes a homogeneous creamy mass, from which the kerosene will not separate on standing. Dilute with water, so that the kerosene will be 1-15 to 1-25 of the entire mixture. If properly prepared, it can be used with safety upon nearly all plants, except squashes, melons, cucumbers, and others of a squash family. A remedy for all sucking insects, and for all others with soft bodies with which it can be brought in contact.

Implements for the Distribution of Insecticides

ON PLANTS AND TREES, AND HORTICULTURAL AND FLORISTS' SUPPLIES.

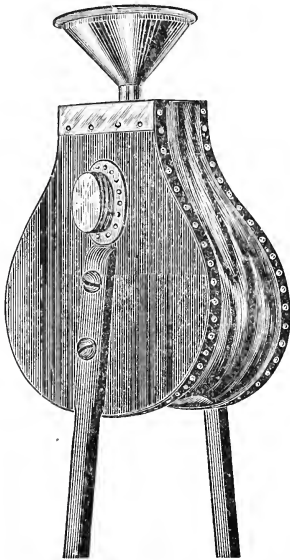

Bellows. Bellows, for vaporizing.
Electric Insect Exterminator.

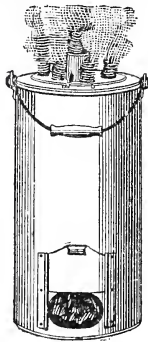

PERFECTION.

Eureka and Perfection Fumigator.

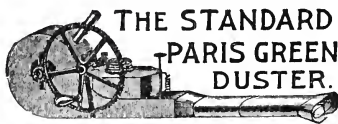

The Standard Paris Green Duster.

Leggett's Improved Paris Green or Dry Powder Gun.

The Lightning Bug Exterminator.

Powder Gun.



Leggett's Paris Green or Dry Powder Gun Distributes any dry powder. Thousands in use.

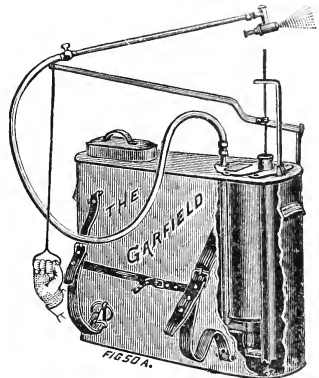

Improved Knapsack Sprayer.



Length of Barrel, 12½ in.; diam., 1½

Syringe. With one spray rose.



Syringe. Specially designed for applying insecticides on the *under side* of the leaves.



Syringe. Open rose syringe, with one spray and one stream rose side attachment and fixed elbow joint; barrel 16x1-2 inch in diameter.

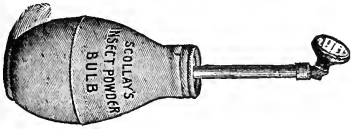

Scollay's Insect Powder Puff.

Whitman's Fountain Pump, and many other kind of Pumps.

The "Stott" Insecticide Distributor.

SPRAYERS.

The Wet Powder Gun. By express, prepaid, \$1.25. It has no equal for spraying *Potatoes, Currants, Rose Bushes, Hot House Plants, Cattle* (to keep off lice), *Hen Houses, Etc.* We have Bucket, Barrel and Pneumatic Spray Pumps.

Vermorel Nozzle.

Masson Spray Nozzle.

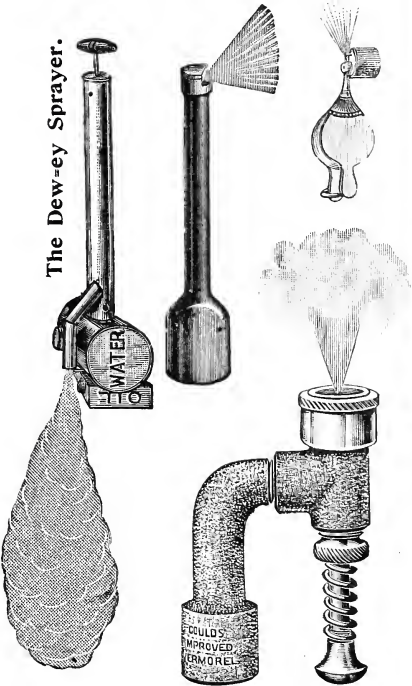

Three-Discharge Vermorel Nozzle. Very useful where a great amount of spraying is done.

"Cyclone" Spray Nozzle.

Two-Row Attachment.

Spray Pump Bamboo Extension.

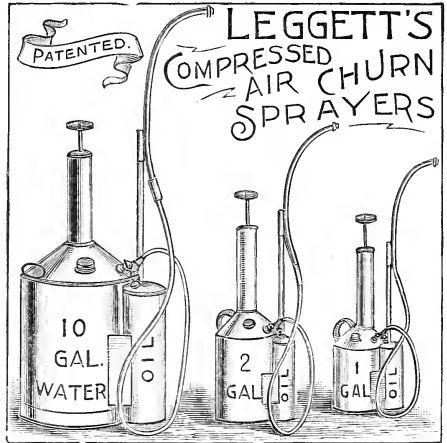

Compressed Air Sprayer. The latest and most practical sprayer in market.

No. 1. All Tin.

No. 2. Tin Cylinder Brass Tank.

No. 3. All Brass.

No. 6. Tin Air Cylinder and galvanized iron tank.

No. 8-9. Have galvanized iron tanks with an air pump, made of heavy seamless brass tubing.

No. 8. Capacity 3 gals. No. 9, 10 gals.

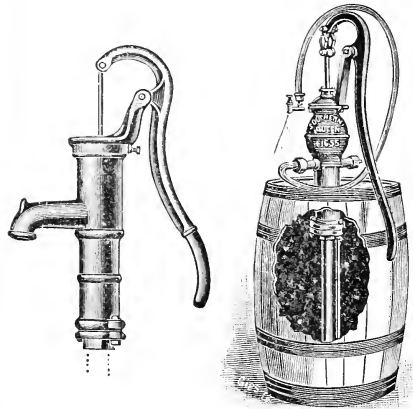

SPRAY and WELL PUMPS.

Interior Stable. House Pitcher.

Spray Force Pump. Acme Pump.

Outdoor Farm, for shallow wells.

Double Acting Spray Pump.

Windmill.

Baskets, Verbena, Marston's Pattern.
Baskets, Raspberry. Strawberry.
Orchid Baskets. Round and square. All sizes and prices.

Rustic Hanging. Artistically made of natural roots and knots. Diameter, 8 to 12 inches.

Baskets, Oval and Round Flats. For centerpieces and floral decorations.

Baskets, Garden. Convenient for carrying fruits, flowers, vegetables.

Bouquet Wire. Price variable. Cut convenient lengths. Nos. 22, 23 and 24.

Burning Brands. Cotton Batting.

Brooms. For greenhouse and garden.

Hair Wire and all sizes in bulk.

Glass Cutter and Glazer.

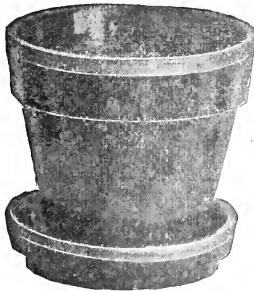

Standard Flower Pots. Inside measurement, height and width equal.

Special prices to parties buying in large numbers. No charge for packing.



Knives, Budding. Saynor's. Our own importations. Different sizes and patterns.

Knives, Pruning. Saynor's. Various styles.

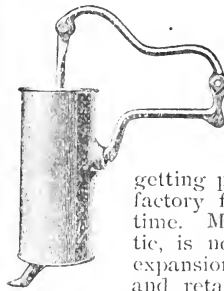

Mastica Glazing Machine.

Mastica. For glazing greenhouses, old or new. Elastic, adhesive, easy to apply. Every florist has experienced difficulty in getting putty that is satisfactory for any length of time. Mastica, being elastic, is not affected by the expansion and contraction, and retains this property for years.

Patent Protecting-Cloths for Hotbeds.

Paper, White Tissue. For cut flowers.

Paper, Manilla. Paper, White Manilla. Wax and Butter Paper.

Raffia. For tying plants.

Silkalene, or Smilax Green Thread Largely used for tying in bouquet work and for training smilax.

Round Seed Pans. 6 to 14 inches.

Square Seed Pans. 6 to 12 inches.

Round Fern Pans. 4 to 10 inches.

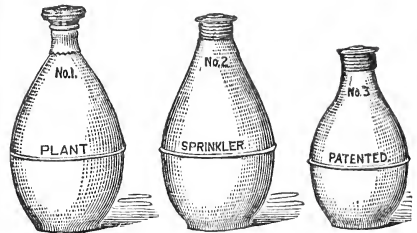

Rubber Sprinklers. Very useful for sprinkling plants, cut-flowers, seedlings, clothes, etc., and for other purposes where fine spray is required.

Sieves. Iron and brass wire.

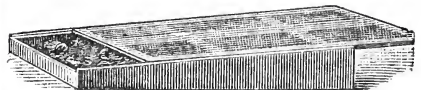

Sashes for Hotbeds. Glazed, 3x6 ft.

Straw Mats. For hotbed. Made by hand from fresh rye straw; thick, and well put together.

Burlap Mats. For protecting cold-frames and hotbeds. These are 6x6 ft. square, made of strong burlap bagging, warmly lined with waste wool and cotton, which is quilted in to hold position.

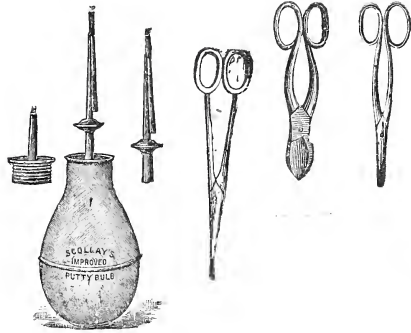

Scolly's Putty Bulb.
Scissors, Grape Thinning.
Flower and Bow-pruning Scissors.
Shears, Hand-pruning.
Thermometers. Wilder's Extra, in japanned case.
Thermometers, Self-registering.
Thermometers. Tin japanned.
Thermometers. For hotbeds.
Tinfoil. For bouquets and designs.
Trowbridge's Grafting Wax.

The Van Reyper Glaziers' Points. Made of steel wire and galvanized. No rights and lefts.

Dibbers. Used for transplanting.

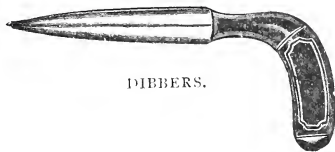

DIBBERS.

Toothpicks. Twine. All Sizes. Soft. Green. Tarred Yarn. Tarred Marline.

Waterproof Flower-pot Saucers, Fibrotta. Made of fibre; no moisture passes through.

Asparagus Knives. For cutting the stalk under the soil.

Forks, Digging or Spading.

Forks, Manure. Forks, Hay.

Rustic House, Lawn and Veranda Furniture in Artistic Designs. Made to order.

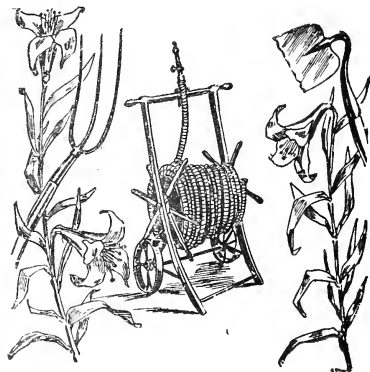

HOSE REEL.

Garden Hose. Usually furnished in 25 and 50-ft. lengths. The above-named brands, together with many other standard grades, always in stock.

The Electric Garden Hose. The most durable in the market; it lasts longer and costs less.



GARDEN HOSE COUPLING.

Garden Hose Couplings. Common, Climax couplings.

Garden Hose Menders. Cooper Hose Mender. Garden Hose Straps. Garden Hose Reel. Garden Trowels. Grafting Chisel. Garden Lines. Gardener's Gloves. Made of sheepskin.

WE OMITTED PRICES BECAUSE WE SELL AT COMPETITION PRICES.

Grass or Sheep Shears.
 Grass Shears, Long-handled Saynor.
 Grass Hooks. Various sizes.
 Grass Edging Knives. Hand Forks.
 Hedge Shears, Notched.
 Hoes, Draw, Dutch. Scuffle or Push.
 Lopping Shears, Saynor. 3 sizes.
 Waters' Improved Tree Pruner.

LABELS FOR PLANTS AND TREES.
 Pot Labels, from 4 to 8 in.
 Garden Labels, from 6 to 12 in.
 Tree Labels, 3 1-2 ins.
 Tree Labels, 3 1-2 ins. Iron wired.
 Tree Labels, 3 1-2 ins. Copper-wired.
 Zinc Labels. Indelible Ink.
 Plant Stakes. Green painted.
 Heavy, or Dahlia Stakes. 4 to 6 feet.
 Cane Stakes for Plants. 10 to 12 feet.
 Pea Brush, for Sweet Peas.
 Poles for Beans, Hops, etc.

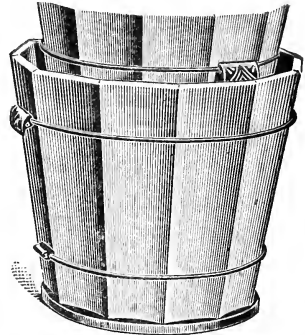
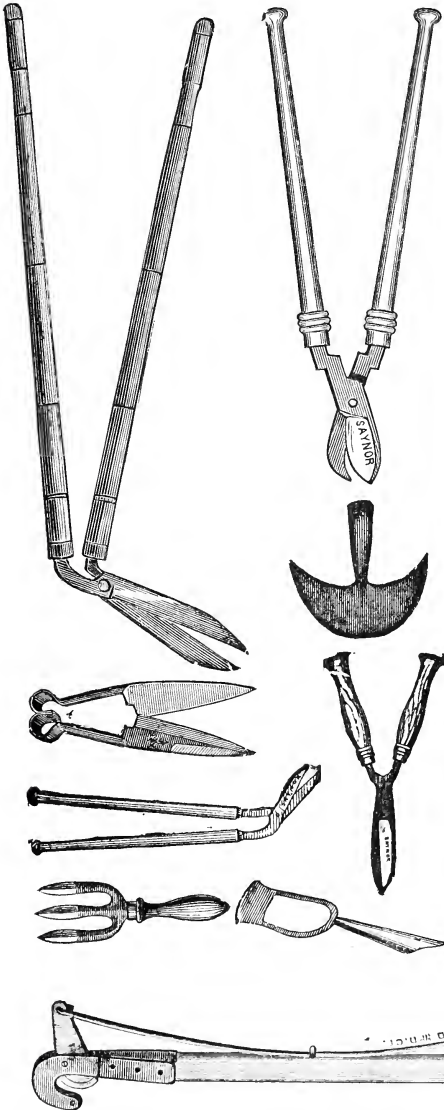

Plant Tubs. 12 ins. to 24 ins. diam.
 Rakes, Garden. Wooden.
 Rakes, Steel, Short and long, Teeth.
 Rakes, Hay. Wooden; close teeth.
 Rakes, Lawn. Weaver's, close teeth, iron claw where the handle goes into the rake, adding much to its strength.
 The Finley Lawn Rake. This machine does nice work, raking up all leaves, paper, stones, etc. It can be regulated to suit lawn and work you want done.
 Rakes, Steel Wire. For lawns, etc.
 Rakes, English Daisy. Very useful.
 Scythes. All sizes and styles.
 Scythe Snathes. Different sizes.
 Scythe Stones. Genuine Welsh.
 Scythe Rifles. Triple-coated.

WATERS'
 IMPROVED TREE
 PRUNER.

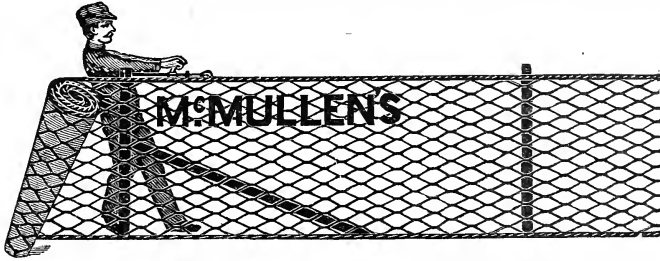

McMULLEN'S WIRE FENCE NETTING.

Randall's Garden Trellis. For peas, sweet peas, tomatoes, and all climbing plants.

Wire Netting. Wire (galvanized).
Wire Guards for borders.
Tree Scrapers. Weeders, Hazeltine.
Weeder, Lang's. Weeder, Excelsior.
Weeder, Noyes'. Weed Puller.
Ricketson Weeding Tong.



VERANDA.

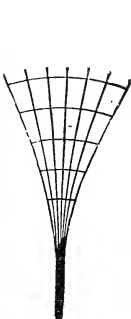

FAN.



BOW.



O 1-2.

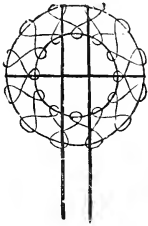

IVY.

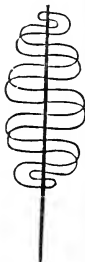

O WIDE.

Plant Trellises.

Spades, Steel. Sod Lifter.
Shovels, Steel, Square.
Shovels, Steel, Round Point.
Shovels, Snow.
Cleveland Lawn Weeder.
Saws, Pruning. Saws, Pole Pruning.



Watering Pots, Wetherspoon. From 6 to 16 qts. **Galvanized.** From 4 to 20 qts. **Green XX.** From 1 to 20 qts.

Lawn Settees and Rustic Furniture.

Rustic House, Lawn and Veranda Furniture in Artistic Designs made to order.

The Imperial Lawn Settee.

Folding Lawn Settee. Durable.



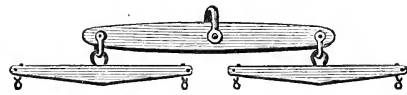
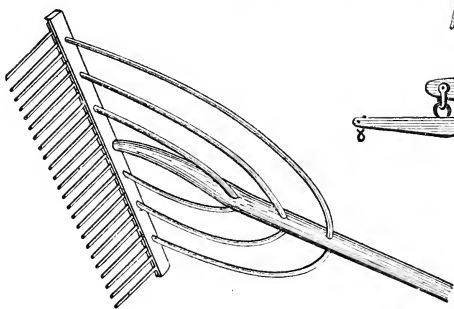
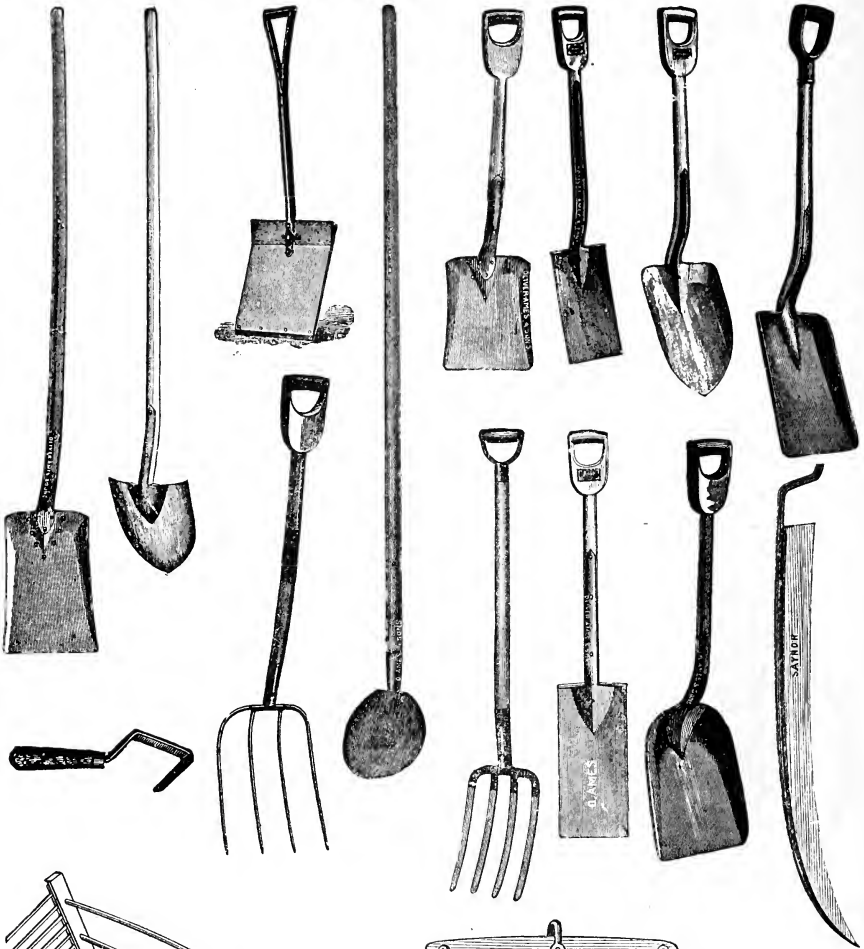

WHIFFLETREES.



SCYTHES.



LIGHTNING HAY AND DITCHING KNIVES.

WE OMITTED PRICES BECAUSE WE SELL AT COMPETITION PRICES.

WEAVER'S GARDEN WHEELBARROWS.

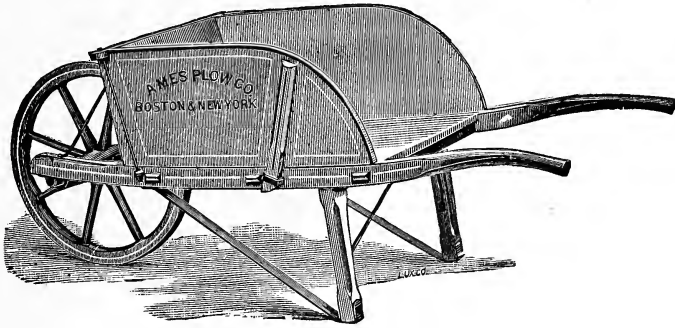

FULL SIZE EIGHT-SPOKE BARROW.

Full-size, Eight-spoke Barrows. No. 4, medium; No. 5, medium; No. 6, large.

Boys' Barrows. No. 1, small; No. 2, medium; No. 3, large.

Gardn Barrows. Furnished with wood hubs, but can be furnished with well-made six-spoke iron hubs, when so ordered.

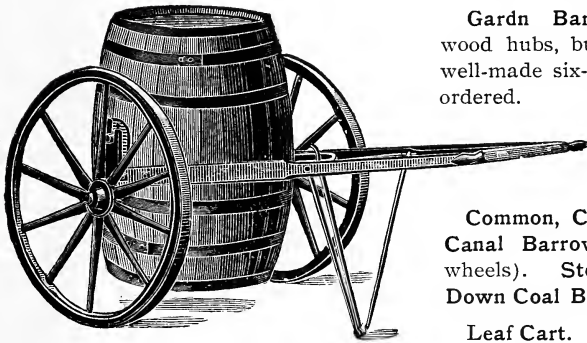

WATER BARREL TRUCK.

Common, Climax, Lansing, Capitol, Canal Barrow (both wood and steel wheels). Steel Coal Barrows, Low-Down Coal Barrows.

Leaf Cart. Lawn Hand-Carts.

Sprinkling Cart.

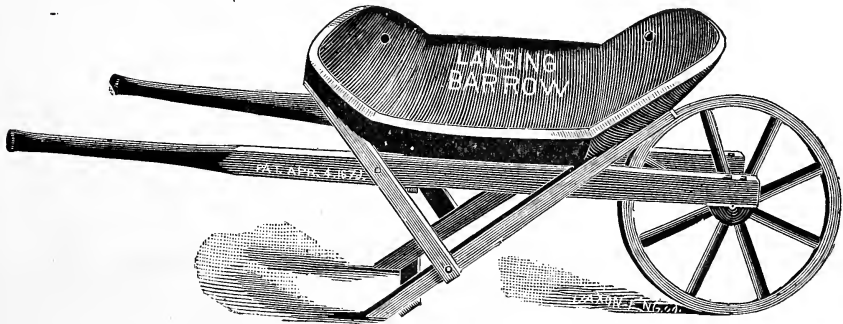

LANSING BARROW.

WE OMITTED PRICES BECAUSE WE SELL AT COMPETITION PRICES.

LAWN MOWERS.

The Cadet. The finest low grade mower in the world, manufactured by the Caldwell Lawn Mower Co. that use nothing but first class material and warrant their products.

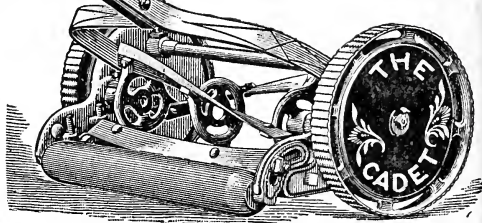

The Imperial Lawn Mower.

Imperial High Wheel. Wheel 10 1-4 in. diam., 14, 16, 18 and 20-in. cut.

Imperial Low Wheel. Wheel 8 1-4 in. diam., 12, 14, 16, 18 and 20-in. cut.

We guarantee the Imperial to be the best lawn mower made for easy running, durability and efficiency.

The Weaver Lawn Mower.

The Stearns Ball-Bearing Lawn Mower.

The Townsend Victory Ball-Bearing Lawn Mower.

Spring Pawl Philadelphia Lawn Mowers.

Other makes of Lawn Mowers furnished at manufacturers' prices.

Philadelphia Horse Mower. Competing prices.

Coldwell's Improved Horse Lawn Mower.

Townsend's Horse Lawn Mower.

Philadelphia Lawn Sweepers.

Grass Catchers for all kinds of Mowers, low wheel.

The Chain-Gear Mower.

Motor Lawn Mower and Roller.

Lawn Mower Repairing.

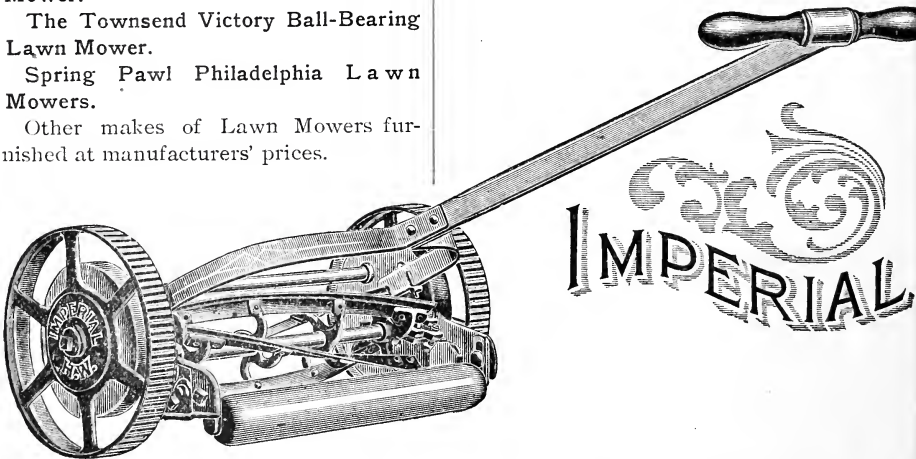

WE OMITTED PRICES BECAUSE WE SELL AT COMPETITION PRICES.

DAIRY SUPPLIES.

Aspinwall, Stoddard and Blanchard
Improved Cylinder Churns.

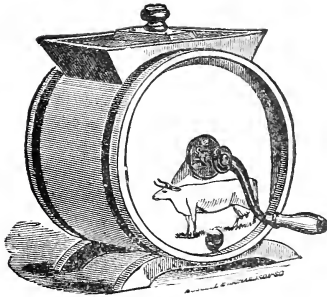

- Philadelphia Butter Worker.
- Milk Pails.
- Combination Butter Prints.
- Milk Pans.
- Floating Dairy Thermometer.
- Butter Molds.
- Hand Butter Stamps.

THE SHARPLES CREAM SEPARATORS.

WE CLAIM

- 1st. That they produce a cream unequalled in quality.
- 2nd That they will get more butter out of the milk than can otherwise be obtained
- 3rd. That in durability and light cost of repairs they have no close competitors.
- 4th. That in ease of management and reliability they excel.
- 5th. That they have greater actual capacity in proportion to first cost than any other.
- 6th. That their record in actual use has proven them the safest of all separators.

We recommend the Sharples Cream Separator to you for the reason that

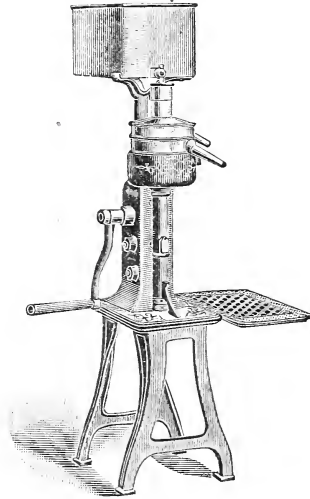

SHARPLES CREAM SEPARATORS.

thousands of people who are using them say they are making money with them—more money than they could possibly make without them. If you have five or more cows, the additional profit by the use of the Separator will be so great as to surprise you. We know this and so we are willing to loan you a Separator free of cost and free of obligation to buy, so that you may try it for yourself. Our Factory Size Separators are sold to all Creamery owners on the absolute guarantee that they will enable greater profits from the same milk than can be had by the use of any other make of cream separator.

If any dairyman who reads this is delivering his milk to a creamery in which any other Separator than the Sharples is in use, he is not getting as much money for his milk as he should get; and the best thing he can do is to quit the creamery using such inferior Separator and manufacture his own butter, for in that way he will secure greater returns from the milk which his cows produce.

P. M. SHARPLES, West Chester, Pa.

Reid's Improved Butter Shipping Boxes.

Reid's Peerless Creamery.

Butter Spats.

Milk Bottles with Clamp Cover.

Commonsense Milk Bottles with Paper Tops.

WE OMITTED PRICES BECAUSE WE SELL AT COMPETITION PRICES.

Butter Moulds, Milk Strainers,
 Butter Pats, Milk Coolers,
 Butter Color, Milk Scales,
 Butter Paper, Milk Tubes,
 Milk Testers.
 Milk Bottle Carriers, Small's Calf
 Weaners.
 Milk Bottle Brushes, Comfort Cattle
 Stanchions.



Tough on Flies. This liquid applied with a brush will protect stock from flies. It will save the stock and increase the milk of cows.

Hammond's Cattle Comfort works with results equal to those of "Tough on Flies," to be mixed in equal parts with kerosene oil.

POULTRY FOOD AND SUPPLIES.

Choice Ground Bone.
 Choice Ground Beef Scrap.
 Bowker Animal Meal.
 Oyster Shells.
 Egg Lime Grit.
 Chicken Founts.



Rust's Haven's Climax Condition Powder.

Rust's Haven's Roup Pills.

Lee's Lice Killer. Sure death to all vermin on Poultry, Hogs and all Domestic Animals.

Death to Lice. Powder, sure death to all insects on Poultry.

Iceline. Keeps Milk without the use of ice for 48 hours in sweet condition.

Cream Albumen. Gives cream a rich smooth body, restores viscosity and makes rich heavy cream from thin cream.

Rust's Egg Producer.
 Imperial Egg Food.
 Sheridan Condition Powders.
 Pigeon Food. Popcorn. Wheat.
 Canada Field Peas. Kaffir Corn. Rye.
 Hemp and Vetches. Barley.
 Sunflower Seed. Unhulled Rice.
 Millet Seed.
 Webster's Clover Cutter.
 Thompson's Root Cutter.
 Mann's Green Bone Mill.

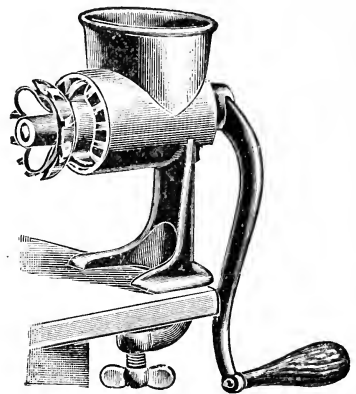

Medicines, Liniment and Foods for Horses Cattie, Poultry and Dogs.

Baum's Horse and Stock Food.
 Cow Cure.
 Daniel's Muscle Oil.
 " Colic Cure.
 " Ointment.
 Sloan's Liniment.
 " Ointment.
 " Chills and Fever Remedy.
 " Condition Powder.
 Tuttle's Elixer.
 Tobias' Liniment.
 Horseman's Embrocation.
 Vitiae Lotion.
 Hopkin's Powder.
 Furbush's Worm Powder.
 Somerville's Anti-pain Cure.
 " Anti-fever Cure.
 Johnson's Anodyne Liniment.
 Spratt's Dog and Puppy Cake.

- Veterinary Vaseline.
- International Poultry Food.
- “ Stock Food.
- “ Colic Cure.
- “ Worm Powder.
- “ Pheno Chloro.
- “ Honey Tar Foot Remedy.
- “ Silver Pine Healing Oil.

- Rust's Healing Powder.
- Virequine Ointment.
- Bickmore's Gall Cure.
- Kendall's Spavin Cure.
- Gray Mineral Ash Insecticide.
- Clover's Mange Cure.
- Shedd's Worm Powder.

A Full line of Spratts and Dent's medicine for Dogs.

PEAT, MOSS, POTTING SOILS, ETC.

- Silver Sand. Rotted Fibrous Peat
- Orchid Peat. Sphagnum Moss.

FOR HOUSE PLANTS.

- Bowker's Plant Food. Plantene.
- Walker's Concentrated Fertilizer.
- Ferteline, a liquid preparation.
- Essex Plant Food.
- XI. All Vaporising Compound.
- XI. All Liquid Insecticide.
- The G. A. W. Co.'s High Grade Fertilizer for all Crops.
- Swift Sure Fertilizer. Sheep Manure.
- Swift Sure Super-Phosphate for Potatoes.



JADOO FIBRE and LIQUID
 Both Meat and Drink to.. Plants.



PAINTS AND OIL DEPT.

Derby Ready Mixed Paints are the highest grade pure linseed oil ready-mixed paints that can be made, and as house paints cannot be excelled.

White Lead. Jewette, Atlantic, Crown German and Eagle.

DeVoe's Colors in Oil and Japan.

Varnishes. Carriage, Crockett's Spar, Furniture, Rubbing, Asphaltum.

Crocketts & Reynolds' Interior and Exterior Finish.

Stains. C. T. Reynolds, Billings and King, Campbell & Rice.

Top Dressings. White and Orange Shellac Roof Paint.

Dry Colors. Butchers and Boston Globe Floor Polish, Furniture Polish, Enamel Paints; Aluminum, Gold and Silver Bronze Powder, Bronzing Liquid, Gold and Aluminum Leaf, Elastic Cement for Roofs, Stove Lining Cement.

Prince's Metallic Paint.

Prince's Liquid Filler.

Prince's Wagon, Buggy and Sleigh Paints will make them look like new.

Our makes of **Roof and Floor Paints** cannot be excelled.

Oils. Castor, Colzia, Cylinder, Crude, Engine, Linseed (Raw and Boiled), Lard, Machine, Neat's Foot, Sperm, Kerosene, Naptha, Turpentine and Liquid Dryer.

Window Glass. Single and Double Thick, all sizes, Single Lights or by box.

Axle Greases. Snowflake, Frazier's Perfection, Union and Albany Grease.

Cold Water Plastico, Muresco and Cal-somine of all shades. Whiting, Plaster Paris, Paris white, can and lump lime.

FARM REQUISITES.

Rich's Patent Improved Lever-Feed Cutters.

Ames' Vegetable Cutter.

Hide Roller Hay Cutters.

Oak Well Buckets.

Gravel and Sand Screens, Ash Sifters, Wire Screens, etc.

Corn Shellers.

Ideal Steel Track Hay Carrier.

Hawkeye Grub and Stump Machine.

Sturtevant's Improved Portable Forges

Roche's Double Wheel Automatic Feeding Machines.

Patent Automatic Lock. Table Blocks

Farm Carts. Road Scrapers.

Farmers' Anvil and Vise Combined.

Steel Road Scraper. Farmers' Vises.

Drag or Stone Boat.

Mal. D Handle Spading Fork, 4-Tine

Wood D Handle Manure Fork, Subsoil

Spades, Drain Spades, R. R. Tamping

Shovels, Nursery Spades, 2 and 3-Bowed

Hay Rakes, Wood Saws, Snathes, Corn

Knife, Self-wetting Stones, Family

Grind Stones.

Ox Bows. Bow Pins. Ox Muzzles.



Brass Ox Balls.

Cow Bells.

Sheep Bells, with straps.



Bull Rings.



Calf Weaners and Sucking Cow Muzzles.

Lane's Steel Carriage Jack, and Special Attachment.

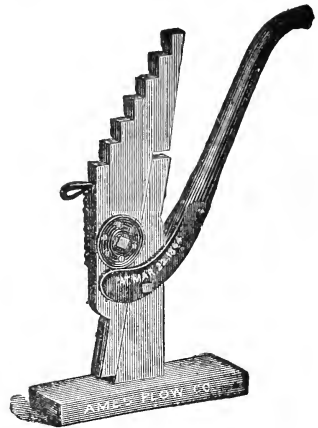

Little Giant Wheel Jack.

Small's Patent Feeders.

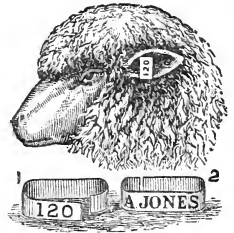

Cattle and Sheep Labels.

Ohio Grindstones.

Nova Scotia Grindstones.

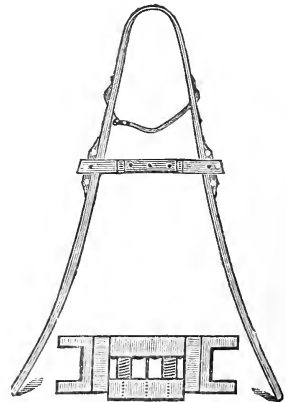

Poke Head.

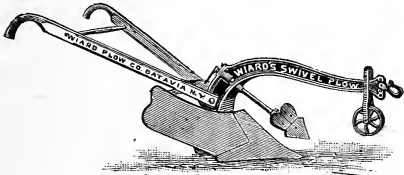

The Wizard Side-Hill Plow.

Oliver Plow, with Wheel and Jointer.
The Oliver Side-Hill Plow.
Conical Plows. Wright's Plows.

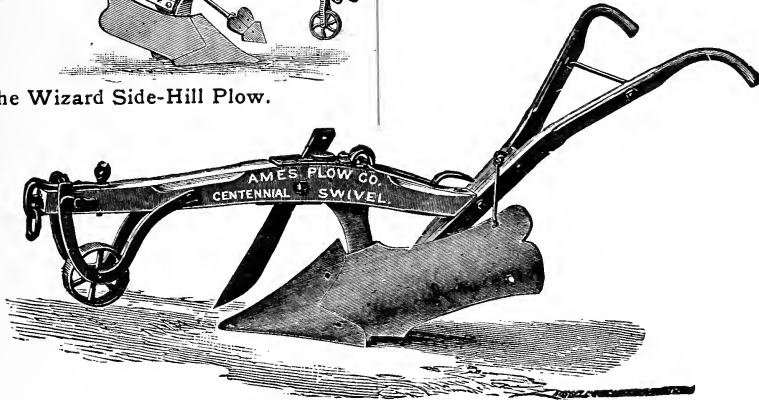

CENTENNIAL SWIVEL PLOW.

Chilled Centennial Swivel Plow.

Imperial Chilled Plow Wood Beam.

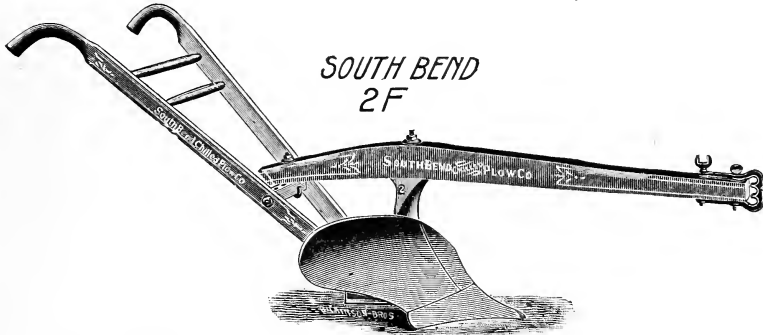

SOUTH BEND PLOW.

Syracuse Plows, with
Steel Beams, Land-
slides and Mould
Boards.

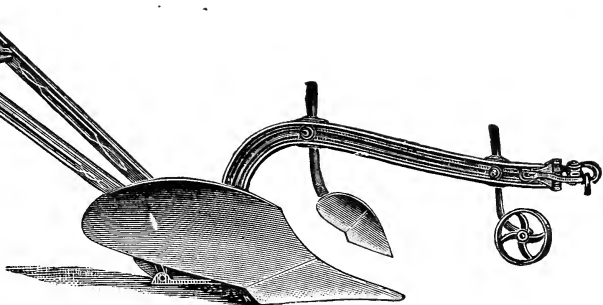

SYRACUSE PLOW.

WE OMITTED PRICES BECAUSE WE SELL AT COMPETITION PRICES.

PRICE LIST.

		Packed Weight.	Price.
"Planet Jr."	No. 5 Hill and Drill Seeder.....	54 lbs.	\$13.00
"	No. 3 " " " "	50 "	10.00
"	No. 4 " " " " & Sing. Wheel Hoe....	54 "	11.00
"	No. 4 " " " " plain (as a drill only)...	42 "	8.00
"	No. 25 " " " "	63 "	13.00
"	No. 20 Fertilizer, Pea and Bean Drill.....	58 "	16.00
"	No. 21 Hill and Drill Seeder and Fertilizer Drill...	96 "	17.50
"	No. 2 Drill Seeder	38 "	7.00
"	No. 1 Combine Drill Seeder and Wheel Hoe.....	46 "	9.50
"	No. 11 Double Wheel Hoe.....	39 "	8.50
"	No. 12 " " "	31 "	6.50
"	No. 13 " " "	26 "	4.50
"	No. 15 Single Wheel Hoe	31 "	9.50
"	No. 16 " " "	26 "	5.50
"	No. 17 " " "	23 "	4.75
"	No. 18 " " "	19 "	3.25
"	No. 10 Double Wheel Hoe.....	37 "	6.50
"	No. 10 " " " plain (with hoes only)...	29 "	4.00
"	Single Wheel Hoe.....	25 "	5.00
"	" " " plain (with hoes only).....	17 "	3.00
"Fire-Fly"	Single Wheel Hoe.....	24 "	4.50
"	Plow	12 "	2.25
"Planet Jr."	Grass Edger.....	26 "	6.00
"	No. 8 Horse Hoe and Cultivator	83 "	8.00
"	No. 7 " "	78 "	7.50
"	No. 9 " " (with wheel).....	75 "	7.00
"	No. 9 " " (without wheel)...	67 "	6.25
"	No. 4 " " (with wheel).....	65 "	6.00
"	No. 4 " " (without wheel)...	56 "	5.25
"	Nine-Tooth Horse Hoe.....	131 "	14.00
"	Sweet Potato Horse Hoe.....	74 "	7.50
"	Leveler.....	102 "	12.00
"	White Potato Digger	140 "	72.50
"	Sweet " "	140 "	17.50
"	Twelve-Tooth Harrow, complete.....	75 "	8.00
"	" " " without pulveriser.....	67 "	6.50
"	" " " without pulv. or wheel....	53 "	5.50
"	No. 9 Cultivator, with wheel.....	67 "	5.75
"	No. 9 " without wheel.....	58 "	5.00
"	No. 4 " with wheel.....	58 "	4.75
"	No. 4 " without wheel.....	49 "	4.00
"	Double Celery Hiller	87 "	13.00
"	Single Celery Hiller	70 "	10.00
"	Orchard and Universal Cultivator.....	365 "	35.00
"	Spring-tooth Orchard Cultivator	355 "	31.00
"	Two Row Pivot Wheel Cultivator.....	472 "	45.00
"	Pivot Wheel Cultivator	436 "	40.00
"	No. 3 Four Row Sugar Beet Horse Hoe.....	475 "	75.00
"	No. 2 " " " " " "	400 "	50.00
"	Single " " " " " "	65 "	7.00

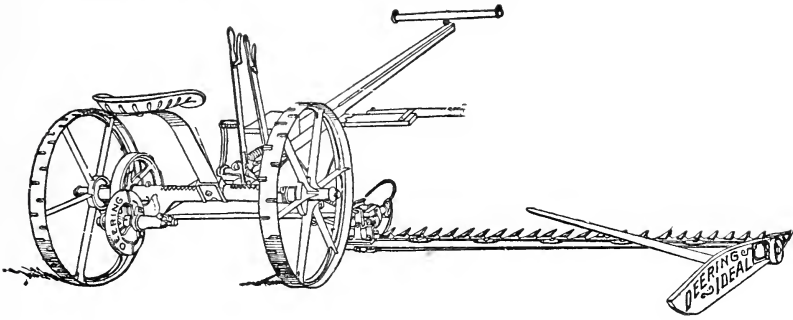

DEERING HORSE MOWER.

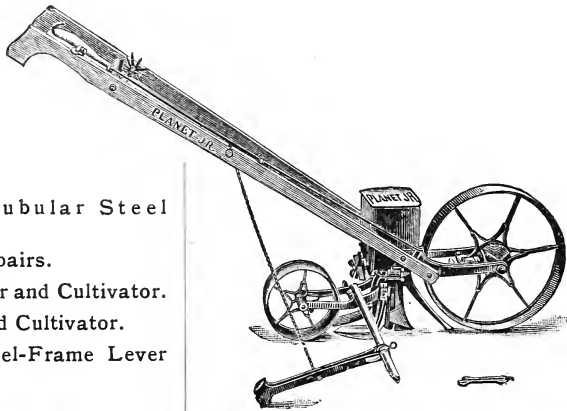

PLANET JR. SEED DRILL.

Walter A. Wood Tubular Steel Mower.
Mower Parts and Repairs.
The Universal Weeder and Cultivator.
Combined Harrow and Cultivator.
No. 38 Syracuse Steel-Frame Lever Cultivator.



THOMAS HARROW.

The Thomas Wood Frame Harrow or Pulverizer.
Morgan Spading, Tiger, and Climax Harrow.
Cut-Away Disc and Steel Lever Smoothing Harrow.
No. 76 Steel Frame Cultivator, Syracuse.
Mudgett's Folding Fork.
Keystone, Hay-Loader.

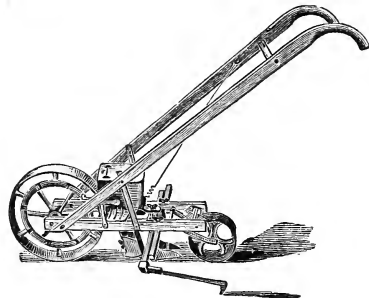

SEED DRILL.

Matthew Hill and Drill Seeder.
"Aspinwall" Corn and Bean Drill.
King of the Corn Field Corn and Seed Planter.
"Aspinwall" Potato Cutter.

WE OMITTED PRICES BECAUSE WE SELL AT COMPETITION PRICES.

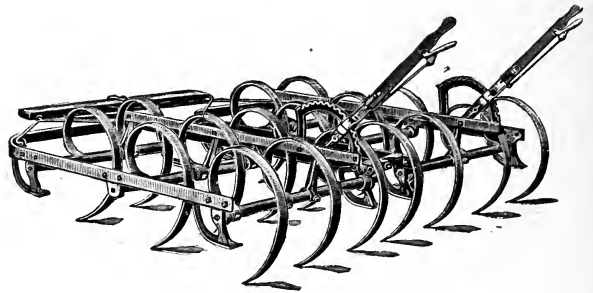

SPRING TOOTH HARROW.

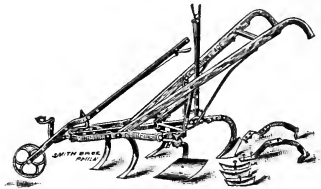

CULTIVATOR.

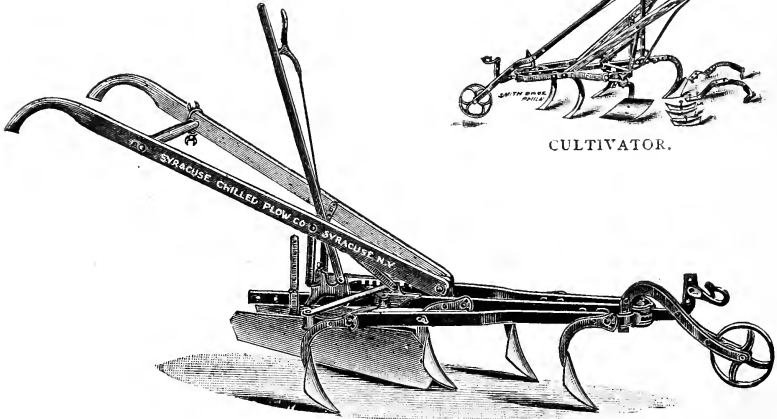

SYRACUSE CULTIVATOR.

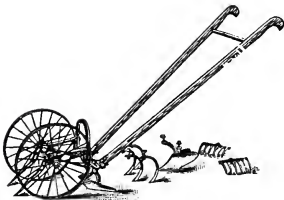

DOUBLE WHEEL HOE.

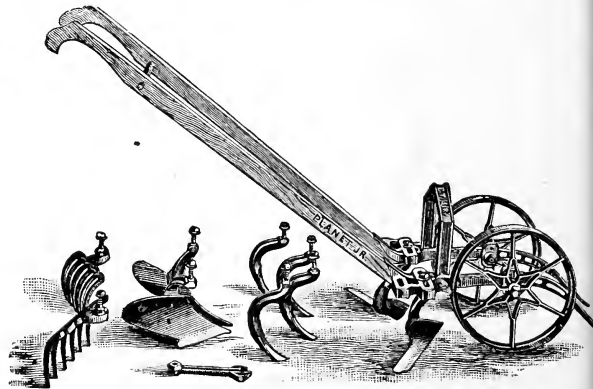

PLANET JR. HOE.

WE OMITTED PRICES BECAUSE WE SELL AT COMPETITION PRICES.

CORN PLANTER.

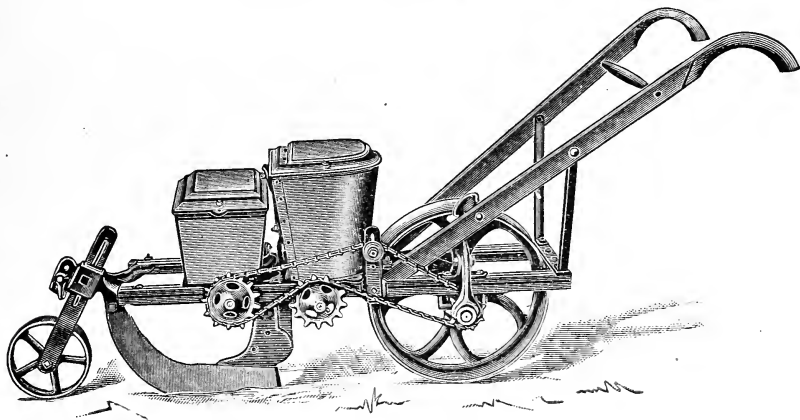

CORN PLANTER.

The Tiger Single Row Continuous Dropping Corn-planter.

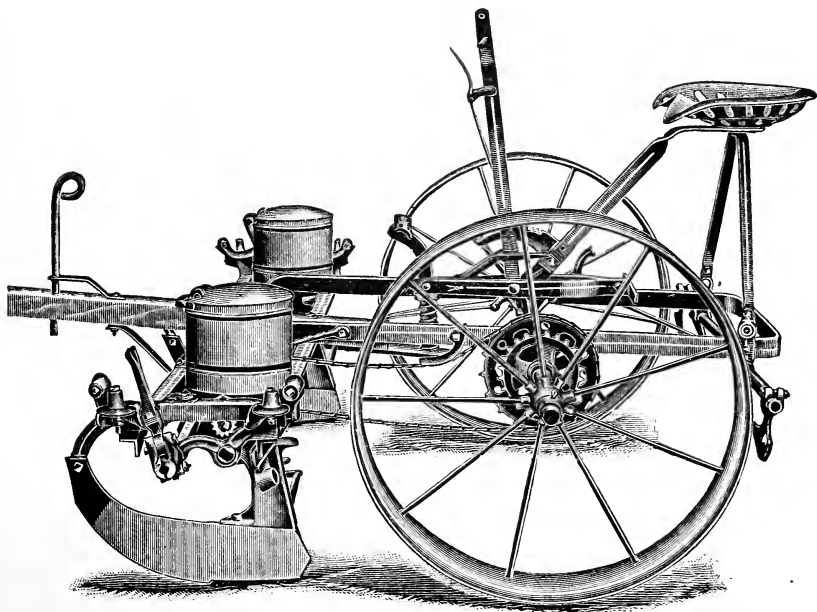

CORN PLANTER.

The Tiger Two-Rowed Hill and Drill Corn-planter, with Fertilizer Attachment.

WE OMITTED PRICES BECAUSE WE SELL AT COMPETITION PRICES.

HAY RAKE.

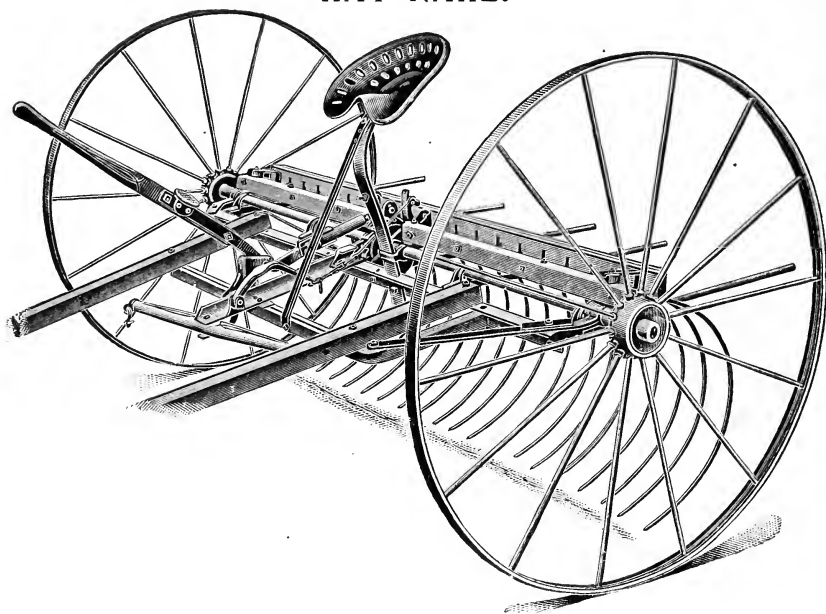

TIGER HAYRAKE.

American Revolving Tedder.
Tiger Tedder.
Tiger Rake, Self-Clamp.
Dodd's Taylor Rake.
New York Champion Rake.

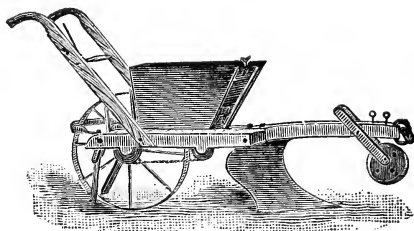

PLOW AND FERTILIZER.

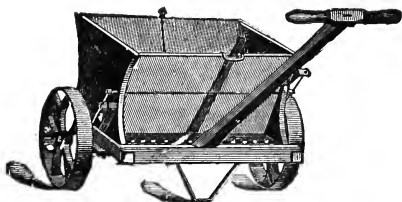
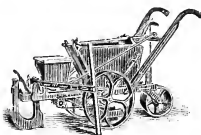

The Strawberry and Lawn Fertilizer Distributor.

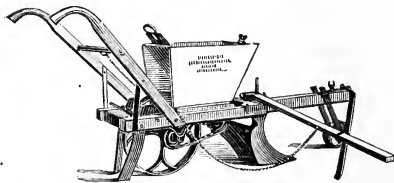

The Plow and Fertilizing Machine.

WE OMITTED PRICES BECAUSE WE SELL AT COMPETITION PRICES.

HORSE AND STABLE REQUISITES.



Harness, Harness Parts.



Blankets.
Wool and Fur
Robes. Coolers.
Nets. Summer
Sheets.
Surcingles.
Sweat Pads.
Halters.

Horse Lawn Boots.
For use upon a lawn,
to prevent horses'
hoofs injuring the sod.



Collars. Jute Halters.
Cow Straps. Humane Bit.
Bits in stock. Blacking.
Oils and Harness Dressing.
Polishers. Soaps.
Sponges for Carriages and Harness.
Stall Cleaners. Feed Mangers.
Cast Stable Gutters.

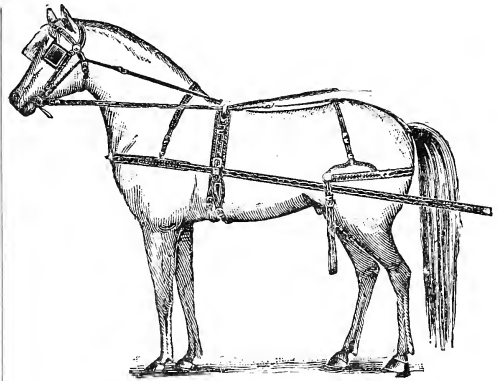

Lanterns.

Corner Hay
Racks.

Rattan Stable
Broom.

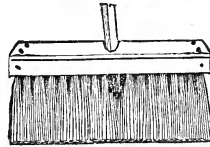

STABLE REQUISITES.

Bandages, Rubbing Cloths, Curry-
combs, Mane-Combs, Cards, Corn
Brushes, Body Brushes, Scrapers,
Washers, Whip-holders, Tail-holders,
Feed Bags, Stall Hooks, Forks, Hose,
Brooms, Iron Mangers, Racks and
Guards, Sponges, Chamois, Lanterns,
Feather Dusters.

WEATHER VANES.

Egyptian Bannerett, Roosters, Dogs,
Deers, Foxes, Eagles, etc., Horses,
Bannerets, Scrolls and Church Vanes in
large variety

LUBRICATORS.

Snowflake, Empire, Union, Zero, Fra-
zier's, Belknap's, Castrolum.

OILS.

Sperm and Lard, Castor, Neats-foot,
Kerosene, Machine, Crude Petroleum,
Cylinder, Lindseed.

Flax Seed, Flax Seed Meal, Excel-
sior Hoof Packing, Oil Meal, Jamieson
Composition, Pearce's Composition.

WE OMITTED PRICES BECAUSE WE SELL AT COMPETITION PRICES.

HARDWARE DEPARTMENT.

Complete Stock of Shelf and Builders' Hardware.

Axes. Ash cans.
 Burning Brands. Bits.
 Butcher Tools Saws, Knives, Steels,
 Scales, Meat Hooks, etc.
 Chisels and Gauges.
 Steel Crow-Bars. Drills and Braces.
 Electrical Supplies. Bells, Batteries,
 Wires, Push-buttons, Floor-buttons, Tape,
 Cords, Gas Lighters.

HAMMERS.

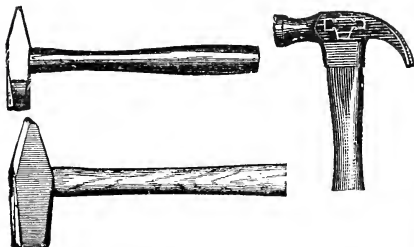

Brick Hammers.
 Blacksmith Hand Hammers.
 Masons, or Cutting-out. Riveting.
 Drilling or Striking. Hand Drilling.
 Macadamizing. Paving.
 Spalling or Stone. Iron Trench.

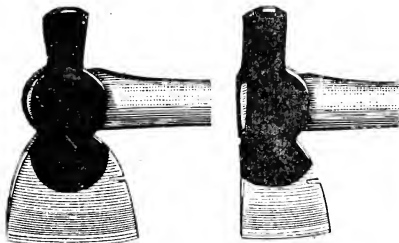

Hatchets, Haines', Plums', Williams'.
 Handles, Axe, Fork.
 Hammer Handles, Walnut.
 Hatchet Handles. Hoe and Rake
 Handles. Ice-Hook Handles.
 Pick and Mattock Handles. Manure
 and Spading, Shovel, Spade and Scoop
 Handles. Sledge Handles, Walnut.
 Oilers. Hods. Levels. Wood Maul.
 R. R. Spike Maul.



Ames Mattocks.

TO BE LET FOR SEWER-
 AGE WORK.

Acme Diaphragm Sewer Pump.

TROWELS.

Pointing Trowels.
 Brick Trowel, Double Ferruled.

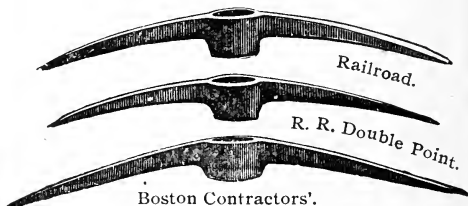

Boston Contractors'.

Contractors' and Railroad Picks.



One-man Cross-cut Saws.
 Cross-cut Saws. Hand and Rip-Saws.

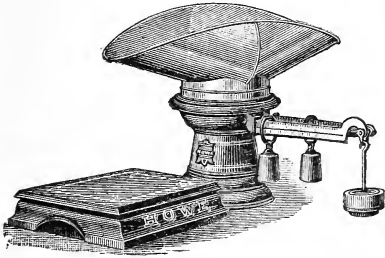

Scales. Planes.



Screw Wrenches. 5, 8, 10, 12, 15-in.
Half-Round Store Truck.
Platform Truck.

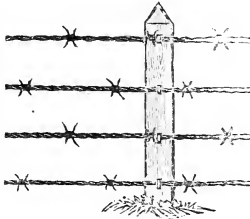

WIRE FENCING and NETTING.

Four-point Barb, about 15-ft. to lb.



Plain Twisted, about 17-ft. to lb.



Twisted Ribbon, about 14-ft. to lb.

Poultry, Chicken and Cellar Window
Netting. Wire Cloth for Doors and
Windows. Staples.

ICE TOOLS.

Boston Tongs.
Chicago Ice-Axe. Chain Tongs.
Ironclad Ice Scales. Vises.
Separating Chisels. Fork Bar.
Ice Hook. Ice Shaver.
Philadelphia Tongs.



No. 1 Hand Saw. 30-inch blade, wood
handle.

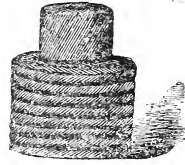

SHIP CHANDLERY AND CORDAGE.

Manilla Rope. Manilla Twine.



Star Pulley Blocks.
Ash, Spruce and Spoon Oars.
Oar Locks. Cleats. Swivels.
Turn Buckles. Galvanized Blocks.
Ship Lanterns. Deck Blocks.
Cheek Blocks. Thimbles. Grapples.
Folding Anchor.

FISHING TACKLE AND SPORTING GOODS.

Rods. Fish Hooks. Reels. Floats.
Rod Cases. Sinkers. Swivels.
The "Harrimac Steel Net Ring and
Staff."

Minnow Dip Nets and Landing Nets.
Lines. Braided, Grass, Silk, Cable-
laid, Cotton and Mackerel.

Cartridges. Club and Climax Shells.
Caps. Primers. Wads.

SHOT GUNS.

Remington, Parker, Belgium, Loomis
and Richard's.

Blanks. Smokeless Cartridges.

RIFLES.

Winchester, Remington, Davenport,
Martin, Pieper's and Flobert's, Steven's
Favorite.

Ramrods and Loading Tools.
Revolvers. Gun Cases.
Hunting Suits Complete.
Game Bags. Tennis Outfits.
Croquet Sets. Base-ball Goods.
Foot Balls. Bicycle Supplies.
Dog Collars.

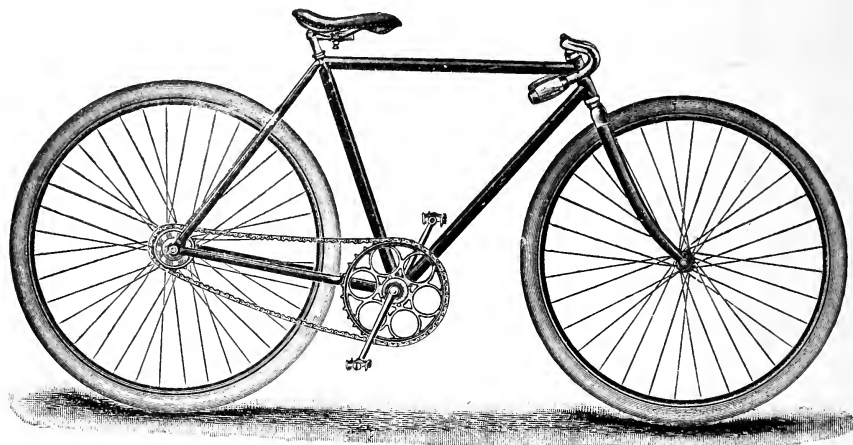

FEATHERSTONE.

↻ BICYCLES. ↻

Complete Assortment of Best Makes in this Country.

— THE —

Featherstone Bicycle

IS OUR BEST SELLER.

Made by the Featherstone Bicycle Mfg. Co., of Chicago, Ill., One of the Largest Bicycle Manufacturers in the World.

The Featherstone Bicycle is Perfect in Mechanical Construction, Material and Finish.

WE CARRY A FULL SUPPLY OF ALL THE LEADING BICYCLE SUNDRIES.

Bells, Brushes, Cement, Chain Lubricant, Child's Seat, Clips, Cyclometers, Enamel, Guard Laces, Handle Bars, Lamps, Lubricants, Oilers, Padlocks, Pumps, Repair Kits, Saddles, Stands, Tire-Tape, Three in One Trouser Guards, Wood Rim Cement, Watch Holder, Wrenches.

REPAIR DEPARTMENT.

We have a fully equipped repair shop on our third floor, with power and machinery that enables us to do most any kind of repairing in mechanical line. Our specialty is sharpening and repairing Lawn Mowers. All machines entrusted to our care we guarantee to work as good as new. We ask all our patrons to give us their machines early, to avoid the rush in early spring.

WE OMITTED PRICES BECAUSE WE SELL AT COMPETITION PRICES.

Stevens' Fine Mechanical Tools

ARE MATEMATICALLY PERFECT IN CONSTRUCTION.

THEY ARE "ALL STEEL."

WOODEN WARE.



STEP LADDER.

Knife Boards, Knife Tray, Ohio Ice Cream Freezer, Fiber Pails, Measures, Tubs, Spittoons, Butter Boxes, Canna Pails, Cedar and Pine Tubs, Moulding Barrels, Chopping Trays, Bosom, Lap, or Cutting Boards, Spice Cabinets, Hat and Coat Racks, Clothes Wringers, Step Ladders, Ironing Boards, Udell's Towel Arm, Clothes Hampers and Pins, Towel Roller, Extension Ladders, Udell's Globe Bar, Library Steps, Udell's Reversible Bar, Wooden

Measures, Medicine Closets, Easels, Cabinets, Ladies' Desks, Folding Card Tables, Blacking Cases, Carpet Sweepers.

BASKETS.

Bushel, Peck, Grocers', Candy, Clothes, Fruit, Lunch, Music, Work, Sewing, and Market Baskets.

BRUSHES.

Paint, Varnish, Sash, Artist, Floor, Whitewash Roofing, Paper-hangers', Counter, Dog, Dust, Dandy, Horse, Hearth, Stove, Silver, Shoe, and Scrub.

DUSTERS.

Carriage, Parlor, Picture, Ostrich, Turkey, Wool, Parlor, House, Kitchen, Stable, Street, Wire, Rattan, and Whisk.

Children's Wagon Carts.

GOAT WAGONS.

Buck-Boards, Sulkyies, Tricycles
and Sleds.

Advance Clothes Dryers.

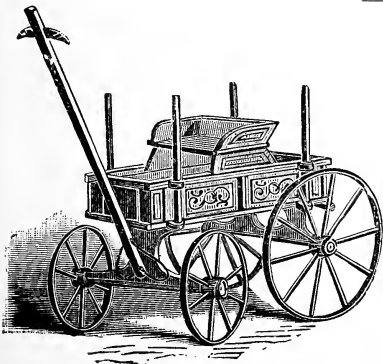

WE OMITTED PRICES BECAUSE WE SELL AT COMPETITION PRICES.

CROCKERY and CHINA.

Haviland, Austrian, Delft, Copenhagen, Dresden and Wedgewood China.
Haviland White China, for Decorating.

We carry a full assortment of

PORCELAIN, C. C., and STONWARE.

TOILET SETS.

From the common White Ware to the Finest Decorated.

Dinner, Tea, and Ice Cream Sets.

GLASSWARE and LAMPS.

CORDIAL, CHAMPAGNE, CLARET, SHERRY and WINE GLASSES,
GOBLETs and TUMBLERS, both Plain and Engraved, LEMONADE SETS,
WATER BOTTLES, PUNCH BOWLS and GLASS TABLE WARE in
GREAT VARIETY.....

OUR LEADERS FOR LAMPS

ARE THE MILLER'S, ROCHESTER, and H. & B.

HALL, TABLE, BRACKET and HAND.

CHIMNEYS, BURNERS and WICKS of Every Style.

LAMPS, GAS GLOBES and DOMES, for Table and Hanging Lamps, both
Plain and Decorated.

PATENT GRANITE IRONWARE.

"St. Louis" Covered Sauce Pan, Improved Lipped Coffee Pot, Pit Bottom Tea
Kettle, "Berlin" Covered Sauce Pan, Dipper, Water Pitcher, Handled Straight
Pot, Pie Plate, Lipped Preserving Kettle, Covered Stove Pot, Soup Ladle, Bast-
ing Spoon, Deep Pudding Pan, Pail, Bed Pan, Deep Dish Pan, "Berlin" Covered
Kettle, "Royal" Covered Sauce Pan.

VENETIAN ENAMELED STEEL WARE

Is the most beautiful and ornamental ware ever offered. It has three coats of hard
enamel and is absolutely pure. The inside is finished in a rich pure white enamel
and the outside in either Venetian Blue or Venetian green, with the wavy effect.

WE OMITTED PRICES BECAUSE WE SELL AT COMPETITION PRICES.

500

EASTER LILIES

IN BLOOM FOR

Easter Sunday

At our Store, from 50 cts. up.

Also large assortment of House Plants, Ferns, Palms and Bedding Plants.



EASTER LILY.

Easter Lily BULBS ready Sept. 1.

FLOWERING BULBS

FOR FALL PLANTING.

We are large Importers of all kinds of Bulbs, such as Dutch Hyacinths, Tulips, Crocus, Narcissus, Jonquils, Roman Hyacinths, Lily of the Valley, Freesia, Bermuda, Japan and China Lilies.

OUR BULB CATALOGUE WILL BE OUT SEPTEMBER FIRST.

OUR PRICES ARE LOW FOR THE GOOD QUALITY OF BULBS WE CARRY.



ROMAN HYACINTH.



HYACINTH
IN GLASS CULTURE.

WE OMITTED PRICES BECAUSE WE SELL AT COMPETITION PRICES.

BREEDERS' MEMORANDUM,

With date on which Cow is due to give birth.

JANUARY	1	Oct. 8	FEBRUARY	1	Nov. 8	MARCH	1	Dec. 7	APRIL	1	Jan. 7
	2	9		2	9		2	8		2	8
	3	10		3	10		3	9		3	9
	4	11		4	11		4	10		4	10
	5	12		5	12		5	11		5	11
	6	13		6	13		6	12		6	12
	7	14		7	14		7	13		7	13
	8	15		8	15		8	14		8	14
	9	16		9	16		9	15		9	15
	10	17		10	17		10	16		10	16
	11	18		11	18		11	17		11	17
	12	19		12	19		12	18		12	18
	13	20		13	20		13	19		13	19
	14	21		14	21		14	20		14	20
	15	22		15	22		15	21		15	21
	16	23		16	23		16	22		16	22
	17	24		17	24		17	23		17	23
	18	25		18	25		18	24		18	24
	19	26		19	26		19	25		19	25
	20	27		20	27		20	26		20	26
	21	28		21	28		21	27		21	27
	22	29		22	29		22	28		22	28
	23	30		23	30		23	29		23	29
	24	31		24	Dec. 1		24	30		24	30
	25	Nov. 1		25	2		25	31		25	31
	26	2		26	3		26	Jan. 1		26	Feb. 1
	27	3		27	4		27	2		27	2
	28	4		28	5		28	3		28	3
	29	5					29	4		29	4
	30	6					30	5		30	5
	31	7					31	6			

DIRECTIONS.

TO USE THE TABLES.—Find the date of service in the first column; then, on the same horizontal line of the next column, write the name and number of the Cow. The date next to this entry is the date of the expected birth.

Cattle Bells. Cast bell metal with clear ring. Weight 9 ozs. Opening $2\frac{1}{2} \times \frac{3}{4}$ ins.

Sheep Bells. Weight 6 ozs. Opening measures $1\frac{1}{2} \times 2$ ins. Furnished with a neck strap. **Copper Bull Rings.** **Bull Nose Punch.** **Sheep, Hog and Cattle Labels.**

Milking Tubes. For sore and obstructed Teats and Hard-Milking Cows.

Great Variety of Medicine for All Kind of Animals.

INDEX.

PAGE.	PAGE
Artichoke, Asparagus, Brussels Sprouts.....	1
Beans, Beets, Broccoli, Cabbage.....	2, 3
Carrots, Cauliflowers, Celery, Chicory.....	4
Chives, Corn, Cress, Cucumbers, Chervil.....	5
Dandelion, Egg-Plant, Endive, Kale.....	6
Kohlrabi, Leeks, Lettuce.....	6
Melons, Mushrooms, Mustard.....	7
Martinia, Okra, Onions, Onion sets.....	8
Parsley, Parsnip, Peas.....	8
Potatoes, Peppers, Pumpkin.....	9-10
Radishes, Rhubarb, Salsify.....	10
Spinach, Squashes, Tomatoes.....	11
Turnip, Bird Seeds, Herbs, Vegetable Plants	12
Fertilizers, Farm Seeds, Grain, etc.....	13-14
Forge, Economical and Miscellaneous.....	14
Lawn Mixtures, Grass and Clover Seeds.....	15
Small Fruits.....	16-17
Flower Seeds, General List, choice.....	18-37
Asters, Asparagus plumosus.....	19-20
Plant dept., Roses, Climbing Plants.....	37-38
Sweet Peas.....	35-36
Nasturtium.....	28-29
Pansies, Papaver (Poppy).....	31-32
Bulbs, Summer-flowering.....	38-39
Bulbs, Winter-flowering.....	70
Hardy Ornamental Shrubs, Hedge Plants.....	40-41
Remedies for Insects, Disinfectants.....	41-42
Formula for Spraying Mixtures.....	43
Implements for Distribution of Insecticides.....	44
Fumigators, Syringes, Bellows.....	44
Paris Green Duster.....	44
Insecticide Distributors, Insect Exterminator	44
Sprayers.....	44-45
Sprinklers, Raffia, Knives, Paper.....	46
Mastica, Mastica Glazing Machine.....	46
Horticultural and Florists' Supplies.....	46
Seed Pans, Sieves, Silkline.....	46
Straw Mats, Hotbed Sashes, Flower Pots.....	46
Protecting Cloth, Baskets.....	46
Glass Cutter and Glazer, Bouquet Wire.....	46
Burning Brands, Brooms.....	46
Putting Bulb, Forks, Twine.....	47
Burlap Mats, Toothpicks, Tinfoil.....	47
Glaziers' Points, Van Reyper's, Reel and Line	47
Grafting Wax, Thermometers.....	47
Fibrotta Flower Pots, Saucers and Vases... ..	47
Rustic House, Lawn and Veranda Furniture	47
Garden and Lawn Supplies.....	47
Garden Hose and Couplings.....	47
Shears and Pruning Scissors, Dibbers.....	47
Rakes, Scythes, Labels, Rifles.....	48
Tree Pruner, Plant Stakes, Plant Tubs.....	48
Hedge Shears, Pea Brush, Poles for Beans...	48
Shovels, Weeders, Weeding Tongs.....	49
Trellises, Saws, Lawn Settee.....	49
Watering Pots, Spades.....	49
Water Barrel Truck, Wheelbarrows.....	51
Lawn Mower.....	52
Farm Cream Separator, Sharples. Vises....	53
Dairy Supplies, Churns.....	53
Poultry Foods and Supplies, Tough on Flies	54
Lec's Lice Killer, Cattle Comfort, Iceline....	54
Death to Lice, Cream Albumen.....	54
Medicine, Linement and Foods for Horses, Cattle, Poultry and Dogs.....	54
Peat, Moss, Soils, Jadoo Fibre and Liquid....	55
Paint and Oil Department, Glass.....	55
Vegetable Cutter, Ames'. Corn Sheller....	56
Grindstones. Buckets, Oak Well.....	56
Hay Cutters, Feed Cutters, Farm Requisites	56
Plows.....	57
Planet Jr. Tools, Hoes. Seeders, Drill.....	58
Horse Mowers, Potato Cutter, Hay Loader..	59
Mowers, Mower Parts and Repairs.....	59
Corn and Seed Planter.....	59
Cultivators, Harrows.....	60
Hay-rake, Fertilizer Distributors.....	62
Strawberry and Lawn Fertilizer Distributor	62
Plow and Fertilizing Machine.....	62
Bits and Halters, Weather Vanes.....	63
Horse Harness and Stable Requisites.....	63
Hardware Department, Pumps.....	64
Shotguns and Rifles, Scales, Wire Netting..	65
Ship Chandlery and Cordage.....	65
Fishing Tackle and Sporting Goods.....	65
Bicycles, Bicycle Sundries, Repair Dept.....	66
Duster, Brushes, Wooden Ware.....	67
Granite Ware, Toilet Sets.....	68
Crockery and China, Glassware and Lamps.	68
Venetian Enameled Steel Ware.....	68

Quantities of Seeds Required to Produce a Given Number of Plants and Sow an Acre.

	Quantity per Acre		Quantity per Acre
Artichoke, 1 oz. to 500 plants	6 ozs.	Grass, R. I. Bent,	3 bush.
Asparagus, 1 oz. to 800 plants	1 lb.	" Red Top, fancy cleaned	8 to 10 lbs.
Asparagus Roots	7250	" Timothy	½ bush.
Barley	2½ bush.	Hemp	½ bush.
Beans, Dwarf, 1½ pints to 100 ft. of drill .	1 bush.	Horse-Radish Roots	15,000 to 20,000
Beans, Pole, 1½ pints to 100 hills	½ bush.	Kale, 1 oz. to 5000 plants	2 ozs.
Beet, Garden, 1 oz. to 100 ft. of drill	7 lbs.	Kohlrabi ½ oz. to 100 feet of drill	4 lbs.
Beet, Mangel, 1 oz. to 100 ft. of drill	5 lbs.	Leeks, ½ oz. to 100 feet of drill	4 lbs.
Broccoli, 1 oz. to 5000 plants	2 ozs.	Lettuce, ¼ oz. to 100 ft. of drill	3 lbs.
Broom Corn	10 lbs.	Martynia, ½ oz. to 100 ft. drill	5 lbs.
Brussels Sprouts, 1 oz. to 5000 plants	2 ozs.	Melon, Musk, 1 oz. to 100 hills	1 to 2 lbs.
Buckwheat	½ bush.	" Water, 4 ozs. to 100 hills	1½ to 2 lbs.
Cabbage, 1 oz. to 5000 plants	2 ozs.	Nasturtium, 2 ozs. to 100 feet of drill	15 lbs.
Carrot, ¼ oz. to 100 ft. of drill	2½ lbs.	Oats	2 bush.
Cauliflower, 1 oz. to 5000 plants	2½ ozs.	Okra, 1½ ozs. to 100 ft. of drill	8 lbs.
Celery, 1 oz. to 15,000 plants	2 ozs.	Onion Seed, ½ oz. to 100 ft. of drill	4 to 5 lbs.
Chicory	4 lbs.	" " for sets	40 to 80 lbs.
Clover, Alsike and White Dutch	10 lbs.	Onion Sets, 1 qt. to 40 ft. of drill	8 bush.
Clover, Lucerne, Large Red and Crim- son Trefoil	8 lbs.	Parsnip, ¼ oz. to 100 ft. of drill	3 lbs.
Clover, Medium	15 to 20 ozs.	Parsley, ¼ oz. to 100 ft. of drill	3 lbs.
Collards, 1 oz. to 5000 plants	2 ozs.	Peas, Garden, 1 pt. to 100 ft. of drill	2 bush.
Corn, Rice (shelled)	2 qts.	" Field	2 bush.
Corn, Sweet, quarter pint to 100 hills	5 qts.	Pepper, 1 oz. to 1,500 plants	3 ozs.
Corn, in drills for soiling	3 bush.	Potatoes	8 bush.
Cress, half oz. to 100 ft. of drill	12 lbs.	Pumpkin, ½ qt. to 100 hills	3 to 4 lbs.
Cucumber, 1 oz. to 100 hills	1 to 2	Radish, two-thirds oz. to 100 ft. of drill, 10 to 12	lbs.
Egg Plant, 1 oz. to 2000 plants	4 ozs.	Rye	1½ bush.
Endive, quarter oz. to 100 ft. of drill	4½ lbs.	Salsify, ½ oz. to 100 ft. of drill	8 lbs.
Flax, broadcast	½ bush.	Spinach, ½ oz. to 100 ft. of drill	8 lbs.
Garlic, bulbs, 1 lb. to 100 feet of drill	1 bush.	Spurry	15 lbs.
Gourd, 2 ozs. to 100 hills	1 bush.	Summer Savory	¾ lb.
Grass, Blue, Kentucky	2 bush.	Sunflower	8 lbs.
" Blue, English	1 bush.	Squash, Summer, 4 ozs. to 100 hills	2 lbs.
" Hungarian and Millet	½ bush.	" Winter, 8 ozs. to 100 hills	2 lbs.
" Mixed Lawn	3 to 5 bush.	Tomato, 1 oz. to 4,500 plants	1 oz.
" Orchard, Perennial Rye, Red Top, Fowl Meadow and Wood Meadow	2 to 3 bush.	Tobacco, 1 oz. to 5000 plants	2 ozs.
		Turnip, 1 oz. to 250 ft. of drill	1½ lbs.
		Vetches	2 bush.
		Wheat	1½ bush.

WEIGHT OF VARIOUS ARTICLES.

	Lbs. per Bush.		Lbs. per Bush.		Lbs. per Bush.
Apples	48	Flax Seed	56	Salt, Coarse	50
" dried	22	Fowl Meadow	12	" Michigan	56
Barley	48	Hemp Seed	44	Sweet Potatoes	56
Beans	60	Hungarian	48	Timothy Seed	45
Buckwheat	48	Millet	50	Turnips	58
Broom Corn	46	Oats	32	Wheat	60
Blue Grass, Kentucky	14	Osage Orange	33	Flour, per bbl., net, 196 lbs.	
" English	24	Orchard Grass	14	Salt,	per bbl., 280 lbs.
Bran	20	Onions	54		
Canary Seed	60	Peach Pits	45		
Clover Seed	60	Peas, Smooth	60		
Corn, shelled	56	" Wrinkled	56		
" on ear	70	Perennial Rye	20		
Corn Meal	50	Potatoes (heaping measure) ..	60	Hay, well settled	4½
Charcoal	22	Rape	50	" on cob, in bin	22
Cranberries	40	Rye	56	" shelled, in bin	45
Dried Peaches	28	Red Top	10	Wheat, in bin	48
				Oats, in bin	25½
				Potatoes, in bin	38½

EVERY YEAR

At the end of the Season, about October the first, we will have a SPECIAL SALE of all our old stock of Peas, Beans and Corn; very valuable for Poultry Food, at Poultry Food Prices.



SPECIALTIES

Seeds, Bulbs,
Fertilizers, Implements,
Hardware and Paints,
Household, Stable and
Horse Supplies,
China and Crockery,
Sporting Goods,
Ammunition

General Repair Department
for all Lines