

# **Historic, Archive Document**

Do not assume content reflects current scientific knowledge, policies, or practices.



62.73

# MICHELL'S

HIGHEST  
QUALITY

# SEEDS

BULBS,  
PLANTS  
& C.



A CERTIFICATE OF MERIT  
FOR THE  
**BEST SWEET PEAS**  
was awarded at the  
**PAN-AMERICAN EXHIBITION, BUFFALO**  
To William Robertson, Gardener to John W. Pepper, Esq.  
JENKINTOWN, PA.  
SEEDS SUPPLIED BY US

---

Price of our Super-fine Mixed SWEET PEAS:  
10 cents per oz.  
20 cents per quarter pound.  
60 cts. per pound. Five lbs. for \$2.50.



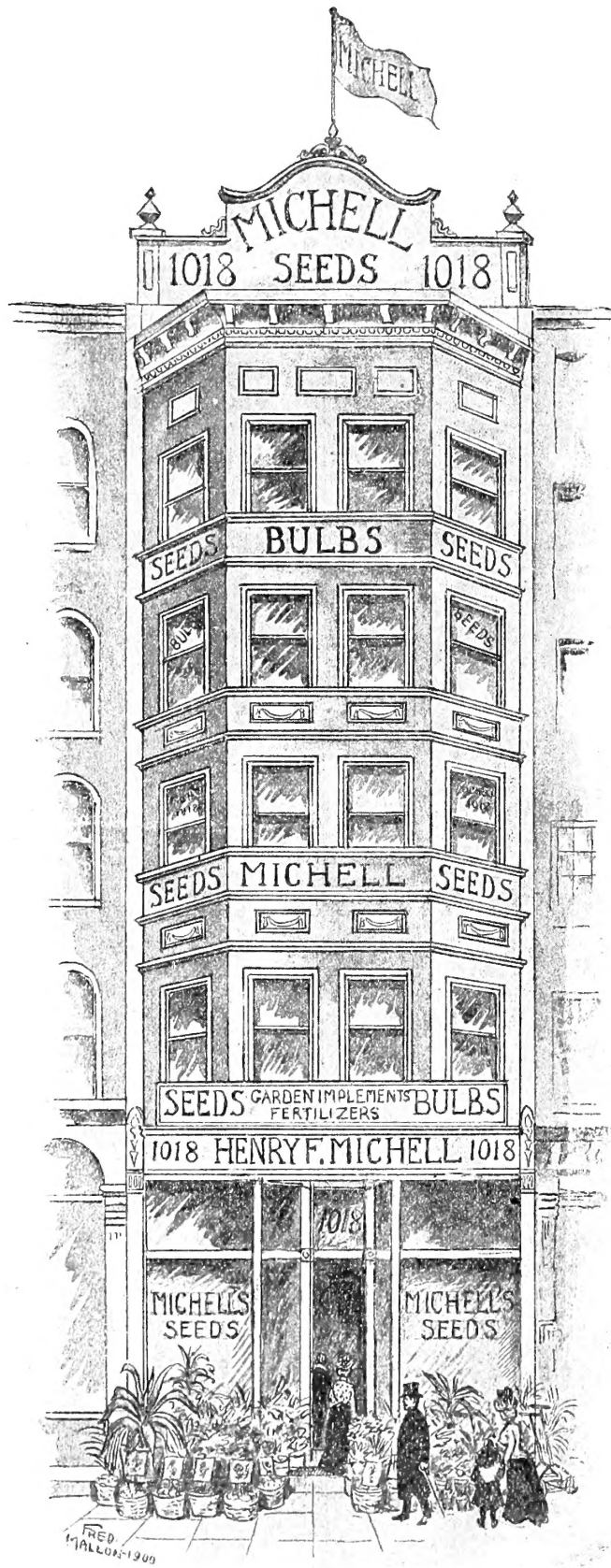

5 floors and basement, 180 feet deep.  
 Total floor area, 21,600 square feet.

**SPECIAL ANNOUNCEMENTS**

No. 1.—If desired we will gladly procure for our customers any SEEDS, PLANTS, or other articles not offered in our catalogue, but quoted in any other catalogue. Customers will kindly mention in their orders the firm offering the Seeds, Plants or articles wanted and the prices quoted for same, and we will ship with our own goods, thus saving extra expense and work for our customers.

No. 2.—We guarantee safe arrival of all goods purchased from us—customers take no risks.



OUR NEW FIVE-STORY WAREHOUSE ON LUDLOW ST.

**HENRY F. MICHELL,**  
**1018 MARKET STREET,**  
**PHILADELPHIA.**

HENRY F. MICHELL.  
 FREDERICK J. MICHELL.

Telephone: 3-55-43 A.



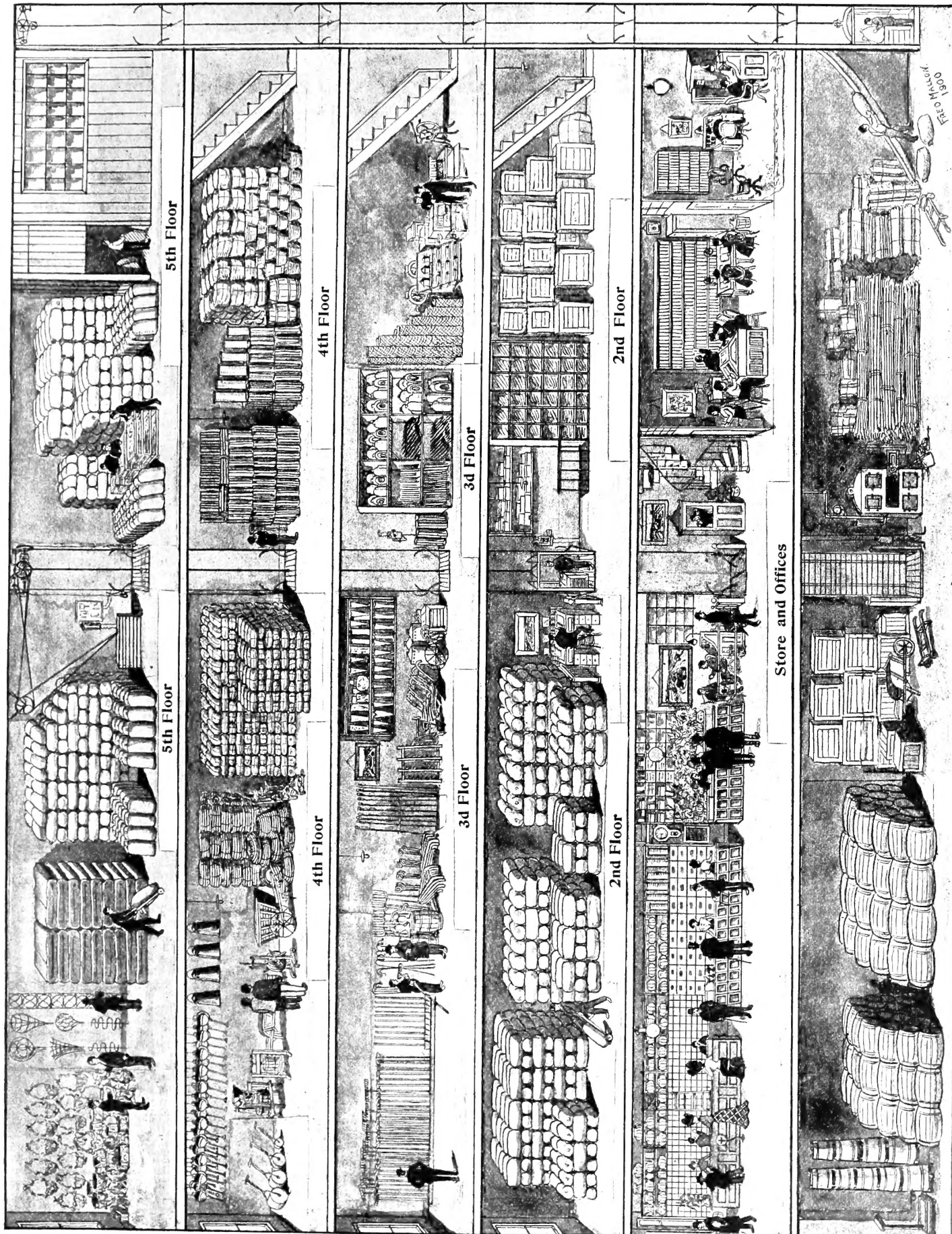

5th Floor

5th Floor

4th Floor

4th Floor

3d Floor

3d Floor

2nd Floor

2nd Floor

Store and Offices

Basement

VIEW SHOWING A SMALL PORTION OF EACH FLOOR DEVOTED TO THE TRANSACTION OF OUR BUSINESS

## Novelties and Specialties of Unusual Merit

*P. S.—We beg to draw the attention of our customers to the fact that NOVELTIES offered herein are those only of PROVEN VALUE and described by us as per DESCRIPTION given by the RESPECTIVE INTRODUCERS. We send these seeds out in ORIGINAL PACKETS ONLY, just as received from the grower. While the amount of seed contained in the papers is not large, yet they are worthy of a trial by all who are in the market for the newest and best. We would advise customers to also order the regular standard sorts to obtain the needed quantities of plants.*



*New Giant Comet Aster "Empress Frederick."*

### No. 1107. New Aster "Empress Frederick"

A variety classed among the finest of dwarf Asters of the Comet type. Bearing flowers of the purest white often 12 inches in circumference and of the most desirable globular form, producing as many as 8 to 12 blooms on a plant at one time. A special feature is its robust growth, which makes it very desirable as a pot plant. Pronounced the best of the recent additions to the Aster family.

Price per pkt., 25c.; 90c. for 4 pkts.

### Dwarf Hohenzollern Aster

One of the very largest flowering varieties yet introduced and will become a favorite standard type.

No. 1116. **Rich Crimson.** 15c. per pkt.

No. 1117. **Pure White.** 15c. per pkt.



*New Single China Aster.*

### Single Flowering China Aster

Quite an acquisition; not to be compared with the old-fashioned single variety of Aster. The flowers have a perfect star form measuring from 9 to 12 inches in circumference, a very desirable cut bloom, borne on stems 20 to 24 inches long, of remarkable keeping qualities; they are of very luxuriant growth, foliage of a dark green color.

No. 1103. **Violet.** Very beautiful. Per pkt., 20c.

No. 1104. **Pink.** " " Per pkt., 20c.

No. 1105. **Mixed.** " " Per pkt., 20c.

One pkt. of each of the above Single Asters for 50c.

### No. 1112. Pink Ostrich Feather Aster.

A tall, branching, large flowering variety borne on long stems, color rich pink. 15c. per pkt.; 3 pkts. for 40c.

### No. 1111. Giant Snow White Victoria Aster.

Of pyramidal habit, free flowering, each plant bearing from 15 to 20 magnificent blooms of pure white. 15c. per pkt.; 3 pkts. for 40c.

### TWO NEW TRIUMPH ASTERS

No. 1118. **Coppery scarlet with white.** 15c. per pkt.; 3 pkts. for 40c.

No. 1119. **Rich Scarlet.** 15c. per pkt.; 3 pkts. for 40c.

These two new shades obtained in this valuable **Extra Early Type** of Asters will please all who may grow them. They begin blooming last week in June and continue a mass of flowers until late in autumn.

### King Humbert Aster—Pure White

In this beautiful novelty the acme of perfection in large-blooming dwarf Comet Asters has been attained. The plants form compact bushes and bear magnificent globular pure white flowers of the genuine long-petalled Comet type, but of extraordinary size, sometimes surpassing 5 inches in diameter. It is extremely seldom that any of these flowers show a yellow centre, a fault often found with the old Giant Comet Asters. Will be unsurpassed in value as a pot-blooming, also garden Aster.

No. 1120. 20c. per pkt.; 3 pkts. for 50c.





No. 1106, New Aster "Sunlight,"  
**ASTER "SUNLIGHT"**

For years experimenting had failed to produce what could be called a good Yellow Aster. In the discovery of this valuable new sort, that object has been attained. It is a pure sulphur yellow in color, and in growth and form of flower cannot be excelled. The flowers are very large, measuring 12 to 16 inches in circumference, born on tall graceful plants well decked with foliage. Especially valuable for bouquet work and cut flowers. No garden should be without it. Price per pkt. 25c., \$1.00 for 5 pkts.

No. 1121.  
**NEW GIANT PURE WHITE ASTER**  
"MICHELL'S PURITY"

A valuable new variety; for cut-flowers it has no superior; is perfectly double and produced on long stiff stems. Price per pkt. 15c., 4 pkts. for 50c.

**NEW WHITE AGERATUM**  
"GRANDIFLORUM ALBUM"

The finest white flowering variety yet introduced. No. 15, 10c. per pkt., 6 pkts. for 50c.

**No. 22 NEW AGERATUM**  
"PRINCESS VICTORIA LOUISE"

The dwarf and compact habit of growth makes this variety particularly adapted for edging and bedding. The plant grows about 3½ inches high and 8 inches in diameter. Flowers white tinted with blue. 15c. per pkt., 4 pkts for 50c.



Arctotis Grandis.

**NEW AFRICAN PLANT**  
**ARCTOTIS GRANDIS**

**Remarkably Handsome** new annual from South-West-Africa, growing luxuriantly and forming profusely branched bushes of about 2 to 2½ feet in height. Its flowerheads, borne on long stems and rising well above the foliage, are large and showy, from 2½ to 3 inches across; the ray flowerets being pure white on the upper surface are embellished by a narrow yellow zone at their base. Being of very easy culture, the plants produce their splendid flowers most abundantly and in constant succession from early summer to the autumn. Magnificent and prominent novelty. No. 106, 15c. per pkt., 4 pkts. for 50c.

**No. 54 ANTIRRLIMUM (SNAPDRAGON)**  
"GOLDEN SUN"



**Foliage**  
canary yellow.  
**Flowers**  
rosy white,  
spotted  
and striped  
with  
carmine.

An  
excellent  
border  
plant.

15c. per  
pkt., 4 pkts.  
for 50c.

## Red and Gold Foliage Begonia Vernon

A new species, will make a beautiful border plant for carpet bedding purposes. Flowers rich pinkish carmine. Foliage, golden yellow edged with bronze red.

No. 148, 15c. per pkt.

## "Giant of Nice" New Carnation

Produces enormous perfect shaped flowers of the richest colors. The plant is a strong robust grower. It is the very best out-door carnation ever introduced.

No. 242. Choicest mixed. 20c. per pkt.; 3 pkts. for 50c.

## Cineraria Hybrida Grandiflora "Stella"

Cineraria, Flowering in the shape of the Cactus-Dahlia

It is well known that the Cactus-Dahlias have become universal favorites ever since their introduction. The whole plant bears a multitude of beautiful flowers much resembling the Cactus-Dahlia. Cineraria "Stella" is remarkable for the singular position of its flowers; it comes true from seed. The colors are Pink, Dark-red, Indigo, Violet, etc.

No. 1300, Choice Mixed, 25c. per pkt.; 5 pkts. for \$1.00.

## No. 241 Celosia (Cockscomb) Spicata



Spicata Cockscomb

Though by no means a novelty, this charming Celosia seems to have quite disappeared from culture for a long period. Growing in an erect pyramidal form. They throw up a main stem about 2½ feet high bearing 20 to 30 side-shoots with fresh green linear leaves, each of which is crowned by a cylindrical flower-spike 2½ to 4 inches long. The flowers open a fresh bright rose tint and the lower petals change gradually to a silvery white, thus presenting to the eye a most charming combination of color. The elegant long-stemmed flowers preserve their beauty for an indefinite period and furnish excellent material for making up bouquets, etc. In addition to this they are very suitable for drying. Suitable either for garden or pot culture. Price 20c. per pkt.; 3 pkts. for 50c.

## No. 263 New Giant Cosmos "Rainbow"

One of the most magnificent new Cosmos that have yet been introduced; large lacinated and frilled flowers, often 3½ to 4 inches in diameter, borne on tall graceful plants, consisting of the finest shades of white, cream, blush and mauve; some are daintily flecked like bird's eggs, others have markings of red, lavender and pink. It is the perfection in form and color of this valuable cut flower now so largely in demand. Per 15c. pkt.; 50c. for 4 pkts.

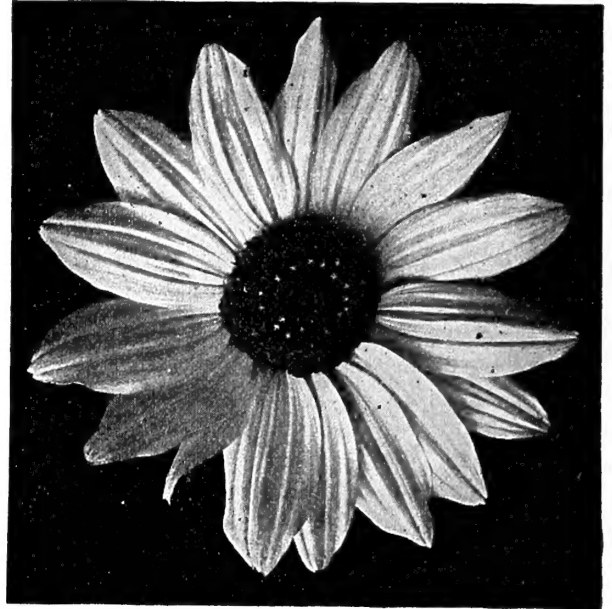

New Giant Shasta Daisy (Natural size 12 inches in circumference)

## No. 1407 SHASTA DAISIES

(*Chrysanthemum Leucanthemum*)

The latest floral wonder. After years of careful growing and selecting the seed from the finest flowers, the peer has at least been obtained. Imagine a pure white flower often a foot or more in circumference, borne on long wiry stems, they thrive in mostly any ordinary soil, are perfectly hardy, blooming the entire summer months, and when cut the flowers remain in perfect condition for two weeks. (You cannot afford to be without this novelty.) Price per pkt. 50c.

No. 365

## Dianthus

"Brilliant Violet"

(China Pink)



Dianthus (chinesis violaceus) Brilliant Violet

A grand addition indeed to the Dianthus and an entirely new color, flowers very large; brilliant violet, handsomely fringed, this novelty should be included in every garden, will bloom the first season from seed. Price per pkt. 20c.; 3 pkts. for 50c.



New Dahlia, "Collarette."

No. 1407. **Dahlia "Collarette"**

A distinct species of a Single Dahlia, being of French origin; were exhibited at the Paris Exposition and awarded a Silver Medal. They were greatly admired by all who saw them. This type includes a very wide range of colors, beautifully marked. The inner part of the flower is tufted around the seed head and makes a very noticeable contrast. Sure to become a universal favorite with the Dahlia lover. It will bloom the first year from seed. Price per pkt., 20c.; 3 pkts. for 50c.

No. 487. **New Helianthus (Single Sunflower)**  
CUT AND COME AGAIN MIXED

This type of flower is becoming more popular year after year by the flower grower. As a summer cut bloom few flowers surpass it. The plants form pyramidal bushes 3 to 4 feet high, well branched, bearing from the ground to the top a continuous supply, from spring until killed by frost, of perfectly formed flowers of the richest shades of yellow, with twisted and frilled petals, making them very desirable and attractive. Per pkt., 15c.; 4 pkts. for 50c.

**Single Sunflower "PERKEO"**

(*Helianthus cucumerifolius nanus compactus*)

The plants form a regular dwarf, round and compact bush, measure when fully developed 10 to 12 inches high and 14 to 16 inches in diameter. The single, brilliant, yellow flowers with black centre are borne on long, strong stems well above the foliage. Will make a handsome display in the garden, the flowers can be cut with long stems and are very decorative. The culture of this novelty is so easy that it ought to be grown in every garden. Seeds may be sown either in pots or pans or in a frame in March or April; the plants may be transplanted in May and treated like other annuals. Seeds can also be sown in open ground. No. 488. 15c. per pkt.; 4 pkts. for 50c.

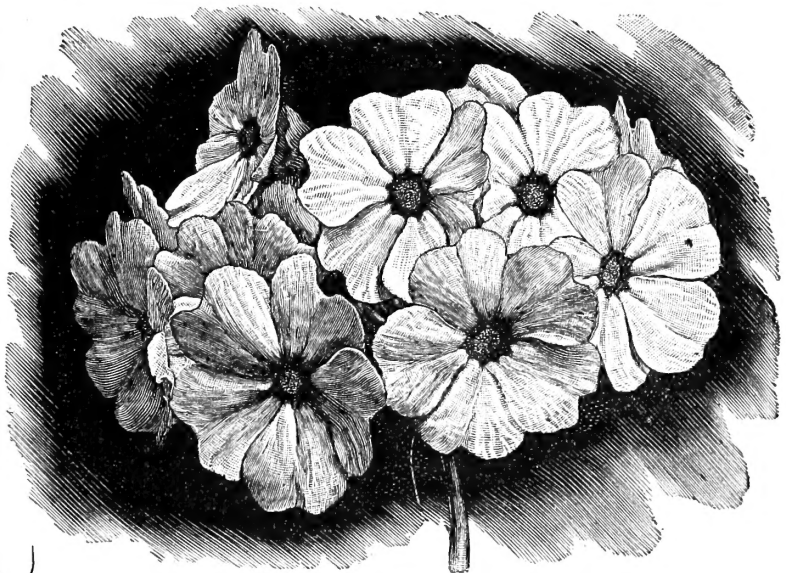

New Red Primula Obconica (*Kermesina*).

**New Red Primula Obconica (*Kermesina*)**

After several years experimenting we have at last succeeded to get hold of the long-desired red color of the Primula obconica, so that plants grown from seeds show the original color.

The plants have the strong growth, the finely built round trusses and the well-shaped middle-sized flowers of the Primula obconica rosea; the color is, however, especially of the older flowers in autumn and winter, of a bright rich crimson red. Equally valuable for growing in pots or for cutting purposes. No. 806. 15c. per pkt.; 4 pkts. for 50c.



**Single Poppy "Miss Sherwood"**

Sturdy plants 2½ feet high, with noble foliage, bear in profusion large single flowers of a shiny satiny white, the upper half of the flower being a silky chamois rose. This is a combination of color quite original in its delicacy, and I am convinced that this beautiful Poppy, which comes quite true from seed, will be found one of the finest of single-blooming varieties, more especially as a cut flower, and quickly meet with the appreciation it deserves. 10c. per pkt.; 6 pkts. for 50c.

**New Dwarf Nasturtium "VESUVIUS"**

This is the "Tom Thumb" variety of the tall climbing Nasturtium "Vesuvius" introduced three years ago. It produces dwarf compact bushes covered with large flowers of a beautiful and brilliant salmony-pink, an extremely bright color showing off well at a great distance. No. 665. 15c. per pkt.; 4 pkts. for 50c.



"New Dwarf Nasturtium Vesuvius."

**New Forget-me-Not "ROYAL BLUE"**

(*Myosotis alpestris stricta grandiflora*.)

Produces flowers of a large size and dark blue. Its bright and handsome flowers, which create a brilliant display, make plants much valuable for bedding purposes as well as for cultivation in pots. No. 618. 15c. per original pkt.; 4 pkts. for 50c.



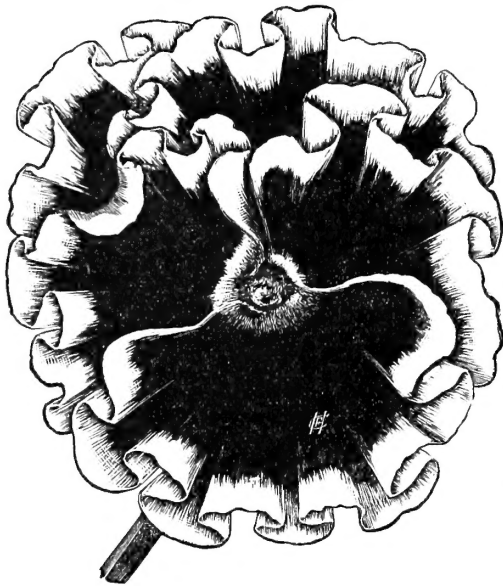

Pansy "Psyche."

No. 1207.

## New Pansy "Psyche"

Few of the many varieties of Pansies have such an attractive appearance as this one; the flowers are elegantly crimped and curled, superb in form and color, and of good size. It consists of five velvety violet petals surrounded with a distinct broad white edge. The plant is perfect in shape and a very free bloomer.

Price per pkt., 25c.; 5 pkts. for \$1.00.

### MINIATURE VERBENA. Purple with White Eye

The plant attains by an average diameter of 12 inches only a height of 6 inches. The numerous trusses of flowers are borne free above the foliage almost thoroughly of equal height; the flowers are of large size and of a bright purple red color with white eye quite distinct. The plant forms a compact branching bush.

No. 950. 15c. per original pkt.; 4 pkts. for 50c.

### NEW STAR PETUNIA (Howard's)

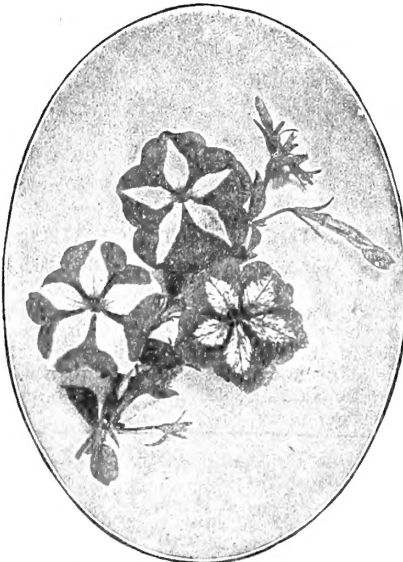

New Star Petunia (Howard's).

This is the finest Petunia of its kind that has come under the observation of the plant grower for years. By a long course of selection and hybridization the peer in color, marking and form have been obtained. Note a few of its special favorable and valuable points:

**Size**—Flowers two and one-quarter inches in diameter.

**Form of Flower**—Almost perfectly round, showing large well-shaped flowers, borne in great profusion on thrifty, robust plants.

**Growth of Plants**—Well branched, foliage of fine dark green color, covering a surface of about 24 inches in diameter, growing 6 to 12 inches in height.

**Color of Flower**—The ground is a dark crim-on maroon, with a rich velvety texture, equal to that of the finest pansy. Showing through the ground color are clear violet veins. From the centre start the points of a five-rayed star of a most delicate pink shade, sometimes almost white, which deepens in color as it approaches the margin, making a beautiful contrast with the maroon ground.

**Blooming Qualities**—The amount of flowers produced is remarkable; single plants have frequently been seen to expand 100 blooms at one time.

Sold only in original packets containing 150 seeds. Prices: Per pkt., 25c.; 5 pkts., \$1.00; 12 pkts., \$2.00; per 1/2 pkt., 75 seeds, 15c.

We advise early ordering of this valuable novelty as stock is limited.

### New Dwarf Compact Phlox "Bunch of Roses"



Phlox "Bunch of Roses."

This new variety is not only most effective on account of its striking beauty of the color, but also the remarkable size and profusion of its flowers and the perfect shape and habit of the plant. The flowers are of an unusually vivid pink color, each petal having toward the base a darker spot, while the centre of the flower is pure white, as it is in Phlox grandiflora stellata splendens. The flowers are large, of perfect form, and appear in abundant profusion.

No. 718. 15c. per pkt.; 4 pkts for 50c.

### No. 936. New Verbena "Elegance"

Indeed quite a novelty in the Verbena class. The plants produce large trusses of flowers with white centre and lavender markings on the border; each flower is almost the size of a silver quarter of a dollar.

Price 15c. per pkt.; 4 pkts. for 50c.

### New Earliest White Sweet Pea "Mont Blanc"

The very best white variety yet introduced. Very valuable on account of its extreme earliness. Sow seeds in a warm, rather dry position; do not cover the seeds over 1/4 inch until well established.

No. 1030. 10c. per pkt.; per oz., 25c.



Single Wallflower "Tom Thumb."

### No. 963. New Wallflower "Tom Thumb" MIXED COLORS.

An entirely new variety of this half hardy plant. The colors range in Light and Dark Yellow, Light Brown, Chamois, Violet and Deep Red. Of compact growth, averaging about 8 inches in height.

Price per pkt., 20c.; 3 pkts. for 50c.



# CHRYSANTHEMUMS, ETC.

**SPECIAL NOTICE.**—We are offering for 1902 the following New **CHRYSANTHEMUM PLANTS**, all of special merit, expressly for exhibition purposes. The varieties all produce monster size flowers, measuring from 24 to 30 inches in circumference, thus insuring prize winners for the Chrysanthemum Show. Large cash prizes will be offered for nearly all of these varieties of Chrysanthemum, for the best cut blooms, at the Chrysanthemum Show of the Penna. Horticultural Society in November, 1902, by Mrs. J. W. M. Cardeza, W. L. Elkins, Esq., and Randal Morgan, Esq. (See schedule of Penna. Horticultural Society.)

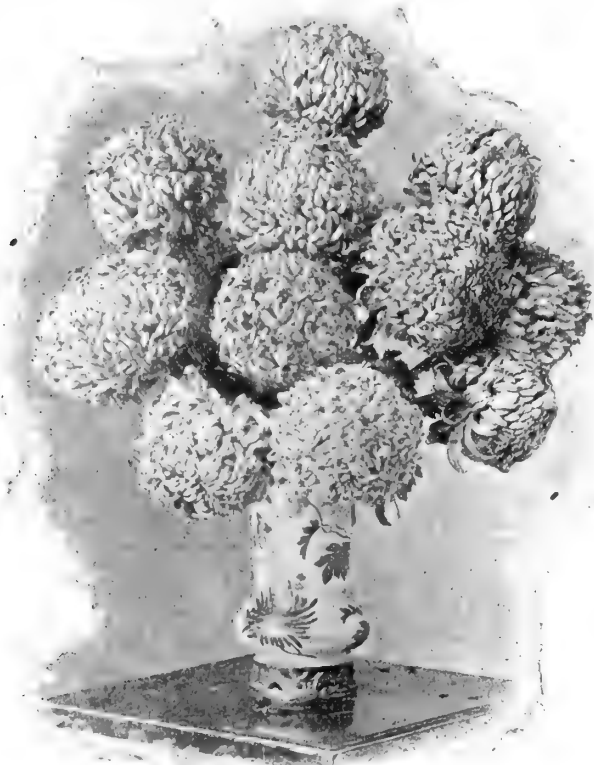

*Pride of Elstowe.*

**Sirius.** A pure white of immense size; reflexed flower, stout stem, and handsome foliage. Price 25c. each, per doz. \$2.50.

**Mira.** Flowers of monster size, averaging 30 inches in circumference; color a delicate pink, shaded white toward the centre; a grand exhibition sort. Price 25c. each, per doz. \$2.50.

**Chrysanthemum "Pride of Elstowe."** (Named after the country seat of W. L. Elkins, Esq.) A beautiful rose pink incurved variety; the petals are arranged evenly and show a good color underneath, a point much sought after in pink flowering varieties; its keeping qualities are marvelous, cut blooms having been kept in perfect condition for 3 weeks after cutting. Was certificated by the Chrysanthemum Society; scored 88 points of merit for commercial and 85 points for exhibition purposes. It is the finest pink Chrysanthemum yet introduced. Strong plants ready April 1st. 50c. each, per doz. \$5.00, \$35.00 per 100.

**"T. D. M. Cardeza."** Especially selected by Mrs. J. W. M. Cardeza. Color a rich golden yellow; flower reflexed and has a specially strong, stiff stem; foliage deep green, of heavy texture. The peer of any yellow sort yet on market. Strong plants ready April 1st. 50c. each, per doz. \$5.00, \$35.00 per 100.

**"Miss Jane Morgan."** A fine incurved Japanese variety; color rich pink, globular shaped flowers, extremely double; fine stem and heavy dark green foliage. Price 50c. each, per doz. \$5.00, \$35.00 per 100. Especially selected by R. Morgan, Esq.

**"Southern Cross."** A rich brilliant yellow, flowerets are incurved and twisted, one of the grandest exhibition sorts; very late flowering; very desirable for Christmas and New Year bloom; carried on good stout stems, clothed with handsome foliage. Price 25c. each, per doz. \$2.50, \$20.00 per 100.

**"Lizzie Adcock."** Color fine yellow; sport from the well-known variety, Souv. d'Or; classed among the finest yellows in existence; used to great advantage as a pot plant, being of dwarf robust growth and very distinct. Care should be taken when growing this sort not to disbud it, as it will lose all of its beauty, therefore should be grown perfectly natural. Price 25c. each, per doz. \$2.50, \$20.00 per 100.

**"Bentley."** An enormous double globular reflexed variety of perfect form and growth, color clear pink, flowers often measuring 30 inches in circumference; an excellent shipper and keeper, the same 6 blooms having been exhibited at three different shows and awarded a certificate of merit. Price 50c. each, per doz. \$5.00, \$30.00 per 100.

**Mrs. Wm. Fraser.** A reflexed flower with broad flat petals, dark Magenta tinted Rose, a very beautiful and uncommon color, fine robust habit, heavy green foliage. Price 25c. each, per doz. \$2.50.

A BEAUTIFUL NOVELTY FROM THE ORIENT.

## JAPANESE OR MIKADO FERN BALL

For the window, drawing room, or suspended from chandelier, over dining table, or used in fern dishes.

What is prettier in winter than a ball of delicate Emerald Green Ferns?

Composed of the Japanese Inland Fern Roots and Sphagnum Moss, and so constructed as to send out leaves of beautiful emerald green from every point. They grow rapidly, and make a handsome ornament for the home conservatory or greenhouse.

**DIRECTIONS:** Place ball in water for several hours and then suspend in any desired position; repeat every two days until growth has started, after which water occasionally as required, being careful that it does not become dry. The greater the growth the more water will be required to keep the ferns in a flourishing condition. To use in fern dish cut ball in halves, placing flat side down, thus getting two dishes of beautiful ferns. The Fern Ball may be allowed to dry up at any time and be set away, and started again by watering as before.

The Fern Ball will be from 1 to 4 weeks in starting, according to degree of heat and moisture. Do not expose to direct rays of sun.

**When used for Fern Dish purposes** divide the ball in four equal parts, submerge cut parts in water for about one hour and place in fern dish in which it is to grow. The results obtained by this method are very satisfactory.

**PRICES:** Extra large size, 75c. each (by mail, 90c.), \$7.50 per doz.; 1st size, 50c. each (by mail, 60c.), \$5.25 per doz.; medium size, 40c. each (by mail, 50c.), \$4.00 per doz.



*Japanese Fern Ball.*

NEW GERANIUMS



GERANIUM, "J. D. Eisele."

**J. D. Eisele.** Single, pure wine red. A Zonale Geranium of most brilliant coloring, producing immense trusses; perfectly sun-proof. Price, 35c. each, \$3.50 per doz.

**James Davidson.** Single, fine lilac. A color which has never before been approached; shows almost a distinct blue color in the evening. Trusses of phenomenal size. A striking novelty. Price, 35c. each, \$3.50 per doz.

**Eben E. Rexford.** Single, fine light pink, with white eye. Price, 10c. each, 75c. per doz., \$5.00 per 100.

**Dr. E. A. Hering.** Single, brilliant scarlet overlaid with red. Price, 10c. each, 75c. per doz., \$5.00 per 100.



CANNAS  
(NOVELTIES)

We offer below a few varieties of Cannas of recent introduction, and do not hesitate in recommending them highly to our customers. As this is now the foremost of bedding plants used, every one should be thoroughly up-to-date in the variety of Canna plants used for bedding. The roots offered below are good, strong, two-eyed bulbs producing heavy bushy plants.

**BLACK BEAUTY.** By far the darkest and handsomest Canna. Flowers rich dark crimson, the foliage is of a superb color, a rare and magnificent variety. 25c. each, \$2.50 per doz., \$18.00 per 100.

**BLACK PRINCE.** Intense velvety maroon, the deepest color among Cannas, almost entirely black; spikes of unusual growth, well shaped and of good substance. Height, 3 to 4 feet. 20c. each, \$2.00 per doz., \$13.00 per 100.

**BETSY ROSS.** The most beautiful shade of pink to date, so large and dense are the spikes that they almost hide the foliage; of compact and dwarf growth, height being 2 to 2½ feet. 40c. each, \$4.00 per doz., \$25.00 per 100.

**HENRY F. MICHELL.** A most remarkable new Canna: the flowers, which are well-formed, are of a pale yellow upon opening, changing to almost clear white dotted with clear rose spots; a strong, robust grower; height about 3 feet. 50c. each, \$5.00 per doz., \$35.00 per 100.

**KING EDWARD.** A fine novelty. The ground of the flower is rich butter yellow, each petal is flaked with blotches of rich vermilion. The growth of the plant is fine and very bold; height about 3 feet. 50c. each, \$5.00 per doz., \$35.00 per 100.

**SHAMROCK.** Its immense banana-like foliage makes it a grand variety; upright in growth, bearing flowers; height about 5 feet. 40c. each, \$4.00 per doz., \$25.00 per 100.

**SIR THOMAS LIPTON.** One of the finest of the orange-yellow varieties; immense flower trusses of a rich orange-yellow produced on good stout plants; of dwarf habit; height about 2 to 2½ feet. 40c. each, \$4.00 per doz., \$25.00 per 100.

**OLYMPIA.** A peculiar bluish carmine shade; a free grower and a constant bloomer; entirely distinct from any other sort. 25c. each, \$2.50 per doz., \$15.00 per 100.

**QUEEN OF HOLLAND.** A rich distinct orange, producing trusses of immense flowers; should be included in every order for Canna Roots. Height about 3 feet. 50c. each, \$5.00 per doz., \$35.00 per 100.

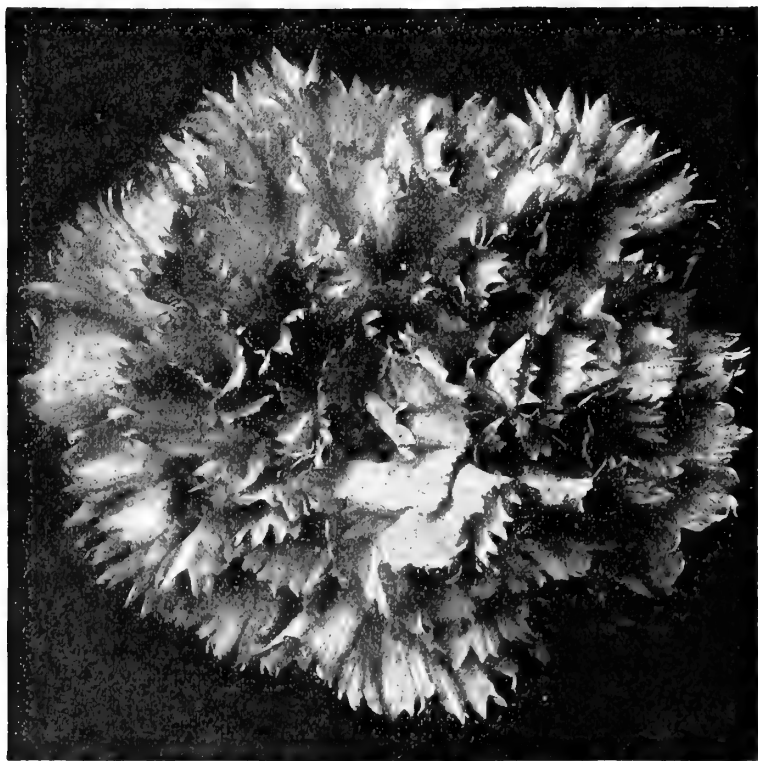

NEW CARNATION, "Mrs. E. A. Nelson."

NEW CARNATION, "MRS. E. A. NELSON"

**ANNOUNCEMENT** We take pleasure in announcing that the new pink carnation, the "Mrs. E. A. Nelson," will be distributed in the Spring of 1902. In offering the "Mrs. E. A. Nelson" we do so thoroughly convinced that, as a commercial variety, it will rank among the very best that were ever introduced, and that all the claims ever made for it will be fully verified by all those who may give it a trial. Those who saw it growing at various seasons during the past four years are unanimous in declaring it to be unquestionably the best commercial pink carnation in sight.

**A FEW MERITORIOUS POINTS.**—**Size**—The average bloom, under ordinary culture, exceeds three inches in diameter. **Color**—A pure glistening pink, similar to that of Joost. **Calyx**—Strong and absolutely non-bursting. **Stem**—2 to 2½ feet, strong and erect, sustaining the largest blooms. **Blooming Qualities**—Although a "fancy" of the highest order, it is withal an early, profuse and continuous bloomer. Scott, in its palmy days, never surpassed the "E. A. Nelson" as to continuity and quantity of blooms.

**Habit of Growth**—Strong, clean and vigorous. It lifts easily and suffers no setback under the most discouraging conditions. **Keeping Qualities**—As good as the best; blooms shipped from Indianapolis to Boston, arriving at their destination in splendid condition. This fact is worthy of note because of the distance between the two points, necessitating three transfers.

**Record**—Scored 94 points in Boston and 91½ in Cincinnati on March 9th.

The "Mrs. E. A. Nelson" will be ready for distribution February 1st, 1902. Orders will be filled strictly in rotation on the principle, "First come, first served."

<b>PRICES—Strong, Healthy, Well-Rooted Cuttings.</b>			
1 dozen.....	\$2.50	25 .....	\$3.50
1000 .....	\$80.00	50 .....	\$6.00
		250 at 1000 rates.	10.00

**GROFF'S NEW HYBRIDS GLADIOLUS**

CHOICEST MIXED OF ALL COLORS



GLADIOLUS. Groff's Hybrids

The most charming species of this favorite summer blooming bulb family, producing immense trusses of the richest colored flowers. Considered the finest of the Gladiolus for bedding or cut-flower use.

Price 5c. each, 50c. per doz., per 100 \$3.50, \$30.00 per 1000, 25 at 100 rates, 250 and over at 1000 rates.

P.S.—See also Page 58 for other varieties of Gladiolus.



PRIMULA VERIS SUPERBA

**HARDY GIANT PRIMROSE**

(Primula Veris Superba)

The plant originated a few years ago in a batch of seedling Polyanthus, and apparently is a hybrid Primrose, having somewhat the growth of a Polyanthus combined with the yellow color and fragrance of the English Primrose.

In size of flower, it is fully three times as large as any hardy Primrose, the average size being over one inch, and they have frequently measured over two inches, with individual trusses of bloom six inches in diameter. It is perfectly hardy, grows from 10 to 12 inches high, and begins to flower earlier and continues in bloom longer than any other plant of the same family. This alone is sufficient to insure its popularity as a plant for the garden, but its greatest merit lies in the fact that it is not only one of the easiest plants we know of to force, but a plant that can readily be brought into flower during the winter and early spring months, and is especially desirable as a cut flower, being of delightful fragrance.

The plants can be stored in cold frames, successive batches being brought into the greenhouse or conservatory as required, allowing about four to five weeks time to bring them into full bloom. Price 25c. each; per doz. \$2.50; \$15.00 per 100.

**NEW PERENNIAL PHLOX**

This is becoming a most popular plant, for the purpose of summer cut flowers, it being in full bloom the entire summer months, furnishing just what is wanted when other flowers are scarce. They are also very effective when massed in groups. They stand the heat remarkably well and, when once established, they remain for years. We offer herewith strong young plants of the best new sorts. They are grown for us by a specialist who, after careful study, has produced what can be termed as really remarkably fine varieties; entirely new and distinct from those offered heretofore.

**Boule de Neige (Snowball).** A splendid variety of perfect form. Height, 3 feet. 15c. each, per doz. \$1.50, \$10.00 per 100.

**Pearl.** Very fine. Pure white. Height, 3 feet. 15c. each, per doz. \$1.50, \$10.00 per 100.

**Snowdown.** Pure white, very early, and free bloomer. Height, 18 inches. 15c. each, per doz. \$1.50, \$10.00 per 100.

**Von Lasburg.** The finest variety yet introduced; very scarce; the largest of any perennial Phlox in existence producing giant pure white flowers. Height, 18 inches. 25c. each, per doz. \$2.50, \$16.00 per 100.

**"Circle."** A fine one, rose colored centre shading to white toward the edge. Height, 18 inches. 15c. each, per doz. \$1.50, \$10.00 per 100.

**"Boule d'Fue."** A Rich Red very early sort producing immense flower trusses. 15c. each, per doz. \$1.50, \$10.00 per 100.

**"H. Hassack."** Scarlet overlaid with Red. Height, 2 feet. 15c. each, per doz. \$1.60, \$11.00 per 100.

**"Lady Masgrove."** White with deep Carmine Eye. 20c. each, per doz. \$2.00, \$15.00 per 100.

**Mrs. Jas. Young.** Pale Lilac almost white with a distinct band or margin of magenta on each floweret petal. The flowers are arranged in a raceme making it excellent for bouquets. 15c. each, per doz. \$1.50, \$10.00 per 100.



HARDY PHLOX

## ROSES



## NEW ROSE "IVORY"

(WHITE GOLDEN GATE)

We are booking orders now for this valuable new addition to the forcing Rose family. All who know of the famous **Golden Gate Rose**, with its free growing habits, will quickly realize the value of this new white sort. It possesses all the good characteristics of its parent, which makes it very desirable and should be in every greenhouse. It produces large flowers on good stout stems of the purest white color.

Strong plants ready April 1st, 1902.

Per doz., \$2.50; \$4.00 for 25; \$15.00 per 100; \$125.00 per 1,000.

50 supplied at 100 rates

250 supplied at 1,000 rates

## New Rose "MRS. OLIVER AMES"

This grand Rose is a sport from Mrs. Pierrepont Morgan, and possesses the same vigorous habit, fine deep green, glossy foliage, erect stout stem, and free blooming qualities as its parent. The flowers are very large, averaging 4 inches in diameter when in perfection. The **color** is a **lovely soft blush**, with a little deeper shading on the edges of the petals, making it the most beautiful of all the delicate colored Roses ever offered. Its keeping qualities are unsurpassed. In short, it is the ideal Rose in size, color, form, etc. It has taken four **Silver Medals**, namely, at New York, October, 1901; Newport, 1901; Orange, N. J., 1901, and at Philadelphia, November, 1901; and Certificates of Merit at Tarrytown, N. Y.; Poughkeepsie, N. Y.; Chicago, Ill.; New York American Institute, N. Y.; Chestnut Hill, Pa.; Madison, N. J., and Burlington, Vt.

Prices strong plants, **ON OWN ROOTS**, ready April 1st, 1902: From 2½ inch pots, 75c. each; 12 for \$7.50; \$12.50 for 25; 50 for \$17.50; \$30.00 per 100; 250 for \$62.50.

**Grafted plants**, \$1.00 each; 12 for \$9.00, 25 for \$15.00; \$25.00 for 50; per 100, \$40.00; \$87.50 for 250.

## New Rose "GREETINGS FROM TEPLITZ"

A choice brilliant scarlet variety surpassing Queen of Scarlets, bearing a profusion of well-shaped flowers, blooming the entire summer, perfectly hardy, and should be included in every garden.

We have an extra fine stock of this variety. Ready March 1st.

4 inch pots, 50c. each; per doz., \$5.00

5 " " 75c. " " " 8.00

6 inch pots, \$1.00 each; per doz., \$10.00

7 " " 1.25 " " " 12.00



**PEAS**

**Michell's "Special Extra Early"**

A distinct early variety coming in at least 3 or 4 days before the other sorts of this class; an immense cropper, producing large pods, each containing about 6 to 8 tender peas of the finest quality; height about 24 inches; no garden should be without this valuable sort. Prices, 10c. per pkt.; per pt. 30c.; 50c. per qt.; 4 qts. for \$1.75.

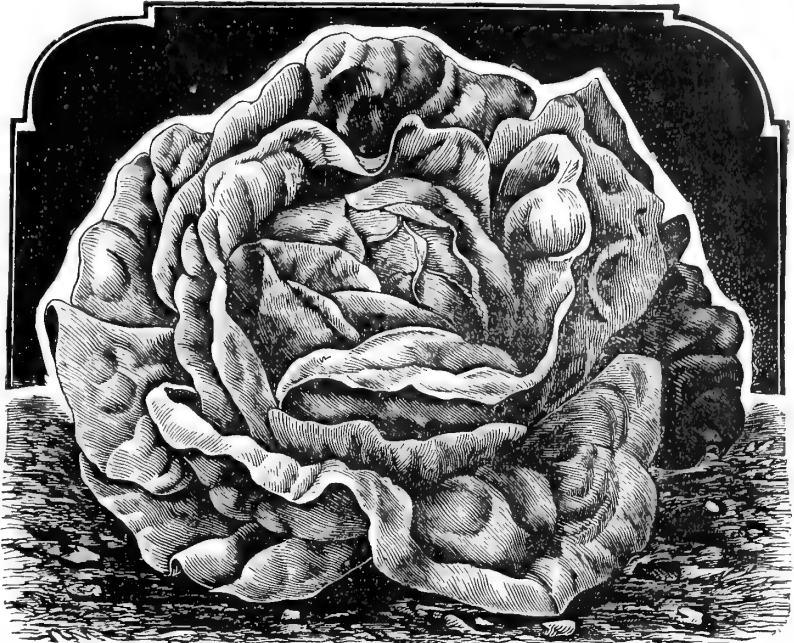

*Michell's All-Right Spring and Autumn Lettuce*

**LETTUCE**

**Michell's "All-Right Spring and Autumn"**

No lettuce has become so popular in as short a time as this valuable sort. For sowing under glass in the early spring and in the open ground for autumn it has no equal, produces immense heads of delicate buttery type, very tender and crisp. Expert market gardeners, who must have the very best, are now sowing this variety extensively, because they can always depend upon it. Prices 10c. per pkt.; per oz. 25c.; 75c. per 1/4 lb.

**CABBAGE**

**Holmes-Houser Cabbage**

A new and entirely distinct round late cabbage, the largest, hardest-heading, fine grained cabbage known, weighing on an average 10 to 12 pounds. They grow so compact and free from spreading leaves that fully 500 more heads can be obtained to the acre than with other cabbages, and in solidity cannot be excelled even by the Danish Ball Head. Heads measuring 36 inches in circumference had hearts measuring only 2 inches.

Mr. Lupton, the noted cabbage specialist, says: "The Holmes-Houser Cabbage is entirely distinct from anything I have ever grown or anything now on the market." Price, 10c. per pkt.; 6 pkts. for 55c.

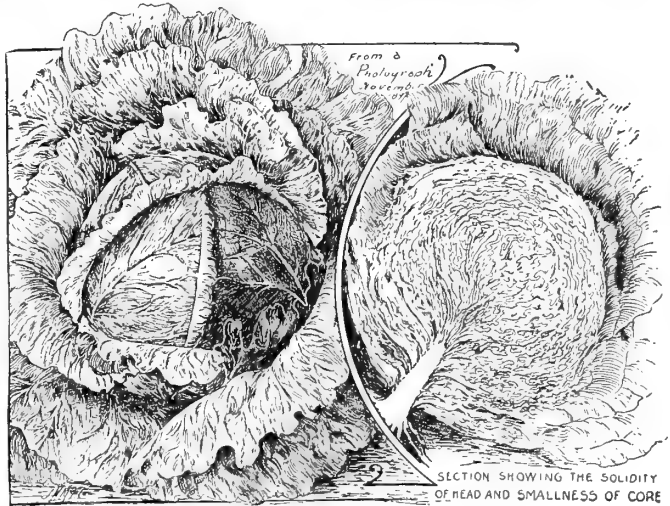

*Holmes-Houser Cabbage. (From a photograph.)*

**New Cabbage—Danish Stoneball**

One of the best winter sorts of recent introduction, producing large smooth round heads of wonderful solidity, even very small heads, sometimes found are as hard as the older fully matured ones, there is no chance crop attached to growing it, always sure to produce excellent heads. Prices, pkt. 10c.; 25c. per oz.

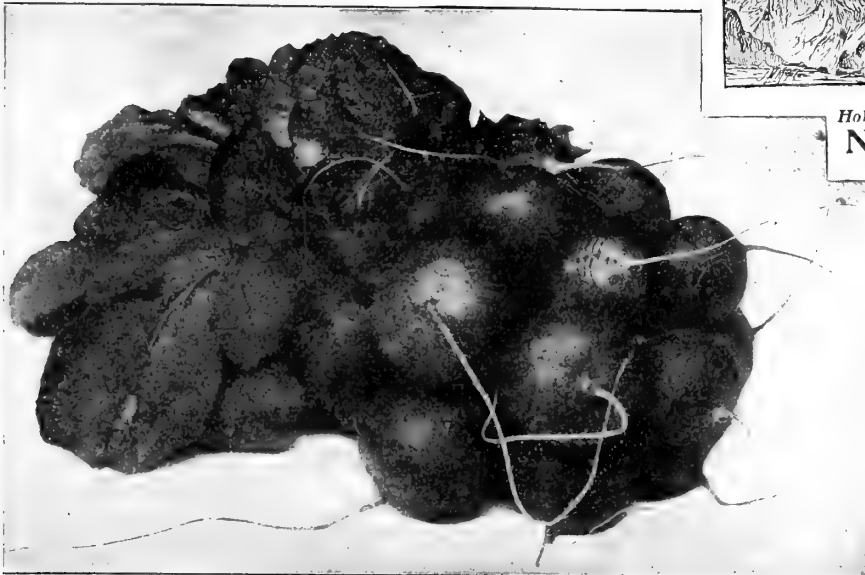

*Michell's Cardinal Globe Radish*

**RADISH**

**Michell's Private Strain  
Cardinal Globe**

This stock is especially selected for us by the original introducer of this valuable sort; color a rich vivid scarlet; its superb form and quality combined make it a most desirable sort. Pkt. 5c.; 15c. per oz.; 30c. per 1/4 lb.; per lb. \$1.00.

## Asparagus

Spargel (Ger.) Asperge (Fr.)

One ounce will sow forty feet of drill, 5 lbs. to the acre.

### Practical Asparagus Culture (Hurley)

Sent free on application.

- ✓ **Columbian Mammoth White.** Pkt. 5c.; 10c. per oz.; per ¼ lb., 25c.; 8cc. per lb.
- ✓ **Conover's Colossal.** The Standard variety, of large size, tender and of excellent quality. Pkt. 5c.; 10c. oz.; 1 lb. 40c.; \$3.50 10 lbs.
- ✓ **Barr's Mammoth.** Pkt. 5c.; 10c. oz.; 1 lb. 50c.; \$4.00 per 10 lbs.
- ✓ **Palmetto.** An early, prolific and very desirable variety. Pkt. 5c.; 10c. oz.; 1 lb. 50c.; \$4.00 per 10 lbs.

## Asparagus Roots

Two Year Old, Extra Healthy and Strong Roots.

About 3,500 roots are required to plant an acre.

Plant two year old roots into permanent beds, which should be well and deeply manured and trenched to the depth of 18 inches. Set the plants in rows from 3 to 4 feet apart, and 2 feet in the rows, spreading out the roots, and cover gradually during the season to 6 or 8 inches. On the approach of winter cover with manure or compost; fork the beds early in spring, and apply a dressing of salt at the rate of 600 lbs. an acre. Cut for use the second year after planting.

- ✓ **Palmetto or Eclipse.** Per 100 80c.; \$5.00 per 1,000.
- ✓ **Columbian Mammoth White.** Per 100 \$1.00; \$6.00 per 1,000.
- ✓ **Conover's Colossal.** Per 100 75c.; \$4.50 per 1,000; \$8.00 per 2,000.
- ✓ **Barr's Mammoth.** Per 100 80c.; \$5.00 per 1,000. 500 of one variety at 1,000 rates.

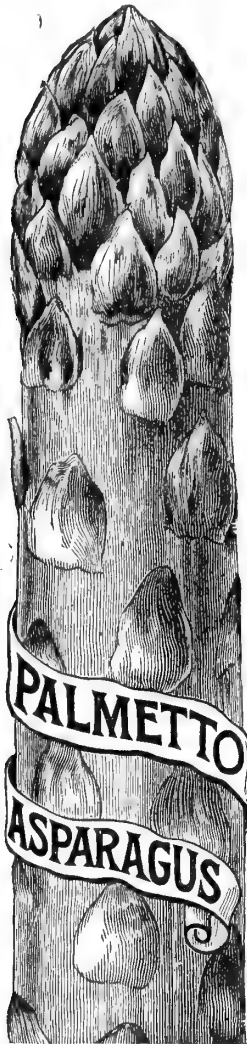
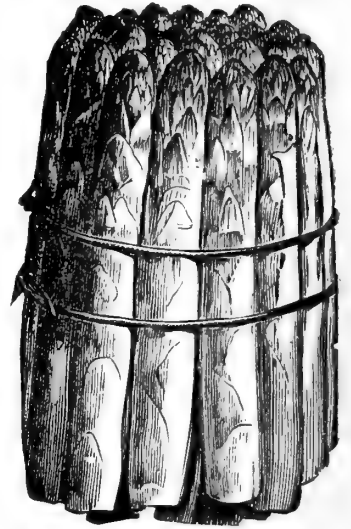

Artichoke (Ger.) **ARTICHOKE** Artichaut (Fr.)

**Green Globe.** Pkt. 5c.; 30c. oz.

**Jerusalem Artichoke Roots.** This variety is not produced from seed. They are sometimes used as a table vegetable when pickled, but their greatest value is for feeding stock. Qt. 15c.; \$1.00 pk.; bush. \$3.00.

Rothe Rüben (Ger.) **BEETS** Betterave (Fr.) One ounce will sow fifty feet of drill 5 lbs. per acre.

The soil best suited for beet culture is that which is rather light and well enriched. Sow in drills one foot apart and one inch deep, as early as the ground can be worked; when the plants are large enough thin out to stand six inches apart in rows; continue for a succession as late as the middle of July. Keep well cultivated.

### VARIETIES FOR TABLE USE

- ✓ **Arlington Favorite Blood Turnip.** Extra early; exceedingly sweet, rich, blood red. Pkt. 5c.; 10c. oz.; ¼ lb. 25c.; 75c. lb.
- ✓ **Bastian's Extra Early Turnip.** The best beet for the market gardener and family use; very early, of quick, large growth, fine turnip form and bright red color; a good forcing variety. Pkt. 5c.; 10c. oz.; ¼ lb. 15c.; 50c. lb.
- ✓ **Bastian's Half-Long Blood.** A valuable variety to follow Bastian's Extra Early; for winter use plant about the middle of July. Pkt. 5c.; 10c. oz.; ¼ lb. 15c.; 50c. lb.
- ✓ **Carter's Excelsior.** A variety of superior quality; color of flesh is perfect, being fine grained with smooth skin and small tops. Pkt. 5c.; 10c. oz.; ¼ lb. 25c.; 75c. 1 lb.

✓ **Crosby's Egyptian.** An improved, perfectly smooth, Egyptian Beet. Much thicker than the original early, of better color and quality. Pkt. 5c.; 10c. oz.; ¼ lb. 25c.; 75c. 1 lb.

✓ **Eclipse.** Remarkable for its rapid growth, extreme smallness of top and extra fine quality. Perfectly smooth and round, skin and flesh intense red. An excellent sort for forcing. Pkt. 5c.; 10c. oz.; ¼ lb. 20c.; 60c. lb.

✓ **Edmand's Blood Turnip.** An early variety, possessing good qualities; flesh dark red, sweet and of good flavor. Pkt. 5c.; 10c. oz.; ¼ lb. 15c., 1 lb. 50c.

✓ **Extra Early Bassano.** A very early flat variety, tender, juicy, flesh white and rose colored. Pkt. 5c.; 10c. oz.; ¼ lb. 15c., 1 lb. 50c.

✓ **Improved Long Blood.** A good late variety for fall and winter use; sweet and tender. Pkt. 5c.; 10c. oz.; ¼ lb. 15c.; 50c. 1 lb.

✓ **Lentz Early Turnip.** A fine sort for early use. Pkt. 5c.; 10c. per oz.; per ¼ lb. 15c.; 50c. per lb.

✓ **Michell's Peerless Beet.** This valuable variety cannot be recommended too highly both for private and commercial use, similar in shape to Edmund's Blood Turnip Beet, and of a dark red color. It forms fine smooth roots of excellent flavor; its winter keeping qualities are also remarkable. Pkt. 5c.; 10c. per oz.; ¼ lb. 25c.; 75c. per lb.

✓ **Swiss Chard.** Grown for its leaves only; the middle of the leaf is served like Asparagus; the other portions of the leaf are used like Spinach. Pkt. 5c.; oz. 10c.; ¼ lb. 20c.; 60c. 1 lb.

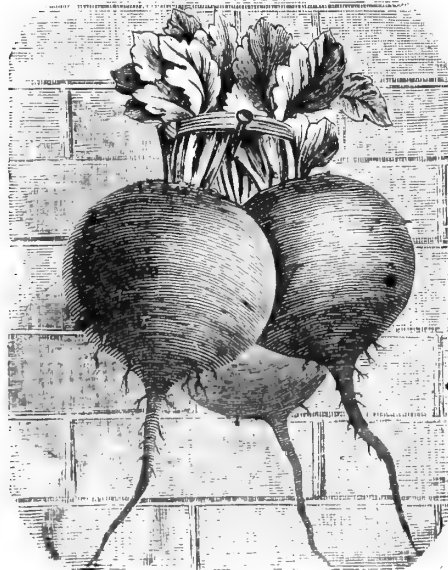

Michell's Eclipse Beet



Michell's Peerless Beet



## Mangel-Wurzel or Cattle Beets

Five pounds are sown to the acre.

Sow in April and May in thoroughly plowed, well-manured soil, in drills two inches deep and about eighteen inches apart. Thin out to twelve inches and keep the weeds down by frequent hoeing and cultivating. Low ground is best adapted for mangel-wurzels.

**Mammoth Long Red.** This is an enormously productive variety, yielding from fifty to seventy tons to the acre, a single root often weighing from twenty to thirty pounds. It is the best long red mangel and very valuable for stock feeding. Oz. 5c.; 10c.  $\frac{1}{4}$  lb.; 30c. lb.; \$2.50 10 lbs.

**Golden Tankard.** The best yellow mangel in cultivation. Relished by milch cows and sheep. Maturing earlier than other large sorts. Oz. 5c.; 10c. per  $\frac{1}{4}$  lb.; 30c. per lb.; \$2.50 per 10 lbs.

**Red Globe.** Oz. 5c.; 10c.  $\frac{1}{4}$  lb.; 30c. lb.; \$2.50 10 lbs.

**Yellow Globe.** Oz. 5c.; 10c. per  $\frac{1}{4}$  lb.; 30c. lb.; \$2.50 10 lbs.

**Norbiton Giant.** Large, small top, one of the best long red varieties. Oz. 5c.; 10c. per  $\frac{1}{4}$  lb.; 30c. lb.; \$2.50 10 lbs.

**Improved Imperial White Sugar Beet.** An improvement on the other varieties of sugar beets, hardier, and containing a greater percentage of sugar. Oz. 5c.; 10c. per  $\frac{1}{4}$  lb.; 30c. lb., \$1.25 5 lbs.

**Lanes Improved White Sugar.** This variety attains an enormous size, growing considerably above the ground, one of the best for stock feeding. Oz. 5c.; 10c. per  $\frac{1}{4}$  lb.; 30c. per lb.; \$1.25 per 5 lbs.

Spargel-Kohl (Ger.). **BROCCOLI** Chou Brocolis (Fr.).

**Grange's Autumn White Cape.** This is the best variety grown; can be grown where cauliflower is an uncertain crop. Pkt. 10c.; 30c. oz.; \$1.00  $\frac{1}{4}$  lb.; \$4.00 lb.

Bohne (Ger.).

## BEANS

[Haricot (Fr.).

One quart will plant about 200 hills or a drill 100 feet long.

### DWARF OR SNAP SHORT

Plant soon as danger from frost is past, in light, warm soil, in drills two inches deep and two feet apart, three inches apart in the drill, or in hills three or four feet apart. Avoid cultivating when wet with rain or dew, as it will injure the crop; hoe often when dry. Plant every two weeks for succession.

### GREEN POD VARIETIES

**Improved Extra Early Red Valentine** One of the very best sorts for private use or market. The pods are round, fleshy, tender, and remain longer in a green state than most varieties. Good for pickling. Pkt. 5c.; by mail 10c.; 25c. qt.; 90c. 4 qts.; \$1.65 pk.; \$6.00 bu.

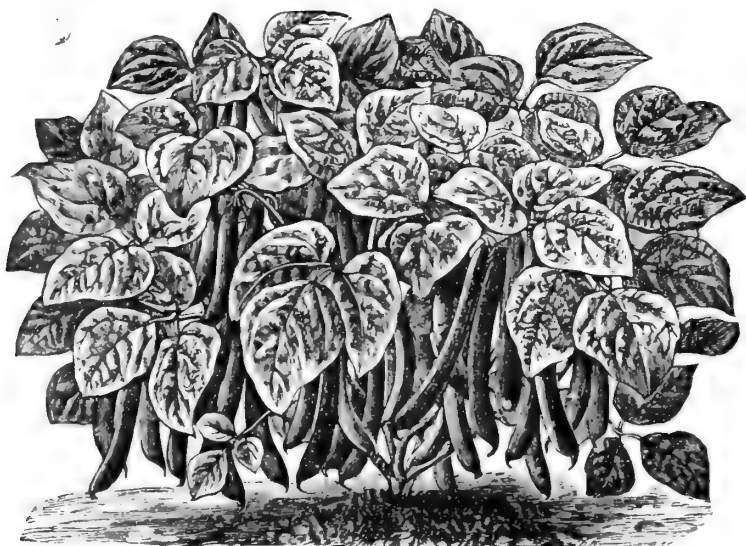

Extra Early Red Valentine

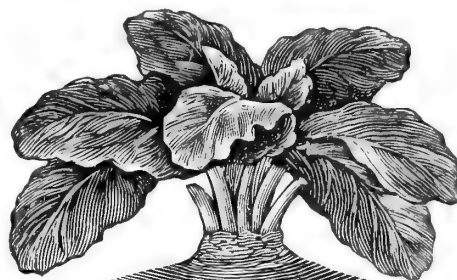

23 lbs.

**MICHELL'S**  
**Mammoth Long Red**  
**Mangel-Wurzel**

We offer \$3.00 in 2 Prizes

for the best 3 specimens of Long Red Mangel-Wurzel Beets exhibited at the Philadelphia Chrysanthemum Show in November, 1902.

**Best of All.** The pods are six inches long, very fleshy, succulent; and of rich flavor; produced early and abundantly. Pkt. 5c.; by mail 10c.; 30c. qt.; \$1.00 4 qts.; \$1.90 per peck; \$6.75 per bush.

**Early Mohawk.** The hardiest of the early varieties, and will endure a slight frost. Pkt. 5c.; by mail 10c.; 25c. qt.; 90c. 4 qts.; \$1.60 pk.; bu. \$5.75.

**Early Long Yellow Six Weeks.** A hardy and prolific variety, a good and reliable cropper. Pkt. 5c.; by mail 10c.; 30c. qt.; 90c. 4 qts.; \$1.65 pk.; \$6.00 bu.

**Mammoth Stringless Green Pod.** An improvement on the Stringless Green Pod variety, possessing the same good qualities but yielding pods of enormous size. Pkt. 5c.; by mail 10c.; 35c. per qt.; \$1.25 4 qts.; \$2.00 per pk.; \$7.00 per bu.

**Stringless Green Pod.** Positively stringless, round pods. Extra early. Pkt. 5c.; by mail 10c.; 30c. per qt.; \$1.00 per  $\frac{1}{2}$  pk.; \$1.75 per pk.; \$6.00 per bu.

**White Kidney or Royal Dwarf.** Pkt. 5c.; by mail 10c.; 25c. qt.; \$1.25 pk.; \$4.50 bu.

**White Marrowfat.** Grown as a dry bean for winter use; excellent shelled. 20c. qt.; \$1.00 pk.; \$3.75 bush.

**Emperor William (Forcing).** Pkt. 15c.; 35c. per pint; 65c. per quart.

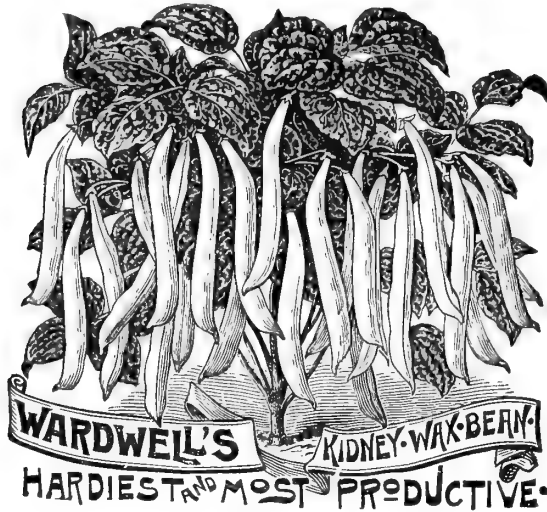

## WAX BEANS

### Yellow Podded Varieties

**Round Podded Kidney Wax.** A valuable addition to the Wax Bean family originated by a specialist, entirely stringless, very tender, and of a rich golden color, producing pods averaging 7 inches in length, considered free from rust. Pkt. 5c.; by mail, 10c.; 25c. per pt.; per qt. 40c.; \$1.30 per 4 qts.

**Dwarf Golden Wax. (Rust Proof.)** Very early and productive, of excellent quality, and entirely free from rust, besides being very crisp and tender and keeps longer than any other after picking, which renders it valuable for distant shipping. Pkt. 5c.; by mail, 10c.; 30c. per qt.; \$1.00 4 qts.; \$1.75 per peck; per bush, \$6.50.

**Wardwell's Kidney Wax.** One of the earliest of all wax podded varieties. Almost entirely free from rust and spots. Long, round, stringless pods. Pkt. 5c.; 30c. per qt.; 4 qts. \$1.00; \$1.75 per peck; per bush, \$6.75.

**Black or German Wax.** Pkt. 5c.; by mail, 10c.; 30c. per qt.; 4 qts. \$1.00; \$1.75 per peck; per bush, \$6.50.

**White Wax.** Pods delicate, waxy white, half transparent. Pkt. 5c.; by mail, 10c.; 30c. qt.; 4 qts. \$1.00; \$1.75 per peck; per bush, \$6.50.

**Saddle-Back Wax.** A cross between the Yosemite Wax and the Black Eyed Wax, pods large, round, very solid and absolutely stringless; an excellent variety. Pkt. 5c.; by mail, 10c.; 30c. qt.; 4 qts. \$1.00; \$1.90 per peck; per bush, \$7.00.

**Perfection Wax.** For vigor of growth and immense productiveness it is scarcely equaled by any other Dwarf Wax Bean. The magnificent, large, golden-yellow pods are handsome, stringless, tender, and of a very rich flavor. Pkt. 5c.; by mail 10c.; 30c. per qt.; 4 qts. \$1.00; \$1.75 per peck; per bush, \$6.50.

**Valentine Wax.** The very earliest wax bean. Round pods, stringless and rust-proof. Pkt. 5c.; by mail 10c.; per qt. 30c.; \$1.00 4 qts., per peck \$1.75; \$6.75 per bush.



Burpee's Bush Lima

## Pole Beans

Plant in hills four feet apart, six to eight beans to hill, eyes downward, afterward thin to three plants in a hill. Set poles eight to ten feet high before planting.

**Early Golden Cluster Wax.** Pods very tender, six to eight inches long, of large size, borne profusely in large clusters of three to six; beautiful golden yellow color, which they retain long after being picked. Snaps easily, is stringless, cooks tender, delicious flavor. Pkt. 10c.; pt. 25c.; qt. 40c.; \$1.35 per 4 qts.

**Kentucky Wonder. (Green Pod.)** One of the best green pod pole beans, producing pods in clusters ready for use about 85 days from time of planting. Pkt. 10c.; 25c. pt.; qt. 40c.

**Lazy Wife's. (Green Pod.)** Pkt. 10c.; 30c. per qt.; per 4 qts. \$1.00.  
**Horticultural or Speckled Cranberry. (Green Pod.)** Pkt. 10c.; 25c. pt.; qt. 35c.; \$1.15 per 4 qts.

**Scarlet Runner. (Green Pod.)** Pkt. 10c.; 20c. per pt.; qt. 35c. \$1.15 per 4 qts.

## English or Broad Windsor Beans

Used only as shelled beans. Plant in strong, heavy soil, in drills three feet apart and two inches deep. Pkt. 10c.; 20c. per pt.; qt. 35c.; \$1.15 per 4 qts.

## LIMA BEANS

These are more tender and require rather more care in culture than the Bush Beans, and should be sown two weeks later. They succeed best in sandy loam, which should be liberally enriched with short manure in the hills, which are formed, according to the variety, from three to four feet apart; from five to six seeds are planted in each hill about two inches deep. Rough cedar or similar poles, about seven or eight feet long, should be used for Lima Beans to climb on. They should be set in the ground at least eighteen inches, so as to prevent being blown over.

## Pole Varieties

Stangen Bohne (Ger.).

Haricots A Rames (Fr.).

One quart will plant 150 hills.

**Ford's Mammoth Podded Large.** The most valuable and prolific variety. Pods six to nine inches long; seed grown from original stock. Pkt. 10c.; 50c. qt.; 4 qts. \$1.50.

**Michell's Selected Large Jersey.** Has proven exceedingly satisfactory; beans are very tender and luscious. An extra selection of seed stock; large fine beans, all hand picked. Pkt. 10c., 35c. qt.; 4 qts. \$1.20; \$2.00 per peck.

**King of the Garden.** Vigorous grower, requiring but two vines to each pole, producing a continuous bloom and fruitage to extreme end of season. Pods are of enormous size, many specimens measuring from five to eight inches, producing as high as six beans to the pod, perfectly formed and of superior quality. Pkt. 10c.; 20c. per pt.; 35c. qt.; 4 qts. \$1.20; \$2.00 per peck.

**Siebert's Extra Early.** The earliest pole Lima. Very productive and tender. Pkt. 10c.; 25c. pt.; qt. 45c.; 4 qts. \$1.25.

**Dreer's Improved.** Earlier and more prolific than Large Lima; beans smaller, extra quality. Pkt. 10c.; 40c. qt.; 4 qts. \$1.35; peck \$2.25.

**Extra Early Jersey.** Pkt. 10c.; 40c. qt.; 4 qts. \$1.35; \$2.25 per peck.

**Small Lima or Sieva.** Pkt. 10c.; 30c. qt.; 4 qts. \$1.00; \$1.75 per peck.

**Horticultural Lima.** A variety of the highest merit. It is a cross between Dreer's Pole Lima and Dwarf Horticultural, combining the excellent quality of the Dreer Lima with the earliness, hardiness and flavor of the Horticultural, being fully three weeks earlier than any other Lima. Pkt. 10c.; 40c. qt.; \$1.25 per 4 qts.; peck \$2.25.

**Early Black Lima.** Pkt. 10c.; 40c. qt.

## Red Cedar Bean Poles

\$5.00 per 50; per 100 \$9.00.

## Dwarf or Bush Varieties

**Dreer's Bush Lima.** A splendid variety. Pkt. 10c.; 30c. per pt.; per qt. 50c.; \$1.60 4 qts.

**Henderson's Bush Lima.** The earliest of all Limas. Pkt. 10c.; 40c. qt.; 4 qts. \$1.35.

**Burpee's Bush Lima.** The only bush form of the true Large Lima Bean. Pkt. 10c.; 20c. pt.; qt. 40c.; \$1.20 4 qts.; per peck \$2.25.

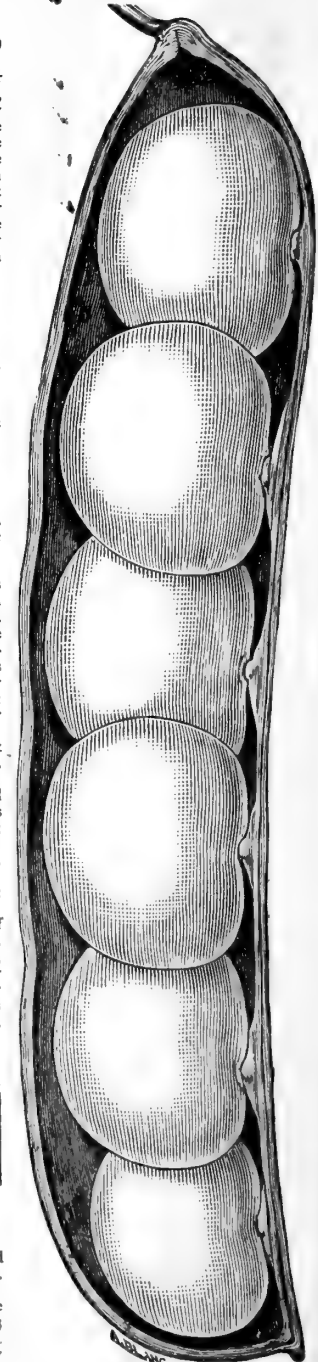

Specimen Pod of Michell's Selected Large Jersey Lima

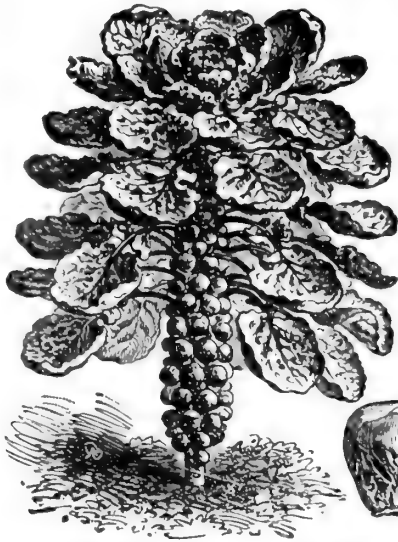

**BRUSSELS SPROUTS**

Brusseler Sprossen (Ger.)  
Chou de Bruxelles (Fr.)

Produces small heads from side of stalk, which are in perfection for use in autumn after early frosts. Sow in May, transplant in June one foot apart each way and cultivate like winter cabbage. A most delicious vegetable very easily grown.

Matchless Improved. Pkt. 5c.; 15c. per 1/2 oz.; 25c. oz.; 75c. 1/4 lb  
Sutton's Exhibition. Per original pkt. 25c.

**IMPROVED BRUSSELS SPROUTS CABBAGE**

(Kopfkohl Ger.) Chou Pomme ou Cabus (Fr.)

One ounce will produce about 2000 plants. Our Cabbage seed is all grown from selected heads only, by a specialist on Long Island.

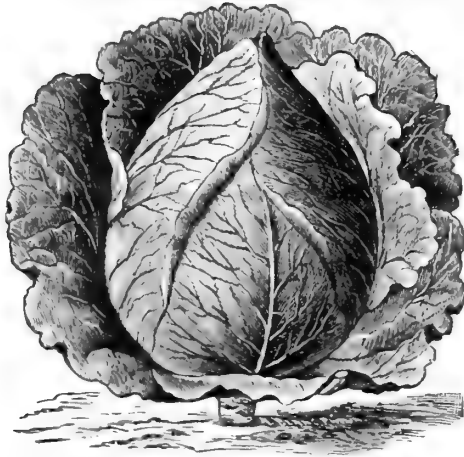

The requirements for a good crop are rich soil, deep plowing, high manuring and good seed. Sow seeds in January or February in hotbeds, and transplant latter part of April or early in May to open ground, or an early sowing in open ground is the custom. Set the plants in rows two feet apart, and 12 to 18 inches apart in the row. For second early sow in April and transplant in May. For late crop sow in July, setting plants in rows three feet apart and two feet in rows.

- Michell's Private Strain Early Jersey Wakefield.** A favorite market gardeners' variety, very early, following the Oxheart, of good size and quality and always sure to head; extra fine selected stock. Pkt. 10c.; 30c. oz.; \$1.00 1/4 lb.; \$3.50 lb.
- Large Early York.** A good old standard variety. Pkt. 5c.; 20c. oz.; 60c. per 1/4 lb.; \$2.00 lb.
- Large Charleston Wakefield.** Selected, large solid heads of good quality, about one week later than Early Jersey Wakefield. Pkt. 10c.; 30c. oz.; \$1.00 per 1/4 lb.; \$3.50 lb.
- Early Winnigstadt.** A solid tender variety, good for either early or late. Pkt. 5c.; 20c. oz.; 60c. 1/4 lb.; \$1.25 per lb.
- Early Flat Dutch.** A valuable second early variety forming large solid heads of fine quality. Pkt. 5c.; 20c. per oz.; 65c. per 1/4 lb.; \$2.00 per lb.
- All Head Early.** Pkt. 10c.; 20c. per oz.; 75c. per 1/4 lb.; \$2.50 per lb.
- Stoneball.** One of the finest winter cabbages yet introduced, it forms large smooth round heads, from which it well deserves its name, its winter keeping qualities are unsurpassed. Pkt. 10c.; 25c. per oz.; 80c. per 1/4 lb.; \$2.75 per lb.
- Henderson's Early Summer.** A second early variety, with large solid heads, coming in a few days later than the Wakefield. Pkt. 10c.; 25c. oz.; 75c. per 1/4 lb.; \$2.50 lb.
- Succession.** A good second early sort producing solid round heads, comes in a few days later than Henderson's Early Summer. Pkt. 10c.; 30c. per oz.; \$1.00 1/4 lb.; \$3.50 per lb.
- Early Drumhead.** A second early, large, solid, flat-heading variety. Pkt. 10c.; 30c. per oz.; 75c. 1/4 lb.; \$2.25 per lb.

**We offer \$3.00 in Two Prizes for the best Six heads of Cabbage exhibited at the Philadelphia Chrysanthemum Show in Nov. 1902.**

**CABBAGE—Continued.**

- All Seasons Selected.** Pkt. 10c.; 25c. oz.; 75c. per 1/4 lb.; \$2.50 per lb.
- Danish Ballhead.** One of the very best medium late sorts. Hardly ever fails to produce a hard, good shape, large head. Pkt. 10c.; 25c. per oz.; per 1/4 lb. 75c.; \$2.50 per lb.
- Holmes Houser.** An excellent winter sort of great merit, selected by a specialist after careful growing for years. Per pkt. 10c.
- Extra Selected Late Flat Dutch.** The favorite Philadelphia winter market variety, short stem and large solid flat heads; superior stock. Pkt. 5c.; 20c. oz.; per 1/4 lb. 60c.; \$2.00 per lb.
- Large Late Drumhead.** A favorite winter variety with market gardeners; extra large solid heads. Pkt. 5c.; 20c. oz.; 1/4 lb. 60c.; \$2.00 per lb.
- Perfection Curled Drumhead Savoy.** The largest solid heading curled sort, of excellent flavor. Pkt. 5c.; 25c. oz.; 1/4 lb. 60c.; \$2.00 per lb.
- Early Green Curled Savoy.** Pkt. 5c.; 25c. oz.; 1/4 lb. 60c.; \$2.00 per lb.
- Red Dutch Drumhead.** A large red-heading variety for pickling. Pkt. 5c.; 20c. oz.; 1/4 lb. 60c.; \$2.00 per lb.

**CABBAGE PLANTS**

**EARLY SORTS.** From hot beds. All the leading varieties ready April 1st. 100 40 cts. per 1000 \$3.00.  
**FROM COLD FRAMES TRANSPLANTED.** 75c. per 100; per 1000 \$6.00.  
**LATE SORTS.** Ready July 1st. 100 30c.; 1000 per \$2.00.  
**SPECIAL PRICES ON LARGE QUANTITIES.**

**CARROT**

Möhren (Ger.) Carotte (Fr.)

One ounce to 100 feet of drill, three pounds to the acre.

- A light sandy loam, well tilled and manured the previous year best suits the carrot; for early crops sow as early as the ground can be worked, in drills ten inches apart, and thin to five inches in the row.
- Very Early Short-Horn Scarlet or French Forcing.** An early forcing variety; small root and excellent flavor. Pkt. 5c., 10c. oz.; 1/4 lb. 30c.; \$1.00 lb.
- Early Scarlet Horn.** The favorite early red variety, fine grained and good flavor. Pkt. 5c.; 10c. oz.; 1/4 lb. 30c.; \$1.00 lb.
- Early Half-Long Scarlet.** A very desirable pointed root variety, coming in between the Scarlet Horn and the Long Orange; early of fine flavor and good color. Pkt. 5c.; 10c. oz.; 1/4 lb. 25c.; 75c. lb.
- Danvers Half Long.** The best variety for general crop; is rich orange color, a very heavy yielding and splendid keeper, first-class Carrot for all soils, and valuable both for table and stock. We have an extra fine strain of seed of this favorite sort. Pkt. 5c.; 10c. oz.; 1/4 lb. 25c.; 75c. lb.
- New Rubicon Half-Long.** An entirely distinct Carrot. It is the best in shape, and its deep red orange-colored flesh is the finest in quality of all. It is earlier than the Danvers and about the same length; extremely well adapted for early forcing, for growing outside at any season of the year, being a wonderfully heavy cropper on any kind of soil. Pkt. 5c.; 10c. oz.; 1/4 lb. 30c.; \$1.00 lb.

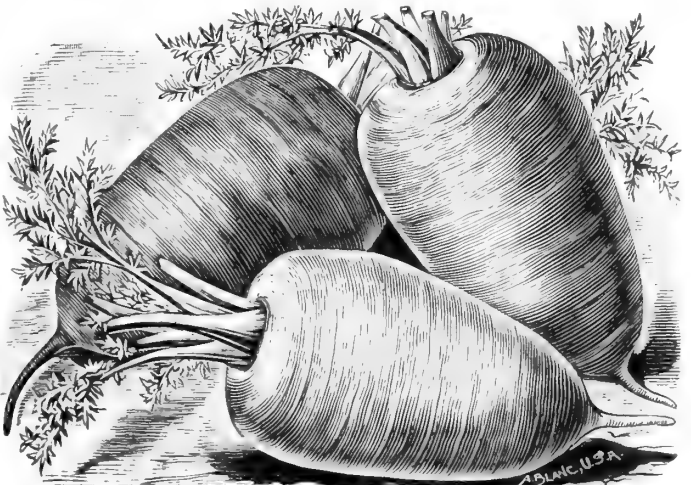

**Rubicon Half Long Carrot**

- Guerande or Oxheart.** A desirable variety on soils too hard and stiff for the longer growing sorts, as it is not over five or six inches long. It frequently grows as thick as long, thus making it really as large as the longer sorts. Pkt. 5c.; 10c. oz.; 1/4 lb. 25c.; 75c. lb.
- Chantenay Half-Long.** Resembles the Nantes; very productive. Pkt. 5c.; 10c. oz.; 1/4 lb. 25c.; 75c. lb.
- Improved Long Orange (Nichol's).** Deep orange color, good flavor, yields heavily; is of excellent table quality, and is also the best for stock. Pkt. 5c.; 10c. oz.; 1/4 lb. 25c.; 75c. lb.; 5 lb. lots \$3.50.



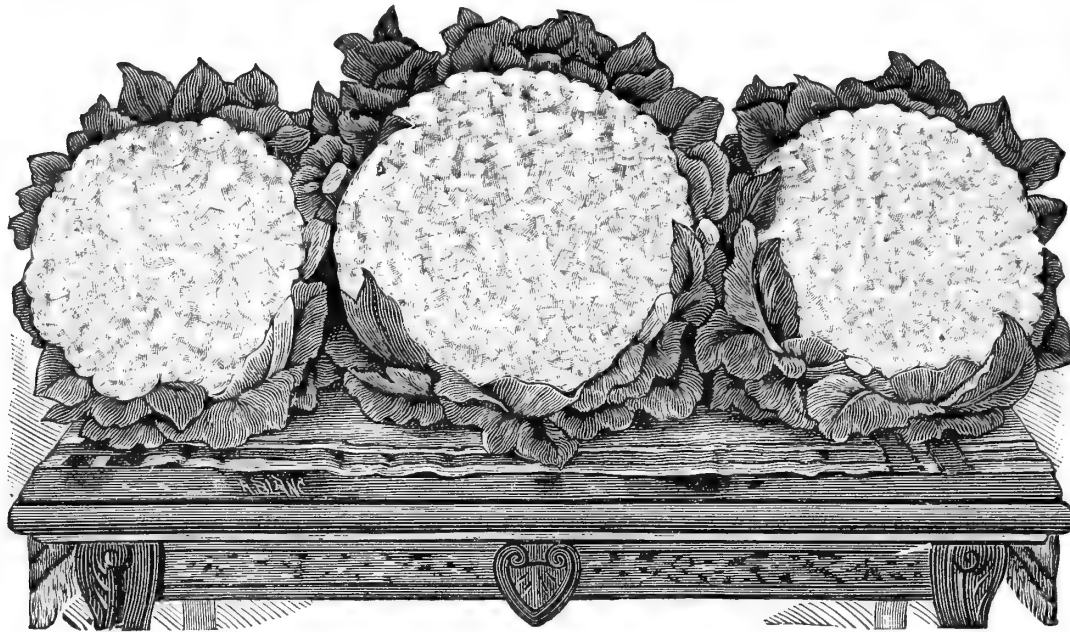

Michell's Special Strain Selected Erfurt Cauliflower.

**We Offer**  
**\$3.00**

in Two Prizes for  
the best Five  
Heads of Cauli-  
flower exhibited  
at the Philadel-  
phia Chrysanthe-  
mum Show in  
November, 1902.

One Ounce Produces  
About 1500 Plants.

## CAULIFLOWER

Blumen-Kohl (Ger.). Chou-Fleur (Fr.).

Sow for early use about the middle of September or October, in a bed of rich earth, transplant in frames and cover with sashes and shutters during severe weather, giving them the light and air every mid day, or they may be had nearly as well by sowing the seed in a hotbed in January or February; when the plants are large enough transplant three inches apart in boxes or in other hotbeds until time to plant out; if hardened off, they are seldom injured by planting out as early as ground can be properly prepared, 2½ feet apart each way; keep well hoed, and bring earth gradually up to their stems, watering freely in dry weather, and especially when they begin to head.

**Michell's Special Strain Selected Erfurt.** One of the earliest in cultivation, small leaved dwarf, for forcing or open ground, producing very solid, pure white heads of the finest quality; ordinary seasons every plant will produce a marketable head. Pkt. 20c.; 75c. quarter oz.; oz. \$2.50; \$8.00 per ¼ lb.

**Earliest Snowstorm.** Earliest and best for forcing; dwarf, with short outer leaves, can be planted two feet apart each way; sure to make large fine heads; must be kept growing constantly, will not stand a check at any period of its growth. Pkt. 25c.; \$1.50 per quarter oz.; per oz. \$5.00.

**Early Snowball.** A splendid early dwarf variety, producing magnificent white heads. Pkt. 20c.; 75c. per ¼ oz.; per oz. \$2.50; \$7.50 per ¼ lb.

**Half Early Paris.** A popular, white, sure heading variety, good for early or late use. Pkt. 10c.; 65c. oz.

**Lenormand's Short Stem.** A large, late short-stemmed variety, with well formed white heads. Pkt. 10c.; 65c. oz.

**Veitch's Autumn Giant.** One of the finest late varieties of robust habit, heads large, compact. Per pkt. 10c.; 65c. oz.

**Sutton's First Crop.** Per original pkt. 50c.

**Algiers.** One of the best late sorts; always produces a good head. 10c. per pkt.; per oz. 75c.

## CAULIFLOWER PLANTS.

Spring plants, best varieties. Ready about April 1st, 25c. per doz.; \$1.25 per 100. Wintered over Cauliflower plants, strong and healthy, 40c. per doz.; \$2.00 per 100.



Water Cress.

## WATER-CRESS.

Brunnenkresse (Ger.). Cresson de Fontaine (Fr.).

The pleasant and peculiar flavor of the water-cress, and also the hygienic properties have caused it to be highly esteemed for table use. Its culture can be carried on anywhere where there is sufficient supply of fresh, pure water; it is not even necessary it should be running water; it can be renewed often enough to keep it clean and pure. It can be grown without water even, in tubs half filled with good soil and kept in a moist, shady position with an occasional watering.  
**True Erfurt.** Pkt. 10c., 40c. oz.; lb. \$3.50.

Kresse (Ger.). **GARDEN CRESS.** Cresson (Fr.).

Sow thickly in early spring in drills one foot apart, and follow every two weeks with a new sowing as it quickly runs to seed. Water-cress should be sown along the margin of ditches, ponds, or better still, of slow running streams. It requires no care except to free it at first from weeds.

**Extra Curled or Pepper Grass.** Fine flavor, can be cut several times. Pkt. 5c.; 10c. oz.; lb. 50c.

**Upland Grass.** Perennial, grown in the same manner as spinach; resembles water-cress in flavor. Pkt. 10c.; 50c. oz.



Curled Garden Cress or Pepper Grass.



Corn Salad.

Acker Salat (Ger.). **CORN SALAD.** Mache (Fr.).

For early spring use sow the seed in September thickly in drills quarter inch deep. Protect with litter when cold weather comes and winter over like spinach. One ounce will sow over 35 feet of row.

**Large Round-Leaved.** Pkt. 5c.; 10c. oz.; ¼ lb. 20c.; 55c. lb.

## CHICORY.

**Large Rooted.** Pks. 5c; 10c. oz.; ¼ lb. 25c.; 80c. lb.

Gartenkerbel (Ger.). **CHERVIL.** Cerfeuil (Fr.).

**Curled or Doubled.** Pkt. 5c.; 15c. oz.; lb. \$2.00

## CARDOON.

The midribs are the edible parts, desirable for soups or stews, after being blanched in the same manner as celery. Sow in April in drills one inch deep; when one year old transplant in trenches of well manured ground three feet apart and one foot in the rows. The roots remain from year to year. Is now much used as a border plant around large beds of cannas and grasses. Pkt. 10c.; 40c. oz.

**CHIVES.** For seasoning. Strong plants, 10c. each; per doz. \$1.00; \$7.50 per 100.



Michell's "Far Superior Many Heart Celery" Leads them all.

5 lbs.

Michell's "Far Superior Many Heart."

**CELERY PLANTS**

All the leading sorts ready July 1st. Per 100, 40c., 1000, \$3.00

We offer \$3.00 in 2 prizes for the best 5 stalks of Celery of any named variety or varieties exhibited at the Philadelphia Chrysanthemum Show in November, 1902.

**Celery.**

Sellerie (Ger.)

Celeri (Fr.)

One ounce of seed will produce about 2000 plants.

Sow the seed late in March, or early in April, on fine, well worked soil. Cover slightly, or better still, roll or press it. Shade the young plants for a week or ten days, and do not let the soil dry out. Cut them once or twice before setting out to make them stocky. When from four to six inches high transplant into broad shallow trenches or to level ground, setting dwarf sorts in rows three feet apart, and tall sorts four feet apart, six inches apart in the rows. To store for winter use select well drained ground, dig trenches one foot wide and deep enough to cover tops of plants. Pack stalks in this in an upright position, covering with boards to shed the water, and in severe weather protect with straw or leaves and celery paper. **Michell's "Far Superior Many Heart."** We can especially recommend this variety to every grower of celery; its quality is superior to most other varieties, an excellent keeper over winter and produces plenty of heart which is now the most important point in celery. Pkt. 10c., 30c. per oz., 85c. per ¼ lb., \$3.00 per lb.

**Crawford's Half Dwarf.** An old and always reliable variety, still in demand, good winter keeper. 10c. per pkt., per oz. 25c., 75c. per ¼ lb.

**Perle Le Grand.** Full golden heart, and rich nutty flavor, a good early celery, and a good winter keeper. Pkt. 10c., oz. 40c., ¼ lb. \$1.25, lb. \$4.00.

**Large white Solid.** (True). Pkt. 5c., oz. 25c., 75c. ¼ lb.

**Improved Dwarf Golden Heart.** Heart large and full, of a golden yellow, excellent for either market or private use; solid, of excellent flavor, and keeps well. Pkt. 5c., oz. 20c., lb. \$2.00.

**Winter Queen.** (New). Very solid half dwarf, will keep fresh later than any other variety. 10c. pkt., 35c. per oz., \$1.00 per ¼ lb., \$3.50 per lb.

**"Fin de Siecle."** This is one of the very best varieties in cultivation, stalks thick and compact, very crisp and fine flavor. Pkt. 10c., oz. 35c., ¼ lb. \$1.00, \$3.50 per lb.

**Cooper's Improved Cutting or Branching.** The leaves are used as greens for flavoring soups. Plants are pulled when few inches high and bunched for market. Pkt. 10c., oz. 15c.

**Giant Pascal.** A superior keeping sort. The stalks are very large, thick, solid, crisp, and of a rich nutty flavor. Pkt. 5c., oz. 25c., ¼ lb. 75c., lb. \$2.50.

**Boston Market.** A short, bushy, white, solid, excellent flavored variety, constantly in demand. Pkt. 10c., oz. 25c., ¼ lb. 75c., lb. \$2.50.

**White Plume, Improved.** (True Stock). The best for early use, crisp, solid, nutty flavor. Pkt. 10c., oz. 25c., lb. \$2.50.

**Sutton's White Gem.** Per original pkt. 40c.

**Golden Self-Blanching.** Compact, large, solid, crisp, and of a nutty flavor, with a rich golden heart. Pkt. 10c., oz. 30c., lb. \$3.50.

**Self-Blanching Paris Pink.** The very best pink variety yet introduced. Its quality is very highly praised by celery growers and has given universal satisfaction. Pkt. 15c., oz. 50c., ¼ lb. \$1.50.

**Red Solid or Rose.** Pkt. 5c., oz. 25c.

**Henderson's "Pink Plume."** Very solid and crisp, extra early and a long keeper. A self-blanching variety, and requires but a slight earthing-up or banking. Pkt. 10c., oz. 30c.

**Heartwell Perfection.** Pkt. 5c., oz. 20c., lb. \$2.00.

**Celeric or Turnip-Rooted. Giant Prague.** The root cooked or sliced and used with vinegar, makes an excellent salad. Pkt. 5c., oz. 20c., lb. \$1.50.

**PAPER FOR COVERING CELERY**

\$1.00 PER ROLL OF 500 SQUARE FEET

**Cucumber.**

Gurke (Ger.)

Concombre (Fr.)

One ounce of seed will plant about fifty hills, or two pounds per acre.

For early use sow in hothouse on small sods overturned, or in small pots plunged in earth. As soon as danger from frost is over, transplant with sod, so as not to disturb the plants, into hills in the open ground. For general crop sow from about the first to the middle of May in rich, mellow, warm soil. Use a shovelful of well-rotted manure in each hill and cover it two inches deep with fine earth. On this sow the seed, about eight or ten seeds to a hill; cover one-half inch with earth and press down. When danger from bugs is past thin out to four plants to a hill. For pickles, plant from June to middle of July.

**Livingston's Evergreen.** Very hardy and probably the most prolific of all varieties. Very early, and the cucumbers retain their beautiful green color longer than any other sort. It is one of the very best varieties for slicing. Pkt. 5c., 10c. oz., ¼ lb. 25c., 80c. lb.

**Early Russian.** The earliest variety; the fruit is of small size and produced in pairs. Pkt. 5c., 10c. oz., ¼ lb. 20c., 65c. lb.

**Early Frame.** A good old popular variety, of medium size. Pkt. 5c., 10c. oz., ¼ lb. 20c., 65c. lb.

[CUCUMBER continued on next page.]

# Michell's Fresh Tested Vegetable Seeds

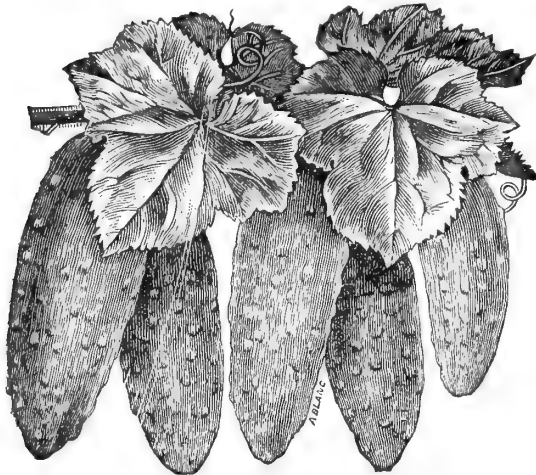

## CUCUMBER—Continued

- Livingston's Emerald.** A new and most excellent rich green variety, either for outdoor culture or for growing under glass. Pkt. 10c., oz., 20c. 40c. per ¼ lb., \$1.00 lb.
- Improved Early White-spined.** The favorite market variety, largely used for forcing, and extensively grown South for shipping North early in the season; of medium large size, deep green, crisp, fine flavor, and very productive. Pkt. 5c., oz. 10c., 20c. per ¼ lb., 60c. lb.
- Everbearing.** Pkt. 5c., oz. 10c., 20c. per ¼ lb., 60c. lb.
- Tailby's Hybrid.** A variety hybridized with the White-spined and English prize, retaining the beauty of the Long English and hardiness of the White-spined; of large size and excellent for slicing; splendid forcing variety. Pkt. 5c., oz. 10c., 25c. per ¼ lb., 75c. lb.
- Jersey Pickle or Green Prolific.** One of the best pickling varieties; dark green, tender, crisp, and great productiveness, of fine flavor, and good for table use. Pkt. 5c., oz. 10c., 20c. per ¼ lb., 60c. lb.
- Long Green Turkey.** The leading long green variety for pickling; of excellent quality and productiveness, fruit dark green, firm and crisp; can be gathered any size while young for pickles. Pkt. 5c., oz. 10c., 20c. per ¼ lb., 60c. lb.
- Small Gherkin or Burr.** Also known as the West India or Jerusalem Pickle; used only for pickling while young and tender. Pkt. 5c., oz. 20c., 40c. per ¼ lb., \$1.00 lb.

## ENGLISH PRIZE FORCING CUCUMBER

Sow the seeds in small pots about the middle of January; when they have grown to three leaves plant in a prepared hill of rich, loose soil in the centre of a sash.

We offer \$3.00 in Two Prizes for the best Three Hot-house Cucumbers exhibited at the Philadelphia Chrysanthemum Show in November, 1902.

Per pkt.	Per pkt.	Per pkt.
Covent Garden ..... 20c	Rochford's Market Garden ..... 25c	Tender and True..... 20c
Marquis of Lorne ..... 20c	Telegraph ..... 20c	Ideal..... 25c
Sion House ..... 20c	Sutton's Matchless in original pkts., 50c.	

## CORN—Field Varieties.



	Per quart.	Per peck.	Per bush.
Blount's Prolific White Ensilage.....	15c.	45c.	\$1.40
Chester County Mammoth	15c.	50c.	1.50
Cloud's Early Yellow Dent	15c.	50c.	1.50
Early Yellow Canada, or Flint.....	15c.	50c.	1.50
Golden Beauty, Improved. The best and most productive, having extra large, broad golden grains and good sized ear.....	15c.	50c.	1.40
Hickory King. White Dent.	15c.	45c.	1.40
Leaming Early Dent.....	15c.	45c.	1.40
New Field Corn (Michell's Goliath). This new variety is one of the most prolific and earliest field corns offered; the immense ears and deep grain produced make it well deserving of its name.....	20c.	80c.	2.50
Red Cob Ensilage.....	15c.	50c.	1.50
Sheeptooth Southern Fodder.....	15c.	50c.	1.50
Sweet or Sugar (Fodder).....	15c.	50c.	1.75
	(\$8.00 per 5 bush.)		
The 100-day Bristol. The largest eared, earliest Yellow Dent corn in cultivation	20c.	50c.	1.50

## SWEET OR SUGAR CORN

Zuckerkorn (Ger.).

One quart will plant 100 hills, 8 quarts to the acre.

Mais (Fr.).

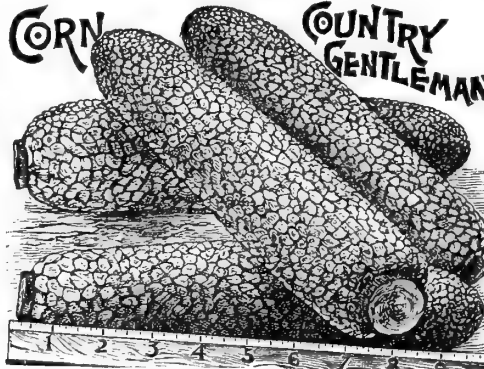

Make the first planting about May 1st, and sow every two weeks thereafter until the middle of July for succession. Plant in hills from three to four feet apart, according to size or variety.

Our Sugar Corn is grown by the most reliable grower in the Connecticut Valley and can be relied on.

### TESTIMONIAL.

CARLISLE, PA., August, 1901.

I wish to give you credit for the very desirable Early Corn sent me. It was exceptionally fine, also of finest quality, producing very freely large ears.

Yours truly,

JESSE ROBBINS.

- Adam's Extra Early.** The earliest variety for table use. Pkt. 5c., 15c. per qt., 4 qts. 50c., 80c. pk.
- Black Mexican.** Pkt. 5c., 20c. per qt., 4 qts. 65c., \$1.00 pk.
- Country Gentleman.** Will delight the most fastidious epicure; the ears are not only of good size, but are produced in great abundance. Pkt. 5c., 20c. per qt., 4 qts. 65c., \$1.00 pk.
- Crosby's Extra Early.** A favorite variety, very early, productive, ears rather short and of a rich sugary flavor. Pkt. 5c., 20c. per qt., 4 qts. 65c., \$1.00 pk.
- Early Evergreen (New).** Pkt. 5c., 20c. per qt., 4 qts. 70c., \$1.25 pk.
- Early Mammoth.** Pkt. 5c., 20c. per qt., 4 qts. 65c., \$1.00 pk.
- Egyptian.** A fine variety, resembling the Evergreen. Pkt. 5c., 20c. per qt., 4 qts. 65c., \$1.00 pk.
- Honey Dew (Selected).** Very luscious and sweet, one of the earliest. Pkt. 5c., 25c. per qt., 4 qts. 85c., \$1.40 pk.
- Improved First of All.** The very earliest sweet corn. Pkt. 5c., 20c. per qt., 4 qts. 65c., \$1.00 pk.
- Kendel's Early Giant Sweet.** We can especially recommend this extra early variety, as it produces a PERFECT good sized ear, which is of very sweet flavor. Pkt. 5c., 25c. per qt., 4 qts. 85c., \$1.40 pk.
- Little Gem, or Shoe Peg.** Pkt. 5c., 20c. per qt., 4 qts. 65c., \$1.00 pk.
- Mammoth Sugar.** The largest late sort, very productive. Pkt. 5c., 20c. per qt., 4 qts. 60c., \$1.00 pk.
- Michell's Delicious.** Unrivalled in flavor and sweetness. Pkt. 5c., 20c. per qt., 4 qts. 35c., \$1.10 per 4 qts.
- New England, or Early Eight-rowed.** Pkt. 5c., 20c. per qt., 4 qts. \$1.00 pk.
- Roslyn Hybrid.** A medium late variety; a large ear, very sweet. Pkt. 5c., 20c. per qt., 4 qts. 65c., \$1.00 pk.
- Squantum (Potter's).** Excellent. Pkt. 5c., 20c. per qt., 4 qts. 65c., \$1.00 pk.
- Stabler's Extra Early.** Of larger size than usual for the early kinds; fine flavor. Pkt. 5c., 20c. per qt., 4 qts. 65c., \$1.00 pk.
- Stabler's Nonpareil.** The second best early corn; large ears. Pkt. 5c., 20c. per qt., 4 qts. 65c., \$1.00 pk.
- Stowell's Evergreen.** One of the sweetest, remaining green longer than any other variety. Pkt. 5c., 20c. per qt., 4 qts. 60c., \$1.00 pk.
- Triumph.** Large ear (early). Pkt. 5c., 20c. per qt., 4 qts. 65c., \$1.00 pk.
- Zigzag Evergreen.** A very fine variety irregular grains on large ears. Pkt. 5c., 20c. per qt., 4 qts. 65c., \$1.00 pk.

## SUGAR CORN ON EARS.

(SELECTED.)

- |                       |                          |
|-----------------------|--------------------------|
| Country Gentleman.    | Late Mammoth.            |
| Crosby's Extra Early. | Little Gem, or Shoe Peg. |
| Early Evergreen.      | Roslyn Hybrid.           |
| First of All.         | Stowell's Evergreen.     |
|                       | Kendel's Giant.          |

5c. per ear, 50c. per doz. ears, \$3.50 per 100 ears.

## POP CORN.

- Golden Queen.** Lb. 10c., 3 lbs. 25c., 100 lbs. \$5.00.
- White Rice.** Lb. 10c., 3 lbs. 25c., 100 lbs. \$5.00.



## Dandelion

The seed should be sown early in the spring in drills twelve inches apart, about one-quarter of an inch deep, thin out to six inches in the drills; the following spring it will be fit for use.

**Thick-Leaved or Cabbaging.** This variety is double the size of the common. Pkt. 10c., oz. 40c., lb. \$4.00.

Endivien (Ger.). **Endive** Chicoree Endive (Fr.).

Sow one ounce for fifty feet.

For early use sow about the middle of April; but for the main crop in June or July in shallow drills; when two or three inches high transplant to one foot each way; when full grown blanch the inner leaves by tying up the outer ones at the top, but tie up only when the leaves are dry; keeps only a short time after blanching.

**Improved Green Curled.** An improvement on the old Green Curled variety. Pkt. 5c., oz. 20c., ¼ lb. 50c., lb. \$1.50.

**White Curled (self-blanching).** This is the finest White Curled variety, grows to a large size, always crisp and very tender. Pkt. 5c., oz. 20c., ¼ lb. 50c., lb. \$1.50.

**Broad-Leaved Batavian.** Leaves broad, light green, nearly plain; used in stews and soups. Pkt. 5c., oz. 20c., ¼ lb. 50c., lb. \$1.50.

**Giant Fringed (Oyster Endive).** A strong growing variety with a large white heart and broad stems; good for fall and winter. Pkt. 5c., oz. 20c., ¼ lb. 60c., lb. \$2.00.

Knoblauch (Ger.). **Garlic Sets** Ail (Fr.).

Per lb. 30c.

## Hop Vine Roots

Ready in April. Per doz. 50c., per 100 \$2.50.

## Herbs

**Anise Seed.** Pkt. 5c., oz. 10c.

**Borage.** For bees. Pkt. 5c., oz. 15c.

**Caraway.** Perennial. Pkt. 5c., oz. 10c.

**Coriander.** Pkt. 5c., oz. 10c. [lb. 60c.

**Dill.** Pkt. 5c., oz. 10c., lb. 75c.

**Fennel.** Perennial. Pkt. 5c.

**Hop.** Perennial. Pkt. 10c.

**Horehound.** Perennial. Pkt. 5c., oz. 30c.

**Lavender.** Perennial. Pkt. 5c., oz. 20c.

**Pot Marigold.** Pkt. 5c.

**Rosemary.** Perennial. Pkt. 5c., oz. 30c.

**Saffron.** Pkt. 5c., oz. 15c.

**Sage.** Pkt. 5c., oz. 15c., lb. \$1.50.

**Summer Savory.** Pkt. 5c., oz. 15c., lb. \$2.00.

**Sweet Basil.** Pkt. 5c., oz. 20c., lb. \$2.00.

**Sweet Marjoram. (Imported.)** 5c. per pkt., per oz. 20c., 60c per ¼ lb.

**Thyme.** Perennial. Pkt. 5c., oz. 30c., lb. \$3.50.

**Wormwood.** Perennial. Pkt. 5c., oz. 30c.



Horse Radish.

## Horse Radish Roots

Extra strong roots will produce large size radish the first season, Per doz. 15c., per 100 50c., per 1000 \$4.00.

**Tarragon Roots. (Estragon.)** Extra Strong roots. 20c. each, \$2.00 per doz.

Michell's  
Selected  
New York  
Improved

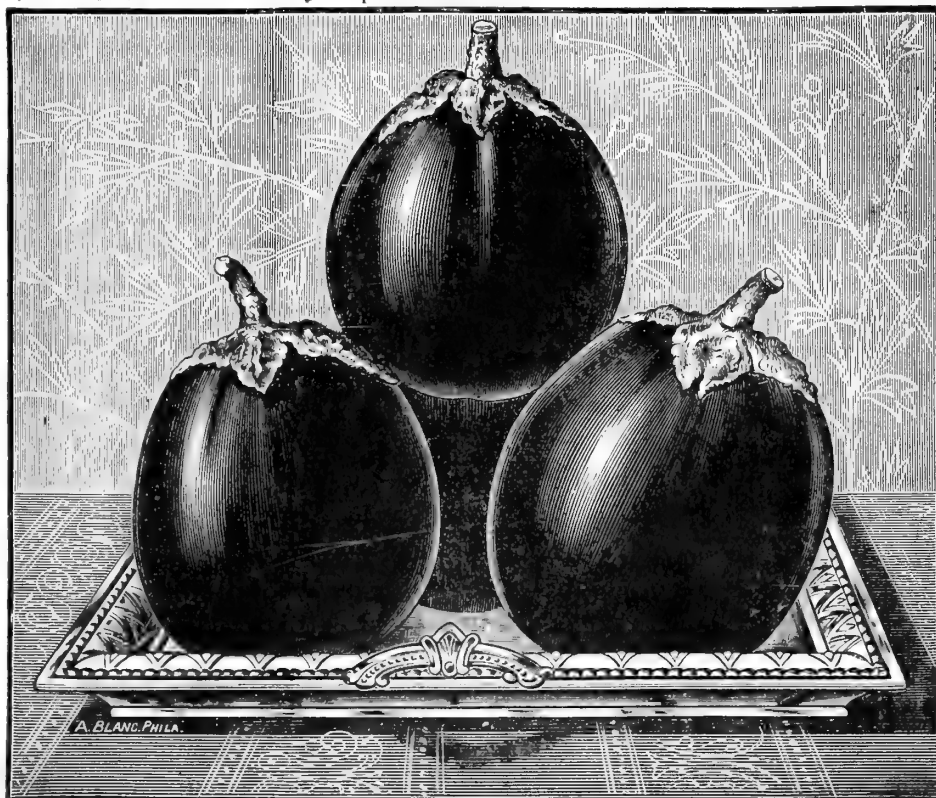

Michell's Selected Stock New York Improved Large Purple Egg Plant. (Grown by a Specialist in New Jersey.)

(Elerpflanze Ger.).

## Egg Plant

Aubergine (Fr.).

ONE OUNCE OF SEED WILL PRODUCE ABOUT 1000 PLANTS

Sow the seed in a hotbed in March or April, when about three inches high pot the plants and plunge in earth; transplant in open ground in May or June according to the warmth of the season. Uniform heat is essential to this plant, and it rarely recovers from the least chill in its early growth. Set out according to richness of soil, two or three feet apart each way.

**Michell's New York Improved Large Purple.** The leading variety; large, round, dark purple, most productive variety. Pkt. 10c., oz. 30c., ¼ lb. 75c. \$2.50 per lb.

**Early Long Purple.** The earliest and hardiest, very productive. Pkt. 10c., oz. 25c., ¼ lb. 75c.

**Black Pekin.** Pkt. 10c., oz. 30c.

## Egg Plants

Ready May 15th.

**New York Improved.** True and pure. Pot grown per doz. 50c.; hotbed grown, per doz. 30c.; per 100, \$2.00.

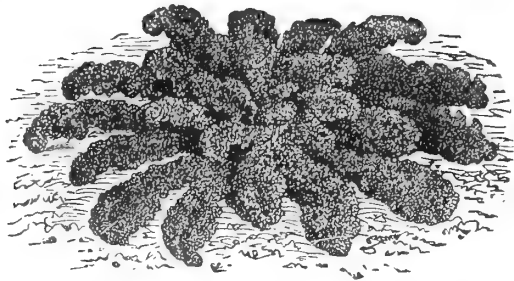

Winter Kohl (Ger.). **Kale or Borecole** Chou-Verts (Fr.).

They are more hardy than cabbage, and are improved by frost, but the time and manner of sowing, and the culture are identical with cabbage.

**Dwarf Green Curled.** Very hardy, leaves numerous, frilled and of excellent quality. Pkt. 5c.; 10c. oz.; ¼ lb. 25c.; 75c. lb.

**New Imperial, or Long Standing.** A beautiful curled and crimped sort, selected by a Philadelphia market gardener; of strong, vigorous habit, perfectly hardy, bright green color, and very attractive in appearance. It is superior to all other sorts, and will stand longer without shooting to seed than any other variety. Height about two feet. Pkt. 5c.; 10c. oz.; ¼ lb. 25c.; 75c. lb.

**Tall Purple Scotch.** Finely curled, one of the best sorts. Pkt. 5c.; 10c. oz.; ¼ lb. 30c.; \$1.00 lb.

Pber-Kohl-Rabi (Ger.). **Kohl=Rabi** Chou-Raves (Fr.).

For early use sow in hotbed, transplant and cultivate like early cabbage. For winter use sow the middle of June or first of July in rows, eighteen inches apart, thin out to eight inches in the row.

**Early White Vienna.** Pkt. 5c.; 25c. oz.; ¼ lb. 75c.; \$2.50 lb.

**Early Purple Vienna.** Pkt. 5c.; 25c. oz.; ¼ lb. 75c.; \$2.50 lb.

## Martynia

**Proboscidea.** The seed pods are used to a considerable extent for pickling when gathered green and tender. Sow in the open ground in May, and transplant two feet apart. Pkt. 10c.; 30c. oz.; ¼ lb. \$1.00; \$3.00 lb.

Kopf. Salad (Ger.). **Lettuce** Laitu (Fr.).

One ounce for 150 feet of drill, or 1,000 plants.

Lettuce thrives best in rich, moist ground. For the principal early crop sow the seed in September in the open ground; transplant when large enough into cold frames, and protect the plants during the winter in the same manner as early cabbage; set the plants out early in April, or sow the seed in hotbeds in February or March, and transplant to a southern exposure. Always thin out well or the plants will not head. When wanted as a cut salad sow the seed thickly in rows or broadcast.

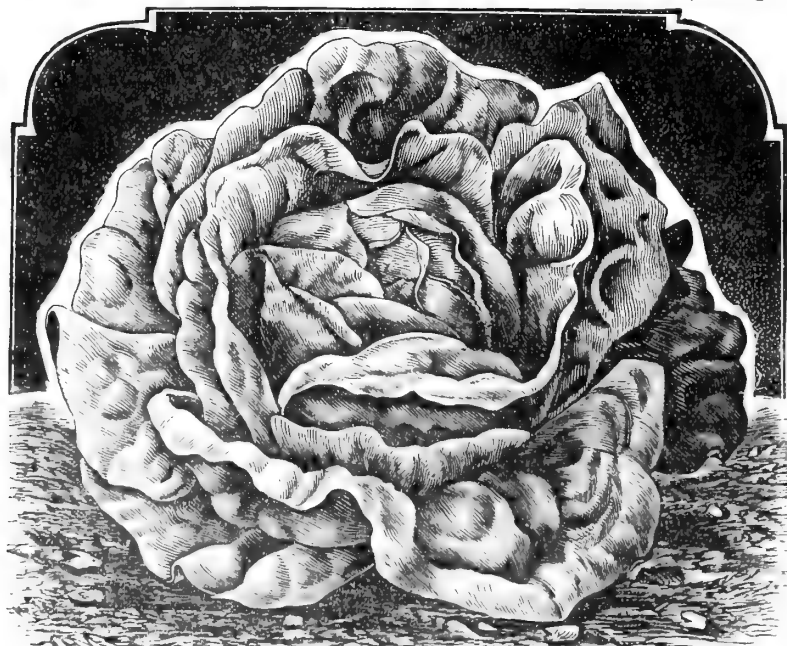

Michell's "All Right" Spring and Autumn Lettuce.

We offer \$3.00 in Two Prizes for the best Six Heads of Lettuce exhibited at the Philadelphia Chrysanthemum Show, Nov. 1902.

**Michell's "All Right" Spring and Autumn.** Without doubt one of the very best smooth varieties. We recommend this variety for every garden. Produces solid large heads of excellent flavor. Pkt. 10c.; 25c. per oz.; per ¼ lb. 75c.; \$2.50 per lb.

**Advancer.** An extra early variety of recent introduction, forms large heads of fine quality, excellent for forcing. Pkt. 10c.; 30c. per oz.; ¼ lb. 75c.

**Big Boston.** A most valuable sort, either for forcing in cold frames or open ground planting, forming large solid heads. Pkt. 5c.; 25c. oz.; ¼ lb. 65c.; \$2.00 lb.

**Black-Seeded Simpson.** Produces a compact mass of leaves, nearly double the size of the ordinary Simpson, standing well the summer heat. Pkt. 5c.; 15c. oz.; ¼ lb. 40c.; \$1.25 lb.

**Boston Market.** White seed. Hardy and crisp; earliest heading variety; one of the best for forcing. Pkt. 5c.; 15c. oz.; ¼ lb. 40c.; \$1.50 lb.

**Dutch Butter Spotted.** The old and always reliable variety, especially adapted for cold frames and hotbeds; produces a solid tender head. Pkt. 5c.; 20c. per oz.; per ¼ lb. 50c.; \$1.50 per lb.

**Defiance. (Summer.)** Pkt. 5c.; 15c. per oz.; per ¼ lb. 40c.

**Deacon Improved.** Excellent summer variety. Pkt. 5c.; 20c. per oz.; per ¼ lb. 50c.; \$1.50 per lb.

**Denver Market Forcing.** A very good curled sort, produces good size, solid heads. Pkt. 5c.; 15c. oz.; per ¼ lb. 40c., lb. \$1.25.

**Early Cabbage or White Butter.** A favorite for sowing in the spring or fall, nearly hardy, requires only a slight protection; produces fine well-formed heads. Pkt. 5c.; 15c. oz.; ¼ lb. 40c.; \$1.25 lb.

**Early Curled Simpson.** Does not head, but forms a close, compact mass of leaves; very early, excellent for forcing. Pkt. 5c.; 15c. oz.; ¼ lb. 50c.; \$1.50 lb.

**Early Tennisball.** Black seed. Forms a close, hard head, the best forcing sort. Pkt. 5c.; 15c. oz.; ¼ lb. 40c.; \$1.25 lb.

**Forcing Emperor (True).** A medium size, compact-growing, very early variety; very crisp and tender and unequalled for forcing. Pkt. 5c.; 20c. oz.; ¼ lb. 50c.; \$1.60 lb.

**Golden Queen.** A very desirable early variety. Very crisp, tender and of fine quality. Pkt. 5c.; 15c. oz.; ¼ lb. 40c.; \$1.50 per lb.

**Grand Rapids Forcing.** An excellent variety, grown extensively, giving the best of satisfaction; does not produce a large head. Pkt. 5c.; 15c. oz.; ¼ lb. 40c.; \$1.25 per lb.

**Giant Crystal Head.** A cross between Hanson and Salamander, producing large, solid heads, quite early in the spring, in original pkts. only. Per pkt. 10c.; 3 pkts. 25c.

**Hanson Improved Hard Head.** A superior curled heading variety. Pkt. 5c.; 15c. oz.; ¼ lb. 40c.; \$1.25 per lb.

**Iceberg.** Fine head, curly and good flavor. Pkt. 5c.; 20c. oz.; ¼ lb. 50c.; \$1.50 per lb.

**Romaine, Cos or Celery.** Long, upright heads of leaves which are tied up and bleached to make them tender. Pkt. 5c.; 20c. oz.; ¼ lb. 50c.; \$1.50 lb.

**Royal Cabbage Summer Drumhead.** Pkt. 5c.; 15c. oz.; ¼ lb. 40c.; \$1.25 lb.

**Salamander.** Summer variety forming good-sized heads. Pkt. 5c.; 15c. oz.; ¼ lb. 40c.; \$1.50 lb.

**Silesian.** One of the best varieties for cutting. Pkt. 5c.; 15c. oz.; per ¼ lb. 40c.; \$1.25 per lb.

**Sensation.** The very best for open ground, will stand the hottest summer. Beautiful light yellowish green color. Forms solid heads. Pkt. 5c.; 25c. oz.; ¼ lb. 75c.; \$2.00 lb.

**Silver Ball Improved.** Excellent for summer; also good for forcing; rich flavor. Pkt. 5c.; 20c. oz.; ¼ lb. 50c.; \$1.35 lb.

**White Russian Summer.** One of the best sorts to withstand the extreme heat. Pkt. 10c.; 30c. oz.; ¼ lb. 90c.; \$3.00 per lb.

**"Wonderful."** The largest cabbage head lettuce, very tender and crisp, and has no bitter taste, stands the heat. Pkt. 5c.; 20c. oz.; ¼ lb. 60c.; \$2.00 lb.

### LETTUCE PLANTS—Ready in April

Best heading varieties. Per 100 40c.; per 1,000 \$3.00



Large Musselburg Leek

## LEEK

Lauch (Ger.)  
Poireau (Fr.)

One ounce to 100 feet.

Plant the seed in April, in drills one foot apart and one inch deep. When six or eight inches high, remove the plants to deep, rich soil, setting them in rows twelve to fifteen inches apart in the rows; plant as deep as possible, and during growth draw the earth to them to blanch stems. One ounce will produce about two thousand plants.

### London Flag.

Hardy, large, strong plant, with broad leaves. Pkt. 5c.; 15c. oz.; ¼ lb. 40c.; \$1.25 lb.

**Large Musselburgh.** Of enormous size, leaves large and broad. Of very mild, pleasant flavor. Pkt. 5c.; 20c. oz.; ¼ lb. 40c.; \$1.50 lb.  
**Giant Carentan.** Pkt. 5c.; 20c. oz.; ¼ lb. 40c.; \$1.50 lb.

## WATER MELON

Wasser Melone (Ger.)  
Melon D'Eau (Fr.)  
One ounce to thirty hills; four pounds per acre.

In light soil, with hot sunny exposure, the water melon thrives best. Plant in hills eight to ten feet apart each way, and cultivate like musk melon. To secure the largest fruit, have but one or two melons to a vine.

**Citron.** For preserving only, small, round, flesh white and solid with red seeds. Pkt. 5c.; oz. 10c.; ¼ lb. 25c.; lb. 75c.

**Cuban Queen.** Pkt. 5c.; oz. 10c.; ¼ lb. 20c.; lb. 50c.

**Dark Icing.** The flavor of this variety cannot be excelled. It is very solid, rind very thin. Pkt. 5c.; oz. 10c.; ¼ lb. 20c.; lb. 50c.

**Dixie.** A large variety, surpassing all others as a shipper, rind thin, ripening within one-quarter inch. Strong grower. Flesh of a rich scarlet; sweet and tender. Pkt. 5c.; oz. 10c.; ¼ lb. 20c.; lb. 60c.

**Iron Clad.** A large growing productive variety. Pkt. 5c.; oz. 10c.; ¼ lb. 20c.; lb. 60c.

**Kolb Gem.** Pkt. 5c.; oz. 10c.; ¼ lb. 20c.; lb. 50c.

**Light Icing or Ice Rind.** Pkt. 5c.; oz. 10c.; ¼ lb. 20c.; lb. 60c.

**Mountain Sweet.** Early, large, oblong, dark green, thin rind; flesh red, solid, rich and sweet. Pkt. 5c.; oz. 10c.; ¼ lb. 20c.; lb. 50c.

**Pride of Georgia.** Pkt. 5c.; oz. 10c.; ¼ lb. 20c.; lb. 50c.

**Scaly Bark.** Pkt. 5c.; oz. 10c.; ¼ lb. 20c.; lb. 50c.

**Striped Gypsy or Rattlesnake.** An early variety, large, oblong; skin green, mottled and striped. Pkt. 5c.; oz. 10c.; ¼ lb. 20c.; lb. 50c.

**Sweet Heart.** A handsome melon, early, oval, large and mottled. Flesh bright red, solid, very tender and luscious. Pkt. 5c.; oz. 10c.; ¼ lb. 20c.; lb. 60c.

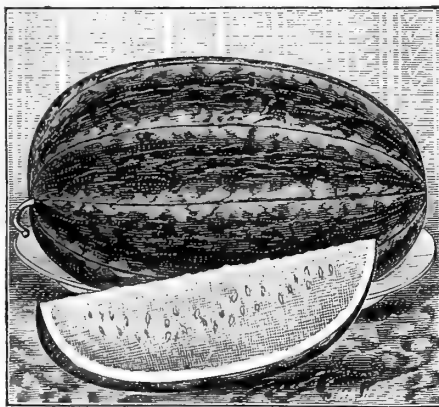

"Sweet Heart" Water Melon.

## MUSK MELON (Cantaloupe)

Melone (Ger.)

Melon (Fr.)

One ounce for seventy-five hills; two and one-half pounds to the acre.

A rich, warm, sandy soil is the best for the musk melon. Plant the seed when the ground is warm. Plant from six to twelve seeds in hills six feet apart each way, and when danger from bugs is past, thin to three vigorous plants in a hill. When the shoots are a foot long pinch off the tips to make them branching and strengthen the vine. Thin out the fruit if it is excessive, the remaining melons will thereby increase in size and ripen earlier.

*Be careful not to grow pumpkins, squashes or cucumbers near musk melons.*



Rocky Ford Muskmelon

**Casaba or Persian.** Of extraordinary size, very delicious and fine flavor. Pkt. 5c.; oz. 10c.; ¼ lb. 20c.; lb. 60c.

**Cosmopolitan.** A good firm grower. Pkt. 5c.; oz. 10c.; ¼ lb. 25c.; lb. 70c.

**Emerald Gem.** Small, early, very luscious and sweet, salmon flesh. Pkt. 5c.; oz. 10c.; ¼ lb. 25c.; lb. 75c.

**Ex. Ea. Cape May Netted.** Flesh of best flavor. Productive and very early. Pkt. 5c.; oz. 10c.; ¼ lb. 25c.; lb. 75c.

**Extra Early Hackensack.** Large size, attractive appearance, excellent flavor. Pkt. 5c.; oz. 10c.; ¼ lb. 20c.; lb. 60c.

**Golden Jenny.** A small early variety, good flavor. Pkt. 5c.; oz. 10c.; ¼ lb. 20c.; lb. 60c.

**Green Citron Netted.** Medium size, deeply netted, nearly round, flesh thick and of a delicious flavor. Pkt. 5c.; oz. 10c.; ¼ lb. 20c.; lb. 60c.

**Jenny Lind.** The earliest variety, netted, of small, round size, excellent flavor. Pkt. 5c.; oz. 10c.; ¼ lb. 20c.; lb. 60c.

**Montreal Market.** Largest of the nutmeg varieties, uniform in shape, netted, flesh green, quality remarkably good. Pkt. 5c.; oz. 10c.; ¼ lb. 25c.; lb. 70c.

**Netted Pineapple or Nutmeg.** An excellent melon, of medium size. Pkt. 5c.; oz. 10c.; ¼ lb. 25c.; lb. 70c.

**Paul Rose (New).** Pkt. 5c.; oz. 15c.; ¼ lb. 30c.; lb. 90c.

**Rockyford.** This is now the best Cantaloupe on the market, it is grown extensively in Colorado, and from there is shipped all over this country for different markets. It commands the highest price on account of its sweet flavor; medium size and finely netted. Pkt. 5c.; oz. 15c.; ¼ lb. 30c.; lb. 75c.

**Sutton's Scarlet.** An excellent sort in original pkt. Per pkt. 40c.

**The Banquet.** A profitable sort. Pkt. 5c.; oz. 10c.; ¼ lb. 25c.; lb. 70c.

**"Tip Top."** Pkt. 5c.; oz. 10c.; ¼ lb. 25c.; lb. 75c.





### Michell's Mushroom Spawn

"Michell's Always Reliable" English Milltrack. Strictly fresh and reliable. We supply a number of the leading and largest growers of Mushrooms with our Superior Spawn, and we have received a large number of testimonials of its high quality. 15c. per brick, \$1.60 per doz. bricks, 25 lbs. for \$2.50, \$8.00 per 100 lbs. Special price for larger quantities. (Directions for growing free).

**We offer \$3.00 in 2 Prizes for the best dish of Mushrooms exhibited at the Philadelphia Chrysanthemum Show, November, 1902.**  
 Wm. Falconer's Book on Mushroom Culture, Price \$1.35.  
 Robinson's Book on Mushroom Culture, Price 50c.  
**Practical Mushroom Culture. (Complete and New.)**  
 Free to applicants.

Senf (Ger.) **MUSTARD** Moutarde (Fr.)  
**White or Yellow.** For salads and flavoring purposes. Oz. 5c., lb. 30c.

Kresse, Indianische (Ger.) **NASTURTIUM** Capucine Grande (Fr.)  
**Indian Cress**  
 The seed pods, which resemble capers, are gathered while green and tender for pickling, and the leaves are used for mixing with salads. Sow early in spring in drills about one inch deep, in light, rich soil, when all danger of frost is over.  
**Tall.** The most profitable pickling variety. Pkt. 5c., oz. 15c., ¼ lb. 35c., lb. \$1.00.  
**Dwarf.** Beautiful colors, mixed. Pkt. 5c., oz. 15c., ¼ lb. 40c., lb. \$1.25.



Improved Dwarf Green Okra

### Okra or Gumbo

Esbarre Hibiscus (Ger.)  
 Gombaud (Fr.)

**One ounce to 20 feet; one pound to 300 feet.**

Sow in May, in hills or drills, three feet apart. If in hills thin out to three plants; if in drills, to ten inches apart in the drills. Seed thickly and cover one inch deep. The young green seed pods are used for soups or like asparagus.

**Improved Dwarf Green.** The most desirable sort, very productive, bears long pods which remain tender a long time and are free from hard ridges. Pkt. 5c., oz. 10c., ¼ lb. 20c., lb. 60c.

**White Velvet or Creole.** Pkt. 5c., oz. 10c., lb. 60c.

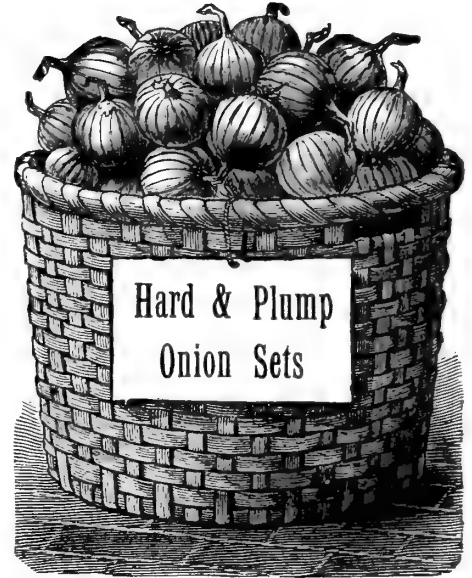

### Onion Sets

Subject to Market Changes.

	Pint	Quart	4 Quarts	Peck	Bush.
<b>YELLOW</b> .....	\$0 10	\$0 15	\$0 50	\$0 90	\$2 75
<b>WHITE</b> .....	.10	.20	.70	1 25	4 00
<b>POTATO ONION</b> .....	.15	.25	.75	1 25	4 00
<b>SHALLOTS</b> .....	.15	.25	.85	1 50	5 00
<b>TREE OR TOP</b> .....	.10	.20	.60	1 00	3 00

**GARLIC SETS.** 25c. per lb.; 10 lbs for \$2.00.



### Onion

Zwiebel (Ger.) Ognon (Fr.)

**One ounce for 100 feet of row; for sets 50 lbs. to the acre.**

For sets, sow the seeds as early as possible, in the spring, very thickly, in drills. As soon as the tops die off in summer, remove them to a dry, airy place; and early in the following spring, replant them by placing sets in shallow drills twelve inches apart and about four inches apart in the drills. They may also be grown to full size during the first season by sowing thinly in drills one foot apart and about one-fourth of an inch deep, in March or early in April, well manured, and thinning them out to stand three or four inches apart in the drills. They delight in a strong, rich, deep, loamy soil, and succeed well if grown successive years on the same ground.

- Bermuda Large White.** The earliest. Pkt. 10c., oz. 30c., ¼ lb. \$1.00, lb. \$3.00.
- Bermuda Large Red.** (Extra early). Pkt. 10c., oz. 30c., ¼ lb. \$1.00, \$3.00 per lb.
- Extra Early Red.** Pkt. 5c., oz. 15c., lb. \$1.50.
- White or Silver Skin.** A mild-flavored early variety, extensively grown for pickling. Pkt. 5c., oz. 25c., ¼ lb. 75c., lb. \$2.50.
- Yellow Danvers.** An excellent early oval, straw colored variety, of mild flavor, productive and a good keeper. Pkt. 5c., oz. 15c., ¼ lb. 45c., lb. \$1.35.
- Prize Taker Mammoth Yellow.** Large round, rapid grower; attains full size in one season. Pkt. 10c., oz. 20c., lb. \$1.75.
- Yellow Strasburg or Dutch.** A good keeper; somewhat flattened shape. Pkt. 5c., oz. 15c., ¼ lb. 45c., lb. \$1.35.
- Large Red Wethersfield.** Grows to full size the first season from seed, almost round, large size, deep red color, and keeps well. Pkt. 5c., oz. 15c., ¼ lb. 45c., lb. \$1.35.
- Southport Yellow Globe.** Pkt. 5c., oz. 20c., ¼ lb., 45c., lb. \$1.50.
- Southport White Globe.** Pkt. 10c., oz. 30c., lb. \$3.00.
- Southport Red Globe.** Pkt. 10c., oz. 20c., lb. \$2.00.
- White Barletta.** Extra early. Pkt. 5c., oz. 20c., ¼ lb. 75c., lb. \$2.50.

**ONION CULTURE, by a Practical Grower, 20c. per copy.**

## Parsley

Petersilie (Ger.) Parsil (Fr.)  
 One ounce sows about 100 feet of drill.

Seed germinates very slowly, plants sometimes not appearing for three or four weeks; soak seed a few hours in lukewarm water before sowing.

**Double Curled Covent Garden.** Finely curled dwarf. Pkt. 5c., oz. 10c., ¼ lb. 30c., lb. 90c.

**Extra Curled Perpetual.** Leaves tender, crimped and very curly; excellent for garnishing. Pkt. 5c., oz. 10c., ¼ lb. 30c., lb. 85c.

**Fern Leaved.** Valuable for garnishing. Pkt. 5c., oz. 10c., ¼ lb. 25c., lb. 90c.

**New Perfection Curled.** 10c. per pkt.

**Sutton's Garnishing.** 25c. per pkt.

**Champion Moss Curled.** Beautifully crimped and curled. It can be cut the year round, rarely runs to seed. Pkt. 5c., oz. 10c., ¼ lb. 25c., lb. 90c.



## Parsnip

Pastinake (Ger.) Panais (Fr.)  
 One ounce to 150 feet; five pounds to the acre.

Sow early in spring in drills fifteen inches apart and one-half inch deep; when plants are two or three inches high, thin out to six inches in the rows, cultivate often until the leaves cover the ground. These roots are improved by frost, and can be left in the ground over winter.

**Improved Sugar or Hollow Corn.** Pkt. 5c.; oz. 10c.; ¼ lb. 20c.; lb. 60c.

**Guernsey or Student.** Half long and thick. Pkt. 5c.; oz. 10c.; ¼ lb. 20c.; lb. 60c.

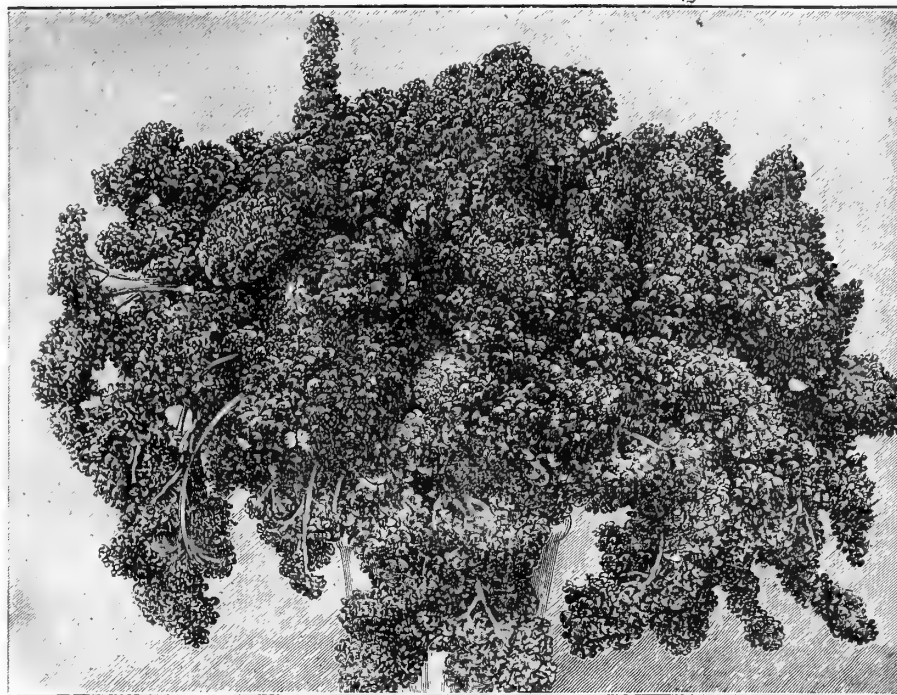

Covent Garden Curled Parsley.

Pfeffer (Ger.)

## Pepper

Piment (Fr.)

One ounce will produce about 100 plants.

Sow in hotbed in April, and transplant the plants to open ground in warm, settled weather to rows two feet apart and eighteen inches in the rows, or when all danger of frost is past, sow at once in the open ground and thin to the same distance as above. Any rich fertilizer, if applied and stirred into the soil when the plants are six inches high, will be found of great benefit.

**Large Sweet Bell or Bull Nose.** Large variety, mild, rind thick, fleshy; best for pickling and pepper sauce, or filled as mangoes. Pkt. 5c., oz. 25c., ¼ lb. 65c., lb. \$2.00.

**Large Sweet Spanish.** Pkt. 5c., oz. 25c. 75c. per ¼ lb.

**Golden Dawn.** Beautiful golden yellow, quite sweet, without any fiery taste; very productive. Pkt. 5c., oz. 25c. 75c. per ¼ lb.

**Cayenne Long Red.** Pkt. 5c., oz. 25c., ¼ lb. 75c., lb. \$2.50.

**Ruby King.** Bright scarlet, large productive sort. Pkt. 10c., oz. 25c., ¼ lb. 75c., lb. \$2.50.

**Celestial.** Pkt. 5c., oz. 25c.

**Coral Gem.** Pkt. 10c., oz. 40c.

**Red Cherry.** Pkt. 5c., oz. 25c.

**Small Chili.** Very hot; used for seasoning and for pepper sauce. Pkt. 5c., oz. 25c.



Sweet Bell or Bull Nose Pepper.

## Pepper

### Plants

Ready May 15th

Large Sweet Bell and Red Cayenne

Dozen 20c., 100 \$1.25.

Erbse (Ger.) **PEAS** Pois (Fr.)

One quart to 100 feet of row

Peas succeed best in light, dry, loamy soil. Early and dwarf sorts require richer soil than the late varieties. If manure is used, let it be old and well rotted, or there will be a rank growth of vines with few pods. Sow the early, smooth, round sorts as early in the spring as the ground can be worked. Seeds of wrinkled varieties are more liable to rot if the ground is cold, and must be planted later. Sow seed in single rows, three feet apart, for dwarf sorts, and four for tall sorts, or in double drills, six to eight inches apart, one inch apart in the drill, and not less than four inches deep, for late sorts seven to eight inches deep. Deep planting prevents mildew.

## Extra Early Sorts

**Michell's Special Extra Early** (New). See Novelties.

**Dandy Extra Early** (Michell's). Selected from first crop of Eureka and are the best extra early pea in the market; height 20 inches. Pkt. 5c.; 15c. pt.; qt. 30c.; \$1.00 4 qts.; pk. \$1.90; \$7.00 bus.

**Alaska Extra Early**. Height 2 feet. Pkt. 5c.; 15c. pt.; qt. 30c.; 95c. 4 qts. pk. \$1.80; \$6.50 bus.

**American Wonder**. Height 12 inches. The earliest wrinkled variety in cultivation of dwarf and robust habit. Will mature in 33 days from time of planting. Pkt. 5c.; 20c. pt.; qt. 35c.; \$1.20 4 qts.; pk. \$2.00; \$7.50 bus.

**Blue Beauty**. Height 18 inches. Compact, and bears a profusion of excellent peas. Pkt. 5c.; 15c. pt.; qt. 30c.; 90c. 4 qts.; pk. \$1.60; \$5.75 bus.

**Early June**. A most excellent very early variety; height 20 inches. Pkt. 5c.; 15c. pt.; qt. 25c.; 90c. 4 qts.; pk. \$1.60; \$6.00 bus.

**Eureka Extra Early**. Earliest, most prolific variety. For a late fall crop it has few equals; height 20 inches. Pkt. 5c.; 15c. pt.; qt. 30c.; 95c. 4 qts.; pk. \$1.80; \$6.75 bus.

**Gradus** (New). Height 12 inches. Wrinkled variety. Considered to be better than all others. Pkt. 10c.; 25c. pt.; qt. 50c.; \$1.80 4 qts.; pk. \$3.25; \$12.00 bus.

**Improved Daniel O'Rourke**. Height 2 feet. A valuable sort, of good flavor, productive. Pkt. 5c.; 15c. pt.; qt. 30c.; 95c. 4 qts.; pk. \$1.80; \$6.50 bus.

**McLean's Little Gem**. Height 12 inches. First early, green-wrinkled variety. Very prolific, superior flavor. Pkt. 5c.; 15c. pt.; qt. 30c.; \$1.00 4 qts.; pk. \$1.85; \$7.00 bus.

**Nott's Excelsior**. Height 15 inches. One of the best of recent introductions. The pods are very large, each contains from 6 to 8 large peas which are of unusually fine flavor and tender. Pkt. 5c.; 20c. pt.; qt. 35c.; \$1.25 4 qts.; pk. \$2.00; \$7.50 bus.

**Premium Gem**. Height 18 inches. A fine favored dwarf, wrinkled variety. Pkt. 5c.; 15c. pt.; qt. 30c.; \$1.00 4 qts.; pk. \$1.85; \$7.00 bus.

## Second Early Varieties

**Bliss' Abundance**. Height 18 inches. Ripens about one week after the earliest kind. Six to eight inches apart in the rows is the nearest that the plants should stand. Pkt. 5c.; 15c. pt.; qt. 30c.; 90c. 4 qts.; pk. \$1.60; \$5.75 bus.

**Daisy**. Height 2½ feet. Sweet and prolific. Pkt. 5c.; 20c. pt.; qt. 35c.; \$1.20 4 qts.; pk. \$1.90; \$7.00 bus.

**Dwarf Telephone**. Height 12 inches. Pkt. 5c.; 20c. pt.; qt. 40c.; \$1.25 4 qts.; pk. \$2.00; \$7.50 bus.

**Heroine**. Height 2 feet. One of the grandest; should be in every garden. Pkt. 5c.; 15c. pt.; qt. 30c.; 90c. 4 qts.; pk. \$1.60; \$5.75 bus.

**Horsford's Market Garden**. Height 3½ feet. A prolific pea for summer crop; pods are full and borne in profusion. Pkt. 5c.; 15c. pt.; qt. 25c.; 85c. 4 qts.; pk. \$1.60; \$5.75 bus.

**Pride of the Market**. Height 18 inches. A medium early dwarf pea of vigorous habit and very productive. Pkt. 5c.; 15c. pt.; qt. 30c.; 90c. 4 qts.; pk. \$1.80; \$6.50 bus.

**Shropshire Hero**. Height 2½ feet. A most desirable wrinkled variety producing well-filled pods. Pkt. 5c.; 15c. pt.; qt. 30c.; 90c. 4 qts.; pk. \$1.80; \$6.25 bus.

## General and Later Varieties

**Black-eyed Marrowfat**. Height 4 feet. Extensively grown, hardy, productive. Pkt. 5c.; 10c. pt.; qt. 20c.; 60c. 4 qts.; pk. \$1.00; \$3.50 bus.

**Blue Imperial**. Height 3 feet. A favorite summer market gardener's variety; good bearer and of fine flavor. Pkt. 5c.; 15c. pt.; qt. 25c.; 85c. 4 qts.; pk. \$1.60; \$5.75 bus.

**Champion of England**. Height 5 feet. One of the best and most popular wrinkled varieties in cultivation, of delicious flavor; a profuse bearer. Pkt. 5c.; 15c. pt.; qt. 25c.; 75c. 4 qts.; pk. \$1.30; \$5.00 bus.

**Duke of York**. Height 4 feet. A very highly recommended wrinkled variety. Pkt. 5c.; 15c. pt.; qt. 30c.; \$1.00 4 qts.; pk. \$1.75; \$6.25 bus.

**Dwarf Sugar (edible pod)**. Height 2 feet. Pkt. 10c.; 25c. pt.; qt. 40c.

**Everbearing**. Height 2 feet. A good pea for summer and autumn use, pods 4 inches long, and contain 6 to 8 peas of rich flavor, very sweet and tender. Pkt. 5c.; 15c. pt.; qt. 25c.; 85c. 4 qts.; pk. \$1.60; \$5.75 bus.

**Fillbasket**. Height 18 inches. Large, prolific, pods long, round and closely filled. Pkt. 5c.; 15c. pt.; qt. 30c.; 90c. 4 qts.; pk. \$1.70; \$6.00 bus.

**Improved Stratagem**. Height 2½ feet. Wrinkled marrow, large size peas of excellent quality. Pkt. 5c.; 10c. pt.; qt. 30c.; 4 qts. \$1.00; \$1.75 pk.; \$6.00 bus.

**Juno**. Height 4 feet. One of the best of the late wrinkled peas, with large pods filled with delicious peas of large size. Pkt. 5c.; 15c. pt.; qt. 30c.; \$1.00 4 qts.; pk. \$1.65; \$6.00 bus.

**Melting Sugar**. Height 5½ feet. A prolific variety of delicious quality. Pkt. 10c.; 25c. pt.; qt. 40c.

**Royal White Marrowfat**. Height 2 feet. A favorite late variety. Pkt. 5c.; 10c. pt.; qt. 20c.; 60c. 4 qts.; pk. \$1.00; \$3.50 bus.

**Telephone**. Height 4 feet. Immensely productive, of the finest quality, and excellent sugary flavor. Pkt. 5c.; 15c. pt.; qt. 30c.; \$1.00 4 qts.; pk. \$1.80; \$6.25 bus.

**Yorkshire Hero**. Height 2½ feet. A splendid wrinkled marrow for market and kitchen gardens. Pkt. 5c.; 15c. pt.; qt. 25c.; 85c. 4 qts.; pk. \$1.60; \$5.75 bush.

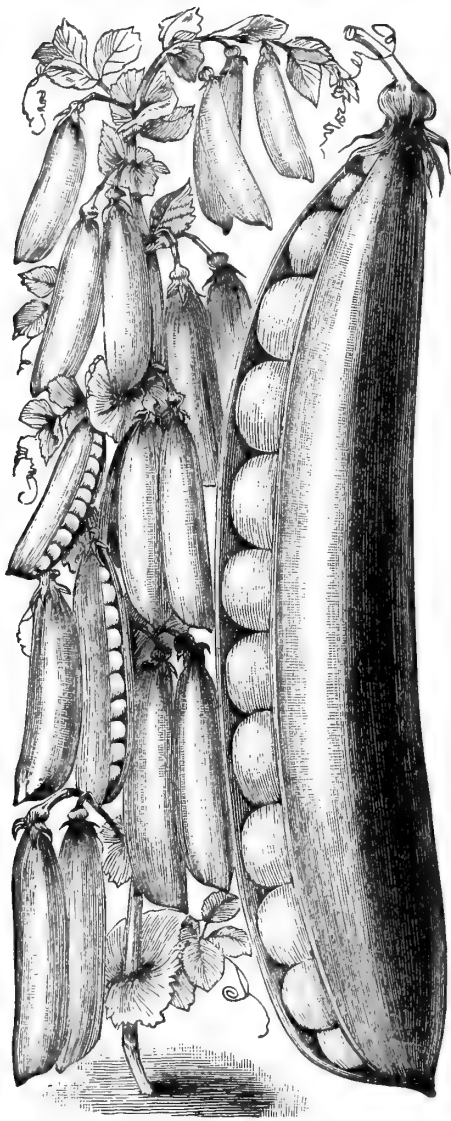

Michell's Dandy Extra Early



Kartoffel (Ger.).  
Pomme de Terre (Fr.).

# POTATOES.

PLANT TEN BUSHELS TO THE ACRE

The soil best suited to the potato is a rich, sandy loam; being a gross feeder, it requires a liberal application of manure; if stable manure is to be used it should be well rotted and not allowed to come in contact with the tubers. On no other crop are the results from the use of phosphates so manifest as on the potato; almost invariably the tubers are brighter, smoother and freer from rust and the destructive influence of wire worms. The best fertilizers are plaster, lime, super-phosphate of lime, and bone dust, for heavy and wet soils especially, as they promote growth, and at the same time, prevent disease. Plant as early in spring as the ground can be thoroughly worked, in rows three feet apart and one foot in the rows.

NOTICE—Our Seed Potatoes are all NORTHERN GROWN. PRICES MAY fluctuate somewhat. SPECIAL PRICES will be quoted on application.

## Michell's Extra Early "Beats Them All."

This is the very best early variety, matures in 87 days; of medium size, fine round shape, of excellent quality, and good producer. No garden is complete without this valuable variety. 75c. per peck; \$2.00 per bu.; \$5.00 per bbl. of 2 1/2 bu.

**Early Rose (Maine).** A leading variety for earliness, quality and productiveness. Pk. 50c.; bush. \$1.50; bbl. \$4.00.

**Early Rose (Michigan grown).** Pk. 50c.; bush. \$1.40; bbl. \$3.50.

**Early Ohio.** A seeding of the Early Rose, ripens about a week earlier, excellent quality. Pk. 50c.; bush. \$1.50; bbl. \$4.00.

**Irish Cobbler.** A good medium size, extra early variety. Peck 60c.; bush. \$1.75; bbl. \$4.50.

**Beauty of Hebron.** A little earlier than Early Rose, very productive, a good keeper. Pk. 50c.; bush. \$1.40; bbl. \$3.50.

**State of Maine.** Medium early, good keeper. Pk. 50c.; bush. \$1.40; bbl. \$3.50.

**Rural New Yorker, No. 2.** A valuable variety of large size, very smooth and a great cropper; in quality unexcelled. Pk. 50c.; bush. \$1.40; bbl. \$3.50.

**Burbank's Seeding.** A medium early variety, producing a large crop. Pk. 50c.; bush. \$1.40; bbl. \$3.50.

**Mammoth Pearl.** Medium late, free from rot, never hollow; skin and flesh white, cooks like a ball of flour; very productive and good keeper. Pk. 50c.; bu. \$1.40; bbl. \$3.50.

**Carman, No. 3.** One of the very best late varieties, a heavy yielder and of excellent quality. Pk. 50c.; bu. \$1.40; bbl. \$3.50.

**White Star.** Baked or boiled, its color, floury texture and delicious flavor are unsurpassed; excellent keeping quality. Pk. 50c.; bush. \$1.40; bbl. \$3.50.

**Irish Daisy.** One of the best new late or main crop potatoes yet sent out. Pk. 60c.; bush. \$1.60; bbl. \$4.00.

We offer \$3.00 in Two Prizes for the best peck of State of Maine Potatoes, exhibited at the Philadelphia Chrysanthemum Show in November, 1902.

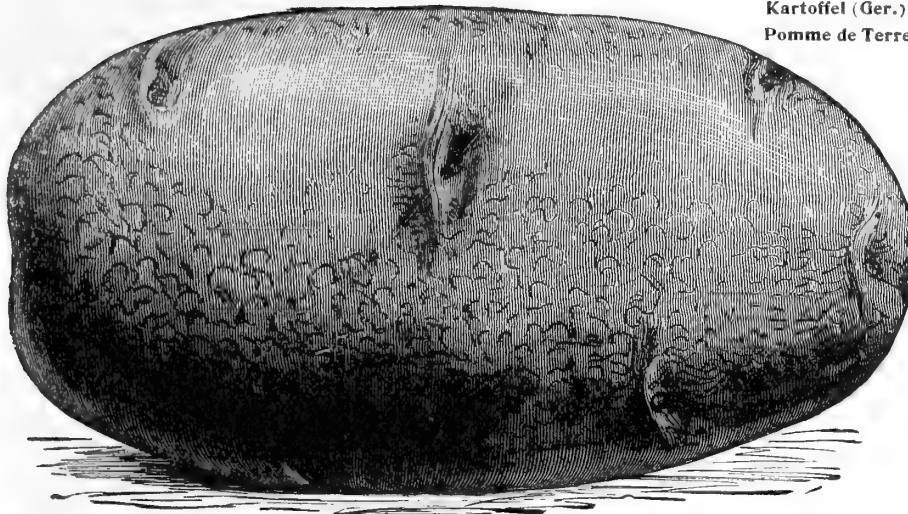

### Advantages of Changing Seed Potatoes.

There is no other crop that we raise that is so much benefited by the introduction of fresh seed from time to time as the potato, provided the change is to a well-selected, stock, and the further north it is grown, the better. They yield nearly double the crop on the same land.

## Sweet Potatoes.

**Vineland Bush Sweet Potatoes.** (Vineless.) Yellow, dry, and most excellent quality. By mail, 3 lbs. for 45c.; 75c. per pk.; \$2.00 per bu.; \$5.00 per bbl.

**Yellow Nansemond.** A thick variety, very productive, and the best for general culture. Pk. 60c.; bush. \$2.00; bbl. \$4.00.

### SWEET POTATO PLANTS.

Ready May 10th.

**Yellow Nansemond.** 100, 30c.; 1000, \$1.75; lots of 5000, \$1.50 per 1000.

**Vineland Bush Sweet Potato Plants.** (Vineless.) 35c. per 100; \$2.25 per 1000. Special prices on larger quantities.

### CONCAVE POTATO KNIFE.

For cutting seed potatoes. This is undoubtedly the best knife for the purpose. Cut a thin slice from centre of potato, hold up to light and see feeders as in small cut.

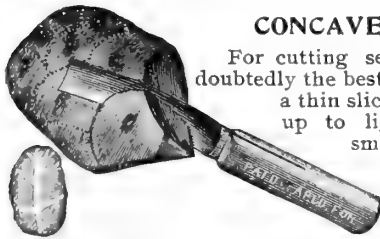

25 cents each,  
postpaid.

Kürbis (Ger.) **Pumpkin** Potiron (Fr.).

One ounce to fifty hills. Three pounds to the acre

Sow in good soil in May, when ground has become warm, in hills eight to ten feet apart each way, or in field corn about every fourth hill; plant at same time with corn, always avoid planting near other vines, as it will hybridize.

**Cashaw.** Long yellow crook neck, the best for table use or feeding stock; flesh yellow, solid, fine grained and sweet. Pkt. 5c., oz. 10c., lb. 50c.

**Large Cheese.** One of the best for table use, skin orange, flesh yellow and sweet. Pkt. 5c., oz. 10c., lb. 50c.

**Large Tours or Mammoth.** Grows to immense size, often weighing over one hundred pounds. Pkt. 5c., oz. 10c., lb. 60c.

**Connecticut or Large Common Yellow Field.** Grown principally for feeding stock. Oz. 5c., qt. 20c., bush. \$4.00.

**True Tennessee Sweet Potato.** A splendid pie and cooking pumpkin. Pkt. 5c., oz. 10c., 1/4 lb. 20c., lb. 60c.

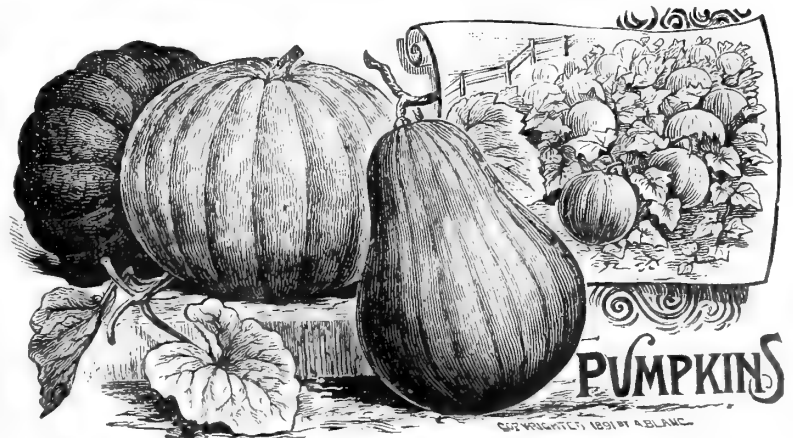

PUMPKINS

Copyright 1891 by A. Blain

## RADISH

Radies (Ger.).

Radis (Fr.).

One ounce to seventy-five feet of row.

Radishes delight in light, rich, mellow soil, and to be crisp and tender, must make rapid growth. For very early use sow in a hotbed in January, and continue sowing every two weeks until September, choosing the varieties suited to the season; sowings should be made in drills ten inches apart, and the plants should be thinned to two inches apart in the row. Sow winter radishes in July and take up before severe frosts and store in sand or earth in a cool cellar.

### Early Sorts

**Brightest Scarlet, Half Long.** Entirely distinct, being a vivid scarlet color, tipped with snow-white. Pkt. 5c.; oz. 15c.;  $\frac{1}{4}$  lb. 20c.; lb. 60c.

**Cardinal or Scarlet Globe.** The very best forcing variety, is of globular shape and brilliant cardinal red color. Pkt. 5c.; oz. 15c.;  $\frac{1}{4}$  lb. 30c.; lb. \$1.00.

**Early Frame Scarlet.** Pkt. 5c.; oz. 10c.;  $\frac{1}{4}$  lb. 25c.; lb. 75c.

**Early French Breakfast.** Oblong shape, rapid growth, very mild and tender, of a beautiful scarlet color tipped with white. Pkt. 5c.; oz. 10c.;  $\frac{1}{4}$  lb. 20c.; lb. 60c.

**Extra Early Olive Shaped White Forcing.** Pkt. 5c.; 15c. per oz.; per  $\frac{1}{4}$  lb. 30c.; \$1.00 per lb.

**Fireball.** Brilliant scarlet color, crisp, tender, of mild flavor; useful only as a forcing variety or for early spring use. Pkt. 5c.; oz. 10c.;  $\frac{1}{4}$  lb. 25c.; lb. 75c.

**Icicle.** A magnificent new *white* variety of fine taste, grows  $3\frac{1}{2}$  to 4 inches long in 22 days. Pkt. 5c. oz.; 15c.;  $\frac{1}{4}$  lb. 50c.; lb. \$1.50.

**Long Scarlet Short Top or Salmon.** The standard variety; long bright scarlet with small top. Pkt. 5c.; oz. 10c.;  $\frac{1}{4}$  lb. 20c.; lb. 60c.

**Round Red Forcing or Button.** Pkt. 5c.; 10c. per oz.; per  $\frac{1}{4}$  lb. 25c.; 75c. per lb.

**Round White Forcing.** Pkt. 5c.; oz. 10c.;  $\frac{1}{4}$  lb. 25c.; lb. 75c.

**White Box, Philadelphia Grown.** Perfectly round, smooth skin, pure white. Pkt. 5c.; 10c. per oz.; per  $\frac{1}{4}$  lb. 25c.; 70c. per lb.

**Felton's White Box** (Private stock). A selection of the old reliable White Box radish, more perfect form, producing shorter tops, and does not have a tendency to grow long in shape. Per pkt. 5c.; per oz. 10c.;  $\frac{1}{4}$  lb. 30c.; lb. \$1.15.

### Summer Sorts

**Beckert's Chartier.** Color bright salmon scarlet, shading to white as it approaches maturity; it is very crisp, tender, and of mild and pleasant flavor. Pkt. 5c.; oz. 10c.;  $\frac{1}{4}$  lb. 20c.; lb. 60c.

**Cincinnati Long Scarlet.** A most desirable variety either for the home garden or for market purposes, excellent quality, remains in a crisp condition for a long time. Pkt. 5c.; oz. 10c.;  $\frac{1}{4}$  lb. 20c.; lb. 65c.

**Golden Globe, Dresden** (New). Pkt. 5c.; oz. 10c.;  $\frac{1}{4}$  lb. 25c.; lb. 75c.

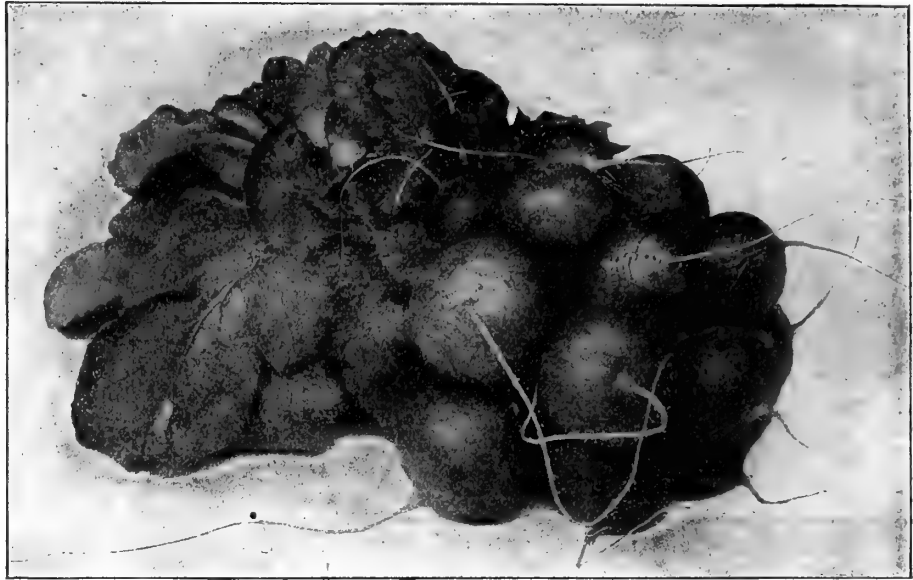

Michell's Private Stock Cardinal Globe Radish

### SUMMER SORTS—Continued

**Large White Summer Turnip.** Large, turnip-shaped, white, crisp and mild. Pkt. 5c.; oz. 10c.;  $\frac{1}{4}$  lb. 20c.; lb. 60c.

**Large Yellow Summer Turnip.** Like the above except in color. Pkt. 5c. oz. 10c.;  $\frac{1}{4}$  lb. 20c.; lb. 60c.

**Long White Lady Finger.** A fine white, crisp and mild variety. Pkt. 5c.; oz. 10c.;  $\frac{1}{4}$  lb. 20c.; lb. 60c.

**White Delicacy** (New). Oblong shape, excellent quality. Pkt. 5c.; oz. 10c.; lb. \$1.00.

**White Strasburg.** Oblong of a pure white color, and mild flavor. Pkt. 5c.; oz. 10c.;  $\frac{1}{4}$  lb. 20c.; lb. 60c.

### Winter Varieties

**California White Winter.** Long. Pkt. 5c.; oz. 10c.; lb. 75c.

**Half Long Black Winter Radish.** A great improvement on the old long Spanish Radish of perfect form and excellent flavor. Pkt. 5c.; oz. 10c.;  $\frac{1}{4}$  lb. 30c.; lb. \$1.00.

**Long Black Spanish Winter.** Pkt. 5c.; oz. 10c.;  $\frac{1}{4}$  lb. 20c.; lb. 60c.

**Round Black Spanish Winter.** Like the above, except form. Pkt. 5c.; oz. 10c.;  $\frac{1}{4}$  lb. 20c.; lb. 60c.

**Round Scarlet China.** Pkt. 5c.; oz. 15c.;  $\frac{1}{4}$  lb. 35c.; lb. \$1.25.

**Scarlet China Winter** ( $\frac{1}{2}$  long). Pkt. 5c.; oz. 10c.;  $\frac{1}{4}$  lb. 20c.; lb. 75c.

## RHUBARB

Rhubarber (Ger.).

Rhubarbe (Fr.).

**Linnæus.** Well-known market variety; early. Pkt. 5c.; 15c. oz.;  $\frac{1}{4}$  lb. 45c.; lb. \$1.50.

**Victoria.** Pkt. 5c.; 15c. oz.;  $\frac{1}{4}$  lb. 45c.; lb. \$1.50.

### RHUBARB ROOTS.

Set in spring and they will furnish leaf stalks the following season. We offer the largest and best variety.

**Victoria.** Clumps. Each 10c.; doz. \$1.00; 100 \$6.00.

Kurbiss (Ger.).

## SQUASH

Courge (Fr.).

One ounce to fifty hills

Squashes should be planted in a warm, light, rich soil, about the middle of May or June. Plant in well manured hills, in the same manner as cucumbers and melons—the bush varieties three or four feet apart each way, and the running kind six to eight feet. Eight to ten seeds should be sown in each hill, thinning out after danger from bugs is over, leave three or four of strongest plants to a hill.

### Early Sorts

**Early White Bush or Patty Pan.** The best early variety; grows to a large size and bears an abundant crop. Pkt. 5c.; oz. 10c.;  $\frac{1}{4}$  lb. 20c.; lb. 60c.

**Golden Custard.** Of similar size and shape to the White Bush, but of rich golden yellow color and fine flavor. Pkt. 5c.; oz. 10c.;  $\frac{1}{4}$  lb. 20c.; lb. 60c.

**Yellow Crook Neck.** Early productive, and of good quality; skin orange-yellow. Pkt. 5c.; oz. 10c.;  $\frac{1}{4}$  lb. 20c.; lb. 60c.

### Summer and Fall Sorts

**Boston Marrow.** About ten days later than the bush varieties; a good keeper, of excellent flavor, flesh orange colored and fine grained. Pkt. 5c.; oz. 10c.;  $\frac{1}{4}$  lb. 20c.; lb. 60c.

**Butman.** Pkt. 5c.; oz. 10c.;  $\frac{1}{4}$  lb. 20c.; lb. 60c.

**Fordhook.** A new winter squash of great merit; of a handsome, bright yellow color. Pkt. 5c.; oz. 10c.;  $\frac{1}{4}$  lb. 20c.; lb. 60c.

**Green Crook Neck Winter.** One of the best winter sorts. Pkt. 5c.; oz. 10c.;  $\frac{1}{4}$  lb. 20c.; lb. 60c.

**Hubbard.** A general favorite, and one of the best late table varieties; of large size, flesh fine grained, dry and of excellent flavor. Pkt. 5c.; oz. 10c.;  $\frac{1}{4}$  lb. 20c.; lb. 60c.

**Sweet Nut.** Medium size, flesh rich and very sweet; enormously productive and valuable both as a summer and a winter squash. Pkt. 5c.; oz. 10c.;  $\frac{1}{4}$  lb. 20c.; lb. 60c.

**Turban.** Flesh very thick, rich color and solid. Pkt. 5c.; oz. 10c.;  $\frac{1}{4}$  lb. 20c.; lb. 60c.

**Vegetable Marrow.** Pkt. 5c.; oz. 10c.;  $\frac{1}{4}$  lb. 25c.; lb. 80c.

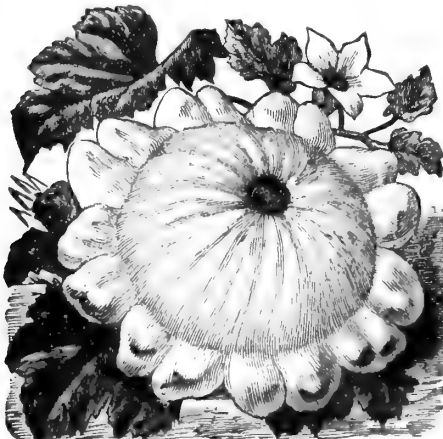

Early White Bush or Patty Pan Squash

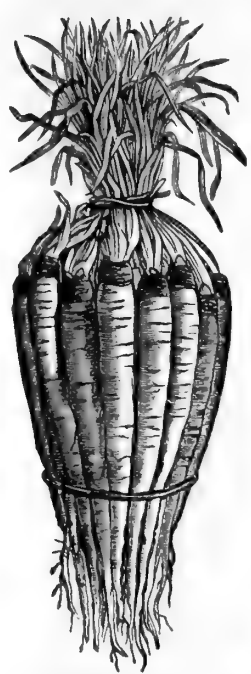

## Salsify

Haferwuzel (Ger.) Salsifis (Fr.)  
(OYSTER PLANT)

One ounce of seed will sow about fifty feet of drill.

Sow in early Spring in drills fifteen inches apart and one to two inches deep, thin to six inches apart. Soil should be very deep and mellow in order that the root may grow straight down. Store same as carrots for winter use, or they can be left in the ground until spring.

**Mammoth Sandwich Island.** This variety is of enormous size, twice as large as the ordinary French; pure white, very tender and delicious. Pkt. 5c., oz. 15c., ¼ lb. 40c., lb. \$1.25.

**Long White.** The favorite market variety, and best flavored. Pkt. 5c., oz. 10c., ¼ lb. 30c., lb. \$1.00.

## Sage

Holt's Mammoth. Strong roots. Each 10c., doz. \$1.00, 100, \$5.00.

## Sorrel

**Sandwich Island Salsify Broad Leaf French.** Pkt. 5c., oz. 15c.

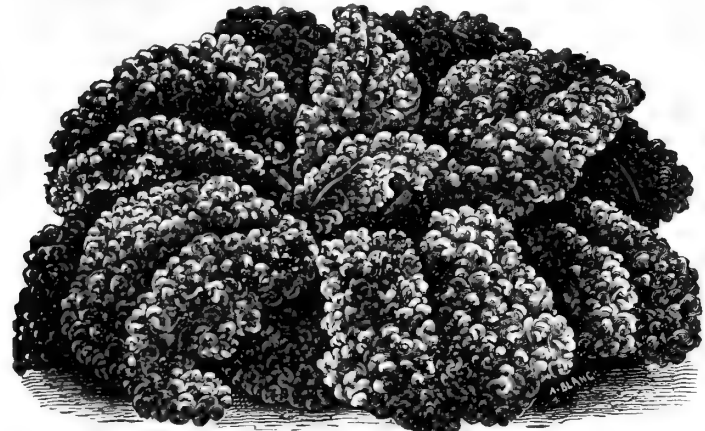

Bloomsdale Savoy Spinach.

## Spinach

(Spinat (Ger.)) Epinard (Fr.)

One ounce to 75 feet of drill, or at rate of ten pounds per acre.

Select very rich, well-drained soil, and sow in drills one foot apart and one inch deep. For spring and summer use, make the first sowing early in March, and continue at intervals of two or three weeks until the middle of July. Sow in August and September for winter or early spring use, and protect with a covering of straw during severe weather.

**Victoria Long Standing (New).** This thick variety is distinguished by the exceedingly dark green color, and also for its long-standing qualities. Pkt. 5c., oz. 10c., 15c. per ¼ lb., lb. 35c.

**Bloomsdale Round-Seeded Savoy.** The hardest large Savoy leaved; curled and crimped, with thick, fleshy leaves; the best for family and market purposes, and the best of all sorts for fall sowing. 5c. per pkt., 10c. per oz., 15c. per ¼ lb., per lb. 35c.

**Long Standing Round-Seeded.** Will stand two weeks longer than any other sort before shooting to seed. The best for spring sowing. Pkt. 5c., 10c. per oz., per ¼ lb. 15c., 35c. per lb.

**Prickly-Seeded, or Fall.** The hardest variety. Oz., 10c., lb. 35c.

**New Zealand.** This variety endures heat and draught; excellent for summer use; produces a large quantity of leaves throughout the season and can be cut from continuously. Pkt. 5c., oz. 10c., ¼ lb. 30c., lb. 90c.

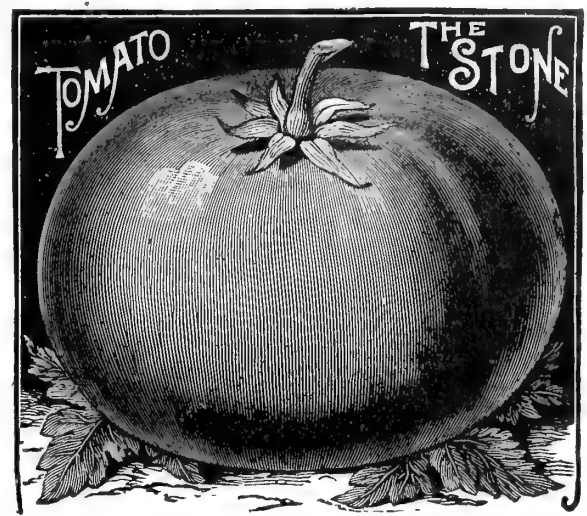

## Tomatoes

Liebes Apfel (Ger.) Tomate (Fr.)  
One ounce will produce about one thousand plants.

Sow the seed in March or April in the hotbed, or in a box in a sunny place in the house. To make very healthy, stocky plants, they may be transplanted when about two or three inches high. When five or six inches high, if the ground has become warm, transplant to the open ground. Set plants four feet apart.

**Acme (Pink).** Pkt. 5c., oz. 20c., ¼ lb. 60c.

**Atlantic Prize.** One of the earliest of all varieties. Pkt. 5c., oz. 25c., ¼ lb. 75c.

**Beauty.** Crimson, with a pinkish tinge, grows in clusters, large size; very smooth and solid. Pkt. 5c., oz. 20c., ¼ lb. 60c., lb. \$2.00.

**Dwarf Champion.** Early and distinct, of compact growth. Pkt. 5c., 25c. oz., ¼ lb. 65c.

**Royal Red (New).** Large size, perfect round shape, vivid red color, very solid, large cropper. Pkt. 10c.; oz. 25c., ¼ lb. 75c., lb. \$2.50

**Imperial (New).** Earliest and best tomato in existence. Color bright red, very solid and smooth. Pkt. 10c., oz. 30c., 75c. ¼ lb.

**Livingston's Favorite.** Ripens evenly and early; very prolific, good flavor, few seeds, flesh solid. Pkt. 5c., oz. 20c., ¼ lb. 60c., lb. \$2.00.

**Livingston's Perfection.** Early, deep red in color, with few seeds. Pkt. 5c., oz. 20c., ¼ lb. 60c., lb. \$2.00.

**Lorillard.** Excellent variety for forcing. Pkt. 10c., 30c. per oz.

**Magnus (New).** Extra fine variety. Either for garden or for forcing. Pkt. 15c., 60c. per oz., ¼ lb. \$1.75.

**Matchless.** Pkt. 10c., oz. 25c., ¼ lb. 75c., lb. \$2.50.

**Mayflower.** One of the earliest, highly recommended for forcing, of a bright red color. Pkt. 10c., oz. 25c., ¼ lb. 65c.

**Paragon Selected.** Early; a heavy bearer and produces fruit until killed by frost. Pkt. 5c., oz. 20c., ¼ lb. 60c., lb. \$2.00.

**Ponderosa.** The largest tomato in existence. Pkt. 10c., oz. 30c., ¼ lb. \$1.00.

**Red Cherry.** Used for preserving. Pkt. 5c., oz. 25c.

**Red Mikado.** Pkt. 10c., oz. 25c., ¼ lb. 75c.

**Stone.** Fruit very large, bright scarlet, very smooth, ripening evenly to the stem without a crack; and not subject to rot. Pkt. 5c., oz. 25c., ¼ lb. 75c., lb. \$2.00.

**Sutton's Best of All.** Best for forcing. 40c. per original pkt.

**Sutton's Eclipse.** A valuable forcing variety. 40c. per original pkt.

**Trophy Selected.** Seed is saved only from the finest ripe specimens. Pkt. 5c., oz. 25c., ¼ lb. 75c., lb. \$2.50.

**Yellow Pear.** Used for preserving. Pkt. 5c., oz. 25c.

**Yellow Prince (Livingston's).** The very best large round yellow tomato. Pkt. 10c., oz. 30c.

### TESTIMONIAL

Wissahickon Hgts., Phila., September 19, 1901.  
MR. HENRY F. MICHELL:—I send a few Stone and Atlantic Prize Tomatoes for you to see. I think they are excellent, the flavor is good and color very attractive; we have a yield of about six to eight baskets daily. Yours respectfully, MRS. J. J. HENRY.

### TOMATO PLANTS—Ready May 15th

Paragon, Selected Trophy, Beauty, Imperial, Mikado, Livingston's Stone  
Transplanted plants, doz. 20c., 100 \$1.00, 1000 \$8.00; not transplanted, 1000 \$5.00.

# TURNIP SEEDS, ETC.

**Ruta-Baga**

SOW 1 1/4 TO 2 POUNDS PER ACRE.

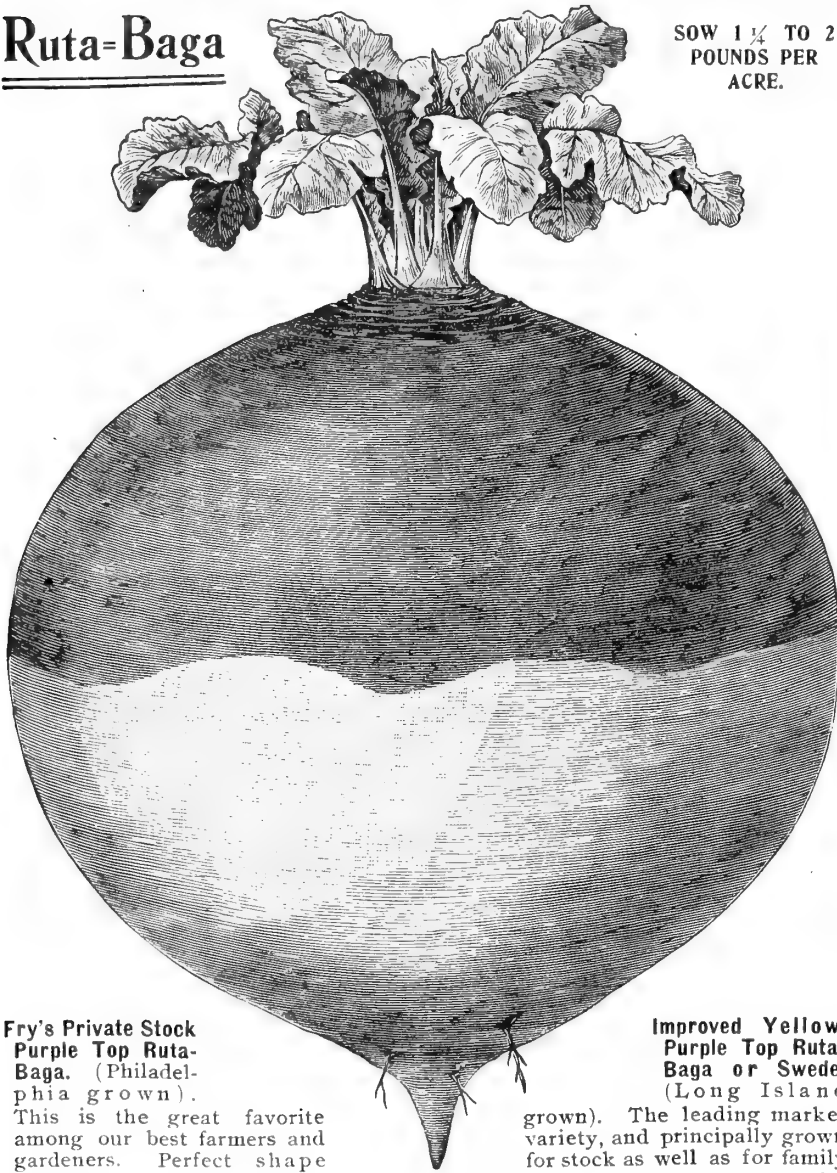

**Fry's Private Stock Purple Top Ruta-Baga.** (Philadelphia grown). This is the great favorite among our best farmers and gardeners. Perfect shape and best in every way. 10c. per oz., 30c. per 1/4 lb., \$1.00 per lb.

**Improved Yellow, Purple Top Ruta-Baga or Swede.** (Long Island grown). The leading market variety, and principally grown for stock as well as for family use; hardy productive, flesh yellow, solid, sweet fine grained and of good flavor. Pkt. 5c., oz. 10c., 1/4 lb. 15c., lb. 50c., 3 lbs. \$1.25

**Robertson's Golden Ball.** Pkt. 5c., oz. 10c., lb. 50c.  
**Yellow Aberdeen.** Pkt. 5c., oz. 10c., lb. 45c.  
**Cow Horn.** Long white. Pkt. 5c., 10c. per oz., 20c. per 1/4 lb., per lb. 50c.

**Yellow Globe or Amber.** One of the best for a general crop, excellent for table use or feeding stock, and keeps well until late in the spring. Pkt. 5c., oz. 10c., 1/4 lb. 15c., lb. 45c., 3 lbs. \$1.15.

**Turnip**  
 Herbst Rube (Ger.) Navet (Fr.)  
**One ounce for 100 feet, two pounds to the acre.**  
 For early use sow the small sorts as soon as the ground can be worked in the spring in drills fourteen inches apart. Kuta-bagas thirty inches. As the seed is fine it should be covered but slightly, except in very dry weather. Of the early varieties, thin the plants to six inches apart and the Swedes to one foot. For fall and winter use the early kinds should be sown from the middle of July to the middle of August, and Swedes from the middle of June to the fifteenth of July.

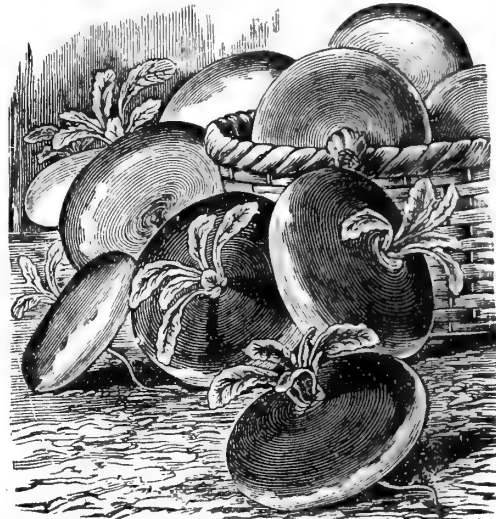

NEW CROP TURNIP

*Purple Top Flat Strap Leaf Turnip.*

**Snowball.** Extra early, perfectly round, pure white, very solid, sweet, short top. Pkt. 5c., oz. 10c., 1/4 lb. 20c., lb. 60c.  
**Extra Early Munich, Purple Top.** A very early variety, white flesh, of fine grain and good flavor. Pkt. 5c., oz. 10c., 1/4 lb. 15c., lb. 50c.  
**Early White Flat Dutch.** An early white-fleshed variety of quick growth, mild flavor and excellent quality. Pkt. 5c., oz. 10c., 1/4 lb. 15c., lb. 40c., 3 lbs. \$1.00.  
**Early White Egg.** An egg-shaped variety for spring or fall sowing. Pkt. 5c., oz. 10c., 1/4 lb. 15c., lb. 50c.  
**Early Red or Purple Top Flat.** This strap-leaved variety is the principal sort for early spring and fall use; top is red or purple, flesh fine grained, of mild flavor and a good keeper. Pkt. 5c., oz. 10c., 1/4 lb. 15c., lb. 45c., 3 lbs. \$1.15.  
**Purple Top White Globe.** Either for table or stock, is a heavy producer, early, of rapid growth and an excellent keeper. Pkt. 5c., oz. 10c., 1/4 lb. 15c., lb. 50c., 3 lbs. \$1.25.

## TOBACCO SEED

Connecticut and Penna. Seed Leaf. Pkt. 10c., 30c. per oz. | Havana Seed Leaf. Pkt. 10c., 50c. per oz.

## VEGETABLE PLANTS AND ROOTS

**Asparagus Roots.**  
 " **Barr's Mammoth.** 80c. per 100, per 1000 \$5.00.  
 " **Conover's Colossal.** 75c. per 100, per 1000 \$4.50.  
 " **Columbian White.** 80c. Per 100, per 1000 \$6.00.  
**Artichoke Roots.** Jerusalem. Qt. 15c., \$1.00 per pk., per bu. \$3.00.  
**Cabbage Plants.** Early Wakefield. 40c. per 100, per 1000 \$3.00.  
 Late Flat Dutch, 30c. per 100, per 1000 \$2.00.  
**Cauliflower Plants.** 20c. per doz., per 100 \$1.25, \$8.00 per 1000.  
**Chives.** 10c. per clump, per doz. clumps \$1.00, \$7.50 per 100.  
**Egg Plants.** Hot Bed Grown. 30c. per doz., per 100 \$2.00.  
 " " Pot Grown. 50c. doz., per 100 \$3.50.  
**Hop Vine Roots.** 5c. each, per doz. 50c., \$2.50 per 100.

**Horse Radish Roots.** 15c. per doz., per 100 50c., \$4.00 per 1000.  
**Lettuce Plants.** Best sorts. 40c. per 100, per 1000 \$3.00.  
**Mint Plants.** 10c. each, per doz. 75c., \$5.00 100.  
**Pepper Plants.** 20c. per doz., per 100 \$1.25.  
**Rhubarb Roots.** 10c. each, per doz. \$1.00, \$6.00 per 100.  
**Sage.** Holt's Mammoth. 10c. each, per doz. \$1.00, \$6.00 per 100.  
**Sweet Potato Plants.** Red and Yellow. 30c. per 100, per 1000 \$1.75. Special prices on larger quantities.  
**Tarragon Roots.** 20c. each, per doz. \$2.00.  
**Thyme Roots.** 10c. each, per doz. \$1.00, \$6.00 per 100.  
**Tomato Plants.** Hot Bed Grown. 20c. doz., per 100 \$1.00. \$8.00 per 1000. Pot Grown. 50c. doz., per 100 \$3.50.



FARM SEEDS, ETC.

Prices Subject to Market Changes.



Crimson Clover.



Wheat.

WRITE FOR SPECIAL QUOTATIONS ON LARGE QUANTITIES BEFORE PLACING YOUR ORDER ELSEWHERE.

**BUCKWHEAT.** Japanese, Silver Hull and Common. Sow about 1 bushel per acre. Per qt. 15c.; per pk. 40c.; per bu., \$1.10.

**BARLEY.** For seeding purposes. Sow 2 to 2½ bushels per acre. Per qt. 15c.; per pk. 45c.; per bu. \$1.30.

**CANADA FIELD PEAS.** Very profitable as a hay and forage crop, also a very early nutritious dry or green feed. Sow in March or April at the rate of 1½ bushels per acre broadcast with ½ bushel oats as a support; cut for hay before the peas mature. Excellent pigeon feed when dry. Per qt. 10c.; per pk. 50c.; per bu. \$1.50.

**CARROT. Improved Long Orange.** This is the best and most satisfactory variety for stock feeding. 75c. per lb.; 5 lb. lots and over at 65c. per lb. Sow 3 to 4 lbs. per acre.

**CARROT. Danver's Half Long.** Highly recommended for stock feeding. 75c. per lb.; 5 lb. lots and over at 65c. per lb.

**CORN.** All the best sorts such as **Chester Co., Mammoth, Golden Beauty, Leaming Dent, etc., etc.** For list of varieties and prices see page 18. Plant 9 to 10 qts. per acre.

**CLOVER. Red, Extra choice re-cleaned "Buckeye" brand.** The very best, entirely free from weeds. Sow ½ bushel (20 lbs.) to the acre. Per lb. 14c.; per pk. \$1.80; per bu. \$7.00.

" **Crimson or Scarlet.** Excellent for cutting as feed or for plowing under, makes a good substitute for manure or other fertilizer; can be sown from June to October 15th; about 20 lbs. per acre. Extra choice seed. Per lb. 10c.; per pk. \$1.25; per bu. \$4.10.

" **Bokhara.** Excellent bee food, 30c. per lb.

" **Alfalfa or Lucerne.** Sow 20 lbs. per acre. An excellent forage crop. Per qt. 15c.; per pk. \$1.95; per bu. \$7.50.

" **Alsike.** Best quality, extra clean. Sow 10 lbs. per acre. The hardiest of all clovers yielding an enormous crop. Per lb. 15c.; per pk. \$2.50; per bu. \$9.60.

" **White Dutch.** Sow 12 to 15 lbs. per acre. This is the clover largely used for lawn, although it is also valuable for permanent pasture use. Per lb. 25c.; per pk. \$3.25; per bu. \$11.40.

" **Millet Golden or German.** Produces hay of very fine quality. Sow 1 bushel per acre. Per lb. 10c.; per pk. 40c.; per bu. \$1.30.

" **Egyptian or East Indian.** Sow 5 lbs. to the acre. Lb. 25c.; \$2.00 per 10 lbs.; per 100 lbs. \$12.50.

" **Hungarian.** A coarse, tall growing sort. Per lb. 10c.; per pk. 30c.; per bu. \$1.00.

" **Mangel Wurzels.** All the very best sorts. For prices and full description see pages 12 and 13. Sow about 5 lbs. to the acre.

**OATS.** All the best and most profitable varieties. Sow 2½ to 3 bushels per acre. Per lb. 10c.; per pk. 25c.; per bu. 70c.

**PARSNIP.** Used by many farmers for stock feeding. **Improved Hollow Crown.** 55c. per lb., 5 lb. lots and over at 50c. per lb. Sow 4 to 5 lbs. per acre.

**PUMPKIN.** Valuable food for stock. Sow 3 lbs. per acre. See page 25 for list of varieties and prices.

**RUTA BAGA.** See page 28 for best varieties and prices. Sow 2 lbs. per acre.

**RYE.** Winter and Spring. Best seed stock. Sow 1½ bushels per acre. Per lb. 10c.; per pk. 40c.; per bu. \$1.10.

**DWARF ESSEX RAPE.** A valuable forage plant. It is a most profitable crop for sheep and cattle, also for turning under as green manure. 6 lbs. per acre, 10c. per lb.; 10 lbs. for 90c.; \$7.00 per 100 lbs.

**SOUTHERN BLACK-EYED COW PEAS.** A small white variety with black eye. Sow in May or June for plowing under. Much used for green manuring purposes. Sow two to three bushels to acre. Per lb. 15c.; per pk. 65c.; per bu. \$2.25.

**SOJA BEANS.** One of the most remarkable drought resisting crops under cultivation. Will thrive under the most adverse conditions, a tremendous yielder and valuable soil improver. Sow ½ bu. per acre. Per lb. 15c.; per pk. 75c.; per bu. \$2.25.

**TIMOTHY.** Extra prime re-cleaned seed. Sow ½ bushel per acre. Per lb. 15c.; per pk. 85c.; per bu. \$3.30.

**WHEAT.** All the leading varieties such as **Dietz, Longberry, Fultz, Jones Winter Fife.** Sow 1½ bushels per acre. Per lb. 10c.; per pk. 50c.; per bu. \$1.35.

MISCELLANEOUS SEEDS.

**FLAX SEED.** Sow 1 bushel per acre. 10c. per qt.; per bu. \$2.50.

**OSAGE ORANGE SEED.** 40c. per lb.; per bu. \$5.00.

**TEOSINTE.** (Reana Luxurians). Sow 4 pounds per acre. Excellent forage plant, also used for ensilage. Oz. 10c.; \$1.00 per lb.

**TARES OR SPRING VETCHES.** (Vicia Sativa). Used for green manuring. Sow 1 to 2 bushels per acre. 10c. lb.; bu. \$2.75; \$4.00 per 100 lbs.

**WINTER VETCHES.** (Vicia Villosa). Used for sowing in autumn. 12c. per lb.; per bu. \$6.00; \$9.00 per 100 lbs.

**SUGAR CANE. Early Amber.** The earliest and most prolific variety. Sow 4 quarts per acre in drills; broadcast sow 8 quarts. 20c. per qt.; bu. \$2.75.

**BROOM CORN. Improved Evergreen.** Sow 6 to 8 quarts per acre. Qt. 15c.; \$2.50 per bu.

BIRD SEEDS, Fresh, Recleaned.

**Canary.** (Sicily). Qt. 15c.; 4 qts. 50c.; \$3.00 per bu.

**Mixed Bird Seed.** Qt. 15c.; 4 qts. 50c.; \$3.00 per bu.

**Hemp Seed.** Qt. 12c.; 5 qts. 50c.; \$2.00 per bu.

**Rape Seed.** Qt. 15c.; 4 qts. 55c.; \$3.25 per bu.

**Sunflower Seed.** Qt. 10c.; 4 qts. 30c.; \$1.75 per bu.

**Millet Seed.** (French). Qt. 25c.; 4 qts. 75c.; \$4.50 per bu.

**Maw Seed.** 15c. per lb.; 4 lbs. for 50c.

**Canada Pigeon Peas.** Qt. 10c.; pk. 50.; \$1.50 per bu.

**Unhulled Rice.** 20c. per qt.

**Cuttle Fish Bone.** 3c. each; 40c. lb.

**Lettuce Seed.** 5c. per oz.; 20c. per lb.

## LAWN GRASS SEEDS

Our Grass and Clover Seeds are of the very finest quality, extra clean and free from weeds, and can be relied upon to give the best of satisfaction. We have a large number of unsolicited testimonials from customers who have sown our seed.

We make a specialty of supplying Country Clubs with the proper grass seed for Golf Links, Tennis Courts, Etc., Etc. Special information as well as Special Prices will be cheerfully given. We can refer to a number of the leading Clubs whom we supply.

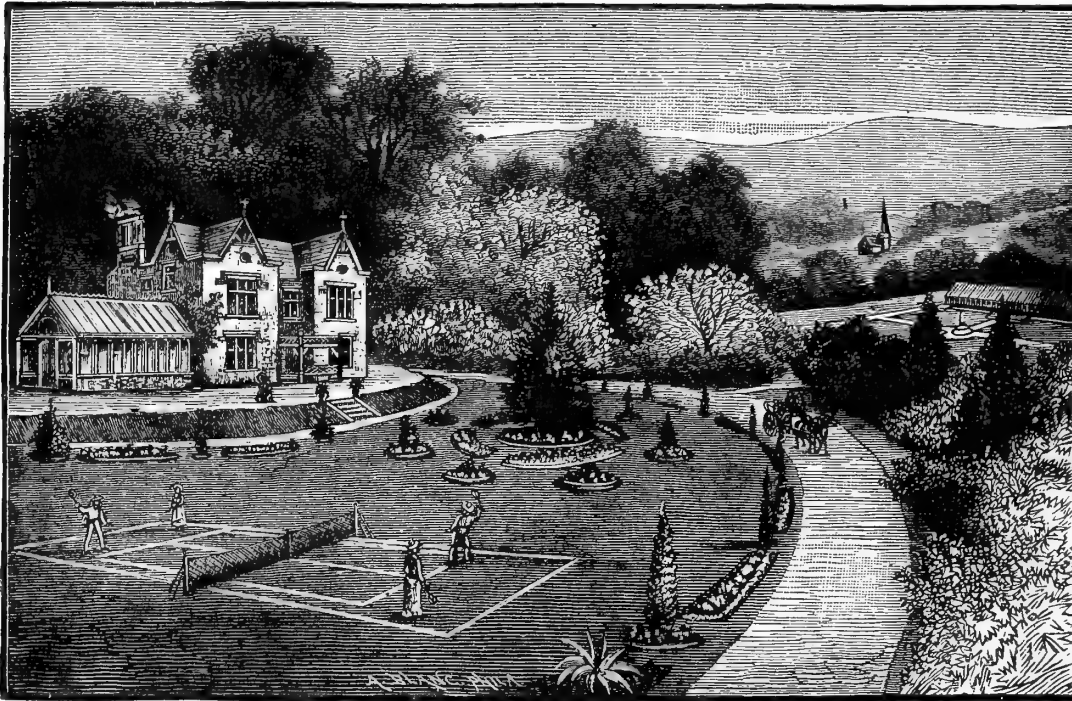

## How to Make a Lawn

Some previous cultivation, or at least a thorough turning over should be given. A clayey loam is the best foundation for a good lawn. Let the surface be graded to the level wanted in all parts and well rolled—a light raking following this will prepare for the seed sowing, which should be done as early in the spring as the ground can be worked, provided the ground has not already been prepared in the fall. The very best time, the ground being in order, is about April 1st. Three to four bushels per acre should be sown; the latter amount is best, for the young plants are but small and if thick, cover the ground better and make a smoother and more even turf. Mowing should be done at least once a week in favorable growing weather, and even in dry weather it should be cut

twice a month. Do not allow the clippings to remain on the ground, except they are very short.

P. S.—We strongly recommend using Michell's Pure Bone Meal and Canadian, Unleached Wood Ashes, for top dressing Lawns.

## Michell's Own Special Formulas of Lawn Grass Seed Mixtures

### Michell's "None-Superior Evergreen" Lawn Grass Seed.

This mixture is made of the finest varieties, presenting the appearance of the lawn like a bed of dark green velvet. We can safely say that there is no better mixture in the market. The seeds used are all fresh and re-cleaned, and enough white clover is added to make it strong and durable. (20 lbs. per bushel.) Qt. 25c.; 4oc. 2 qts.; 4 qts. 65c.; \$1.00 pk.; bus. \$4.00; (5 bu. lots \$3.65 bu.)

*Please note that we give 20 pounds per bushel, which is equivalent to 1 1/3 bushel.*

**Fairmount or Central Park Lawn Mixture.** A very fine mixture which we can highly recommend. (15 lbs. per bushel.) Qt. 20c.; 35c. 2 qts.; 4 qts. 50c.; 75c. pk.; bus. \$2.75; (5 bu. lots \$2.50 bu.)

**Phila. Country Club Golf Grounds Mixture.** P. F. Foy's special formula. Strictly reliable. (15 lbs. per bushel.) Qt. 20c.; 35c. 2 qts.; 4 qts. 50c.; 70c. pk.; bus. \$2.50; (5 bu. lots \$2.25 bu.)

**Michell's Lawn Tennis Mixture.** Contains a special mixture of short growing varieties. (20 lbs. per bushel.) Qt. 25c.; 4oc. 2 qts.; 4 qts. 60c.; \$1.00 pk.; bus. \$4.00; (5 bu. lots \$3.65 bu.)

**Michell's Putting Greens Mixture.** This is a new mixture of our own; made up especially from such grasses as will grow very short and make a solid surface to withstand heavy wear.

(20 lbs. per bushel.) Qt. 25c.; 4oc. 2 qts.; 4 qts. 65c.; \$1.00 pk.; bus. \$4.00; (5 bu. lots \$3.65 bu.)

**Michell's Shady Lawn Mixture.** Specially adapted for lawns on which there are trees, and where the usual grass seeds do not thrive. (20 lbs. per bushel.) Qt. 25c.; 4oc. 2 qts.; 4 qts. 65c.; \$1.00 pk.; bus. \$4.00; (5 bu. lots \$3.75 bu.)

**Michell's Special Terrace Mixture.** This mixture consists of such varieties of grasses that will form a well bound turf, to withstand washing by rain, etc.; also excellent for exposed embankments. (20 lbs. per bushel.) Qt. 25c.; 4oc. 2 qts.; 4 qts. 65c.; \$1.00 pk.; bus. \$4.00; (5 bu. lots \$3.60 bu.)

### TESTIMONIALS

TRENTON, N. J., June 1, 1901.  
Your Evergreen Lawn Grass Seed has produced a splendid lawn; it's a grand mixture indeed.  
Very truly yours,

HENRY T. CLINKABERRY,  
Gardener to C. G. Roebling, Esq.

FRANKFORD, PHILADELPHIA; Sept. 26, 1901.  
Please send me — bushels of Special Formula Grass Seed, same as purchased before. I found it the best seed that I have ever sown.

Yours respectfully,  
W. H. WEIKEL,  
Supt. of North Cedar Hill Cemetery.

P. S. For separate varieties of Grass Seed and Pasture Mixture see next page (31).

# GRASS SEEDS

## Michell's Special Formula Permanent Pasture Grass Seed



Loading Michell's Special Formula Permanent Pasture Grass.

This special mixture is made by us after careful study of the very best permanent, hardy varieties of grasses, such as will produce a quick growth and of a permanent nature. All the different varieties contained in this special formula are especially adapted either for cutting for hay or pasturing horses and cattle, and can be relied upon to give the very best results. We recommend this mixture either for making entirely new pasture fields, or for replenishing partly worn-out pastures.

20 lbs. per bushel, \$3.00 per bu.; (5 bu. lots \$2.60 per bu.); (10 bu. lots and over at \$2.50 per bu.)

2½ bushels per acre IS THE PROPER QUANTITY TO SOW ON NEW FIELDS, WHEREAS ONE TO 1½ BUSHELS PER ACRE IS SUFFICIENT FOR RE-SOWING AND REPLENISHING OLD FIELDS.

P. S.—We have numerous unsolicited testimonials from our best customers, praising the results derived from this mixture.

# GRASS SEEDS—Separate Varieties

**Awnless-Brome Grass** (*Bromus inermis*). A valuable grass for light, dry soils. Will stand long droughts and produce heavy growth where other grasses frequently fail. The United States Agricultural Department has been making repeated tests of this variety with the best results. Forty lbs. to the acre. Lb. 22c.; bu. (14 lbs.) \$2.50; 100 lbs. \$15.00.

**Blue Grass** (*Kentucky*). Extra fancy cleaned. One of the most valuable sorts for lawn purposes, and as a pasture grass is indispensable. This grade is the best for sowing lawns. Sow 3 to 5 bu. per acre for lawn; for pasture, sow 2½ bu. Qt. 15c.; bu. (14 lbs.) \$1.75; (original sacks, cont'g 8 bu., \$1.60 per bu.)

**Creeping Bent Grass** (*Agrostis stolonifera*). Excellent for lawns, succeeds well in all conditions, makes a low velvety growth. Lb. 25c.; bu. (20 lbs.) \$4.50; 100 lbs. \$20.00.

**Canadian Blue Grass**. Adapted especially to high, dry situations. Lb. 15c.; bu. (14 lbs.) \$1.50; 100 lbs. \$9.50.

**Crested Dogstail**. An excellent grass for hard, dry soils, valuable for pastures or lawns, 25 lbs. to acre. Lb. 35c.; bu. (21 lbs.) \$6.00; 100 lbs. \$25.00.

**English Rye Grass** (*Perennial Rye*). Lb. 18c.; bu. (24 lbs.) \$2.25; 100 lbs. \$7.50.

**Fancy Herd or Red Top**. Extra recleaned seed, free from chaff. Lb. 20c.; bu. (32 lbs.) \$5.50; 100 lbs. \$15.00.

**Herd or Red Top Grass**. Lb. 15c.; bu. (10 lbs.) \$1.00; sack of 50 lbs. \$4.00.

**Hard Fescue**. Thrives well in dry situations, where many other grasses fail; 30 lbs. to the acre. Lb. 25c.; bu. (12 lbs.) \$2.75; 100 lbs. \$17.00.

**Italian Rye Grass**. Lb. 12c.; bu. (22 lbs.) \$2.25; 100 lbs. \$8.50.

**Meadow Fescue**. English Blue Grass. An excellent grass for permanent pasture or hay; the foliage is highly nutritious. Lb. 20c.; bu. (22 lbs.) \$3.25; 100 lbs. \$14.00.

**Natural Green Grass**. Lb. 20c.; bu. (14 lbs.) \$2.00; 100 lbs. \$12.00.

**Orchard Grass**. For pasture, sowing under orchards or shady places. Lb. 20c.; bu. (14 lbs.) \$2.00; 100 lbs. \$13.00.

**Rhode Island Bent Grass** (*Agrostis Canina*). Resembles Herds Grass, forming a fine turf even on thin soils. Doing especially well in salt atmospheres. The only Lawn Grass used at Newport. Sow 40 lbs. to the acre. Lb. 25c.; bu. (15 lbs.) \$2.50; 100 lbs. \$15.00.

**Sheeps' Fescue** (*Festuca Ovina*). Sow 40 lbs. to the acre. Lb. 20c.; bu. (12 lbs.) \$2.25; 100 lbs. \$16.00.

**Sweet Vernal** (*Perennial*). Very fragrant. Lb. 65c.; 5 lbs. \$2.50. " " (*Annual*). Lb. 25c.; 5 lbs. \$1.00.

**Timothy Seed**. Prime. About \$3.30 per bu.

**Wood Meadow Grass** (*Poa Nemoralis*). Particularly adapted for pleasure grounds and lawns; will grow under trees where few other grasses can exist. Lb. 35c.; bu. (14 lbs.) \$4.25; 100 lbs. \$27.50.

# CLOVER SEEDS—Prices subject to market changes. 60 lbs. per bu.

**Alsike or Swedish**. Valuable for pasturage or ensilage. Lb. 20c.; pk. \$2.50; bu. \$9.60.

**Alfalfa or Lucerne**. Sow early in spring to secure a good stand before winter. Lb. 15c.; pk. \$1.95; bu. \$7.50.

**Bokhara Clover**. Excellent for bee food. Lb. 30c.

**Red Clover**. The seed we offer is recleaned and free from weeds. Lb. 14c.; pk. \$1.80; bu. \$7.00.

**Scarlet or Crimson Clover**. Delaware grown. Lb. 10c.; pk. \$1.25; bu. \$4.10.

**White Dutch Clover**. The best variety for lawns; remains green throughout the season; highest grade of seed only. Lb. 25c.; pk. \$3.25; bu. \$11.40.

See also page 18 for Farm Seeds.

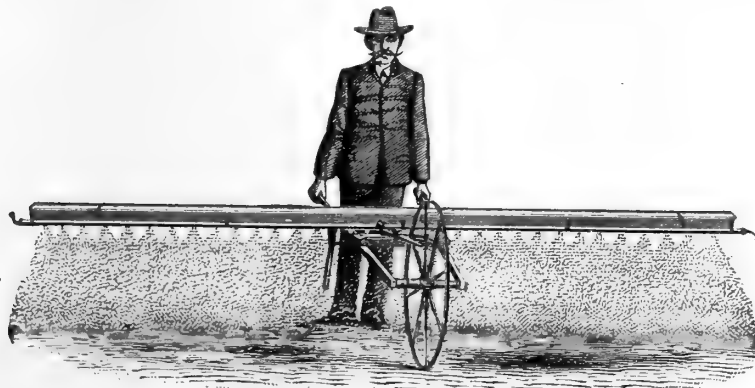

Thompson's Grass Seeder.

## Thompson's Grass Seeder

This is the only machine for properly sowing Grass Seeds on lawns, fields, etc., distributing it very evenly. Five acres can be sown with seed by this method while one can be sown by hand. It is very easily handled; simply requires pushing like a wheelbarrow. An agitator is provided inside to prevent clogging, covering area 13½ feet. Price, \$6.50.

P. S.—We especially invite large buyers of Grass, Clover and Millet Seeds to ask us to quote prices and allow us to submit our samples before purchasing elsewhere.

Fresh Tested  
Reliable

# FLOWER SEEDS

Strictly of the  
Finest Quality

For \$1.00	Select Flower Seeds to the Amount of \$1.15
" 2.00	" " " " " " " 2.30
" 5.00	" " " " " " " 6.00

Collections of 12	Choice Annuals, Each Separate,	\$0.50
" " 18	" " " " " "	.75
" " 24	" " " " " "	1.00

For the Convenience of Customers we have numbered all the Flower Seeds, which saves a great deal of time and labor. For instance, if you wish 1 pkt. of *Alyssum Little Gem*, order 1 pkt. No. 23, etc. Please be careful to give the correct number, as a mistake in the number would result in getting the wrong seeds.

**Abronia.** Trailing plants, producing clusters of sweet-scented, verbena-like flowers; effective in beds, rock-work or hanging baskets. Half hardy annuals; height, six inches.

1 **Umbellata.** Rosy lilac, with a white eye. Pkt. 5c.

**Abutilon.** Sown any time before April, in a temperature of sixty degrees, they will produce fine flowering plants the first season.

4 **Choice Mixed.** All colors; two to six feet high. Pkt. 15c.

**Aconitum** (*Monk's Hood or Wolfsbane.*) A hardy perennial, producing curiously shaped flowers in abundance.

7 **Napellus.** Very pretty blue and white flowers; three feet high. Pkt. 5c.

**Adonis** (*Flos Adonis.*) Also known as Pheasant's Eye. Hardy annuals of easy culture, with pretty fine-cut foliage.

13 **Æstivalis.** Dark crimson flowers, with a light centre; one foot high. Pkt. 5c.

14 **Agathea Cœlestis.** Beautiful blue flowers. Pkt. 10c.

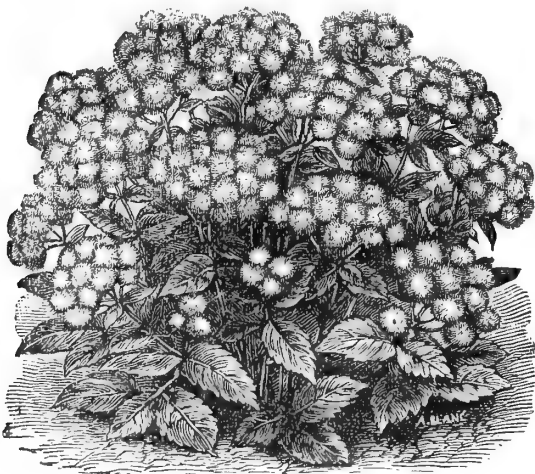

Blue Perfection Ageratum.

## Ageratum.

For beds or borders, blooms all summer; half-hardy annuals.

- 20 **Blue Perfection** (Dwarf). New. 10c. per pkt.; 35c. per 1/4 oz.
- 16 **Large-Flowered Dwarf Blue.** Pkt. 5c., per oz. 30c.
- 17 **Large-Flowered Dwarf White.** Pkt. 5c., per oz. 30c.
- 18 **Large-Flowered Dwarf Mixed.** Pkt. 5c. per oz. 25c.

**Ampelopsis** (*Miniature Virginia Creeper or Japanese Ivy.*) A hardy perennial from Japan; leaves turn to scarlet in autumn; will adhere to brick or stone walls.

21 **Veitchi.** Pkt. 10c., oz. 30c.

**Achillea.** Useful for cut flowers or for placing in cemeteries; hardy perennial; eighteen inches high.

10 **Ptarmica Plena.** Pure white double flowers. Pkt. 15c.

31 **Amayllis Veitch's Hybrids.** Free flowering type, can readily be grown from seed. Pkt. 15c.

**Amaranthus** (*Half-hardy annuals.*)

33 **Cruentus** (*Prince's Feather.*) Erect flowering, bright scarlet. Pkt. 5c.

34 **Caudatus** (*Love Lies Bleeding.*) Blood red. Pkt. 5c.

35 **Gordoni or Sunrise.** Bronzy crimson foliage, shading off to brilliant scarlet. Three feet high. Pkt. 10c.

36 **Salicifolius** (*Fountain Plant.*) Pkt. 5c.

37 **Tricolor Splendens** (*Joseph's Coat.*) Leaves red, yellow and green; three feet high. Pkt. 5c., oz. 50c.

38 **Mixed.** All sorts. Pkt. 5c.

SWEET

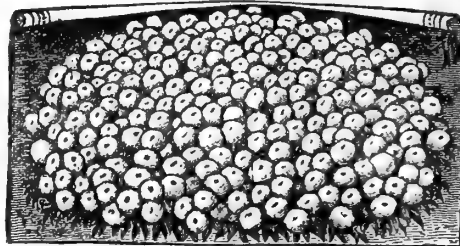

"Carpet of Snow" Alyssum.

## Alyssum

Free flowering plants for beds, edgings or rock-work, or winter blooming; the annual variety blooms all summer.

23 **Little Gem.** Of dwarf habit, each plant covering a circle fifteen to thirty inches in diameter. Pkt. 5c., 1/4 oz. 15c., oz. 50c.

24 **Sweet Alyssum.** White. Pkt. 5c., oz. 25c.

25 **"Carpet of Snow."** Dwarf. Pure white. 5c per pkt.; 50c. per oz.

26 **Saxatile Compactum.** Showy golden yellow flowers; hardy perennial, blooms the first season; one foot high. Pkt. 5c.

28 **Adlumia Cirrhosa.** (Allegheny Vine.) Pkt. 10.

**Anemone** (*Wind Flower.*) A very pleasing hardy perennial, easily grown from seed, producing large flowers early in the spring; one foot high.

45 **Coronaria, Mixed.** Scarlet, purple, blue, white, strip'd. Pkt. 10c

## Antirrhinum

(*Snappedragon.*) A most showy and useful border plant; large flowers of most brilliant colors, with beautifully marked throats; succeed in any good garden soil; very effective in beds;

hardy perennials, blooming first year if seed is sown early. One foot high.

48 **Queen of the**

**North.** The finest of all Snapdragons, forms

an excellent plant

one foot high;

each plant occupies

a space of 1

to 1 1/2 feet, and is

densely covered

with large white

flowers. A beauty

for beds and borders,

also valu-

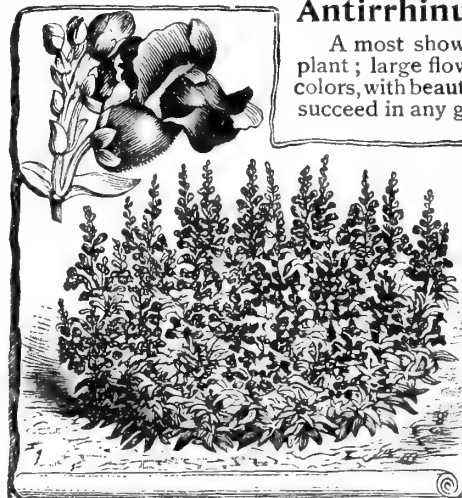

Antirrhinum or Snapdragon.

able for pot culture. Pkt. 10c., 1/4 oz. 25c.

49 **Dwarf Mixed.** Finest Tom Thumb. Pkt. 5c., oz. 40c.

50 **Tall Mixed.** Pkt. 5c., per oz. 30c.

51 **Imported Collections.** Ten dwarf varieties, 40c.

55 **Giant Yellow.** Pkt. 10c.

107 **Giant Scarlet.** Pkt. 10c.

53 **Dwarf Firefly.** Pkt. 10c.

52 **Imported Collections.** Ten tall varieties, 40c.

108 **Asperula.** (Sweet Woodruff) Hardy annual, sweet scented blue flowers. 1 foot. 5c. pkt., 50c per oz.

115 **Auricula Choicest Mixed.** Half hardy perennial. Pkt. 10c.

29 **Asparagus Plumosa.** Per 100 seeds \$1.25., 25c. per pkt.

30 **Asparagus Sprengeri.** Per 100 seeds \$1.00. 20c. per pkt.

The above two varieties of Ornamental Asparagus are now in great demand. They are easily grown from seed.



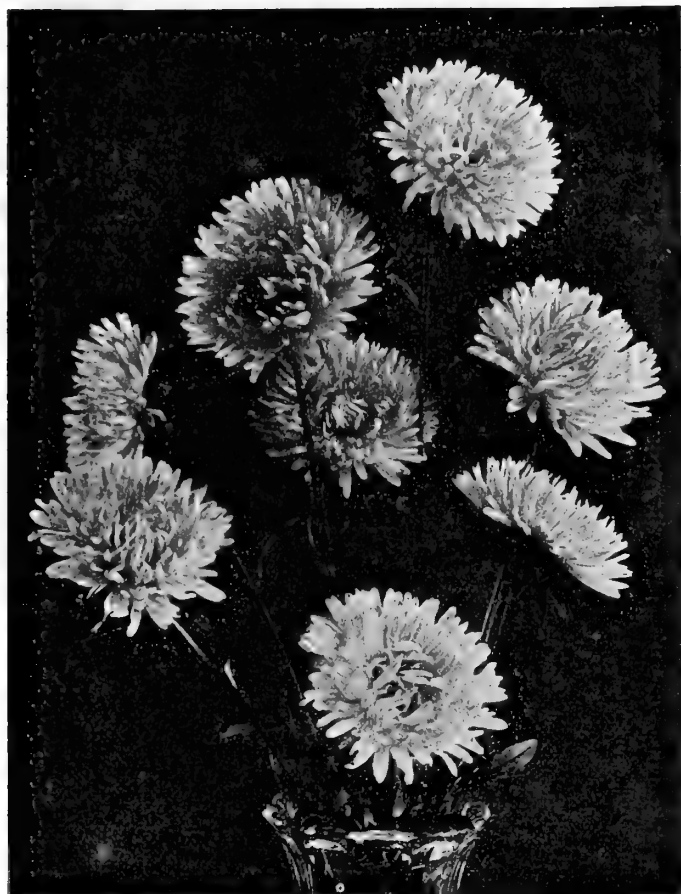

Branching Asters (Semple's True Strain) from a Photograph.

## Asters (Queen Margaret)

There is no flower which combines so much beauty and variety of habit and shape, with such brilliancy and richness of color, as this; it is splendid for bedding, bordering or pot culture. Give it rich soil and plenty of water for the best results. The seed we offer has been saved from the very best double flowers only.

**Semple's Branching Large Flowering.** Without doubt the best garden aster, produces flowers of immense size on very long stems, which make them a most desirable cut flower.

- 88 **Semple's Bright Red.** Pkt. 10c., 1/8 oz. 30c.
- 89 " **Pure White.** Pkt. 10c., 1/8 oz. 30c.
- 90 " **Shell Pink.** Pkt. 10c., 1/8 oz. 30c.
- 91 " **Lavender.** Pkt. 10c., 1/8 oz. 30c.
- 92 " **Blue.** Pkt. 10c., 1/8 oz. 30c.
- 87 " **Choicest Mixed.** Pkt. 10c., 1/8 oz. 30c., oz. \$2.00.

## Improved Victoria Asters.

- 63 **Blue.** . . . . . pkt. 10c. 1/8 oz. 30c. | 66 **Scarlet.** . . . . . pkt. 10c. 1/8 oz. 30c.
- 64 **Pink.** . . . . . " 10c. " 30c. | 67 **Purple.** . . . . . " 10c. " 30c.
- 65 **White.** . . . . . " 10c. " 30c. | 68 **Finest Mixed.** " 10c. " 30c.
- 70 **Dwarf Pyramidal Bouquet.** The plants form a complete bouquet of flowers. Mixed, one foot high. Pkt. 10c.
- 71 **Cocardeau or Crown.** With white centres, bordered with bright rich colors. Pkt. 10c.
- 76 **Vick's White Branching.** Very long stems, pure white, four inches in diameter. The blooms have the appearance of large and graceful Chrysanthemums. Pkt. 10c., 1/8 oz. 30c.
- 80 **Perennial Mixed.** Hardy, herbaceous plants. Pkt. 10c.
- 81 **Aster-Mignon Mixed.** Semi-dwarf; bear, when well grown, forty to fifty flowers of a beautiful shape. Pkt. 10c.
- 82 **Mignon, Pure White.** Pkt. 10c., 1/8 oz. 40c.
- 83 **Yellow Betteridge's Quilled.** The flowers being quilled and very double show the most clearly pronounced yellow among asters. Pkt. 10c., 3 pkts. 25c.

## Comet Asters



### Jewel or Ball Shaped Asters.

A new and most beautiful class, obtained from the well-known "Paeony Perfection," forming perfectly round flowers.

- 93 **Sky or Light Blue,** pkt. 10. | 94 **Reddish Violet,** pkt. 10c.
  - 95 **Pure White,** pkt. 10c. | 96 **Bright Pink,** pkt. 10c.
  - 97 **Brilliant Scarlet,** pkt. 10c. | 98 **Mixed, all colors,** pkt. 10c.
- One pkt. of each of the above, 6 pkts. in all, 50c.

### Truffaut's Prize Asters.

**Improved Paeony-Flowered.** Very double, large and finely shaped, the petals beautifully incurved. Considered the finest aster for garden or for cutting. One and a half feet.

- |                                     |              |  |
|-------------------------------------|--------------|--|
|                                     | Pkt. 1/8 oz. | Pkt. 1/8 oz.                             |
| 56 <b>Pure White</b> . . . . . 10c. | 30c.         | 59 <b>Glowing Crimson Scarlet</b> . 10c. |
| 57 <b>Light Blue</b> . . . . . 10   | 30           | 60 <b>Finest Mixed</b> . . . . . 10      |
| 58 <b>Pink</b> . . . . . 10         | 30           | 61 <b>Purple Violet</b> . . . . . 10     |

### Comet Asters.

A very handsome class, resembling the popular Japanese Chrysanthemum.

- 72 **Pink and White.** Pkt. 10c. | 44 **Pure White Giant.** Pkt. 10c.
- 1100 **Rich Carmine.** Pkt. 10c.
- 1101 **Blue.** Pkt. 10c.
- 1102 **Peach Blossom.** Pkt. 10c.
- 46 **Choicest Mixed.** All colors. Pkt. 10c., 30c. per 1/8 oz.
- 73 **Dwarf Chrysanthemum-Flowered.** Mixed. Pkt. 10c.
- 74 **Dwarf Queen.** Choicest mixed. Pkt. 10c., 1/8 oz. 30c.
- 75 **Triumph.** The color is peculiarly brilliant, pure scarlet. Each plant bears at least thirty to forty flowers of exquisite beauty. Pkt. 10c., 3 pkts. 25c.
- 78 **German Quilled, Mixed.** Perfectly double quilled flowers of beautifully mixed colors; two feet high. Pkt. 5c., 1/4 oz. 30c.
- 79 **China or German, Mixed.** Pkt. 5c., oz. 60c.

### Queen of the Market Extra Early Asters.

Very choice class. About three weeks earlier than any other class.

- 39 **Pure White.** Pkt. 10c. | 40 **Rich Pink.** 10c. per pkt.
- 41 **Bright Scarlet.** Pkt. 10c. | 47 **Light Blue.** 10c. per pkt.
- 43 **Choicest Mixed.** Pkt. 5c. | 42 **Dark Blue and Purple.** Pkt. 10c.

One pkt. of each of these, 6 pkts. in all, 50c.

- 69 **Vicks New Daybreak.** A most beautiful distinct class—the color is a delicate rich pink, the flower is of good size, the stems are long, in fact it is one of the loveliest asters for cutting purposes. Per 1/8 oz. 40c., 10c. per pkt.

### IMPORTED COLLECTIONS OF ASTERS.

- 84 **Finest Quilled.** Ten varieties, 50c.
- 85 **Truffaut's Paeony Perfection.** Twelve varieties, 75c.
- 86 **Victoria.** Eight colors, each separate, 50c.
- 77 **Pictorial collection of 10 best classes,** each variety separate, 50c.

## Aquilegia (Columbine.)

- 100 **Chrysantha** (*Golden Spurred*). Strong grower, forming bushy plants three feet high, bearing all through the season an abundance of bright golden yellow flowers. Pkt. 10c.  
 101 **Cœrulea**. Flowers are very large, violet blue, and inner petals pure white; two feet high. Pkt. 10c.  
 102 **Single**. All colors mixed. Pkt. 5c., oz. 30c.  
 103 **Double**. All colors mixed. Pkt. 5c., oz. 40c.



## Balsam (*Lady Slipper or Touch-Me-Not.*)

- Improved Camelia-Flowered**. Very choice strain.  
 123 **White Perfection**. Very double. Pkt. 10c., oz. \$1.00.  
 124 **Pink**. Very double. Pkt. 5c., oz. \$1.00.  
 125 **Scarlet**. Very double. Pkt. 5c., oz. \$1.00.  
 126 **Mixed**. Choicest. Pkt. 10c., oz. \$1.00.  
 127 **Mixed**. Very fine. Pkt. 5c., oz. 50c.  
 129 **Collection**. Six varieties, each separate. Pkt. 30c.
- 
- 120 **Balloon Vine**. A favorite climber. Pkt. 5c., oz. 20c.  
 121 **Balsam Apple**. Very useful. Pkt. 5c., oz. 25c.  
**Beans**. Very rapid climber; flowering profusely, and admirably adapted for covering screens, etc.  
 138 **Scarlet Runner**. Fiery Scarlet. Pkt. 5c., pt. 20c.  
 139 **White Runner**. Pure white. Pkt. 5c.  
**Bidens** (*Dahlia Zimapani*). A free flowering tender annual, having beautiful foliage and bearing fine and attractive flowers. One foot high.  
 159 **Atrosanguina**. Rich dark crimson, with yellow anther. Pkt. 10c.  
**Brachycome** (*Swan River Daisy*). Free flowing plants, covered during the greater part of summer with a profusion of pretty Cineraria-like flowers. Half hardy annual.  
 163 **Iberidifolia Mixed**. Light blue and white. Six inches high. Pkt. 5c.  
**Beet**. The ornamental-leaved beets are most useful for planting in ribbon beds or in groups.  
 155 **Red Chilian**. Brilliant red foliage. Pkt. 5c., oz. 15c.  
 156 **Yellow Chilian**. Golden yellow. Pkt. 5c., Oz. 15c.  
**Browallia**. One of our favorite bedding plants, covered with rich, beautiful flowers during the summer and autumn months, growing freely in any rich soil; blooms finally in winter if sown in August. Half hardy annuals, eighteen inches high.  
 170 **Elata Granoiflora Cœrulea**. Large sky blue flowers. 5c.  
 171 **Speciosa Major** (*New.*) Very large, rich blue. Pkt. 10c.

## TUBEROUS



## BEGONIA

### Begonia (*Tuberous-Rooted Varieties.*)

- 143 **Choicest Strain**. Single Mixed. Pkt. 15c.  
 144 **Double Mixed**. Choicest strain. Pkt. 25c.  
 145 **International Prize**. Saved from best English, French and German tuberous-rooted varieties. Pkt of about 500 seeds. 25c.



*Begonia Vernon.*

### Begonia (*Semperflorens, Etc.*)

- 142 **Vernon**. Rich orange carmine flowers and bronze colored foliage. Very effective for bedding, being covered with bloom from May until autumn. Pkt. 10c., 30c. per  $\frac{1}{8}$  oz.  
 149 **Queen of Carpet Bedders**. A dwarf variety of the well-known Begonia Vernon. Grows only five inches high, bright red flowers, dark leaves. Pkt. 15c.  
 140 **Crimson Gem**. Brilliant variety; flowers rich red, foliage bronzy crimson. Per pkt. 15c.  
 150 **Coccinea Vulcan**. (Scarlet.) Pkt. 15c.  
 151 **Compacta Rosea**. (Pink.) Pkt. 15c.  
 152 **Compacta Alba**. (White.) Pkt. 15c.  
 147 **Erfordii**. (Pink.) Pkt. 15c.  
 153 **Rex**. New Hybrids. Ornamental foliage. Pkt. 25c.

### Campanula (*Canterbury Bells*)

- 199 **Choice Mixed Double**. Pkt. 5c., 50c. per oz.  
 200 **Choice Mixed Single**. Pkt. 5c., 30c. per oz.  
 201 **Cup and Saucer** (*Calycanthema*). Choice mixed. Pkt. 10c.  
 202 **Cup and Saucer**. Pure White. Pkt. 10c.  
 203 **Persicifolia Blue**. Beautiful Species. Pkt. 15c.  
 204 **Persicifolia White**. Beautiful Species. Pkt. 15c.

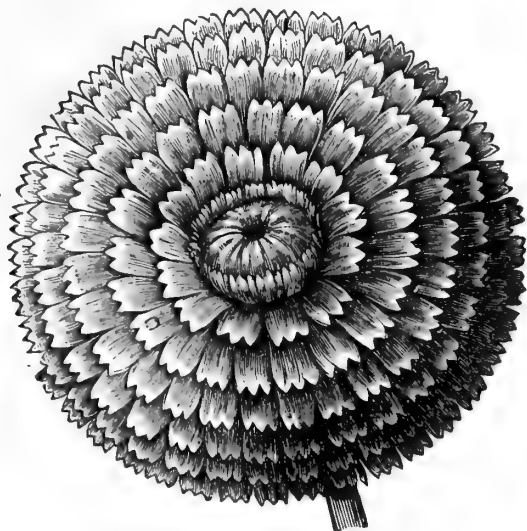

**Calendula** (*Pot Marigold*).

Showy, free-flowering, hardy annuals, growing in any good garden soil, producing a fine effect. One foot high.

- 175 **Grandiflora**. Beautiful large double yellow flowers. Pkt. 5c., oz. 30c.
- 176 **Meteor**. A splendid variety. Pkt. 5c., oz. 20c.
- 177 **Prince of Orange**. The stripes around each petal are of a deep orange color, making a brilliant appearance. Pkt. 5c., oz. 30c.
- 178 **Sulphurea**. Double. Very handsome sulphur yellow. Pkt. 5c., oz. 40c.
- 180 **Orange King (New)**. Very large double, rich dark orange. Pkt. 5c.

**Canary Bird Flower**

(*Tropaeolum Peregrinum* or *Canariense*.)

One of the most charming climbers, bearing an abundance of bright yellow fringed flowers. Pkt. 10c.

C  
A  
L  
L  
I  
O  
P  
S  
I  
S



*Calliopsis Golden Wave.*

**Calliopsis or Coreopsis**

Showy and useful free-flowering plants, of easy cultivation. Hardy annuals

- 224 **Golden Wave**. A very showy sort, with large yellow flowers two inches in diameter. Pkt. 5c., oz. 30c.
- 225 **Lanceolata**. A hardy perennial sort, bearing large flowers of a golden yellow color. Pkt. 10c., oz. 75c.
- 226 **Mixed**. All the choicest kinds. Pkt. 5c., oz. 25c.
- 228 **Nigra Speciosa**. Rich crimson. Pkt. 5c.

**Coreopsis California Sunbeams**

- 227 **Lanceolata Grandiflora**. These lovely improved varieties are much larger than any heretofore offered; the flowers are beautifully formed; some saucer-shaped, others flat, some exquisitely incurved, while others are like great buttercups. The petals are broad, with irregularly fringed edges. Some are very light yellow, others a deeper shade, darker around the eye. Pkt. 10c.

C  
O  
R  
E  
O  
P  
S  
I  
S

**Canna** (*Indian Shot Plant*).

- 206 **Madam Crozy**. Large red, yellow border. Pkt. 5c., oz. 20c.
- 209 **A. Bouvier**. Rich crimson. Pkt. 5c., oz. 20c.
- 210 **Chas. Henderson**. Bright scarlet. Pkt. 5c., oz. 20c.
- 211 **Florence Vaughan**. Best yellow. Pkt. 5c., oz. 20c.
- 207 **Crozy's New Dwarf**. Choicest mixed. Pkt. 5c., oz. 20c.
- 212 **Flamingo**. Rich red. Pkt. 10c., oz. 20c.
- 213 **Queen Charlotte**. Red. bordered yellow. Pkt. 10c., oz. 20c.



*Candytuft: Little Prince.*

**Candytuft** (*Iberis*).

- 183 **Empress or Snow Queen**. A complete mass of pure white flowers; immense size. Pkt. 10c., oz. 40c.
- 184 **White Rocket** (*Amara*). Large trusses of pure white flowers. Pkt. 5c., oz. 20c.
- 185 **White Tom Thumb**. Six inches. Pkt. 5c., oz. 50c.
- 190 **Little Prince**. Very dwarf compact massive spikes of pure white flowers; long time in bloom. Pkt. 10c., 1/4 oz. 30c.
- 186 **Fine Mixed**. All the above tall growing varieties; one foot high. Pkt. 5c., oz. 15c.
- 187 **Sempervirens**. A profuse white blooming hardy perennial; one foot high. Pkt. 10c.
- 188 **Collection of Six Annual Sorts**. Pkt. 25c.

**Castor Oil Bean** (*See Ricinus*).

- 174 **Cactus**. Choicest mixed. Pkt. 15c.



*Centaurea Gymnocarpa.*



*Centaurea Candidissima.*

**Centaurea** (*Ornamental Foliage Sorts*).

- 249 **Gymnocarpa**. Fine cut, silvery gray foliage. Pkt. 10c., 500 seeds 30c., 1,000 seeds 50c.
- 250 **Candidissima**. Splendid silvery, broad-cut leaves; one foot high. Pkt. 10c., 1,000 seeds 75c., 500 seeds 40c.





Marguerite  
Carnation

**CARNATIONS**

239 **New Marguerite Excelsior**. The best of this class. They bloom the first season from seed, and perpetually during the summer months. Of the most varied and beautiful colors. Pkt. 15c.; 4 pkts. for 50c.  
231 **Marguerite**. Choice Mixed Double. Pkt. 10c.; ¼ oz. 30c.

238 **Marguerite Yellow**. Pkt. 10c.  
232 **Marguerite Snowflake** (White). Pkt. 10c.; ¼ oz. 50c.

234 **Finest German**. Mixed. Pkt. 25c.

235 **Very Early Vienna**. Mixed. Pkt. 10c.  
236 **Fine Mixed**. Pkt. 5c.; 30c. per ¼ oz.



**CINERARIA**

Michell's Giant  
Prize Cineraria

- 279 **Dwarf Giant Prize**. Mixed; all colors; best sort as a pot plant. Pkt 35c.; 75c. per pkt. of 500 seeds.  
280 **Tall Giant Prize**. Mixed; desirable to grow as a decorative plant, also for cutting. Pkt. 35c.; 75c. per pkt. of 500 seeds.  
278 **James' Giant Strain**. Half dwarf, mixed. Pkt. 50c.  
276 **Prize Crimson**. Halfdwarf. Pkt. 40c.  
277 **Prize White**. Half dwarf. Pkt. 40c.  
285 **Prize Blue**. Half dwarf. Pkt. 40c.  
281 **Choice Mixed Hybrid**. All colors. Pkt. 25c.  
297 **Sutton's "Superb"**. Mixed colors, extra large, fancy. Pkt. 60c.  
282 **Stellata (Sutton's) New**. Choice Mixed. Pkt. 60c.  
283 **Choicest Double Mixed**. Beautiful. Pkt. 50c.  
284 **Maritima Candidissima**. White foliage, for borders. Pkt. 10c.

**CYPRESS VINE** A favorite climbing vine

- 293 **White**. Pkt. 5c.; oz. 25c.  
294 **Scarlet**. Pkt. 5c.; oz. 25c.  
295 **Mixed**. Pkt. 5c.; oz. 25c.



Michell's  
Calceolaria

**CALCEOLARIA**

An ornamental plant, a universal favorite for decorating the greenhouse or conservatory.  
218 **James' Superb Strain**. Superfine mixed. Pkt. 50c.  
214 **Hybrida Grandiflora, Tall, Mixed**. Large flowering, completely covered with beautiful, rich, self-colored flowers; saved from choice collections; all colors. Pkt. 25c.  
216 **Hybrida Grandiflora Pumila Compacta**. Dwarf, compact, robust growth, producing immense trusses of large and varied brilliant self colored and spotted flowers. 1 foot high. Pkt. 40c.  
217 **Rugosa, Mixed (Shrubby)**. For bedding; the finest colors. Pkt. 50c.  
215 **Sutton's "Perfection"**. Very choice mixed. Per orig. pkt. 90c.

**254 CENTROSEMA GRANDIFLORA**

(Butterfly Pea)

A hardy perennial vine of rare and exquisite beauty. It blooms in June from seed sown in April, and bears profusely large inverted pea-shaped flowers, ranging in color from rosy violet to purple with a broad, feathered, white marking through the centre and of a delightful odor. Well adapted for every garden purpose, especially as a climber. Pkt. 10c.; 3 pkts. 25c.



Giant Paris Daisy

**Chrysanthemum**

(Paris Daisies or Marguerites).

Showy and effective garden favorites extensively grown for cut flowers.

- 1370 **Princess Henry**. The finest of all giant white Paris Daisies. 15c. per pkt.; 4 pkts. for 50c.  
269 **New Large White "Perfection"**. Flowers nearly 5 inches across, beautiful. Pkt. 15c.; 2 pkts. 25c.  
271 **Burridgeanum Eclipse**. Crimson with white edge, and inner white circle. Pkt. 5c.  
272 **Frutescens Grandiflorum**. The popular White Paris Daisy. Pkt. 10c.  
273 **Segetum Grandiflorum**. Yellow Paris Daisy. Pkt. 10c.  
270 **Choice Mixed**. All colors. Pkt. 5c.  
275 **Large Flowering Autumn Varieties**. Including Japanese and Chinese. Pkt. 15c.





Michell's Giant Flowering.

**COSMOS**

An autumn flowering plant. The flowers are borne profusely, and present a charming appearance when the plants are in full blossom as they wave to and fro in every passing breeze. Seed should be sown early in spring and the plants transplanted in the open border when danger from frost is past

- 257 "Dawn." New dwarf early flowering. White and pink. Pkt. 10c.; 30c. 1/8 oz.
- 262 Dwarf Early Choice Mixed. Pkt. 10c.; 25c. 1/8 oz.
- 258 White Mammoth Flowering. Pkt. 10c.; 20c. 1/8 oz.
- 259 Pink Mammoth Flowering. Pkt. 10c.; 20c. 1/8 oz.
- 260 Crimson Mammoth Flowering. Pkt. 10c.; 20c. 1/8 oz.
- 255 Orange Mammoth Flowering. Pkt. 10c.; 20c. 1/8 oz.
- 261 Choice Mixed Mammoth Flowering. Pkt. 5c.; 20c. 1/8 oz.
- 256 Fancy Varieties. The very largest flowering mixed. Pkt. 10c.; 30c. 1/8 oz.

**COBÆA SCANDENS**

A climber of rapid growth, flowering the first season if sown early in the house or hot-bed. In sowing place the seeds edge-wise and merely cover them with light soil.

- 305 Purple. Pkt. 10c.; oz. 60c.
- 306 White. Pkt. 15c.

**COLEUS**

- 244 Choicest Selection Mammoth Leaved. Mixed. Pkt. 25c.

**CELOSIA OR COCKSCOMB**

- 219 Glasgow Prize or Pres. Thiers. Pkt. 10c.
- 220 New Giant Empress. Pkt. 10c.
- 221 Plumosa (Feathered). Dwarf scarlet. Pkt. 10c.
- 222 Choice Mixed. Pkt. 10c.
- 223 "All Aglow." Extra large heads, most beautiful scarlet color. Pkt. 10c.
- 230 "Paris Pink Comb." Very desirable and showy. Pkt. 10c.
- 237 Variegated Red and Yellow. Pkt. 10c.
- 229 Sutton's Prize Dwarf Scarlet Comb. Pkt. 35c.



Giant Empress Cockscomb



Cobæa Scandens

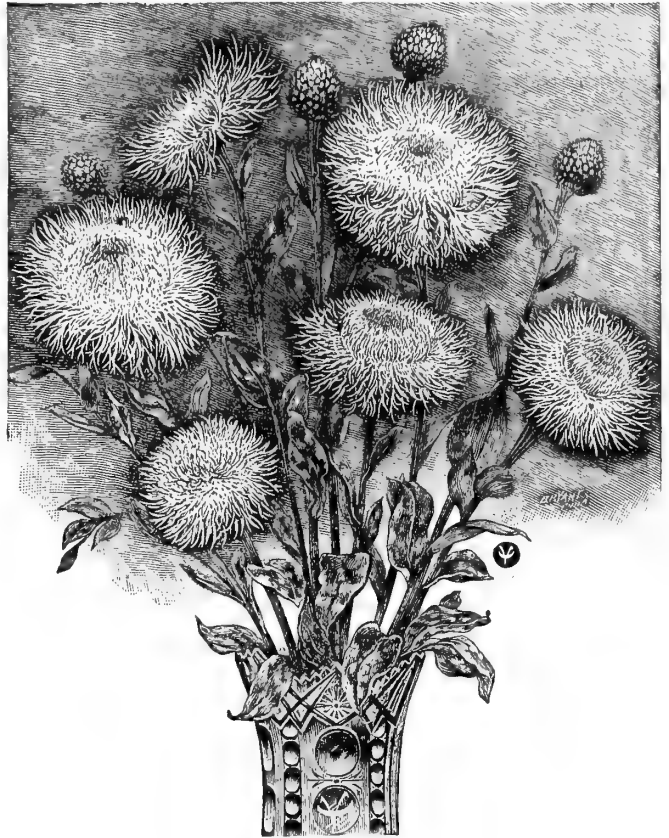

**CENTAUREA IMPERIALIS**

**(NEW GIANT CORN FLOWER)**

This is doubtless the best corn flower for cut-flower purposes. Beautiful, sweet-scented and noble-shaped flowers of very large size. The color of the flowers vary in pure white, lilac, rose, purple, dark red and other similar tints. The flowers are supported by strong, long stalks and remain fresh for a long time after being cut. One of the finest of all annuals; easily cultivated, and flowers continually from spring until autumn.

- 301 Light Pink. 10c. pkt.; 40c. per 1/4 oz.
- 308 Deep Pink. 10c. pkt.; 40c. per 1/4 oz.
- 302 Lilac. 10c. pkt.; 40c. per 1/4 oz.
- 307 Lavender. 10c. pkt.; 40c. per 1/4 oz.
- 303 Purple (Dark). 10c. pkt.; 40c. per 1/4 oz.
- 300 White. 10c. pkt.; 40c. per 1/4 oz.
- 318 Yellow. 10c. pkt.; 40c. per 1/4 oz.
- 304 Mixed, all Colors. 10c. pkt.; 40c. per 1/4 oz.

**CENTAUREA (Cyanus)**

- 286 Yellow (Suaveolens). Pkt. 5c.; oz. 25c.
- 287 Emperor William, Single Blue. Pkt. 5c.; oz. 30c.
- 288 Pure White. Pkt. 5c.; oz. 30c.
- 292 Pink. Large flowering Pkt. 10c.; oz. 30c.
- 289 Choice Mixed. All colors. Pkt. 5c.; oz. 25c.
- 290 Double Blue. Pkt. 10.; oz. 50c.
- 291 New Dwarf Mixed. Pkt. 10c.
- 296 "Margarita." New mammoth flowering Corn Flower. The blooms which are snow white measure 3 to 4 inches across and are very fragrant. Pkt. 10c.

**CONVOLVULUS MAJOR**

**(MORNING GLORY)**

**Climbing Varieties**

- 326 Single. All colors mixed. Pkt. 5c.; oz. 10c.
- 327 Collection of Morning Glory. Ten varieties, 40c
- 530 New Double. All colors mixed. Pkt. 10c.
- 524 New Imperial Japanese, large Flowering Morning Glory. Exceedingly vigorous in growth, decorative in foliage. The flowers are nearly always of immense size, frequently six inches across, and mostly all of entirely new colors, such as ashy grays, bronzy reds, browns, shades of sea green, blues bordered with red, purples marbled with black, whites spotted with blue, flame streaked, marbled, fringed edges, and all of incomparable beauty. Pkt. 10c; 3 pkts. 25c.; 40c. per oz.
- 328 Dwarf Morning Glory. Choicest mixed. Pkt. 5c.; 15c. per oz.

## Cyclamen Giganteum



Giant Cyclamen

Beautiful mottled leaves, broad petals and stout flower stalks.

309 **Rubrum.** Red. Pkt. 35c.; \$1.25 100 seeds.

310 **Album.** White. Pkt. 35c.; \$1.25 100 seeds.

311 **Roseum.** Pink. Pkt. 35c.; \$1.25 100 seeds.

313 **White with Eye.** Pkt. 35c.; \$1.25 100 seeds.

315 **Collection of Six Varieties Sutton's Giant.** \$2.50

312 **Mixed.** Pkt. 25c.; \$1.00 100 seeds.

314 **Persicum.** Choice mixed. Pkt. 10c.

## Cyclamen Papilio—Butterfly New

- 349 White. Per pkt. 50c.  
328 Rose. Per pkt. 50c.  
329 Red. Per pkt. 50c.  
336 White with eye. Per pkt. 50c.  
337 Rose with eye. Per pkt. 50c.  
316 Mixed. Per pkt. 40c.

- 320 **Cuphea Platycentra.** Pkt. 10c.  
343 **Cyperus Alternifolius** (*Umbrella Plant*). Pkt. 10c.  
268 **Cleome Pungens** (*Giant Spider Plant*). Rose-colored flowers; the stamens look like spiders' legs; annual; three feet. Pkt. 5c.

- Clematis.** Hardy Perennial Climbers. 15 to 20 feet high.  
267 **Paniculata Japanese** (*Virgin's Bower*). Pkt. 10c.  
265 **Flammula** (*Virgin's Bower*). Pure white. Pkt. 10c.  
266 **Jackmani Type.** Large flowering, mixed. Pkt. 20c.

## Dahlia

Tuberous-rooted, half-hardy perennials; blooming the first year from seed if sown early. Protect the roots during winter in a dry cellar in sand.

P. S.—See Color Plate for effect; also for special offer of Dahlia Roots.

### DOUBLE

- 330 **Large Flowering.** Saved from the finest flowers. Mixed. Pkt. 10c.  
335 **Cactus Varieties.** Mixed. Pkt. 10c.

### SINGLE

- 332 **Collection of Six Sorts.** Each separate. 50c.  
333 **Tom Thumb.** New varieties in beautiful mixed colors; a highly interesting class of neat, compact and dwarf habit, growing about one foot in height, very free flowering, invaluable for cutting purposes. Pkt. 10c.  
1400 **Cactus.** Mixed. Pkt. 10c.  
1401 **Brilliant Scarlet.** Pkt. 10c.  
1402 **Golden Yellow.** Pkt. 10c.  
1403 **Maroon.** Pkt. 10c.  
1404 **White.** Pkt. 10c.  
1405 **Striped and Spotted.** Pkt. 10c.  
1406 **Semi Dwarf.** Mixed. Pkt. 10c.  
334 **Giant Perfection.** Mixed. Pkt. 10c.  
**Datura** (*Trumpet Flower*). In large clumps and borders of shrubbery they produce an excellent effect, flowering the first year from seed if sown early. Half-hardy perennials, 3 feet high.  
344 **Double Golden.** Pkt. 5c.  
345 **Double Mixed.** Pkt. 5c.  
346 **Brugmansia.** Large white fragrant trumpets. Pkt. 15c.  
347 **Cornucopia Variegated.** (*New*). Pkt. 10c.; 25c. 3 pkts.



New Royal Pink "Nobilis"

## Dianthus—Pinks

Classed among the most popular flowers in cultivation; producing a great variety of brilliant colors and profusion of bloom.

- 356 **Nobilis New Royal Japanese.** Semi-Double. The handsomest species of annual pinks yet introduced. The flowers are much larger than any other variety. **Choicest Mixed.** Pkt. 15c.; 50c. 4 pkts.  
357 **Extra Double China.** Choice mixed. Pkt. 5c.; 30c. oz.  
358 **Choicest Double Diadem or Japan.** Mixed colors. Pkt. 10c.; \$1.50 oz.  
359 **Large-Flowered Fringed.** Double. Pkt. 10c.  
360 **Double Pure White.** Pkt. 5c.; 50c. oz.  
361 **Extra Double Scotch.** Hardy. Pkt. 15c.  
362 **Single Pheasant's Eye.** Hardy. Pkt. 5c.  
363 **Garden or Clove Scented.** Double. Mixed. Pkt. 10c.  
366 **New Oriental.** Semi-Double. Choice Mixed. Pkt. 15c.  
364 **Collection of China and Japan Dianthus.** Single and double. 12 varieties, 40c.  
368 **Eastern Queen.** Single. Beautifully marbled. Pkt. 10c.  
369 **Crimson Belle.** Single. Very large, fringed. Pkt. 10c.  
371 **Salmon Queen.** Single. Pkt. 10c.  
370 **Choicest Mixed Single.** Large flowering. Pkt. 10c.

## Daisy (*Bellis Perennis*)

Daisies can be easily raised from seed sown in the spring.

- 341 **Giant Double.** Pure White. Pkt. 15c.  
342 " " Mixed. Pkt. 15c.  
343 **Snowball.** Double White. Pkt. 10c.  
339 **Longfellow.** Of unusual size, very double dark rose flower. Pkt. 10c.  
340 **Mixed.** Very choice. Pkt. 10c.

## Digitalis (*Foxglove*)

A handsome hardy perennial.

- 353 **Monstrosa** (*Mammoth Foxglove*). The largest and best type; all colors mixed. Pkt. 10c.  
354 **Gloxinaeflora.** All colors mixed. Pkt. 5c.

## Delphinium (*Perennial Larkspur*)

Sow very early in spring or in August and September.

- 373 **Formosum.** Rich blue flowers with a white centre. Pkt. 10c.  
374 **Nudicaule.** Spikes of bright scarlet flowers. Pkt. 10c.  
376 **Zalil.** Beautiful sulphur yellow. Pkt. 10c.  
375 **Hybrid Mixed.** Pkt. 10c. See also *Larkspur*.  
379 **DICTAMNUS** (*Fraxinella*). Hardy perennial. Pkt. 10c.  
380 **DRACENA INDIVISA.** For vases. Pkt. 10c.; 60c. per oz.  
381 " **Australis.** Pkt. 10c.; oz. 75c.



Helichrysum (Straw Flower).

⌘  
Straw  
Flowers  
⌘

Everlastings

- 383 **Acroclinium.** Double-flowering. Pkt. 10c.
- 384 **Acroclinium.** Single-flowering. Pkt. 5c.
- 385 **Ammobium Alatum Grandiflorum.** Pkt. 5c.
- 390 **Helichrysum Monstrosum.** Choice mixed. Pkt. 5c.
- 391 **Rhodanthe.** Choice mixed. Pkt. 5c.
- 392 **Statice Suworowi.** Pkt. 10c.
- 393 **Xeranthemum Superb. Fl. Pl.** Mixed. Pkt. 10c.
- 394 **Collection** as above, one pkt. each for 40c.



California  
Poppies



Eschscholtzia (California Poppy).

- 407 **Golden West.** Magnificent large orange flowers measuring 4 to 6 inches across. 10c. per pkt., 3 pkts. for 25c.
  - 402 **Orange** (Hardy annual). Pkt. 5c., oz. 20c. | 401 **White.** Pkt. 5c.
  - 403 **Mandarin.** Hardy annual. Pkt. 10c.
  - 404 **Cardinal Rose.** Hardy annual. Pkt. 10c.
  - 405 **Choice Mixed.** Hardy annual. Pkt. 5c., oz. 25c.
- 
- 396 **Echinocystis** (Climbing Cucumber.) Pkt. 5c., oz. 25c.
  - 397 **Eupatorium** (Fraseri). Hardy perennial, white flowers. Pkt. 10c.
  - 414 **Fern Seed.** Choice mixed. Pkt. 15c.
  - 415 " " **Adiantum** (Maiden Hair). Mixed. 15c. per pkt.
  - 416 " " **Pteris Cretica Alba.** Pkt. 15c.
  - 417 " " " " **Mixed.** Pkt. 15c.
  - 409 **Euphorbia** [Variegated Snow on the Mountain]. Pkt. 5c.
  - 410 " **Heterophylla** [Mexican Five Plant]. Pkt. 5c.
  - Feverfew** [Matricaria Eximia]. Hardy annual, eighteen inches.
  - 413 **Grandiflora, Double White.** Pkt. 10c.
  - 422 **Freesia** [Refracta Alba]. The flowers are pure white with yellow throat, and are exquisitely fragrant. Pkt. 10c.
  - 419 **Ficus Elastica** (Rubber Plant). Pkt. 15c.
  - 476 **Golden Rod.** Perennial. Pkt. 5c.
  - Foxglove.** [See Digitalis.]
  - Forget-Me-Not.** [See Myosotis.]
  - 426 **Fuchsia** [Lady's Ear Drop]. Mixed. All colors. Pkt. 15c.

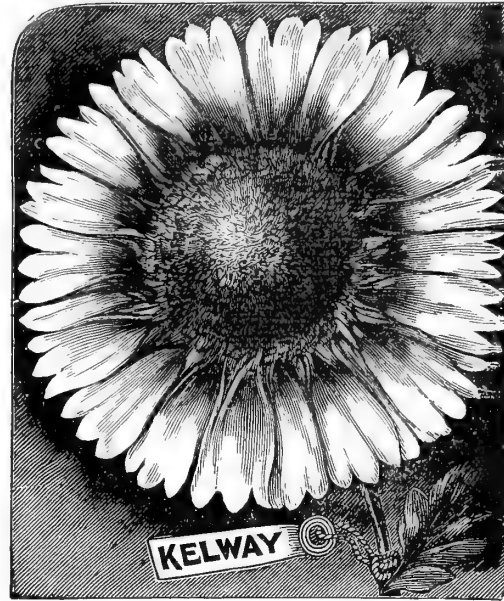

G  
A  
I  
L  
L  
A  
R  
D  
I  
A

Gaillardia

Splendid bedding plants, continuing in beauty during the summer and autumn; half-hardy annuals.

- 451 **Picta Mixed.** Pkt. 5c., oz. 20c.
- 452 **Picta Lorenziana.** Called the double variety on account of the fullness of the flower. Pkt. 5c., oz. 60c.
- Hardy Perennial Gaillardias.** Will bloom the first season if sown early.
- 454 **"James Kelway," New Perpetual Blooming.** A beautiful giant flowering Gaillardia from Europe, with magnificent flowers, measuring five or six inches across, of the brightest scarlet, with a golden margin and fringed edge. Pkt. 15c.
- 455 **Grandiflora Compacta.** Choice mixed, dwarf. 10c. per pkt.
- 453 **Grandiflora Superba.** The most beautiful of all the Gaillardias; choice mixed, all colors. Pkt. 10c., oz. 75c.

- 433 **Geranium—Zonale, Mixed.** A superb strain of the largest and finest varieties; mixed colors. Pkt. 10c.
- 434 **Apple Scented.** Sow in light soil, and keep moist until they germinate. Pkt. 10c.

- 436 **Gentiana** [Blue Gentian]. A charming hardy perennial. Pkt. 10c.

**Gomphrena** [Globe Amaranth Bachelor Button].

- 388 **Red. Nana Compacta.** Suitable for bedding. Pkt. 5c.
- 389 **Mixed.** Pkt. 5c.
- 440 **Gnaphalium Leontopodium** (Edelweiss.) This is becoming very popular in this country. Can easily be grown if seed is sown in shallow pans in sandy soil and leaf mould; when large enough transplant into similar soil. Keep cool and moist. Pkt. 15c.

**Glaucium** [Horn Poppy]. An ornamental foliage plant, recurved, silvery leaves, deeply cut to the rib. Flowers are orange yellow, bell-shaped and drooping; hardy biennial, two feet high.

447 **Corniculatum.** Pkt. 5c., oz. 50c.

**Golden Feather.** [See Pyrethrum.]

**Godetia.** An attractive hardy annual. The plants bloom profusely, and bear showy flowers of rich and varied colors.

- 473 **Choice Mixed.** Pkt. 5c.
- 474 **Gloriosa** (New). Satiny blood red. Pkt. 10c.

**Gourd** [Cucurbita].

- 477 **Calabash** [The Dipper]. Pkt. 5c.
- 478 **Hercules' Club.** Club-shaped. Pkt. 5c.
- 479 **Egg-Shaped.** Fruit white like an egg. Pkt. 5c.
- 480 **Orange-Shaped, or Mock Orange.** Pkt. 5c.
- 481 **Luffa** [Dish Rag or Bonnet Gourd]. Pkt. 10c.
- 482 **Tricosanthes** [True Serpent Gourd]. Pkt. 5c.
- 483 **Fine Mixed.** From a large collection. Pkt. 5c., oz. 20c.



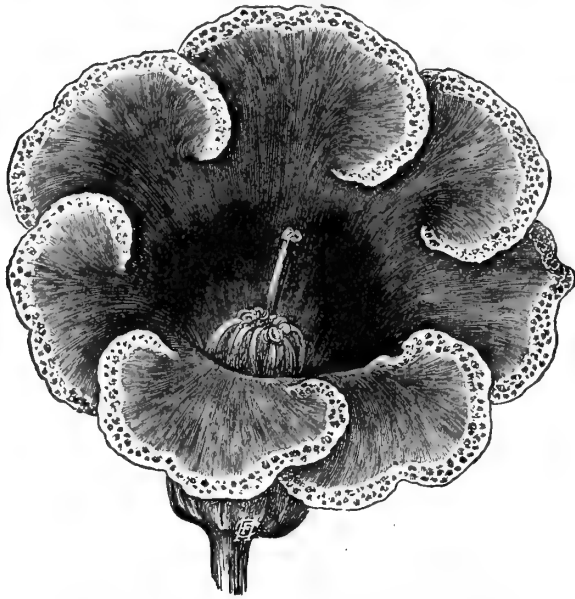

## G L O X I N I A

### Gloxinia. (*Grassifolia Grandiflora.*)

442 **International Mixture.** The best strain in existence, embracing all the choicest self and tigered flowers. Pkt. 25c.

500 **Heuchera Sanguinea.** Hardy perennial, bright crimson flowers, foliage light green. Fine for cutting. Pkt. 10c.

485 **Grevillea Robusta.** A very beautiful fernlike plant. Pkt. 10c.

518 **Hunnemannia Fumarifolia.** (**Yellow Tulip Poppy.**) Pkt. 10c.

489 **Gypsophila.**

**Paniculata.** White flowers, hardy perennial; 2 feet. Pkt. 5c.

### Hyacinth Bean—(*Dolichos*)

A rapid growing plant for covering arbors, trellises, etc.

520 **Daylight.** Fine, pure white variety. Pkt. 10c.

519 **Mixed.** All colors. Pkt. 5c.; 10c. oz.

### Ipomœa—(*Large Morning Glory.*)

524 **New Imperial, Mixed.** Pkt. 10c.; 40c. oz.

526 **Grandiflora Superba.** Large blue flower, with broad white border. Pkt. 5c.; 20c. oz.

528 **Mixed.** All colors. Pkt. 5c.; 15c. oz.

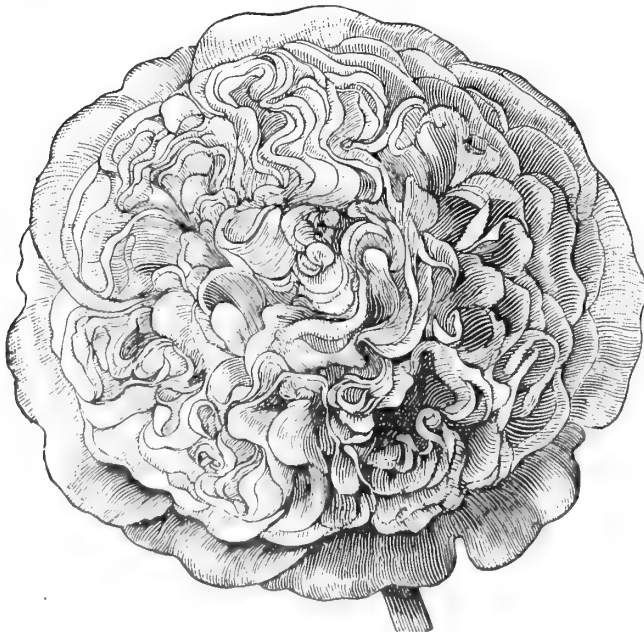

Michell's Double Hollyhock

## Grasses—Ornamental

Cut when in full bloom, tie in small bunches and hang up in a dry, dark place, with heads down. Sow in May and transplant.

459 **Arunda Donax** (*New Zealand Pampas*). Pkt. 10c.

460 **Avena Sterilis** (*Animated Oats*). Pkt. 5c.

461 **Briza Maxima** (*Quaking or Rattlesnake Grass*). Pkt. 5c.

462 **Bromus Brizaeformis.** Pkt. 5c.

463 **Coix Lachrymæ** (*Job's Tears*). Pkt. 5c.

464 **Eulalia Japonica.** Pkt. 5c.

465 **Gynerium Argenteum** (*Pampas Grass*). Pkt. 10c.

466 **Hordeum Jubatum** (*Squirrel Tail*). Pkt. 5c.

467 **Pennisetum Longistylum.** Pkt. 5c.

468 **Stipa Pennata** (*Feather Grass*). Pkt. 10c.

469 The above collection, 1 pkt. of each, 50c.

## Heliotrope

Seed sown in the spring will make fine plants for summer blooming.

517 **Giant Hybrids Lemoines.** Produces extra large flower spikes in abundance. Pkt. 15c.; 25c. 2 pkts.

1825 **New Regal.** The finest, large flowering species. Pkt. 15c.; 4 pkts. for 50c.

515 **Mixed.** Pkt. 10c.

| 516 **Collection** of six sorts. Pkt. 40c.

## Helianthus or Sunflower.



492 **Golden Bouquet** (New Single). Pkt. 10c.

498 **Stella.** Very large, single. Pkt. 10c.

493 **Oscar Wilde.** Single, yellow with black centre. Pkt. 5c.

490 **Polar Star.** The first introduction of white sunflower, with black center. Excellent for cut flowers. Pkt. 10c.; 25c. 3 pkts.

494 **Dwarf Double.** Pkt. 5c.

495 **Cucumerifolius Single.** Pkt. 5c.

496 **Double Globe.** Pkt. 5c.

497 **Mammoth Russian.** Pkt. 5c.; 10c. qt.

## Hibiscus

Showy ornamental plants for mixed beds or shrubby borders. Perennial.

499 **Golden Bowl.** Giant yellow. Cup-shaped flowers, 7 to 9 inch. in diameter. Pkt. 10c.

501 **Palustris, Pink.** Pkt. 5c. | 502 **Crimson Eye.** Pkt. 10c.

## Impatiens Sultani

523. Of compact neat habit of growth, and almost a perpetual bloomer. The flowers are of a brilliant rosy-scarlet color, about one and one-half inches in diameter. Pkt. 15c.

522 **Impatiens Hybrida.** Choicest mixed of all colors. Pkt. 20c.

## Hollyhock

### FRINGED PERPETUAL BLOOMING "ALLEGHENY"

(Semi-Double.)

Blooms the first season from seed if sown early. Its points of merit are: The novel shape of the flower and the fringed edges, and its large size, from 5 in. to 7 in. diameter. In addition hereto, the color is something fine, and the appearance of the petals convey the idea that they were made of crushed silk, on account of the delicate colors. The **immunity from disease is a good point**, and the fact that at each axis are 3 to 4 buds, which all develop, is also a good point; this prolongs the blooming season. They come 90 per cent. true from seed.

510 Choicest mixed of all colors. Pkt. 10c.; 50c. 6 pkts.

513 Beautiful pink. Pkt. 15c.

514 Rich scarlet. Pkt. 15c.

503 Maroon. Pkt. 15c.

### Hollyhock—Chater's Improved Double

Our seed has been saved from the best-named varieties. Seed sown in June and July will flower the following summer; hardy.

504 **Pink.** Extra Double. Pkt. 10c.; 40c.  $\frac{1}{4}$  oz.; oz. \$1.25

505 **White.** Extra Double. Pkt. 10c.; 40c.  $\frac{1}{4}$  oz.; oz. \$1.00.

506 **Red.** Extra Double. Pkt. 10c.; 40c.  $\frac{1}{4}$  oz.; oz. \$1.25.

507 **Yellow.** Extra Double. Pkt. 10c.; 40c.  $\frac{1}{4}$  oz.; oz. \$1.25.

509 **Mixed.** Extra Double. Pkt. 10c.; 30c.  $\frac{1}{4}$  oz.; oz. \$1.00.

511 **Chater's Collection.** Twelve colors, each separate, \$1.00.

512 " " Six colors, each color separate, 50c.

521 **Single Mixed.** Improved. Pkt. 10c.;  $\frac{1}{4}$  oz. 30c.

- 531 **Japanese Hop Vine** (*Humulus japonicus*). A very ornamental and fast growing climbing plant. Undoubtedly one of the best climbers for covering verandas, trellises, etc., never suffering from the heat, but retains its fresh color until late in the summer. Pkt. 10c.
- 532 **Variegated Japanese Hop Vine**. Pkt. 10c.
- 535 **Kenilworth Ivy** (*Linaria Cymbalaria*). A charming small, neat trailing plant, suitable for baskets, vases, pots and rock work. Pkt. 5c.
- Lantana**. A most desirable bedding plant, constantly in bloom.
- 538 **Mixed Colors**. Pkt. 10c.
- 539 **New Dwarf Mixed**. Pkt. 10c.
- Lavender**. An aromatic plant, the leaves and flowers of which are dried and used for scenting clothing, rooms, etc.
- 541 **Blue**. Pkt. 5c.

**Larkspur Annual Sorts.**

- 544 **Dwarf Double Rocket**. Mixed colors. Pkt. 5c., oz. 25c.
- 545 **Tall Stock Flowered**. Mixed colors. Pkt. 5c., oz. 25c.
- 546 **Sinensis**. Large spikes of bright blue flowers. Pkt. 10c., oz. 60c.
- For Perennial Larkspur see Delphinium.

**Lobelia.**

- A dwarf plant with delicate, graceful foliage and pretty, fine flowers. For hanging baskets, pot culture or bedding.
- 548 **Barnard's Perpetual**. One of the finest Lobelias grown. Brilliant blue flowers, with white blotch. Highly recommended for pots, vases or bedding. Pkt. 10c., 3 pkts. for 25c.
- 549 **Crystal Palace Compacta**. A densely compact miniature variety, which, during the summer months, is studded with rich deep blue flowers, forming a perfect ball. Best for borders. Pkt. 10c.
- 550 **Emperor William**. A very compact variety, with fine, sky-blue flowers. Pkt. 10c.
- 551 **Crystal Palace Speciosa**. Of trailing growth; flowers of a superb ultramarine blue. Pkt. 10c.
- 559 **Pumila Splendens** (New). Large purple flowers with large white eye. Pkt. 10c.
- 558 **Double Flowering**. Compact bushes covered with rich deep blue double flowers. Pkt. 10c.
- 552 **Royal Purple**. Very rich violet purple. Pkt. 10c.
- 557 **Goldelse**. Rich blue flowers. Yellow foliage. Pkt. 10c.
- 553 **Gracilis**. A favorite trailing blue sort. Pkt. 5c.
- 554 **White Gem**. Forms a perfect ball of snow-white flowers; very charming appearance. Pkt. 10c.
- 556 **Mixed**. All colors. Annual. Pkt. 5c.
- 555 **Cardinalis** (*Cardinal Flower*). A hardy perennial native variety, with spikes of brilliant scarlet flowers. Pkt. 10c.

- 561 **Linum** (*Scarlet Flax*). One of the most effective and showy bedding plants; hardy annual; one foot high. Pkt. 5c., oz. 20c.
- 564 **Lily of the Valley—Convallaria Majalis**. Lovely plants, bearing pure white fragrant bell shaped flowers. Pkt. 10c.
- 565 **Lophospermum Scandens**. Splendid climber. Pkt. 10c.
- Lychnis**. Handsome plants for massing in beds and borders, blooming the first year if sown early; hardy perennials.
- 568 **Haageana Mixed**. One foot high. Pkt. 10c.
- 569 **Haageana Scarlet**. Makes a brilliant effect. Pkt. 10c.
- Lupinus**. [*Sun Dials*.] The seeds should be sown where they are to bloom, as they do not transplant well.
- 572 **Mixed**. All colors of annual varieties. Two feet high. Pkt. 5c., oz. 15c.
- 575 **Marvel of Peru** (*Four o'clocks*).—**Choice Mixed**. 5c.; 10c. oz. 576 **Mandevilla**. Beautiful yellow fragrant climber. 15c.
- 592 **Maize—Striped-Leaved Japanese**. An ornamental corn, beautifully striped with green and white. Pkt. 5c., oz. 15c.
- Mimulus** (*Monkey Flower*). Showy, profuse flowering plants. Fine for greenhouse, or moist shady situations.
- 619 **Tigrinus, Choice Mixed**. The finest tigered and spotted varieties, rivaling the Calceolaria in its brightness. Pkt. 5c.
- 620 **Moschatus** (*Musk Plant*). Fine for hanging baskets, etc., small yellow flowers, fragrant foliage. Pkt. 5c.

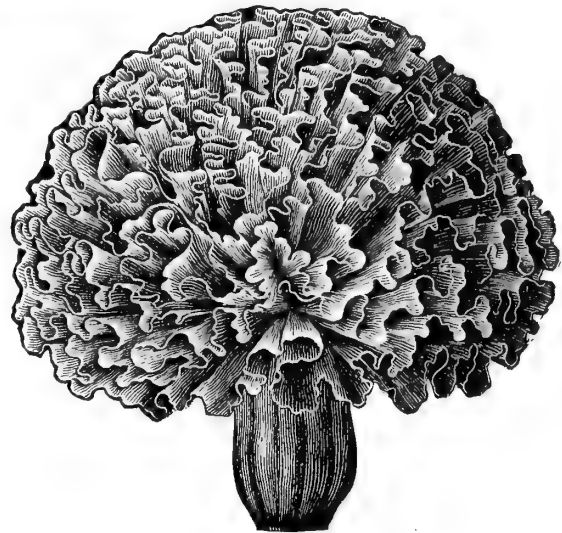

M  
A  
R  
I  
G  
O  
L  
D

**Marigold** (*Tagetes*).

- 587 **Legion of Honour** ("Little Brownie"). Single flowering, six inches high, golden yellow, marked with a large spot of crimson velvet. Pkt. 5c.
- 589 **Dwarf Striped**. Very choice. Pkt. 10c.
- 579 **Gold Nugget**. Dwarf. Immense double flowers of a shade of golden yellow, resembling Australian gold. Pkt. 10c., oz. 40c.
- 580 **El Dorado**. The flowers are three to four inches in diameter, perfectly imbricated and double. Pkt. 10., oz. 40c.
- 581 **Lemon Yellow**. Large flowering, very showy. Pkt. 5c.
- 582 **Large African**. Tall, double, orange brown and yellow mixed. Two feet high. Pkt. 5c., oz. 30c.
- 583 **Dwarf French**. Mixed; double. 1 ft. high. Pkt. 5c., oz. 40c.
- 584 **Double Pulchra**. The plants grow only twelve inches high; the numerous bright flowers stand out in bold relief. Each flower is perfectly double, of rich golden yellow with deep velvety-brown centre. Pkt. 10c.
- 585 **Collection Dwarf Marigold**, 6 varieties, 25c.
- 586 **Collection of Large African Marigolds**, 6 varieties, 25c.
- 588 **Gold Ring**. Beautiful rich red single flowers with a gold ring around each petal. Pkt. 10c.
- See also *Calendula* and *Tagetes*.

**Mignonette** (*Reseda Odorata*).

- 626 **Golden Machel**, (New). Large spikes. Pkt. 10c.
- 627 **Machel or French**. Without doubt the best as well as the sweetest sort in existence. Pkt. 10c., oz. 75c.
- 628 **Allen's Defiance**. The largest of all. Pkt. 10c.
- 638 **Quaker City**. Pkt. 10c.
- 639 **"Bismark"**. Spikes of immense size. Especially showy as a bedding variety outdoors. Compact, strong grower. Pkt. 10c.; 3 pkts. 25c.
- 629 **Bird's Plammoth**. Pkt. 10c. oz. \$1.00
- 530 **Miles Hybrid Spiral**. Of dwarf, branching habit, with spikes from eight to ten inches long. Pkt. 5c., oz. 50c.
- 631 **Parson's White**. Large spikes, very fragrant. Pkt. 5c.
- 633 **Golden Queen**. Very attractive golden yellow. Pkt. 10c., oz. 25c.
- 634 **Sweet Scented**. Pkt. 5c., oz. 15c.
- 632 **Gabrielle**. Pkt. 10c., oz. 75c.
- 635 **Grandiflora**. Plants pyramidal. Pkt. 5c., oz. 30c.
- 637 **Sutton's Giant**. Produces very heavy flower stems. Pkt. 25c.
- 636 **Collection of Mignonette**, ten varieties. Pkt. 50c.

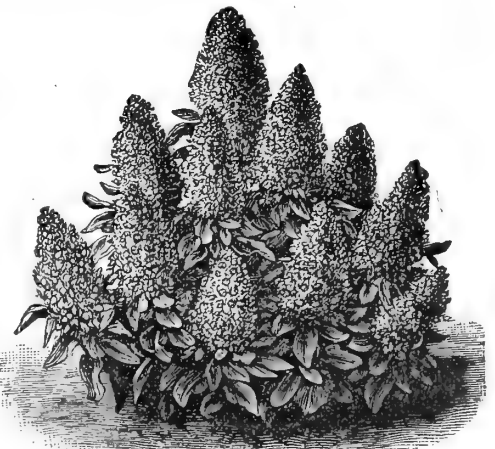

**Machel Mignonette.**

## Maurandia

A most beautiful climber of rapid and slender growth, producing an abundance of pretty, tube-shaped flowers, which continue to bloom until late in fall. Ten feet high.

- 595 **Pink.** Pkt. 10c.  
 596 **Barclayana.** Purple. Pkt. 10c.  
 597 **White.** Pkt. 10c.  
 598 **Mixed.** All colors. Pkt. 10c.

## Mesembryanthemum (Ice Plant.)

- 602 **Crystallinum, White.** Pkt. 5c.  
 603 **Cordifolium Variegatum.** Pkt. 10c.

## Moon Flower (Ipomœa).

- 527 **Noctiflora.** Blooms the first season from seed. At night and during dull days the plants are covered with an abundance of large, pure white, fragrant flowers, five to six inches in diameter. It grows very rapidly, and will cover a large surface. Pkt. 10c., oz. 60c.  
 525 **Heavenly Blue.** Flowers four to five inches across, in large clusters of light blue with a yellow throat. This climber is so completely covered with bloom as to almost cover the foliage. It is also a splendid conservatory climber. Pkt. 10c.



New Forget-Me-Not "Nixenauge".

## Myosotis (Forget-Me-Not).

Neat and beautiful little plants, succeeding best in a shady, moist situation. Half-hardy perennials, blooming the first year from seed, if sown early.

- 607 **Alpestris Victoria.** Of bushy habit, bearing large, bright blue flowers. The plant attains a diameter of eight to ten inches, and when fully grown is globular in shape and perfectly covered with flowers. Pkt. 10c., oz. \$3.00.  
 608 **Alpestris Cœrulea (Alpine.)** Bright blue. Pkt. 10c.  
 609 **Eliza Fanrobert.** The most robust grower; specially adapted for outdoor growing; flowers very large, blue. Pkt. 10c.  
 615 **"Nixenauge."** The real Forget Me Not, flowering during the whole summer when other varieties have gone to seed. Beautiful sky blue flowers on long stems. Pkt. 10c.  
 613 **Grandiflora Alba.** Pure white variety. Pkt. 10c.  
 617 **Fair Maiden.** Rich pink, erect growing. Pkt. 15c.  
 610 **Dissitiflora.** Compact habit; pinkish blue. An attractive bedding plant; six inches high. Pkt. 10c.  
 611 **Palustris Semperflorens.** The most desirable sort for cutting or greenhouse use. Pkt. 10c.  
 612 **Mixed.** All sorts. Pkt. 5c.

- 643 **Mina Lobata.** Half hardy annual (climber). Pkt. 10c.  
**Morning Glory.** [See *Convolvulus and Ipomœa.*]  
 625 **Musa Ensete, Abyssinian Banana.** Pkt. 10 seeds, 25c.

**Nierembergia Gracilis.** Half-hardy perennial, perpetually in bloom, flowering the first year if sown early; desirable for baskets or vases; one foot high.

- 644 **White.** Tinted with lilac. Pkt. 10c.  
 646 **Nicotiana Colossa.** Grows five to six feet in one season. Very desirable for large tropical beds. Pkt. 15c.  
 647 **Nicotiana Affinis.** Large white fragrant flowers. Pkt. 5c.  
 650 **Nemophila Insignis.** Blue. 5c.  
**Nolana.** Desirable plants for hanging baskets, bearing bell-shaped flowers. 654 **Mixed.** Pkt. 5c.

## Oxalis

Beautiful small plants, suitable for the greenhouse, baskets or outdoor culture; flowering the first year if sown early.

- 661 **Floribunda Rosea.** Very desirable for hanging baskets and vases. Pkt. 10c.  
 662 **Mixed.** Pkt. 10c.  
 663 **Tropæoloides.** Very desirable border plant, foliage dark copper color. Pkt. 10c., ¼ oz. 50c.

## Oenothera (Evening Primrose or Sun Drops).

- 658 **Hardy Annual.** Mixed colors. Pkt. 5c.

- 704 **Perilla (Nank. Atrop. Laciniatus).** Very showy bronze foliage, adapted for large beds. Pkt. 5c.  
 705 **Pelargonium.** (Lady Washington Geranium). Grand plants for pot culture, colors are rich in the extreme and beautifully marked. Height, 1 to 2 feet. Finest mixed. Pkt. 25c.  
**Pinks.** [See *Dianthus.*]

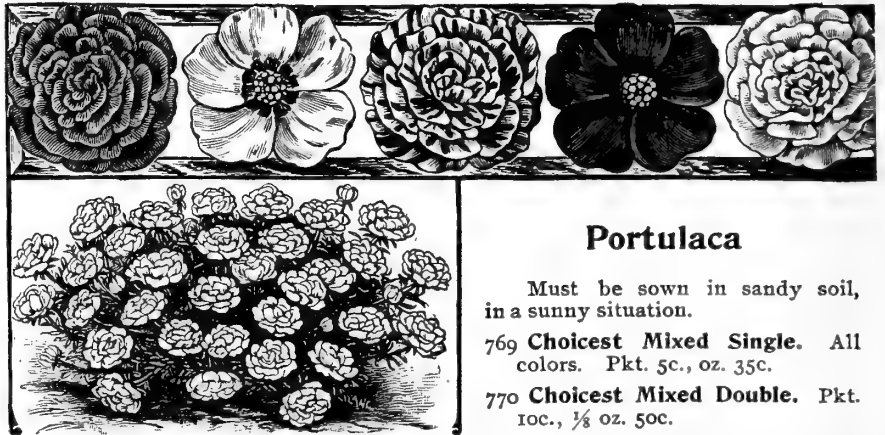

## Portulaca

Must be sown in sandy soil, in a sunny situation.

- 769 **Choicest Mixed Single.** All colors. Pkt. 5c., oz. 35c.  
 770 **Choicest Mixed Double.** Pkt. 10c., ½ oz. 50c.

**Polyanthus.** These rank among the prettiest of plants for borders, rockeries, etc. When once established they grow in any common soil, but they succeed best in rich soil, and a position somewhat moist and shaded.

- 774 **Choicest English Mixed.** Including the gold laced. Pkt. 10c.  
 775 **Double Mixed (Hose in Hose).** Pkt. 15c.

## Pyrethrum [Feverfew].

**Yellow Foliage Sorts for Bedding.**

- 778 **Aureum [Golden Feather].** Best for edging. Pkt. 10c., oz. 80c.  
 779 **Selaginoides [Fern Leaved].** Pkt. 10c.

## Pyrethrum

**Flowering Sorts (Perennial.)**

- 780 **Hybridum.** Hardy perennial bearing large flowers ranging in color from light pink to deep red; bright yellow centres; 2 ft. high. Per pkt. 10c., per ¼ oz. 25c.  
 783 **Hybridum Double Mixed.** (Handsome). Pkt. 25c.  
 781 **Roseum [Dalmatian, or Persian Insect Powder Plant]** Flowers bright rose, of large size. Pkt. 10c.  
 782 **Uliginosum.** Giant white daisy. Pkt. 10c.

## Passiflora (Passion Flower.)

- 700 **Southern Beauty.** Mixed colors. Climbing. Pkt. 10c.  
 701 **Buchani (Tacsonia.)** Rich Pink. Climbing. Pkt. 15c.  
 702 **Coccinea.** Rich scarlet for greenhouse. Climbing. Pkt. 15c.



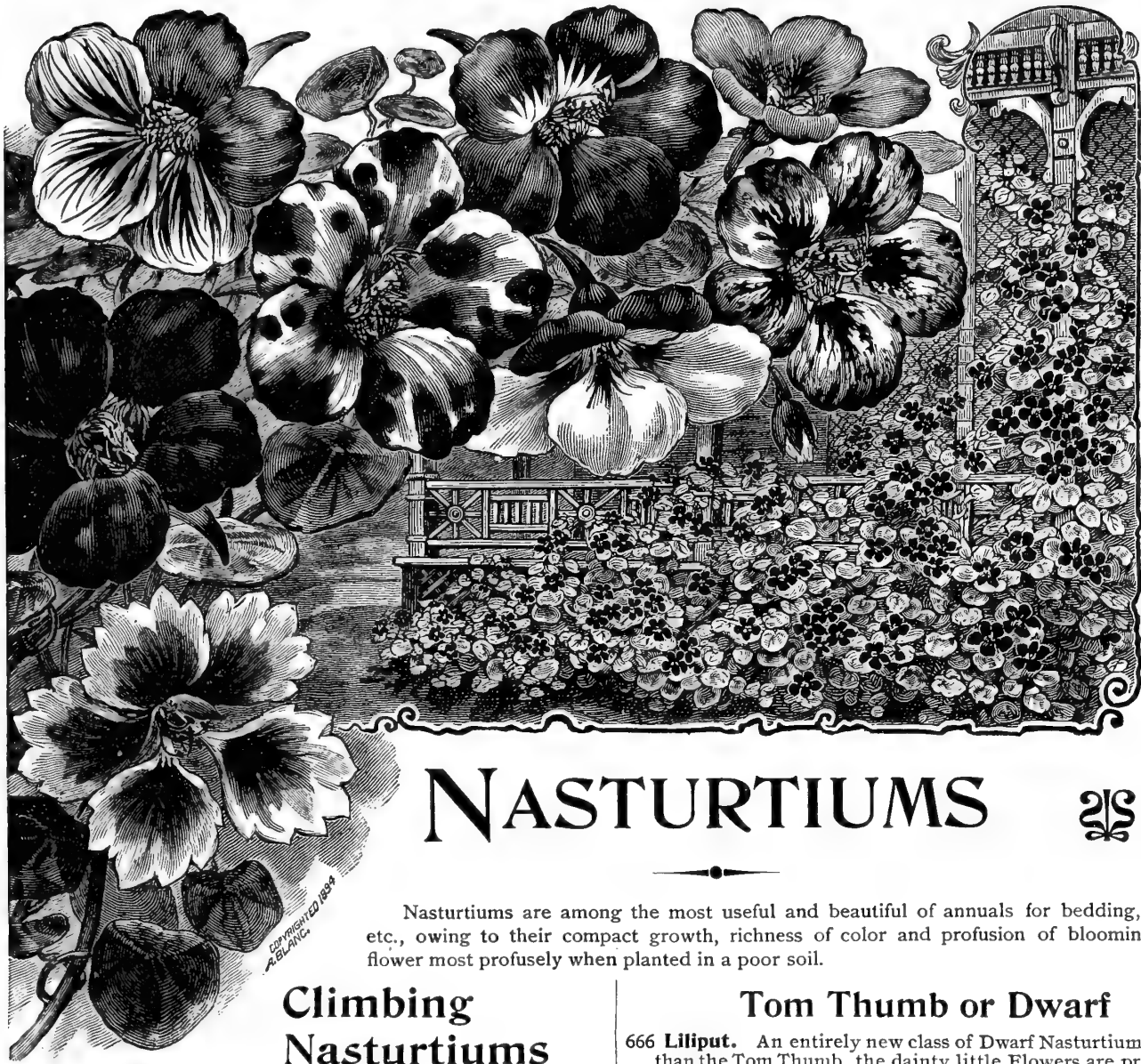

N  
A  
S  
T  
U  
R  
T  
I  
U  
M  
S

# NASTURTIIUMS



Nasturtiums are among the most useful and beautiful of annuals for bedding, massing, etc., owing to their compact growth, richness of color and profusion of blooming. They flower most profusely when planted in a poor soil.

## Climbing Nasturtiums

Specially adapted for verandas, vases and hanging baskets. See Illustration on front cover page.

- 685 **Madam Gunther's Hybrids.** For richness and variety of colors these new hybrids have no equals among Nasturtiums. The foliage is mostly dark, contrasts very effectively with the rich colors. 5c. per pkt., per oz. 20c., 3 ozs. 50c.
- 696 **Golden Queen.** (New.) Beautiful. Pkt. 10c.
- 686 **Crimson.** Pkt. 5c., oz. 20c.
- 687 **Violet.** Pkt. 5c., oz. 20c.
- 688 **Straw-Colored Striped.** Pkt. 5c., oz. 20c.
- 689 **Orange.** Pkt. 5c., oz. 20c.
- 690 **King Theodore.** Dark foliage and almost black flowers. Pkt. 5c., oz. 25c.
- 691 **Scarlet.** Pkt. 5c., oz. 20c.
- 692 **Mixed.** All colors. Pkt. 5c., oz. 15c., lb. \$1.00.
- 693 **Collection of Climbing Nasturtiums, 12 varieties** 50c.
- 694 **Lobbianum, Choice Mixed.** Especially adapted for greenhouse or conservatory. Pkt. 5c., oz. 25c.
- 695 **Spitfire, Bright Crimson.** Pkt. 5c., oz. 25c.

## New Climbing Nasturtium

- 684 "**Vesuvius.**" The most lively colors of all yet known and admired sorts of *Tropæolum Majus* are still by far surpassed through this novelty. The color is a dazzling fiery-rose, may be termed the most effective and brilliant of all large flowering Nasturtiums. Pkt. 5c., oz. 25c.

## Tom Thumb or Dwarf

- 666 **Liliput.** An entirely new class of Dwarf Nasturtiums, smaller than the Tom Thumb, the dainty little Flowers are produced in the greatest profusion, well above the small bushy foliage. The seed is much smaller than the one in the Tom Thumb Nasturtiums and similar to that of the Lobbianum section, the best evidence that we have an entirely new break in the *Tropæolum* family. All colors in choicest mixture. Pkt. 5c., oz. 25c.
- 667 **Aurora.** A new dwarf. The plant forms a perfect globe and is literally covered with yellow, blotched with crimson flowers, completely hiding the foliage when in full bloom. Pkt. 5c., oz. 25c.
- 668 **Ladybird.** A new and distinct sort. The ground color is a rich golden yellow, each petal barred with a broad vein of bright ruby crimson; very showy and charming. Pkt. 5c., oz. 25c.
- 669 **Scarlet.** Pkt. 5c., oz. 25c. 670 **Yellow.** Pkt. 5c., oz. 25c.
- 671 **Pearl.** Pkt. 5c., oz. 25c. 672 **Spotted.** Pkt. 5c., oz. 25c.
- 673 **King Theodore.** Almost black. Pkt. 5c., oz. 25c.
- 674 **Pink.** Pkt. 5c., oz. 25c.
- 675 **Golden King.** Deep golden yellow flowers. Pkt. 5c., oz. 25c.
- 676 **Empress of India.** Splendid new dwarf variety, with very dark leaves and crimson flowers. Pkt. 5c., oz. 25c.
- 677 **Cloth of Gold.** Beautiful for borders or edging. Foliage bright golden yellow; flowers scarlet. Pkt. 5c., oz. 25c.
- 678 **Dwarf or Tom Thumb Mixed.** All colors. Pkt. 5c., oz. 15c., 1/4 lb. 35c., lb. \$1.25.
- 679 **Collection of Dwarf Nasturtiums, 12 varieties, each color separate,** 50c.

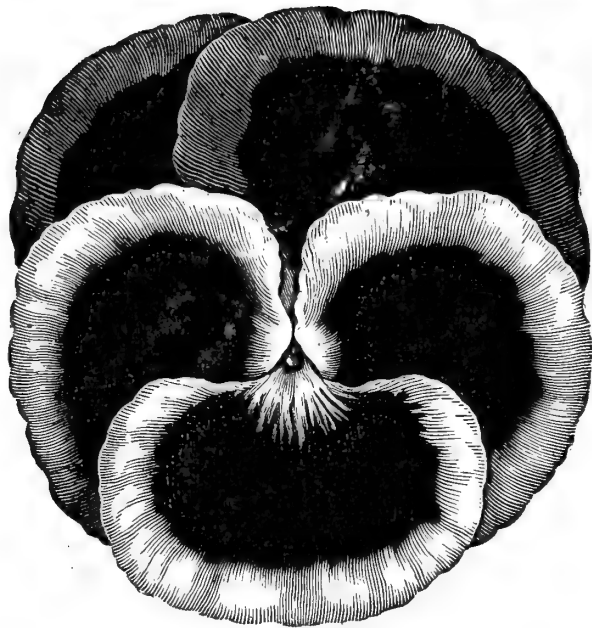

Single Bloom of Michell's Giant Exhibition Pansy

# MICHELL'S GIANT PANSIES

- 746 **Michell's Giant Exhibition Pansy, Mixed.** A strain which we have secured from one of the leading pansy specialists in Germany to which we added the cream of the Paris strain, also the choicest to be had from Scotland. It can be relied upon to give flowers of immense size, very heavy texture, and of the most brilliant colors. Per 1/2 oz. \$1.00; per oz. \$6 00..... \$0.25
- 776 **Masterpiece.** New Giant curled Pansy..... .25
- 768 **New French Large Stained.** Choicest mixed..... .25
- 748 **Bugnot's Giant French Mixed.** Per 1/2 oz. \$1.00..... .25
- 771 **Peacock.** A striking variety, upper petals beautiful blue, lower petals of a deep claret with white margin..... .15
- 751 **Cassier's Strain, Odier.** Very large blotched flowers in mixture Per 1/2 oz. \$1.00..... .25
- 772 **Mad-Perret.** (New) Giant wine color..... .25
- 1201 **Giant Prize.** Black blue..... 1/2 oz. \$0.75 .25
- 1202 " " Azure blue..... " .75 .25
- 747 " " Emperor William..... " .75 .25
- 1203 " " Lord Beaconsfield (violet)..... " .75 .25
- 1204 " " Striped and Mottled..... " .75 .25
- 744 " " White with Eye..... " .75 .25
- 773 " " Mahogany..... " .75 .25
- 743 " " Snow Queen, pure white..... " .75 .25
- 745 " " Yellow with Eye..... " .75 .25
- 1205 " " Brown and red..... " .75 .25
- 1206 " " Red and scarlet..... " .75 .25
- 750 **Ne Plus Ultra.** Immense flowers of the most beautiful colors. 3 pkts. 60c. .25
- 749 **Trimardeau.** Choicest Mixed..... Per oz. \$3.00 .15
- 755 **Faust.** Black..... " 1.00 .10
- 759 **Yellow Gem.** Pure yellow..... " 1.00 .10
- 756 **Emperor William**..... " 1.00 .10
- 754 **Lord Beaconsfield.** The best rich violet..... " 1.25 .10
- 757 **Belgian Striped**..... " 1.00 .10
- 766 **Havana Brown**..... " 1.00 .10
- 762 **Purple.** Silver edged..... " 1.00 .10
- 760 **Gold Margined**..... " 1.00 .10
- 761 **Silver Edged**..... " 1.00 .10
- 767 **Mahogany Color**..... " 1.00 .10
- 763 **Yellow**..... " 1.00 .10
- 758 **Snow Queen.** Largest white..... " 1.00 .10
- 752 **Very Large Flowering.** Choicest mixed..... " 1.50 .10
- 753 **Choice Mixed.** First quality..... " .75 .05
- 764 **Collection.** Containing 6 pkts., in 6 colors, 4c.
- 765 **Collection.** Containing 12 pkts., in 12 colors, 75c.

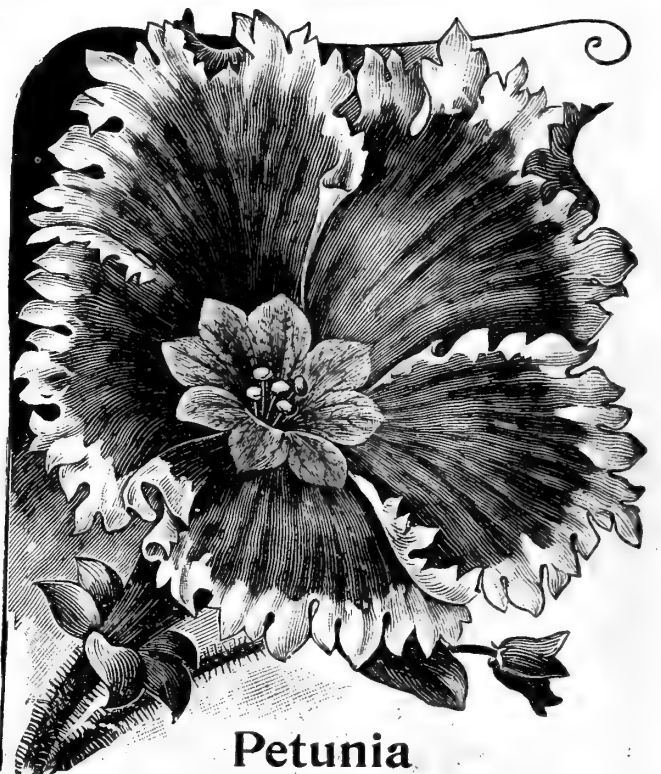

Petunia

- 731 **Giants of California Mixed.** Enormous size flowers. Pkt. 25c.
- 739 **Ruffled Giants Mixed.** Beautiful, resembling ruffled lace. Pkt. 25c.
- 2310 **Adonis.** Pink, with white throat. Very free flowering. Pkt. 10c.
- 733 **Fringed Grandiflora.** Of dwarf, bushy habit. Brightest colors, mixed. Very choicest strain. 20c. per pkt., \$1.00 per 1/2 oz.
- 734 **Hybrida Nana Compacta Multiflora ("The Star").** Dwarf habit and profuse bloomer, eight inches high. Pkt. 10c.
- 742 **Snowball.** Pure white, for bedding or pot culture. Pkt. 10c.
- 735 **Very Choice Mixed.** Blotched and striped. Pkt. 10c., oz. \$1.00.
- 736 **Fine Mixed.** All colors Pkt. 5c., oz. 60c.
- 737 **Collection of large-flowering single petunias, six varieties, 50c.**
- 738 **Collection of Large Flowering, single.** Twelve varieties \$1.00.



Double-Fringed Petunia.

- 732 **Double-Fringed and Hybridized.** Selected and hybridized with the greatest of care. Pkt. 25c.; five pkts. \$1 00.
- 740 **Double Pure White.** Pkt. 25c.

## Pentstemon

706 Beautiful half hardy, herbaceous plants. Choice mixed. 10c. per pkt.



Phlox

## Phlox Drummondii.

A very hardy annual, invaluable for bedding, masses and cut flowers, from its bright colors, which vary from the purest snow white to the deepest blood red, and the unusual length of its blooming season. There is no annual which can compare for beauty, duration of bloom, brilliancy of colors and usefulness to the phlox.

### Grandiflora Varieties.

Grown by a Specialist

- 708 **Alba, Pure White.** Excellent for cutting. Pkt. 10c., oz. \$1.00.
- 709 **Coccinea, Scarlet.** Pkt. 10c., oz. \$1.00.
- 710 **Striped.** Brilliant scarlet striped with white. Pkt. 10c.
- 711 **Pink.** Delicate and bright shades. Pkt. 10c.
- 712 **Stellata Splendens.** Brilliant red, with large white star. Pkt. 10c.
- 715 **Collection** of twelve varieties. Pkt. 75c.
- 713 **Choice Mixed.** Contains twenty-five colors. Pkt. 10c., oz. 75c.
- 714 **Very Fine Mixed.** Pkt. 5c., oz. 60c.

### Dwarf or Compact Varieties.

- 719 **Snowball.** Pure white. Pkt. 10c., 1/8 oz. 50c.
- 720 **Fireball.** Brilliant scarlet. Pkt. 10c., 1/8 oz. 50c.
- 721 **Pink.** Beautiful shade. Pkt. 10c., 1/8 oz. 50c.
- 722 **Scarlet.** Striped with white. Pkt. 10c., 1/8 oz. 50c.
- 716 **Deep Scarlet.** Pkt. 10c.
- 707 **Violet with White Eye.** Pkt. 10c.
- 717 **Crimson with White Eye.** Pkt. 10c.
- 724 **Choicest Mixed.** Dwarf. Pkt. 10c., oz. \$2.50.
- 723 **Double White.** A profuse bloomer. Pkt. 10c.

### Phlox—Other Varieties.

- 729 **Heynholdii, Half Dwarf, Choicest Mixed.** The best for bedding purposes. Pkt. 15c.
- 725 **Double Scarlet.** Pkt. 10c.
- 726 **Fringed or Star (Star of Quedlinburg).** Mixed. Pkt. 10c.
- 727 **Hardy Phlox (Phlox Decussata).** These rank among the finest herbaceous perennials for beds and borders; mixture of the finest flowers. Pkt. 10c.
- 728 **Double Yellow (New).** Pkt. 10c.

Chinese  
Primrose

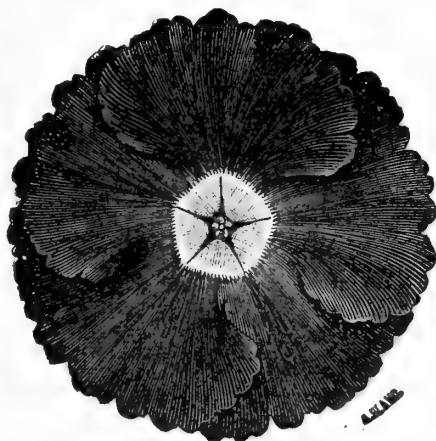

Michell's Prize Fringed Primula.

**Primula** (*Sinesis Fimbriata*—Chinese Primrose.)

- 794 **Michell's Prize Mixture.** Grown by a primula specialist, who has received prizes wherever he has exhibited the plants. The seed is of crop of 1900, and can be relied upon. Pkt. 25c., 3/2 oz. \$1.00, 1/2 oz. \$3.75.

### PRIMULA CHINENSIS—Continued.

- 795 **Williams' Superb Strain.** The finest English mixture; can be relied upon to produce satisfactory results. Pkt. 40c.
- 796 **Kermessina Splendens.** Brilliant red with yellow centre. Pkt. 25c.
- 797 **Holborn Blue.** Fully 50 per cent. will come blue. Pkt. 40c.
- 798 **Alba Magnifica.** Large white flowers with citron eye. Pkt. 40c.
- 799 **Collection** containing eight separate varieties. Pkt. 75c.
- 800 **Fern Leaved, Choice Mixed.** Pkt. 25c.

### Double Primrose

- 804 **Pure White.** Pkt. 50c. 805 **Choice Mixed.** Pkt. 50c.

### Primula—Other Sorts.

- 802 **Cortusoides Sieboldi.** Very handsome pink flowers. Pkt. 25c.
- 808 **Floribunda.** Yellow, fragrant. Pkt. 25c.
- 809 **Obconica Grandiflora.** White. Pkt. 15c.
- 812 **Obconica Grandiflora Fimbriata.** White. Pkt. 15c.
- 807 **Obconica Grandiflora.** Pink. Pkt. 15c.
- 806 **Obconica Kermessina.** Rich scarlet. Pkt. 20c.
- 810 **Forbesi.** Baby Primrose. Pink. Pkt. 25c.
- 814 **Stellata (Star).** Sutton's. Mixed. \$1.25 per original pkt.

### Hardy Primrose.

- 811 **Primula Veris (English Cowslip).** Flowers of different colors, yellow, brown and yellow edged, etc.; very fragrant. Pkt. 10c.
- 813 **Primula Vulgaris.** Hardy English variety, light canary yellow. Pkt. 10c.

- 793 **Rose—Midget or Baby.** Mixed, of pink and white. Blooms the first season, if seed is sown in January or February. Pkt. 15c.
- 792 **Rose—Hybrid Polyantha or Fairy.** These beautiful little roses are borne in large clusters, and will flower throughout the summer until frost, from seed sown early in the spring. Flowers are of various colors, most of them double, although a few of them will come semi-double and single. Mixed colors. Pkt. 15c.

### Schizanthus (Butterfly Flower).

- 847 **Papilionaceus Mixed.** One of the finest annuals in cultivation. The flowers are as handsome as some of the orchids, and productive continually. Pkt. 5c.

### Silene (Catchfly).

- 861 **Mixed.** Producing charming flowers in profusion. Pkt. 5c.
- 862 **Pendula.** Beautiful pink flowers—excellent for cutting. Pkt. 10c.



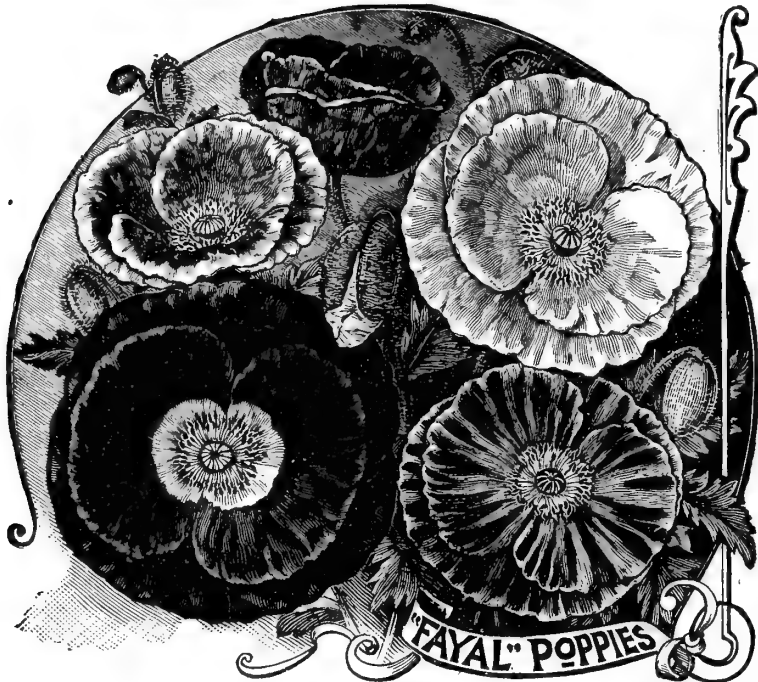

**Poppy**

Showy and ornamental plants with large flowers of brilliant colors. Very attractive in large beds, clumps and mixed borders. They are of very easy culture, and succeed in any garden soil; the seed should be sown where it is to remain, as they do not stand transplanting.

**Single Varieties (Annual).**

- 835 "Irresistible" (New). One of the grandest semi-double types. Choice mixed. Pkt. 10c.
- 816 **Maid of the Mist** (New). California introduction. Mixed. Pkt. 10c.
- 826 **Fayal**. From the Fayal Islands. Very dwarf and free blooming. Flowers resemble crinkled tissue paper. Pkt. 10c.
- 817 **Shirley Poppies**. These charming poppies are generally single or semi-double. The range of color extends from pure white, through the most delicate shades of pale pink, rose and carmine, to deepest crimson. The blooms, if cut when young, will stand for several days. Pkt. 5c., 50c. per oz.
- 834 "Double Shirley". Beautiful, choicest mixed. Pkt. 10c.
- 818 **Umbrosum**. Rich vermilion with a deep shining dark purple spot. Pkt. 5c., oz. 50c.
- 819 **Danebrog**. Flowers of a brilliant scarlet, bearing a silvery white spot on each of the four petals, resembling a cross. Pkt. 5c., oz. 40c.
- 827 **Iceland Mixed**. The colors range from the purest white and yellow to the deepest glowing orange scarlet, and have a delicious fragrance. The profusion of flowers is really astonishing. They are very fine cut flowers and will last a week if cut as soon as they are open. Mixed Colors. Pkt. 10c., three pkts for 25c. Iceland Poppies can also be treated as perennials.
- 833 **Iceland**. Double mixed. New. Pkt. 10c.

I  
C  
E  
L  
A  
N  
D



Oriental Perennial Poppy.

**SINGLE ANNUAL POPPIES.—Continued.**

831 **Tulip Poppy**. No adequate idea can be gained of the strikingly beautiful effect presented by a bed or mass of this magnificent poppy when the plants are in full bloom, the color being, even when seen from a distance, of such a glowing scarlet as to perfectly dazzle the eye, suggesting at once a bed of scarlet tulips. The plants grow about fourteen inches high, and produce from fifty to sixty flowers, well above the foliage. Pkt. 10c.

**Double Varieties (Annual).**

- 825 **Mikado**. Striped Japanese. Very handsome. Pkt. 10c.
- 820 **Crimson King**. Flowers perfectly double and round as a ball. Pkt. 10c.
- 815 **Giant Paeony Flowered Nankeen, Yellow**. (New). Pkt. 15c.
- 821 **Snowdrift**. Pure snow white, very double, of large size. Pkt. 10c.
- 846 **Giant Paeony Flowered Snowball, White**. (New). Pkt. 15c.
- 822 **Fairy Blush**. Very double pink flowers, elegantly fringed. Pkt. 10c.
- 823 **Paeony-flowered**. Large and very double; mixed colors. Pkt. 5c., oz. 20c.
- 824 **Imported Collections of Dwarf Double Poppies**, six varieties 25c.

**Poppy, Perennial Sorts**

This class of poppies has become one of the most popular flowers of late, so that no garden is complete without them. Seed can be sown early in the spring and they will bloom the first season. Seeds can also be sown in August and September in the open ground and they will bloom early the following summer.

- 828 **Giant Orange**. Pkt. 10c., three for 25c.
- 829 **Giant Scarlet**. Pkt. 10c., three for 25c.
- 830 **Collection of eight varieties**. Each color separate. 40c.
- 832 **Oriental Hybrids Mixed**. Extra choice strain. 10c. per pkt., 3 pkts. for 25c.



Ricinus Cambodgensis (Castor Oil Bean).

— fleur-de-lis —  
**Castor  
Bean**  
— fleur-de-lis —

**Ricinus [Castor Oil Bean].**

Stately, strong-growing plants, with very ornamental foliage, particularly well adapted as centre plants of groups of cannas, Japanese maize, caladiums, dahlias, etc. Height, four to fifteen feet.

- 785 **Cambodgensis**. This new sort grows from six to eight feet high, with large, palm-like leaves of the darkest bronzy maroon; stalk and stem nearly black. Very effective. Pkt. 5c., oz. 30c.
- 786 **Borboniensis Arboreus**. Very large and beautiful foliage; fifteen feet high. Pkt. 5c., oz. 20c.
- 787 **Gibsoni or Duchess of Edinburgh**. Dwarf branching habit, deep red foliage; five feet high. Pkt. 5c., oz. 25c.
- 788 **Sanguineus**. Blood-red stalks and clusters of red fruit; eight feet high. Pkt. 5c., oz. 20c.
- 790 **Mixed**. All sorts. Pkt. 5c., oz. 15c.
- 789 **Zanzibariensis**. Stately, plants attain a great size. Very ornamental. Foliage dark and light colors. Pkt. 5c., 20c. per oz.
- 791 **Philippiensis**. Very tall, 10 feet. Pkt. 5c., 15c. per oz.

- 784 **Rudbeckia Bicolor Superba** (New Ox-Eye Daisy). 2 feet high, flowers yellow with a brown disc in centre. Excellent for cutting. Pkt. 10c., 3 pkts. 25c.
- 2400 **Newmanii**. Hardy perennial. Bright yellow, black centre. Pkt. 10c.

**Solanum (Jerusalem Cherry).**

A very ornamental pot plant for winter decoration, of dwarf branching habit; bearing in the greatest profusion bright scarlet globular berries.

- 866 **Hendersonii**. Pkt. 10c.

**Sensitive Plant (Mimosa Pudica).**

850 Curious and interesting plants, with pinkish-white flowers; the leaves close and droop when touched or shaken; they require a mixed soil of peat, loam and sand. Pkt. 5c.

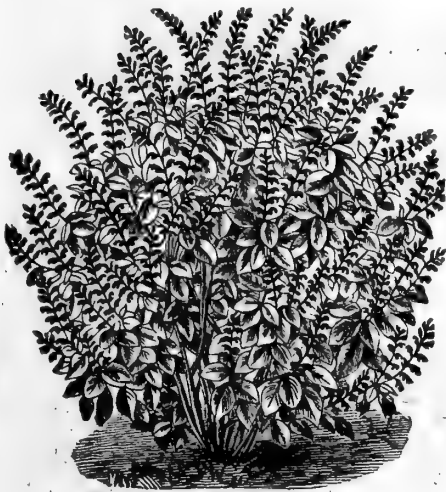

Scarlet Sage

Salvia (Scarlet Sage).

- A favorite bedding plant, bearing long spikes of flowers in great profusion from July to October; half-hardy perennials, blooming the first year from seed; three feet high.
- 836 **Splendens** (*Scarlet Sage*). Bright Scarlet Pkt. 10c., ¼ oz. 50c.
  - 837 **Coccinea**. Very free flowering, brilliant scarlet. Pkt. 5c.
  - 838 **Clara Bedman** (*New Dwarf*). One of the showiest and most brilliant in existence; its habit is very dwarf and has twice as many flowers on the plant at one time as Splendens. Pkt. 10c.; ½ oz. 30c.
  - 839 **Patens**. Rich blue. Pkt. 15c.
  - 840 **Bonfire**. The finest yet introduced, very compact, only 2½ ft. high, produces very large scarlet flowers spikes. Pkt. 10c., ¼ oz. 40c.
  - 841 **Silver Spot** (*New*). Dwarf compact plants, brilliant scarlet flowers, and most beautiful variegated foliage, each leaf bearing a silver like spot. Pkt. 15c.

STRAWBERRY (Trailing).  
(*Fragaria Indica*.)

412 These are very interesting and attractive plants, producing fruit similar in shape and color to a strawberry. Very desirable as a greenhouse plant. Per pkt. 10c.

STREPTOCARPUS.

- 865 **Veitch's New Hybrid Mixed**. Beautiful greenhouse perennials of dwarf, neat habit. Seedlings produce from two to five blooms on a stem the first season. Pkt. 25c.
- 871 **Sweet Rocket, Mixed**. Hardy perennial. Pkt. 5c.

STREPTOSOLEN JAMESONI.

860 Greenhouse plant of great value and easy culture, bears bright orange colored flowers. Pkt. 15c.

SAINTPAULIA IONANTHA.

875 Beautiful greenhouse plants resembling violets both in color and shape. Pkt. 25c.

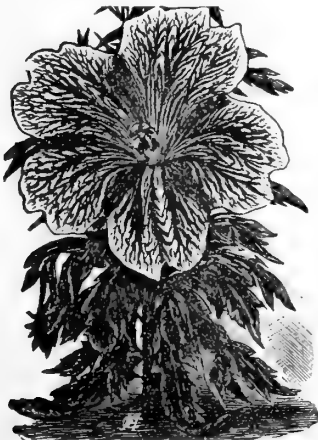

Salpiglossis "Emperor".

Salpiglossis.

A class of highly ornamental autumn flowering plants with beautifully veined and tinted funnel-shaped flowers similar to a fancy Petunia, rendering them very effective in beds and borders. A very choice annual, 18 inches high.

- 842 **Grandiflora**. Fine mixture of new large flowering varieties. Pkt. 5c.
- 843 **Collection** of six separate colors of the large flowering varieties. Pkt. 30c.
- 844 **Emperor** (*New*). The very handsomest yet introduced. Choicest mixed colors. Pkt. 15c.

Smilax

858 Soak the seed for twenty-four hours in warm water before sowing. Pkt. 10c., oz. 50c., lb. \$3.00.

Stevia Serrata

864 Free-blooming plant, bearing a multitude of fragrant white flowers; suitable for summer or winter blooming. Pkt. 10c.

Scabiosa (*Mourning Bride*).

One of the handsomest summer plants, producing in great profusion very double flowers in a variety of shades and colors; a splendid flower for table bouquets; hardy annuals.

- 877 **Grandiflora** (*New*). Enormous size, very double flowers of brilliant colors. Mixed 10c. per pkt., 3 pkts. for 25c.
- 884 **Caucasica**. One of the handsomest of hardy perennials, especially valuable for cutting, the blooms lasting a long time in water; lilac-blue; 3 feet. Pkt. 10c.
- 883 **Dwarf Mixed**. Double, all colors, one foot high. Pkt. 5c., oz. 25c.
- 878 **Double White**. Pkt. 5c., oz. 25c.
- 879 **Double Blue**. Pkt. 5c., oz. 30c.
- 880 **Double Pink**. Pkt. 5c., oz. 30c.
- 881 **Double Red**. Pkt. 5c., oz. 30c. | 882 **Double Yellow**. Pkt. 5c.

STOCKS



STOCKS

Stocks

885 **Princess Alice** (*Cut and Come Again*). Perpetual blooming, growing about two feet high. If sown early, it commences blooming in June and continues until destroyed by frost. It throws out numerous side branches bearing clusters of very double, pure white fragrant blossoms, and is excellent for cutting. Pkt. 10c., ½ oz., 50c.

Ten-Week Stocks (*Large-flowering Dwarf Sorts*.)

Very desirable as a pot plant or for outdoors. The seed we send out is from pot-grown plants, therefore will produce at least seventy per cent. of large double flowers. For early flowering, start the seeds in a greenhouse or hotbed, and transplant into the garden in May after all danger of frost is over.

- 886 **Yellow**. Pkt. 10c., 50c. ½ oz.
- 887 **White**. Pkt. 10c., ½ oz. 50c.
- 888 **Blood-Red**. Pkt. 10c., ½ oz. 50c.
- 889 **Blue and Purple**. Pkt. 10c., ½ oz. 50c.
- 890 **Pink**. Pkt. 10c., ½ oz. 50c.
- 895 **Mixed**. All colors. Pkt. 10c., ½ oz. 50c.
- 891 **Snowflake**. Best white for pot culture. Pkt. 15c.
- 892 **Wallflower-leaved, Mixed**. Pkt. 10c.
- 897 **Wallflower-leaved, White**. Pkt. 10c.
- 899 **Wallflower-leaved, Blood-Red**. Pkt. 10c.
- 893 **Intermediate Blooming**. Choice mixed. Pkt. 10c.
- 900 **Winter or Brompton, Mixed**. Pkt. 10c.
- 896 **Collection** of eight varieties; ten-week stocks. Pkt. 50c.

Virginian Stock

898 Mixed. All colors. Pkt. 5c.

Sweet William (*Dianthus Barbatus*).

A well known plant which has been greatly improved of late years producing splendid effect in beds and shrubbery; hardy perennial; 1½ feet high.

- 867 **Auricula-flowered, Mixed**. A beautiful class of "eyed" single varieties, all colors. Pkt. 5c., oz. 40c.
- 868 **Double Mixed Giant**. The handsomest strain on the market. All double flowers. Pkt. 10c., \$1.00 per oz.

Sweet Sultan

873 Choice Mixed. Pkt. 5c., oz. 25c.

**Michell's  
Gilt Edge  
Mixture**

All  
Large Flowering  
Long Stems  
Brightest Colors

Per pkt. \$0.55  
Per oz. .10  
Per 1/4 lb. .20  
Per 1/2 lb. .35  
Per 1 lb. .60  
Per 5 lbs. 2.50

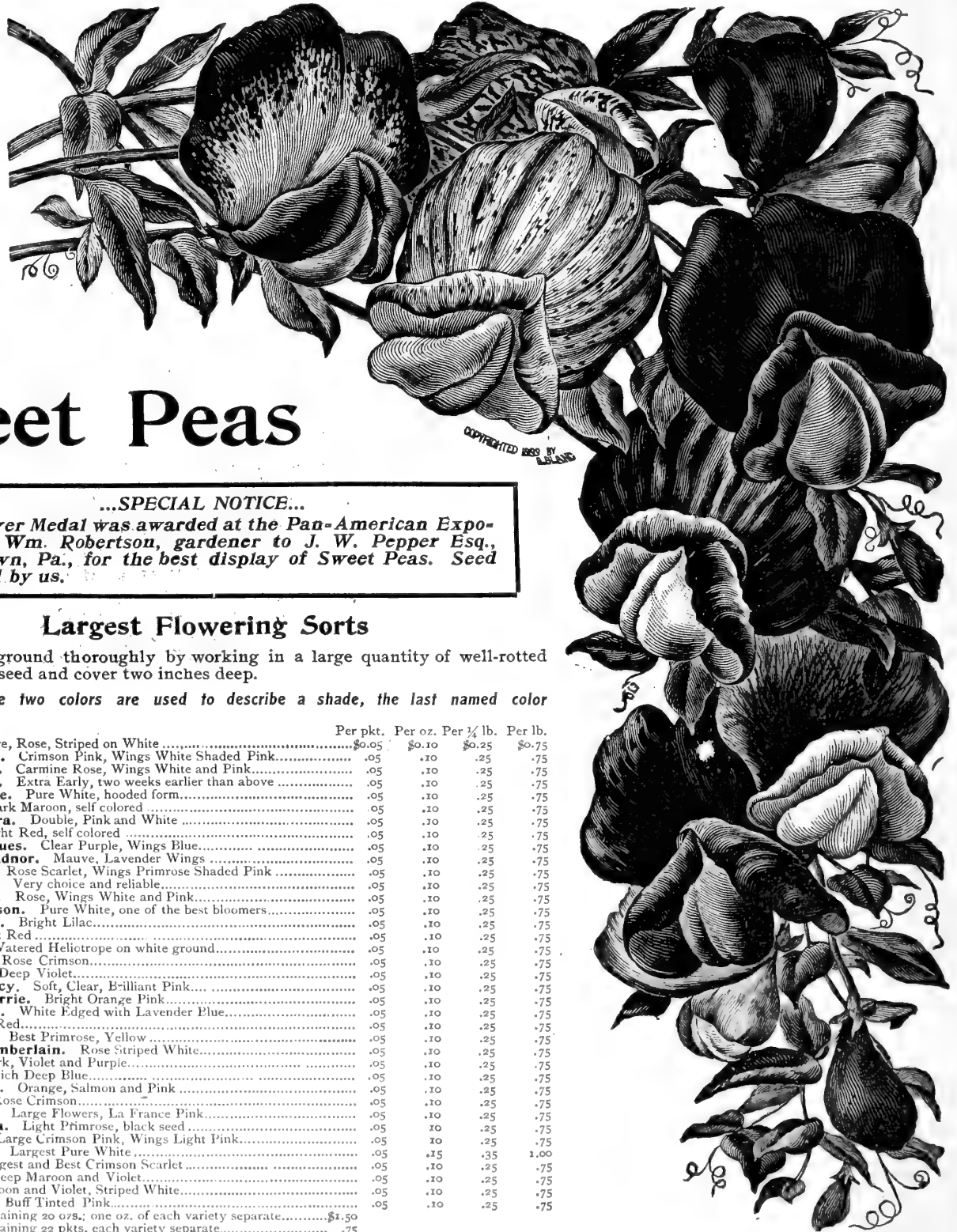

# Sweet Peas

**...SPECIAL NOTICE...**

*A Silver Medal was awarded at the Pan-American Exposition to Wm. Robertson, gardener to J. W. Pepper Esq., Jenkintown, Pa., for the best display of Sweet Peas. Seed furnished by us.*

## Largest Flowering Sorts

Prepare the ground thoroughly by working in a large quantity of well-rotted manure, sow the seed and cover two inches deep.

NOTE.—Where two colors are used to describe a shade, the last named color predominates.

	Per pkt.	Per oz.	Per 1/4 lb.	Per lb.
1005 <b>Aurora.</b> Orange, Rose, Striped on White	\$.05	\$.10	\$.25	\$.75
901 <b>Apple Blossom.</b> Crimson Pink, Wings White Shaded Pink	.05	.10	.25	.75
918 <b>Blanche Ferry.</b> Carmine Rose, Wings White and Pink	.05	.10	.25	.75
917 <b>Blanche Ferry.</b> Extra Early, two weeks earlier than above	.05	.10	.25	.75
924 <b>Blanche Burpee.</b> Pure White, hooded form	.05	.10	.25	.75
902 <b>Boreatton.</b> Dark Maroon, self colored	.05	.10	.25	.75
1007 <b>Bride of Niagara.</b> Double, Pink and White	.05	.10	.25	.75
903 <b>Cardinal.</b> Bright Red, self colored	.05	.10	.25	.75
1026 <b>Capt. of the Blues.</b> Clear Purple, Wings Blue	.05	.10	.25	.75
937 <b>Countess of Radnor.</b> Mauve, Lavender Wings	.05	.10	.25	.75
1008 <b>Duke of York.</b> Rose Scarlet, Wings Primrose Shaded Pink	.05	.10	.25	.75
1009 <b>Double White.</b> Very choice and reliable	.05	.10	.25	.75
1018 <b>Earliest of All.</b> Rose, Wings White and Pink	.05	.10	.25	.75
904 <b>Emily Henderson.</b> Pure White, one of the best bloomers	.05	.10	.25	.75
1027 <b>Emily Eckford.</b> Bright Lilac	.05	.10	.25	.75
1001 <b>Firefly.</b> Bright Red	.05	.10	.25	.75
1013 <b>Gray Friar.</b> Watered Heliotrope on white ground	.05	.10	.25	.75
1021 <b>Her Majesty.</b> Rose Crimson	.05	.10	.25	.75
908 <b>Indigo Blue.</b> Deep Violet	.05	.10	.25	.75
921 <b>Katharine Tracy.</b> Soft, Clear, Brilliant Pink	.05	.10	.25	.75
1020 <b>Lady Mary Currie.</b> Bright Orange Pink	.05	.10	.25	.75
907 <b>Lottie Eckford.</b> White Edged with Lavender Blue	.05	.10	.25	.75
1022 <b>Mars.</b> Bright Red	.05	.10	.25	.75
1010 <b>Mrs. Eckford.</b> Best Primrose, Yellow	.05	.10	.25	.75
1004 <b>Mrs. Jos. Chamberlain.</b> Rose Striped White	.05	.10	.25	.75
912 <b>Monarch.</b> Dark, Violet and Purple	.05	.10	.25	.75
1019 <b>Navy Blue.</b> Rich Deep Blue	.05	.10	.25	.75
910 <b>Orange Prince.</b> Orange, Salmon and Pink	.05	.10	.25	.75
909 <b>Ovid.</b> Bright Rose Crimson	.05	.10	.25	.75
1024 <b>Prima Donna.</b> Large Flowers, La France Pink	.05	.10	.25	.75
1023 <b>Queen Victoria.</b> Light Primrose, black seed	.05	.10	.25	.75
1006 <b>Royal Rose.</b> Large Crimson Pink, Wings Light Pink	.05	.10	.25	.75
1025 <b>Sadie Burpee.</b> Largest Pure White	.05	.15	.35	1.00
1028 <b>Salopian.</b> Largest and Best Crimson Scarlet	.05	.10	.25	.75
1029 <b>Shazada.</b> Deep Maroon and Violet	.05	.10	.25	.75
922 <b>Senator.</b> Maroon and Violet, Striped White	.05	.10	.25	.75
1017 <b>Stella Morse.</b> Buff Tinted Pink	.05	.10	.25	.75
915 <b>Collection</b> containing 20 ozs., one oz. of each variety separate	\$1.50			
923 <b>Collection</b> containing 22 pkts., each variety separate	.75			
1002 <b>Collection</b> containing 10 pkts., each variety separate	.40			
916 <b>Michell's Mixture</b> of all Eckford's large flowering varieties	.05	.10	.20	.60
1003 <b>Fine Mixed.</b> All colors, very good			.15	.50

## Everlasting Peas

	Per pkt.	Per oz.	Per 1/4 lb.	Per lb.
920 <b>Choicest Mixed.</b> Hardy perennial. Will bloom the first season if sown early	\$.05	\$.30		
1015 <b>Pure White.</b>	.10	.30		
299 <b>Yellow.</b> (Crotolaria Retusa)	3 pkts. for 25c.	.10		

DWARF OR CUPID SWEET PEAS	
925 <b>White.</b> Pkt. 5c.; 20c. per oz.; per 1/4 lb. 25c.; 75c. per lb.	
1012 <b>Pink.</b> Pkt. 5c.; 10c. per oz.; per 1/4 lb. 25c.; 75c. per lb.	
1031 <b>Grey Friar.</b> Heliotrope on White Ground. Pkt. 10c.; 20c. per oz.	
1032 <b>Monarch.</b> Dark Violet and Purple. Pkt. 10c.; 20c. per oz.	
1033 <b>Senator.</b> Maroon and Violet. Pkt. 10c.; 20c. per oz.	



## Tagetes (Single Marigold).

A dwarf Globular compact, bushy plant, densely covered with flowers, valuable for borders as well as beds. Half hardy annual.

969 **Pumila Golden Ring.** Orange color. Pkt. 5c.

## Torenia

Splendid for vases, hanging baskets or borders out of doors; they are covered until late in the season with one mass of bloom.

970 **Fournieri — Princess Helen of Montenegro.**

(New). Pkt. 15c.

971 **Fournieri Grandiflora.** Flowers much larger and more showy than Fournieri. Pkt. 10c.

973 **Bailloni.** Flowers bright golden yellow with a brownish red throat. Pkt. 10c.

974 **White Wings.** Pkt. 15c.

## Thunbergia (Black Eyed Susan).

Rapid growing climbers, thrive in light, rich soil; very pretty; borne profusely during the season. Fine for vases rustic work, etc.

940 **Alba Oculata.** White, dark eye. Pkt. 5c., oz. 50c.

941 **Alata.** Buff, dark eye. Pkt. 5c., oz. 50c.

642 **Aurantiaca.** Orange, dark eye. Pkt. 5c., oz. 50c.

944 **Mixed.** All colors. Pkt. 5c., oz. 50c.

## Tropæolum. (See Nasturtium, page 30).

945 **Valeriana.** Very showy border hardy perennial; growing in any garden soil, doing well in the shade; producing large corymbs of flowers, fine for bouquets. Mixed colors; two feet. Pkt. 5c.

## Vinca (Madagascar Periwinkle).

946 **Rosea.** Rose, with dark eye. Pkt. 10c., oz. \$1.00.

947 **Alba.** White, with crimson eye. Pkt. 10c., oz. \$1.00.

948 **Alba Pura.** Beautiful pure white. Pkt. 10c., oz. \$1.00.

949 **Mixed.** Pkt. 10c., oz. \$1.00.



## Verbenas.



If sown early in spring they will flower quite early in the season. The seed has been saved from the finest collections.

936 "Elegance." Lavender, white centre, very distinct. Pkt. 10c.

928 **White Mammoth.** Pkt. 10c.

929 **Scarlet Mammoth.** Pkt. 10c.

931 **Pink.** Pkt. 10c.

930 **Blue.** With large eye. Pkt. 10c.

927 **Striped.** 10c.

933 **Fine Mixed.** Pkt. 5c., oz. \$1.00.

934 **Michell's Mammoth Choicest Mixed.** These cannot be surpassed for size and color. Pkt. 10c., 1/8 oz. 50c., oz. \$2.50.

## Lemon Verbena.

935 **Aloysia Citriodora.** Fragrant lemon-scented foliage. Pkt. 10c

## Zinnia (Youth and Old Age).

979 **Haageana.** Choicest mixed single. Pkt. 5c.

980 **Improved Pompone.** Differing from older ones in habit of growth and immense size; very double flowers of various striking colors; plants are dwarf and bloom freely for a long period. Pkt. 10c., oz. 60c.

981 **Tom Thumb.** A miniature Zinnia, forming compact, round bushes, six to twelve inches in height and eight to fifteen inches in diameter, covered with flowers of the brightest colors. Pkt. 10c., oz. 75c.

982 **White.** Pure white flowers. Pkt. 10c., oz. 50c.

983 **Striped or Zebra.** Pkt. 10c., oz. 50c.

984 **Robusta Plenissima or Giant.** Flowers five to six inches across, perfectly formed, very double and of striking colors. Pkt. 10c., oz. 50c.

985 **Gen'l Jacqueminot.** Rich crimson, handsome. Pkt. 10c., oz. 75c.

988 **Curled and Crested.** Beautiful new type, all colors, choicest mixed. Pkt. 10c.

986 **Extra Choice Mixed.** Saved from selected double flowers only. Pkt. 5c., oz. 30c.

987 **Collection,** in imported pkts., six separate colors. Pkt. 25c.

## Viola Cornuta.

Very desirable for borders or beds to make a solid color effect. Sow seeds early and transplant.

957 "Admiration". Large purple flowers. Pkt. 15c., 30c. 1/2 oz.

958 "Perfection". Large lavender flowers. Pkt. 15c., 30c. 1/2 oz.

## Violet (Viola Odorata).

Thrives best in a shady situation, in a rich deep soil, hardy perennials.

954 **Single Blue Czar.** Very sweet scented flowers. Pkt. 10c.

955 **Single White.** Very fragrant and free flowering. Pkt. 10c.

956 **Single Mixed.** White and blue. Pkt. 10c.

## Wallflower.

964 **Double Yellow.** Pkt. 10c.

965 **Double Dark Brown.** Pkt. 10c.

960 **Single Mixed.** All colors. Pkt. 5c.

961 **Finest Double Mixed.** All colors. Pkt. 10c.

962 **Collection** containing 8 double varieties each separate. Pkt. 50c.

**Wild Flower Garden.** 966 A mixture of about 100 popular annuals and perennials; will make a good effect wherever sown. Pkt. 5c., oz. 15c., lb. \$1.00.



Choicest Mixed Zinnia.

COPYRIGHTED BY WILKINSON & ANDRÉUX (1913)

**SPECIAL NOTICE.**—When ordering plants, please state whether we shall send them by express or freight.

## AKEBIA QUINATA.

**Hardy Climber.** Chocolate colored, fragrant flowers. Each 25c., \$2.50 per doz.

## AZALEAS.

**All Shades.** Each \$1.00, \$1.50, \$2.00, \$2.50.

**ALTERNANTHERA** (*Used for carpet bedding and edging*).

**Aurea Nana.** Bright golden yellow.

**Amœna Spectabilis.** Crimson pink and brown; the finest and brightest. Per doz. 80c.; per 100 \$4.50, per 1,000 \$40.00.

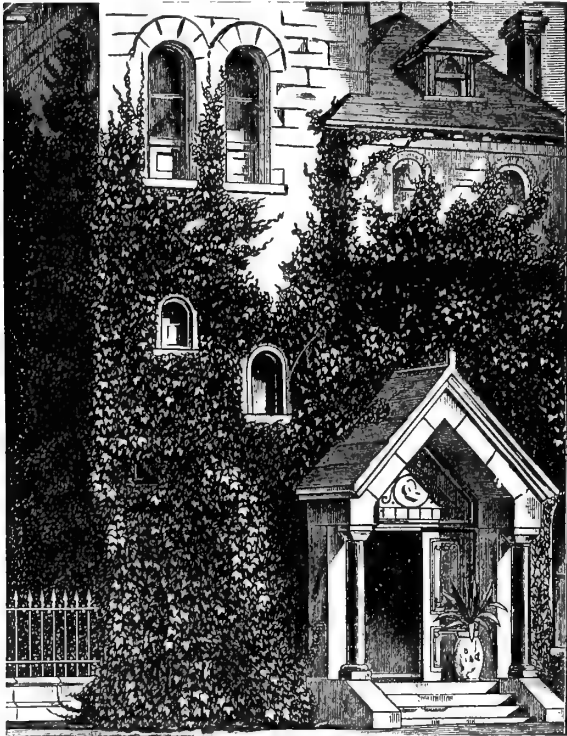

*Ampelopsis Veitchii.*

## AMPELOPSIS VEITCHII (*Japanese or Boston Ivy*).

Perfectly hardy, of Japanese origin. It grows as rapidly as the old Virginia Creeper, and attains a height of fifty feet. It clings firmly to any wall, tree, etc. Two-year-old plants, each 25c., per doz. \$2.50, per 100 \$12.00; one-year-old strong young plants, per doz. \$1.50, per 100 \$9.00.

## AMPELOPSIS QUINQUEFOLIA (*Virginia Creeper*).

The old variety; strong plants. Each 25c., per doz. \$2.50.

## ARISTOLOCHIA SIPHO (*Dutchman's Pipe*).

A strong growing vine, flowers of a brownish color; large plants. Each 50c., per doz. \$5.00.

## ABUTILONS.

Each 10c., per doz. \$1.00.

## ANEMONES (*Hardy Wind Flowers*).

**Named Sorts.** Each 15c., per doz. \$1.50.

## ACALYPHA MACAFAEANA.

A beautiful variegated foliage bedding plant; can be used for ornamental and sub-tropical bedding. Each 15c., per doz., \$1.50, per 100 \$7.00.

## ASPARAGUS PLUMOSUS NANUS.

Strong plants. Each 25c. to 50c.; per doz. \$2.50 to \$5.00.

**Asparagus Sprengeri** (New). Each 25c., per doz. \$2.50.

## AQUILEGIA (*Columbine*).

**Separate Varieties.** Each 15c., per doz. \$1.50.

## BIGNONIA (*Trumpet Creeper*).

**Grandiflora.** Large flowering variety. Each 50c., per doz. \$5.00.

**Radicans.** Small flowering variety. Each 25c., per doz. \$2.50.

## AQUATIC OR WATER PLANTS.

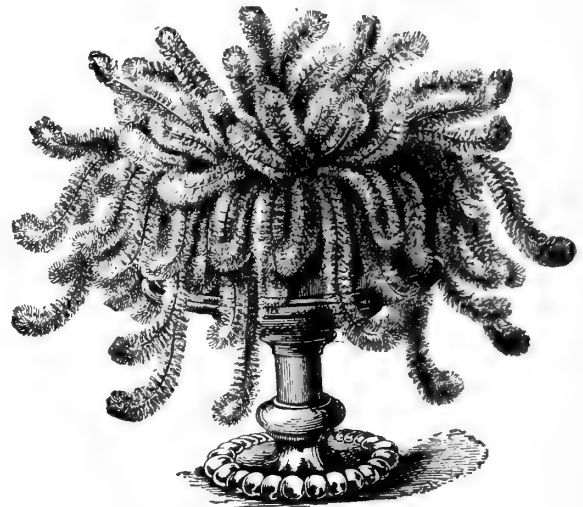

**PARROT'S FEATHER.** An aquatic hanging plant, a novelty indeed. Each 15c., per doz. \$1.50.

## WATER HYACINTHS.

Strong plants. Each 15c.  
Per doz. \$1.50.

## WATER LILIES.

**Nolubium Speciosum** (Egyptian Lotus). This grand lotus is perfectly hardy. The flowers when just expanding are pink. Each 75c. and \$1.50.

**Nymphaea Alba Candidissima.** This is a large flowered variety. Each 75c.

“ **Odorata Gigantea.** This is a superb variety. Each 20c., doz. \$2.00.

“ **Odorata Rosea** (Cape of Good Water Lily). Pink, hardy. Each 50c.

“ **Odorata Sulphurea.** One of the very best yellow water lilies. 50c.

“ **Zanzibarensis Azurea.** Deep rich azure blue. Each 50c.

“ **Rosea.** The flowers are a beautiful deep rose color. Each 50c.

“ **Dentata.** The largest and best white. Each 50c.

“ **Devoniansis.** The flowers are a brilliant rosy red. Each 50c.

## BOUVARDIAS.

**White, Pink, Red.** Each 15c., per doz. \$1.50.

## COLEUS.

**Golden Bedder.** Per doz. 75c., per 100 \$4.50, per 1,000 \$40.00.

**Queen Victoria.** Per doz. 75c., per 100 \$4.50, per 1,000 \$40.00.

**Vershaeffelti.** Per doz. 75c., per 100 \$4.50, per 1,000 \$40.00.

Also all other leading sorts.

## CARNATIONS.

*Varieties of special merit.*

We have made arrangements with the best growers to furnish us strong and healthy rooted cuttings early in the spring.

**Pink.** Wm. Scott, Victor, Melba, Joost, Lawson, Crocker Marquis.

**White.** Flora Hill, Lizzie McGowan, White Cloud, Evelina, Peru.

**Yellow.** Major Pingree, Eldorado, Gold Nugget, Buttercup.

**Scarlet.** Jubilee, America, Mrs. Crane, Estelle.

**Variegated.** Olympia,

Armazinda, Mrs. Geo.

M. Bradt.

**Dark Red.** Empress,

Meteor, Maceo, Go-

mez.

Price of the above stand-

ard varieties, strong

rooted cuttings, per

doz. \$1.00, per 100

\$6.00. (See also Nov-

elties.)

## CYCLAMEN

### GIGANTEUM.

The very finest large

flowering varieties.

Each 30c., per doz.

\$3.00.

Extra fine large speci-

men plants. Each

50c. to \$1.00, accord-

ing to size.

A  
M  
P  
E  
L  
O  
P  
S  
I  
S



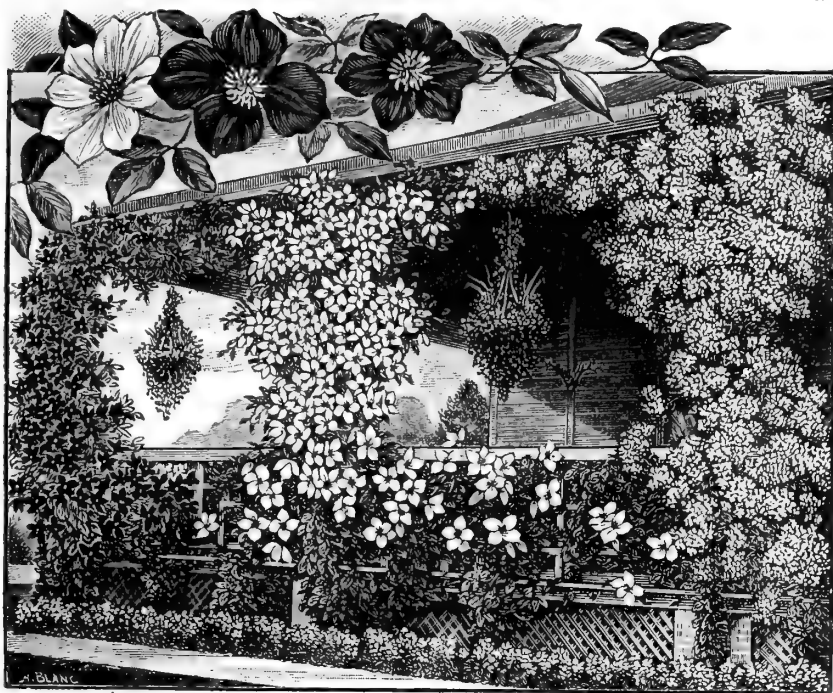

Clematis.

## Clematis.

### HARDY PERENNIAL CLIMBERS.

Clematis have, up to date, been mostly imported from Holland. Their climate is too mild for our extreme winters, therefore cannot stand same. The following recommended are raised in Philadelphia by a Specialist and given good results.

### LARGE FLOWERING VARIETIES.

- Alexandra.** Pale reddish violet.
- Andre LeRoy.** Lavender.
- Belle of Woking.** Double purple, free bloomer.
- Duchess of Edinburgh.** Double pure white, fragrant.
- Gypsy Queen.** Dark velvety purple.
- Henryil.** Creamy white.
- Jackmanl.** Violet purple.
- Madame Edouard Andre.** Deep Crimson.
- Madame Baron Veillard.** Pinkish lilac.
- Seiboldil, or Ramona.** Dark lavender.

Strong two-year-old plants in pots, 50c. each, \$5.00 per doz.

### SMALL FLOWERING CLEMATIS.

- Davidiana.** Deep lavender.
  - Flamula.** Is covered with fragrant white flowers.
  - Graveolens.** The best of the yellows.
  - Paniculata.** This is a new Japanese, pure white flowers of most pleasing fragrance.
  - Coccinea.** Thick bell shaped scarlet flowers.
- Strong two-year-old plants 25c. each, \$2.50 per doz.

**NOTICE:** We can also supply all other varieties of Clematis.

## CHRYSANTHEMUMS.

### THE GIANT CHRYSANTHEMUM.

#### "TIMOTHY EATON"

Captured numerous First Prizes this past Autumn wherever exhibited. The largest white variety ever introduced.

25c. each; per doz. \$2.25; per 100 \$15.00.

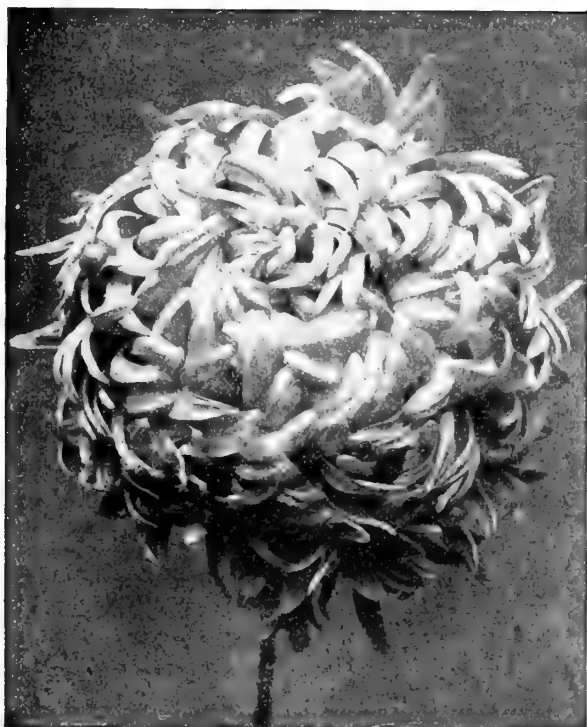

### Best Large Flowering Varieties

#### Best Pink VARIETIES

- Autumn Glory
- Glory de Pacific
- Helen Bloodgood
- Katharine Leech
- Lady Harriet
- Maud Dean
- Mrs. Potter
- Mrs. Perrin
- Mrs. Geo. C. Jenkins
- Vivian Morel

#### Best Crimson VARIETIES

- Black Hawk
- Cullingfordi
- Geo. W. Childs
- John Shrimpton
- Intensity

#### Best Yellow VARIETIES

- E. Dalledouze
- Golden Wedding
- Gold Mine
- Pennsylvania
- R. Hooper Pearson
- Mrs. Trenor L. Park
- Miss G. Pitcher
- Modesto
- Col. Appleton
- Nagoya
- Maj. Bounafon
- H. W. Rieman
- Chas. Davis

#### Best White VARIETIES

- Lady Fitzwygram
- Merry Christmas

- Mrs. Jerome Jones
- Mrs. H. Robinson
- Philadelphia
- Silver Cloud
- Polly Rose
- Ivory
- Fee du Champsaur
- Eureka
- Mrs. H. Weeks
- Western King
- Md'lle Lucie Faure
- Wm. H. Chadwick

#### Best Bronze VARIETIES

- Barrington
- Rustique
- W. L. Elkins

Strong, healthy, young plants from 2 1-2 inch pots, ready March 15th. Per doz. \$1.50; per 100 \$8.00.

### Hardy Pomponé Chrysanthemum.

These are very desirable Perennials either for cutting or massing in groups, blooming continuously until damaged by frost. Below are a very good selection of only the best varieties.

- |   |   |  |
|---|---|--|
| <ul style="list-style-type: none"> <li>Brown Bessie (Terra Cotta)</li> <li>Ben Hur (Very Small pink)</li> <li>Blushing Bride (Early Light pink)</li> <li>Chivver (Small white)</li> <li>Eleganta (Deep pink, white tip)</li> <li>Eagle d'Or (Good yellow)</li> <li>Flag of Truce (Large full white)</li> <li>Fred Peele (Deep crimson tipped gold)</li> </ul> | <ul style="list-style-type: none"> <li>Fire Ball (Yellow tipped white)</li> <li>Globe d'Or (Light yellow)</li> <li>Golden Pheasant (Golden yellow)</li> <li>Golden Nugget (Deep orange)</li> <li>Goldfinch (yellow shading bronze)</li> <li>Julia Largavere (Deep bronze)</li> <li>Kadar (Brown yellow centre)</li> <li>Maid of Kent (White tipped rose)</li> </ul> | <ul style="list-style-type: none"> <li>Nellie Rainsford (Buff)</li> <li>Princess Louise (Bronze)</li> <li>President (Carmine)</li> <li>Prince of Wales (Best white)</li> <li>Regulus (Deep crimson)</li> <li>Sunlight (Light bronze)</li> <li>Sant. Ilario (Silver pink)</li> <li>Tiber (Early yellow)</li> <li>Thalia (Fine white)</li> <li>Veuve Cliquot (Early yellow)</li> </ul> |
|---|---|--|

Strong plants 10c. each; per doz. \$1.00; \$6.00 per 100.



## COREOPSIS

**Lanceolata Grandiflora.** A very fine perennial bearing a profusion of golden yellow flowers, strong clumps. 15c. each; doz. \$1.50.

## COBEA SCANDENS

An annual climber, blue flowers, strong plants. 20c. each; doz. \$2.00.

## DELPHINIUM (*Hardy Larkspur*)

**Chinensis.** A handsome variety varying in color from light blue to almost white. 15c. each; per doz. \$1.50.

**Formosum.** The most popular sort. Large spikes of a deep blue color with white eye. 15c. each; per doz. \$1.50.

**Sulphureum.** A distinct variety of a pure sulphur yellow color. 25c. each; per doz. \$2.50.

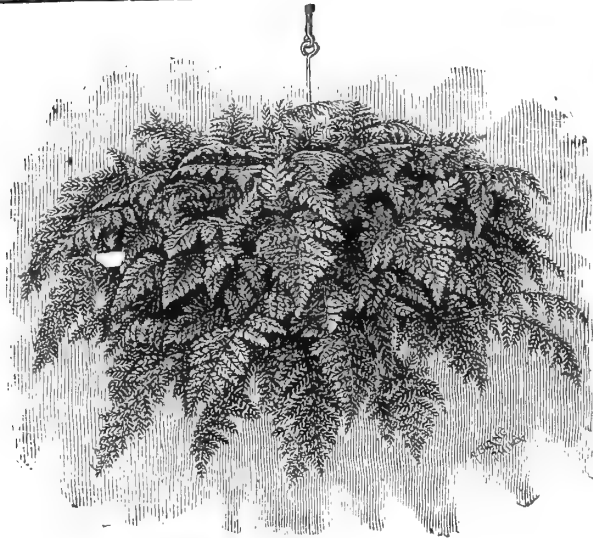

*Japanese Fern Ball in Foliage*

## JAPANESE FERN BALLS (*Dormant*)

A very attractive novelty. Extra large balls. 75c. each; doz. \$7.50.

## FERNS

The best sorts for fern dishes, rock work, etc. 2½ in. pots. \$1.00 per doz.; per 100 \$6.00; 3 in. pots, \$1.25 doz.; per 100 \$9.00.

## GERANIUMS

All the best and most satisfactory bedding varieties. \$1.50 per doz.; \$9.00 per 100; \$75.00 per 1000.

**New Geranium "AMERICA."** A great improvement on "Mars." Single, very rich pink with white border around each flower. Per doz. \$1.75; \$10.00 per 100.

## HELIANTHUS (*Sunflower*)

**Multiflorus fl. pl. (Double Hardy Sunflower).** An extremely useful, hardy plant; bears profusely large double flowers of a bright yellow. Each 15c.; per doz. \$1.50.

**Maximilliana.** Large single golden yellow flowers. Each 15c.; per doz. \$1.50.

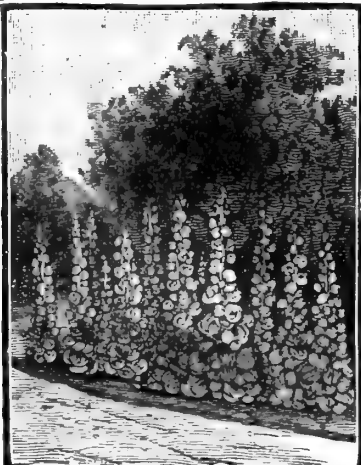

*A Bed of Hollyhocks*

## HONEYSUCKLE

(*Woodbine*)

**Halliana.** Flowers pure white, turning to yellow. Fragrant, hardy evergreen; flowers freely.

**Variegated.** Foliage beautifully mottled yellow and green, strong plants 25c. each; per doz. \$2.50. Extra large plants 50c. each; per doz. \$5.00.

## HOLLYHOCKS

(*Chater's Double*)

**Strong Plants.** Will bloom the first season. White, Yellow, Pink, Scarlet, each 20c.; per doz. \$2.00.

**Mixed.** 15c. ea.; doz. \$1.50.

## GAILLARDIA GRANDIFLORA

Hardy perennial; begin to flower in June and continue the entire season. The flowers are large, from 2½ to 3½ inches in diameter, produced on long stems, excellent for cutting. Strong Clumps, for immediate effect, 15c. each; \$1.50 per doz.; \$10.00 per 100. Strong young plants which will flower freely this summer, 10c. each; \$1.00 per doz.; \$8.00 per 100.

## Gnaphalium Leontopodium Alpinum (*Edelweiss*)

A favorite perennial, native of the Mountains of Switzerland. 20c. each; per doz. \$2.00.



(*Japanese Iris*)

## IRIS

### KAEMPFERI

(*Japanese*)

**Named Varieties.** The very best. Per clump, 25c.; per doz. \$2.50 mixed.

**Mixed.** All colors. Per clump, 15c.; \$1.50 per doz.

## Hydrangea

**Paniculata Grandiflora.** The popular hardy Hydrangea. Strong plants, each 25c.; doz. \$2.50; extra large plants, each 50c.; \$5.00 per doz.

**Otakka.** A beautiful Japanese variety, producing immense pink flowers; extra large plants, 50c. each; per doz. \$5.00.

**Hortensis.** Blue large flowering 25c. each; per doz. \$2.50; extra large plants 50c. each; per doz. \$5.00.

P. S.—The last two named varieties require protection during winter.

## HARDY GRASSES

**Arundo Donax (*Great Reed*).** A magnificent variety, growing to a height of 15 feet, and forming dense clumps. 25c. each; per doz. \$2.50.

**Variegata.** A beautiful variegated form of the above. Foliage creamy-white and green; growing 6 to 8 feet high. 25c. each; per doz. \$2.50.

**Eulalia Gracillima Univittata:** Of compact habit, with very narrow foliage; of a bright green color, with a silvery midrib. 25c. each; \$2.50 per doz.; extra large clumps, 50c. each; per doz. \$5.00.

**E. Japonica Variegata:** A very graceful variety from Japan. Its long, narrow leaves are striped green, white and often pink or yellow. It throws up flower stalks from 4 to 6 feet in height; very ornamental. 25c. each; \$2.50 per doz.; extra large clumps, 50c. each; per doz. \$5.00.

**E. Zebrin (*Zebra Grass*).** The long blades of this variety are marked with broad yellow bands across the leaf. It makes a very attractive specimen plant for the lawn. 25c. each; \$2.50 per doz.; extra large clumps, 50c. each; per doz. \$5.00.

**Gynlerium Argenteum. (*Pampas Grass*).** One of the most effective. Its silvery plumes are produced on stems 8 to 10 feet high. Well-established plants can remain in the open ground if protected. 25c. to 50c. each.

**Phalaris Arundinacea Variegata (*Variegated Ribbon Grass or Garden-er's Garter*).** Large variegated foliage; an excellent grass for bordering large beds. 10c. each; \$1.00 per doz.; \$6.00 per 100.



*Eulalia Japonica Variegata*

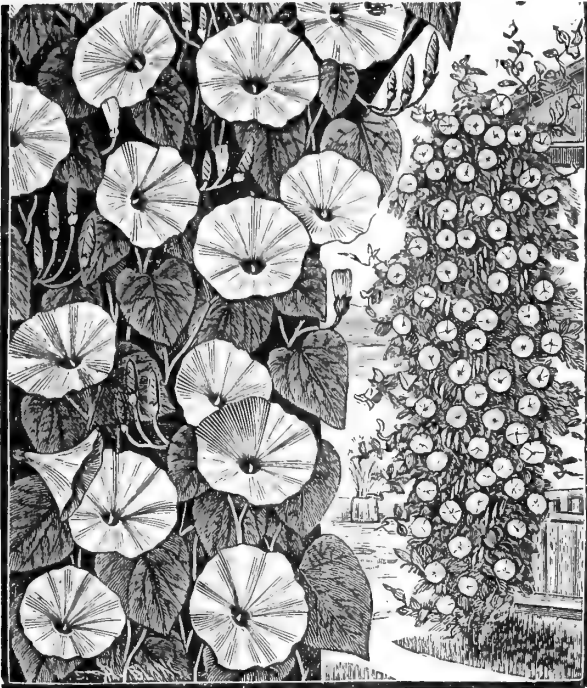

Moon Flowers

**Moon Flowers—(Ipomoea)**

- Noctiflora (White).** Young plants. Each 10c.; \$1.00 per doz.
- Noctiflora (White).** Strong plants. Each 15c.; 4 for 50c.; doz. \$1.25.
- Hardy Day Blooming.** Extra large selected roots. Each 10c.; \$1.00 doz.
- Ipomoea Learii (Blue Moon Flower).** Intense violet blue flowers, six inches in diameter. Each 10c.; \$1.00 for twelve.
- Ipomoea Mexicana (Pink Moon Flower).** Large pink or rose colored flowers, a grand companion to the above, being tuberous. rooted it can be wintered the same as a Dahlia root. Each 15c.; \$1.50 per doz.

**Perennial Phlox**

The Perennial Phloxes are among the most desirable herbaceous plants, and should be planted plentifully; they succeed in any position and can be used to advantage either as single specimens in the mixed border or as large clumps or beds in the garden; 25 separate and best varieties

Each 15c.; \$1.50 per doz.; per 100 \$10.00.

P. S.—See also New Varieties of Hardy Phlox offered on Novelty pages in front part of Catalogue.

**Pansy Plants**

**Very Choicest Strain.** \$1.00 per doz. Extra strong plants \$3.00 to \$6.00 per 100.

**Pæonies**

Extra large fine clumps with three and four eyes. Finest varieties.

- Double Pink.** Each 25c.; \$2.50 per doz.; per 100 \$15.00.
- Double White.** Each 25c.; \$2.50 per doz.; per 100 \$15.00.
- Double Red.** Each 25c.; \$2.50 per doz.; \$15.00 per 100.
- Double Mixed.** Each 20c.; \$2.00 per doz.; per 100 \$14.00.
- Tenuifolium.** Fine feathery graceful foliage; flowers very rich crimson. Very highly recommended. Each 30c.; \$3.00 per doz.

**Pinks—(Hardy Garden)**

**Her Majesty,** pure white. **Juliette,** white and crimson. **Stanislaus,** rosy pink. Each 15c.; \$1.50 per doz.

**Passion Vines**

**Blue and White.** Extra strong. Each 25c.; \$2.50 per doz.



Poppies

**Papaver—(Poppy)**

**Oriente (Oriental Poppy).** Nothing can equal these in gorgeous effect, and, whether planted singly or in masses, their large flowers, rich brilliant colors and freedom of bloom render them conspicuous in any position. Each 15c.; \$1.50 per doz.; per 100 \$10.00.

**Nudicaule (Iceland Poppy).** These range in color from the purest white and yellow to the deepest orange-scarlet. The plants form tufts of fern-like foliage, from amongst which the slender stalks rise to about a foot in height, and bear elegant cup-shaped flowers. Mixed colors. Each 15c.; \$1.50 per doz.

**Rhododendrons**

Fine shaped plants in bud. Each \$1.00; \$11.00 per doz. Extra fine plants. Each \$1.50; \$17.00 per doz.

**Tritoma Uvaria Grandiflora—(Red Hot Poker Plant)**

Rich orange red flowers. Each 15c.; \$1.50 per doz.

**Verbenas**

Choice mixed colors. Per doz. 75c.; \$5.00 per 100.

**Wisteria—(Glycine)**

**Sinensis.** The best blue. Each 30c. and 50c.  
**Sinensis Alba.** White. Each 50c.



Double Hardy Pæonies

# ROSES

Our stock of these is extra fine, grown for us by a specialist.



Souv. de Malmaison

## SPECIAL NOTICE

As the season advances it is sometimes impossible to produce such varieties of Roses that are ordered. Please mention whether we can substitute similar varieties for those of which our stock is exhausted.

### Extra Strong Plants

Best Hardy Hybrid Perpetual Varieties

- |   |  |
|---|--|
| <b>American Beauty.</b> Crimson, very fragrant.                     | <b>Gloire de Margottin.</b> Dazzling scarlet.  |
| <b>Anna de Diesbach.</b> Carmine.                                   | <b>John Hopper.</b> Bright pink.   |
| <b>Baron de Bonstettin.</b> Deep red.                               | <b>Jules Margottin.</b> Bright carmine. [pink.   |
| <b>Baroness Rothschild.</b> Rich satiny pink.                       | <b>La France.</b> Splendid satiny  |
| <b>Captain Christy.</b> Deep flesh color.                           | <b>Louis Van Houtte.</b> Dark velvety crimson, of good form.                             |
| <b>Coquette des Blancches.</b> Pure white.                          | <b>Label Morriison.</b> Pure white.  |
| <b>Dinsmore.</b> Rich crimson.                                      | <b>Magna Charta.</b> Pink.   |
| <b>Eugene Furst.</b> Velvety crimson.                               | <b>Mme. Gabriel Luizet.</b> Fine satiny rose, very free.                                 |
| <b>Fisher Holmes.</b> Rich velvety crimson, large double.           | <b>Margaret Dickson.</b> Pure white.   |
| <b>Gen'l Jacqueminot.</b> Crimson.                                  | <b>Souv. de Malmaison</b> (see cut). A fine flesh colored variety. A continuous bloomer. |
| First size, extra heavy 2-year-old plants . . . 40c. \$4.00 \$27.50 | <b>Ulrich Brunner.</b> Rich red.   |
| Good size 1-year old plants . . . . . 20c. 2.00 15.00               | Each. Per doz Per 100.   |

### Best Tea Roses

- |  |   |
|--|---|
| <b>Bon Silene.</b> Pinkish carmine.        | <b>Maman Cochet.</b> Deep pink.                         |
| <b>Bridesmaid.</b> Satin pink.             | <b>Papa Gontier.</b> Crimson, shading to pink.          |
| <b>Bride.</b> Pure white.                  | <b>Perle des Jardins.</b> Yellow.                       |
| <b>Etoile de Lyon.</b> Yellow.             | <b>Souv. de Wootton.</b> Red. Also all other varieties. |
| <b>Kaiserin Aug. Victoria.</b> Pure white. | Each. Per doz Per 100.                                  |
| Extra strong plants . . . . .              | 40c. \$4.00 \$27.50                                     |
| Good size plants . . . . .                 | 20c. 2.00 15.00   |

### Climbing Roses—(Hardy)

- |                                |                                   |
|--------------------------------|-----------------------------------|
| <b>Baltimore Belle.</b> White. | <b>Prairie Queen.</b> Light red.  |
| <b>Crimson Rambler.</b>        | <b>Royal Cluster.</b> Rosy white. |
| <b>White Rambler.</b>          | <b>Sweet Briar.</b> Pink.         |
| <b>Pink Rambler.</b>           | <b>Tennessee Belle.</b> Blush.    |
| <b>Yellow Rambler.</b>         | <b>Yellow Persian.</b>            |
| <b>Marchal Neil.</b> Yellow.   |                                   |
- Extra strong plants 40c. each ; per doz. \$4.00.

### Penzances Hybrid Sweet Briars

30c. each ; per doz. \$3.00.

### Rosa Rugosa

**White and Crimson.** Extra strong plants 40c. each ; per doz. \$4.00.

### Memorial Rose—(Wichuriana)

A popular sort used to cover graves and cemetery lots. **Pure White.**  
 One-year-old 20c. each ; per doz. \$2.00.  
 Two " 40c. " " 4.00.

### Moss Roses

Best varieties, extra strong, 40c. each ; per doz. \$4.00.

### Varieties of Recent Introduction

**Queen of Edgely** (Pink American Beauty). A lovely type similar to the old American Beauty, but pink in color. Strong young plants 30c. each ; per doz. \$3.00.  
**Liberty.** Fine rich Crimson Jacque Rose type. Strong young plants 25c. each ; per doz. \$2.50.

We can also supply all other varieties of Roses.

P. S.—See Our Novelty Pages for New Varieties for 1902.





Amaryllis

## Amaryllis

**Seedlings.** Largest flowering and brightest colors. 25c. each; \$2.50 per doz.

**Johnsoni.** Very large flower, rich crimson scarlet color, striped with white. Each 30c; per doz \$3.00. Extra large bulbs 50c. each; per doz. \$5.00.

**Treatia Alba.** Pure white. Each 5c.; per doz. 50c.

**Treatia Rosea.** Bright rose. Each 5c.; 50c. per doz.

**Belladonna Major.** Bright pink. Each 15c; per doz. \$1.50.

**Formosissima (Jacobus Lily).** Crimson blooming. Each 5c.; per doz. 50c.

**Hybrids of Vittata.** Beautiful species, flowers striped and flaked. 50c. each; per doz. \$5.00.

## Calla Lily

**Spotted Foliage.** Each 10c.; per doz. \$1.00; per 100 \$5.00.

**Black.** Each 15c.; per doz. \$1.50; per 100 \$10.00.

**Yellow.** Each 50c.; per doz. \$5.00; per 100 \$35.00.

## Cinnamon Vine

One of the most rapid creepers. Hardy. Each 5c.; per doz. 50c.; \$3.00 per 100.

## Cycas (Sago Palm).

**Fresh Bulbs.** Ready March 1st. Will produce strong plants. 15c. per lb.; 5 lbs. 65c.; 100 lbs. \$11.00.

VERY EFFECTIVE PLANTS FOR LARGE BEDS



Caladium (Elephant's Ear)

## Caladium (Elephant's Ear)

Especially adapted as a Border for cannas and tall-growing grasses

Small sound bulbs. Each 5c.; doz. 50c.; 100 \$4.00.

Medium size sound bulbs. Each 10c.; doz. \$1.00; 100 \$7.00.

Large size sound bulbs. Each 10c.; doz. \$2.00; 100 \$11.00.

Extra Large (Mammoth). Each 30c.; doz. \$3.00; 100 \$16.00.



Gold Medal Tuberos-Rooted Begonias

## Begonias (Tuberos-Rooted—Extra Large Bulbs).

Our strain of these is the very finest to be had, the bulbs producing immense flowers.

	Each	Per doz.	Per 100	Per 1000
Single White.....	\$0.06	\$0.60	\$4.00	\$35.00
" Yellow.....	.06	.60	4.00	35.00
" Pink.....	.06	.60	4.00	35.00
" Scarlet.....	.06	.60	4.00	35.00
" Crimson.....	.06	.60	4.00	35.00
" Orange.....	.06	.60	4.00	35.00
" Mixed, all colors.....	.05	.50	3.50	30.00
Double White.....	.15	1.25	8.00	75.00
" Yellow.....	.15	1.25	8.00	75.00
" Pink.....	.15	1.25	8.00	75.00
" Scarlet.....	.15	1.25	8.00	75.00
" Orange.....	.15	1.25	8.00	75.00
" Mixed, all colors.....	.12	1.15	7.50	70.00

Six bulbs of any one variety at dozen rates, 25 at 100 rates, 250 at 1000 rates.



Fancy Leaved Caladium

## Fancy Leaved Caladiums

A most attractive plant either for the greenhouse or window garden.

In 9 best and most distinct named varieties, 20c. each, \$2.00 per doz.; \$12.00 per 100.

**Choicest Mixed.** 12c. each; \$1.25 per doz.

## CANNAS. The Best Varieties.

We have a large supply of Cannas, grown under contract for us by one of the leading growers in this country. They can be relied upon to be true and sure-blooming roots, mostly all with two or three shoots.

**Alphonse Bouvier.** Rich velvety red; very large truss and flower; petals broad and wavy. Each 8c., per doz. 75c., per 100 \$5.00.

**Austria.** A splendid variety; grows five feet high; leaves 15 to 18 inches long and 8 to 10 inches broad. Flowers 6 to 7 inches across and borne erect in immense trusses; color pure deep golden yellow, truly magnificent. 10c. each, \$1.00 per doz., \$6.00 per 100.

**Alsace** (White Canna). A vigorous grower with green foliage, four feet high, 10c. each, \$1.00 per doz., \$7.00 per 100.

**Allemania.** Very large salmon flowers with yellow border; foliage dark green; a most desirable bedding variety. 12c. each, \$1.25 per doz., \$8.00 per 100.

**Burbank (New).** Very large flowering, rich yellow, with very substantial heavy light green foliage. Height about four feet. 10c. each, \$1.00 per doz., \$6.00 per 100.

**Charles Henderson.** A grand variety of a fine crimson color; 3½ feet in height, a desirable companion to Florence Vaughan. Each 8c., per doz. 75c., per 100 \$5.00.

**Chicago.** Four feet; green foliage. The large flowers open out nearly flat, petals 1½ inches wide and five in number; in this respect the Chicago fairly out-classes all Cannas. The color is a clear, deep vermilion scarlet. 15c. each, \$1.25 per doz., \$8.00 per 100.

**Columbia.** A perfect gem; color rich cardinal red; of branching habit, sometimes has three or four trusses of bloom on the same spike, all open at the same time producing a mass of blooms at an even height. Price 15c. each, \$1.25 per doz., \$8.00 per 100.

**Eldorado.** Bright clear yellow, lightly marked with crimson, light green foliage. The best yellow Canna for general effect, being a very profuse bloomer. 10c. each, \$1.00 per doz., \$6.00 per 100.

**Engendale.** Valuable as a bedding variety, bronzy foliage, with large bright cherry red flowers of good shape and substance. It is of compact uniform growth, height four feet, is considered one of the very best dark foliage varieties. Each 10c., per doz. \$1.00, per 100 \$6.00.

**Florence Vaughan.** Bright rich golden yellow, spotted with bright red; the flowers which are large size; of great substance and perfect form, are borne in large heads and in the greatest profusion; the foliage is massive and of a rich green color, three feet in height. Each 10c., per doz. \$1.00, per 100 \$6.00.

**Flamingo.** Crimson, growing about three feet high. Each 15c., per doz. \$1.50, per hundred \$7.50.

**Golden Star.** Rich golden yellow flowers, rich dark green foliage of a strong healthy substance. 10c. each, \$1.00 per doz., \$7.00 per 100.

**Gloriosa.** Color; bright rich crimson, with a deep yellow border; height, three feet. 10c. each, per doz. \$1.00, \$6.00 per 100.

**Italia (Orchid-Flowered Canna).** Rich golden yellow with a broad blotch of dark crimson maroon in the centre of each petal and throat. 10c. each, \$1.00 per doz., \$6.00 per 100.

**Maidens Blush.** The best pink variety. 15c. each, \$1.50 per doz., \$10.00 per 100.

**Madame Crozy.** Brilliant vermilion scarlet; bordered with deep golden yellow. The foliage is green, broad and massive; the habit of the plant is compact and vigorous; height four feet. Each 8c., doz. 75c., 100 \$5.00.

**President Carnot.** A distinct bronze foliage variety, with very large flowers of a rich vermilion scarlet. 10c. each, \$1.00 per doz., \$6.00 per 100.



French  
Canna.

**Philadelphia.** (New). This is one of the finest of the new sorts. The flowers are intense deep crimson borne well above the plant, foliage bright green, plant very dwarf; three feet. 20c. each, \$2.00 per doz., \$12.00 per 100.

**President William McKinley.**—Novelty 1898. Color brilliant crimson. Plant dwarf, growing from 2½ to 3 feet high in rich soil. Foliage deep green, with heavy chocolate margin. An abundant and very early bloomer. The trusses are large, of good shape and held well above the foliage, and the growth is compact and even. The effect when massed is extremely brilliant, the rich crimson color contrasting finely with the deep green foliage. 15c. each, \$1.50 per doz.

**J. D. Cabos.** 4 to 4½ feet. Flower light orange, large truss. Foliage purple bronze. A good variety. 8c. each; 75c. per doz.; \$5.00 per 100.

**Souv. de Antoine Crozy.** The richest gold border variety yet introduced. Dazzling scarlet flowers with yellow border, three feet, green foliage. 10c. each, \$1.00 per doz., \$7.00 per 100.

**Queen Charlotte.** Rich crimson scarlet with wide gold border on every petal. A very handsome plant, medium in height, compact grower, broad, green leaves, profuse bloomer. Each 10c., per doz. \$1.00, per 100 \$5.00.

**Mixed Dwarf French.** Containing the best sorts only. Each 6c., per doz. 60c., per 100 \$4.00.

**Robusta Perfecta.** Very tall growing, dark foliage; variety specially adapted for the centre of Canna beds. Each 8c., per doz. 75c., per 100 \$5.00.

**Tall Sorts Mixed.** 6c. each, 60c. per doz., \$4.00 per 100.

SEE KEY FOR NAMES OF THESE VARIETIES ON OPPOSITE PAGE.



**SEED OF THE VERY BEST SINGLE DAHLIAS**

<b>CACTUS FLOWERED.</b>	Choicest Mixed.	<b>GOLDEN YELLOW.</b>
<b>DWARF GROWING.</b>	" "	<b>RICH MAROON.</b>
<b>GIANT PERFECTION.</b>	" "	<b>WHITE QUEEN.</b>
<b>TOM THUMB.</b>	" "	<b>STRIPED AND SPOTTED.</b>
<b>BRILLIANT SCARLET.</b>	Dwarf.	

Each of the above 10 cts. per pkt. or the collection of 9 pkts., 75 cts.



**DAHLIAS FROM SEED. READ CAREFULLY.**

MANY flower lovers do not know that Dahlias will grow and bloom profusely the first year from seed. A small amount invested in Dahlia seed will give a fine lot of Dahlia plants that will bloom by August 1st. Beside each packet of seed may give one or more new varieties to surpass anything yet raised. This gives the greatest pleasure of anticipation as the plants develop and the first buds expand. Our seed was raised from the varieties illustrated in color-plate and more than thirty other choicest and most distinct varieties.

Where a particular color or variety is wanted, especially a number of a kind for special purposes, it is necessary to procure roots. (SEE OTHER SIDE).

**Michell's "Superb" Single Dahlias**  
 GROWN FROM OUR SEED

Michell's Dahlias were awarded the Silver Medal at the Pan-American Exposition, Buffalo, 1901.



KEY, NAMING VARIETIES ON COLOR PLATE :

No. 1—POLLY ECCLES No. 3—ENCHANTMENT No. 5—SNOW QUEEN  
No. 2—SILVION No. 4—JOHN COUAN No. 6—NEW SEEDLING 1901

# DAHLIAS

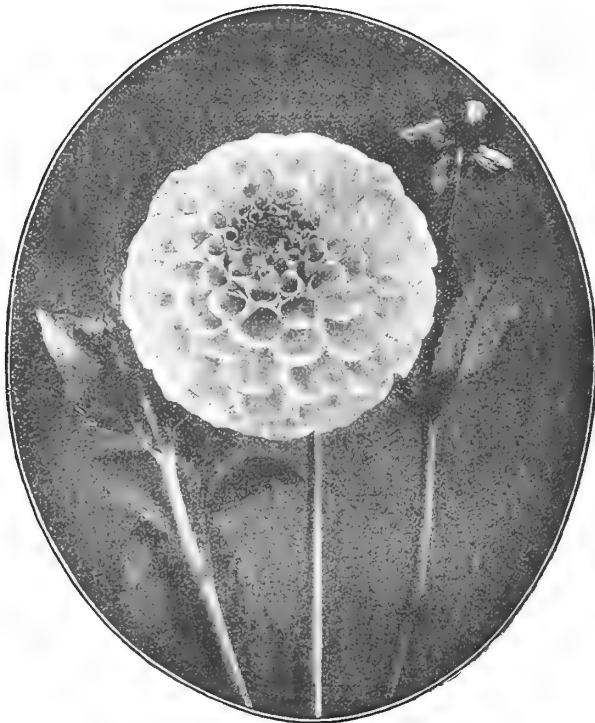

NEW DAHLIA, "PENELOPE"

Our Dahlias are grown for us by the Dahlia Specialist, W. P. Peacock, of New Jersey, which is sufficient guarantee of their being true to name and of first quality. Mr. Peacock does not sell at retail but we have arranged to supply any one of the hundreds of varieties of Dahlias grown by him in addition to the following select list of prize-winners.

18 NEW DAHLIAS OF SPECIAL MERIT

- ALETA (Show). Lovely delicate pink, color of Melba carnation. 40 cts. each, 3 for \$1.00.
- BEATRICE (Cactus). Very large, deep pink, long pointed petals.
- BLIZZARD (Storm King). An early and profuse blooming, snow white; the best White Show Dahlia.
- CINDERELLA (Cactus). Deep rich crimson, shaded plum, fine form.
- CHAS. WOODBRIDGE (Cactus). Bright glistening crimson, richly shaded.
- HARMONY. A superb blending of yellow, gold and amber, beautifully formed.
- ISLAND QUEEN (Cactus). Of medium size, bright rosy lavender.
- LAURENCE KRAMER (Single). Exquisite deep pink on long stems, fine for cutting.
- MR. MOORE (Cactus). Dark velvety maroon, finely formed flowers.
- MRS. BARNES (Cactus). Lovely clear primrose shading to rosy pink.
- HON. MRS. P. WYNDHAM (Show). Very large cream heavily tipped peach shading to crimson, fine form.
- MRS. N. HALL'S (Show). Of largest size; color deep rich purple.
- PHILIP FREUD (Pompon). A pleasing golden buff shading to rich salmon.
- RED HUSSAR (Show). Bright glistening crimson scarlet; a strong vigorous grower on long stems; fine for cutting. 50 cts. each, 3 for \$1.25, \$5.00 per doz.
- ROYAL QUEEN (Show). Buff, heavily tipped crimson maroon; fine.
- THE QUEEN (Cactus). Pure white, large and fine; should be planted early. 40 cts. each, 3 for \$1.00.
- TOMMY DALY (Pompon). White, shading to pinkish lavender, tipped dark maroon.
- WILDFIRE (Single). The finest pure scarlet single to date; large size; extremely profuse on long stems. 50 cts. each.

Price of above, unless noted, 25 cts. each, \$2.50 per doz. Set of 18, one strong root of each, for \$4.50. (Regular value, \$5.40).

50 BEST DOUBLE LARGE FLOWERING

- ADMIRAL DEWEY. Rich imperial purple; an exquisite variety.
- ADOLPH PEPPERHORN. Large purplish crimson.
- AMERICAN FLAG. Striped crimson and white.
- ARABELLA. Primrose, shaded rose.
- ARRAH NO POGUE. Maroon tipped white.
- BEAUTY. A beautiful large white.
- CELESTINE. Yellow, suffused with orange.
- DECORATOR. White, penciled crimson.
- DUKE OF CAMBRIDGE. White tipped purple.
- ELEGANS. Rosy purple tipped white.
- EMPERESS OF INDIA. Deep crimson maroon.
- GENERAL GRANT. Deep buff striped crimson.
- GRAND DUKE ALEXIS. Quilled white and pink.
- HENRY PATRICK. Large pure white.
- HERCULES. Immense red penciled yellow.
- HERO. Bright purple; large fine form, profuse bloomer.
- JAPAN PINK. Deep pink, quilled petals.

GENERAL COLLECTIONS

- KEYSTONE. Pink striped bright crimson.
- LADY G. HERBERT. White tipped deep purple.
- LADY JANE ELLIS. Pinkish white; veined purple.
- LANCELOT. Orange scarlet; large and fine.
- LEIBERHEIMER. Very profuse crimson, tipped white.
- LUCIUS CRAMMOCK. A fine dark purple.
- MAD. MOREAU. Very large, deep pink.
- MAID OF KENT. Cherry red tipped white.
- MARG. BELL. Very large, soft purple.
- MILDRED. Small, profuse; scarlet tipped white.
- MISS MAY LOMAS. White suffused rosy lavender.
- MISS BARRY. Fine deep rosy lake.
- MISS JENNINGS. Fawn shaded salmon pink.
- MISS BROWNING. Clear yellow tipped white.
- MISS CANNELL. Fine, white suffused crimson.
- MRS. DEXTER. Large; rich golden salmon.
- MRS. STANCOMBE. Straw and amber striped white.
- MODEL OF PERFECTION. Fine lilac pink; free.
- PSYCHE. Primrose shaded rose.
- PRESIDENT. White veined purple.
- QUEEN OF YELLOWS. A beautiful clear yellow.
- RED AND BLACK. Cherry red, margined black.
- RAYON D'OR. Rich orange striped white.
- RED HEAD. Very large; dwarf, deep red.
- SATURN. Dark crimson; serated petals.
- OCTOPOON. Dark velvety purple tipped and suffused white; fine.
- S. SICKMAN. Dark maroon, tipped white.
- THOS. HOBBS. Large; deep purple.
- TRIOMPHE DE SOLFERINO. Large, bright solferino.
- UNCERTAINTY. Varies white, carmine and crimson.
- VERDIFLORA. Green flowers; a curiosity.
- WM. PIERCE. Deep butter yellow.
- WILLIE GARRET. Richest crimson scarlet; large fine formed show.

Price 15 cts. each, \$1.50 per doz. Set of 50, \$5.50; \$10.00 per 100.

12 BEST POMPON DAHLIAS

- ALLIE MOWREY. A fine deep pink.
- CATHERINE. Pure canary yellow; fine form.
- ELEGANTE. The best bright pink pompon.
- KLEIN DOMITEA. Salmon buff, profuse, fine.
- LEILA. Flesh, mottled and suffused crimson.
- LITTLE LUCY. Small, bright orange red.
- LITTLE NIAD. White tipped crimson; a beautiful flower.
- LITTLE PET. Very profuse, yellow tipped pink.
- MISS LOW KRAMER. Yellow tipped, bright crimson.
- PRINCE CHARMING. Deep crimson lake.
- SNOWCLAD. Best white pompon.
- SUNSHINE. Bright deep scarlet.

Price 15 cts. each. Set of 12 for \$1.50.

12 BEST SINGLE DAHLIAS

- ANNIE HUGHES. Sulphur tip'd purple.
- ASTEROIDES. Pure white, margined crimson.
- AMI BARRILET. Rich garnet; purple foliage.
- C. E. VARNUM. Large, red tipped lighter fashion. The finest single Dahlia. Maroon flamed crimson with white disc around centre. 5 first prizes.
- JUNO. White tipped lavender.
- JOHN HUMMERSTEIN. Dark crimson.
- MRS. L. C. BASSETT. Dark crimson striped lilac.
- NANCE. Large size, a soft clear lavender.
- NOVELTY. Pink spotted and penciled crimson.
- SERATIPETALA. Bright scarlet, cleft petals.
- SUNNINGDALE WHITE. A fine large white; strong and free.

Price 15 cts. each. Set of 12 for \$1.50.

20 BEST CACTUS DAHLIAS

- GREEN'S GEM. Richest orange; finely pointed petals.
- IONA. Rich terra cotta shading to orange.
- JOHN H. ROACH. The finest pure yellow cactus.
- MABEL KEITH. Delicate sulphur, open centre.
- MATCHLESS. A superb Dahlia; darkest maroon shading to black; over 30 prizes awarded.
- MISS ANNIE JONES. Bright flaming scarlet cactus; exquisite.
- MRS. BENNETT. Rich red of fine form; one of the best.
- MRS. MONTEFIORE. Rich glowing crimson; beautiful twisted cactus form.
- ROBERT CANNELL. Rich magenta tinged blue.
- ST. CATHERINE. Large, yellow, shaded red.
- SIGLINDE. A lovely shade of primrose, shading to glistening salmon.
- VISCOUNTESS FOLKESTONE. Primrose to sulphur.

Price 15 cts. each, \$1.50 per doz. Set of 20 for \$2.50.

12 PRIZE-WINNING DAHLIAS—A Separate Collection for Every Garden

- HENRY F. MICHELL. Immense size, long pointed petals, beautifully blended, shades from yellow to orange red.
- Prizes for Henry F. Michell: { 6 best blooms \$3.00, 3 " " 2.00, 1 " " 1.00 }
- A. D. LIVONI. Beautiful clear soft pink show.
- BRONZE BEAUTY. A profuse bloomer, golden yellow, overlaid bronze.
- CLIFFORD W. BRUTON. Pure yellow; immense size, of fine form; on long stems. 17 first prizes.
- EMILY. Very large, rosy lavender; one of the best for cutting or exhibition. 9 first prizes.
- EARL OF PEMBROKE. Bright plum, deeper and more velvety toward the center; petals long, pointed and regularly arranged. One of the best.
- NYMPHAEA. Delicate shrimp pink tinting to white at centre; an exquisite variety. 23 first prizes.
- at September Dahlia Show, Horticultural Hall, Philadelphia.
- Only one entry from one garden or by one exhibitor.
- OAKFIELD. Dark glowing velvety crimson; long stems and free bloomer; fine for cutting. 4 first prizes.
- PENELOPE. White delicately flaked rosy lavender, very beautiful; cutting and exhibition. 16 first prizes.
- STRIPED BANNER. Bright and red striped white.
- ZULU. Dark maroon, shading to jet black. The original "Black Dahlia." 9 first prizes.
- WHITE SWAN. Pure white; considered one of the best.

Price 15 cts. each, \$1.50 per doz., \$10.00 per 100

DAHLIAS IN SEPARATE COLORS

- WHITE, PINK, PURPLE, YELLOW, RED, MAROON VARIEGATED, SALMON.
- 12 cts. each; per doz., \$1.25; per 100, \$9.00.
- MIXED. All colors. Per doz., \$1.00; per 100, \$8.00.

**SPECIAL OFFER!** Strong root of every Named Dahlia on this page for \$16.25. Complete collection consisting of all named sorts on this page also the color plate collection and "20th Century" and "Mrs. Roosevelt" for \$18.00 (REGULAR VALUE, \$24.05)

NEW  
D  
A  
H  
L  
I  
A  
S  
FOR  
1902

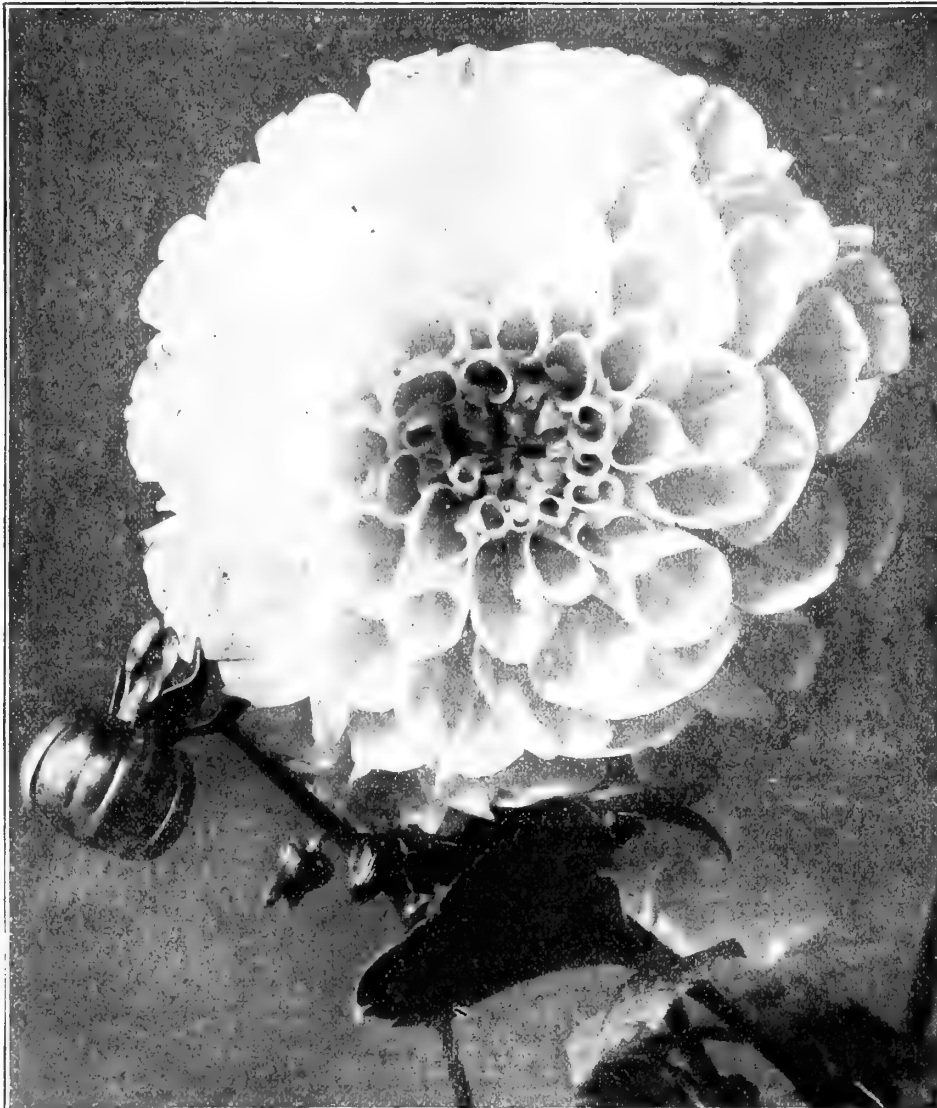

SPECIAL  
NOTICE



Our display of  
Dahlias at the

PAN-AMERICAN  
EXPOSITION

was pronounced  
the finest on  
the grounds and  
was awarded

A  
SILVER  
MEDAL

Superb New Dahlia, Mrs. Roosevelt.

SUPERB SHOW DAHLIA.

**Mrs. Roosevelt.** This new Dahlia which we now introduce for the first time, is acknowledged to be superior to the celebrated *Dahlia Grand Duke Alexis*. It is of larger size, better color, more graceful in form, has better stems for cutting; blooms more freely, and last, but not least, will keep much longer when cut. The flowers are perfectly double, of largest size, 6 to 8 inches across, while the color is a delicate blush white, shading to soft, clear pink. We have a fine stock and can offer strong plants after April 1st. Price 50c. each; \$5.00 per doz.

The Exquisite Orchid-Flowered Single  
Dahlia.

**20th Century.** The most exquisite Dahlia ever introduced and the first of a new race. No orchid could be more delicate in color or yet richer in shading. It is purest white at the tips and base of the petals, shading to delicate blush rose. The flowers are of largest size, 6 to 8 inches in diameter, of splendid form and good texture, lasting when cut, longer than ordinary single Dahlias; while the plant is a strong vigorous grower and profuse bloomer. MR. SAMUEL S. PENNOCK, Wholesale Florist, Phila., says: "I consider *20th Century* the finest Single Dahlia I know of and would advise you to grow a large quantity for next year's cut flower trade." All flower lovers should have this Dahlia, while no florist can afford to be without it. Stock limited. Price, strong plants, ready March 15, 1902, \$1.00 each; \$10.00 per doz.

Our 6 Color Plate Dahlias. (See Color Plate.)

**No. 1. Polly Eccles.** A striking plant of dwarf habit bearing in greatest profusion, long stemmed flowers: color a lovely, satiny fawn, with a red disc around the centre.

**No. 2. Silvion.** New. The most striking single, introduced in 1901. Color a bright cardinal red with hood, white stripe running through the centre of each petal. Sometimes the flowers are solid cardinal. Price, strong roots, 35c. each; \$3.50 per doz.

**No. 3. Enchantment.** Very large; a pretty combination of red and yellow.

**No. 4. John Cowan.** Dark crimson; of large size and fine form; a profuse bloomer and a strong, vigorous grower.

**No. 5. Snow Queen.** Purest snow white, in marked contrast with many single white Dahlias that are tinted pink, lavender and purple. We anticipate a great demand for this fine variety and have a large stock of fine, large clumps.

**No. 6. New Seedling, 1901.** Large size; of good form and a good vigorous grower; the plant is distinct and ornamental in itself as it has fern-like foliage; ground color white suffused pink, splashed, spotted and penciled deep crimson; free bloomer. Price, strong roots, 40c. each; \$4.00 per doz.

Price of above Single Dahlias, except where noted, 15c. each, per doz. \$1.50. Set of 6 for \$1.25 or with *20th Century* and *Mrs. Roosevelt*, 8 in all, for \$2.50.



Photograph of Gloxinias grown by F. Canning, Gardener to S. T. Bodine, Esq. Bulbs furnished by us.

## GLOXINIA BULBS

One of the handsomest summer blooming plants.

### CULTURAL DIRECTIONS.

Pot the bulbs as soon as received in a mixture of soil consisting of two parts loam, and one part of leaf mould and sand, they should then be placed in a temperature of not less than 60°, water sparingly until the roots are well developed. A warm moist temperature, care in watering, a shady position, and care to prevent cold draughts from striking them, are necessary in order to secure the very best results. When their blooming period is over they should gradually be left to dry out, watering can be avoided by laying the pots on their side, placing them in the sun as the foliage begins to disappear in order to thoroughly ripen the bulbs; start them the following spring by repeating the above described treatment.

**Separate Colors.** Crimson, White, Spotted, Blue, Red bordered. Each, 15c.; Per doz. \$1.25; per 100, \$7.00. **Choicest Mixed**, Each, 10c.; per doz., \$1.00; per 100, \$6.00.

### TESTIMONIAL

MR. HENRY F. MICHELL:

SIR:—Enclosed please find a photograph of a bunch of Gloxinias grown from bulbs purchased of you. The wide range of colors are extremely beautiful, and were admired by all who saw them. I have no hesitancy in saying they are the best I have ever grown. You are to be congratulated on possessing the best strain of Gloxinias the market affords.

Gardener to SAMUEL T. BODINE, ESQ.

VILLA NOVA, PA., Sept. 24th, 1901.  
Respectfully yours,  
FRANCIS CANNING.

### HYACINTHUS CANDICANS.

Summer Blooming Hyacinth.  
Extra large bulbs. Each 5c., per doz. 50c.

### LILIES (Hardy)

- Auratum (Golden banded Japan.)** Extra large bulbs, 11 to 13 inches in circumference. Each 20c., per doz. \$2.00, 100 \$12.00. Bulbs 9 to 11 inches in circumference. Each 15c., per doz. \$1.50, per 100 \$9.00. Bulbs 7 to 9 inches in circumference. Each 10c., doz. \$1.00, per 100 \$7.00.
- Lancifolium Speciosum Album.** Extra large bulbs. Pure white Japan Lily. Each 20c., per doz. \$2.00, per 100 \$12.00.
- Lancifolium Speciosum Rubrum.** Very large bulbs. Each 15c., per doz. \$1.50, per 100 \$10.00.
- Lancifolium Speciosum Roseum.** Extra large bulbs 15c. each, \$1.50 per doz., per 100 \$10.00.
- Spec. Melpomene.** Very large crimson. Beautifully spotted. 15c. each, per doz. \$1.50.
- Tigrinum (Tiger Lily).** Each 12c., per doz. \$1.25, per 100 \$9.00.

### Madeira or Mexican Vine.

Large Selected Bulbs. Each 5c., per doz. 40c.

### OXALIS.

- Summer Blooming.
- Deppi, White.
- Lasiandra, Pink. 15c. per doz., per 100 \$1.00.

### TIGRIDIAS (Shell Flower)

- Conchiflora. Orange and Crimson.
- Pavonia Grandiflora. Red and Yellow.
- Grandiflora Alba. White and Maroon. 5c. each, per doz. 40c., \$3.00 per 100.



Lilium Auratum

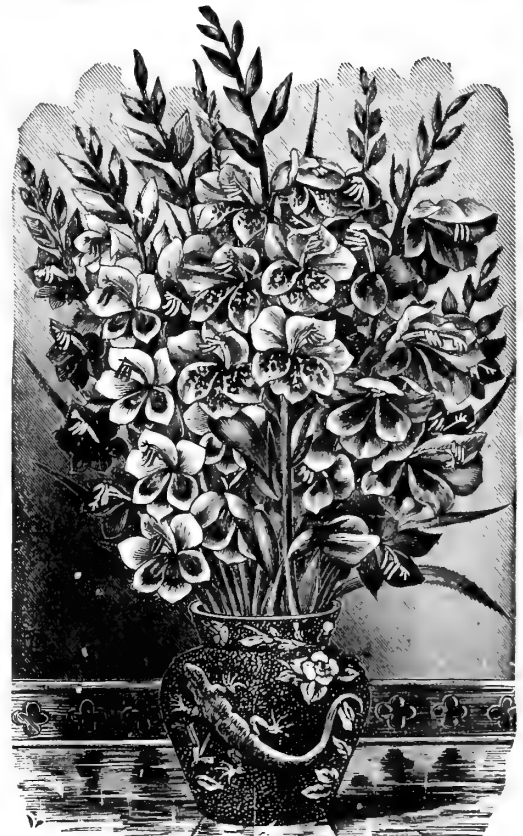

Lemoine's "Butterfly" Gladiolus.

## GLADIOLUS.

### CHOICE NAMED SORTS.

- Augusta.** The finest White variety. Each 15c., per doz. \$1.50, per 100 \$10.00.
- Brenchleyensis.** Vermillion Scarlet. Each 5c., per doz. 30c., per 100 \$1.50.
- Canary Bird.** Exquisite light yellow. Each 20c., per doz. \$2.00, per 100 \$16.00.
- Eugene Scribe.** A grand sort, Rich pink. Each 12c., per doz. \$1.25, per 100 \$8.50.
- Fatma.** Immense flowering, White striped and blotched w'th Salmon. Each 10c., per doz. \$1.00, per 100 \$7.00.
- May.** Almost pure white, penciled crimson. Each 5c., per doz. 50c., per 100 \$3.50.
- Shakespeare.** White, shaded carmine, pink blotched. Each 10c., per doz. \$1.00, per 100 \$7.50.
- Groff's New Hybrids.** (See novelties for description.) Each 5c., per doz. 50c., per 100 \$3.50.

### GLADIOLUS. (In Sep. Colors and Mixtures).

All Colors, very Choice, Mixed. Each 4c., per doz. 25c., per 100 \$1.75, per 1000 \$14.00.

**White and Light Colors.** Each 5c., per doz. 40c., per 100 \$2.25, per 1000 \$20.00.

**Yellow Shades.** Each 5c., per doz. 45c., per 100 \$3.50, per 1000 \$32.50.

**Scarlet and Crimson** Each 4c., per doz. 25c., per 100 \$1.75, per 1000 \$15.00.

**Pink and Variegated.** Each 5c., per doz. 40c., per 100 \$2.25, per 1000 \$20.00.

**Lemoine's Butterfly.** Extra fine mixed. Each 5c., per doz. 30c., per 100 \$2.00, per 1000 \$18.

**Chidsi.** A distinct mammoth race. They bloom freely, many plants producing 3 to 5 spikes of bloom. The flowers are of exceptional large size, frequently 6 or 7 inches across. Mixed of all bright colors. 6c. each, 60c. per doz., \$4.50 per 100.

### TUBEROSE BULBS.

**Excelsior Pearl Double.** 4c. each, per doz. 25c., \$1.50 per 100, per 1000 \$10.00.

**Extra Mammoth Bulbs.** 5c. each, 40c. per doz., per 100 \$2.25, \$15.00 per 1000.



Pearl Tuberose.



# SMALL FRUITS, ETC.

We send out only Extra Strong Plants of bearing size.

Do not compare prices with Young Shoots offered at lower price.

## Currants

Currants should be planted in good soil, which must be kept rich and well worked. Sprinkle ashes around the roots occasionally, to keep the borers away. The currant worm may be destroyed by sprinkling the bushes with powdered white hellebore while they are wet with dew. Where it has been applied, the fruit should not be used without first being washed.

- Black Naples.** Vigorous and productive; used for jelly and jams and highly profitable for market in some sections. Two years, per doz. \$1.00, per 100 \$6.00.
- Fay's Prolific.** Color rich red. Per doz. \$1.50, \$7.50 per 100.
- Red Dutch.** Medium size; in large bunches; the old and well-known currant of the garden. Per doz. \$1.00, per 100 \$6.00.
- Red Cherry.** Large. Per doz. \$1.00, per 100 \$6.00.
- White Grape.** The best white variety; large, sweet and good; best for the table; a good bearer. Per doz. \$1.00, per 100 \$6.00.

## Blackberries

Plant in good rich soil, in rows five feet apart, and three or four feet apart in the row. After the fruiting season or in early spring, cut out all the dead wood. Should be planted early, before the buds start. A good top dressing of stable manure, applied annually, produce large crops. Keep the ground clean and well worked.

- Erie.** An excellent early berry; ripens its entire crop at once. Berries good size, black, firm, sweet and of good quality. Per doz. 60c., per 100 \$3.00.
- Kittatinny.** Large, juicy, sweet and excellent; hardy and productive. Considered the best and most profitable late berry. Per doz. 60c., per 100 \$3.00.
- Wilson's Junior.** Of large size, unsurpassed productiveness, fine flavor and early. The largest and best early blackberry yet introduced. Per doz. 60c., per 100 \$3.00.

## Gooseberries

Treatment same as for Currants.

- Downing.** Large pale green; soft, juicy and good for family use. Two years, per doz. \$1.00, per 100 \$6.00.
- Houghton's Seedling.** Pale red. Per doz. \$1.00, per 100 \$6.00.
- Industry.** Although a foreign sort, it has done admirably, being a vigorous grower and an immense yielder, and showing no signs of mildew. We confidently recommend it for the garden, being unequalled for size, flavor, productiveness and vigorous growth. Color dark red. Each 20c., per doz. \$2.00.

## Strawberry Plants—Extra Strong (Layer Plants)

All the leading and tested varieties. Per doz. 25c., per 100 \$1.00, per 1000 \$6.00.

## Pot Grown Strawberry Plants

Ready August 1st. Per 100 \$3.00, per 1000 \$25.00.

## Raspberries

Plant in rows five to six feet apart, two to four feet apart in the row. Cut the tops off within a few inches of the ground when planted. Pinch the vigorous young shoots several times during the summer, they will then grow stout enough to stand without staking.

- Brandywine.** Large; bright red; hardy and productive; an old variety, extensively grown. Per doz. 50c., per 100 \$2.50.
- Cuthbert.** Large, firm, deep rich crimson, of excellent quality; perfectly hardy and very productive. Per doz. 50c., per 100 \$2.50.
- Philadelphia.** Dark crimson; hardy and productive. Per doz. 75c., per 100 \$2.50.
- Golden Queen.** The best yellow variety. Per doz. 75c., per 100 \$2.50.
- Gregg.** A large black variety; fruit firm, of excellent quality and a good shipper. Per doz. 50c., per 100 \$2.50.
- Japanese, or Wineberry.** Large clusters of red berries, excellent for jelly or preserving. Each 10c., per doz. \$1.00.

## NEW STRAWBERRY RASPBERRY

Tested here for three years, and constantly growing in favor; one of the most beautiful fruits ever seen. Berries the size and shape of the largest strawberries, bright, rich glowing scarlet; fine for jams, jellies and cooking. Bush grows from 18 inches to 2 feet high, bears the first season and continues fruiting for three months; dies down in winter, but is entirely hardy, and does well everywhere regardless of drought or heat. Every garden should have some of these really good berries, they are sure to please. Per doz. \$1.50, per 100 \$6.00.

## Hardy Grape Vines

- Catawba.** A very good keeper; red, sweet and rich, with pleasant flavor. Does best against buildings.
  - Concord.** One of the most profitable of all hardy grapes. Bunch and berry large; black, juicy and sweet.
  - Delaware.** Light red, very sweet.
  - Duchess.** Medium size; greenish white; excellent quality.
  - Lady.** Bunch compact and of good size; berry yellowish green; flavor rich, sweet and sprightly.
  - Martha (White Concord).** Large, pale yellow; strongly resembles the Concord in all points except color; hardy and vigorous.
  - Moore's Early.** Bunch and berry round and large; black.
  - Niagara.** Bunches very large and very compact; berries large, light greenish white, skin thin but tough, and does not crack.
  - Pocklington.** Golden yellow.
  - Worden.** Large, black.
  - Salem (Rogers' No. 22)** Large; bright reddish brown; fine rich aromatic flavor.
- Very strong two year old roots, true to name. Each 25c., per doz. \$2.50, per 100 \$12.50.
- ☞ We also have some extra strong vines of the above sorts at 50c. each, per doz. \$5.00.

# HEDGE PLANTS

## California Privet—Large Stock, Strong Plants

Exceedingly beautiful, nearly evergreen hedge plants. Very vigorous and hardy; leaves deep green, bright and very glossy. Especially adapted for hedges at the seashore; very easily transplanted. Beware of spurious kinds of privet which are being offered for the above and which are not nearly so desirable. Ours are the genuine California, or Japan Privet (Ligustrum Ovalifolium). Most of them have been transplanted and are furnished with an abundance of fine fibrous roots, are well branched and are sure to give satisfaction.

- 1 and 2 year old, 12 to 18 inch, per 100 \$2.50, per 1000 \$20.00
  - 2 year old, 18 to 24 inch, " 3.00, " 25.00
  - 2 " " 24 to 30 inch, " 4.00, " 35.00
- Also larger sizes quoted on application.

## Osage Orange

Extra strong two year old plants. Per 100 \$1.00, per 1000 \$7.50.

## American Arbor Vitae

3 to 4 feet. Per 100 \$35.00.

## Hemlock Spruce

2 to 2½ feet, per 100 \$75.00; 2½ to 3 feet, per 100 \$125.00.

## Norway Spruce

3 to 4 feet, per 100 \$40.00; 4 to 5 feet, per 100 \$60.00.

# BOOKS

## On Horticultural and Other Kindred Subjects

How to Grow Mushrooms	\$ 10
How to Grow Chrysanthemums	25
Greenhouse Management. Taft Most Practical	1 50
Landscape Gardening. Parsons	3 50
Gardening for Profit. Henderson	1 50
Gardening for Pleasure. Henderson	1 50
Practical Floriculture. Henderson	1 50
Handbook on Plants. Henderson	3 00
Profit in Poultry	1 00
Grape Growers Guide. Chorlton	75
Chrysanthemum Culture	60
Mushroom Culture. Robinson	50
Mushroom Culture. Falconer	1 25

## PLANT CULTURE (Oliver)

A new book giving the latest instructions on the care of Ornamental Garden and Greenhouse Plants. Price, \$1.00.

## SUCCESS WITH HOUSE PLANTS

Scores of books and booklets there are on this subject, but it has been reserved to our author to write a text book, the result of her own practical experience that, faithfully followed, will enable every lady to keep her home delightful with dainty and fragrant flowers all through the dreary winter. 12mo., 220 pp., cloth; profusely illustrated, with complete and ready reference index to all plants enumerated. Price, \$1.00.

## VIOLETS

### You can learn how to Grow Violets for Profit or for Pleasure

**Commercial Violet Culture**, by Prof. B. T. Galloway, U. S. Dept. Agriculture, Washington, D. C. The only comprehensive work on the subject, gives every detail necessary to success. Superbly illustrated with over sixty plates, plans, diagrams, etc. Bound in flexible covers of royal purple and gold. 224 pages. Price, postpaid, \$1.50.

We have other books not mentioned above, and supply same at lowest prices. Any of the above books, postpaid on receipt of price.

# TREES AND SHRUBS



OUR Trees have been grown under a clean thorough, system of cultivation, and frequently transplanted. They are free from borers, and are in a vigorous, healthy condition. Those wishing to plant trees in large quantities, it will pay them to ask us for **special quotations before placing their orders elsewhere.**

## Selected Hardy Shrubs

- Althea** (Hibiscus). 20 varieties. 35c. each, per doz., \$3.50; ex. selected, 50c. each, per doz., \$5.00.
- Almond** (Flowering). Pink and White. 35c. each, per doz., \$3.50.
- Azaleas**. Fine Plants. 75c. each, per doz., \$8.00.
- Berberries**. Purple and Green and Thurbergii. 35c. each, per doz., \$3.50.
- Calyeanthus** (Sweet Shrub). 35c. each, per doz., \$3.50.
- Caryopteris Mastacanthus** (Blue Spirea). 35c. each, per doz., \$3.50.
- Cytissus Laburnum** (Golden Chain). 50c. each, per doz., \$5.00.
- Deutzias**. 2 varieties. 35c. each, per doz., \$3.50.
- Dogwood**. Red branched and other varieties. 35c. each, per doz., \$3.50.
- Euonymus** (or Burning Bush). 35c. each, per doz., \$3.50.
- Exochorda**, Grandiflora. 35c. each, per doz., \$3.50.
- Elder**. Golden and Cut Leaved. 35c. each, per doz., \$3.50.
- Forsythia** (Golden Bell). All varieties. 35c. each, per doz., \$3.50.
- Fringe**. Purple, 35c. each, per doz., \$3.50. White, 50c. each, per doz., \$5.00.
- Globe Flower** (Kerria). 35c. each, per doz., \$3.50.
- Honeysuckle**. Upright in variety. 35c. each, per doz., \$3.50.
- Hydrangeas**. All varieties. 35c. each, per doz., \$3.50; extra size, 50c. each, per doz., \$5.00.
- Japan Quince** (Pyrus Japonica). 35c. each, per doz., \$3.50.
- Lilacs**. In variety. 35c. each, per doz., \$3.50; named varieties, 50c. each, \$5.00 per doz.
- Magnolias**. Dwarf varieties. 75c. each, per doz., \$8.00.
- Mock Orange** (Philadelphus). 35c. each, per doz., \$3.50.
- Plums**. Ornamental and Flowering. 35c. each, per doz., \$3.50.
- Spireas**. All varieties. 35c. each, per doz., \$3.50.
- Snowberry**. 35c. each, per doz., \$3.50.
- Viburnum** (Snowball). 35c. each, per doz., \$3.50.
- Wiegelsias**. In great variety. 35c. each, per doz., \$3.50.

## Ornamental and Shade Trees

- Ash**—8 ft., 75c. each; 10 to 12 ft., \$1.50 each.
- Beech**—Purple, 6 to 7 ft., \$1.50. 7 to 8 ft., \$2.00.
- Birch**—White and Yellow, 6 to 8 ft., 75c.
- Catalpa**—(Indian Bean) Grafted, 5 to 7 ft., \$1.50.
- Dogwood**—Red flowering, 4 to 5 ft., \$1.25; 5 to 6 ft., \$2.00.  
—White flowering, 4 ft., 75c.
- Elms**—American and English, 8 to 10 ft., 75c.; 10 to 12 ft., \$1.50.
- Horse Chestnut**—White flowering, 7 to 8 ft., \$1.00; 8 to 10 ft., \$1.50.
- Judas**—(Japan). 2 to 3 ft., \$1.25.
- Linden**—American and broad leaved, 9 to 10 ft., \$1.00; 10 to 12 ft., \$1.50.
- Maples**—Norway and Sycamore, 10 ft., \$1.00; 11 to 12 ft., \$1.50 to \$2.00.  
—Sugar, 10 ft., 75c.; 11 to 12 ft., \$1.50 to \$2.00.  
—(Japanese) selected specimens, \$2.50 each; per doz., \$25.00.
- Oaks**—English, 8 to 9 ft., 75c.; 10 to 12 ft., \$1.50; 14 to 15 ft., \$3.00.  
—Pin, 7 to 8 ft., \$1.25; 9 to 10 ft., \$1.50 to \$2.50.  
—Red and Scarlet, 5 to 6 ft., \$1.25; 6 to 8 ft., \$2.00.

## EVERGREENS

- Arbor Vitae**—All varieties, from 2 to 6 ft., 50c. to \$2.00 each.
- Fir**—All varieties, 75c. to \$4.00 each.
- Pine**—All varieties, 3 to 6 ft., 75c. to \$4.00 each.
- Retinospora**—All varieties, 2 to 7 ft., 75c. to \$10.00 each.
- Spruce**—All varieties, 2 to 6 ft., 35c. to \$8.00 each.
- Yew**—English, Irish and Japan, \$1.00 to \$5.00 each.

## FRUIT TREES

- APPLES**—Trees of Bearing age 50c. each, per doz. \$5.00. Baldwin, Early Harvest, Maidens Blush, also all other varieties.
- APRICOTS**—40c. each, per doz. \$4.00. Acme, Peach, Rowan, also other varieties.
- CHERRIES**—Trees of Bearing age \$1.00 each, per doz. \$9.00. First-class trees 60c. each; per doz. \$6.00. Black Tartarian, Downers Late Red, Gov. Wood, also all other varieties.
- PEARS**—Trees of Bearing age \$1.00 each, per doz. \$9.00. First-class trees 60c. each; per doz. \$6.00. Bartlett, Kieffer, Seckel, also all other varieties.
- PEACHES**—Trees 4 to 6 feet 25c. each, per doz. \$2.50. Crawford's Early, Crawford's Late, Elberta, also all other varieties.
- PLUMS** (Japan)—50c. each, per doz. \$5.00. Abundance, Burbank.
- PLUMS** (European)—Trees of Bearing age 75c. each, per doz. \$8.00. First-class trees 60c. each; per doz. \$6.00. Bradshaw, Golden Drop, Reine Claude, also all other varieties.
- QUINCE TREES**—2 year old trees 35c. each, per doz. \$3.00. Bearing age trees 50c. each, per doz. \$5.00. Champion, Meech's, Prolific, also all other varieties.

## NUT TREES

- ALMONDS**—Hard and Soft Shell, 40c. each; per doz. \$4.00.
- CHESTNUTS**—Japan Giant, 1 yr. grafted, \$1.00 each, 2 yr. grafted \$1.50. Paragon, 1 yr. grafted \$1.00; 2 yr. grafted, \$1.50. Spanish, from seed, 4 ft. 35c., also all other varieties.
- FILBERTS**—40c. each, per doz. \$4.00.
- SHELLBARKS**—50c. each, per doz. \$5.00.
- PECANS**—40c. each, per doz. \$4.00.
- WALNUTS**—Black English, Japan, 50c. each, per doz. \$5.00.

### SPECIAL ANNOUNCEMENT

We are in position to furnish competent men, who thoroughly understand **Landscape Gardening, Grading, Tree Planting, etc.**

### P. S.

**For full description of Trees and Hardy Shrubs, write for our illustrated catalogue, sent free to all applicants.**

Highest Quality.

# FERTILIZERS Sold with our Guarantee.

**Ashes.** (Canada Unleached Hard Wood). These contain all of the fertilizing elements except nitrogen. They drive away insects, and are indispensable for all crops requiring potash. Apply about 1000 lbs. to the acre. Per 100 lbs. \$1.50; bbl. of 250 lbs. \$2.50; ton of 2000 lbs. \$18.00.

*THE COST OF WOOD ASHES can be reduced \$3.00 per ton by customers giving us their order two weeks ahead, to enable us to ship it direct from Canada to the customer. Special rate on application.*

**Bone Meal.** **Michell's Strictly Pure and Fresh.** In fertilization nothing takes precedence in importance over animal bones, because they furnish the soil with the essential requisite of nitrogen as well as phosphoric acid. The most substantial fertilizer for lawns and plants. It keeps on feeding the soil for fully ten months. 3 lb. box 15c.; 5 lb. bag 25c.; 10 lbs. 40c.; 25 lbs. 75c.; 100 lbs. \$2.00; sack of 200 lbs. \$3.50; ton \$30.00.

**Baugh's Celebrated \$25.00 Phosphate.** \$3.00 per 200 lb. sack; \$25.00 per ton.

**Blaker's "Odorless" Lawn Dressing.** One of the best fertilizers, supplying just what every worn-out lawn requires. 25 lbs. \$1.00; \$1.75 per 50 lbs.; per 100 lbs. \$3.00. Special price will be quoted on larger quantities.

**Bone Flour.** **Pure.** Ground perfectly fine; excellent for pot plants or beds where an immediate effect is wanted. 5 lbs. 25c.; 25 lbs. \$1.25; 100 lbs. \$2.50; bag or bbl. of 200 lbs. \$4.50; ton \$40.00.

**Bassics Slag,** considered by those who have used it to be the finest fertilizer for tennis courts, golf grounds, etc. \$16.00 per ton, f.o.b. factory; \$9.00 per 1/2 ton, f.o.b. factory.

**Blood (Dried).** Very rich in nitrogen. \$3.00 per 100 lbs.; \$5.00 per 200 lbs.; \$40.00 per ton.

**Bowker's CHEMICAL FERTILIZERS.** For general forcing (indoors or out), apply at the rate of about one pound to each hot-bed sash, or six pounds to every one hundred square feet of bed, thoroughly worked into the soil to the depth of two or three inches.

For forcing lettuce, cabbage, tomato plants, etc., apply from four to six pounds per one hundred square feet, thoroughly mixed with the soil. Half the quantity may be applied a month later.

For carnations, violets and similar plants use at the rate of four to six pounds for every 100 square feet, and then a month later apply two or three pounds more. 5 lbs. 30c.; 10 lbs. 50c.; 25 lbs. \$1.00; 50 lbs. \$1.75; 100 lbs. \$3.00.

**Bowker's Plant Food.** Made especially for plants grown in conservatory, house or garden. Clean, free from offensive odor. Full directions with each package. Package 15c. and 25c.; by mail 25c. and 40c.

**Clay's Fertilizer.** Imported manure especially recommended for flowers or vegetables, to bring the highest perfection. Should be used in potting soil, and spread on staging of greenhouses planted with flowering plants. Per bag of 25 lbs. \$2.00; 50 lbs. \$3.50; 100 lbs. \$6.50.

**Cotton Seed Meal.** \$2.00 per 100 lb. sack; \$25.00 per ton. Special price will be quoted on larger lots.

**Guano. Pure Peruvian.** 1 1/2 lb. box 15c.; 3 1/2 lb. box, 25c.; 10 lbs. 50c.; 100 lbs. \$2.50; per ton \$40.00.

**Guano. Potato, Corn and Truck. Sharpless and Carpenter's Brand.** Guaranteed analysis: Actual Potash, 6 to 8 per cent.; Ammonia 1 1/2 to 2 1/2 per cent.; available Phos. Acid, 6 to 8 per cent. Price \$3.50 per sack of 200 lbs.; \$30.00 per ton.

**Guano. Native or Poudrette.** Very rich in quality and very low in price. 5 lbs. 20c.; 25 lbs. 60c.; \$1.50 per 100 lbs.; \$15.00 per ton. Special price on larger quantities.

**Horn Shavings.** A very valuable and rich fertilizer, especially for roses, chrysanthemums, etc. 10c. per lb.; 25 lbs. \$1.75; \$5.00 per 100 lbs.

**Thomson's Flower and Vegetable Manure.** This is one of the very best fertilizers, introduced from England, and can be highly recommended to any one wishing an immediate effect in forcing. Highest testimonials from those who have tested its merits. Put up in original bags. 28 lbs. (1/2 cwt.), \$1.75; 56 lbs. (1 cwt.), \$3.25; \$6.00 per cwt.

**Imperial Liquid Plant Food.** One of the best and most reliable plant fertilizers now on the market. Highest testimonials received from all who are using it now. Per 10 gallon cask \$3.85; \$6.50 per 20 gallon cask. F. O. B. factory.

**"Jadoo" Liquid.** Is the cheapest fertilizer sold. Both meat and drink to plants. Revives drooping plants, strengthens the weak and nourishes the strong; above all, it increases the size, causes greater profusion of bloom, and heightens the colors of all flowers and plants. Can be used on plants that are grown in earth. \$1.50 per 2 gallon jug.

**Kainit.** One of the most useful fertilizers. Apply at the rate of 1000 lbs. per acre. Should be spread during winter. 100 lbs. \$1.25; 200 lbs. \$2.00; per ton \$15.00.

**Land Plaster.** For mixing with Paris Green, also for top dressing to sweeten the soil. 25 lbs. 50c.; 100 lbs. \$1.00; bbl. \$1.50; ton \$9.50.

**Lawn Dressing.** (Odorless). A scientific food for lawns. Guaranteed. 10 lbs. 40c.; \$1.00 per 25 lb. bag; 50 lb. bag \$1.75; 100 lb. bag \$3.00.

**Manure.** We can supply at short notice, strictly first-class, clean, short or long manure. Our large sales these past three years prove that we send out a choice article. In car load lots only at \$1.25 per ton. Special price will be quoted on larger quantities.

**Mapes' Celebrated Fertilizers.** Prices quoted here are f.o.b. Phila. It is, however, more advantageous to the customer to have them shipped direct from Mapes' factory as the price will be 25c. less per sack, and \$2.00 less per ton than prices herewith quoted, only paying one freight charge.

	Sack of 200 lbs.	Ton of 2000 lbs.
Potato manure	\$4.50	\$39.00
Corn manure	4.25	36.00
Cabbage and cauliflower manure	4.25	38.00
Fruit and vine manure	4.25	39.00
Grass and grain spring top dressing	4.25	40.00
Complete manure, for general use	4.25	38.00
Complete manure, for heavy soils	4.50	39.00
Complete manure, for light soils	4.50	41.00
Vegetable manure, for all soils	4.50	41.00
Early vegetable and truck manure	4.50	41.00

**Muriate of Potash.** 50 lbs. \$2.25; 100 lbs. \$3.25; \$48.00 per ton.

**Nitrate OF SODA.** For all crops. Contains the largest percentage of nitrogen; equal to 19 per cent. of ammonia. It is very quick in action, and hastens maturity of crops fully two weeks. Should not be applied until the plants are above the ground, when 100 to 150 lbs. per acre should be sown with other fertilizers, or mixed with phosphates. Shipped in double bags. 50 lbs. \$2.00; 100 lbs. \$3.50; 200 lbs. \$6.00; per ton \$48.00.

**Poudrette.** Per lb. 10c.; 26c. by mail; 5 lbs. 20c.; 35c. per 10 lbs.; 25 lbs. 60c.; \$1.00 per 50 lbs.; \$1.50 per 100 lbs.; per 200 lb. sack \$2.50; \$9.00 per 1000 lbs.; \$15.00 per full ton.

**Phosphate. Baugh's Celebrated \$25.00 Brand.** \$3.00 per 200 lb. sack; \$25.00 per ton.

**Phosphate. Super High Grade.** Analysis: Ammonia 4 to 6 per cent.; bone phosphate 24 per cent.; available phos. acid 6 to 8 per cent.; sulph. potash 1 to 2 per cent. It stands without a rival as the largest crop producer. Apply 400 lbs. per acre. 25 lbs. 90c.; 100 lbs. \$2.00; 200 lbs. \$3.25; per ton \$28.00.

**Phosphate, No. 1 Brand.** Very good. 200 lb. sack \$2.75; ton \$20.00.

**Potato Manure (Baugh's).** Very high grade. Guaranteed \$3.50 per 200 lb. sack; per ton \$30.00.

**Soot Imported Scotch.** Per lb. 10c.; per 5 lbs. 35c.; per 100 lbs. \$4.00

**Salt (Agricultural Brand).** for topdressing lawns or asparagus beds. Apply early in spring, at rate of 800 to 1000 lbs. per acre. 200 lbs. \$1.50; ton \$9.50.

**Sheep Manure. Pure, Fresh, Pulverized.** One of the richest general fertilizers. **Elliott's XX Brand,** 2 lbs. 15c.; 4 lbs. 25c.; 10 lbs. 50c.; 25 lbs. \$1.00; 50 lbs. \$1.50; \$2.25 per 100 lbs.; \$32.00 per ton, "A Brand." Very good. \$1.75 per 100 lbs.; \$28.00 per ton.

**WE CAN ALSO SUPPLY ALL OTHER FERTILIZERS AT VERY LOWEST MARKET PRICES.**



## INSECT DESTROYERS

**Aphis Punk.** (*Nikoteen*.) Especially designed for use in private places and in houses without convenient furnaces for heating irons necessary for vaporizing **NIKOTEEN** or Tobacco Extract. The Punk is lighted with a match and allowed to burn, which it does without flaming, at the same time giving off dense white fumes of nicotine that kill aphis and thrip very effectively. 60c. per box. Per twelve boxes, \$6.50.

**Ant Exterminator.** Very effectual for destroying ants in gardens and lawns. 25c. per 1/4 lb., 40c. per 1/2 lb., 75c. per lb.

**Bowker's Bodlime.** Stops canker worms, caterpillars and all creeping insects from crawling up trees. Superior to all other articles heretofore on the market. 5 lbs. 90c., 10 lbs. \$1.35; 25 lbs. \$2.75.

**Bordeaux Mixture.** For black rot, downy mildew, and anthracnose of grape, potato blight, potato rot, leaf blight of cherry, pear, quince, and other fungus diseases. 5 lbs. 60c., makes 25 gallons spray; 10 lbs. \$1.00, makes 50 gallons spray; 25 lb. box, makes 125 gallons, \$2.50.

**Bordeaux Mixture.** In liquid form, 40c. per qt., \$1.00 per gallon.

**Copperdine.** For black rot, carnation rust and anthracnose of the grape, pear leaf blight, apple scab and powdery mildew. One gallon can (makes 100 gallons wash), per qt. 50c., per gal. \$1.50.

**Copper Soap (Permol).** Positive cure for mildew, rust and all fungus. 75c. per can.

**Dalmation or Persian Powder.** Pure, 1/4 lb. 15c., lb. 40c., 5 lbs. \$1.50.

**Fir Tree Oil.** For destroying insects, such as mealy bug, red spider, scale, thrip, green fly, etc. Full directions with each can. 1/2 pint 50c.: 75c. per pint; per qt. \$1.50; \$2.75 per 1/2 gal.; per gal. \$5.00.

**Fir Tree Oil Soap.** Per can 25c. and 50c. each.

**Fostite.** Prevents mildew. Five lbs. 60c., 25 lbs. \$2.50.

**Gishurst's Compound.** Extensively used for preventing and destroying green fly, mildew, thrip, mealy bug and scale. Box 50c., 3 lb. box \$1.00.

**Good's Caustic Potash Whale Oil Soap.** 20c. per lb.; 5 lbs. 75c.

**Grape Dust.** Best remedy for mildew. 5 lb. pkge. 30c.; 100 lb. keg \$5.00.

**Hellebore.** For destroying rose slugs. 25c. per lb.; 5 lbs. \$1.00; 10 lbs. \$1.85.

**Kerosene Emulsion.** (Paste.) For plant lice of any kind, cabbage worms, scale, insects on pear and other trees. One lb. 15c.; 5 lb. can 60c., makes 50 gallons of spray; 25 lb. can \$2.50, makes 250 gallons of spray.

**Kerosene Emulsion.** (Liquid.) 50c. per qt.; per gal. \$1.50.

**Kerosene Soap.** (Permol.) 15c. per pkge.; 25c. per lb.; 10 lb. pails \$1.75 25 lbs. \$3.75.

**Kraft's Palm Wash.** 75c. per pt.; \$1.40 per 1/2 gal.; \$2.65 per gal.

**Kraft's Tonic and Insecticide.** 25c. per bottle; 75c. per qt.; \$2.65 per gal.

**Lemon Oil.** Will destroy mealy bug, scale, thrip, red spider, etc. 25c. per 1/2 pt.; per pt. 40c.; 75c. per qt.; per 1/2 gal. \$1.25; \$2.00 per gal.; per 5 gal. keg \$9.00.

**London Purple.** Cheaper and less dangerous than Paris green. Lb. 25c.; 5 lbs. \$1.10. Special price on larger quantity.

**Nicotide.** A powerful insecticide for evaporizing. \$1.25 per 1/2 pint; per pint \$2.50. Lamps for fumigating 50c. each.

**Paris Green Pure.** Lb. 25c.; 5 lbs. \$1.20; 14 lb. buckets \$3.00.

**Persian Insect Powder.** Fresh and pure. 15c. per 1/4 lb.; per lb. 40c.

**Pillar Catter.** 15c. per yard; \$12.50 per 100 yards.

**Rose Leaf Extract of Tobacco.** Per qt. 50c.; per gal. \$1.25; 5 gal. \$4.25.

**Seal Oil Soap.** 1 lb. can 25c.; 10 lbs. for \$2.20; 30 lb. cans 20c. per lb.

**"Shoo Fly."** Keeps the flies from cattle and horses. 50c. per qt.; \$1.50 per gal.

**Slug Shot.** 5 lbs. 25c.; 10 lbs. 50c.; 100 lbs. \$4.25. Bulk, in barrels weighing about 225 lbs. 3 3/4 c. per lb.

**Sulphur.** A preventive and cure for mildew. Lb. 7c.; 5 lbs. 30c.; 100 lbs. \$4.00.

**Sulphate of Copper.** For spraying. Per lb. 10c.; 80c. per 10 lbs.

**Tobacco Dust.** Cheaper than snuff and quite as effectual. Sure remedy for green fly. 10c. per lb.; 5 lb. pkge. 25c.; 100 lbs. \$3.50.

**Tobacco Soap.** (Pinners.) For destroying insects, parasites and their eggs, infesting either plants or animals. 1/2 lb. 20c.; lb. 40c.

**Tobacco Stems Fresh.** For fumigating. Lb. 10c.; bbl. \$1.00; bales of about 250 lbs. \$2.00; per 1/2 ton \$6.00; per ton \$11.00.

**Whale Oil Soap.** For destroying and preventing insects on plants, trees, vines, etc., for washing down the bark of trees, grape vines, etc. With directions, 15c. per lb.; 50c. per 5 lbs.; 90c. per 10 lbs.; per 25 lbs. \$1.75.

**Worm Eradicator.** The best article for destroying worms. 50c., \$1.00 and \$3.00 per bottle.



1 lb. pkge. 15c.; 3 lb. pkge. 35c.; 5 lb. pkge. 50c.; 12 1/2 lb. pkge. \$1.00; \$7.00 per 100 lbs. **Shaker.** For applying Bug Death, etc., 65c.

**X. L. All Vaporizing Compound.** In solid dry cake form; one cake is sufficient to fumigate 1,000 cubic feet of space. Price 35c. per cake; \$3.90 per dozen cakes. **Fumigators**, complete, \$1.25, each.

**"Peerless" Sulphur and Insecticide Blower.** This is the most satisfactory distributor of Sulphur and other insecticide in powder form. Will never wear out. Satisfaction guaranteed. Price \$4.75.

**How and When To Spray**

Complete Treatise Sent Free on Application.

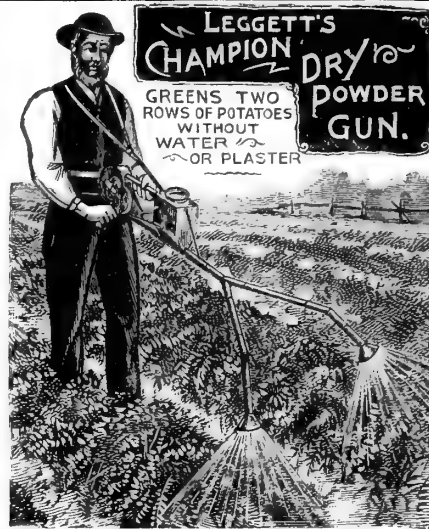

**Leggett's "Champion" Paris Green Gun.**

The most practical and satisfactory implement for applying Paris Green.

Price complete, \$7.00

This machine distributes over 2 rows by one application.

**Knapsack Sprayer**

DEMING'S BEST

Copper - \$12.00  
With kerosene attachment - 16.00

### The Fairmount Weed Killer

Will keep your paths and roadways clear of all organic growth, will clean and not injure marble or any kind of stone or gravel.

**It Kills Weeds Scientifically.**

1/2 gal. tin	makes 20 gals. treating liquid,	\$0.75
1 " "	40 " " " "	1.25
5 " " "	200 " " " "	6.00
10 " " "	400 " " " "	11.00
25 " " "	1000 " " " "	25.00
50 " " "	2000 " " " "	45.00

Please note the strength of the Fairmount when comparing with lower-priced weed-killers offered. The "Fairmount" is by far the cheapest.

One gallon is sufficient to effectually cover 100 to 150 square yards of surface. Can be spread over the ground with an ordinary rose sprinkler.

Full directions on every container.

### Fumigators

**Perfection**, No. 1, holds 1 pk. of stems, \$3.00.  
**Perfection**, No. 2, holds 1/2 bushel of stems, \$3.50.  
**Perfection**, No. 3, holds 3/4 bushel of stems, \$4.00.  
**Perfection**, No. 5, holds 1 bushel of stems, \$5.50.  
**Eureka**, No. 1, height 12 in., for a house 10x20 ft., \$1.25.  
**Eureka**, No. 2, height 16 in., for a house 12x40 ft., \$1.75.  
**Eureka**, No. 3, height 20 in., for a house 15x100 ft., \$2.25.  
**Eureka**, No. 4, height 24 in., for a house 20x100 ft., \$3.25.  
**Tobacco Stems**, (Fresh.) For fumigating. 5 lbs. for 25c., \$1.00 per bbl., \$2.00 per bale of 250 lbs., \$11.00 per ton.

See also **Aphis Punk** and **Nikoteen** for other fumigating materials.

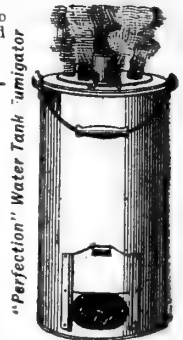

### BELLOWS

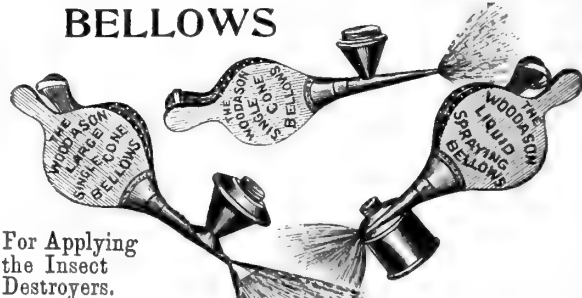

BELLOWS

For Applying the Insect Destroyers.

Large Double Cone Each \$3.00  
 Large Single Cone Each 2.00  
 Small Single Cone Each 1.00  
 Liquid Spraying Sulphur Bellows Each \$1.50 and \$2.00  
 Each 1.50

### Cataract Insect Exterminator.-All Brass.



\$1.00 Each.

# PLANTS, TUBS, POTS, ETC.



## Standard Flower Pots.

Full inside measurement, height and width.

No charge for barrels or packing.  
6 supplied at dozen rates. 50 supplied at 100 rates.  
500 supplied at 1000 rates.

Please note the reduction in prices. Compare with others.

Size, inches height and width inside	Per doz.	Per 100	Per 1000	Size, inches height and width inside	Each	Per doz.	Per 100	Per 1000
1 1/2	\$0.06	\$0.44	\$3.46	5 1/2	\$0.41	\$3.13	\$24.75	
2	.07	.50	3.96	6	.05	.49	3.75	29.70
2 1/2	.08	.56	4.45	6 1/2	.07	.62	4.80	44.00
3	.09	.60	5.45	7	.08	.78	6.00	55.00
3 1/2	.11	.88	6.93	8	.11	1.09	8.40	77.00
4	.14	1.06	8.41	9	.16	1.56	12.00	110.00
4 1/2	.19	1.38	10.89	10	.22	2.11	16.20	148.50
5	.20	1.56	12.37	11	.29	2.81	21.60	
5 1/2	.24	1.88	14.85	12	.40	3.90	30.00	
6	.32	2.50	19.80	14	.80	7.80	60.00	

We can also supply the old fashioned Hand Made Pots. Price List sent on application

## "NEPONSET" Flower Pots.

(Water-Proof Paper.)

Used principally for shipping plants and for temporary potting.

Size	Per doz.	Per 100	Per 1000
2 1/2	\$0.10	\$0.25	\$2.20
3	.12	.30	2.40
3 1/2	.15	.45	3.90
4	.20	.60	5.15
4 1/2	.25	.80	6.90
5	.35	1.20	10.35
6	.45	1.65	14.55

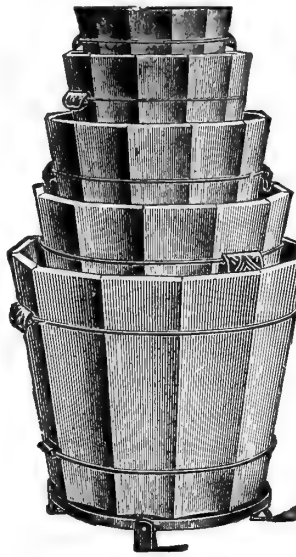

## Columbia Plant Tub.

We have had numerous demands for low priced tubs, and find these suitable, ornamental and durable.

12 in. diam. x 11 in. high.	\$1.00
15 " " x 14 " "	1.50
18 " " x 16 " "	2.00
21 " " x 18 " "	2.50
24 " " x 20 " "	3.00

## "UNION" Plant Tub.

Made of cypress, painted green, iron feet,

No. 1, 13 in. diam., 11 in. staves, price,	\$0.75
No. 2, 14 1/2 " " " " " "	1.25
No. 3, 16 " " " " " "	1.75
No. 4, 20 " " " " " "	2.25
No. 5, 24 " " " " " "	2.75

## CUT FLOWER VASES

Made of Wood Fibre. Unbreakable and Practical.

No.	Diam. in. inside	Depth in. inside	Each	Per doz.
0	8	13	\$0.45	\$4.80
1	5 1/2	70	.40	4.20
2	4 1/2	9	.35	3.60
3	4	6	.30	3.00
4	3	4 1/2	.25	2.40
00	9	21	.90	9.00
11	5	18	.60	6.00
22	4 1/2	15	.45	4.80
33	4	12	.40	4.20
44	3	9	.35	3.60

## Flower Pot Saucers—Made of Wood Fibre.

Are not porous, and will protect woodwork, tables, etc., on which plants are to stand.

UNBREAKABLE.



4 in. each,	7c. per doz.,	\$0.75, per 100,	\$6.00
5 in. " " 8	" " 8	" " 80	6.25
6 in. " " 8	" " 8	" " 85	6.75
7 in. " " 9	" " 9	" " 90	7.10
8 in. " " 9	" " 9	" " 95	7.60
9 in. " " 10	" " 10	" " 1.00	8.20
10 in. " " 11	" " 11	" " 1.05	8.70
12 in. " " 12	" " 12	" " 1.35	10.00
13 in. " " 15	" " 15	" " 1.50	12.00
14 in. " " 20	" " 20	" " 2.00	15.00
16 in. " " 25	" " 25	" " 2.50	18.00

## ROLLING STANDS.

For Heavy Plants and Palms. Made of Indurated Fibre Ware.

Will not soak or rust. Casters have ball bearings. Every heavy plant sold needs one to save carpets and floors.

Size	Will fit pot or tub	Each	Doz.
12 in.	10 in.	\$0.50	\$5.50
14 in.	12 in.	.60	6.75
16 in.	14 in.	.75	8.50
18 in.	16 in.	.85	10.25
20 in.	18 in.	1.00	11.25
22 in.	20 in.	1.20	14.00

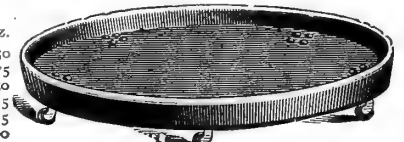

## Bulb Pans.

(Earthenware).

Diameter	Each	Per doz.	Per 100
6 in.	\$0.07	\$0.68	\$3.75
7 "	.08	.78	4.80
8 "	.10	.98	6.00
9 "	.15	1.30	8.40
10 "	.20	1.63	10.80
12 "	.25	2.28	15.00
14 "	.50	4.55	30.00
16 "	.90	7.80	60.00
18 "	1.25	11.70	90.00



## Pot Stands or Saucers.

Each	Per doz.	Per 100
4 in.	2c.	\$0.15
5 "	3 "	.18
6 "	4 "	.24
7 "	5 "	.31
8 "	6 "	.47
9 "	8 "	.62
10 "	9 "	.78
11 "	11 "	.94
12 "	15 "	1.17
14 "	25 "	1.95

## SEED PANS (Earthenware).

6 in. each	20c.	\$2.00 doz.	10 in. each	30c.	\$3.00 doz.
8 " "	25 "	2.50 "	12 " "	40 "	3.50 "



## FERN PANS.

Width	Height	Each	Per Doz.	Per 100
4 in.	1 1/2 in.	\$0.04	\$0.31	\$1.65
4 1/2 "	2 1/2 "	.05	.33	2.20
5 1/2 "	2 1/2 "	.06	.41	2.75
6 1/2 "	2 1/2 "	.07	.49	3.30
7 "	2 1/2 "	.09	.55	3.85
8 "	3 1/2 "	.11	.79	5.50
9 "	3 1/2 "	.15	.95	6.60

## AZALEA POTS.

Width	Height	Each	Per Doz.	Per 100
6 in.	5 in.	\$0.06	\$0.51	\$3.93
7 "	6 "	.09	.82	6.30
8 "	7 "	.12	1.14	8.82
10 "	8 "	.24	2.21	17.00



## Improved White Cedar Plant Tub

Made of white cedar, bound with extra heavy iron hoops. Drop handles of special pattern, serving as hooks. Substantial iron feet of original design. Removable perforated bottoms, painted green outside and brown inside.

No.	Outside diam.	Length of stave	Per 100
0	27 in.	24 in.	\$5.00
1	25 "	22 "	4.50
2	23 "	20 "	4.00
3	21 "	18 "	3.50
4	19 1/2 in.	16 "	2.75
5	18 "	14 "	2.50
6	16 1/2 "	13 "	2.00
7	15 "	12 "	1.75
8	14 "	10 "	1.50

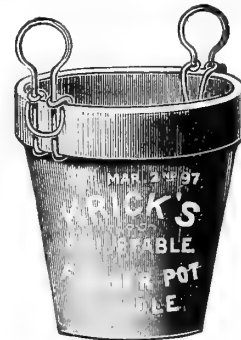

## Pot Hangers.

The best device for lifting plants in and out of jardinières; also for suspending plants, such as Asparagus Sprengeri, Ferns, etc.

No. 1.	40 cts. per doz.	for 3 to 5 inch pots.
No. 2.	50 cts. per doz.	for 6 and 7 inch pots.
No. 3.	60 cts. per doz.	for 8 to 10 inch pots.

## Wood Orchid Baskets.

	Each	Per doz.
6 in.	\$0.30	\$3.50
8 "	.40	4.25
10 "	.50	5.00
12 "	.60	6.50

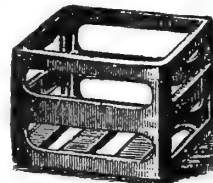

## Orchid Baskets (Earthenware.)

	Each	Per doz.
Square, 4 in.	\$0.15	\$1.35
" 6 "	.25	2.25
" 7 "	.30	3.00
Round, 6 in.	\$0.20	\$1.80
" 8 "	.30	2.50
" 10 "	.40	3.60

Cork Bark—for Orchids, 30 cts. per lb.

## THOROUGHbred POULTRY.

**Brown and White Leghorns—Single Comb.** They mature very early, and make good table fowls. Splendid layers, producing large eggs. Price, either Brown or White, single male, \$3.00; pair, \$5.50; trio, one cockerel and two pullets, \$7.50.

**Brown and White Leghorns—Rose Combed.** Similar to above except the comb. Price, either Brown or White, single male, \$3.00; pair, \$5.50; trio, one cockerel and two pullets, \$7.50.

**White Plymouth Rock.** Have all the good points that make Plymouth Rock such a favorite, but have a pure white plumage. They are very prolific layers and make excellent mothers; a most profitable breed for either the farmer or fancier. Single male, \$3.00; pair, \$5.50; trio, one cockerel and two pullets, \$7.50.

**Barred Plymouth Rock.** For general purposes may be justly entitled the "Farmers' Fowl." They are very hardy, most excellent layers, and one of the very best market fowls. Single male, \$3.00; pair, \$5.50; trio, one cockerel and two pullets, \$7.50.

**Buff Plymouth Rock** Rich, buff plumage, golden yellow legs and grand carriage; the finest of this family. Single male, \$3.50; pair, \$6.00; trio, one cockerel and two pullets, \$8.00.

**Light and Dark Brahmas.** No breed makes larger or better broilers at 8 to 10 weeks than the Brahmas. Very docile. Price for either Light or Dark Brahmas, single male, \$3.00; pair, \$5.50; trio, one cockerel and two pullets, \$7.50.

**Buff Cochins.** They thrive well in the smallest yards, and are most excellent winter layers. Single male, \$3.00; pair, \$5.50; trio, one cockerel and two pullets, \$7.50.

**White Wyandottes.** Similar to Silver Laced except in plumage, which is pure white. Single male, \$3.00; pair, \$5.50; trio, one cockerel and two pullets, \$7.50.

**White-faced Black Spanish.** One of the handsomest fowls, and also one of the best layers. Single male, \$3.00; pair, \$5.50; trio, one cockerel and two pullets, \$7.50.

**Indian Games.** The quickest growing chick from the shell up to 10 or 12 weeks of any breed; at 12 weeks old we have seen males weigh 3 to 4 pounds each. The flesh is of the finest quality, juicy and tender. They are easily cared for, and are without doubt the fowl for those who want quick growth, good size, good laying and eating qualities, and beauty in appearance combined. Single male, \$3.50; pair, \$6.00; trio, one cockerel and two pullets, \$8.00.

**Silver Spangled and Silver Penciled Hamburgs.** A very handsome breed; cannot be praised too highly for beauty and usefulness; most excellent layers. Price of either breed, single male, \$3.50; pair, \$6.00; trio, one cockerel and two pullets, \$8.00.

**Golden Seabright Bantams.** The most popular of bantams; very gay, rich golden plumage; good layers and brooders. Hardy both as fowls and chicks; thrive well in enclosure as well as running at large. Single male, \$3.00; pair, \$5.50; trio, one cockerel and two pullets, \$7.50.

**Pekin Ducks.** They are without doubt the best laying duck known. When fully mature and fat will weigh 12 to 15 pounds per pair. Single drake, \$3.00; pair, \$5.00; trio, one drake and two ducks, \$7.50.

## INCUBATORS, BROODERS.

### PRIZE BROODER.

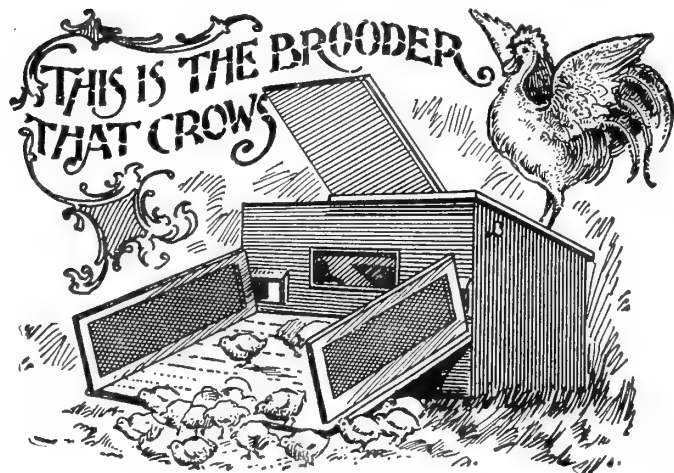

For in or outdoor use

### PRIZE BROODER.

100 chick capacity, . . . . . \$5.50

### PEEP-O'-DAY BROODERS.

No. 1. 150 chick capacity, with sun parlor, . . . . . \$12.00

without sun parlor, . . . . . 10.00

No. 3. 50 chick capacity, . . . . . 7.00

### VON CULIN INDOOR BROODER.

50 chick capacity, . . . . . \$4.00

100 chick capacity, . . . . . 6.00

### VON CULIN OUTDOOR BROODER.

50 chick capacity, . . . . . \$6.50

100 chick capacity, . . . . . 8.00

We also supply CLARK'S PREMIER INCUBATORS and BROODERS.  
Prices on application.

P. S.—If you are interested in Poultry, send for our complete illustrated Poultry Catalogue. Mailed free.



### The Improved Von Culin Incubator.

This is pronounced by experts to be, without a doubt, the most simple and satisfactory incubator in existence. Can be used with or without moisture.

#### PRICES.

60 egg capacity, . . . . . \$ 8.00 | 120 egg capacity, . . . . . \$18.00

100 egg capacity, . . . . . 11.00 | 288 egg capacity, . . . . . 25.00

MOULTON INCUBATOR (The World's Standard Hatcher).

66 egg capacity, . . . . . \$8.00



**Animal Meal.** (Bowker's.) 5 lbs. 20c.; 10 lbs. 40c.; 25 lbs. 75c.; 50 lbs. \$1.20; 100 lbs. \$2.25.  
**Barley.** Per qt. 15c.; bush. \$1.35.  
**Bone (Granulated).** The use of ground bone tends to keep fowls in good health, and materially aids laying hens. 5 lb. pkge. 25c.; 25 lbs. \$1.00; 100 lbs. \$2.25.  
**Buckwheat.** For pigeons and young poultry. Per qt. 10c.; peck 30c.; bush. \$1.00.  
**Clover Meal (Pioneer).** Best quality. 5 lbs. 25c.; 25 lbs. 75c.; 50 lbs. \$1.10; 100 lbs. \$2.00.  
**Charcoal (Ground).** A little ground charcoal mixed with the soft feed in the morning, once or twice a week, keeps them healthy. 1 lb. 10c.; 5 lbs. 40c.; 10 lbs. 75c.; \$4.00 per 100 lbs.  
**Cut Clover Hay (Niagara Brand).** Excellent food for winter and early spring. 50 lb bag \$1.25; 100 lbs. \$2.00.  
**Chick Manna, or Food for Little Chicks.** Specially prepared for little chicks when first hatched. Should be the first and only food, and continued for 10 or 12 days before feeding anything else. Directions for feeding on each package. 1 lb. pkge. 10c., by mail 25c.; 5 lb. pkge. 40c.; 60 lb. box, bulk \$4.20.  
**Death to Lice Powder.** (Lambert's.) 15 oz. box 25c.; 48 oz. box 50c.; 100 oz. box \$1.00.  
**Death to Lice Ointment.** (Lambert's.) 1 oz. size 10c.; 5 oz. postpaid 25c.  
**Eggs (Nest).** Porcelain, per doz. 25c.; Medicated, per doz. 30c.  
**Egg Testers.** 35c. each.  
**Gape Cure.** (Madoc.) 6 oz. can 20c.; 7/8 lb. can 35c.  
**"H. O." Poultry Food.** 5 lbs. 20c.; 25 lbs. 75c.; 100 lbs. \$2.00; per ton \$36.00.  
**Hemp Seed.** Used largely for feeding birds and pigeons. Per qt. 15c.; peck 60c.; bush. \$2.00.  
**Imperial Egg Food.** For making hens lay winter and summer. Keeps the fowls in the best condition. 26 oz. pkge. 25c.; 60 oz. pkge. 50c.  
**Life to Chicks.** Prices 25c., 50c., \$1.00.  
**Cracklings.** Similar to Poultry Meat. 50 lb. cakes only, 3 1/2 c. lb.  
**Kaffir Corn.** Excellent poultry food. Qt. 15c.; pk. 65c.; bu. \$1.50.  
**Meat for Poultry (Prepared).** This is prepared with great care. It is the finest thing we know of to cause hens to lay during the winter; extremely profitable to feed. 5 lbs. 25c.; 10 lbs. 40c.; 50 lbs. \$1.25; 100 lbs. \$2.50; 500 lbs. \$12.00; per ton \$42.00.  
**Multum in Parvo Poultry Powder.** 1/2 lb. 20c., by mail 28c.; 1 lb. 25c., by mail 50c.  
**Mica Crystal.** For digestion. 5 lbs. 15c.; 10 lbs. 25c.; 25 lbs. 40c.; 100 lbs. 85c. Three grades—Fine, coarse and pigeon.  
**Oyster Shell (Fresh Ground).** The finest article to feed for shell making. 5 lbs. 10c.; 25 lb. bag 40c.; 100 lbs. 65c.; ton \$10.00.  
**Peas (Canada Field).** Per qt. 10c.; peck 50c.; bush. \$1.50.  
**Dried Blood.** A great egg producer. 5 lbs. 30c.; 10 lbs. 50c.; 25 lbs. \$1.00; 100 lbs. \$3.00.  
**Pratt's Food.** Will make hens lay all the year, and is excellent for feeding to young chicks. For large fowls mix one ounce with the food for fifteen or twenty. For fifteen or twenty chicks give one half ounce every other day. 1 1/2 lb. pkge. 25c.; 5 lb. pkge. 60c.; 12 lb. bag \$1.25; 25 lb. bag \$2.50.  
**Pratt's Horse and Cattle Food.** 5 lb. pkge. 50c.; 12 lb. bag 75c.; 25 lbs. \$1.50; 50 lbs. \$3.00.  
**Roup Preparation.** Sure cure. 1/2 lb. pkge. 20c.; 1 lb. pkge. 40c.  
**Roup Pills.** (Sturtevant's.) 50 pills 25c.; 50c. per 250.  
**Roup Pills.** (Haven's.) Per box 25c.; per box of 250 pills \$1.00.  
**Rust's Egg Producer.** 1 lb. 25c.; 2 1/2 lbs. 50c.; 6 lbs. \$1.00; 10 lbs. \$1.50; 25 lbs. \$3.50.  
**Rust's Havens Condition Powder.** Per pkge. 25c.; large size 50c.; 5 lb. box \$1.00; 8 lb. box \$1.50; 20 lb. box \$3.50.  
**Sheridan's Condition Powder.** 4 oz. pkge. 25c.; 2 1/4 lb. can \$1.00; six 2 1/4 lb. cans \$5.00.  
**White Flint Grit.** 50c. per 100 lbs.

# Michell's Specialties

## FOR POULTRY RAISERS

OF EXTRA ORDINARY MERIT

### Michell's Pioneer Mash Food



Just the proper thing to feed young chicks, ducks, geese, etc., on, contains nothing but what is essential to health and vigor. 5 lbs. 20c.; 35c. 10 lbs.; 25 lbs. 65c.; \$1.15 per 50 lbs.; per 100 lbs. \$2.00.

### Michell's Pioneer Poultry Food

A combination of different grains scientifically prepared. 5 lbs. 25c.; 40c. per 10 lbs.; 25 lbs. 85c.; \$1.40 per 50 lbs.; per 100 lbs. \$2.50.

### Michell's Pioneer Scratch Food

A food to be thrown among litter and straw in the poultry house during winter weather, making the fowls search for their food, which keeps them healthy. 5 lbs. 25c.; 40c. 10 lbs.; 25 lbs. 85c.; \$1.40 per 50 lbs.; per 100 lbs. \$2.50.

### Rolled Wheat for Young Chickens

5 lbs. 25c.; 40c. 10 lbs.; 25 lbs. 75c.; \$2.00 100 lbs.

### Gape Cure—(Michell's)

A sure cure for this dread disease. 25c. and 40c. per bottle (postpaid).

### Hen Tonic

A long felt want is supplied in this infallible remedy; positively prevents hens from laying soft shelled eggs, hitherto a great annoyance and loss to the poultryman. Bottle 25c. and 40c. (postpaid).

### Egg Tonic

Will make your hens lay, when other remedies have failed. 25c. and 40c. per bottle (postpaid).

### Spongia

The sovereign remedy for roup in all stages. Results obtained are remarkable; also acts as a preventative against this dread disease. 25c. and 40c. per bottle (postpaid).

#### THE BEST BOOK ON POULTRY

**"Profits in Poultry."** A practical treatise on the business, giving designs for houses; artificial incubation; preparing for market; caponizing, etc. Price \$1.00.



#### French Poultry Killing Knife.

Made of fine steel. Price, with full instructions, 50c. each.

**"Progressive" Killing Knife.** Highly recommended. 50c.

P. S.—The above Preparations can be had from us only.

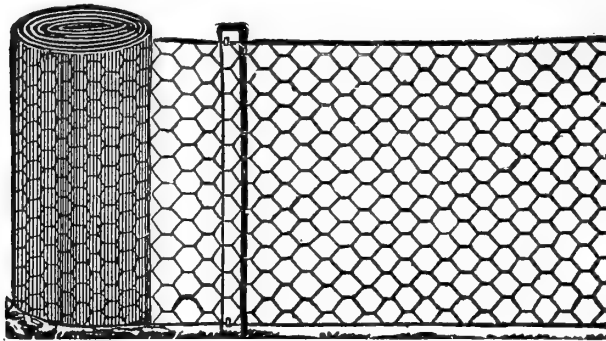

## Galvanized No. 19, Wire Netting—2 inch

Galvanized after the netting is made, which makes it strong and durable. Special prices will be quoted on larger quantities.

The best thing for making poultry yards; better looking and cheaper than laths, and permits more light and air to enter. Prices may fluctuate.

12 in. wide, per bale 150 lineal feet, \$0.76	42 in. wide, per bale 150 lineal feet, \$2.50
18 " " " 1.50 " 1.24	48 " " " 1.50 " 2.85
24 " " " 1.50 " 1.52	60 " " " 1.50 " 3.57
30 " " " 1.50 " 1.90	72 " " " 1.50 " 4.28
36 " " " 1.50 " 2.13	

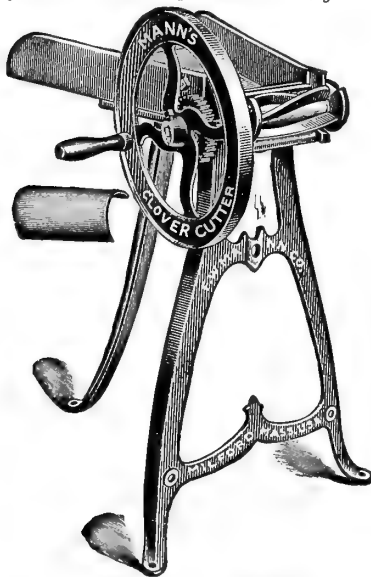

Mann's Clover Cutter

## Mann's Clover Cutter for Poultry

Made entirely of iron and steel. Cannot warp or shrink. \$8.00 without stand. \$10.00 with stand.

## Mann's Standard Green Bone Cutters

The most economical machine for converting green bones, with the meat and gristle attached, into poultry food.

No. 1—C. Without wheel.....	\$6.00
" 1—B. With wheel.....	7.50
" 1—BM. With wheel (on stand).....	10.00
" 2—Best. With wheel (on stand).....	18.40
" 8—Double—Hand Cutter.....	22.40

## Webster & Hannum Bone Cutters

No. 4. With crank.....	wt., 26 lbs.	\$5.00
" 4. With bal. wheel.....	" 46 lbs.	7.00
" 6. Without legs.....	" 80 lbs.	12.00
" 6. With legs.....	" 135 lbs.	15.00
" 3. Power Machine.....	" 225 lbs.	30.00

## Wilson's Best Oyster Shell and Dry Bone Mill

Weight 39 lbs. Price \$4.50 With legs \$6.50. This mill is adapted for grinding oyster shells, dry bones, corn, meal, etc.; and by means of a regulating wedge on the back, can be made to grind to any desired fineness.

## Humphrey Green Bone Mill

Pronounced by number of Poultry Raisers to be the best and cheapest mill on the market. Price \$12.00.

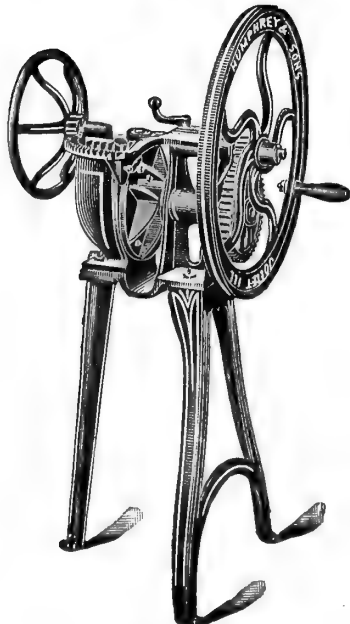

Humphrey's Bone Mill



Climax Band

## Leg Bands

We can stamp two letters or numbers on any of these bands. In ordering state what breed they are for.

**Novelty.** Price, per dozen, 25c.; per 50, 75c.; per 100, \$1.25.  
**Climax.** Price, per dozen, 25c.; per 50, 75c.; per 100, \$1.25.

## Spratt's Dog Cakes

A well known article particularly suitable for feeding hunting dogs, etc.  
 3 lbs. 25c.; 40c. per 5 lbs.; 25 lbs. for \$1.75; \$6.00 per 100 lbs.

# THEY FIGHT FOR SPRATT'S

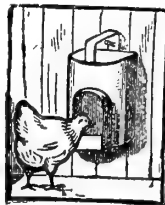

The Hub

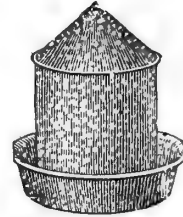

The Philadelphia

## Poultry Drinking Fountains

All the most improved and reliable kinds; both in galvanized iron and stoneware.

Prices, 25c. to \$1.00 each.

## Thompson's Banner Root Cutter No. 7 FOR POULTRYMEN

Choking an Impossibility Feed left in long, small, thin strips. Price \$5.00.

## Mann's Swinging Feed Tray for Poultry

PRICES  
 18 inch . . . . . \$1.00  
 27 inch . . . . . 1.25  
 36 inch . . . . . 1.50

## Sanitary Grit Box (Atsatt's)

These are fitted with divisions, so as to be enabled to feed three different foods at one time. Made of sheet iron. Price, 60c. each. Also other makes of Grit Boxes.



Atsatt's Grit Box



Mann's Swinging Feed Tray for Poultry

# Coldwell's Imperial Lawn Mowers

Easiest Running Lawn Mower Made.

	High Wheel 4 Blade	5 Blade	Low Wheel	Grass Catchers
14 inch	\$7.50	\$8.00	\$6.50	\$1.50
16 inch	8.25	9.00	7.50	1.60
18 inch	9.00	10.00	8.50	1.70
20 inch	10.00	11.00		1.85

## Coldwell's New Ball Bearing Mowers

HIGH WHEEL			
14 in.	16 in.	18 in.	20 in.
\$8.00	\$9.00	\$10.00	\$11.00

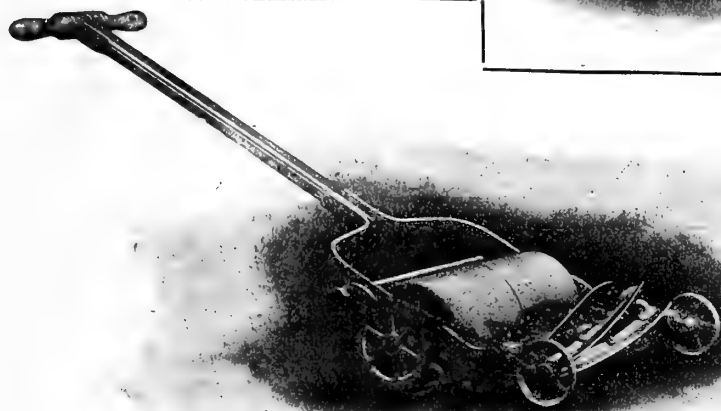
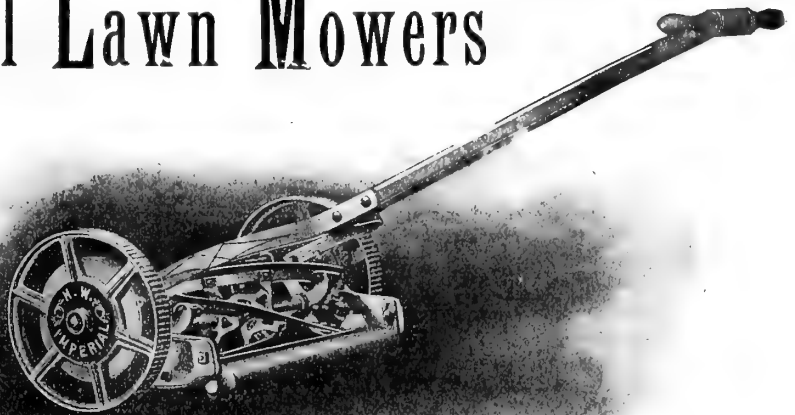

Coldwell's Golf Greens Mower

## NEW GOLF GREENS MOWER

**Roller Mower.**—Used on the leading Golf Links in this country; offered with either four or six blades in the Revolving Cutter. It has no equal where fine work is required. Considered the finest cutting and lightest running Roller Mower made in the world. It shaves the grass, leaving the greens as smooth as a billiard table.

14-inch, including Grass Catcher,	\$13 00
16 " " " " "	14 00
18 " " " " "	16 00
20 " " " " "	18 00

Showing Grass Catcher on these Golf Greens Mowers.



## COLDWELL'S IMPROVED HORSE MOWERS

EVERY MOWER IS GUARANTEED TO GIVE SATISFACTION OR NO SALE.

These Mowers are used on the Public Parks of Paris, (France), New York City, Brooklyn, Baltimore, Chicago, Buffalo and Washington.

### SPECIAL.

We are prepared to do all kinds of repairing and sharpening of Hand and Horse Mowers. Satisfaction guaranteed.

We also carry in stock nearly all the different separate parts for Lawn Mowers.



### Horse Boots for Lawn

Extra well made; will wear out two sets of cheap boots.

\$8.00 per set of four.

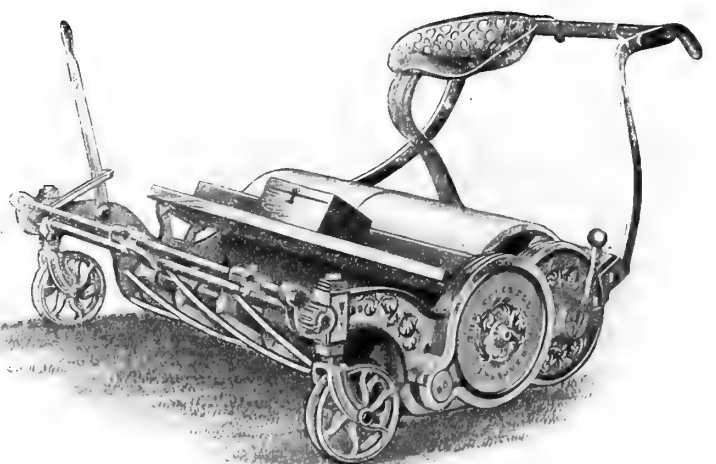

## Coldwell's Improved Horse Lawn Mower

25-inch, no shafts . . . . .	\$37 50	35-inch, with seat and shafts	\$75 00
30 " with draft irons . . . . .	55 00	40 " with draft irons . . . . .	85 00
30 " with seat and shafts	60 00	40 " with seat and shafts	90 00
35 " with draft irons . . . . .	70 00		

We Prepay Freight Charges on all Coldwell's Horse Mowers Shipped New from the Factory



# Lawn Mowers, Etc.

## Pennsylvania Horse Lawn Mower

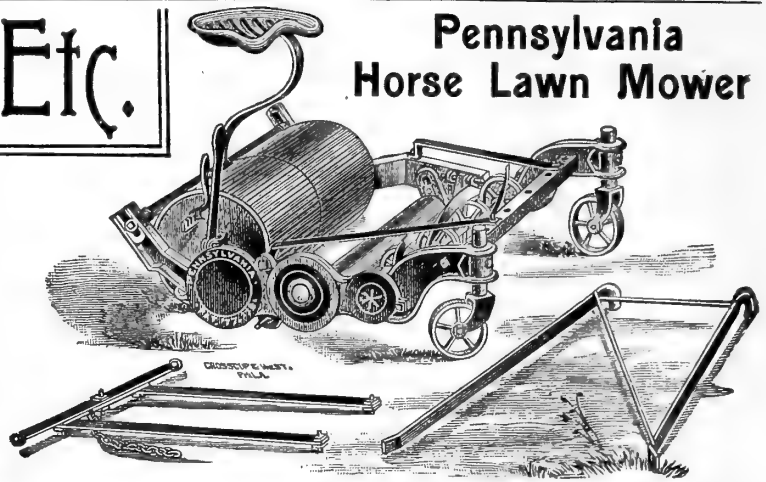

### Pennsylvania and Continental Lawn Mowers

High Wheel		Low Wheel	
15-in. cut, . . . . .	\$10.00	10-in. cut, . . . . .	\$5.25
17-in. cut, . . . . .	11.00	12-in. cut, . . . . .	6.00
19-in. cut, . . . . .	12.00	14-in. cut, . . . . .	6.75
21-in. cut, . . . . .	13.00	16-in. cut, . . . . .	7.50
		18-in. cut, . . . . .	8.25

### The "Great American" Ball-Bearing High Wheel Lawn Mowers

15-inch cut, . . . \$7.50	19-inch cut, . . . \$9.00
17-inch cut, . . . 8.25	21-inch cut, . . . 9.75

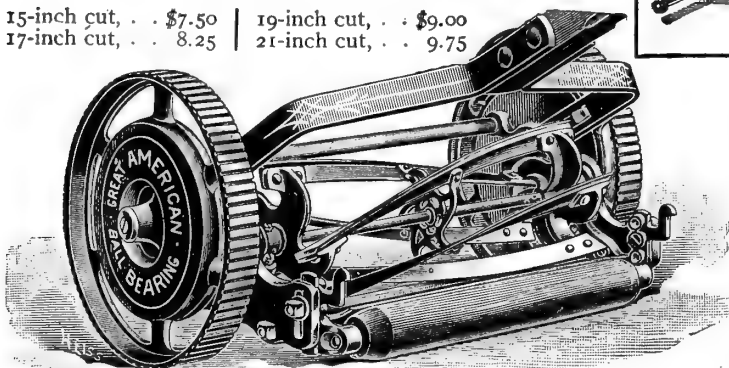

Open Cylinder with draft irons, 30 in. cut, . . . . . \$60.00  
 Seat, Shafts and Springboard for these Mowers, . \$12.00 extra  
 38 in. with Draft Irons, . . . . . 78.00  
 With Seat and Shafts, . . . . . \$12.00 extra

### Pennsylvania and Continental Pony Lawn Mower

25-inch cut, High Wheel . . . . . \$30.00

### Philadelphia Horse Lawn Mowers

30-inch cut with draft irons, \$66.00 With seat and shafts, \$79.00  
 35-inch cut with draft irons, \$79.00 With seat and shafts, \$92.50

### PHILADELPHIA LAWN MOWERS

10-inch cut . . . \$4.75	Style S,	16-inch cut . . . \$7.00
12-inch cut . . . 5.50	14-inch cut . . . \$6.25	18-inch cut . . . 7.75

### The "New Departure" Lawn Mowers

No Sharpening.—No Setting.

10-in. cut \$3.25 | 12-in. cut \$3.50 | 14-in. cut \$3.75 | 16-in. cut \$4.25

### "New Departure" High Wheel Mowers

15-inch cut . . . \$6.75 | 17-inch cut . . . \$7.25 | 19-inch cut . . . \$8.00

### Girard Low Wheel Mowers

10-in. cut \$2.50 | 12-in. cut \$2.75 | 14-in. cut \$3.00 | 16-in. cut \$3.25

### Girard New High Wheel Mowers

14-inch cut . . . \$3.75 | 16-inch cut . . . \$4.25 | 18-inch cut . . . \$4.50

### GRASS CATCHERS

MADE TO FIT THE  
 Penna., Continental,  
 Great American,  
 New Departure,  
 and Girard  
 Mowers

(Brauns)

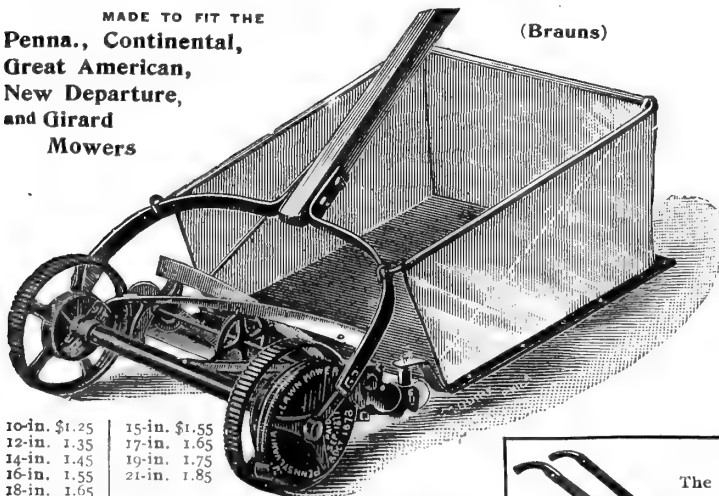

10-in. \$1.25	15-in. \$1.55
12-in. 1.35	17-in. 1.65
14-in. 1.45	19-in. 1.75
16-in. 1.55	21-in. 1.85
18-in. 1.65	

### Philadelphia Lawn Sweeper

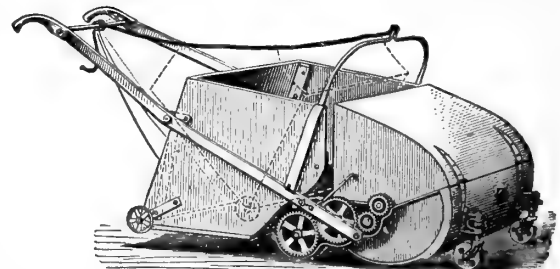

A simple machine for cleaning the lawn. A driving roller gives motion to a revolving brush placed directly in front, causing it to sweep the sod clean and throw the sweepings backward from the top of the brush into a large box in the rear of the roller. The box can be dumped without stopping. Sweeps 40 inches wide. \$70.00

### The New Champion Sod Cutter

The best and most satisfactory machine on the market. \$20.00

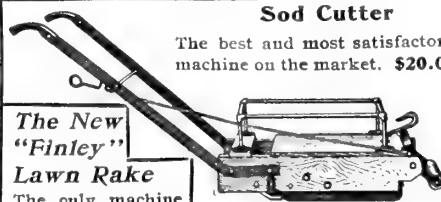

### The New "Finley" Lawn Rake

The only machine which gathers up anything and every thing on the lawn. \$12.00  
 Sweeping area, 24 inches.

EMERY for sharpening Lawn Mowers, 15c. per lb.; 5 lbs. for 60c.

LAWN MOWER FILES, 25c. each

### CHAMPION LAWN BOOTS

Extra strong. \$8.00 per set of four.

#### Lawn Boots for Horses

Made of best Quality Leather. All hand riveted. With extra Toe Piece. \$7.50 per set of four.

Lawn Mower Oil. Highest Quality. Put up expressly for us. 35c. per qt.; per half gal. 60c.; \$1.00 per gal.

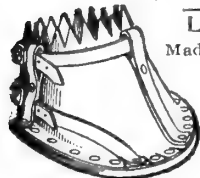

### Improved 1901 Pattern Clipper Hand Mower

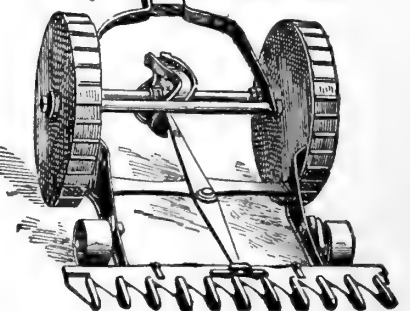

IT  
ROLLS  
UP  
HILL

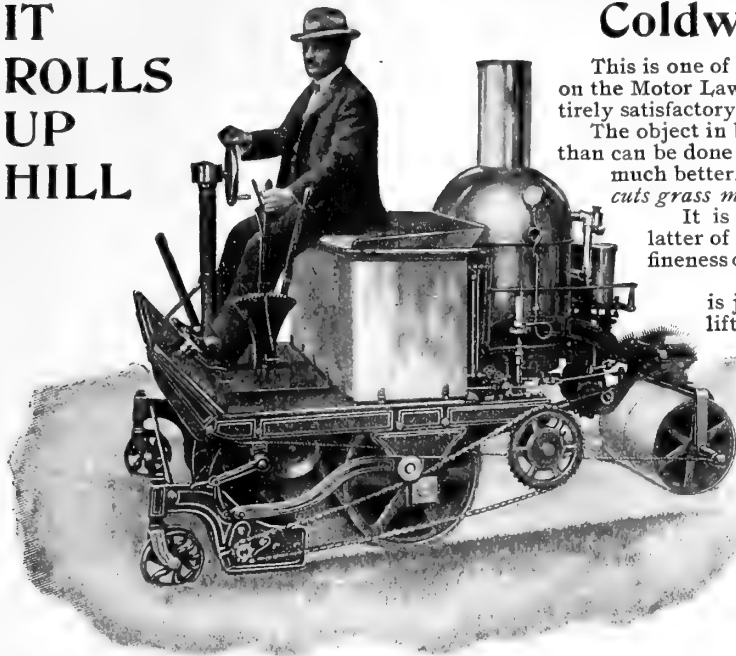

Coldwell's New Motor Lawn Mower.

### Coldwell's Motor Lawn Mower

This is one of the latest and best inventions. Experimenting and improving on the Motor Lawn Mower for a number of years has at last produced one entirely satisfactory.

The object in building this machine was not only to do the work much quicker than can be done with either Horse and Hand Mowers, but also to do the work much better. *We have no hesitation in saying that our Motor Lawn Mower cuts grass more perfectly than is possible with any other kind of machine.*

It is especially adapted for use on Parks and Golf Grounds, the latter of which it is especially recommended for, as its great weight and fineness of cut, leaves the ground in the very best condition for the game.

As a STEAM ROLLER FOR LAWNS it has no equal; its weight is just right for this work. When so used the lawn mower part is lifted by means of a lever and left suspended free from the ground.

The Motor (8-horse power), of the latest improved design, is the same as is used on an up-to-date automobile.

The machine complete and ready for operation weighs about 3,000 pounds. It cuts a swath 40 inches wide, and travels at the rate of from 250 to 500 feet per minute over any ordinary grade.

AS A PORTABLE ENGINE to be used for pumping water, sawing wood, etc., it is perfect.

Considering the amount, quality and variety of work this machine will do, we consider it the most economical machine that can be used on a large place.

We guarantee that a man can do as much cutting with this machine in a single day as can be done with two or three Horse Mowers in the same time.

PRICE, \$1500.00 NET.

CORRESPONDENCE SOLICITED.

### Buckeye Mowers

Now Largely Used on Lawns and Golf Courses

Also for ordinary field mowing generally required on a gentleman's place. Considered the finest machine of its kind; very simple and durable in construction. We can supply these mowers for one horse, with either chain or gear drive, 3½ or 4 ft. cut. Guaranteed to give satisfaction.

PRICE, \$38.00.

P. S.—We will be pleased to quote prices also on large Mowers for two horses.

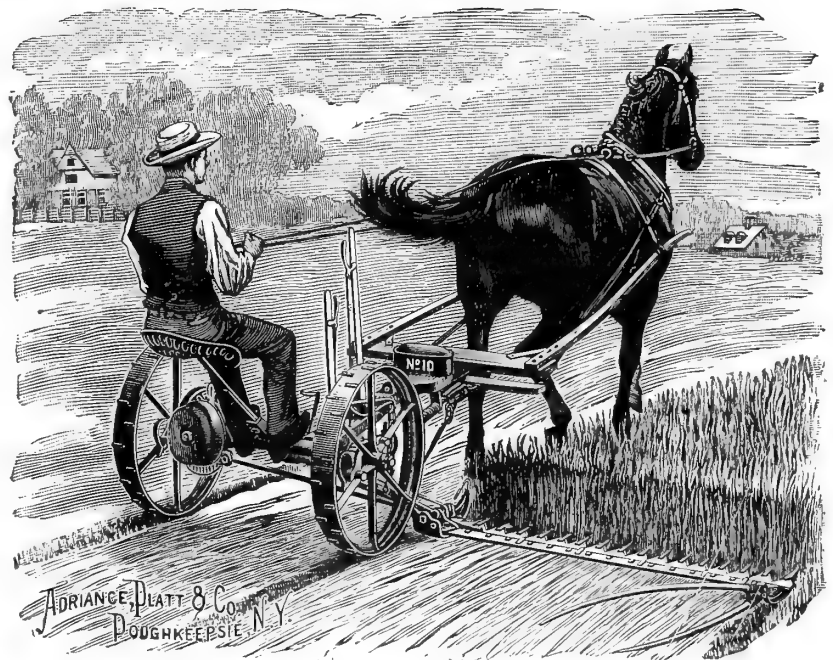

Buckeye Field Mower (One Horse).

### Finley Rotary Lawn Rake

1902 Model.

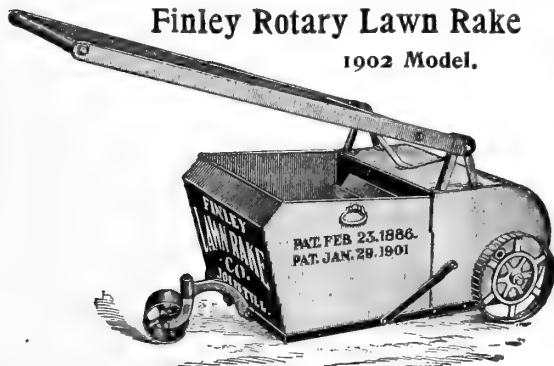

This is the very best device known for raking lawns. Takes up grass, leaves, sticks, stones and every sort of litter which will accumulate on lawns, leaving the grass like a velvet carpet. Highest testimonials from those who are using them. Sweeping area 20 inches. PRICE..... \$12.00

Just what you want for taking the Crab or Fall Grass out of your lawn.

### Testimonials on the Finley Lawn Rake

MR. MICHELL.

PHILA. COUNTRY CLUB, BALA, PA., September 30, 1901.

Dear Sir: I have had the Finley Lawn Rake thoroughly tested and find it the most useful and economical rake that I have ever used. It will do the work of four men in the same amount of time required. It is also a splendid help to the lawn, as it lifts up the grass, so that the mower can cut it more easily. It takes up sticks, stones and anything that go between the teeth and the cover.

Yours,

JNO. CRAWFORD,

Gardener to the Phila. Country Club.

HENRY F. MICHELL.

PHILADELPHIA, November 1, 1901.

Dear Sir: I purchased from you last month one of the Finley Lawn Rakes, with the understanding if not perfectly satisfactory I could return it. I find it is all you claim for it, saves fully 80 per cent. in labor, besides puts my lawn in better condition than is possible with hand rakes.

Very truly yours,

M. W. MARSDEN

## "PLANET JR." FARM AND GARDEN TOOLS

Space will not permit our showing and describing all of the "Planet Jr." tools, but we will send a fully illustrated catalogue free for the asking to any who desire it. "Planet Jr." goods are standard machines; the best; yet great improvements have been made for 1902. You can rely on getting a bottom price from us on any of the "Planet Jr." Tools.

### "PLANET JR." No. 3, Hill Dropping Seed Drill.

We all know that a seed sower that does not drop in hills is fast becoming a thing of the past. Why? Because all crops that are to be grown from seed and thinned to a regular stand should be planted in hills at just the distance apart the plants are desired; for in drilling, unless the seed is sown unnecessarily thick, there will not always be a plant at the proper spot, and the crop is therefore irregular. This means that a seed sower should drop in hills, and at various distances. The new No. 3 "Planet Jr." drops at 4, 6, 8, 12 and 24 inches apart, and also in a continuous row, without injury to the seed and can be changed from hill to drill instantly, or from one distance to another very quickly. The index is at the top of the handle, with hair breadth adjustment and instantaneous cut-off.



Sow  
Either in  
Hills or  
in Con-  
tinuous  
Rows.

Price  
\$10.00

### "PLANET JR." No. 4 Combined Hill Dropping Seeder and Single Wheel Hoe.

This is exactly the same style of seeder as No. 3 "Planet Jr." Hill Dropper. It is smaller in capacity, though still of good size, holding two quarts. It drops in hills at 4, 6, 8, 12 and 24 inches apart and in drills any thickness, handling the smallest paper of seed perfectly, and is simple, durable and very light running. Throws out of gear instantly by simply raising the handles. The drill is detached and the tool frame substituted by moving but one bolt. It then becomes one of the most admirable Single Wheel Hoes of the "Planet Jr." family.

Price complete \$10.00.

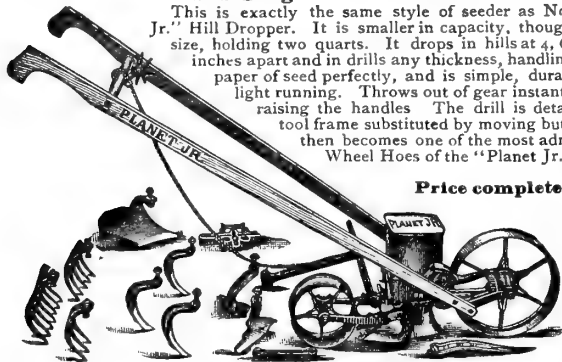

As a  
Drill only  
\$8.00

### "PLANET JR." No. 11 Double Wheel Hoe, Cultivator, Rake and Plow

This tool combines in itself the good points of its predecessors, with valuable new ideas. It has 11-inch wheels which can be set at four different distances apart; the frame is malleable, with ample room for tool adjustment, and can be set at three different heights. The handles are adjustable, and being attached to the arch, are entirely undisturbed in making changes of the height of frame, width of wheels or in the adjustment of the tools themselves. The arch is of stiff steel unusually high. The design of the frame is novel, allowing all changes of tools to be made without removal of the nuts from the standards. A pair of model rakes and a pair of new style hoes are added to the usual equipment—seven pairs of tools in all. The variety of the work possible with this machine is incredible, covering the whole range of wheel hoe work, both in the garden and on the farm, and has our unqualified endorsement.

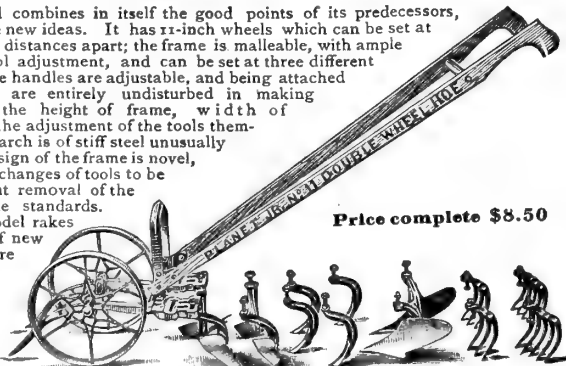

Price complete \$8.50

### "PLANET JR." No. 12 Double Wheel Hoe.

This tool is identical with No. 11 except that it has a less complete equipment, as shown in the cut, but at a correspondingly less price. The set of tools with No. 12 is what gardeners need most.

Price \$6.50



### The "PLANET JR." No. 13 Double Wheel Hoe

This tool is the No. 11 with 6-inch hoes only, this pair of tools being most generally useful at all seasons. Any or all of the No. 11 tools may be added at any time, and are sure to fit. Price \$4.50.

### "PLANET JR." No. 25 Combined Drill and Double Wheel Hoe

This new combined machine is intended for those who have a large enough acreage to use a Double Wheel Hoe to advantage, and yet prefer not to buy a separate machine. It holds 2½ quarts, and has 11¼ inch wheels, which are just the right size. As a drill it is almost identical with the No. 4, and as a wheel hoe, is identical with the "Planet Jr." No. 12 Double Wheel Hoe. The change from drill to double wheel hoe takes but a moment, and the entire combination is one we can heartily recommend and guarantee satisfactory.

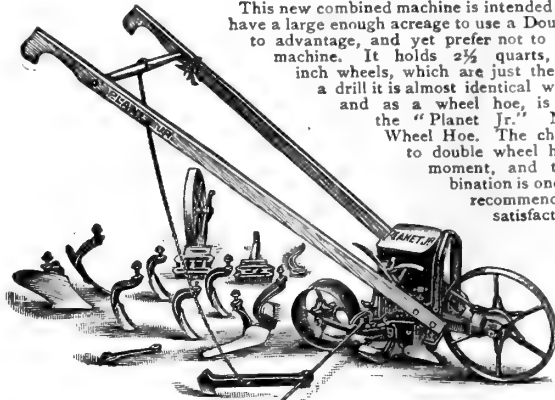

Price  
\$13.00

### "PLANET JR." No. 17 Single Wheel Hoe, Cultivator, Rake and Plow

This latest and best Single Wheel Hoe has an 11-inch wheel with broad face, and a conveniently arranged and very valuable set of tools. It is very light, strong and easy running. Has adjustable handles and frame, and is the most perfect wheel hoe for market gardeners and private places. Frame changes in height; and the wheels to the other side of the frame, to allow of hoeing both sides of the row at one passage.



Price  
\$4.75

### The "PLANET JR." No. 18 Single Wheel Hoe.

With the same frame and handles as No. 17, it has one pair of 6-inch hoes only, but they are the most constantly useful through the season of all the list. The remainder you buy as wanted Price \$3.25.

### The "FIRE-FLY" PLOW.

This tool is invaluable for those having small gardens. The mould-board is tempered and polished steel. The depth may be changed very quickly. Price \$2.25

### "PLANET JR." Harrow and Cultivator.

Price, Plain \$5.00 with Wheel, \$6.00 Complete, \$7.50.

This tool has rapidly grown into favor with farmers, market gardeners and strawberry growers. It has a high frame and the chisel-shaped teeth cut an inch wide each. The foot lever pulverizer is a capital addition for preparing ground for the seed drill or for plant setting, and controls the depth of the rear teeth. Hand levers regulate both width and depth while in motion; it contracts to 12 inches and expands to 32 inches. It cultivates deep without throwing dirt upon the plants, and the smooth round-throated teeth turn strawberry runners without injuring them. For cutting strawberry runners we make a special attachment, consisting of a ten-inch flat steel disc mounted on an outrigger. Strawberry Runner Cutter Attachment extra \$1.60.

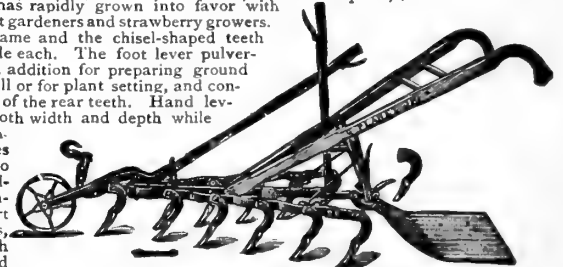

### "PLANET JR." No. 8 Horse Hoe.

Price as in cut \$7.50.

Without Depth Regulator \$7.00.

No. 4 Horse Hoe, complete \$5.50.

No. 9 Horse Hoe, complete \$6.50.

Probably no other cultivating machine is so widely known as the "Planet Jr." Combined Horse Hoe and Cultivator. It is so strongly built as to withstand incredible strain, yet it is light and easy to handle.

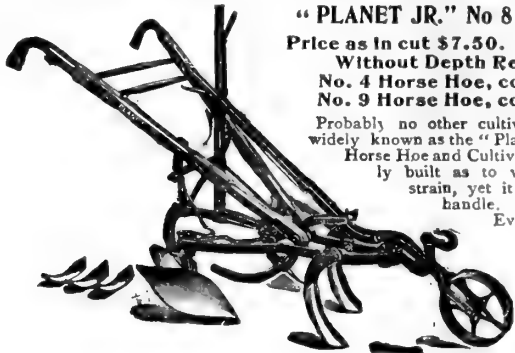

Every part is perfected to make the tool comprehensive to the intelligent farmer, who knows the best is always the cheapest.

**"IRON AGE" GARDEN AND FARM IMPLEMENTS.**

Below we illustrate a few of the leading "IRON AGE" Farm and Garden Implements for 1902. To all of our readers desiring a full description of the Tools named below, we send free upon application a copy of the "Iron Age" Catalogue.

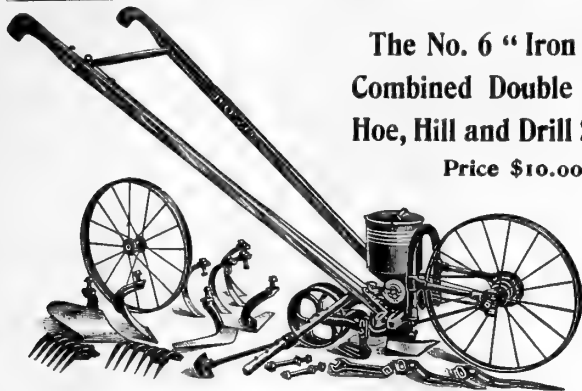

The No. 6 "Iron Age"  
Combined Double Wheel  
Hoe, Hill and Drill Seeder.  
Price \$10.00

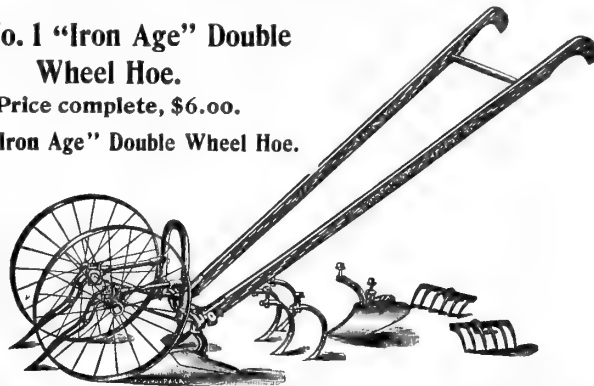

The No. 1 "Iron Age" Double  
Wheel Hoe.  
Price complete, \$6.00.  
No. 3 "Iron Age" Double Wheel Hoe.

Side  
Hoes  
Only,  
\$3.50.

No. 12 "Iron Age" Wheel Plow  
and Cultivator.

Price \$3.00.



No. 11  
"Iron Age"  
Wheel Plow.  
\$2.00.

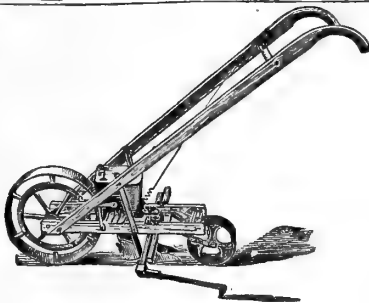

"New Model"  
Seed Drill.

Price \$6.50.

The No. 8 "Iron Age" Hill and  
Drill Seeder.

Price  
\$9.00.



No. 9 "Iron Age" Single Wheel Hoe.

Price complete,  
\$4.50.



No. 10,  
Side  
Hoes  
Only,  
\$2.75.

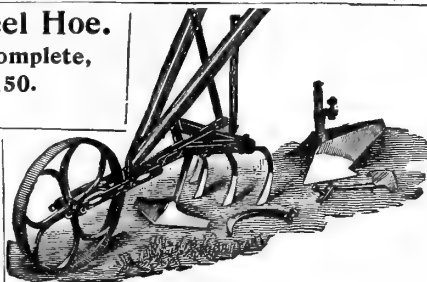

"Gem of the  
Garden" Single  
Wheel Hoe.  
Price complete \$3.75  
Gem Double  
Wheel Hoe.  
Price complete \$4.50

The No. 4 "Iron Age" Combined Double  
Wheel Hoe and Seed Drill.

Price  
complete,  
\$9.00.



No. 1 "IRON AGE" Combined Harrow and Cultivator



Price as in cut  
\$4.75  
Without wheel  
\$4.25  
Plain without  
wheel and  
lever,  
\$3.75

The No. 6 "Iron Age"  
Horse Hoe.

Price \$7.25 as in cut.  
Without Furrow Closing At-  
tachment,  
\$6.00.





# WATERING APPLIANCES, HOSE, ETC.

## SYRINGES.

Length of Barrel,  $13\frac{1}{2}$  in.; diam.,  $1\frac{1}{8}$  in.



### Deakin's Brass Garden Syringes.

No. A.	1 stream and spray hose, 12 x 1 inches	.....	\$2.00
No. B.	1 " " " " " " " " " " " "	.....	2.75
No. C.	1 " " " " " " " " " " " "	.....	3.25
No. 2.	1 " " " " 2 roses, $13\frac{1}{2}$ x $1\frac{1}{8}$ "	.....	4.00
No. 5.	1 " " " " " " " " " " " "	.....	6.00
No. H.	18 inches long, $1\frac{1}{2}$ inches in diameter (with movable spray)	.....	\$2.30

## A. & W. HOSE BAND.



No special tools required. Engage the lever in the farthest notch it can reach, press down lever, then hammer down ears and the lever is locked. The lever cannot slip. Each 5c.; per doz. 45c.

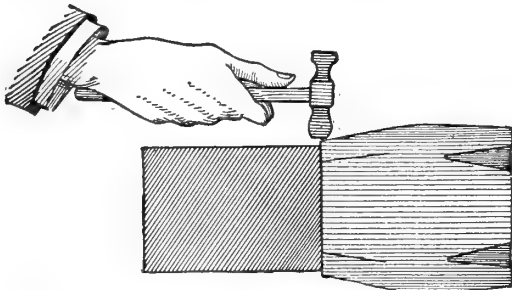

## New Standard Hose Mender.

5c. each. 50c. per doz.

### HUDSON'S HOSE MENDERS.

Complete outfit of Six Menders with Pliers, 65c.; by mail, 75c.

COOPER'S HOSE MENDERS (All Brass)  
10c. each; \$1.00 per doz.

### HOSE MENDERS (Woodason's, Iron).

$\frac{3}{8}$  inch 5c. each, doz. 45c.;  $\frac{1}{2}$  inch, each 5c., doz. 50c.; 1 inch, each 8c., doz. 75c.



## THE "PERFECT SUCCESS"

### Combination Spray Pump.

For Spraying Trees, Plants, &c., &c.

There is no better and more complete outfit for so little money. The "Perfect Success" Pump includes "Bordeaux" Nozzle. Price complete \$5.00.

### SUCCESS SPRAY PUMP.

Similar to the "Perfect Success", but without bucket fastener attachment, \$4.00. Extra 7 foot section of hose suitable for either the Success or Perfect Success Pump, \$1.25.

### GEM HOSE NOZZLES.

For throwing fine or coarse spray, or straight stream. Each 35c.



## Deming's Barrel Spray Pump.

Fig. 550, Pump only \$6.50

Outfit A.—Pump as above with  $12\frac{1}{2}$  feet of  $\frac{1}{2}$  inch hose, Bordeaux nozzle and pole connection. \$8.75

Outfit B.—Pump as above with two  $12\frac{1}{2}$  foot sections of  $\frac{1}{2}$  inch hose, Bordeaux nozzles and pole connection. \$11.00.

Fig. 550.

$1\frac{1}{2}$ inch tire, truck, barrel and pump complete,	\$16.50
$2\frac{1}{2}$ " " " " " " " " " " " "	17.25
$3\frac{1}{2}$ " " " " " " " " " " " "	18.25



Fig. 651.

## "THE GARDENER'S CHOICE"

$\frac{1}{2}$  Barrel, Cart and Pump complete. \$12.00 complete.



## THE NEW AUTO SPRAY

(Com. Air)

This is the very best Compressed Air Sprayer now on the market. Will not get out of order. Can be suspended from the shoulder thus allowing the free use of both arms.

Copper, . . . . . \$6.00

Galvanized Iron . . . . . 4.50

### EXTRA EXTENSION PIPES

Two feet long, to reach trees, 25c. each.

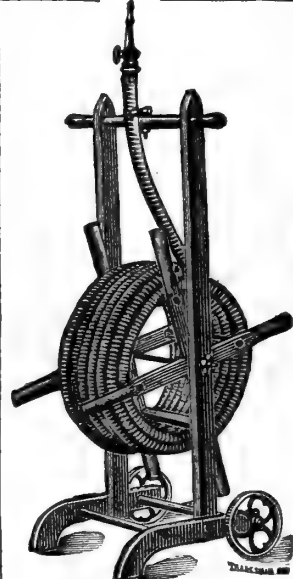

## Rubber Hose.

Red Cross Brand.  $\frac{3}{4}$  in. 7 $\frac{1}{2}$ c. per foot.  
Standard Brand.  $\frac{3}{4}$  in. 11c. per foot.  
Extra Standard Brand.  $\frac{3}{4}$  in., 3-ply. 12 $\frac{1}{2}$ c. per foot. With our guarantee.  
Extra Standard Brand.  $\frac{3}{4}$  in., 4-ply. 15c. per foot. With our guarantee.  
Chicago Electric (New). 16c. per foot.  
"Bull Dog." Extra heavy. 16c. per ft.  
Wire Wrapped (Sphincter).  $\frac{3}{4}$  in. 17c. per foot.



### Boston Spray Nozzle

Made of copper. Fine or coarse spray. 50c. each.



### Fig. 963. Vermorel Nozzle

75c. each.

## The Improved "Bordeaux" Spray Nozzle.

The "Bordeaux" Nozzle is the simplest and best combination spraying nozzle on the market. It throws solid stream or a fan-shaped spray adjustable to any fineness. It will also throw a long distance coarser spray for spraying very large trees; features possessed by no other spray nozzle. It can be used with any spray pumps. Furnished with  $\frac{1}{2}$  and  $\frac{3}{4}$  inch hose connection. Price  $\frac{1}{2}$  inch pipe and  $\frac{1}{2}$  inch hose, as per cut 75c.



### Water-Tight Hose Coupler.

Instantaneous in operation. Simplicity itself. Can be operated by a child. No screws to get out of order. Nothing to get damaged or broken. Per pair 55c.; per doz. pairs \$2.50.



### ACME HOSE CROOK AND SWIVEL JOINT.

Saves the hose and doubles its life. Attached to ground pipe or spigot. Bending of the hose is avoided. Hose does not wear out from the friction of the water, but from the constant bending and twisting to which it is subjected. The use of the crook removes the greatest cause of wear. Each 50c.; per doz. \$5.00.

**"BOSS" ROLLERS**



**WROUGHT STEEL GARDEN and LAWN ROLLERS**

Made of the best wrought steel, and filled with concrete to give additional weight.  
 10 in. diameter, 13 in. long, weight about 130 lbs., about \$7.50.  
 12 in. diameter, 18 in. long, weight about 200 lbs., about \$9.00.  
 14 in. diameter, 21 in. long, weight about 300 lbs., about \$10.75.

Also, a full line of larger sizes.

**CHAMPION STEEL LAWN and FIELD ROLLERS**

These rollers are made of the best wrought steel and filled with concrete to give them additional weight, and are preferable to cast iron, as they are not so liable to break.  
 24 in. diameter, 30 in. long, weight about 450 lbs., about \$40.00.  
 24 in. diameter, 36 in. long, weight about 550 lbs., about \$55.00.

Special prices quoted on application for larger sizes.

**HAND ROLLERS "BOSS"**

No. 1.	15 in. diameter,	15 in. long,	in 2 sections;	7½ in. face;	150 lbs.	Price \$6.50
No. 2.	15 in.	22 in.	in 3	7½ in.	200 lbs.	8.10
No. 3.	20 in.	16 in.	in 2	8 in.	225 lbs.	9.25
No. 4.	20 in.	20 in.	in 2	8 in.	250 lbs.	10.25
No. 6.	20 in.	24 in.	in 3	8 in.	300 lbs.	12.50

**"BOSS" ROAD AND GOLF GROUND ROLLERS**

No. 25.	36 in. diameter,	4 ft. long,	in 4 sections;	12 in. face;	2500 lbs.	Price \$ 93.75
No. 26.	36 in.	5 ft.	in 5	12 in.	3000 lbs.	112.50

**"BOSS" HORSE LAND ROLLERS** Note these low prices  
 With either Pole or Shafts. In ordering state which you want.

No. 14.	20 in. diameter,	4 ft. long,	in 4 sections;	12 in. face;	850 lbs.	Price \$33.75
No. 15.	20 in.	5 ft.	in 5	12 in.	1000 lbs.	37.50
No. 16.	24 in.	4 ft.	in 4	12 in.	1100 lbs.	41.25
No. 17.	24 in.	5 ft.	in 5	12 in.	1250 lbs.	45.00
No. 18.	24 in.	6 ft.	in 6	12 in.	1400 lbs.	52.50
No. 19.	28 in.	4 ft.	in 4	12 in.	1150 lbs.	45.00
No. 20.	28 in.	5 ft.	in 5	12 in.	1400 lbs.	52.50
No. 21.	28 in.	6 ft.	in 6	12 in.	1600 lbs.	60.00
No. 22.	30 in.	4 ft.	in 4	12 in.	1300 lbs.	48.75
No. 23.	30 in.	5 ft.	in 5	12 in.	1500 lbs.	56.25
No. 24.	30 in.	6 ft.	in 6	12 in.	1700 lbs.	63.75

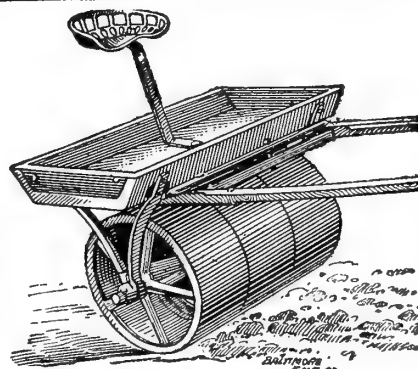

**Horse, Road and Golf Ground Rollers**



**LEAF RACK**

Light and durable. Can be easily folded and detached, and the truck used with water barrel.

1½ in. wheel	.....	\$ 9.75
2½ " "	.....	10.50
3½ " "	.....	11.25
Leaf Rack only	.....	4.25

**Sieves**

For sieving sand, soil, etc. 20 in. 65c.; 18 in. 55c.; 16 in. 45c.

**Cider Mills**

Buckeye Junior	. \$12.00
Buckeye Medium	16.00
Buckeye Senior	20.00

**Berry Presses**

No. 1	.....	\$3.75
No. 2	.....	4.50
No. 2½	.....	5.75
No. 3	.....	6.25

**Water Truck and Barrel**

Barrel can be detached from truck without difficulty, or tilted to empty contents. Other barrel leaf rack and box can be used.  
 1½ in. wheels.....\$8.00  
 2½ " " ..... 8.50  
 3½ " " ..... 9.25  
 Large box to fit on truck, extra..... 2.75  
 Leaf rack attac'm't to the water truck 4.25  
 Sprinkling attachment..... 3.50  
 Extra barrels with trunnions..... 2.50

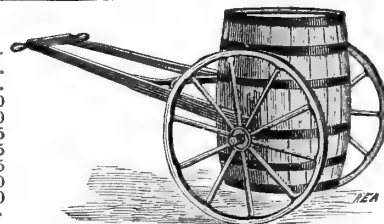

**WOTHERSPOON'S MAKE.**

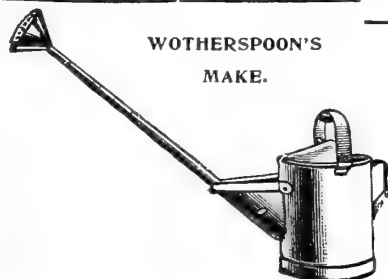

**GALVANIZED WATER POTS**

The best and most durable watering pot made. Each has two roses—one fine and one coarse.

4 quart round,	\$1 60	Oval,	\$
6 " "	1.85	"	2.10
8 " "	2.00	"	2.35
10 " "	2.25	"	2.60
12 " "	2.60	"	2.85
16 " "	3.15	"	

**Galvanized Iron Clad Watering Cans**  
 The best cheap watering can in the market. Very durable. Sizes 4 to 20 qts., 35c. to \$1.50 each.

**Rubber Aprons**

Will protect your clothes while watering and doing greenhouse work. \$1.50 each.

**MISCELLANEOUS MATERIALS.**

**..SOUTH BEND..**

Considered to be the best all-around plow on the market.  
 No. 1, one horse ..... \$5.50  
 No. 2, one horse ..... 7.50  
 No. 3, two horse with jointer and wheel ..... 11.00

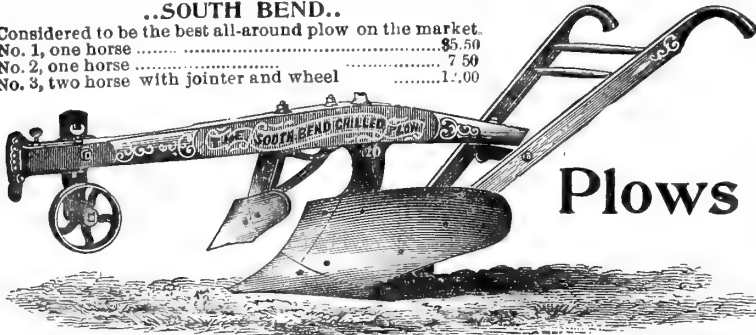

**Plows**

Gale Plow, No. 25, one horse.....\$5.50 | Subsoil Plow (Ames'), No. 0 ..... \$8.00  
 Gale Plow, No. 20A, two horses.....12.00 | Farmers' Friend (small size) ..... 3.50  
 No. 2 Syracuse Steel Beam 2-Horse Plow. \$14.00.  
 Syracuse 1-Horse Plow. With reversible Mould Board \$6.50.

**WHEEL BARROW SEED SOWERS**

Especially made for sowing Grass and field Seeds;  
 13½ feet wide. \$6.50 each.

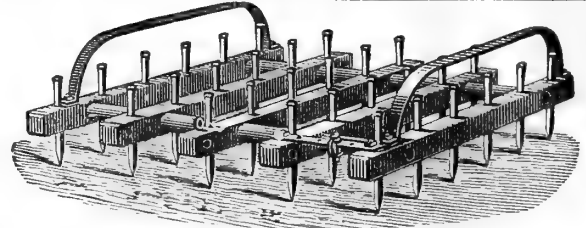

**EVANS HARROWS** 24 Teeth \$5. 50; 30 Teeth \$6.50.

**SOIL OR SAND SIEVES**

We can supply any size mesh, from No. 1 to 30. Made extra strong. 20 in. 65c.; 18 in. 55c.; 16 in. 45c.

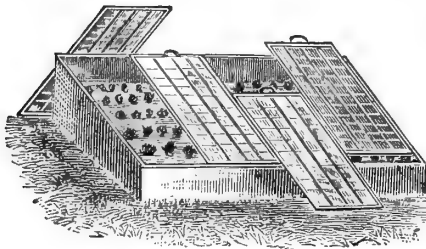

**HOT BED SASH.**

3 ft. 2 in. x 6 ft.  
 Unglazed, \$1.15 each.

Special price will be quoted on quantities, also on glazed and painted complete sash.



**PLANT BED CLOTH.**

A Substitute for Glass Sash on Hot-beds and Cold Frames.

**LIGHT GRADE.** Mostly used for shading greenhouses. Per yard, 4c.; by the piece of 68 yards, 3½c. yard.

**MEDIUM GRADE.** The best for general purposes. Yard, 8c.; by the piece of 50 yards, 7c. yard.

**HEAVY GRADE.** Water-proof and advised for States north of Pennsylvania. Per yard, 10½c., by the piece of 40 yards, 10c. per yard.

**Putty Bulbs.**

Used for Applying Putty when Glazing.  
 90c. each.

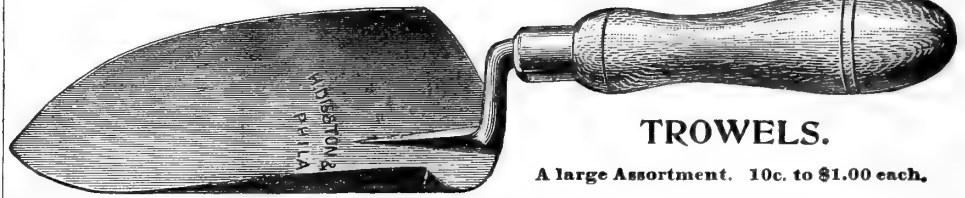

**TROWELS.**

A large Assortment. 10c. to \$1.00 each.



**Seed Sower.**

**CAHOON'S BROADCAST SEED SOWER.**

The most practical and satisfactory machine for accurately sowing Timothy, Clover and other similar seeds. Price \$3.50 each.

**VAN REYPER'S PERFECT GLAZING POINTS.**

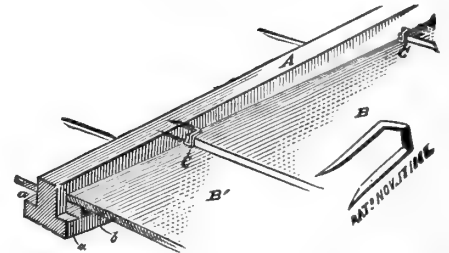

These are made of steel wire and galvanized, having double points and lap over the glass in such a manner as to positively keep it from sliding. They

Per box of 1000 60c.; 5000 lots at 55c. per 1000.  
 Pincers for driving, 50c.

**VAN REYPER'S POINTS.** Made of Brass \$1.00 per 1000.

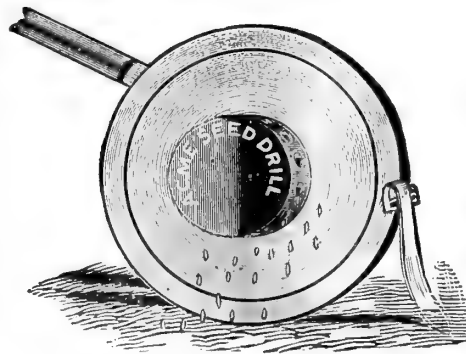

**The "ACME" Seed Drill.**

The cheapest seed drill on the market. Does the work very correctly and saves time and labor.  
 75c. each.

**ZEMENTINE.** Better than whitewash for shading glass. More durable. 15c. per 2 lb. package.

½ barrels, containing about 150 lbs., 7c. per lb.  
 Full barrels, containing about 300 lbs., 6c. per lb.



**Mastica**

**FOR GLAZING GREENHOUSES**

(New or Old).

Machine for applying Mastica.

Used now extensively, and highly recommended by all the up-to-date gardeners and florists.

One gallon will cover about 300 running feet.

Per gal. \$1.25; half gal. 65c.; 5 gals. \$3.75.

Machines for applying Mastica, \$1.25 each.

**TWENLOW'S ENGLISH GREENHOUSE**

**PUTTY.** Used for glazing. Highly recommended. 16 lb. can \$1.25; \$3.75 for 50 lb. kit; 80 lb. kit for \$6.00.

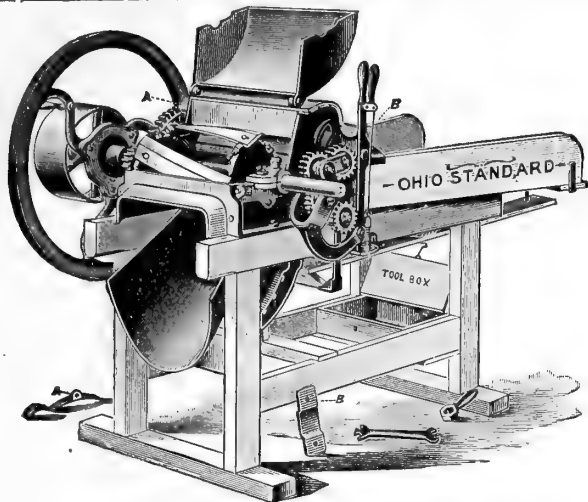

**OHIO HAY AND FEED CUTTER**

This is considered the finest machine in the market for cutting hay ensilage, etc. We can furnish it with single and double knife. Single knife, price, \$12.50; double knife, \$16.50.

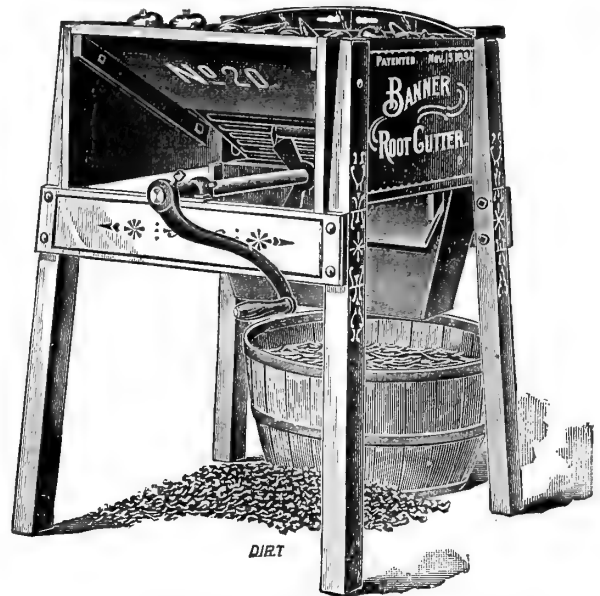

**ROOT CUTTERS**

No. 16 Banner. Price, \$12.00. No. 20 Banner. Price, \$8.50. No. 7 Banner Junior. Price, \$5.00. Ames. Price, \$12.00.



**FORKS**

Manure and Digging. A large assortment. 60c. to \$1.35 each.

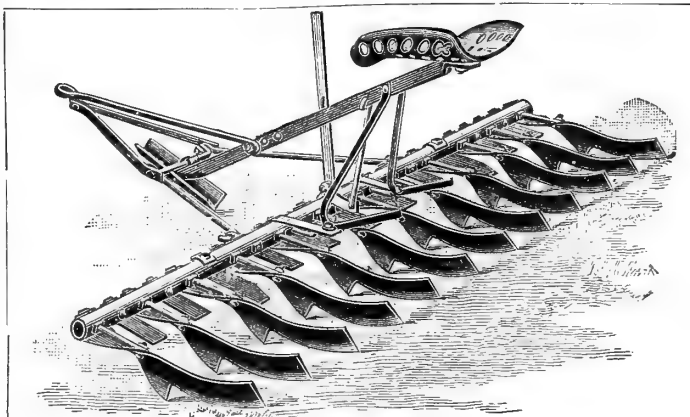

**Acme Harrow**

The most satisfactory implement for properly crushing and pulverizing the soil, covering area 5 1/2 feet. All steel. Price, \$16.00.

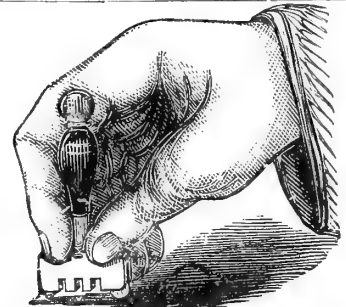

**GLASS CUTTERS**

Steel Wheel. 15c. each. Genuine Diamond, with Ebony Handle. Price, \$2.50 each.

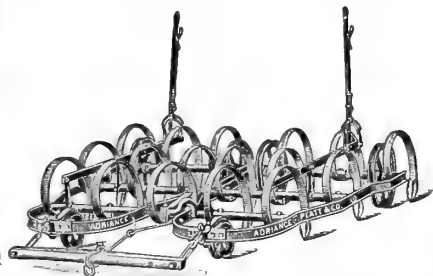

**SPRING TOOTH HARROW**

Adriance Spring Tooth Harrow. Can be raised and lowered at will; runs on wheels. Price, \$16.00.

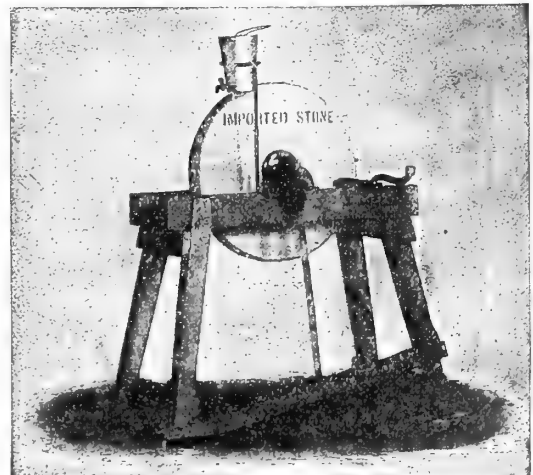

**GRINDSTONES**

Cleveland No. 2. Price, \$4.00. Cleveland No. 3. Price, \$3.50. Bi-Treadle, with seat. Price, \$5.00.

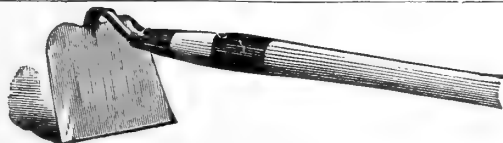

**HOES**

1/2 Moon and Square for field and garden use. 35c. to 75c. each.



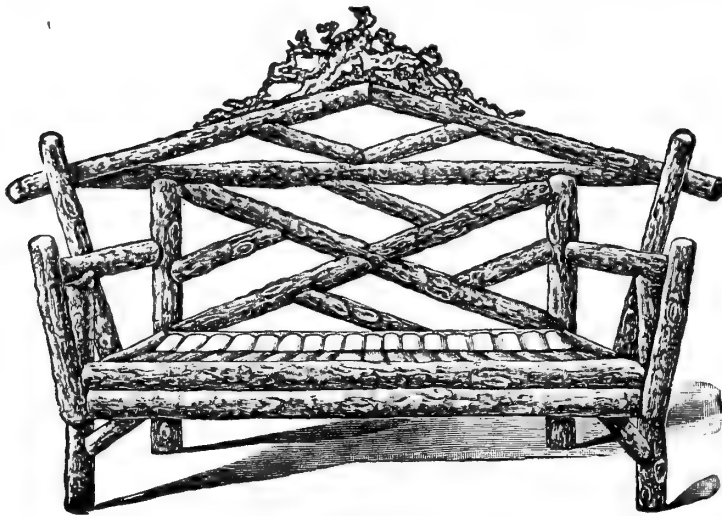

Rustic Settee  
Rustic Work

A full assortment of Settees, Chairs, Bird Houses, Baskets, etc.

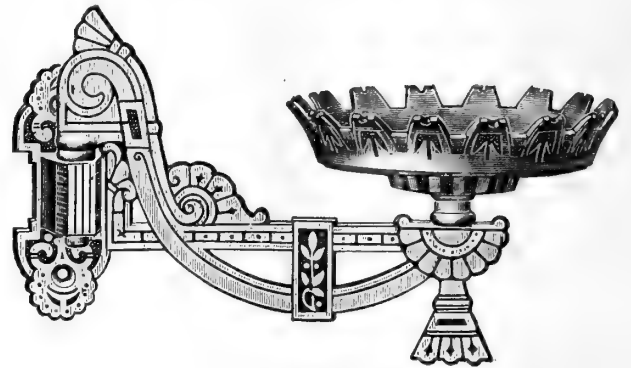

Pot Brackets

Small size, for single Pot, 25c and 50c. each.  
Large " " 50c. each.  
Large size, to hold 2 Pots, 75c. each.

LAWN SPRINKLERS, HOSE REELS, ETC.

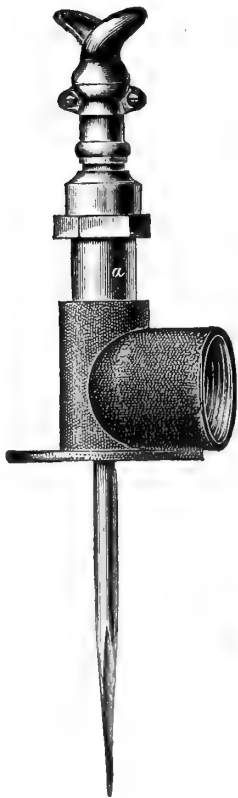

Waterwitch Lawn Sprinkler

65c. each.

A large selection of Lawn Sprinklers 25c. to \$5.00 each.

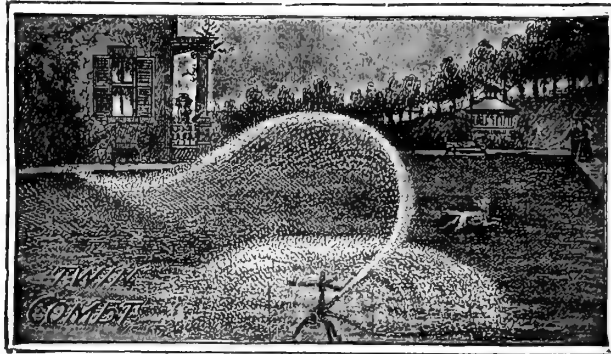

Twin Comet Lawn Sprinklers

Wills sprinkle an area four times greater than any other sprinkler made. Endorsed and adopted by Mr. Wm. Doogue, Superintendent of the Public Grounds, of Boston, and in hundreds of other places. \$5.00 each.

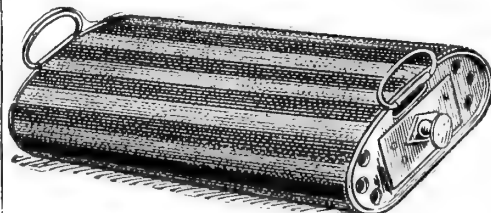

Lehman's Carriage and Wagon Heaters

Over 150,000 now in use; pronounced the best made.

No. 5, with one compartment, \$2.75 each.  
No. 3, with three compartments, \$7.25.

Tongs for handling the hot coal 25c. each.

Coal for burning 85c. per doz. bricks; per 100 \$6.50.

Illustrated Catalogue and Price List of these heaters free.

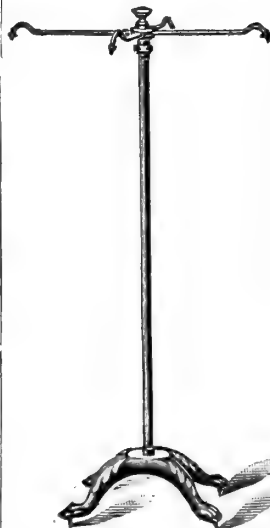

Peck Lawn Sprinkler

4-arm \$3.00 each.  
8-arm \$3.75 each.



Rustic Baskets (1.00 to 2.00 each)

Wire Hanging Baskets

8 in. 15c.; 10 in. 20c.; 12 in. 25c.; 14 in. 30c. each.

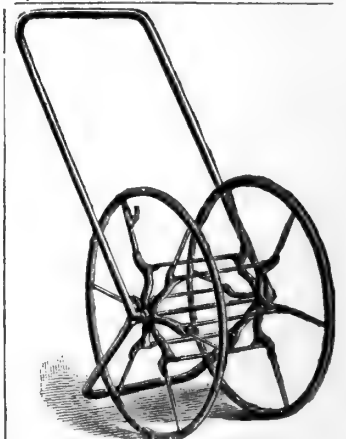

Wirt's Hose Reel (All-Iron)

No. 10, holds 100 ft. hose, \$2.75  
" 20, " 150 " 3.00  
" 30, " 300 " 5.00  
Duke Hose Reel (Wood), holds 75 feet hose, 75c. each.  
Sylph Hose Reel (Wood), holds 150 ft. hose, \$2.25 each.

**PLANT STAKES, STANDS, LABELS, ETC.**

**PAINTED STAKES**

1 1/2 ft., painted green.....	Doz. \$0.15	100 \$0.00	3 ft. heavy or dahlia.....	Doz. \$0.67	100 \$4.30
2 " " " " " " " " " "	.25	1.55	3 1/2 " " " " " " " " " "	.78	5.00
2 1/2 " " " " " " " " " "	.38	2.35	4 " " " " " " " " " "	.88	5.70
3 " " " " " " " " " "	.46	2.95	5 " " " " " " " " " "	1.10	7.10
3 1/2 " " " " " " " " " "	.58	3.70	6 " " " " " " " " " "	1.30	8.50
4 " " " " " " " " " "	.67	4.30			
5 " " " " " " " " " "	.80	5.50			

**HYACINTH STAKES. (Wood.)**

12 in., per 100 20c., per 1000 \$1.25; 18 in., per 100 30c., per 1000 \$1.75.

**GALVANIZED STEEL PLANT STAKES.**

	100	1000		100	1000
2 feet long.....	\$0.65	\$5.25	4 feet long.....	\$1.50	\$11.75
2 1/2 " " " " " " " " " "	.80	6.25	4 1/2 " " " " " " " " " "	1.65	13.00
3 " " " " " " " " " "	1.00	8.00	5 " " " " " " " " " "	1.75	14.00
3 1/2 " " " " " " " " " "	1.25	10.00	6 " " " " " " " " " "	2.00	16.00

**UNPAINTED STAKES OR DOWELS.**

36 inches long, 1/4 inch diameter.....	100 \$0.55	1000 \$4.75
42 " " " " " " " " " "	.65	5.00
42 " " " " " " " " " "	.75	6.00
42 " " " " " " " " " "	1.00	7.50

**BAMBOO OR CANE STAKES**

Always on hand.

\$1.00 per 100; 250 for \$2.00; \$6.00 per 1000.

**GALVANIZED WIRE IN ROLLS.**

No. 16, 18, 19, 20, 22, 24, 10c., 12c., 13c., 14c., per lb.; 85c., 95c., \$1.05, \$1.15, \$1.25, \$1.35 per stone of 12 lbs

**The New "Superior" Iron Plant Stands**

**T**HIS is the very best and only stand that fills a *long felt want*. You can tilt and set your plants at any angle desired to produce the proper decorative effect. (For Azaleas and similar style plants it is especially invaluable). They are neat, durable, very strong, and suitable for either parlor, store, hall, conservatory or greenhouse. They are also desirable for elevating plants above others to save space.

Height	Size of Plates	Price	Height	Size of Plates	Price	Height	Size of Plates	Price
12 inch.....	5x7	\$0.85	30 inch.....	8x10 1/2	\$1.35	42 inch.....	8x12	\$1.75
18 " " " " " " " " " "	5x7	.95	30 " " " " " " " " " "	8x12	1.45	48 " " " " " " " " " "	8x12	1.85
18 " " " " " " " " " "	8x10 1/2	1.05	36 " " " " " " " " " "	8x10 1/2	1.55	60 " " " " " " " " " "	8x12	1.95
24 " " " " " " " " " "	8x10 1/2	1.15	36 " " " " " " " " " "	8x12	1.65	72 " " " " " " " " " "	8x12	2.05
24 " " " " " " " " " "	8x12	1.25	42 " " " " " " " " " "	8x10 1/2	1.65			

When ordering please state size of plates and height wanted,



The New "Superior" Iron Plant Stand showing an Azalea in TILTING position.

**"Star" Iron Plant Stands**

12 inch.....	\$0.70 each	30 inch.....	\$1.15 each
18 inch.....	.80 each	36 inch.....	1.40 each
24 inch.....	.95 each	42 inch.....	1.55 each

**Tying Materials**

**Green Silkaline.** The best material for tying; does not fade; is very strong and durable.

20c. per spool, \$1.50 per lb.

**Raffia.** For tying. 20c. per lb.

**String.** For tying. All sizes. 5c. to 20c. per ball; 15c. to 35c. per lb.

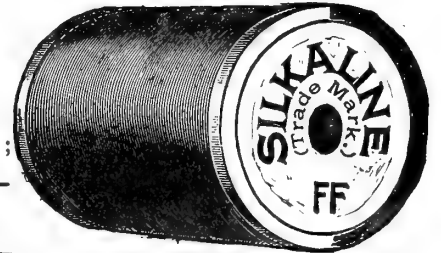

**Cut Flower Boxes**

(Wooden and Paper.) A large assortment.

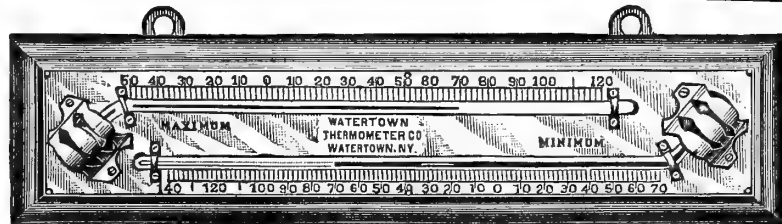

**Mushroom or Hotbed Thermometers**  
BRASS TIP

\$1.50 each.

**THERMOMETERS**

Each	Per doz	Each	Per doz
Guaranteed Tested, 8 inch	\$0.50 \$5.00	Tin Case, Standard, 8 inch	\$0.20 \$2.00
" " " " 10 "	.65 6.50	" " " " 10 "	.25 2.50
" " " " 12 "	.75 7.50	" " " " 12 "	.30 3.00

**Maximum and Minimum Thermometers** Registering the Coldest and Warmest Temperature. Each, \$2.50 and \$3.00

**PAINTED POT LABELS**

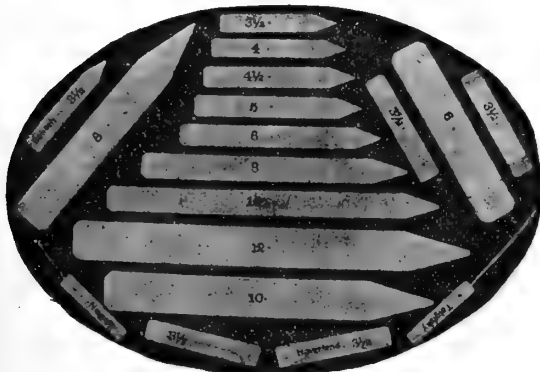

3 1/2 inch	100 \$0.10	1000 \$0.75
4 " "	.12	.85
4 1/2 " "	.15	1.00
5 " "	.20	1.10
6 " "	.25	1.25
8 " "	.35	2.50
10 " "	.50	4.00
12 " "	.75	5.25

**Painted Tree Labels**

3 1/2 in. notched, per 100 15c.; per 1000 \$1.00. **Copper Wired**, \$1.25 per 1000.

**Indelible Marking Pencil**  
10c. each.

**Indestructible Copper Labels.** Made of copper, thin and pliable; can be written on with a pencil, which indents the copper, leaving a permanent impression. Per doz. 20c.; \$1.00 per 100

**Dodge's Everlasting Glass Labels.** Will never wear out. Sample mailed free on application. 50c per doz.; \$3.50 per 100.

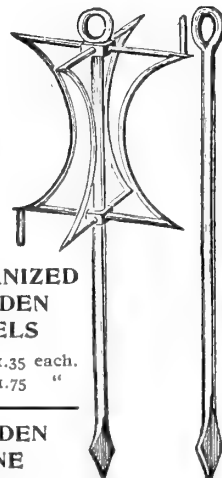

**GALVANIZED GARDEN REELS**

Single, \$1.35 each.  
Double, \$1.75 "

**GARDEN LINE**

30c. to \$1.25 per hank.

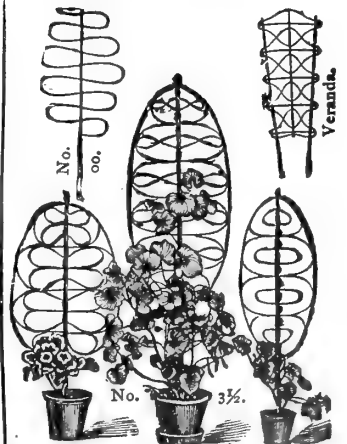

**TRELLISES**

For training vines. Each 10c. to \$1.00.

# MICHELL'S CATALOGUE OF SEEDS, ETC.

## GARDEN TOOLS AND IMPLEMENTS.



**SHEEP OR GRASS SHEARS.**  
30c. to \$1.25 each.

**Gibbs' Lawn Rake**

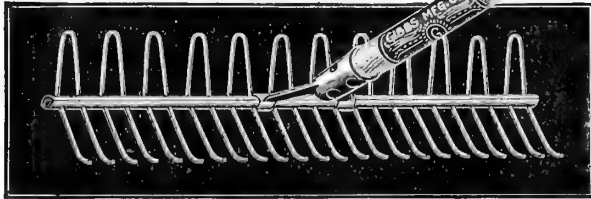

**RAKES.**  
Lawn King, 50 teeth, 4 feet long.....\$1.00  
" " 38 " ..... .75  
" " 26 " ..... .50  
Automatic, 22 teeth..... .40  
" " 26 " ..... .70  
" " 38 " ..... 1.00  
Regular Wooden Lawn and Straw Rakes,  
each..... .35  
Gibbs'.....each .50  
Coldwell....." .50

**STEEL GARDEN AND GRAVEL RAKES.**  
6 to 18 teeth, 35c. to 75c. each.

**HAND WEEDERS.**  
Large assortment. All the latest makes  
10c. to 85c. each.



**WATER'S IMPROVED TREE PRUNERS.**

4 ft. pole, .....\$0.75  
6 " ..... 0.85  
8 " ..... 1.00  
10 " ..... 1.15  
12 " ..... 1.25  
14 " ..... 1.50

**Extra Blades, 25c. each**

**Disston's Little Giant Pruner**  
\$1.00 each.  
With saw, \$1.35



**PRUNING SHEARS**  
Very large assortment. 30c. to \$1.75 each.

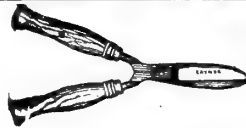

**Hedge Shears**

All sizes. \$1.50 to \$2.50 each.



**ENGLISH BILL HOOKS**  
\$1.50 each.



**GRASS EDGING KNIVES**  
50c. to \$2.00 each.



**SLASHING HOOK for trimming out small fruits. Price \$1.25.**



**DISSTON'S PRUNING SAWS**

Best quality. 70c. to \$1.25.

**EVERY'S DOUBLE EDGE.** 18 inch, 80c. each; 20 inch, \$1.00 each.



**TRANSPLANTING DIBBLE**  
The best and cheapest. 40c.  
**Brass Dibbles. 60c. each.**



**Maynard's Solid Steel Spade.**

The best spade on the market.  
\$1.40 each.

**MAYNARD'S SHOVELS.**  
\$1.40 each.

WE CARRY A VERY LARGE ASSORTMENT OF SHOVELS AND SPADES AT LOWEST PRICES.



Maynard's Spade.

**SPRING STEEL SCOOP SHOVEL.**

For Potatoes, Coke, etc.  
\$1.45 each.

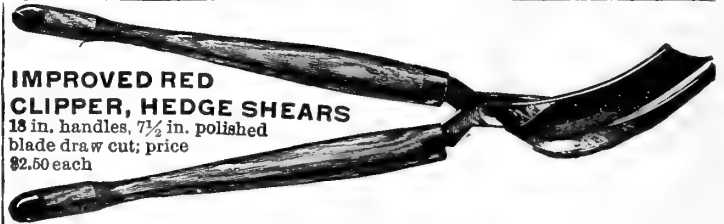

**IMPROVED RED CLIPPER, HEDGE SHEARS**  
18 in. handles, 7 1/2 in. polished blade draw cut; price \$2.50 each

**YOU NEEDN'T BREAK YOUR BACK WITH A CLEVELAND LAWN WEEDER.**



The only practical device on the market.  
50c. each.

**FRUIT PICKERS**

Each.  
Universal.....\$1.00  
Lee's..... .75  
Plumley..... 1.00  
Boss..... .40

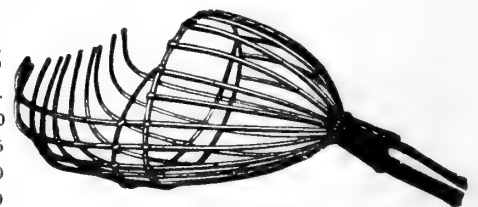

Boss Fruit Picker.

**SNOW SHOVELS.**

Solid Steel.  
50 and 75 cts. each.



**PRUNING AND BUDDING KNIVES**  
75c. to \$1.25 each.

**Sickles or Grass Hooks.**  
All sizes, 25c., 35c., 40c., 50c., 60c. and 70c. each.

**English Rivet Back Lawn Scythes.**  
Each \$1.25, \$1.35, \$1.50.

**American Scythes.** 80c. each.  
**Snathes for Scythes.** 75c. each.

**Lawn Border Shears.**  
\$2.00, \$2.50 and \$3.00 each.

We carry a full stock of  
**Hoes, Spades, Shovels, Forks, &c.**  
of the best quality only, at the very lowest prices.





# INDEX TO CONTENTS OF THIS CATALOGUE.

## NOVELTIES

in Plants, Seeds, etc.....2-11

### SEEDS.

<b>VEGETABLE</b> .....	12-28
<b>FARM</b> .....	29
<b>GRASS</b> .....	30-31
<b>BIRD</b> .....	29
<b>MISCELLANEOUS</b> .....	29
<b>FLOWER</b> .....	32-49

### PLANTS:

<b>Akebia</b> .....	50
<b>Azaleas</b> .....	50
<b>Alternanthera</b> .....	50
<b>Abutilons</b> .....	50
<b>Ampelopsis</b> .....	50
<b>Acalpha</b> .....	50
<b>Asparagus</b> .....	50
<b>Aristolochia</b> .....	50
<b>Aquatics</b> .....	50
<b>Anemones</b> .....	50
<b>Aquilegia</b> .....	50
<b>Asparagus Roots</b> .....	12-28
<b>Bignonias</b> .....	50
<b>Bouvardias</b> .....	50
<b>Blackberry Bushes</b> .....	59
<b>Coleus</b> .....	50
<b>Carnations</b> .....	50
<b>Cyclamen</b> .....	50
<b>Clematis</b> .....	51
<b>Chrysanthemums</b> .....	51
<b>Currant Bushes</b> .....	59
<b>Cabbage Plants</b> .....	28
<b>Cauliflower Plants</b> .....	28
<b>Celery Plants</b> .....	17-28
<b>Coreopsis</b> .....	52
<b>Cobea Scandens</b> .....	52
<b>Delphinium</b> .....	52
<b>Dutchman's Pipe</b> .....	50
<b>Evergreens</b> .....	60
<b>Egg Plants</b> .....	28
<b>Edelweiss</b> .....	52
<b>Ferns</b> .....	52
<b>Fern Balls</b> .....	52
<b>Fruit Trees and Bushes</b> .....	59-60
<b>Gaillardia</b> .....	52
<b>Gooseberries</b> .....	59
<b>Geraniums</b> .....	52
<b>Grasses (Hardy)</b> .....	52
<b>Gnaphalium</b> .....	52
<b>Grape Vines</b> .....	59
<b>Honeysuckle</b> .....	52
<b>Helianthus</b> .....	52
<b>Hollyhocks</b> .....	52
<b>Hydrangeas</b> .....	52
<b>Hedge Plants</b> .....	59
<b>Horse Radish Roots</b> .....	28
<b>Hop Vine Roots</b> .....	28
<b>Iris</b> .....	52
<b>Ipomeas</b> .....	53
<b>Larkspur</b> .....	52
<b>Lettuce Plants</b> .....	28
<b>Moon Plants</b> .....	53
<b>Osage Orange</b> .....	59
<b>Pepper Plants</b> .....	28
<b>Pansy</b> .....	53
<b>Phlox</b> .....	53
<b>Privet</b> .....	59
<b>Pinks</b> .....	53
<b>Poppies</b> .....	53
<b>Paeonies</b> .....	53
<b>Passion Vines</b> .....	53
<b>Rhododendrons</b> .....	53
<b>Raspberries</b> .....	59
<b>Roses</b> .....	54
<b>Red Hot Poker Plant</b> .....	53
<b>Shrubs</b> .....	60
<b>Strawberry Plants</b> .....	59
<b>Sunflowers (Hardy)</b> .....	52

<b>Trumpet Creeper</b> .....	50
<b>Tritoma</b> .....	50
<b>Trees</b> .....	60
<b>Tomato Plants</b> .....	28
<b>Verbenas</b> .....	53
<b>Virginia Creeper</b> .....	50
<b>Wisteria</b> .....	53
<b>Water Lilies</b> .....	50
<b>Woodbine</b> .....	52

### BULBS.

<b>Amaryllis</b> .....	55
<b>Begonias</b> .....	55
<b>Callas</b> .....	55
<b>Caladium</b> .....	55
<b>Cinnamon Vine</b> .....	55
<b>Cycas Stems</b> .....	55
<b>Cannas</b> .....	56
<b>Dahlias</b> .....	57
<b>Elephant Ears</b> .....	55
<b>Gloxinias</b> .....	58
<b>Gladiolus</b> .....	58
<b>Hyacinth Candicans</b> .....	58
<b>Lilies (Hardy)</b> .....	58
<b>Mexican Vine</b> .....	58
<b>Montbretias</b> .....	58
<b>Oxalis, (Summer Blooming)</b> .....	58
<b>Sago Palm Roots</b> .....	55
<b>Summer Hyacinths</b> .....	58
<b>Shell Flower</b> .....	58
<b>Tuberoses</b> .....	58
<b>Tigridias</b> .....	58

### MISCELLANEOUS

<b>Animal Meal</b> .....	65
<b>Ant Exterminator</b> .....	62
<b>Aphis Punk</b> .....	62
<b>Aprons (Gum)</b> .....	72
<b>Ashes (Canada)</b> .....	61
<b>Barley</b> .....	65
<b>Baskets (Garden)</b> .....	79
<b>Baugh's Phosphate</b> .....	61
<b>Bellows</b> .....	62
<b>Bill Hooks</b> .....	78
<b>Blood (Dried)</b> .....	61-65
<b>Bone Cutter</b> .....	64
<b>Bone Flour</b> .....	61
<b>Bone (Ground)</b> .....	61
<b>Bone (Granulated)</b> .....	65
<b>Bone Meal</b> .....	61
<b>Bone Mill</b> .....	62
<b>Books on Gardening</b> .....	56
<b>Books on Poultry</b> .....	65
<b>Bordeaux Mixture</b> .....	62
<b>Bowker's Chemicals</b> .....	61
<b>Bowker's Food</b> .....	61
<b>Boxes for Flowers</b> .....	77
<b>Brooders</b> .....	64
<b>Carnation Supports</b> .....	79
<b>Carriage Heaters</b> .....	76
<b>Caustic Potash Soap</b> .....	62
<b>Celery Paper</b> .....	17-79
<b>Chairs (Rustic)</b> .....	76
<b>Charcoal</b> .....	65
<b>Chick Manna</b> .....	65
<b>Cider Mills</b> .....	73
<b>Clay's Fertilizer</b> .....	61
<b>Clover Meal</b> .....	65
<b>Cocoa Fibre</b> .....	79
<b>Condition Powder</b> .....	65
<b>Copperdine</b> .....	62
<b>Copper Soap</b> .....	62
<b>Corn Planter</b> .....	79
<b>Cotton Seed Meal</b> .....	61
<b>Cultivators</b> .....	70-71
<b>Cut Clover Hay</b> .....	65
<b>Dalmation Powder</b> .....	62
<b>Death to Lice Powder</b> .....	65
<b>Dibble</b> .....	78
<b>Dog Cakes</b> .....	66

<b>Edging Knives</b> .....	78
<b>Eggs (Nest)</b> .....	66
<b>Egg Food</b> .....	65
<b>Emery</b> .....	63

<b>Fertilizers</b> .....	61
<b>Feed Cutters</b> .....	75
<b>Fibre Saucers</b> .....	63
<b>Fibre Vases</b> .....	63
<b>Field Mowers</b> .....	69
<b>Files (Lawn Mower)</b> .....	68
<b>Finley Rake</b> .....	69
<b>Fir Tree Oil</b> .....	62
<b>Fir Tree Oil Soap</b> .....	62
<b>Flower Pots</b> .....	63
<b>Flower Vases</b> .....	63
<b>Forks</b> .....	65
<b>Fostite</b> .....	62
<b>Fruit Pickers</b> .....	78
<b>Fumigators</b> .....	62

<b>Gape Cure</b> .....	65
<b>Garden Hoes</b> .....	75
<b>Garden Lime</b> .....	77
<b>Garden Reels</b> .....	77
<b>Gishurst's Compound</b> .....	62
<b>Glass Cutters</b> .....	75
<b>Glazing Points</b> .....	74
<b>Grafting Wax</b> .....	79
<b>Grape Dust</b> .....	62
<b>Grass Catchers</b> .....	68
<b>Grind Stones</b> .....	75
<b>Guano</b> .....	61

<b>Hanging Baskets</b> .....	76
<b>Harrow</b> .....	74-75
<b>Hay (Cut Clover)</b> .....	65
<b>Hellebore</b> .....	62
<b>"H. O." Poultry Food</b> .....	65
<b>Hoes (Garden)</b> .....	75
<b>Horn Shavings</b> .....	61
<b>Horse Cultivators</b> .....	70-71
<b>Horse Boots</b> .....	68-69
<b>Hose Band</b> .....	72
<b>Hose Coupler</b> .....	72
<b>Hose Crook</b> .....	72
<b>Hose Menders</b> .....	72
<b>Hose Nozzles</b> .....	72
<b>Hose Protector</b> .....	79
<b>Hose Reels</b> .....	76
<b>Hose (Rubber)</b> .....	72
<b>Hot Bed Sash</b> .....	74
<b>Hot Bed Mats</b> .....	79

<b>Insecticides</b> .....	62
<b>Incubators</b> .....	64
<b>Jadoo Liquid</b> .....	61

<b>Kaffir Corn</b> .....	65
<b>Kainit</b> .....	61
<b>Kerosene Emulsion</b> .....	62
<b>Knapsack Sprayer</b> .....	62
<b>Knives</b> .....	68

<b>Labels</b> .....	77
<b>Land Plaster (Calcined)</b> .....	61
<b>Lawn Sweeper</b> .....	68
<b>Lawn Clipper</b> .....	68
<b>Lawn Dressing</b> .....	61
<b>Lawn Mower Oil</b> .....	68
<b>Lawn Mowers</b> .....	67-68-69
<b>Lawn Mower Sharpening</b> .....	69
<b>Lawn Rakes</b> .....	69-78
<b>Lawn Scythes</b> .....	68
<b>Lawn Shears</b> .....	68
<b>Lawn Sprinklers</b> .....	73
<b>Leaf Rack</b> .....	76
<b>Lehman Heaters</b> .....	66
<b>Lemon Oil</b> .....	62
<b>Lily Pans</b> .....	63
<b>Line (Garden)</b> .....	77
<b>London Purple</b> .....	62

<b>MOTOR MOWER</b> .....	69
<b>Manure</b> .....	61
<b>Mapes' Fertilizers</b> .....	61
<b>Mastica</b> .....	74
<b>Mats (Burlap)</b> .....	79
<b>Mats (Straw)</b> .....	79
<b>Meat for Poultry</b> .....	65
<b>Mica Crystal</b> .....	65
<b>Mole Traps</b> .....	79
<b>Moss (Green)</b> .....	79
<b>Moss (Sphagnum)</b> .....	79
<b>Muriate of Potash</b> .....	61

<b>Nest Eggs</b> .....	66
<b>Nikoteen</b> .....	62
<b>Nitrate of Soda</b> .....	61
<b>Orchid Baskets</b> .....	63
<b>Orchid Peat</b> .....	79

<b>Oyster Shell</b> .....	65
<b>Oyster Shell Mill</b> .....	64

<b>Paper, All Kinds</b> .....	79
<b>Paris Green</b> .....	62
<b>Paris Green Duster</b> .....	62
<b>Peat (Jersey)</b> .....	79
<b>Pencil (Indelible)</b> .....	77
<b>Persian Powder</b> .....	62
<b>Phosphate</b> .....	61
<b>Planet Jr. Implements</b> .....	70
<b>Plant Bed Cloth</b> .....	74
<b>Plant Stakes</b> .....	77
<b>Plant Stands</b> .....	77
<b>Plant Tubs</b> .....	63
<b>Plows</b> .....	74
<b>Presses (Wine)</b> .....	73
<b>Putty Bulbs</b> .....	74
<b>Pot Brackets</b> .....	76
<b>Pot Hangers</b> .....	63
<b>Pot Labels</b> .....	77
<b>Pot Saucers</b> .....	63
<b>Potato Knives</b> .....	65
<b>Potting Soil</b> .....	79
<b>Pots</b> .....	63
<b>Poultry (Live)</b> .....	64
<b>Poultry Supplies</b> .....	65
<b>Poultry Cure</b> .....	65
<b>Poultry Fountains</b> .....	64
<b>Pratt's Poultry Food</b> .....	65
<b>Pratt's Horse and Cattle Food</b> .....	65
<b>Propagating Sand</b> .....	79
<b>Pruners (Tree)</b> .....	78
<b>Pruning Knives</b> .....	78
<b>Pruning Saws</b> .....	78
<b>Pruning Shears</b> .....	78
<b>Pumps</b> .....	72

<b>Raffa</b> .....	77
<b>Rakes</b> .....	69-78
<b>Reel (Garden)</b> .....	67
<b>Rollers</b> .....	73
<b>Rolling Stands</b> .....	63
<b>Root Cutters</b> .....	64-75
<b>Rose Leaf Extract</b> .....	62
<b>Roup Pills</b> .....	65
<b>Roup Preparation</b> .....	65
<b>Rubber Sprinklers</b> .....	79
<b>Rustic Work</b> .....	76

<b>Salt (Agricultural)</b> .....	61
<b>Saucers for Pots</b> .....	63
<b>Saucers for Plant Tubs</b> .....	63
<b>Saws</b> .....	78
<b>Scythes</b> .....	78
<b>Seal Oil Soap</b> .....	61
<b>Seed Drills</b> .....	70-71-74
<b>Seed Pans</b> .....	63
<b>Seed Sowers</b> .....	31-74
<b>Settees (Rustic)</b> .....	76
<b>Shears (all kinds)</b> .....	77
<b>Sheep Manure</b> .....	61
<b>Shovels</b> .....	68
<b>Sickles</b> .....	



**ORDER SHEET.**

*Please tear this out and use in ordering.*

PLEASE DO NOT WRITE IN THIS SPACE.

**HENRY F. MICHELL,**

HENRY F. MICHELL  
FRED'K J. MICHELL

**SEEDS, BULBS, PLANTS  
and IMPLEMENTS**

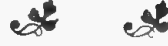

1018 Market Street,

PHILADELPHIA, PA.

TELEPHONE 3-55-43A

Date of Shipment? .....

Name? .....

(Name of Gardener?) .....

Post Office? .....

Shipping Address? .....

County? ..... State? .....

**AMOUNT ENCLOSED**

P. O. Order, \$ .....

Cash, . . . \$ .....

Check, . . . \$ .....

Stamps . . . .....

SHALL WE SHIP VIA  
**MAIL, EXPRESS OR FREIGHT**

Date .....

**SPECIAL NOTICE!**

*If desired, we will gladly procure for our customers any Seeds or other articles not offered in our Catalogue, but may be quoted in any other Seed Catalogue. Customers will kindly mention in their orders the firm offering the articles required, and the prices quoted.*

**\$160.00**

**SPECIAL NOTICE!**

**\$160.00**

During 1902 we will distribute \$160.00 in Cash Prizes at the Regular Monthly Meetings and at the Chrysanthemum Show of the Pennsylvania Horticultural Society, as follows:

	1st Prize	2d Prize
<b>At the January Meeting:</b>		
Violets—One bunch (50) single } .....	\$2.00	\$1.00
One bunch (50) double } .....		
<b>At the February Meeting:</b>		
Tomatoes—Hot house, 6 specimens.....	2.00	1.00
<b>At the Spring Show to be held in March:</b>		
Cineraria Hybrida—Three best plants.....	2.00	1.00
Cyclamen—Three best plants in bloom.....	2.00	1.00
Hyacinths—Twelve best single spike blooms grown in 5 inch pots.....	2.00	1.00
Lilium Harrisii or Lil. Longiflor—Three best plants.....	3.00	2.00
Narcissus—Von Sion, double, one pan.....	1.00	
<b>At the April Meeting:</b>		
Beans—Forcing, one dish, any variety.....	2.00	1.00
Cineraria Stellata—Specimen plant.....	2.00	1.00
<b>At the May Meeting:</b>		
Calceolaria Hybrida—Three plants.....	2.00	1.00
Cauliflower—Three heads, any variety.....	2.00	1.00

	1st Prize	2d Prize
<b>At the June Meeting:</b>		
Sweet Peas—One vase of mixed.....	\$2.00	\$1.00
Sweet Peas—Best collection, separate colors .....	2.00	1.00
<b>At the July Meeting:</b>		
Lettuce—Six heads, any variety.....	2.00	1.00
Potatoes—Twelve specimens, Michell's Earliest of All.....	2.00	1.00
<b>At the August Meeting:</b>		
Pelargoniums—Two plants, any variety.....	2.00	1.00
<b>At the September Meeting:</b>		
Cannas—Best Tenspikes, 5 varieties.....	2.00	1.00
Dahlias—Six varieties in separate vases, 10 blooms in each.....	2.00	1.00
<b>At the October Meeting:</b>		
Cosmos—Best vase.....	3.00	2.00

	1st Prize	2d Prize
<b>Premiums—Chrysanthemum Show, November, 1902. Total Amount, \$51.00.</b>		
Beets (table)—Bunch of 6.....	2.00	1.00
Cabbage—Six heads, best.....	2.00	1.00
Cardoon—Three best stalks.....	2.00	1.00
Carrot—Two Var. Six Danvers 1/2 long; Six Long Orange.....	2.00	1.00
Cauliflower—Five best heads.....	2.00	1.00
Celery—Five stalks, White Plume.....	2.00	1.00
Michell's Many Heart, 5 best stalks .....	2.00	1.00
Cucumber (hot house)—Three, any variety .....	2.00	1.00
Grapes (hot house)—One bunch.....	2.00	1.00
Lettuce—Six heads, best.....	2.00	1.00
Mangel Wurzel—Six roots.....	2.00	1.00
Mushrooms—One plate, 12 specimens.....	2.00	1.00
Potatoes—One peck, State of Maine.....	2.00	1.00
Radish—Cardinal Globe, 3 bunches, 12 each.....	2.00	1.00
Spinach—Six best heads.....	2.00	1.00
Tomatoes (hot house)—One dish of 12.....	2.00	1.00
Turnips—Three distinct named varieties, 3 of each; Ruta Baga's admissible.....	2.00	1.00
<b>At the December Meeting:</b>		
Lily of the Valley, 25 blooms.....	2.00	1.00
Mushrooms—Best dish, 12 specimens.....	2.00	1.00

If PINTS and QUARTS of BEANS, CORN, ONION SETS and PEAS are desired sent by MAIL, please ADD to Catalogue Prices, 15 cents per quart, 8 cents per pint; on Lawn Grass Seed, 5 cents per quart; also 8 cents per pound on other Seeds.

QUANTITY	NAMES OF ARTICLES WANTED	PRICE		TOTAL AMOUNT
		\$	CTS	

(FORWARD)

QUANTITY

NAMES OF ARTICLES WANTED

PRICE

\$

CENTS

TOTAL AMOUNT





# \$160.00

To encourage advancement in horticulture, we will distribute \$160.00 during 1902 through the Penna. Horticultural Society at its monthly meetings (held every third Tuesday evening) at Horticultural Hall; also at the Spring Exhibition in March and Chrysanthemum Show in November.

## IMPORTANT NOTICE

To Gentlemen wishing the services of a Gardener. We have on our register the names of very good men who are open for positions. We will be careful to recommend only such men as would be most suitable and with best references.

To Gardeners wishing situations. We constantly have calls for first-class gardeners, and to supply such openings we cheerfully ask gardeners who are in want of a position to apply to us, and we will endeavor to find a suitable place for good men.

We positively make no charge for this service, either to employer or employee, and exact no obligations whatever, as we consider it a strictly business matter and part of our business.

# POUDRETTE [Odorless Fertilizer] (Or Native Guano)

Wherever we have sold this valuable fertilizer the past year we received highly complimentary testimonials as to the satisfactory results obtained from it. We can highly recommend its use on **Lawns and Golf Grounds, Vegetable and Flower Gardens, Pasture Fields, Wheat, Rye and Timothy Fields**, and for all other purposes where a rich fertilizer is needed.

Ask for our descriptive circular and testimonials.

### ESPECIALLY ADAPTED:

- For **Lawns**
- " **Golf Grounds**
- " **Vegetable Gardens**
- " **Truck Farms**
- " **Flower Gardens**
- " **Pasture Fields**
- " **Fruit Farms**
- " **Wheat Fields**



### PRICES

Per pound package . . . . .	\$ .10
Per 5-pound package . . . . .	.20
Per 25-pound package . . . . .	.60
Per 50-pound package . . . . .	1.00
Per 100-pound bag . . . . .	1.50
Per 500 pounds . . . . .	5.00
Per 1000 pounds . . . . .	9.00
Per 2000 pounds (one ton) . . . . .	15.00
Per 5 tons (10,000 pounds) . . . . .	70.00
Per 10 tons (20,000 pounds) . . . . .	130.00



## Fairmount Weed Killer

### Kills Weeds Scientifically

Will keep your paths and roadways clear of all organic growth, will not injure marble or any kind of stone or gravel.

**WEEDS** are the bane, the nerve destroyers of all forms of life; they are the vegetable rats. We are only concerned, however, with the weeds that destroy nature's beauty.

For some time past we have devoted our time to the ways and means of quickly, effectively and economically destroying them. Our success has surpassed our expectations, and we have now passed the experimental stage.

*One gallon of our Weed Killer mixed with forty-nine gallons of water and spread over 100 to 150 square yards of surface with a rose sprinkler, will save the labor and expense of several men. It destroys all organic growth, therefore is only intended for use in places where grass is not wanted.*

By using our Weed Killer you avoid digging up your paths and roads; they then become firm and free from dust.

The best time to use it is about 24 hours after rain, so that it will penetrate to the roots. Our Weed Killer acts by destroying the seed germs and roots of plants. Park and Cemetery Superintendents and care-takers of private grounds should test its valuable merits without delay.

### LIST OF PRICES

½-gallon tin—makes 25 gallons treating liquid . . . . .	\$0.75
1-gallon tin " 50 " " " . . . . .	1.25
5-gallon keg " 250 " " " . . . . .	6.00
10-gallon keg " 500 " " " . . . . .	11.00
25-gallon cask " 1250 " " " . . . . .	22.00
50-gallon barrel " 2500 " " " . . . . .	39.50

FULL DIRECTIONS ON EVERY CONTAINER

## Quantity of Seeds usually Sown upon an Acre.

LBS. PER BUS.	LBS. PER BUS.	LBS. PER BUS.
Beans, Dwarf, in drills, . . . . . 60	1½ bus.	Grass, Orchard, . . . . . 14
Beans, Pole, in hill, . . . . . 60	10 to 12 qts.	Grass, English Rye, . . . . . 24
Beets, Table, in hill, . . . . . 6	lbs.	Grass, Red Top, . . . . . 20
Beets, Mangel Wurzel, . . . . . 5	lbs.	Grass, Lawn, . . . . . 3
Buckwheat, . . . . . 48	1 bus.	Grass, Hungarian, . . . . . 48
Cabbage, in beds to transplant, . . . . . ¼ lb.		Kale, . . . . . 5
Carrot, in drills, . . . . . 3 to 4 lbs.		Melon, Musk, in hills, . . . . . 2 to 3 lbs.
Clover, Red, . . . . . 60	20 lbs.	Melon, Water, in hills, . . . . . 4 to 5 lbs.
Clover, White, . . . . . 60	12 to 15 lbs.	Millet and Hungarian, . . . . . 48
Clover, Alsike, . . . . . 60	10 lbs.	Oats, broadcast, . . . . . 32
Clover, Lucerne or Alfalfa, . . . . . 60	40 lbs.	Onion, in drills, . . . . . 50
Corn, in hills, . . . . . 56	8 to 10 qts.	Onion for sets, in drills, . . . . . 6 to 12 bus.
Corn for fodder, . . . . . 56	3 bus.	Onion Sets in drills, . . . . . 4 to 6 lbs.
Cucumber, in hills, . . . . . 3	bus.	Parsnip, in drills, . . . . . 1½ bus.
Grass, Kentucky Blue, . . . . . 14	3 bus.	Round Peas, in drills, . . . . . 60
		Wrinkled Peas in drills, . . . . . 1½ bus.
		Peas, broadcast, . . . . . 3 bus.
		Potatoes, . . . . . 10 bus.
		Pumpkin, in hills, . . . . . 3 lbs.
		Radish, in drills, . . . . . 8 to 10 lbs.
		Rye, broadcast, . . . . . 1½ to 2 bus.
		Salsify, in drills, . . . . . 8 to 10 lbs.
		Spinach in drills, . . . . . 15 lbs.
		Squash, bush varieties, in hills, . . . . . 4 lbs.
		Squash, running varieties, in hills, . . . . . 3 lbs.
		Timothy Seed, . . . . . 12 to 16 qts.
		Tomato, to transplant, . . . . . ¼ lb.
		Turnip, in drills, . . . . . 2 lbs.
		Turnip, broadcast, . . . . . 2 lbs.
		Wheat, broadcast, . . . . . 1½ to 2 bus.

# MICHELL'S SEEDS, BULBS, PLANTS & c.

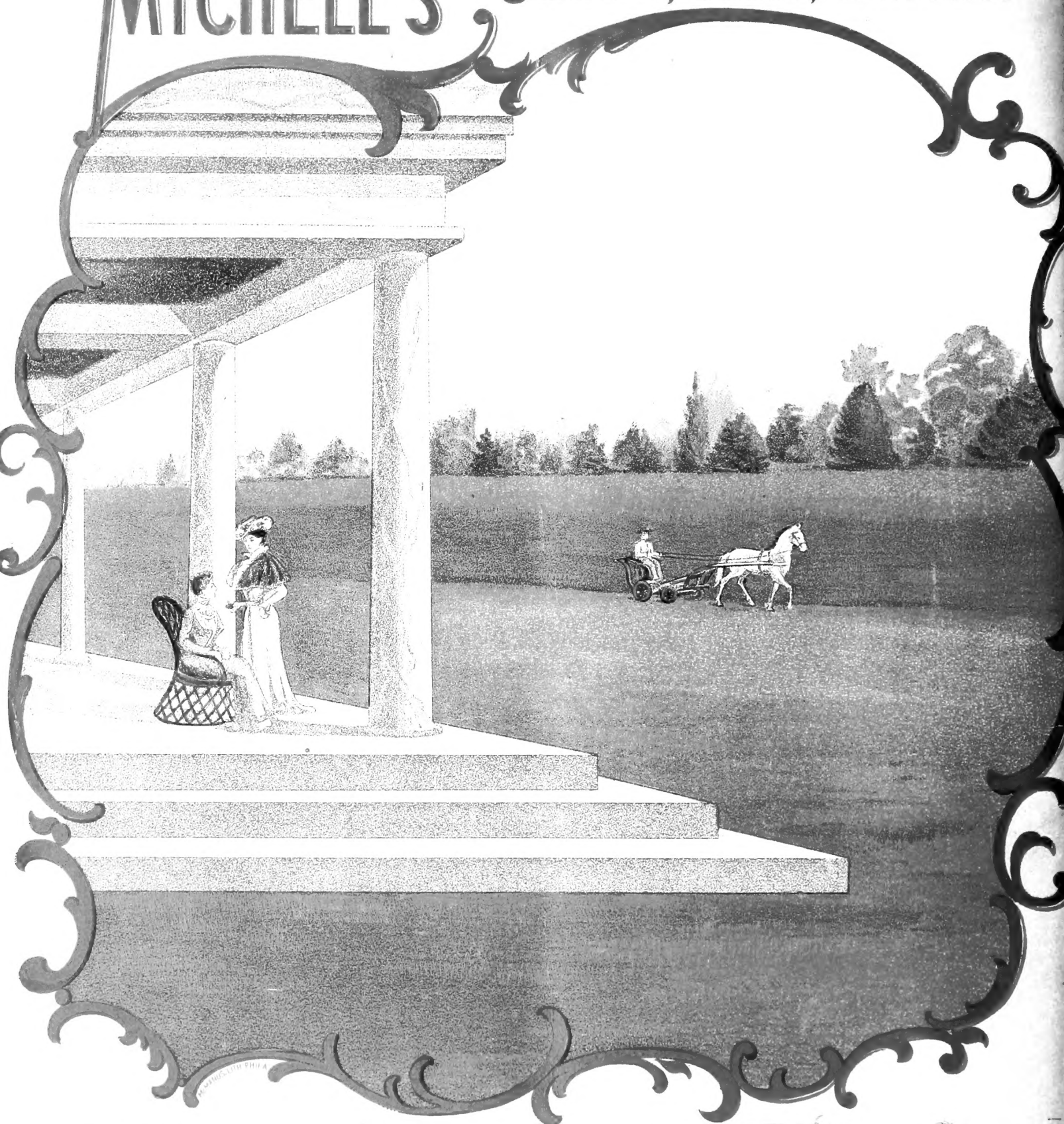

**MICHELL'S**  
OUR OWN  
SPECIAL FORMULA

**SUPERIOR EVERGREEN**  
**Lawn Grass Seed**