

Historic, Archive Document

Do not assume content reflects current scientific knowledge, policies, or practices.

62.13

1903

The Frank S. Platt Co.

SEEDS

374-376 STATE STREET
NEW HAVEN, CONN.



St. Charles, Red Cob, Ensilage.
Special value for
Silos purposes.

CONTENTS.

VEGETABLE SEEDS.

Page	Page	Page	Page	Page
Anise38	Celeriac16	Endive22	Milletts42	Saffron38
Artichoke9	Celery16, 17, 39	Fennel.....4, 22, 38	Mushroom Spawn...27	Sage38
Asparagus9	Chervil16	Flax39	Mustard27	Salsify34
Asparagus Roots.....9	Chicory16	Garlic Sets.....23	Nasturtium27	Soja Bean.....39
Balm38	Chives17	Gourds56	Novelties2-3	Spinach34
Barley40	Chufas17	Grains40	Oats40	Squash ...6, 7, 8, 35, 36
Beans, Bush...2, 3, 10, 11	Clover Seeds.....43	Grass Seeds...41, 42, 43	Okra27	Sugar Cane.....39
Beans, Pole.....3, 12	Collards18	Hemp39, 87	Onion28	Summer Savory.....38
Beets2, 12, 13	Coriander38	Herbs38	Onion Sets.....28	Sunflower.....39, 87
Borage38	Corn, Field...6, 18, 39	Horehound38	Parsley29	Sweet Basil.....38
Brocoli14	Corn, Popping.....18	Kaffir Corn.....39	Parsnip29	Sweet Marjoram.....38
Broom Corn.....39	Corn, Sweet.. 4, 19, 20	Kale23	Peas..5, 6, 29, 30, 31, 39	Thyme38
Brussels Sprouts....14	Corn Salad.....20	Kohl-Rabi23	Peppers31	Tobacco36
Buckwheat40	Cow Peas.....39	Lawn Grass Seed...41	Potatoes31, 32	Tomato8, 36, 37
Cabbage.....14, 15	Cress or Pepper- grass20	Lavender38	Pumpkin32	Turnip.....7, 8, 37, 38
Canada Field Peas31, 39	Cress, Water.....20	Lettuce24, 25	Radish5, 32, 33	Vegetable Plants.....81
Caraway38	Cucumber.....3, 4, 21	Mangel Wurtzel ..2, 13	Rape34	Vegetable Seeds...9, 38
Cardoon15	Dandelion22	Martynia26	Rue38	Vetches, Spring...39
Carrots15	Dill38	Melon, Musk25	Ruta Bagas.....38	Wheat8, 40
Cauliflower16	Egg Plant.....22	Melon, Water..4, 26, 27	Rye40	Wormwood38

FLOWER SEEDS.

Page	Page	Page	Page	Page
Abronia44	Canna49	Eschscholtzia54	Larkspur59	Portulaca62
Acroclinium45	Canterbury Bells.....48	Euphorbia.....54, 55	Lathyrus59	Primula67
Adonis44	Carnation50	Everlastings.....45, 55	Linum59	Pyrethrum66
Ageratum44	Castor Oil Beans.49, 6756, 57, 67	Lobelia59	Rhodanthe67
Agrostemma...45	Celosia49	Feverfew55	Lupins60	Ricinus.....49, 67
Alyssum, Sweet.....45	Centaurea50	Flower Seeds...44 to 72	Marigold59	Rudbeckia68
Amaranthus45	Chrysanthemum..50, 51	Forget-me-not....55, 61	Maurandia60	Salpiglossis68
Antirrhinum45	Cineraria51	Gaillardia55	Marvel of Peru.....61	Salvia68
Aquilegia45	Clarkia51	Geranium55	Mignonette60	Sanvitalia68
Asperula46	Cleome51	Gilia55	Mimosa60	Scabiosa68
Aster46	Clianthus51	Globe Amaranth....55	Mimulus60	Schizanthus68
Balloon Vine.....47	Coboea51	Gnaphalium56	Momordica.....47, 60	Smilax.....61, 68
Balsam47	Cockscomb49	Godetia56	Morning Glory ..52, 60	Solanum69
Balsam Apple....47, 60	Coleus52	Gourds56	Myosotis.....55, 61	Stocks69
Bartonia47	Collinsia52	Grasses56	Myrsiphyllum...61, 68	Sweet Peas.....70, 71
Bellis Perennis.....47	Columbine.....45, 52	Helianthus57	Nasturtium.....61, 62	Sweet William69
Branchycome47	Convolvulus52	Helichrysum57	Nemophila62	Thunbergia71
Browallia47	Cosmos52	Heliotrope57	Nicotiana62	Tropaeolum.....61, 62
Cacalia47	Cucumis52	Helipterum San- fordi57	Nigella62	Verbena71
Calandrinia48	Cyclamen53	Hollyhock.....57, 58	Pansy63	Vinca71
Calceolaria48	Cypress Vine.....53	Honesty58	Petunia64	Wall Flower72
Calendula.....48, 59	Dahlia53	Hyacinth Bean56	Phlox.....64, 65	Wild Flower Gar- den72
Calliopsis48	Daisy47, 53	Ice Plant.....58	Physalis Francheti..65	Zinnia72
Campanula48	Delphinium53	Impatiens Sultani...58	Polyanthus65	
Canary Bird Flower..48	Dianthus.....53, 54	Ipomea.....58, 59	Poppy.....65, 66	
Candytuft49	Digitalis54			

MISCELLANEOUS.

Bulbs.		Page	Page	Page	Page
Begonias74	Clematis79	Phlox, Hardy.....78	Bouquet Holder98	Mole Traps95	
Caladium75	Currants83	Plum81	Brooders96, 97	Nest Eggs.....87	
Canna73	Deutzia80	Quince81	Cages87, 88	Plant Stakes...95	
Cinnamon Vine78	Dielytra Spectabilis.76	Raspberries83	Caponizing Tools...87	Potato Knife.....92	
Dahlia74	Exochorda Grd80	Rhododendrons80	Chairs98	Poultry Supplies.86, 87	
Gladioli75	Forsythia80	Roses79	Corn Planter.....93	Poultry Fountains...87	
Lilies77	Fringe Smoke Tree..80	Roses, Climbing...79, 79	Dog Food.....87	Poultry Grit Boxes...87	
Tuberose76	Funkia76	Snowball80	Egg Food.....86	Powder Guns.....89, 91	
Madeira Vine76	Golden Glow.....76	Spirea80	Fertilizers85	Pumps88, 89, 90, 91	
	Gooseberries83	Spruce81	Fir Tree Oil.....84	Rolling Stands94	
	Grape Vines82	Strawberries82-83	Flower Stands96	Seed Sower93	
	Grasses, Ornamen- tal77-78	Tritoma78	Flower Pots96	Shears, Pruning92	
	Hemlock81	Vegetable Plants and Roots81	Glazier's Points93	Sprinklers and Syringes91	
	Honeysuckle79	Weigela80	Glazing Tools92	Thermometers98	
	Horse Chestnut...80	Wistaria79	Grafting Wax93	Tree Labels93	
	Hydrangea80		Hanging Baskets...96	Tree Pruners92	
	Ivy, English.....79		Hot Bed Mats.....92	Tree Tubs94	
	Japan Quince.....80		Incubators97	Trellises96	
	Lilac80		Insect Extermina- tors83, 84, 85	Trowels93	
	Peach81		Labels, painted93	Tying Materials98	
	Pears81		Lawn Dressing.....85	Watering Pots91	
	Peony78		Lawn Mowers.....93	Weeding Hooks ..89-90	
	Peony, Mouton...78		Marking Punch.....87		

The FRANK S. PLATT CO.'S

1903 Price List and Descriptive Catalogue

OF

SEEDS AND SUPPLIES

FOR THE

FARM AND GARDEN

To Our Friends and Patrons

We issue the TWENTY-SEVENTH ANNUAL with sentiments of pride and satisfaction. The confidence and support of our large constituency in agricultural pursuits have demonstrated the acceptable service of the house for so many years and the demands for greater facilities to meet the increasing business have made it necessary to classify various and important branches, under separate heads, with superintendents to personally direct same.

Fully appreciating the services of our experienced assistants, and desiring to further improve every opportunity for good service and business development, we were incorporated July 1st, 1902, under the state laws.

We solicit your business and will endeavor to supply everything in our line of unquestionable quality, purity and vitality, at prices to meet any market or honorable competition.

FRANK S. PLATT,
FRANK H. GRISWOLD,
AMASA L. DOOLITTLE,
CHAS. C. OSTERMANN.

THE FRANK S. PLATT CO., Inc.

Terms. Cash with order, or satisfactory city reference. We will ship by express, C. O. D., on orders exceeding \$10.00, if 25 per cent. of the amount is remitted with order. Cannot ship C. O. D. by freight.

Write Address Plainly. Write your Name, Post Office and State plainly, and in full on every letter. When Express or Freight Office is different from Post Office, advise us of the same.

Seeds, etc., by Weight or Measure. *Less than one-quarter pound and one-quarter bushel* will be charged at slight advance in price above pound and bushel rates.

Postal Service. The postal arrangements admit the sending of seeds to any part of the United States at the rate of eight cents a pound. *We will send, postpaid, all Garden and Flower Seeds, sold in packets or by the ounce up to one-quarter pound; but for Seeds in bulk, postage to the amount of eight cents per pound must be added to Catalogue prices.* For postage on Peas and Beans add 15 cents per quart, on Corn 10 cents, to Catalogue prices.

Market Fluctuations. Prices are subject to variation without notice, on extreme changes in market values.

About Warranting Seeds. We do not warrant Seeds in any sense of the term, and while we consider the goods we sell of *superior order and quality*, and exercise the greatest care to secure *only pure and reliable seeds*, the fact is pertinent and undeniable that crops may fail, no matter how fresh or pure the seeds sown to produce them may be, owing to causes the most expert cultivator cannot control. Therefore if the purchaser does not accept the seeds on these terms and conditions, they must be returned at once, and the money that has been paid for them will be refunded.

THE FRANK S. PLATT COMPANY,

374 and 376 State Street,

NEW HAVEN, CONN.

New and Valuable Varieties

Worthy of Special Consideration.



Round Stringless Green Pod Bean.

Is the only **Stringless Green-Pod** Bush Bean in cultivation. The pods are round, long and large, and ready to market **two weeks earlier** than the best stock of *Improved Extra Early Red Varieties*. Price per qt., 20c.; per bu., \$4.00.

Rivenhall Giant Yellow Mangel.

A new type of intermediate form, very large in circumference and longer than the *Globe* varieties. Stands about half out of ground. The color is a light yellow, and it is an enormous cropper. In lots of 10 lbs., 25c.; per oz., 5c.; per lb., 30c.

CRIMSON GLOBE BEET.

This is a new comer of considerable merit. It is almost spherical, with small tops and root. The flesh is fine grained, dark crimson color, with skin of lighter shade, making it very attractive as bunched for the market. While not one of the largest type, it grows to good size and is very early. Price per pkt., 5c.; per oz., 10c.; per lb., 50c.



Crimson Globe Beet.

SCARLET KASHMYR.

A new and entirely distinct Turnip. The outer color is rich scarlet, while the flesh is snow-white. It is an *extra early sort*, small, rarely exceeding three inches in diameter, and flat; the leaves are small, full and strap-leaved; the flesh is very solid, tender, fine-grained and of good quality. Price per pkt., 5c.; per oz., 10c.; per ¼ lb., 25c.; per lb., 75c.

Golden Bronze Squash.

Mr. Lowe, who originated this squash, thus describes it: "A cross of the Bay State and Boston Marrow. In form the same as the last named, with stem and blossom end precisely like that variety. Size averaging from eight to ten pounds; color, a dark, grayish green; flesh, an exceedingly bright golden yellow; fine grained, very sweet. Early in maturing, a good keeper, and yielding largely of squashes of very uniform size and appearance. As a squash, combining the qualities desired for the table and pies, this has no superior. Specimens grown in 1897 were kept until June, 1898. Price per pkt., 5c.; per oz., 10c.; per lb., \$1.00.

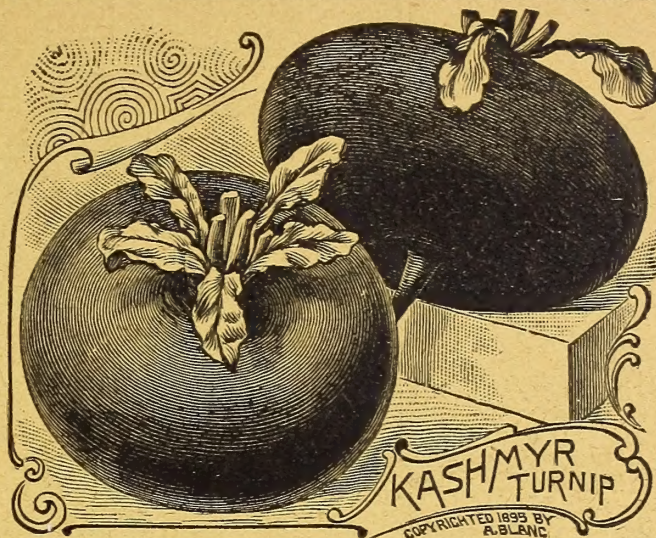

Golden Bronze Squash.

The Delicious Squash.

The Delicious is the product of the work of years in careful selection, crossing and isolating. In form the Delicious is an oval. Its color is almost uniformly of a green shade, with occasionally a blue specimen, it being just about as pure in this respect as the Faxon, weighing between five and ten pounds. In thickness of flesh it surpasses nearly every variety, the color being dark orange. For table use no squash compares with it in its remarkable combination of fineness and compactness of grain, dryness, sweetness and exceeding richness of flavor. It is a fall and winter squash, being excellent at all seasons, but like the old Hubbard, though at any time excellent, does not acquire its best quality until winter. When but half grown it will be found to surpass in quality most varieties when fully ripe. Price per pkt., 15c., 4 for 50c.

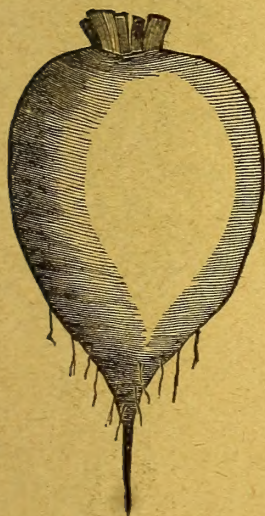

White Egg Turnip.

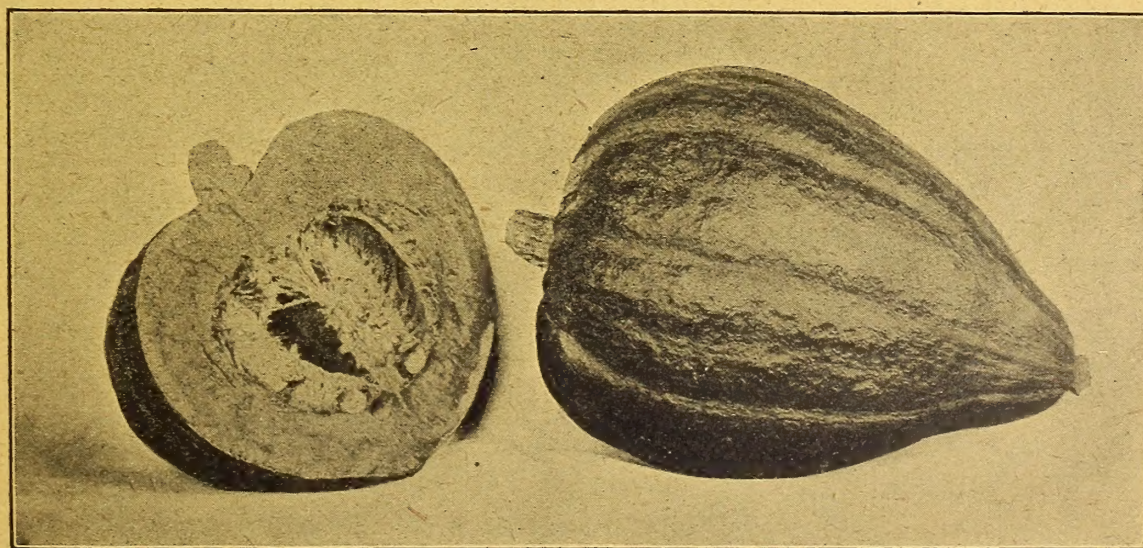

Delicious Squash.

WHITE EGG TURNIP.

The White Egg Turnip is no stranger, being numbered among my first introductions, but the fact of its superiority having been so thoroughly appreciated as to tempt other dealers to bring it out again under the name of *Early Snowball* is sufficient evidence that all the recommendations of its introduction have been realized. Price per pkt., 5c.; per oz., 10c.; per lb., 50c.

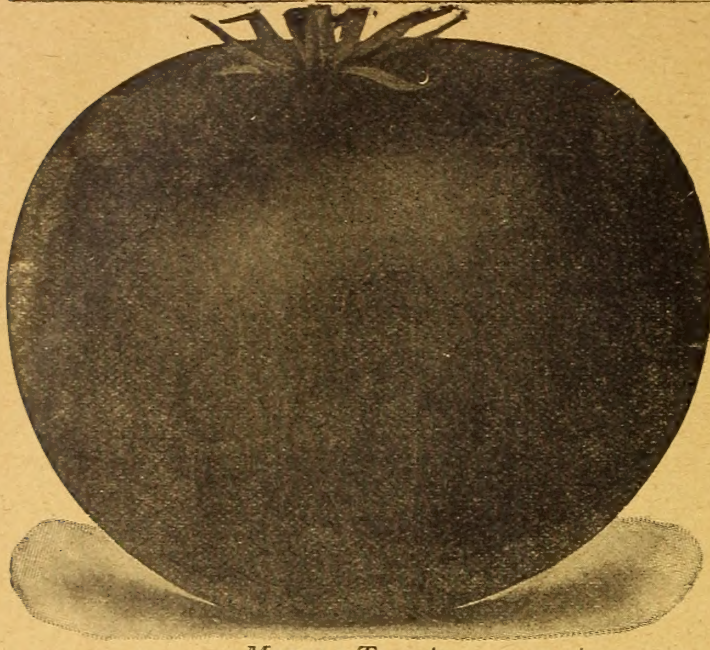

Magnus Tomato.

MAGNUS TOMATO.

A very distinct variety, color of Beauty and Acme. It is thicker, heavier, and more solid than either. It is unsurpassed in quality and production. The form is perfect; large and attractive. Flesh is very firm. It is a robust grower, with short joints, setting its fruit clusters closer together than most varieties, and it is therefore a heavy cropper. Price per pkt., 5c.; per oz., 30c., per lb., \$4.00.

The Michigan Squash.

This is a valuable member of the late summer and fall contingent and distinct in every way if properly grown. In length it is from eight inches to one foot and three to four inches in diameter, having small seed cavity and weighing two to three pounds. The exterior is a very dark green, and it is often designated as the Long Black Squash. The flesh is extremely fine grained, peculiarly delicate and sweet, and lacking that decided squash flavor so prominent in some high-

ly esteemed varieties. It has a very high local reputation and the party from whom my seed stock was obtained sold 100 dozen for 1.00 in the New Haven market from one load, which he brought in a few years ago. Price per pkt., 10c.; per oz., 25c.; per lb., 3.00.

Rhode Island Rock, The Wonderful Keeping Turnip.

In this new variety we have a great improvement on the White French Turnip, made after years of selection, by a Rhode

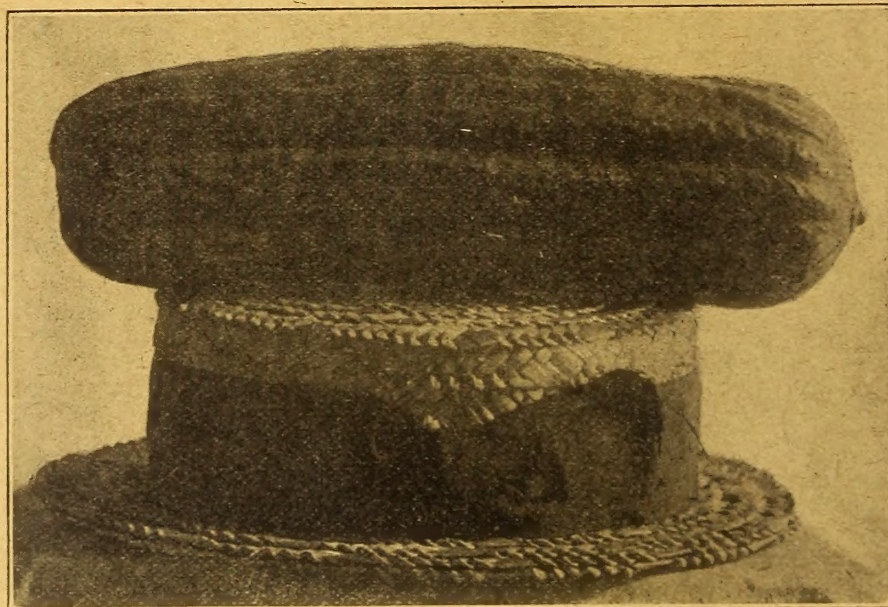

Island market gardener. It is fully three weeks earlier than any turnip of its class and can be planted later to follow such crops as peas, corn, beets, etc. It is very hard and solid, flesh pure white, fine grained, brittle and sweet. Its crowning point, however, is its wonderful keeping qualities, excelling all other Turnips in this respect. Price per pkt., 5c.; per oz., 10c.; per lb., 60c.



Rhode Island Rock Turnip.

Jones' Early Red Chief New Fall Wheat.

Originated from Early Red Clawson and Red Arcadian (new), Red Chief will prove a wonder in the wheat line, being without exception the strongest growing and most productive of all the Jones' wheat yet introduced. Its growth in the fall is strong, foliage being large, thick and dark, covering the ground early in the season, and can be sown very late. It is one of the first to start in the spring. Straw exceptionally thick walled and strong heads, carried erect, which is bald, wide, long and of a reddish brown shade, completely packed with large, medium long dark red kernels. It seems to be one that will also prove of great value on low lands not considered suitable for wheat growing. This is a wheat that has a grand future. Price per bu., \$2.00.



GENERAL LIST

OF

Select Vegetable Seeds.

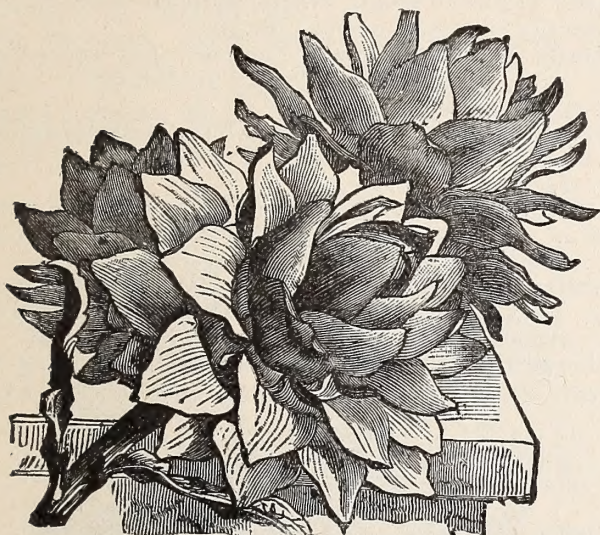

Artichoke.

ARTICHOKE.

(*Artischoke—Carciofo—Alcachofa.*)

Large French Globe. The *flower heads* of this variety are the portions for the table. Sow early in spring, in rich soil, and transplant the following spring to permanent beds, in rows (or hills) three feet apart, and two feet between the plants. It requires a deep, rich loam, and should be protected in winter by a covering of leaves or coarse manure. Perennial. Price per pkt., 10c.; per oz., 30c.

Tuberous-Rooted Artichoke. *Jerusalem Artichoke.* This is quite distinct from the Globe Artichoke, being grown exclusively for its tubers. Price per lb., 10c., 3 lb., 25c.; per pk., \$1.00; per bu., \$3.50.

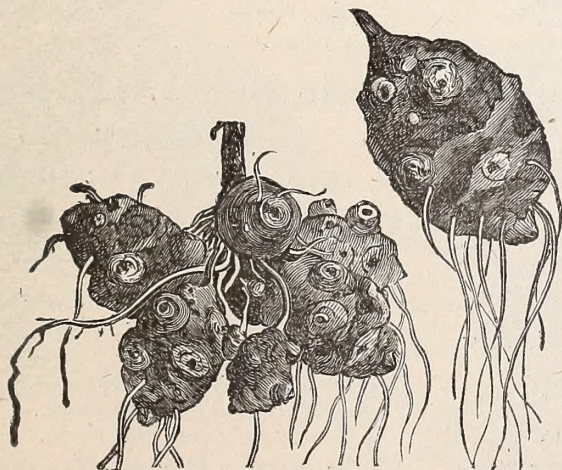

Tuberous-Rooted Artichoke.

ASPARAGUS.

Spargel—Esparrago—Asparago.

Sow the seed early in the spring, in drills about one inch deep, and rows about a foot apart, and in the fall or the succeeding spring the plants may be set out

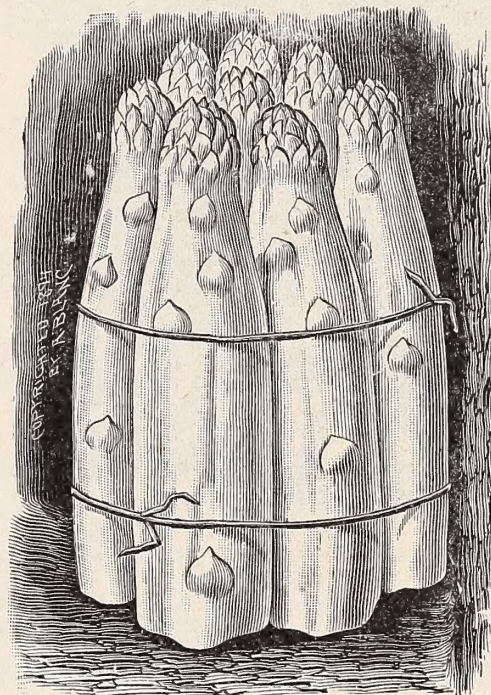

Asparagus.

in beds about two feet apart each way, leaving the crown of the root about four inches below the surface. Before winter, cover the bed with a dressing of manure. *Purchasing roots instead of seed will save a year in time.*

Palmetto.

Very early, large and pale green. Price per pkt., 5c.; per oz., 10c.; per lb., 40c.

Barr's Mammoth.

Very large, tender stalks, light color and very early. Price per pkt., 5c.; per oz., 10c.; per lb., 40c.

Conover's Colossal. Large, early, green and very prolific. Price per pkt., 5c.; per oz., 10c.; per lb., 40c.

Columbian Mammoth White. A large white variety, maturing early. Price per pkt., 5c.; per oz., 10c.; per lb., 50c.

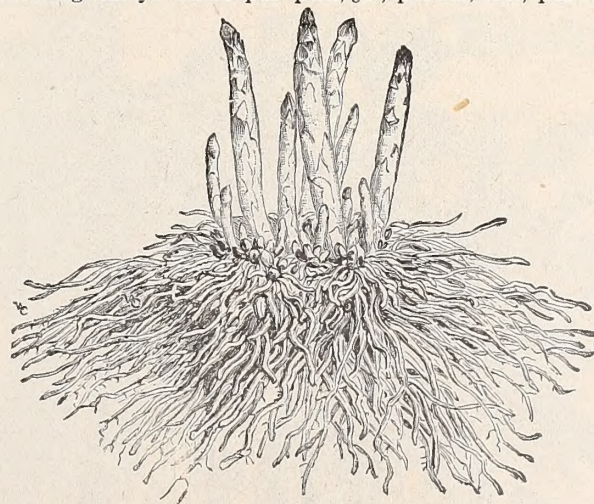

Asparagus Roots.

Asparagus Roots.

<i>Conover's Colossal</i> , 1-year old,	100, \$.50; 1000, \$3.50
<i>Conover's Colossal</i> , 2-years old,	100, 1.00; 1000, 5.00
<i>Palmetto</i> , 2-years old,	100, 1.00; 1000, 5.00
<i>Barr's Mammoth</i> ,	100, 1.00; 1000, 5.00
<i>Columbian Mammoth White</i> ,	100, 1.00; 1000, 6.00

BEANS--Dwarf, Bush or Snap.

WAX POD VARIETIES.

Bohnen—Frigoles—Faggioli.

A succession of sowing can be made from the first week in May until August. Plant in drills about two inches deep and from eighteen inches to two feet apart, according to the richness of the soil. The plants should be about three inches apart.



Allan's Imperial Wax. Pods long, broad and straight, of beautiful waxy color with fine texture and flavor, vine vigorous and healthy. Pods must be picked when young and tender. Seed white, splashed with chocolate brown. Price per qt. 30c; per bu; \$6.00.

Golden Crown Stringless Wax. (See Novelties page 3.) Price per ½ pt., 15c.; per pt., 25c., per qt., 40c.; per bu., \$10.00.

Jones' Stringless White Seed, Round Pod Wax. (See Novelties page 3.) Price per ½ pt., 10c.; per pt., 20c.; per qt., 35c.; per bu., \$8 00.



Kidney Wax.

Keeney's Rustless Golden Wax. The pods are thick, flat when young, and semi-round later; of rich yellow color. Price per qt., 25c.; per bu., \$5.00.

Currie's Rust Proof. Pods long, flat and straight, of a beautiful golden color. Price per qt., 25; per bu., \$4.50.

Davis Wax. A rustless, wax bean, pods flat, long and straight, seeds clear white. Price per qt., 25.; per bu., \$5.00.

Kidney Wax. Pods long, broad, flat and of a delicate waxy yellow. Beans white, mottled with purple. Price per qt., 25c.; per bu., \$4.50.

Yosemite Mammoth Wax. The pods are large, plump and pulpy, nearly round, bright golden color. Price per qt., 40c.; per bu., \$7.00.

Golden-Eye Wax. An early variety, pods flat and of a beautiful waxy appearance. Price per qt., 25c.; per bu., \$4.50.

Dwarf Golden Wax. Very early; entirely stringless, and of a rich golden color, flat pods. Price per qt., 25c.; per bu., \$4.50.

Grenell's Improved Golden Wax. A rust-proof variety, pods long, straight and thick. Price per qt., 25.; per bu., \$4.50.

Challenge Black Wax. An extra early strain of the Dwarf Black Wax. Price per qt., 25c.; per bu., \$4.50.



Black Wax or Butter. An excellent string bean. The pods, when ripe, are round, waxy, yellow. Price per qt., 25c.; per bu., \$4.50.

White Wax. Pods flat, yellow and good every way. Price per qt., 30c.; per bu., \$5.00.

Beans--Dwarf, Bush or Snap.

GREEN POD VARIETIES.

Round Green Pod. Stringless (See Novelties, page 2). Price per qt., 20c.; per bu., \$4.00.

Extra Early Refugee. Round pods dark colored seed. Price per qt., 20c.; per bu., \$4.00.

Extra Early Valentine. Improved round pod Red Valentine. Price per qt., 20c.; per bu., \$4.00.

Early Long Yellow Six Weeks. Long flat pods, seeds yellow. Price per qt., 20c.; per bu., \$4.00.

BEETS—Continued.

Eclipse. Very early; dark red flesh and skin, small tops, almost spherical in form. Price per pkt., 5c.; per oz., 10c.; per lb., 40c.

Bastian's Early Blood Turnip. Very dark skin and flesh. Quality the best. Price per pkt., 5c.; per oz., 10c.; per lb., 40c.

Edmand's Early Blood Turnip. Deep blood skin, and very dark flesh of best quality. Price per pkt., 5c.; per oz., 10c.; per lb., 40c.

Early Bassano. Flesh circled with bright red, grows to a large size. Price per pkt., 5c.; per oz., 10c.; per lb., 30c.

Dewing's Early Blood Turnip. Deep blood red, free from fibrous roots. Price per pkt., 5c.; per oz., 10c.; per lb., 40c.

*Swiss Chard.*

Early Yellow Turnip. Flesh yellow, tender and sweet. Price per pkt., 5c.; per oz., 10c.; per lb., 50c.

Long Smooth Blood. An excellent late variety and good for winter use; smooth skin, flesh dark red. Price per pkt., 5c.; per oz., 10c.; per lb., 40c.

Early Blood Turnip. Price per pkt., 5c.; per oz., 10c.; per lb., 30c.

Lentz Blood Turnip. Price per pkt., 5c.; per oz., 10c.; per lb., 40c.

Columbia. Price per pkt., 5c.; per oz., 10c.; per lb., 40c.

Swiss Chard or Silver. This variety is cultivated for its leaves. The mid rib is boiled and served like asparagus, and the other portions of the leaves are used as spinach. When wanted, cut close down to the ground, and new leaves will grow. Price per pkt., 5c.; per oz., 10c.; per lb., 50c.

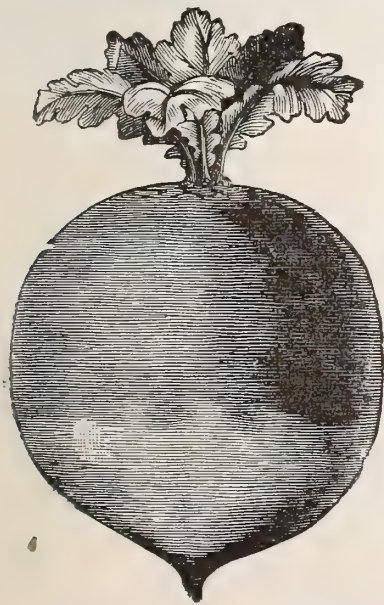
*Orange Yellow Globe.*

BEETS

Mangel Wurtzel.

LARGELY GROWN FOR FEEDING STOCK.

Red Globe. A large, round, red skinned variety, and good keeper. In lots of 10 lbs., 15c.; per oz., 5c.; per lb., 20c.

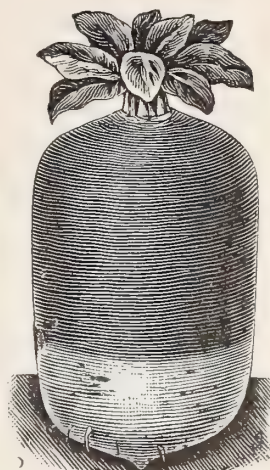
*Golden Tankard.***Orange Yellow Globe.**

Grows smooth; free from small roots. Large size and good color. In lots of 10 lbs., 15c.; per oz., 5c.; per lb., 20c.

Golden Giant Intermediate.

A very large yellow sort, with russet skin and light, yellow-colored flesh. In lots of 10 lbs., 20c.; per oz., 5c.; per lb., 25c.

Golden Tankard.

Half long, nearly uniform diameter from top to bottom; good quality. In lots of 10 lbs., 20c.; per oz., 5c.; per lb., 25c.

Rivenhall Giant Yellow.

(See Novelties, page 2). In lots of 10 lbs., 25c.; per oz., 5c.; per lb., 30c.

Mammoth Long Red. Grows to an enormous size, and acknowledged the most desirable of its class. In lots of 10 lbs., 25c.; per oz., 5c.; per lb., 30c.

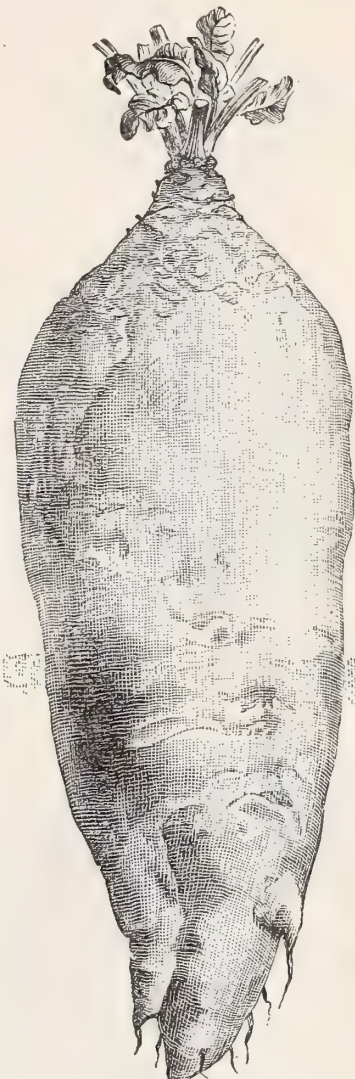
*Mammoth Long Red.*

Sugar Beets.

White French Sugar. This attains a large size, and is extensively grown for feeding, though employed largely in the manufacture of beet sugar. In lots of 10 lbs., 15c.; per oz., 5c.; per lb., 20c.

Lane's Improved Imperial Sugar.

This was obtained through successive careful selections from the French Sugar Beet. In lots of 10 lbs., 20c.; per oz., 5c.; per lb., 25c.

Klein Wauzleben Sugar. In lots of 10 lbs., 20c.; per oz., 5c.; per lb., 25c.

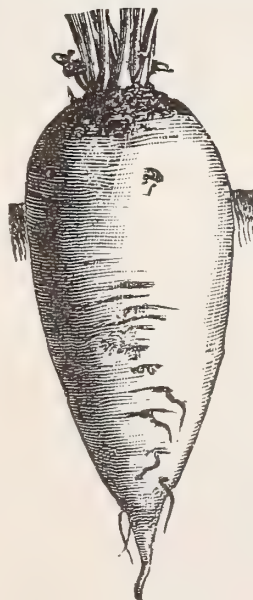
*White French Sugar.*

BROCCOLI.

Spargel Kohl—Broccoli—Broccoli.

Broccoli is a variety of cabbage nearly allied to cauliflower; succeeds only under cool, damp conditions. Sow thinly in seed beds about the middle of spring, transplant and cultivate according to directions for winter cabbages. The plants in seed beds are very apt to run up tall and slender, unless they are thinned and kept free from weeds.

Early White Cape. The heads when full grown are large, white and compact, and one of the most certain to head. Price per pkt., 10c.; per oz., 40c.

Early Purple Cape. Differs from the white in color only. Price per pkt., 10c.; per oz., 40c.

BRUSSELS SPROUTS.

Sprossen Kohl—Berza de Brussels—Broccolo di Carolo.

A very desirable vegetable. The plant grows two or three feet high, and produces from the sides of the stalk numerous little sprouts one or two inches in diameter, resembling cabbages. The leaves look like the Savoy, and should be broken down in the fall, to give the little cabbages more room to grow. They are used for fall and winter greens, are quite hardy, and should be treated in all respects like winter cabbage or kale.

Dalkeith. Dwarf, compact, producing larger sprouts than the older varieties. Price per pkt., 5c.; per oz., 20c.; per lb., \$2.00.

CABBAGE.

Kopf Kohl—Berza de Repollo—Cappuccie.



Brussels Sprouts.

THREE MAIN CROP VARIETIES



Surehead.

Succession.

The cabbage requires a deep, rich soil and thorough working. For early use the plants should be started in a hotbed or cold frame; but seed for winter cabbage should be sown in a seed bed early in the spring. Some of the large late varieties seem to do best if the seed is sown in hills where they are to remain, and in that case sow two or three seeds where each plant is desired, and then pull up all but the strongest. Plant the large varieties three feet apart; the small, early sorts, from a foot to eighteen inches. The Savoy cabbage have wrinkled leaves, and are of fine flavor, especially after a little frost has touched them in the autumn.

Early Etampes. Very early, good quality. Price per pkt., 5c.; per oz., 20c.; per lb., \$2.00.

Extra Early Express. The earliest of all, similar to Etampes. Price per pkt., 5c.; per oz., 25c.; per lb., \$2.50.

Early York. One of the earliest, cone-shaped variety. Price per pkt., 5c.; per oz., 15c.; per lb., \$1.25.

Early Jersey Wakefield. Heads very solid pyramidal blunted at the top. Price per pkt., 5c.; per oz., 25c.; per lb., \$2.50.

Charleston or Large Wakefield. Similar to Early Jersey Wakefield, but larger and a little later. Price per pkt., 5c.; per oz., 30c.; per lb., \$3.00.

Early Winningstadt. Heads good sized, cone-shaped and solid. Price per pkt., 5c.; per oz., 15c.; per lb., \$1.25.

All Seasons or Vandergaw. The heads of this cabbage are large and thick through; an excellent variety for early or fall marketing. Price per pkt., 5c.; per oz., 20c.; per lb., \$2.00.

Early Flat Dutch. Medium early, fair size, flat head. Price per pkt., 5c.; per oz., 20c.; per lb., \$2.00.

All Head. It is a large, flat, early summer variety of fine quality. Price per pkt., 5c.; per oz., 20c.; per lb., \$2.00.

Early Summer. Medium early, good size, of the Drumhead order. Price per pkt., 5c.; per oz., 20c.; per lb., \$2.00.

Surehead. Very large thick flattened heads. Price per pkt., 5c.; per oz., 20c.; per lb., \$2.00.

CELERY--Continued.

Giant Pascal. Large, thick and solid stalks, dark green foliage and golden heart. Price per pkt., 5c.; per oz., 20c.; per lb., \$1.50.

Golden Self-Blanching. The ribs are perfectly solid, crisp and brittle, and of delicious flavor. Price per pkt., 5c.; per oz., 25c.; per lb., \$2.50.



Golden Self-Blanching.

Kalamazoo Broadribbed. Cream-white color throughout, attains a very large size, of quick growth, stiff and close habit, very solid. Price per pkt., 5c.; per oz., 20c.; per lb., \$1.50.

White Plume. This is very early; its stalks, inner leaves and heart blanching naturally to a cream white. Price per pkt., 5c.; per oz., 20c.; per lb., \$2.00.

Golden-Hearted Half Dwarf. Center stalks and leaves blanching a rich yellow; solid, good cropper and keeper. Price per pkt., 5c.; per oz., 20c.; per lb., \$1.50.

Perfection Heartwell. A vigorous and stocky growing kind, with large and compact heart of pure golden color; good late variety. Price per pkt., 5c.; per oz., 20c.; per lb., \$1.75.

Crawford's Half Dwarf. A very popular variety, grows to a good size. Price per pkt., 5c.; per oz., 20c.; per lb., \$1.50.

Schumacher. Yellow center, solid and crisp. A late variety and good keeper. Price per pkt., 5c.; per oz., 20c.; per lb., \$2.00.

Giant White Solid. One of the old standard sorts and a very large variety. Price per pkt., 5c.; per oz., 20c.; per lb., \$1.50.

Boston Market. Short, compact and solid, and keeps well through the winter. Price per pkt., 5c.; per oz., 20c.; per lb., 1.50.

Winter Queen. Valuable on account of its excellent winter-keeping qualities. It grows very thick, solid heavy stalks, with a large heart. Price per pkt., 5c.; per oz., 25c.; per lb., \$2.50.

Pink Plume. A strong, compact grower; stems solid and crisp; extra early and a long keeper. Price per pkt., 5c.; per oz., 25c.; per lb., \$2.50.

New Rose. This is very ornamental, the delicate tracing of rose shading with the white in the blanched stalks and heart. Very solid, rich, and nutty in flavor; keeps well. Price per pkt., 5c.; per oz., 25c.; per lb., \$2.50.

Celery Seed. For flavoring. Old seed. Price per oz., 5c.; per lb., 40c.

CHIVES.

Schnittlauch—Cipollette.

Chives are perfectly hardy little perennial members of the onion tribe and are grown exclusively for their tops, which are used whenever the flavor of onion



Chives.

is required. Planted in small clumps in any common garden soil, they will grow rapidly, and in time increase so as to render a division necessary. The tops appear very early in spring, and can be cut throughout the season. Roots, per bunch, 10c.

CHUFAS OR EARTH ALMONDS.



Chufas.

These resemble in sweetness and flavor a cocoanut. Very prolific, a single one yielding from two to four hundred. Plant one foot to eighteen inches apart.

Chufas. Price per oz., 10c.; per qt., 30c.

COLLARDS OR COLEWORTS.

Blätterkohl—Cabu—Cavoli.

A class of plants closely allied to the cabbage family, which are used in the South, when small, as greens. Sow in early spring in drills one foot apart. The young plants are ready for use as soon as they have attained sufficient size, but if it is desired to keep them in good condition, thin the plants to six or eight inches apart and pull off the larger leaves before using.

True Southern. Per pkt., 5c.; per oz., 15c.; per lb., \$1.00.



Collards.

CORN FOR POPPING.

Granone per Scoppio.

Nonpareil White. Eight-rowed. Long ears, pops very large. Price per dozen ears, 25c.; per qt., shelled, 40c.

Silver Laced. Small kernel, twelve to sixteen-rowed. Price per dozen ears, 25c.; per qt., shelled, 40c.

White Rice. Sharp-pointed kernels, twelve to sixteen-rowed. Price per dozen ears, 25c.; per qt., shelled, 40c.

Red Rice. Sharp-pointed kernels, twelve to sixteen-rowed. Price per doz. ears, 25c.; per qt., shelled, 50c.

Queen's Golden Pop. The ears large, twelve to sixteen-rowed, bright yellow. Price per doz. ears, 35c.; per qt., shelled, 50c.

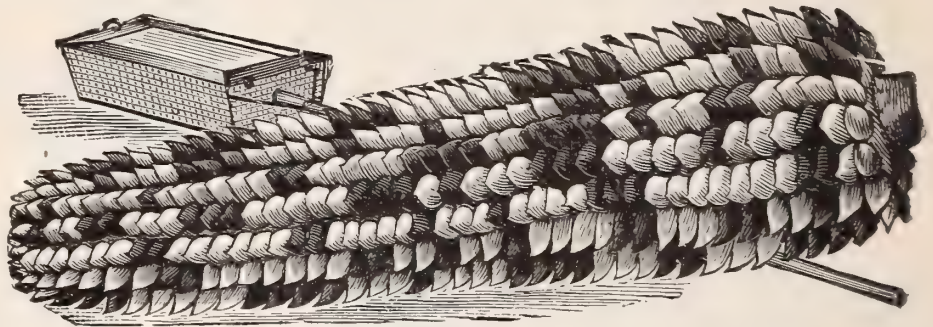

CORN--Varieties for Field Culture.

Granone o Grano —turco.

Early Mastodon. Very early, large eared, and large dented kernel. Price per 100 ears, \$2.50; per qt., 12c.; per bu., \$2.00.

Golden Dew Drop. It is an early yellow, eight-rowed flint variety. Grains of good size; small white cob. Price per 100 ears, \$2.00; per qt., 12c.; per bu., \$2.00.

Early Eight-Rowed Yellow Canada. The earliest corn, a yellow glazed or flint variety, eight-rowed and cob small; produces two or three ears to the stalk, and grows from four to five feet high. Price per 100 ears, \$1.50; per qt., 12c.; per bu., \$2.00.

Compton's Early. A very early and prolific yellow flint variety, twelve to sixteen-rowed, small kernel and rather large cob. Price per 100 ears, \$2.00; per qt., 12c.; per bu., \$2.00.

Longfellow. The ears are remarkably long, cob small, kernels large eight-rowed yellow flint. Price per 100 ears, \$2.00; per qt., 12c.; per bu., \$2.00.

Improved Sanford. A large white flint sort; ears large and very productive. This variety is used largely for ensilage or fodder corn. Price per 100 ears, \$2.00; per qt., 12c.; per bu., \$2.00.

Rural Thoroughbred. White flint, eight to twelve rows, long ears, heavy stalks and foliage, excellent for ensilage. Price per 100 ears, \$2.00; per qt., 10c.; per bu., \$1.50.

Large Yellow Flint. Similar to the preceding, except in color. Price per 100 ears, \$2.00; per qt., 12c.; per bu., \$2.00.

Queen of the Prairie or Pride of the North. This is an early Yellow Dent variety. It will mature in ninety days. Price per 100 ears, \$2.00; per qt., 12c.; per bu., \$2.00.

Leaming. The ears are large, with deep, large dented grain; orange-yellow color and small red cob. Price per 100 ears, \$2.00; per qt., 12c.; per bu., \$2.00.

Golden Superb (Dent). A very productive variety; fourteen to sixteen-rowed; very large kernel. Price per 100 ears, \$2.00; per qt., 12c.; per bu., \$2.00.

Hickory King. Extremely large grain and small cob; white Dent. Price per 100 ears, \$3.00; per qt., 15c.; per bu., \$2.00.

Southern White Fodder. A white Dent corn, bearing a medium sized ear, with very deep kernels on small cob. It is generally grown for its stalk and foliage, which attain a height of fourteen to eighteen feet. Used extensively as an ensilage or fodder crop. Price per bu., \$1.50.

Red Cob Ensilage. A white corn on red cob. Stalks short-jointed and very tall, with heavy foliage. One of the best for ensilage. Price per bu., \$1.50.



Improved Sanford.



Leaming

GARLIC.

Aglio.



Garlic.

Garlic thrives best in a light, well-enriched soil; the sets should be planted in early spring, in rows one foot apart and from one to five inches between the plants in the rows. The crop matures in August, when it is harvested like the onion. Used

in flavoring soups, stews and other dishes.

Garlic Sets. Price per lb., 25c.

KALE OR BORECOLE.

Blätter Kohl—Col—Cavalo Riccio.

Sow in April, in drills fourteen to eighteen inches apart, covering the seeds thinly and evenly, and thin out when hoeing to from four to six inches apart. The varieties are extremely hardy, and are best when touched by frost. For winter and spring use, sow in August or September.



Dwarf Moss Curled.

German Greens or Sprouts. Light green, very curly, good for spring or fall sowing. Price per pkt., 5c.; per oz., 10c.; per lb., 60c.

Dwarf Moss Curled. Very dwarf, light green. Closely curled and crimped. Price per pkt., 5c.; per oz., 10c.; per lb., \$1.00.

Dwarf Green Curled Scotch. Very dwarf, of spreading habit, hardy, and improved by light frost. Price per pkt., 5c.; per oz., 10c.; per lb., 75c.



Improved Siberian.

Tall Green Curled Scotch. Similar to the dwarf except that it grows eighteen to twenty-four inches high. Price per pkt., 5c.; per oz., 10c.; per lb., 60c.

Improved Siberian. Dwarf, curly, dark-green leaves, very hardy and an immense cropper. Undoubtedly the best adapted to our climate and more extensively grown than any other variety. Price per pkt., 5c.; per oz., 10c.; per lb., 50c.

Purple, Curled or Brown Kale. A beautifully curled variety, with dark-colored leaves. Price per pkt., 5c.; per oz., 10c.; per lb., 80c.

KOHL-RABI OR TURNIP CABBAGE.

Kohlrabi—Colinabo—Rapa.



Kohl-Rabi or Turnip Cabbage.

Half way between a turnip and a cabbage, partaking of the nature and flavor of both. The bulbs are cooked like turnips. Sow from April to July; plant and cultivate the same as cabbage. Set in drills eighteen inches apart, and eight inches in the drills. As they are difficult to transplant, they are sometimes sown where they are to stand, and afterward thinned out.

Early White Vienna. Grows to a fair size, skin light green, flesh white; short stump and tops. Price per pkt., 5c.; per oz., 20c.; per lb., \$2.00

Early Purple Vienna. Differs from the above in color only. Price per pkt., 5c.; per oz., 20c.; per lb., \$2.00.



Large Musselburg Leek.

LEEK.

Lauch—Puerro—Cipollette.

Sow as early in the spring as the season admits, either in seed beds or places where they are intended to grow. When four inches in height thin to three inches; when from six to eight, transplant to ten inches apart, leaving those in the drills about six inches apart. Set as deep as possible without covering the small center leaves.

Large Musselburg. The largest and most prolific. Price per pkt., 5c.; per oz., 15c.; per lb., \$1.50.

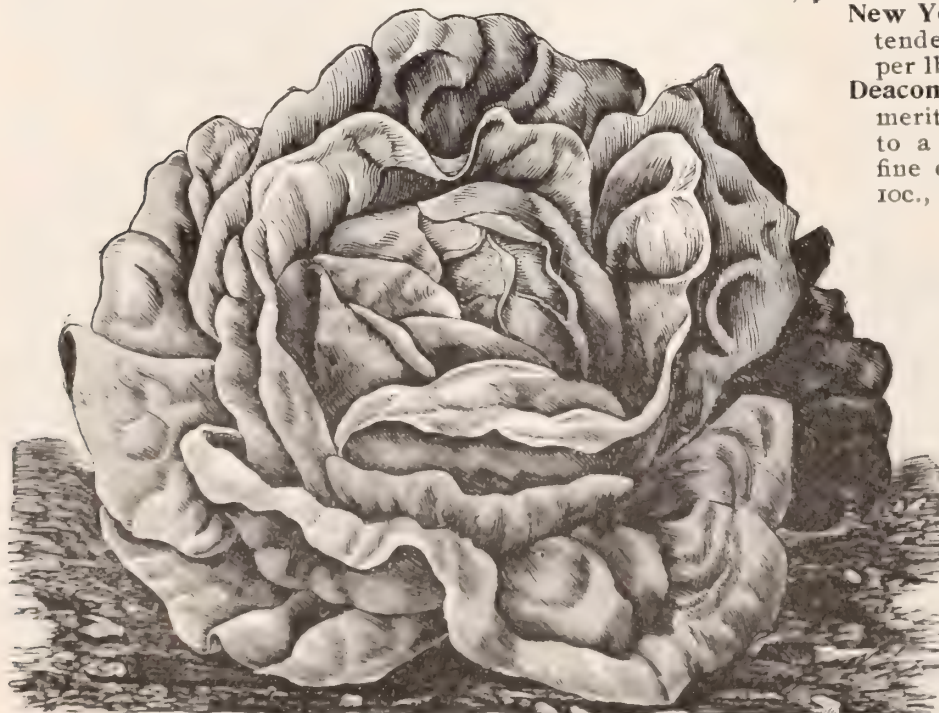

The Deacon.

American Flag. A large and strong plant. Price per pkt., 5c.; per oz., 15c.; per lb., \$1.25.

Large Rouen. A large variety remaining long in good condition, and sometimes called Winter Rouen. Price per pkt., 5c.; per oz., 15c.; per lb., \$1.50.

LETTUCE.

Salat—Lechuga—Lattuga.

Culture. Sow early in spring in a hotbed; transplant in April for summer use. Again, sow from April at intervals in the open ground, and for winter and



Prize Head.

spring use, in August and September. Protect by means of a cold frame during the winter.

Prize Head. Forms large, loose heads of bronzed-edged leaves. Price per pkt., 5c.; per oz., 10c.; per lb., \$1.00.

New York. It grows large and is crisp and tender. Price per pkt., 5c.; per oz., 10c.; per lb., 80c.

Deacon. A large Butter-Head variety of great merit. Outer leaves are light green shading to a pale yellow center of exceptionally fine quality. Price per pkt., 5c.; per oz., 10c., per lb., \$1.00.

Tennis Ball Black Seeded. One of the earliest; forms a close, hard head, not large, but very tender and crisp. Price per pkt., 5c.; per oz., 10c.; per lb., \$1.00.

Boston Market or White Seeded Tennis Ball. Grows very compact, one of the best for forcing. Price per pkt., 5c.; per oz., 10c.; per lb., \$1.00.

Big Boston. Large head, excellent for forcing. Price per pkt., 5c.; per oz., 10c.; per lb., \$1.00.

Grand Rapids. This is a very large, thin-leaved, curly-head lettuce. Price per pkt., 5c.; per oz., 10c.; per lb., 80c.

LETTUCE—Continued.

Salat—Lechuga—Lattuga.

Early Curled Silesia. Very early, tender and crisp; forming close center but not heading. Price per pkt., 5c.; per oz., 10c.; per lb., 80c.

Early Curled Simpson. Resembles Silesia, but grows larger. Price per pkt., 5c.; per oz., 10c.; per lb., 90c.

Black Seeded Simpson. It does not properly form a head, but a compact mass of leaves; stands the summer heat excellently, and attains a large size. Price per pkt., 5c.; per oz., 10c.; per lb., \$1.00.

Denver Market. It forms large solid heads of a good light green color. Price per pkt., 5c.; per oz., 10c.; per lb., 90c.

White Summer Cabbage. A fine large-headed variety, and one of the best for garden culture. Price per pkt., 5c.; per oz., 10c.; per lb., 80c.

Hubbard Market. A large white cabbage variety; equally valuable for forcing or open ground. Price per pkt., 5c.; per oz., 10c.; per lb., \$1.00.



Paris White Cos Lettuce.

Satisfaction or Salamander. One of the best for summer use, forming good-sized, compact heads. Price per pkt., 5c.; per oz., 10c.; per lb., \$1.00.

Hanson. Heads very large and solid, sometimes weighing two or three pounds. Price per pkt., 5c.; per oz., 10c.; per lb., \$1.00.

Continuity. Is a brown variety, superior to any other of the brown sorts, in quality, size, solidity and duration of edible condition. Price per pkt., 5c.; per oz., 20c.; per lb., \$2.00.

Brown Dutch. Round head, leaves edged with brown, very hardy and good quality. Price per pkt., 5c.; per oz., 10c.; per lb., \$1.00.

Paris White Cos. This grows upright, with long, narrow leaves, and should be tied up to blanch a week or more before cutting. Price per pkt., 5c.; per oz., 15c.; per lb., \$1.25.

MUSK-MELON.

Cantalupe—Melon Muscatel

—Phone o Mellone.

Culture. Plant in the spring, in hills five or six feet apart each way, well manured with old rotton compost. Scatter a dozen seeds to the hill, and after they are out of danger from bugs, thin to three or four plants. A light, dry, sandy soil and a dry atmosphere are most suitable. Melons should not be planted near any other varieties if it is desired to preserve them pure.

Rocky Food. This is an oval-shaped melon of medium size and thickly netted. The flesh is green, firm, sugary and of exquisite flavor. Price per pkt., 5c.; per oz., 10c.; per lb., \$1.00.

The Petoskey or Paul Rose Musk-melon. It is a cross between the Osage and Netted Gem, and combines the best features of the originals. The fruit is oval, medium size, dark exterior, thickly netted; with rich salmon flesh, so thick as to nearly close the seed cavity. Price per pkt., 5c.; per oz., 10c.; per lb., \$1.25.

Osage or Miller's Cream. This is a popular variety, medium size, thick, hard, salmon flesh, decidedly rich and sugary. Price per pkt., 5c.; per oz., 10c.; per lb., \$1.00.

Delmonico. Flesh, an orange pink color. The melons are oval shaped and very deeply netted. Price per pkt., 5c.; per oz., 10c.; per lb., \$1.00.

Emerald Gem. This variety is small, but prolific. Has a thin green rind and very small seed cavity, almost the entire body of the fruit consisting of rich, luscious meat of a salmon color. Price per pkt., 5c.; per oz., 15c.; per lb., \$1.50.

Hacksack. It attains a large size, is round in shape flattened at the ends, green flesh, most deliciously flavored and wonderfully productive. Price per pkt., 5c.; per oz., 10c.; per lb., \$1.00.

Anne Arundel or Acme. Very large round, flattened at both ends, flesh green, thick and fine flavored. Price per pkt., 5c.; per oz., 10c.; per lb., \$1.00.

Golden Netted Gem. Flesh light green in color, and of fine luscious flavor, skin green, regularly ribbed and thickly netted. Price per pkt., 5c.; per oz., 10c.; per lb., \$1.00.

Surprise. Skin cream colored, thickly netted; flesh thick, of bright salmon color, and excellent flavor; early and fair size. Price per pkt., 5c.; per oz., 10c.; per lb., \$1.00.

Tip-Top Nutmeg. This is a very large melon, deeply ribbed, and thickly netted skin. The flesh is green, thick, very sweet and delicious. Price per pkt., 5c.; per oz., 10c.; per lb., \$1.00.

Nutmeg. Grows to a good size, nearly round, thickly netted, green flesh. Price per pkt., 5c.; per oz., 10c.; per lb., \$1.00.

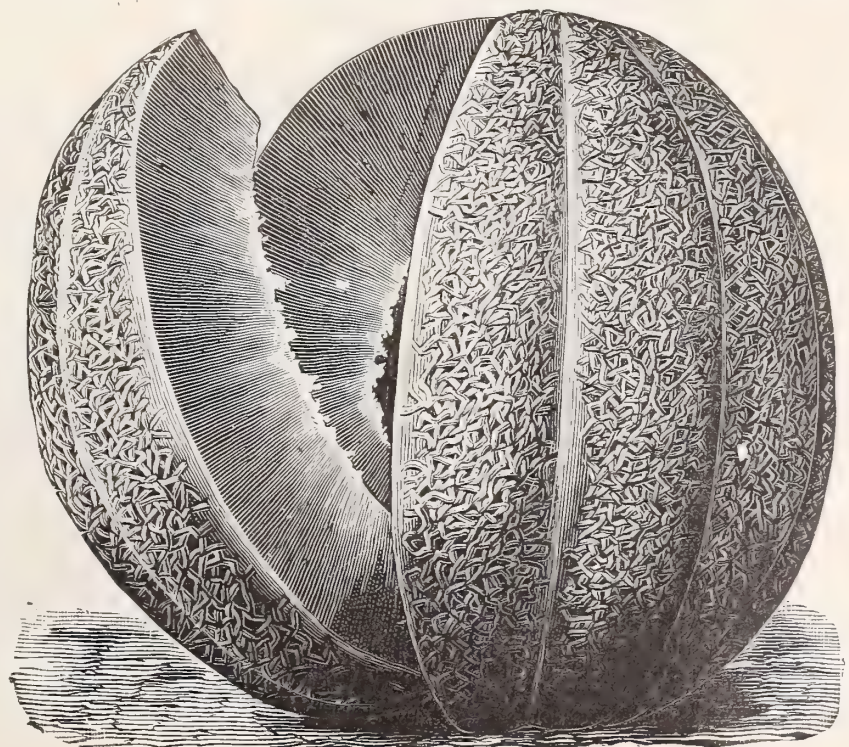

Osage.

*Martynia.*

MARTYNIA.

The seed pods are used to a considerable extent for pickling, when gathered green and tender. Sow in the open ground in May, and transplant two feet apart. **Martynia Proboscidea.** Price per pkt., 5c.; per oz., 25c.; per lb., \$2.50.

WATER-MELON.

Wassermelone—Zandia—Anguria o Mellone.

Culture. Plant in hills six or eight feet apart, in May. Select warm, light, dry ground, and in preparing the hills let them be dug out as broad and deep as the soil will admit; fill at least one-third full of the best decomposed stable manure, and mix thoroughly with the soil; fill up a little above the level of the ground.

Cole's Early. A striped early variety, nearly round, medium size, crimson flesh of superior quality. Price per pkt., 5c.; per oz., 10c.; per lb., 60c.

Phinney's Early. Flesh deep red; superior quality, early and productive. Price per pkt., 5c.; per oz., 10c.; per lb., 60c.

Hungarian Honey. This is a small melon with dark green exterior. It is richer and sweeter than any other water-melon, ripening thoroughly up to within one-fourth inch of the outer skin. The seeds are very small. It is early and very productive. Price per pkt., 5c.; per oz., 10c.; per lb., 60c.

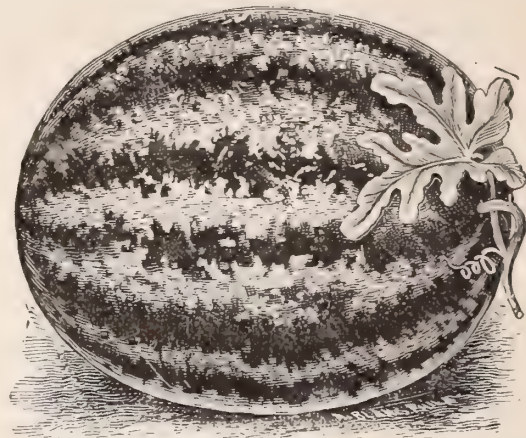
*Cole's Early.*

Kleckley Sweets or Monte Cristo. (See Novelties page 4). Price per pkt., 5c.; per oz., 10c.; per lb., 75c.

Jordan Gray Monarch. The skin is a mottled gray, shape long, flesh bright crimson. Price per pkt., 5c.; per oz., 10c.; per lb., 50c.

Seminole. It is oblong in shape. Two colors, gray and light green. Melons of both colors are frequently found on the same vine. It is extra early, large and productive. Price per pkt., 5c.; per oz., 10c.; per lb., 50c.

Dixie. It is productive, fine-quality and fine flavor. It has a remarkably hard but very thin rind. Price per pkt., 5c.; per oz., 10c.; per lb., 60c.

Sweet Heart. Mottled light green; large, oval, heavy; red flesh; fine shipper. Price per pkt., 5c.; per oz., 10c.; per lb., 60c.

Kolb's Gem. This is a striped oblong melon, of large size, solid, and rich in quality. Price per pkt., 5c.; per oz., 10c.; per lb., 50c.

The Triumph. Rind dark green color. Seed large and dark. The flesh is bright red. It is very early, large and prolific. Price per pkt., 5c.; per oz., 10c.; per lb., 60c.

Pride of Georgia. Dark green in color, nearly round, and grows partly upon its end. Flesh bright crimson and very fine white seeds. Price per pkt., 5c.; per oz., 10c.; per lb., 50c.

Ice Cream or Peerless. White seed; of medium size, early; green skin, very thin rind; flesh solid, scarlet, crisp. Price per pkt., 5c.; per oz., 10c.; per lb., 50c.

Cuban Queen. This is a large variety; skin is striped, flesh bright red, remarkably solid. Price per pkt., 5c.; per oz., 10c.; per lb., 50c.

Mountain Sweet. One of the best for general culture; color dark green; rind thin; flesh solid, scarlet, sweet and delicious. Price per pkt., 5c.; per oz., 10c.; per lb., 50c.

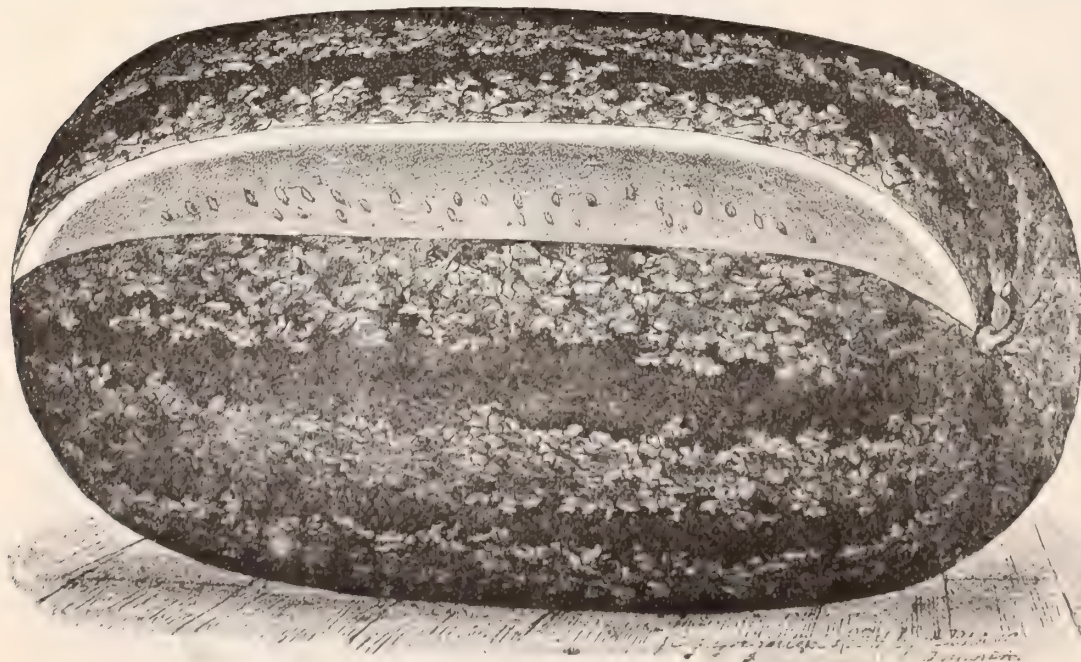
*Dixie.*

Citron for Preserves and Sweetmeats. Round, striped, very productive. Price per pkt., 5c.; per oz., 10c.; per lb., 75c.

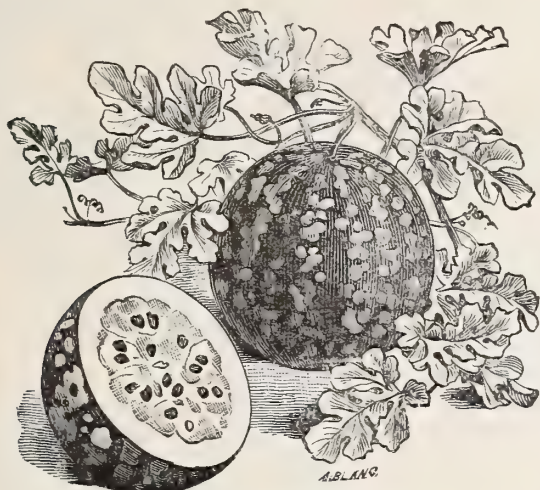

Citron for Preserving.

Colorado Preserving Citron. Grows to a very large size, often thirty to forty pounds; flesh very firm and solid. Price per pkt., 5c.; per oz., 10c.; per lb., 75c.

MUSHROOM SPAWN.

Champignonbrut—Seta—Funghi.

Mushrooms may be cultivated much easier than is generally supposed. They may be grown in a cellar or shed, or in beds prepared in the open air in the same



Mushrooms.

manner as hotbeds. Price per lb., 12c.; 10 lbs. for \$1.00, in bricks.

MUSTARD.

Senf—Mostaza—Mortarda.

Sow in April, in drills a foot apart, and thin out moderately when about three inches high.

White London. The seed is ground and used for various purposes. Used for salads or greens. Price per oz., 5c.; per lb., 20c.

Brown or Black. More pungent in flavor than the white. Price per oz., 5c.; per lb., 20c.

New Chinese. Leaves twice the size of the ordinary White Mustard. Price per pkt., 5c.; per oz., 10c.; per lb., 60c.

NASTURTIUM OR INDIAN CRESS.

Nasturtium—Maraneula—Narturzio.

Plant in April and May in rows; the climbing varieties to cover some trellis, or twine around poles or other support; the dwarf kind in rows or hills, three feet apart, along a border or walk. The seeds, when tender enough to be easily punctured by the finger nail, are used for pickles.

Dwarf. Mixed. This grows from six inches to a foot in height. Price per pkt., 5c.; per oz., 10c.; per lb., 80c.

Tall. Mixed. An ornamental climber. From six to ten feet. Price per pkt., 5c.; per oz., 10c.; per lb., 80c.



White Velvet Okra.

OKRA OR GOMBO.

Safran—Quimbon.bo—Othro.

Select warm, rich soil and plant in rows two feet apart, thinning plants a foot apart in the row. The pods are used to thicken soups, being gathered young. Okra is preserved for winter use by slicing the pods into rings and drying them upon strings hung up and exposed to the air.

White Velvet. Pods round, smooth, free from seams, very prolific. Price per pkt., 5c.; per oz., 10c.; per lb., 40c.

Dwarf Green Prolific or Density. A very dwarf and prolific variety. Pods green, smooth and thickly set. Price per pkt., 5c.; per oz., 10c.; per lb., 40c.

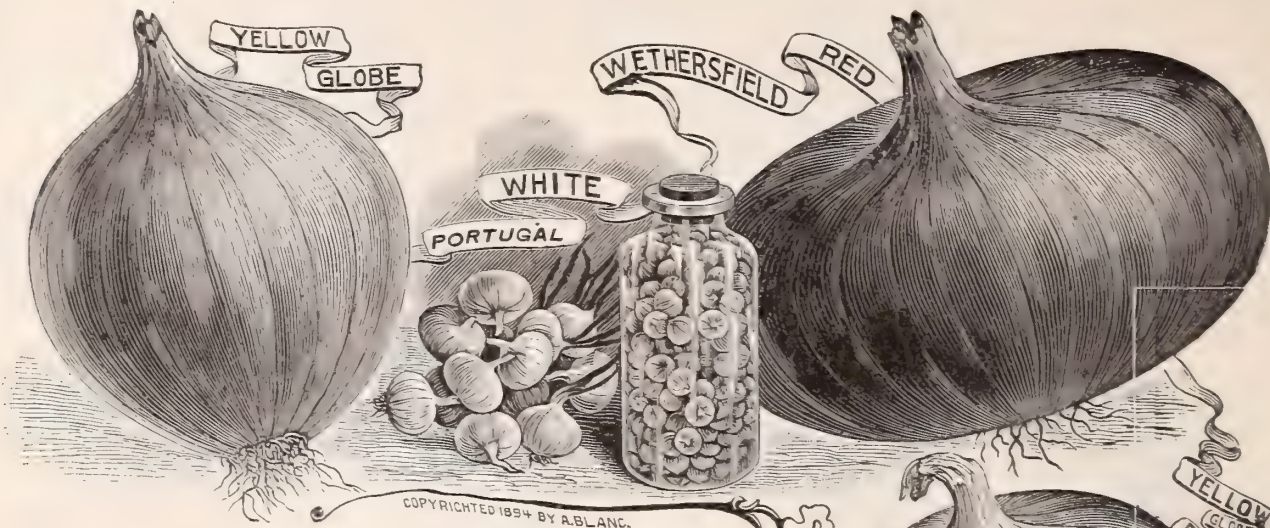

ONIONS.

Zwiebel—Cebolla—Cipolle.

Onion seeds should be sown as early as it is possible to work the ground, in drills one inch deep and twelve to sixteen inches apart, in rich soil, deeply dug and lightly rolled. Thin to one inch apart. When sowing for sets, seeds must be put in very thick, at the rate of about twenty pounds to the acre. The same patch may be used year after year for onions and never made too rich.

Danvers Yellow Globe. Large, nearly round, and productive; very mild, ripens early, and is a good keeper. Price per pkt., 5c.; per oz., 15c.; per lb., \$1.00.

Southport Yellow Globe. My seed of this valuable, heavy, cropping sort is raised from the finest Southport Onions. Price per pkt., 5c.; per oz., 15c.; per lb., \$1.25.

Yellow Dutch or Strasburg. Large and flat. A great yielder. Sown extensively for sets. Price per pkt., 5c.; per oz., 10c.; per lb., \$1.00.

Large Yellow Spanish or Prize Taker. They are rich straw color and of enormous size. The flavor is mild and delicate. Price per pkt., 5c.; per oz., 15c.; per lb., \$1.25.

Australian Brown. Nearly round, medium size, with skin of a deep amber brown, extremely hard and firm, of fine flavor and will keep almost indefinitely. Price per pkt., 5c.; per oz., 10c.; per lb., \$1.00.

Extra Early Red. About ten days earlier than Large Red. Price per pkt., 5c.; per oz., 15c.; per lb., \$1.25.

Large Red Wethersfield. A large flat variety, keeps well, and is mild in flavor. Price per pkt., 5c.; per oz., 15c.; per lb., \$1.25.

Southport Red Globe. This is a large, round, deep red-skinned variety; very mild, good keeper. Price per pkt., 5c.; per oz., 15c.; per lb., \$1.50.

Southport White Globe. In form nearly ovoid, very regular and symmetrical; skin white, mild and pleasant flavor. Price per pkt., 5c.; per oz., 15c.; per lb., \$1.50.

White Portugal or Silver Skin. Very early, mild flavor, prized for pickling. Price per pkt., 5c.; per oz., 20c.; per lb., \$2.00.

ONION SETS.

Onion sets, both rare-ripes and tops, are placed on the surface, in shallow twelve-inch drills, about four inches apart, and lightly covered. Potato onions are planted in spring or fall, as they will survive the winter. By this process early onions may be obtained several weeks earlier than from seed.

White Onion Sets. Per qt., 15c.

Yellow Onion Sets. Per qt., 15c.

Red Onion Sets. Per qt., 15c.

Potato Onion Sets. Per qt., 20c.

Egyptian or Perennial Tree. Per qt., 15c.

Shallots. Per qt., 15c.

For sets in quantity, get special quotations, as prices vary during the season of planting.



RADISH—Continued.

Extra Early Scarlet Forcing Turnip. Matures in about twenty days. Bright red, globe shaped, small leaved. Price per pkt., 5c.; per oz., 10c.; per lb., 60c.

Extra Early Scarlet Forcing (White Tipped.) It is a week earlier than Scarlet Turnip. Its shape is perfectly globular, with rich, deep scarlet top, blending into pure white at the bottom. It is fit to pull in three weeks from sowing. Price per pkt., 5c.; per oz., 10c.; per lb., 60c.

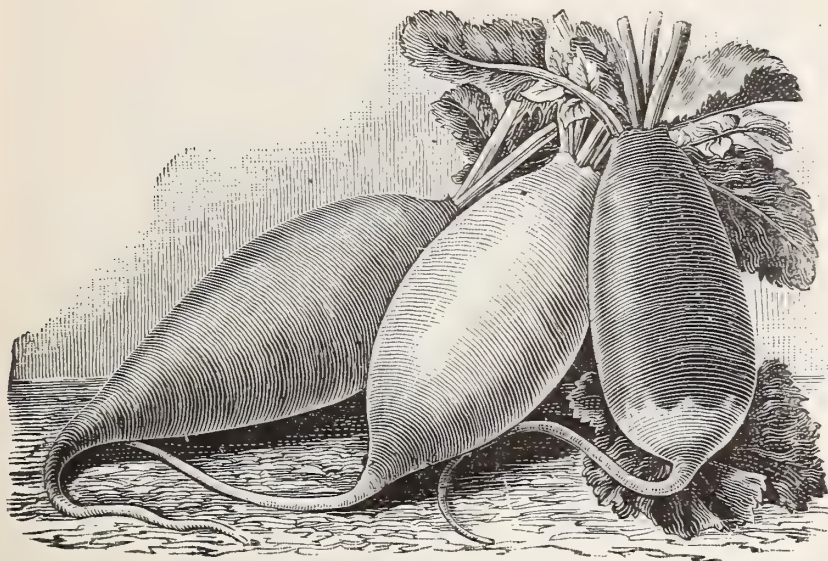

Olive-Shaped Radishes.

Early Scarlet Globe. One of the best for forcing, perfectly round, bright cardinal color. Price per pkt. 5c.; per oz., 10c.; per lb., 60c.

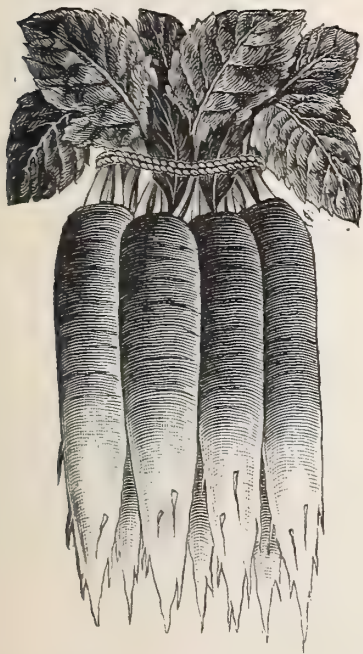

Chartier.

ing, but darker skin. Price per pkt., 5c.; per oz., 10c.; per lb., 60c.

New Icicle. (See Novelties, page 5.) Price per pkt., 10c.; per oz., 20c.; per lb., \$2.00.

Early Scarlet Turnip (White Tipped.) Early, fine grain and flavor; round, with white tip. Price per pkt., 5c.; per oz., 10c.; per lb., 50c.

Early Scarlet Turnip. Small, round, mild and crisp; a standard early sort. Price per pkt., 5c.; per oz., 10c.; per lb., 40c.

Deep Scarlet Turnip. Very early and a good forcing variety. Price per pkt., 5c.; per oz., 10c.; per lb., 40c.

Triumph Radish. (See Novelties, page 5.) Price per pkt., 10c.; per oz., 30c.

White Summer Turnip. Same shape as Scarlet Turnip, but pure white. Price per pkt., 5c.; per oz., 10c.; per lb., 50c.

Gray Summer Turnip. Similar to the preceding

Early Long Scarlet Short Top. Bright red color, very small. Price per pkt., 5c.; per oz., 10c.; per lb., 40c.

French Breakfast. A quick growing, oval-shaped radish, light color and white tip. Price per pkt., 5c.; per oz., 10c.; per lb., 50c.

Early Olive-Shaped Scarlet. Very early, oblong in shape. Price per pkt., 5c.;

per oz., 10c.; per lb., 40c.

White Strasbourg. Pure white, firm and brittle; grows to a large size. Price per pkt., 5c.; per oz., 10c.; per lb., 60c.

Chartier. It is an early summer variety; deep pink, blending into a pure, waxy white at the roots. Price per pkt., 5c.; per oz., 10c.; per lb., 60c.

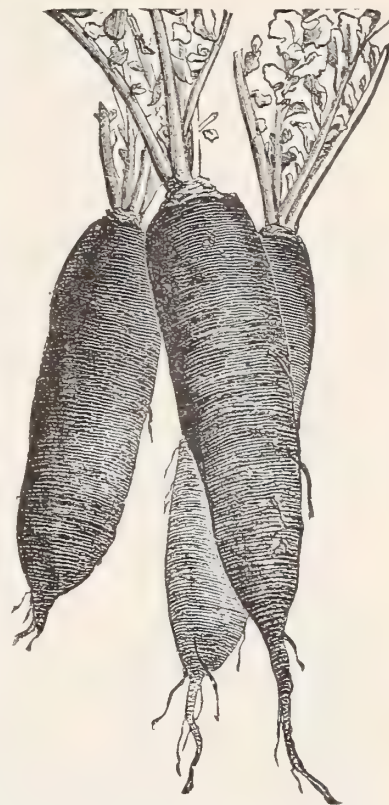

Black Spanish or Fall Radish.

Winter Radishes.

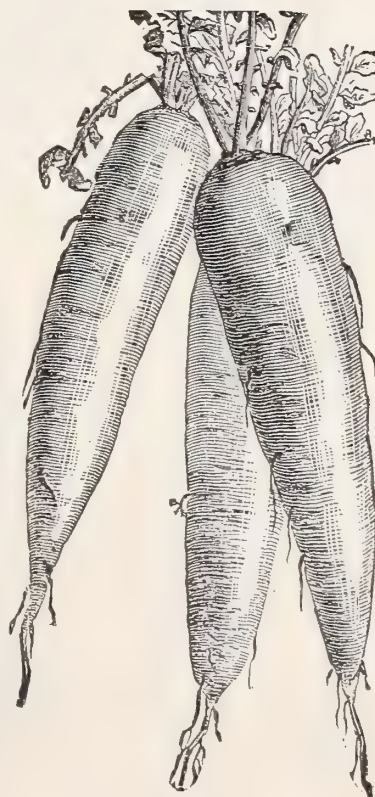

California Mammoth White.

Black Spanish or Fall. (Round.) For winter use; texture firm and solid. Price per pkt., 5c.; per oz., 10c.; per lb., 50c.

Black Spanish or Fall. (Long.) Like the above, differing only in shape. Price per pkt., 5c.; per oz., 10c.; per lb., 50c.

China Rose or Winter. Very fine for winter use; large and tender. Price per pkt., 5c.; per oz., 10c.; per lb., 60c.

California Mammoth White. A winter sort, grows eight to ten inches long, and keeps well. Price per pkt., 5c.; per oz., 10c.; per lb., 60c.

RAPE--English.

Dwarf Essex, forage plant of great value. Of rapid and luxuriant growth, attaining a height of two or three feet. It may be sown throughout the season, and in a few weeks from sowing, stock can be turned in on it. For broadcasting, sow ten pounds to the acre; in drills, five pounds.

Used also for greens and salad. Price per lb., 12c.; ten pounds for \$1.00.

Salsify or Oyster Plant.

Haferwurzel—Ostion Vegetal—Sassefrica.



Salsify or Oyster Plant.

crop should be sown from the middle of August to the beginning of September. It should always be sown in drills from one to two inches deep, and from twelve to eighteen inches apart, scattering the seed thinly and covering them with the finest of soil. Protect the winter crops on the approach of severe frosts.

Norfolk Savoy Leaved. (Bloomsdale.) It is very productive and the hardiest of all the smooth-leaved varieties. Price per pkt., 5c.; per oz., 10c.; per lb., 30c.; ten pounds and over, at 25c.

Victoria. It is a very large, crumpled-leaved, dark green plant, spreading well on the ground. Price per pkt., 5c.; per oz., 10c.; per lb., 40c.; ten pounds and over, at 35c.

Improved Large Round Leaf. A variety with very thick leaves. Price per pkt., 5c.; per oz., 10c.; per lb., 30c.; ten pounds and over, at 25c.

Sow in early spring, in light, rich soil, in drills fourteen inches apart; thin the plants to three inches in the row. The roots will be ready for use in October, and, like the parsnip, improve by remaining in the ground through the winter.

Mammoth Sandwich Island. Roots grow long, large, smooth and white. Price per pkt., 5c.; per oz., 10c.; per lb., \$1.00.

Long White French. The standard variety. Price per pkt., 5c.; per oz., 10c.; per lb., \$1.00.

SPINACH.

Spinat—Espinaca—Spinaci.

Culture. For the summer crop, sow early in March, and at intervals of a fortnight, till the middle of July, in quantities according to the demand. The round-seeded varieties are the best for summer use. The winter

Giant Thick Leaf or Round Viroflay. Similar to the lettuce-leaved, but much larger in habit of growth. Price per pkt., 5c.; per oz., 10c.; per lb., 35c.; ten pounds and over, at 30c.



Giant Thick Leaf or Round Viroflay.

Long Standing. A fine round-leaved summer variety, slow to run up its seed stalks. Price per pkt., 5c.; per oz., 10c.; per lb., 35c.; ten pounds and over, at 30c.

Prickly or Fall. The hardiest variety; leaves thick and triangular in form. Price per pkt., 5c.; per oz., 10c.; per lb., 30c.; ten pounds and over, at 25c.

SQUASH.

Speise Kürbiss—Calabaza—Zucche.

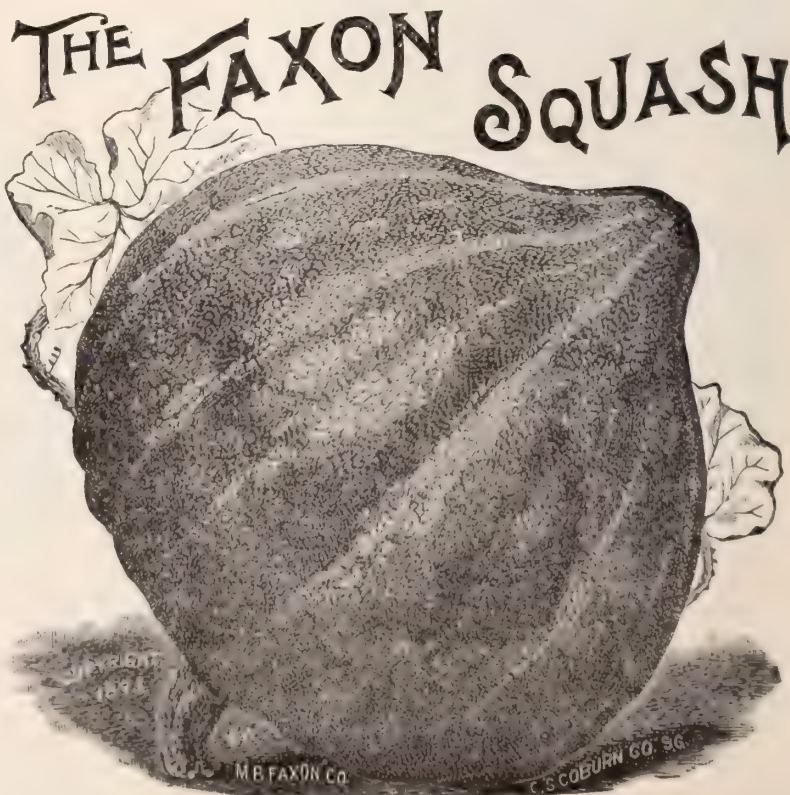

SQUASH—Continued.

The squash is a very tender vine, and so sensitive to the cold that it cannot with safety be planted out until the weather becomes warm and settled. Plant in hills ten feet apart for running varieties; five feet for bush sorts; working some fine rich manure into each hill. Sprinkle liberally with plaster, wood ashes, or air-slacked lime, in the early stages of growth. Cultivate until runners are well started.

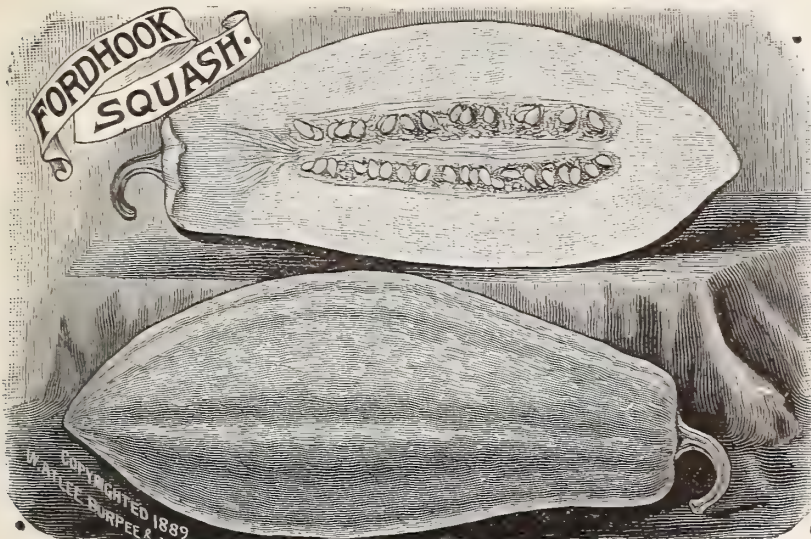

Yellow Bush Scallop Summer. One of the earliest; grows flat, with scallop edges, and is a good market sort. Price per pkt., 5c.; per oz., 10c.; per lb., 60c.

White Bush Scallop. Like the above in everything except color, which is creamy white. Price per pkt., 5c.; per oz., 10c.; per lb., 60c.

Early Summer Crookneck Bush. Early and productive; the best kind for summer use. Price per pkt., 5c.; per oz., 10c.; per lb., 65c.

Pineapple. It is very peculiar and distinctive in shape; the skin is a cream white. Good both for summer and winter. Price per pkt., 5c.; per oz., 10c.; per lb., 60c.

Cocoanut. This is very prolific, producing from six to twelve on a vine; the flesh fine grained and solid. Price per pkt., 5c.; per oz., 10c.; per lb., 75c.

Boston Marrow. A superior fall squash, of rich orange color and very productive. Price per pkt., 5c.; per oz., 10c.; per lb., 60c.

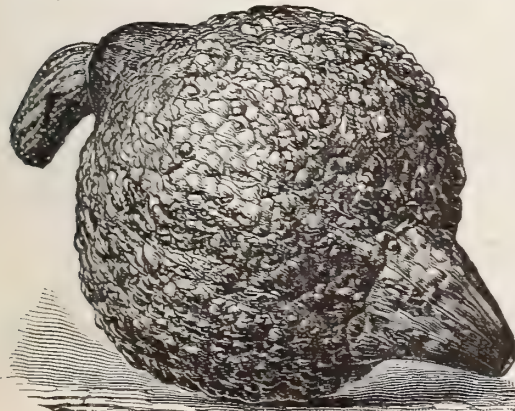

New Red or Golden Hubbard.

Hubbard. Dark green, hard shelled variety; flesh fine grained, dry and of good flavor. Price per pkt., 5c.; per oz., 10c.; per lb., 70c.

Warted Hubbard. Similar in shape and color to the original Hubbard Squash, but developing at least one-third to one-half larger fruits in great abundance, with hard, roughly warted surface. Quality of flesh is equal to any of its class. Price per pkt., 5c.; per oz., 10c.; per lb., 75c.

New Red or Golden Hubbard. A reproduction of the old Green Hubbard except in color, which is a bright, deep orange yellow. Flesh, deep golden yellow, much richer in color than Hubbard; fine grain, cooks very dry, and is of excellent flavor. Its keeping qualities and productiveness are unexcelled. Price per pkt., 5c.; per oz., 10c.; per lb., 80c.

Giant Crookneck. (Summer.) Grows about double the size of the Early Summer Crookneck and is about as early. Price per pkt., 5c.; per oz., 10c.; per lb., 60c.

Michigan. (See Novelties, page 8). Price per pkt., 10c.; per oz., 25c.; per lb., \$3.00.

Fordhook. Of a light yellow color outside, and straw yellow within. The flesh is sweet and fine grained. Price per pkt., 5c.; per oz., 10c.; per lb., 80c.

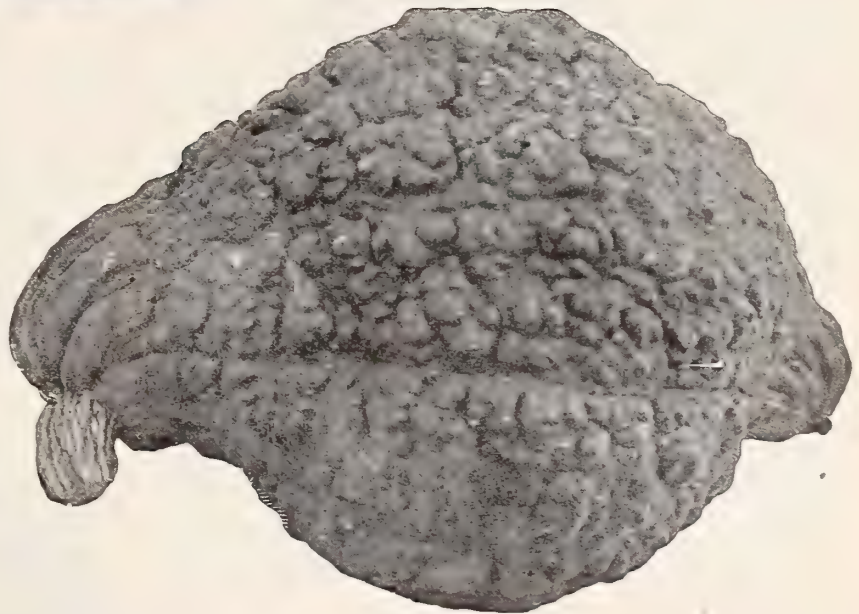

Warted Hubbard.

Delicata. (See Novelties, page 6). Price per pkt., 5c.; per oz., 10c.; per lb., 60c.

Perfect Gem. From four to six inches in diameter, of a creamy yellow color, slightly ribbed, thin, smooth skin, fine grained and sweet. Price per pkt., 5c.; per oz., 10c.; per lb., 60c.

Cocozella. (See Novelties, page 6). Price per pkt., 5c.; per oz., 10c.; per lb., 90c.

The Faxon. Medium size, winter variety; orange flesh of fine quality. Price per pkt., 5c.; per oz., 10c.; per lb., 80c.

Winter Crookneck. Flesh close grained, sweet and fine flavored. Price per pkt., 5c.; per oz., 10c.; per lb., 50c.

Pike's Peak or Sibley. Fine grain and wonderfully productive. The flesh is thick and rich colored, shell hard and flinty. Price per pkt., 5c.; per oz., 10c.; per lb., 60c.

The Delicious Squash. (See Novelties, page 7). Price per pkt., 15c.; 4 for 50c.

SQUASH—Continued.

Golden Bronze. (See Novelties, page 7). Price per pkt., 5c.; per oz., 10c.; per lb., \$1.00.

Essex Hybrid. This is a cross between the Turban and the Hubbard, having the shape of the former and the shell of the latter. Price per pkt., 5c.; per oz., 10c.; per lb., 65c.

Bay State. Flattened at ends, skin blue green, flesh rich yellow and quality fine. Price per pkt., 5c.; per oz., 10c.; per lb., 80c.

TOBACCO.

Sow the seed in frames the latter part of March, or in open ground when the soil has become settled and warm. Keep well watered, and when the plants are two inches high they may be transplanted in rows three feet apart each way. Tobacco requires a very rich, light, mellow soil.

Connecticut Seed Leaf. The popular kind cultivated in this vicinity, and produces a very heavy crop of fine broad leaves. Price per pkt., 5c.; per oz., 20c.; per lb., \$2 00.



Tobacco.

Havana. An excellent variety; leaves narrow, long and pointed. Price per pkt., 5c.; per oz., 20c.; per lb., \$2.50.

TOMATO.

Liebesapfel—Tomates—Pomodoro.

To obtain fruit very early, sow the seeds in greenhouse during February or March, or in hotbed when season has sufficiently advanced. In about five weeks plants should be transplanted to another hotbed, until about the middle of May; they may be put into the ground in hills about four feet apart each way. The richer the soil the ranker will be the growth of vines, but an ordinary, warm, light soil, with fine, well-rotted manure in the hill, and a sunny location, will produce the more handsome and plentiful fruit.

Dwarf Champion. It stands up well, having a stiff bush stem. The crop ripens early and evenly. It is a good cropper, smooth, medium in size; in color, purple, tinged with crimson. Price per pkt., 5c.; per oz., 20c.; per lb., \$2.00.

The Aristocrat. An exceedingly dwarf variety; the color of the fruit is fine rich, glossy red. It is solid and smooth, and in size from medium to large. Valuable for forcing. Price per pkt., 5c.; per oz., 25c.; per lb., \$2.50.

Earliana. Is not only remarkable for its earliness but for its very large size, handsome shape and bright red color. Price per pkt., 5c.; per oz., 30c.; per lb., \$3.00.



Fordhook. Extra early, purple tinged; fine, smooth, solid; medium size. Price per pkt., 5c.; per oz., 20c.; per lb., \$2.00.

Matchless. Extra large, smooth, bright, red and solid. Price per pkt., 5c.; per oz., 25c.; per lb., \$2.50.

Golden Queen. A good yellow sort, of first quality. It is solid, very smooth, large in size; ripens early. Price per pkt., 5c.; per oz., 30c.; per lb., \$3.00.



Livingston's Stone.

TOMATO.—Continued.

Atlantic Prize. Very early; smooth, bright red and solid. Price per pkt., 5c.; per oz., 20c.; per lb., \$1.75.

Livingston's Stone. Bright scarlet, very smooth, ripening evenly to the stem; solid and firm fleshed. Price per pkt., 5c.; per oz., 25c.; per lb., \$2.50.

Livingston's Beauty. Dark red, large size, smooth and fair. Price per pkt., 5c.; per oz., 20c.; per lb., \$2.00.

Essex Hybrid. Color purplish red, ripening throughout with great uniformity. Price per pkt., 5c.; per oz., 20c.; per lb., \$1.75.

Acme. Very prolific; in color a purplish crimson; very smooth and solid. Price per pkt., 5c.; per oz., 20c.; per lb., \$2.00.

Livingston's Favorite. Is large and smooth, bright red. Does not crack after ripening. It has very few seeds and is very productive. Price per pkt., 5c.; per oz., 20c.; per lb., \$2.00.

Trophy. This fine tomato is large in size, bright red, solid, smooth; a great yielder. Price per pkt., 5c.; per oz., 20c.; per lb., \$1.75.

Buckeye State. Very solid; color, deep purplish red, and very large in size. Price per pkt., 5c.; per oz., 20c.; per lb., \$2.00.

Livingston's "Magnus." (See Novelties, page 8). Price per pkt., 5c.; per oz., 30c.; per lb., \$4.00.

Mikado. The tomatoes are perfectly solid, generally smooth, but somewhat irregular. The color is purplish red, foliage distinct; coarse leaved. Price per pkt., 5c.; per oz., 25c.; per lb., \$2.50.

Ponderosa. This excels in size, weight and solidity. Its color is light crimson, and almost seedless. Price per pkt., 5c.; per oz., 40c.; per lb., \$3.50.

Honor Bright. Its chief peculiarities are its solidity, and changes of color the fruit undergoes during development; first it is light green, then an attractive waxy white, then lemon, changing to red. It is one of the longest keeping varieties. Price per pkt., 5c., per oz., 25c.; per lb., \$2.50.

Peach. Resembles a peach in shape, size and color; beautifully blended and covered with a delicate bloom like a peach. Price per pkt., 5c.; per oz., 20c.; per lb., \$2.00.

Yellow Pear. Pear shaped and used for pickling or preserving. Price per pkt., 5c.; per oz., 25c.; per lb., \$2.50.

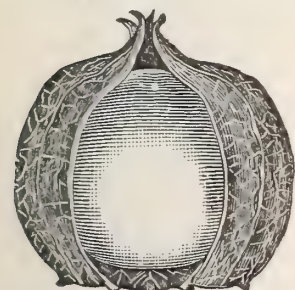

Strawberry or Ground Cherry.

5c.; per oz., 25c.; per lb., \$2.50.

Strawberry or Ground Cherry. This, unlike other varieties, grows in a husk or pod, and may be kept all winter if the husks are not removed. The fruit is yellow and has a very sweet, pleasant flavor; may be eaten raw, but is generally used for preserves. Price per pkt., 5c.; per oz., 30c.; per lb., \$3.00.

Red Cherry. A small, round, red tomato; size and shape like a cherry. Price per pkt.,

TURNIP.

Rübo—Nabo—Rape.

For early use, sow as soon as the ground can be worked in the spring, in drills fourteen inches apart, covering but slightly, except in dry weather. The soil should be light and, if possible, new. Manure with plaster, ashes or phosphate. Thin the early varieties to six inches apart, and the Ruta Bagas from eight to ten inches. For fall and winter use, the early kinds should be sown in July and August, and the Ruta Bagas through June. Hoe them a month after sowing.



White Egg.

growing broader and rough edged. Price per pkt., 5c.; per oz., 10c.; per lb., 40c.

Early White Strap Leaf. A good flat turnip for early or late culture, and grows to a large size. Price per pkt., 5c.; per oz., 10c.; per lb., 40c.

Early Red-Top Strap Leaf. This is similar to the preceding in all respects except the top of the turnip, which is red or purple where exposed above ground. Price per pkt., 5c.; per oz., 10c.; per lb., 35c.

Scarlet Kashmir. (See Novelties, page 7). Price per pkt., 5c.; per oz., 10c.; per lb., 75c.

Long White or Cow Horn. A long, quick, growing turnip, fine grained, tender and sweet. Price per pkt., 5c.; per oz., 10c.; per lb., 50c.

Red Top White Globe. It is a white turnip with a red top. Price per pkt., 5c.; per oz., 10c.; per lb., 40c.

Golden Ball. Rapid grower, globe shaped, and of a deep yellow color. Price per pkt., 5c.; per oz., 10c.; per lb., 40c.

Yellow Stone. This is a small, early fall variety of light yellow color. Price per pkt., 5c.; per oz., 10c.; per lb., 40c.

White Egg. (See Novelties, page 7). It is an early, very smooth, fine, hard grained, white oval turnip, as its name indicates, and unsurpassed for table use. Price per pkt., 5c.; per oz., 10c.; per lb., 50c.

Early White Milan. A flat, pure white, very fine grain, extra early. Price per pkt., 5c.; per oz., 10c.; per lb., 50c.

Extra Early Purple Top Milan. This is a pure white fleshed early sweet purple top variety. Best of all for forcing. Price per pkt., 5c.; per oz., 10c.; per lb., 50c.

Early White Flat Dutch. A fine garden variety, differing from White Strap Leaf only in the shape of its leaf, this

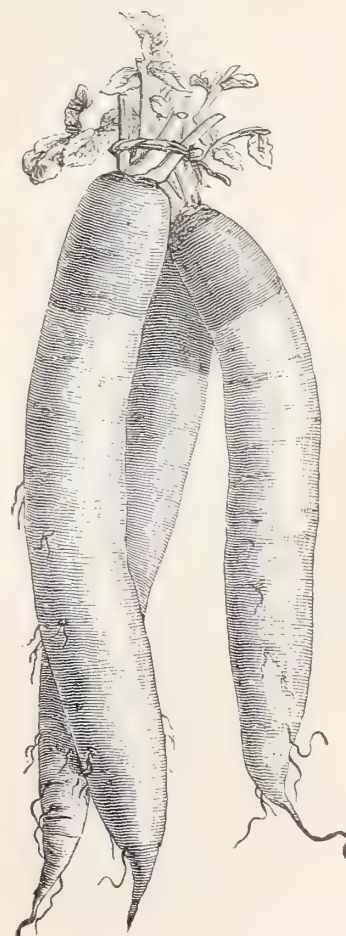

Long White or Cow Horn.

TURNIP.—Continued.



Early Red-Top Strap Leaf.

Yellow Globe. This grows to a large size, and is one of the best for general crop. Price per pkt., 5c.; per oz., 10c.; per lb., 40c.

Yellow Aberdeen. (Green Top). This is globe-shaped, and a good keeper. Price per pkt., 5c.; per oz., 10c.; per lb., 40c.

Swedish or Ruta-Baga Varieties.

Rhode Island Rock. A white fleshed hard, fine grained sweet variety possessing exceptional keeping qualities, which together with its quick maturing habit gives it advantages over the Breadstone and White French. Price per pkt., 5c.; per oz., 10c.; per lb., 60c.

White French. Sometimes called White Rock, on account of its firmness and solidity; flesh pure white, mild, very sweet, and good flavor. Price per pkt., 5c.; per oz., 10c.; per lb., 40c.

Sweet German. White, sweet, and an excellent keeper; very hard and solid. Price per pkt., 5c.; per oz., 10c.; per lb., 40c.

Long Island Smooth Yellow. This is a fine-grained, hard, solid and sweet turnip; green top and good for table use or stock feeding; is very prolific and a good keeper. Price per pkt., 5c.; per oz., 10c.; per lb., 40c.

Yellow French. An old variety; texture very firm and quality excellent; keeps through the winter and till late in the spring. Price per pkt., 5c.; per oz., 10c.; per lb., 40c.

Laing's Improved Ruta Baga. One of the earliest Swedes; a desirable variety, of excellent quality. Price per pkt., 5c.; per oz., 10c.; per lb., 40c.

American Purple-Top Ruta Baga. This is largely grown for feeding stock, but is very popular with the market gardeners for the table. Price per pkt., 5c.; per oz., 10c.; per lb., 50c.

Skirving's Ruta Baga. This has a purple top; yellow, solid and fine grained. Price per pkt., 5c.; per oz., 10c.; per lb., 40c.

SWEET, OR POT AND MEDICINAL HERBS.

A few pot herbs, or sweet herbs, as they are usually called, should have a place in every vegetable garden. A very small space in the garden will give all the herbs needed in any family. The culture is very simple, and the best way is to make a little seed bed in early spring, and set the plants out as soon as large enough in a bed. As a general rule, it is best to cut herbs when in flower, tie them up in small bunches and hang in the shade to dry. The following are a list of herbs most cultivated and prized:

Anise. Price per pkt., 5c.; per oz., 10c.
Balm. Price per pkt., 5c.; per oz., 25c.
Borage. Price per pkt., 5c.; per oz., 15c.; per lb., \$1.00.
Caraway. Price per pkt., 5c.; per oz., 10c.; per lb., 50c.
Coriander. Price per pkt., 5c.; per oz., 10c.; per lb., 75c.

Dill. Price per pkt., 5c.; per oz., 10c.; per lb., 75c.

Horehound. Price per pkt., 5c.; per oz., 30c.

Lavender. Price per pkt., 5c.; per oz., 20c.

Rue. Price per pkt., 5c.; per oz., 20c.

Saffron. Price per pkt., 5c.; per oz., 10c.; per lb., \$1.00.



Sweet Basil.



Sage.

Sage, Broad Leaf English. Price per pkt., 5c.; per oz., 15c.; per lb., \$1.50.

Sweet Basil. Price per pkt., 5c.; per oz., 20c.

Sweet Fennel (Large). Price per pkt., 5c.; per oz., 10c.; per lb., 75c.

Sweet Marjoram. Price per pkt., 5c.; per oz., 20c.; per lb., \$2.00



Thyme.



Sweet Marjoram.

Summer Savory. Price per pkt., 5c.; per oz., 15c.; per lb., \$1.50.

Thyme, Broad Leaf English. Price per pkt., 5c.; per oz., 25c.; per lb., \$2.50.

Wormwood. Price per pkt., 5c.; per oz., 25c.

HOME-GROWN HERBS.

We frequently have calls for **Pure, Home-Grown, Dried Herbs**, and realize that the dirty, dry, hayed materials packed and pressed into small packages and sold for **Pure, Fresh Herbs** are not up to the requirements. They are often **too old and ripe** before cutting, and frequently stock that has been beaten by storms and become too much damaged and gritty to dispose of any other way. There is no good reason why every garden should not have its little patch of herbs from which the daily cuttings can be made, as wanted, all through the summer, and a nice quantity cut at the proper time and cured for winter use, **preserving the fine green, fresh color, strength and aroma so desirable**, but seldom secured in the regular stock packages. Sage, Summer Savory, Thyme, Sweet Marjoram, etc., are so easily managed that it would seem hardly necessary to offer the suggestion, but as we have all these good things in our garden, hope others may appreciate them as we do.

The Frank S. Platt Company's

Choice Selections

... OF ...

Grains, Grasses,

AND

FARM SEEDS.

Special Mixtures

For Lawns, Permanent Pastures or
Hay are Unexcelled.

FARM SEEDS.

Evergreen Broom Corn. Best for general cultivation; brush fine and long. Price per lb., 15c.; per 100 lbs., \$7.00.

Early Amber Sugar Cane. Grows ten to twelve feet high. Price per lb., 15c.; per 100 lbs., \$6.00.

Kaffir Corn. Will make a fine crop for forage if cut in early bloom, and the shoots that then follow will mature a full crop of seed and forage. Both grain and fodder are excellent, the whole stalk tender to the full maturity of seed. The grain is extremely valuable for feeding to poultry and will make a flour that is like wheat. Cultivated the same as our common Indian corn, requiring four or five pounds of seed per acre. Price per lb., 8c.; per 100 lbs., \$5.00.

Flax Seed. Price per lb., 6c.; per 100 lbs., \$4.00.

Sunflower. Mammoth Russian; large heads, grown for seeds. Price per lb., 10c.; per 100 lbs., \$5.00.

Hemp. Price per lb., 6c.; per 100 lbs., \$5.00.

Celery Seeds. For flavoring. Price per oz., 5c.; per lb., 40c.; per 100 lbs., \$25.00.

Spring Vetches or Tares. A specie of the pea, grown extensively in England and to a considerable extent in Canada for stock. Culture same as field peas, two bushels per acre. Price per qt., 15c.; per bu., \$4.50.

Canada Field Peas. See page 31. Price per qt., 10c.; per bu., \$1.75.

Southern Cow Peas. A valuable crop for ploughing under, and especially desirable for light lands. Sow about one and one-half bushels per acre. Price per bu., \$2.00 per bu.

Black, \$2.00 per bu.

Whippoorwill, \$2.50 per bu. **Black Eye,** \$2.50 per bu.

Soja Bean or German Coffee Bean. Its principal value consists in its uses as a forage crop—for feeding green—and for ploughing in as a fertilizer. Price per bu., \$2.50.

Green Soy or Soja Bean. This matures earlier and is consequently better adapted to this climate and latitude than the yellow Soy. Price per bu., \$3.00.



Imperial Barley.



White Rye.

GRAIN. SPRING WHEAT.

China Spring. A white chaff, bearded, standard variety. Price per bu., \$1.75.

White Russian Spring. A light colored variety of red wheat. An enormous cropper, and bears long heads. Price per bu., \$1.75.

WINTER WHEAT.

Golden Straw or Red Chaff. The straw is very strong and stands up well until the grain is matured. The heads are broad, beardless and of good length, with the grains set close together. The chaff is of a golden reddish tint, grains large and very heavy. Is a very heavy stooler; in fact, is a very desirable variety in every respect. Price per bu., \$1.50.

Jones' Early Red Chief (Bald). (See Novelties, page 8) Price per bu., \$2.00.



Japanese Buckwheat.

Hamilton Red. A new variety, being first heard from a year ago in Livingston County, N. Y. This is the ideal wheat for farmers wishing a red colored wheat and heavy yielder. Heads are heavily bearded, compact and of good length; color of chaff, a dark bronze; grains large, very heavy and set closely together. Straw stiff, of medium height, and heavy stooling proclivities. Price per bu., \$1.50.

WINTER WHEAT—Continued.

Red Mediterranean. This is one of the most desirable kinds for this locality; heads bearded, well filled and ripens early. Price per bu., \$1.50.

BUCKWHEAT.

Japanese. The straw is heavier, it branches more, and does not need to be sown as thickly as the other kinds. Price per bu., \$1.25.

Silver Hull. A heavy yielder; the berry is of a light silvery gray color. Price per bu., \$1.50.

Common Gray. An old and well-known variety. Price per bu., \$1.00.

SPRING BARLEY.

Orzo.

Barley. (For cutting, green.) Dairy-men who sow barley with peas early in spring obtain a most nutritious and milk-producing food. It may profitably be sown late in summer, also, as it will stand considerable frost and furnishes a rich pasture clear into November. Price per bu., \$1.25.

Imperial. A six - rowed productive variety; straw tall and stiff, with long, full heads; stools freely. Price per bu., \$1.25.

RYE.

Spring. It is an excellent catch-crop where winter grain has been killed out, making good straw and fair yield. Price per bu., \$1.25.

Choice White. Light colored grain, large kernel, and makes superior flour. Price per bu., \$1.00.

Winter. This is the ordinary variety sown in the fall, but my seed is from choice selected stock. Price per bu., 85c.

OATS.

Avene o Biada.

Lincoln. Enormously productive; early, stiff straw, thin hull and heavy meated, and as near rust proof as any. Price per bu., 90c.

Welcome. A heavy barley oat, with stiff straw. Price per bu., \$1.00.

Choice White. Price per bu., 75c.

Also other improved sorts for spring sowing not here enumerated.



Golden Straw Wheat.

OUR SPECIAL GRASS MIXTURES

GRASS SEED FOR LAWNS, ETC.

In laying out a piece of ground for a lawn, care should be exercised to obtain the proper grade and slope, and perfect the general plan of the grounds before attempting to sow any seed at all. After the correct grade has been obtained, and the surface sufficiently plowed or spaded, it should be thoroughly harrowed to pulverize the lumps, and so left, that there may be at least from five to ten inches of good, rich soil over the whole surface. Then all the roots and loose stones should be removed, and the surface bushed or raked down perfectly smooth and in a suitable condition for successful germination and growth of the fine seed which is used for seeding. The preparation of most lawn seeds is composed of the finest kind of grasses, and for that reason should be sown much thicker than the coarse sorts that are used in field seeding. After sowing the seed, rake or harrow the surface lightly, and then roll thoroughly, to smooth off, and leave in good condition.

PLATT'S EVERGREEN LAWN MIXTURE.

This mixture is the finest in quality that we prepare for general situations. It is composed of a judicious combination of the short fine-growing varieties that have proved most valuable. It is perfectly adapted to the soil and climate of New Haven, as evidenced by the many beautiful lawns and parks that have been developed and seeded with "Platt's Evergreen Lawn Mixture" for twenty-five years. Price per qt., 20c.; per bu., \$4.00.

LAWN GRASS SEED. FINE MIXTURE.

This is composed entirely of indigenous grasses of the finer grades, and in sufficient variety to produce throughout the spring, summer and autumn very satisfactory results. Price per qt., 15c.; per bu., \$3.00.

GRASS SEEDS.

Prices subject to variations. Special quotations for large quantities.

Mixture for Hay and Permanent Pasture. Consists of a number of grasses long recognized as the best combination for this latitude; two bushels per acre. Price per bu. of 20 lbs., \$3.00.

English Rye Grass. (*Lolium Perenne*.) A nutritious, permanent grass for meadows and pas-

tures; also for mixing with others for lawns. Price per qt., 15c.; per bu., \$2.00., per 100 lbs., \$12.00.

Red Top Grass. (*Agrostis Vulgaris*.) (In chaff.) A valuable native, permanent grass, as a mixture in meadows, pastures or lawns, growing in almost any soil, moist or dry, and standing our hot climate. Price per qt., 10c.; per bu., \$1.00.; per 100 lbs., \$7.00.

Red Top, Fancy Cleaned. Absolutely pure seed. Weight thirty-five pounds per bushel. Price per qt., 20c.; per bu., \$6.00.; per 100 lbs., \$14.00.

Rhode Island Bent Grass. (*Agrostis Canina*.) A valuable grass for lawns, sow three or four bushels to the acre for lawns; for pasture, one and one-half to three bushels. Price per qt., 20c.; per bu., \$3.00.; per 100 lbs., \$18.00.



PLATT'S "COUNTRY CLUB GOLF LINKS" GRASS SEED.

A good article for large areas, or seeding the grounds about the new home. It is prepared with a well-balanced proportion of fibrous rooted grasses that alone are the perfect composition of a firm, tenacious turf. These varieties are not selected with especial reference to their height, as that feature is regulated by the lawn mower, but more particularly the turf-forming properties and continuity of development, thus insuring a succession of ripening. Price per qt., 20c.; per bu., \$4.00.

GRASS SEEDS—Continued.

Extra Clean Kentucky Blue Grass. (*Poa Pratensis*.)

Valuable for lawns when mixed with other varieties, retaining its verdure in the hottest weather. Price per qt., 20c.; per bu., \$2.00; per 100 lbs., \$12.00.

Meadow Fescue or English Blue Grass. (*Festuca Pratensis*.)

A highly valuable species for permanent grass land. It does not, however, attain to its full productive power till the second or third year, when it far exceeds most other sorts in the quantity of its produce and nutritive matter. It is relished by stock, both in hay and pasture, and is one of the most desirable permanent grasses for general culture. Price per qt., 20c.; per bu., \$2.50; per 100 lbs., \$14.00.



Mixture for Hay and Permanent Pasture.

Wood Meadow Grass. (*Poa nemoralis*.) It makes a very early growth in spring and is strongly recommended for pasture, thriving well under close feeding, also valuable in lawn mixture. Price per lb., 35c.; per 100 lbs., \$30.00.

Orchard Grass. (*Dactylis Glomerata*.) One of the most desirable pasture grasses for stock and for shady places. Price per qt., 15c.; per bu., \$2.25; per 100 lbs., \$14.00.

Sheep's Fescue. (*Festuca Ovina*.) Grows freely in dry and open pastures. Its chief merit for sheep pasture is that it occupies land which better grasses refuse. Grows from six to ten inches high. Price per qt., 20c.; per bu., \$2.50; per 100 lbs., \$15.00.

Sweet Vernal Grass. (*Anthroxanthum odoratum*.) True perennial sweet vernal. Useful to mix with other grasses for pastures and lawns, on account of its early growth, and emitting an agreeable odor when cut for hay. Price per lb., 75c.; per 100 lbs., \$70.00.

Timothy. (*Phleum Pratense*.) A well-known grass, and on some soils it will produce a larger crop than any other variety. We carry a large stock of this seed, which is graded as "Prime," "Strictly Prime" and "Choice." Prices on application.

MILLETS.

Hungarian Grass Millet. Early; height two to three feet; abundant foliage and small head; yields well on light soils. Price per qt., 10c.; per bu., \$1.25; per 100 lbs., \$2.25.

Siberian. Sometimes called Russian Millet. The plant grows larger than Common Millet, with beard and chaff similar to Hungarian; making a ranker growth, produces more leaves than either Common Millet,

German Millet, or Hungarian, leaves starting close to the ground and continuing nearly to top of stem; leaves wide and tender making it preferable to other Millets for Hay. Yield of Hay reported one-third to one-half more per acre, besides Hay softer when cured, greener in color and preferred by stock to other Hay or Millets. Price per qt., 10c.; per bu., \$1.25; per 100 lbs., \$2.25.

Golden or German. This is a valuable forage plant and yields very heavy crops; grows from two to four feet high, heads single and similar to Hungarian, though larger and with bright yellow seeds. Price per qt., 10c.; per bu., \$1.50; per 100 lbs., \$2.50.

True Southern or Golden Millet. Equal in quality to any of the other millets and far superior in yield, growing from three to eight feet high, with abundant foliage, and terminating with large seed heads, formed by numerous panicles of small, round, bright golden yellow seeds. Price per qt., 10c.; per bu., \$2.00; per 100 lbs., \$3.50.



German or Golden Millet.

Japanese or Barn Yard. This is a new forage plant of great value, growing luxuriantly on most any soil and under indifferent conditions. My experiments with it, in a small way, have convinced me that it will produce a larger amount of hay than any of the other small stalk varieties. It will grow in seasons of extreme drought, and attain a height of six to twelve feet. Price per qt., 20c.; per lb., 10c.; per 100 lbs., \$8.00.

CLOVER.

Crimson Trefoil or Scarlet Italian Clover. (*Trifolium Incarnatum.*) This is a variety in common use in the South for feeding green. The yield in fodder is immense, and after cutting, it at once commences growing again, and continues until severe, cold, freezing weather. In warm climates, four or five cuttings are made during the season. It grows about one foot high, blossoms long, pointed, and of a very deep red or carmine color. Makes good hay. Price per lb., 12c.; per 100 lbs., \$10.00.

Red Clover, Mammoth or Pea Vine. Grows five or six feet high, with large, coarse stalks, and is largely used for plowing under for manure. Prices on application.



Crimson Clover.

Alsike or Hybrid Clover. (*Trifolium Hybridum*) Even clover-sick lands will produce a good crop of this; perennial and very hardy. It is very valuable both for pasturing and soiling; very productive, sweet and fragrant. The flowers are a distinct light pink, and much liked by bees. Sow in spring or fall, six pounds per acre. Price per lb., 20c.; 25 lbs. and over at 18c.

Lucerne or Alfalfa. (*Medicago Sativa.*) Very productive, succeeds in any good soil, and lasts for a number of years. It thrives on dry, rich sandy soil, producing three to four cuttings annually, and even in seasons of severe drought is always fresh and green, because the roots extend so deep into the soil. It grows two to three feet high, with purple blossoms. It yields an immense amount of green food for cattle, and should be cut when commencing to bloom, or it can be used as ordinary clover hay. Instead of exhausting the land, it increases fertility, but does not succeed on compact clay or on land with impermeable subsoil. Sow 10 to 15 pounds per acre. Price per lb., 15c.; 25 lbs. and over at 13c.

White Dutch. (*Trifolium Repens.*) Thrives best in damp locations, and while not a heavy producer, it is valuable in permanent pastures. In connection



Alsike or Hybrid Clover.

with Blue Grass it affords the most nutritious food for sheep and cattle, and also makes a fine mixture for lawns. Price per oz., 5c.; per ¼ lb., 10c.; per lb., 25c.; 25 lbs. and over, 20c.



Lucerne or Alfalfa.

Red Clover, Medium. (*Trifolium Pratense.*) The common variety, used with other grasses for either pasture or meadow. Prices on application.



PLATT'S

SELECTED

FLOWER SEEDS.

ABRONIA.

Extremely pretty creeping plant; verbena-like heads of sweet-scented flowers; very effective in beds, rock work or hanging baskets. Half-hardy annual.

Umbellata. Rosy Lilac. White. Price per pkt., 5c.

Arenaria. A beautiful yellow variety. Price per pkt., 10c.



Abronia.

AGERATUM.

A Mexican flower of blush-like appearance, suitable for bedding or pot culture. Blooms continually. Annual.

Mexicanum Lavender. Blue, two feet. Price per pkt., 5c.



Ageratum.

Tom Thumb. Blue, dwarf, six inches. Price per pkt., 5c.

Imperialis. Dwarf, white, eight inches. Price per pkt., 5c.

ADONIS.

Showy border flowers, with pretty, fine cut foliage; hardy annual, lasting a long time in bloom.



Adonis.

Æstivalis. (*Flos Adonis.*) Scarlet. Price per pkt., 5c

ACROCLINIUM.

Pretty summer-flowering annuals, bearing quantities of large double, everlasting flowers of white, rose, etc.

Double Mixed. Price per pkt., 10c.

Rose. Price per pkt., 5c.

White. Price per pkt., 5c.

AGROSTEMMA OR CROWN OF THE FIELD.

An attractive, free-flowering hardy perennial, producing flowers on long, slender stems like a single pink; blossoms the first season. White and rose-colored flowers.



Acroclinium.



Agrostemma or Crown of the Field.

Cæli Rosea. (Rose of Heaven.) Mixed. Price per pkt., 5c.

ALYSSUM SWEET.

A very pretty little plant for edging or ribbon lines, blooming all summer. Hardy annual.

Little Gem or Tom Thumb. (*Compactum Erectum.*)

A fine plant for low beds and edgings. Price per pkt., 5c.

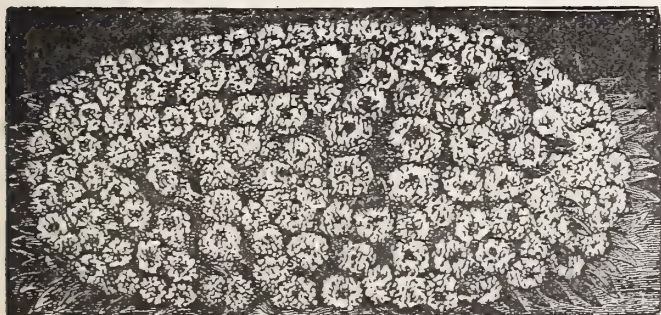

Alyssum, Little Gem or Tom Thumb.

White. In clusters, very sweet. Price per pkt., 5c.; per oz., 25c.

Saxatile Compacta. Golden yellow flowers. Hardy perennial. Blooms the first season. Price per pkt., 5c.

AMARANTHUS.

Ornamental foliage plants of extremely brilliant and showy colors. Half-hardy annual.

Tricolor. (*Joseph's Coat.*) Leaves yellow, red and green. Price per pkt., 5c.

Caudatus. (*Love Lies Bleeding.*) Flowers in bunches of long, drooping, chenille-like tassels. Price per pkt., 5c.

Salicifolius. (*Fountain Plant.*) Gracefully drooping, willowy-shaped leaves. In the latter stages of growth the leaves are brilliantly banded and tipped with orange, carmine and bronze. Price per pkt., 5c.

ANTIRRHINUM.

Snapdragon.

One of the most useful summer-flowering perennials, producing long spikes and beautiful bright-colored flowers, the first season.

Tom Thumb. Mixed. Price per pkt., 5c.

Tall Mixed Colors. Price per pkt., 5c.



Aquilegia.

AQUILEGIA.

Columbine.

A very showy class, with curiously shaped blossoms in great variety of colors; ranks among the finest early flowering plants. Hardy perennials.

Double Varieties. In finest mixture. Price per pkt., 5c.

Single Varieties. All colors mixed. Price per pkt., 5c.

Chrysantha. Golden spurred flowers. Price per pkt., 10c.

Chrysantha Alba. Pure white, with long spurs. Price per pkt., 15c.

ASPERULA.

A profuse blooming, hardy annual, attaining an average growth of one foot. The flowers, which are beautiful light blue, are very sweet scented, and last long while in perfection.

Odorata. (*Sweet Woodruff.*) The dried flowers and leaves have a delicious perfume and impart an agreeable perfume to clothes, etc., when kept among them. Price per pkt., 5c.

ASTER.

VICTORIA. A magnificent strain of asters, flowers very large, double, globular and of striking and beautiful colors.



Snow White. Price per pkt.; 10c.; per oz., \$1.00; per lb., \$12.00.

Rose. Price per pkt., 10c.; per oz., \$1.00; per lb., \$12.00.

Dark Blue. Price per pkt., 10c.; per oz., \$1.00; per lb., \$12.00.

Fine Mixed. Price per pkt., 10c.; per oz., 80c.; per lb., \$10.00.

AMERICAN BRANCHING. This is a fine type of the California branching asters, growing eighteen inches to two feet high. Flowers very large and a little later than all other varieties.

White. Price per pkt., 10c.; per oz., 80c.; per lb., \$8.00.

Pink. Price per pkt., 10c.; per oz., 80c.; per lb., \$8.00.

Crimson. Price per pkt., 10c.; per oz., 80c.; per lb., \$8.00.

Lavender. Price per pkt., 10c.; per oz., 80c.; per lb., \$8.00.

Purple. Price per pkt., 10c.; per oz., 80c.; per lb., \$8.00.

Mixed. Price per pkt., 10c.; per oz., 60c.; per lb., \$7.00.

COMET OR PLUME. The flowers are large, quite double, with long, loose wavy petals. Fine mixed. Price per pkt., 10c.; per oz., 80c.

White. Price per pkt., 10c.; per oz., \$1.00.

Light Blue. Price per pkt., 10c.; per oz., \$1.00.

Rose. Price per pkt., 10c.; per oz., \$1.00.

Dwarf Chrysanthemum-flowered. The largest flowering of the dwarf asters, and produces a succession of grand flowers. Fine mixed. Price per pkt., 10c.

Corcardeau or Crown. Flowers large and double, with white centers bordered with some bright color. Mixed. Price per pkt., 10c.

Queen of the Market, Mixed. A large, early variety of branching habit. Price per pkt., 5c.; per oz., 50c.; per lb., \$6.00.

White. Price per pkt., 5c.; per oz., 50c.; per lb., \$7.00.

Quilled Mixed Double. Flowers are of tube or quill shape, except the outer flat petals, which are frequently different color than the center. Price per pkt., 5c.

Pæony-flowered Perfection. Flowers very large, perfectly round with slightly incurved petals, borne on single stems. Price per pkt., 10c.; per oz., 80c.

China. The common double flowering variety. Mixed. Price per pkt., 5c.; per oz., 50c.; per lb., \$5.00.

BALLOON VINE.

Cardiospermum. Love in a Puff.

A genus of rapid-growing, handsome climbers, remarkable for an inflated membraneous capsule, from which it is sometimes called "Balloon Vine."

Halicacabum. White.
Price per pkt., 5c.



Balloon Vine.

BALSAM.

They are among the showiest and most popular of our summer garden annuals, forming bushy plants, covered with large double flowers, of brilliant colors.



Balsam.

Double Fine Mixed.
Per per pkt., 5c.

Double Camelia Flowered. Finest mixed. Price per pkt., 5c.

Double Camelia White. Price per pkt., 5c

Double Scarlet.
Price per pkt., 5c.

Double Flesh Color.
Price per pkt., 5c.

Balsam Apple.

(See *Mormordica*.)

BRANCHYCOME.

Swan River Daisy.

An annual, growing six to eight inches high, and covered all summer with a profusion of single blue and white daisy-like flowers. Fine mixed. Price per pkt., 5c.



Branchycome.

BARTONIA.

Half-hardy annual. The flowers are a very bright metallic yellow, and exceedingly brilliant in the sunshine. It likes considerable moisture and suffers in a drought. Plants grow seventeen inches to two feet high, with thistle-like, downy leaves.

Aurea. Golden yellow. Price per pkt., 5c.

BELLIS PERENNIS.

Double Daisy.

Prefers a cool, sheltered situation, and needs some protection in the winter. Flowers are quilled or flat petaled, white, red or variegated. Half-hardy perennial.



Snowball Daisy.

Snowball. Pure white, large and very double. Price per pkt., 10c.

Longfellow. Fine, large, double dark rose flowers. Price per pkt., 10c.

Double Quilled. Mixed. Price per pkt., 10c.

Double Mixed. Price per pkt., 10c.

BROWALLIA.

Profuse blooming plants, continuing throughout the summer, studded with blue and white flowers, growing freely in any rich soil. Half-hardy annual.



Browallia.

Elata Cœrulea. Sky blue with white eyes. Price per pkt., 5c.

Elata Alba. Pure white. Price per pkt., 5c.

CACALIA.

Tassel Flower.

A pretty half-hardy annual, with tassel-shaped flowers, scarlet and golden yellow. Blooms from July to September.

Mixed Colors. Price per pkt., 5c.

CALANDRINIA.



Calceolaria.

Very pretty plants, succulent stems and fleshy leaves, belonging to the Purslane family. Annual.

Grandiflora. Large flowered rosy pink. Price per pkt., 5c.

Calceolaria.

Splendid plants for greenhouse decoration, forming in spring dense masses of beautiful pocket-like flowers. The seeds germinate best without heat, and should be grown in pans or pots.

Large Flowered. Mottled and spotted. Price per pkt., 25c.

Rugosa Shrubby or Bedding Varieties. Mixed. Price per pkt., 25c.

CALENDULA.

Marigold.

Showy, free-flowering hardy annuals, growing in any good garden soil, producing a fine effect in beds or mixed borders, and continuing in bloom until killed by frosts.

Meteor. Large, double, light yellow flowers, striped with bright orange. Price per pkt., 5c.; per oz., 25c.

Pongei fl. pl. Large, pure white. Semi-double. Price per pkt., 5c.



Calceolaria.

Pure Gold. Large double flowers of pure golden yellow. Price per pkt., 5c.



Calendula.

Prince of Orange. Grows from ten to twenty inches in height, with a profusion of flowers during the entire summer. Price per pkt., 5c.; per oz., 25c.



Calliopsis or Coreopsis.

Calliopsis or Coreopsis.

Few, if any, annuals are more useful than these; the colors are rich and striking; flowers numerous and beautiful. Hardy annual.

Fine Mixed. Price per pkt., 5c.

Lanceolata. (*Perennial*) Golden yellow. Price per pkt., 5c.

Coronata. Large single yellow flowers. Price per pkt., 5c.

Golden Wave. (*Drummondii*) Plants very bushy and compact and covered with large golden blossoms having dark centers. Price per pkt., 5c.

Double. Rich golden yellow, maroon spotted. Price per pkt., 5c.

Campanula.

Hardy, herbaceous perennials, bearing attractive bell flowers, thriving best in light rich soil; some of the varieties flower in first season if planted early. *Carpatica* and *Speculum* are fine for beds, edgings and ribbon gardening.

Campanula Pyramidalis. Blue and white mixed; hardy perennial; three feet. Price per pkt., 5c.

Carpatica Mixed. Free flowering, blue and white mixed, continuing in bloom the whole season; hardy perennials; six inches. Price per pkt., 5c.



Campanula.

CANTERBURY BELLS.

Media, Single Mixed. Beautiful, large, bell-shaped flowers; hardy biennials; two and one-half feet. Price per pkt., 5c.

Media, Double Mixed. Two and one-half feet. Price per pkt., 5c.

Media Calycanthema. (*Cup and Saucer.*) This is the finest variety of *Campanula*, producing plants with white and blue flowers, resembling cup and saucer; mixed. Price per pkt., 10c.

Canary Bird Flower.

Tropaeolum Canariensis.

An exceedingly ornamental creeper, with bright, yellow fringed flowers, resembling a canary bird with wings partly spread, and neat, finely divided foliage; a general favorite.

Yellow. Price per pkt., 5c.



Canary Bird Flower.

CANDYTUFT.

Seed sown in April flower from July to September, and some of the sorts till frost comes. All the varieties are hardy and easy to cultivate. Single plants look well and bloom profusely. Hardy annuals, one foot high.

Hyacinth Flowered White.

A variety of very decided merit, growing long stiff stems of large headed blooms, suitable for bouquets and cut flower work. Price per pkt., 10c.; per oz., 50c.

Empress or Snow Queen.

Pure white flowers, borne on a candelabra-shaped plant. Per pkt., 10c.

Carmine. Price per pkt., 5c.

Crimson. Price per pkt., 5c.

Lilac. Price per pkt., 5c.

White Fragrant. Price per pkt., 5c.

White Rocket. Price per pkt., 5c.

Mixed Colors. Price per oz., 20c.; per pkt., 5c.



Celosia Plumosa.



Hyacinth Flowered White.

Perennial. (*Iberis Sempervirens.*) Hardy, low growing, compact, plant; blooms early in spring, in masses of pure white. Fine for border edges or cemetery planting. Price per pkt., 10c.

CANNA.

(*Indian Shot.*)

The seed shells are very hard, and to facilitate germination it is a good plan to soak them in warm water ten to twelve hours before planting.

Dwarf Large Flowered French. Their great merit lies in the large size and brilliant hues of the flowers, ranging through all the shades of yellow and orange to the richest crimson, scarlet and vermilion; some are also beautifully spotted. Mixed. Price per pkt., 10c.

CASTOR OIL BEANS.

(*See Ricinus.*)

CELOSIA or COXCOMB.

A very desirable and showy plant, producing large combs of crimson or yellow flowers. The "Cristata" sorts are the well-known Coxcombs.

Cristata, the True Cockscomb.

Mixed. Including many colors. Price per pkt., 5c.

Rosea. One foot, " " " 5c.

Golden Beauty. Golden yellow, " " " 5c.

Japonica. Pyramidal plant, composed of crimson branches, each bearing a comb of the same color, and finely ruffled. Price per pkt., 5c.

Glasgow Prize. Very dwarf, immense crimson combs, One foot. Price per pkt., 10c.

Plumosa, or Feathered Coxcomb.

Plants surmounted with long feathery plumes; exceedingly handsome.

Plumosa, Golden Yellow. Three feet. Price per pkt.; 10c.

Scarlet. Three feet. Price per pkt. 10c.



Canna.



Cristata.

CARNATION.

Carnations and Picotee Pinks are general favorites for their delicious fragrance and richness of colors. The seed we offer will produce many splendid novelties in double or semi-double flowers; protect during the winter; half-hardy perennials; 1½ feet.

Carnation, Finest German. Mixed colors; saved from fine double-named flowers. Price per pkt., 15c.

Fine Double Mixed. The hardiest and best varieties for garden culture. Price per pkt., 10c.

Marguerite. Flowers four months after sowing the seed, its profusion of bloom, variety of beautiful colors and delicious perfume, insure its popularity in all gardens where cut flowers are in demand. Price per pkt., 10c.



Carnation Marguerite.

GENTAUREA.



Centaurea Cyanus.

Centaurea Cyanus.

Known as "Blue Bottle," "Corn Flower," "Ragged Sailor," etc., fine for cut flowers; two to three feet.

Blue. A very old, favorite annual, flowering freely in almost any situation. Price per pkt., 5c.

Centaurea Marguerite. Large, pure white blooms. Price per pkt., 10c.

Mixed. Price per pkt., 5c.



Centaurea Candidissima.



Centaurea Gymnocarpa.

White-Leaved or Dusty Miller Varieties.

Valuable plants for ribbon bedding. The silvery whiteness of the leaves being very effective with other colored leaved plants.

Gymnocarpa. Graceful, fine-cut silvery white foliage. One and one-half feet. Price per pkt., 10c.

Candidissima. Silvery, broad-cut leaves. Price per pkt., 15c.

CHRYSANTHEMUM.

The annual varieties are exceedingly pretty. They are bright, free bloomers, rapid in growth and merit a prominent place in every annual garden. They are also good for ordinary bouquet cutting. All the annual Chrysanthemums make beautiful pot plants, if sown in cold frames and pricked off singly into six-inch pots. They are perfectly hardy.

Segetum Grandiflorum. The golden Marguerite; large, bright yellow flowers. Price per pkt., 10c.

Burridgeanum, or Lord Beaconsfield. Crimson, maroon edged, and striped gold, brown eye, ringed yellow. Price per pkt., 10c.

Carinatum Eclipse. Pure golden, with a bright, purplish-scarlet ring and dark brown disc; very striking. Price per pkt., 10c.

Mixed Single Annual Varieties. Price per pkt., 5c.

Coronarum, Double Yellow. Handsome border plants, two feet. Price per pkt., 5c.

Double White. Very showy, two feet. Price per pkt., 5c.

Mixed Double Annual Varieties. Price per pkt., 5c.



Single Chrysanthemum.

CHRYSANTHEMUM

Continued.

The following varieties are for pot culture in the house and for florists' bouquets.

Japonicum, fl. pl. (*New Japanese variety.*) Flowers of peculiar form and much beauty, combining numerous shades of color. Very interesting. Half-hardy perennial. Price per pkt., 25c.

Inodorum Plenissimum. Dwarf-growing, double white variety, very fine flowering and beautiful for pot culture. Price per pkt., 10c.

Frutescens Grandiflorum. (*"The Marguerite" or "Paris Daisy."*) Immense quantities are grown by French florists, and find a ready sale. It produces freely its white, star-like flowers under the most unfavorable conditions. Price per pkt. 10c.

CLEOME.

(*The Giant Spider Plant.*)

Seed sown in the open ground in May will commence blossoming July 1st, and continue until frost, attaining a height of five or six feet. The flowers are deep purple pink when they first open, but fade to a light pink. The stamens are several inches long, which gives it the name of Spider flower.

Pungens. Price per pkt., 5c.



CINERARIA.

A magnificent greenhouse plant having a range and brightness of color seldom equaled. Sow seeds from May to July.

Hybrida. Large Flowering. Brilliant blossoms, beautifully marked colors. Price per pkt., 25c.

Fine Mixed. Choice strain of showy and bright colors. Price per pkt., 15c.

Maritima. (*Dusty Miller.*) Silvery foliage, fine for bedding, edging and ribbon planting. Price per pkt., 5c.



Clarkia.

CLARKIA.

An old favorite annual, growing and producing freely its flowers under almost any circumstances. Price per pkt., 5c.



Cineraria.

CLIANTHUS.

(*Australian Glory Pea.*)

Magnificent plants which should be grown in light, rich soil. A shrubby, tender greenhouse perennial.

Dampieri. Flowers in clusters, pea-shaped; four to six inches in length; of brilliant scarlet. Price per pkt., 10c.



Clianthus Dampieri.

COBOEA.

A beautiful rapid-growing climbing plant, with large, handsome, bell-shaped flowers. Sow early and plant out about June. In sowing, plant the seeds edge-wise, and cover lightly.

Scandens. Price per pkt., 10c.



Coboea.

COCKSCOMB. (See *Celosia*.)



COLEUS.

A distinctive foliage plant with large, brilliantly colored leaves ranging through shades of scarlet, yellow, green and variegated markings. Sow early in spring.

Fine Mixed. Price per pkt., 10c.

Choice Large Leaved Varieties. Price per pkt., 25c.



COLLINSIA.

Very pretty free-flowering plants, blooming in whorls and several whorls around each flower stem; hardy annual; 1½ feet.

Collinsia Mixed. Price per pkt., 5c.

COLUMBINE.

(See *Aquilegia*.)

Convolvulus.

Collinsia.

(*Morning Glory*.)

Major. Free-flowering climber, succeeds in almost any situation. Height, fifteen feet. Fine mixed. Price per pkt., 5c.; per oz., 15c.

The Japanese Morning Glory. The flowers are almost unlimited in variety of colors, from purest white through all the different shades

of pink, rose, red, carmine, crimson, blue, purple and maroon. Sow early in a warm, sunny place, or, to gain time, start the seeds in the house.

Choice Mixed. Price per pkt., 5c.; oz., 20c.

Tricolor Minor. "Bush Morning Glories" grow only about one foot high; the flowers are



Convolvulus Major.

freely borne, and, if pleasant, remain all day. The plant spreads with much regularity, and a bed of them is a beautiful object all summer. Price per pkt., 5c.

COSMOS.

An autumn flowering plant, with feathery foliage. The flowers are borne profusely in loose clusters. Seed should be sown early in the spring and the plants transplanted in the open border when danger from frost is past. It begins blooming in August and continues until cut down by frost. For planting in shrubbery it will be found very valuable.



Convolvulus Minor.



Cosmos.

Early Dwarf Dawn. Delicate pink. Price per pkt., 5c.

Hybridus Mixed. Price per pkt., 5c.

Hybridus, White Pearl. Price per pkt., 5c.

Dwarf Yellow Cosmos. This forms a plant about 2 feet high; the flowers, about 1½ inches across, are star-shaped and of a rich golden yellow. Price per pkt., 5c.

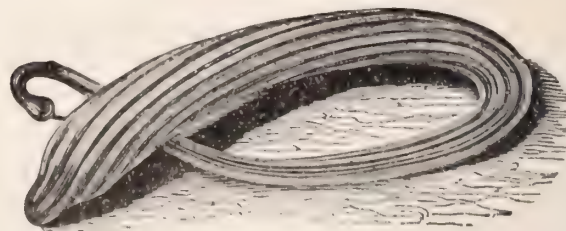

Snake Cucumber.

CUCUMIS OR SNAKE CUCUMBER.

Flexuosus. It is a rapid growing vine, quite ornamental, and often attaining a length of six feet. The fruits are curious, and, if allowed to fully ripen, can be kept for some time. Annual. Price per pkt., 10c.

CYCLAMEN.

A genus of the most beautiful and elegant winter and spring blooming plants for pot culture in parlor or conservatory, universally admired. If sown early in spring under glass, and well grown, will make flowering bulbs in one year.

Persicum. Mixed, selected from finest varieties. Price per pkt., 10c.

Giganteum. Flowers of an extraordinary size, broad petals and stout flower stalks. Price per pkt., 25c.



Cyclamen.

CYPRESS VINE.

A clinging plant with very delicate, fern-like foliage, and masses of beautiful, star-shaped flowers borne in clusters. Half-hardy annual.

Scarlet. Per pkt., 5c.; per oz., 30c.
White. " 5c.; " 30c.
Mixed. " 5c.; " 30c.

DAHLIA.

One of our best autumnal flowering plants; blooms until killed by frost; tuberous rooted, half-hardy perennials; blooming the first year from seed, if sown early; protect the roots during winter in a dry cellar in sand; two to eight feet.

with flowers averaging three inches in diameter, and of the most brilliant colors.

DOUBLE ANNUAL VARIETIES.

Chinensis. (*China or Indian Pink.*) Finest double mixed. One foot. Price per pkt., 5c.; per oz., 25c.

Snowflake. Large double fringed flowers. Price per pkt.; 5c.

Heddewigii, fl. pl. (*Double Japan Pink.*) Very beautiful mixed colors. One foot. Price per pkt., 5c.



Pheasant's Eye Pink.

Mourning Cloak or White Frill. (*Dianthus Hedde- wigii.*) The flowers are very dark and rich, some maroon color. It has a rich clove fragrance. Half-hardy annual and grows a foot high. Price per pkt., 5c.



Cypress Vine.

Large Flowering. Saved from the finest double flow- ers. Price per pkt., 10c.

Small Flowering. (*Bouquet or Lilliputian.*) Saved from choice double flowers; mixed colors. Price per pkt., 10c.

Single Mixed. Large showy flowers. Price per pkt., 10c.

DAISY. *Bellis Perennis.*

DELPHINIUM.

(*Perennial Larkspur.*)

The tribe of Delphinium, to which the well-known Larkspur belongs, is one of the handsomest and most useful of all perennials, producing magnificent spikes of bloom in great profusion throughout the summer; if sown early they will flower the first season. Half-hardy perennial.

Formosum. Beautiful single variety; blue with white



Delphinium.

center. Price per pkt., 5c.

Grandiflorum fl. pl. Finest double. Price per pkt., 15c.

Finest Mixed. Price per pkt., 5c.

DIANTHUS.

Dianthus Caryophyllus and its varieties are the much ad- mired Carnation and Picotees. *Dianthus Barbatus* is the well-known Sweet William. *Dianthus Chinensis* and varieties are known as Indian Pinks. *Dianthus Heddewigii* and *Di- adematus* are splendid sorts,



Dianthus.

Diadematus Flora Plena (*Double Diadem Pink.*) A striking variety; luxuriant, but dwarf and compact of growth. Flowers double, comprising all shades of color. Price per pkt., 5c.

Imperialis, fl. pl. (*Double Imperial Pink.*) Fine mixed. Price per pkt., 5.

SINGLE ANNUAL VARIETIES.



Eastern Queen Dianthus.

Laciniatus. A beautiful fringed variety; various colors. One foot. Price per pkt., 5c.
"Eastern Queen." The broad bands of mauve upon the paler surface of the petals are very striking and pretty. Price per pkt., 5c.
"Crimson Belle." A rich crimson color, flowers of very large size. Price per pkt., 5c.

Little Gem. A dwarf variety, growing about six inches high. Almost covered with rosy veined and carmine flowers. Price per pkt., 5c.

HARDY PERENNIAL VARIETIES.

Highly valued for the great beauty and fragrance of their flowers. These make splendid bushy plants, from one to two feet high, for permanent beds and borders.

Gardnerianus, fl. pl., Mixed. (*Double Hardy Garden Pink.*) Large fringed flowers. Price per pkt., 5c.

Plumarius, fl. pl., Mixed (*Double Pheasant's Eye Pink.*) Double fringed flowers of white, crimson or purple shades, spotted and variegated; ten to twelve inches high. Price per pkt., 10c.

Scoticus, Mixed. (*Scotch Paisley Pink*) Large flowering, with fringed edges of various colors. Price per pkt., 10c.

DIGITALIS.

(*Foxglove.*)



Digitalis.

Handsome and highly ornamental plants, of stately growth, bearing long spikes of large, showy flowers, running through shades of white, rose, yellow and purple. Fine for shrubberies and half-shady places. Hardy perennial.

Fine Mixed. Price per pkt., 5c.

Monstrosa. Very long spike with large, novel and beautiful flowers. Price per pkt., 10c.

ESCHSCHOLTZIA.

(*California Poppy.*)

Very attractive plants for beds, edgings or masses; profuse flowering and fine cut foliage. In bloom from June till frost. Hardy annuals. One foot.

SINGLE VARIETIES.

Hunnemannia. (*Yellow Bush Eschscholtzia.*) This is a most profuse bloomer, growing 12 to 18 inches high and the bright yellow flowers are born on good stiff stems suitable for cutting. Seed sown in April or May will bloom in July. Price per pkt., 10c.

Golden West. Sulphur yellow with orange center. Price per pkt., 5c.

Rose Cardinal. Beautiful rose color. Price per pkt., 5c.

Mandarin. Large flowers of a bright scarlet; inner side, rich orange. Price per pkt., 5c.

Finest Mixed. Includes many fine single sorts. Price per pkt., 5c.

DOUBLE VARIETIES.

Double White. Price per pkt., 5c.

Double Yellow. Price per pkt., 5c.

Double Mixed. Price per pkt., 5c.



Eschscholtzia.
(*California Poppy.*)



Hunnemannia or Yellow Bush Eschscholtzia.

EUPHORBIA.

(*Snow on the Mountain.*)

Marginata Variegata. It grows about two feet in height. The large leaves are nearly two inches long, and small at the tops of branches; light green and white margined. A native of our western states and territories. Price per pkt., 5c.



Euphorbia Marginata.

EUPHORBIA—Continued.

Mexican Fire Plant, or Fire on the Mountain. This is a hardy annual of the easiest culture, and resembles in habit and color the hot-house Poinsettia. The plants grow two to three feet high, of branching, bush-like form, with smooth, glossy leaves, which are at first entirely green; but about midsummer clusters of small, white flowers appear on the end of each branch, surrounded by beautiful orange-scarlet bracts, presenting a striking and brilliant combination of colors. Price per pkt., 10c.

FEVERFEW.

Matricaria.

Free-flowering, herbaceous plants, succeeding in any garden soil; blooms until frost; hardy, perennial, blooming the first season if sown early.

Alba Plenissima Double White. Seeds saved from fine double flowers. Eighteen inches high. Price per pkt., 10c.

FORGET-ME-NOT.

(Myosotis)



Gaillardia

GAILLARDIA.

Showy and universally admired annuals, flowering the first year; among the gayest ornaments of summer flower beds.

Picta Lorenziana. A double variety, blooming profusely in large flowers of bright colors. Price per pkt., 5c.

Grandiflora Hybrida. Rich crimson and yellow. Price per pkt., 5c.

Fine Mixed. Price per pkt., 5c.

GERANIUM.

Single Mixed Zonale. Including many varieties. Price per pkt., 10c.

Double Mixed. Including many varieties. Price per pkt., 25c.

Pelargonium. (*Lady Washington*) Desirable plants for pot culture; the flowers are borne in clusters, are rich and beautifully marked. Price per pkt., 25c.



Gilia.

GILIA.

Hardy annual, grows in almost any situation; profuse bloomers and fine for beds and rockeries.

Fine Mixed. Price per pkt., 5c.

GLOBE AMARANTH.

"Bachelor's Buttons" These are annuals, forming bushy plants about two feet high and bearing a great many flowers of purple, white, striped, etc. Quite ornamental as summer blooming plants, and very desirable "Everlastings."



Globe Amaranth.

Mixed Colors. Price per pkt., 5c.

White. Price per pkt., 5c.

Crimson. Price per pkt., 5c.



Geranium.

GNAPHALIUM.

(*Edelweiss.*)



Godetia.

Leontopodium. The famous "Edelweiss" of the Alps. The flowers are star-shaped, of downy texture, and pure white, and are sought after as souvenirs. They retain their natural appearance for years. Very desirable for dried bouquets, etc. Price per pkt., 15c.

GODETIA.

(*Satin Flower.*)

Very handsome and showy annual, of dwarf, compact growth, bearing large flowers

of exquisite colors and shades that glisten in the sun light like satin.

Lady Albemarle. Carmine, shading to lilac. Price per pkt., 5c.

Duchess of Albany. Pure satin white. Price per pkt., 5c.

Lady Satin Rose. Glossy rose pink. Price per pkt., 5c.

Finest Mixed. Price per pkt., 5c.



Nest Egg Gourd.

shape of an egg. Price per pkt., 5c.

Orange. The fruit resembles an orange in shape and color. Price per pkt., 5c.

Lemon. The fruit resembles a lemon in shape and color. Price per pkt., 5c.

Hercules Club. Club shape. Grows 4 to 6 feet in length. Price per pkt., 5c.

Dipper. Its name indicates its use. Price per pkt., 5c.

Dish Cloth. A vegetable dish cloth; the seeds are enveloped in a sponge-like cloth, tough and elastic, and admirably answering the purpose of its name. The fruit is about two feet in length. Price per pkt., 5c.

Sugar Trough. This variety grows to a large size. Price per pkt., 5c.

Miniature. Small, green bottomed and bottle-shaped. Price per pkt., 5c.



Mixed Gourds.

Gourds.

A very ornamental class of rapid growing climbers. The fruit is of curious shapes, sizes and colors. All are hard shelled and will keep indefinitely. Useful for covering fences, brush, or unsightly places.

Nest Egg. A capital nest egg. Produces a fine white fruit the

Bottle. Singularly shaped and resembling a bottle. Price per pkt., 5c.

Fancy and Ornamental. Mixed varieties. Price per pkt., 5c.

Large. Mixed varieties. Price per pkt., 5c.

GRASSES—Ornamental.



Briza Maxima.

Briza Maxima. (*Quaking Grass.*) Price per pkt., 5c.

Bromus Brizæformis. One of the best grasses for dried bouquets. Price per pkt., 5c.

Coix Lachrymæ. (*Job's Tears.*) Price per pkt., 5c.; per oz., 20c.

Eragrostis Elegans. (*Love Grass.*) Price per pkt., 5c.

Gynerium Argenteum. (*Pampas Grass.*) Price per pkt., 5c.

Stipa Pennata. (*Feather Grass.*) Indispensable in grass bouquets. Price per pkt., 5c.

For winter decoration these are very beautiful. For this purpose they should be cut before they are thoroughly ripe. The plants should be transplanted or thinned out sufficiently to afford space for growth of each as soon as they can be handled; this will allow them to develop their character.

Avena Sterilis. (*Animated Oats.*) Long, drooping panicles. Price per pkt., 5c.



Coix Lachrymæ.



Gynerium Argenteum.



Stipa Pennata.

HYACINTH BEAN.

(*Dolichos.*)

A beautiful class of quick-growing ornamental climbers, often growing fifteen or twenty feet in a season, producing an abundance of clustered spikes of purple and white flowers, which are followed by exceedingly ornamental seed pods.

Mixed. Price per pkt., 5c.

HELIANTHUS.

Sunflower.



Helianthus Cucumerifolia.

Tall growing plants, with large and showy yellow flowers. Hardy annuals.

SINGLE VARIETIES.

Miniature. (*Cucumerifolia*.) Dwarf, bushy habit, profuse in its bloom of bright yellow, black-centered flowers. Price per pkt., 5c.

Stella. Flowers from two to three inches in diameter with black centers, borne on long stems; suitable for cutting. Price per pkt., 5c.

Oscar Wilde. The flowers are small, and consist of a small, black center, surrounded by a row of bright golden petals. Price per pkt., 5c.; per oz., 10c.



Helianthus Oscar Wilde.



Helianthus Globosus Fistulosus

Mammoth Russian. Very rank in its growth, often eight to twelve feet high, bearing single heads measuring from fifteen to eighteen inches in diameter. Price per pkt., 5c.; per oz., 10c.

DOUBLE VARIETIES.

Chrysanthemum Flowered. Grows six feet high and bears profusely all summer. Perfectly double, the color is bright golden yellow. The flowers are so perfect in form that they resemble very double chrysanthemums. Price per pkt., 10c.; per oz., 25c.

Californicus. Extra large and double. Five feet. Price per pkt., 5c.

Globosus Fistulosus. Flowers very large and globular formed. Six feet. Price per pkt., 5c.



Helichrysum (Straw Flower).

HELICHRYSUM.

Straw Flower.

Bright and attractive summer blooming annuals, of free growth, and producing in abundance large double red, white and yellow flowers, valuable as an "Everlasting."

Large Flowering, Double Mixed. Price per pkt., 5c.

HELIOTROPE.

A half-hardy perennial, flowering during the whole season; it is a deliciously fragrant and most desirable bouquet flower; also a splendid bedding plant. Seeds sown in the spring will make fine plants for summer blooming.

Mixed. Price per pkt., 10c.

Helipterum Sanfordi.

A very pretty annual, and good border plant of dwarf habit, bearing large globular clusters of bright golden yellow flowers, perhaps the best known of the "Everlasting," and sold in bunches as immortelles. Price per pkt., 5c.

HOLLYHOCK.

For majestic growth and massive beauty the hollyhock stands unrivalled. Flowers very large, perfectly double, and of great variety of color.

Good Mixed. Price per pkt., 5c.

Extra Choice, Double Finest Mixed. Price per pkt., 10c.

Double Yellow. Price per pkt., 10c.

Double Crimson. Price per pkt., 10c.

Double Maroon. Price per pkt., 10c.

Double Salmon. Price per pkt., 10c.



Hollyhock.

HOLLYHOCK.

Continued.

Canary Yellow. Price per pkt., 10c.

White. Price per pkt., 10c.

Mammoth Fringed Alleghany Mixed.

Price per pkt., 10c.

Honesty.

Silvery, transparent seed vessels,

of beautiful effect for dried bouquets. Price per pkt., 5c.

ICE PLANT.

A very pretty little trailing plant, the leaves of which are covered with crystalline globules, thus giving it the appearance of being coated with ice. Half-hardy annual.

Mesembryanthemum Crystallinum. Price per pkt., 5c.



Ice Plant.

Impatiens Sultani.

A beautiful decorative plant, producing cherry-red, waxy flowers continuously.

Zanzibar or Sultana's Balsam. Price per pkt., 10c.



IMPATIENS SULTANI.

IPOMEA.

This is a rapid and luxuriant summer climber, profuse in its blooming of large, beautiful flowers, and invaluable for covering walls, trellises, arbors or stumps of trees.



Ipomea.

Coccinea. (Star Ipomea.) Small scarlet flower. Price per pkt., 5c.

Bona Nox. (Evening Glory or Good Night.) Large, pure white, fragrant flowers. Price per pkt., 10c.



Ipomea Bona Nox.

IPOMEA—Continued.

Noctiflora. (*Moon Flower.*) The flowers, which expand in the evening, are white, from five to six inches in diameter, and emit a Jasmine-like odor; the vines grow very rapidly, attaining a height of twenty-five feet. Price per pkt., 10c.

LARKSPUR ANNUAL.

Delphinium.

A beautiful genus of plants, very dwarf and compact habits, possessing almost every requisite for the adornment of the garden, blooming in the greatest profusion, and of every variety of the most brilliant colors.

Emperor. Of bushy habit, remarkably floriferous, with beautiful dark blue, red-striped and tri-colored flowers. Price per pkt., 5c.

Double Dwarf Rocket Mixed. Price per pkt., 5c.

Tall, Double Rocket Mixed. Price per pkt., 5c.

LATHYRUS.

Everlasting Pea.

Showy, free-flowering plants, growing in any common soil; very ornamental on trellis work, old stumps, or for covering fences or walls. Hardy perennials.



Lathyrus.

Latifolius, White. Price per pkt., 10c.

Latifolius, Scarlet. Price per pkt., 10c.

Mixed. Price per pkt., 15c.

LINUM.

Flowering Flax.

A showy bedding plant of the flax family, having brilliant flowers of various colors, borne on slender stems, with fine foliage. Does well in any light garden soil. Hardy annual.

Grandiflorum Coccineum. Bright scarlet. Price per pkt., 5c.

Flavum. Beautiful golden yellow. Price per pkt., 5c.

Mixed. Price per pkt., 5c.

LOBELIA.

The following dwarf and trailing varieties of this popular and beautiful flowering plant will be found most desirable for pot culture, edgings, hanging baskets, etc., blooming profusely from June to November. Half-hardy annual.

Erinus Varieties for Baskets, Vases, Etc. Six to nine inches.



Alba. Pure white. Price per pkt., 5c.

Speciosa. Bright blue. Price per pkt., 5c.

Gracilis. Light blue; long, slender, trailing stems. Price per pkt., 5c.

Mixed. Contains many sorts. Price per pkt., 5c.



Compacta Varieties for Edgings, Etc. Four to six inches.

White Gem. Pure white. Price per pkt., 5c.

Crystal Palace. Dark blue; fine for bedding. Price per pkt., 5c.

Lobelia.

Prima Donna. Dwarf, bushy plants, with rich velvety crimson maroon flowers. Price per pkt., 10c.

Mixed Varieties. Price per pkt., 5c.

MARIGOLD.

Very effective, half-hardy annual; very showy in the garden, and continuing in flower from early in the summer till frost. The African, the tallest, is the most



Marigold.

effective in large beds, mixed flowers and shrubbery borders. The Dwarf French makes splendid compact edging for beds and borders.

Double French Dwarf Mixed. Price per pkt., 5c.; per oz., 50c.

African Double Mixed. Tall—Orange brown. Price per pkt., 5c.; per oz., 40c.

Eldorado. Tall—Large flowers in all shades of yellow. Price per pkt., 5c.; per oz., 50c.

LUPINS.



Lupins.

Hybrida Atrococcineus. Scarlet and white. Price per pkt., 5c.
Mixed Colors. Price per pkt., 5c.

MAURANDIA.

These beautiful summer climbers cannot be too highly recommended, whether for the adornment of the conservatory or greenhouse, or for trailing on trellis work. Blooms the first season from seed.

Barclayana. Rich violet. Price per pkt., 10c.
Finest Mixed. Price per pkt., 10c.



Defiance Mignonette.

A well-known genus; very conspicuous and showy. Many of the varieties are of a stately, robust growth, which make them valuable for mixed flowers and shrubby borders. Hardy annual.

Affinis. Blue, white and purple. Per pkt., 5c.
Crookshanki. Blue, white and yellow. Per pkt., 5c.

MIGNONETTE.

A well-known favorite, highly esteemed for its fragrance; essential in every garden. If it is well thinned out as soon as the plants are large enough, they will grow stronger and produce larger spikes of bloom. Hardy annual.

Reseda Odorata. Improved, large flowering. Price per pkt., 5c; per oz., 15c.

Parson's White. A distinct, almost white variety. Price per pkt., 5c.

Hybrid Spiral. Produces flower spikes from eight to ten inches in length. Price per pkt., 5c.

Machet. A dwarf, bushy, French variety, excellent for pot culture. Price per pkt., 5c.; per oz., 50c.

Bird's Mammoth. Flower spikes of immense size, often measuring eight or nine inches in length. Price per pkt., 10c.

Allen's Defiance. When grown under favorable conditions its spikes will be of remarkable size—from twelve to fifteen inches long. Price per pkt., 15c.

MIMOSA.

Sensitive Plant.



Mimosa (Sensitive Plant).

A very interesting and curious plant, its leaves closing if touched or shaken.

Pudica. Price per pkt., 5c.

Mimulus.

Monkey Flower.

The mimulus is a beautiful, tender-looking plant, with almost transparent branches. Succeeds best in moist, shady situations; fine for baskets under shelter, verandas or vases, and for culture in the house.

Mixed. Blotched and spotted hybrid. Price per pkt., 5c.

Moschatus. (*Musk Plant*). Foliage emits a strong musky perfume; flowers, canary yellow. Price per pkt., 10c.

Mormordica.

Luxuriant annual climbers, with ornamental foliage, fruit golden yellow, warted, and when ripe, opens, showing the seeds and its brilliant carmine interior. Ten to fifteen feet.

Mormordica Balsamina. Apple-shaped fruit. Price per pkt., 5c.

Charanta. Pear-shaped fruit. Price per pkt., 5c.



Mimulus.
(Monkey Flower).

MORNING GLORY.

(See Convolvulus).

MARVEL OF PERU.

Four O'clock.



Marvel of Peru.

This grows two feet in height, well branched, bright foliage, fragrant flowers and desirable colors. Set plants two feet apart. It is really a good plant, and makes a nice summer hedge. Seeds should be planted in the open ground where the plants are desired.

Marvel of Peru or Four O'clock. Mixed. Price per pkt., 5c.

Marvel of Peru. Variegated. Price per pkt., 5c.

MYOSOTIS.

Forget-me-not.

A well-known plant, bearing clusters of star-like flowers, best adapted to moist situations, though growing in almost any soil. Half-hardy perennial.

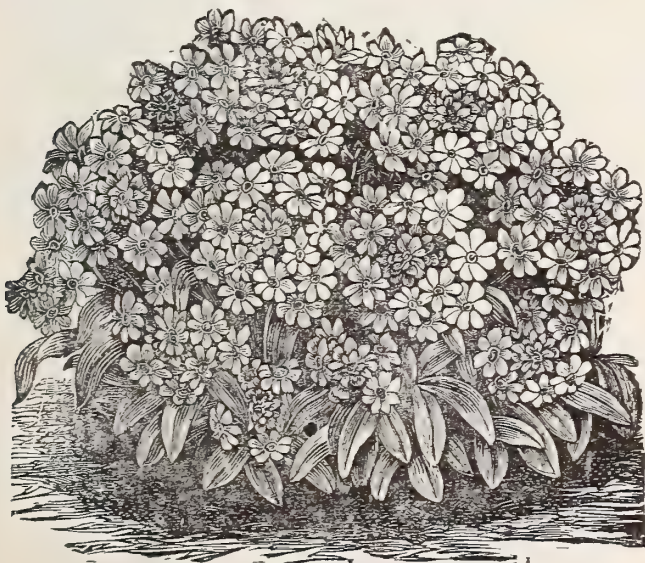

Myosotis

Alpestris Cœrulæ. Bright blue. Price per pkt., 5c.

Alpestris Alba. Pure white. Price per pkt., 5c.

Dissitiflora. Large flowering, dark blue; (the true forget-me-not). Price per pkt., 10c.

MYRSIPHYLLUM.

(See *Smilax*.)

NASTURTIUM.

Tropæolum.

Plants of great beauty, blooming throughout the summer and fall, and in the greenhouse during winter. The tall varieties make good covering for walls and trellises. The compact growth and rich colored flowers of the dwarf varieties make them desirable for bedding plants. They succeed best in light soil, not very rich.

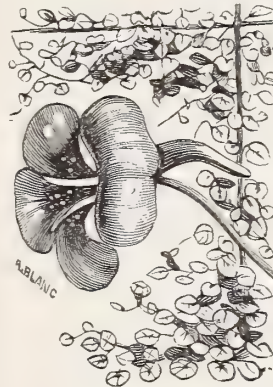

Nasturtium, Tall.

Mixed. All colors. Price per lb., \$1.25; per oz., 15c.; per pkt., 5c.

TALL VARIETIES.

Crimson. Rich color. Price per oz., 20c.; per pkt., 5c.

Pearl. White. Price per oz., 20c.; per pkt., 5c.

Rose. Beautiful shade. Price per oz., 20c.; per pkt., 5c.

Scarlet. Brilliant red. Price per oz., 20c.; per pkt., 5c.

Yellow. Spotted crimson. Price per oz., 20c.; per pkt., 5c.

DWARF VARIETIES.

Aurora. Salmon rose, shading from pink to carmine. Price per oz., 20c.; per pkt., 5c.

Beauty. Yellow, striped with red. Price per oz., 20c.; per pkt., 5c.

Cloth of Gold. Scarlet flowers with golden yellow foliage. Price per oz., 20c.; per pkt., 5c.

Empress of India. Very dark green foliage; flowers bright crimson. Price per oz., 20c.; per pkt., 5c.

Crystal Palace Gem. Sulphur yellow, spotted maroon. Price per oz., 20c.; per pkt., 5c.

King of Tom Thumbs. Intense scarlet. Price per oz., 20c.; per pkt., 5c.

King Theodore. Deep maroon flowers and dark foliage. Price per oz., 20c.; per pkt., 5c.

Lady Bird. Golden yellow, striped and spotted with bright red. Price per oz., 20c.; per pkt., 5c.

Pearl. Creamy white. Price per oz., 20c.; per pkt., 5c.

Rose. Dark pink. Price per oz., 20c.; per pkt., 5c.



Nasturtium, Dwarf.

Golden King. Pure bright yellow. Price per oz., 20c.; per pkt., 5c.

Mixed. All colors. Price per lb., \$1.50; per oz., 15c.; per pkt., 5c.

LOBBIANUM NASTURTIUMS.

The brilliance and profusion in blooming of the Lobbianum varieties render them superior for greenhouse or conservatory decoration in winter; also for trellises, arbors and vases, etc., in summer; half-hardy annuals. Six to ten feet.

LOBBIANUM NASTURTIUMS—Continued.*Nasturtiums.*

Brilliant. Rich scarlet.

Price per pkt., 5c.

Spitfire. Crimson.

Price per pkt., 5c.

Finest Mixed. Price per oz., 25c.; per pkt., 5c.

Nasturtium Peregrinum. (See *Canary Bird Flower*.) Price per pkt., 5c.

Nigella.

Love in a Mist or Devil in a Bush.

A compact, free-flowering plant, with finely cut foliage, curious looking flowers and seed pods; of easy culture, growing in any garden soil. Hardy annual. One foot.

Damascena. Blue and white mixed. Price per pkt., 5c.

*Nicotiana Affinis.***NICOTIANA.**

Affinis. A very ornamental plant with long, tubular white flowers, deliciously fragrant, and as easily grown as the common tobacco. Price per pkt., 5c.

Giant Red Flowered. The foliage is luxuriant; surmounted with crimson flowers. They grow rapidly, and continue until cut down by frost. Price per pkt., 5c.

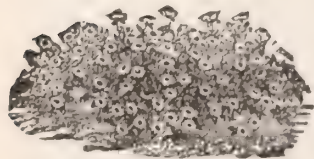
NEMOPHILA.*Nemophila.*

A charming class of dwarf - growing, free-flowering hardy annuals, of spreading habit.

Marginata. Azure blue, edged with white. Price per pkt., 5c.

Finest Mixed Colors. Price per pkt., 5c.

PORTULACA.

These brilliant and popular hardy annuals are of the easiest culture, luxuriating in an exposed, sunny situation, and producing throughout the summer their various colored flowers in the greatest profusion.

Golden Striped. Straw color with golden or orange stripes. Price per pkt., 5c.

Alba. Clear white. Price per pkt., 5c.

Pink. A delicate pink shade. Price per pkt., 5c.

Splendid Mixed Single. Price per pkt., 5c.

Large Flowering, Double Mixed. Flowers perfectly double, making a gorgeous display, remaining open all day. Price per pkt., 10c.

*Portulaca; Large Flowering, Double Mixed.*



Pansy.

PANSY.

Heartsease.

It will flower better in the middle of summer if planted where it is somewhat shaded from the hot sun, and especially if furnished with a good supply of water, but in almost any situation will give fine flowers in the spring and autumn.

Mixed. Good quality. Price per pkt., 5c.

Mixed Seeds. English grown. Price per pkt., 10c.

Mixed Seeds. German grown. Price per pkt., 15c.

Giant Trimardeau. Extra large and fine. Mixed. Price per pkt., 15c.

Large Belgian or Butterfly. Mixed. Price per pkt., 25c.

King of the Blacks. Almost coal black. Price per pkt., 5c.

Emperor William. Ultramarine Blue, with purple violet eyes. Price per pkt., 5c.

Peacock Blue. Rich velvety blue, white edge. Price per pkt., 10c.

Light Blue. Sky blue. Price per pkt., 10c.

Violet. With white border. Price per pkt., 10c.

Bugnot's Superb Striped and Blotched. Extra and very showy. Price per pkt., 15c.

Yellow Margined. Beautiful color, with margin or belt of yellow. Price per pkt., 10c.

Mahogany Colored. A rich bronzy red. Price per pkt., 10c.

Bronze. Copper colored. Price per pkt., 10c.

Red Victoria. Bright coppery colors, but not strictly red. Price per pkt., 10c.

Pure Yellow. Fine for bedding. Price per pkt., 10c.

White. Sometimes slightly marked with purple. Price per pkt., 10c.

Odier or Large Eyed. Dark spots on each petal, and large eyes. Price per pkt., 10c.

*Petunia.*

PETUNIA.

The brilliancy and variety of its colors, combined with the duration of its blooming period render it invaluable. The plants are of easy culture and thrive well in any good garden soil.

Fine Mixed. Price per oz., 75c. Price per pkt., 5c.

Extra Choice Mixed. Largest flowered. Price per pkt., 10c.

California Giants. Striped and blotched; extra fine mixed. Price per pkt., 25c.

Striped and Blotched. Large flowered, extra. Price per pkt., 10c.

Large Single Fringed. Blotched and striped; large flowering, mixed. Price per pkt., 25c.

Finest Double. Beautiful shades of crimson, white, rose, striped and blotched. Price per pkt., 25c.

PHLOX.

This splendid genus of plant is unrivaled for richness of color, profusion of blossoms, length of duration in bloom, and whether in clumps or masses, looks equally beautiful.

Phlox Drummondii. Mixed. Price per oz., 50c.; per pkt., 5c.

LARGE FLOWERING PHLOX.

The large-flowering kinds are a decided improvement on the Drummondii, producing flowers twice the size of the latter, with the most brilliant colors.

Alba. Pure white, extra large. Price per pkt., 5c.

Brilliant Scarlet. Price per pkt., 5c.

Rosy Carmine. White Eye. Price per pkt., 5c.

Rosea Pink. White Eye. Price per pkt., 5c.

Vivid Crimson. Large White Eye. Price per pkt., 5c.

Large Yellow. A very fine color. Price per pkt., 5c.

Splendid Mixed. Includes all of the above, and many other shades and colors. Price per pkt., 10c.

Star of Quedlinburgh. Star-shaped Phlox of dwarf habit, with very pretty flowers, mixed colors. Price per pkt., 10c.

DOUBLE-FLOWERING PHLOX.

Flowers are double and semi-double, and last much longer than those of the Single Phlox. The white is especially valuable as a cut flower.

Double White. Price per pkt., 10c.

Double Scarlet. Price per pkt., 10c.

Double Mixed Price per pkt., 10c.

DWARF PHLOX.

Phlox Drummondii Nana Compacta.

These are the best for ribbon-bedding or borders. The plants grow very symmetrically in neat little bushes about eight inches high; covered with flowers during the whole summer and fall, as large as those of the Drummondii, and as easy to grow.

DWARF PHLOX.

Continued.

Snowball. Flowers pure white; the plants resemble large snowballs when in full bloom. Price per pkt., 10c.

Fireball. Glowing, brilliant scarlet. Price per pkt., 10c.

Dwarf Phlox, Mixed. Price per pkt., 10c.

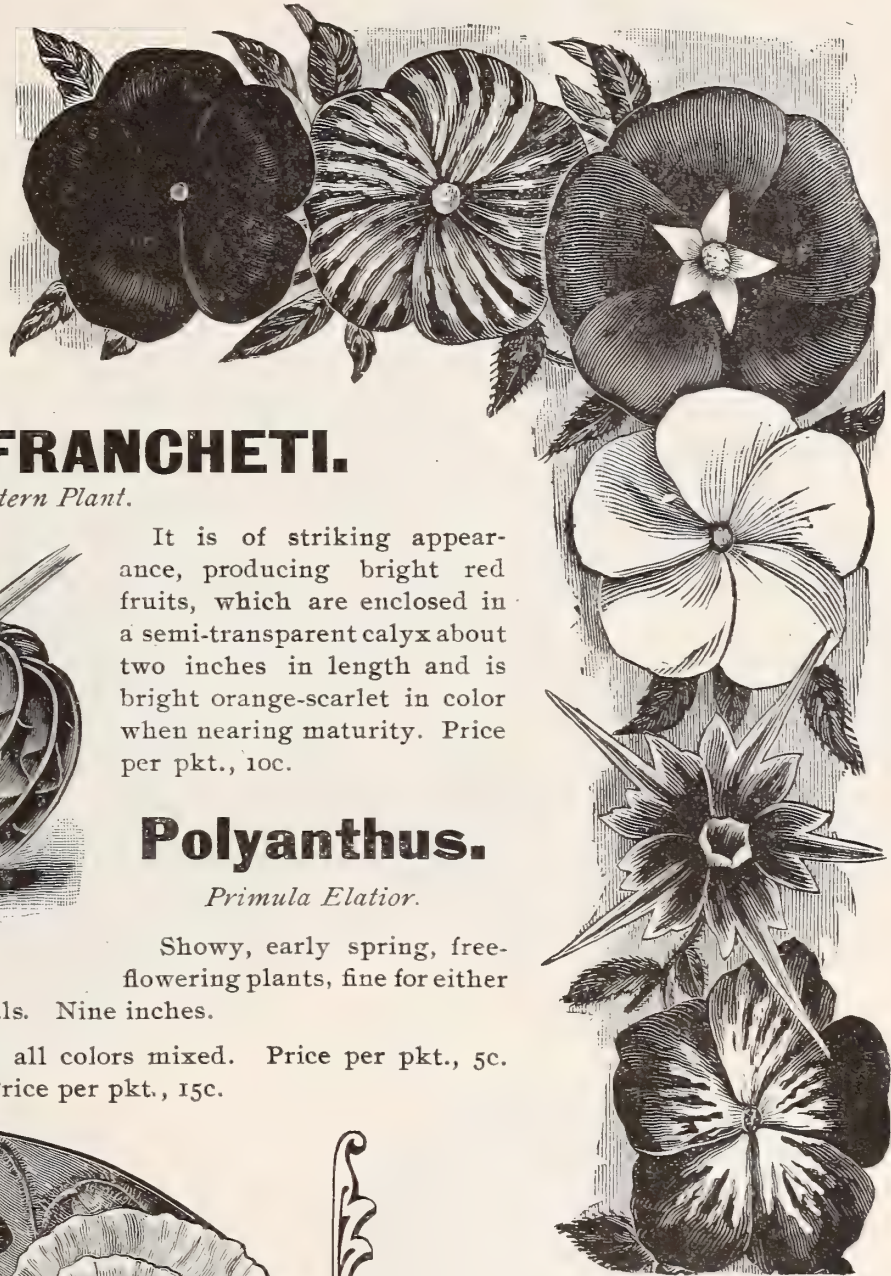

PHYSALIS FRANCHETI.

Chinese Lantern Plant.

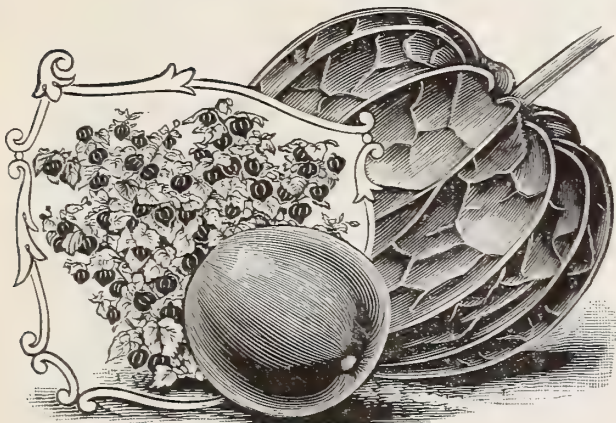

Physalis Francheti.

It is of striking appearance, producing bright red fruits, which are enclosed in a semi-transparent calyx about two inches in length and is bright orange-scarlet in color when nearing maturity. Price per pkt., 10c.

Polyanthus.

Primula Elatior.

Showy, early spring, free-flowering plants, fine for either

pot or outdoor culture; hardy perennials. Nine inches.

Polyanthus, English. The best single, all colors mixed. Price per pkt., 5c.

Duplex. Double hose-in-hose, mixed. Price per pkt., 15c.

Large Flowering Phlox.

POPPIES.

Plants with large and brilliant colored flowers, growing freely in any common soil, producing a rich and effective display in mixed flower borders and shrubbery.

SINGLE ANNUAL POPPIES.

Tulip Poppy. A magnificent species from Armenia. The plants grow about fourteen inches high and produce from fifty to sixty large tulip-like flowers of dazzling scarlet. Price per pkt., 10c.

Shirley Poppies. These are generally single or semi-double; the color extending from pure white through the most delicate shades of pale pink, rose and carmine. Price per pkt., 10c.

Danebrog. Large bright scarlet, white cross in center. Price per pkt., 5c.



POPPIES—Continued.

Umbrosum. Richest vermilion, with a deep, shiny black spot on each petal. Price per pkt., 5c.

English Scarlet. The common field poppy of Great Britain, dazzling scarlet. Price per pkt., 5c.

Flag of Truce. Satiny white flower, three to four inches across. Price per pkt., 5c.

Single Mixed. Price per pkt., 5c.

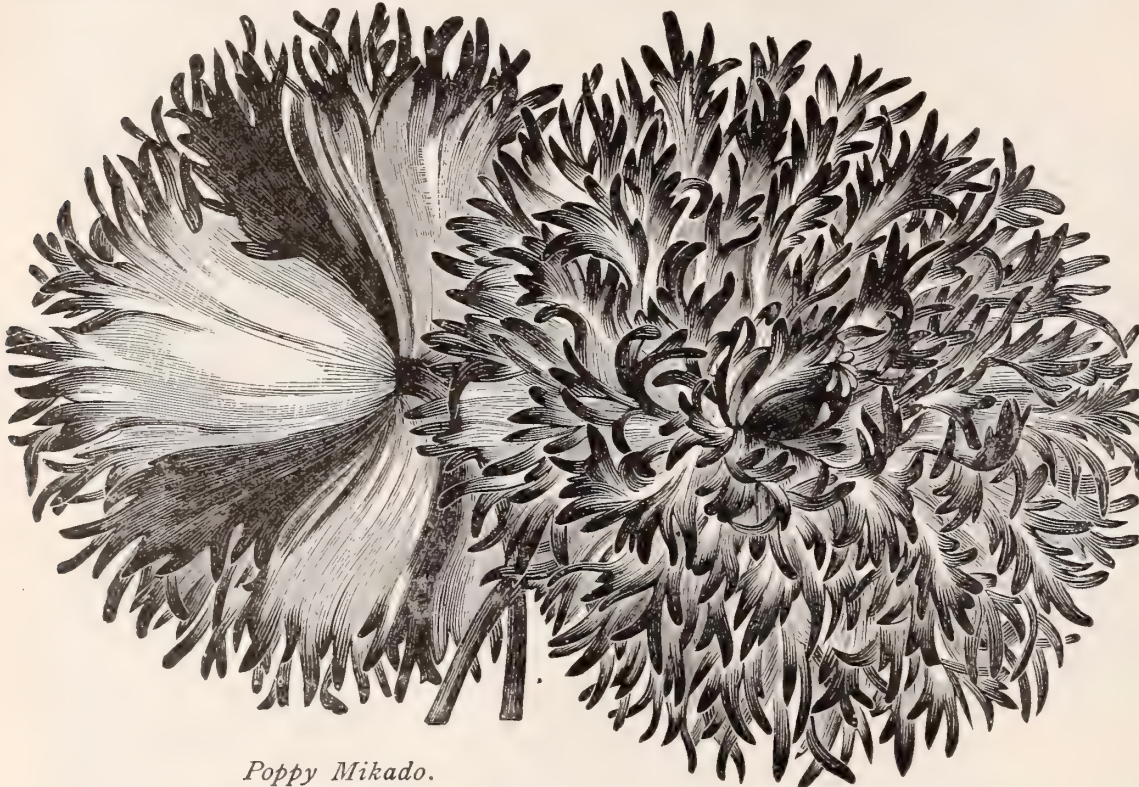

Poppy Mikado.



Nudicaule.
(*The Iceland Poppy.*)

DOUBLE ANNUAL POPPIES.

Fairy Blush. Very double flowers, white, elegantly fringed and tipped with rose. Price per pkt., 10c.

White Swan. Immense double flowers, beautifully fringed, and of purest white. Price per pkt., 10c.

Mikado. The flowers are brilliant scarlet and white, with elegantly curved petals, like a Japanese chrysanthemum, the fringed edges being crimson scarlet. Price per pkt., 10c.

Carnation Flowered. Splendid double fringed flowers, mixed colors. Price per pkt., 5c.

HARDY PERENNIAL POPPIES.

Bracteatum. Very large orange-scarlet flowers, averaging five inches in diameter. Perennial variety. Price per pkt., 10c.

Nudicaule. (*The Iceland Poppy.*) Perfectly hardy, and produce an endless profusion of flowers which are most useful for cutting. They have bright green, fern-like foliage, formed in tufts, from which issue tender stalks about twelve inches in height, surmounted by yellow, white or orange-scarlet flowers. Price per pkt., 10c.

PYRETHRUM.

Handsome herbaceous plants of easy culture. *P. Aureum* is the well-known Golden Feather, so much

used for carpet bedding, edging, etc. From the flowers of *P. Roseum* is obtained the Persian insect powder. *P. Hybridum* and varieties are among the handsomest of hardy flowering herbaceous plants.



Pyrethrum.

Aureum. (*Golden Feather.*) Bright yellow foliage. Price per pkt., 5c.

Roseum. (*Persian Insect Powder Plant.*) Flowers bright rose; one and one-half feet. Per pkt., 10c.

PRIMULA.

Chinese Primrose.

This is a beautiful flowering plant for winter or spring decorations in the home or conservatory. It is usually advised to sow Primula seeds in July and August, but in our hot, dry climate it is very difficult for them to germinate at that season. I have found that the best time to sow is in February, March or April. Then sown, the seeds germinate freely, and fine plants can be had for winter flowering.



Primula.

SINGLE VARIETIES.

Single White Fringed. Price per pkt., 25c.

Single Red Fringed. Price per pkt., 25c.

Superb Mixed. This strain of English Primula is universally admired, and contains the finest varieties and colors. Price per pkt., 25c.

Fine Mixed Colors. Price per pkt., 15c.

DOUBLE CHINESE PRIMROSE.

White. Price per pkt., 50c.

Mixed. Price per pkt., 50c.

HARDY PRIMROSES.

These are among the best of the early spring blooming plants. With a slight protection they will stand the winter, but do better if protected by a cold frame.

Primula Japonica. (*Japanese Primrose.*) Bright and showy flowers, borne in whorls on stems six to nine inches long; mixed colors. Price per pkt., 10c.

RHODANTHE.

Maculata, Mixed. Half-hardy annual. Valuable for garden or pot culture, as they come into flower early and continue for a long time. An everlasting. Flowers of various colors; white, pink, crimson, etc. Price per pkt. 5c.



Rhodanthe.

RICINUS.

Castor Oil Beans.

Large, luxuriant, rapid-growing foliage annual, with palm-like leaves; much used for sub-tropical effects on the lawn, or for centers of beds of foliage plants.

Zanzibarensis. The different varieties included in our mixture have light and dark green leaves and some of coppery bronze changing to dark green, with reddish ribs; six to ten feet. The seeds are quite distinct in color and beautifully marked. Price per oz., 20c.; per pkt., 5c.

Cambogiensis. Leaves of a bronzy red maroon color, with large, red veins; the main stem or trunk, ebony black. Price per pkt., 10c.

Borboniensis. Fifteen feet; grows very large and rank; foliage green. Price per pkt., 5c.

Gibsonii. Six feet; red foliage and stems. Price per pkt., 5c.

Finest Mixed. Price per oz., 15c.; per pkt., 5c.



Ricinus.

RUDBECKIA.

Cone Flowers.

These robust growing plants are fine free flowering annuals. They are of very easy culture and produce showy flowers during summer and autumn.

Bicolor. An annual variety; bright yellow, with black-purple center. Price per pkt., 10c.

Newmanii. Perennial; grows two feet; large, golden-yellow flowers with velvety maroon center cone. Price per pkt., 10c.

SALPIGLOSSIS.

One of the most beautiful of flowering annuals, forming strong, bushy plants about eighteen inches high, and bearing throughout the season large flowers



Salpiglossis.

of many beautiful colors, all exquisitely veined and laced.

Large Flowering Mixed. Price per pkt., 5c.

SALVIA.

Sage.



Salvia. (Sage.)

Splendid ornamental plants for outdoor decorations, their beautiful spikes of brilliant scarlet and blue flowers being produced in great profusion from July until October. Half-hardy annual.

Splendens. Scarlet, free bloomer. Price per pkt., 10c.; per oz., \$1.50.

Splendens "Bonfire." (*Nana Compacta Erecta.*) Growing in a compact bush about two feet high. Its erect spikes of flowers of brilliant scarlet stand clear above the dark green foliage and completely cover the plant. Price per pkt., 15c.

Patens. Splendid deep blue. Price per pkt., 20c.

Sanvitalia.

Pretty, dwarf-growing, free-flowering plants, suitable for small beds, rock work or edgings, continuing in bloom during the summer and autumn months. Hardy annual.

Procumbens. Double, golden yellow. Price per pkt., 5c.



Sanvitalia.

Scabiosa.

Mourning Bride.

A beautiful border plant, producing a profusion of flowers in great variety of colors; excellent for cutting for table bouquets, etc. The flowers are quite double and globular, varying in all shades of white, carnation, maroon, lilac, etc. Hardy annual.



Scabiosa. (Mourning Bride.)

Mixed Dwarf Double. One foot. Price per pkt., 5c.

Tall, Large Flowering, Double. Mixed. Price per pkt., 5c.

Schizanthus

The Butterfly Flower.

A class of plants combining elegance of growth with a rich profusion of curiously striped and blotched flowers. Half-hardy annual.

Best Mixed Varieties. Price per pkt., 5c.



Schizanthus.

SMILAX.

Myrsiphyllum.

There is no climbing plant in cultivation that surpasses this in the graceful beauty of its foliage. In cut flowers it is considered indispensable by florists.

Smilax. Price per oz., 50c.; per pkt., 10c.

STOCKS.*Stock—Princess Alice.***GERMAN TEN-WEEKS.**

The Ten-Weeks' Stock ("Stock Gilly," or "Gilly-flower," as they are sometimes called) are especially recommended on account of their long continuance in bloom and vigorous habit. Very desirable for pot culture or out-door blossoming. Flowers very double. Half-hardy annual.

German Ten-Weeks. Fine mixed. Price per pkt., 5c.

Large Flowering. Choice mixed. Price per pkt., 10c.

Pure White. Price per pkt., 10c.

Scarlet Victoria. Brilliant red. Price per pkt., 10c.

Princess Alice. (Cut and Come Again.) A fine perpetual blooming stock, growing about two feet high. If sown early it commences blooming in June, and continues until destroyed by frost. It throws out numerous side branches bearing clusters of very double, pure white, fragrant blossoms. Price per pkt., 10c.

Large Flowered Dwarf Pyramidal. Very finest mixed. Price per pkt., 10c.

Intermediate or Autumnal Flowering. Very beautiful choice double flowers; mixed. Two feet. Price per pkt., 10c.

SOLANUM.

An ornamental and interesting genus of fruit-bearing plants; singularly grotesque in fruit and foliage.

Capsicastrum.

(*Jerusalem Cherry*). Covered with scarlet fruit during winter. 1½ ft. Price per pkt., 5c.

*Solanum.***SWEET WILLIAM.***Dianthus Barbatatus.**Sweet William.*

A very beautiful class of plants, of extreme neatness and diversity of color. For display in the garden or borders, the Sweet William is indispensable; grown in clumps, twelve to eighteen inches high. Hardy perennial.

Fine Mixed. Price per pkt., 5c.

Double Flowering. Finest mixed. Price per pkt., 10c.



SWEET PEAS.

Free-flowering climber, continuing in bloom all summer; valuable in trailing or trellis work, covering rough fences, etc. Seeds should be sown as early in the spring as is practicable to work the ground, and covered deeply, four to six inches.

Apple Blossom. Standard crimson pink shaded, wings white tinged with pink. Price per pkt., 5c.; per oz., 10c.; per lb., 40c.

Aurora. Large size, orange rose, striped on white. Price per pkt., 5c.; per oz., 10c.; per lb., 60c.

Blanche Burpee. Largest, pure white. Price per pkt., 5c.; per oz., 10c.; per lb., 60c.

Blanche Ferry. Standard, is a bright pink and the wings nearly white. Price per pkt., 5c.; per oz., 10c.; per lb., 50c.

Black Knight. Very large, and darkest maroon. Price per pkt., 5c.; per oz., 10c.; per lb., 60c.

Fashion. Medium size, rose magenta. Price per pkt., 5c.; per oz., 10c.; per lb., 75c.

Golden Gleam. Light primrose. Price per pkt., 5c.; per oz., 10c.; per lb., 75c.

Gorgeous. Standard scarlet orange, wings bright rose strongly tinged with orange. Price per pkt., 5c.; per oz., 10c.; per lb., 75c.

Katherine Tracy. Soft, rosy pink. Price per pkt., 5c.; per oz., 10c.; per lb., 50c.

Mars. Bright fiery crimson. Price per pkt., 5c.; per oz., 10c.; per lb., 60c.

Mrs. Eckford. Delicate primrose-yellow. Price per pkt., 5c.; per oz., 10c.; per lb., 50c.

Navy Blue. Bright blue, finest of its color. Price per pkt., 5c.; per oz., 10c.; per lb., 60c.

New Countess. Delicate lavender. Price per pkt., 5c.; per oz., 10c.; per lb., 60c.

Othello. Very dark maroon showing veins of almost black. Price per pkt., 5c.; per oz., 10c.; per lb., 75c.

Royal Rose. Standard crimson pink, shading deeper at mid-rib. Wings of lighter pink. Price per pkt., 5c.; per oz., 10c.; per lb., 75c.

Senator. Standard maroon and violet, wings violet and indigo, both striped on white. Price per pkt., 5c.; per oz., 10c.; per lb., 75c.

Eckford's Hybrids. Finest mixed, a carefully proportioned mixture of the best of the preceding varieties, which cannot fail to give flowers of the best form and a wide range of color. Price per pkt., 5c.; per oz., 10c.; per lb., 40c.

Choice Mixed. This mixture contains some of the newer and rarer kinds, and while not being equal to the above, yet can be depended upon to make a fine display and give satisfaction. Price per pkt., 5c.; per oz., 10c.; per lb., 30c.



COPYRIGHTED
1935 BY
W.A.B. & CO.

Cupid, Dwarf or Bedding Sweet Peas.

Pink. Rosy pink standard, white wings. Price per pkt., 5c.; per oz., 10c.; per lb., 75c.
White. Pure white. Price per pkt., 5c.; per oz., 10c.; per lb., 80c.
Mixed. Price per pkt., 5c.; per oz., 10c.; per lb., 75c.

THUNBERGIA.

Sometimes called "Black-eyed Susan." Extremely ornamental, free-blooming climbers of rapid growth, handsome foliage and much-admired flowers; good for greenhouse culture, or in warm situations out-doors. Half-hardy annuals.
Fine Mixed. Price per pkt., 5c.



Thunbergia.

VERBENA.

Well-known and universally admired plants; invaluable for summer decorations, blooming freely the first year from seed. Half-hardy perennial.

Fine Mixed. Price per pkt., 5c.
Mammoth Choice. Mixed. A grand collection of magnificent varieties. Price per pkt., 10c.
Mammoth White. Price per pkt., 10c.
Mammoth Scarlet. Price per pkt., 10c.

VINCA.

Free-flowering, compact, greenhouse evergreen shrubs, with shining green foliage and handsome circular flowers. If sown early in spring will flower the same season, and will be very useful for bedding or pot culture.

Rosea. Rose. Price per pkt., 5c.
Rosea Alba. White, with crimson eye. Price per pkt., 5c.



Vinca.



Verbena.

WALL-FLOWER.

A well-known plant of the Gillyflower family, producing its rich orange or chocolate flowers in the spring



Wall-Flower.

if protected in the house during the winter. Half-hardy perennial.

Single. Finest mixed. Price per pkt., 5c.

Double. Finest mixed. Price per pkt., 10c.

ZINNIA.

Annual of great beauty and brilliancy; of branching habit and superb colors; continues in bloom a long time; very effective in beds, groups or mixed borders. Half-hardy annual.

Large Flowering, Double White. Price per pkt., 5c.

Large Flowering, Double Scarlet. Price per pkt., 5c.

Zebra. A very pretty strain of striped flowers. As the colors vary on each plant, they present a curious as well as pretty appearance. Price per pkt., 10c.

Double Lilliput. Close, bushy plants bearing small double pompon-shaped flowers of brightest colors. Price per pkt., 10c.

Extra Double Mixed. Price per pkt., 10c.



Zinnia.



MIXED WILD GARDEN SEED.

The seeds I offer for the Wild Flower Garden are a mixture of over *one hundred and fifty* different varieties, and as such can be offered at a much less price than when sold in separate packets. Sow in open ground in May or June, in carefully prepared beds of good, rich loam, thoroughly incorporated with well-rotted manure. Cover with a thin coating of fine, dry earth; keep the plants thinned to prevent overcrowding. Price per pkt., 5c.; per oz., 20c.

MISCELLANEOUS BULBS.

NEW LARGE-FLOWERING FRENCH CANNAS.

Unquestionably the finest plants of our entire list for summer blooming and lawn decoration. They produce the tropical luxuriance of foliage of the common kinds, to which is added the gorgeousness of their flaming panicles of bloom, which are borne in immense heads at the terminous of every shoot, the colors ranging through all the shades of orange, scarlet and crim-

Robusta. Foliage dark bronzy maroon, interlaced with green. A perfect dark-leaved variety. Flower heads of compact form; color, bright cherry. Six feet. Price each, 10c.; per doz., \$1.00.

Florence Vaughan Bright, rich golden yellow, spotted with red; flowers of the largest size; foliage rich green. Three feet. Price each, 10c.; per doz., \$1.00.

Francoise Crozy. The color is a shade of apricot,



French Cannas.

son. Many are striped, spotted, veined, or beautifully margined. The main requisite for culture is rich soil, deeply dug and heavily manured.

Alphonse Bouvier. The color is rich, brilliant crimson; foliage deep green. Five to six feet. Price each, 10c.; per doz., \$1.00.

Burbank. Very large canary-yellow flowers, flecked with carmine spots in the throat. Foliage green and vigorous. Price each, 10c.; per doz., \$1.00.

Charles Henderson. A fine crimson, very popular. Its habit of growth is compact and uniform, rarely exceeding three and one-half feet in height. Price each, 10c.; per doz., \$1.00.

bordered with bright yellow. Price each, 10c.; per doz., \$1.00.

Flamingo. Red flowers, bronze shaded leaves. Price each, 10c.; per doz., \$1.00.

Madame Crozy. The flowers are of the largest size, scarlet, bordered with golden yellow. The plant is dwarf in habit; foliage light green. Price each, 10c.; per doz., \$1.00.

Paul Marquant. Large flowers in bold, shapely trusses; salmon rose. Price each, 10c.; per doz., \$1.00.

Queen Charlotte. Resembling the Madame Crozy, but having a much wider band of yellow around each petal. Price each, 15c.; per doz., \$1.50.

TUBEROUS-ROOTED BEGONIAS.

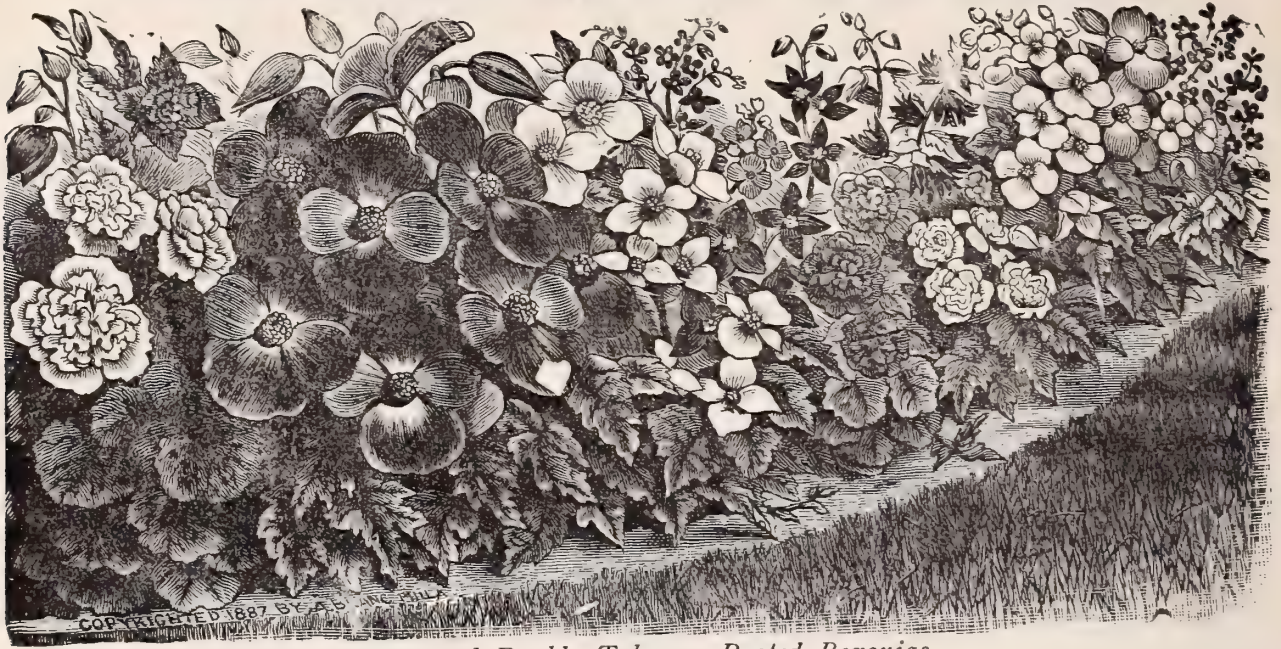

Single and Double Tuberous-Rooted Begonias.

The begonias grow best if planted in partial shade, in a soil composed of leaf mold, sand, and a portion of well-rotted manure. They also make splendid specimen plants when grown in pots. When through flowering they should be dried off and shaken free from earth and packed in charcoal dust or dry leaf mold and kept in a warm room until February or March, when they may be started again.

Single, Scarlet, Orange, Crimson, Pink, White, Yellow. Price each, 10c.; per doz., \$1.00; per one hundred, \$6.00.

Mixed Single. Price each, 6c.; per doz., 60c.; per one hundred, \$4.50.

Mixed Double. Price each, 15c.; per doz., \$1.50; per one hundred, \$10.00.

DAHLIAS.

Single. Finest named sorts. Price each, 10c.; per doz., \$1.00.

Pompon or Bouquet. Finest known varieties, like Guiding Star, White Aster, etc., etc. Price each, 10c.; per doz., \$1.00.

Large Flowering Double. We have a fine collection of the finest sorts in existence. Named sorts. Price each, 10c.; per doz., \$1.00.

Finest Mixed. Unnamed bulbs. Price per doz., 60c.



Dahlia.



The most brilliant and showy of all the summer-flowering bulbs. Their immense spikes of gorgeous bloom comprise in color all the shades from white to the deepest scarlet, purple and yellow, with blotchings and markings of charmingly contrasted shades. They will grow in any good garden soil and bloom with the most ordinary care. The bulbs should be planted at intervals, in April and May, to secure a succession of bloom. Take up in the fall and store in a dry cellar or other cool place, well protected from frost.

GLADIOLUS BULBS.

(Choice Mixtures).-

All Colors Mixed. Price each, 2c.; per doz., 20c.; per one hundred, \$1.50.

My "Choice Mixture." Price each, 3c.; per doz., 35c.; per one hundred, \$2.00.

Shades of White and Light. Price each, 3c.; per doz., 35c.; per one hundred, \$2.50.

Shades of Yellow. Price each, 3c.; per doz., 35c.; per one hundred, \$2.50.

Shades of Pink and Variegated. Price each, 3c.; per doz., 35c.; per one hundred, \$2.50.

Shades of Red. Price each, 3c.; per doz., 25c.; per one hundred, \$1.75.

Caladium Esculentum.

Elephant's Ears.

One of the largest of ornamental foliage plants, grows in any

garden soil, and when full size stands four or five feet high, with immense leaves, often measuring four feet in length, by two and one-half feet in breadth.

Extra Large. Price each, 25c.; per doz., \$2.50.

First Size Bulbs. Price each, 15c.; per doz., \$1.50.

Second Size Bulbs. Price each, 10c.; per doz., \$1.00.

Third Size Bulbs. Price each, 5c.; per doz., 50c.



Caladium Esculentum.

If by mail
add 15c.
per dozen.



Tuberose.

DOUBLE TUBEROSE.

The tuberose, being a native of a tropical climate, requires the extreme heat of summer, and will not bloom till late unless started in the forcing-house or hot-bed in February or March. They may be transferred to open ground after the soil has become warm and settled summer weather prevails. The bulbs are extremely sensitive; a slight freezing destroys the crown or heart.

EXCELSIOR DWARF PEARL.

First Size. Price each, 3c.; per doz., 25c.; per one hundred, \$1.50.

Second Size. Price each, 2c.; per doz., 15c.; per one hundred, \$1.00.

Third Size. Price each, 1c.; per doz., 10c.; per one hundred, 75c.

HARDY AND HERBACEOUS PLANTS MADEIRA VINE.

The Madeira vine is a beautiful climber, with thick, glossy, light green leaves, climbing twenty feet or more, and twining in any desired form. Price each, 5c.; per dozen, 50c.



RUDBECKIA
GOLDEN GLOW

GOLDEN GLOW.

New Double Rudbeckia.

A hardy perennial plant growing four to eight feet high, branching freely, and blooming profusely, on long, graceful stems; exquisite double blossoms of the brightest golden color. Price each, 25c.; per doz., \$2.50.

DIELYTRA SPECTABILIS.

Bleeding Heart.

One of our most ornamental spring plants, with handsome pæony-like foliage and long, drooping racemes of bright pink and white heart-shaped flowers.



Dielytra Spectabilis.

Dielytra Spectabilis. Price each, 20c.; per doz., \$2.00.

FUNKIA.

Day Lily.

The roots should be set out in the autumn to become well established, and they will bloom the following spring. They need not be disturbed for many years.

Alba. Pure white, fragrant flowers, green foliage. Price each, 25c.; per doz., \$2.50.

Funkia Variegata. Foliage very handsome, green and white; flowers lilac. Price each, 25c.; per doz., \$2.50.

LILIES.

Auratum, the Golden Banded Lily of Japan. Flowers a foot across, pure white, spotted crimson, with a golden band through the center of each petal; very fragrant; the king of lilies. Price each, 15c.; per doz., \$1.50.

Tigridias. Tiger lily, orange-spotted. Price each, 10c.; per doz., \$1.00.

Roseum or Rubrum. Rose or pink, spotted darker; very beautiful. Price each, 20c.; per doz., \$2.00.

Speciosum Melpomene. Very large crimson flowers, heavily spotted. Price each, 15c.; per doz., \$1.50.



L. Auratum.

Monstrosum Album. Pure white, with immense clusters of bloom, often fifty in a bunch; grand. Price each, 25c.; per doz., \$1.50.

Candidum. (Annunciation or St. Joseph Lily.) The well-known garden lily; snow-white, fragrant blos-

soms; it is also one of the best forcing lilies for florists. Three to four feet. Blossoms in the open ground about June. Price each, 10c.; per doz., \$1.00.

Longiflorum. Large white trumpet shaped flowers. Price each, 15c., per dozen, \$1.50.

Harrisii, the Bermuda or Easter Lily. Flowers pure white and trumpet-shaped. Its great value consists in the earliness and free-blooming qualities, a single plant frequently producing from eight to twelve flowers at a time; extremely valuable for forcing, but not sufficiently hardy for out-door planting, unless well protected. First size bulbs, price each, 25c.; per dozen, \$2.50. Second size bulbs, price each, 15c.; per dozen, \$1.50. Third size bulbs, price each, 10c.; per dozen, \$1.00.

HARDY ORNAMENTAL GRASSES.

Very effective and picturesque groupings are made in parks and large lawns, and single plants are often used to great advantage in small areas.



Eulalia Japonica Zebrina.

Arundo Donax. A magnificent hardy grass, growing to a height of fifteen feet, and forming dense clumps. Price, 25c.; to \$1.00 each.

A. D. Variegata. A hardy, broad-leaved variegated Bamboo; foliage creamy white and green; growing six to eight feet high. Price, 25c.; to \$1.00.

Bambusa Metake. (*Japanese Bamboo*.) A perfectly hardy variety of dwarf habit, attaining a height of not over five to six feet. The foliage is of a rich, dark green, and is retained on the plant in a fresh condition almost the entire winter. It makes a most desirable addition to the border in connection with shrubbery, or as an individual specimen for the lawn. Price, 5c.; to \$1.00.

Festuca Glauca. A pretty tufted grass with glaucous foliage. Price, 25c. to 50c. each.

Uniola Litifolia. One of the best of our native perennial grasses, growing from three to four feet high, with large flat flower heads in graceful drooping panicles. Price, 25c. each; per dozen, \$2.50.

HARDY ORNAMENTAL GRASSES

Continued.

Eulalia Japonica Variegata. A very graceful, tall, ornamental grass from Japan. Its long, narrow leaf-blades are striped green, white and often pink or yellow. It throws up stalks from four to six feet in height, terminated with a cluster of flower spikes. Price, 25c. each; per doz., \$2.50; clumps, 50c. to \$1.00.

E. Gracillima Univittata. This is a grand addition of compact habit, with very narrow foliage, of a bright green color with a silvery white mid-rib. Price, 25c. each; per dozen, \$2.50; clumps, 50c. to \$1.00.

E. Japonica Zebrina. This variety resembles japonica in hardiness, growth and bloom. The long blades are marked with broad yellow bands across the leaf. It makes a very attractive specimen plant for the lawn. Price, 25c. each; per doz., \$2.50; clumps, 50c. to \$1.00.

Erianthus Ravennæ. A hardy ornamental grass, which grows from nine to twelve feet high, frequently throwing up from thirty to fifty flower spikes. It resembles the pampas grass, but blooms much more abundantly. Price, 25c. each; clumps, 50c. and 75c.

Phalaris Arundinacea Variegata. (*Variegated Ribbon Grass.*) Large variegated foliage; an excellent grass for bordering large beds. Price, 10c. each; per dozen, \$1.00; per one hundred, \$6.00.

HARDY PHLOX.

The Phloxes are among the most desirable of the hardy perennials; their large and very brilliant trusses of beautiful flowers comprise all shades of color, from white to crimson, striped and mottled. Divide and replant in freshly prepared soil each alternate year. They delight in sunny situations and a rich soil.

Bacchante. Dark crimson rose; large and fine.

E. Levavasseur. Fine dwarf white; extra early.

H. O. Wigers. Purest white with rich crimson eye.

Moliere. Salmon-pink with white eye.

Nettie Stewart. Fine, large, pure white, with just the faintest tinge of rose near the base of petals.

Robert Werner. Soft, tender rose, with carmine center; very large and distinct from all others.

The Pearl. The best late pure white.

Torpilleur. Rich, bright magenta.

William Robinson. Rosy salmon, with large, dark center. Price each, 15c.; per doz., \$1.50.

PEONIES.

The Peonies are greatly prized on account of their large, vigorous, healthy, bushy form and abundance of magnificent bloom of large, bright, double flowers. They are extremely hardy, and may be planted either in fall or spring, growing well in any soil.

White. Large double, pure white. Price, large root, 25c.; clump of roots, 50c.

Rose. Sweet scented. Price, large root, 25c.; clump of roots, 50c.

Crimson. Very dark crimson. Price, large root, 25c. clump of roots, 50c.

Mixed Colors. Price per doz., \$1.50.

PEONY MOUTAN.

Tree Peonies.

A beautiful group of hardy Japanese shrubs, having flowers of immense size, both single and double, varying in color from white to scarlet, splashed, spotted and striped in every conceivable manner. They form bushes four to five feet high, and as many through. In three sizes. Price, 50c. and \$1.00 each.



*Tritoma, Flame Flower,
Torch Lily or
Red Hot Poker.*

Tritoma, Flame Flower. Torch Lily or Red Hot Poker.

Blooms from midsummer till freezing weather. The stalks shoot up from three to four feet high, and continue blooming for several weeks. As the flowers bud, open and fade, they pass through the shades of yellow, red and blue, that a bar of hot iron does in cooling. Price each, 25c.; per doz., \$2.50.

CINNAMON VINE.

Beautiful summer climber; glossy foliage and fragrant flowers; stem dies down in winter, but the root is hardy. Large selected roots. Price each, 5c.; per doz., 50c.



*Cinnamon
Vine Root.*

Hardy Hybrid Roses.

The varieties given below and many recent introductions will be carried in stock for spring sales.

Culture. Roses require a rich, well-drained soil, enriched with well-rotted manure. Applications of liquid manure during the growing season will stimulate a more vigorous growth.

Anne de Diesbach. Clear rose ; large flowers ; vigorous.

Coquette des Alps. White shaded rose. A very profuse bloomer throughout the season.

Earle of Dufferin. Dark, velvety crimson.

General Jacqueminot. Velvety red. One of the most widely known of hardy roses.

Clio. A large white rose ; very fine.

Harrison's Yellow. Golden yellow ; medium size ; semi-double.

Persian Yellow. Bright yellow, small, nearly full.

Mme. Gabriel Luizet. Silvery pink ; vigorous grower.

Mme. Plantier. Vigorous grower ; summer bloomer.

Paul Neyron. Immense size ; pink ; good, tough foliage.

Prince Camille DeRohan. Velvety crimson.

Ulric Brunner. Cherry red.

Prices: Selected two-year-old, each, 30c.; per doz. \$3.00.

Extra selected two-year-old, each, 50c. per doz., \$4.50.

Extra strong, transplanted, three-year-old, each, 75c.; per doz., \$7.00.

Climbing Roses.

New Climbing Rose—Dorothy Perkins.

A hardy climbing rose, which in strong, vigorous growth resembles the popular Crimson Rambler ; its flowers are born in clusters of 30 to 40 and are of a beautiful shell pink, double and large size for a cluster Rose and deliciously scented. Extra strong one-year-old plants, 30c. each ; per doz. \$3.00. Young plants 15c. each, \$1.50 per dozen.

Crimson Rambler. The plant makes a rapid growth of many branches and smaller shoots, all of which bear clusters of bright crimson flowers. Price, 25c., 50c. and \$1.00 each.

Yellow Rambler. (*Aglaia*.) A perfectly hardy yellow climbing rose. The flowers are of fair size and borne in large clusters. Price, 25c., 50c., and \$1.00 each.

Baltimore Belle. A beautiful rose, producing large clusters of double flowers, blush white, changing to light rose. Price, 25c. to 50c. each.

Queen of the Prairie. Large double flowers of a deep rosy carmine and very fragrant. Price, 25c. to 50c. each.

CLIMBING SHRUBS.

Ampelopsis Veitchii. ("Boston Ivy" or "Japan Ivy.") It is perfectly hardy, clinging to stones, brick or

wood work with the greatest tenacity. In the summer the foliage is a rich shade of green, but in the fall it changes to gorgeous tints of scarlet, crimson and orange. Price, 20c. ea., per doz. \$2.00.

Ampelopsis Quinquifolia. The old Virginia creeper. Invaluable where a coarse rapid climber is desired. The foliage is larger than the above. Price, 20c. ea., per doz. \$2.00.

Aristolochia Sipo. A vigorous and rapid-growing climber, bearing singular brownish colored flowers, resembling in shape a Dutchman's pipe. Price, 25c. each ; per dozen, \$2.50. Extra strong plants, 50c. each.

Bignonia Radicans. (*Trumpet Creeper*.) A very rapid grower ; flowers in large bunches, of a rich orange scarlet. Price, 25c. each ; per dozen, \$2.25. Extra size plants, 50c. each.

Clematis Paniculata. (*Japan's Sweet Clematis*.) Its foliage is a rich glossy green. Flowers delicate, star like in form, and pure white, borne in large panicles and extremely fragrant. A very rapid grower. Price, two-year plants, 35c. each ; per dozen \$3.50. Extra three-year plants, 50c. each ; per dozen, \$5.00.

Clematis Jackmani. The best known and most popular variety. Color dark rich royal purple. Price 35c. each ; per dozen \$3.50.

Clematis Henryi. Creamy white, large and handsome. Price 35c. each ; per dozen, \$3.50.

Honeysuckle, Japan. Golden leaved. Price, 25c. to 50c. each.

Honeysuckle, Chinese Evergreen. Fragrant ; blooms all summer. Price, 25c. to 50c. each.

Honeysuckle, White Japan. Fragrant ; a fine healthy grower and profuse bloomer. Price, 20c. to 50c. each.

Ivy, English. Invaluable from the fact of remaining green throughout the year. Large plants. Price, 25c. to 50c. each.

Wistaria, Sinensis. The favorite variety, producing thousands of pendulous clusters of delicate violet blue blossoms. Price 25c. to 50c. each.

Wistaria Sinensis Alba. Of similar habit to Sinensis, with pure white flowers. Price, 25c. to 50c. each.



Dorothy Perkins Roses.



Clematis Paniculata.

SHRUBS AND DWARF ORNAMENTAL TREES

Althea, Double Rose or Rose of Sharon. Strong, erect-growing shrubs of the easiest culture, which bear large and showy flowers during the last half of summer. Price, 50c. to \$1.00 each.



Calycanthus.

Exochorda Grandiflora. A finely shaped shrub, with a profusion of pure white flowers, borne in racemes of five or six. Price, 50c.

Forsythia. Leaves and branches deep green; flowers bright yellow. Blooms very early in spring. Price, 25c. to 50c.

Hydrangea Grandiflora. This is a beautiful shrub, with enormously large and dense flower heads, opening pure white, becoming tinged with rose color in their mature bloom. Blossoms profusely during the summer months; perfectly hardy. Price, 25c., 50c. and \$1.00.

Japan Quince. Has bright scarlet-crimson flowers in great profusion in early spring. Price, 25c., 50c. and \$1.00.

Lilac, Common. The common purple species; good shrub. Price, 25c. and 50c.

Lilac, Common White. Flowers pure white; very fragrant. Price, 25c. and 50c.

Purple Fringe Smoke Tree. A shrub much admired for its curious fringe of hair-like flowers that cover the whole surface of the plant in the summer. Price 50c. each.

Rhododendrons. These are among the most valuable of our hardy flowering shrubs and cannot be surpassed for lawn decoration. The flowers range through shades of rose, pink, crimson, white, etc., six to twelve inches in diameter. Plants with four to eight buds. Price, \$1.00 to \$1.50.

Spirea Prunifolia. (*Bridal Wreath.*) Flowers in clusters, covering the whole length of the branches; white and very double; May. Price, 25c. to 50c.

Spirea Reevesii. Double white. Blooms in large clusters, very fine. Price, 25c. to 50c.

Weigelia Rosea Nana Variegata. One of the most conspicuous shrubs that we cultivate; leaves beautifully margined creamy white; flowers pink. Price 25c. to 50c. each.

Althea, Double White.

Like the rose, except in color. Price, 50c. to \$1.00 each.

Calycanthus. (Strawberry scented shrub.) Wood and flowers fragrant. Blossoms in June. Price, 25c. to 50c. each

Deutzia Gracilis. Entirely hardy; flowers white. Price, 25c., 50c and \$1.00.

Deutzia Crenata. Double white; rose tinged. Price, 25c., 50c. and \$1.00.

Deutzia Scabra. A rapid growing single variety; flowers white, large. Price, 25c. and 50c.

Van Houtteii. The finest of all the white Spireas. A beautiful ornament for the lawn at any season, but when in flower it is a complete fountain of white bloom. Clusters of twenty to thirty flat white florets make up the raceme, and are set close along the drooping stems. Price, 25c. to 50c.

Japan Snowball. (*Vibenum Plicatum.*) Foliage corrugated, olive green through summer, but towards fall it turns much darker. Flowers, though hardly as large as the old variety, are much more numerous and pure white. There are often as many as twenty balls on a branch eighteen inches long. Price, 50c., 75c. and \$1.00.

Snowball. A favorite shrub, with clusters of white flowers. Price, 25c. to 50c.

Weigelia. An elegant shrub, with clusters of pink and white flowers. Price, 25c. to 50c.

HORSE CHESTNUT. Price, 50c. to \$1.50.

HEDGE PLANTS AND EVERGREENS.

California Privets. One to two feet. Price per dozen, 60c.; per one hundred, \$4.00.

Two to two and one-half feet. Price per dozen, \$1.00; per one hundred, \$8.00.

Two and one-half to three feet, bushy. Price per dozen, \$2.00; per one hundred, \$15.00.

Arbor Vitea. (*American*) Eight inches. Price per dozen, \$1.00; per one hundred, \$5.00.

Ten to twelve inches. Price per dozen, \$1.50; per one hundred, \$7.00.

Eighteen to twenty-four inches. Price per dozen, \$2.00; per one hundred, \$12.00.



Hydrangea Grandiflora.

Arbor Vitae. (*Siberian.*) One foot. Price per dozen, \$1.50; per one hundred, \$10.00.

Eighteen to twenty-four inches. Price per dozen, \$3.00; per one hundred, \$20.00.

HEDGE PLANTS AND EVERGREENS.

Continued.

- Hemlocks.** One foot. Price per dozen, \$1.50; per one hundred, \$10.00.
One to one and one-half feet. Price per dozen, \$3.00; per one hundred, \$20.00.
One and one-half to two feet. Price per dozen, \$4.00; per one hundred, \$30.00.
- Spruce.** (*Norway.*) One foot. Price per dozen, \$1.50; per one hundred, \$10.00.
Eighteen to twenty-four inches. Price per dozen, \$2.50; per one hundred, \$15.00.
Two to two and one-half feet. Price per dozen, \$3.50; per one hundred, \$25.00.

FRUIT TREES.

- Apples.** Standard. Four to five feet. Price, 25c.
Standard. Five to seven feet. Price, 40c.
Standard. Seven to nine feet. Price, 75c.
Dwarf and Crab. Price, 30c.
- Pears.** Standard. Four to five feet. Price, 50c.
Standard. Five to six feet. Price, 65c.
Standard. Six to eight feet. Price, \$1.00 to \$1.50.
- Pears on Quince Stock.** Four to five feet. Price, 50c. to 75c.
- Cherries.** Four to five feet. Price, 50c.
Five to seven feet. Price, 75c.
Extra size. Price, \$1.00 to \$2.00.
- Peaches.** Two to four feet. Price, 15c.
Four to six feet. Price, 25c.
Six to eight feet. Price, 50c.
- Plums.** Abundance, Lombard, Washington. Price, 50c. to \$1.00.
- Quinces.** Three to four feet. Price, 30c.
Four to six feet. Price, 50c.
Large sizes. Price, 75c. to \$1.00.

VEGETABLE PLANTS AND ROOTS.

We grow large quantities of vegetable plants and roots, and can supply all the varieties listed below in their proper season.

- Artichoke.** (*Jerusalem.*) Price, 25c. per qt.; per pk., \$1.00.
- Asparagus.** (*Conover's Colossal.*) Two years old. Price per one hundred, \$1.00; per one thousand, \$5.00.
- Asparagus.** (*Barr's Mammoth.*) Price per one hundred, \$1.00; per one thousand, \$5.00.
- Asparagus.** (*Palmetto.*) Price per one hundred, \$1.00; per one thousand, \$5.00.
- Cabbage Plants.** (*Hot-bed.*) Ready after April 1st. Early Jersey Wakefield, Early Drumhead, Succession. Price per one hundred, 50c.; per one thousand, \$4.00.
- Cauliflower Plants.** (*Hot-bed.*) Price per doz., 15c.; per one hundred, \$1.00.
- Celery Plants.** Ready July 1st. Golden Self-Blanching, Golden Dwarf, White Plume, Giant Pascal, etc. Price per doz., 10c.; per one hundred, 50c.; per one thousand, \$4.00.
- Chives.** For flavoring. Price per clump, 10c.; per doz., \$1.00.
- Egg Plants.** Ready in May and June. New York Improved Large Purple. Grown in pots. Price per doz., 35c. and 75c.; per one hundred, \$4.00.
- Fennel Roots.** Three years old. Price each, 10c. to 25c.; per doz., \$1.00 and \$2.00.
- Hop Vine Roots.** Price per doz., 50c.; per one hundred, \$2.50.
- Horse Radish Sets.** Price per doz., 10c.; per one hundred, 50c.; per one thousand, \$3.00.
- Lettuce Plants.** Ready in April and May. Price per doz., 10c.; per one hundred, 50c.
- Pepper Plants.** Ready in May and June. Large Sweet Mountain. Price per doz., 15c.; per one hundred, \$1.00.

Rhubarb Roots. Linnæus and Victoria. Strong roots; price each, 20c.; per doz., \$2.00. Small roots, each, 15c.; per doz., \$1.50; per one hundred, \$10.00.

Sage. Broad leaf. A large-leaved variety. Price each, 15c.; per doz., \$1.00.

Sweet Potato Plants. Yellow Nansmond. Price per bunch of twenty-five, 20c.; per one hundred, 50c.; per one thousand, \$4.00.

Sweet Potato Plants. Red Nansmond. Price per bunch of twenty-five, 20c.; per one hundred, 50c.; per one thousand, \$4.00.

Tomato Plants. Ready in May and June. We can always supply through season well-grown plants of the leading varieties. Price per doz., 15c. and 20c.; per one hundred, \$1.00 and \$1.25.

Wormwood Roots. Price each, 25c.; per doz., \$2.00.

Special quotations on application for large quantities.



Sweet Potatoes.

HARDY GRAPE VINES.

Agawam. Large; dark red; sweet. Price each, 25c.; per doz., \$2.50.

Brighton. Berry medium size; color, light red. Price each, 25c.; per doz., \$2.50.

Clinton. A small black grape, very hardy and excellent for wine. Price each, 20c.; per doz., \$2.00.

Concord. Very hardy and good quality; the best for general culture. Price each, 20c.; per doz., \$2.00.

Eaton. Bunch very large, compact, often double-shouldered; berries very large, round, black, covered with a heavy bloom; adheres firmly to the stem. Price each, 35c.; per doz., \$3.00.

Golden Pocklington. The vine is a strong grower; never mildews. The fruit is of a light golden yellow; berries round, very large and thickly set on a bunch. Price each, 25c.; per doz., \$2.50.

Green Mountain. A white grape. Bunch medium to long, irregular; stem long above bunch; berry medium; pale green. Price each, 35c.; per doz., \$3.00.

Lindley. (*Rogers No. 9.*) A red grape of the best quality, and one of the most desirable of Rogers' Hybrids. Ripens with Concord, and keeps well; medium to large in bunch and berry; flesh tender, sweet, and of a high, aromatic flavor. Vine vigorous, hardy and healthy. It seems to be more productive when mixed with other varieties. Price each, 25c.; per doz., \$2.50.

Merrimac. (*Rogers No. 19.*) Black, vigorous growth, and large, sweet fruit. Price each, 25c.; per doz., \$2.50.

Moore's Diamond. White; bunch large, compact, shouldered; berries large, round; skin thick, firm. Vine a good grower, with healthy foliage. Price each, 25c.; per doz., \$2.50.

Moore's Early. Ripens early. The bunches are large and compact; berries large, black, and good flavor; strong, healthy grower, an immense bearer. Price each, 25c.; per doz., \$2.50.

Niagara. Bunches very large and compact; berries large as Concord, mostly round; light greenish white, slightly ambered in the sun. Price each, 35c.; per doz., \$3.00.

Worden. Large, black, early and very productive. Price each, 25c.; per doz., \$2.50.

The varieties of grape vines have become so numerous that I catalogue only those that have proved most valuable and desirable in this vicinity, but can supply any of the others if wanted.

STRAWBERRIES.

Bubach. Very strong, healthy, vigorous plant. Very productive, large berries, and ripens early. Price per doz., 30c.; per one hundred, \$1.50.

Crescent. (*P.*) Bright scarlet, immensely productive, early and profitable. Berries medium size. For near markets a profitable variety. Price per doz., 30c.; per one hundred, \$1.50.



Marshall Strawberry.

Marshall. Very large, round, dark crimson; very vigorous and productive; medium to late. Price per doz., 30c.; per one hundred, \$1.50.

Mary. The berries are conical in form with blunt apex, exceptionally uniform in size and shape, deep crimson color, and of rich, high quality. Price per doz., 40c.; per one hundred \$2.50.

STRAWBERRIES.

Continued.

Sharpless. Very large, irregular berries of a good flavor. Very productive. Price per doz., 30c.; per one hundred, \$1.50.

Rio. (*Perfect.*) This is a good early variety, strong, healthy foliage, perfect blossoms, fruit large size, evenly colored and firm. Price per doz., 25c.; per one hundred, \$1.50.

Parker Earle. The plant is a robust grower, with perfect flowers, berries large, conical, regular and uniform, glossy crimson, flesh firm, and in quality excellent. Price per doz., 30c.; per one hundred, \$1.50.

RASPBERRIES.

Cumberland. This is a very hardy and the most profitable market variety, because of its immense size, firmness and great productiveness. Price each, 10c.; per doz., \$1.00; per one hundred, \$6.00.

Cuthbert. Canes hardy and strong, with large healthy foliage, exceedingly productive. Berries large red, firm and of good flavor. Price per doz., 75c.; per one hundred, \$4.00.

Gregg. (*Black Cap.*) Canes of strong, vigorous growth, very productive; berries large, covered with heavy bloom, firm and fine flavor. Price per doz., 75c.; per one hundred, \$4.00.

Golden Queen. A yellow raspberry, of large size, great beauty, high quality, hardiness and productiveness. Price each, 10c.; per doz., 75c.; per one hundred, \$4.00.

BLACKBERRIES.

Kittatinny. Very large and of excellent flavor. Price per doz., 75c.; per one hundred, \$4.00.

Lawton. Very large, juicy and sweet. Price per doz., 75c.; per one hundred, \$4.00.

Snyder. Very productive. Flavor rich and good, ripens early. Price per doz., 75c.; per one hundred, \$4.00.

WHITE BLACKBERRY.-

"ICEBERG."

Is a cross between the Lawton and the Crystal White. Clusters are larger than those of Lawton, berries are large white, are earlier, sweeter, and more tender and melting throughout, though as firm as Lawton when ripe. Price each, 10c.; per doz., \$1.00; per one hundred, \$8.00.

GOOSEBERRIES.

Downing. Fruit large, smooth, and roundish; color light green, with delicate veins; flesh rather soft, juicy and very good.

Industry. Fruit very large and hairy; color dark red; flesh very rich and excellent flavor.

Red Jacket. As large as the largest; berry smooth, very prolific and hardy; quality the best.

Prices.—2 years, 10c. each; 75c. per dozen; \$5.00 per 100.

CURRANTS.

Fay's Prolific. A red variety, very large and productive. Price each, 10c.; per doz., \$1.00; per one hundred, \$6.00.

Red Cherry. Large and fine for market. Price each, 10c.; per doz., \$1.00; per one hundred, \$5.00.

White Grape. The best white currant. Price each, 10c.; per doz., \$1.00; per one hundred, \$6.00.

Black Naples. For jams and jellies. Price each, 10c.; per doz., \$1.00; per one hundred, \$6.00.

INSECT EXTERMINATORS.



Use Bug Death liberally on rose bushes, house plants, shrubs, etc.; the results will be marvelous. It is the best powder on the market for hen lice.

It is perfectly safe to handle. Will not injure stock or animals in the least. Must be kept perfectly dry, so it will not clog in the shaker.

The experience of those who have used Bug Death shows conclusively that the extra yield in the crop more than pays the entire cost.

Price per one-pound package, 15c.; three-pound package, 35c.; five-pound package, 50c.; twelve-and-one-half-pound package, \$1.00; per 100 lbs., \$7.00.

London Purple. One of the best destroyers for insects. The proper proportions for using are at the rate of one pound to 150 gallons of water. Price per pound, 20c.; ten pounds, \$1.75.

Hellebore. A powder used for destroying insects on plants and bushes. Price per oz., 5c.; per one-fourth pound, 10c.; per pound, 25c.; per five pounds, \$1.00.

Sulphur. For the extermination of fungi and mildew on grape vines and other plant foliage. Price per pound, 8c.; per one hundred pounds, \$5.00.

Slug Shot. To destroy potato bugs, and those on tomato and egg plants, currant worms, cabbage lice and worms, flea beetles and striped bugs on melons, squash, turnips, beets, onions, etc.; canker worms and caterpillars on fruit and ornamental trees. Five and ten-pound packages, 5c. per pound. In barrel lots (225 to 260 pounds per barrel), 4c. per pound.

INSECT EXTERMINATORS.—Continued.

Hammond's Grape Dust is a preparation to kill the destructive mildew that strikes the grape vine, affecting leaves, fruit and stems in unfavorable seasons. Also for like use upon any other plants or trees affected with mold, mildew or rust mites, and for any use where a fumigator or antiseptic is required, either in greenhouses or in the open air. Price, five-pound package, 35c.; keg of one hundred pounds, \$5.00.



Paris Green or Fungoid. Half and half; ready for use against fungi and insects. Price, 25c. per pound; five pounds, \$1.00.



Paris Green. The most practical and generally employed substance for destroying the potato bug and other insects. Strictly pure. Price per pound, 25c.; five pounds for \$1.00; \$18.00 per one hundred pounds.

Fungoid. Prevents blight and mildew, and mixed with Paris Green is a valuable combination against slugs, bugs, worms and fungi. Price, two sizes, 15c. and 75c.

Tobacco Dust. This is the leaf and refuse of tobacco manufacture, ground to a fine powder and a specific for aphids, fleas, beetles, etc. It is also a good fertilizer and preventive for insects in the ground and about roots. Price per pound, 10c.; five pounds, 25c.; by the barrel, \$3.00; per one hundred pounds.

Tobacco and Sulphur Insecticide and Fertilizer. It will destroy rose bugs, lice, cut worms, vine bugs, tomato worms, currant worms, cabbage lice and parasites of all descriptions. Mix thoroughly with earth in pots; or in the hills, one part powder to five parts earth. Easy of application, and will not burn or injure the plants. Earth worms will not live where this is used. In 25c. and 50c. packages.

Whale Oil Soap. For removing and preventing the ravages of insects, grubs, slugs, etc., on trees, plants and vines. Dissolve at the rate of one ounce of soap to a gallon of water, and syringe the plants every day or two until the insects are removed. Price per package, containing one pound, 15c.; eight pounds, \$1.00; one hundred pounds, \$6.00.

Carbolic Disinfecting Soap. For washing horses, cattle, dogs, pigs and other domestic animals (except cats). Use like other bug soap, rubbing it well in, and allow the solution to dry on the animal; or dissolve one ounce of soap in one quart of boiling water, and when sufficiently cool, use freely with sponge or brush. Price per package, 20c.; per pound, 70c.

Tobacco Soap. An excellent specific for the destruction of plant-infecting insects and parasites. Is equal-

ly valuable for removing vermin from animals, furniture, etc. Price, per one-half-pound bar, 20c. each. "Nicoticide" is, unquestionably, the cheapest insecticide on the market; the first cost is the only cost; no labor is required in its application, and it does its work so thoroughly that a house well fumigated will require no further attention for many weeks. Difficult to kill as are some of the hardier insects, "Nicoticide" will certainly do it, as its fumes are fatal to all insect life. Price per one-half pint, \$1.25; per pint, \$2.50; per gallon, \$18.00.



The Fumigators, consisting of pan, wire frame and the lamp, are very durable, and will last for years. Price, 50 cents.

Full directions for using both compound and fumigators are printed on each can.

After the lamp is lit, and the pan containing the compound placed over it, the person should leave the house, AND SHOULD NOT RE-ENTER FOR AT LEAST TWO HOURS, as the lamp will die out shortly after the compound has all evaporated.

Nicoticide Fumigator.

Nikoteen is used either by fumigating or spraying.

Is composed of that element in tobacco which gives it its value as an insecticide and *nothing else*. Is recommended by the United States Department of Agriculture and by all horticultural authorities as the best remedy for most of the insects that attack plants and flowers. One part of Nikoteen to six hundred parts of water is a sufficiently strong spraying solution for all insects except scale on palms. For scale the solution may be used one part Nikoteen to four hundred parts water. Price per pint bottle, \$1.50.

Aphis Punk is specially designed for use in private places. It is very effective as an insecticide and so easy of application that its advantages in this respect are instantly apparent to the user. The Punk is lighted with a match and allowed to burn, which it does without flaming, at the same time giving off dense white fumes of nicotine that kills aphids and thrip very effectively. The fumes from Aphis Punk contain no ammonia, the element in tobacco smoke that damages sensitive plants, so that it can be used anywhere without danger of injuring the most delicate blooms. A box contains one dozen rolls, each containing sixty grains of nicotine—sufficient for fumigating six hundred feet of floor space in houses of ordinary height. Price per box, 60c.

Persian Insect Powder. This is powder made from the flower of the Russian Pyrethrum, and valuable as a poison for lice on plants, water bugs, roaches, bed bugs, etc. Price per pound, 40c.

Gishurst's Compound. A certain remedy for green fly, scale, mealy bugs, etc., etc. Price per pound, 50c.

Kerosene Emulsion. Manufactured on the most approved formulæ. Not injurious to foliage and a sure remedy for lice, scale and other insect pests. Price per quart can, 40c.; gallon, \$1.25; five-gallon, \$3.75.

Soluble Fir Tree Oil. For destroying all insects and parasites that infest fruit trees, plants and animals, whether on the foliage or at the roots, such as mealy bugs, American blight, red spider, scale, thrip, green or black fly, woolly aphid, caterpillars, grubs, ants, worms, lice, fleas, etc. Price per half-pint, 40c.; per pint, 75c.; per quart, \$1.25.

Bordeaux Mixture.

Ready for immediate use by adding water. Forty-nine gallons of water to one gallon of mixture. Price per qt., 40c.; per gallon, \$1.00.

Fly Fluid, or Cattle Comfort.

Save your horses, cattle and other animals from tortures of flies, midges, mosquitoes and other insects. Price per pint, 25c.; quart, 50c.; gallon, \$1.25.

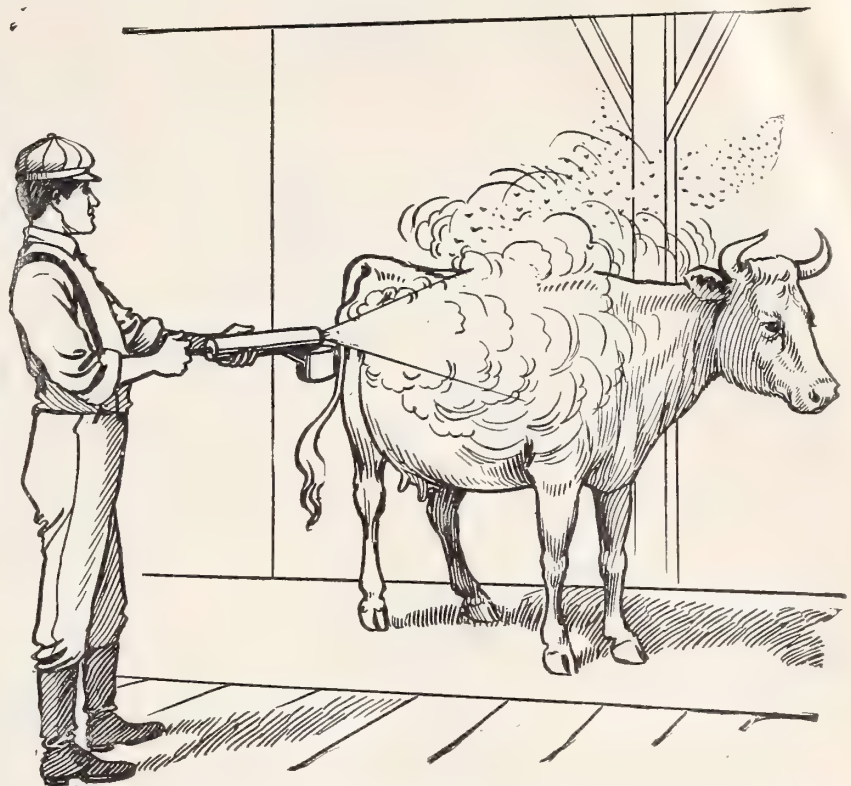
**FERTILIZERS.****Feed Your Plants and See Them Grow.**

Essex Flower Food. It produces rapid growth, rich foliage, and generous and perfect flowering. Price, small size, 10c.; large size, 25c.

Bowker's Food for Flowers. An excellent fertilizer for house plants. Easily applied by dissolving in water. Clean to handle, without odor; produces rich, green growth, and profusion of flowers. Price, small packages, 10c.; large packages, enough for twenty plants one year, 25c.

Lawn Dressing. This dressing is so prepared that it acts gradually through the season, producing a luxuriant growth of grass of rich, green color. Ten-pound bags, for 1,000 square feet, 50c.; twenty-five-pound bags, for 2,000 square feet, \$1.00; one hundred pounds, for one-quarter acre, \$3.00; per ton, \$50.00.

A - A - Superphosphate. Benefits the crops more quickly than will any other form of bone, and on account of its really available properties promotes early maturity, and it is invaluable for most crops, affording constant nourishment during their entire season's growth. Quantity required for garden and field crops, 500 to 600 pounds per acre. For garden crops it is best drilled in at seed-sowing time. For top dressing grass, 600 pounds per acre. Price per one hundred pounds, \$2.50; per ton, \$40.00.

Harvest Home Bone Phosphate. A good fertilizer for grass or garden crops, quick in action, requiring 600 to 800 pounds per acre. Price per one hundred pounds, \$2.00; per ton, \$30.00.

Pure Pulverized Sheep Manure. A pure natural manure, and most nutritious for plants. Its effect is immediate and lasting. Excellent for mixing with the soil for greenhouse plants (one part manure and six parts soil). Strewn over and dug into the vegetable garden, or placed directly in drills or hills, it promotes a rapid, steady growth until maturity. It makes rich, safe and quick liquid manure; one pound to five gallons of water can be used daily, if necessary, with safety. Price, five pounds, 25c.; ten pounds, 50c.; per one-hundred-pound bag, \$2.50; per ton, twenty bags, \$25.00.

Ground Bone. This is for general fertilizing purposes and valuable on the lawn, meadow or in the

garden. The finer particles are immediately beneficial, the coarse keeping up the supply of plant food for a long period. Price, six pounds, 25c.; twenty-five pounds, 75c.; per one-hundred-pound bag, \$2.50; per ton of two thousand pounds, \$35.00.

Land Plaster or Gypsum. It is an excellent addition to land requiring lime and sulphates, particularly for such crops as turnips, potatoes, grasses and clovers. Its fertilizing action is not so much due to its value as a plant food as to its absorbing and fixing ammonia, and rendering soluble the inert plant foods of the soil so that the growing crops can take them up. Quantity required, broadcast and harrowed in, one-half to one ton per acre. Price per one-hundred-pound bag, 75c.; per ton, \$10.00.

Hard Wood Ashes. Contain all fertilizing elements except nitrogen. They drive away insects, and are beneficial for all crops requiring potash. They are also very good for garden and field crops, and are of high value for cabbage, potatoes, onions, strawberries, fruit trees, grass-lands and lawns. Apply one to two tons per acre. Price per barrel, about two hundred fifty pounds, \$2.50; per ton (two thousand pounds), in barrels, \$18.00.

Nitrate of Soda. This is valuable solely for the nitrogen it contains. It is very quick in action and hastens the maturity of crops. Being extremely soluble, it should not be applied until the plants are above ground, when one hundred to five hundred pounds per acre, mixed with wood ashes or land plaster, for convenience in applying, are generally used. Price per five-pound package, 30c.; ten-pound package, 50c.; per one hundred pounds, \$4.00.

Muriate of Potash. Eighty per cent. pure, equivalent to 48 to 50 per cent. actual potash. A high-grade fertilizer, and one of the best orchard fertilizers known. Especially adapted for all stone fruits, and as a general fertilizer. Muriate of potash and ground bone stands as a leader. Five pounds, 30c.; ten pounds, 50 cents; twenty-five pounds, \$1.00; one hundred pounds, \$3.00. Original sacks of 224 pounds, \$5.50.

FOR THE BIRDS.



Best Canary Bird Seed. Price per quart, 15c.; two quarts, 25c.

Best Mixed Canary Bird Seeds. Price per quart, 15c.; two quarts, 25c.

German Rape. Price per quart, 15c.; two quarts, 25c.

Millet, French. Price per pound, 15c.

Millet, American. Price per quart, 10c.; three quarts, 25c.

Hemp Seed. Price per quart, 10c.; three quarts, 25c.

Sunflower Seed. Price per quart, 10c.; three quarts, 25c.

Flax Seed. Price per pound, 25c.

Paddy or Unhulled Rice. Price per pound, 10c.

Mocking Bird Food. Price per bottle, 25c.

Meal Worms. Price per one hundred, 50c.

Canary Powder or Song Restorer. Price per bottle, 25c.

Audubon's Bird Tonic. Price per bottle, 25c.

Peter's Treat. Price per roll, 10c.; per dozen rolls, \$1.00.

Bird Gravel. Price per quart box, 5c.

Cuttle Fish. Price each 3c., two for 5c.; per pound, 50c.

Peas. Round, white; for pigeons. Price per quart, 10c.; per bushel, \$1.75.

POULTRY SUPPLIES.

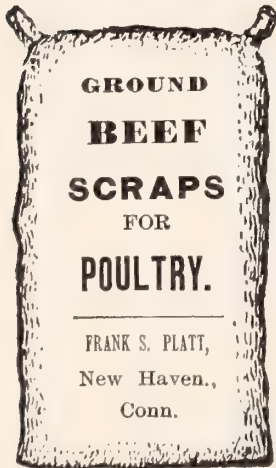

Price per one hundred pounds, \$2.50.

Price per twenty - five pounds, 75c.

Price per five pounds, 25c.

ANIMAL MEAL.

Price per one hundred pounds, \$2.50.

Price per twenty-five pounds, 75c.

Price per five pounds, 25c.

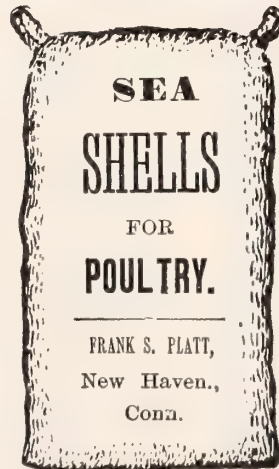

Price per barrel, \$1.25.

Price per ten-barrel lots, F. O. B. cars, at \$1.00.

GROUND OYSTER SHELLS.

Price per ton, \$10.00.

Price per one hundred pounds, in bags, 75c.

Price per ten pounds, in bags, 25c.

BONE MEAL.

Price per one hundred pounds, \$3.00.

Price per twenty-five pounds, \$1.00.

Price per five pounds, 25c.

CRACKED BONE.

Price per one hundred pounds, \$2.50.

Price per twenty-five pounds, 75c.

Price per five pounds, 25c.

Mica Crystal Grit. Price per pound, 2c.; per one hundred pounds, \$1.00.

White Lime Rock Grit or Egg Lime Grit. Price per pound, 2c.; per one hundred pounds, \$1.00.

Clover Meal. This is *Clover Hay* cut and ground to a consistency of coarse meal, and in combination with other poultry foods, fed in the morning mash, forms an invigorating and nourishing ration. Price per five pounds, 25c.; per twenty-five pounds, 75c.; per one hundred pounds, \$2.00.

Cut Clover. It is the second crop or rowen of the *Clover Hay*; cut to proper length for mixing with the scalded food for the morning mash, and when fed hot with a little *Egg Producer* is sure to result satisfactorily to the egg basket. Price per fifty-pound sack, \$1.25; per one-hundred-pound sack, \$2.00.

IMPERIAL EGG FOOD.

For All Varieties of Poultry.

Laying Hens, Young Chicks, Ducks and Turkeys. Will make hens lay winter and summer, support fowls during moulting, keep them constantly in fine condition and increase their profit 100 per cent. Half of the chicks die annually; this makes bone and muscle early and will save them.

Package to mix with fifty pounds of ordinary feed, 50c.; larger for \$1.00 and \$2.00. Sent prepaid on receipt of price.

RUST'S EGG PRODUCER.

As **Rust's Egg Producer** makes eggs plentiful and keeps fowls vigorous and healthy, it is just what is needed to make poultry keeping the *most profitable* operation on a farm or place. Price per one pound box, 25c.; per two-and-one-half-pound box, 50c.; per six-pound box, \$1.00; per ten-pound box, \$1.50; per twenty-five-pound keg, \$3.50. (If by mail, add 10c. a pound for postage.)

Rust's Havens' Climax Condition Powder.

It cures diseases and keeps stock and fowls healthy.

It will cure gapes and fowl cholera.

It expels worms from horses, etc.; harmless.

It gives great and *lasting* benefit in heaves without the slightest injury.

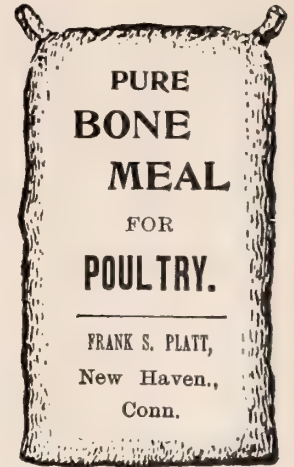

It is highly concentrated to make the dose small. It is not a food, but an honest medicine at an honest price. Price per thirteen-ounce package, 25c.; if by mail, 16c. extra for postage. Five-pound box (equal to six packages), \$1.00.



PRATT'S POULTRY FOOD.

It is a sure cure for Chicken Cholera, roup, gapes, and all diseases of the flock. It regulates the bowels blood and digestive organs; it produces bone, muscle, feathers and

larger fowl.

It sells for 10c., 25c. and 60c. per package.

Roup Pills. They act directly on the glands and mucous membranes, allay all tendency to fever, promote healthy action of the liver, correct unhealthy conditions of the blood and stomach, restore appetite, and carry off all morbid matter from the system. They are entirely free from anything harmful, and are believed to be the best remedy ever discovered for roup, catarrh, colds, etc. Price 25c. per box of fifty pills; \$1.00 per box of two hundred and fifty pills.



Lambert's Death to Lice. 5 oz., package 10c., 15 oz. pkt., 25c., 48 oz. pkt., 50c., 100 oz., pkt., \$1.00.

Lee's Lice Killer. 1 qt. can 35c., 2 qt. can 60c., 4 qt. can \$1.00.



Marking Punch. For marking chicks or fowls. Price each, 25c.

Caponizing Tools. Pilling's Sets with instructions. Price each, \$2.50.

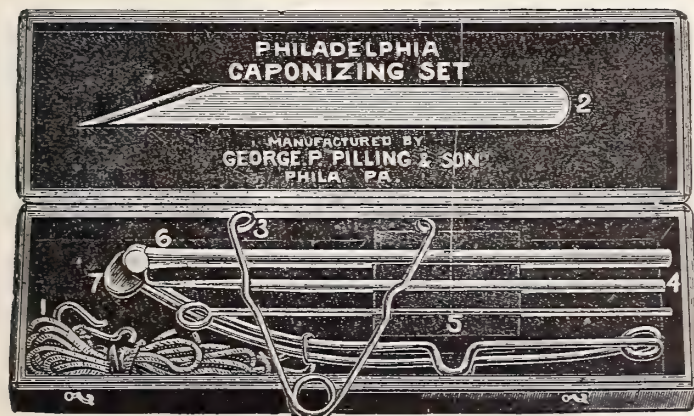

NEST EGGS.

China. Price each, 3c.; per dozen, 25c.; per gross, \$2.00.

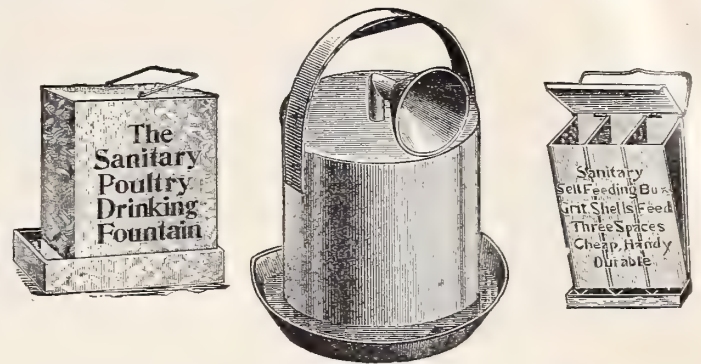

BATES' SELF-FEEDING POULTRY FOUNTAIN.

Price, one gallon, \$1.00; three gallons, \$1.50.

THE "SANITARY" POULTRY FOUNTAIN.

This is made of galvanized iron, and is so designed that it can be easily opened and thoroughly cleaned, thus overcoming the objection to many other drinking fountains. Price, one gallon, 50c.; two gallons, 85c.

"SANITARY" SELF-FEEDING BOX.

For grit, shells, bone, charcoal, feeds, etc. Made of heavy galvanized iron. Saves waste. Hangs on a nail. Neat, cheap and convenient. Price, 50c.

DOG FOOD.

Austin's Patent Dog Biscuit. Price per pound, 8c.; four pounds, 25c.; per one hundred pounds, \$5.50.

Old Grist Mill Dog Biscuit. Per pound, 8c.; four pounds, 25c., one hundred pounds, \$5.50.

Squirrel Cages with Wheel.

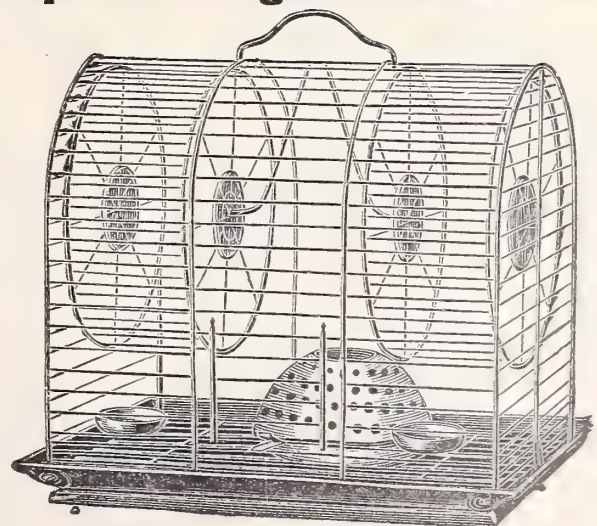

Squirrel Cages.

Chip, one wheel \$2.50 each.
 Red, one wheel 3 00 each.
 Gray, one wheel 4.00 each.
 Gray, 2 wheel brass \$10.00 to \$13.00.

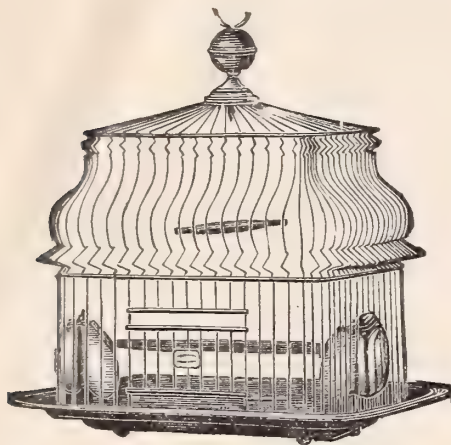

Canary Cage.

CANARY BIRD CAGES.

In brass, silver and japanned finish, and all the desirable shapes, at prices ranging from 80 cents to \$5.00.

PARROT CAGES.

All sizes. Prices from \$1.25 to \$4.00.

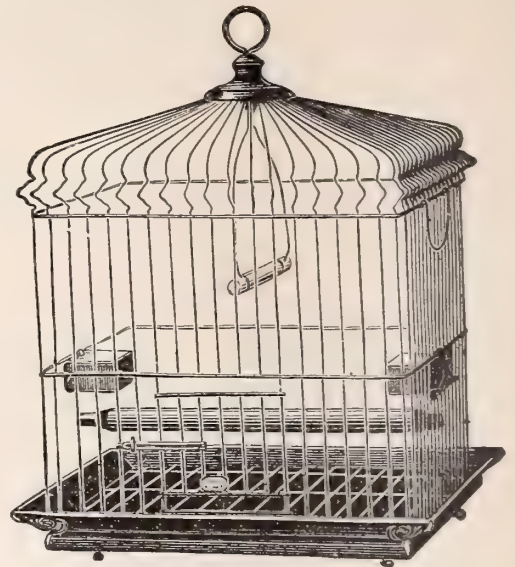

Parrot Cage.

Force Sprinkler and Novelty Pump.

It Throws a Strong Stream Sixty Feet or More.

With the sprinkler attached it spreads the water in a gentle shower or spray. For washing windows or carriages and showering lawns, gardens and green-houses it has no equal. It is adapted to throwing liquid solutions of all kinds to destroy noxious insects and bugs of every nature on plant, vine and tree. Price, \$5.00.

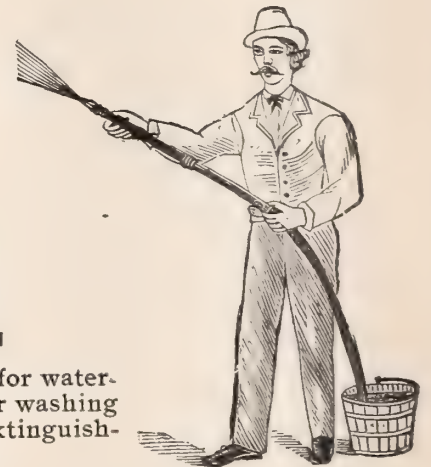

Fountain Pump.

A most useful and convenient apparatus for watering shrubbery, gardens or conservatories; for washing windows, sidewalks, carriages, etc., and for extinguishing fires. Prices, \$4.00 and \$4.50

The Aquapult Or Portable Hand Force Pump.

A valuable article, which discharges a continuous stream. It will throw about eight gallons per minute. The various uses of this pump are obvious. It is recommended by agriculturists as the best spraying pump for Paris green and London purple. Price, \$4.50.

Cyclone Spray Pump.

Large Tank and double seamed heads. Tube stationary, so that there is no danger of getting out of place.

No. 1, All Tin. Price, 50c.

No. 2, Tin Cylinder and Galvanized Iron Tank. Price, 75c.

No. 3, Tin Cylinder and Copper Tank. Price, \$1.00.

No. 4, All Copper. Price, \$1.25.

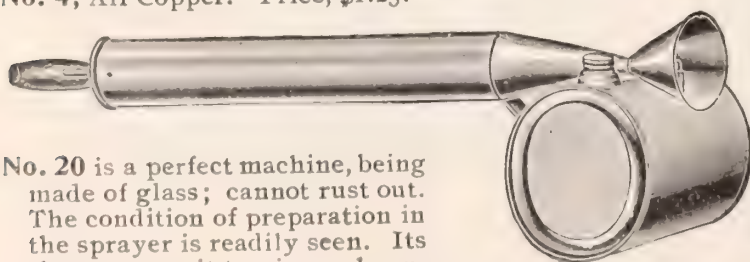

No. 20 is a perfect machine, being made of glass; cannot rust out. The condition of preparation in the sprayer is readily seen. Its shape causes it to give a churning motion when in use, thus keeping the ingredients thoroughly mixed. Price, \$1.00.



No. 20.

"AUTO-SPRAY" PUMPS.

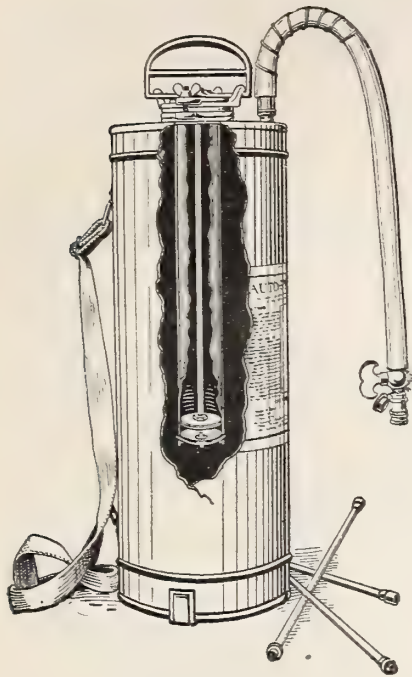

Auto-Spray.

We are headquarters for Spray Pumps of all capacities and for all uses. The "Auto-Spray" is our leader and is warranted perfect in material and workmanship, and guaranteed the most efficient and useful device made for spraying potatoes, tobacco, small fruits, vines, hen houses, green houses, pig pens, small orchards, etc. It is used and endorsed by nearly all State Experiment Stations. Spray calendar with solution formulas, the most complete published furnished with each machine.

Extension Pipes are necessary in spraying tall trees. With three lengths of pipe and our new spraying machine, a spray can be thrown to the height of 27 ft. These pipes are all made in lengths of 2 ft. for convenience in shipping with our machines.

Elbow Extension is used for low-down work and reaching the underside of leaves on grape vines, etc.

"Auto-Spray, No. 1," Brass Tank\$5.50
 "Auto-Spray, No. 1," Galvanized Tank..... 4.50

Extras.

Extension pipes, 2 foot lengths, Galvanized Steel, Brass Ends..... .30
 Extension pipes, 2 foot lengths, Solid Brass35
 Elbow Connection, Solid Brass..... .35

THE "AUTO-SPRAY TORCH."

Is marvelously effective in burning worms and nests, and is the only torch that has ever been used successfully. Most torches simply warm up the worms and make them more active. The "Auto Spray Torch" burns kerosene oil vaporized with oxygen of the air, and is so intensely hot that a single blast is sufficient to destroy a nest of worms.

It is used by simply screwing to the end of the extension pipe, and is operated by opening and closing the stop cock attached to the rubber hose. By simply opening the cock a blast of air is thrown through the flame, which is then carried to a height of 4 feet six inches. As the flame is entirely controlled by the operator, there is no danger of damage to any part of the tree except that which is infested with caterpillars. No "Auto-Spray" user can afford to be without the "Auto-Spray Torch." Price each, \$1.00.



Daisy Hand Weeder.

It is especially adapted to thinning out plants and weeding among all vegetables or flower plants, doing the work better, easier and quicker than by ordinary methods. Price each, 25c.; per doz., \$2.50.

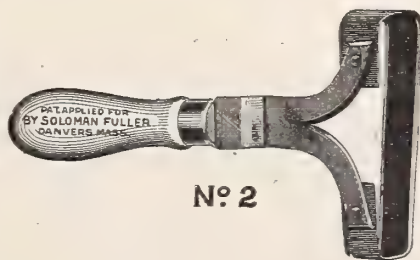

No 2

Daisy Hand Weeder.

The Perfect Fruit Picker.

Galvanized steel wire, attaches to pole of any length. Price without pole, 35c, price of pole 10c.

Lang's Hand Weeder.

This is not only a good weeder and scraper, but with its point becomes a good implement for the thinning out where plants are too thick and for lightening the soil. The blade is solid steel, and is sharp on all its edges. Capital for weeding, thinning and stirring soil among onions, carrots, strawberries, etc. Price each, per express, 25c; per mail post paid, 30c.

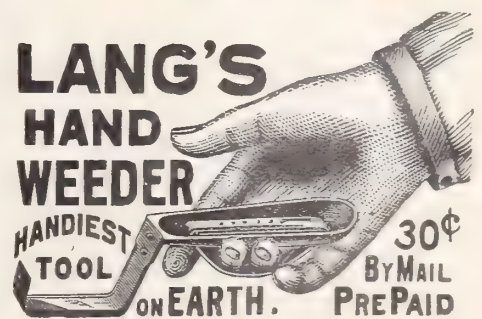

**LANG'S
 HAND
 WEEDER**
 HANDIEST
 TOOL
 ON EARTH.

30¢
 BY MAIL
 PREPAID

The Empire King Spraying Pump.

Will Spray 200 Trees per Hour.

Has AUTOMATIC MECHANICAL AGITATOR, which insures the perfect mixing of the poison and water, and an AUTOMATIC BRUSH for keeping strainer clean.

You cannot scorch the foliage with this pump. Has a seamless brass cylinder $2\frac{1}{2}$ inches inside diameter, 8 inches long, with solid brass plunger and rod, brass valves without leather or rubber, and brass screw spout with stop cock.



Fig. 63.—Patented July 19, 1892—April 17, 1900.

YOU NEEDN'T BREAK YOUR BACK WITH A
CLEVELAND LAWN WEEDER.



This little device gets at the root of the evil and removes it bodily. The curved edge of the blade enters and loosens the soil; pressure on the lever then causes the toothed jaw to grasp the plant, and a slight pull suffices to dislodge same without disturbing the surrounding sod. Price, 50c.

Diamond Hand Weeder.

This is a convenient, cheap and useful little implement for clearing away weeds, working between plants, dressing pots, and for other small work where a large hoe could not be easily used. Price each, 10c.; per dozen, \$1.00.



This agitator works in connection with cogs from the lever, connecting with a companion gear at the upper end of the steel shaft; at the lower end of the shaft is a horizontal wooden bar, to which are attached two upright paddles. Thus when the lever is moved upward or downward these paddles travel in a semi-circle in bottom of cask and prevents the poison from settling.

The pump has a fine brass strainer at bottom of suction pipe. It also has a brush on the agitator arm which swings under the suction strainer and keeps it clean. Hence no clogging of pump or nozzles.

This pump has a long lever, works easily and is guaranteed in every respect.

The air chamber is large which insures an even flow, and the stop-cock on the spout is a valuable feature of this pump. Weight, not including barrel, 55 pounds.

See that brush, it keeps the strainer clean.

When not wanted for spraying, the agitator may be disconnected and this pump can be used for any purpose about the farm. It will pump acid, oil or water.

See those paddles, they stir and thoroughly mix the poisons and water.

Remember every King pump is furnished with a shut-off cock and our complete agitator and brush, without extra charge.

Directions for mounting are furnished with each pump.

Additional hose at 14c. per foot.

FIGURE 63, PRICES, ETC.

Pump and outfit "A." *Empire King Pump* with single brass spout and shut-off cock, also with galvanized suction pipe and brass strainer, no hose or nozzle, no barrel. \$13.00.

Pump and outfit "B." *Empire King Pump* with single brass spout and shut-off cock, also with galvanized suction and strainer, and with one 10-foot lead of heavy hose and one Niagara nozzle, no barrel. \$15.50.

Pump and outfit "C." *Empire King Pump* with double brass spout and shut-off cock, also with galvanized suction and strainer, also with two ten-foot leads of hose and with two Niagara nozzels, no barrel. \$18.00.

Excelsior Weeding Hook.

This implement can be used to great advantage among small and tender plants. Price each, 15c.

Improved Brass Syringes.

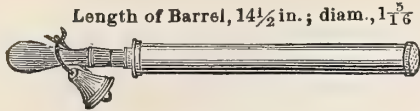

Length of Barrel, $14\frac{1}{2}$ in.; diam., $1\frac{5}{16}$

American Improved Syringe, 18 inches long; diameter, $1\frac{1}{2}$.

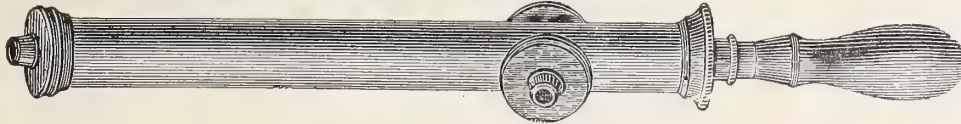

Of various sizes and patterns applicable to conservatory, greenhouse or garden purposes. A, \$2.00; B, \$2.50; C, \$3.50; D, \$4.50; No. 2, \$4.75; No. 3, \$6.75; No. 5, \$7.50; No. 7, \$10.00.

Japaned Tin Syringes. Price, 75 cents each.

The Water Witch Lawn Sprinkler.

The waterflow is unimpeded, scattering in fine drops evenly over a circular area twenty-five to forty feet diameter. Price, without stand (*i. e., with spur to stick in the ground*), 50c. each; by mail, 60c. Price with stand, \$1.00 each.

Elastic Plant Sprinkler.



This article is made of rubber, with a flat bottom. The cap is of brass, finely perforated, which can be removed if desired. It is an indispensable article for showing the foliage of plants, sprinkling bouquets and dampening clothes.

Three sizes. Price, 50c., 75c. and 85c.

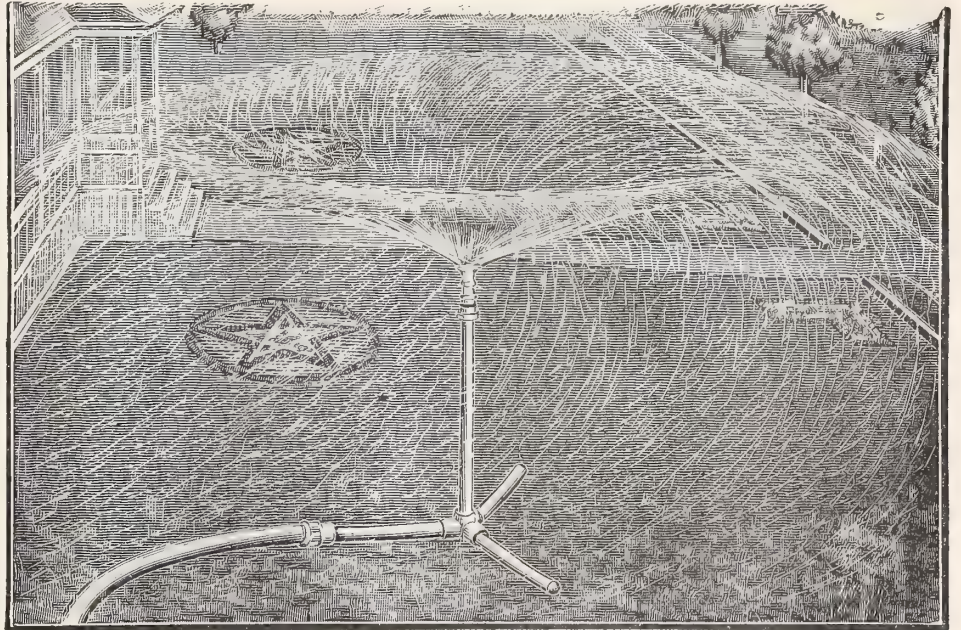

The Champion or Dry Powder Gun.

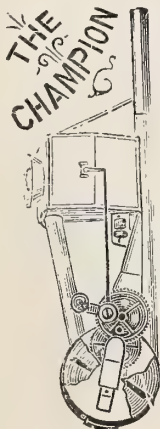

It will distribute insecticides in a dry or powdered state, effectively and satisfactorily. Price each, \$7.50.

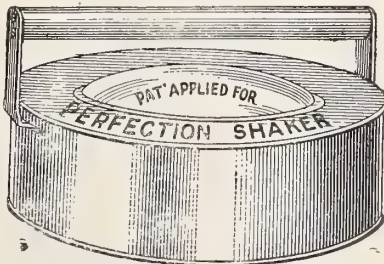
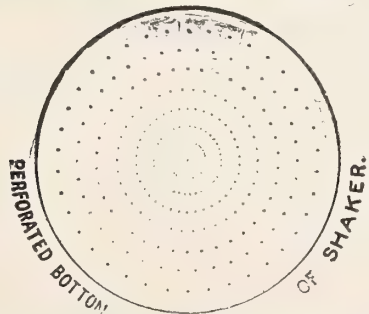

Perfection Shaker.

Especially for applying Bug Death to potato vines. Price each, 65 cents.

Watering Pots.

Heavy Tin Watering Pots Painted Green.

One quart, 15c.; four quarts, 25c.; six quarts, 30c.; eight quarts, 40c.; ten quarts, 50c.; twelve quarts, 60c.; sixteen quarts, 75c.

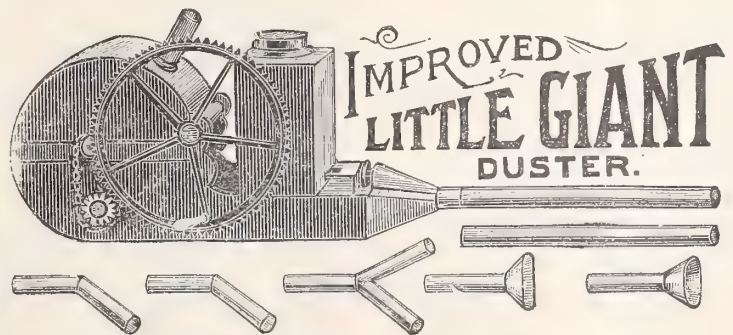

The Standard Powder Gun.

Almost any dry powder may be used, such as Paris Green, Fungiroid, Spanish Pink, London Purple, Sulphur, etc. Price each, \$5.00.

Henry's New Tree Pruner.

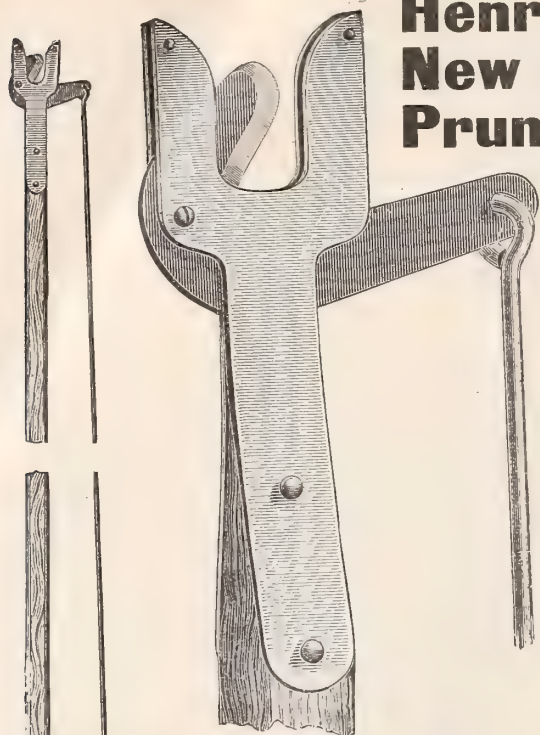

By referring to the illustration, it will instantly be seen that this pruner commences the cut at the upper part of the limb instead of the under part. This fact alone is sufficient to convince all of its superiority, but the immense advantage thus obtained can only be fully appreciated by a personal trial.

Prices—Four-foot pole, 75c.; six-foot pole, 85c.; eight-foot pole, \$1.00; ten-foot, \$1.25. Extra blades, each, 25c.

Henry's Pruning Shears.

These shears have an extensive sale among wool growers for trimming sheep's feet, and are largely used among orange growers for pruning orange trees. Handle, malleable iron. Blades best cast steel. Price each, 50c.

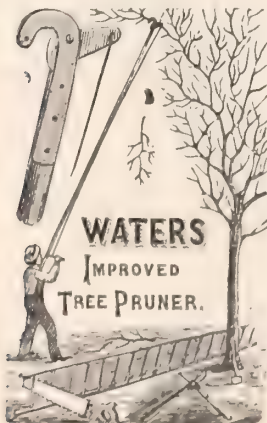
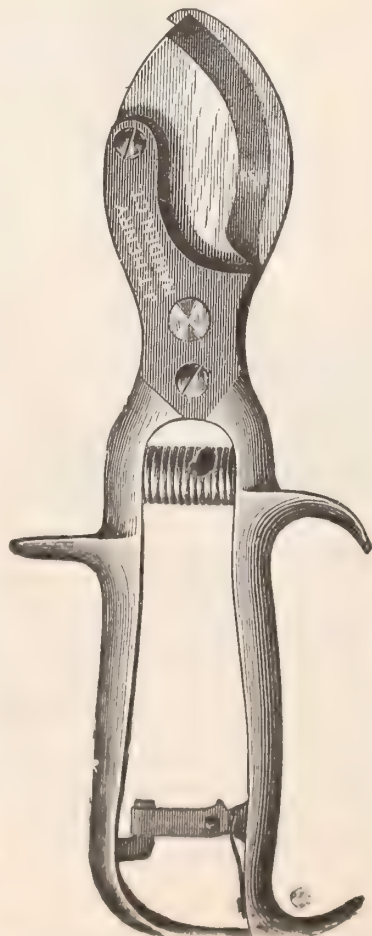

Water's Improved Tree Pruner.

The small space required for working the knife allows it to be used among close, dense branches where great difficulty is found in using the old-fashioned shears.

For pruning raspberry, blackberry and rose bushes: it has proven peculiarly serviceable.

For removing worms' nests and thinning out fruits: it is very desirable, and can be used as a fruit picker.

Length of pole, 4 ft.; weight, 2½ lbs.; price each, \$.75.
 " " 6 " " 2¾ lbs.; " " .85.
 " " 8 " " 3½ lbs.; " " 1.00.
 " " 10 " " 4½ lbs.; " " 1.25.

Extra knives, each, 25c; per doz., \$3.50.

Glass Cutting and Glazing Tools.

Workmen who use this instrument find it cuts glass as rapidly as a glazier's diamond, and for all the purposes of cutting and setting glass is just about equally valuable, though it costs not one twentieth as much. A tool which contains the appliances for cutting and setting glass has also attached to it a steel for sharpening knives and scissors, and also a corkscrew. Price each, 10c.; per doz., \$1.00.

Lightning Sack and Bag Holder

The bag is attached and detached as quick as lightning. Hence, the name. Don't think because it's cheap it is not good. If you don't consider it as good as any bag holder you ever saw, and far more convenient, send it right back and get your money. After you get one you will want another or several. You will find several around the farm as convenient and desirable as several pockets in your every-day suit of clothes.



Lightning Sack and Bag Holder.

Remember, only 25 Cents for the Best Bag Holder on Earth.

Burlap Hot Bed Mats.



Heavy burlap exterior with wool filling, securely quilted and bound. An excellent

winter covering for hot-beds, cold frames, in fact, anything requiring a heavy mat covering for winter protection. 76 x 76 inches, \$1.00 each.

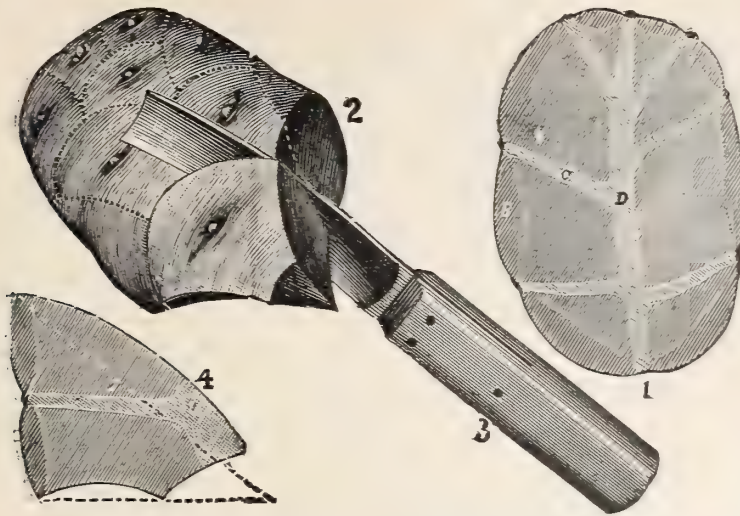

Humphrey's Concaved and Curved Potato Knife.

This knife will cut two or three eyes in a piece. One eye will be as good or better than half a potato cut in any other way. The potato can be cut easier, faster and better. If you cut no more than one bushel of potatoes, it will pay to cut them with the concaved and curved seed potato knife. Price, 25c.

Broadcast Hand Seed Sowers.

This machine runs so easily and smoothly that the weight of the handle will run the machine. Equipped with agitator and accurate seed gauge.

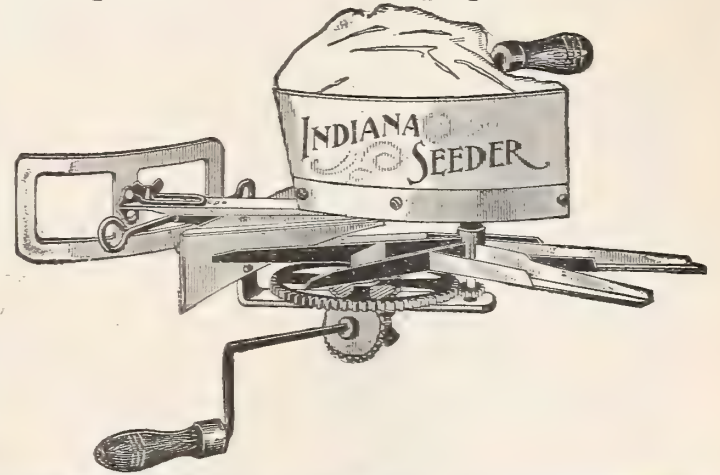

Humphrey's Concaved and Curved Potato Knife.

It will sow Wheat, Rye, Oats, Rice, Flax, Millet, Turnip Seed, Clover Seed, Grass Seed, including light grasses, in fact any kind of seed broadcast. Also Plaster, Fertilizer, Salt, Ashes, etc. The "Indiana Seeder" will sow at a round, Wheat or Rye, 50 feet; Buckwheat, 45 feet; Flax Seed, Clover and Millet, 36 feet; Grass Seeds 20 to 36 feet; other seeds, etc., according to their nature and condition. Full directions sent with each machine. Price, \$1.50.

Trowels.

Cleve's Angle Trowel. A weed digger, transplanter and cultivator. This handy digger was originally intended for digging weeds from the lawn, but has found great favor among florists and amateurs for transplanting seedlings and stirring the soil. Price each, 15c., 20c. and 25c.

Common Garden Trowel. Price each, five-inch, 10c.; six-inch, 12c.; seven-inch, 15c.



The Automatic Corn Planter.

Simple, durable, economical; has no complicated machinery, and requires no special skill to use it with proper satisfaction. It is not liable to get out of order, and will last a lifetime. Plants with one hand as fast as a man can walk, and with more precision as to depth and amount of seed than can be done in the old way. The old laborious system of planting corn and beans is changed to a pastime, and more than three-fourths the expense saved by this simple but ingenious contrivance. Price, \$1.75.

Trowbridge's Grafting Wax.

In one-pound, one-half-pound, one-quarter-pound packages. Price per one-quarter-pound, 10c.; per one-half-pound, 15c.; per pound, 25c.

Tree Labels, Painted.

Notched and Copper Wired. Price per one hundred, 20c.; per one thousand, \$1.50.

Garden and Pot Labels, Painted.

Four and one-half inch. Price per dozen, 5c.; per one hundred, 20c.; per one thousand, \$1.00.
Six inch. Price per dozen, 6c., per one hundred, 25c.; per one thousand, \$1.25.
Eight inch. Price per dozen, 10c.; per one hundred, 50c.
Twelve inch. Price per dozen, 20c.; per one hundred, 90c.

Van Reyper's Perfect Glaziers' Points.

Endorsed by leading florists. Try them and you will use no other. Made of steel wire and galvanized; no rights and lefts; over 8,000,000 in use. Made in four sizes—Nos. 1, 2, 3, 4. Price per box of 1,000, 65.; in lots of 5,000 by express, 55c. per 1,000; pincers for driving the points, 40c.; by mail, 50c.

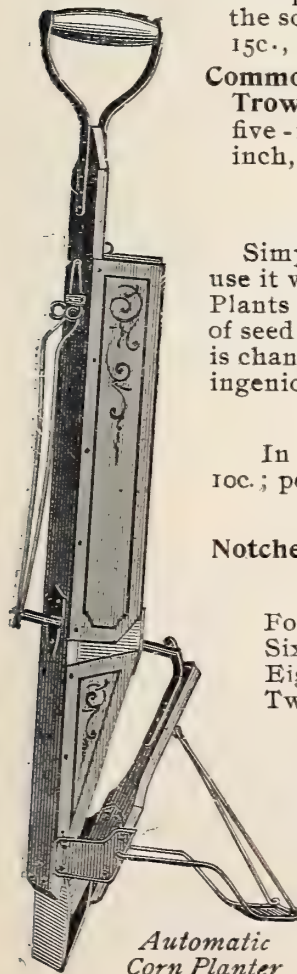
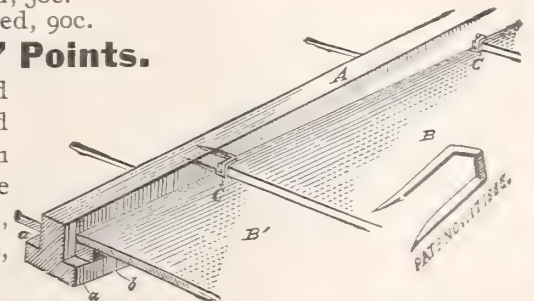

Automatic Corn Planter



Columbia Flower Tubes.

Made of cypress. Will last a long time and will not fall apart.

12 inches in diameter,	\$1.00 each.	21 inches in diameter,	\$2.50 each
15 " " " "	1.50 "	24 " " " "	3.00 "
18 " " " "	2.00 "		

Cypress Tub Painted Green with Feet.

No. 1. 13½ inches diameter,	\$1.25 each	No. 4. 20 inches diameter,	\$2.50 each
No. 2. 14 " " " "	1.50 "	No. 5. 24 " " " "	3.00 "
No. 3. 16 " " " "	2.00 "	No. 6. 28 " " " "	4.00 "

White Cedar, Painted Green with Feet.

No. 8. 14 inches diameter, \$1.65 each	No. 3. 21 inches diameter, \$3.85 each
No. 7. 15 " " " " 1.95 "	No. 2. 23 " " " " 4.40 "
No. 6. 16½ " " " " 2.20 "	No. 1. 25 " " " " 4.95 "
No. 5. 18 " " " " 2.75 "	No. 0. 27 " " " " 5.50 "
No. 4. 19½ " " " " 3.05 "	

Mann's Tub, Painted Green without Feet.

No. 4. 12½ inches diameter, \$.75 each	No. 1. 18 inches diameter, \$1.15 each
No. 3. 14 " " " " .95 "	No. 0. 19½ " " " " 1.35 "
No. 2. 15 " " " " 1.05 "	

INDURATED FIBRE-WARE

is practically indestructible under ordinary conditions of use and abuse. It is absolutely impervious to moisture, as the water will not creep through the tubs or over and down the sides. A non-conductor of heat and cold—light weight and has no joints or seams. They protect the table, stands, decorations, etc., from moisture and mold. Florists and decorators will find the **Saucers and Rolling Stands** particularly valuable for plant and palm-displays at social functions.

The **Rolling Stands** will meet a ready sale when displayed to the plant-loving house-keeper.

Indurated Fibre-Ware Vases and Pot Saucers will prevent 90 per cent of the usual waste of breakage of pottery around the greenhouse. They protect the carpets or floors from all moisture and damage, and are as easily moved as a table or rolling-stand—no matter how heavy the plant.



Parlor Plant Tub

is a new specialty—lighter, cleaner, dryer and in every way better than the old-fashioned wood tub.

It never shrinks or leaks.
12½ inch diameter at top, \$1.00 each
13½ inch diameter at top, \$1.25 each

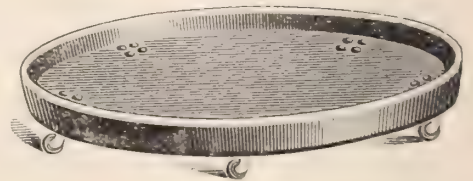

Price-List Flower-Pot Saucers.

4 in. \$.07 ea., \$.80 doz.	7 in. \$.10 ea., \$1.00 doz.	10 in. \$.13 ea., \$1.20 doz.
5 " .08 " .85 "	8 " .11 " 1.05 "	12 " .15 " 1.35 "
6 " .09 " .90 "	9 " .12 " 1.15 "	14 " .20 " 2.25 "

Price-List Rolling Stands.

Outside diameter about 12 inches, will take pot of diameter at bottom, 10 in. \$.60 ea.
" " " 14 " " " " " " " " 11 " .70 ea.
" " " 16 " " " " " " " " 13 " .85 ea.
" " " 18 " " " " " " " " 15 " 1.00 ea.
" " " 20 " " " " " " " " 17 " 1.25 ea.
" " " 22 " " " " " " " " 20 " 1.50 ea.

Price-List of Florists' Vases. For Displaying Cut Flowers.

8 inches diameter inside. 13 in. depth inside. No. 0. \$4.80 per doz. plain \$.45 each.
5½ " " " 10 " " " " " " " " 1. 4.20 " " " .40 "
4½ " " " 9 " " " " " " " " 2. 3.60 " " " .35 "
4 " " " 6 " " " " " " " " 3. 3.00 " " " .30 "
3 " " " 4½ " " " " " " " " 4. 2.40 " " " .25 "
9 " " " 22 " " " " " " " " 00. 9.00 " " " .85 "
5½ " " " 18 " " " " " " " " 11. 5.40 " " " .50 "
4½ " " " 15 " " " " " " " " 22. 4.80 " " " .45 "
4 " " " 12 " " " " " " " " 33. 4.20 " " " .40 "
3 " " " 9 " " " " " " " " 44. 3.60 " " " .35 "

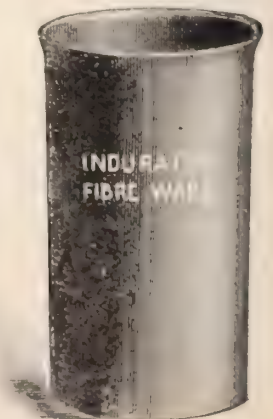





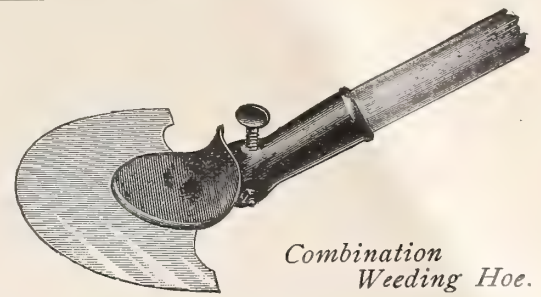





Border Knife and Weeding Hoe.

For edging up walks and borders. Expressly adapted for cutting turf, cleaning walks from weeds, working in gardens, around shrubbery and flower beds, the combination permitting instant change from edger to shuffle hoe. Price, seven-and-one-half inch each, 50c.; nine-inch, 65c. each.



Combination Weeding Hoe.

Light, for Frail Plants. Plant Stakes. Heavy, or Dahlia Stakes.

Each.	Doz.	100.	6 FT.	Each.	Doz.	100.
				\$.15	\$1.50	\$12.00
\$.08	\$.90	\$7.00		.12	1.25	10.00
						
.07	.80	6.00		.10	1.00	8.00
						
.06	.65	5.00				
						
.05	.50	4.00		.07	.75	6.00
.04	.40	3.00				
.03	.30	2.00				
.02	.15	1.00				

1/2 FT. TO 6 FT. LONG

Made for supporting frail plants, such as fuchsias, carnations, tuberose, etc. They are round, taper to the top, and are painted green.

The New Model Mole Trap.

This trap is made of all malleable iron and steel; it has eight needles in the pin plates. It is light, neat, durable and attractive. Price each, \$1.50.

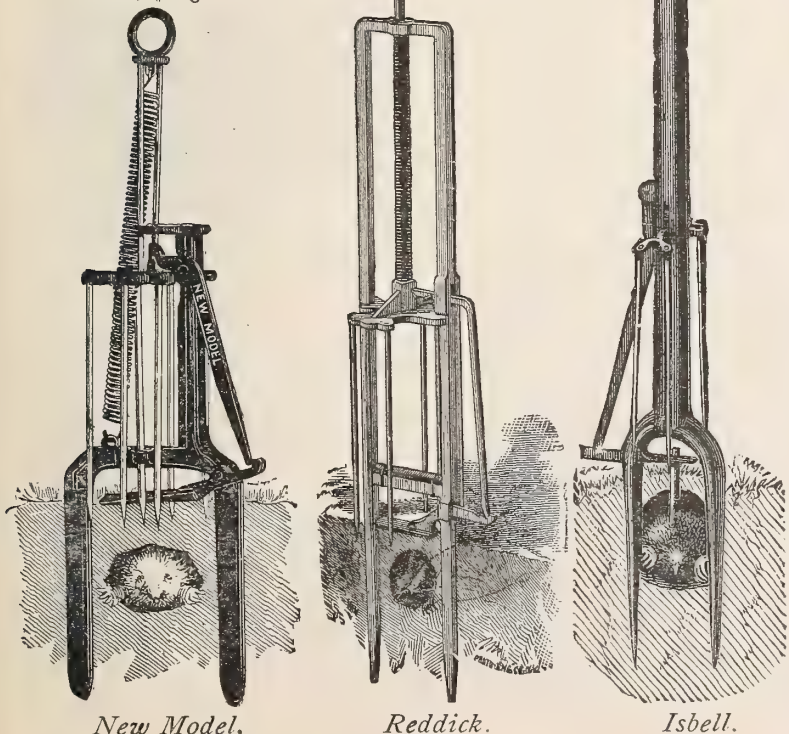

New Model.

Reddick.

Isbell.

The Reddick Mole Trap.

This is a \$1.00 trap, practical and effectual; galvanized throughout to prevent rust.

Cedar Bean Poles.

Good quality, straight and sharpened. Price per dozen, 50c.; per one hundred, \$3.50.

Best quality, eight to ten feet, large and straight, sharpened. Price per dozen, 75c.; per one hundred, \$5.00.

Isbell Mole Trap.

Strong, durable, simple and practical. Price each, \$1.75.

"Out o' Sight" Mole Trap.

The "Out of Sight," has only to be tried to be appreciated. The secret of mole catching is a good trap and to know their habits. Full information sent with each trap. Price each, 75c.

Lawn Mowers.

Every mower cuts paper before being boxed. It will continue to cut as well if kept in order. Prices: 14-inch, \$3.00; 16-inch, \$3.50

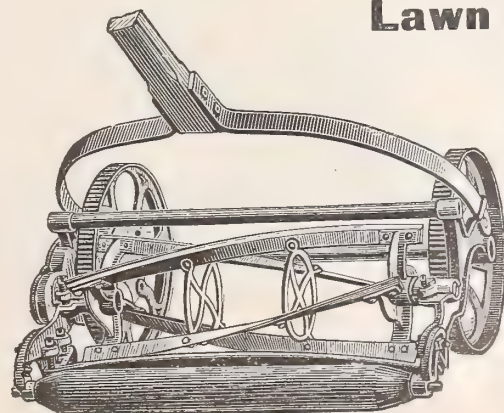

Wire Stands for Plants.

No. 1. 27 inches high. Shelf 33 inches long, 8 inches wide. \$2.25.
 No. 2. 57 inches high. Shelf 36 inches long, 10 inches wide. \$2.75.
 Styles Nos. 3 and 4 have two shelves.

Styles Nos. 3 and 4 Have Two Shelves.

No. 3. 27 inches high by 18 inches deep. } Height between shelves 8
 Shelves 33 inches long, 8 inches wide. } inches.
 No. 4. 27 inches high by 21 inches deep. } Height between shelves 8
 Shelves 36 inches long, 10 inches wide. } inches.
 No. 5. 36 inches high by 24 inches deep. Shelves 33
 inches long, 8 inches wide. \$4.00. Height between
 shelves 8 inches.
 No. 6. 36 inches high by 30 inches deep. Shelves 36
 inches long, 10 inches wide, \$5.00. Height between
 shelves 8 inches.

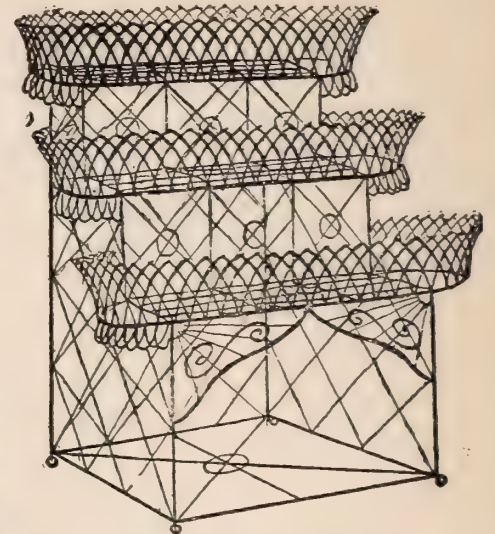

Style of Nos. 5 and 6.

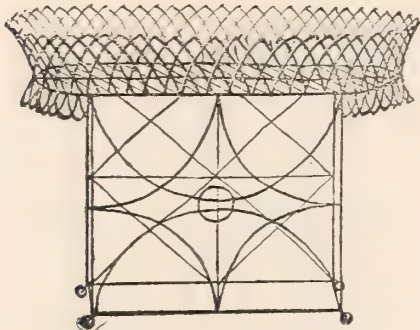

Style of Nos. 1 and 2.

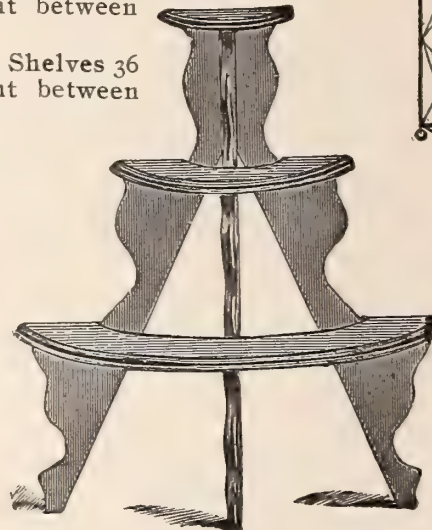

Wooden Plant Stand.

Wooden Plant Stand.

3 shelf, \$1.25
 4 " " 1.50



Flower and Vine Trellis.

Rustic Hanging Baskets.

Ten inch, price each, 85c.; eleven inch, \$1.00; twelve inch, \$1.25.

Flower and Vine Trellis.

1½ feet high,.....	\$.15	5 feet high,.....	\$.85
2 " " "	.25	6 " " "	1.00
3 " " "	.40	7 " " "	1.25
4 " " "	.60	8 " " "	1.35

The \$5.00 Champion Brooder.

When a chick is placed in the \$5.00 Champion Brooder it is as certain of living as anything under the charge of frail humanity. There is no good reason why every chick or duck

put into it should not be raised to maturity, if healthy when hatched and the brooder is in charge of a person of ordinary intelligence.

Our brooder is the perfect embodiment of the successful artificial brooder, and its works prove its title to its name. It will raise every chick hatched; so certain is this result that our phrase, "it makes success sure," is borne out by it every time.

The construction of the case of our \$5.00 Champion Brooder is planned on a scientific basis and conforms to the best method for all purposes. It is so constructed that the brooder can be operated either out-doors or in-doors, one way equally as well as the other. It is well made, strong and durable, to withstand years of hard usage. The material used is one inch pine lumber, tongued and grooved and planed both sides.



Rustic Hanging Basket.

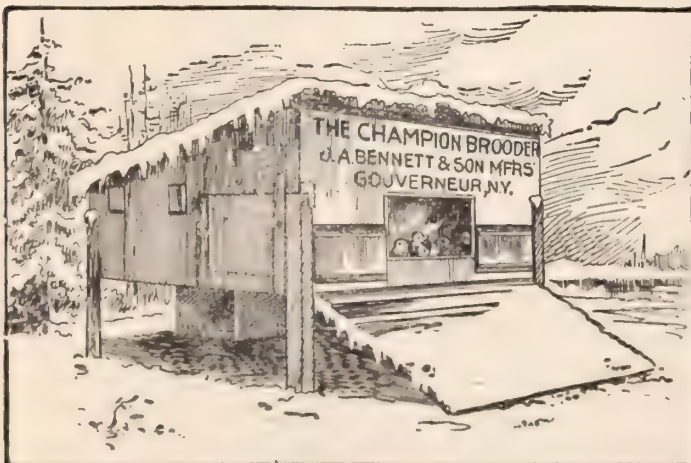

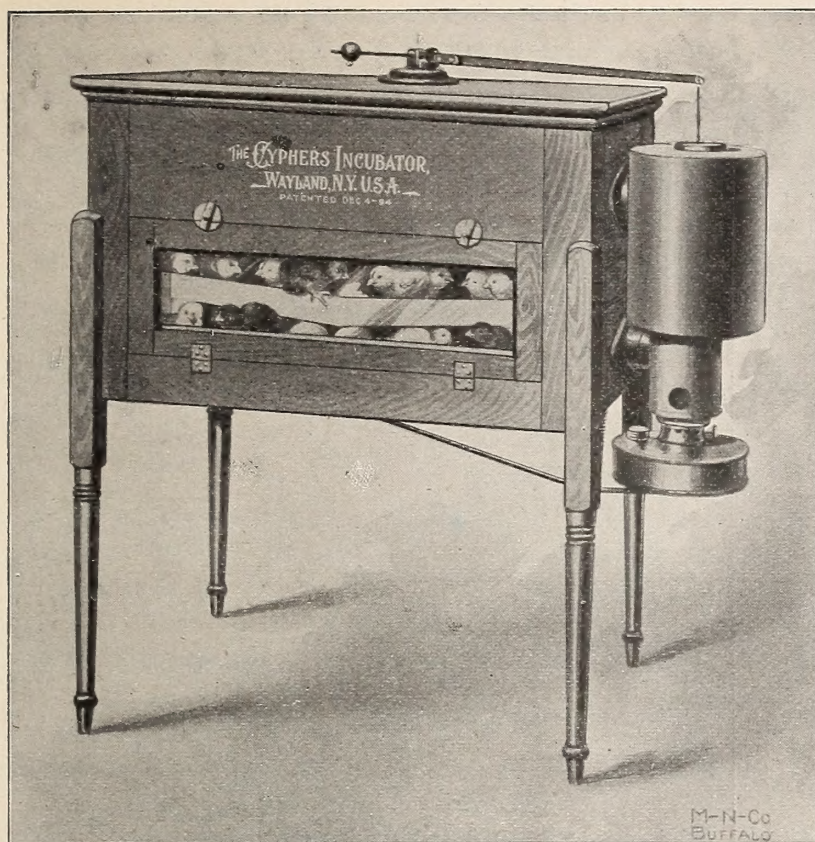

The Cyphers Incubator.

It is the original and only genuine patent diaphragm, non-moisture and self-ventilating incubator. It is used with uniform success on twenty-six government experiment stations in the United States, Canada, Australia, and New Zealand; also by a majority of America's best known poultrymen, and by thousands of persons in every walk of life. Winner of gold medal and highest award at the Pan-American Exposition, October, 1901.

"The Standard Hatcher of the World."

Every Cyphers incubator is sold under a positive agreement that it will do satisfactory work in the hands of any purchaser who will give it a fair trial, or it can be returned and the price paid for it will be refunded. As agent for the Cyphers Incubators, I am authorized to stand back of this guarantee in every particular.

For proof of the superior qualities of the Cyphers, send for illustrated descriptive circular, mailed free, or call on the undersigned and examine the machine personally.

You save freight by purchasing of me. I sell them at factory prices, free on board cars, at this point.

Price list of Cyphers Incubators: No. 0, 60 hen eggs, 48 duck eggs, \$14.00; No. 1, 120 hen eggs, 100 duck eggs, \$20.00; No. 2, 220 hen eggs, 190 duck eggs, \$29.00; No. 3, 360 hen eggs, 290 duck eggs, \$37.00; No. 2, Double Decker, \$58.00; No. 3, Double Decker, \$74.00.

The Cyphers Brooder.

Many customers of the Cyphers Company have bought these unequalled outdoor brooders for use in poultry houses, brooder houses, etc., during mid-winter and early spring, placing them out of doors, under trees or in the open as soon as the warm spring days came with their bright sunshine.

The style A is positively the best outdoor brooder in all particulars that the Cyphers Company knows how to build. Quantity and quality of material and workmanship considered, we guarantee it to be the cheapest and best outdoor brooder on the market.

Price list of the Cyphers indoor and outdoor brooders: Style O, indoor, \$8.00; style O, outdoor, \$9.00; style B, indoor, \$10.00; style A, outdoor, \$12.00.

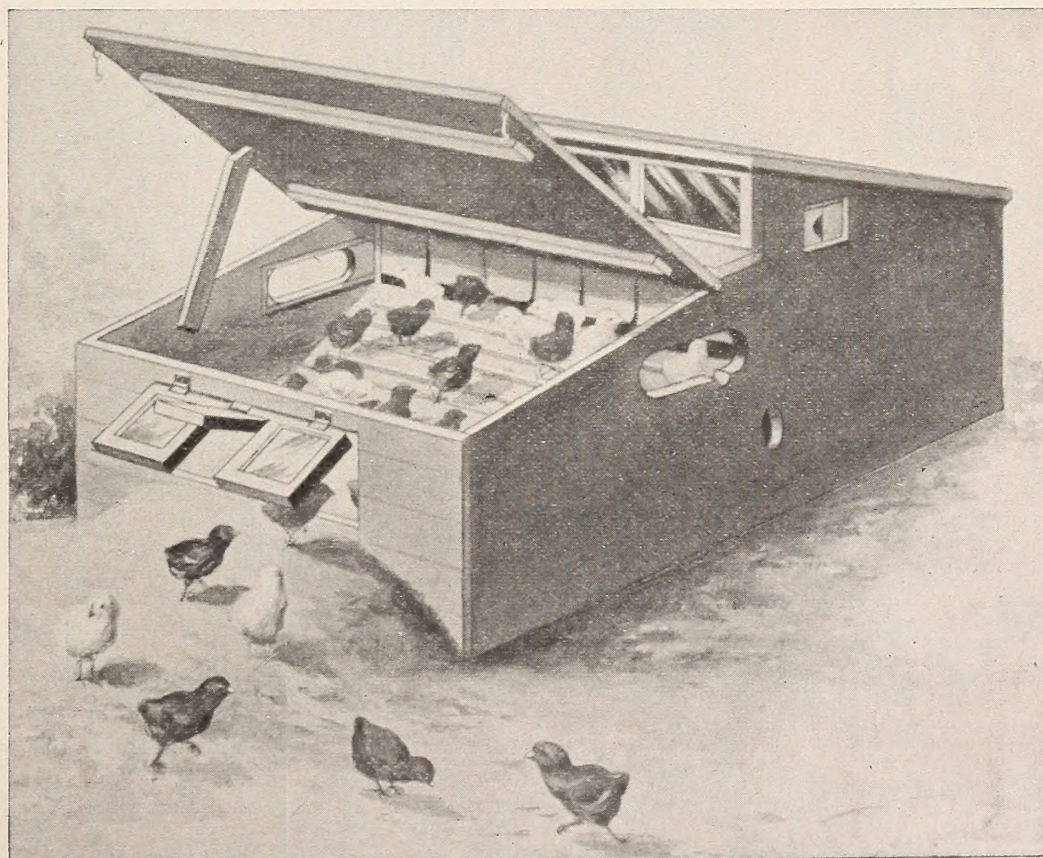

The "Anchor"

Flower Bed and Lawn Guard and Tree Guard.

Entirely constructed of No. 8 and 9 galvanized Steel Wire. The Horizontal Wires being absolutely locked to the Upright Wires by our patented Anchor Clamp make the joints "rivet tight." They cannot Slip. Any one can put the "Anchor" in place and when in place it is a GUARD.

Lawn Guard.

Height, 16 inches 22 inches per lineal foot. Price, 15c. 20c. per lineal foot.

Special Heights or Lengths Made to Order.

Tree Guard.

Size, 8 inch diameter,

Three heights, 5x2, 5x8, 6x2 feet.

\$12.00 per dozen.

Size, 10 inch diameter.

Three heights, 5x2, 5x8, 6x2 feet.

\$14.00 per dozen.

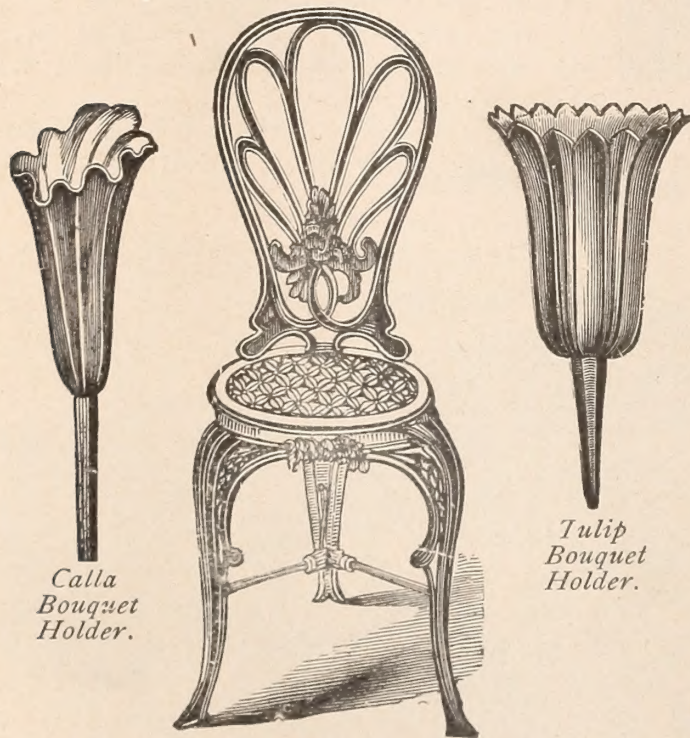

Calla Bouquet Holder.

Tulip Bouquet Holder.

Iron Chair—\$4.50.

Calla Bouquet Holder.

Green. Prices—No. 0, 25c.; No. 1, 35c.

Galvanized. Prices—No. 0, 35c.; No. 1, 50c.

Tulip Bouquet Holder.

Green. Prices—No. 4, 20c.; No. 5, 25c.; No. 6, 30c.

Galvanized. Prices—No. 4, 25c.; No. 5, 35c.; No. 6, 40c.

Mastica.

For glazing green-houses, sashes, etc. Elastic adhesive and easy to apply. Far superior to putty. Price per gallon, \$1.25.

Mastica Machines. For applying above, \$1.25.

Wrought Iron Pot Brackets.

No. 1, holding 5 inch pot,	30c.
No. 2, " 6 " "	35c.
No. 3, " 7 " "	40c.



Flower Pots.

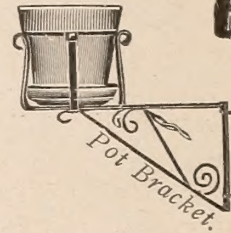

Pot Bracket.



Dibber.



Shuffle Hoe.

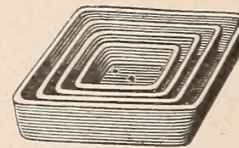

Seed Pans.



Grafting Knife.



Edging Knife.

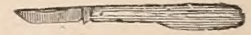

Pruning and Budding Knife.



Garden Line.



Garden Reel.

- Floral Tools (in sets.)
- Excelsior Weeding Hooks.
- Garden Tools.
- Border Forks.
- Shuffle Hoes.
- Garden Lines.
- Garden Reels.
- Dahlia Poles and Flower Sticks.
- Pot, Plant and Flower Trellises.
- Fancy Flower Pots.
- Hanging Flower Pots.
- Crocus Pots.
- Window Boxes.
- Common Flower Pots.
- Grass Hooks.
- Paris Green Dusters.
- Sulphur Bells.
- Plant and Tree Labels.
- Wire Flower Stands.
- Seed Pans.
- Stemming Wire.
- Wire Forms.
- Tin Foil.

- Edging Knives.
- Grafting, Pruning and Budding Knives.
- Pruning Shears.
- Round and Square Ferneries.
- Fernery Globes.
- Hyacinth Glasses.
- Flower Pot Covers.
- Flower Pot Brackets.
- Flower Pot Shelves with Swinging Brackets.
- Wood Flower Stands.
- Hanging Basket Hooks.
- Bird Cage Hooks.
- Hedge Shears.
- Box Shears.
- Pruning Hooks.
- Rustic Work.
- Hanging Baskets.
- Tooth Picks.
- Fancy Splint Baskets.
- French Moss.
- Bouquet Papers.
- White Stuffed Doves.

Tying Materials.

- Cuba Bass. Price per pound, 20c.
- Jute Tying Twines. Price per pound, 15c.
- Raphia. Price per pound, 20c.

Thermometers.

- Japanned Tin Cases. Seven-inch, 10c.; eight-inch, 12c.; ten-inch, 15c.; twelve-inch, 25c.

A TABLE

Showing the number of pounds per bushel, quantity usually sown per acre.

	<i>Lbs. per bushel.</i>	<i>Quantity usually sown per acre.</i>		<i>Lbs. per bushel.</i>	<i>Quantity usually sown per acre.</i>
Barley, broadcast.....	48	2 to 3 bush.	Mustard, broadcast.....	50	½ bush.
Beans, dwarf in drills.....	60	1½ bush.	Melon, Musk, in hills.....		2 to 3 lbs.
Beans, pole in hills.....	60	10 to 12 qts.	Melon, Water, in hills.....		3 to 4 lbs.
Beets, in drills.....		5 to 6 lbs.	Millet, broadcast.....	48	½ to ¾ bush.
Beets, in drills, Mangel Wurtzel.		4 to 5 lbs.	Oats, broadcast.....	32	2½ to 3 bush.
Broom Corn, in hills.....		8 to 10 qts.	Onion, in drills.....		5 to 6 lbs.
Buckwheat.....	48	1 bush.	Onion, for sets, in drills.....		30 lbs.
Cabbage, in beds to transplant..	50	¼ lb.	Onion Sets, in drills.....		8 to 12 bush.
Carrot, in drills.....		3 to 4 lbs.	Parsnip, in drills.....		4 to 6 lbs.
Clover, red.....	60	15 to 20 lbs.	Peas, Green Wrinkled.....	56	1¼ to 1½ bush.
Clover, white.....	60	12 to 15 lbs.	Peas, Round Hard, in drills....	60	1½ bush.
Clover, Alsike.....	60	10 lbs.	Peas, broadcast.....	60	3 bush.
Clover, Lucerne or Alfalfa.....	60	20 lbs.	Potatoes, cut tubers.....	60	6 to 10 bush.
Corn, in hills.....	56	8 to 12 qts.	Pumpkin, in hills.....		4 to 6 lbs.
Corn, for soiling.....	56	3 to 4 bush.	Radish, in drills.....		8 to 10 lbs.
Cucumber, in hills.....		2 lbs.	Rye, broadcast, Fall.....	56	1½ to 2 bush.
Flax, broadcast.....	56	1 bush.↓	Sage, in drills.....		6 to 8 lbs.
Grass, Kentucky Blue.....	14	2 bush.	Salsify, in drills.....		8 to 10 lbs.
Grass, Orchard.....	14	3 bush.	Spinach, in drills.....		10 to 15 lbs.
Grass, English Rye.....	20	2 bush.	Spring Rye.....	56	1½ to 2 bush.
Grass, Sweet Vernal.....	12	1½ bush.	Spring Wheat.....	60	2 bush.
Grass, Red Top.....	12	1 to 2 bush.	Squash, (bush varieties,) in hills		4 to 6 lbs.
Grass, Rhode Island Bent.....	12	1 to 2 bush.	Squash, (running varieties,) "		3 to 4 lbs.
Grass, Timothy or Herd's Grass.	45	½ bush.	Sugar Cane.....		12 lbs.
Grass, Hungarian.....	48	½ to ¾ bush.	Tomato, to transplant.....		¼ lb.
Grass, Mixed Lawn.....	20	3 to 4 bush.	Turnip, in drills.....	50	1½ to 2 lbs.
Hemp.....	40	1½ bush.	Turnip, broadcast.....	50	¾ to 1½ lbs.
Kale.....	50	5 lbs.	Wheat, broadcast, winter.....	60	2 bush.

The Number of Plants, Trees, etc., Required to Set an Acre.

<i>Distance.</i>	<i>Number.</i>	<i>Distance.</i>	<i>Number.</i>	<i>Distance.</i>	<i>Number.</i>
1 ft. by 1 ft.....	43,560	3 ft. by 3 ft.....	4,840	15 ft. by 15 ft.....	194
1½ ft. by 1½ ft.....	19,360	4 ft. by 4 ft.....	2,722	18 ft. by 18 ft.....	134
2 ft. by 2 ft.....	10,890	5 ft. by 5 ft.....	1,742	20 ft. by 20 ft.....	105
2½ ft. by 2½ ft.....	6,970	6 ft. by 6 ft.....	1,210	25 ft. by 25 ft.....	70
3 ft. by 1 ft.....	14,520	9 ft. by 9 ft.....	537	30 ft. by 30 ft.....	40
3 ft. by 2 ft.....	7,260	12 ft. by 12 ft.....	302	40 ft. by 40 ft.....	27

Our Cut Flower and Greenhouse Department

Is under the immediate superintendence of a member of the firm, and we aim to keep it up to the standard of excellence earned by many years of careful and painstaking attention to the wants and requirements of our patrons. Cut Flowers and Decorations are a specialty, and we strive to always have every feature of its season in superior quantity and quality. Palms and plants for decorations are also supplied in any quantity, and at prices agreeable to the purchaser.

THE FRANK S. PLATT COMPANY.

The Frank S. Platt Co.
New Haven, Connecticut

W RULE CO