

Historic, Archive Document

Do not assume content reflects current scientific knowledge, policies, or practices.

6261

LIBRARY
U.S. Department of Agriculture
Washington, D. C.

STUMPP AND WALTER COMPANY

50 BARCLAY STREET
BRANCH STORE
404 EAST 34th STREET NEW YORK



HIGH GRADE BULBS AND SEEDS

FOR FALL PLANTING, 1903

STUMPP & WALTER CO.'S

Fall Catalogue
1903 ————— of ————— 1903

BULBS, PLANTS AND SEEDS

FOR AUTUMN PLANTING AND SOWING

SPECIAL PREMIUM OFFER

We will allow on all orders amounting to \$1.00 or over a Special Premium of 10 per cent. to be selected in Bulbs, Flower Seeds or Vegetable Seeds. This discount applies to Seeds and Bulbs only.

We cannot allow this premium on Fertilizers, Insecticides, Implements, Farm Seeds or Grass Seeds.

Our list of bulbs comprises all the standard varieties, together with those apparently most valuable of recent introduction. The bulbs we offer have been raised under the supervision of our most reliable growers, and are unsurpassed in quality.

We Deliver Free

all Bulbs and Seeds to any Post Office or Railroad Express Office in the United States at prices quoted in this catalogue, except where noted. Purchaser pays transit charges only on Bulbs, etc., where specially noted.

Remittances

Remittances should be made by Draft on Bank, Post Office Order, Registered Letter or Express Money Order. Small sums may be sent in Postage Stamps of small denominations.

Customers can also shop by express, as all express companies have purchasing departments in all their offices. If you wish to order goods from us to be sent by express, ask for a Purchasing Order Blank at any express office, and it will be supplied and forwarded without charge, other than usual rates for returning goods.

If goods are wanted C. O. D., 25 per cent. of the amount must accompany the order.

Orders from unknown correspondents, without remittance, should be accompanied by New York City references, to save delay.

Packing and Shipping

We make no charge for packing excepting for cloth bags, and no charge for cartage or delivery of goods to any shipping office in New York City.

Safe arrival assured. We guarantee the safe arrival of all Bulbs and Seeds sent by express. Should anything be injured in transit, notify us at once and send us a list of what has been damaged, so that we can replace such without delay.

PLEASE TAKE NOTICE that we have opened a branch store at **404 EAST 34th STREET**, near the Long Island Ferry, making it convenient for our Long Island friends and patrons to leave their orders said store, where they will be given the same prompt and careful attention as is practiced in our down-town store.

Asking a fair examination of this Catalogue and soliciting your future orders, we remain, with thanks for past favors,

Very respectfully,

STUMPP & WALTER CO., 50 Barclay St., New York

Julian H. Walter, Pres.
George G. Stumpp, Treas.
Henry Eicke, Sec'y.

BRANCH STORE, 404 E. 34th Street, N. Y.

BULBS

FOR FALL PLANTING

FOR THE
**Garden, Conservatory and
Window Garden.**

BULBOUS plants are among the showiest of our garden favorites, and with little care and following the cultural instructions the growing of bulbs can be made a pleasure.

Beginners have an impression that there are many difficulties to overcome in the management of bulbs, in order to have them produce their flowers to perfection, while in reality no other plants succeed as well, under all circumstances, as the different classes of bulbs and tuberous-rooted plants, with as simple and little care as bulbs require.

There are a few necessary points to be considered, and these will be found in the various cultural instructions, which, if you follow them closely, will remove the supposed difficulties.

The growing of bulbs, other than the charms their flowers possess, has many advantages over that of any other class of flowering plants; among others, and a very great one, is that many of them produce their flowers in very early spring, at a season when few other plants are in blossom.

At this season, in a sheltered, sunny spot, a few clumps of Snowdrops, Crocus, Scillas, will present a mass of color, in graceful forms, while the snow yet lingers in shaded places; before these are gone the Hyacinths refresh us with their grateful fragrance; these are soon followed by the Narcissus and Early Tulips, and all before vegetation is fairly started. In rapid succession follow the gorgeous Parrot Tulips, Crown Imperials, and before these are gone the Lilies commence their long succession of bloom. Interspersed with these is a host of other bulbs, equally valuable for their flowers, but whose names are rarely mentioned.

Please be particular in ordering to write **Name and Address** distinctly and in full.

Order Your Bulbs Early.—We shall be able to fill all orders selected from this price list previous to November 1st; after that date the supply of many varieties is apt to be sold out. We advise our customers to forward their orders as soon as possible upon receipt of this price list.



"Russian" Lily of the Valley. For price and description, see page 15.

EXTRA SELECTED NAMED ... Dutch Hyacinths

Specially suited for growing in pots or glasses, or for high-class bedding, at a uniform price of 15c. each ; \$1.25 per doz. ; \$8.00 per 100. Delivered free anywhere in the United States.

The bulbs offered here are first size and best quality grown in Holland.



Single Pink Gigantea.

SINGLE RED AND ROSE HYACINTHS.

- Cavignac.** Salmon rose, one of the best bedding Hyacinths.
- Fabiola.** Beautiful, rose striped, large bells, compact spike.
- Fiancee Royal.** Very dark rose, fine color, large truss.
- General Pelissier.** Deep scarlet, compact, very good for early forcing.
- Gertrude.** Rosy pink, large erect spike, of exceptional value for pots or bedding; a splendid forcer.
- Gigantea.** Rose and blush, large bells, extra large close truss, one of the best pink hyacinths for either forcing or bedding.
- Lord Macaulay.** Rosy carmine, large bells and spike.
- La Incomparable.** Deep crimson, fine spike.
- Robert Steiger.** Fine deep crimson, large truss. A very popular variety for either bedding or pot culture.
- Roi des Belges.** Very large, full spike, fine deep color.
- Von Schiller.** Deep salmon pink, striped with crimson, large broad spike, forces easily.

SINGLE PURE AND CREAMY WHITE HYACINTHS.

- Alba Superbissima.** Pure white, large spike, a favorite early variety.
- Baroness von Thuyll.** Snow white, large compact truss of many bells, splendid for bedding and pot culture, one of the best for early forcing.
- Blanchard.** Pure white, early variety.

- Grandeur a Merveille.** Finest blush white, extra fine large truss; it is the best of this color to grow in quantity.
- La Franchise.** Blush white, large bells, fine for forcing.
- La Grandesse.** Pure white, long spike, very compact, excellent for pots or forcing.
- L'Innocence.** Pure white, large bells, extra large spike; one of the best forcing varieties.
- Mme. Van der Hoop.** Pure white, large bells, dwarf spike.
- Paix de l'Europe.** Pure white, waxy bells, large spike, very fine.

SINGLE LIGHT AND DARK BLUE HYACINTHS.

- Blondin.** Beautiful silvery blue, a compact large spike; splendid for forcing or bedding.
- Charles Dickens.** Bright blue, shading porcelain, excellent, large and compact spike; unexcelled for bedding or pot culture, and good for forcing.
- Czar Peter.** Porcelain blue, extra fine, large spike.
- Grand Maitre.** Grand large spike, pure ultramarine blue, shaded porcelain, strong grower.
- La Peyrouse.** Fine light blue, large bells, fine large spike; a splendid variety for bedding out, and a great favorite for forcing, very early.
- Leonidas.** Clear, light blue, handsome spike, early.
- Lord Derby.** Light porcelain, one of the finest varieties.
- Lord Melville.** Dark indigo blue, white eye.
- Marie.** Deep purple blue, with light blue stripe, extra good compact and large truss; a splendid variety for pots.
- Regulus.** Fine porcelain blue, large bells, compact and large truss.
- King of the Blues.** Rich dark blue, large bells, broad spike; splendid for forcing and pot culture.
- Queen of the Blues.** Porcelain, large compact spike, large bells.

SINGLE YELLOW HYACINTHS.

- Herman.** Fine orange yellow, large bells.
- King of Holland.** Rich orange, fine large spike and bells.
- La Pluie d'Or.** Pale yellow.

All of the above are selected first size bulbs, for which we make a uniform price of 15c. each ; \$1.25 per doz. ; \$8.00 per 100. Delivered free anywhere in the United States.

DATE SOLD

Salesman

BINDER FOLIO

DATE BILLED

TERMS

No. _____
Sold to _____
Town and State _____

LEDGER FOLIO

Ship by _____

SHIPPER'S CHECK

QUANTITY

Register No.

WEIGHT

PRICE

SALESMEN MUST NOT USE THESE COLUMNS

Amount Forward

SHIPPER'S CHECK	QUANTITY		WEIGHT	PRICE	

Stumpp & Walter Co
50 Barclay St.
New York.

S.&W.Co.'s Mammoth Named Hyacinths

These bulbs are the largest size and finest varieties imported, and where extra large blooms are wanted for show and exhibition purposes, would recommend trying this stock. The undermentioned twelve varieties consisting of four shades of White, four shades of Blue and four shades of Red, are the twelve best flowering varieties of all the named sorts.

Price, 20 cts. each; \$2.25 per doz.; \$15.00 per 100. Delivered free anywhere in the United States.

LA GRANDESSE. Pure white.

GRANDEUR A. MERVEILLE. Blush white.

LA INNOCENCE. Waxy white.

BARONESS VON THUYLL. Snow white.

GRAND MAITRE. Blue shaded porcelain.

LORD DERBY. True porcelain blue.

KING OF THE BLUES. Dark blue.

QUEEN OF THE BLUES. True light blue.

ROI DES BELGES. Fine deep red.

GERTRUDE. Fine rosy pink.

MORENO. Fine deep pink.

GIGANTEA. Light pink.

The above collection 1 bulb each, 12 varieties for \$2.25; 2 collections for \$4.25. Delivered free anywhere in the United States.

Double Named Hyacinths

Double Red and Rose Hyacinths

Bouquet Royal. Fine rose, dark shaded, very handsome truss.

Bouquet Tendre. Brilliant carmine red, good truss, early.

Czar Nicholas. Pale pink, large bells, fine spike.

L'Esperance. Rose, dark shaded, fine spike.

Lord Wellington. Very early pink, large bells and truss.

Noble Par Merite. Deep rose, large bells and spike, one of the finest double Hyacinths.

Prince of Orange. Large, semi-double, light pink, fine spike.

Double Pure and Creamy White Hyacinths

Anna Maria. Very early, purple center, very double, fine spike.

Flevo. Pure white, large full bells, compact spike, extra.

La Tour d'Avergne. The earliest pure white, extra fine,

La Virginite. Pale blush rose center, good bells, fine broad spike, very early.

Sceptre d'Or. Pure white, late, very double and large compact truss.

Bedford. Pure white, very double, large bells, compact spike.

Double Yellow Hyacinths.

Goethe. Light yellow, fine bells, large truss, extra fine.

Jaune Supreme. Splendid rich yellow, tall stiff spike; well furnished with large bells, one of the yellowest, early.

Minerva. Salmon, with rosy carmine stripe, fine double bells, compact rounded spike.

All the above named double hyacinths, 12 cts. each; \$1.25 per doz; \$8.50 per 100. Delivered free in the U. S.

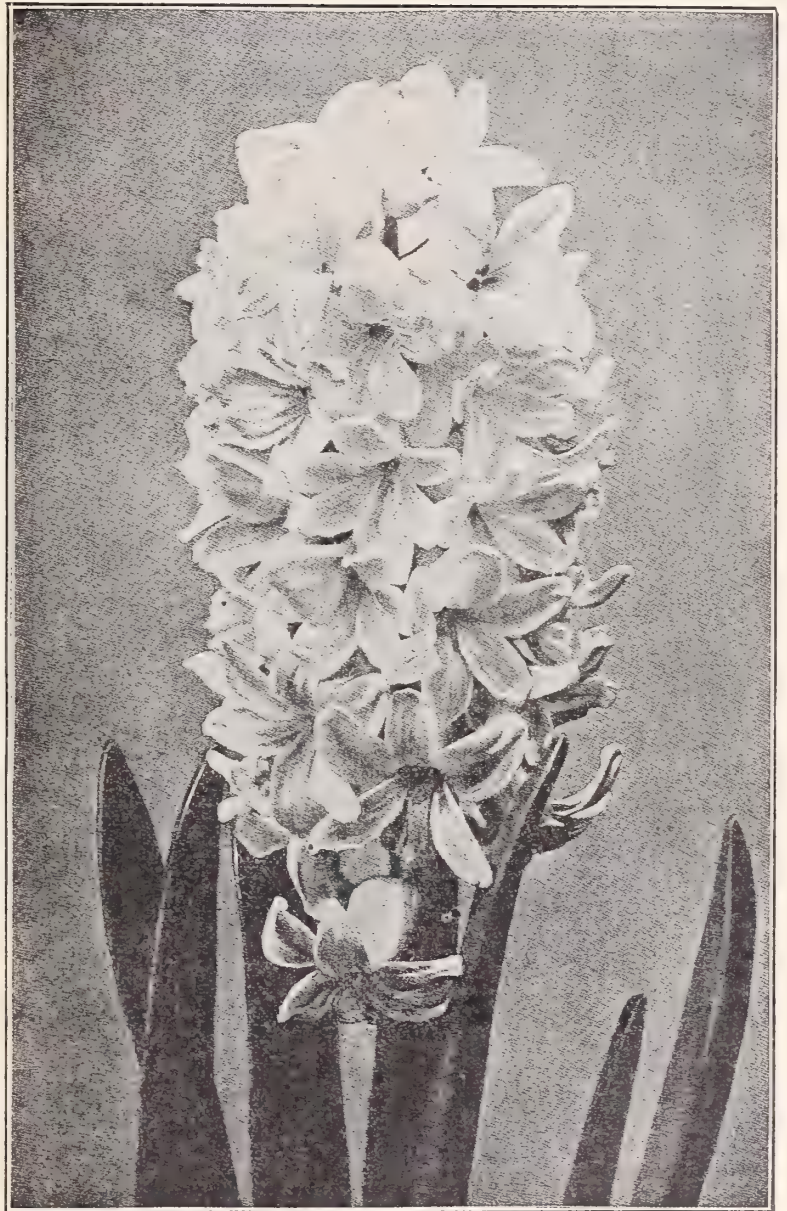

Hyacinth Single White La Grandesse.

William III. Yellow, tinged orange, rose center, fine compact spike.

Double Light and Dark Blue Hyacinths

Blocksberg. Light blue, marbled, extra large, bells, magnificent large compact spike; the finest double light blue, early.

Charles Dickens. Magnificent dark blue, shaded lilac, excellent, large and compact.

Crown Prince of Sweden. Tall, slim spike, compactly furnished, with good sized double bells of reddish heliotrope.

Garrick. Splendid bright blue, with dark center, extra large truss, early.

General Antinck. Violet, very double, excellent for pot culture.

Lord Wellington. Rich blue, striped with lilac, dark center.

How to Grow Hyacinths Outdoors.

For the open border but one condition is absolutely necessary, viz., they must be protected against frost. Although Hyacinths are classed with the hardy bulbs, they are by no means such, and where the bulbs are cultivated for purposes of sale the ground is so thoroughly mulched that the frost rarely, if ever, touches the bulbs

In planting the Hyacinth, no matter what the nature of the soil may be, make it deep, and work in liberal quantities of well-rotted manure; if it is a heavy loam the bulbs should not be covered more than two inches; if in a light sandy soil, cover them fully four inches. Upon the approach of frost, cover the beds with newly fallen leaves, to the depth of six inches; this covering should be extended at least eighteen inches beyond the bed on all sides, and then kept in place by Evergreen boughs, brush or pieces of boards. Thus protected, the Hyacinth will be among the first plants to put in an appearance above ground in spring.

No further work will be required for the perfect development of the flower. Bulbs should be planted from 4 to 6 inches deep and about 6 inches apart.



Round Bed of S. & W. Special Bedding Hyacinths

Our S. & W. Special Bedding and Forcing Hyacinths.

The bulbs under this heading are of a much larger size than those put in ordinary mixtures; in fact, most of these average as large as those often sent out as "First Size Named" by some dealers. They are of the same age as the first size fancy named Hyacinths offered by us, from which they are the second selection. They will produce grand spikes of bloom, and the different sorts, as offered below, all being of one shade of color and all blooming at one time, render them of great value for forcing or bedding out, especially in designs, enabling one to secure the exact color effect desired, which is a great advantage over mixed reds, mixed blues, etc., at but a slight advance in price.

Prices of S. & W. Bedding and Forcing Hyacinths.

	Each.	Per Doz.	Per 100.		Each.	Per Doz.	Per 100.
Single brilliant crimson . . .	6c.	70c.	\$5.00	Single bright blue	6c.	70c.	\$5.00
" bright scarlet	6c.	70c.	5.00	" purple	6c.	70c.	5.00
" light rose	6c.	70c.	5.00	" blush white	6c.	70c.	5.00
" deep pink	6c.	70c.	5.00	" pure white	6c.	70c.	5.00
" porcelain blue	6c.	70c.	5.00	" snow white	6c.	70c.	5.00
" lavender	6c.	70c.	5.00	" special mixed	6c.	70c.	5.00

Delivered Free anywhere in the United States.

Mixed Dutch Hyacinths.

These Hyacinths are all large-sized healthy bulbs, well adapted for outdoor planting. The colors being kept separate, the purchaser can make his selection of colors as his taste may dictate. The bulbs can also be forced for winter flowering or cutting. Bedding and forcing varieties are kept separate. Please state which to send when ordering.

Single Mixed Varieties.

Pure white, blush white, rose, red, light blue, dark blue, yellow, mixed all colors. Each, 5c.; doz., 50c.; 100, \$4.00.

Double Mixed Varieties.

Pure white, blush white, rose, red, light blue, dark blue, yellow, mixed all colors. Each, 5c.; doz., 50c.; 100 \$4.00.

The above prices include delivery anywhere in the United States.

HYACINTHS IN POTS.

For pot culture there is no plant that succeeds better than the Hyacinth. Let the soil under the bulb be quite loose, in order that the numerous roots may penetrate the soil without obstruction, but press the soil firmly around and over the bulb, which should be even with the rim of the pot, which will afford more room for the roots. After potting they should be plunged in some convenient, unsightly place in the garden, where they can be easily reached at any time and covered to the depth of a foot or more with soil, coal ashes, or whatever is the most convenient, and over this throw some coarse leaves or litter of any kind, to keep the frost from the soil, in order that the pots may be reached without difficulty as wanted.

Let them remain in this situation until the middle of December, by which time they will have made considerable growth; bring into the conservatory, or bring as many at a time as is desirable. When first brought in they should be kept as cool as convenient, the temperature not to fall below the freezing point.

A four-inch pot is amply sufficient for a single bulb, and three will grow nicely in a six-inch pot, and if one bulb each of Red, White and Blue is used, the effect is very pleasing.

The Hyacinth is one of the few plants that will perfect their flowers without sunshine. While a little is preferable, they will thrive well in rooms where the sun's rays rarely enter, which makes them in many cases particularly desirable.

Although most varieties do well grown in pots, some sorts are more desirable than others, owing to their strong growing habit, producing full spikes of bloom. The following "Exhibition Collection" is especially adaptable for this purpose, as it comprises a variety of exceptionally beautiful sorts, such as we have found to succeed best when grown in pots.

Exhibition Collection of Hyacinths for Pot Culture.

- CHAS. DICKENS.** Single rose Hyacinth, beautiful rose, white shaded, very large spike well filled.
LORD MACAULAY. Rosy carmine Hyacinth, with very large bells, and strong spike.
IORENO. Pink, magnificent large bells, strong spikes, and handsome pink color.
ROI DES BELGES. Very large full spike; very fine deep red color.
ALBA SUPERBISSIMA. Large, pure white Hyacinth; one of the earliest flowering Hyacinths.
LA GRANDESSE. Very large spike and pure white color. A very desirable variety.
BARON VON THUYLL. Handsomest pure white Hyacinth known.
MADAME VAN DER HOOP. Pure white, fine truss of large bells.
CHAS. DICKENS. Bright blue, shading porcelain, excellent, large and compact spike.
LA PEYROUSE. One of the greatest favorites of all blue Hyacinths. It produces very large bells, strong spike. The color is porcelain, shaded lavender.
KING OF THE BLUES. Rich dark blue, the finest of deep blue Hyacinths. Broad spike with large bells, erect and extra fine.
GRAND MAITRE. Very fine, bright blue, very large bells and tall fine spike.

One Bulb each of the above 12 sorts, each Bulb named, \$1.25 postpaid.



Single Hyacinth

HYACINTHS IN GLASSES.

Hyacinths grown in glasses are beautiful ornaments for the sitting room or parlor and can be easily grown, by forcing only such sorts suitable for this purpose, and by following the directions.

Directions.—Place the Bulbs in Hyacinth Glasses as early in the season as possible, making sure that only the base of the bulb touches the water; keep in cool, dark room, closet or cellar, until the roots nearly reach the bottom of the glass. Then bring them to the light, taking the precaution, however, not to keep them in the glaring sunshine, nor on the hot mantelpiece where, as in both instances, the fluctuations of heat and cold will make these positions most unsuitable for successful cultivation.

Collection of Water Hyacinths.

- ARGUS.** Fine violet blue, pure white eyed.
FIANCEE ROYAL. Very brilliant pink, fine color.
BLONDIN. Silvery blue, compact grower.
GRANDEUR a MERVEILLE. Finest blush white, extra fine, large truss.
GENERAL PELISSIER. Fine deep red, large flowers.
L'INNOCENCE. Pure white, fine bells and truss.

- LEONIDAS.** Clear bright blue, handsome spike, early bloomer.
MARIE. Deep purple blue, extra good, compact and large truss.
VON SCHILLER. Very fine pink, large truss.
PAIX DE L'EUROPE. Pure white, long spike, compact grower.
REGULUS. Very large bells, light blue, strong spike.
VERONICA. Bright crimson, very handsome.

One Bulb each of the above 12 sorts, each Bulb named, \$1.25 postpaid.

HYACINTH GLASSES. Tall, each, 15c.; per doz., \$1.50. Buyer paying expressage.

HYACINTH GLASSES. Low, each, 15c.; per doz., \$1.50. Buyer paying expressage.



Hyacinth in glass.

PAN HYACINTHS (Sometimes called Dutch Romans).

This method of growing Hyacinths for winter flowering in the house has given the most satisfactory results. A number of florists used this method for creating something new in the line of an Easter display, with the result that there was a much greater demand than supply, owing to the beautiful display the Hyacinths in pans make. The secret of acquiring success is simply the following: Plant only one kind of Hyacinth in one pan, in order to have them all bloom at once, and to have them all the same shade. The various sorts of Hyacinths invariably grow different from one another, and if planted together, the result will turn out accordingly. The following varieties of pan Hyacinths are the best known sorts for this mode of growing, and if by planting 10 to 12 bulbs of either of the twelve varieties mentioned in a pan 8 to 9 inches in diameter, and following the directions of planting Hyacinths in pots, the most satisfactory results will be obtained.

In ordering bulbs for this purpose, be sure to mention **Pan Hyacinths**.

VARIETIES AND PRICES.

Gertrude. Fine pink.
Roi des Belges. Bright red.
Lord Macaulay. Rosy carmine.
Gigantea. Pale pink.
L'Innocence. Pure white.
La Grandesse. Pure white, large spike.
Paix de la Europe. Pure waxy white.
Baroness Von Thuyll. Snow white.
Grand Maitre. Bright blue.
King of the Blues. Dark blue.
Lord Derby. Light blue, large spike.
Czar Peter. Porcelain blue, extra fine.

Price of any of above named varieties 50 cts.
 per doz., by mail prepaid, or \$3.50 per
 100 by express prepaid.



Pan Hyacinths.

ROMAN HYACINTHS.

Make splendid plants for the window garden, grown in whatever device may be desirable. They should be treated in all respects like the other classes, only that they come into flower much earlier, and should, for first flowers, be brought in by the 15th of November; by so doing, they will give their flowers in perfection by Christmas.

The great beauty of this class of Hyacinths is their profusion of flowers, each bulb giving from three to six spikes, according to the size and strength of bulb. The flowers are smaller than those of the Dutch Hyacinths, but more graceful. The bulbs being small, three can be put in a 5-inch pot.

	Mailed Postpaid.	By Express Prepaid.
Pure White Roman. Extra large bulbs.	Each, 5c., per doz., 50c. ; per 100, \$3.50.	
Mammoth Bulbs. Per doz	75c. ;	5.00.
Double Rose Roman.	Each, 5c. ; doz., 50c. ; 100, 3.50.	
Single Rose Romans.	Each, 5c. ; doz., 50c. ; 100, 3.50.	
Single Blue Romans.	Each, 5c. ; doz., 50c. ; 100, 3.50.	
Single Yellow.	Each, 5c. ; doz., 75c. ; 100, 5.00.	



Grape Hyacinths.

Grape Hyacinths.

Very pretty, producing flower spikes that are from 2 to 3 inches in length, resembling a bunch of grapes.

Blue Grape Hyacinths. Per doz., 25c. ; per 100, \$1.00.

White Grape Hyacinths. Per doz., 25c. ; per 100, \$1.00.

Feathered Hyacinths.

Exceedingly pretty; feathery, plume-like spikes.

Per doz., 25c., per \$100, 1.00.



Roman Hyacinths.

Single Early Tulips.

Tulips are such universal favorites that it is scarcely necessary to dwell upon their merits here. Their ease of culture, combined with beauty of form and gorgeous coloring, renders them the most popular bulbs grown for spring bedding, and for winter flowering in the greenhouse and window garden they are incomparable. The Tulip is perfectly hardy and of easy culture, flowering as freely in the shade as in the sunshine, and producing as fine flowers in a confined town garden as in a more favored place. Double and Single Tulips, when associated together and planted in front of shrubs, maintain a longer display than if either is separately planted. In gardens where the flower beds are to be kept gay from the earliest day of spring, plant between the lines of Tulips, Scilla Sibirica, Chionodoxas, Snowdrops or Crocus, as these flower first and are through when the Tulips come into bloom.

	Each	Doz.	100
Artus (Garibaldi). B7. Scarlet	\$0 05	\$0 25	\$1 50
Belle Alliance (Waterloo). B9. scarlet	05	40	2 50
Canary Bird. A8. Pure rich golden yellow. Excellent for forcing or bedding	05	30	2 00
Cardinal's Hat. B9. Dark brownish red, very showy	05	20	1 25
Chrysolora. B9. Pure yellow	05	30	2 00
Cottage Maid. B9. White, edged rose	05	30	2 00
Couleur de Cardinal. B7. Brilliant crimson	05	50	3 50
Duchesse de Parma. B8. Red, yellow border	Each \$0 05	Doz. \$0 30	100. \$1 75
Duc van Thol Tulips. Very early and especially valuable for forcing and pot culture. Height from 6 to 7 inches.			
	Each	Doz.	100
Duc van Thol, red and yellow	\$ 00	\$0 20	\$1 25
" " gold striped		20	1 25
" " rose		30	2 25
" " scarlet		25	1 75
" " white		30	2 25
" " yellow		40	2 50
Joost van Vondel. B10. Deep cherry red, with white feather through center of petals; very pretty	05	30	2 00
Keizerskroon. B10. Deep crimson, with broad orange yellow margin, large and exceedingly effective	05	30	2 00
King of the Yellows. B9. Grand, rich yellow, large, fine flowers	05	50	3 00
La Reine (Queen Victoria). B8. White very faintly tinted rose, good for both bedding and forcing	05	25	1 75
L'Immaculee B9. Pure white, yellow base, large, broad petaled flower; very early and fine	05	20	1 50
Montesor. B9. Grand, rich, yellow, extra large, fine flower	05	50	3 50
Pottebakker, White. A9. Pure white, fine large and showy flowers, excellent forcer	05	35	2 50
Pottebakker, Scarlet. Bright dazzling scarlet; very large and fine flowers	05	35	2 50
Pottebakker, Yellow. A9. Large, fine, bright yellow, feathered crimson	05	35	2 50
Prince of Austria. B9. Glittering copper red. Very large flower; fine for pots	05	40	3 25
Proserpine. B12. Rich silky rose, of			



Single Tulips. Cottage Maid, Yellow Prince, Belle Alliance, La Reine.

	Each	Doz.	100
perfect form, large and very effective	05	45	3 50
Purple Crown. A8. Dark blood-red. A good bedder		25	1 50
Rachel Ruisch. B9. Delicate rose, shaded white, fine for forcing, beautiful	05	20	1 75
Rembrandt. A9. Superb, rich glowing crimson, large flower, early and fine forcer	05	30	2 50
Rosamundi Huyckman. B9. Carmine, pink, feathered white, through center of petals, white base, large flower	05	30	2 00
Rose Luisante. C8. Dark rose extra fine	05	60	4 00
Standard Silver. B8. White, feathered with rosy crimson		30	2 00
Thos. Moore. B10. Orange, effective, large Tulip, sweet-scented	05	35	2 50
Vermilion Brilliant. B5. Deep, dazzling vermilion, magnificent; extra fine for pots and massing	05	50	3 50
Wouwerman. C8. Dark claret violet. Very large flower, beautiful color		30	2 00
Yellow Prince. B9. Bright yellow, large and showy, the finest low-priced yellow tulip for bedding out	05	35	2 25
S. & W. Special Mixture. Made up of made sorts, proper proportions of bright colors, blooming together and of uniform height		20	1 25
All Colors. Special mixture		15	1 00

The letters A, B, C, following the varieties, indicate their earliness of bloom; those marked A flower together and are the earliest; B's follow before the A's are out of bloom, etc. The figures indicate average height in inches. All the above prices include delivery anywhere in the U. S.

Late Flowering or Show Tulips.

This group of Late-Flowering Garden Tulips generally is in full flush of bloom about "Decoration Day." They differ from the Early Single Tulips by their taller growth and later bloom. They are brilliant in the extreme for bedding purposes. The flowers are very large, symmetrically formed and their magnificent colors, with interesting and delicate featherings and markings, make a sight not soon to be forgotten, particularly when bedded out in quantity. They are very hardy and do well through all sorts of weather.

Giant or Gesneriana Tulips. For out-door cultivation. The tallest largest flowering and showiest of all Tulips for bedding purposes. Scarlet, crimson scarlet with blue black center . . .	Each	Doz.	100	
	\$0 04	\$0 30	\$2 00	
Gesneriana Yellow. Bright, rich, effective yellow	04	30	2 00	
Gesneriana Rose. White base	04	30	2 00	
Gesneriana Rose. Flamed	04	30	2 00	
Bridesmaid. Brilliant scarlet, striped pure white, very beautiful	05	45	3 00	
White Swan. A grand pure white late-flowering Tulip, just what is wanted for contrasting with the reds, yellows and purples, which heretofore predominated in late Tulips	04	35	2 25	
Bouton d'Or. Pure golden yellow. Handsome globe-shaped flowers	05	40	2 50	
Breeder Tulips. (Mother Tulips.) Immense flowers of solid colors including scarlet, crimson, violet, etc. Choice mixed	04	35	2 00	
Golden Eagle. (Golden Crown.) Large, showy yellow flowers, edged crimson pointed petals.	04	35	2 00	
Maiden's Blush. An elegant long-shaped flower, the petals elegantly reflexed, are clear white, margined and penciled on the edges with pink	05	50	3 50	
Greigi. The "Queen of Tulips." Handsome and distinct. Flowers very large, of brilliant orange scarlet, with a yellow and black center	15	1 50	10 00	
Retroflexa. Large clear yellow flower	10	1 00	8 00	
Bizarres. Crimson, violet purple, on yellow ground.	05	30	2 00	
Violets. Violet on white ground	05	30	2 00	



	Each	Doz.	100
Byblooms. Purple, violet and maroon, on white ground	\$0 05	\$0 30	\$2 00
Rosy on White. Rose, cherry-pink, on white ground	05	30	2 00

DARWIN TULIPS.

Darwin Tulips belong to the late or May-flowering section, are destined to be extensively grown for bedding or massing purposes. The flowers are very large, of symmetrical form, and are borne on tall strong stems, often two feet high. They by far surpass in colors and brilliancy anything before known in Tulips. They include almost every conceivable color and shade, from the daintiest blue to the darkest violet, from soft rose to the most brilliant red, and from light brown to what is believed to be the darkest black in the floral world.

Aesculope. Purplish wine.	Edmond Rostand. Bright orange crimson.	Pallas. Dark brownish red.
Bieren de Haan. Light carmine red.	Herold. Silvery lilac.	Bruno. Violet blue.
Chapieus. Fiery rich blood red.	J. Malcolm. Rosy flesh color.	Tolosa. Lavender.
Chas. III. Mahogany red.	Longfellow. Dark crimson.	T. Winkler. Heliotrope.

Price, Collection 1 Bulb, each, 12 varieties	\$0 50	} Delivered free anywhere in the United States or Canada.
“ “ 6 “ “ 12 “ (72 Bulbs in all).	2 75	
“ “ 8 “ “ 12 “ (96 “ “ “ “).	3 25	
“ Darwin Tulips, mixed per doz., 40 cts.; per 100, 3 00		

DOUBLE PÆONY FLOWERED TULIPS.

The very largest and best flowering of the double varieties, producing flowers of enormous size, often measuring 5½ to 6 in. in diameter. Each Doz. 100	Each	Doz.	100
Double Paeony flowered scarlet . . . \$.10 \$1.00 \$5.00	\$.10	\$1.00	\$5.00
“ “ “ white10 1.00 5.00	.10	1.00	5.00
Double Paeony flowered yellow . . . \$.10 \$1.00 \$5.00	\$.10	\$1.00	\$5.00
“ “ “ pink10 1.00 5.00	.10	1.00	5.00

All the above varieties of Tulips by mail or express, carriage paid.

DOUBLE TULIPS.

DDOUBLE TULIPS have massive flowers of brilliant and varied colors, shades and markings, and being double, the flowers last much longer in bloom than single varieties, and in consequence, when singles and doubles are planted in conjunction the "time of the Tulips" is greatly prolonged. Double Tulips are beautifully adapted for beds on the lawn, in the garden, and for mingling in clumps of half a dozen or more around the edges of shrubbery. Are robust growers and exceedingly effective.

- Alba Maxima.** B8. Fine pure white, very large. Ea., 5c.; doz., 25c.; 100, \$1.50.
- Arabella.** A9. Carmine rose flowers. Ea., 5c.; doz., 40c.; 100, \$3.00.
- Blanche Hative.** A10. Very fine, large, semi-double, pure white, very early. Ea., 10c.; doz., 60c.; 100, \$4.00.
- Coronne d'Or.** B10. Large flower, very double, rich golden-yellow, shaded orange. Ea. 8c.; doz., 60c.; 100, \$4.00.
- Count Leicester.** B7. Orange and yellow, feathered. Ea., 5c.; doz., 35c.; 100, \$2.50.
- Crown of Roses.** B9. Large, very double, rich dark satiny rose-carmine color, shaded cerise. Ea., 10c.; doz., 70c.; 100, \$5.00.
- Duc Van Thol.** A7. Red and yellow; very early dwarf, fine for forcing. Ea., 5c.; doz., 20c.; 100, \$1.50.
- Duc Van Thol.** A8. Scarlet, very fine color. Ea., 5c.; doz., 20c.; 100, \$1.50.
- Duke of York.** B10. Very double, carmine-rose, edged broadly with white, suffused rose, showy and fine. Ea., 5c.; doz., 30c.; 100, \$1.50.
- Gloria Solis** A9. A grand flower, deep crimson, with broad golden margin, very large. Ea., 5c.; doz., 25c.; 100, \$1.75.
- Imperator Rubrorum.** A9. Splendid bright scarlet, yellow base; a fine full double. Ea., 5c.; doz., 50c.; 100, \$3.00.
- Lady Grandison.** Bright scarlet, one of the earliest of double Tulips. Ea., 5c.; doz., 25c.; 100, \$1.50.
- Le Blason.** A9. A beautiful variety of delicate rose, shaded and striped with white, extra fine. Ea., 5c.; doz., 50c.; 100, \$2.75.
- La Candeur.** B8. Pure white, very full and large, extensively grown for bedding. Ea., 5c.; doz., 35c.; 100, \$1.75.
- Murillo.** B8. Magnificent blush-white, shaded rose, large flowers, fine for forcing. Ea., 5c.; doz., 40c.; 100, \$3.00.
- Purple Crown, Double.** A8. Dark crimson-maroon, velvety and fine. Ea., 5c.; doz., 30c.; 100, \$2.00.
- Queen Victoria.** Cherry red, very pretty. Ea., 5c.; doz., 25c.; 100, \$1.50.
- Rex Rubrorum.** B9. Bright crimson-scarlet, superb for bedding, large and showy. Ea., 5c.; doz., 35c.; 100, \$2.50.
- Salvator Rosa.** A7. Beautiful deep rose, flamed with white, fine for forcing. Ea. 10c.; doz., 50c.; 100, \$4.00.
- Titian.** A7. Claret red, petals tipped white, yellow base. Ea., 5c.; doz., 25c.; 100, \$1.75.



Double Tulips.

- Tournesol.** A9. Splendid showy tulip, orange scarlet, with broad yellow tips and yellow base. Very large double flower. Ea., 5c.; doz., 35c.; 100, \$2.75.
- Tournesol Yellow.** A9. Bright golden yellow, shaded orange. Very fine large and showy flower; forces well. Ea., 10c.; doz., 80c.; 100, \$4.50.
- Mixed.** All colors, for bedding or forcing. Per doz., 20c.; 100, \$1.00.
- Mixed.** Separate colors—red, pink, striped, white or yellow. Per doz., 25c.; 100, \$1.50.

PARROT TULIPS.

These Tulips belong to the late-flowering garden varieties, which are generally in full bloom during the latter part of May. The Parrot Tulips have immense picturesque forms and brilliant showy colors. The petals have peculiarly feathered and fringed edges, and the shape of the flower, especially before it opens, resembles the neck of a parrot. They form extravagantly showy beds, an unlimited variety of colors, making a very effective display in the flower garden.

Admiral de Constantinople. Large red flowers, tipped with orange	Doz.	100		Gloriosa. Very large yellow flowers, with red stripes	Doz.	100
	\$0	.35	\$2.50		\$0	.35
Couleur Cafe. Large brown and yellow flowers35	2.50	Markgraf Von Baden. Yellow, striped with scarlet and green35
Cramoisi Brilliant. Deep carmine, very handsome45	3.00	Monstre Rubra Major. Very handsome, deep crimson-scarlet35
Lutea Major. Large bright yellow35	2.50	Perfecta. Yellow and red striped35

A collection of one of each of the above named eight sorts for 25c., postpaid. Mixed Paris Tulips, per doz., 25c.; per 100, \$1.75.

Crocus.

THE CROCUS is one of the earliest flowers of spring, and occupies a prominent place in every garden. When planted as an edging, in triple lines of one or more colors, the effect is striking. No spring display surpasses that of Crocus; the broad wavy bands of golden yellow, striped, purple, or of pure white, when they expand their blossoms in February and March, are incomparable. In lawns and pleasure parks, planted in the grass, the Crocus is extremely effective. They are easily planted indiscriminately in the turf with the aid of a dibber—after fall rains have made the soil moist. The flowers and foliage are gone before the lawn needs mowing, so they do not interfere with the summer beauty of the lawn. For several years past Crocus, Snowdrops, Daffodils, etc., have been planted in our parks and lawns, in wild places, woodland walks, etc., to the great delight of visitors and enhanced decoration of the parks. In one of the parks thousands of Crocus were used in the grass, and the effect was matchless. If ordered by mail, add 25 cents per 100 for postage. Larger lots sent by express, buyer paying transit.



Mixed Crocus.

Blue, White, Purple and Yellow. Per doz., 10 cts.; per 100, 40 cts.; per 1000, \$2.50.
Striped. Doz., 10 cts.; 100, 40 cts.; 1000, \$2.50.
All colors mixed. Doz., 10 cts.; 100, 40 cts.; 1000, \$2.50.

Named Large Flowering Crocus.

	Doz.	100.	1000.		Doz.	100.	1000
Albien. Large striped, white and blue	\$0 15	\$0 70	\$5 00	Madame Mina. Striped purple and white	\$0 15	\$0 70	\$5 00
Baron von Bruno. Purplish blue	15	60	5 00	Miss Nightingale. Striped blue and white	15	70	5 00
Caroline Chisholm. Fine white	15	60	5 00	Mont Blanc. Pure white	15	70	5 00
Cloth of Gold. Golden, striped brown	15	70	5 00	Prince Albert. Large brilliant purple	15	70	5 00
Cloth of Silver. White, striped lilac	15	60	5 00	Princess of Wales. Large pure white	15	70	5 00
David Rizzio. Dark purple, large	15	70	5 00	Sir Walter Scott. Striped blue and white	15	70	5 00
Ida Pfeiffer. Striped blue and white	15	70	5 00	Sir John Franklin. Dark purple	15	70	5 00
King of the Blues. Large blue	15	70	5 00	Yellow, Large Mammoth	15	80	6 50
King of the Whites. Very large, pure white	15	70	5 00	Yellow, Large	10	60	5 00

Autumn Flowering Crocus (Colchicum).

Colchicum Autumnale. Very effective and handsome, hardy plants, the flowers of which come through the ground without leaves in the fall, the leaves appearing the following spring. These bulbs can also be grown in the fall of the year in shallow bowls of water, or in pots of earth, when they will come into bloom in two weeks after planting, making a very pretty display at a time when blooming plants are very scarce. The flowers comprise many shades of white, purple, rose and striped. Mixed sorts, 5 cts. each; 50 cts. per doz.

NARCISSUS OR DAFFODILS.

In this genus we have a long list of established favorites, remarkable for their fragrance and precocity of their flowers. They are all hardy, with the exception of *Bulbocodium* and the *Polyanthus* varieties. Give them the same treatment as *Hyacinths* for outdoor cultivation.

LARGE AND MEDIUM TRUMPET VARIETIES. If ordered by mail, add 12 cents per dozen for postage.

ALBICANS. The *White Spanish Daffodil*. Creamy white, with a silvery white trumpet slightly flushed with primrose and elegantly recurved at brim. 10 cts. each; \$1.00 per doz.; \$7.00 per 100.

BARRI CONSPICUA. The finest of this class, long-stemmed flowers with beautiful broad petaled perianth $3\frac{1}{2}$ inches across, sparkling canary yellow with deep golden cup richly edged with orange scarlet; awarded a first-class certificate. 10 cts. each; \$1.10 per doz.; \$8.00 per 100.

CYNOSURE. Large across, light yellow, with rich, deep yellow broad cup; a great beauty, and one of the best for either forcing or open ground planting. 5 cts. each; 30 cts. per doz.; \$2.00 per 100.

MAXIMUS OR HALE'S BEATEN GOLD. One of the largest and most beautiful of this class. Very large flower, of rich, deep golden yellow. Remarkable for an elegantly twisted perianth. Trumpet deep golden, large, well flanged and deeply fluted. The darkest and richest yellow of all Daffodils. 10 cts. each; 75 cts. per doz.; \$5.00 per 100.

PRINCEPS. Very early. This is one of the most popular winter-flowering and forcing varieties grown. Flowers large, perianth sulphur, an immense rich yellow trumpet. 5 cts. each; 30 cts. per doz.; \$2.00 per 100.

SIR WATKIN. "The Giant Chalice Flower," or "Big Welshman." A gigantic variety, immense long-stemmed flowers, sometimes measuring $5\frac{1}{2}$ inches across, being the largest variety grown. Color a rich light yellow, with a very large dark cup, tinted with orange. (See cut.) 10 cts. each; 90 cts. per doz.; \$7.00 per 100.

STELLA. One of the first in flower and wonderfully free-blooming. White star-shaped flowers, 3 inches across, with bright yellow cups, very beautiful, and one of the most popular forcing and cutting varieties for the London flower market. 5 cts. each; 30 cts. per doz.; \$1.50 per 100.

TRUMPET MAJOR. Flower large and almost of a uniform deep golden. Highly prized as an early forcing sort and largely planted for outside bedding. 5 cts. each; 30 cts. per doz.; \$1.75 per 100.

LEEDSI. *Circe*. Fine pure white, cup slightly tinted with light straw but changes to white. A very distinct and pretty variety. 40 cts. per doz.; \$2.50 per 100.

WM. WILKS. Large broad-petaled flower, sulphury white, with orange yellow cup; very distinct and beautiful. 8 cts. each; 75 cts. per doz.; \$5.00 per 100.

MIXED LARGE TRUMPET NARCISSUS. Plant liberally of these for cutting purposes and naturalizing. 30 cts. per doz.; \$1.50 per 100; \$10.00 per 1000.



Narcissus Sir Watkin.

DUCHESSE DE BRABANT. Fine pure white; the cup is slightly tinted with light straw at first, but changes to white. A very distinct and pretty variety. 4 cts. each; 40 cts. per doz.; \$2.50 per 100.

EMPRESS. A magnificent, large variety, bold and erect. A rare beauty. Some give this the Palm of being the best of the two colored Trumpets. Perianth white and of great substance, trumpet rich yellow. 10 cts. each; \$1.00 per doz.; \$8.00 per 100.

EMPEROR. One of the finest Daffodils in cultivation; entire flower of the richest yellow trumpet of immense size, and the petals of the perianth are so broad that they overlay and measure $3\frac{1}{2}$ inches across. Grand for cutting. 10 cts. each; \$1.00 per doz.; \$8.00 per 100.

GOLDEN SPUR. One of the grandest Daffodils, with extra large, bold, rich yellow flowers, foliage very broad and striking. It is of unusually robust habit, and unsurpassed for gardens, pots or forcing. Early and extremely free flowering. 10 cts. each; 90 cts. per doz.; \$6.00 per 100.

GRANDEE. Flowers large, with broad white perianth, the petals of which are wide and overlapping, tube a magnificent yellow, beautifully imbricated; a flower of great substance and grand for cutting. 12 cts. each; \$1.35 per doz.; \$9.00 per 100.

HENRY IRVING. A magnificent flower, with beautifully frilled trumpet, nearly two inches wide at the mouth, of rich golden yellow color. The petals of the perianth are very wide, overlapping, color bright yellow. A most perfect flower; received a first-class certificate. 10 cts. each; 90 cts. per doz.; \$6.00 per 100.

HORSEFIELDI. The *Queen of the Daffodils*. Very large flowers of pure white, with rich yellow trumpet. Very stately and beautiful, and one of the most elegant for ladies' corsage wear. The flowers are the largest of this class, very early and free-blooming, a grand cut flower; and eagerly sought after as one of the finest. 10 cts. each; 90 cts. per doz.; \$6.00 per 100.

POET'S NARCISSUS.

(Miniature Saucer-Shaped Cups.)

Poeticus Biflorus. Twin flowers, borne on one stalk, pure white, with yellow cup. Per doz., 25 cts.; per 100, \$1.25.

Poeticus Burbidgei. An early-flowering Poeticus, fully a month earlier. Flowers $2\frac{3}{4}$ inches across, round, broad, overlapping petals. Pure white, cup edged with orange-scarlet, very fine for both forcing and outside planting. Per doz., 25 cts.; per 100, \$1.25.

Poeticus Ornatus. The improved "Poeticus." A grand flower for cutting purposes. Larger and more symmetrical than the old variety and considerably earlier. Beautiful pure white flowers, with saffron cup, tinged with rosy scarlet. A magnificent cut flower. Each, 5 cts.; per doz., 30 cts.; per 100, \$1.75.

Narcissus Jonquilla or Jonquils.

Much prized for their charming golden and deliciously sweet-scented flowers, perfectly hardy, and flowering very early in the spring; they are also admirably adapted for winter forcing.

Rugulosus. (The Giant Jonquil.) Broadly imbricated perianth, with large, wrinkled cup, full yellow. Per doz., 25 cts.; per 100, \$1.25.

Single Jonquil. The well-known favorite, delicately scented and beautiful for forcing. Rich yellow, very fragrant. Per doz., 15 cts.; per 100, 75 cts.

Double Jonquil. Heads of small, but very double deep golden yellow flowers, powerfully scented and good for forcing. Each, 5 cts.; per doz., 40 cts.; per 100, \$2.50.



Poet's Narcissus.

Campernelle. Large six-lobed yellow flowers, four to six on a stem, fine for forcing, and the one generally preferred by florists. Per doz., 20 cts.; per 100, \$1.00.

The Chinese Sacred or Oriental Narcissus.

The "Shui Sin Far," or Water Fairy Flower, or Flower of the Gods, as it is called by the Celestials, is a variety of Narcissus, bearing in lavish profusion chaste flowers of silvery white, with golden yellow cups. They are of exquisite beauty and entrancing perfume. The bulbs are grown by a method known only to themselves,

whereby they attain great size and vitality, ensuring luxuriant growth and immense spikes of flowers. They do well in pots of earth, but are more novel and beautiful grown in shallow bowls of water, with enough of fancy pebbles to prevent them from toppling over when in bloom. A dozen bulbs started at intervals will give a succession of flowers throughout the winter. Price, buyer paying transit, 10 cts. each; \$1.00 per doz.; \$7.50 per 100.

Mammoth Bulbs. bearing twice the number of flowering stems as the regular size, 15 cts. each; \$1.50 per doz.

Narcissus Paper White Grandiflora.

A decided improvement over the ordinary Polyanthus Paper White Narcissus, producing a vigorous growth and a very large truss, bearing beautiful clusters of large, pure white flowers. This variety of Narcissus is grown in the southern part of France, and generally arrives here about August 15th or September 1st, and if planted about that date, they can be brought into bloom as early as Thanksgiving Day, and when several bulbs are planted together will keep in bloom longer than a month, providing they are kept in a cool place. Give the bulbs the same treatment as you would any other Narcissus for indoor culture, except when grown in shallow dishes as described below:

How to Grow Narcissus Paper White Grandiflora in Water.

A very unique, simple and novel way to grow this variety of Narcissus is to place six or eight bulbs in a shallow glass or China bowl with water. Support the bulbs with pebbles or gravel as you would the Chinese Sacred Lily bulbs and you will have a beautiful and luxuriant display of elegantly perfumed flowers in a comparatively short time; in fact, inside of six weeks after planting if desired. After the plants have been set, place the bowls in a dark place until the roots have started, when you should bring them to the light. Keep the bowls filled with water and the bulbs will take care of themselves.

Price, 5 cts. each; 40 cts. per doz.; \$2.00 per 100.



Chinese Narcissus.

Polyanthus Narcissus.

The Polyanthus varieties of Narcissus are not only beautiful, but deliciously sweet-scented and of the easiest culture; very free-flowering, and suitable for window garden, conservatory or garden, continuing long in bloom. They bear tall spikes of bloom, bearing from six to twenty-four flowers each. The pure white petals and gold cups of some varieties, the yellow with deep orange cups of others, and the self whites and yellows render them great favorites.

If ordered by mail, add 20 cents per dozen for postage.

	Each.	Per Doz.	Per 100
Gloriosus. Immense trusses of pure white, with primrose-colored cups; very early; splendid to force . . .	\$0 05	\$0 40	\$3 00
Grand Monarch. Large white flowers, with lemon-yellow cup. Can be successfully grown in water like the "Chinese Sacred" mentioned below . . .	05	40	3 00
Grand Soleil d'Or. Rich yellow, with reddish orange cup, a favorite bedding and cutting variety . . .	05	40	3 00
Double Roman. Clusters of white flowers with double citron-colored cups. It is very early, and is grown largely for forcing . . .	05	30	1 50
States General. Clusters of white flowers, with citron-colored cups shading to white. Very early . . .	05	40	3 00
White Pearl. Extra fine clusters of satiny white flowers, with citron-colored cups, profuse bloomer . . .	10	75	5 00
Paper White. Pure snow-white flowers in clusters. This variety is perhaps more largely forced for cut flowers than any other; millions of them being used . . .	05	30	1 50



Narcissus Polyanthus, Grand Monarch and Grand Soleil d'Or.

	Each	Per Doz.	Per 100
Mixed, White Sorts	\$0 05	\$0 45	\$2 50
Mixed, Yellow Sorts	05	45	2 50
Mixed, All Colors	05	45	2 00

Double Narcissus.

	Each	Per Doz.	Per 100
ALBA PLENA ODORATA. "The Double White Poet's Narcissus or Gardenia-flowered Daffodil." Double snow-white Gardenia-like flowers, exquisitely scented.	\$0 05	\$0 25	\$1 50
INCOMPARABLE, fl. pl. "Butter and Eggs." Full double flowers of rich yellow, with orange nectary. Splendid variety for either forcing for winter cut flowers or for open ground planting.	05	20	1 25
ORANGE PHENIX. "Eggs and Bacon." Beautiful double white flowers, with orange nectary. Splendid for pot culture and cutting or garden decoration.	05	40	3 00
SULPHUR (OR SILVER) PHENIX "Coddins and Cream." Large creamy white flowers, with sulphur nectary. Exquisite corsage flower, and fine for growing in pots.	15	1 50	10 00
VON SION (Telamonious Plenus). The famous "Old Double Yellow Daffodil" Rich golden yellow perianth and trumpet. One of the best forcing sorts, immense quantities being grown for this purpose in Europe and America.	05	30	2 00
"DOUBLE NOSE" VON SION. Extra large bulbs, capable of producing two and three flowers each.	05	50	3 00
MIXED DOUBLE NARCISSUS. Plant liberally of these for cutting purposes or for naturalizing.	05	25	1 25



Narcissus Double Von Sion.

HARDY JAPANESE LILIES.

LILIES are matchless amongst hardy plants for beauty of form and variety of color in the garden. They commence flowering in May, and with the various species maintain a continuous and unbroken succession of bloom until Autumn. Their stately habit, rich and varied colored flowers, often deliciously fragrant, and easy culture render them so distinct from all other hardy plants that no collection, however select, should be without a few of the choicer sorts. The best time to plant Lilies is in October and November.

- L. Auratum.** (*The Golden-rayed Lily of Japan.*) The flowers are pure white, thickly studded with crimson spots, while through the center of each petal runs a clear golden band. Fully expanded, the flowers measure nearly a foot across, are produced abundantly from June to October, and possess a most delicious fragrance. 3 to 5 feet.
9 to 11 in. bulbs 15c. ea.; \$1.50 doz.
11 to 13 in. bulbs 30c. ea.; 3.00 doz.
- L. Auratum Vittatum Rubrum.** Probably the grandest Lily in cultivation. Magnificent flowers 10 to 12 inches across, clear waxy white with a burnished crimson stripe, half an inch wide, through the center of each petal, and the rest of the flower beautifully spotted with crimson. Highly perfumed. 75c. ea.; \$7.50 doz.
- L. Auratum Pictum.** A very choice variety, pure white with a band through each petal, one-half of which is red and the other half yellow, entire flower spotted crimson. 30c. ea.; \$3.00 doz.
- L. Auratum Witteii.** A magnificent Lily, immense flowers, widely expanded, color purest white with a wide yellow stripe through the center of each petal; often grows 6 feet high, very free-blooming. 75c. ea.; \$7.50 doz.
- L. Auratum Platyphyllum.** The flowers are similar in color to Auratum, heavily spotted but are much larger, the petals more overlapping and of greater substance. The leaves are very long and broad, and the stems attain a height varying from 7 to 10 feet. 30c. ea.; \$3.00 doz.
- L. Batemanæ.** A Japanese Lily, growing from 3 to 4 feet high and producing bright apricot-tinted flowers; blooms in July. 15c. ea.; \$1.75 doz.
- L. Brownii.** One of the most beautiful Lilies, immense trumpet-shaped flowers 10 inches in length; interior pure white with chocolate colored anthers; exterior brownish purple; easily grown in any light sandy loam, also in pots. 25c. ea.; \$2.50 doz.
- L. Candidum.** (*Annunciation, Madonna or St. Joseph Lily.*) The well-known garden Lily, snow white fragrant blossoms; it is also one of the best forcing Lilies for florists; 3 to 4 feet; blooms in the open ground about June. 12c. ea.; \$1.25 doz. Mammoth bulbs, 25c. ea.; \$2.40 doz.
- L. Dahuricum.** 20c. each; per doz., \$2.00.
- L. Elegans Incomparable.** The richest red known in Lilies; a deep ox-blood crimson, slightly spotted with black; very free and easily grown. 15c. ea.; \$1.50 doz.
- L. Elegans Orange.** Rich bright orange. 25c. ea.; \$2.50 doz.
- L. Elegans Semi Pleno.** A distinct and very pretty variety. Flowers are erect; the flowers are half double and rich scarlet, excepting underneath the petals, which are of soft apricot-yellow. 40c. ea.; \$4.50 doz.
- L. Elegans Medeoloides.** Shaded yellow medium size flower. 75c. ea.; \$7.00 doz.
- L. Elegans Alice Wilson.** One of the most beautiful and distinct Lilies; the flowers, of a bright lemon yellow, are very large, borne erect and in clusters; very hardy, succeeds almost anywhere; height, 1½ feet; very rare. 60c. ea.; \$6.00 doz.
- L. Elegans Atrosanguineum.** Very hardy and succeeds anywhere. Flowers are erect and borne in clusters, blood-red, shading to scarlet. 75c. ea.; \$7.50 doz.
- L. Hansoni.** (*The True Japanese Yellow Martagon.*) This is one of the best of the Martagon group, unsurpassed in vigor of growth and beauty by any other Lily. The flowers are large, of a bright yellow, tinged orange and spotted maroon, with thick wax-like petals. Very robust and free. 75c. ea.; \$7.50 doz.
- L. Krameri.** Distinct from all other Lilies, large flowers of a soft, beautiful rose color. 20c. ea.; \$2.00 doz.
- L. Lancifolium Album.** White. 8 to 9 in. bulbs, 20c. ea.; \$2.00 doz.
- L. Lancifolium Roseum.** White, shaded and spotted with rose. 8 to 9 in. bulbs, 15c. ea.; \$1.50 doz.
- L. Lancifolium Rubrum.** White, shaded with deep rose and spotted red. 8 to 9 in. bulbs, 15c. ea.; \$1.50 doz.
- L. Lancifolium Melpomene.** Rich blood-crimson, heavily spotted. 8 to 9 in. bulbs, 20c. ea.; \$2.00 doz.
- L. Leichtlini.** A free flowering variety, producing a number of blooms, of a light-orange color with bright red spots. 25c. ea.; \$2.50 doz.
- L. Longiflorum Varigated Foliage.** The same flower as the common Longiflorum, but the outer edge of the leaves has a white band. 50c. ea.; \$5.50 doz.
- L. Longiflorum.** Pure white, trumpet-shaped flowers; 5 to 7 inches in circumference, 10c. ea.; 75c. doz.
7 to 9 inches in circumference, 15c. ea.; \$1.50 doz.
9 to 11 inches in circumference, 30c. ea.; \$3.00 doz.
- L. Rubellum.** A novelty in Lilies. Easily forced under glass as well as being perfectly hardy makes it one of the most desirable varieties known. It bears medium sized drooping flowers of a soft, beautiful rose color and blooms very freely. 40c. ea.; \$4.00 doz.
- L. Tigrinum.** (*Tiger Lily.*) Orange-salmon. 10c. ea.; \$1.00 doz.
- L. Tigrinum fl. pl.** (*Double Tiger Lily.*) 15c. ea.; \$1.50 doz.

Collection 1 bulb each of the above 26 varieties, all separately marked, \$7.50, express paid.

Collection 2 bulbs each of the above 26 varieties, all separately marked, \$14.00, express paid.



Liliun Harrisii

S. & W. Co.'s Selected Stock LILIUM HARRISII

The True Bermuda Easter Lily.

This beautiful Lily has pure white trumpet-shaped flowers, delightfully fragrant, which can be kept for two weeks after being cut. The bulbs are perfectly hardy, except in northern climates, making it a desirable garden plant. Or they can be forced to bloom for Christmas by putting the bulbs in August, or be held back so as to bring them into bloom in time for Easter.

Complete cultural directions for forcing *Liliun Harrisii* mailed upon application.

PRICES OF BERMUDA EASTER LILY.

	Each	Dozen	100
FIRST SIZE 6 x 7	\$0 10	\$1 00	\$7 00
SELECTED SIZE . . . 8 x 9	20	2 00	15 00
EXTRA SIZE 9 x 11	35	3 50	25 00
MAMMOTH SIZE . . 13 and over	60	6 00	50 00

Lily of the Valley

The Lily of the Valley is a plant so well-known and such a universal favorite that little need be said in its description. If they are to be forced during the winter place the pips in shallow boxes during the month of November; put them in a cold frame or in the open ground, covering them so that they do not get severely frozen. They should remain in this condition for at least four weeks previous to being forced. They should be kept covered

with boards or any light covering until the pips have attained a height of four inches, when the covering may be lifted a few inches to admit air and light. When they are six inches high remove the covering altogether. If required for outdoor culture, plant in some partially shaded spot where they may remain for years without being disturbed.

LARGE FLOWERING "RUSSIAN" LILY OF THE VALLEY.

All lovers of Lily of the Valley should not fail to give our "RUSSIAN" Valley a trial. Introduced a few years ago, it has now become famous, being forced very extensively by a large number of celebrated Lily of the Valley growers.

The Russian Valley produces strong spikes of flowers, about 15 to 18 inches in height, bearing from twelve to twenty extra large pure white bells, which are delightfully fragrant. (See cut page 1).

PRICE, per bundle, 25 pips \$1 00 | PRICE, per 1000 pips \$20 00
 " 4 bundles, 100 pips 3 00 | " per 2,500 pips 45 00



Extra Selected BERLIN VALLEY

Three years old, for forcing, pot culture, or open ground planting. Per bundle, 25 pips, 50c.; per 100, \$1.75; per 1000, \$13.00; per case 2500, \$30.00.

Extra Selected HAMBURG VALLEY.

Three years old, for late forcing, pot culture or open ground planting. Per bundle, 25 pips, 50c.; per 100, \$1.75; per 1000, \$13.00; per case 2500, \$30.00.

LILY OF THE VALLEY CLUMPS

For Outdoor Planting.

Each, 30c.; per doz., \$3.00; per 100, \$20.00.

Miscellaneous Bulbs and Roots.



Agapanthus.

AGAPANTHUS.

(AFRICAN LILY.)

Splendid and useful ornaments in pots or tubs for lawns, piazzas, or for the decoration of the conservatory. Foliage is of a rich green, flowers are borne in immense clusters, which measure 20 to 30 inches in diameter.

If ordered by mail, add 5 cents each for postage.

Umbellatus, bright blue. Each, 20 cts.; per doz., \$2.00.

ALLIUM.

The varieties we offer are among the most beautiful for pot culture or garden decoration. They are of the easiest culture.

Neapolitanum. Another excellent variety for winter flowering, now extensively forced by florists for cut flowers, being of pure white, with green stamens, borne in large loose umbels; height, 15 to 18 inches. 3 for 10 cts.; 20 cts. per doz.; \$1.50 per 100.



Allium Neapolitanum.

AMARYLLIS.

All the varieties in this list are of the easiest culture; the great secret being to give them alternately a season of growth and one of rest. To do this well, the plants should be abundantly supplied with water and heat, and placed near the glass when they are coming into flower, and water should be withheld from them gradually when they have ceased flowering, when they should be laid away in a dry, cool place. The soil suitable for their culture is a rich loam, one-fourth part of well-rotted manure and a slight proportion of sand.

If ordered by mail add 5 cts. each for postage.

	Each.
Belladonna Major , large violet and white	\$0 15
Equestris (the Barbadoes Lily), bright orange scarlet, with white throat	20
Formosissima (Jacobian Lily), brilliant scarlet	15
Johnsonii , crimson, striped with white	25
Defiance , carmine-red, bars white, running through petals	1 00
Vittata , white, red stripes	60

CALLAS.

A well-known plant, of easy culture; the only particular attention it requires is constant watering, and as warm a room as can be conveniently given it.

White Calla, or Lily of the Nile. Dry roots. Each, 15 cts.; per doz., \$1.50.

Mammoth Bulbs. 25 cts. each, \$2.75 per doz.

Spotted Leaf Calla (*Richardia Alba Maculata*). Dark green foliage, beautifully spotted with white. Each, 20 cts.; per doz., \$2.00.

Tom Thumb Calla (Little Gem). A very pretty little variety, about 12 inches in height, and blooms most abundantly.

Very much superior as a house plant to the larger growing variety. Each, 20 cts.; per doz., \$2.00.



Little Gem Callas.

Yellow Calla, Elliottiana. A grand acquisition—the finest Yellow Calla we have seen; large, rich, deep golden flowers, often 4 to 5 inches across at the mouth; habit of growth and foliage like the old favorite White Calla, excepting the leaves of Elliottiana are spotted with white, rendering it an unusually showy pot plant. Blooming bulbs, \$1.75 each; extra large bulbs, \$2.50 each.

Cornutum, or Red Calla. A very handsome Arum with red flowers spotted with black; stems curiously mottled green and white; foliage palm-like and very handsome; a showy pot plant for winter decoration. 15 cts. each; \$1.50 per doz.

Sanctum, or Black Calla. The plant produces one large flower the shape of a Calla, but from 14 to 18 inches long and 4 inches broad, and of a rich, dark purple color and green underneath. The spathe rising from the center of the flower is about 10 inches long, velvet-like and quite black. The leaves are large and of a rich green color, and resemble those of the Calla *Æthiopia*. Large bulbs, 15 cts. each. \$1.50 per doz.

ANEMONES.

Very showy flowering plants, valued for their hardy nature, and also because they will flower at any required season, according to the time the roots are kept out of the ground. May be grown in pots or forced in frames.

Single Poppy Flowered. These handsome Single Anemones have large, beautiful saucer-shaped, Poppy-like blossoms, flowering continuously throughout spring and early summer.

Helene Maria. Blue	Each 5 cts. ; per doz., 40 cts.
The Bride Pure white	" 5 " " 40 "
Scarlet. Very brilliant	" 5 " " 40 "
Single Mixed	40 cts. per doz. ; \$2.50 per 100.

DOUBLE FLOWERING VARIETIES.

Celeste. Blue	Each 5 cts. ; per doz., 40 cts.
Ceres. White, veiled with rose	" 10 " " 75 "
Cramoisi, Royal. Brilliant crimson	" 5 " " 40 "
Josephine. Scarlet	" 5 " " 40 "
Lord Derby. Splendid bright rose	" 5 " " 40 "
Double Mixed	40 cts. per doz. ; \$2.50 per 100.

Anemone Fulgens. The rich, dazzling, scarlet flowers and light, elegant growth render it the most attractive flower of spring. It is valuable for cutting, as it lasts a long time. Each, 5 cts. ; per doz., 35 cts.

Fulgens fl. pl. A double flowering variety of the above, very beautiful. Each, 5 cts. ; per doz., 50 cts.

CROWN IMPERIALS.

Well-known hardy border plants, bearing clusters of immense pendent bell-shaped flowers, surmounted with a tuft of green leaves. They do better if planted in good rich soil and may be left undisturbed for years.

If ordered by mail, add 5 cts. each for postage.

	Each
Aurora, red	\$0 15
Crown on Crown, several whorls of flowers, one above the other	20
Gold Striped, crimson, variegated foliage	25
Sulphureus, sulphur-yellow	20
Mixed Varieties	10

CHIONODOXA, or Glory of the Snow.

Most charming spring-flowering bulbs. They produce flower-spikes bearing ten to fifteen Scilla-like flowers. They are perfectly hardy, and will thrive in any good garden soil. Fine for pot culture for winter-blooming.

Luciliae. Bright blue, with clear white center. Each, 2 cts. ; per doz., 20 cts. ; per 100, \$1.25.

Sardensis. Very deep blue. Each, 3 cts. ; per doz., 25 cts. ; per 100, \$1.25.

CYCLAMEN PERSICUM GIGANTEUM.

We have a magnificent strain of this most desirable greenhouse bulb, which has been grown especially for us, and which we know to be far superior to any stock heretofore offered.

Large Size Bulbs. Each, 15 cts. ; per doz., \$2.00.



Anemones.



Chionodoxa.



Cyclamen Persicum Giganteum.

FREESIAS.

Refracta Alba. Pure white. One of the most popular and charming bulbs for pot culture, flowering in the winter in the conservatory or window garden. They force very easily, and can be had in bloom by Christmas if started in pots in the month of September. Plant half a dozen bulbs in a four-inch pot, in good rich soil, water well, and keep them at a temperature of 60 degrees. By having a number of pots in a cold frame they can be brought in at intervals, thereby having a succession of blooms throughout the winter. Each, 3c.; per doz., 25c.; per 100, \$1.25; per 1000, \$10.00.

Mammoth Bulbs pure white, per doz., 35c.; per 100, \$2.00.

IXIAS.

Very desirable for pots or for the open ground. They require for outdoor planting the same treatment as Dutch Hyacinths, except that they should be more heavily mulched.

If ordered by mail, add 5 cts. per doz. for postage.

Extra Choice Mixture of 25 named varieties. Each, 5c.; per doz., 25c.; per 100, \$1.25.

SPARAXIS.

They were formerly included in the genus Ixia, and bear a close resemblance to them; the main points of difference being that the Sparaxis are of more compact habit of growth, the flowers more bold, and somewhat larger, and the flower spikes are not more than half as high, rarely growing more than six inches. Especially desirable for the window curtain.

If ordered by mail, add 5 cts. per doz. for postage.

Splendid mixed varieties. Per doz., 20c.; per 100, \$1.25.

GLADIOLUS.

The Bride (Colvillei Alba). Pure white. Very largely grown by florists for decorative purposes. The bulbs should be potted as early in the fall as possible. After potting, water thoroughly, place them under a bench, or in some moderately dark place, until they commence to grow, then bring them forward into a moderately heated house. Each, 5c.; per doz., 25c.; per 100, \$1.75. If ordered by mail, add 5c. per doz. for postage.

Rosy Gem. Delicate rosy pink; invaluable for cutting. Each, 10c.; per doz., \$1.00.



GLOXINA.

Most desirable greenhouse plants. The richness of their foliage, and their graceful and delicate tinted flowers have gained for them a prominent place among the more choice flowering plants.



Gloxinia.

	Each	Per Doz.
Emperor Frederick , red, bordered white	\$0 15	\$1 25
Emperor William , violet, bordered white	15	1 25
Princess Elizabeth , white, bordered blue	15	1 25
Mount Blanc , pure white	15	1 25
Violacea , dark violet	15	1 25
Madame Helene , white, crowned violet	15	1 25
Princess Mathilda , white, bordered rose	15	1 25
Queen Wilhelmina , dark rose	15	1 25
Defiance , scarlet	15	1 25
King of the Reds , deep scarlet	15	1 25
Prince Albert , dark violet	15	1 25
Fine Mixed	10	1 00

Collections, 1 bulb each of the above 12 varieties, \$1.50; 2 collections, \$2.75; per 100 bulbs assorted 12 varieties, \$8.00.

SPRING SNOWFLAKES.

(LEUCOJUM VERNUM.)

These produce flowers like monster Snowdrops, having the delicate fragrance of the Violet. It is one of our earliest spring flowers, with white blossoms distinctly tipped green; handsome in outline and prized for bouquets. Very graceful in growth, they should be grown in quantities in the borders or in clumps on the edges of shrubbery, where they are beautifully effective, and when established produce enormous quantities of flowers. They can also be slowly forced into pots for winter bloom. 3 for 10c.; 30c. per doz.; \$2.00 per 100.

GERMAN IRIS.

(IRIS GERMANICA.)

This variety is the true "Fleur-de-Lis," the national Flower of France. They are perfectly hardy, thrive anywhere, grow and bloom luxuriantly, particularly if plentifully supplied with water.

Mixed Varieties. Each, 10 cts.; per doz., \$1.00.

English (Anglica). Large handsome flowers, with rich purple, blue and lilac colors predominating. Perfectly hardy.

Mixed varieties. 3 for 10 cts.; 25 cts. per doz.; \$1.50 per 100. By mail, \$1.75 per 100.

Spanish (Hispanica). This variety is well adapted for pot culture blooming in the winter, earlier than the English, but smaller; beautiful shades of violet, yellow, blue and white. Mixed varieties, two for 5c. 20c. per doz.; \$1.00 per 100. By mail, \$1.15 per 100.

JAPAN IRIS.

(IRIS KÆMPFERI.) Due early in October.

The magnificence of these new Irises surpasses description. The flowers are of enormous size, averaging from 8 to 10 inches across, and of indescribable and charming hues and colors, varying like watered silk in the sunlight, the prevailing colors being white, crimson, rose, lilac, lavender, violet and blue; each flower usually representing several shades, while a golden-yellow blotch, surrounded by a halo of blue or violet at the base of the petals, intensifies the wealth of coloring. The Japan Iris is perfectly hardy, and flowers in great profusion in July and August, and attains greatest perfection if grown in moist soil, or if plentifully supplied with water while growing and flowering. (See cut.)

Kæmpferi, or Japan Iris, mixed, single varieties, each, 15c.; per doz., \$1.50.

" " mixed, double varieties, each, 20c.; per doz., \$2.00.

The Bermuda "Buttercup" Oxalis.

AN UNRIVALED WINTER-FLOWERING POT PLANT OF THE EASIEST CULTURE, SUCCEEDING WITH EVERYBODY.

This is one of the finest flowering plants for pot culture that we have ever seen; it is such a strong, luxuriant grower that one bulb will be sufficient for a 6 or 8 inch pot. Place in a dark, cool position for several days to root thoroughly, and remove to a sunny situation in the window or conservatory in a temperature of about 60° Fahr., and the great profusion

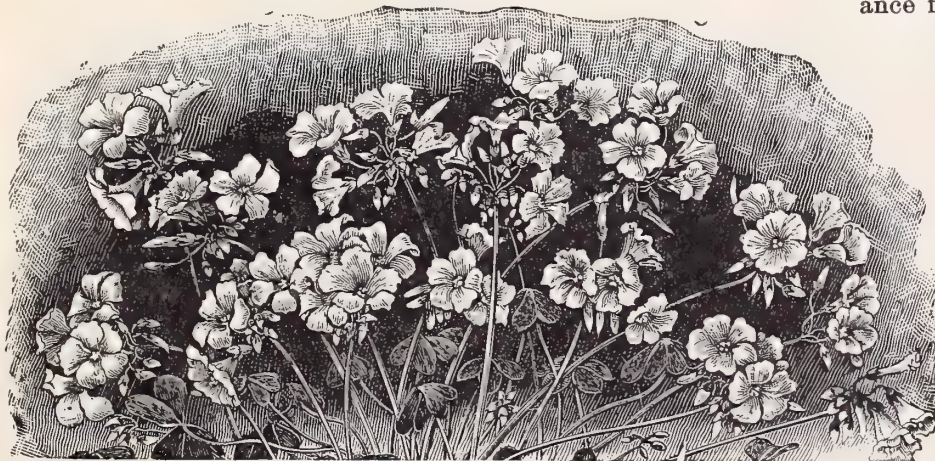

Bermuda "Buttercup" Oxalis.



Iris Kæmpferi.

of bloom produced in uninterrupted abundance for weeks will astonish and delight you. The flowers are of the purest bright buttercup-yellow. Well-grown plants have produced as high as seventy flower stems at one time, and over 1,000 flowers in one season. Properly treated, the plant will flower in six weeks from the time the bulbs are planted. (See cut.) Ea., 3c.; 30c. doz.

OXALIS.

Very desirable and charming plants, particularly adapted for pot culture in the greenhouse or window garden. Plant the bulbs in September or October and keep in a moderate temperature. They are of the easiest culture and will bloom profusely during the winter months.

Alba, white. Each, 3c.; per doz., 25c.; per 100, \$1.75.
Bowiei, crimson. Each, 3c.; per doz., 25c.; per 100, \$1.75.
Lutea, yellow. Each, 3c.; per doz., 25c.; per 100, \$1.75.
Lutea, fl. pl., double yellow. Each, 3c.; per doz., 25c.; per 100, \$1.75.

Rosea, rose. Each, 3c.; per doz., 25c.; per 100, \$1.75.
Versicolor, crimson and white. Each, 3c.; per doz., 25c.; per 100, \$1.75.
Mixed. Each, 3c.; per doz., 25c.; per 100, \$1.00.



Spiraea Astilboides.

Double Chinese Paeonies

A well-known garden favorite of easy culture, bearing flowers of great size and in magnificent rich colors, combined with handsome and massive foliage. If ordered by mail, add 5 cents each for postage.

	Each	Per doz.
Double White	\$0 25	\$2 50
“ Rose	25	2 50
“ Crimson	25	2 50
“ Mixed	25	2 50
Aborea (Tree Pæony), mixed colors	1 00	10 00

SCILLAS.

Most charming and desirable spring flowering bulbs. The flowers resemble the Hyacinth, but are much smaller; their colors are more intense, and they come into flower much earlier. As an edging, or for filling small beds, if planted sufficiently thick, the effect is matchless. Treat in the same manner as Hyacinths for outdoor culture, or for pots in the window garden.

	Per doz.	Per 100
Sibirica, dark blue	\$0 25	\$1 50
“ mammoth bulbs	40	2 00
Campanulata, white	25	1 50
“ rose	25	1 50
“ blue	20	1 25

SPIRÆA.

WASHINGTON and GLADSTONE. Two new Spiræas of recent introduction. The trusses are as white as snow, and supported on good strong stalks 1½ feet long, and standing well erect, and emitting an agreeable odor. Plants often produce from 30 to 40 of these trusses. 35 cts. each; \$3.50 per doz.

S. JAPONICA	15 cts. each;	\$1 50 per doz.
S. ASTILBOIDES FLORIBUNDA	20 “	2 00 “
S. NANA COMPACTA MULTIFLORA	25 “	2 50 “

STERNBERGIA.

One of the most charming and useful of autumnal flowering bulbs. The flowers, which are produced from September to November, are much like a Crocus, but larger, and the petals more fleshy and of such firm texture that they withstand any amount of bad weather, brightening up our garden long after other flowers are gone. They are not only very hardy, but increase rapidly.

S. Lutea. Large, pure yellow. Crocus-like flowers, which are produced with the leaves during late autumn. This is supposed by some writers to be the true Lily of Scriptures, as it grows abundantly in the vales around Palestine, etc. 3 for 10 cts.; 30 cts. per doz.; \$2.00 per 100.

SNOWDROPS.

These elegant little flowers, the first to open in spring, should be found in every garden, not only because they are the earliest spring flowers, but because they are the loveliest. The Snowdrop thrives in almost any situation or soil, and should be planted as early in the autumn as possible, as they suffer much if left long out of the ground.

	Per doz.	Per 100
Single Snowdrops	\$0 15	\$0 75
Double	25	1 50
Elwesii, Giant Snowdrops	25	1 00



RANUNCULUS.

Very charming, dwarf-flowering bulbs, of various bright and attractive colors. Plant late in the autumn, about three inches deep and protect by straw or leaves.

	Each	Per doz.	Per 100
French Mixed	\$0 05	\$0 20	\$1 00
Persian Mixed	05	20	1 00
Turban Mixed, hardiest sort	05	20	1 00

TRILLIUM.

Grandiflorum (Great American Wood Lily). This is one of the most beautiful American plants, perfectly hardy, growing and flowering profusely in partially shady nooks about the lawn, under trees, etc. The flowers are large, of the finest white, changing in a few days to soft rose; if grown several in a pot, it makes one of the best white winter flowers. 5 cts. each; 50 cts. per doz.; \$3.00 a hundred.

TRITONIA.

Exceedingly bright and free blooming bulbous plants, highly valuable for both garden and pot culture. A dozen roots in a 10-inch pot will, in the autumn, make a beautiful display. The bulbs should be grown in pots, in a cold frame, during winter, and they can either be brought into the conservatory toward spring for blooming or the bulbs can be kept dormant and planted out in May, like Gladioli, and then be lifted in the autumn for winter blooming.

Mixed Colors 3 for 10 cts.; 30 cts. per doz.; \$2.00 per 100.

TROPAEOLUM.

Beautiful and graceful climbing plants for the conservatory or window garden, producing in the early spring months richly colored flowers. They can be grown in pots and trained over low trellises—or as a bracket plant in the window.

Jarrattii. Scarlet, yellow and black, 15 cts. each; \$1.50 per doz.



Ranunculus.

VALLOTA.

Purpurea (Scarborough Lily). A valuable free summer and autumn bloomer; color, rich red. It does well planted in the open ground in May, and when in bud can be potted and removed for conservatory or window decoration, or it can be grown continuously in pots or tubs, as it improves with age. Requires repotting but seldom, and can be left to grow, blossom and increase for several years, as well-established plants when in flower are simply magnificent. We know of no plant that will give more continued delight than this. It is one of the few really good window plants. 30 cts. each; \$3.00 per doz.

ORNITHOGALUM ARABICUM.

(**Star of Bethlehem.**)

Very desirable for pot culture in the window garden. The flowers are large, pure white, with a black center, borne on a tall spike. In pots they should be treated in the same manner as the Hyacinth. At 100 rate buyer pays transit. Each, 10 cts.; per doz., 40 cts.; per 100, \$2.50.

S. & W. Co.'s Special Collection of Bulbs

For winter flowers in the conservatory or window garden.

Collection A.

12 Hyacinths, named varieties; 12 Hyacinths, Roman, 3 colors; 12 Tulips, single mixed; 12 Narcissus, mixed; 2 Chinese Sacred Lilies; 6 Jonquil Campernelles; 6 Allium Neapolitanum; 1 Calla Lily Bulb; 2 Cyclamen Bulbs; 12 Freesia Bulbs; 6 Oxalis Bulbs; 2 Easter Lilies; 15 Crocus, mixed.

The above collection, 100 bulbs, delivered free, for \$3.50.

Collection B.

For planting in the open ground for spring flowering.

12 Hyacinths, mixed; 20 Tulips, mixed; 12 Narcissus, mixed; 25 Crocus, mixed; 25 Snowdrops, single and double; 12 Scilla Sibirica.

This collection, 106 bulbs, delivered free, for \$1.50.



Vallota Purpurea.



Ampelopsis Veitchii

Sometimes called "BOSTON IVY" and
"JAPAN IVY."

This is the most deservedly popular of all climbing plants, being entirely hardy in the most exposed places, attaining a height of 30 feet in two or three years, clinging to stones, brick or woodwork with the greatest tenacity.

Prices:—First size, pot grown, 2 to 3 feet, 50 cts. each; \$5.00 per dozen. Second size, pot grown, 1 to 2 feet, 30 cts. each; \$3.00 per dozen. Third size, pot grown, 6 to 9 inches, 15 cts. each; \$1.50 per dozen.

A. Quinquifolia. The old Virginia Creeper. Invaluable where a coarse, rapid climber is desired. Large plants, 50 cts. each.

Apios Tuberosa. A valuable, hardy, tuberous-rooted climber, closely resembling the common Wistaria in vine and foliage, and having clusters of rich, deep purple flowers, which have a strong, delicious violet fragrance. 15 cts. each; \$1.50 per doz.

Aristolochia Sipho (Dutchman's Pipe). Large, showy, light green foliage, flowers long and pipe-shaped, hence the name. 50 cts.

Bignonia Grandiflora. Scarlet Trumpet Vine. A most rapid grower, flowers in large bunches of a rich orange scarlet.

Clematis Jackmanni. The best known and most valued variety of this popular family. A most perfect mass of bloom when in full flower. Color, dark, rich, royal purple. Price, 60 cts. each; \$6.00 per doz.

Henryii. A pure white, large flowery variety, of fine form, and recognized as by far the finest of the single white sorts. Large strong plants, 60 cts. each; \$6.00 per doz.

Paniculata. One of the most beautiful of our hardy fall-blooming vines. The flowers are pure white, very fragrant, borne in large clusters fairly covering the plant, so that it is a mass of fleecy white; the fragrance is delicious.

Honeysuckles. Yellow, coral or scarlet, white, pink, evergreen and golden leaved, fine plants.

Lonicera Belgica. The grandest of all Honeysuckles, and always scarce. Everblooming and very fragrant. Flowers bright red, with yellow and buff markings at the end of the tubes. 50 cts.

Wistaria Sinensis (White). Flowers borne in long, drooping clusters, as in the blue variety; pure white in color, making a most striking and elegant contrast. Plants average from 3 to 5 feet in length. 75 cts. and \$1.50 each, according to size. Smaller plants 30 cts. each.

Wistaria Sinensis (Blue). Flowers in drooping clusters, like a bunch of grapes; color, soft lavender blue; fragrant.

All of the above Hardy Climbing Plants at 25 cts. each; \$2.50 per dozen, except where noted.

Hardy Flowering Shrubs

Amygdalus (Flowering Almond). Red and white, 50 cts.

Azalea Amoena. Small double reddish purple flower. 75 cts. each.

Althea, Double White. Beautiful shrub, double flowers.

Althea, Double Red. Similar to above, except in color, which is red.

Calycanthus Floridus. Strawberry-scented shrub.

Deutzia Crenata. Pure white, tinged rose color.

Deutzia Gracilis. Pure white throughout, low compact habit.

Forsythia Viridissima. Yellow flowers, blooms very early.

Hydrangea Paniculata Grandiflora. Price, 15 cts., 25 cts., 50 cts., or \$1.00 each.

Japan Snowball (*Viburnum Plicatum*). Price, 50 cts. each; \$4.50 per dozen.

Philadelphus Coronarius. The popular Syringa or Mock Orange.

Lilac. The well-known purple flowering variety.

MAGNOLIAS (Hardy Varieties). **Conspicua**, pure white; **Lennel**, pink, with purple base; **Soulangeana**, creamy white and purple; **Speciosa**, silvery white; **Purpurea**, purple; **Tripetala** (Umbrella Magnolia). All extra large trees, 4 to 5 feet high, at \$3.00 each.

Rhododendron, Grafted. Named sorts, \$1.50 each; \$15.00 per dozen. Extra size, \$2.00 each; \$20.00 per dozen.

Spiræa Thunbergii. Flowers white, foliage graceful as fern.

Viburnum Opulus (Snowball). Large drooping white flowers.

Weigelia Candida. Pure white flowers, blooms in fall.

Weigelia Rosea. Rich rose colored flowers.

Weigelia Variegated. Rose color, foliage marked white.

Yucca (Adam's Needle). 40 cts. each; \$4.00 per dozen.

" " " 60 cts. each; \$6.00 per dozen.

All the shrubs on this page we can supply at 30 cts. each; \$3.00 per dozen, except where noted.



Hardy Hybrid Perpetual Roses.



These are especially grown for us by one of the leading rosarians of England, where roses develop firm wood and fibrous roots. They are much better adapted to our severe and changeable climate than the soft-wooded plants grown on the meadows of Holland, so generally sold here, and which so frequently cause disappointment. Roses should be planted with the diverging roots at least nine inches below the surface of the ground, the soil made firm about them and liberally watered.

Our collection comprises the most select sorts of all colors and of the finest forms.

Strong Dormant Plants, each 30c.; doz., \$3 00. **Extra Strong Plants**, each, 50c.; doz., \$4.00; per 100, \$25.00.

Alfred Colomb. Brilliant carmine-crimson; large.

Anna de Diesbach. Clear, bright rose.

Baroness Rothschild. Pale flesh pink; very fine.

Captain Christy. Delicate rose; center deeper.

Fisher Holmes. Rich velvety crimson.

General Jacqueminot. Brilliant scarlet-crimson.

John Hopper. Brilliant rosy crimson.

Jules Margottin. Bright cherry.

Ulrich Brunner. Cherry crimson.

Victor Verdier. Deep rose; center bright rose.

La France. Bright lilac-rose; center silvery white.

Louis Van Houtte. Deep red, shaded with maroon crimson.

Mabel Morrison. White, faintly flushed with pink.

Madame Gabriel Luizet. Fine satiny rose.

Magna Charta. Bright pink, suffused with carmine.

Margaret Dickson. White, pale flesh center.

Mrs. John Laing. Soft pink; superb flowers.

Paul Neyron. Deep rose, very large.

Prince Camille de Rohan. Very dark velvety crimson.

HARDY MOSS ROSES.

For Spring Delivery. Each, 50 cents.

Baronne de Wassenair. Fine deep rose.

Blanche Moreau. Large white.

Crested. Deep rose-pink.

AUSTRIAN ROSES.

For Spring Delivery. Each, 50 Cents.

Harrisonii. Harrison's double yellow.

Persian Yellow. Very deep and full.

RUGOSA ROSES.

Each, 50 cents.

This is a very interesting and beautiful group of Japanese origin. The plant is highly ornamental on account of its fine habit and beautiful, glossy foliage; the flower buds, both of the single and double varieties, are long and charmingly beautiful. All the varieties are particularly desirable.

Rugosa Alba. Large, single, pure white flowers, of five petals highly scented. A splendid shrub.

Rugosa Rubra. Single, beautiful rosy crimson; very free and highly ornamental.

HARDY CLIMBING ROSES.

Crimson Rambler. This is unquestionably the finest hardy climbing rose in cultivation. It is a rampant grower, perfectly hardy, and in profusion and brilliancy of flower unapproached by any other climbing rose. The blossoms are borne in immense clusters, often 150 in a cluster; they are of a brilliant crimson color and produce a most gorgeous display. **Extra large grafted plants, for forcing in pots for Easter Decoration, \$1.00 each; \$10.00 per doz.**

Yellow Rambler, Aglaia. A climbing rose of the style of the Crimson Rambler, but with double flowers, which are yellow in the bud, but almost pure white when full open.

Baltimore Belle. White; large; double.

Dawson. Flowers deep pink; in large clusters; fragrant.

Gem of the Prairies. Crimson; fragrant.

Multiflora, or Seven Sisters. White; free.

Queen of the Prairies. Bright red; globular.

White Rambler. **Pink Rambler.**

Flowering Plants, each 25c.; per doz., \$2.00.

First Size " " 50c.; " 4 00.

Extra Large, " " 75c.; " 6.00.

TRAILING ROSES.

Wichuraiana. Low trailing Japanese species, with stems creeping on the ground like Ivy. Very valuable as a covering for banks, etc. Leaves small and shining; flowers white; price, 20c. to 40c. each.

NEW HYBRID WICHURAIANA ROSES.

The under noted are beautiful additions to this class of low trailing roses, for banks, rockeries, etc.

Manda's Triumph Double pure white, free and constant bloomer. **Universal Favorite.** Double; beautiful pink.

South Orange Perfection. Double; a perfect gem, petals white, edged with rose.

Price, 25c. each; per doz., \$2.50.

Large plants, 50c. each; \$5.00 per doz.

WINTER-FLOWERING PLANTS.

PYRETHRUM.

Too much cannot be said in favor of this grand hardy perennial. The flowers are large, double, white and red, and measure 2 inches in diameter. Their main season for blooming is June, but if the old flower stems are removed they will flower during the entire summer.

Double red, price, 30c. each; \$3.00 per doz.
 " white, " 30c. " \$3.00 "



Double Pyrethrum.

VIOLET MARIE LOUISE. The well-known winter-flowering, double purple variety. We offer strong, healthy plants, so that any amateur should easily grow them. 15c. each; \$1.50 per doz.; \$10.00 per 100.

HARDY ENGLISH VIOLET. Entirely hardy, double, a deep violet color and most deliciously fragrant. It is for spring blooming only. Price, first size, 30c. each; \$3.00 per doz.; \$18.00 per 100; 2d size, 15c. each; \$1.50 per doz.; \$10.00 per 100.

CHINESE PRIMROSE. For winter flowers there is no more desirable plant than the Chinese Primrose. They are easily grown and flower incessantly throughout the winter. Our plants comprise all the shades of crimson, pink, white and variegated. 1st size, 25c. each; \$2.25 per doz.; 2d size, 15c. each; \$1.50 per doz.

"BABY" PRIMROSE. (*Primula Forbesii*.) The sprays of rosy lilac flowers are very graceful and exceedingly useful for cut flowers. Price, 25c. each; \$2.25 per doz.

PRIMULA OBCONICA. A favorite pot plant for house and conservatory culture on account of its wonderful blooming qualities. Price, 25c. each; \$2.25 per doz.

WINTER-FLOWERING CARNATIONS.

FINE, HEALTHY, FIELD-GROWN PLANTS, SPECIALLY SELECTED FOR WINTER FORCING.

MRS. THOMAS W. LAWSON. The flowers are the largest, deepest, best formed. The stems are the longest and strongest. The color, purest rose-pink, which illuminates splendidly under artificial light.

GOVERNOR ROOSEVELT. A large, full flower, symmetrical to a degree, strong, stiff stems and perfect calyx. Color, deep rich, brilliant scarlet, shaded with maroon so as to give a general crimson-scarlet effect.

GENEVIEVE LORD. A bright, clear, exquisite shade of soft pink. This is by all standards the best of the new pink varieties, large blooms, healthy grower.

GEN'L GOMEZ. Brilliant cardinal maroon. $2\frac{1}{2}$ in. to $2\frac{3}{4}$ in. in diameter, fine stems, 16 in. to 24 in. long. Strong, vigorous; very healthy habit. The color is magnificent, and as rich and brilliant as the cardinal flower, without the slightest tendency to turn back.

OLYMPIA. The largest monthly carnation yet produced; well-grown flowers, measuring $3\frac{3}{4}$ inches across. The color is clear glossy white, with delicate pencillings of bright scarlet running through the petals.

MRS. GEO. M. BRADT. The most beautiful and striking of the fancy varieties, of largest size and most perfect form, with full high center. Color pure white, striped and beautifully penciled on the edges with bright scarlet.

WHITE CLOUD. White, habit same as Daybreak, but taller, stronger, more vigorous, and an earlier and much freer bloomer. It commences blooming among the earliest, and throws a fine, long, stiff stem from the beginning, and continues its crop through the season.

G. H. CRANE. The best scarlet Carnation, wonderfully productive. Tested four years, it stands pre-eminent. An early, continuous, all-season bloomer, averaging 3-inch blooms; a well-formed flower and calyx, and 16 to 18-inch stems, stiff and erect throughout the whole season. Color, a clear, brilliant scarlet.

WM. SCOTT. Delicate light pink, with finely fringed petals; flowers of large size on long stems, that hold the flower erect. A splendid keeper, lasting a long time when cut.

LIZZIE MCGOWAN. A grand white variety. Very large; often measuring $2\frac{1}{2}$ to 3 inches in diameter. The calyx never bursts, and the flowers, which are very fragrant, keep fresh a remarkable length of time after being cut.

LILY DEAN. Large, pure white, penciled cerise pink.

Prices for any of the above-named field-grown Carnations, 20c. each; \$2.00 per dozen.

CINERARIA—JAMES' GIANT STRAIN.

Magnificent and indispensable flowering plants for spring decoration for the conservatory or window garden. The flowers, measuring 2 to 3 inches across, are of white, blue, violet and crimson shades, covering the plant with a sheet of bloom. Plants ready in October, 10c. each; \$1.00 per doz.

BEGONIA GLOIRE DE LORRAINE.

Soft Rosy Pink of a Fine Form.

Plants, 3 in. pots, 25c. each; \$2.50 per doz.
 " 4 " 50c. " \$5.00 "

Winter Rye

Winter. The variety most commonly cultivated. Per bushel, \$1.20; per 10 bushel lots, \$1.10 per bushel.

Mammoth White Winter. Noted wherever tried for its productiveness both in grain and straw, the excellent quality of bread made from the flour, and its ability to yield heavy crops with but little or no manure. Per bushel, \$1.75; per 10 bushel lots, \$1.60 per bushel.

Winter Wheat

Gold Coin (Bald). A very productive variety. The grain is white, the head long and well filled, frequently having five kernels abreast. The straw is strong and stiff, and will not lodge on the richest land. Per peck, 60c.; per bushel, \$2.00; per 10 bushels, \$1.75 per bushel.

Jones' Winter Fife Wheat (Bald). The longest-headed wheat, and one of the hardiest winter wheats known, well adapted for all soils, grows to a medium height, matures medium early, and should be left until fully ripe. Peck, 50c.; per bushel, \$1.60; per 10 bushels, \$1.50 per bushel.

Winter Vetches or Tares (*Vicia villosa*). Also called sand or hairy vetch. Sow from one-half to one bushel to the acre, together with one-half bushel of Rye. Per lb., 15c.; per bushel (60 lbs.), \$7.50.

Dwarf Essex Rape. The true Dwarf Essex Rape is valuable as a fattening food for pasturing sheep in autumn. It is particularly adapted as a "catch crop," for it grows best late in the season. In the Northern States it can be sown at any time from May until the end of August, but in the Southern States it should not be sown until September or October for winter pasture. Its fattening properties are said to be twice as good as clover. Sow ten to twelve pounds to the acre broadcast, or four to five per acre in drills fifteen inches apart. Per lb., 10c.; 10 lbs., 75c.; 100 lbs., \$7.00.

Crimson or Scarlet Clover. It can be seeded at any time from June to October, at the rate of 15 to 20 lbs. per acre, and makes the earliest possible spring pasture, blooming the latter part of April or May, and for feeding as hay should be cut just before coming into full bloom. If sown with Italian Rye Grass or Orchard Grass, which matures at the same time, it yields luxuriant and nutritious crops for pasture. Sow Crimson Clover at the last working of all crops like Beans, Corn, Melons, Cucumbers, Tomatoes, and other crops. Per lb., 12c.; per 100 lbs. \$8.00.

STUMPP & WALTER CO.'S

Grass Seed M I X T U R E S

FOR HAY and PERMANENT PASTURE

For every different kind and condition of soil there are a large number of grasses, either indigenous or introduced, which are especially suitable. Some sorts do best on high ground and in dry weather; others prefer plenty of moisture. Some mature so early and others so late that from the beginning of spring until winter sets in there is no time when one species or another is not at its best. From these considerations the importance of sowing many varieties for pasture and meadow purposes will be apparent, consisting of the following varieties: Orchard Grass, Meadow Foxtail, Sheep's Fescue, Rhode Island or Creeping Bent, Hard Fescue, Sweet-Scented Vernal (True Perennial), Meadow Fescue, English Rye Grass, Italian Rye Grass, Red Top, Timothy and Red Alsike Clover, blended in proportions which, we have found from actual use, give the most satisfactory results.

On ordinarily fertile soil three bushels of this mixture are sufficient to seed an acre, but where the land is poor a larger quantity will be necessary. Taking one soil with another, a fair average would be three bushels to the acre.

For Hay and Permanent Pasture for Light Soils,	}	\$2.50 per bushel of 14 lbs.
" " " " " Medium Soils,		20 bushel lots, \$2.45 per bushel
" " " " " Heavy Soils,		50 " 2.40 "
" Orchard and Shady Places.		100 " 2.35 "
" Hay only. Specially recommended for large hay crop.		
" Pasture only. Will stand close cropping without injury.		

GENERAL LIST OF GRASSES AND CLOVERS.

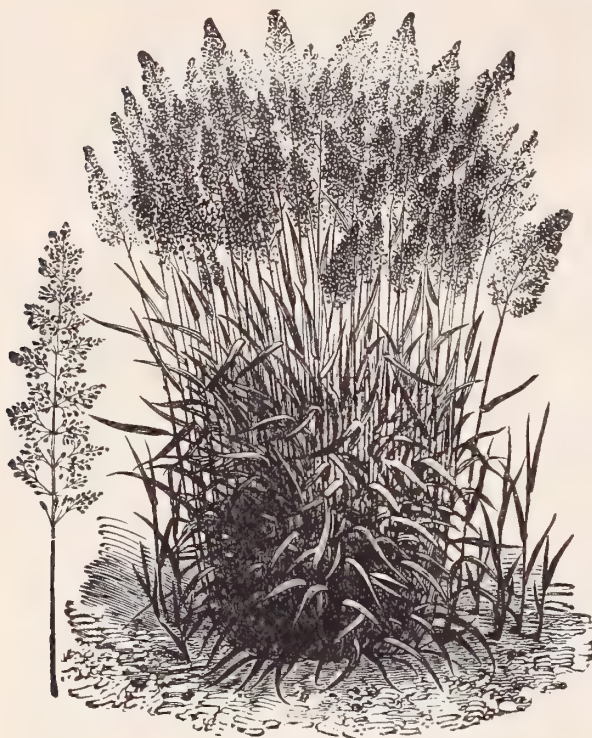

Red Top.

- Red Top.** Choice seed. Per bush. (14 lbs.) \$2.00; lb. 20c., postpaid.
- Fancy Red Top.** Clean seed, free from chaff. Per bush. (32 lbs.) \$5.00; lb. 25c., postpaid.
- Kentucky Blue Grass** (*Poa Pratensis*). Well-known and extensively grown in all parts of the country. Per bush. (14 lbs.) \$2.25; lb. 25c., postpaid.
- ORCHARD GRASS.** A valuable pasture grass, relished by stock of all kinds; particularly adapted for growing in shady places. Per bush. (14 lbs.) \$2.75; lb. 30c., postpaid.
- TIMOTHY.** A variety well-known and highly appreciated, producing a profitable hay crop in almost any soil; $\frac{3}{4}$ bush. per acre. Per bush. (45 lbs.) about \$2.85; lb. 15c., postpaid.
- Meadow Foxtail** (*Alopecurus Pratensis*). One of the earliest and best pasture grasses; grows rapidly when cut or eaten down by stock. Per bush. (7 lbs.) \$2.50; lb. 40c., postpaid.
- Sweet Vernal Grass** (*Anthoxanthum Odoratum*). Prized more for its early growth than nutritive value. It should be sown in connection with other grasses. Per lb. 85c., postpaid.
- TALL OAT GRASS** (*Avena Elatior*). Producing an early and luxuriant growth; this is a valuable variety for pastures. Per bush. (10 lbs.) \$2.75; lb. 40c., postpaid.
- Johnson Grass.** Per bush. (25 lbs.) \$4.00; lb. 30c., postpaid.
- Rhode Island Bent** (*Agrostis var.*). Excellent for lawns or pastures. Per bush. (14 lbs.) \$5.25; lb. 50c., postpaid.
- CRESTED DOGSTAIL.** An excellent grass for hard, dry soils; valuable for pastures and lawns. Per lb. 50c., postpaid.

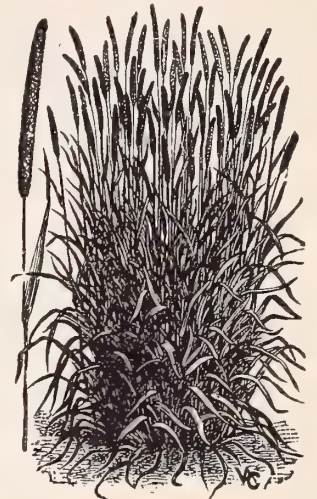

Timothy.

- HARD FESCUE** (*Festuca Duriuscula*). One of the most desirable dwarf grasses; excellent for dry soils. Per bush. \$2.50; lb. 25c., postpaid.
- MEADOW FESCUE** (*Festuca Pratensis*). A valuable grass for permanent pastures; very productive and nutritious. Per lb. 35c., postpaid.
- SHEEP FESCUE** (*Festuca Ovina*). An excellent grass for sheep pastures. Per lb. 35c., postpaid.
- English Rye Grass** (*Lolium Perenne*). A very nutritious, rapid-growing variety, valuable for meadows and pastures. Per bush. (24 lbs.) \$2.50; lb. 25c., postpaid.
- Italian Rye Grass** (*Lolium Italicum*). A valuable European variety, adapted to any climate, and produces large and nutritive crops. Per bush. (18 lbs.) \$2.50; lb. 25c., postpaid.
- Rough Stalked Meadow Grass** (*Poa Trivialis*). Produces an abundant crop of highly nutritious herbage; valuable for either moist or dry soils. Per lb. 50c., postpaid.
- Wood Meadow Grass** (*Poa Nemoralis*). A very productive and nutritive grass, adapted for lawns or pastures. Thrives well under trees. Per lb. 50c., postpaid.
- HUNGARIAN GRASS** (*Panicum Germanicum*). This is a species of millet, growing less rank, with smaller stalks, often yielding two or three tons of hay per acre; 1 bushel per acre. Per bush. (48 lbs.) \$2.00; lb. 25c., postpaid.

CLOVER SEEDS.

	Weight per bush. lbs.	Per bush.	Per lb.	Per 100 lbs.
Red Clover, Medium (<i>Trifolium Pratense</i>). Common or medium clover. The leading varieties of clover for pastures or meadows	60	\$10 20	\$0 20	\$17 00
White Dutch Clover (<i>Trifolium Repens</i>). The best variety for lawns, as it forms a close herbage and remains green throughout the season. It is also valuable when mixed with grass seeds for pasture	60	18 00	35	30 00
Alfalfa, or Lucerne (<i>Medicago Sativa</i>). One of the best varieties, succeeding especially in the South and West, and bearing heavy crops of forage. For bringing up poor land it is one of the best of the clovers. Sow early in the spring to secure a good stand before winter. 20 lbs. to the acre	60	12 00	25	18 00
Alsike, or Swedish (<i>Trifolium Hybridum</i>). Hardest of all clovers, and on rich, moist soils, yields an enormous quantity of hay or pasturage. Lasts many years. Valuable for sowing with other clovers or grasses, as it forms a thick bottom and increases the yield of hay. Sow 6 lbs. per acre when used alone	60	11 50	25	17 00
Crimson or Scarlet Clover. It can be seeded at any time from June to October, at the rate of 15 to 20 lbs. per acre, and makes the earliest possible spring pasture, blooming the latter part of April or May, and for feeding as hay should be cut just before coming into full bloom. If sown with Italian Rye Grass or Orchard Grass which matures at the same time, it yields luxuriant and nutritious crops for pasture. Sow Crimson Clover at the last working of all the crops like Beans, Corn, Melons, Cucumbers, Tomatoes, and other crops	60	4 50	10	7 00

Vegetable Seeds for Fall Sowing and Forcing.



Cucumber.



Cauliflower.

BEET.

	Pkt.	Oz.	¼lb.	Lb.
Eclipse.....	5	10	20	60
Edmand's.....	5	10	20	60
Crosby's Egyptian.....	5	10	20	50

BRUSSELS SPROUTS.

Dalkeith.....	10	30	1 00	
Dwarf Improved.....	10	25	80	3 00
Tall French.....	5	20	70	2 50

CABBAGE.

Early Jersey Wakefield.....	5	30	1 00	3 00
Early Summer.....	5	25	80	3 00
Early Winningstadt.....	5	20	60	2 00
Large Early York.....	5	20	60	2 00
Succession.....	10	40	1 25	3 50

CABBAGE, Late or Winter.

Autumn King.....	10	40	1 25	3 50
Premium Flat Dutch.....	5	20	60	1 75
Selected Flat Dutch.....	10	20	70	2 50

CABBAGE, Savoy.

American Drumhead.....	10	25	75	2 50
Netted Savoy.....	5	25	75	2 50

CARROT.

Carentan Early Half Long Scarlet.....	5	10	30	90
Chantenay.....	5	10	30	90
Danvers.....	5	10	30	90
French Forcing.....	5	15	40	1 25
Early Half Long, Scarlet, pointed.....	5	10	30	90

CAULIFLOWER.

Extra Early Dwarf Erfurt.....	15	3 00	10 00	
Snowball.....	25	4 00	14 00	48 00
S. & W., best of all.....	50			

CORN SALAD.

Large Leaved.....	5	10	25	80
-------------------	---	----	----	----

CUCUMBER.

White Spine Improved Early.....	10	20	75	2 00
---------------------------------	----	----	----	------

English Frame Varieties.

Telegraph, Lord Kenyon's Favorite, Duke of Edinburgh, Cuthill's Black Spine, 25 cts. pkt. each.

EGG PLANT.

	Pkt.	Oz.	¼lb.	Lb.
Black Pekir.....	10	50	1 50	
New York Improved Spineless.....	10	50	1 50	

LETTUCE, Head Varieties.

Big Boston.....	10	25	70	2 00
Black Seeded Butter.....	5	15	40	1 25
Boston Market.....	5	15	40	1 25
Hanson.....	5	15	40	1 25
Hardy Green Winter.....	5	15	40	1 25
Tennis Ball.....	5	15	40	1 25
Yellow Seeded Butter.....	5	15	40	1 25

LETTUCE, Curled or Loose-Leaved Varieties.

Boston Curled.....	5	15	40	1 25
Simpson, Early Curled.....	5	15	40	1 25
" Black Seeded.....	5	15	46	1 25

ONION.

Wethersfield Large Red.....	5	15	40	1 50
White Portugal, or Silver Skin.....	5	25	80	2 50
Southp't White Globe.....	10	25	80	2 50
" Yellow.....	10	20	40	1 20
" Red.....	5	15	40	1 20
Yellow Globe Danvers.....	5	15	40	1 10

PARSLEY.

Champion Moss Curled.....	5	10	30	1 00
Extra Double Curled.....	5	10	30	90

MUSK MELON.

English Frame Varieties.

	Per Pkt.
Sutton's Invincible Scarlet Flesh.....	25 cts.
Blenheim Orange.....	25 cts.
Eastnor Castle Green Flesh.....	25 cts.
Sutton's Perfection Pale Green Flesh.....	25 cts.

RADISH, Round Varieties.

	Pkt.	Oz.	¼lb.	Lb.
Early Scarlet Turnip.....	5	10	20	60
Early Scarlet Turnip, White Tipped.....	5	10	20	65
Early Round Dark Red.....	5	10	20	65
Rapid Forcing.....	5	15	40	1 00

RADISH, Olive-Shaped.

French Breakfast.....	5	10	25	80
Olive-shaped Scarlet.....	5	10	25	80
" White.....	5	10	20	65

RADISH, Long Varieties.

Brightest Scarlet (Cardinal).....	10	15	30	80
Chartier (Beckert's).....	5	10	25	75
Giant White Stuttgart.....	5	10	25	80
White Strasburg.....	5	10	25	80
Wood's Early Frame.....	5	10	20	65

SPINACH.

Round Leaved.....	5	10	15	35
Savoy Leaved Norfolk (Bloomsdale).....	5	10	15	35

TOMATO.

Beauty.....	5	20	70	2 50
Dwarf Champion.....	5	25	75	2 50
Early Ruby.....	10	30	80	2 50
Essex Hybrid.....	5	20	60	2 00
Lorillard.....	5	20	60	2 00
Perfection.....	5	20	70	2 50
Ponderosa.....	10	60	2 00	
Trophy, extra selected.....	10	30	1 00	3 00
Yellow Plum.....	5	20	70	2 50

TURNIP.

Early White Milan.....	10	20	60	2 00
Aberdeen, Yellow, Purple Top.....	5	10	20	60
Early Flat Dutch.....	5	10	20	55
Extra Early Milan, Purple Top.....	10	20	50	1 50
Golden Ball.....	5	10	25	75
Long White Cowhorn.....	5	10	20	60
Purple Top White Globe.....	5	10	20	60
Red Top Strap Leaf.....	5	10	20	55
Snowball.....	5	10	25	75
White Egg.....	5	10	20	60
White Strap Leaf.....	5	10	20	55
Yellow Globe.....	5	10	25	70
Yellow Stone.....	5	10	25	75

FLOWER SEEDS FOR FALL SOWING.



Pansy.

S. & W. CO.'S NON PLUS ULTRA.

Our Non Plus Ultra Pansy is a mixture containing the largest, handsomest, most perfect varieties ever sent out. The beautiful coloring and variety of marking give a bed of these pansies a most brilliant appearance. The seed having been saved from the greatest assortment of types, including only the best of Giant Cassiers, Bugnots, Trimardeaux, and Giant English, French and German strains. Per pkt. 15c.; 250 seeds, 25c.; 1000 seeds, 75c.

CINERARIA AND CALCEOLARIA.

JAMES' GIANT STRAIN.

These magnificent strains still maintain their position as the finest in the world. Price, per pkt., Calceolaria, 25c.; Cineraria, 25c.

ALLEN'S DEFIANCE MIGNONETTE.

This gorgeous Mignonette has qualities heretofore unknown in large flower varieties, being deliciously fragrant. When grown under favorable conditions and with proper care, its spikes will be from twelve to fifteen inches long; the individual florets are of remarkable size and stand out boldly, forming a graceful as well as compact spike. Its remarkable strength is accompanied by extraordinary keeping qualities; retaining their grace and fragrance until every bud opens. Price, per pkt., 10c.; per 1/4 oz., \$2.00



Mushroom Spawn.

CYCLAMEN PERSICUM GRANDIFLORUM.

This strain is grown for us by the most celebrated grower in England, is outdoor grown stock, and must not be confounded with low price strains, coming from south of France.

Finest Mixed, \$1.50 per 100 seeds; 25c. pkt.

SWEET PEA. Christmas Forcing.

The most desirable variety of Sweet Peas for forcing under glass for winter cut flowers. Its dwarf habit renders it much more easily grown on benches, and from seed sown the latter part of August, blooms can be cut by Christmas. The standards are bright, rich pink, while the wings are almost pure white.

Price, Christmas Forcing, pink, per pkt., 25c.; oz., 50c.

" " " pure white, " 25c.; " 50c.



Sweet Pea.

MUSHROOM SPAWN,

Ten lbs. will spawn 10 feet square.

Culture.—Mushrooms are easily grown, with little care and attention, under a square shed, portion of a cellar, or any dark, dry place. Collect a quantity of fresh horse droppings, throw them into a heap, leaving it until it commences to ferment, then turn it over and mix it up well, and place it where you intend to make the bed; spread it regularly about 18 inches thick, tread firmly and level the surface, then apply the soil about three inches in thickness all over the bed. Leave this to heat for a few days, and as soon as the heat drops to 90 degrees, make holes in the bed about a foot apart each way, into which put pieces of the spawn about the size of an egg; fill up the holes with the compost. Beat the surface level, afterward keep it dry, and the mushrooms will make their appearance in about five or six weeks. When the first crop has been taken give the bed a good watering, leaving it as before, when they will again make their appearance. Beds can be made at any time of the year, and as one declines another should be made, to keep a constant supply. The spawn should be kept in a cool, dry place. When gathering, remove the stalks; do not cut them or they will rot and breed maggots.

English Spawn. per lb., 12c.; 10 lbs., \$1.00; 100 lbs., \$8.00

French Spawn. per 2-lb. box, 75c.



BIRD SEED, BIRD FOOD, ETC.

Bird Seed and Prepared Bird Food.

Making a specialty of Bird Foods, etc., our facilities are unsurpassed for producing the best articles at the most reasonable prices.

	Per lb.	Per 3-lb. pkg.	Per 100 lbs.	Per lb.	Per 5 lbs.
Canary Seed, Spanish	\$0 10	\$0 25	\$6 00	Millet Seed, Imported Yellow	\$0 07
" Sicily	10	25	6 00	" White	20
Rape Seed, German Summer	10	25	6 50	Mow Seed, Blue	15
Hemp Seed, Imported	10	25	6 00	Lettuce Seed	30
Millet Seed, American	7	15	4 00	Sunflower Seed	10
				Unhulled Rice or Paddy	10

Song Restorer or Treat. An invigorating Tonic and Restorative for Canary Birds, Goldfinches, Linnets and all Seed Birds. This preparation will in every case, restore to their natural notes, birds who have lost their song from the effects of cold or excessive moulting. For breeding birds and their young it is invaluable, strengthening their voice and improving their plumage. Price, per bottle, 25 cts.; by mail, 30 cts.

Prepared Mocking Bird Food. (Gold Medal Brand.) For Mocking Birds, Thrushes, Black Birds, Robins, Nightingales, Skylarks and all soft bill birds, this preparation is the purest, healthiest and cheapest bird food known. Its ingredients approximating closely to the food of birds in their natural state, and its use in all cases causing a marked improvement in their song and appearance. Price, 1 lb. bottles, screw top, per bottle, 35 cts.; 1 lb. tin cans, 35 cts.; in bulk, price, 25 cts. per lb.; 5 lbs. for \$1.00.

Imported Mixed Bird Seed. In lb. boxes (full weight). 10 cts. each; dozen, \$1.00.

Washed Silver Gravel for Birds. Prices, qt. boxes, 60 cts. doz.; case of 3 doz., \$1.50.

Genuine German Bird Lime. For catching birds, flying insects, etc. Price, per bottle, 25 cts.

Genuine Prepared Fish Food. A perfectly pure article, specially prepared for feeding Gold Fish, etc., kept in aquaria or globes. Price, per box, 10 cts.; dozen boxes, \$1.00. By mail, postpaid.

Prepared Food for Parrots. For Parrots, Macaws, Paroquets, etc. This food is composed of a mixture of seeds, etc. Recommended by the most experienced bird fanciers. Price, per lb. box, 15c.; dozen, \$1.60.

Ant Eggs—a Treat or Relish. For Mocking Birds, Thrushes, Robins, etc. Price, per box, postpaid, 25 cts.

PIGEON SEEDS AND GRAINS.

	Quart.	Bush.		Quart.	Bush.
Barley	\$0 15	\$1 25	Hemp Seed	\$0 10	\$2 00
Buckwheat	15	1 40	Lentils	15	2 50
Canada Peas	15	1 50	Millet Seed	15	3 00
Canary Seed	15	2 50	Small Corn	15	2 50
English Vetches or Tares	15	3 00	Sunflower	15	2 00

SPECIAL PRICES ON LARGE LOTS GIVEN UPON APPLICATION.

HOLDEN'S BOOK ON BIRDS.

Illustrated, 120 pages, regarding food, care and treatment for Cage Birds. Price, 20 cents each by mail, postpaid.

FERTILIZERS.

Clay's Celebrated Fertilizer.

On account of the high reputation which this Fertilizer has in England, and as we have had many inquiries for it by gardeners here, we have imported some from Messrs. Clay & Son, which we offer at the following prices. It is undoubtedly one of the best manures for all horticultural purposes, either in greenhouse or garden, and we believe its high reputation is well deserved. It is productive and lasting, and notwithstanding its apparently high price it is quite economical. Prices in bags, 1 cwt. (112 lbs.), \$7; ½ cwt. (56 lbs.), \$4; ¼ cwt. (28 lbs.), \$2.25; ⅓ cwt. (14 lbs.), \$1.25.

Raw Bone Meal.

The best all around fertilizer for garden, lawn and farm.

Our Raw Bone Meal is made from Hard Bones, is evenly ground, and very white and pretty in appearance. For such as prefer a raw to a steamed Bone, we recommend our Raw Bone Meal—nothing finer can be made. 5 lbs., 25c.; 10 lbs., 40c.; 25 lbs., 70c.; 50 lbs., \$1.25; 100 lbs., \$2.00.

Sheep Manure.

Especially recommended for Roses and Flowering Plants. Sheep manure is one of the very best fertilizers we have used, either in liquid form or mixed with the soil at the time of planting. We have proof of the power of sheep manure as a fertilizer if we look at the crops of grain produced on land that has been pastured with sheep. Ground fine, per 2-lb. box., 15c.; 5 lbs., 25c.; 10 lbs., 40c.; 25 lbs., 75c.; 50 lbs., \$1.10; 100 lbs., \$2.00. Per ton, \$30.00.

Bowker's Ammoniated Food for Flowers.

Made especially for plants grown in the conservatory, house or garden; clean, free from offensive odor. Full directions with each package. Small size, 15c.; large size, 25c.; by mail, 25c. and 35c.

Emerald Lawn Dressing.

A clean, portable and convenient lawn dressing, which we have found to be never failing in inducing a rapid and rich green growth. It should be sown broadcast in the spring or fall, though it can be put on during the summer without injury or danger of burning the grass, and a remarkable improvement will soon be observed. It is in every way more desirable than manure, which is so often full of weed seeds. The use of "Emerald Lawn Dressing" entirely does away with the old process of top-dressing lawns with stable manure, which was so objectionable on account of unsightliness and disagreeable odors.

Quantity Required.—A 10-lb. package is sufficient to go over an area of 300 square feet, or for forming a new lawn, from 1,000 to 1,500 lbs. per acre, or a smaller quantity for renovating an old one. Price, 4-lb. pack, 15c.; 50-lb. bag, \$1.50; 100-lb. bag, \$2.50; per ton of 2,000 lbs., \$40.00.

Walker's Excelsior Brand.

For House Plants.

Price, per small packet, 15c. Large size, 25c.

Nitrate of Soda.

Should be sown broadcast, and it is very important to sow it evenly. Two or three pounds on a square rod will be beneficial. 5 lbs., 25c.; 25 lbs., \$1.00; 50 lbs., \$1.85; 100 lbs., \$3.25. Subject to market changes.

Prepared Potting Soil.

One of the principal elements of success in the growing and flowering of plants and bulbs is proper soil. No matter how much care and attention are given afterward, if the soil is not right, best results cannot be attained. Price, per peck, 25c.; per bush., 75c.; per bbl., \$2.00, delivered at express office in New York.

INSECTICIDES.

Fir Tree Oil.

The most popular and probably, for "all 'round" purposes, the best insecticide in the market for greenhouse and house plants; it frees plants of nearly all insects to which they are subject, and for the following it has no superior: Mealy bug, scale, red spider, aphid (black and green), thrip, blight, worms and slugs, and is also a valuable remedy for animal parasites and insects. Price, ½-pint tin, 40c.; pint, 75c.; quart, \$1.40; ½ gallon, \$2.50; gallon, \$4.25.

Dilute ½ pint to about 10 gallons of soft or rain water (for tender plants or young growth make weaker). Spray on with vaporizer, syringe or bellows.

Fir Tree Oil Soap.

This is the same as the Fir Tree Oil, but in soap form. It is useful for the same purposes. Mix at the rate of one ounce to a gallon of water, and apply with the bellows or syringe. Price, ½-lb. tin, 25c.; 2-lb. tin, 75c.; 5-lb. tin, \$1.75.

Gishurst's Compound.

A certain remedy for green fly, scale, mealy bug, etc. Excellent for greenhouse use. Full directions for use in each box. Price, per lb. box, 50c.

Nikoteen.

A powerful insecticide, specially prepared for use in greenhouses and conservatories. Price, per pint bottle, \$1.50.

Whale Oil Soap.

Makes an excellent wash for trees and plants where insects and eggs affect the bark, and for smearing on the trunks of trees, to prevent worms from crawling up. Price, per lb., 15c.; 2 lbs., 25c.; 5 lbs., 50c.; 25 lbs. and over, per lb., 8c.

Lemon Oil Insecticide.

The best and cheapest insecticide in the market. Used now by nearly all the leading growers. It effectually destroys mealy bug, scale, thrip and red spider. Half pint, 25c.; pint, 40c.; quart, 75c.; ½ gallon, \$1.25; gallon, \$2.00.

Rose Leaf Insecticide.

Extract of Tobacco.

One of the most effectual articles for the destruction of all insects and scale on plants, a pure concentrated extract of tobacco. Full instructions for the various methods of applying, including testimonials from leading florists, are given in our "Rose Leaf" pamphlet, mailed on application. Pint can, 30c.; quart can, 50c.; gallon can, \$1.75.

Dilute with from 30 to 150 parts of water, according to the delicacy of the plants to be treated, and apply with spraying bellows or syringe with spraying nozzle.

Dilute as above, and apply with watering pot sufficient to reach the roots.

Tobacco Dust, Fine.

For green and black aphid, fleas, beetles, etc. Splendid fertilizer and preventive for insects in the ground and around roots. Price, 10c. per lb.; 5 lbs., 35c.; 10 lbs., 65c.; \$3.00 per barrel.

For insects on plants, apply with powder duster or bellows.

For worms or grubs in the soil, apply liberally to the surface and rake in, or strew thickly in the drills before planting.

Tobacco Stems.

Indispensable for fumigating greenhouses and conservatories—for the destruction of green and black aphid, and other insects. Dampen thoroughly a few hours before using; place about half a pound over a handful of shavings in a fumigator, and light. Price, per bale, about 125 lbs., \$1.75.

Nikoteen Aphid Punk.

It burns, kills aphid and thrip cheaply. Does not injure the most delicate blooms. By mail, 75c. per box of 12 rolls, post paid.

Nicotinide.

A nicotene extract for use in greenhouses for fumigating or spraying. Price, 4 ozs., 75c.; ½ pint, \$1.25; 1 pint, \$2.50; per gallon, \$18.00. Lamp, measure and frame complete, 50c. each.

MISCELLANEOUS.



HYACINTH GLASSES.

Tall per doz., \$1 50
 Tall each, 15
 Low per doz., 1 50
 Low each, 15

CHINESE SACRED LILY BOWLS.

As used by the Celestials for growing their famous "Joss Flower" in. The bulbs should be surrounded with pebbles to keep them from toppling over when in flower, and then water enough put in to cover about one-half of the bulb; place them in a dark cool closet for a couple of weeks to become rooted and then bring them into the light.

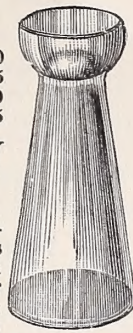

Tokio Chinese Lily Bowls.

China, handsomely decorated in curious Japanese designs.
 7 inch, for 1 bulb \$0 40
 8 " 2 " 60
 9 " 3 or four bulbs.. 80

Glass Chinese Lily Bowls.

6 in. diam., for 1 bulb \$0 25
 7½ " " 2 " 30
 8½ " " 3 " 35

SCOLLAY'S AUTOMATIC VALVE SPRINKLER.

An indispensable article for window gardening, it being one of the best inventions for washing the foliage and sprinkling plants kept in the house during winter, and for washing and moistening cut flowers. Price, each, large size, \$1.00; small size, 75 cts.; by mail, post-paid.



The Perfect flower Pot Handle and Hanger is used for lifting plants out of jardinières, also for hanging up plants, for decorations on walls, etc., and will sustain a weight of 100 lbs.

No. 1, will fit from 2 to 6-in. pots, per pair, 10 cts.
 No. 2, will fit from 5 to 8-in. pots, per pair, 15 cts.
 No. 3, will fit from 8 to 12-in. pots, per pair, 20 cts.

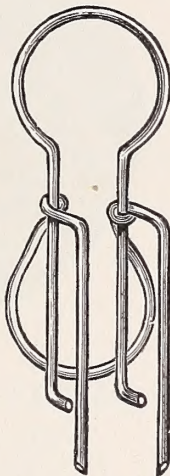

SPRING STEEL DOUBLE EDGE PRUNING SAW.

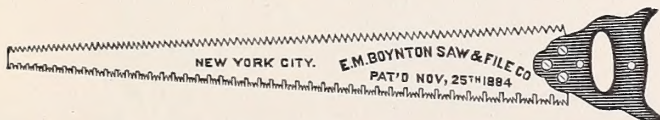

Length, 16 in., 18 in., 20 in. Price, 60c., 70c., 80c.

WATERPROOF FLOWER POT SAUCERS.

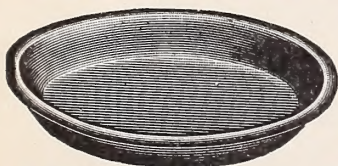

If you have ever been annoyed with ordinary flower pot saucers absorbing moisture and dispensing it imperceptibly until the article it sat on was ruined, you will then fully appreciate the value of these new indurated fiber-ware saucers; they do not absorb moisture and are not easily broken.

Color terra-cotta brown.

Size	Each	Doz.	Each	Doz.	
4 inch	6 cts.	\$0 70	10 inch	12 cts. \$1 20	
5 " "	7 " "	80	11 " "	13 " "	1 30
6 " "	8 " "	85	12 " "	14 " "	1 40
7 " "	9 " "	90	13 " "	15 " "	1 50
8 " "	10 " "	1 00	14 " "	16 " "	1 60
9 " "	11 " "	1 10			

ROLLING STANDS FOR HEAVY PLANTS.

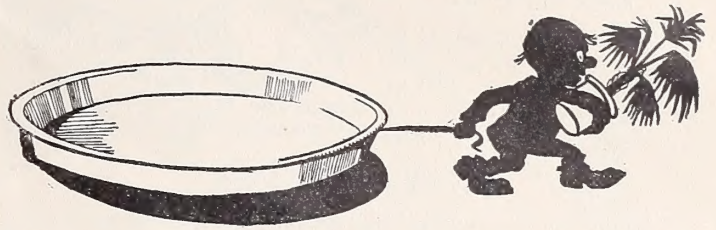

Platforms are indurated Fiber Ware. Will not soak or rust. Casters have Ball-Bearings. Every heavy plant sold needs one to save carpets and floors, and to enable carpets and floors to be readily cleaned.

PRICE LIST ROLLING STANDS.

Outside diameter about	Will take pot of diameter at bottom	Casters	PRICE.
12 inches	10 inches	3	\$0 75
14 " "	11 " "	3	85
16 " "	13 " "	4	1 00
18 " "	15 " "	4	1 10
20 " "	17 " "	4	1 20
22 " "	20 " "	5	1 40

BURLAP MATS.

For Protecting Cold Frames and Hotbeds.

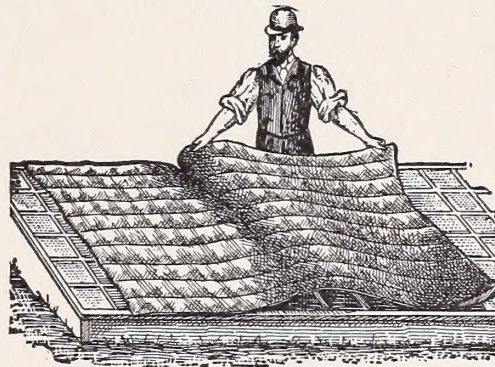

These are 6x6 ft. square, made of strong burlap bagging, warmly lined with waste wool and cotton, which is quilted in to hold position. They are excellent substitutes for straw mats, being, if anything, warmer than straw, more easily handled, less bulky, and they do not harbor lice or vermin. We were afraid that they would hold

moisture, and either rot or mildew, but our trial for two winters proves them to be far more durable than straw mats.

Price, Burlap	Inches	Each	Per Doz.
.....	76 x 76	\$1 25	\$14 00
" Duck	40 x 76	1 50	16 00
" Duck	76 x 76	2 00	22 00
		Feet	Each Per Doz.
" Rye Straw Mats	3 x 6	1 00	11 00
" " "	6 x 6	1 75	20 00

SYRINGES, Solid Brass.

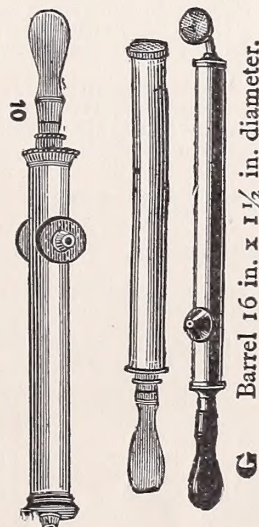

Price

No. A. Barrel, 12 in. long, 1 spray and 1 stream rose \$2 00

No. 2. Barrel 13½ in. long, 1 coarse and 1 fine spray, and 1 stream rose 3 50

No. 10. Barrel, 18 in. long, 1 coarse, and 1 fine spray and 1 stream rose, with patent valves and elbow joint..... 5 50

No. 11. Same as No. 10, without valves 4 50

No. G. Barrel, 16 in. long, 1 spray and 1 stream rose and elbow joint 4 00

No. H. Barrel, 18 in. long (sheet brass). 1 stream rose 2 25

Syringe Vaporizer. Zinc for applying fluid insecticides or fungicides 0 10

MISCELLANEOUS—Continued.

WOODASON'S BELLOWS.

- Single Cone Powder, small \$1 25
- “ Cone Powder, large 2 00
- Small Sized Liquid 1 50
- Large Sized Liquid 2 00
- Double Cone Powder 3 00

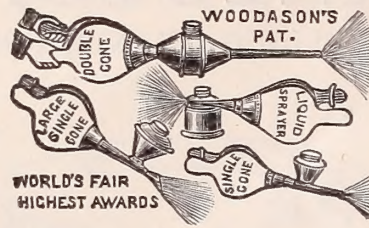

PLANT STAKES.

Round, tapering and painted green. The neatest and best plant stake made.

Height	Doz.	100	Height	Doz.	100
1½ feet.....	\$0 15	\$0 90	3½ feet.....	\$0 60	\$4 25
2 feet.....	25	1 70	4 feet.....	72	5 10
2½ feet.....	36	2 50	5 feet.....	80	6 00
3 feet.....	48	3 40			

DAHLIA POLES—Tapered.

Height	Doz.	100	Height	Doz.	100
3 feet.....	\$0 75	\$5 10	5 feet.....	\$1 10	\$8 75
4 feet.....	90	6 90	6 feet.....	1 30	10 50



UNION FLOWER TUBS.

Made of Cypress, painted green, with iron hoops and feet and handles; perforated bottom; very strong.

No.	Diam.	Height	Price Ea.	Doz.
1....	11 ins....	13 ins....	\$0 90	\$10 00
2....	13 “ “	14½ “ “	1 10	12 00
3....	15 “ “	16 “ “	1 50	15 00
4....	18 “ “	20 “ “	2 25	24 00
5....	21 “ “	24 “ “	2 75	33 00

CEDAR TREE TUBS.

Heavy iron hoops. Drop handles, serving as hooks for carrying poles. Iron legs. Removable perforated bottoms. Painted green outside and brown inside.

No.	Outside Diam.	Length of Stave	Price
0.....	27 inches.....	24 inches.....	\$6 00
1.....	25 “ “	22 “ “	5 00
2.....	23 “ “	20 “ “	4 50
3.....	21 “ “	18 “ “	4 00
5.....	18 “ “	16 “ “	3 50
6.....	16 “ “	14 “ “	2 75
7.....	14 “ “	12 “ “	2 25
8.....	13 “ “	11 “ “	2 00
9.....	12 “ “	10 “ “	1 75

HOSE.

The Rubber Hose we offer is all made of the best rubber and will outlast cheap hose ten times over. We guarantee our “greenhouse” and our 4-ply Special Hose, and will replace same if returned within reasonable time, in season, and found to have any defects the fault of the manufacturer.



Price, Greenhouse Brand, ¾ in., 25 ft., \$4.00; Special 4-ply, ¾ in., 25 ft., \$2.50; 50 ft., \$5.00 coupled, Florists' Special, 25 ft., \$3.75; 100 ft., \$14.00.

FUMIGATORS—Eureka.

For Smoking Plants.

For fumigating greenhouses with dampened tobacco stems; made of galvanized sheet iron; a damper regulates the draft. No danger of fire, no ashes or litter.

- No. 1, 12 in. high \$1.50. No. 3, 20 in. high \$2.00
- No. 2, 16 in. high 1.75. No. 4, 24 in. high 2.75

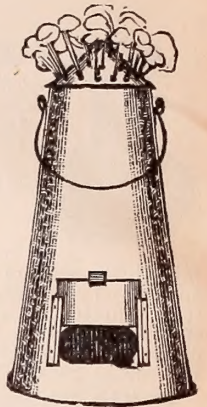

PRUNING SHEARS.

Solid steel, clock spring, 75c., \$1.00, \$1.50, each. Solid steel French Shear, 8 in., \$1.00; 9 in., \$1.50, each.

Pruning Knives, 75c., \$1.00 and \$1.50 each. Budding Knives, 50c., 65c., 75c., and \$1.00.

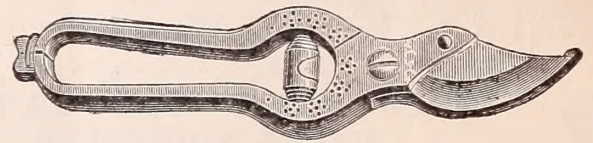

PRUNING SHEARS.

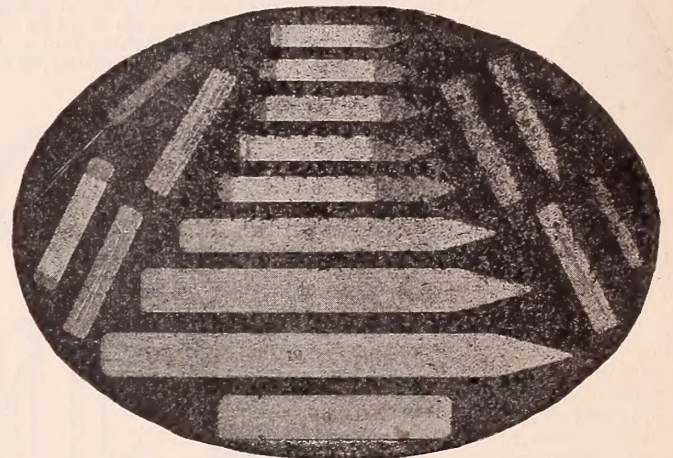

LABELS—Wooden, Pot and Garden.

	PLAIN		PAINTED	
	Per 100	1000	Per 100	1000
4 inch.....	\$0 15	\$0 60	\$0 15	\$0 90
4½ “.....	15	80	20	1 00
5 “.....	15	90	20	1 25
6 “.....	20	1 00	25	1 35
8 “.....	40	3 50	50	4 00
12 “.....	55	4 50	55	5 00

CELLULOID PLANT LABELS.

Made from 1st quality celluloid, nicely finished, wired with copper wire, just the thing for those desiring a neat and practical label for wiring on plants. 1 box contains 50 assorted labels with bottle of indelible ink. Price, \$1.50 per box, postpaid.

“STANDARD” FLOWER POTS.

We pack carefully, but will make no allowance for breakage.

Breakage is not one-half as great as in other pots, the deep rim protecting them. The foot keeps the pot up from the bench, so that it is impossible for hole to become clogged. The concave bottom and large hole insure perfect drainage.

STANDARD FLOWER POTS.				ROUND SEED, OR LILY PANS.		SQUARE SEED PANS.		COMMON FLOWER POT SAUCERS.					
Doz.		100		Height—Width. Doz.		Doz.		Doz.		Doz.		Doz.	
2 inch..	\$0 12	\$0 75	6 inch...	\$0 75	\$4 25	4 x 8 inches.....	\$1 50	4 inch.....	\$0 25	9 inch.....	\$0 85		
2½ “	15	90	7 “	1 25	6 50	5 x 10 “	1 75	5 “	30	10 “	1 00		
3 “	20	1 25	8 “	1 50	9 00	6 x 12 “	3 00	6 “	35	11 “	1 25		
4 “	35	2 00	10 “	3 00	18 00	7 x 14 “	6 00	7 “	40	12 “	1 50		
5 “	45	2 75	12 “	4 00	27 00	8 x 16 “	10 00	8 “	50	14 “	1 75		
						9 x 18 “	15 00						

MISCELLANEOUS—Continued.

“MODEL” EXTENSION CARNATION SUPPORT.

Recognized by leading carnation growers as the best carnation support in use.

	Per 100	Per 1000
Price, 2 ring (see cut).....	\$3 50	\$30 00
“ 3 “	4 00	35 00

HEDGE SHEARS.

USED FOR BOTH TRIMMING HEDGES AND CUTTING GRASS

8 inch blade.....	each	\$1 00
9 “ “	“	1 25
9 “ “ notched	“	1 50
10 “ “	“	1 75

FRUIT PICKERS.

Wire, without pole..... \$0 40

RAFFIA.

For tying, 20 cts. per lb.; 5 lbs., 90 cts.

FLOWER VASES.

(Fiber Ware)

No.	Diam.	Deep	Each	Doz.
0	8 inch,	13 inch.....	\$0 50	\$4 80
1	5½ “	10 “	40	4 50
2	4½ “	9 “	35	3 60
3	4 “	6 “	35	3 00
4	3 “	4½ “	25	2 40

RIPPLEY'S WHITEWASH AND PAINTING MACHINE

By using this machine every crevice and corner which cannot be reached with a brush, can be thoroughly painted or whitewashed, at the same time saving a great deal of labor and expense. One man can do as much work in one hour as five men could do with brushes in the same length of time. Price, No. 6—8 gallon, Galvanized Iron Machine, with all attachments, \$12.00. No. 7—16 gallon Galvanized Iron Machine, with all attachments, \$15.00. Extra hose, per foot, 8c. Nozzle, 85c.

TREE PRUNERS.

Waters. The best pruner on the market. Cuts limbs up to ¾ inch in diameter.

With 4 foot handle.....	\$0 75	With 10 foot handle.....	\$1 15
“ 6 “	85	“ 12 “ “	1 25
“ 8 “ “	1 00		

JONES' FLOWER POT BRACKET.

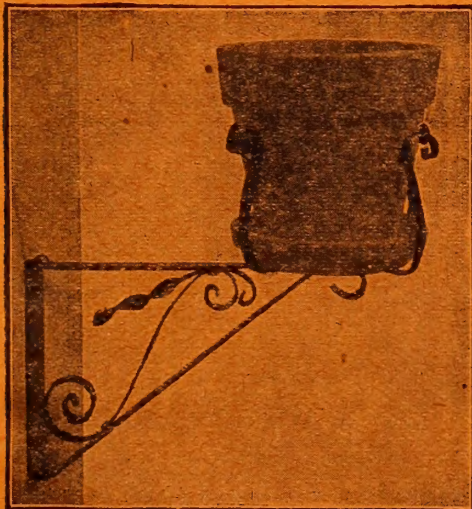

Especially adapted to hold Plain Flower Pots and Saucers.

No.	Length of Arm	Clasp to Hold	Price Each
1 A	8 inch	5 inch pot	\$0 30
2 A	10 “	6 “ “	0 40
3 A	12 “	7 “ “	0 45

Made of Steel, artistic in design and finish.

Finished black, very strong and durable. Flower Pots and Saucers are absolutely secured by the spring clasp.

French or Oval Watering Pots.

Made specially for greenhouse work, with 2 copper-faced roses and long spout. 6 quart, \$1.50; 8 quart, \$1.75



WATERING POTS.

“Common Sense” Watering Pots.

2 quart.....\$0 75 4 quart.....\$2 00

Galvanized Round.

Wotherspoon's Patent.

Fitted with 2 copper roses, one fine and one coarse, with each pot. 6 quart, \$1.75; 8 quart, \$2.00; 10 quart, \$2.25; 12 quart, \$2.50; 16 quart, \$3.00.

HOT BED SASH.



Our hot bed sash are made from selected gulf cypress, painted with 2 coats paint, finished edges, with neat iron cross pieces running through center.

Price, complete 2 coats white paint, glazed with 10 x 12 glass, \$3.50 each; \$40.00 per dozen.

Price, complete 2 coats white paint, glazed with 10 x 12 double-thick glass, \$4.00 each; \$46.00 per dozen.

Hot bed frames for 3 x 6 sash, \$7.50 each.

For extra sizes, send for prices.

JONES' FOLDING PLANT STAND.

The most compact, durable and strong plant stand ever offered for sale.

PRICES.

No. 20, with wire shelves, 3 trays, \$3.00; 2 trays, \$2.75 each.

No. 25, with 2 wood shelves, \$2.00; 3 shelves, \$2.50 each.

Wood shelves are finished imitation of cherry.

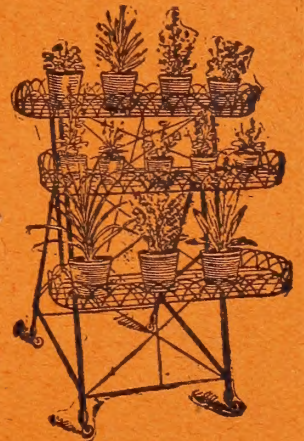

PEERLESS GLAZING POINTS.

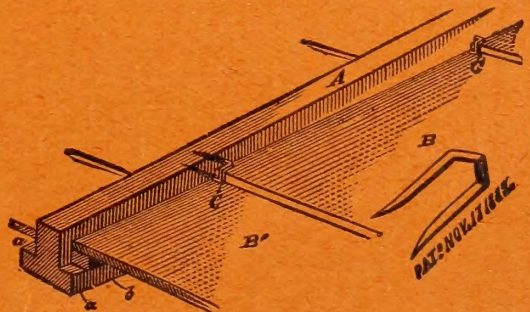

Endorsed by leading florists. Try them and you will use no other. Made of steel wire and galvanized, no rights and lefts. Price, per box of 1000, 60c. Pincers for driving the points, 50c.

SIEBERTS' never rust glazing points. Per 1000 points, 40 cts.

STUMPP & WALTER COMPANY'S
HIGH GRADE
Lawn Grass Seed

For Lawns, Grass Plots, Tennis Courts
Cricket Grounds and Golf Links *o o o*

STUMPP & WALTER COMPANY'S
High-Grade LAWN SEED



Sow "High Grade" **Lawn Grass Seed** and you will obtain a beautiful deep green lawn, which, owing to the varieties used in this mixture, will retain its velvety appearance during the entire summer. Weight, 22 lbs. per Bushel.

Price, 25c. per Quart; 85c. per 4 Quarts; \$1.50 per Peck; \$5.00 per Bushel.

EMERALD LAWN DRESSING induces rapid growth of a rich dark green sward. Ten pounds is sufficient for 300 feet square; 1000 pounds per acre.

Per 10-lbs., 40c.; per 50-lb. Bag, \$1.50; per 100-lb. Bag, \$2.50; per Ton, \$40.00.

STUMPP & WALTER COMPANY
50 Barclay Street, NEW YORK.