

## **Historic, Archive Document**

Do not assume content reflects current scientific knowledge, policies, or practices.



Y & H  
YOUNG & HALSTEAD

U.S. DEPARTMENT OF AGRICULTURE  
LIBRARY  
Washington, D. C.  
N. Y.

by  
Troy,

1903

# SEEDS



1903.

**A** NICE VELVETY LAWN adds more to the beauty of a place than any other adornment, and even the humblest home may be made attractive with such surroundings, while without a good lawn even the finest flowering plants and elegantly arranged beds seem insignificant. How important it is then to plan for the best lawn obtainable. Do not spend money in sodding a lawn, for it is expensive and seldom satisfactory. It costs much less to sow the seed, and the lawn is far better.

## GRASS

### Congress Park Lawn Seed Mixture

This mixture forms a close thick turf. It is composed of those grasses which will endure and keep getting thicker and better the longer it stands. In this mixture we combine the quick growing grasses, which give immediate effect, with those of lasting character. This lawn grass is suitable for any location, having in its composition all the requirements for sandy loam, clayey soil and for a combination of soils. Even under trees this mixture succeeds well. It is our standard lawn grass. No preparation of grasses can be blended which will give such universal satisfaction.

### Shady Ramble Mixture

Just the thing for sowing under shade trees, as it is a combination of grasses which grow naturally in the woods and are of Dwarf Evergreen growth.

### Embankment or Terrace Mixture

To get a good stand from seed upon a terrace or embankment requires a special blend of these grasses having thick spreading roots. The soil is usually shallow on side hills and embankments, consequently heavy rains tend to wash out the grass unless roots are exceedingly strong and tenacious. This mixture has been found equal to all requirements and will give perfect satisfaction.

### City Yard Mixture

We prepare this mixture for city yards where the grass is trodden down during the freezing and thawing of one winter by the tireless feet of children who must play somewhere out of doors. This mixture is made of the quick growing grasses and will give immediate results in early spring.

### Young & Halstead Golf Link Mixture

There is no use to which a grass mixture is put that is so exacting as that used for pleasure grounds, golf links, etc. No other turf is required to stand such wear and rough usage; hence the necessity of sowing such grasses as will produce a thick and healthy growth and withstand the constant tramping of many feet. We have devoted much time to experimenting in order to produce the correct mixture, such as will quickly produce a rich green turf.

### For the Putting Green

A careful study of the requirements for making the most substantial turf for putting greens developed, the mixture herewith offered by us for this purpose. It has given perfect satisfaction wherever used, and produces a thick, tough, beautiful green turf. The varieties composing this mixture are all the finest bladed, low growing and most hardy kinds, and will maintain their rich velvety color throughout the season.

### For the Links

Made from our own formula with the object of producing a turf that will stand rough usage. For cricket table, golf links, polo grounds, or wherever a good sward is wanted, this seed will give perfect satisfaction.

### Y. & H. Plant Food

This is the quickest and surest acting plant food for house plants ever put on the market. It is composed of quick acting and long lasting fertilizers and chemicals which will produce a bright, handsome foliage of rich texture and larger and more brilliant flowers. It is very soluble and is readily assimilated, so that marked improvement is noticed in ten days. It is fine and dry and easy to apply. One package is enough for twenty ordinary plants for three months. Detailed directions with each package. We recommend it very highly for green house use, as the ingredients used in this Plant Food will keep off all earth insects without injuring the plants. Special price in large quantities. Small packages, price 15c each. Large packages, price 25c each. By mail, 20c and 35c.



# Supplement

To Young & Halstead's  
1903 Seed Catalogue

## Refugee or 1000 to 1-Bean

**T**HIS very popular medium or late variety has always been a leader among the market gardeners. The pods are round, tender and nearly stringless, which makes it one of the best Beans in cultivation for canning and pickling. Pkt. 10c.; pint 20c.; quart 35c.

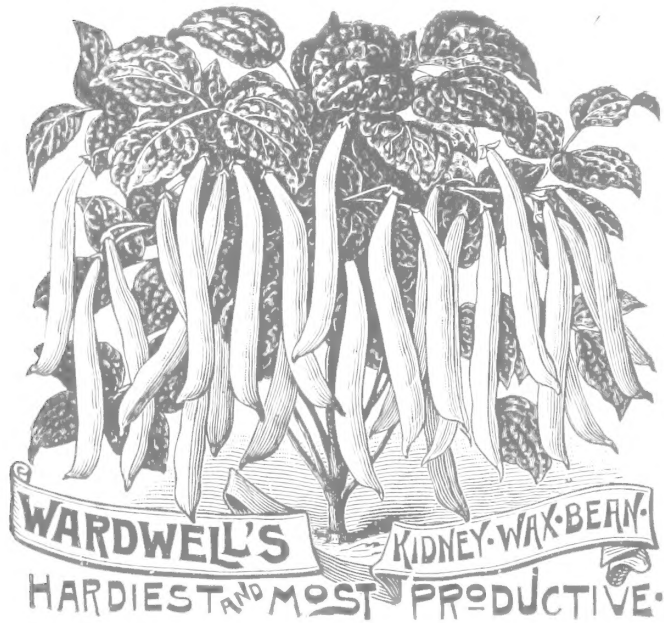

**Wardell's Kidney Wax Bean.** This is the most hardy and productive best wax-podded bean in cultivation. Pods long and nearly straight, of a beautiful appearance, which makes it one of the best for market and family use. It matures about the same time as the Golden Wax. Pkt. 10c.; pint 20c.; quart 40c.

## Detroit Dark Red Turnip Beet

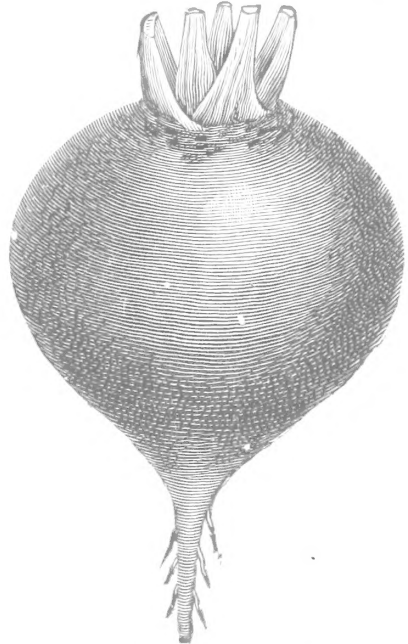

*Detroit Dark Red Turnip Beet*

**Detroit Dark Red Turnip Beet.** A splendid Beet of dark red color for home or market. By far the best for canning on account of its color and quality. For early bunching or winter use, it has no equal. Pkt. 5c.; oz. 10c.;  $\frac{1}{4}$  lb. 20c.; lb. 60c.



*Burpee All Head Cabbage* (See page 2.)

## Charleston Large Wakefield Cabbage

The best pointed head cabbage. This selection will average about 50 per cent. larger in size than the old type of Wakefield, and is only a few days later. Pkt. 10c; oz. 30c;  $\frac{1}{4}$  lb. 90c; lb. \$3.25.

**Burpee All Head Cabbage** A comparatively new flat head cabbage of distinct characteristics, now widely planted. It has proved itself to be adaptable to a wide range of both climate and soil. Nothing better of its kind is within the reach of market gardeners. The deep flat heads are remarkably solid and the most uniform in color, form and size of any variety.

Seed sown in June and the plants set the latter part of July, will produce fine large heads for winter. Pkt. 10c; oz. 30c;  $\frac{1}{4}$  lb \$1 00; lb. \$3.50.

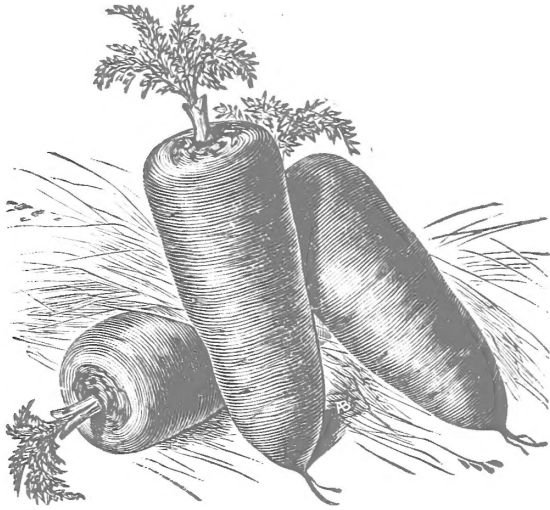

*Danver's True Carrot*

## Danver's True Carrot

Our strain of this carrot will produce more bushels to the acre than any of the larger varieties. Color, rich orange, large at top, stump rooted, and very smooth. The best for stock or table. Pkt. 5 oz. 10c;  $\frac{1}{4}$  lb. 25c; lb. 80c.

## Y. & H. Private Stock Snowball Cauliflower

This is the finest of all cauliflowers. Has fully maintained all the merits we claim for it. It is sure to produce large pure white heads of regular form and fine quality. In good soil the heads will measure from 8 to 10 inches across.

This seed is especially selected for us in Germany, and market gardeners, growing cauliflower on a large scale, can plant this variety with full assurance that it is the choicest and most reliable strain that can be procured.

Pkt. 25c;  $\frac{1}{4}$  oz. \$1.00; oz. \$3.50.

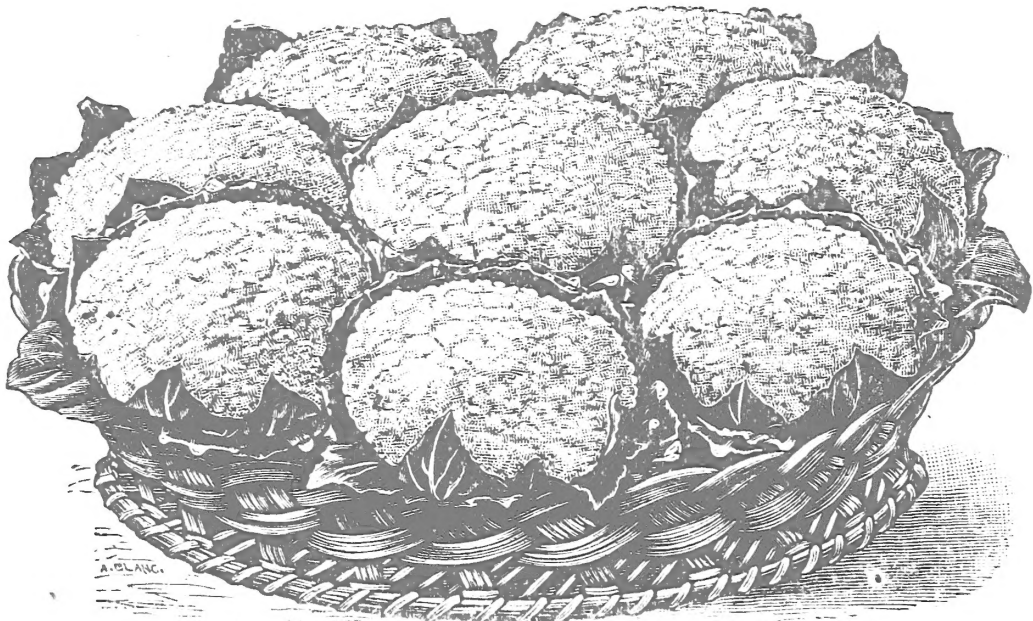

*Y. & H. Private Stock Snowball Cauliflower*

## Golden Self-Blanching Celery

This is the best celery in cultivation and certainly the most popular. It is of dwarf or half dwarf habit, growing about 18 to 20 inches high, wonderfully stocky, perfectly solid, of delicious flavor and a good keeper.

Our seed of this strain is foreign grown, which is far better than American grown seed. Pkt. 10c.; oz. 35c.;  $\frac{1}{4}$  lb. \$1.10; lb. \$4.00.

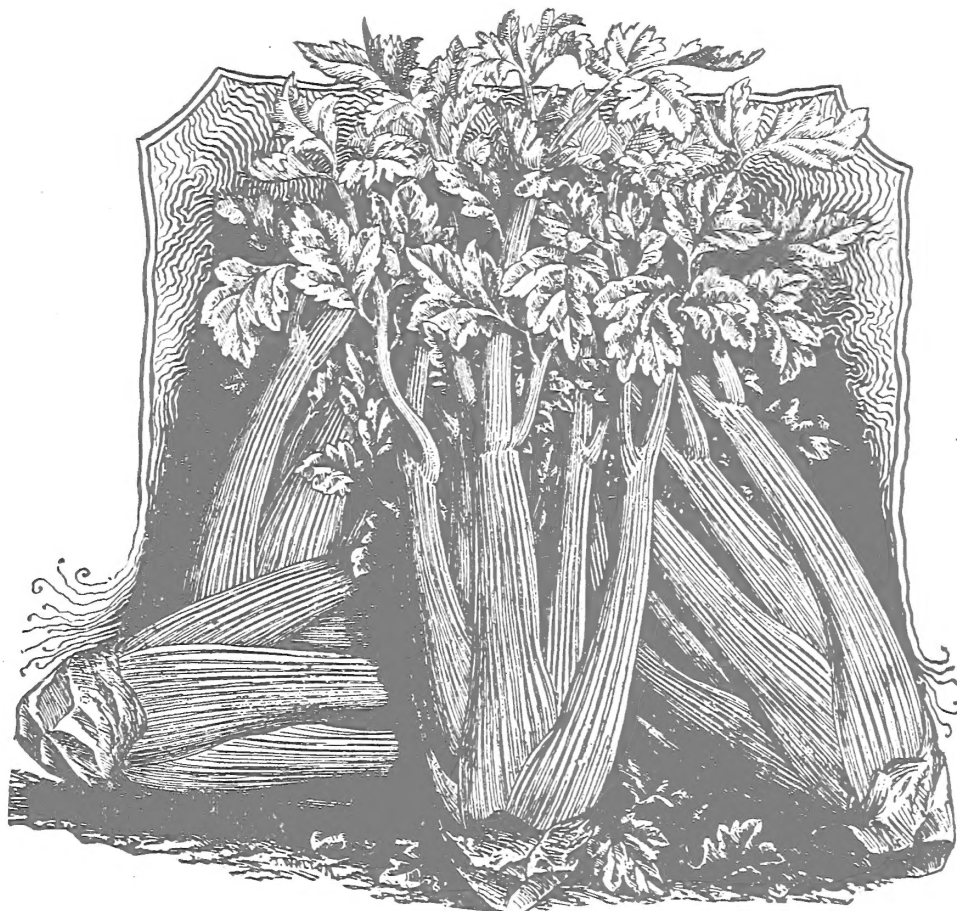

*Golden Self-Blanching Celery*

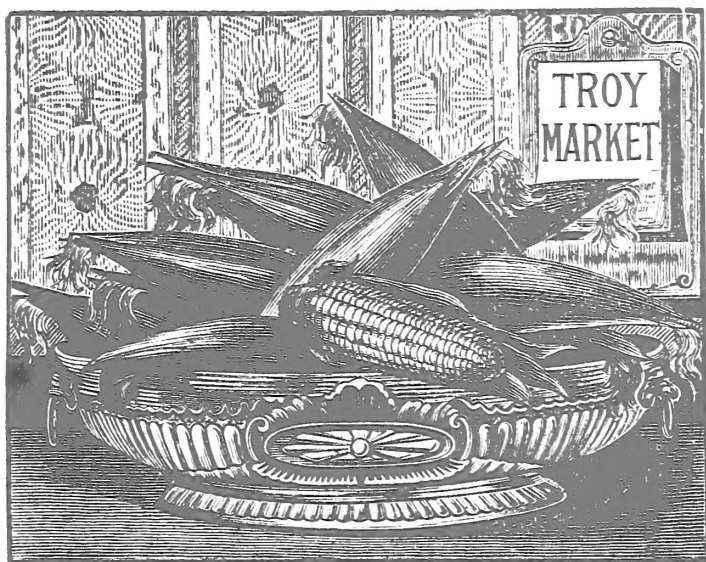

*Troy Market Corn*

## Troy Market Corn

*The largest eared and best True Sweet Corn.* This grand, new variety produces fine large ears the size of Champion or Crosby, as early as Cory, of much finer quality. Market gardeners who have grown this excellent variety, claim it to be the best. Pint 15c; qts. 30c.; 2 qts. 50c.

**Page's First of All Corn.** This new corn reaches maturity from two to seven days earlier than the Cory, and we can confidently recommend it. It produces larger ears than the Cory and more to the stalk, and will prove a boon to gardeners, who desire to be first in market. The stalks grow 4 to 5

feet high, and bear two good sized ears. The ears are handsome, the grain being in ten or twelve rows. This corn grows both red and white cob, and red and white kernels. The table quality is excellent. Pt. 15c.; qt. 30c.; 2 qts. 50c.



## Fordhook White Spine Cucumber

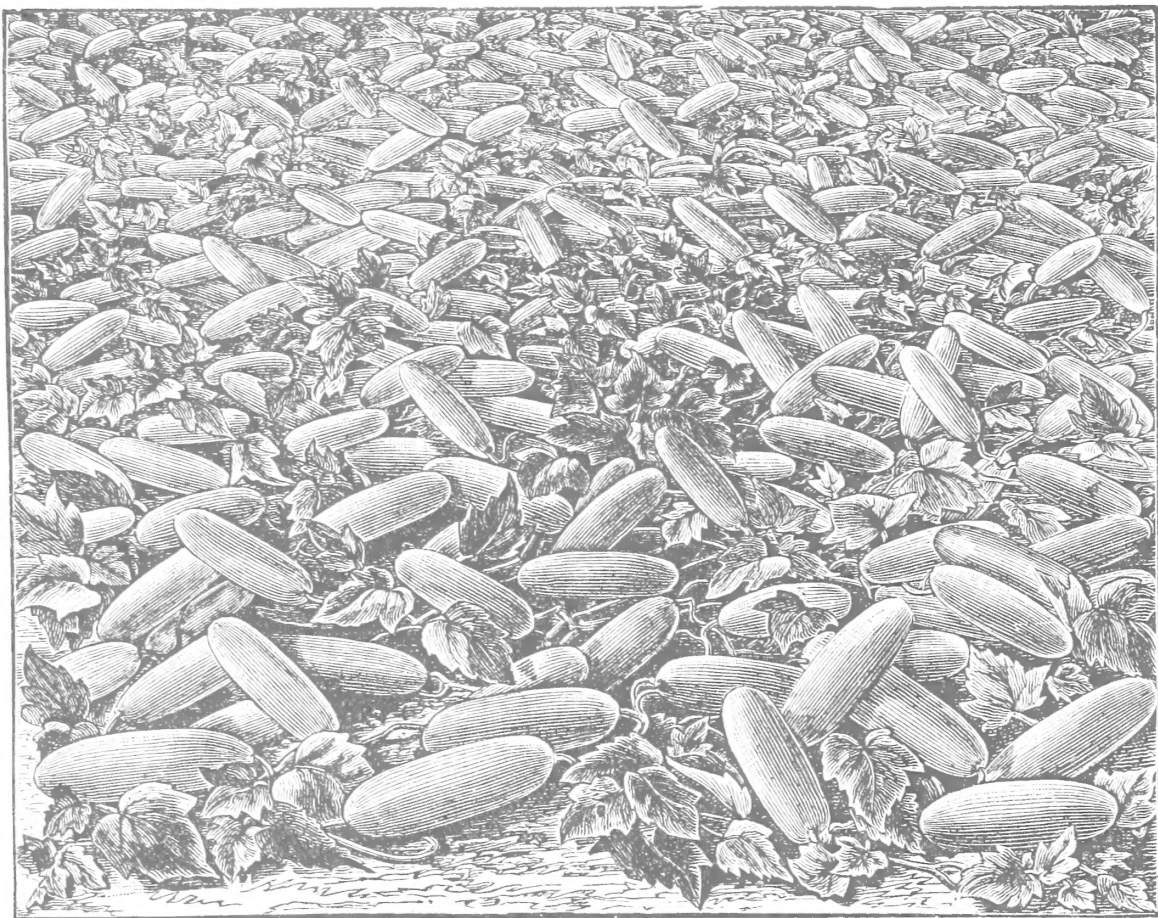

*Fordhook White Spine Cucumber*

The Fordhook is a marked improvement over all strains of white spine. The cucumbers are almost cylindrical in form, slightly pointed at the ends and handsome in appearance, being perfectly smooth and not ridged as in other strains. The vines are of vigorous growth and enormously productive. The fruits retain their dark green color after being picked, longer than any other variety; even while practically white, they still present a greenish tinge. Decidedly the best strain of White Spine. Pkt. 5c; oz. 20c;  $\frac{1}{4}$  60c; lb. \$2.00.

## Corning's Improved Albany Market Musk Melon

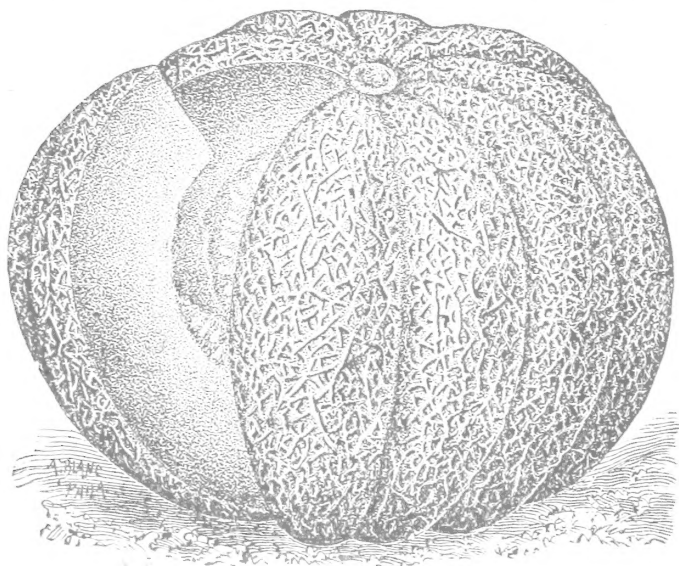

*Corning's Improved Albany Market Musk Melon*

We cannot say too much in praise of this splendid Musk Melon, which originated near Albany, N. Y. We have had grown for us seed from the original stock, and are in a position to supply the wants of all who wish to plant this superb variety. Its fine form and handsome netting make it attractive before cutting. The thick green flesh extending to the thin, but hard and firm rind, makes it still more attractive when served, while the uniformly high quality of the flesh gives perfect satisfaction when eaten. We think this the best green fleshed sort yet produced. Pkt. 5c; oz. 10c;  $\frac{1}{4}$  25c; lb. 80c.

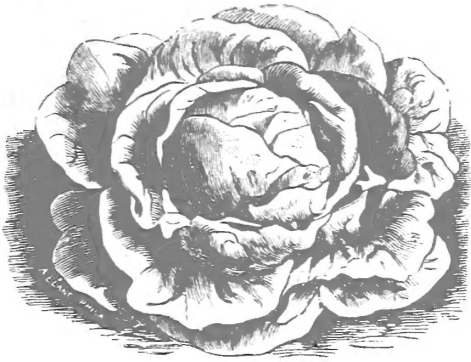

*Salamander Lettuce*

finest in quality of all water melons and most desirable to plant for home use or nearby market. Fruits are of large size, oblong in form with dark green skin, very thin rind. Flesh bright scarlet with broad solid heart. The melons average 18 to 20 inches in length, by 8 to 10 inches in diameter, of handsome appearance and most uniformly superior quality. Pkt. 10c; oz. 20c;  $\frac{1}{4}$  lb. 50.

## Salamander Lettuce

One of the best for summer use, forming good sized, compact heads. Color, light green outside, and white inside. It will remain longer in head, and stand a greater amount of heat without burning or running to seed, than any other variety. Pkt. 5c; oz. 15c;  $\frac{1}{4}$  lb. 35c; lb. \$1.25.

## Kleckley Sweet Water Melon

The sweetest of all melons. While the skin of this splendid variety is too tender to admit of its fruit being shipped any distance to market, it is the

## True Yellow Globe Danver's Onion

Our strain of this standard variety is unsurpassed. It always attains good size, with deep bulbs and small neck. It is choice in flavor, being rather mild. It is a market favorite, and is the best yellow onion on the market, frequently producing 500 to 600 bushels to the acre. We confidently assure our customers that we have the best known strain. *Strictly Eastern grown and tested.*

Pkt. 5c; oz. 15c;  $\frac{1}{4}$  lb. 45c; lb. \$1.50.

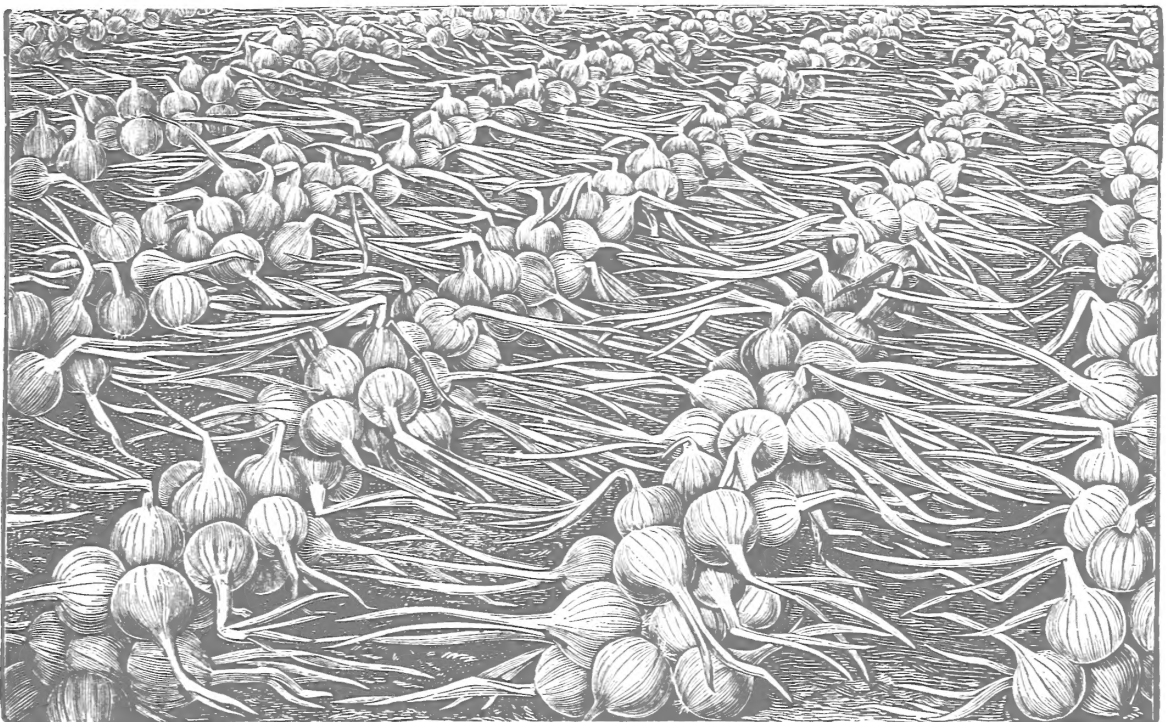

*True Yellow Globe Danver's Onion*

**Campbell's New White Dutch Onion** for bunching.

This new strain of onion is ready for market two or three weeks earlier than the set onion, and of much finer quality.

Sow the seed in the spring and cultivate same as the ordinary onion. Early in August, pull and cut off the root and about one-half of the top. Then transplant same as the ordinary onion sets and leave them in the ground all winter. The following spring they are ready for market, as soon as the frost is out of the ground. They do not form a bulb, but multiply, and in many cases, one set in the fall will make one bunch in the spring.

Pkt. 10c; oz. 15c;  $\frac{1}{4}$  lb. 50c; lb. \$1.75.



## New Red Pepper, Chinese Giant



*New Red Pepper, Chinese Giant*

**Golden Queen Pepper.** Golden Queen is the best of all yellow peppers; it is always large, specimens reaching 8 to 10 inches in length and 4 to 5 inches in diameter. A large plant sometimes carries twenty large peppers at the same time. The flavor is mild and pleasant, and may be eaten raw. To say this pepper is a yellow Ruby King, is the highest praise that can be bestowed upon it. Pkt: 10c.; oz. 30c.

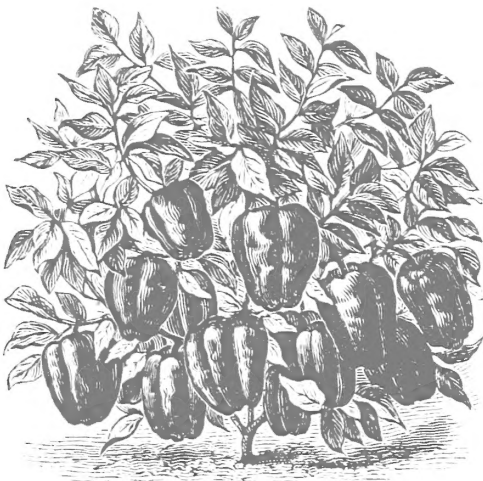

*Golden Queen Pepper*

**Y. & H. Improved Pride of the Market Pea.** Vines of medium height, stiff, with large dark green leaves, and bearing at the top, generally in pairs, a fine crop of large dark green pods well filled with large peas of good flavor. We have given this variety special attention, and the stock we offer is so much superior to that commonly sold, as to seem a different sort. We recommend it as one of the *very best* of the large podded varieties. Pkt. 5c.; pt. 15c.; qt. 25c.

The largest and finest mild red pepper. Truckers planting for market will find the Chinese Giant the most profitable variety ever handled. The plants are of strong, stocky growth of bushy, erect habit, growing 18 inches to 2 feet high. The strong growth of the plants enables them to mature the large number of fruits nearly as early as the Ruby King. The monstrous fruits are of thick, blocky form and of most brilliant glossy scarlet. They grow four or five inches broad at the top, and are of equal length. *All are uniformly of most enormous size.* The flesh is as sweet as an apple. The enormous fruits yield so little seed, that the genuine seed must always be high in price. Pkt. 15c.;  $\frac{1}{2}$  oz. 60c.; oz. \$1.

## Y. & H. Improved Pride of the Market Peas

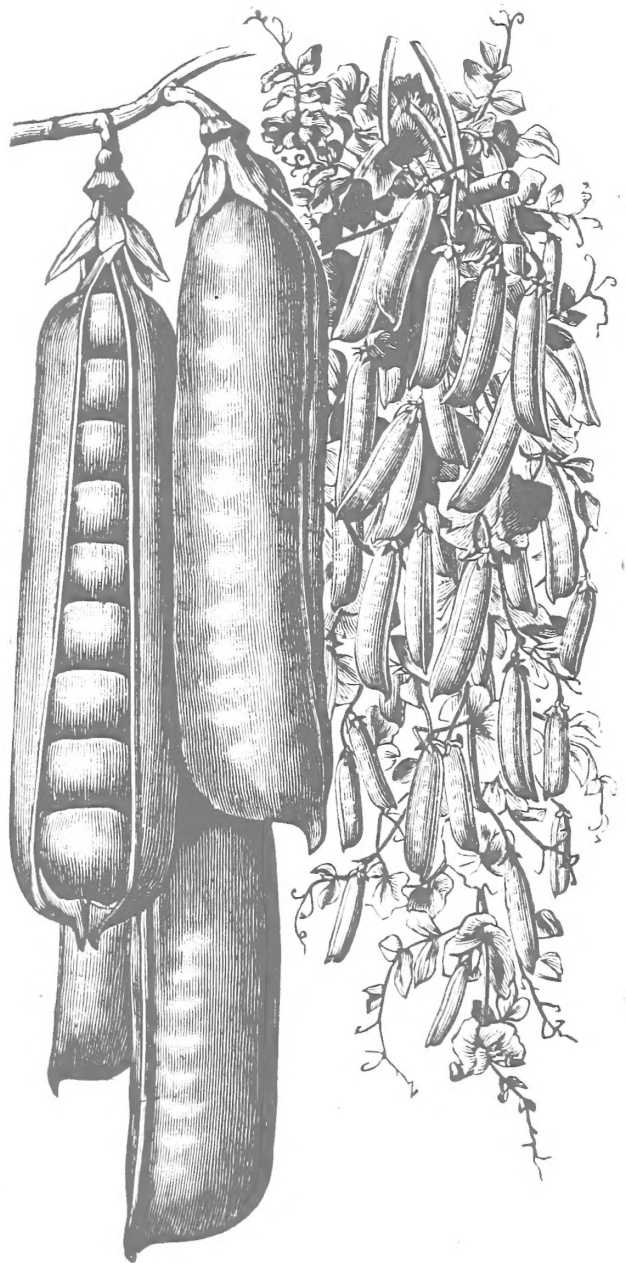

*Y. & H. Improved Pride of the Market Peas*

## New Pumpkin==Winter Luxury

This is a very prolific, small fruited variety of superior quality. Fruits nearly round or slightly oblong, averaging six or eight inches in diameter. Flesh deep golden yellow, of fine quality. Pkt. 5c.; oz. 15c.;  $\frac{1}{4}$  lb. 50c

## New Triumph Radish

A beautiful, delicious and profitable new radish for forcing or open air culture. The roots are globe-shaped, with strips of bright scarlet on a white skin. The flesh is tender, mild juicy and sweet, making it a very desirable table radish. It is very early, maturing in about three weeks. Its peculiar beauty gives the Triumph Radish an unusual value to market gardeners, and we recommend it to all who wish a fine radish. Pkt. 15c.; 2 pkts. 25c.

## Spinach==New Victoria

The foliage is heavy, the broad, dark green leaves being of the Savoy appearance and of finest quality. Its most remarkable feature that makes it of special value, is the fact that it is in prime condition from two to three weeks after all other varieties of spinach have run to seed. Pkt. 5c.; oz. 10c.;  $\frac{1}{4}$  lb. 15c.; lb. 40c.

## Squash==White Summer Crookneck

This beautiful variety of squash is the result of years of careful breeding and selection, and is now one of the most fixed and distinct of our summer squash. The fruit is similar in size and shape to the Summer Crookneck, but of a beautiful, ivory white color and unsurpassed in quality. We recommend this sort as the most beautiful, and one of the very best of summer squash. Per pkt. 5c.; oz. 10c.;  $\frac{1}{4}$  lb. 35c.; 1 lb. \$1.00,

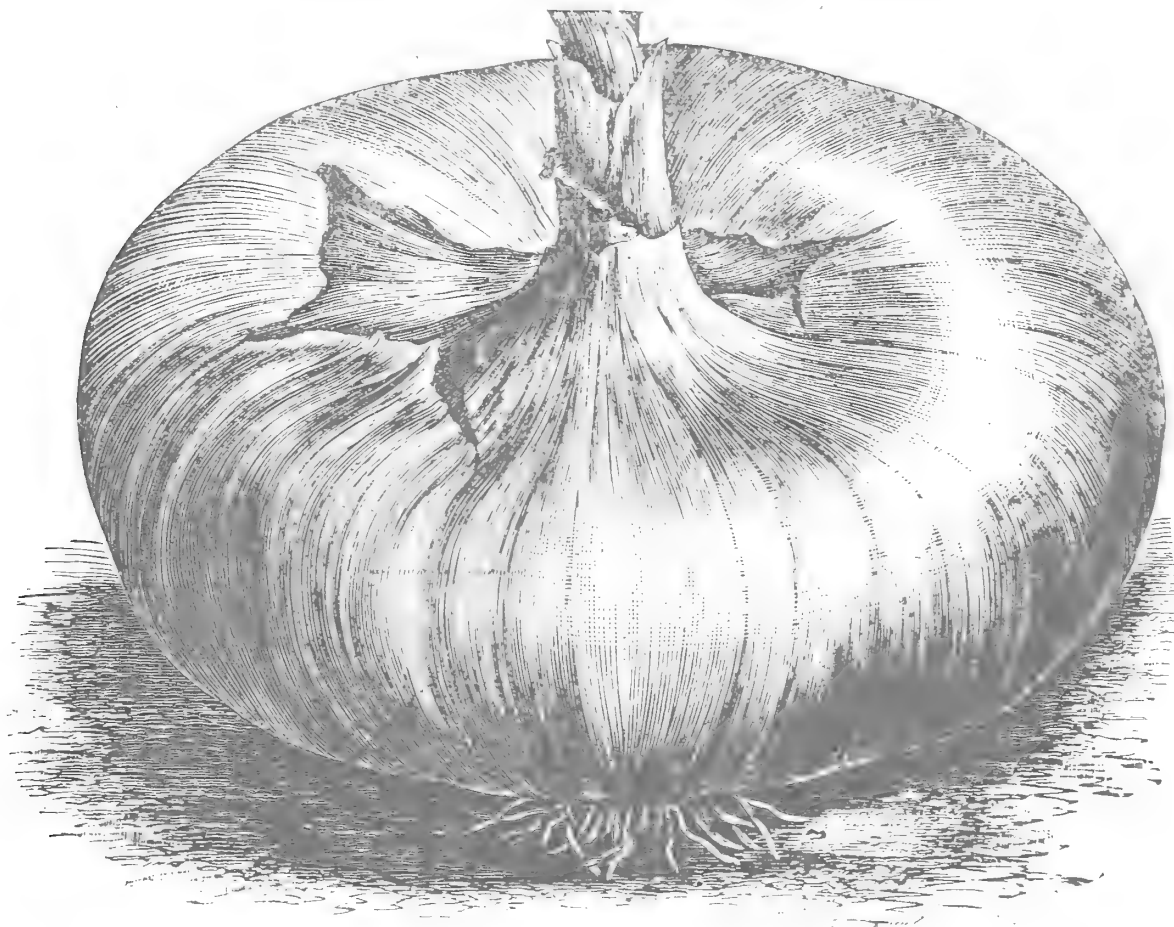

*Silver King*

**Silver King**—This is a mammoth in size and the largest in cultivation. The bulbs are very attractive in form, finely shaped, flattened but thick, with a silvery white skin; the flesh is snow-white, finely grained, exceedingly mild and of pleasant flavor. It matures quite early. Pkt. 5c.; oz. 30c.;  $\frac{1}{4}$  lb. 80c.



## Tomato==Trojan

*The best Extra Early Tomato in existence. Two weeks earlier than any other tomato grown, and superior in other respects. Its value lies not only in the actual time in ripening its first fruits, but that such enormous quantities of fruit can be gathered while all other so-called "earliest" are ripening only a few. The fruits are of large size, perfectly round and remarkably handsome, smooth as glass and of brilliant scarlet. The flesh is solid, having few seeds. The flavor is perfect, absolutely free from any acidity; the fruits are borne in large clusters in phenomenal abundance. We recommend it highly, not only for its extreme and bountiful earliness, but as a good all-season variety. Pkt. 20c; pkts. 50c; 7 pkts. \$1.00.*

# YOUNG & HALSTEAD'S Farm and Garden Catalogue

FOR  
≡1903≡



OUR Catalogue this year contains a very complete list of all the good things for the farm and garden, all of which have been tried and found entirely reliable, each and every article being a valuable acquisition in its own way. Not only does this catalogue give a list of the best seeds grown, but it also furnishes directions for the successful cultivation of almost all crops, which may be followed with confidence, a few changes in the time of sowing and planting necessitated by peculiar climatic conditions, being left, of course, to the good judgment of the cultivator.

**Farm Seeds.** We make a specialty of the handling of clean and reliable seeds. On our pages will be found a complete list of cereals, grasses, clovers and other forage plants of great value to the farmer.

We guarantee the safe arrival of seeds. In the event of the arrival of packages in bad condition, notice should be sent to us at once, and we will replace same free of charge. When customers do not receive their goods in a reasonable time, they should inform us at once, and also send us a copy of their order, so we can have it traced at once.

We handle seeds in large quantities, and contract for them direct from the growers. Our facilities for handling seeds, receiving and filling orders, packing and shipping, are being improved wherever possible. With all of these advantages, we are enabled to make very low prices, and we are confident they compare favorably with those of any reliable seed house in the United States. Our aim is to give reliable seeds, at reasonable prices.

**Free Delivery.** At the price quoted in this catalogue, we deliver free, all vegetable and flower seeds in packets, ounces,  $\frac{1}{4}$  pounds, to any postoffice in the United States, except peas, beans, sweet corn, field corn and farm seeds, on which, if wanted by mail, add to farm seeds, 8c. per lb.; to peas, field corn and beans, 8c. per pt.; 15c. per qt.; sweet corn, 5c. per pt.; 10c. per qt., to cover cost of mailing.

Purchasers will also pay shipping charges on all tools, fertilizers, insecticides, etc., unless otherwise noted. We make no charge for packing cases or barrels, or delivery to freight depots; we, however, charge for cloth bags. 2 bu. bag, 15c.

**Instructions to our Customers.** Orders from new customers, persons unknown to us, to avoid delay, will please send a remittance, or satisfactory city reference with their order. We will not ship C. O. D. to unknown customers unless sufficient money is sent to guarantee acceptance.

**How to Remit.** Money may be sent at our risk, P. O. money order, bank draft on Troy, express money order or registered letter. Money sent in any other way than as specified above, is entirely at the risk of the sender.

**How to Order Seed.** *It is most important that the full name and address be given and plainly written.* Often we receive orders with neither name or address attached, and delays which we are powerless to avoid occur in consequence. Full shipping directions should be given us, stating distinctly whether large quantities are to be sent by express or freight, otherwise we must use our own judgment regarding the best route: give name of express company or railroad running to your place.

## GUARANTEE

Complaints as to the germination of seeds should most times be attributed to other causes, than to the vitality of the seed. There are hundreds of contingencies continually arising to prevent the best seed giving satisfaction, such as sowing too deep, too shallow or in too wet or too dry soil; insects of all descriptions, destroying the plants as soon as, or before, they appear: wet weather, cold weather, frosts, chemical changes in the seeds induced by temperature, etc.

For the above reasons, it is impracticable to guarantee seeds under all circumstances.

Young & Halstead give no warranty, expressed or implied, as to description, quality, productiveness, or any other matter of any seeds, bulbs or plants we send out, and we will not be in any way responsible for the crop. If the purchaser does not accept the goods on these terms, they are at once to be returned.

YOUNG & HALSTEAD.



## How to Build and Manage Hot Beds

For early vegetables, some provision for starting certain plants earlier than can be done in the open air is desirable; for this purpose nothing is better than a good hot-bed, and its construction is so simple and the expense so slight that every garden should have one. A hot-bed not only protects plants from the cold, but supplies *bottom heat*. By this term the gardener means that the soil is constantly kept several degrees warmer than the air above, that being the condition so far as heat is concerned, which is most favorable for rapid and vigorous growth, and gardeners usually secure it by making a compact pile of some fermenting material and covering it with the earth in which the plants are to grow.

**Heating Material.** The best heating material that is easily available is *fresh* horse manure, containing a liberal quantity of straw bedding. Such manure, if thrown into a loose pile, will heat violently and unevenly and will soon become cold. What is wanted in the hot-bed is a steady and moderate but lasting heat. To secure this, the manure should be forked over, shaken apart, and if dry, watered and allowed to stand a few days and then be forked over again, piled and allowed to heat a second time, the object being to get the whole mass into a uniform degree of fermentation, and as soon as this is accomplished, it is fit for use.

**Sash.** Some gardeners use sash made especially for hot-beds and glazed with small lights cut from odds and ends, and so furnished at very low rates. Such sash can usually be procured in any of our large cities, and costs much less than if made to order.

**The Frame.** This may be made of sound one-inch lumber, the back twelve to fourteen inches high, the front ten to twelve. It should be well fitted to the sash so as to leave as little opening as possible and yet allow the sash to be easily moved up and down, even when the frame is quite wet.

**The Soil.** This should be *light, rich, friable*. Any considerable amount of clay in it is very objectionable. If possible, it should be unfrozen when put into the bed; for this reason it is much better to prepare it the fall before, and cover the pile with enough coarse manure or straw to keep out the frost.

**Making the Bed.** This requires careful attention, as future success depends largely upon the manner in which this work is done. Having cleared away snow and ice, build a rectangular bed one foot larger each way than the frame to be used, carefully shaking out and spreading each forkful and repeatedly treading down the manure so as to *make the bed as uniform as possible in solidity, composition and moisture*. It is of the *utmost importance* that this shaking apart and evenly pressing down of the manure should be carefully and thoroughly done; unless it is, one portion will heat quicker than the others, and the soil will settle unevenly, making it impossible to raise good plants. The proper depth of the bed will vary with the climate, season and the kind of plants to be raised. A shallow bed will quickly give a high temperature which will soon subside; a deeper one, if well made, will heat more moderately, but continue much longer.

For general purposes, a bed about two feet deep will be the best.

The bed completed, the frame and sash may be put on and fresh manure carefully packed around the outside to the very top (if the weather is at all severe, this outside banking should be replenished as it settles). The bed should then be allowed to stand with the sash partially open for a day or two to allow the steam and rank heat to pass off. The earth should then be put on and carefully leveled. Care should be taken that the soil is dry and friable. If wet or frozen soil must be used, it should be placed in small piles until well dried out before spreading. The heat at first will be quite violent, frequently rising to 120 degrees; but it soon subsides, and *when it recedes* to 90 degrees the seed may be planted. The importance of using dry soil and allowing the first rank heat to pass off is very great. Every season thousands of hot-beds fail of good results from these causes, and seedsmen are blamed for failure resulting from overheat, or wet, soggy soil.



**Management of the Bed.** The essentials for success are a steady, uniform degree of heat and moisture; keeping the soil at all times a few degrees warmer than the air, and the careful "hardening off" (by exposure to the air and diminishing the supply of water) of the plants before transplanting into the open air. Simple as these may seem to be, there are many difficulties in the way of securing them, prominent among which are overheating the air under the bright sun. Without experience one would scarcely believe how quickly the temperature inside of a well-built hot-bed will rise to 90 or 100 degrees upon a still sunny day, even when the temperature outside is far below freezing, or how quickly the temperature will fall to that outside, if upon a windy, cloudy day the sash is left open ever so little. A rush of cold air driven over the plants is far more injurious than the same temperature when the air is still. Again, in cloudy weather, a bed will go several days without watering, but will dry up in an hour when open on a sunny day. The details of management, however, must be learned by experience, but may be easily acquired by one who gives the matter careful attention, keeping constantly in mind the essentials given above.

**A Cold Frame.** Is a simple construction of boards for wintering over young plants, cabbage, lettuce, cauliflower, brocoli, etc., and is also extremely useful to protect and harden off plants from the green house or hot-bed before fully exposing them in the open air. Select a dry southern exposure, form a frame from four to six feet wide and as long as required. The back should be fourteen to eighteen inches high and the front eight to twelve, with a cross-tie every three feet. The frame may be covered with sash or cloth. Seeds of the vegetables to be wintered, sown in open border early in September, will be ready to plant in cold frames about the last of October. The soil should be well prepared and smoothly raked before planting. Admit air freely on pleasant days, but keep close in severe weather.

These frames are particularly useful in the south, and may be covered more cheaply with cloth shades than by sash. The shades are made as follows: Make light but strong wooden frames to fit over the bed, and of a width to receive some common brand of cotton cloth. The cloth may be unbleached and should be stretched over and securely tacked to the frames. We have found that Plant-Bed Cloth, which we have for sale, is superior to any ordinary cloth for this purpose.

**Transplanting.** In transplanting, the main points to be regarded are: Care in taking up the plants so as to avoid injury to the roots, planting firmly so as to enable the plant to take a secure hold of the soil, reducing the top to prevent evaporation, and shading to prevent the hot sun from withering and blighting the leaves. In transplanting from a hot-bed, harden the plants by letting them get quite dry a day or two before, but give an abundance of water a *few hours* before they are taken out. It is most apt to be successful if done just at evening, or immediately before or during the first part of a rain; about the worst time being just *after* a rain, when the ground being wet it is impossible to sufficiently press it about the plant without its baking hard. If water is used at all it should be used freely, and the wet surface immediately covered with dry soil.

**Watering.** The best time to water plants is between sunset and sunrise. Water may be given to the roots at any time, but should never be sprinkled over the leaves while they are exposed to bright sunshine. If watering a plant has been commenced, continue to supply it as it is needed, or more injury than good will result from what has been given. One copious watering is better than many scanty sprinklings. The ground should always be stirred with a hoe or rake as soon after watering as it can be done without making the soil muddy.

**Burlap Hot-Bed Mats.** Lined with wool and cotton quilted.

Size A—40x36 inches \$1.00 each..... Per dozen, \$11.00

Size B—76x76 inches \$1.25 each..... Per dozen, \$14.00.

**Hot Bed Thermometers,** \$1.00 each.



## ASPARAGUS

**Culture**—Sow thinly in rows one foot apart in April or May. Have ground in condition for seed, keep free from weeds. When plants are of suitable height, thin to three or four inches in the rows, saving only the best plants. When one year old transplant into rich sandy loam well mulched with rotten manure. For private use, plant in beds five feet wide three rows to each bed. Never cut too closely. Top dressing every fall with manure, spade this in the spring with two or three pounds of salt to the square yard. One oz. or 60 foot drill, 4 or 5 pounds to the acre.



*Asparagus*

**Conover's Colossal**—The oldest and most reliable variety for market gardeners use. Pkt. 5c; oz. 10c;  $\frac{1}{4}$  lb. 20c; lb. 50c.

**Palmetto**—Earlier than Conover's. Of southern origin but suitable for north also. Large and productive. Pkt. 5c; oz. 10c;  $\frac{1}{4}$  lb. 20c; lb. 50c.

**Columbia Mammoth White**—A new and entirely distinct variety, that produces shoots which are white and stay white as long as fit for use. It is more robust and vigorous in habit and throws up larger shoots and fully as many of them as Conover's Colossal, and requires no earthing up in order to furnish the white shoots so much sought after. Pkt. 5c; oz. 10c;  $\frac{1}{4}$  lb. 20c; lb. 60c.

## Beans==Green=Podded Variety

**Culture**—Beans are rather tender, and should not go into the open ground until all danger of frost is over. Of bush beans, use 1 quart to 100 feet of drill,  $1\frac{1}{2}$  bushel to the acre. Of pole beans, use 1 quart to 125 hills, 10 to 16 quarts per acre. Cover bush beans 2 inches, pole beans 1 inch. Sow bush beans in drills 2 to 4 feet apart, pole beans in hills 4 feet each way. Hoe well in dry weather to keep down the weeds, sow every two weeks for a succession.

**Burpee's Stringless Green Pod**—It is the earliest and most valuable green podded snap bean for the market or house garden. No other green-podded bean is so satisfactory. The pods are a rich green, very round and straight, five inches long, solid, meaty and broad. Pkt. 5c; pt. 15c; qt. 25c.

**Longfellow**—This is an ideal green pod bush bean. It is remarkably early, in fact, it is one of the earliest green pod sort yet offered. It is also a good cropper equal to any of the so-called early varieties. The pods are long, round and perfectly straight, with a soft delicate green color which is preserved almost intact for a long period after picking. The pods are free from that tough, stringy inner lining, which is so common among snap beans. All of these good points, when combined, we think, make *Longfellow* one of the truckers' favorite. Pkt. 5c; pt. 15c; qt. 25c.

## Beans—Continued

**Burpee's Bush Lima** The largest and most prolific of the bush Limas, grows about 20 inches in height and bears an abundance of beans about same size as large white Lima. Pkt. 10c; pt. 20c; qt. 35c.

**Refugee Extra Early**—Similar in every respect to the ordinary Refugee, but is nearly two weeks earlier. It is very prolific and from its earliness is almost certain to produce a crop. In quality it is unexcelled, being exceptionally free from strings and very tender at all stages of growth. Pkt. 5c; pt. 15c; qt. 25c.



*Burpee's Bush Lima.*

**Dreer's Bush Lima** This is a dwarf or semi running type of the Potato Lima. The pods are short, but thick, containing three to four fat short beans which are slightly flattened from being so closely packed in the pods. While later in maturing than Burpee's Bush Lima, the plants are very productive, beans easily shelled and of excellent flavor if gathered before they become dry and mealy. Pkt. 10c; pt. 25c; qt. 40c.

**Early Long Yellow Six Weeks**—Very productive—green pods which are neither flat nor round, often measure eight inches in length. Very desirable for market gardeners. Pkt. 10c; pt. 15c; qt. 25c.

**Improved Early Red Valentine**—This variety is very early and desirable for market or home use, very tender and of excellent flavor, fully ten days earlier than the common Valentine. Pkt. 10c; pt. 15c; qt. 25c.

**Early Mohawk**—Very early and will stand more cold than most bush varieties. Pods are from five to six inches long. Pkt. 10c; pt. 15c; qt. 25c.

**Refugee or 1000 to 1**—This very popular medium or late variety has always been a leader among the market gardeners. The pods are very tender and are of fine flavor. The beans present a handsome appearance, and are largely grown for pickling purposes. Pkt. 10c; pt. 15c; qt. 25c.

**Dwarf Horticultural or Speckled Cranberry**—A dwarf variety of the well known Horticultural pole bean, very prolific and of fine flavor. Pkt. 10c; pt. 15c; qt. 25c.

**White Marrowfat**—A variety largely grown to be sold in the dry state, also valued as a string bean, and one of the best field varieties that can be found. Pkt. 5c; pt. 15c; qt. 25c.

### Beans, Wax-Podded Varieties

**Wardwell Kidney Wax**—Extra early and hardy, very robust and prolific. Shape of beans very distinct from other wax varieties, being of a perfect kidney shape. Pods long and flat and purely wax and not liable to rust or blister, the best for market use. Pkt. 10c; pt. 20c; qt. 40c.

**Davis' Kidney White Wax**—The best white bean for early market use. Pods oval, long and clear waxy color, very productive. Used largely by canners. These pods do not discolor in canning. Pkt. 10c; pt. 20c; qt. 40c.

**Refugee Wax**—A perfect extra early Refugee, with long, round wax pods of a golden yellow color, and of finest quality. Bears immense crops free from rust. Pkt. 10c; pt. 20c; qt. 35c.

## Beans—Continued

**Hodson Wax**—It is an early bean with round pods, requiring forty-five to forty-eight days to make it ready for market. The pod is solid, free from toughness and almost wholly stringless. It is a tender and succulent bean of first rate table quality, and well adapted to nearby markets. It is very handsome in appearance, and entirely rustless, and is a heavy cropper. Pkt. 10c; pt. 15c; qt. 30c.

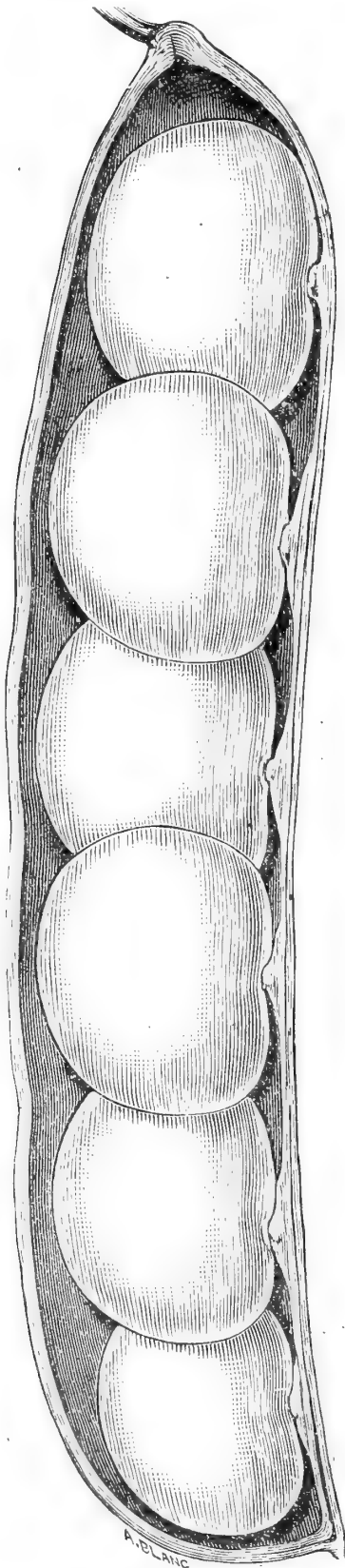

*Lima, Large White, Extra Size*

**Perfection Wax**—Unequaled for productiveness, plant being loaded with long golden yellow pods of handsome appearance and of fine quality. Earlier and larger than the golden wax. Pkt. 10c; pt. 20c; qt. 35c.

**Golden-eyed Wax**—This variety is also classed among the early productive varieties, used largely by market gardeners. Pods of long waxy appearance. Pkt. 10c; pt. 20c; qt. 40c.

**Golden Wax**—Pods long and entirely stringless and of rich golden wax color, very prolific, of dwarf, compact growth. As a snap sort it excels in rich buttery flavor. Pkt. 10c; pt. 20c; qt. 35c.

**New Prolific Black Wax**—An improved strain of the old black wax; a stronger grower, with longer, straighter, and rounder pods, and twice as prolific. Its handsome, yellow, fleshy, stringless pods, commend it for both home and market use. Pkt. 10c; pt. 20c; qt. 40c.

### Pole or Running Varieties

**Lima, Extra Early Jersey**—This particular strain of limas is two weeks earlier than other varieties, making it profitable to the grower on account of earliness and productiveness. Pkt. 10c; pt. 15c; qt. 25c.

**Lima, Dreer's Improved**—These early limas have a distinctive feature of early maturity, large yield and extra quality. Pods thick and of a fine quality. Pkt. 10c; pt. 25c; qt. 45c.

**Lima, Large White Extra Size**—One of the old standard variety. It produces an abundance of pods. The beans are of exceptionally good flavor, excellent for private use. Pkt. 10c; pt. 20c; qt. 35c.

**Horticultural or Speckled Cranberry**—Well-known sort of excellent quality; pods streaked with red same as bean when ripe. Pkt. 10c; pt. 15c; qt. 25c.

**Scarlet Runner**—A popular English pole of excellent flavor, very ornamental, flowers bright scarlet. Pkt. 10c; pt. 25c; qt. 40.

**German Wax. Black**—Old but true sort, excellent for private or market use, fine flavor and somewhat later than the golden cluster wax. Pkt. 10c; pt. 25c; qt. 40c.

**Early Golden Cluster Wax**—The finest of all the wax-podded pole beans. It bears profusely its long yellow pods in clusters of three to six from bottom to top of pole, and continues in bearing from the middle of July till the vines are cut by frost. Pkt. 10c; pt. 15c; qt. 30c.

## BEET

**Culture**—Sow as early in the spring as the ground can be worked, and every two weeks after for a succession, up to the first week of July. For general crop, sow about the middle of May. The soil should be light, sandy loam, well enriched with stable manure and plowed and harrowed until very fine. Sow in drills 1 foot to 15 inches apart, and when well up, thin from 4 to 6 inches. 1 oz. to 50 feet drill; 5 to 6 lbs. per acre.

**Dirego**—This beet has been used by the market gardeners for the past three seasons and has proved to be one of the best early beets in the market. It has little tops, slender stems, smooth skin, flattish round in shape like an orange, and has but one tap root. The flesh is sweet and crisp, the color is rich dark crimson with faint lighter colored rings, especially adapted for frame work. Pkt, 5c; oz. 10c;  $\frac{1}{4}$ lb, 20c; lb, 50c.

**Detroit Dark Red Turnip**—A splendid beet of a dark red color, for home or market. By far the best for canning, on account of its beauty. Small upright tops and perfectly smooth roots, flesh zoned with lighter and darker bands, tender and sweet. Pkt, 5c; oz, 10c;  $\frac{1}{4}$ lb, 20c; lb, 60c.



*Early Golden Cluster Wax.* (See page 6.)

**Egyptian Turnip**—One of the old standard early varieties of dark red color, flesh sweet, flat in shape. Pkt, 5c; oz, 10c;  $\frac{1}{4}$ lb, 15c; lb, 50c.

**Crosby Egyptian**—A distinct improvement on the older forms of Egyptian beet, with a larger and more globular root. It is extremely early and is smooth and of better color and quality than the original sort; in favor with market gardeners for earliest sales. We have the true stock. Pkt, 5c; oz, 10c;  $\frac{1}{4}$ lb, 15c; lb, 50c.

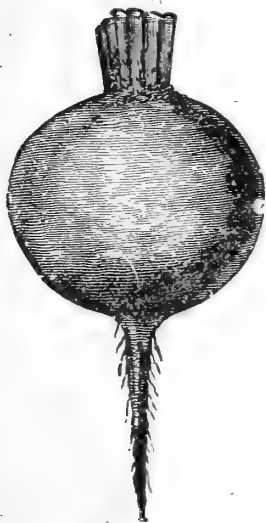

*Dirego.*

**Albani Extra Early Forcing**—An excellent early variety for forcing; exceptionally early, similar in growth to early Crosby, round in shape, dark red, fine flavor. Pkt, 5c; oz, 10c,  $\frac{1}{4}$ lb, 20c; lb 60c.

**Eclipse**—A very popular variety. Very early, of dark red color, both skin and flesh. Almost-spherical in form. Pkt, 5c; oz, 10c;  $\frac{1}{4}$ lb, 15c; lb, 50c.

**Edmund's Blood Turnip**—One of the finest medium early sort, very regular in shape; skin deep blood red, flesh very dark and of good quality. Pkt, 5c; oz, 10c;  $\frac{1}{4}$ lb, 15c; lb, 50c.

**Lentz' Blood Turnip**—Very large beet, small top, as early as Egyptian; flesh tender, sweet at all times. Will produce a crop in about six weeks from time of planting. Pkt, 5c; oz, 10c;  $\frac{1}{4}$ lb, 20c; lb, 50c.

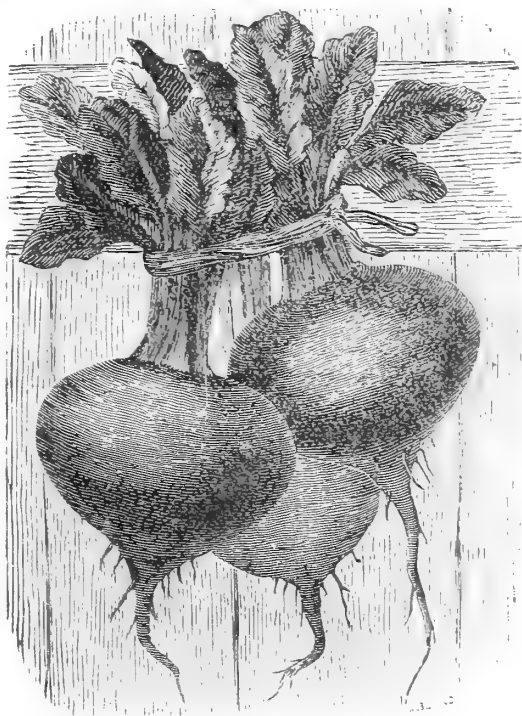

*Eclipse.*



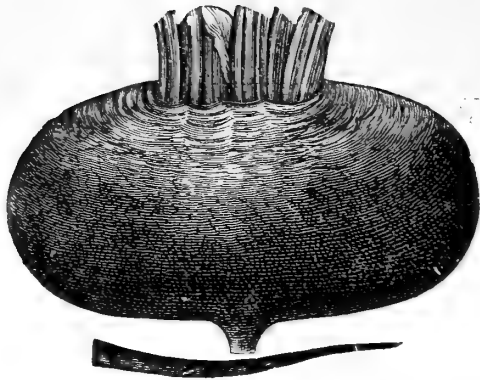

*Dewing's Improved Blood.*

**Dewing Improved Blood Turnip**—Excellent dark red variety, about two weeks earlier than the Blood Turnip; of good uniform size, smooth and rich in color, very tender and sweet. Pkt. 5c; oz. 10c;  $\frac{1}{4}$  lb. 15c; lb. 50c.

**Bastin's Blood Turnip**—This variety is larger than Egyptian, very tender and sweet, retains its blood red color after cooking. Pkt. 5c; oz. 10c;  $\frac{1}{4}$  lb. 15c; lb. 50c.

**Early Blood Turnip**—This old standard blood red variety, is well known by market gardeners. One of the best for family use. Pkt. 5c; oz. 10c;  $\frac{1}{4}$  lb. 15c; lb. 45c.

**Early Bassano Flat**—Flesh almost white, very sweet and tender. Pkt. 5c; oz. 10c;  $\frac{1}{4}$  lb. 15c; lb. 50c.

**Long Smooth Blood**—An old standard variety, very useful for cattle, and eating purposes. Resists drought better than other varieties. Color dark red, flesh sweet. Pkt. 5c, oz. 10c;  $\frac{1}{4}$  lb. 15c; lb. 45c.

**Swiss Chard**—Sometimes called Silver beet. The beet is grown for its leaves. Only the middle of the leaf or midrib is cooked, and served like asparagus. The other portions of the leaf may be used like spinach. The seed should be sown in spring, in drills a foot apart. This beet does not make a large root, but is a delicious summer vegetable when cut young, and used for "greens," or when matured and used in manner already described. Pkt. 5c; oz. 10c;  $\frac{1}{4}$  lb. 15c; lb. 45c.

### Sugar Beet

**Vilmorin's Improved Sugar**—Contains more saccharine matter than any other beet. Fine for cattle or sugar.  $\frac{1}{4}$  lb. 10c; lb. 25c.

**Yellow Sugar**—Fine for stock; a superb variety; a large yielder. Sow from 6 to 8 lb. per acre for sugar beets.  $\frac{1}{4}$  lb. 10c; lb. 25c.

## MANGEL WURZEL

**Culture**—Sow in April or May. The value of these for stock feeding cannot be overestimated; for sheep, dairy stock, and fattening cattle, experience has proved the Mangel Wurzel to be at once healthful, nutritious and economical. 1 oz. 50 ft. drill, 6 lb. per acre.

**Norbition Giant**—One of the largest and most productive mangels ever grown; an enormous cropper.  $\frac{1}{4}$  lb. 10c; 25c lb.

**Yellow Globe**—Roots large and spherical in form. Keeps full as well as other varieties and is well adapted for shallow soils.  $\frac{1}{4}$  lb. 10c; 25c lb.

## BROCCOLI

**Culture**—This plant is suited only for culture in cool, moist locations. It greatly resembles the cauliflower, and is grown in the same manner as the latter, but being more hardy, can be grown in cooler locations, and for late fall use. It is of no value in warm localities, and the heads are not so fine as the cauliflower.

**Purple Cape**—Close heads of brownish purple color. Pkt. 10c; oz. 25c;  $\frac{1}{4}$  lb. \$1.00; lb. 3.50.

**White Cape**—Differs only in color from above variety. Pkt. 10c; oz. 30c;  $\frac{1}{4}$  lb. \$1.10, lb. \$4.00.

*Brussels Sprouts.*

## Brussels Sprouts

**Culture**—Plants should receive the same culture as cabbage. The numerous small heads are formed at each leaf joint on the stalk. They are very hardy and are much improved in sweetness and quality, by frost. 1 oz., 2,000 plants,  $\frac{1}{2}$  lb. to the acre.

**Improved Dwarf**—This produces sprouts of compact and excellent quality. This is the best variety for home and market use. Pkt. 10c; oz. 20c;  $\frac{1}{4}$  lb. 45c; lb. \$1.50.

## CABBAGE

**Culture**—All that the cabbage tribe requires is the soil to be rich, deep, well drained and abundantly manured. For the early kind plant thirty inches between the rows and sixteen inches between the plants. For late kind, three feet between the rows and two feet between the plants. For very early use, sow in January or February in hot beds. Set out when the plants are strong enough, into other hot beds, or set in cold frames in March. Transplant when danger from frost is past, to the open ground. For a succession, sow in open ground last of March or early in April. Late plants are sometimes subject to attack of cabbage fly, which destroys them as fast as they appear above ground. To prevent this destruction, sprinkle the plants with wood ashes when the plants are wet with dew. 1 oz., 1,500 plants,  $\frac{1}{2}$  lb. to the acre.

**Early Jersey Wakefield. Extra Selected**—Well known variety and invaluable for home or market use; heads pointed, and by far the earliest sort, heads of this variety being harder and more compact than other early cabbage. Northern market gardeners wholly depend on this for their first crop. Pkt. 10c; oz. 25c;  $\frac{1}{4}$  lb. 75c; lb. \$2.50.

**Charleston Wakefield**—Heads larger than above variety; not quite as early but a finer variety. Pkt. 10c; oz. 30c;  $\frac{1}{4}$  lb. 90c; lb. \$3.25.

**Burpee's All-Head Early**—This is the earliest of the flat head cabbages by at least one week, and fully one third larger than any other early summer cabbage. The deep flat heads are remarkably solid and the most uniform in color, form and size, of any variety. The heads grow so compactly and so free from spreading leaves, that more cabbage can be obtained from an acre. Pkt. 10c; oz. 30c;  $\frac{1}{4}$  lb. \$1.00; lb. \$3.50.

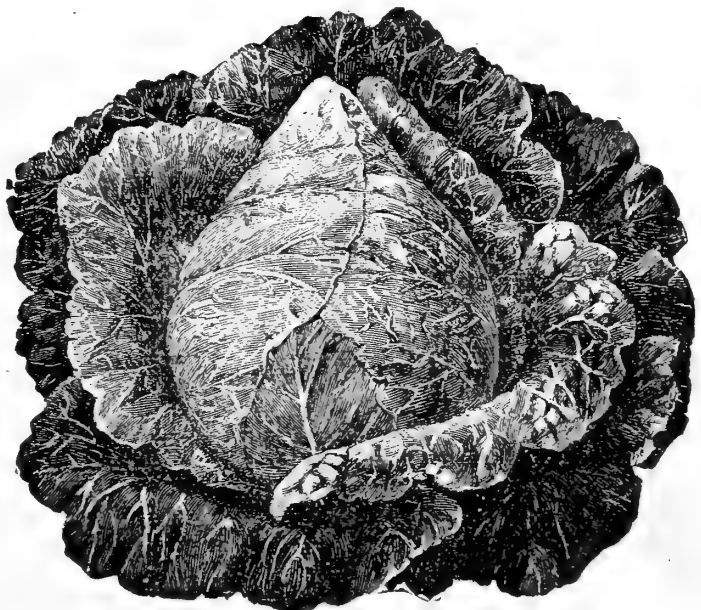
*Early Jersey Wakefield.*

## Cabbage—Continued

**Early Winningstadt**—One of the best for second early, size of heads, medium, fine keeper both early and late. Useful for summer or winter. Heads very solid. Pkt. 5c; oz. 15c;  $\frac{1}{4}$  lb. 40c; lb. \$1.25.



*Early Winnigstadt.*

**Henderson's Early Summer**—A second early variety, about one week later than Jersey Wakefield. Heads much larger and will stand in ground longer than any of the early sorts, without bursting. Heads of uniform shape; are solid and of excellent quality. Pkt. 10c; oz. 15c;  $\frac{1}{4}$  lb. 55c; lb. \$2.00.



*Henderson's Early Summer.*  
(See page 9.)

**Selected Newark Flat Dutch**—For second or medium early, this superb variety is unsurpassed; heads large and flat and of excellent quality. Pkt. 10c; oz. 20c;  $\frac{1}{4}$  lb. 75c; lb. \$2.50.

**Early Deep Head**—Very fine early variety. Pkt. 5c; oz. 20c;  $\frac{1}{4}$  lb. 65c; lb. \$2.25.

**Vandergraw**—An old reliable variety, medium early, grows quickly, heads flat, sure to head. Pkt. 10c; oz. 25c;  $\frac{1}{4}$  lb. 75c; lb. \$2.75.

**Henderson's Early Spring**—The earliest flat headed variety. Very solid and of fine quality. Although it does not come to full maturity as early as the Jersey Wakefield, it becomes solid enough for use about as early, and is by far the best early sort for those markets that demand a cabbage of the flat Dutch type. Pkt. 5c; oz. 25c;  $\frac{1}{4}$  lb. 90c; lb. \$2.50.

**Fottler's Improved Brunswick**—The best second early cabbage in cultivation. The heads are large, solid and compact, flat on top with very few outside leaves. This variety is invaluable for early fall use, used largely by factories, also truckers. Pkt. 5c; oz. 20c;  $\frac{1}{4}$  lb. 60c; lb. \$2.25.

**Henderson's Succession**—This variety is unsurpassed as second early; comes into market about one week later than Early Summer; has no tendency to run to seed. Heads large and uniform, very hardy, averaging in weight from ten to twelve pounds. Fine for late or medium crop. We consider it one of the finest cabbages ever introduced. Pkt. 10c; oz. 25c;  $\frac{1}{4}$  lb. 80c; lb. \$3.00.

**Autumn King**—One of the best late varieties, heads often averaging fifteen to eighteen pounds; interior of the heads creamy white, solid and by far the best keeper. Autumn King may be planted closer together than any other variety. Leaves crimped in appearance, making this a distinct variety. Pkt. 10c; oz. 25c;  $\frac{1}{4}$  lb. 75c; lb. \$2.75.

**All Seasons**—Heads very large, solid, round. Pkt. 10c; oz. 20c;  $\frac{1}{4}$  lb. 75c; lb. \$2.50.

**Sure Head**—This variety is always sure to head, with few outer leaves; very strong grower, heads uniform, excellent for late crop. Pkt. 5c; oz. 20c;  $\frac{1}{4}$  lb. 65c; lb. \$2.25.

## Cabbage—Continued

**Danish Bald Head**—This variety is the best for winter use and always commands a price double that brought by others. Heads medium, as hard as a stone. Even the smaller heads are salable on account of their solidity. Our seed is of Danish origin, and cabbage grown from this seed keeps well into the spring; quality is superior to all other winter varieties. Pkt. 5c; oz. 25c;  $\frac{1}{4}$  lb. 75c; lb. \$2.50.

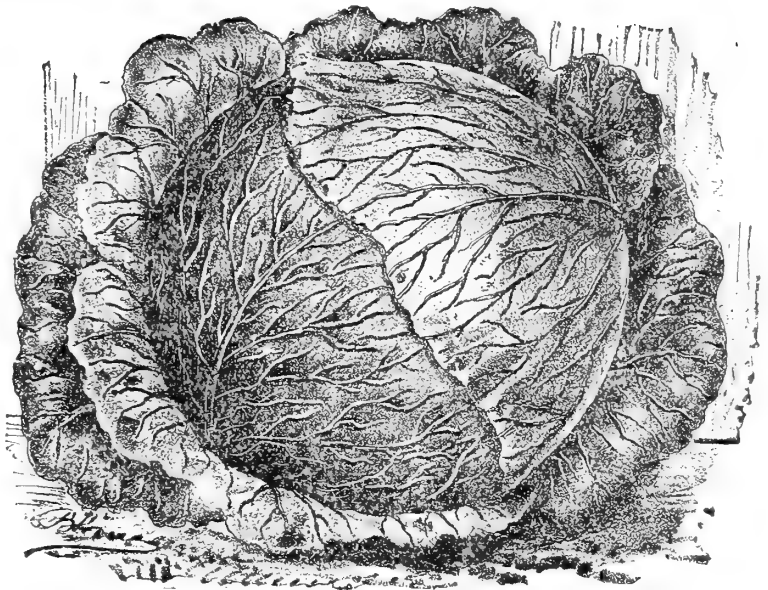

*Danish Bald Head*

**Excelsior Flat Dutch**—Old standard variety. Heads flat, solid, very good for late crop. Pkt. 5c; oz. 20c;  $\frac{1}{4}$  lb. 60c; lb. \$2.00.

**Premium Flat Dutch**—Superb winter variety for market use. Heads flat and large. Pkt. 5c; oz. 20c;  $\frac{1}{4}$  lb. 60c; lb. \$2.00.

**Lupton**—This variety has been named after its originator and is largely grown on Long Island among the truckers. A fine variety for medium to late. Pkt. 5c; oz. 25c;  $\frac{1}{4}$  lb. 75c; lb. \$2.50.

**Bristol Improved**—Extra strain suitable for heavy loam, heads large, solid and flat, excellent for late use. Pkt. 5c; oz. 20c;  $\frac{1}{4}$  lb. 65c; lb. \$2.50.

**Large Late Drumhead**—A standard winter variety for main crop. Grows large sized heads; shape of heads round and compact, fine keeper during the winter months. Pkt. 5c; oz. 20c;  $\frac{1}{4}$  lb. 65c; lb. \$2.50.

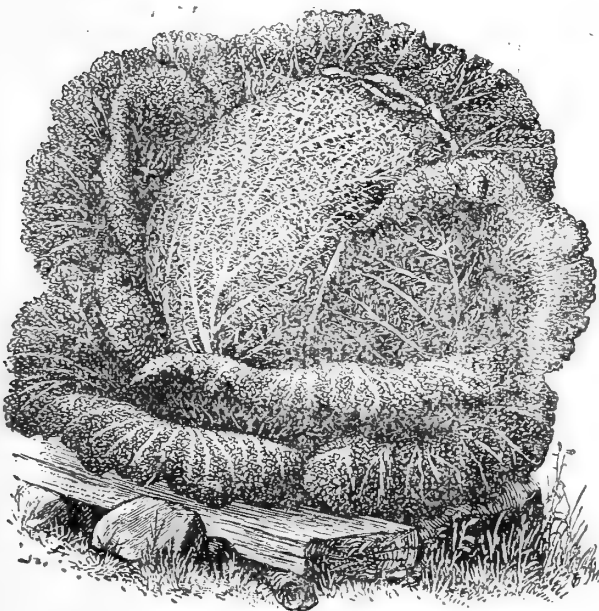

*Drumhead Savoy*

**Drumhead Savoy**—The Savoy cabbages are noted for their fine and delicate flavor. The leaves are wrinkled in a peculiar and characteristic manner. The heads in this strain of Savoy are large and compact and of a most attractive appearance. It is an excellent winter keeper and we recommend it to market gardeners and amateurs. Pkt. 5c; oz. 20c;  $\frac{1}{4}$  lb. 60c; lb. \$2.00.

**Mammoth Rock Red**—The best and largest of the red cabbages; late and used largely for pickling. Retains same deep red color through the center of head. Heads weigh from ten to twelve pounds. Pkt. 10c; oz. 25c;  $\frac{1}{4}$  lb. 85c; lb. \$3.00.

**Warren's Stone Mason**—This is a popular variety among New England growers, being a sure header. It makes a deep round and very hard head, the outer leaves arching above it handsomely. In reliability for heading, no cabbage sur-

passes it; it gives general satisfaction and we can recommend it. Pkt. 5c; oz. 20c;  $\frac{1}{4}$  lb. 65c; lb. \$2.50.

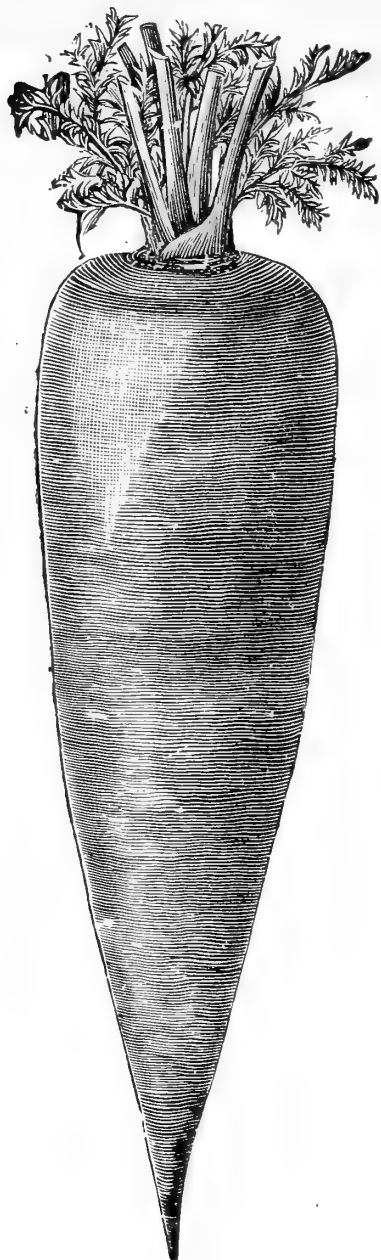

*Intermediate, or Danver's  
Pointed.*

## CARROT

**Culture**—Carrots are grown largely both for feeding to stock and culinary purposes; the long variety used for the former, the "Horn" and medium sorts for the latter. The "Horn" sorts can be grown on thin soil and mostly for early use. The others prefer deep, sandy loam that was well manured the previous year for some other crop, such as potatoes or onions. Sow in April or May about one inch deep in drills fifteen inches apart for garden sorts, the rows in field culture should be two feet apart, according to variety. 1 oz. will sow 100 feet drill, 4 lbs. to the acre.

**Extra Early French Forcing**—This early variety is especially adapted for hot bed use. They mature earlier than any other variety. Roots short. Pkt. 5c; oz. 10c;  $\frac{1}{4}$  lb. 25c; lb. 80c.

**Guerande or Ox-Heart**—This strain has exceptionally fine flavor and very desirable for table use; color bright orange, roots short and thick. Pkt. 5c; oz. 10c;  $\frac{1}{4}$  lb. 25c; lb. 80c.

**Early Scarlet Horn**—Largely grown for early use either in hot bed or out-of-door. Roots short. Pkt. 5c; oz. 10c;  $\frac{1}{4}$  lb. 25c; lb. 80c.

**Nantese**—This is the sort so common in the markets of New York and vicinity. It attains only a medium size, but is admirably adapted to bunching; good for either hot beds or out-of-door. Pkt. 5c; oz. 10c;  $\frac{1}{4}$  lb. 25c; lb. 80c.

**Danver's True**—There are many varieties called Danver's carrot, but we offer only true stock. This strain is very productive and an immense yielder. Our strain of Danver's will produce more bushels of carrots to the acre than many of the longer varieties. Color rich orange, large at top, stump rooted and very smooth. Pkt. 5c; oz. 10c;  $\frac{1}{4}$  lb. 25c; lb. 80c.

**Chantenay**—This variety is half long stump-rooted, has broad shoulders and is very productive; one of the best for bunching purposes. The Chantenay has a tendency of being smooth and very easily dug, it also holds its top during the hot summer months. Color bright yellow. Pkt. 5c; oz. 10c;  $\frac{1}{4}$  lb. 25c; lb. 90c.

**Intermediate or Danver's Pointed**—A medium long variety tapering generally from the shoulder, which averages about three inches in diameter at the top. Color bright. Smooth and very productive. Pkt. 5c; oz. 10c;  $\frac{1}{4}$  lb. 20c; lb. 65c.

**Long Orange Improved**—This old reliable sort has won its reputation among the farmer and dairymen as the best and most productive carrot to be grown for feeding cattle; grows larger than any other variety, and has a deep orange color. Pkt. 5c; oz. 10c;  $\frac{1}{4}$  lb. 20c; lb. 70c.

**New Intermediate**—A variety growing very smooth, of medium length. Color bright orange, very productive and unequalled for table use. Pkt. 5c; oz. 10c;  $\frac{1}{4}$  lb. 20c; lb. 70c.



## CAULIFLOWER

**Culture**—Cauliflower is the most delicate and delicious of the cabbage family. For the production of the cauliflower, a rich deep loam is required, a low moist situation being preferable. A liberal supply of water when possible produces very marked results. Seed of the very early variety should be sown in a hot bed in February or March. For later supply, sow seed in May, choosing a cool moist place. When large enough, transplant, making the rows about 2½ feet apart, and 18 inches between the plants. Transplanting should be done in damp weather.

1 oz. of seed produces about 1,500 plants.

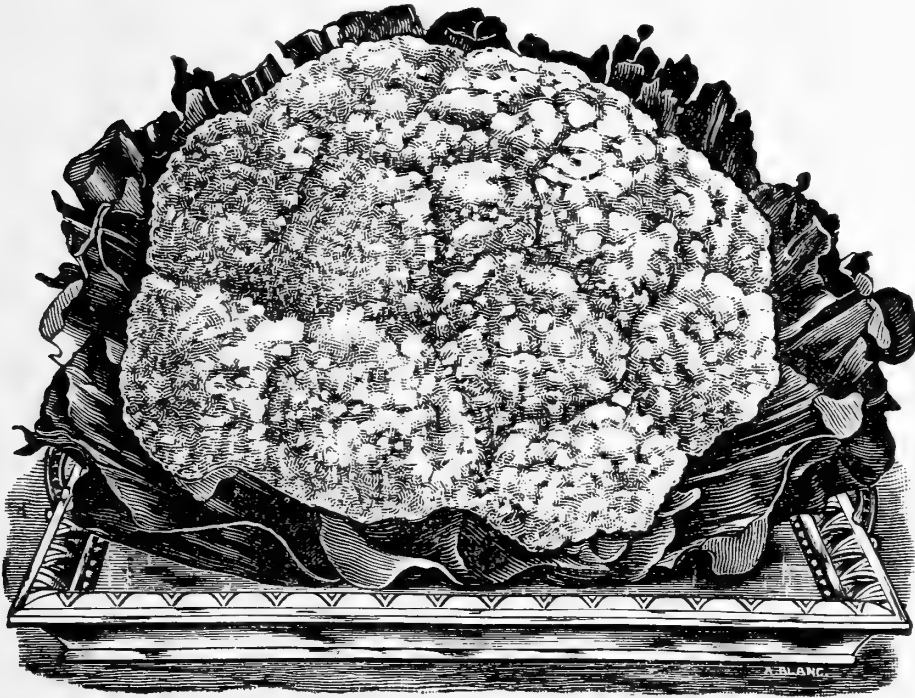

*Henderson's Snowball.*

**Y. & H. Private Stock Snowball**—This, the finest of all cauliflowers, has fully maintained all the merits we claim for it. It is remarkable for its earliness and certainty with which the plants produce fine heads. In good soil, the heads measure from 8 to 10 inches across. Pure snowy white, with very close compact heads of extra fine quality. This seed is especially selected for us in Germany, and market gardeners growing cauliflower on a large scale can plant this variety with full assurance that it is the choicest and

most reliable strain that can be procured. Pkt. 25c; ¼ oz. \$1.00; 1 oz. \$3.75.

**Henderson's Early Snowball**—This is not the common snowball many dealers put on the market, but is seed which is grown from Henderson's true stock in Denmark and is superior to other so-called snowball cauliflowers. It can be used both early and late. This cauliflower forms a fine white head. Careful attention in the matter of destroying insects and watering, will be repaid. Pkt. 25c; ¼ oz. 75c; oz. \$2.50.

**Large Late Algiers**—This is one of the best large late varieties. It is largely grown for fall use, never failing to produce fine large heads, very popular with canners. Pkt. 10c; ¼ oz. 25c; oz. 75c.

**Le Normand's Short Stem**—Large late variety, of excellent quality, stem short, mammoth heads, well formed. Pkt. 10c; ¼ oz. 25c; oz. 75c.

**Early Dwarf Erfurt**—Dwarf, and very solid, pure heads of fine quality. Pkt. 20c; ¼ oz. 60c; oz. \$2.00.

## CELERY

**Culture**—Celery seed is slow to germinate, and allowance must be made for that fact, and ample time given. It must be sowed with care, and covered very lightly with the finest soil and kept constantly moist. It may be started under glass, but seed for main crop is always sowed in the open boarder and transplanted to garden or field. We recommend smooth seed rows, two or three inches wide, with the seed scattered thinly thereon; if set in the field in four feet rows, six inches apart in row, it will require over 20,000 plants to the acre. When the seedling plants are three inches high, their tops should be clipped to favor stocky growth. Trench culture has been mostly abandoned for level culture, as the self blanching sorts require little hilling. In private gardens it is best to plant late celery in double rows, and store it where it grows, without disturbing the roots. In market gardens it is planted in single rows and lifted for winter storage. 1 oz. about 5,000 plants. 4 oz. per acre.

## Celery—Continued

**Golden Self-Blanching**—This is the best celery in cultivation today, and is certainly the most popular. It gives the largest return for the least labor. It ranks, in quality, with the highest; it is in equal favor with the amateur and the market gardener, and is of a half dwarf habit, growing about 18 or 20 inches high, very stocky, perfectly hardy, of delicious flavor and a good keeper. It requires the same early cultural treatment as other sorts of celery up to, and including handling, except that the rows may be set closer together, as it will need no banking. The handling should be thoroughly and carefully done in order to give the stalks a compact, upright close position to encourage blanching, and to favor the growth of the heart. Our seed of this particular strain is foreign grown, which is far better than American grown seed. Pkt. 10c; oz. 35c;  $\frac{1}{4}$  lb. \$1.10; lb. \$4.00.

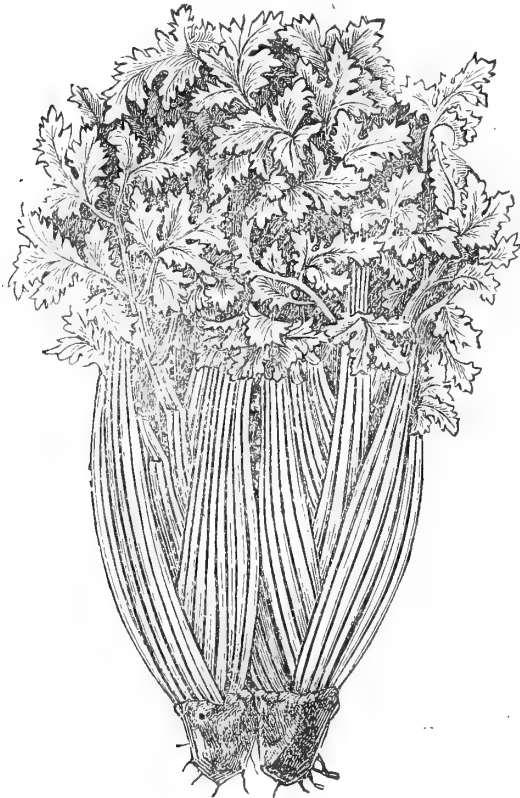

*White Plume, Extra Selected.*

**Crawford's Half Dwarf**—A very good variety of vigorous growth and excellent flavor. Pkt. 10c; oz. 20c;  $\frac{1}{4}$  lb. 60c; lb. \$2.00.

**Golden Heart**—A distinct variety of sturdy dwarf habit. It is solid and an excellent keeper, of the nutty flavor. The hearts when blanched present a fine appearance, being full center. Very desirable for market or private use. Pkt. 5c; oz. 15c;  $\frac{1}{4}$  lb. 50c; lb. \$1.50.

**Pink Plume**—Similar to white plume, but of better flavor, superb quality, and when prepared for the table makes a beautiful dish; stalks white, with lines of bright pink on the outside. Pkt. 10c; oz. 30c;  $\frac{1}{4}$  lb. 90c; lb. \$3.50.

**Céleriace or Turnip Rooted Celery**—Sow the seed and cultivate the same as celery with the exception of hilling, as céleriace or knob celery needs no earthing up, and may be planted in rows one foot apart.

**Large Early Erfurt**—Roots not so large as Prague céleriace; used for soups and stews. Pkt. 5c; oz. 20c;  $\frac{1}{4}$  lb. 50c; lb. \$2.00.

**Golden Jewel**—Fine variety for early, produces fine stalks and is self-blanching. It requires the same treatment as Golden Self-Blanching. Pkt. 10c; oz. 35c;  $\frac{1}{4}$  lb. \$1.10; lb. \$4.00.

**White Plume, Extra Selected**—Best celery for early fall use, leaves and heart white, requires very little banking to be ready for use. This variety is an improvement on the common white plume, and gives perfect satisfaction. Pkt. 10c; oz. 30c;  $\frac{1}{4}$  lb. 90c; lb. \$3.00.

**New Giant Pascal**—This choice celery partakes of the sweet, nutty flavor of Golden Self-Blanching, of which it is an offspring. The height is about two feet; the stalks are thick, solid and stringless, and almost as brittle as glass; it blanches easily and keeps well. Pkt. 5c; oz. 20c;  $\frac{1}{4}$  lb. 50c; lb. \$1.75.

**Boston Market**—An old standard sort of widely known excellence. When blanched it is crisp, tender and finely flavored. It is of medium height but a vigorous grower, will blanch early and is a fine keeper. Pkt. 5c; oz. 20c;  $\frac{1}{4}$  lb. 60c; lb. \$2.00.



*New Giant Pascal.*

## Celery—Continued

**Perfection Hartwell**—An excellent large, solid growing variety of creamy white color, a fine variety for market and a good keeper. Pkt. 10c; oz. 20c;  $\frac{1}{4}$ lb. 60c; lb. \$2.00.

**Large Smooth Prague**—The best of all turnip rooted celery. Large roots and smooth, almost round. This plant is of vigorous growth and when once used no other variety will do. Pkt. 5c; oz. 20c;  $\frac{1}{4}$ lb. 50c; lb. \$2.00.

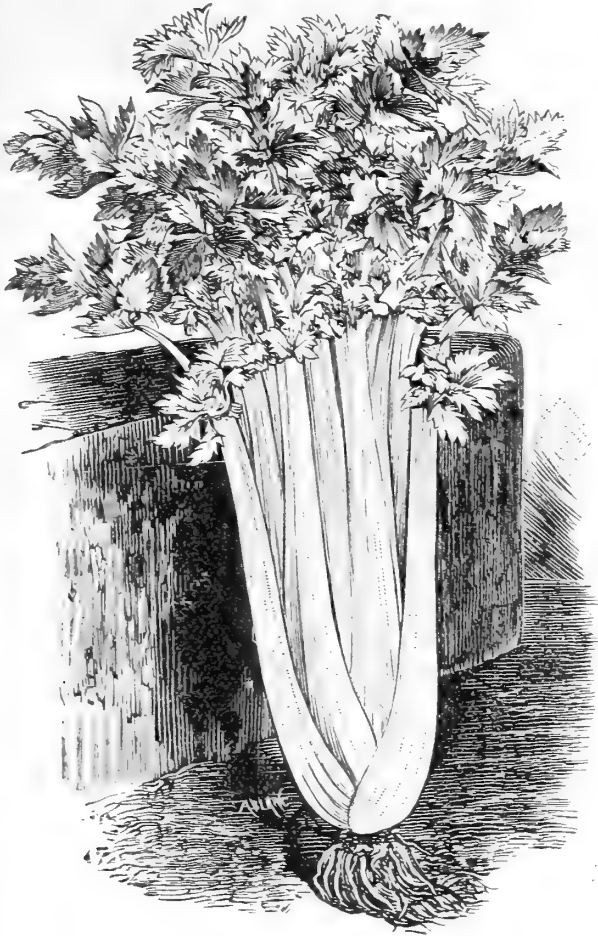

*Perfection Hartwell.*



*Large Smooth Prague.*

## Corn Salad or Fetticus

**Culture**—This is a hardy, quick growing plant, the leaves of which furnish a good substitute for lettuce during the winter months. Seed is best sown on the approach of cool moist weather in the fall to produce leaves for late fall, winter and early spring use. It is quite hardy, and the larger plants may be protected by a light mulch of straw during severe weather for early spring months. It does not give satisfaction during hot summer months.

**Large Seeded**—Oz. 10c;  $\frac{1}{4}$ lb. 20c; lb. 60c.

## Cress or Pepper Grass

**Culture**—Sow seed in shallow drills, every two or three weeks, and cut often. It will continue to grow. Very useful for salad.

**True Water Cress**—Sow where it is damp, near water edge, or on outside margin of a hot bed where it is always cool. Pkt. 20c; oz. 40c;  $\frac{1}{4}$ lb. \$1.50; lb. \$5.00.

**Curled or Pepper Grass**—Pkt. 5c; oz. 10c;  $\frac{1}{4}$ lb. 20c; lb. 60c.



*Corn Salad.*

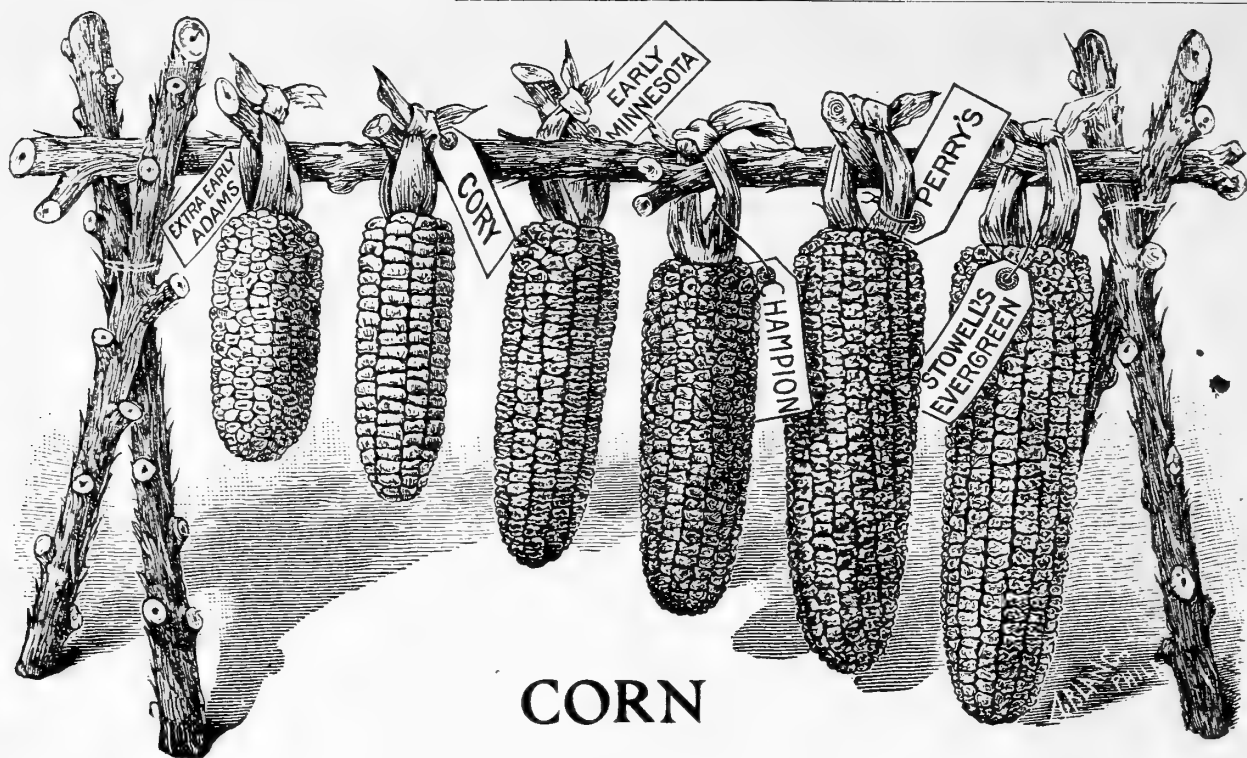

## CORN

**Culture**—Plant as soon as the ground becomes warm in the spring, in hills about three feet apart; five or six grains to the hill, and when up thin them out, allowing three or four of the strongest plants to remain; give thorough cultivation. Our sweet corn is carefully grown and selected, only the choicest, most perfect ears being shelled for seed. Planting corn at different times, will enable the grower to have corn until killed by frost. 1 qt., 200 hills; 10 qts. to the acre.

**Extra Early Adams**—A VERY EARLY twelve-rowed Dent Corn. \$3.00 per 100 ears.

**Red Cob, Cory**—This is one of the earliest sweet corns. It was originated in Rhode Island by a market gardener named Cory, and for years headed the list of quick growing varieties. Very dwarf, and may be closely planted, two ears to a stalk; cob red, fit for use in fifty-two days from planting. Pt. 10c; qt. 20c; 4 qts. 65c; peck \$1.00.

**Extra Selected White Cob, Cory**—This has for years been the most popular variety with market gardeners, for first early market, and until the introduction of the *Troy Market* it was grown more largely than any other early variety. It is of a dwarf growth and yields well, ears being of medium size. Pt. 10c; qt. 20c; 4 qts. 65c; pk. \$1.00.

**Troy Market**—*The largest eared and Best early True Sweet Corn.* This grand new variety produces fine large ears. In size of ear and fine quality, it equals the best second earlies, such as *Champion* or *Crosby*. The stalks grow about 5 feet high, the ears are of most handsome appearance. The cob is pure white and the ear holds its thickness throughout the entire length, and is well filled. It is needless for us to say anything more about this corn, as it speaks for itself, and those who have grown it say that it is the finest corn they have ever grown. Pt. 15c; qt. 30c; 2 qts. 50c; 4 qts. 75c. Short crop.

**Burpee's First of All**—The first of all is ready for the table about three days earlier than the *Cory*, making it very desirable not only for family gardens, but extremely valuable to grow for the market, where the earliest corn brings the best price. The ears are of medium size, well filled with grain to the very tip. In habit of growth it is rather dwarfer than the *Cory*, although similar in appearance. Pt. 10c; qt. 20c; 4 qts. 65c; pk. \$1.00.

**Perry's Hybrid**—Very early, of large size, valuable for market. One of the well known standard sorts. Pt. 10c; qt. 20c; 4 qts. 50c; pk. 85c.

**Early Minnesota**—A standard early variety that has held a high place in the list of sweet corns ever since its introduction. The ears are

of good size, well flavored, and of the best cooking qualities. Pt. 10c; qt. 20c; 4 qts. 65c; pk. \$1.00.



*Burpee's First of All*



## Corn—Continued.



*Early Mammoth.*

peg-tooth shaped. One of the best. Pt. 10c; qt. 20c; 4 qts. 60c; pk. 85c.

**Black Mexican**—Although the ripe grain is black, or bluish black, the corn, when in condition for table, cooks remarkably white, and is surpassed by none in tenderness. This, by many, is considered the most desirable for family use. Will stand more hot, dry weather than any other. Pt. 10c; qt. 20c; 4 qt. 60c; pk. 85c.

**Large Late Mammoth**—The name of the variety fully describes the size of the ears. They are of immense size, excellent quality, enormous yielder, very sweet. Pt. 10c; qt. 20c; 4 qts. 60c; pk. 85c.

## CUCUMBER

**Culture**—Cucumbers flourish best in a rich, warm, moist loam. Sow when danger of frost is over, in hills four or five feet each way or in rows. The seed should be used in abundance, as the young plants have many enemies. Plant half an inch below the surface and thin out finally to three or four plants to the hill. The cucumber should be gathered (by cutting not tearing) every day or every other day; leave none to ripen if you want a full crop. Sprinkle the vines with *plaster* to protect them from bugs, or use *Bug Death* to kill the bugs. 1 oz., 75 hills; 3 lbs. to the acre.

**Early Russian**—The earliest cucumber in cultivation, and one of the smallest, being only about three inches long. It is hardy and very prolific; adapted to pickling and also table use, as it is of high quality. It is solid, with few seeds.

On account of its earliness is adapted to sections having short growing seasons. Pkt. 5c; oz. 15c;  $\frac{1}{4}$  lb. 50c; lb. \$1.75.

**Early Green Cluster**—A short, prickly, seedy variety growing in clusters. Pkt. 5c; oz. 15c;  $\frac{1}{4}$  lb. 50c; lb. \$1.75.

**Short Green, or Early Frame**—An old sort still in favor, and used for pickles. It is of medium size, straight and handsome. At maturity is a good table cucumber. Pkt. 5c; oz. 15c;  $\frac{1}{4}$  lb. 50c; lb. \$1.75.

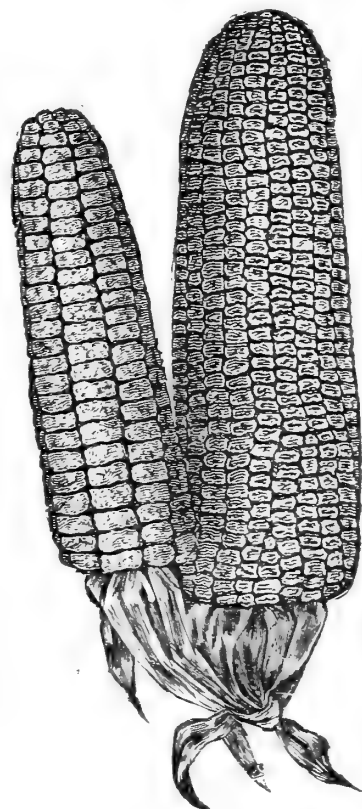

*Large Late Mammoth.*

**Shaker's Early**—Very large ears of fine quality, grains white and quite early. Pt. 10c; qt. 20c; 4 qts. 60c; pk. 85c.

**Stabler's Pedigree**—This variety is excellent for main crop; ears very large, and of finest quality, very profitable for market or canning. Pt. 10c; qt. 20c; 4 qts. 60c; pk. 85c.

**Crosby**—Early, and a great favorite. Rather small ears, but productive and of excellent quality. Pt. 10c; qt. 20c; 4 qts. 60c; pk. 85c.

**Early Mammoth**—Very large ears, and much earlier than late Mammoth. Very fine quality. Pt. 10c; qt. 20c; 4 qt. 60c; pk. 85c.

**Hickox Improved**—Earlier than Stowell's Evergreen, and makes a large attractive ear of white and handsome grain. It is one of the best varieties for canner's use. By planting it at the same time as Stowell's Evergreen, the season will be lengthened considerably, as the Hickox will be about through by the time the Evergreen comes in. Very prolific; ordinarily every stalk will produce two large fully developed ears. Pt. 10c; qt. 20; 4 qts. 60c; pk. 85c.

**Stowell's Evergreen**—One of the best of the late varieties of sweet corn. Ears large and of excellent flavor. This variety is too well-known throughout the country to need further description. Pt. 10c; qt. 20; 4 qt. 60c; pk. 85c.

**Champion**—This variety is second early, sweet, desirable for market use. Ears good size. Pt. 10c; qt. 20c; 4 qt. 60c; pk. 85.

**Country Gentleman**—Late variety, large ears averaging from nine to ten inches, cob white and small, kernels large and



## Cucumber—Continued

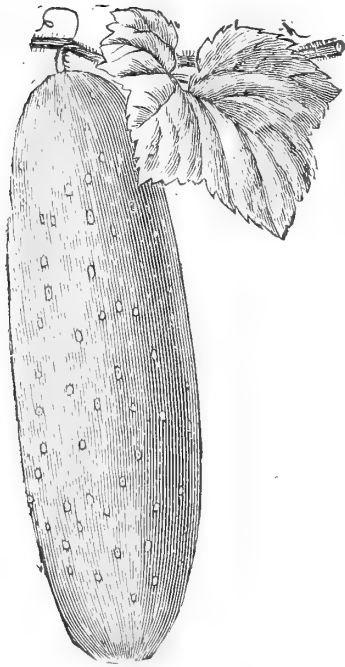

*Improved White Spine.*

**Y. & H. Improved Early White Spine**—This cucumber cannot be praised too highly. It is nothing more nor less than an extra fine type of what is unquestionably the best and most widely grown variety in America. It is unsurpassed as a table and market sort, and is also used for pickling. No other kind exceeds it in productiveness, and it is equally good for forcing under glass or grown in the open air. The fruit is from five to seven inches long, or two to three inches in diameter. Color a beautiful bright green (see illustration). Pkt. 5c; oz. 15c;  $\frac{1}{4}$  lb. 50c; lb. \$1.75.

**Arlington White Spine**—The earliest for pickling; is largely used by market gardeners, and is a leader. Pkt. 5c; oz. 15c;  $\frac{1}{4}$  lb. 50c; lb. \$1.75.

**Peerless**—A noted pickling cucumber. It is very prolific, early, of good size, straight, well formed and full at both ends. It carries its deep green color until it reaches maturity, which is a very desirable characteristic. It is one of the best strains of pickling cucumbers on the market. Pkt. 5c; oz. 15c;  $\frac{1}{4}$  lb. 50c; lb. \$1.75.

high place in the list of pickling sorts, and second to none for slicing when matured. Useful for forcing; color dark green, flesh crisp and tender, size medium, always straight and smooth, and uniform in appearance. Grown largely for supplying pickle factories. Pkt. 5c; oz. 15c;  $\frac{1}{4}$  lb. 50c; lb. \$1.75.

**Long Green**—This fine cucumber grows from 12 to 16 inches or more in length and is of superior quality. The young fruits are very largely used for pickling, and it is a standard sort for that purpose. Full size cucumbers are in high favor for making the so-called sweet pickles; vines are strong growers, and the fruit is always produced in great abundance making it one of the most productive varieties in cultivation. We have a fine stock. Pkt. 5c; oz. 15c;  $\frac{1}{4}$  lb. 50c; lb. \$1.75.

**Green Prolific**—This is one of the most popular pickling cucumbers. It is of the very best form and quality, and has yielded at the rate of over 200,000 pickles per acre. The fruit is uniform in shape and appearance and its enormous productive ability makes the variety a favorite one with pickle growers and gardeners. Pkt. 5c; oz. 15c;  $\frac{1}{4}$  lb. 50c; lb. \$1.75.



*Long Green.*

**Thorburn's Everbearing**—This is a very unique and highly meritorious pickling variety; meritorious because of its quality, and unique in its ability to go right on bearing, whether the ripened cucumbers are picked or not. It is enormously productive, and a general favorite. Fruits of every age, and also blossoms may be found on a single vine, and bearing continues until the coming of frost. Pkt. 5c; oz. 15c;  $\frac{1}{4}$  lb. 50c; lb. \$1.75.

**Westerfield's Chicago Pickling**—This variety is preferred above all others by the largest pickling establishments in Chicago and elsewhere. It is one of the best for the purpose. Pkt. 5c; oz. 15c;  $\frac{1}{4}$  lb. 50c; lb. \$1.75.

**Boston Pickling**—A favorite eastern sort of superb quality. Pkt. 5c; oz. 15c;  $\frac{1}{4}$  lb. 50c; lb. \$1.75.

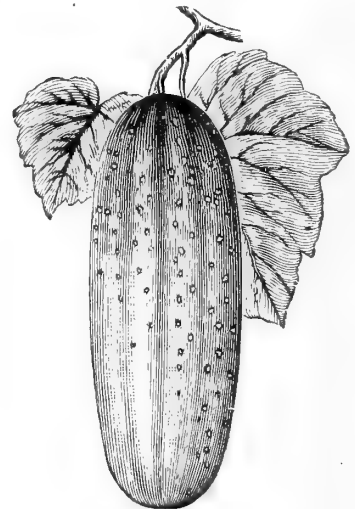

*Peerless.*

*Y. & H. Improved Early White Spine Cucumber*

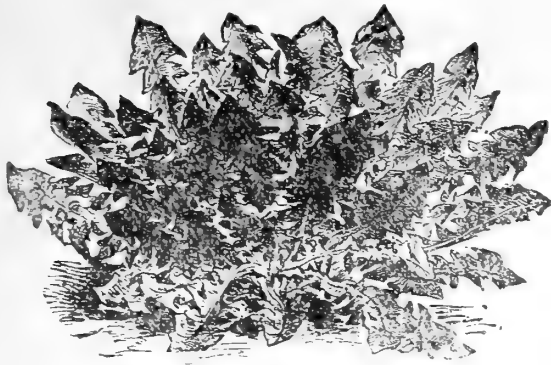
*Dandelion*

blanching may be done by placing a couple of boards over the rows; this excludes the light, and improves the greens, rendering them far superior to those found growing wild in the grass without cultivation, which are almost sure to be bitter, and often very tough.

**French Garden—**

Pkt. 10c;  $\frac{1}{2}$  oz.  
40c; oz. 75c.

**Improved Thick Leaf—**

Pkt. 10c;  $\frac{1}{2}$  oz.  
40c; oz. 75c.

## DANDELION

**Culture**—The dandelion is a hardy perennial plant, and one of the most desirable early spring salads. Sow in the early spring, in drills one half inch deep and eighteen inches apart; thin out the plants to eighteen inches. Keep clear of weeds during the summer and the ensuing spring the leaves will be fit to cut. They are the best however, where blanched, which makes them tender, and destroys to some extent, their bitter taste, without in any way impairing the qualities which makes them desirable as greens. The

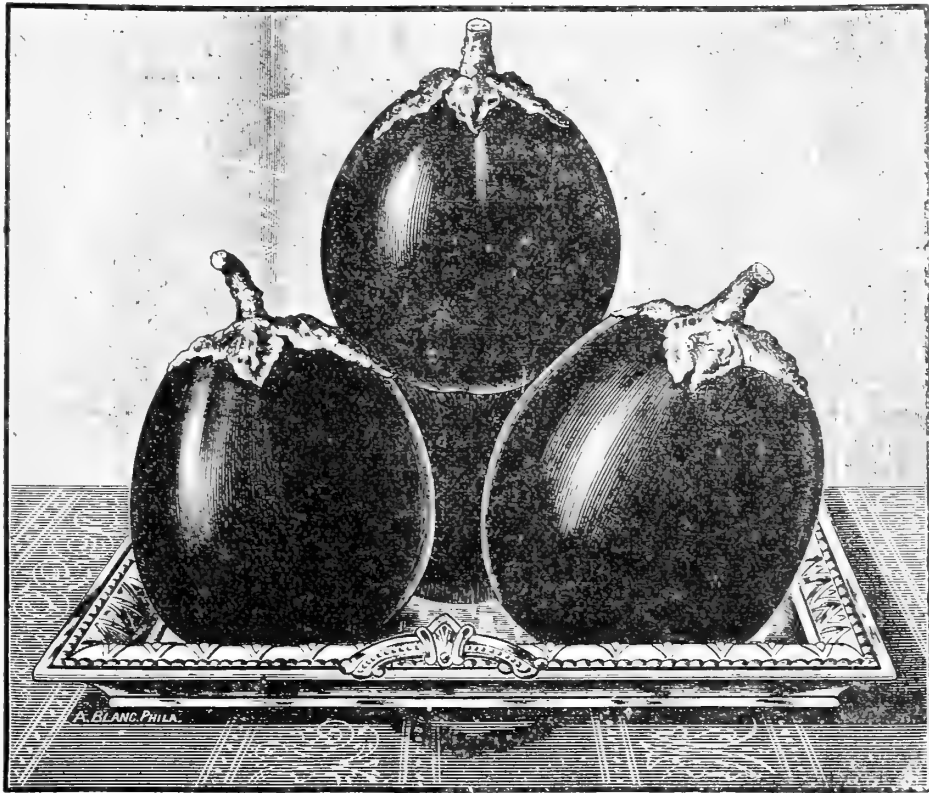
*Egg Plant*

## EGG PLANT

**Culture**—The egg plant demands heat. Its growth should never be checked after germination of the seed. It is best started in a hot bed, not too early in the spring; it should not be set out while the nights are cold. The plants may be set two by three feet. Use four ounces of seed to the acre.

**New York Improved Purple Spineless**—The leading sort for home and market. Is a vigorous grower, fruit large, fine and free from thorns, and produces until frost. Skin rich purple, flesh white and of good flavor. We can recommend our selected stock to market gardeners. Pkt. 10c; oz. 35c;  $\frac{1}{4}$  lb. \$1.00; lb. \$3.75.

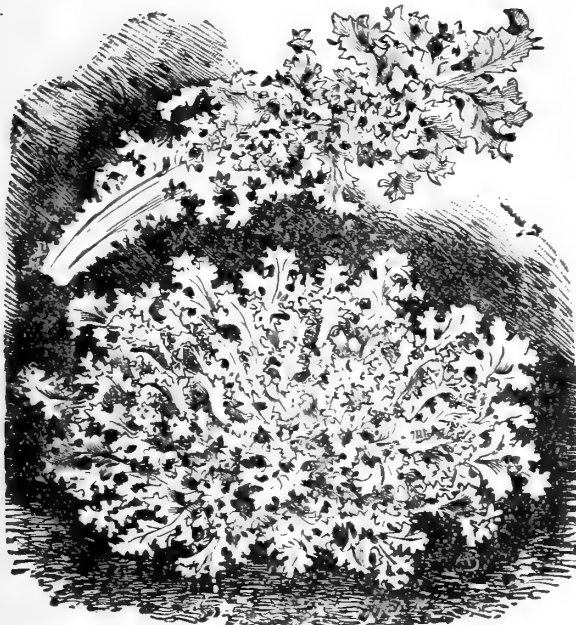
*Curled Endive.*

(See Page 20.)

## ENDIVE

**Culture**—Sow in June, July and August; when up thin out to 8 inches apart, and water well afterwards, if dry. When the leaves are 6 to 8 inches long, blanch by gathering in the hand and tying together near the top with twine. This must be done when quite dry, or they will rot. At the approach of winter, take up carefully, with plenty of earth on roots, and place together in frame or cellar for winter use. They must be kept dry, and have plenty of air, or they will rot.

**Green Curled**—This is the main standard variety for fall and winter use. Very tender and crisp. Pkt. 5c; oz. 20c;  $\frac{1}{4}$  lb. 40c; lb. \$1.50.

**Broad Leaved Batavian**—This variety is distinct from the green curled, having broad wrinkled leaves. Pkt. 5c; oz. 20c;  $\frac{1}{4}$  lb. 40c; lb. \$1.50.

## HERBS

**Summer Savory**—Used as a culinary herb. Pkt. 5c; oz. 10c.

**Sage**—Used as a culinary herb, also used in medicine. Pkt. 10c; oz. 15c.

**Thyme, Broad Leaved**—Used as seasoning. Pkt. 10c; oz. 30c.

**Sweet Marjoram**—Used as seasoning. Pkt. 10c; oz. 25c.

**Caraway**—Used in flavoring liquors and bread. Pkt. 10; oz. 15c.

**Dill**—Seed used for flavoring vinegar. Pkt. 5c; oz. 20c.

**Saffron**—Used as a medicine, also for dyeing. Pkt. 5c; oz. 20c.

**Wormwood**—Used for medicinal purposes. Pkt. 10c; oz. 60c.



*Summer Savory*



*Sage*



*Thyme Broad Leaved*



*Sweet Marjoram*



*Caraway*

## KALE OR BORECOLE

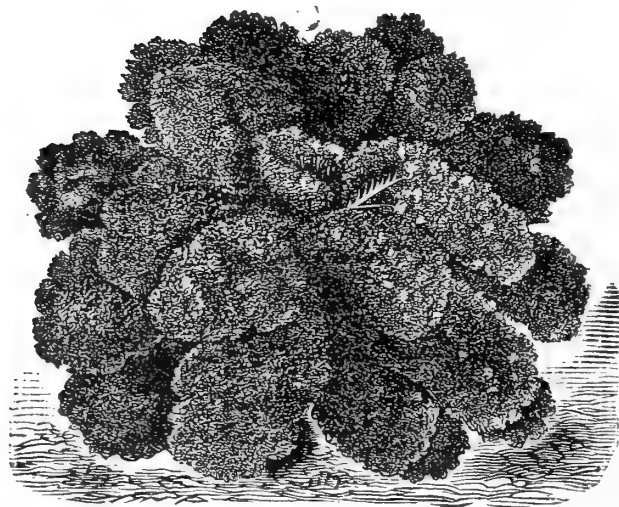

*Kale, or Borecole.*

**Culture**—Sow early in the spring in prepared beds, covering the seed thinly and evenly; transplant in June, and treat in the same manner as cabbage. They are extremely hardy and will endure quite a low temperature. 1 oz. will sow 150 feet drill.

**Dwarf Green-Curled Scotch**—Leaves of a bright green and very tender, and closely curled. This variety should be sown in the spring; the quality is improved if the plants are touched by frost. Pkt. 5c; oz. 15c;  $\frac{3}{4}$  lb. 25c.

**Tall Green-Curled Scotch**—Similar to the dwarf, but of more vigorous growth. Pkt. 5c; oz. 15c;  $\frac{1}{4}$  lb. 25c.

## Kale or Borecole—Continued



*Kohl-rabi.*

### Kohl-Rabi, or Turnip-Rooted Cabbage—

An intermediate vegetable between the cabbage and turnip, grown in the same manner as cabbage, though the seed may be sown thinly in drills where the plants are to stand, and when well started thin out to eight inches apart, but the best results will be had from transplanted plants in rich, well-cultivated soil. The bulbs must grow quickly and be gathered for market while young and tender, so that several plantings should be made rather than one large one. 1 oz. 2,000 plants.

**Early White Vienna**—Has beautiful white balls and is fit for use when ball is three or four inches in diameter; flesh white and tender. Pkt. 10c; oz. 25c;  $\frac{1}{4}$  lb. 60c.

**Early Purple Vienna**—Similar to the white in form and size, the main difference being the color, which is purple. Pkt. 10c; oz. 25c;  $\frac{1}{4}$  lb. 60c.

## LEEK

**Culture**—Makes a valuable second crop on land that has been used for cabbage, but the soil should have received a liberal dressing of well-composted manure before being planted. Sow seeds in April in rows one foot apart, and transplant in July. Transplant quite deeply into rows fifteen inches apart, with six inches between the plants. Hoe up the earth around the stems when they begin to grow, so as to blanch and make them tender. 1 oz. will sow 100 foot drill.

**Broad American Flag**—This variety is largely used among the gardeners and truckers, who pronounce it the best kind; very hardy. Pkt. 5c; oz. 15c;  $\frac{1}{4}$  lb. 40c.



*Leek.*

**Large Rouen**—A standard sort with broad leaves and short stem. An excellent large variety for market use. Pkt. 5c; oz. 15c;  $\frac{1}{4}$  lb. 40c.

**Scotch Musselburgh**—The largest and most prolific of the leek family; a superb and vigorous sort. Pkt. 5c; oz. 15c;  $\frac{1}{4}$  lb. 40c.

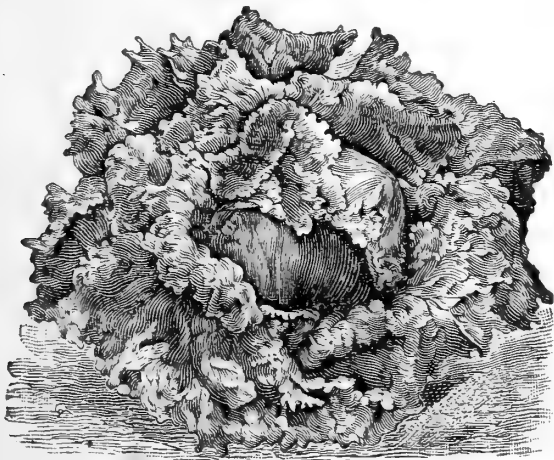

*Lettuce.*

## LETTUCE

**Culture**—The most easily grown of all open-air plants; used for salads. It requires a warm soil that has had a liberal dressing of well rotted manure and abundant moisture, to be of a satisfactory quality; the growth should be rapid and vigorous. Seed may be

sown in a frame in February or March, the plants set out as early as the ground can be worked, as light frosts will not injure them. Set the plants 9 inches apart in the rows and 18 inches between the rows. For successive crops, sowing may be made every two weeks up to the end of August. 1 oz. to 1,000 plants.

**Big Boston**—for forcing. This variety of lettuce is considered by many of the gardeners the only lettuce to grow in the greenhouse for a winter crop. We have taken special pains to purchase a strain of seed that will produce the finest heads. Pkt. 5c; oz. 15c;  $\frac{1}{4}$  lb. 40c.



## Lettuce—Continued

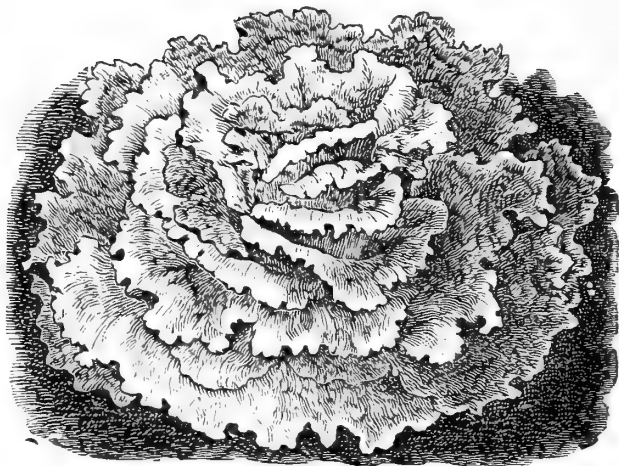

*Grand Rapids.*

**Grand Rapids Forcing**—Heads medium size, tender and crisp, a superb hot house variety. Pkt. 5c; oz. 10c;  $\frac{1}{4}$  lb. 35c.

**Improved Hanson**—This lettuce is particularly adapted to market gardening purposes. It is a perfect open air lettuce in all respects, for both amateur and professional gardeners; it is hardy, and may be set out in earliest spring or grown late in the fall. In cool weather or warm, it is a thoroughly reliable and satisfactory sort. Pkt. 5c; oz. 10c;  $\frac{1}{4}$  lb. 30c.

**Deacon**—Excellent for early and summer use, forms large heads, very solid; of light green color, very tender. Pkt. 5c; oz. 10c;  $\frac{1}{4}$  lb. 30c.

**Early Prize Head**—Large, loose heads tinged with brown; very early. Pkt. 5c; oz. 10c;  $\frac{1}{4}$  lb. 30c.

**Boston Market**—An improvement on white seeded Tennis Ball. Large heads, fine for forcing. Pkt. 5c; oz. 10c;  $\frac{1}{4}$  lb. 30c.

**Henderson's New York Cabbage**—Is of unusual size and solidity of head, with but little tendency to run to seed. We have had it time and again 18 inches in diameter, with heads almost as solid as an early summer cabbage, which in general form, it somewhat resembles. The variety blanches naturally, is crisp, tender and of excellent flavor, and always free from bitterness. It is not a forcing variety. Pkt. 5c; oz. 10c;  $\frac{1}{4}$  lb. 30.

**Salamander**—An excellent spring, summer and fall variety forming good sized heads that stand drought and heat longer without injury, than any other sort. Matures very early. Pkt. 5c; oz. 15c;  $\frac{1}{4}$  lb. 40c.

**Early Curled Silesia**—Very early, tender and crisp, fine for hot beds. Pkt. 5c; oz. 10c;  $\frac{1}{4}$  lb. 30c.

**Early Curled Simpson**—A well known standard variety; one of the best curly lettuce grown. Pkt. 5c; oz. 10c;  $\frac{1}{4}$  lb. 25c.

**Black Seed Simpson**—The best of the non-heading lettuce; an old and popular standard sort. of large size and highest quality. It is light colored, with inner leaves almost white; good for forcing under glass or for spring and early summer culture in the open air; resists heat and remains long in edible condition. We can recommend our strain to any one desiring a first class lettuce. Pkt. 5c; oz. 10c;  $\frac{1}{4}$  lb. 30c.

**Black Seed Tennis Ball**—One of the earliest heading sorts, quality excellent. It makes but few outer leaves, it can be set six to seven inches apart. Pkt. 5c; oz. 10c;  $\frac{1}{4}$  lb. 30c.

**Mammoth Black Seed Butter Lettuce**—This is a very large variety with broad, slightly undulated leaves almost smooth, of handsome pale green color, selling well on the market. The head is compact, very large; we recommend it for early spring or late fall, but it is not desirable as a mid-summer variety. Pkt. 5c; oz. 10c;  $\frac{1}{4}$  lb. 40c.

**Paris White Cos.**—Cos. lettuce is served exclusively in European hotels. It is about eight inches high, of attractive green color, and of such close habit of growth as to be self-blanching. It is early, crisp, tender and slow to seed. Pkt. 5c; oz. 10c;  $\frac{1}{4}$  lb. 35c.



*Paris White Cos.*



## MELONS==Musk

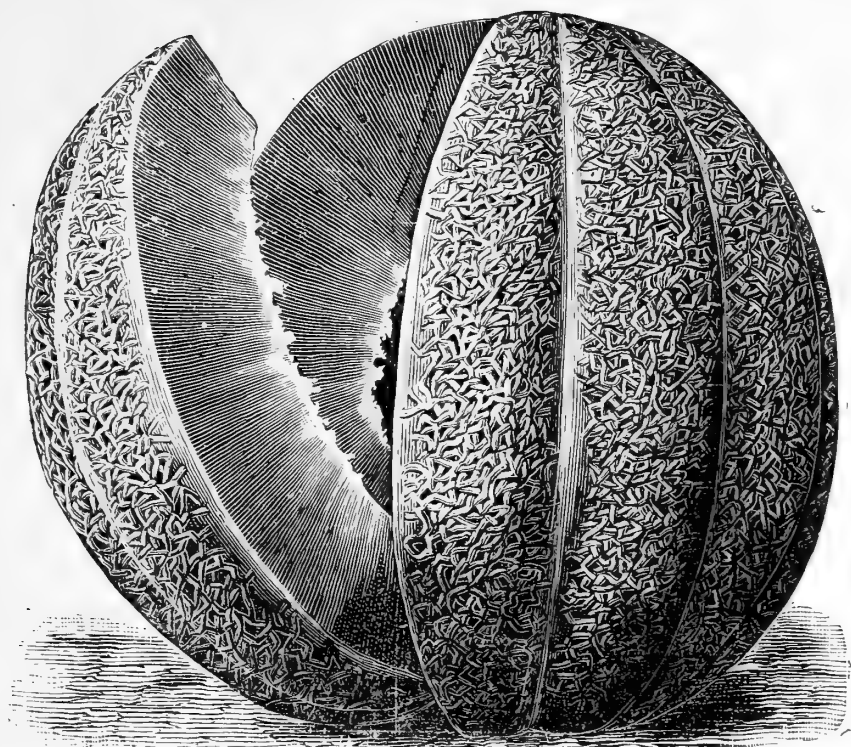

*Melons—Musk*

**Culture**—Select a light sandy, rich soil, and after all danger of 'frost is over, and the ground has become warm and dry, plant in hills 4 to 6 feet each way, 5 to 10 seeds to a hill. When up and all danger of insects have passed, pull out all but three plants. Cultivate until the vines cover the ground, and pinch the ends of the growing shoots, to induce early fruiting. Ashes or Bug Death is excellent to sift over the young plants when the dew is on, to prevent the attacks of insects. A few hills for early use may be had by sowing in hot beds, on pieces of sod or in pots; the seed may also be started out of doors under hand frames or glasses. 1 oz. 60 hills, 8 lbs. to the acre.

**Corning's Albany Market**—This superb variety of melon is the leading melon in Troy and Albany markets. We have grown for us seed from the original stock, and are in a position to supply the wants of all who wish to plant this superb variety, characteristic of this melon being very early, green flesh, rich and juicy. Pkt. 5c; oz. 15c;  $\frac{1}{4}$  lb. 25c; lb. 80c.

**Jenny Lind Improved**—An extra early green fleshed melon, one of the sweetest in cultivation. Fruit not over large, globular, flattened on ends, ribbed and covered with shallow netting; fine for restaurant use. Pkt. 5c; oz. 10c;  $\frac{1}{4}$  lb. 30c.

**Montreal Market**—Fruit of the largest size, often measuring twelve to fourteen inches in diameter; spherical or slightly oval in shape, with regular shallow ribs, and sparsely covered with netting; flesh light green, very juicy, sweet, and of excellent flavor. Pkt. 5c; oz. 10c;  $\frac{1}{4}$  lb. 40c.

**Paul Rose**—This extra fine salmon fleshed melon, is a hybrid between Osage and netted Gem, being a full brother to the new Osage Gem; it is, however, larger than the Osage Gem, with deeper flesh. It is the thickest fleshed yellow or salmon colored musk melon within our knowledge. It is of the netted Gem family, being smaller in size, slightly elongated in shape, and of the highest flavor. Pkt. 5c; oz. 10c;  $\frac{1}{4}$  lb. 25c.

**Banquet**—The banquet is a medium sized melon, flat at both ends, more beautifully netted than any other known variety; quality has no equal, color rich salmon. Pkt. 5c; oz. 10c;  $\frac{1}{4}$  lb. 25c.

**Emerald Gem**—This beautiful small melon, is early and prolific. It is truly a gem; the ribs are marked, but the skin is smooth, of a deep emerald green color. The salmon colored flesh is thick and fine, ripening almost to the rind, and of the richest and best flavor. The vines are hardy and vigorous. Pkt. 5c; oz. 10c;  $\frac{1}{4}$  lb. 35c.

**Extra Early Grand Rapids**—This extremely early musk melon matures a full week earlier than any other sort. The flesh is yellow almost to the rind; the skin is finely netted, and the melon is handsome in appearance, and sure to attract attention in the market. We advise growers to pinch off the ends of the main shoots when two or three feet long, to encourage more abundant blossoming and earlier maturity; this practice makes the fruit heavier as well as earlier. Pkt. 5c; oz. 10c;  $\frac{1}{4}$  lb. 25c.

## Melon==Musk—Continued

**New Early Hackensack** (Green flesh)—A productive and profitable strain of the old popular Hackensack. The new form is earlier, and of almost equal size, the melons weighing from five to ten pounds each. In color and shape it is similar to the parent, the main point being the difference in earliness, which is sufficient to commend it to market gardeners. It is a round melon, flattened on the ends, and well ribbed. The skin is netted, and the flesh, which is green, is rich and sugary. The vines make a good strong growth and bear abundantly; it is also considered a good shipper. Pkt. 5c; oz. 10c;  $\frac{1}{4}$  lb. 20c.

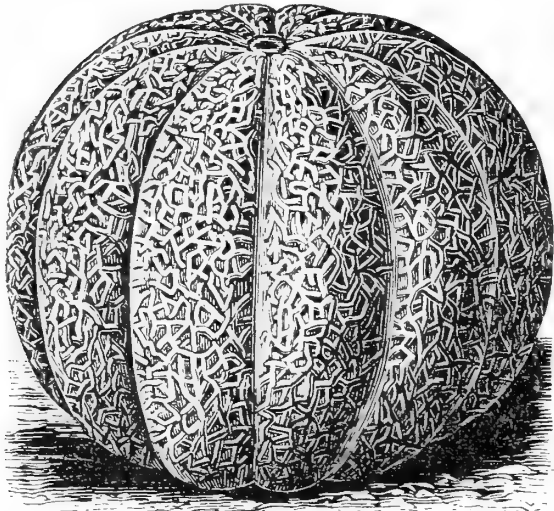

*New Early Hackensack*

color, except next the seeds, where it inclines toward yellow. The flavor is exceedingly fine. It is a firm solid melon, and will carry in perfect condition for a week or more after its removal from the vine; it is a heavy cropper, and is in wide favor as a market melon. It has many local names: In Colorado it has taken the name of *Rocky Ford* from a locality where it grows in great abundance and perfection, and from whence it is shipped all over the country. We have the original stock of this celebrated melon. Pkt. 5c; oz. 10c;  $\frac{1}{4}$  lb. 30c.

**Surprise**—Very early, oblong, with rich orange flesh of superb quality, one of the best melons for market gardeners. Pkt. 5c; oz. 10c;  $\frac{1}{4}$  lb. 20c.

**Miller's Cream**—This, in our opinion, is one of the very finest varieties in cultivation; the fruits are medium to large in size, oval in shape, and handsomely netted; the flesh is extremely deep, of a rich salmon color, fine texture, which makes it a valuable shipping variety. Pkt. 5c; oz. 10c;  $\frac{1}{4}$  lb. 25c.

**Princess**—Similar to Miller's Cream, superior variety. Pkt. 5c; oz. 10c;  $\frac{1}{4}$  lb. 30c.

**Osage**—Of medium size nearly round, with skin ribbed and somewhat netted. Flesh salmon color, of luscious flavor; vine prolific, regarded by many growers as the most profitable market variety. Pkt. 5c; oz. 10c;  $\frac{1}{4}$  lb. 30c.

**Orange Christiana**—Flesh yellow, very rich and sweet; one of the leading round varieties. Pkt. 5c; oz. 10c;  $\frac{1}{4}$  lb. 20c.

**Baltimore Market**—This melon is large, showy and quite early. It is strongly netted, and has thick green flesh of rich flavor and aroma; it is a great favorite in the vicinity of Baltimore, and is also popular in the hotels and restaurants of other eastern cities. It is a well shaped and well marked melon. Pkt. 5c; oz. 10c;  $\frac{1}{4}$  lb. 25c.

**Long Island Beauty**—This is a new variety of the Hackensack type. It was originated on Long Island. It is claimed for this variety that it is as early as extra Early Hackensack, and is a much better melon; the flesh is thicker and sweeter. Pkt. 5c; oz. 10c;  $\frac{1}{4}$  lb. 25c.

**Rocky Ford**—This delicious melon is nothing more than a form of the old standard netted gem. It is a small early melon; the flesh is deep and thick and light green in

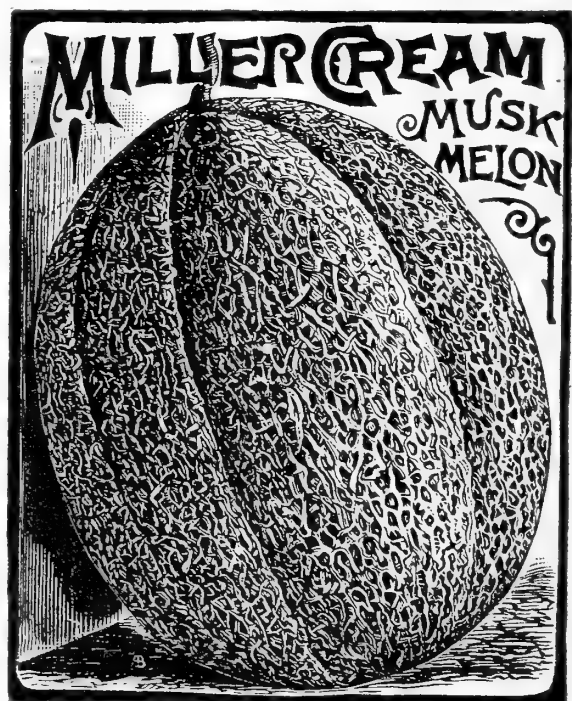

## WATER MELONS

**Culture**--Water melons do best on light, well drained soils; the hills should be eight feet apart each way, with some well rotted manure in each hill, thoroughly incorporated with the soil. Plant the seed as soon as the weather is really warm and settled. Allow two or three plants to remain in each hill. 1 oz. to 30 hills. 3 lbs. to the acre.

**Ford Hook Early**--One of the largest of the extra early varieties and claimed to be the earliest of them all. Shape nearly round, color a medium shade of green; flesh bright red, and of deliciously sweet flavor. Pkt. 5c; oz. 10c;  $\frac{1}{4}$  lb. 30c.

**Seminole**--A large and very productive early watermelon; color usually gray; sometimes a light green, flesh carmine; of good quality and flavor. The rind is very thin, but so tough as to make the melon a most excellent shipper. Pkt. 5c; oz. 10c; 1 lb. 55c.

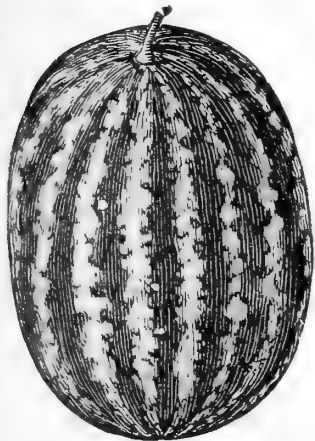

*Pinney's Early.*

**Phinney's Early**--Melons of medium size, and oblong shape, marked with two shades of green; the rind is thin, the red flesh is very sweet and tender. The vine is productive and a sure cropper; the melons maturing early; adapted to northern states. Pkt. 5c; oz. 10c; 1 lb. 50c.

**Peerless**--A water melon which we recommend for garden culture; size medium, color mottled green, flesh rich scarlet, and sweet. Pkt. 5c; oz. 10c; lb. 50c.

**Hungarian Honey**--An early sort, round shaped and red fleshed, fine for northern climate. Pkt. 5c; oz. 10c; lb. 60c.

**Improved Mountain Sweet**--Flesh red; late variety. Pkt. 5c; oz. 10c; lb. 50.

**Vick's Early**--This variety is prized for its earliness; it is oblong in shape, smooth, with a very dark skin, rather small in size; flesh bright pink, solid, and sweet. It makes a good extra early market or house garden melon. Pkt. 5c; oz. 10c; lb 50c.

**Dark Icing**--Solid, with thin dark green skin, early seed white. Pkt. 5c; oz. 10c; lb. 50c.

### **Citron for Preserving** (Green Seed)

Round and of good quality. Pkt. 5c; oz. 10c.

**Citron**--(Red seed) similar to above variety.  $\frac{1}{2}$  Pkt. 5c; oz. 10c.

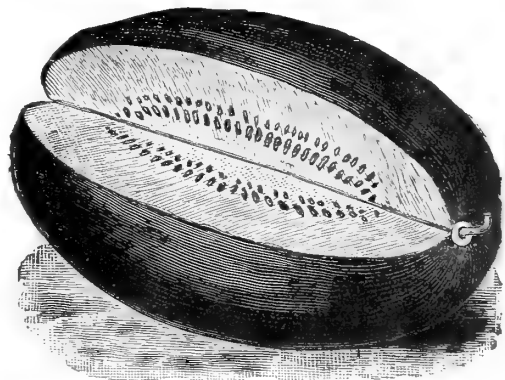

*Vick's Early.*

## MUSHROOMS

**Culture**--Mushrooms can be grown in any dark room or cellar, where the temperature can be maintained at 50 or 60 degrees. Procure the soil from old pastures, and store it away. To one bushel of this soil add two bushels of fresh horse manure; of this well mixed compound; prepare a bed, say four feet wide, put down a thin layer and pound it down hard, and go on until you have a bed eight inches thick. It will soon become pretty hot, but let the heat recede until it is only 85 or 90 degrees, then make holes one foot apart, and put in the spawn, two or three pieces as big as a walnut in each hole; cover the holes and press the soil solid and smooth. Let the bed remain in this condition about twelve days, then cover it with two inches of fresh loam and over this place four or five inches of hay or straw, and the work is done, and if the temperature is right, in six or eight weeks you may expect mushrooms. The bed will continue bearing from twenty to thirty days. After the first crop is gathered, spread over the bed an inch of fresh soil, moisten with warm water and cover with hay as before; success is not always certain with the amateur and is usually to be attained only after more or less experience. One pound of spawn is enough for a bed 3 and 6 feet. English spawn in bricks about 1 lb. each, 15c per lb. Quotations on larger quantities.

## NASTURTIUMS

Nasturtiums of all varieties are useful for furnishing tender seed-pods which make delicious pickles. The seed for pickling should be gathered while green, and with a portion of the stem attached. Pick them over and place in a jar until filled; then cover them with cider vinegar which has been brought to a boil and is still warm, to keep for winter use.

Tall Mixed—Pkt 5c; oz. 10c;  $\frac{1}{4}$  lb. 25c.

Dwarf Mixed—Pkt 5c; oz. 10c;  $\frac{1}{4}$  lb. 25c.



*Okra, White Velvet.*

## Okra, or Gumbo

The pods of this plant are regarded as a household necessity in the southern states, but not so well-known nor so extensively grown as they should be in the north. The seed should be sown quite thinly in drills two or more feet apart when the trees are well in leaf. For either cooking or drying, the pods must be gathered when young and tender, before any woody fibre is formed.

**Dwarf Prolific**—Dwarf, stocky growth, wonderfully prolific. Pkt. 5c; oz. 10c.

**White Velvet**—Of tall growth, with long pods, which are perfectly round, smooth, and of a velvety white coloring. Pkt. 5c; oz. 10c.

## ONION

**Culture**—Onions must have a clean and very rich soil; it is useless to attempt to grow them on a poor unsuitable one. A liberal use of manure is more essential to this than any other crop; it should be of the best quality, well fermented, and thoroughly worked over during the previous summer. If it is too rank, it is liable to make soft onions, with many scallions. *Reed's* or *Lister's* fertilizers will often benefit soils that are already very rich; get the seed in as early as possible in the spring, no matter if it is cold and unpleasant; a week too late in sowing makes the difference between a good and bad harvest. If onions do not get a good growth before hot dry weather, the crop is sure to be a failure. Sow in drills not less than a foot apart nor more than half an inch deep; keep the soil mellow and clear of weeds. Three days of neglect when the weeds are growing rapidly, will sometimes ruin a crop. In cultivating, to destroy weeds, and keep the ground mellow, do not cover the young bulbs with earth, as onions grow on the top of the ground. They may be allowed to remain pretty thick, no matter if they crowd each other. With proper manuring, onions can be grown on the same land for a score of years, and it will become cleaner and better every year. 1 oz.—100 feet drill, 6 lbs. per acre.

**Yellow Globe Danvers**—Our strain of this standard variety is unsurpassed. It always attains a good size, with deep bulb and small neck. It is choice in flavor, being rather mild, and is invariably a market favorite; it is, in fact the best yellow onion on the market; it frequently produces 500 to 600 bushels to the acre. It is early and profitable, and a splendid keeper. There will always be a demand for yellow globe Danvers onion, and we confidently assure our customers that we have the best known strain, in fact we have only one stock of Globe Danvers, and devote our energies to the perfection of that one. Pkt. 5c; oz. 15c;  $\frac{1}{4}$  lb. 45c; lb. \$1.50.

**Notice**—The onion is such an important crop to large growers, and the preparation of the soil and culture so expensive, and consequently a failure from bad seed and other causes is so disastrous, that we have determined to sell no seed except what we know to be new, true, and of good stock.



Onion—Continued

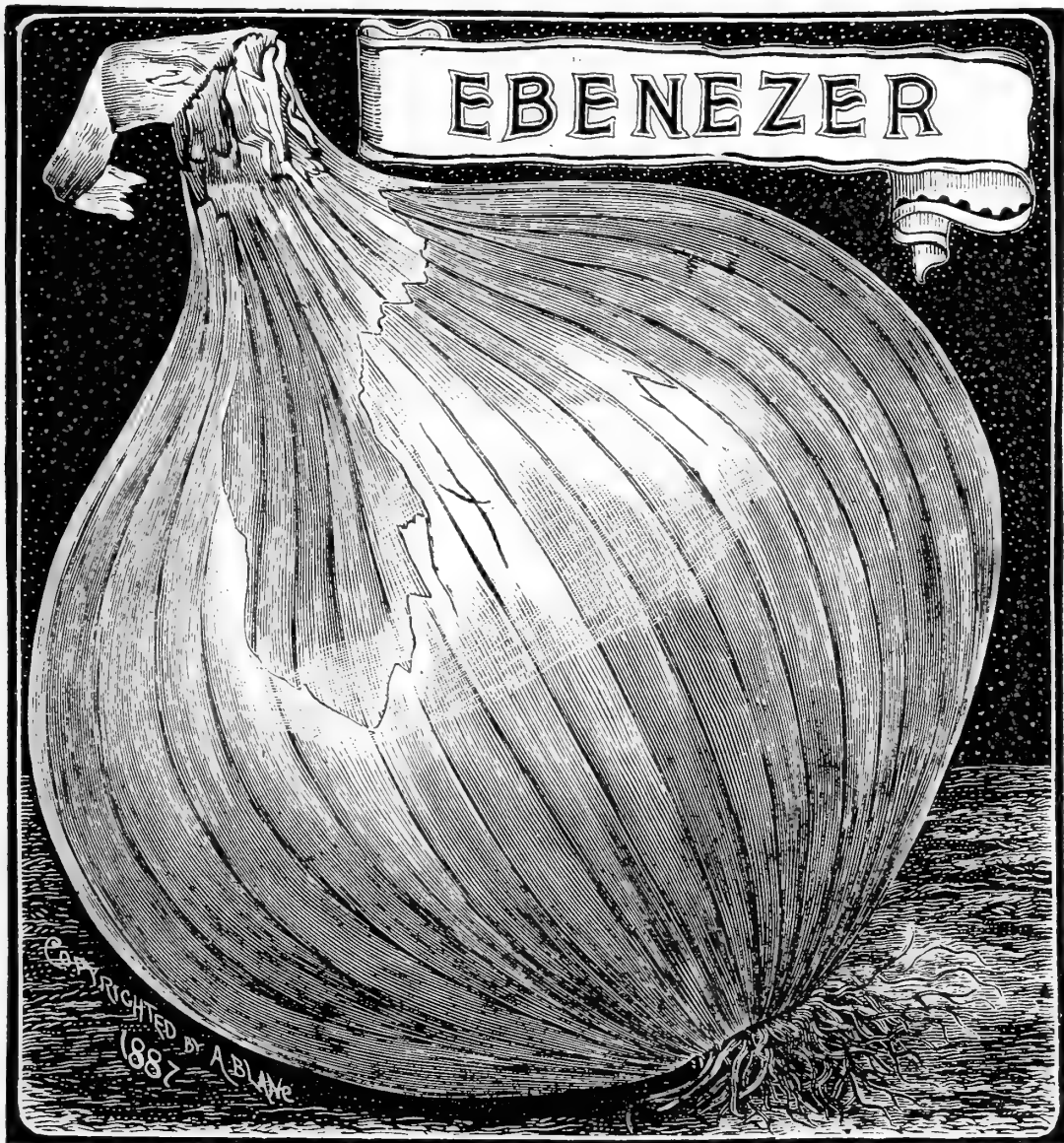

**Ebenezer**—We can recommend this variety as one of the best winter onions; it is a perfect globe shaped onion, a fine keeper and very large and mild. Our Ebenezer onion seed is grown under our own care from the finest selected bulbs. Very short crop. Pkt. 5c; oz. 30c.

**Yellow Dutch**—A flat yellow onion; a good yielder. Pkt. 5c; oz. 10c;  $\frac{1}{4}$  lb. 40c; lb. \$1.50.

**New Queen for Bunching**—This is the earliest ripening onion in cultivation; the small bulbs are of a pure white; seedling plants of the Queen started early under glass, may be used instead of sets. Pkt. 5c; oz. 20c;  $\frac{1}{4}$  lb. 55c; lb. \$2.00.

**Prize Taker**—Has now been several years on the market and is recognized as one of our standard varieties. Its immense size and mildness of flavor delight everyone who raise it. The exterior color is pale yellow and the interior clear sparkling white. It is easily grown, medium early maturity. Pkt. 5c; oz. 20c;  $\frac{1}{4}$  lb. 55c; lb. \$2.00.

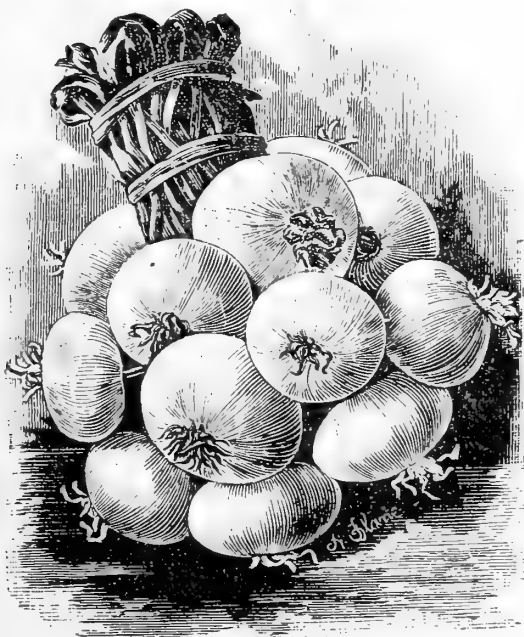

*New Queen for Bunching.*

*Campbell's Onions*



## Onion—Continued

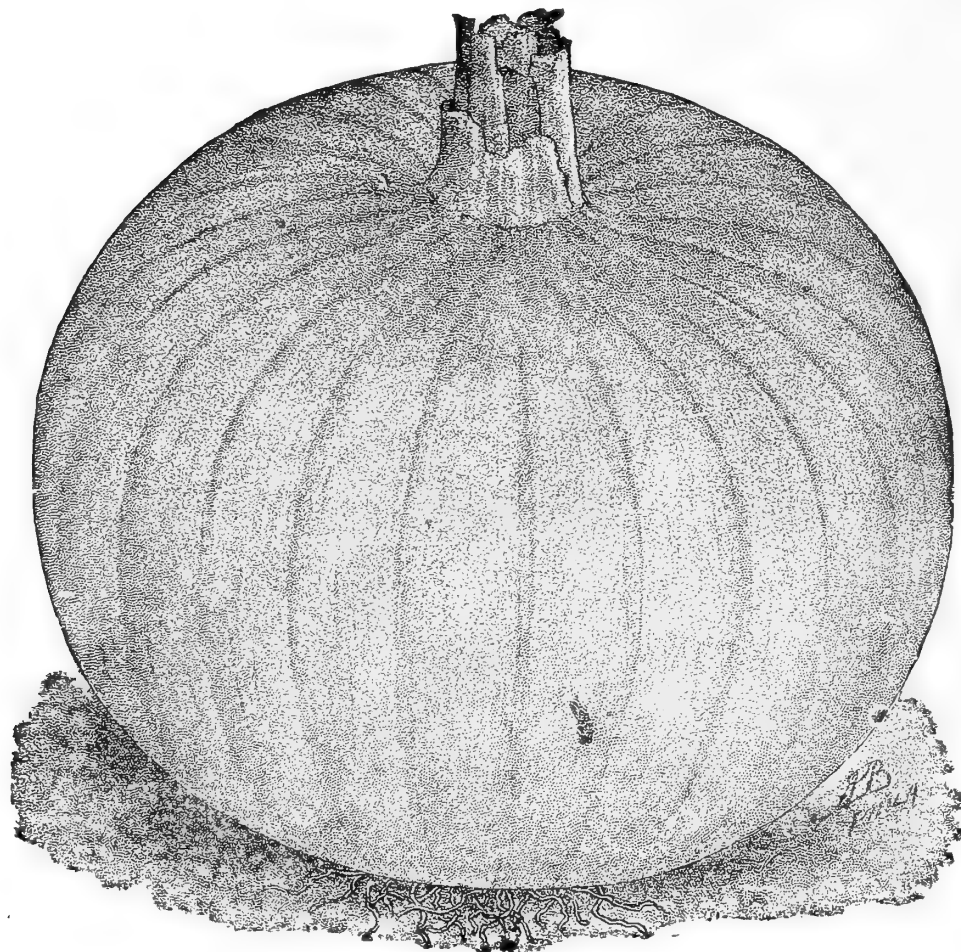

*Extra Selected Improved Yellow Globe Danvers.*

**Southport Large Yellow Globe**—This is similar in size and form to the large White Globe, but has a pale straw-yellow skin; the bulbs are larger in size, more perfectly globe-shaped than the Globe Danvers, but late in ripening; it is an excellent keeper and of mild flavor; a heavy cropper, and owing to its handsome appearance and delightful flavor, sells readily in all markets. Pkt. 5c; oz. 20c;  $\frac{1}{4}$  lb. 45c; lb. \$1.75.

**White Victoria**—A handsome, large, pure snow white globe onion of mild flavor and is largely planted for green bunch onions, in the spring. Pkt. 5c; oz. 30c;  $\frac{1}{4}$  lb. 80c; lb. \$3.00.



**Southport Large Red Globe**—Our strain is unsurpassed; it is used for growing the exceedingly fine large bulbs seen in the markets; its beautiful form makes it extremely desirable. It is a good keeper. Pkt. 5c; oz. 25c;  $\frac{1}{4}$  lb. 60c; lb. \$2.25.

**Large Red Weathersfield**—This is the most popular standard variety for winter market. The large onions are thick through, the outer skin is a deep rich purplish red, smooth and glossy; flesh white, lightly tinged with pinkish rose. Its splendid keeping qualities make it easy to hold crop for winter. Pkt. 5c; oz. 15c;  $\frac{1}{4}$  lb. 40c; lb. \$1.45.

**Extra Early Red**—Is a very fine flat, deep red bulb; a good cropper. Matures early, ripens evenly, and is an excellent keeper. Pkt. 5c; oz. 15c;  $\frac{1}{4}$  lb. 45c; lb. \$1.75.

**Onion Sets**—White, pk. \$1.00; 4 qt. 60c; 2 qt. 35c; 1 qt. 20c. Yellow, pk. 90c; 4 qt. 55c; 2 qt. 30c; 1 qt. 15c.



*Large White Portugal, or Silverskin.*

**Southport Large White Globe**—A very handsome, a silvery-white and perfectly ball shape onion of large size, commanding the highest prices in the markets; flesh finely grained, of mild flavor, and an excellent keeper. Its even, regular size, perfectly globular form, combined with the clear silvery whiteness of the thin skin, make it one of the handsomest onions grown; owing to its large size, it is later in ripening than the white Portugal or Silverskin. Pkt. 5c; oz. 30c;  $\frac{1}{4}$  lb. 75c; lb. \$2.80.

**White Portugal Silverskin**—A large flat white onion of exceedingly mild flavor; it is a popular sort, and when young, excellent for bunching or pickling. It is also especially adapted for growing sets. Pkt. 5c; oz. 30c;  $\frac{1}{4}$  lb. 80c; lb. \$3.00.

## PARSLEY



**Culture**—As Parsley seed germinates very slowly, it should be planted in a bed. For out door sowing, always prepare the seed by placing it in hot water to soak for twenty-four hours in a warm place. Sow thickly in rows one foot apart and half an inch deep, pressing down well after sowing. When well up, thin to six inches apart. Parsley lives through the winter and seed may be sown in the Autumn.

**Champion Moss Curled**—A compact growing, very ornamental plant; leaves, a bright green color, finely crimped and beautifully curled. Pkt. 5c; oz. 10c.

**Extra Double Curled**—One of the best for market use; a handsome dwarf compact sort; leaves bright pale green, extra curled and crimp. Pkt. 5c; oz. 10c.

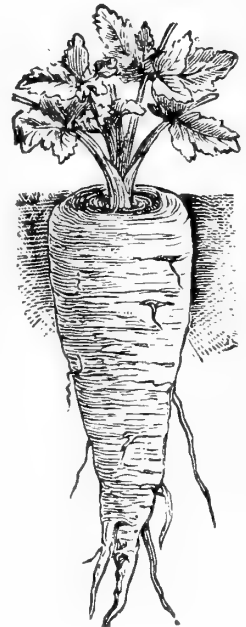

*Guernsey Half-Long.*

*Long Island Hollow Crown or Sugar*

**Culture**—Parsnip seed germinates very slowly, and does best in a cool moist soil, therefore it should be sown as early as possible, in drills, from fifteen to eighteen inches apart, and about half an inch deep. The soil should be deep, mellow and moderately rich. When well up, thin the plants from three to five inches apart; the roots may remain in the ground for spring use. If needed for winter they may be dug and covered like potatoes; a light covering will answer. 1 oz. 200 feet drill; 5 pounds to the acre.

**Long Island Hollow Crown or Sugar**—The old standard, and one of the best for general farm use and for home or market purposes. Long, smooth, tender, and sugary; very hardy, will keep throughout the winter with very little protection. Pkt. 5c; oz. 10c;  $\frac{1}{4}$  lb. 15c; lb. 40c.

**Guernsey Half-Long**—The roots are not so long as those of the long Hollow Crown; are larger in diameter, and more easily gathered; smooth, finely grained, and of excellent quality. Pkt. 5c; oz. 10c;  $\frac{1}{4}$  lb. 15c; lb. 40c.

## PARSNIP

## PEPPERS

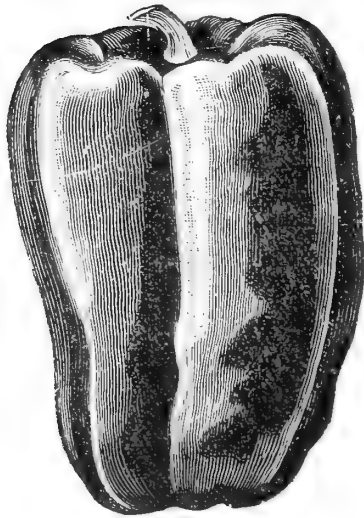

*Ruby King.*

**Culture**—The culture of Peppers is precisely the same as Egg Plant. Transparent when three inches high. 1 oz. seed, 1500 plants.

**Ruby King**—A handsome and very productive variety. Fruits from four to six inches long by four inches broad; remarkably mild and pleasant; when ripe they are bright ruby red. Pkt. 5c; oz. 25;  $\frac{1}{4}$  lb. 65c.

**Large Bell or Bull Nose**—Very large, nearly four inches long and three inches in diameter; excellent quality for use in salads and pickles. Pkt. 5c; oz. 25c;  $\frac{1}{4}$  lb. 65c.

**Sweet Mountain or Mammoth**—Much like the large Bell but larger and milder. Fruit thick and sweet; fine for making stuffed mango pickles. Pkt. 5c; oz. 25c;  $\frac{1}{4}$  lb. 65c.

**Red Cluster**—A distinct beautiful variety, bearing a profusion of bright scarlet fruit in clusters in an upright position. Hot and pungent. As a decorative plant for the flower garden or for pots, it will be found very useful. Pkt. 5c; oz. 20c;  $\frac{1}{4}$  lb. 55c; lb. \$2.00.

**Long Cayenne**—Beautiful and productive; fruit four inches long, bright red, slim, pointed pod; flesh thick and pungent. Pkt. 5c; oz. 20c;  $\frac{1}{4}$  lb. 55c; lb. \$2.00.

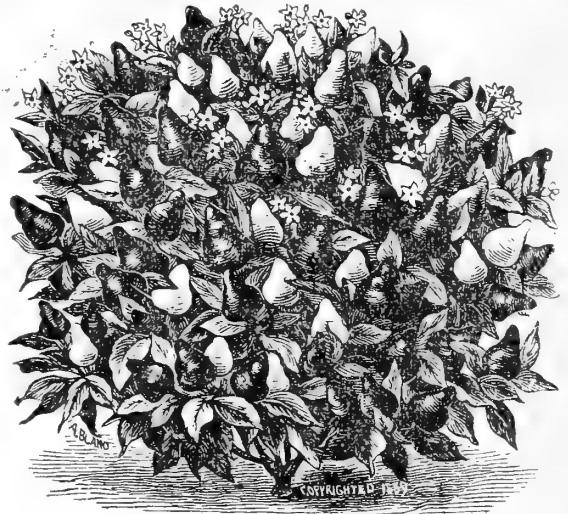

*Red Cluster.*

## PUMPKIN

**Culture**—May be planted middle of spring, among the corn or in the field or garden, in hills eight or ten feet apart each way, four seeds in a hill. In other respects are cultivated same as melons or cucumbers. Avoid planting them near other vines.

**Mammoth Tour**—Grows to an immense size, often weighing over 100 pounds. Pkt. 5c; oz. 10c; lb. 60c.

**Large Cheese**—One of the best for table use and very productive; shape flat, skin mottled light green and yellow, changing to a rich cream color; flesh yellow, thick and tender. Pkg. 5c; oz. 10c;  $\frac{1}{4}$  lb. 15c; lb. 50c.

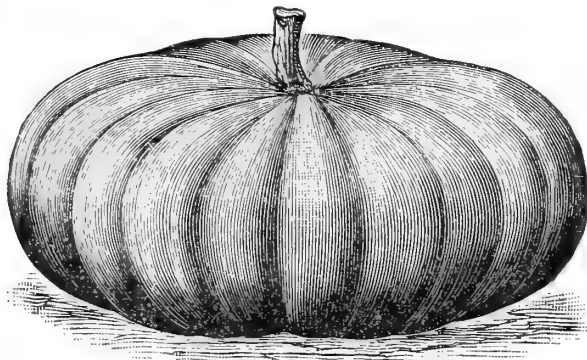

*Large Cheese Pumpkin.*

**Small Sweet Sugar**—A rather small, but handsome variety. shape round, with deep orange color skin; flesh finely grained, very sweet flavor; superior for pies. Pkt. 5c; oz. 10c;  $\frac{1}{4}$  lb. 15c; lb. 50c.

**Jonathan**—A large, bottle shaped variety with a crook neck; of most attractive appearance. It is very prolific, and the flesh is fine, clear and sweet. Its hard shell makes it an excellent keeper. Pkt. 5c; oz. 10c;  $\frac{1}{4}$  lb. 20c; lb. 70c.

**Field Pumpkins**—Very productive; largely grown for feeding stock. Pkt. 5c; oz. 10c; lb. 25c.

## PEAS

**Culture**—A light soil, moderately rich, should be selected for the *early varieties*, and old, decomposed manure or leaf-mould should be scattered along the bottom of the drill and covered lightly with fine earth, so that the seed may not come in direct contact with the fertilizer. For general crops, a good dressing should be applied, and for drawf kinds, the soil should be very rich. The earliest peas are mostly round and smooth-seeded; they are very hardy, and should be sown as early as possible in spring; later sowings of the fine, sweet, wrinkled varieties should

## Peas—Continued

follow. Sow peas in drills and cover not less than four inches for the lowest sorts, the drills should be two feet apart; those growing taller should be three or four feet apart, according to height. When growing for private use, peas should be staked with brush, except the very dwarf-growing varieties. One quart to 100 feet drill; 1½ bushels to the acre.

**First of All**—This variety is unequalled for excellence, yield, size of pod and regularity of ripening. Height 2½ feet, extra early, and produces pods of good size, which are well filled with round, smooth peas of splendid flavor. It is a great bearer, and in this last feature, and in its extreme earliness, consists its great value to market gardeners and truckers. Pt. 15c; qt. 25c; 4 qt. 80c.

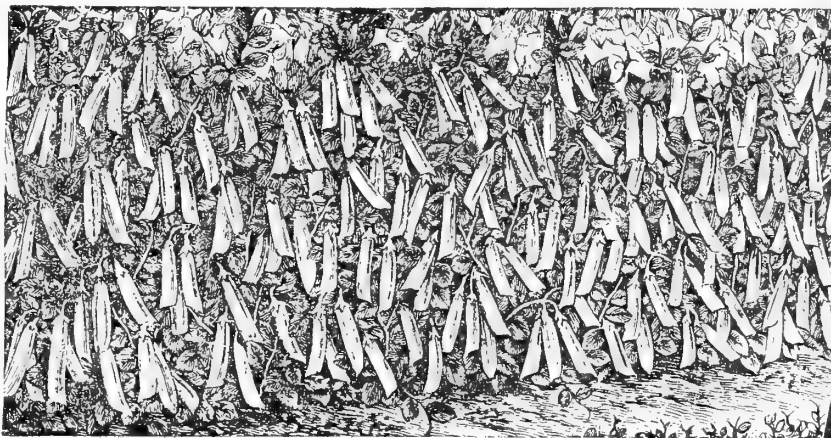

*First of All*

**Improved Daniel O'Rourke**—A standard extra early variety, too well known to describe. Pt. 15c; qt. 25c; 4 qt. 80c.

**Alaska**—A smooth blue pea, the earliest of all the extra earlys; of good flavor, and bearing pods of a dark green color, which are well filled and ripen uniformly; are of the very best for market gardeners; vines 2 feet long. Pt. 20c; qt. 30c; 4 qt. 90c.

**Gradus (Prosperity)**—This is the earliest tall wrinkled or marrow pea grown, planted at the same time as the earliest tall "round" or hard shell peas—like the Daniel O'Rourke or First of All, etc. It is usually ready for picking at the same time or within three or four days after. Reports show that Gradus sown from the middle to latter part of April was ready for the table early in June. The advantage of procuring deliciously flavored wrinkled peas, tender, melting and sweet, so early in the season, is too apparent to need comment from us. It is vigorous and robust, a large yielder of immense pods, filled with extra large and luscious peas. Vine grows about 2½ feet. Pt. 30c; qt. 50c; 4 qts. \$1.75.

**Nott's Excelsior**—Extra Early Dwarf. Green wrinkled sort. The peas are superior in sweetness and quality; the vines larger and more vigorous than the American Wonder, and yields one quarter more and very prolific vines, 15 inches high. Pt. 20c; qt. 30c; 4 qts. \$1.00.

**American Wonder**—Is one of the very best of the earliest wrinkled peas in cultivation, and is a superior cropper, bearing large, well filled pods, having from six to nine peas in a pod; vines twelve inches. Pt. 20c; qt. 30c; 4 qt. \$1.20.

**Premium Gem**—A fine early wrinkled pea, the pods are long, and are produced in abundance. It is an improvement on the Little Gem, and more robust; one of the most profitable early wrinkled peas for market or family use; vines about 15 inches high. Pt. 20c; qt. 30c; 4 qt. \$1.00.

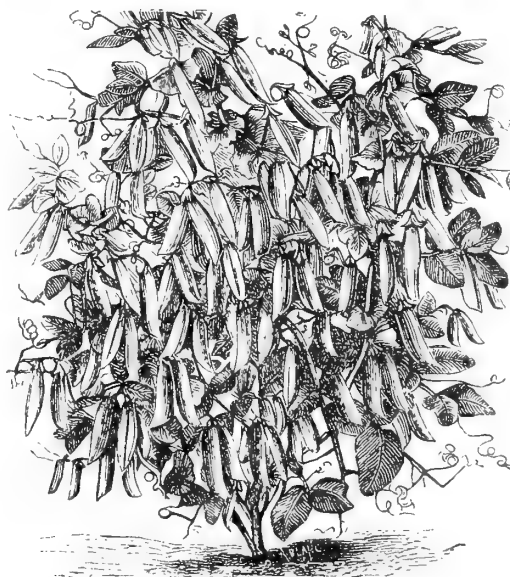

*Carter's Daisy (See page 32)*

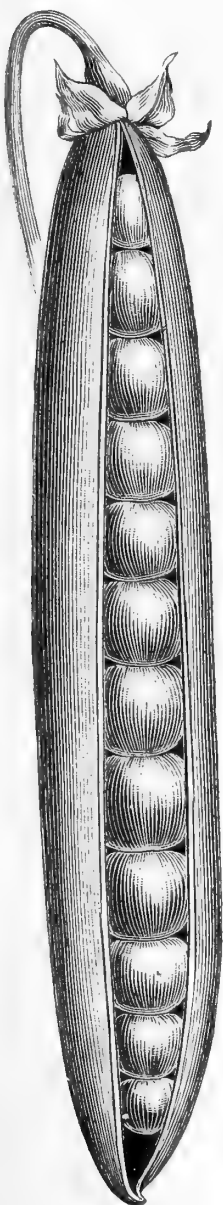

*Gradus*

*Y & H. Pride of the Market*



## Peas—Continued

**Carter's Daisy**—The Daisy is a second early pea of robust habit; bearing an abundance of well filled pods containing seven to nine large peas. It is one of the finest dwarf early green wrinkled peas in cultivation, and one that ought to be grown in every garden whose owner appreciates peas; sturdy and branching in habit, requiring no stakes, coming early and remaining late in profitable productiveness; vines about two feet in height. Pt. 20c; qt. 35c; 4 qt. \$1 15.

**McLean's Little Gem**—A variety similar to the premium Little Gem. Pt. 20c; qt. 30c; 4 qt. \$1.50

**McLean's Advancer**—A fine early market variety, exceedingly prolific, with well filled pods of green wrinkled peas of a delicious flavor. It is also known as *Dwarf Champion*. Vines two to two and one-half feet high. Pt. 15c; qt. 25c; 4 qt. 80c.

**Hosford's Market Garden**—A grand wrinkled variety coming in between little Gem and Advancer. It is a prolific bearer and has yielded more shelled peas per acre than any other American variety. The pods although of medium size, are numerous, and are literally packed with peas of a delicious, sweet flavor; vines two feet high. Pt. 15c; qt. 25c; 4 qts. 80c.

**Allen's Dwarf Telephone**—One of the most productive sorts, possessing all the fine qualities of the Tall Telephone, but vines only two feet high. Pt. 20c; qt. 30c; 4 qt. \$1.10.

**Duke of Albany, (American Champion)**—It is one of the largest peas, enormously productive and its flavor and quality closely approach that of the well known Champion of England. The pods are produced in pairs, and are well filled; each pod contains from nine to twelve large, fine peas. It is of branching habit; *it should be sown thinly*. Vine grows 4½ feet. Pt. 20c; qt. 30c; 4 qts. \$1.00.

**Long Island Mammoth**—One of the most productive peas; pods large and handsome, and well filled with peas of excellent flavor. This is another one of those popular sorts for the market gardeners, as the large pods soon fill a basket, requiring but little time for gathering the crop. Vines about 4½ feet in height. Pt 15c; qt. 25c; 4 qts. 80c.

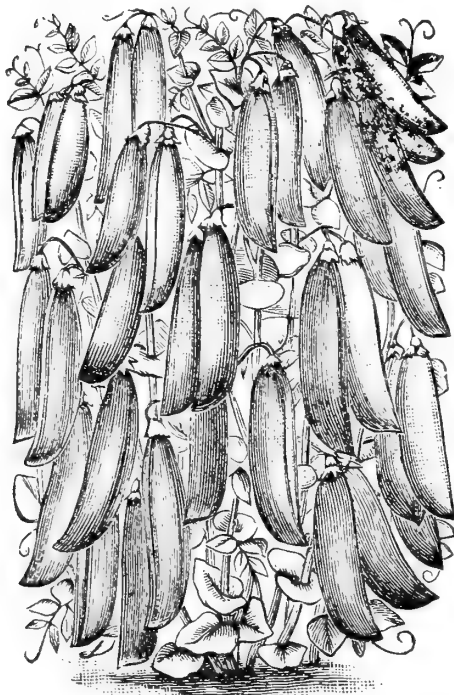

*Telephone*

**Improved Stratagem**—An excellent wrinkled pea, with sturdy vine; it is vigorous, productive and satisfactory, each seed as a rule, produces two stalks, and this gives ample bearing capacity to the vine. The pods are of extra large, size often measuring five inches in length, and are always well filled, frequently containing ten peas to the pod. The flavor is first class; Vine two feet in height. Pt 20c; qt. 30c; 4 qts. \$1.00.

**Telephone**—This is a fine wrinkled pea; the peas are large and of a pale green color, and possess a superior sugary flavor. It is a second early or medium variety, robust in habit of growth, and a great bearer. The pods are of large size; of especial value in the choice of family gardens. Vines 4 feet high. Pt. 20c; qt. 30c; 4 qts. \$1.00.

**Pride of the Market, (Extra Selected)**—Smooth pea of English origin; it has a robust branching habit, and requires no sticks. It is excellent in productiveness; the pods are large in size, and handsome in appearance, and the variety is popular as a market garden pea. Vine 1 and 1½ to 2 feet high. Pt. 15c; qt 25c; 4 qts. 75c.

**Yorkshire Hero**—A very fine, large, dwarf, wrinkled variety, of extra fine quality and very productive,

Vines 2½ feet high. Pt. 15c; qt. 20c; 4 qts. 75c.

**Champion of England**—An old standard wrinkled variety. It is late but very productive, The pods being large, and the pea being tender and sweet. The bearing period is prolonged, it being a hardy and rampant grower. Vine 4 to 5 feet high. Pt. 15c; qt. 20c; 4 qts. 75c.

**Black-Eyed Marrow Fat**—An old, and still widely popular smooth variety, grown extensively as a market variety for a main crop, very hardy and productive, largely used by the canning establishments. Vine 3 to 5 feet high. Pt, 10c; qt. 15c; 4 qts. 50c.

## Peas--Continued

**Canada Field**—The foliage and habit of growth quite similar to garden peas. The Canada field pea is one of the very best soiling crops at the north, and is largely used for that purpose and for green manuring. It is sometimes grown alone, but the most satisfactory dairy results come from the sowing it with oats, rye or barley. It makes good ensilage, and is an admirable food either green or dry, for cattle, being highly nutritious and rich in milk-producing elements. It is quite hardy and may be sown early in the spring, and will be ready to cut in May or June. \$2.00 a bushel.

## RADISH

**Culture**—Radishes require a light, rich sandy loam; heavy or clayey soils, not only delay their maturity, but produce crops much inferior, both in appearance and especially in flavor. For a constant supply, sow from the middle of March until September, at intervals of two or three weeks. For an early supply, they may be sown in hot-beds in February. For winter radishes, sow the seed about beginning of July, and keep the roots during winter in a cool cellar, covered with earth. They should be placed in cold water an hour or so before using. One oz. to 100 feet drill; 10 lbs. the acre.

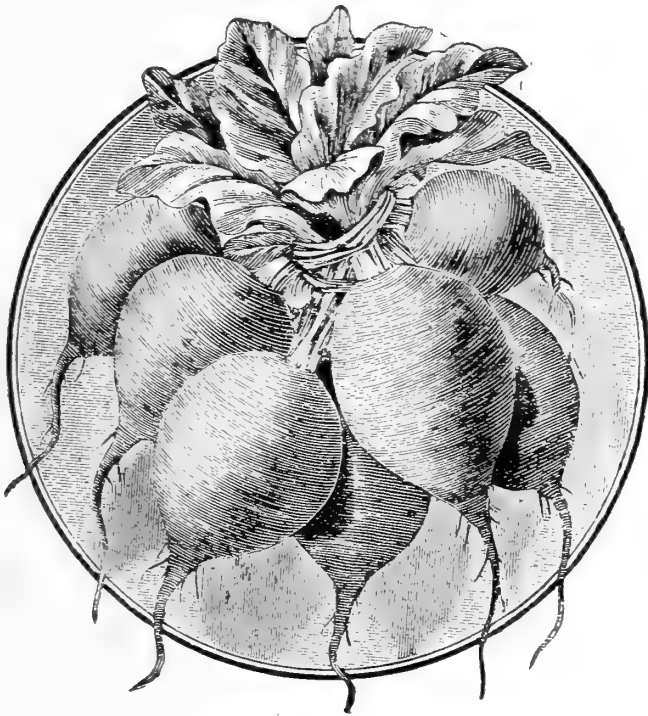

*Scarlet Globe.*

**Scarlet Globe**—People who desire to have the finest and first red radishes, should sow this variety. It is crisp and brittle, the skin is of a rich, scarlet color, while the flesh is pure and white, and always tender, mild and sweet. It has a small, short top, and is well adapted to open air culture or to forcing under glass. In favorable weather and in good soil, it will mature in eighteen or twenty days from sowing of seed. It is extensively used by market gardeners, who hold it in high esteem. We do not think it can be surpassed. Pkt. 5c; oz. 10c; ¼ lb. 20c

**Early Scarlet Turnip White Tipped**—The favorite variety for out door cultivation; medium size, uniform shape, color bright scarlet—with white tip, which makes it most attractive. It grows quickly. Pkt. 5c; oz. 10c; ¼ lb. 20c.

**Early Scarlet Turnip**—The most popular sort, medium in size, bright scarlet color; grows quickly, and is very mild in flavor. Pkt. 5c; oz. 10c; ¼ lb. 15c.

**Early Deep Scarlet Turnip**—Similar to the above but darker; extra fine. Pkt. 5c; oz. 10c; ¼ lb. 20c.

**Scarlet Turnip White Tip Forcing**—The color is scarlet and white, as indicated by its name. It is extremely quick to mature; it is as valuable for out of doors as well as forcing under glass. The skin is very smooth, and its clear color gives it an appetizing appearance on the table. Pkt. 5c; oz. 10c; ¼ lb. 20c.

**Vick's Scarlet Globe**—Similar to the Scarlet Globe with the exception that it is a beautiful oval shape; its foliage is very small and color a rich scarlet. The flesh is crisp and tender and is equally as good for open garden culture as for forcing. Pkt. 5c; oz. 10c; ¼ lb. 15c.

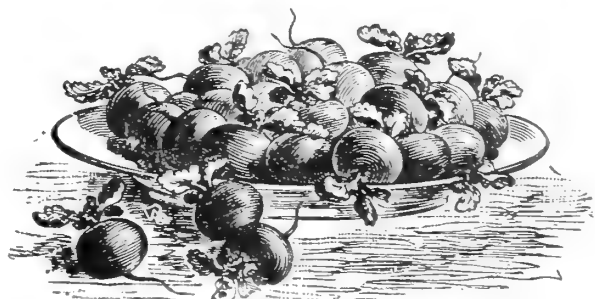

*Vick's Scarlet Globe.*

*Triumph Radishes*

## Radish--Continued

**Rosy Gem**—Superb, of mild flavor, and is grown very extensively by market gardeners. Pkt. 5c; oz. 10c;  $\frac{1}{4}$  lb. 20c.

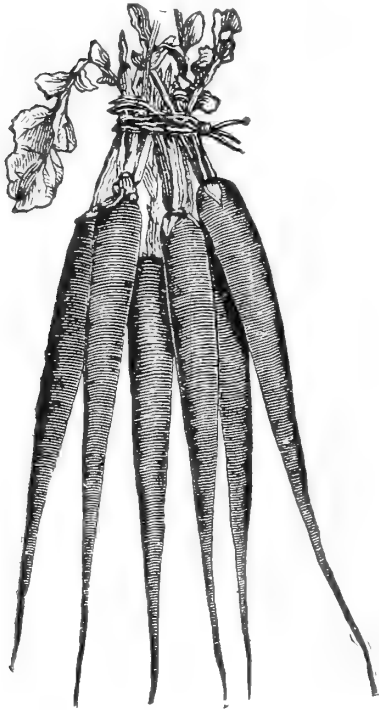

*Long Scarlet Short Top*

**Giant White Stuttgart**—A popular variety, early, of quick growth and large size; in shape like a top, both flesh and skin are pure snowy white. Pkt. 5c; oz. 10c;  $\frac{1}{4}$  lb. 15c.

**Golden Yellow Olive-shaped**—New—a vast improvement on the old yellow sorts; color a brilliant golden-yellow; roots smooth, entirely free from small roots; flesh pure white, and of mild flavor; retaining its crispness until quite late. It is early, and can be used for forcing as well as open ground. Pkt. 5c; oz. 10c;  $\frac{1}{4}$  lb. 15c.

**French Breakfast**—A great favorite; beautiful bright scarlet, with pure white tip, oval in shape. Pkt. 5c; oz. 10c;  $\frac{1}{4}$  lb. 15c.

**Long Scarlet Short Top**—This is the standard long red variety so popular everywhere. It matures in 25 to 30 days from seed. The root is bright red, brittle and sweet. Pkt. 5c; oz. 10c;  $\frac{1}{4}$  lb. 15c.

**Long White Vienna or Lady Finger**—An extremely popular sort. It is the best and finest of the Large White Radishes. It is graceful in form, brittle, and sweet in flavor. Pkt. 5c; oz. 10c;  $\frac{1}{4}$  lb. 20c.

## Summer Radishes

**White Strassburg**—A White Radish. It is of large size, good quality, and has ability to resist severe heat. We recommend White Strassburg for summer planting. Pkt. 5c; oz. 10c;  $\frac{1}{4}$  lb. 20c.

**Golden Summer Turnip**—Grown quickly to a fair size, and withstands heat and drought wonderfully well: of excellent flavor. Pkt. 5c; oz. 10c;  $\frac{1}{4}$  lb. 20c.

## Winter Radishes

**Chinese Rose or Scarlet Winter**—A popular favorite, with rose colored skin. It is a large and finely shaped Radish, growing partly above the ground. The portion above

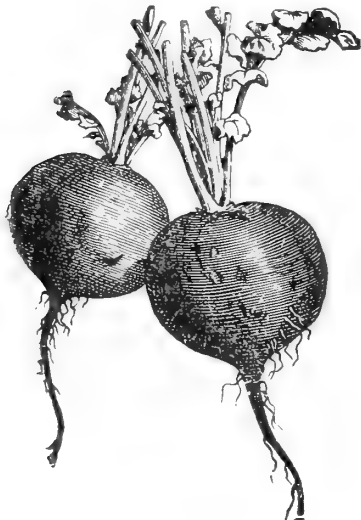

*Black Spanish Winter.*

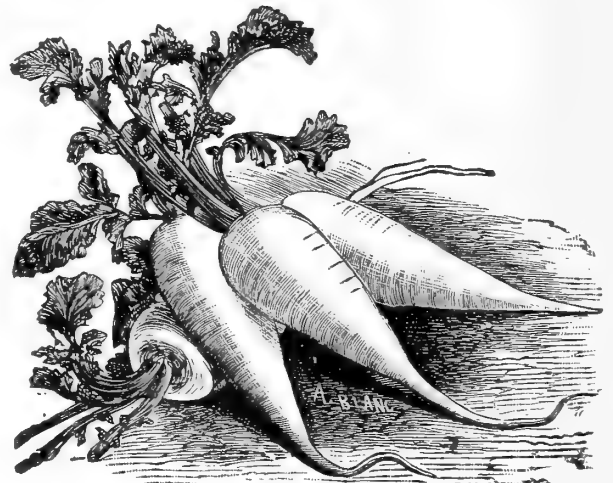

*White Strassburg*

ground is darker in color than that below ground. Flesh pure white; flavor mild or slightly pungent. A splendid keeper for winter use. Pkt. 5c; oz. 10c;  $\frac{1}{4}$  lb. 20c.

**Round Black Spanish**—A large, round, black-skinned radish, with firm white flesh of pungent flavor. It is a good keeper. Pkt. 5c; oz. 10c;  $\frac{1}{4}$  lb. 20c.

**Long Black Spanish**—One of the latest as well as the hardiest of radishes; an excellent sort for winter use. Roots oblong, black, of very large size and firm texture. Pkt. 5c; oz. 10c;  $\frac{1}{4}$  lb. 20c.

**Half Long Black Spanish**—An American sort of the same general character as the Long Black Spanish, but by many considered superior to either the round or the Long Black Spanish. It is intermediate in shape, between the two, and seems to combine the good qualities of each. Pt. 5c; oz. 10c;  $\frac{1}{4}$  20c.

## RHUBARB

**Culture**—Rhubarb succeeds best in deep, somewhat retentive soil; the richer its condition, and the deeper it is stirred, the better. Sow in drills an inch deep, and thin out the plants to six inches apart. In the fall, transplant the young plants into very highly manured and deeply stirred soil, setting them from four to six feet apart each way and give a dressing of manure every spring. The stalks should not be plucked until the second year, and the plant never allowed to exhaust itself by running to seed.

Victoria—Pkt. 5c; oz. 10c;  $\frac{1}{2}$  30c.



*Large Victoria.*

## SALSIFY, OR OYSTER PLANT

**Culture**—It succeeds best in a light well enriched soil, which should be stirred to a good depth. Coarse and fresh manure should be avoided, as it will surely cause the roots to grow uneven and ill shaped. Sow early and quite deep, giving the general culture recommended for Parsnips. The roots are perfectly hardy, and may remain out all winter. One oz., 200 feet drill. 8 lbs. to the acre.

**Mammoth Sandwich Island**—This is in every way superior to the large White, being larger, stronger growing, and less liable to branch. Pkt. 5c; oz. 15c;  $\frac{1}{2}$  lb. 30c.

## SPINACH

**Culture**—Sow in drills or broadcast, in spring or autumn. It costs no more to produce spinach in winter than in summer, as it is not liable to shoot to seed in cold weather, and can be cut whenever not covered by snow. The seed is cheap, and we recommend spinach as a cover crop for small pieces of land that would otherwise lie bare all winter. One oz. 200 feet drill.

**Early Giant Thick Leaved**—A variety which grows very rapidly, forming a cluster of large, very thick, slightly wrinkled leaves of fine color and quality; especially recommended for market gardeners. Pkt. 5c; 1 lb. 15c; 10 lbs @ 12c.

**Long Standing**—An improved strain of excellent merit, having all the good qualities of other sorts and continuing in condition for use, much longer. The leaves are smooth and very dark, rich green. Pkt. 5c; 1 lb. 18c; 10 lb. @ 15c.



*Spinach, Long Standing.*

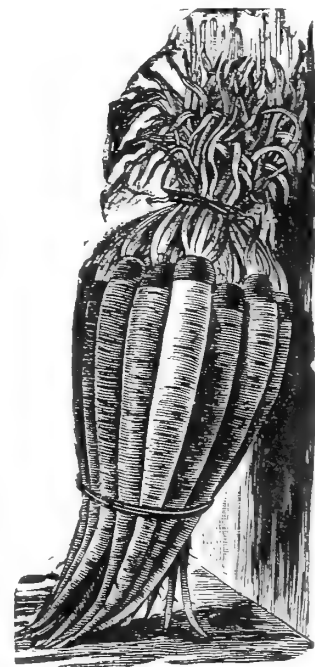

*Mammoth Sandwich Island*

**Bavoy or Bloomsdale**—In appearance the leaf is wrinkled in the same way peculiar to the Savoy Cabbage, hence the name. It should not, however, be sown in the spring, as it is almost certain to run to seed. One of the best for autumn sowing. Pkt. 5c; 1 lb. 18c; 10 lb. @ 15c.

*Victoria Spinach*



## SQUASH

**Culture**—It is useless to plant squash until the soil is quite warm, and all danger of frost of cold nights is over, and as they make a very rapid growth, there is no necessity for haste in getting the seed into the ground. Squash likes a rich soil, and it is best to manure in the hill. Plant a dozen seeds in each hill, and when danger from "Bugs" is over, pull up all but three or four. A mellow, warm soil is best. For bush sorts, make hills four or five feet apart each way, and for the running kinds, twice that distance. Squashes are in two classes, summer and winter.

The summer are used when young and tender, and the winter, when well ripened, will usually keep until spring. Winter squashes should be ripened thoroughly, or they will be watery and lack sweetness and richness, and will not keep through the winter. (Use Bug Death for squash bugs.) One oz. to 50 hills; 3 to 4 lbs. to acres.

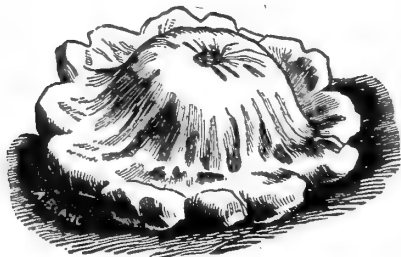

*Early White Bush Scallop.*

**Early White Bush Scallop**—The Bush or Patty Pan squashes are earlier than any other summer variety. The skin of this one is white and it is tender when ready for use; it is of dwarf habit, quite hardy and very productive. Pkt. 5c; oz. 10c;  $\frac{1}{4}$  lb. 20c.

**Early Yellow Scallop Bush**—Similar to the White Bush in every way, except color, which is a clear yellow. Pkt. 5c; oz. 10c;  $\frac{1}{4}$  lb. 20c.

**Early Orange Marrow or Prolific**—Pronounced the earliest and finest fall variety, maturing ten days sooner than the Boston Marrow. Skin orange colored, flesh yellow, fine grain, thick, dry and sweet. The squash is medium in size and a good keep. Pkt. 5; oz. 10c;  $\frac{1}{4}$  lb. 20c.

**Giant Summer Crookneck**—Vine a little larger and stronger growing than the Summer Crookneck, producing fruit fully twice as large, deeper colored and with rough surface. Its large size and attractive color make it a favorite with market gardeners. Pkt. 5c; oz. 10c;  $\frac{1}{4}$  lb. 20c.

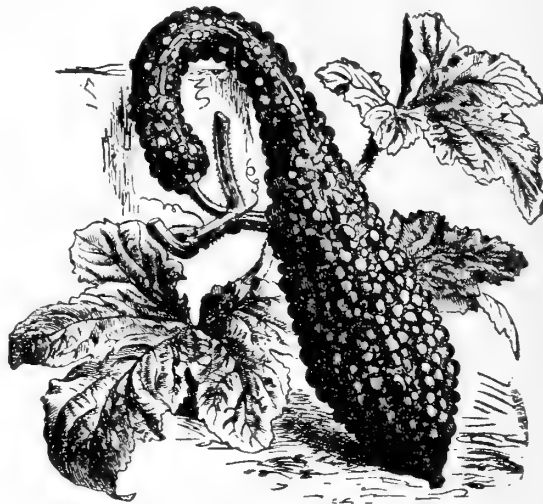

*Giant Summer Crookneck.*

**Early Summer Crookneck**—A much esteemed variety; the fruit is orange yellow, covered with warty excrescences. It is considered the best flavored of the summer varieties. Pkt. 5; oz. 10c;  $\frac{1}{4}$  lb. 20c.

**American Turban**—Orange flesh, and of good flavor. Pkt. 5c; oz. 10c;  $\frac{1}{4}$  lb. 20c.

**Golden Hubbard**—A new and valuable squash, a sport of the old Hubbard. It has the shape and virtues of its parent, but is earlier and more productive. The color of the skin is very pleasing, being deep yellow or orange red; flesh richer in color than Hubbard, and of equal quality. Finely grained and sweet. It cooks dry, and is perfect for table squash and making pies. Pkt. 5c; oz. 10c;  $\frac{1}{4}$  lb. 30c.

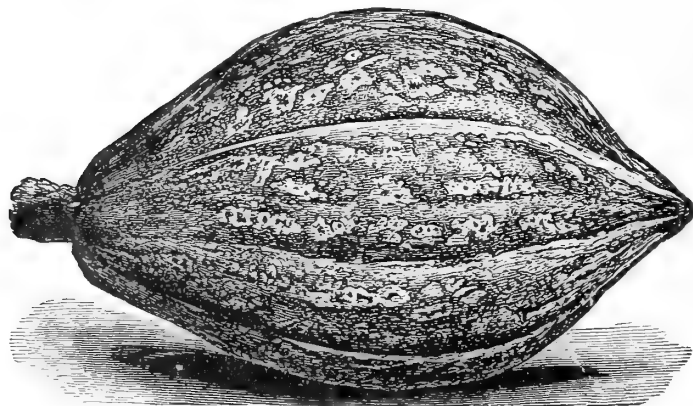

*Golden Hubbard.*

The meat is thick and the seed [cavity small.  $\frac{1}{4}$  lb. 30c.

**Ford Hook**—The flesh of this squash is very dry and sweet. It is one of the earliest of the winter variety, and if stored in a cool, dry place, will keep until the following June. The outside color is a bright yellow; inside color, straw yellow; the skin is so thin that it need not be removed for cooking. Immensely productive. Pkt. 5c; oz. 10c;

## Squash--Continued

**Chicago Warty Hubbard**—A sport of the old Hubbard with an extra rough exterior, popularized by growers in the vicinity of Chicago.

With the additional merits of thicker flesh, finer color, and immense size, its rough hardy watery shell, makes it one of the best keepers among squash. Pkt. 5c; oz. 10c;  $\frac{1}{4}$  lb. 30c.

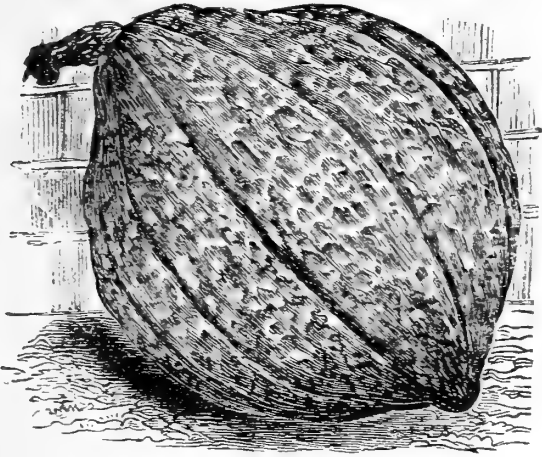

*Boston Marrow.*

**Boston Marrow**—A Fall and Winter variety, very popular in the Boston market; of large, size, oval form; skin thin. When ripe, bright orange with a netting of light cream color, flesh rich salmon yellow, finely grained, and for sweetness and excellence, unsurpassed, but not as dry as the Hubbard. Pkt. 5c; oz. 10c;  $\frac{1}{4}$  25c.

**Mammoth Chili**—The outer skin of this great squash is a rich orange yellow. The flesh is yellow and very thick and the quality is good and nutritious. It is of the highest value as a stock food, far exceeding ordinary pumpkins in this respect; it is a prolific variety, and a good winter

keeper; has reached the great weight of 300 pounds. It is a typical sort to grow for exhibition at the fairs. Pkt. 5c; oz. 15c;  $\frac{1}{4}$  lb. 40c.

**Hubbard**—This is a superior variety, and one of the best winter squashes; flesh bright orange yellow, finely grained, very dry, sweet and richly flavored; keeps perfectly good throughout the winter. Pkt. 5c; oz. 10c;  $\frac{1}{4}$  lb. 25c.

**Marblehead**—An excellent variety resembling the Hubbard. The flesh is lighter in color than that variety, a good yielder and a fine keeper. Pkt. 5c; oz. 10c;  $\frac{1}{4}$  lb. 20c.

**Essex Hybrid**—One of the richest flavored, finest grained and sweetest of squashes, also one of the very best keepers. Short cylindrical shaped, having on the blossom end a small cap-shaped enlargement. The flesh is dry, sweet and thick, and of a bright orange color. Pkt. 5c; oz. 10c;  $\frac{1}{4}$  lb. 30c.

## TOMATO

**Culture**—Tomatoes do best on light, warm, not over rich soil, and success depends upon securing a rapid, vigorous and unchecked growth during the early part of the season. Sow in hot beds from six to eight weeks before they can be set out of doors, which is when danger from frost is past. When the plants have four leaves transplant into shallow boxes or cold frames, setting them four or five inches apart; give plenty of air and endeavor to secure a vigorous but steady and healthful growth, so that at the time of setting in the open ground they will be strong and stocky, even a slight check while the plants are small, will materially diminish their productiveness. Set out of doors as soon as danger from frost is over, but before doing so harden off the plants by gradually exposing them to night air and by the withdrawal of water until the wood becomes hard and thick leaved, and of a dark green color. Transplant carefully and cultivate well as long as the vines will permit.

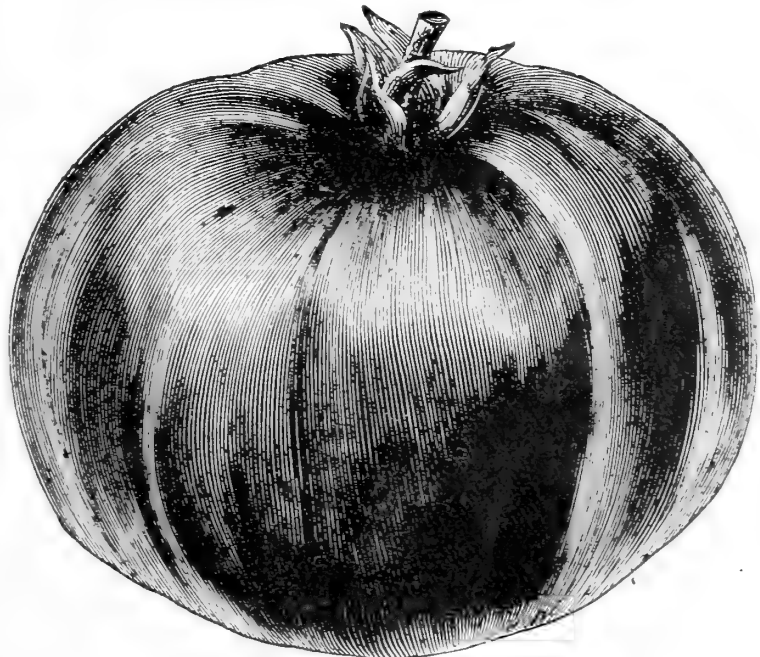

*Ford Hook First (See page 38)*

## Tomato—Continued

**Ford Hook First**—A splendid variety especially adapted for cool, moist or heavy soils; plants of strong running growth; fruit three to four inches in diameter, very smooth and free from cracks, quite deep through and richly colored deep purple. Very fleshy with but few seeds and of the finest flavor. It is one of the earliest and at the same time produces smooth, handsome fruit while other extra early sorts are quite rough and irregular in form. Pkt. 5c; oz. 35c;  $\frac{1}{4}$  lb. 90c.

**Early Ruby**—The great value of this variety lies in the fact that it is the earliest of all the large-sized tomatoes, which combine good form, rich scarlet color and solidity. Pkt. 5c; oz. 25c;  $\frac{1}{4}$  lb. 80c.

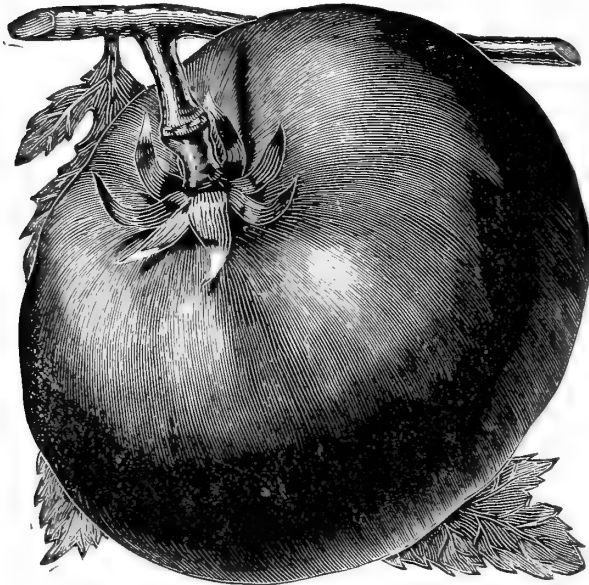

*New Stone Tomato.*

vines vigorous and productive, fruit round, apple-shaped, very large, very deep red in color, and very heavy. Pkt. 5c; oz. 25c;  $\frac{1}{4}$  lb. 80c.

**Bondeross**—One of the largest and heaviest tomatoes grown; color a glowing crimson, skin smooth, shape quite regular, considering size. Will mature under favorable conditions in 100 days from seed. Pkt. 5c; oz. 35c;  $\frac{1}{4}$  lb. \$1.10.

**Dwarf Champion**—The famous Dwarf Champion tomato owes its wide popularity to its stiff vigorous upright growth, with fruit well above the soil, and to the earliness with which it reaches its maturity. In color the fruit is purplish pink, and it is always round and smooth; size medium. Table quality superior; a good shipper. Pkt. 5c; oz. 25c;  $\frac{1}{4}$  lb. 95c.

**Livingston Beauty**—Fruit large, in clusters of four or five; color a rich gloss crimson. For early market use it cannot be excelled. It can be picked when green and will ripen up afterward. Pkt. 5c; oz. 20c;  $\frac{1}{4}$  lb. 90c.

**Livingston Favorite**—A smooth tomato which does not crack; color a very dark red, inclined to purple; it is quite large, and has but few seeds. In proportion to size, it is one of the heaviest tomatoes. Pkt. 5c; oz. 20c;  $\frac{1}{4}$  lb. 90c.

**Atlantic Prize**—We have in this variety a sort which, because of its small, compact vine, can be set much closer than the later sorts, and which will under similar conditions ripen up the greater portion of its crop before the fruits of the later sorts begin to color. The fruit is of good size, form and color; though a little soft, it commands a ready sale as it comes into market when there is no other sort to compete with it. Pkt. 5c; oz. 25c;  $\frac{1}{4}$  lb. 80c.

**Truckers' Favorite**—A very large purple tomato of superior quality; very solid and free from cracks or rot. Very popular. Pkt. 5c; oz. 35c;  $\frac{1}{4}$  lb. 95c.

**New Stone**—This is the heaviest and most solid fruited of the large tomatoes of good quality. Our stock is distinctly superior to most of that offered under this name, being more uniform, better colored and larger;



*Dwarf Champion.*

## Tomato—Continued

**Livingston Perfection**—This is one of the handsomest tomatoes grown, and all who have tried its invariably large, round, smooth, handsome red fruit pronounce it of the highest quality. Pkt. 5c; oz. 20c;  $\frac{1}{4}$  lb. 90c.



*Acme Tomato.*

**Acme**—Vine large, hardy and productive, ripening its first fruit almost as early as any, and continuing to bear abundantly until cut off by frost. Fruit in clusters of four or five, invariably round, smooth and of good size, free from cracks and stands shipment remarkably well; flesh solid and of excellent flavor. For market gardeners who want an early purple tomato, either for home market or to ship, it is one of the best. Pkt. 5c; oz. 20c;  $\frac{1}{4}$  lb. 60c.

**Improved Trophy**—The Trophy was the first of the modern improved sorts, and it had qualities of color, size and solidity which entitled it to hold a place against the much lauded new kinds; though all admitted it lacked in smoothness and regularity. By most careful breeding and selection there has been produced a strain in which all the original good qualities are retained and even more highly developed, yet it compares favorably with any in smoothness, regularity and symmetry of the fruit. We offer our improved Trophy as sort, whose large, strong growing, vigorous and productive vine, very large, very smooth, solid, finely flavored and beautiful, deep rich red fruit, will satisfy the most exacting. Pkt. 5c; oz. 20c;  $\frac{1}{4}$  lb. 60c.

## TURNIP

**Culture**—For feeding stock in fall and winter, there is nothing superior to Turnips and Ruta Bagas, as they are much liked by all kinds of stock and serve to keep them in good condition. We cannot too earnestly recommend farmers to increase their sowings largely, for we are sure the crop will prove remunerative. This wholesome and agreeable vegetable is most easily affected in its form and flavor, by soil, climate and mode of cultivation. There are a great many varieties, but our list comprises the best for the garden or farm. Sow in drills about sixteen inches apart, and half an inch deep; sow broadcast, but in either case be sure to have the ground rich and freshly dug. Be careful to weed and thin out, so the young plants will not be checked and injured, as over crowding will result in rough and poorly flavored fruit. It is important to get the spring and summer crops started early so that the turnips may have time to grow to sufficient size before hot weather causes them to become tough and bitter. To preserve turnips in good order for winter, store in a cool cellar and cover with sand or turf to keep them fresh. Another method is to put them in a pit dug in dry soil, where there will be no danger of water standing, and to cover with straw overlaid with earth sufficiently deep to keep out frost. Thus protected, turnips will keep well till spring.

**Pomeranian White Globe**—This is one of the most productive kinds, and in good, rich soil, roots will frequently grow to ten or twelve pounds in weight. It is of perfect globe shape; skin white and smooth, leaves large and dark green. Pkt. 5c; oz. 10c;  $\frac{1}{4}$  lb. 15c.

**Long White or Cow Horn**—This variety is pure white, except a little shade of green at the top and is carrot like in form, growing nearly half out of the ground, and slightly crooked. It is delicate and well flavored, of very rapid growth, and has obtained considerable favor as a market sort for fall and winter use. Pkt. 5c; oz. 10c;  $\frac{1}{4}$  lb. 20c.



## Turnip—Continued

**Extra Early White Milan**—This variety is remarkably early, the tops are very small, upright and compact, so that the rows can be planted close together. The clear white roots are very smooth, symmetrical and beautiful; the flesh is white, tender and sweet. Pkt. 5c; oz. 10c;  $\frac{1}{4}$  lb. 25c.

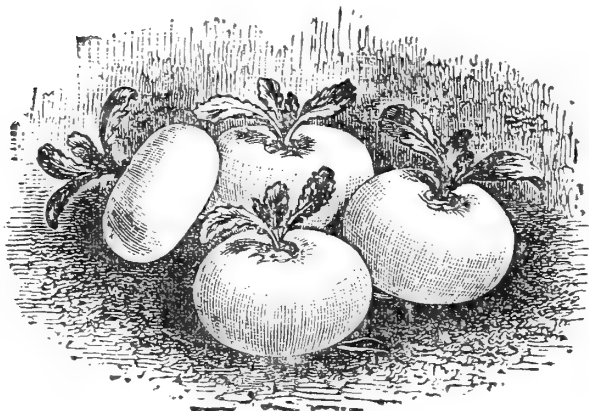

*Extra Early White Milan*

side, flat; color white; very early, sweet and tender. It is desirable for table use, but spongy when overgrown. Pkt. 5c; oz. 10c;  $\frac{1}{4}$  lb. 15c; lb. 45c.

**Early White Egg**—A quick growing, egg-shaped, perfectly smooth pure white variety, with small top and rough leaves. It grows half out of the ground; the flesh is very sweet, firm and mild, never having the rank, strong taste of some of the early varieties. Pkt. 5c; oz. 10c;  $\frac{1}{4}$  lb. 20c.

**Extra Selected Purple Top White Globe**—A variety that originated from the purple to flat turnip. It is globular and nearly as large as the White Globe, of beautiful appearance, of most excellent quality, and equally desirable for table or stock; it keeps well and is a fine market variety. Pkt. 5c; oz. 10c;  $\frac{1}{2}$  lb. 15c.



*Extra Selected Purple Top White Globe*

**Robertson's Golden Ball or Orange Jelly**—This is the most distinct yellow turnip we know. The flesh is of a very fine texture, making it one of the best table varieties; its beautiful color and fine flesh have earned for it the name of "orange jelly," which well describes its appearance when ready for the table. The bulb is of medium size, with small top. Pkt. 5c; oz. 10c;  $\frac{1}{4}$  lb. 15c.

**Sweet German or Large White**—This variety is very popular in many sections, notably so in the New England states. It partakes largely of the nature of the Ruta Baga, and should be sown a month earlier than the flat turnip. The flesh is white, hard, firm and sweet; highly recommended for winter and spring use. Pkt. 5c; oz. 10c;  $\frac{1}{4}$  lb. 15c; lb. 50c.

**Green Top Amber Globe**—One of the best varieties for a field crop for stock; flesh yellow, finely grained and sweet, color of skin yellow; top green; hardy, keeps well; a good cropper. Pkt. 5c; oz. 10c;  $\frac{1}{4}$  lb. 15c; 1 lb. 50c.

**Early White Dutch**—An excellent garden variety, resembling white strap leaf; the best variety for early spring. Pkt. 5c; oz. 10c;  $\frac{1}{4}$  lb. 15c.

**Red Top Strap Leaf**—Rapid grower and of mild flavor; the most popular variety for early use, either for table or stock. Pkt. 5c; oz. 10c;  $\frac{1}{4}$  lb. 15c; lb. 45c.

**Early White Top Strap Leaf**—A most excellent early garden variety; roots medium



*Red Top Strap Leaf.*

## RUTA BAGA

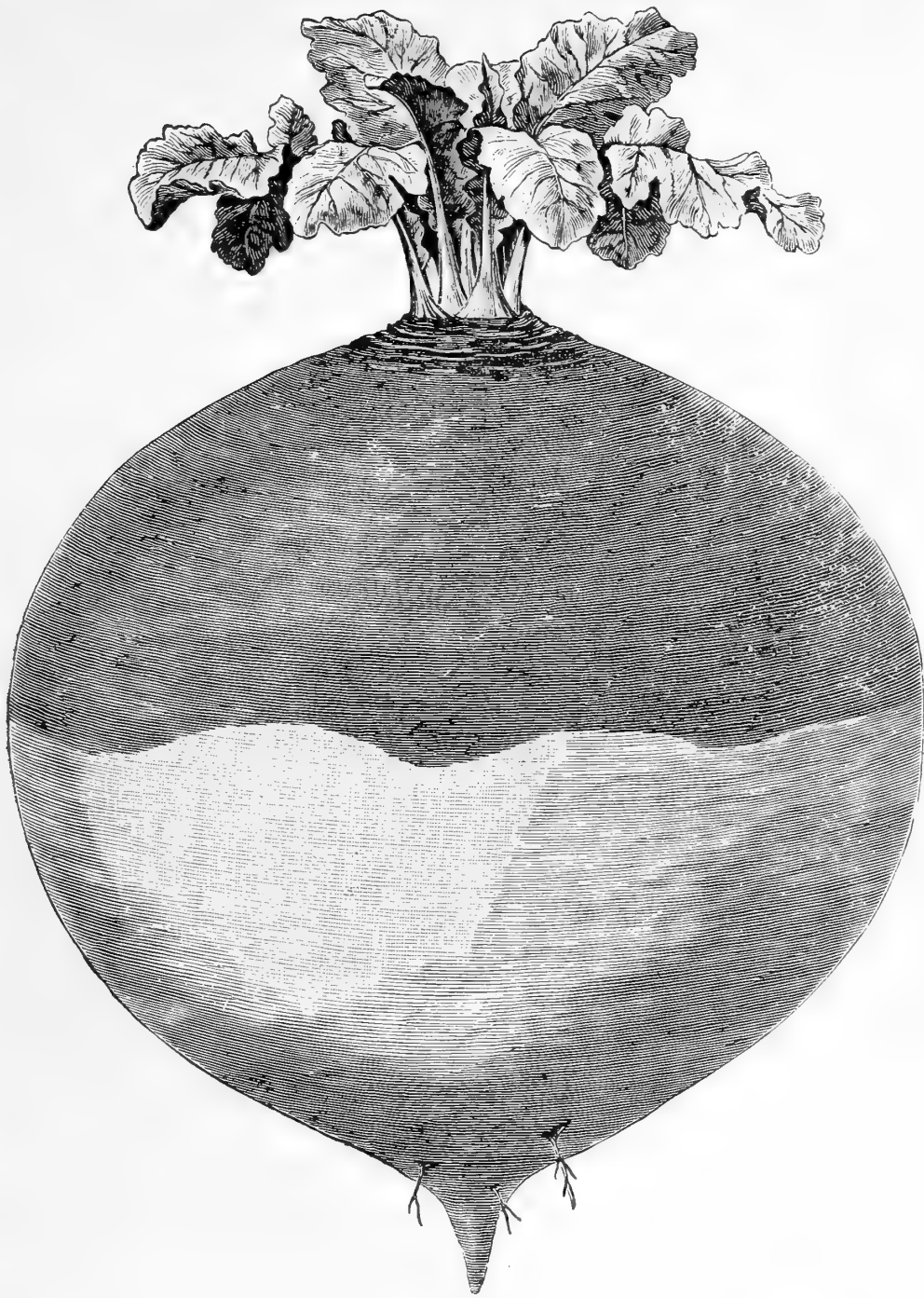

*Long Island Improved.*

**Culture**—Sow the seed about a month earlier than the preceding varieties of turnips. Ruta Bagas should be sown on ground enriched with well rotted manure, in drills two and one-half feet apart, and should be thinned six to eight inches apart in the row. Keep the weeds thoroughly in check with the hoe or cultivator, and when the roots are full grown, and before hard freezing weather, pull them, cut off the tops and store in a root cellar or pit.

**Long Island Improved**—This is a strain of Purple Top Yellow Ruta Baga of American origin, selected to a smaller top and much shorter neck than is usually found, while the roots grow to a large size and are of the finest quality. We consider this one of the most desirable kinds on our list. Pkt. 5c; oz. 10c;  $\frac{1}{4}$  lb. 15c.

**Champion Purple Top**—We place this old standard variety next in place to our Improved Long Island Ruta Baga. It is of fine quality and is widely grown, it keeps perfectly all winter. Pkt. 5c; oz. 10c;  $\frac{1}{4}$  lb. 15c; 1 lb. 50c.

**Improved American Purple**—Very hardy and productive; flesh yellow, solid, sweet; good for stock or table use. Pkt. 5c; oz. 10c;  $\frac{1}{4}$  lb. 15c; 1 lb. 50c.

**Large White French**—A superior variety; white solid, and rich. Pkt. 5c; oz. 10c;  $\frac{1}{4}$  lb. 15c; 1 lb. 55c.

**Budlong's**—A choice strain of white Swede, said to be earlier and of better form than the other sorts. Pkt. 5c; oz. 10c;  $\frac{1}{4}$  lb. 15c; 1 lb. 50c.

## GRASSES

**Culture**—The grasses are receiving increased agricultural attention in America, which means better farming. Success in grass culture demands nice and exact methods. The soil should be worked to a depth of nine to twelve inches, heavy applications of both natural and artificial fertilizers should be made. The mixture of fertilizers with the soil, and the pulverization of the soil should be perfect. Seeding should be extremely shallow, much grass seed is buried too deeply and lost. Sowing may occur in spring or fall but we prefer early spring sowing as a rule. Many farmers are now sowing grasses and clover alone, in the spring in well prepared soil, and treating them in the best possible manner, giving them the full benefit of the original manures and also annual application of fertilizers afterward.

**Note.** Prices on grass and clover seeds are net cash. Send for prices and samples.

**Red Clover**—The agricultural favorite of the east and also largely sown in the west: well and favorably known everywhere, especially valuable for dairy cows on account of high percentage of nitrogenous elements or proteine. Sow ten to twelve pounds per acre in early spring; lives several years but not so long as Alfalfa.

**Mammoth or Pea Vine Cover**—This is a variety of red clover of greater size and strength than the original type. It has a longer life than ordinary red clover; it attains a height or length of five or six feet.

**Alaska Clover**—The same as Swedish or Hybrid Clover, perfectly hardy, and one of the very best of all clovers for cow pasturage, bee pasturage, or for hay making. Delicious, fragrant, and highly nutritious, lasts well for many years, on both wet and dry soil. Sow ten to fifteen pounds per acre.

**Kentucky Blue Grass**—Also called June grass: best of all native grasses for pasture. Blooms in June; a true perennial, but requires two or three years to become established; succeeds everywhere, but prefers a rich soil and a rather dryer situation than red top. One of the most desirable lawn grasses, especially in mixtures. Height nine to eighteen inches. Three bushels to the acre.

## Orchard Grasses

Some times called dock's foot. Height three feet. Admirable for pasturage or for mowing, but unsuited to lawn, on account of its tendency to bunch. Will grow in the sun or shade. Use 3 to 4 bushels to the acre. 14 pounds to bushel.

**English or Perennial Rye**—Largely used in lawn and pasture mixtures. It makes a rich, green sod and a nutritious hay, and lasts for several years. Use 60 pounds to the acre.

**Rhode Island Bent**—A valuable perennial for lawns and pasturage. Much like red top, though smaller, thrives on light, dry soils as well as on rich, moist ones. For lawn purposes, if used alone, it should be sown at the rate of about forty pounds to the acre. For pasture, if used alone, twenty-four pounds to the acre.

**Wood Meadow Grass**—Grows from one to one and a half feet high; has a perennial creeping root, and an erect, slender, smooth stem. One of the best varieties to sow in shaded situations, such as orchards and parks, for either hay or pasturage. Sow about thirty pounds to the acre.

**Alfalfa or Lucerne Clover**—The great agricultural clover of the west; now rapidly coming into favor in the east; well adapted to dry sections, but thriving anywhere on well-drained soil. It is a perennial plant, lasting many years under good treatment, and may be cutting several times each season when well established; perfectly hardy, root system remarkable for development. Alfalfa roots not infrequently descends ten or more feet into the soil, indicating ability to resist drought. It is not to be recommended for wet or heavy soils, but should be tried by all dairymen whose land has good under drainage. Use thirty to thirty-five pounds per acre. Sow in April and May on well-lined land. An Alfalfa field is worthy of all care and expense required to produce it.

**White Dutch Clover**—This thrives in almost any and every soil and climate, succeeding equally well on heavy moist land and thin dry hillsides. It is of low-creeping growth and most valuable both in pasture mixtures and for green velvety lawns. Per pound 20c. Larger quantities, prices on application.

**Timothy**—This is the most valuable of all the grasses for hay, especially in the north; thrives best on moist, loamy soils of medium tenacity. It should be cut just when the blossoms fall. Sow early in spring or fall; sow  $\frac{1}{2}$  bushel to acre, but less if mixed with other grasses.

## Grasses--Continued

**Red Top or Herds Grass**—One of our best native pasture grasses; blooms in July, useful for lawn or field, prefers a moist situation, but grows well, almost everywhere. Height one to two feet. Three bushels to the acre, 14 lbs. to bushel.

**Fancy Red Top**—Same as above, but no chaff. Use  $\frac{3}{4}$  bushel to acre; about 28 lbs. to bushel.

**Y. & H. Special Grass Mixture**—For hay and permanent pasture. Will last from fifteen to twenty years without renewal. We offer two carefully made mixtures for permanent pastures, one for light and one for heavy land. Grasses are chosen that will stand for a number of years. With either mixture whether intended for mowing lands or for pasture, should be sown ten pounds of mixed clover seed per acre. The clover seeds being much heavier, should be sown separately. More and more land is being laid down to permanent pasturages in our dairy states, and it is of increasing importance not only to use the best grasses but to employ those which by their differing habits of growth, will produce an unbroken succession of succulent food for grazing stock. Use 3 bushels of grass to acre. Bushel 14 lbs, \$2.50; 10 lbs. mixed clovers, \$2.00.

**Sorghum, or Sugar Cane**—All the sorghums have better drought resisting qualities than Indian corn, and hence have attracted the attention of agriculturalists in search of summer forage crops. The variety of sorghums are many, and may be classed as saccharine and non saccharine, (sweet and not sweet). The first includes sugar cane, etc.; and the second group milo maize, Jerusalem corn, Kaffir corn, etc. Within recent years, dairymen have widely recognized the high economic value of thickly sown sorghum as a summer food for milk cows, and the demand for such seed is now great. Use about 18 lbs. to the acre.

## OATS--Improved American

This grand variety, introduced by us, has become the leading sort in many locations. It is very productive, growing with a strong stiff straw from four to five feet in height; grains plump, and of a bright yellow color. 65 cts. bu.

## BUCKWHEAT--Japanese

The best, most productive and most profitable variety in cultivation. From one-half bushel sown, a crop of forty bushels has been harvested. In color the grain is a rich, dark brown: it ripens a week earlier than Silver Hull, and yields two or three times as much. Excellent for bees.

## BARLEY

Barley succeeds best on rich lands more sandy and lighter than those adapted to wheat. It is sown in the spring, and can be grown farther north than any other grain. Use about two and a half bushels per acre. Our stock is unusually fine.

## RAPE--Dwarf Essex. Imported Stock

This is the best mid-summer and autumn sheep forage known, and it is also used for pigs and dairy cows with success. It is a plant of the cabbage family, requiring the same treatment as the turnip; stock should be fed alternately on grass and rape; not an exclusive rape diet, and rape-fed animals should have access to salt. Sow in May for mid-summer pasturage, or in June or July for autumn pasturage. Sow three pounds of seed to acre in drills or five or ten pounds broadcast. Rape is an excellent green manure for plowing down. lb. 10c. Larger quantities, prices on application.

## SOUTHERN COW PEAS

Cow peas are held in very high esteem for forage purposes, especially in sandy soils. It is said that the cow peas has almost as much agricultural importance as red clover or alfalfa. Great changes are now in progress, however, in farming methods, and there is to-day, a widespread disposition to plant cow peas farther north than formerly, on account of their quick growing habit, their drought resisting ability, and their great value for silage and soil improvement purposes. They will thrive whenever conditions favor corn. The yield per acre often reaches five tons, and is sometimes as much as eight or nine tons.

Some growers turn the mature vines under the plow, some harvest the hay and plow down the stubbs; others ripen and pick the seed, and then plow the vines under. Sow seed at the rate of one to one and one-half bushels per acre. The cow pea is a nitrogen gatherer, and hence improves the soil.



## Cow Peas—*Continued*

### Black

It is very quick to mature, and is adapted to northern localities and late plantings; it is one of the best cow peas for land improvement purposes, and yields a very large amount of forage; it belongs to the class of trailers.

### Whip-Poor-Will

One of the best. Largely grown in the north and west; an early bush variety, with brown speckled seeds. An old favorite, largely planted for forage and soil improvement.

### Vicia Villosa or "Hairy Vetch"

A hardy pea-like plant which grows strongly during the late fall and early winter. It is more satisfactory for the north than crimson clover, as it may be sown later and will make a larger crop of green foliage earlier in the spring. As a cover crop, it will prevent the land from washing during winter storms, and at the same time enrich the soil by storing nitrogen from the air. It succeeds well on light sandy soils or thin, poor hillsides. Seed should be sown broadcast or drilled in at the rate of one bushel per acre. If a half bushel of rye is sown or drilled with the Vetch, the straw will furnish a support for the vines to run on, making them easier to mow for feed, or to turn under with the plow.

### Fodder Corn

*Sweet Fodder*—For cutting in the green state for cattle or other live stock, sweet corn is superior to any of the ordinary field corn. Under this head we offer the *Evergreen Sweet* corn. This makes fodder, and will mature ears in almost any part of the state. From one and a half to two bushels of fodder corn are required to the acre, according to how the seed is planted. It may be planted in hills the same as other field corn, drilled, or sown broadcast. The best fodder is that which makes the greatest amount of leaves, and has the greatest amount of nourishment at the same time.

### Delaware Sheep's Tooth

The most popular variety for green fodder.

### Improved Leaming Dent

A very popular and extremely productive variety. On good lands the stalks grow tall, producing two ears to each stalk; the ears are long, with small red cob well filled with grain of medium size, of a rich golden color. It ripens in one hundred to one hundred and ten days, and makes a good crop even in dry seasons, by reason of its strong vigorous growth. The stalks are leafy, making excellent fodder, while the grains being so deep, yield an extra large quantity of shelled corn per bushel of ears.

### Pride of the North

This is a very early variety and is excellent for short cool seasons, or where a late planting is made. The ears are from eight to ten inches in length and have from fourteen to sixteen rows of slender deep grains.

**Rice Pop Corn**—A very handsome and prolific variety, ears short, kernels long pointed, and resemble rice: color white. Probably no variety of pop corn is superior to this for parching.

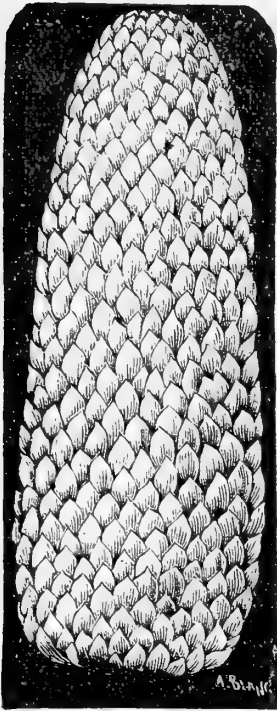

*Rice Pop Corn*  
See page 44

## MILLETS

The Millets are all grasses. They are of several genera and many species. They are mostly of foreign origin. In Asia they furnish food for human beings, the seed being ground and eaten. In America they are largely employed for forage purposes. Most of them have quick growing and drought resisting qualities, and truly high agricultural values.

**Siberian Millet**—A Millet introduced from Russia which gives excellent results in the United States. It attains a height of from three to four feet and has the habit of stooling or branching at the root, thus producing a very large crop of forage. It is earlier than German Millet. The forage is well liked by live stock. Use seed at the rate of  $\frac{1}{2}$  bushel to the acre, and sow not later than June.

**Hungarian Millet**—Often called Hungarian grass. In general favor for summer forage purposes as it can be sown in June, as a second crop, and will be ready for the scythe in 60 days. It will yield two to three tons of hay per acre. It grows on light soils, and withstands heat and drought. Sow seed broadcast at the rate of one bushel to acre.

**German or Golden Millet**—This is a larger and heavier variety than the so-called Hungarian Millet, but is closely allied to it botanically. The German or Golden has yellow, drooping heads, while the Hungarian has heads which are smaller, more erect and more compact, with bristles usually purplish. German Millet is a fine crop for both soiling and hay. For the latter purpose, it must be cut just as it

begins to head, before blooming, for it is liable to injure stock after the seeds are formed. It is ready for use in sixty to sixty-five days after sowing. When used at the proper stage of development, it is one of the most valuable of soiling plants. Sow at the rate three-quarter to one bushel per acre for hay.

## FERTILIZERS

The following are our leading brands with guaranteed analyses. We quote special prices when drawn from the cars.

### Read's Standard

This brand is a general favorite for all crops, vegetable or grain, on all soils, and moderate in price. Remember, in this brand you are getting four per cent. actual potash, which element is largely deficient in all soils, and in many brands of fertilizers. Price, \$25 per ton.

### Practical Potato Special

Potatoes and many other vegetable crops are very large feeders on potash. You have in this brand a "practical fertilizer," complete in formula, yet moderate in price.

We would advise caution in applying this brand, especially on potatoes. It should not come in direct contact with the potato seed, as it is a very strong concentrated fertilizer. Practical Potato Special is equally economical in growing celery and onions. We have several customers using it on these crops exclusively, who speak volumes in its praise. In a practical test against four competing brands it took first place. Price, \$27 per ton.

### Leader Guano

This is a complete fertilizer of correct proportions made from same material as other brands, and is becoming very popular as a grain grower. We recommend it especially for early garden crops. Price, \$20 per ton.

### Lister's Ammoniated Dissolved Bone Phosphate

In this brand of fertilizer may be found all the required elements of plant food necessary to not only give the plant a quick, vigorous start, but to carry it to maturity. We dare say there has been no brand of fertilizers used to such an extent as has this brand. It is widely known as an excellent guano for cotton, having for years led the van in every cotton-growing state; and not alone for cotton, but for tobacco, cereals, vegetables of every class and variety, it has given marked results. Manufactured from the best material.

Nitrogen derived from dried blood, sulphate of ammonia, meat and fish. Phosphoric acid derived from animal bone, Potash derived from high-grade sulphate. Price per ton \$26.00.

## Fertilizers--*Continued*

### "Success" Fertilizer

This brand, first placed upon the market 1885, has met with great success wherever used. We have many flattering reports from those whose who have tested it. It is a complete Fertilizer as well as a complete "success," and that it has in every way met the requirements for which it was made, there is no question. Price per ton, \$25.00.

### Oneida Special Fertilizer

In Oneida County, New York, this fertilizer has the call, and it is gradually becoming introduced in other sections. A great many use it as a seeding-down fertilizer, also on general crops. Per ton, \$20.00.

### Ground Bone

This finely ground bone is excellent for rose culture. It decomposes very rapidly, and is very quick and effective; is excellent for mixing with the soil, for potting or mixed with wood ashes, can be used on your lawns with good results. 5 lbs. 25c; 50 lbs. \$1.50; 100 lbs. \$2.50. Per ton, \$35.00.

### Sheep Manure

A very rich, pure natural manure; it is excellent as a top dressing for lawns. Its effect is immediate and very lasting. There is nothing better for mixing with the soil for greenhouse plants—one part manure and six parts soil. It is recommended for use in the vegetable garden, promoting a steady and rapid growth. It makes a rich and safe liquid manure; one pound to 5 gallons of water. 5 lbs. 30c; 50 lbs. \$1.50; 100 lbs. \$2.50. Price on application for ton lots.

### Canada Hard Wood Ashes

Drives away insects and improves the texture of the soil; indispensable for all crops requiring potash; very beneficial for garden and field crops, of high value for grass and lawns. Apply one to two tons per acre, as one heavy application will do more than the same quantity would, applied in fractions. Per hd. \$1.00; per ton \$12.00

**Young & Halstead Oderless Lawn Dressing**—It is the most complete and satisfactory lawn dressing ever placed upon the market. It is manufactured expressly for us, and we vouch for its containing all the constituents required to produce a luxuriant *oderless lawn dressing*; it is also so clean that the most fastidious person can apply it without offending the organs of sight or smell, it being quick in action, the effect can be seen immediately after the first rain or sprinkling of the hose, and going directly to the root of the grass, stimulates them to greater activity, thereby thickening the sward and producing a firmer growth, which remains green and velvety throughout the season. Its superiority over stable manure can scarcely be estimated, as the latter, in addition to disfiguring the lawn by its unsightly appearance, also gives out an unpleasant odor, and always contains weeds and other undesirable seeds. It can be applied at any time during the year, from April to November as often as the grass seems to need nourishment. In making new lawns, apply at the same time the seed is sown and rake in with the seeds; never apply the dressing while the grass is wet with dew or rain; any time the grass is perfectly dry will answer, but the best time is just before a shower. Five lb. packages 25c; 25 lb. \$1.00; 50 lb. \$1.75; 100 lb. \$3.00.

Nitrate of Soda and other Chemicals. Prices on application.

**Y. & H. Plant Food**—This is the quickest and surest acting plant food for house plants ever put on the market. It is composed of quick acting and long lasting fertilizers and chemicals which will produce a bright, handsome foliage of rich texture and larger and more brilliant flowers. It is very soluble and is readily assimilated, so that marked improvement is noticed in ten days. It is fine and dry and easy to apply. One package enough for twenty ordinary plants for three months. Detailed directions with each package. We recommend it very highly for Green House use, as the ingredients used in this Plant Food will keep off all earth insects without injuring the plants. Special prices in large quantities. Small packages, price, 15c each; by mail 20c. Large packages, price 25c; by mail 35c.

## DAIRY SUPPLIES

**Aquatic Cream Separator**—With this separator you can secure your cream in two hours' time and for the rapid and clear separation, it has advantages over anything in this line which has ever been offered to the dairymen of this country. The milk goes direct from the cow into the separator, and you don't have to bother to get the milk to any certain temperature in order to get out the cream quickly. The cream obtained from the milk is uniform, most free from taints, smooth and sweet. This new separator has no cranks to turn, no machinery to run and keep in order, no repairing expenses, and will get the cream in thirty to sixty minutes' time; all that is required is well water.



*Aquatic Cream Separator.*

Sizes, No. 0,	7 gallons,	1 to 2 cows,	60 lbs. milk per day.....	\$5 00
" " 1,	11 "	" 2 to 4 "	100 lbs. " " .....	6 00
" " 1 1/4,	18 "	" 3 to 4 "	150 lbs. " " .....	7 00
" " 2,	30 "	" 5 to 7 "	200 lbs. " " .....	8 00
" " 3,	50 "	" 8 to 15 "	400 lbs. " " .....	10 00

### Rice's Calf Weaners.

Also prevents cows from sucking themselves.

Prices, No. 1, 25c. No. 2, 35c. No. 3, 50c.



*Rice's Calf Weaners*

### The Keystone De-horning Clippers.

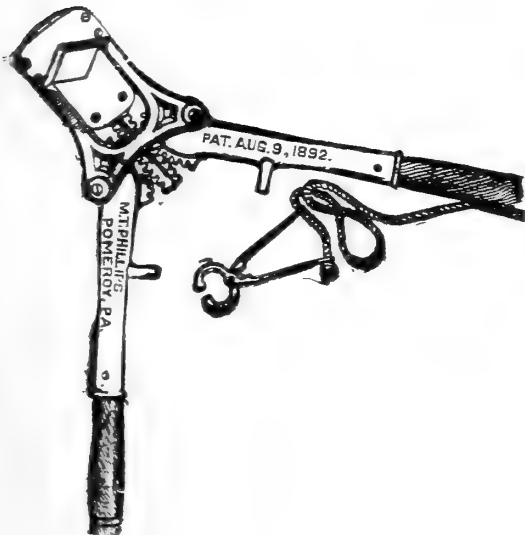

*The Keystone De-horning Clippers.*

The practice of dehorning cattle is coming more and more into vogue. It is a mercy to the animal prevents goring, does not crush the horns, no twisting motion or second cut on horn. Parts are all interchangeable and can be replaced at any time. It is approved by veterinary surgeons and leading dairymen.

Clippers complete, with leader and rope, \$11 00.

### Milk Cans--Iron Clad.

It is the standard milk can, smooth inside surface, without crevices or protruding rivet heads, which enables cans to be easily, quickly and thoroughly cleaned.

Prices, 20 qts., \$2.50; 30 qts., \$2.80; 40 qts., \$3.00.

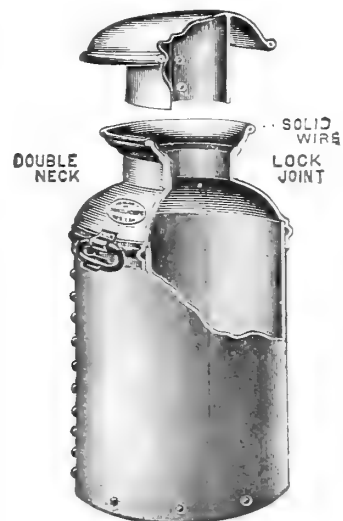

*Milk Cans--Iron Clad*



## Perfection Milk Cooler and Aerator

When in use, the whole inner chamber is filled with water up to the water mark, near the top of central tube, thus bringing in contact with the milk, the greatest possible amount of cooling surface. Aeration is perfect, yet the milk cannot be blown off on the ground if set out in the wind. It is low down, being from six to ten inches lower than any other cooler, and nearly double the cooling surface. Milk receiver is easily removed, but cannot be tipped off by resting the pail on its edge when pouring in milk. Ice can be renewed without removing the milk receiver.

No. 1,	12 quarts,	1 to 10 cows	\$5 00
" 2,	25 "	10 to 25 "	5 50
" 3,	32 "	25 to 50 "	6 00
" 4,	50 "	50 to 75 "	8 00
" 5,	80 "	75 to 125 "	10 00
" 6,	112 "	125 to 200 "	13 00



*Perfection Milk Cooler and Aerator*

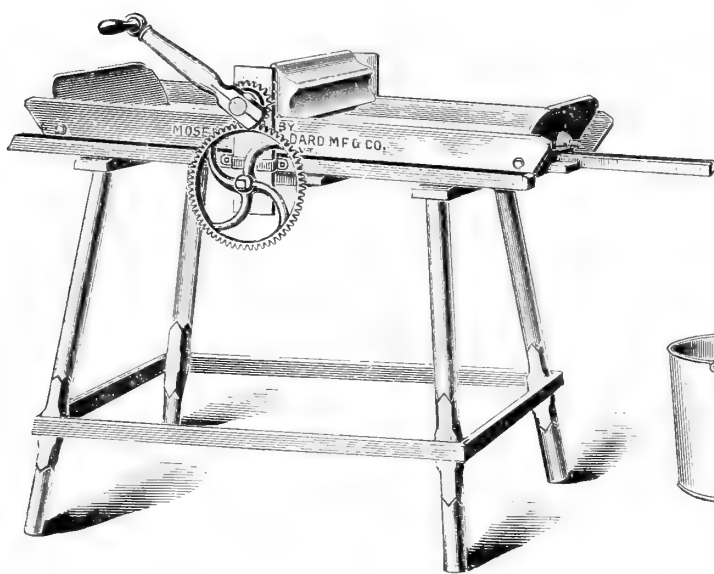

*Waters' Butter Worker.*

## Waters' Butter Worker

The best device ever offered to the public for working butter in the dairy, is Waters' butter worker. It combines more advantages than any other; is practicable, efficient, durable. The tray is removable, and thus takes the place of a butter bowl. Will work butter in any condition satisfactorily. Price, \$8.

## Davis' Swing Churn

The demand for a better grade of butter in these times of low prices, has called attention to the fact that the quality depends very much upon the churn in which it is made. The experience of years makes it an assured fact that flats and paddles inside a churn box invariably injures the grain of the butter, whipping and beating and threshing the cream until the firm texture of the butter is destroyed. The best dairy men are doing away with such churns, and the inquiry is for simple, inexpensive churns, which will bring the butter by simply moving the mass, the particles of cream coming in contact with each other only. *The Davis Swing Churn meets these requirements.*

No. 1 will churn 4 gallons or less, \$7.00. No. 2 will churn 5 gallons or less, \$8.00. No. 3 will churn 8 gallons or less, \$10.00. No. 4 will churn 10 gallons or less, \$12.00.

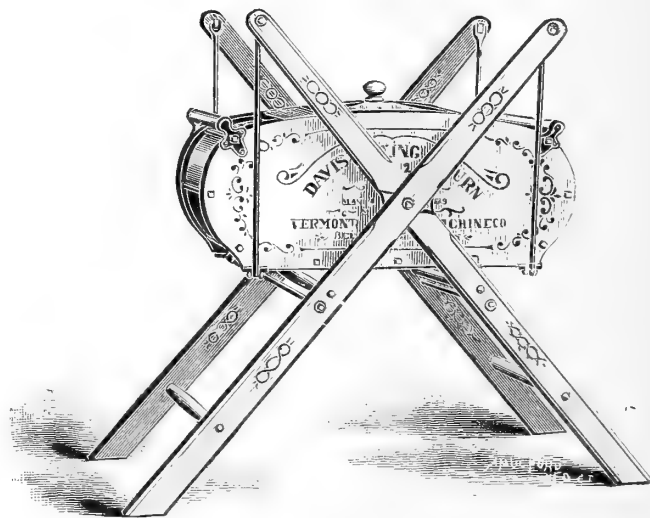

*Davis' Swing Churn*

## Dairy Supplies--Continued

### Acme Bail Churn



Acme Bail Churn

Has steel bails attached to malleable iron ears, thus making an almost unbreakable bail fastening. The rim is very narrow, which renders it easy to remove butter, and clean churn. *In fastening cover on churn, turn top handle sufficiently to hold bails in place only.* By turning top handle too far to the right, the pressure is so great as to sometimes injure the cork packing. No. 0 churns from 1 to 2 gallons, \$3.50. No. 1 churns from 1 to 4 gallons, \$4.00. No. 2 churns, from 2 to 7 gallons, \$4.50. No. 3 churns, from 3 to 9 gallons, \$5.00. No. 4 churns from 4 to 12 gallons, \$5.50. No. 5 churns from 5 to 16 gallons, \$6.50.

### Blanchard Churn

No. 3 churns 2 gallons or less, \$4.50. No. 4 churns 4 gallons or less, \$5.25. No. 5 churns 8 gallons or less, \$6.00. No. 6 churns 12 gallons or less, \$7.50. No. 7 churns 16 gallons or less, \$9.00.

### Lightning Churns

No. 0 churns 2 gallons or less, \$2.00. No. 1 churns 3 gallons or less, \$2.50. No. 2 churns 4 gallons or less, \$3.00. No. 3 churns 5 gallons or less, \$3.50.

### Dash Churns

Wooden and Earthen Ware.  
75c to \$1.50. 65c to \$1.00.

### Calf Meal

The perfect milk substitute for raising calves. Thousands of farmers say it raises calves fast and well with much less expense and trouble than any other milk substitute. Calves can be raised upon it alone, without milk at all, after they are a few days old. Used with separator milk or skim milk, it replaces the butter fats in same and makes them as nutritious as new milk. Even when whole milk is used the feeding of it with the milk builds up much finer, bigger and sturdier calves in half the usual time. It is also a great preventive of scouring and worth its cost alone for this purpose. 100 lb. bag \$3.50; 50 lb. bag \$2.00; 20 lb. bag \$1.00.

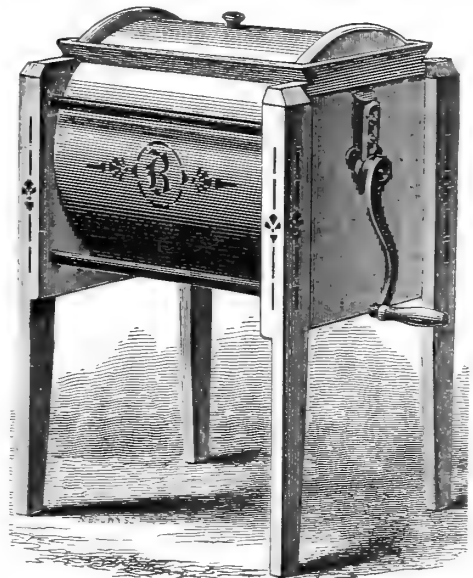

Blanchard Churn

### Lamb Food

For rapidly maturing young lambs and preventing scouring. Price, \$3.50 per 100 lbs.

### Sugar and Flax Seed

The finest food for stock at  $\frac{1}{4}$  the price of stock food. Price, \$3.50 per 100 lbs.

### Wilder's Adjustable Swing Stanchion

With patent Steel Latch. We claim the Wilder Improved Stanchion combines all the merits set forth as required in the best fastening, and in a better manner than in any other on the market. We claim that it saves feed; gives largest freedom, keeps cattle cleaner, is the safest fastener; furnishes the quickest, easiest, and simplest manner of fastening cattle. Price, \$1.50.

### Salt

Retsof No. 2, for Ice Cream packing, bag 200 lbs. 90c.  
Retsof C. for Cattle, bag 140 lbs. 55c.  
Lump Salt for Cattle and Horses, bbl. 280 lbs, market price.  
Solar Salt for Cattle, bag 56 lbs, market price.  
Solar Salt for Cattle, bag 140 lbs, market price.  
Solar B. C., for Ice Cream packing, bbl. 280 lbs, market price.  
Solar F, for Ice Cream packing, bbl. 280 lbs, market price.

# The Prairie State Incubator and Brooder

PRAIRIE STATE INCUBATORS,  
"SPECIALS."

INDOOR  
HOT-AIR BROODERS

These machines are made of the very best material procurable, are built with double walls throughout, with insulating packing between the walls. They are the models which established the reputation of the Prairie State, and are sold with the strongest warranty that we can possibly give them.

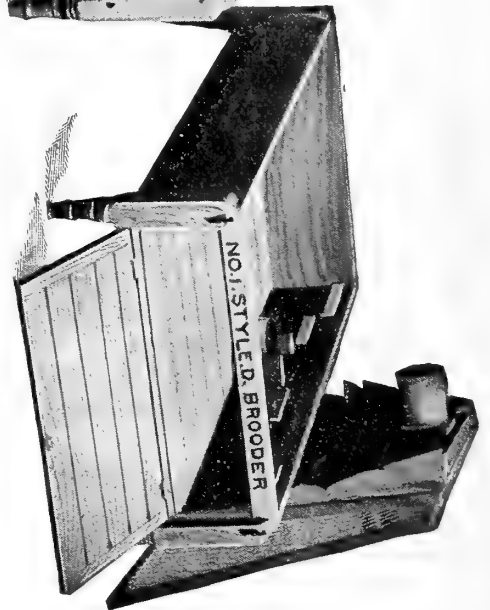
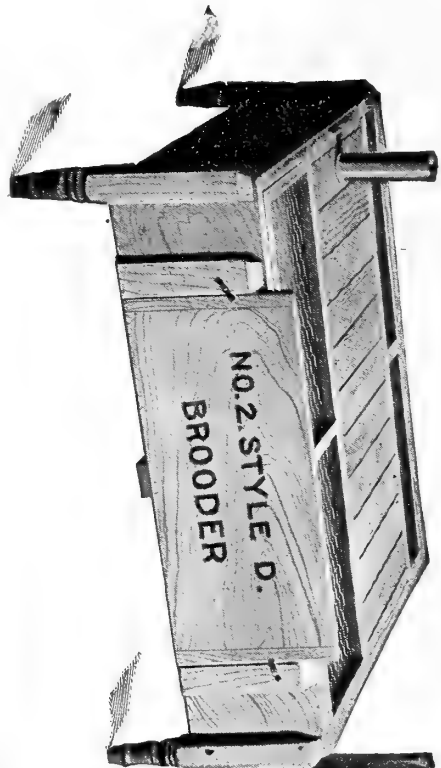
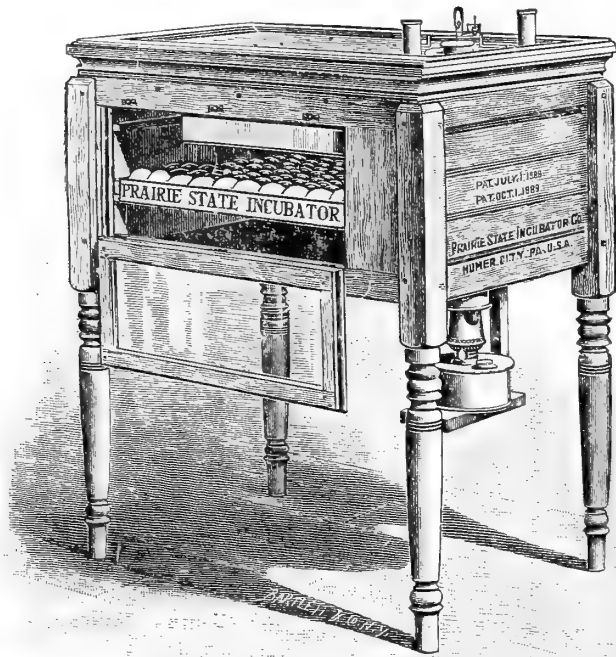

NO.	CAPACITY	WEIGHT, LBS.	PRICE
0	60 to 65 Eggs	80	\$12 00
1	110 to 120 Eggs	135	18 00
2	220 to 240 Eggs	240	29 00
3	330 to 360 Eggs	350	38 00
4	440 to 480 Eggs	425	50 00
Duck	288 Duck Eggs	425	44 00
	400 Hen Eggs		
Goose	50 Goose Eggs	160	25 00

## OUR BABY INCUBATORS

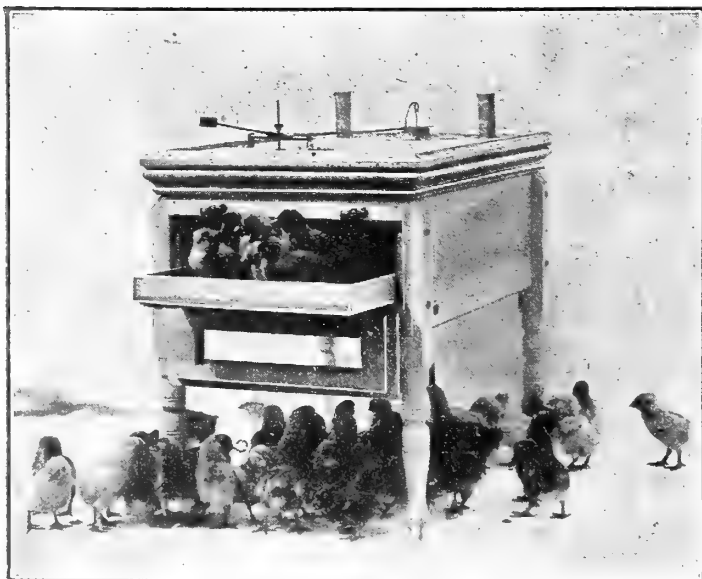

BABY NO. 1—50 EGGS

### BABY

NO.	CAPACITY	WEIGHT, LBS.	PRICE
1	50 Eggs	45	\$6 00
2	100 Eggs	70	10 00

### STYLE "A"

NO.	CAPACITY	WEIGHT, LBS.	PRICE
1	150 Eggs	170	\$20 00
2	210 Eggs	215	26 00

### STYLE "B"

NO.	CAPACITY	WEIGHT, LBS.	PRICE
1	150 Eggs	150	\$15 00
2	210 Eggs	195	22 00

# The Prairie State Incubator and Brooder—*Cont.*

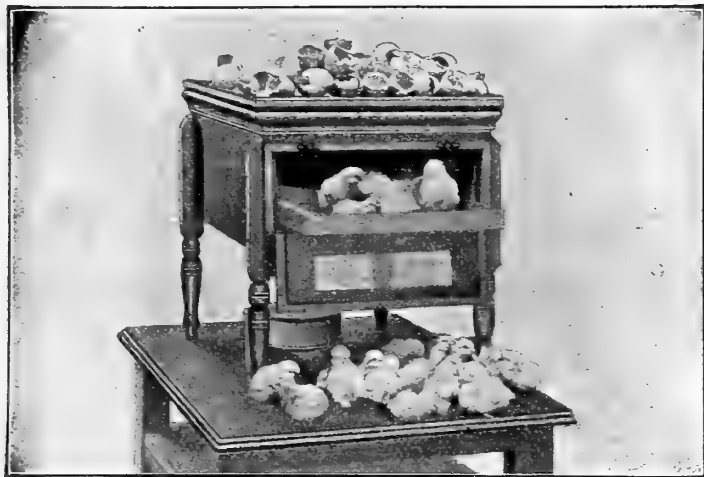

BABY NO. 2—100 EGGS (See page 50)

## Outdoor Brooder

### INDOOR BROODER

NO.	SIZE	CAPACITY	PRICE
1	25½ x 36	80 Chicks	\$7 00
2	36 x 36½	125 Chicks	9 00

### OUTDOOR BROODER

NO.	SIZE	CAPACITY	PRICE
1	36 x 36	100 Chicks	\$12 00
2	48 x 48	150 Chicks	16 00

Special Catalogue on application

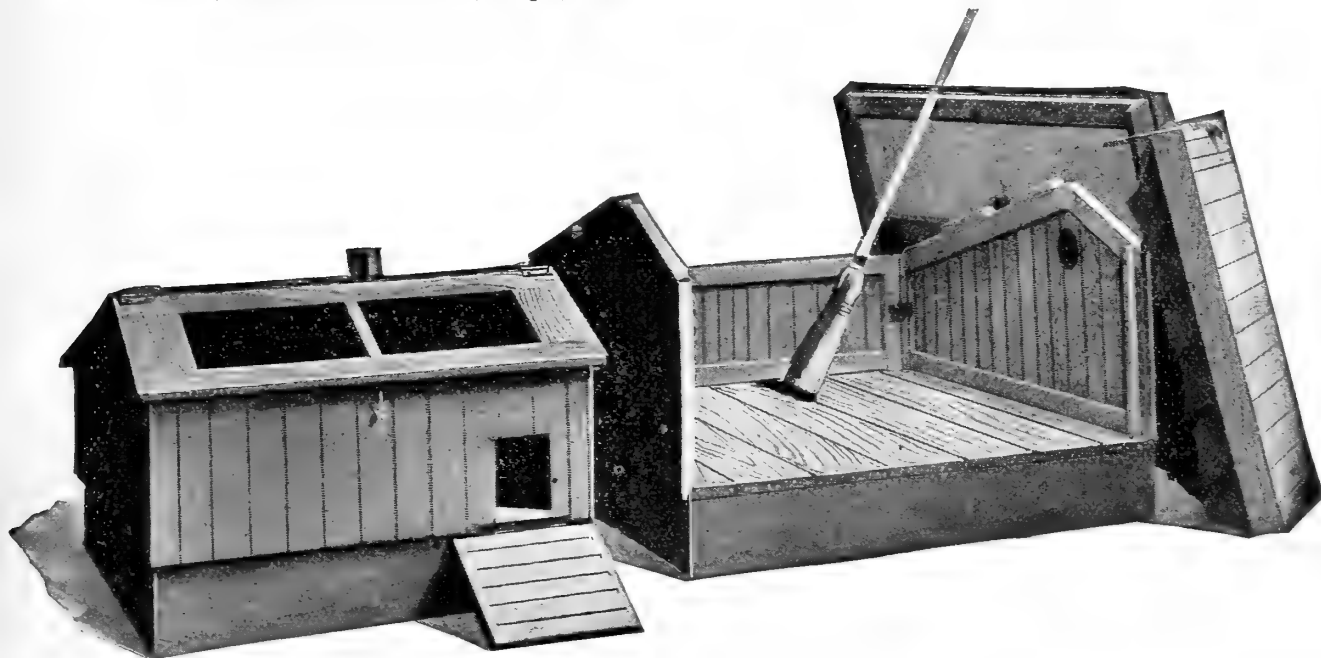

## POULTRY SUPPLIES

**Crushed Oyster Shells**—This is a most important article for the poultry yard through the winter, and should be liberally supplied to the fowls in summer. When left to run at large they can find their own shell-making material, but when everything is frozen or covered with snow, they must be helped out if eggs are wanted. Price, 1c per pound.

**Crystal Grit**—To aid digestion, it is necessary to feed some gritty material. This supplies the want better than any other known article. Per lb. 1c. Per bag, 100 lb., 50c.

**Mann's Granite Crystal Grit**—Sharp, hard and clean. Rich in iron, silica, aluminum and mica; each crystal has sharp edges which cut and grind, until the last particle is worn away.

X—Brooders and Pigeons.

XX—Chickens.

XXX—Hens, Ducks, Turkeys.

Price, 60c per 100 lbs.

**Sunflower Seed**—Highly recommended for poultry as one of the best egg-producing foods known, keeping them in good condition. Per lb. 10c. Get prices on large quantities.

**Crushed Poultry Bone**—This article is manufactured from fresh, clean bones, and is perfectly pure and sweet. The bones are selected, being first boiled to remove the meat, and then ground. No chemicals whatever are applied to them in the course of manufacture; should be fed to the poultry daily; an excellent bone and egg producer, keeping the fowls strong on their legs and largely increasing their laying qualities. 5 lbs. 25c; 10 lbs. 40c; 30 lbs. \$1.00.



## Poultry Supplies--Continued.

**Meat Meal**—This is a true egg-producer, flesh and bone-forming food, and supplies just what laying hens and growing chickens require. It is not a medicine, it is fed with other food; fed to small chickens about three times a week will promote health, growth and vigor. 5 lbs. 25c; \$2 00 per 100 lbs; 10 lbs. 40c; 25 lbs. 75c.

**Chick Manna or Health Feed** for little chicks—This preparation is especially prepared for little chicks when first hatched. This should be the first and only food, and continued from ten to twelve days before feeding anything else. \$3.00 per 100 lbs.

We have also for poultry—wheat screenings, buckwheat, barley, corn, cracked corn, meal, and oats. Prices on application.

**Ground Beef Scraps**—Our ground beef scraps are especially prepared for us. Feed three times a week at the rate of about a handful to every three birds in the morning meal of hot food. During hot weather the scraps need not be fed but once a week. 5 lbs. 25c; 10 lbs. 40c; 50 lbs. \$1.25; 100 lbs. \$2.25

**Union Lock Poultry Netting**—This new fencing for poultry yards will supersede the old 2-in. mesh wire fence as soon as its merits become known. In the wider sizes it is no more expensive than the regular 2-in. mesh netting, and the fine mesh at the bottom will appeal to every practical raiser as a great advantage. The horizontal lines of this fence are all composed of two No. 20 galvanized steel wires, twisted together. In strength, closeness of mesh, adjustability and economy, it excels all others.

10 rod rolls (165 feet) 24 inches wide.....	\$2 75
10 " " " 36 " .....	3 50
10 " " " 48 " .....	4 00
10 " " " 60 " .....	4 75
10 " " " 72 " .....	5 25
10 " " " 84 " .....	5 75

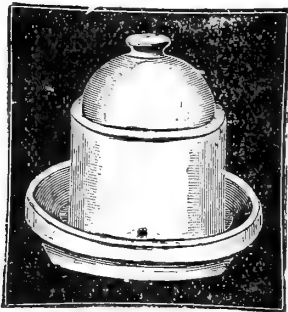

Stone Drinking Fountain

**Stone Drinking Fountain**—Sanitary, ½ gal. 30c; 1 gal. 35c; 2 gal. 40c. Beauty, 1 gal. 25c; 2 gal. 35c.

**Galvanized Steel Wire Netting**—For pigeon houses, poultry yards, lawn fences and trellises. Put up in rolls of 150 feet. We carry in stock the various sizes. 24 in. 36 in. 48 in. 60 in.

**Mann's Bone Cutter**—The poultry raiser wants eggs, and wants them when eggs are worth the most. Green bone and meat produce them; there is no doubt about that, experience proves it; science knows why. The hen will do her part if you give her

a chance. The Mann's bone cutter gives you a chance to give her a chance.

No. 5-C with crank handle.....	\$6.00
" 5-B with balance wheel.....	8.0
" 5-B M. " " " and iron standard.	10.40
" 7 " " " " " " " " " " " "	12.00
" 9 " " " " " " " " " " " "	18.40
" 7½ Hand and power.....	16.00

**Humphrey Bone Cutter**—In construction the Humphrey is entirely unlike any other bone cutter made. We have kept in mind the necessity of producing a powerful cutting action, sufficient to attack and reduce the large bones of a beef, at the same time requiring no more motive power than that furnished by the right arm of a healthy boy or a woman. The knives of the Humphrey cutter act upon the shear principle, producing a granulated cutting, without question the best form in which to feed green bone. Chickens are not so apt to gorge themselves with the bone in this form as they are when it is reduced to a salve-like hash. This is a vital point to which poultry raisers will do well to give special attention.

No. 1, Hand power, \$12.00.

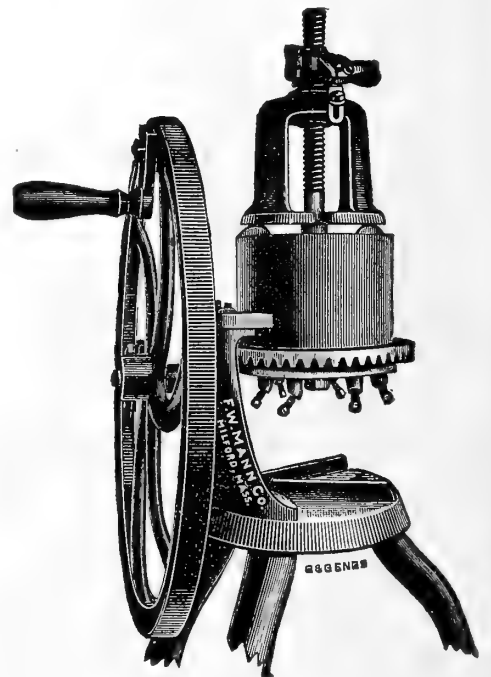

Mann's Bone Cutter

## Poultry Supplies—Continued

**Cut Clover Hay**—Excellent food for winter and early spring. 50 lbs. \$1.25; 100 lbs. \$2.00.

**Clover Head**—The best and most economical way of feeding clover; can be fed in mash with other food. 50 lbs. \$1.25; 100 lbs. \$2.00.

**Granulated Charcoal**—A little ground charcoal mixed with the soft feed in the morning once or twice a week, is an excellent corrective for fowls, and keeps them healthy. Per lb. 10c.

**Rust's Liquid Lice-Killer**—This is a highly concentrated preparation containing no kerosene or other inflammable ingredient. It is wonderfully efficacious, and its effect so lasting that it does not have to be used so often as many preparations, making it more satisfactory and more economical. Per qt. can 35c;  $\frac{1}{2}$  gallon can 60c.

**Pigeon Food**—Canada Field Peas. Buckwheat. Hempseed.

**French Poultry Killing Knife**—The most expeditious and humane way of killing and dressing poultry is by the French method. These knives are made of the finest steel. Price with instructions, 50c.

**Poultry Marker**—This little instrument is used for marking young and old chickens. It is invaluable to breeders and farmers. They are made in two sizes for large or small chickens; nicke-plated, have steel cutter and spring, are made small and neat to carry in pocket. Price 25c.

**Climax Leg Brands**—Made of spring brass and so made that the tag acts as a clasp, holding them securely in place. 12 for 25c; 25 for 40c; 50 for 75c; 100 for \$1.25.

**Knox Lice Expelling Nest Egg**—Lice-killer and nest egg combined in one. Lasting, effective, not expensive, do not affect the flavor of the egg or injure it for hatching. Price 5c each; 50c a dozen

**Haven's Roup Pills**—For the cure of roup, catarrh, cold, etc. Per box, 25c.

**Rust's Lice-Killing Paint**—This paint is to be dissolved in kerosene or coal oil and then used with a brush for destroying vermin in cracks or crevices, and on roost supports, roosts, dropping boards etc. Per pkg. 25c.

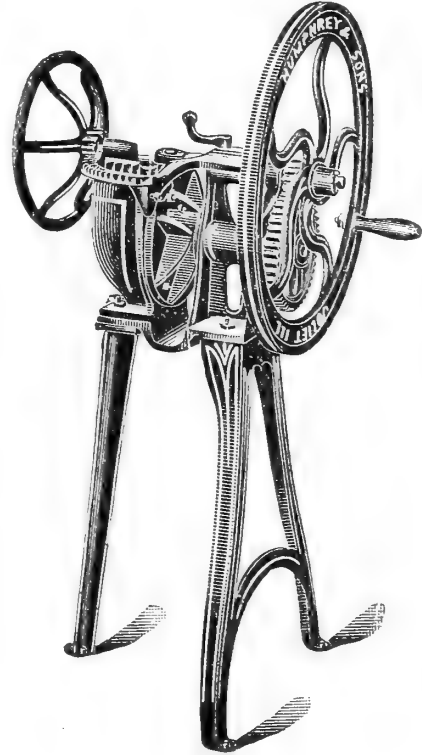

*Humphry Bone Cutter  
See page 52*

**Pratt's Poultry Food**—Pratt's poultry food will make hens lay all the year, and is excellent for feeding your chicks. For large fowls, mix 1 ounce with the food for 15 or 20 chickens.  $1\frac{1}{2}$  lb. pkg., 25c; 5 lb. pkg., 60c; sample pkg, 10c.

**Rust's Egg Producer**—This has given our customers universal satisfaction; it supplies those substances which produce egg growth and development. So moderate in price, it should be used winter and summer. 1 lb. pkg. 25c;  $2\frac{1}{2}$  lb. 50c; 6 lb. \$1.00.

**Lee's Lice Killer**—Is the result of long experiment with various insecticides and possesses the unique advantage of not requiring contact with the vermin to kill. Being a liquid paint, it has manifold advantages over any form of powder. It is easily applied to roost poles and about the poultry house, and

kills all vermin, mites, bed bugs, etc., that have their lodging in the cracks and crevices. Per qt. 35c; half gal. 60c; gal. \$1.00.

**Rust's Haven's Climax**—The only positive preventive and cure for gapes and poultry cholera, and a most excellent medicine for young turkeys that have been exposed to the weather; also an excellent medicine. Per pkg. 25 and 50c.



## Poultry Supplies—Continued

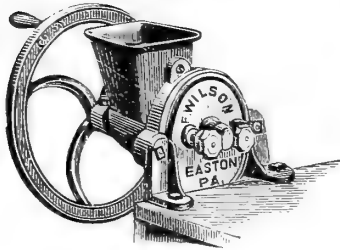

Wilson's Bone and Shell Mill—Grinds oyster and clam shells and dried bones, and is an excellent mill and largely used: will also grind corn. No. 1, \$4.00.

### Stearn's Clover Cutter

For a low priced clover cutter, we offer the Stearn's. It is simple in operation, and gives satisfaction to fanciers and others who wish to cut clover on a small scale. This little machine will cut all kinds of hay easily and readily, making eight cuts to each revolution of the crank. It is a self-feeder and self-sharpener. Price, \$3.00.

### Albany Poultry-Food Cooker

This cooker was designed to meet the demands of the poultry man who wants a low price cooker and water heater with the added advantages of a dumping arrangement. This cooker has no grate. The bottom of the fire box should be covered with ashes to a depth of about 2 inches before starting the fire.

25 gallons with dumping arrangements ..... \$9 00  
50 gallons without dumping " ..... 10 00

## INSECT DESTROYERS

**Bordeaux Mixture**—A valuable and indispensable fungicide for grape growers, thereby insuring larger crops and finer grapes, and preventing failure; a sure cure and preventive from black rot, mildew and rust, and also of great value for other plants with kindred disease. Per gallon \$1.25

**Whale Oil Soap**—Makes an excellent wash for trees and plants where insects and eggs effect the bark, and for smearing on the trunks of trees to prevent worms from crawling up. Per lb. cake, 15c.

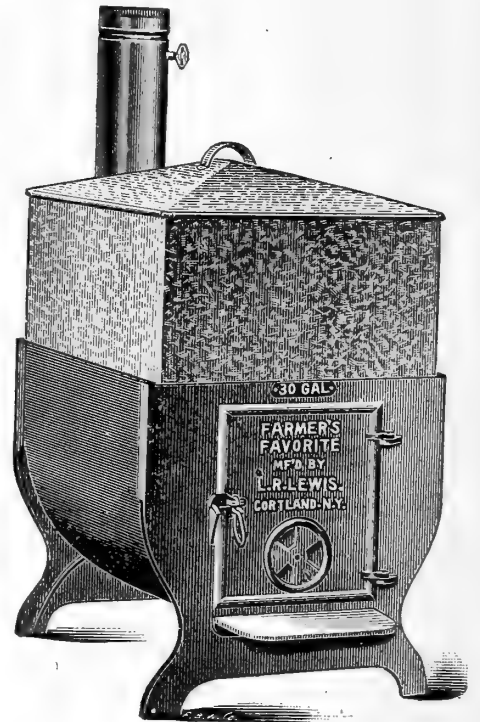

Albany Poultry-Food Cooker

### Tobacco Dust

For green and black aphids, fleas, beetles, etc. Splendid fertilizer and preventive for insects in the ground and around roots. Five pounds 25c.

**Paris Green**—We keep the purest and best grade only. Impure Paris green, as often sold, is the cause of much loss to farmers. With the genuine article, faithfully applied, potato bugs may be gotten rid of without difficulty. For all insects that eat foliage, this insecticide is very effective. Per ½ lb. 15c, market price.

**Slug Shot**—A non-poisonous powder, and a very popular insecticide; it requires no further mixing or preparation; easily applied, and not injurious or dangerous to animals, to the person applying it, or fruits and vegetables treated. Per pkg, 5 lbs. 25c.



Slug Shot

### Crel-Oil, What it Does and How it Does It

Crel-Oil is a preventive and cure for all germ diseases, such as abortion and tuberculosis in cows, scours in calves, horse distemper, sheep distemper, sheep catarrh and intestinal troubles, hog cholera, roup, grapes, etc., in poultry; also an insect exterminator, disinfectant and deodorizer. Per pt. 60c; per qt. \$1.00. Send for booklet on "Crel-Oil."

## Insect Destroyers—Continued

### Bug Death



Pat. March 16 and Nov. 9, 1897.  
Pat. in Canada Nov. 2, 1897,  
and Jan. 25, 1900.

Is a non-poisonous powder that effectually takes the place of Paris Green and other dangerous insect powders, when used as directed. It is sure death to the potato, squash and cucumber bugs, currant and tomato worms, also other plant-eating pests, a plant food of great merit, aene fit instea l of an injury to all plants, and a prevention of blight or rust to the potato tops, keeping them healthy; until the potato fully matures, which means a more starchy and perfect potato, less liable to rot. Use Bug Death liberally on rose bushes, house plants, and the result will be marvelous. 1 lb. 15c; 5 lbs. 50c. Shakers for using Bug Death 65c.

### Acme Powder Bellows

The best of all powder distributors, excellent for effectually and economically applying powder insecticides to plants, the best bellows manufactured for the purpose. Single, 75c; double, \$1.50.

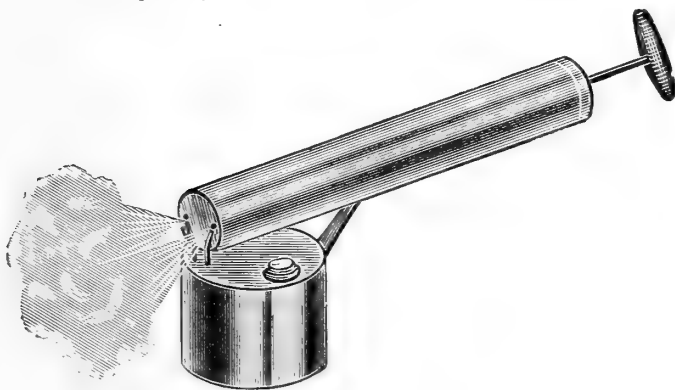

Sprayers

### Sprayers

No. 1, Tin or galvanized, 35c each; No. 2, copper, 65c each.

### Leggett's Dry Powder Guns

For distributing dry insecticides and fungicides; will green two rows of potatoes at once as fast as man can walk; will do as much work in a day as a horse power sprayer. Distributes Paris green, London purple, hellebore, sulphur, lime and tobacco dust; for the farm, orchard, vineyard and garden. The Champion price, \$7.50; Improved Little Giant, \$5.00.

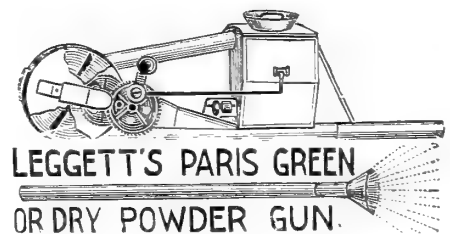

LEGGETT'S PARIS GREEN  
OR DRY POWDER GUN.



### Leggett's Compressed Air Churn Sprayers

These sprayers make a perfect mechanical kerosene emulsion, distributing oil and water simultaneously, and throws a continuous spray by simply working the pump for a few minutes at intervals, spraying in the proportion of about one part of oil to nine parts of water; works equally well with water and Paris green or other insecticides. Quite tall trees may be sprayed by using more rubber tubing and a longer pole; will throw equally well at a height of fifty feet if sufficient tubing is used. 2 gal. size, \$4.50 each; 10 gal. size, \$8.50 each.

**New Century Fly Killer**—The oil is perfectly harmless to both man and beast. It is healing to any sore and for killing lice in poultry houses and all disinfecting purposes. Per gal. 75c.

**Cattle Comfort**—The humane farmer's friend; protects cattle and horses from fly pests and vermin, a sure preventive, perfectly harmless, easily applied. 2 quarts, 35c.



## Insect Destroyers—Continued

**Hammond's Sheep Wash**—*Good dipping makes good wool and meat.* Destroys parasites on sheep, dogs, and all domestic animals. Pint 40c.

### Double Cylinder Sprayer

On account of its shape it is easily carried. Four gallon capacity; made of heavy galvanized iron, strongly braced, heads swelled, and double seams. Heavy cast brass filler cap and screw. Strong 2 in. force pump with heavy plunger rod, best calf leather plunger with spring, brass spreader against the leather plunger. This sprayer can be charged in half a minute; for fifteen minutes will give a continuous spray and throw a stream thirty feet high. With 30 in. hose and fitted with the Utica Spray Nozzle, which by reversing the key will clear itself of sediment. Price \$4.00.

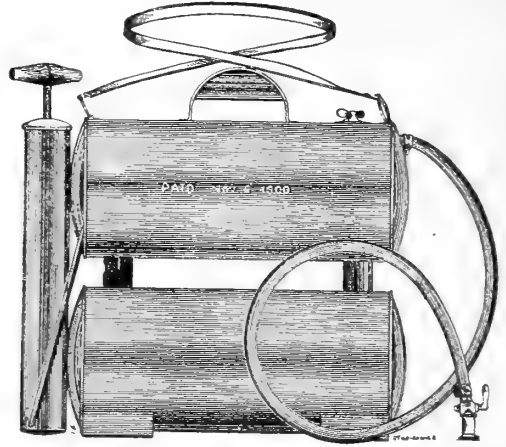

*Compressed Air Sprayer*

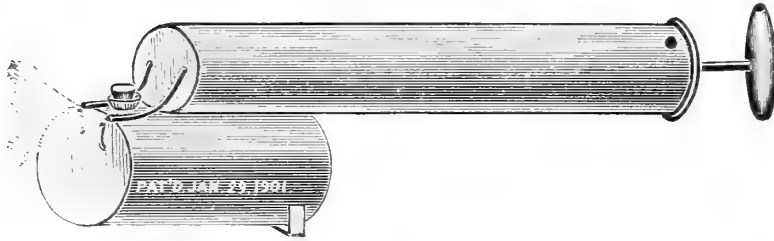

*No. 7 Brass Tank Sprayer*

**No. 7 Brass Tank Sprayer**—A long easy stroke will give two fine misty sprays of full volume. The plunger rod is heavy; the plunger is of best calf leather, backed up with spring brass spreader, that keeps the sucker in position for the full length of the stroke, thus avoiding all lost motion. The tank being of brass will not corrode. Capacity 1½ qts. Price 60c.

**No. 35 Galvanized High Pressure Sprayer**—Holds 1 gallon of mixture. After a few strokes of the pump, throws a broad spray like mist. By reversing the cock, will give coarse Bordeaux spray ten feet high, or a straight stream, higher. Price \$1.50.

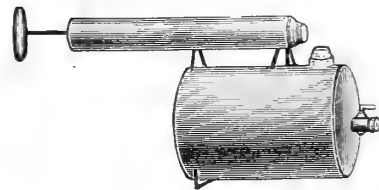

*No. 35 Galvanized High Pressure Sprayer*

### Auto Grindstone

Mounted with genuine Berea or Huron stones. This frame is made of seasoned hardwood, and is designed to supply a demand for an extra heavy frame, embracing the bicycle features of our "Bi-Treadle." It is fitted with our regular detachable fixtures, with *ball bearings* throughout, on the Pitman rod as well as the shaft, it is supplied with a comfortable saddle and clothes protection.

(Usual thickness, 1½ to 2¼ inches.) No. 1 stone weighs 100 to 110 lbs., price \$3.35; No. 2 stone weighs 70 to 80 lbs., price \$3.10; No. 3 stone weighs 40 to 50 lbs. Price, \$3.00.

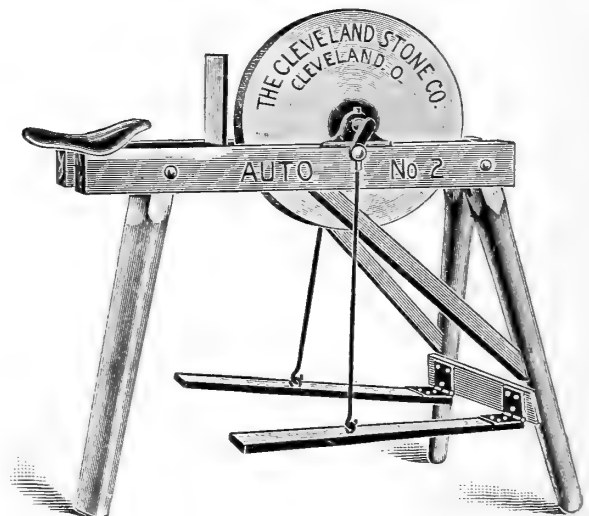

## Grindstones—Continued

**Grind Stones**—All sizes from 12 in. to 78 in.; 1 in. to 12 in. face.

**Sampson Wood Frame**—No. 1 stone weighs 100 to 110 lbs, thickness  $1\frac{3}{4}$  to  $2\frac{1}{4}$  in., \$3.10. No. 2 stone weighs 70 to 80 lbs, thickness  $1\frac{1}{2}$  in. to 2 in., \$2.90. No. 3 stone weighs 40 to 50 lbs., thickness  $1\frac{1}{2}$  to  $2\frac{1}{4}$  in., \$2.75.

**Bicycle Tread Iron Frame Grindstone**—\$3.50.

**Patent Cast Iron Grindstone Frames**  
—Handsomely finished with adjustable tool rests, all ready to belt on to power, to swing stone 30 in. x  $4\frac{1}{2}$  in.; price \$15 00

### Cutters--Belle City

Our illustration is that of the No. 9 Lever Cutter. This machine is especially appreciated because it does not tip over easily. Price \$3.50.

**Swiss Feed Cutters.**—No. 9 Swiss Cutter as illustrated, is a much stronger and heavier machine than the No. 8, and adapted to the heaviest kind of work that can be done by hand power. While we know that many of these machines are being used by power, we do not advocate such use for the reason that if party intends to use power, our No. 10 machine will give a larger capacity than No. 9, and cost is so little more, that it will pay user well to get the larger machine.

**Splitter Attachments**—To those who desire them, we are prepared to furnish splitter or crushing attachments for any size of our machine, as shown in cut. Preceding the cutting knives, are a series of steel blades arranged on a curved bar, these blades are set close together so as to split, crush and cut corn stalks, ears of corn and all coarse material into small particles. These blades operate at right angles with the cutter knives, and are arranged in curved lines from main shaft; by this device the blades precede each other, and operate easily; these splitter bars are detached by removing the two bolts. Price for No. 9, complete, \$22.00; No. 10 Jr., \$ 27.00; No. 10 Sr., \$30.00.

**Cyclone Special Cutting Machine**—These machines are fitted with the new enlarged patented compound spiral cylinder, also our semi-automatic clutch, which together with their heavy and substantial frame, make them the most desirable hand and power cutter today upon the market. They are adapted for filling silos, as they have a very large diameter cylinder and all feed is thrown directly from center allowing no material whatever, to come in contact with sides of spout, thus obviating "choking," which is a common occurrence in many machines when cutting green material, forage, etc.

Capacity of No. 11, special machine, ensilage 4 to 5 ton per hour.

Capacity of No. 15, special machine, ensilage 9 to 10 ton per hour.

Price of No. 11, complete, \$50.00. Price of No. 15, complete, \$80.00.

### Cyclone Carriers.

The Cyclone Swivel Carrier will elevate at any angle from 25 degrees to 70 degrees, and to any point within the radius of a half circle. The web tighteners or adjusters on our Carriers are unequalled; for instance, in most carriers it is impossible to adjust the web until carrier has been placed in position. In ours it is the reverse, as the web is adjusted before carrier is elevated. If after running some time you should wish to draw tension on web, all that is necessary is simply to ascend to top of carrier, empty handed, and give handle of screws the number of turns required. Another point which helps to makes our carrier the foremost in point of improvement is the short section furnished at top of every carrier. By means of this three foot section at top, any length can be inserted in the future; thus a party having a carrier of four sections, can use two, three or all of them at one time. and as every joint is hinged instead of solid bolted, changes can be made in a very few moments. Prices on application.

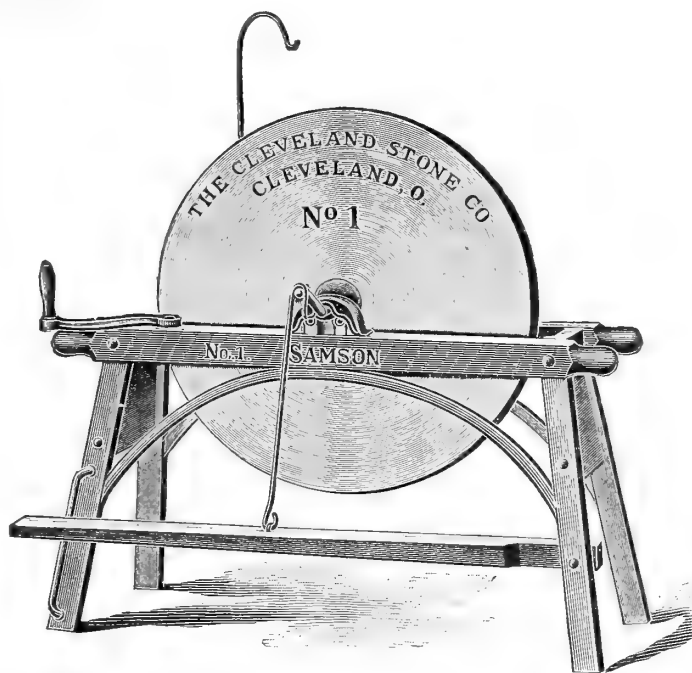

## Spalding Bolster Springs.

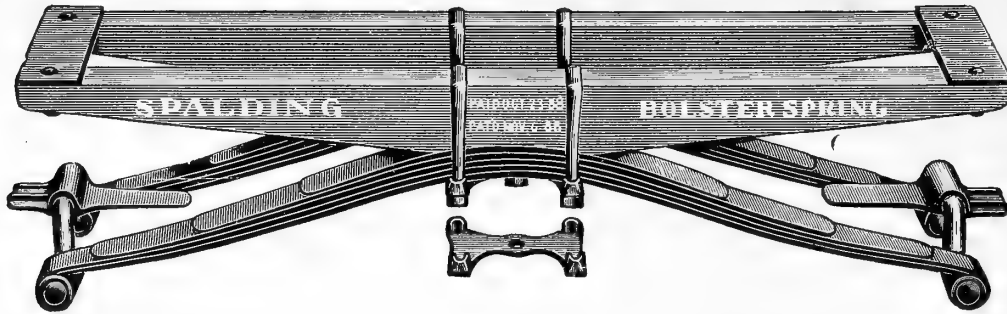

This spring stands without a rival, and while being the most lasting, is also the handsomest, adding both life and beauty to the wagon upon which it is used. They differ

materially from any other wagon spring on the market, being so constructed that when loaded beyond their carrying capacity they do not break, nor do they lose of their elasticity. The springs require no bolting to the box, leaving them free to be removed at any time.

1,000 lbs. capacity.....	\$6 00
1,500 " " .....	6 50
2,000 " " .....	7 00
2,500 " " .....	7 50
3,000 " " .....	8 00
4,000 " " .....	8 50
5,000 " " .....	9 00
Cliff's Seat Springs.....	80
Krug's " " .....	75

## The Handy Truck

For bags, boxes or barrels. Price, from \$1.75 up.

We have a full line of barrel and warehouse trucks of all sizes and will be pleased to send you circulars and prices for same.

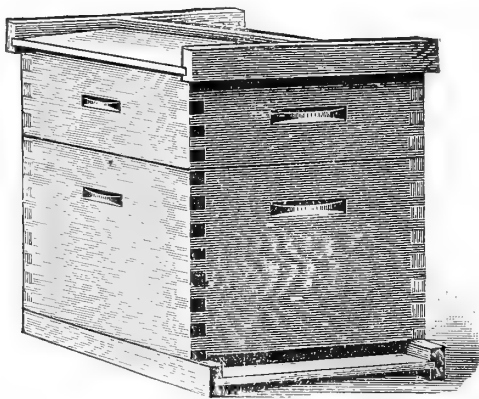

*The Dove-tailed Hive*

## BEE SUPPLIES

The Dove-tailed Hive—The dove-tailed hive is taking the lead of the single walled hives, as it contains many of the most desirable features of the various hives for rapid handling of bees, and is one of the cheapest hives manufactured. Price, complete, \$2.50.

- Bee Veils—These veils have a rubber band around the top so as to fit the hat snugly. Price 50c each. Garlin Foundation cutters. Price 25c each. Daisy Fountain Roller. Price 15c each.

Dove-tailed Super.

Section ..	Market price	\$1.00 each
Light.....	" " "	"
Heavy....	" " "	"

Corneil Smoker—\$1.00.

Sections .....	50c per 100
----------------	-------------

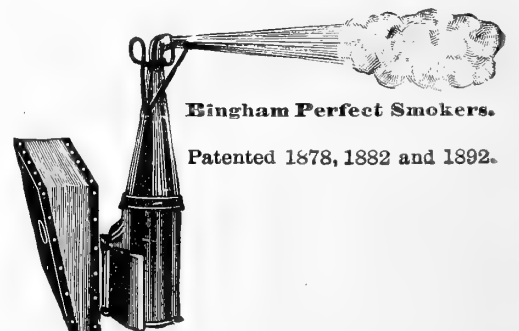

**Bingham Perfect Smokers.**

Patented 1878, 1882 and 1892.

## Binder Twine, Rope and Oil

Always on hand, the best Manilla and Cotton rope in coils or by the piece, at prices consistent with quality. Prices on application.

Few farmers realize the importance of securing their *Binder Twine* early, before the season opens. They can in most every instance save money by so doing, as the price is frequently higher during harvest season than at any other time. We make a specialty of Binder Twine, and carry a large stock and can supply in any quantity desired, such as sisal Standard or Standard Manilla. Will be pleased to open correspondence as to kind and prices.

## Separator and Harvester Oil

Possesses all the elements which fit it for use in the cream separators or harvesting machines. It is not a mixture, but a straight run product. Separator Oil per qt. 25c; per gal. 75c. Harvester Oil per qt. 15c; per gal. 40c.

## Scythes, Snaths, Cradles and Hay Knives

Scythe snaths, rim fastening socket, price .....	\$
Scythe snaths, patent loop, solid plate, price .....	
Grape Vine, price .....	
Turkey Wing, price .....	
Oats and Barley Forks, price .....	
Bush, Weed and Grass Scythe, price .....	
Lightening Hay Knife, price .....	\$ 1.00

## The Harder Silo

The one factor of storage room is a big one. A ton of hay requires 500 cubic feet of storage space, while the same amount would store ten ton of ensilage. This and the nature of ensilage makes almost a total absence of fire risk. The farmer who carries his barn full of hay to take his cattle through the winter, is carrying much greater risks and paying much more in insurance premiums than his neighbor who has his winter feed stored in a little round barn of moderate cost, which could hardly be coaxed to burn, and which would injure its contents but little if it should burn. Compare the expense of building a barn to store your hay, to the cost of a silo, and add to both the difference in insurance. Calculate the amount of space to store ten ton of hay in your barn at 500 feet to the ton, and see the results. Write for special catalogue giving prices and different kind of woods.

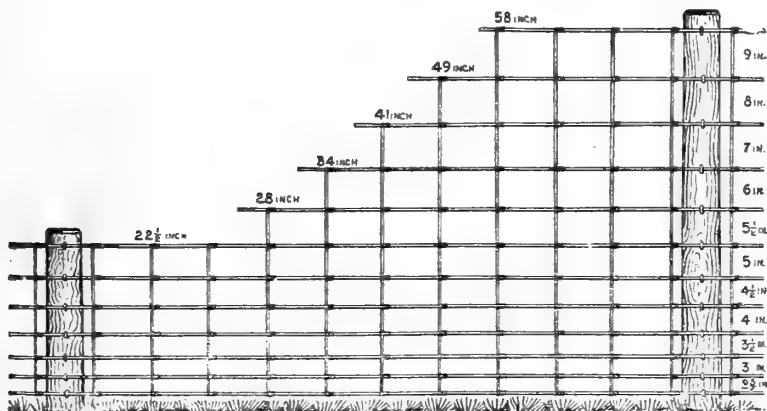
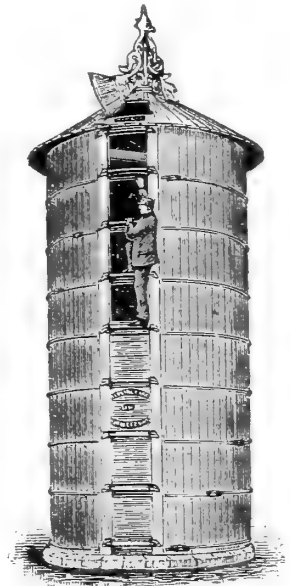

Wire Fencing (see page 60)

## Wire Fencing

The Fences that Fence—Are the fences that have been sought for many years. People who needed fences have been looking for them. People who make fences have been trying to solve the problem. There has been a gradual evolution from the rail fence on the prairies, and the rock wall on the hills, in which every form of wood and metal, and their combination have been tried and found wanting in some essential feature until *The American*

*Field and Hog fence*, made of galvanized woven steel wire, was produced.



## Fence--Continued

The strength and durability of the American Fence, together with their comparatively low cost, combine to give them a wonderful popularity, tasking the ability of the mills and compelling them to increase their original capacity, until it is safe to say that more of these fences are used than all other form of fences in the world, because they have proven themselves "the fences that fence," at least cost. American Special Farm Fence (8 bars, 45 inches high). Prices on application.

### Lott Stretcher

This is the only perfect tool ever devised for stretching woven fence. Many other stretchers have been tried, but they have fallen by the wayside, as compared with the wonderful simplicity and giant strength of the Lott stretcher, which is the easiest to operate as well as the surest. Price \$3.50.

### Baling Ties

The cost of bale ties is from 40 to 60 cents per ton of hay. To get the length of the tie required, add three inches to the measure around the bale when under pressure. We carry in stock only the standard sizes, No. 15—7 ft. 3, 7 ft. 6, 7 ft. 9, 8 ft. 0, 8 ft. 3, and 8 ft. 6. Prices on application.

## The American Solid Steel Drag Scraper

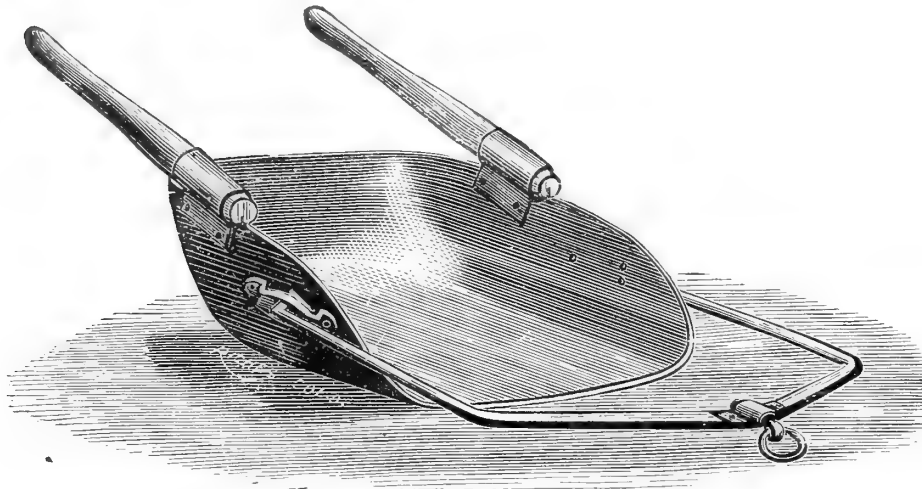

Solid steel bowls, without slit, seam or lap, made of superior quality of steel, and are of the most approved pattern. They fill easily, and work in any soil; they have steel hooks, steel bails, and perfect working steel swivels; the dirt does not go over the back while filling. These scrapers are strong and durable.

- No. 1, capacity 7 cubic feet, weight 90 lbs., price..... \$7.00
- No. 2, capacity 5 cubic feet, weight 80 lbs., price..... 6.50
- No. 3, capacity 3 cubic feet, weight 70 lbs., price..... 6.00

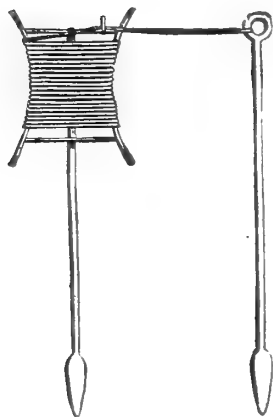

Garden Reel

### Our Steel Hog Troughs

Are made entirely of steel, including ends and feet. We have them in any length from three feet to six feet. Prices on application.

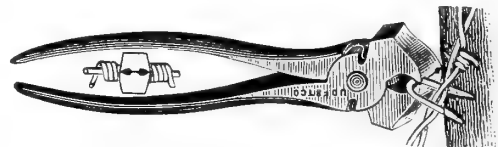

Russell Staple Puller See page 61

### Garden Reels

- Small size ..... 40c
- Large size ..... 60c

### Garden Trowels

One of the best trowels ever offered It is made of forged steel, strong and durable. English 6 in., 35c

### Grass Hooks

Barden's, just the thing for trimming around trees, 50c.

### Burlap Hot Bed Mats

Lined with wool and cotton, quilted. Size A, 40x36 inches, \$1.00 each. Per doz, \$11.00. Size B 76x76 inches, \$1.25 each. Per doz. \$14.00.

## Thermometers

Hot Bed, \$1.00 each.

## GRASS OR SHEEP SHEARS

### Scythe Stones

Five and 5c each; 50c and \$1.00 per dozen.

## Russell Staple Pullers

If you build or take down a wire fence you need this tool; it is a staple puller, hammer, double wire cutter, and a pleyer. Price, \$1.00.

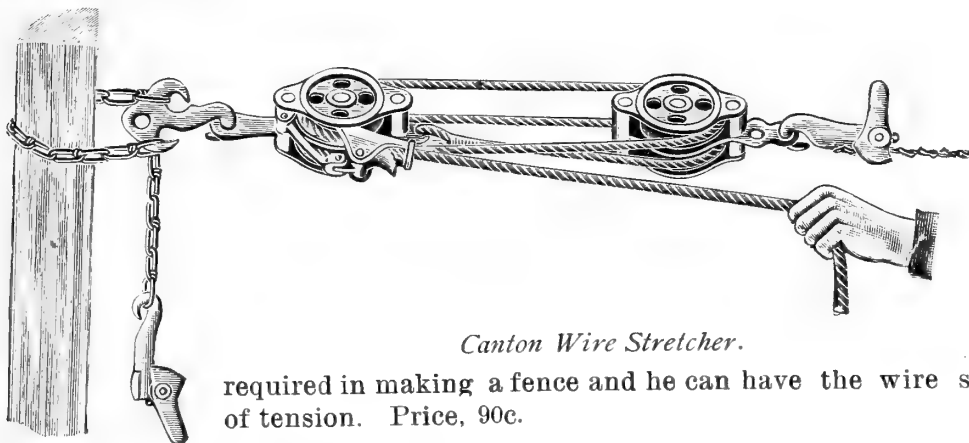

## Canton Wire Stretcher

The prime advantage in this wire stretcher is the automatic brake which holds the wire taut, thus only one man is

required in making a fence and he can have the wire stretched to any degree of tension. Price, 90c.

*Canton Wire Stretcher.*

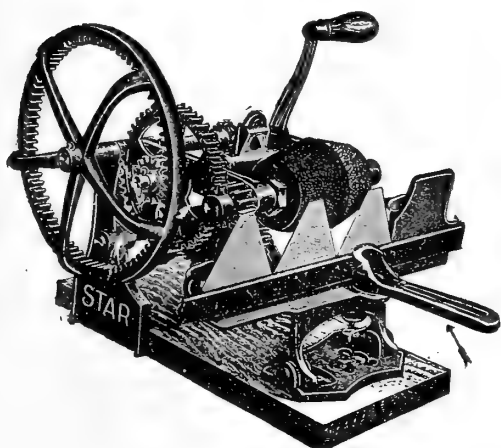

## Star Sickle and Tool Grinder

Price, \$5.00.

*Star Sickle and Tool Grinder*

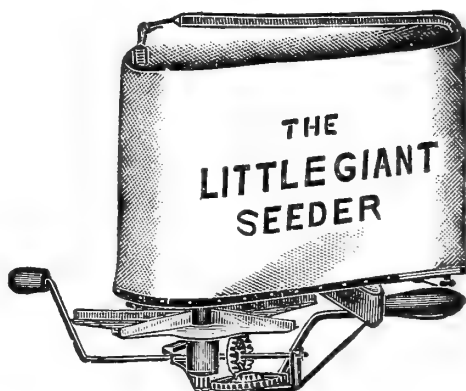

Price \$2.00.

## The Star Suction Washer

This washer is in every sense of the word a high grade machine.

### ITS SUPERIOR POINTS.

First—The suction principle and the manner in which it is applied.

Second—The short movement of only seven inches being required to operate it.

Third—No rubbing or twisting of clothes, merely forcing air and suds through them.

Fourth—All iron attachments galvanized, thus avoiding rust.

Price, \$7.00.





### Pumps

Chain pump curb.....	\$1 40
Tubing, per foot.....	04
Chain, per pound.....	06
Buckets, per piece.....	06
Bottom plates.....	10
Suction wood pumps, 6ft. 6x6 in. porcelain lined.....	4 50
Suction wood pumps, 6 ft. 7x7 in. porcelain lined.....	5 00
Douglass iron pump, No. 1, 3 in..	4 50
Cistern pumps.....	1 25

### Water Elevator and Purifier

A new device embodying increased capacity, increased strength and durability, increased convenience. Double geared fixtures, no valves to pack or wear; no wooden tube to rot; no iron rust to taint; no freezing possible. A great sanitary device, cold, clean and healthy; water immediately discharges.

Price, complete for a ten foot well..\$6 50

### The Old's Stationary Portable Gas and Gasoline Engines

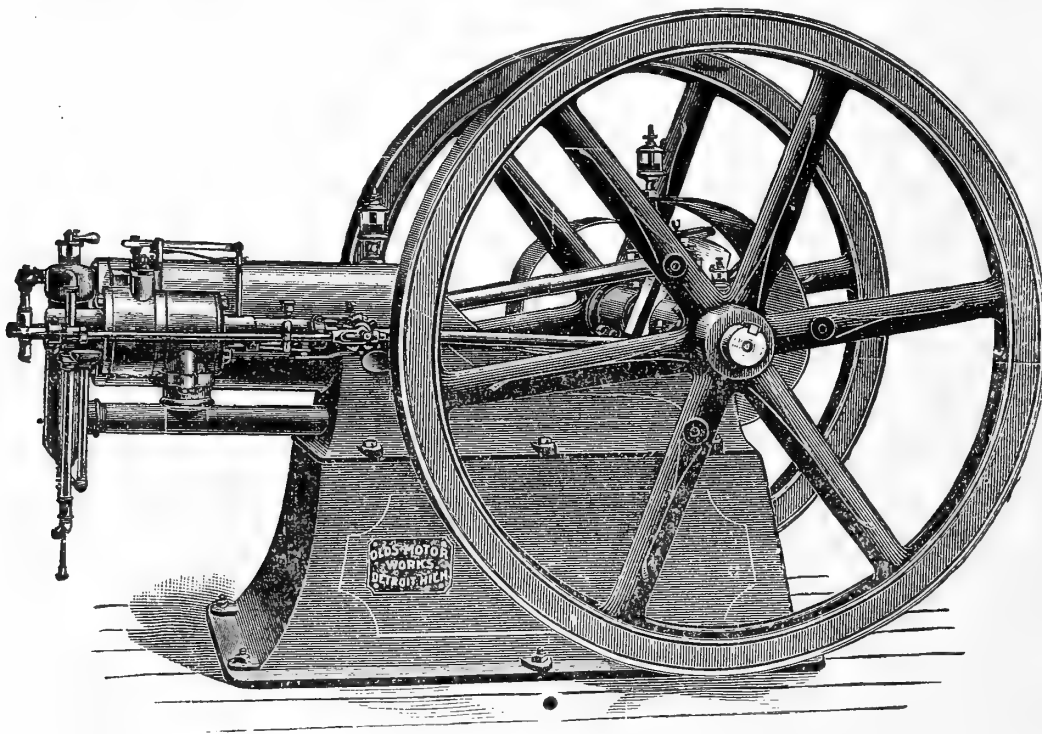

They are especially designed for farmers for threshing, sawing wood, running ensilage cutters, grinding grain, pumping water, running dairy outfits and many other uses; far superior to steam or horse power, as they do not require attention after starting, and always develop their

full power. They are the *latest*, most original, most compact and simplest engine on the market: everything in sight, and easy of access; do not require the services of an engineer. If you will investigate the *Old's Gasoline Engine*, you will understand why there has never been a gasoline engine on the market that has taken the lead so rapidly. Is there any wonder, when you look at the neat designs and simplicity of this engine? All manufacturers boast of having a simply constructed engine. Note the comparison:

We have no cut gears on this engine; the inlet valve, outlet and governor, are operated by an eccentric rod. The star wheel takes the place of many complicated devices common to other makes of gasoline engine for operating the inlet and outlet valves. The speed can be varied at will without stopping the engine. Its construction is such that its poppet valves are opened and closed in a straight line, and not by means of a rock arm. Our engines have the largest bearings for valve stems of any engine on the market. As to its first cost, it is the lowest priced engine on the market when you measure the dimensions of the working parts. This engine is economical in the use of fuel, as it takes in only the amount of gas or gasoline that is required to perform the work, and no more. When the engine is not working to its full capacity, the inlet valve is closed, and the charge of gas is taken in just in proportion to the work the engine is doing; in other words, a six horse power, doing three horse power actual work, will use but one-half of the fuel as when doing six horse power work. Every engine is guaranteed to develop its full horse power when properly operated. If you are interested, call at our store and we will show you its working, or will send you a special catalogue on application.

## Hand, Field and Garden Tools

- |  |  |
|--|--|
| Manure Forks.                                    | Oat Scoops, Hercules, 1 bu. \$2.25; Philo, 1 bu. \$2.00. |
| Hay Forks,                                       | Coal Bags and Baskets.                                   |
| Spading Forks.                                   | Buck Saws and Buck.                                      |
| Spading Forks, long handle.                      | Watering Pots, French,                                   |
| Garden Rakes, steel, 14, 16 and 18 teeth.        | Wooden Rakes, common.                                    |
| Lawn Rakes, automatic, self-cleaning.            | Whiffletrees, plow.                                      |
| Lawn Rakes, wire.                                | Oil Cans, steel.   |
| Lawn Rakes, wood.                                | Sections for all Mowing Machines.                        |
| Potato Hooks, flat and oval. Four tine.          | Brooms, stable and house.                                |
| Corn Knives.                                     | Brushes, horse.  |
| Shovels, round pointed, long handle.             | Combs, curry.  |
| Shovels, square pointed, long handle.            | Jacks, screw.  |
| Shovels, snow, square pointed, long handle.      | Vises, steel-faced jaws, \$1.50.                         |
| Shovels, square pointed, short handle.           | Post Hole Diggers, \$1.25.                               |
| Shovels, scoop, short handle.                    | Post Hole Bar, \$2.25.                                   |
| Shovels, wire scoop, for potatoes, short handle. | Scoops for Contractors.                                  |
| Spades, long handle.                             | 4 Bros. Axle Grease, in tins from 1 to 10 lbs,           |
| Spades, short handle.                            | Barrel Headers, Climax, \$1.00.                          |
| Hoes, garden, common.                            | Johnson's Bag Holders, Perfection, 75c.                  |
| Hoes, garden, Washington Co.                     | Corn Huskers, 10c.                                       |
| Axe, pick, best quality steel.                   | Lanterns, Dietz, \$1.00 each.                            |
| Axe, wood, best quality steel.                   | Jacks, Little Giant, Wagon, No. 1, 2 and 3.              |
| Mattocks, best quality steel.                    | Nails, Cut and Wire.                                     |
| Wooden Scoops.                                   | Flower Pots, 1½ in. to 16 inches.                        |
| Sod Pounders.                                    |  |
| Post Mauls, with hard wood plugs, 14 lb. 90c;    |  |
| 16 lb. \$1.00; 18 lb. \$1.10.                    |  |

## Land Roller

Land Roller — Roller has three sections, 32 inches long each, making roller 8 feet long. Diameter, 24 inches; average weight about 600 pounds. Has no neck yoke or whiffletrees. Have a substantial hard wood weight box, which can also be used as a convenient way for clearing fields of loose stones. Price, \$26.00.

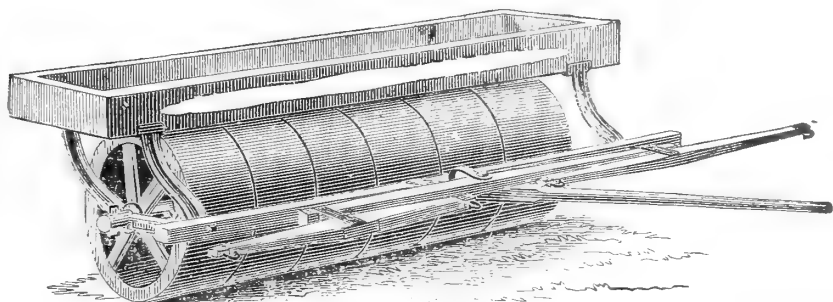



# BARN FIXTURES

## The Ney Carrier

This carrier has been on the market so long, and met with such high favor that much comment is unnecessary. It cannot pass the bumper or trip block while in operation, and is easily and quickly reversed from the floor. It is constructed entirely from malleable iron; travelers and shears revolve on turned steel bushings, making it the easiest running and most durable carrier on the market.

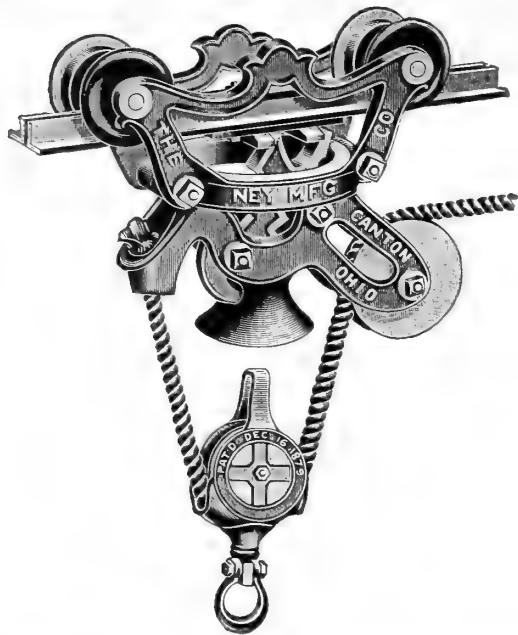

*The Ney Carriers*

## Haying Tools

No. 5, Ney Carrier.....	\$4.50
Steel track, per ft .....	11c
Malleable track eyes, each .....	9c
Crimped rafter brackets, each.....	5c
Barbed Nails for brackets, per lb.....	6c
Rafter Grabs, each.....	50c
Whiffletree Hook for rope end.....	25c

Hay Slings, set .....	\$7.00
Floor Hooks, each .....	8c
Double Harpoon Fork.....	1.00
Double Harpoon Fork, extra long.....	1.20
No. 115 Iron Pulleys.....	35c
Iron Pulleys with loop, each.....	25c
Knot Passing Pulley, each .....	25c
Wood Frame Self-oiling Pulley, each.....	25c

# BARN TRIMMINGS

No. 0. Iron Manger with food guard.....	75c
No. 1. Iron Manger with food guard .....	90c
Iron Hay Racks, project from corner, 22 in. and 27 in. high	1.00

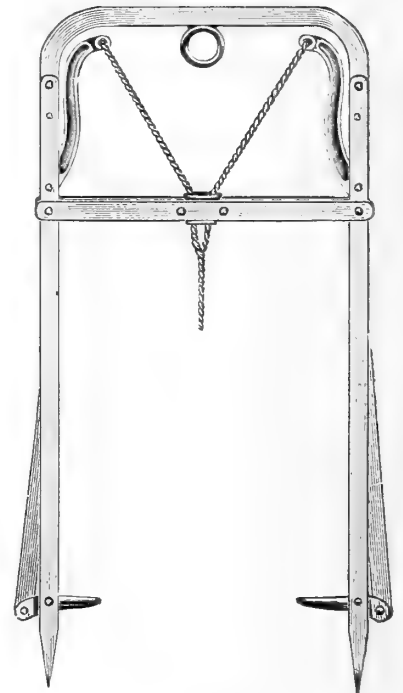

*Double Harpoon Forks*

# LAWN MOWER

The Rensselaer Lawn Mower—While this is not a ball bearing mower, its simplicity of construction insures durability. We therefore have to offer a low priced mower, which is at the same time guaranteed to do perfect work. Take one on trial and if not entirely satisfactory, you may return it and money will be refunded.

All parts are interchangeable and in case of wear or breakage can be at once duplicated.

14 inch cut.....	\$2 50
16 " " .....	2 75
18 " " .....	3 00

## Victory Lawn Mower

Victory Lawn Mower—Has ball bearing of the very highest grade, exact to  $\frac{1}{4}$  of 1-1000 of an inch, which reduces the friction astonishingly, even more in a mower than in a bicycle, and renders it possible to use much wider machines than heretofore with parallel bearings. A 24-inch mower can now be operated as easily as the old parallel bearing mower only 16 inches wide; hence mowing the lawn becomes a fascinating pastime, and the lawn is mown in one-quarter of the time formerly consumed.

The Victory mower is built without regard to cost, to be the best, most durable, and easiest working mower on the market, and while the prices are necessarily a little higher than those of mowers simply made to sell, yet in the end it will prove much cheaper.

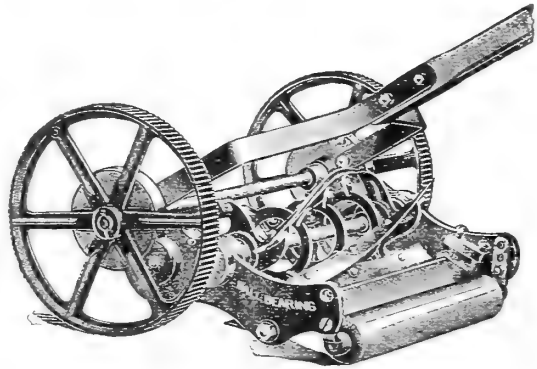

16 inch cut.....	\$ 8 00
18 " ".....	9 00
20 " ".....	10 00
22 " ".....	11 00
24 " ".....	12 00



## Baskets

We carry a very large line of baskets, and will be pleased to name prices when desired. We quote as of special interest to marketmen, the following:

$\frac{1}{2}$ bushel Stave basket, rim basket,	\$1.00 doz
1 " " " " " "	1.00 doz.
$\frac{1}{2}$ " Oak splint, drop bail basket,	.25
1 " " " " " "	.40

Coal Baskets, 75c each.

Market Baskets, 12 qt., 40c doz; 14 qt., 40c doz.

Strawberry Baskets, \$2.75 thousand.

1 bu. drop bail or Side Handle Galvanized Baskets, 65c.

## Standard Hand Corn Planters

This planter has reached a large sale, has proved more popular, and has given better satisfaction, than any other hand planter ever manufactured. It is the only planter having an adjustable, rotary drooping disc. Price \$1.25.

## Thompson's Wheelbarrow Seeder

For sowing all kinds of grass seed, wheat, rye, oats, etc.

Fourteen foot Hooper, \$6.50

Sixteen foot Hooper, \$7.00.

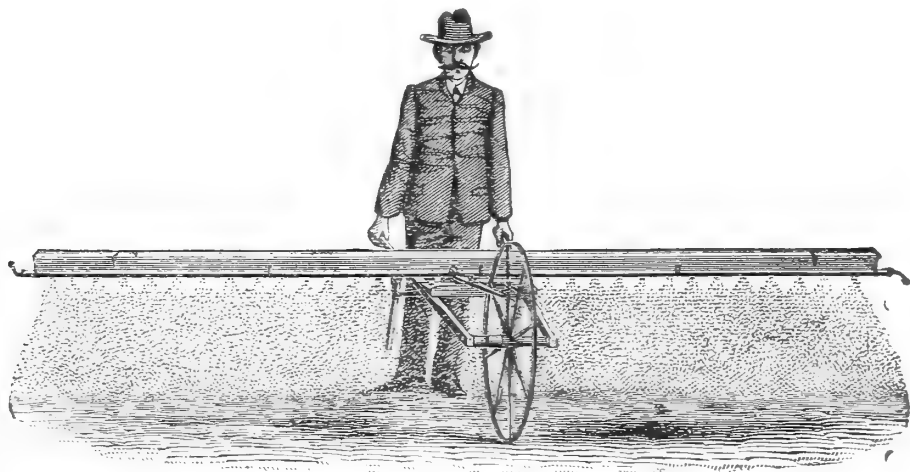

## Wheelbarrows

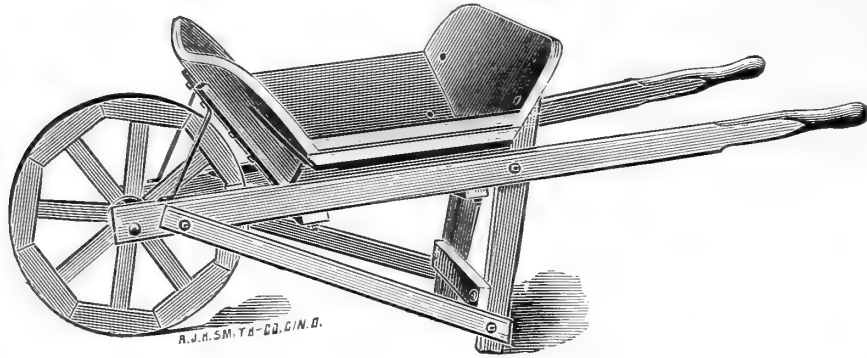

We carry in stock a large line of Canal barrows, Garden barrows and Hand Carts.  
Canal Barrows, bolted, from \$1.75 to \$2.25.

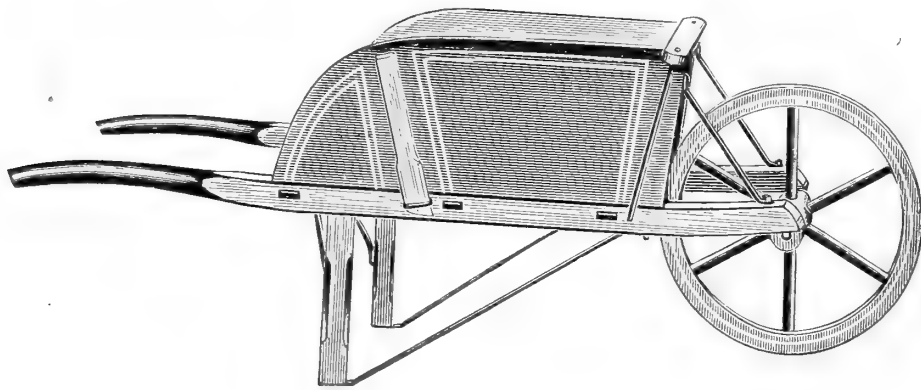

Garden Barrows, from \$2.75 to \$4.75.

Hand Carts—Circulars and prices on application.

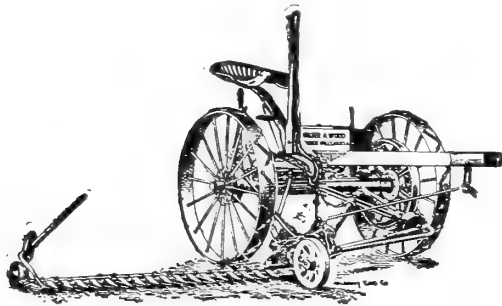

We are agents for the celebrated Walter A. Wood Mowers, Harvester and Binder, Corn Harvester, Tedder and Rakes and carry all in stock, where they can be seen. We also carry a full line of repairs for the above machines. Write for prices and special catalogues.

We also carry in stock the Royce Reaper, which is lightest and best machine on the market. Price, \$45.00.

We carry a full line of repairs for the McCormick machines.

## Keystone Weeder.

The "Keystone Adjustable" is not only a weed exterminator, but its frequent use puts the soil in such condition as to greatly assist the growth of the various crops, as it creates a mulch that will readily absorb moisture and retard evaporation; any farmer can appreciate this. Adjustable to any depth or width. Can be expanded from 30 inches to 7½ feet. Price, \$8.00.

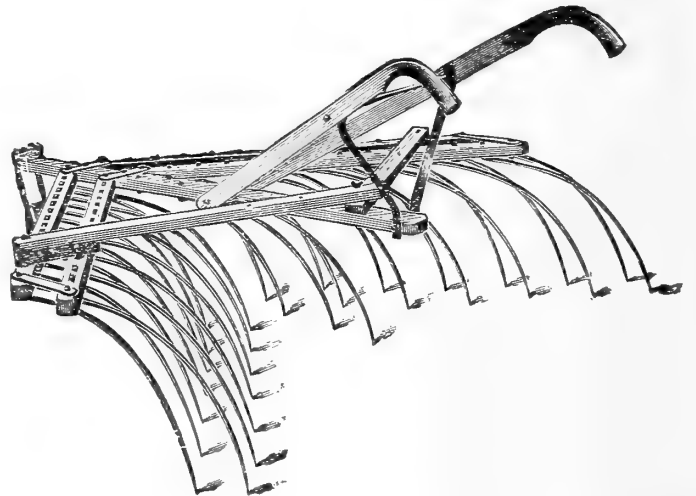

## Corn Shellers

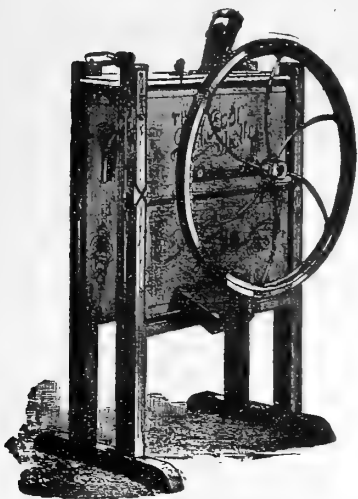

"Nox-All"

"Nox-All" Corn Sheller—This sheller has a side screen delivery which cleans the corn perfectly, making it a popular style. Price, \$6.50.

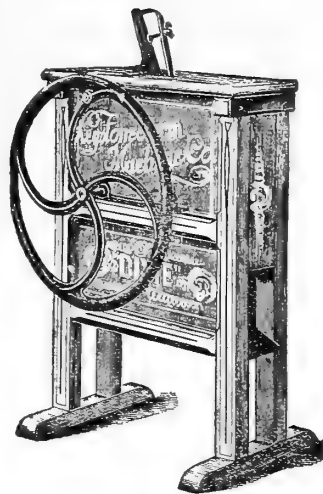

"Dixie"

"Dixie" One Hole Sheller—This popular sheller is constructed as a left hand sheller, and an all cast iron fly wheel is used, instead of the wrought iron spokes. Price, \$5.50.

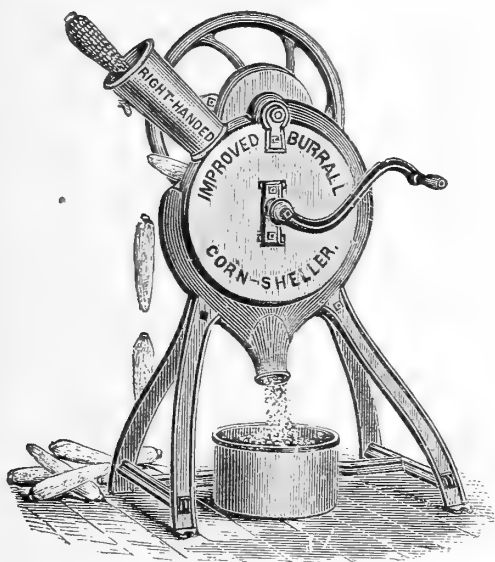

"Burrall"

"Burrall"—This all cast iron Sheller is an old and well known pattern; it separates the corn from the cob. Instead of constructing with cast iron shafts the wheels cast thereon, cold rolled steel shafts are now used, on which the wheels are keyed, so that they are now separate, and if they should break, it is not necessary to purchase a full set



Wine Press

of wheels and shafts. Besides, with steel shafts the sheller runs more easily, and is more durable. Price, \$5.50.

## Cider and Wine Presses

Wine Presses, size No, 1, \$3.25. No. 2, \$3.50. No. 2½, \$4.50  
No 3, \$5.50.

Cider Mill. No. 0, \$7 00. No. 1, \$8.00. Keystone, \$20.00.

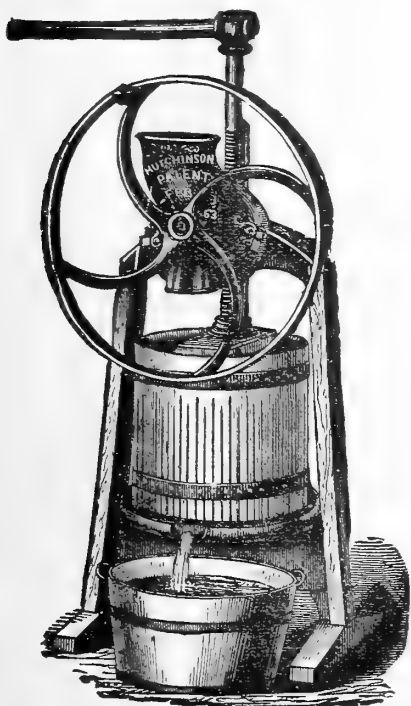

Cider Mill

## Eclipse Corn Planter and Fertilizer Distributor

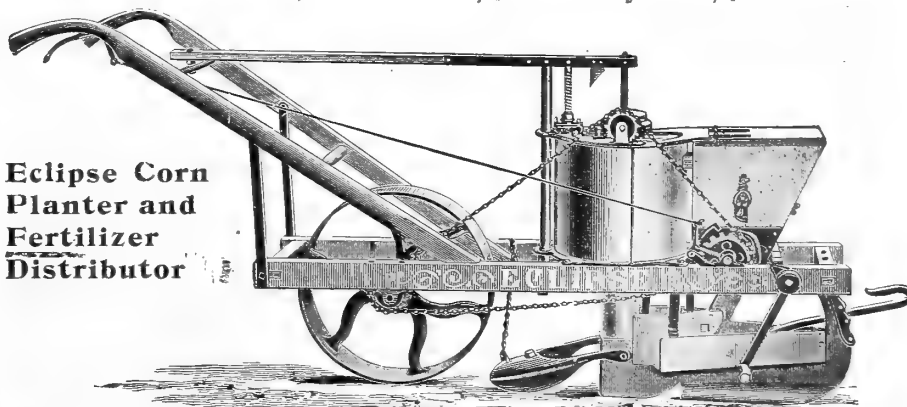

For planting field or ensilage corn, beans, peas or beet seed, in hills, drills or checks.

It is the only planter on the market which has concave places each side of the plow, which are of great importance in placing moist earth on the seed, just before the fertilizer is dropped each side of seed, a great advantage on very dry ground in a dry season. It is the only planter that



will accurately distribute all commercial fertilizers, wet as well as dry, pulverized hen manure, plaster, ashes and other fertilizers of like consistency. Price, \$20.00.

## New Model Seed Drill

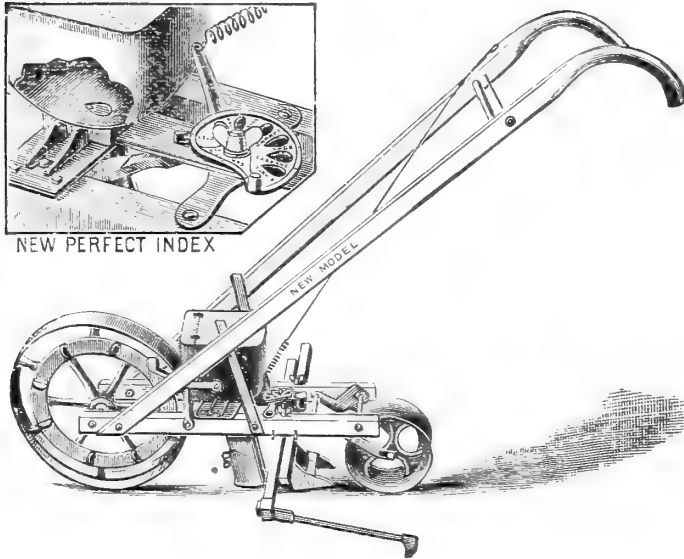
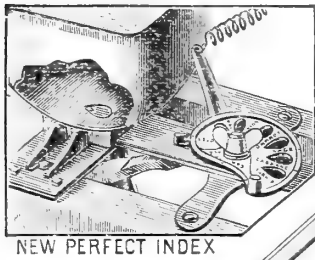

Probably this Drill is used more generally by market gardeners than any other make. It is reliable and a satisfactory drill. Price, \$7.00.

## Acme Seed Drill.

For sowing small seeds in hot beds; easily regulated as to quantity to be sown and depth. Will sow a small packet of seed as well as a larger bulk. Price, 75c.

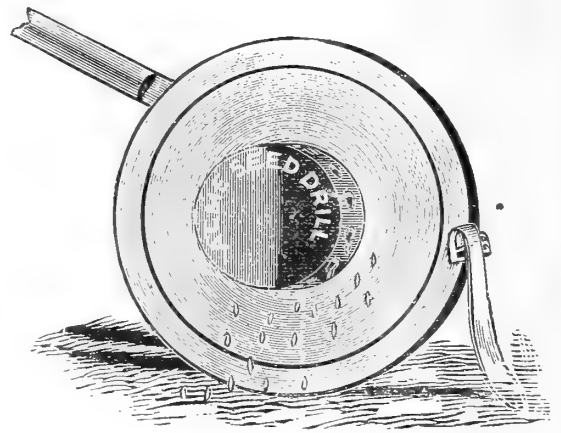

## No. 6, Iron Age, Combined Double and Single Wheel Hoe, Hill and Drill Seeder

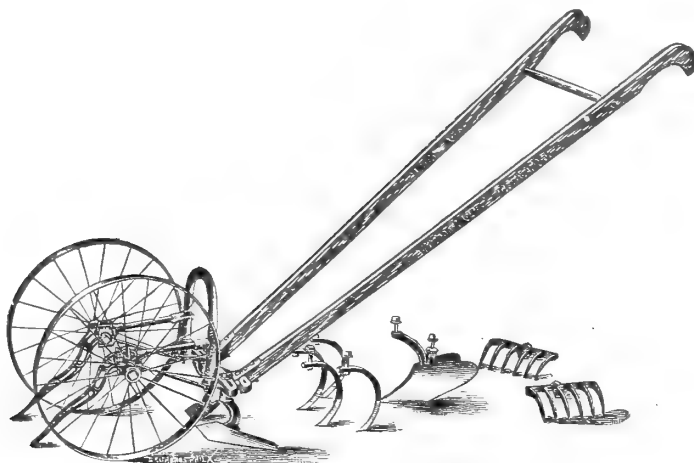

Prior to the introduction of our Famous Combined Wheel Hoes and Seed Drills, combined tools were regarded by many as impracticable, owing to the time and knowledge required to change them one to the other, to say nothing of the advantages lost over those of the separate implements. The simplicity and completeness of the "Iron Age" combined implements in all their forms, make their use practical even with the busiest gardeners. From seed drills these tools can be converted into wheel hoes, either single or double. It requires but about three minutes to change to double wheel hoes, and

about two minutes to single wheel hoes, by an inexperienced operator. The completeness of this tool and the universal satisfaction it has given, places it among our list of garden implements. Combined in this tool are three distinct and thoroughly practice tools, a hill and drill seeder, a double wheel hoe, and a single wheel hoe. Price, complete, \$11 00.

## No. 1, "Iron Age." Double and Single Wheel Hoe

Among the principal labor-saving tools in the hands of the market gardener must be considered Wheel Hoes, nay, we may insist that it leads all others, for they are really indispensable. They have done away with the back-breaking and time killing methods of olden times, one man performing in a more thorough manner and with greater ease to himself, the labor of several men. As with all other improved methods of labor it requires a little practice to enable one to realize the best results with a wheel hoe. We wish to strongly emphasize the really extraordi-

nary ease with which the "Iron Age" Wheel Hoe is operated, the lightness and construction of the tool being such that every ounce of effort goes direct to the work accomplished. Price, No. 1, complete, \$6.00; No. 3, plain (with side hoes only), \$3.75.

## The No. 11 "Iron Age" Wheel Plow

Following out the idea of bicycle construction, we also offer a wheel plow constructed in same manner, and we think we cannot be accused of extravagant language in claiming it to be a little "beauty." Its graceful shape and exceeding lightness, accord well with its ease of operation and perfection of work; adjustable in depth. It will plow from three to four inches deep and throw a furrow four to six inches wide. Poultrymen will find this tool to be the easiest, quickest and most efficient implement for turning under the accumulated filth and droppings in the poultry yard. Price \$2.25.

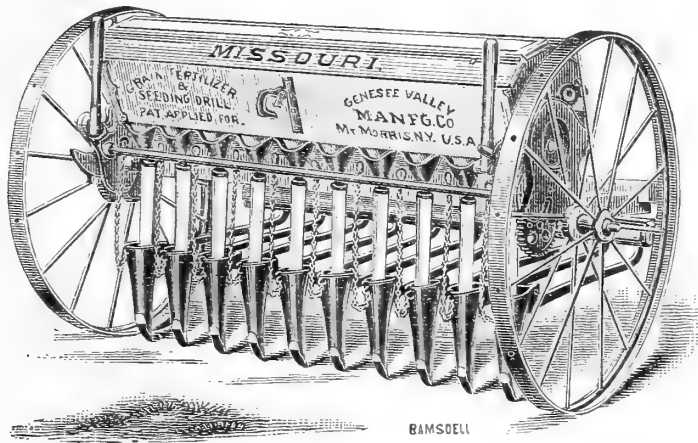

## Missouri Seed Drill

Has force, feed and grain seed Sower, and a genuine force feed fertilizer attachment, distributing all kinds, as ashes, plaster, phosphates, etc., without clogging. It is exceedingly simple, and commends itself at sight. The quantity sown is regulated by cog wheels, same as grain sower. No more power required to propel the fertilizer than the seeder, consequently the draft of the combined drill is but a trifle more than the plane drill. By means of the lever the gearing may be thrown in or out while at work,

so that fertilizer may be sown on poor, and shut off on fertile lands in the same field. Also Force Feed Grass Seeder. Therefore our combined drill is furnished with Three Positive Force Feeds, none of which are used by any other drill made. Our machine combines more good points than any other machine in the market.

## Combined Drills

9—Peg Hoe, 7 in . . . . .	\$67.00	9—Spring Hoe, 7 in . . . . .	\$69.50
10—Peg Hoe, 7 in . . . . .	70.00	10—Spring Hoe, 7 in . . . . .	73.00
11—Peg Hoe, 7 in . . . . .	74.00	11—Spring Hoe, 7 in . . . . .	77.00

We also carry in stock the new Disk Drill.

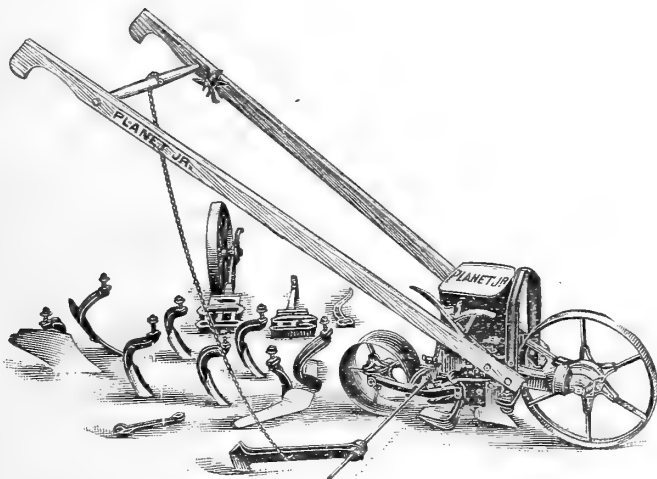

Planet, Jr., No. 4, combined Hill and Drill Seeder and Wheel Hoe. This new tool combines in a single implement a capital hill dropping seeder, a continuous row seeder, an admirable single wheel hoe, a cultivator, a rake and a plow. It sows in a continuous row with perfect uniformity, or drops with accuracy in hills. Price, complete, \$10.50. Price, drill only, \$8.50.

## Syracuse Plows

Steel Mold board, beam and landslide. These plows have a large and unprecedented sale, and are popular in all sections where combination plows are used. The mold board

of highest grade of soft centre plow steel, is so fashioned that a furrow may be turned smoothly up or down on sloping land, which feature has greatly increased its sale in all sections where the land is somewhat rolling. We recommend these plows to all parties desiring a perfect com-

combination plow for general purpose work. We sell them on trial, and if not entirely satisfactory, they may be returned to us and the money refunded. No. 32 medium size, two-horse, furrow 5 to 7½ in. deep, 10 to 13 in. wide, \$14.50. No. 31, large two-horse, furrow 5 to 8½ in. deep, 12 to 15 in. wide, \$15.

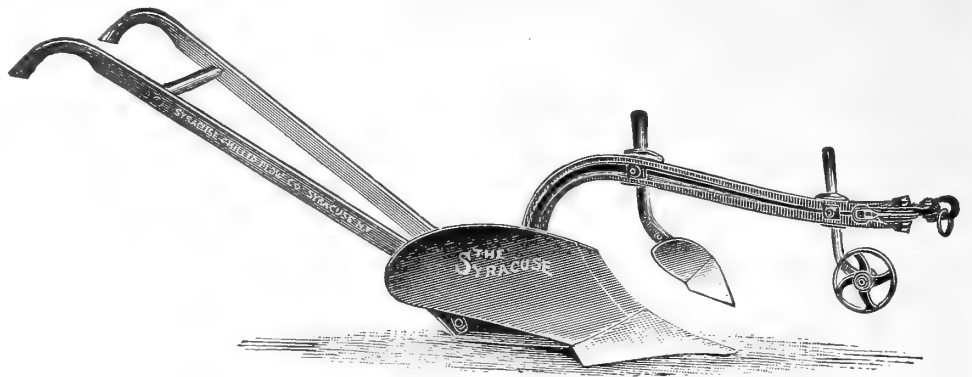

No. 432 is a new, two-horse plow, with short beam and handles, with all the good points of the No. 32. Cast shin piece, steady running and easily handled. Price \$13.50.

## Chilled Plows

*Chilled Iron Mold Boards, Chilled Iron landside, Chilled Iron share.* Steel beam, jointer and wheel standards, warranted not to bend or break. They are the best general purpose chilled plows made. The mold boards have the same superior turning qualities of our 31 combination plows, but better adapted to gravelly and stony soils. They are of good capacity, steady running and handled easily, and are immensely popular in all sections where they have been introduced. We can safely recommend to all.

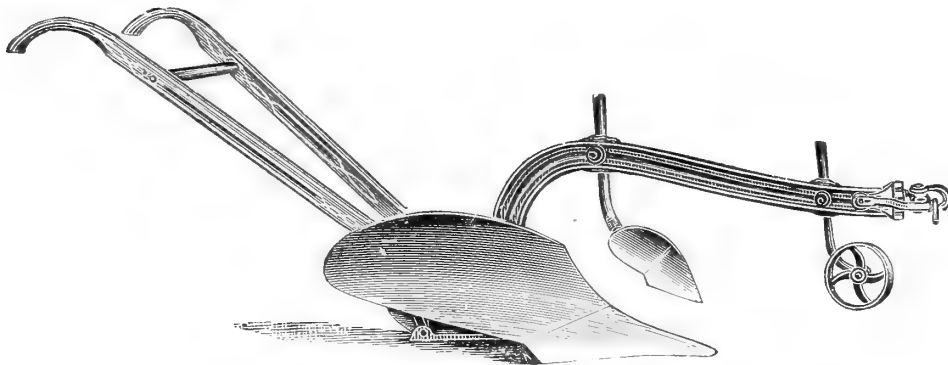

No. 401, large two-horse, furrow 5 to 8 in. deep, 12 to 15 in. wide. Price \$12.00.

No. 402, medium two-horse, furrow 5 to 7 in. deep, 11 to 13 in. wide. Price \$12.00.

No. 403, light two-horse, furrow 4 to 6 in. deep, 9 to 12 in. wide. Price, complete, \$11.00.

## Syracuse Vineyard and Garden Plows

Gardeners pronounce them superior to all others. Horse can walk in the furrows or on the land; handles can be adjusted sideways or up and down.

No. 5—1878, one-horse, furrows 3 to 5½ inches deep, 7 to 10 inches wide.

Price, complete, \$6.00.

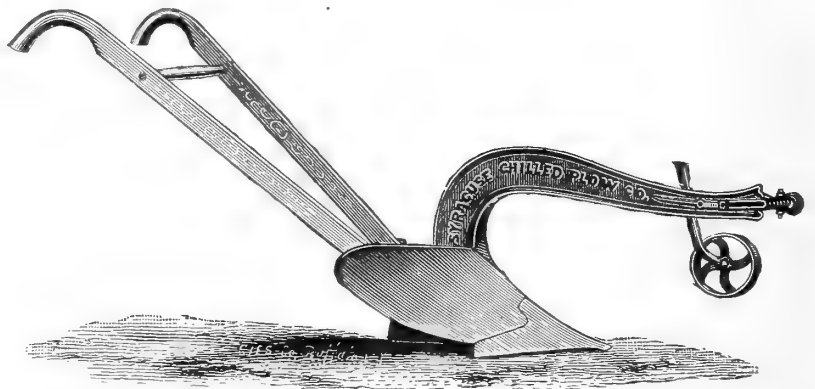

**Syracuse Hill Side Plow**—A steel truss beam, combining lightness with strength; side shifting and adjustable handles, giving increased comfort to user as he can always walk squarely behind the plow; handles which are alike and interchangeable; an automatic, uncloggable jointer; a success in weedy land. An automatic colter always in line cutting edge of the share. An automatic steel shifting lever clevis changing line of draft; an unequalled spring foot latch with quickly adjustable tension; patented steel frog shields, lessening mold-board breakage; a perfect adjustable wheel, inclining forward or back, practically lengthening or shortening the beam

No. 812, medium, two-horse, furrow 4 to 7 inches deep, 10 to 15 inches wide. Price, \$13.50.

## Syracuse Plows--Continued.

**Syracuse Corn Plow, B one handle**—This corn plow has wood beam and is used mostly for marking corn and potato ground; is sometimes used for plowing with one horse. Price, \$4 00.

**One-horse, General Purpose, or Corn Plow. 50 L**—Two handle, chilled iron mold-board, sloping chilled landside, index beam, quickly set to take more or less land. Mold-board is made high, with gradual turning. Price, \$5 50.

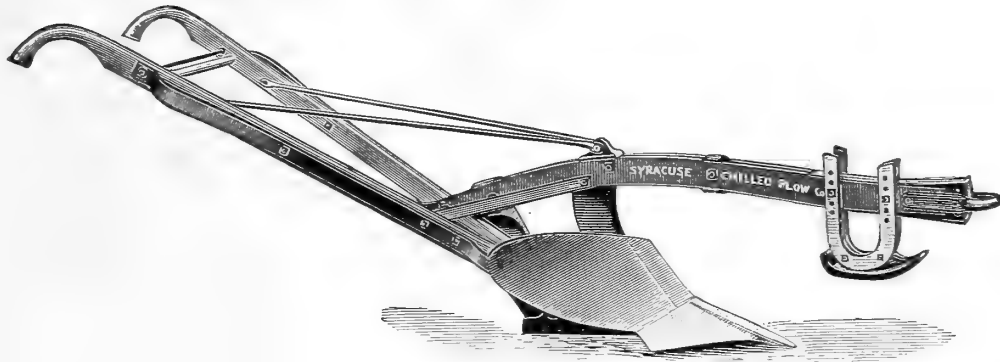

**Syracuse Contractor's Plow No 99**—Four to eight horses weight with shoe 310 pounds; steel truss beam, steel mold-board and wrought steel point, adjustable shoe in place of wheel;

loop handle wear irons, very strongly built, slight turning capacity, suitable for severe grading purposes in shale or hard pan. Price, \$33 00.

**Contractor's Plow, No 1, 1878**—Hard iron wearing parts, extra heavy beam, shore and strip. Steel wheel standard. Wide turn furrow, 5 to 9 inches deep, 12 to 15 inches wide. A good plow for general grading purposes. Price, \$12 00.

**Syracuse Spike Tooth Harrow**—Each section is furnished with a lever so that the teeth can be set at any angle without stopping the team; this enables the operator to clear the teeth of trash or make it a smoothing harrow at will. With the teeth laid flat, the harrow is supported at the corners by shoes, making it easy of transportation.

Sections are made with five u-bar of steel well braced, which holds twenty-five or thirty, five eighths inch steel teeth; each tooth is securely held in malleable holders with one bolt, and the holders constructed so that teeth of one-half or five-eighths inch can be used. The cross bars are of heavy steel well braced, making a strong, durable harrow. The sections are fastened to the draw bar so as to be independent of each other, and to turn readily without lapping.

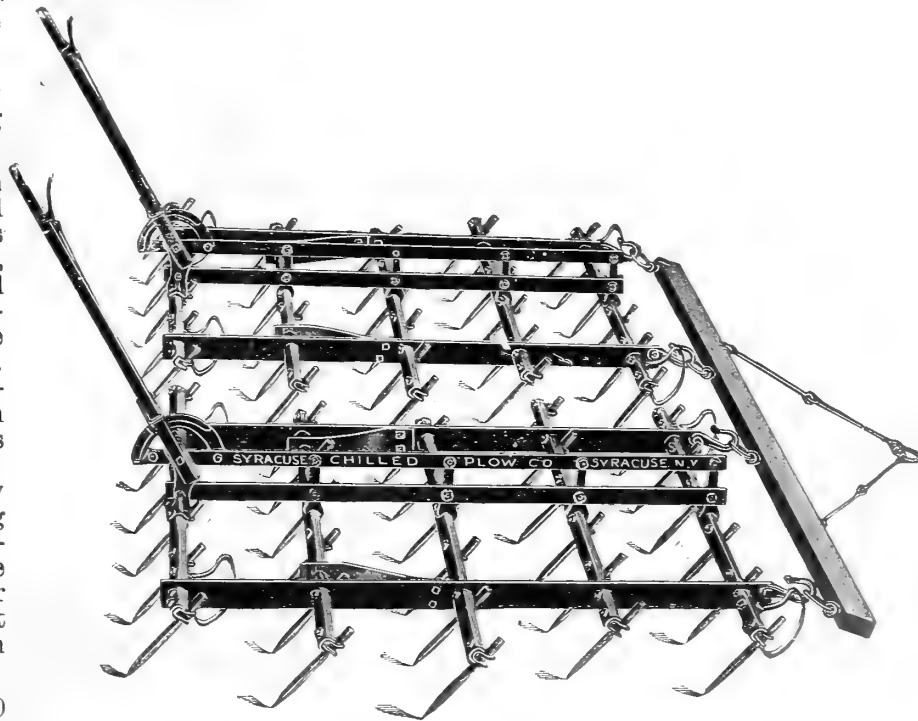

Fifty teeth..... \$12.50  
Sixty teeth .. . . . 13.50

**Syracuse Steel Frame Disc Harrow**—The frame, both in the cross-head and gang beams, is made of double bars of highly tempered angle steel, giving both strength, and rigidity. Attached to the frame are steel arms, which connect the bearing boxes; each gang has a double jointed hinge which acts vertically and horizontally, giving flexibility and free action when working on uneven ground. By means of the adjustable hold-down castings, the harrow can be made to cut at a uniform depth the full length.

12 Discs, 16 in. 4½ feet cut, 2 horses, price... ..\$25 00  
12 " 18 in. 4½ feet cut, 3 " " .. . . . . . 27 00





## HARROWS

**Syracuse Lever Spring Tooth Harrow**—Frame bars of angle steel, thoroughly protected by steel shoes, doubling the life of the harrow. Frame bars raised at the rear inner ends, as

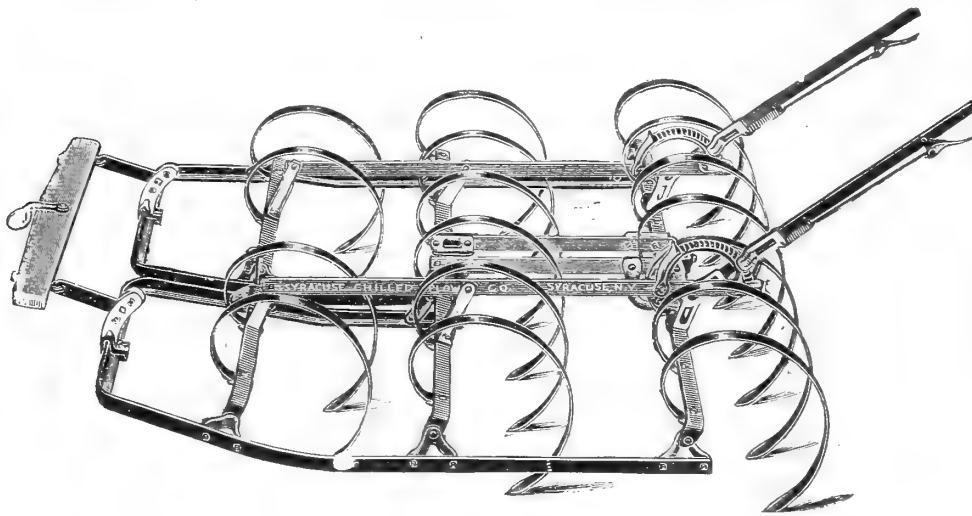

shown in cut, giving free outlet to trash; frame with small opening at front, absolutely preventing all loading at this point, so common in other makes. Tooth bars of channel steel journaled in malleable brackets above the frame, which gives the teeth high support and greater range of adjustment for depth of cultivation and clearance.

Teeth with reversible points, which give double wear; teeth raised by levers, so that the harrow rests upon the frame or runners, making it convenient for transportation. Seventeen teeth, two sections. Price, \$17.50.

**Syracuse Wheel Lever Spring Tooth Harrow**—The Syracuse wheel tooth harrow has the following meritorious features: *First*, a frame of channel steel carried at such height from

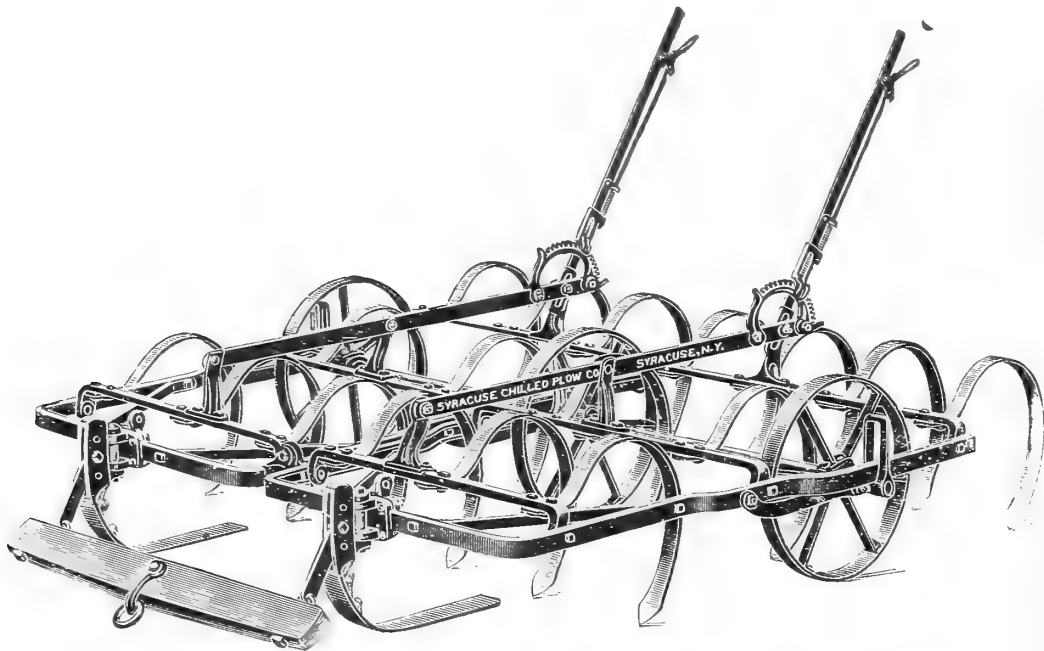

the ground on high wheels as absolutely to prevent loading. *Second*, spring steel teeth without bolt holes and adjustable on the frame to wear. *Third*, broad faced steel wheels and dirt proof bearings, and so made that by the removal of two bolts, new hubs with removal boxes can be quickly substituted. The wheels are so placed that there are no wheel tracks. *Fourth*, the entire weight of the driver, together with nearly all that of the harrow, is carried on the wheels, which greatly reduces draft. The frame work is independent of the wheel axle, which is hinged in the centre, and so allows the harrow to conform to uneven ground. *Fifth*, Caster steel shoes of angle steel, adjustable to depth, placed in front, which move always in the line of draft, steadying the running of the harrow, and also prevents it from working downward when used on side hills or rolling land. The harrow is quickly and easily turned at corners without buckling, making it unequalled for transportation or use in the field. Seventeen teeth, two sections, price \$19.00.

## Harrows==Continued

### Cambridge Plow

The No. 26 and No. 27 Steel Plow, fitted with wheel and jointer. Made from the best material obtainable, turns light draft, runs evenly, and in every way adapted to give perfect satisfaction. No. 26, medium two horse plow with capacity from 10 to 13 in. wide, 5 to 8 in. deep. No. 27, large two horse plow, capacity from 11 to 15 in. wide, 5 to 9 in. deep. Price, complete, \$13.00.

### Cambridge Shovel Plow

Blades and wings of steel; wings adjustable to throw more or less earth. Especially adapted for hilling potatoes and other light work. Price \$4.00.

**U-Bar Spike Tooth Harrow**—Excellent for pulverizing and leveling, and for the cultivation of young crops. For transportation the levers are thrown forward, thereby throwing harrow on the runners and lifting the teeth from the ground. Depth of cut is regulated with greatest ease. Fifty teeth, \$11.50. Sixty teeth, \$12.50.

## CULTIVATORS.

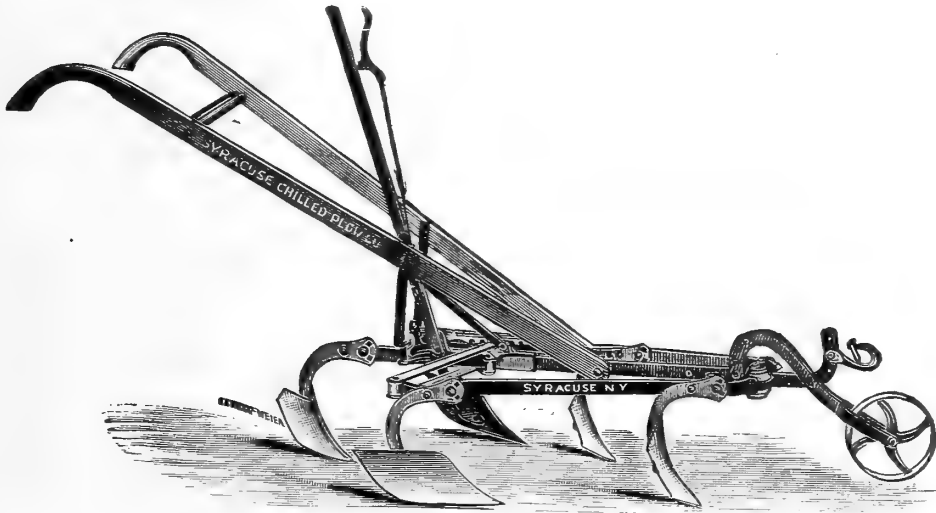

**Syracuse Horse Hoe and Cultivator**—The frames of Syracuse Cultivators are of good length, well braced and constructed, and painted a deep green.

The handles are adjustable and may be shifted to the right or left, so that the user can walk at the side of the row. Three inch points are furnished

which are reversible for wear and adjustable for pitch, by changing the position of the standards. With the wing points, which we also furnish, the dirt can be thrown toward or away from the crop.

No. 121, Expansion Lever, 5 points and Stationary Wheel . . . . . \$4 25  
 No. 123, " " 5 " and Wing Shovel Points and Stationary Wheel, 5 00

### Syracuse Spring Tooth Cultivator

No. 64—Is excellent for use in rough and stony, or smooth land, and for the cultivation of orchards or vineyards, or for field work. The frame is of steel, strongly put together, and adjustable to wide or narrow rows. The teeth are interchangeable and adjustable, both for angle and depth. Price, \$6.50.

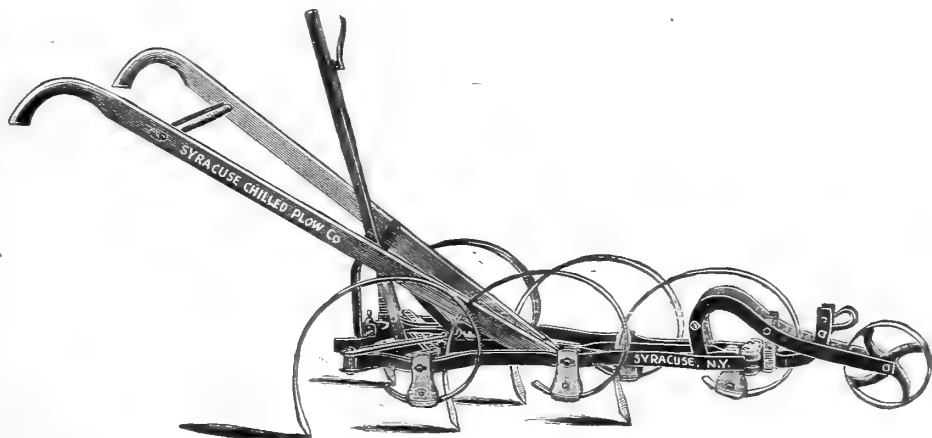

## Cultivators—Continued

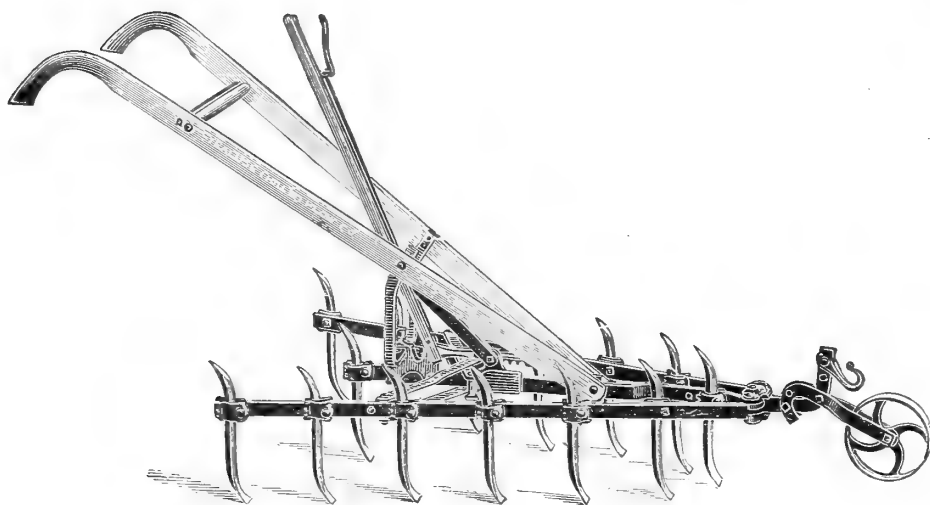

**Syracuse Spike Tooth Cultivator—No. 114** is an excellent cultivator for flat cultivation, as it thoroughly stirs and pulverizes the entire surface. It is strongly made, being largely of steel, and all castings of malleable iron. The teeth are double pointed, and that of one end flattened, so making a wider cut. By simply loosening one nut, the teeth can

be made to slant forward or back, which is of great assistance in corn cultivation. Price \$5.50.

**Rensselaer Horse Hoe Cultivator—No. 1** Expansion Lever, 5 cultivator points, wing and shovel points. Price \$5.50

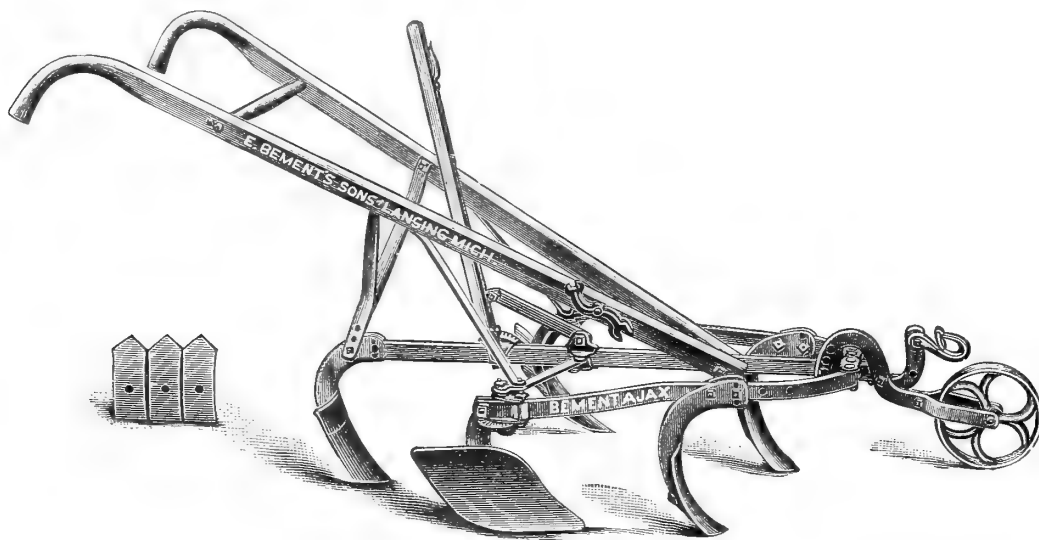

No. 2, Wheel Lever, and depth regulator, expanding lever; 5 cultivator teeth, wing and shovel points. Price \$6.50.

**Planet Jr. Cultivator and Horse Hoe**—The "Planet Jr." Horse Hoe in all forms is so strongly and so thoroughly made, as to be practically indestructible; the plates are cheaply replaced and the attachments are so useful that one tool will do a large portion of the preparation for any crop, and the cultivation of it. The patent frame is made of stiff steel, is extra long, and one to two inches higher than any other make.

Planet Jr. No. 6, Cultivator and Horse Hoe, \$6.50.  
 " " 8, " " " 8.50.  
 " " 9, " " " 7.40.

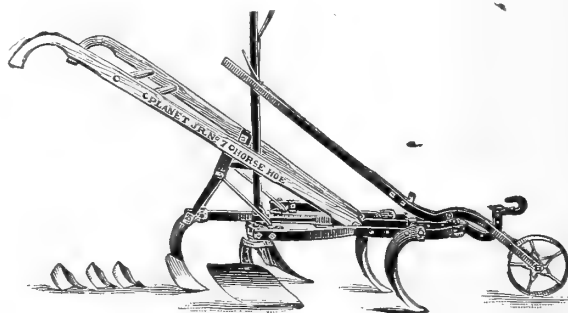

## No. 6, STANDARD NARROW RUNNER BOB SLEIGH

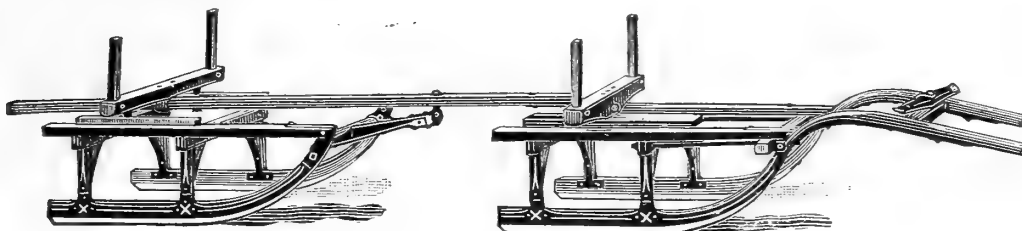

### Dimensions

RUNNERS,  $1\frac{1}{8}$  in. x  $2\frac{3}{4}$  in. 5ft. 2 in.  
 BEAMS,  $1\frac{1}{8}$  in. x  $2\frac{3}{4}$  x 3 ft. 2 in.  
 BOLSTERS, 38 in. between stakes.  
 HEIGHT, 15 in.

Cast Shoes.  
 Full Iron Circle.

KNEES,  $1\frac{1}{8}$  in. x  $1\frac{1}{8}$  in. x  $2\frac{3}{4}$  in.  
 RAVES,  $1\frac{1}{4}$  in. x 6 in. x 4 ft. 7 in.  
 TRACK, 35 in. from center to center of runner.  
 SHOES, top  $1\frac{3}{4}$  in.; depth  $1\frac{1}{4}$  in.; face  $1\frac{1}{4}$  in.; length 3 ft. 9 in. on run.

Special Bolsters furnished any length with or without stakes, if ordered.

## No. 10, STANDARD ONE HORSE BOB SLEIGH

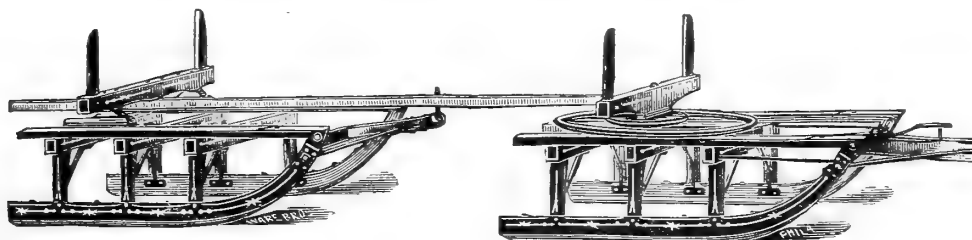

### Dimensions

RUNNERS,  $1\frac{1}{2}$  in. x  $2\frac{1}{8}$  in. x 5 ft. 1 in.  
 BEAMS,  $1\frac{1}{2}$  in. x 2 in. x 3 ft.  $1\frac{1}{2}$  in.  
 BOLSTERS, 38 in. between stakes.  
 HEIGHT, 15 in.

Straight or Bent Shafts.  
 Cast Shoes.  
 Full Iron Circle.

KNEES,  $1\frac{1}{2}$  in. x  $1\frac{1}{2}$  in. x 2 in.  
 RAVES, 1 in. x 5 in. x 4 ft.  $3\frac{1}{2}$  in.  
 TRACK, 36 in. from center to center of runner.  
 SHOES, top,  $1\frac{1}{2}$  in.; depth  $1\frac{1}{4}$  in.; face  $1\frac{1}{8}$  in.; length 3 ft. 5 in. on run.

Special Bolsters furnished if ordered.

### STRONG AND LIGHT

## No. 16, STANDARD PIN BOB SLEIGH

### Dimensions

RUNNERS,  $1\frac{1}{8}$  in. wide x  $3\frac{1}{2}$  x 5 ft. 9 in.  
 BEAMS,  $2\frac{1}{2}$  in. x 3 in. x 3 ft. 6 in.  
 BOLSTERS, 4 in. x 3 in. x 52 in. No stakes.  
 HEIGHT, 14 in.

Cast Shoes.

RAVES,  $1\frac{1}{2}$  in. x  $7\frac{1}{2}$  in. x 5 ft. 4 in.  
 TRACK, 38 in. from center to center of runner.  
 SHOES, top  $1\frac{3}{4}$  in.; depth  $1\frac{1}{4}$  in.; face  $1\frac{1}{2}$  in. length 4 ft. 4 in. on run.

Furnished with draft Rod running from pole to first knee.  
 Special Bolsters furnished with or without stakes, if ordered.



## OUR "KNOX-ALL"

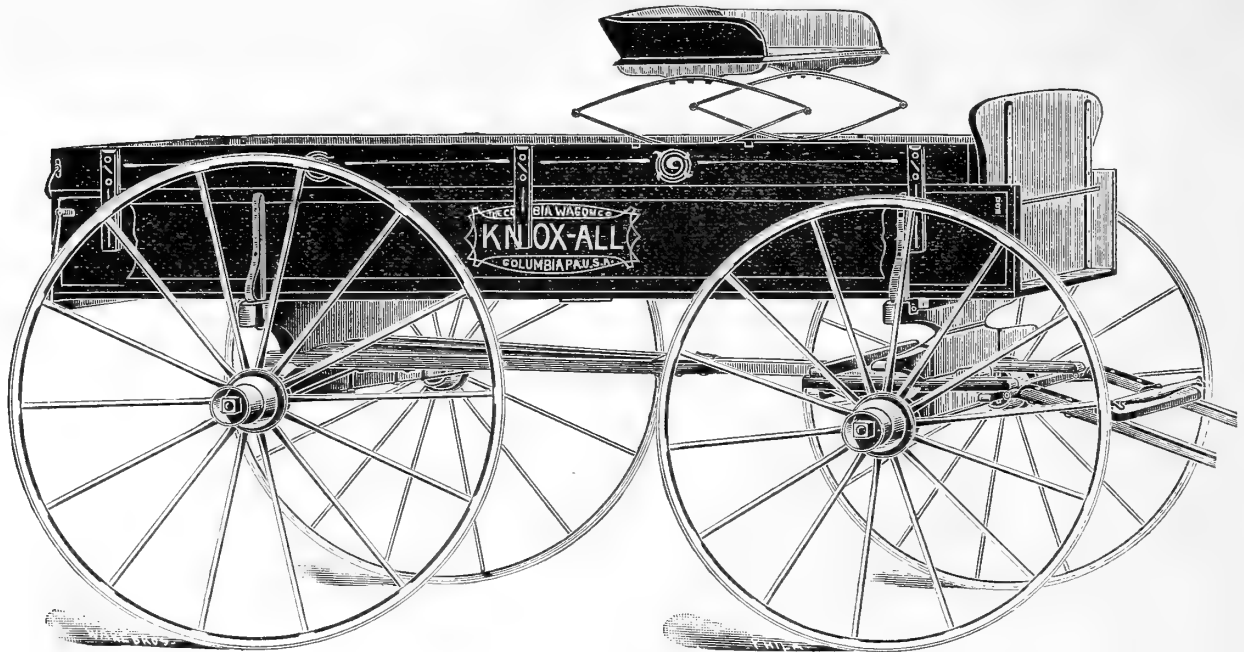

Our "Knox-All" is a light one-horse farm wagon, built with  $1\frac{1}{4}$  inch steel axles,  $1\frac{3}{8}$  inch Warner or Sarven wheels 3 feet 6 inches and 4 feet high. Body, for wide track, 8 feet long, 3 feet 6 inches wide, 10 inches high, with 4 inch top box; for narrow track, bodies are 9 feet long, 3 feet 2 inches wide, 10 inches high, with 4 inch top box, as shown in the opposite cut; with spring seat.

**Price, \$35.00**

Weight, about 500 pounds. Capacity, 1,200 pounds.

These wagons have front hounds so arranged that tongue can be fitted easily.

## OUR IMPROVED "ELI" ONE-HORSE WAGON

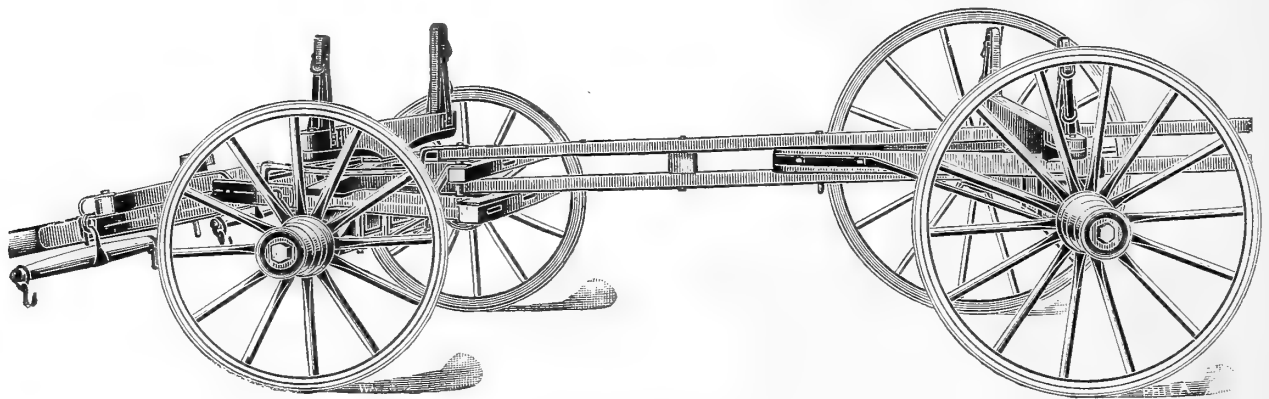

Our improved "Eli" is our best grade, light one-horse farm wagon,  $1\frac{3}{8}$  inch steel axles,  $1\frac{1}{2}$  inch Warner or Sarven wheels, 3 feet 6 inches and 4 feet high. Tires, regular, narrow track bodies, lower box 10 inches, top box 4 inches wide, as shown in opposite cut, with spring seat.

These wagons have the front hounds arranged that a drop tongue can easily be fitted. All wheels felloe plated and bolted. More wagon than ever offered before for the money. We build them in large quantities and defy competition both in grade and price.

**Price, \$45.00**

This is one of our specialties, and as a live dealer you cannot afford to be without them in stock.

## DIMENSIONS OF OUR "COLUMBIAN" BLOCK TONGUE WAGON

**Built for New York Trade**

NUMBER	Size of Wood Axles	Size of Tubular Axles	Size of Solid Steel Axles	Low Wheels		Length of Box Outside	Width of Box Outside	Height		Size of Tire	Carrying Capacity	Price complete	Gear
				Front	Hind			Lower Side	Top Side				
502	2¾ x 8	2¼ x 8	1½	3 ft. 4 in.	3 ft. 10 in.	12 ft	3 ft. 2 in	14 in.	8 in.	1½ x ½	2500	\$63.00	\$53 00
503	3 x 9	2¾ x 9	1½	3 " 4 "	3 " 10 "	12 "	3 " 2 "	14 "	8 "	1½ x ½	3500	64.00	55.00
504	3¼ x 10	2¾ x 10	1¾	3 " 4 "	3 " 10 "	12 "	3 " 2 "	14 "	8 "	1¾ x ½	4500	66.00	57.00
505	3½ x 11	2¾ x 11	2	3 " 4 "	3 " 10 "	12 "	3 " 2 "	14 "	8 "	2 x ½	6500	70.00	61 00

ORDER BY NUMBER.

This style wagon is used quite extensively in certain sections of New York State. We claim to build the slickest block tongue wagon in the market. Parties that desire a wagon of this kind write us for further particulars.

The above wagons are furnished with any style axle. Always state kind wanted in ordering.

**Wagon Seat Springs**—The King patent seat spring, only four bolts used. A saving of eighteen parts for each set of springs by using King's patent, besides great saving in labor. Price, 75c.

**Cliff's Seat Spring**—Price, 80c.

**"Handy" Farm Truck**—Furnished with wood tongue and ten-foot reach. Our new metal wheels having depressions formed in tire, permitting a large rivet head on end of spoke without projecting beyond surface of tires. Diameter 30 and 38 inches, with 4-inch tires. Renewable wheel boxes and axle skeins. Without whiffletree and neck yoke. Capacity two tons weight, 600 pounds. Price, \$37.00.

## Round Agricultural Drain Tile



2 inches, \$15 00 per 1000 pcs.....	Weight	3000 lbs.
3 " 25 00 " " .....	"	5000 lbs.
4 " 45 00 " " .....	"	8000 lbs.
6 " 100 00 " " .....	"	13000 lbs.

## Flue or Chimney Linings

Square, in 2 feet lengths, outside measure,	4½ in. x 8½ in.....	\$	30 per foot.
" " " " " "	4½ in. x 13 in.....		45 "
" " " " " "	4½ in. x 18 in.....		1 00 "
" " " " " "	8½ in. x 8½ in.....		45 "
" " " " " "	8½ in. x 13 in.....		65 "
" " " " " "	8½ in. x 18 in.....		90 "
" " " " " "	13 in. x 13 in.....		85 "
" " " " " "	13 in. x 18 in.....		1 20 "
" " " " " "	18 in. x 18 in.....		2 00 "

We carry a full line of Ditching Tools.

# SEWER PIPE

We carry a very large stock of all sizes of sewer pipe and fittings, and all orders for less than car load lots are shipped promptly from Troy.

CAR LOAD BUSINESS A SPECIALTY. We represent the largest sewer pipe factories, and can furnish any kind of pipe wanted. Write for discounts.

APPROXIMATE WEIGHTS PER FOOT. Adopted December 19, 1901.

<b>Young &amp; Halstead TROY, N. Y.</b>		6 IN. Pipe, per foot . . . \$0.30	15 IN. Pipe, per foot . . . \$1.35
		Bends . . . . . 1.10	Bends . . . . . 5.40
		16 LBS. Branches . . . . . 1.35	67 LBS. Branches, 2 ft. each, 6.10
		PER FT. Traps . . . . . 3.50	PER FT. Traps . . . . . 22.00
7 IN. Pipe, per foot . . . \$0.16	8 IN. Pipe, per foot . . . \$0.50	18 IN. Pipe, per foot . . . \$1.70	
Bends . . . . . .50	Bends . . . . . .20	Bends . . . . . .60	
8 LBS. Branches . . . . . .72	24 LBS. Branches . . . . . 2.25	84 LBS. Branches, 2 ft. each, 7.65	
PER FT. Traps . . . . . 1.50	PER FT. Traps . . . . . 6.60	PER FT. Traps . . . . . 6.60	
4 IN. Pipe, per foot . . . \$0.20	10 IN. Pipe, per foot . . . \$0.75	20 IN. Pipe, per foot . . . \$2.25	
Bends . . . . . .65	Bends . . . . . .30	Bends . . . . . .90	
10 LBS. Branches . . . . . .90	34 LBS. Branches . . . . . 3.40	100 LBS. Branches, 2 ft. each, 10.13	
PER FT. Traps . . . . . 2.00	PER FT. Traps . . . . . 9.00	PER FT. Traps . . . . . 9.00	
5 IN. Pipe, per foot . . . \$0.25	12 IN. Pipe, per foot . . . \$1.00	24 IN. Pipe, per foot . . . \$3.25	
Bends . . . . . .85	Bends . . . . . .40	Bends . . . . . 13.00	
12 LBS. Branches . . . . . 1.13	48 LBS. Branches, 2 ft. each, 4.50	140 LBS. Branches, 2 ft. each, 14.63	
PER FT. Traps . . . . . 2.50	PER FT. Traps . . . . . 15.00	PER FT. Traps . . . . . 15.00	

**Inlets**—15 inches or larger, for any size pipe, 50% additional.  
**Increases and Reducers**— Price of four feet of pipe, size of larger end.  
**Stoppers**— One-third of one foot of pipe, of the size on which it is used.  
**Channel or Split Pipe**— Each piece three-fifths of a whole pipe.  
 Every shipment at the risk of the purchaser.

# SYRACUSE HAND CARTS

Wood or steel wheels of improved pattern, which do not project above box. Furnished with three leaf springs. Box well ironed, and the leg folds up to handle. Box painted olive, and wheels red. Handsomely striped and varnished. Will carry 400 pounds and can be handled by a boy.

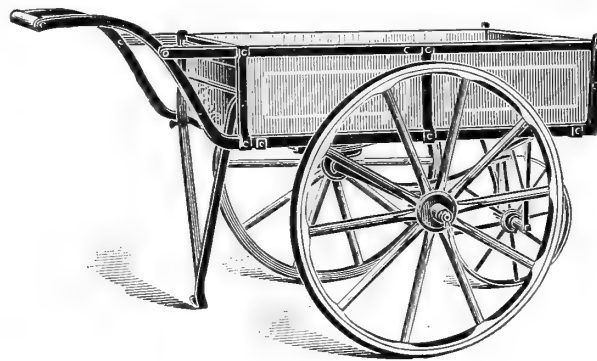

No. and Letter	Size and Body	Depth of Box	Diameter Wheels	Weight	Each
No. 332A—	39x20½ in.	10 in.	30 in.	90 lbs.	\$10 00
No. 332B—	39x24 "	10 "	30 "	95 "	10 50
No. 332C—	40x26 "	10 "	30 "	100 "	11 00

Drop end gate, \$1.00 additional. Wood wheels, 50 cents additional.

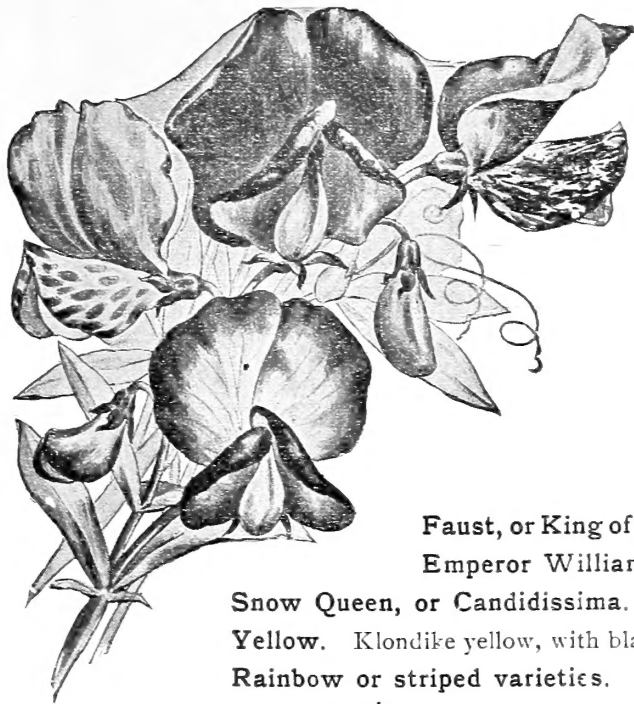

*Sweet Peas.*

**PANSIES**

**Bugnot's Superb Pansies.** This splendid choice sort resembles the Lady Washington Geranium. The plants are of sturdy habit, and the flowers loom up above the leaves, which present a beautiful appearance. This is the prettiest Pansy that has come on the market for years . . . . . per pkt. 40c

**Yellow Giant Trimardeau.** Large, bright yellow, with black spots, . . . . . per pkt. 25c

**Faust, or King of the Blacks.** Dark, velvety black. Very fine.

**Emperor William.** Bright blue, with dark purple eye.

**Snow Queen, or Candidissima.** Pure satiny white, with yellow eye.

**Yellow.** Klondike yellow, with black eye.

**Rainbow or striped varieties.** Very beautiful and curious, striped with many colors.

**Light Blue.** Excellent.

**Gold-margined sorts.** Golden edges. Very fine and tasty.

**Shades of Brown.** Very odd and produce a striking appearance.

**Choice Mixed** . . . . . per pkt. 10c

Price of each, except where noted, per pkt. 10c.; 1 pkt. each of 10 sorts, \$1.00.

**SWEET PEAS—New.**

**Cupid. New Dwarf Sweet Pea.**

Grows but five or six inches high, but is literally covered with pure white blooms. This plant grows upright and has no tendency to climb. It is a free bloomer, and begins to bloom as early as May, and continues to bloom until frost . . per pkt. 10c.; oz. 25c

**Cupid. New Dwarf Pink.** Similar in growth to White . . per pkt. 10c.; oz. 30c

**Extra Early Blanche Ferry.** An excellent variety for forcing under glass or in open ground. Covered with large pink and white flowers. Blooms two weeks earlier than any other sort. Flowers larger and finer than the Blanche Ferry, which has been very popular until the introduction of this new improved variety . . . per pkt. 10c.; oz. 20c

**Katherine Tracy.** One of the leading novelties. A brilliant pink. This variety originated in this country and is excellent in hot sun. Long stems, beautiful for cutting . . . per pkt. 10c.; oz. 20c

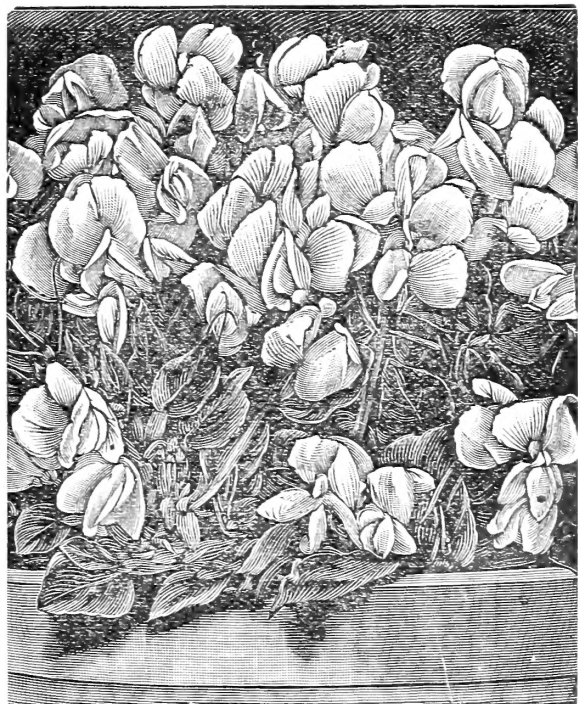

*Sweet Peas, Dwarf Cupid.*

One packet each of four above sorts, 25c.

**All seeds are tested before leaving our establishment.**

# YOUNG & HALSTEAD

## INDEX

	PAGE		PAGE		PAGE
Adjustable Swing Stanchion,	49	Feed Cookers, - - -	54	Pepper Grass, - - -	51
Agricultural Implements		Feed Cutters, - - -	57	Plant Food, Inside front cover	
and Garden Tools,-	59-78	Fencing, - - -	59	Planters, Hand, - - -	65
Alfalfa, - - -	42	Fertilizers, - - -	45-47	Plows, - - -	69-71
Asparagus, - - -	4	Fetticus, - - -	15	Pop Corn, - - -	44
Bale Ties, - - -	60	Flue or Chimney Linings,	77	Potatoe Coverer, - - -	74
Barley, - - -	43	Fodder Corn, - - -	44	Poultry Food Cooker, - - -	54
Barn Fixtures and Trimmings,	64	Garden Trowels, - - -	60	Poultry Netting, - - -	52
Barrel Headers, - - -	63	Garden Reels, - - -	60	Poultry Supplies, - - -	51-54
Barrows, - - -	66	Grasses, - - -	42, 43	Power Grindstone Frame,-	57
Baskets, - - -	65	Grass Hooks, - - -	60	Powder Guns, - - -	55
Beans, - - -	4-6	Grass Seeders, - - -	65	Pumpkins, - - -	30
Bee Supplies, - - -	58	Grindstones, - - -	56, 57	Pumps, - - -	62
Beets, - - -	7, 8	Grit, - - -	51	Putting Green, Inside front cover	
Binder Twine and Rope, - - -	59	Golf Mixture, Inside front cover		Radishes, - - -	33, 34
Blue Grass, - - -	42	Gumbo, - - -	26	Rakes, - - -	63
Bob Sleighs, - - -	75	Guns, - - -	55	Rape, - - -	43
Bolster Springs, - - -	55	Hand Carts, - - -	78	Reapers, - - -	66
Bone Cutter, - - -	52	Handy Truck, - - -	68	Red Top, - - -	43
Borecole, - - -	20, 21	Harrows, - - -	71-73	Rhode Island Bent, - - -	42
Broccoli, - - -	8	Harvesting Machinery, - - -	66	Rhubarb, - - -	35
Brooders, - - -	50-54	Hay Carriers, - - -	64	Ruta Bagas, - - -	41
Brussels Sprouts, - - -	9	Hay Racks, - - -	64	Rye Grass, - - -	42
Buckwheat, - - -	43	Hay Rakes, - - -	63	Saffron, - - -	20
Bug Death, - - -	55	Herbs, - - -	20	Sage,- - -	20
Butter Worker, - - -	48	Herd's Grass, - - -	43	Salt, - - -	49
Cabbages, - - -	9-11	Hoes, - - -	68	Salsify, - - -	35
Calf Meal, - - -	49	Hog Troughs, - - -	60	Savory, - - -	20
Calf Weaners, - - -	47	Horse Hoes, - - -	74	Scrapers, - - -	60
Caraway, - - -	20	Hot Bed Mats, - - -	60	Scythes and Snaths, - - -	59
Carriers, - - -	57	Hungarian, - - -	45	Seat Spring, - - -	77
Carrots, - - -	12	Incubators, - - -	50, 51	Seeders, - - -	65
Cauliflower, - - -	13	Insect Destroyers, - - -	54-56	Seed Dril s, - - -	68, 69
Celery, - - -	13-15	Kale, - - -	20, 21	Separators, - - -	47
Celery, - - -	13-15	Kohl-Rabi, - - -	21	Sewer Pipe, - - -	78
Chain Pump, - - -	62	Land Rollers, - - -	63	Silos,- - -	59
Chicken Feed, - - -	51, 52	Lamb Food, - - -	49	Sheep Shears, - - -	61
Churns, - - -	48, 49	Lawn Grass, Inside front cover		Shovel Plows, - - -	73
Cider and Wine Presses,	67	Lawn Seed, Inside front cover		Sleighs, - - -	75
Citron, - - -	28	Lawn Mowers, - - -	64-68	Slug Shot,- - -	54
Clover, - - -	42	Leek, - - -	21	Sorghum, - - -	43
Clover Cutter, - - -	54	Lettuce, - - -	21, 22	Spinach, - - -	35
Cookers, Feed, - - -	54	Mangel-Wurzel, - - -	8	Sprayers, - - -	55, 56
Corn, - - -	16, 17	Mangers, - - -	64	Spring Tooth Harrow, - - -	72
Corn Marker, - - -	71	Meat Scrap, - - -	52	Staple Pullers, - - -	61
Corn Planter, - - -	65	Mann's Bone Cutter,-	52	Squash, - - -	36, 37
Corn Salad, - - -	15	Marjoram, - - -	20	Sugar and Flax Seed,-	49
Corn Shellers, - - -	67	Melons—Musk,- - -	23, 24	Sweet Peas, 79, Inside back cover	
Coverers, Potato, - - -	74	Melons—Water, - - -	25	Tile, Agricultural, - - -	77
Cow Peas, - - -	43, 44	Milk Cans, - - -	47	Timothy, - - -	42
Cradles and Hay Knives, - - -	59	Milk Cooler and Aerator, - - -	48	Thyme, - - -	20
Cream Separators, - - -	47	Millet, - - -	45	Tomatoes, - - -	37-39
Crel Oil, - - -	54	Mushrooms, - - -	25	Tool Grinders, - - -	61
Cress, - - -	15	Musk Melons, - - -	23, 24	Trucks, - - -	55
Cucumbers, - - -	17, 18	Nasturtiums, - - -	26	Turnips, - - -	39, 40
Cultivators, - - -	73, 74	Oats, - - -	43	Vetch, - - -	44
Cyclone Carriers, - - -	57	Oil, - - -	59	Wagons, - - -	76, 77
Dairy Supplies,- - -	47-49	Okra, - - -	26	Washer, - - -	61
Dandelions, - - -	19	Onions, - - -	26-29	Water Elevators, - - -	62
De-Horning Clippers, - - -	47	Orchard Grass,- - -	42, 43	Water Melons, - - -	25
Drain Tile, - - -	77	Oyster Plant, - - -	35	Weeders, - - -	66
Drills, - - -	68, 69	Oyster Shells, - - -	51	Wheelbarrows, - - -	66
Drinking Fountains, - - -	52	Pansies, - - -	79	Wheel Hoes, - - -	68
Egg Plant,- - -	19	Parsley, - - -	29	White Clover, - - -	42
Emery Grinder,- - -	56, 57	Parsnips, - - -	29	Wire Fencing, - - -	59
Endive, - - -	20	Pasture Mixture, - - -	25	Wire Stretchers, - - -	61
Engines, - - -	62, 63	Peas,- - -	30-33	Wood Meadow Grass, - - -	42
Feeds, - - -	42-45	Peppers, - - -	30	Wormwood, - - -	20



## SWEET PEAS—Choice.

- |   |  |
|---|--|
| <p><b>Adonis.</b> Bright carmine-rose.</p> <p><b>Blanche Ferry.</b> An improved Painted Lady.</p> <p><b>Butterfly.</b> White ground, with lavender and blue markings.</p> <p><b>Black.</b> Very dark purple.</p> <p><b>Crown Princess of Prussia.</b> Blush, excellent.</p> | <p><b>Emily Henderson.</b> Seedling from Blanche Ferry. Fine.</p> <p><b>Painted Lady.</b> Pink and white.</p> <p><b>Scarlet Invincible.</b> Deep scarlet-crimson, very fine.</p> <p><b>White.</b> Very fragrant.</p> |
|---|--|

All above nine sorts, per pkt. 5c.; oz. 10c.;  $\frac{1}{4}$  lb. 25c.; lb. 75c.



*Sweet Pea, Blanche Burpee.*

## SWEET PEAS—Eckford's Hybrids.

- Gaiety.** Very large; long stems; bright and lively stripes of crimson on white ground . . . . . per pkt. 10c.; oz. 20c
- Blushing Beauty.** Very large, rich, soft, fleshy rose, of very large form. Excellent . . . . . per pkt. 10c.; oz. 20c
- Countess of Radnor.** A very excellent variety of two colors, light and mauve, shading to lilac . . . . . per pkt. 10c.; oz. 20c
- Apple Blossoms.** Large, beautiful; wings white, shaded lilac, standards bright pink . . . . . per pkt. 10c.; oz. 20c
- Indigo King.** Dark maroon-purple, with dark blue wings . . . . . per pkt. 10c.; per oz. 20c
- Blanche Burpee.** Newest and best of all the white sweet peas. Flowers pure white and of immense size. Profuse bloomer, very hardy; long stems . . . . . per pkt. 10c.; per oz. 25c

**REMEMBER we have best assortment of Sweet Peas of BEST quality.**

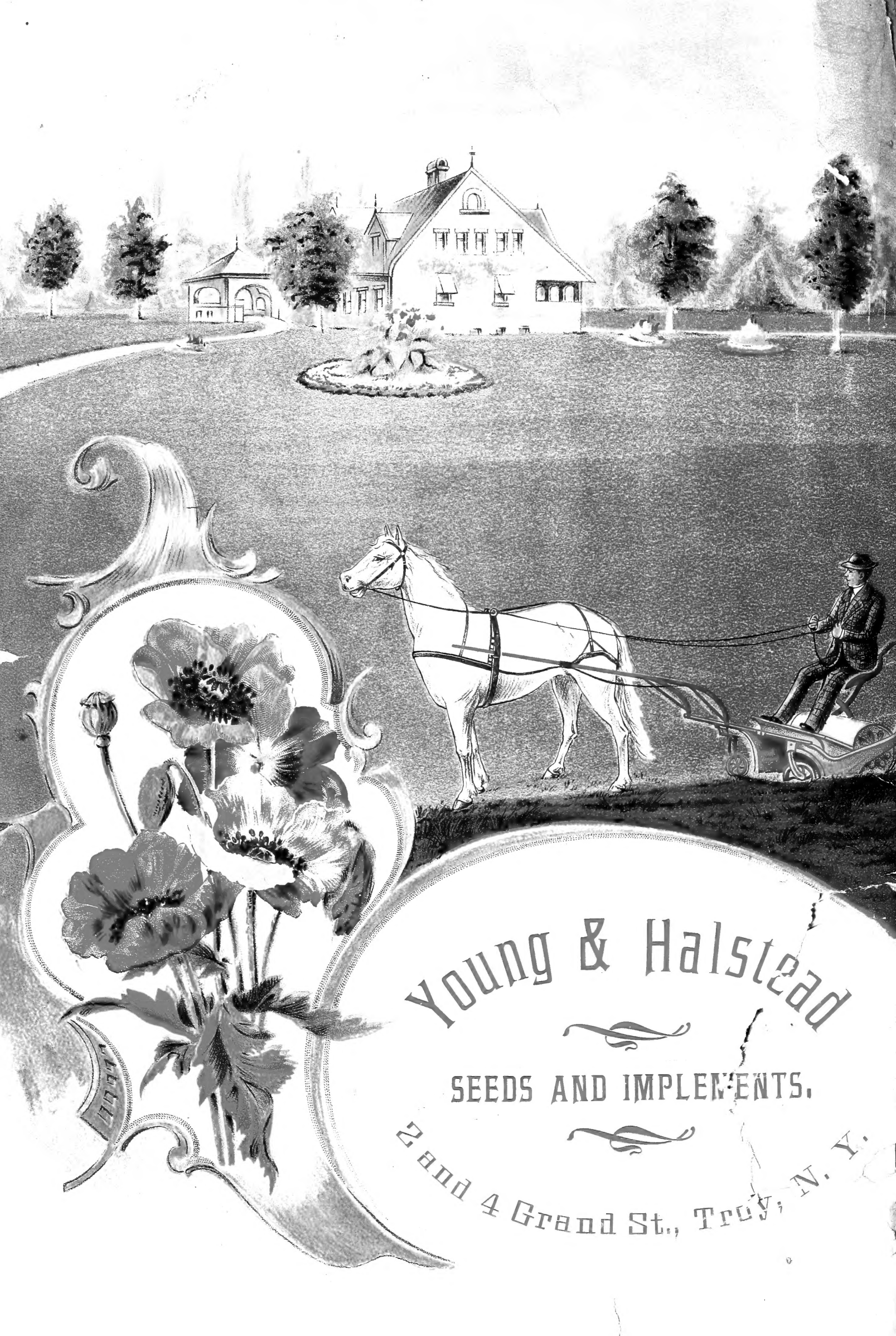

Young & Halstead

SEEDS AND IMPLEMENTS.

2 and 4 Grand St., Troy, N. Y.