

Historic, Archive Document

Do not assume content reflects current scientific knowledge, policies, or practices.

MICHELL'S

BULBS

1905

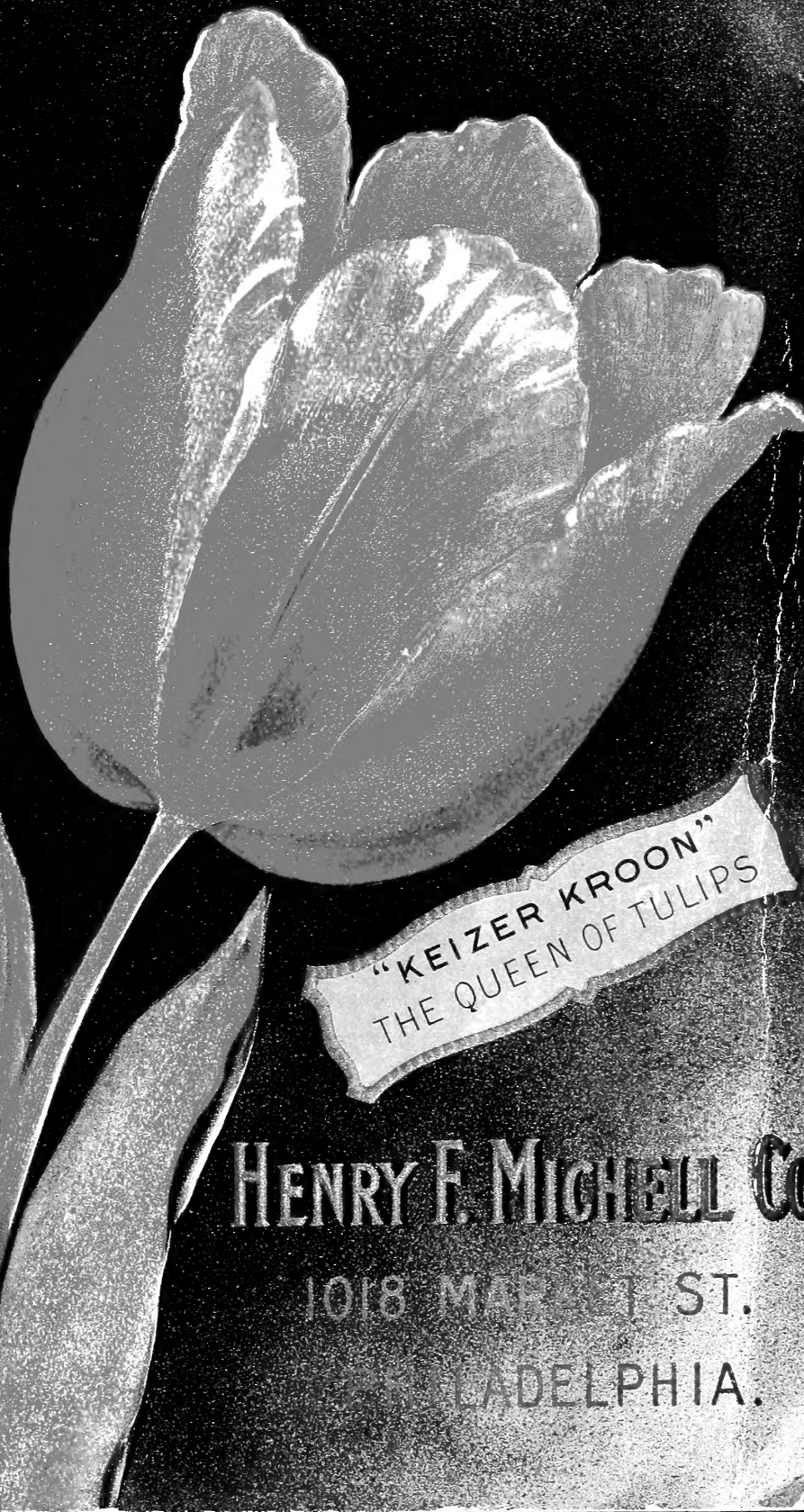

"GRAND MAITRE"
THE KING OF
HYACINTHS

"KEIZER KROON"
THE QUEEN OF TULIPS

HENRY F. MICHELL CO.

1018 MARKET ST.

PHILADELPHIA.



HYACINTH GROWING
IN WATER

Extra Bulbs "Free"

Be sure and avail your-
self of these offers

We will include in all orders (if asked for at the time the order is placed) a collection of fine, assorted bulbs, all carefully labeled, in the following sized orders:—

- Offer No. 1. On orders amounting to \$1.00 (one dollar) and over, 12 Bulbs (our selection) Gratis
 Offer No. 2. On orders amounting to \$2.00 (two dollars) and over, 25 Bulbs (our selection) Gratis
 Offer No. 3. On orders amounting to \$3.00 (three dollars) and over, 50 Bulbs (our selection) Gratis
 Offer No. 4. On orders amounting to \$5.00 (five dollars) and over, 100 Bulbs (our selection) Gratis
 Offer No. 5. On orders amounting to \$10.00 (ten dollars) and over, 250 Bulbs (our selection) Gratis

Hints on Bulb Culture for Amateurs

COVERING PRINCIPALLY WINTER AND EARLY SPRING FLOWERING SORTS

HYACINTHS

Directions for Planting in the Open Ground.—This should be done in October and November, but they can be set out at any time, as long as the ground is open and the bulbs remain sound, but early planting always insures good root development and thorough establishment. The best compost for their culture is the following: One-third river sand, one-third well rotted cow manure and one-third good garden mould; or, where the soil is naturally light, well rotted cow manure liberally intermixed is all-sufficient. Special care should be taken not to add any bone fertilizers, as they usually draw vermin. The beds composed of the above compost should be well dug to a depth of fourteen inches, and raised from two to four inches above the level of the walks. The bulbs should be planted evenly about six inches deep (to the bottom of the bulbs) and from five to six inches apart; if planted at uneven depths they will not bloom at the same time, but irregularly. Care must be taken not to press the earth too firmly around and over the bulbs; some successful gardeners follow the plan of setting each bulb in a handful of clean sand, which insures drainage. After planting, rake the bed smooth, and after the ground has frozen tolerably hard in early winter cover with dry litter, leaves or coarse manure. If this covering be applied before freezing weather it renders the bulbs liable to the predations of field mice.

For Culture in Pots.—Prepare the above compost, adding, if possible, a quantity of leaf mould. The most favorable time for planting is September, October and November. The size of the pot depends on the number of bulbs planted in a single one; three bulbs in a pot of, say, six inches diameter make a rich, massive effect; one or two bulbs in each may be planted in proportionately smaller pots—two bulbs in each are very effective. In potting, each bulb should remain one-half above the surface of the soil; when thus planted water them well; to imbue the bulbs firmly in the soil, allowing them to remain in this condition one or two days; then bury the pots in the open ground to the depth of six inches for eight weeks, in which condition the preparatory root growth necessary to a vigorous development of their flower spikes is made. After this period take up the pots and remove them to a room not heated, but not so cold as to freeze. Being exposed to the light for the first time, they are, of course, very delicate. Care should therefore be exercised not to place them in the direct rays of the sun for two or three days. When about ready to flower bring them to the ordinary living-room, where the warmth will soon cause them to bloom. By so bringing them out, a few at a time, you can secure a succession of beautiful flowers all winter. They will need occasional watering until they begin to grow, when they should have an abundance of air in mild weather and plenty of water.

For Growing in Glasses.—Single varieties are the best for this purpose, as they produce much more satisfactory blooms than the double ones. Place the bulb in the glass, which should be filled with water so it touches the bottom of the bulb, place them in a close box in a cool place, or on a shelf in the dark part of the cellar, changing the water every ten days or two weeks; keep them in the dark, cool place from six to eight weeks, then remove them to the light (not too strong). If then kept in a cool room they will produce very fine spikes and remain in bloom a long time.

P. S.—A small piece of lump charcoal placed in the water will prevent it from getting foul.

IMPORTANT NOTICE.—When using a dibble, or planting-iron, for making holes in the ground, before inserting the bulbs be sure and throw a little sand or soil in the opening, to insure proper drainage. When dibble is plunged in the ground, it packs or compresses the soil all around; and when the bulb is inserted, it does not touch the bottom, which provides a space for water to settle, and the bulb cannot root properly.

THESE SPECIAL DIRECTIONS ARE FOR OUTSIDE PLANTING OF BULBS.

TULIPS

These are most satisfactory for blooming indoors as well as for bedding in the garden. Few bulbs can be had at so little cost that will produce such splendid results.

For Bedding Out.—The bed should be formed of a compost similar to that recommended for Hyacinths; the bulbs should be planted about four inches apart and about five inches deep (close planting makes a much finer effect and prevents the flowers breaking off when swaying in the wind); they should then be covered with a litter shortly before the severe freezing weather sets in, and left in this condition until spring approaches.

For Pot or Pan Culture.—Plant about four bulbs in a six-inch pot or five bulbs in a six-inch pan, water thoroughly and then remove to the open ground or in a cold frame, covering with coal ashes; after they have rooted thoroughly they should be brought into a moderately cool room and gradually warmer; by bringing in a fresh supply from the outside every ten days, and by careful treatment, they can be had in bloom continually.

NARCISSUS

One of the most successful bulbs to be grown by the amateur. The double and single trumpet varieties should be planted in soil. For indoor culture, plant in boxes or pots, and treat similar to Hyacinths, Chinese Lilies and Paper White Narcissus, and the Polyanthus types, such as Grand Soleil d'Or, etc., succeed very well and are quite interesting if planted in water and pebbles, as one can watch their progress of growth. A small lump of charcoal prevents the water from getting foul, although changes of water are advisable.

CROCUS

A real show can be obtained from these tiny bulbs; purchased at so small an expense, the results obtained are wonderful. They will bloom in a few weeks from time of planting inside. Place a few bulbs, or as many as the size of crock will warrant, in a receptacle, perforated. In a short space of time the bulb will start to grow and make a grand display. Planted out in the open ground, they bloom among the first of the spring flowers, coming up through the grass (where they may be planted with little trouble).

LILIES

The Easter Lily is imagined by many hard to succeed with; though handled properly, the trouble is well repaid by beautiful flowers. Plant the bulb in a pot suitable to the size of same, watering same thoroughly; then plunge it outside, until about December 10th, twelve inches deep in ashes, sand or soil, not giving any more water than naturally received from rainfalls. Then bring it in the house and place in a moderately warm room. Keep as dark as possible, as this somewhat prevents too long a growth of the plant. CALLA LILIES are also an excellent winter flowering plant. Planted in suitable pots inside and given plenty of water, they bloom very freely.

TELEPHONES

Bell--3973 Filbert
 Bell--3974 Filbert
 Keystone--1933 Race

Henry F. Michell Co.

Bulbs Plants Seeds 1018 Market St.
 Supplied 1018 Phila., Pa.

Henry F. Michell, Pres.

Fred. J. Michell, V. Pres.

A Newspaper Clipping from the *Philadelphia Press*, October 29, 1904.

PLANTING 100,000 BULBS

Gardeners Arranging Floral Treat for Philadelphia Next Spring.

City Forester Lewis began yesterday his preparation for a floral treat in the larger city squares next springtime. A force of gardeners was set to work planting the 100,000 bulbs of tulips, hyacinths and narcissus. The main displays will be in Independence and Logan Squares, but there will be beds in all the Philadelphia Public Parks.

Henry F. Michell & Co., 1018 Market Street, have had the City's contract for Bulbs for five years. Bids are awarded on merit of previous year's display and lowest prices. This firm supplies a number of the principal parks throughout the country, also many of the largest private gardens and estates. The dependability of color, luxurious flowering qualities of the Michell importations has given this firm an enviable position and ranks it as one of the largest importers of bulbs in America.

P. S. We have again been awarded the contract for furnishing the city with bulbs for this autumn delivery for next spring's display.

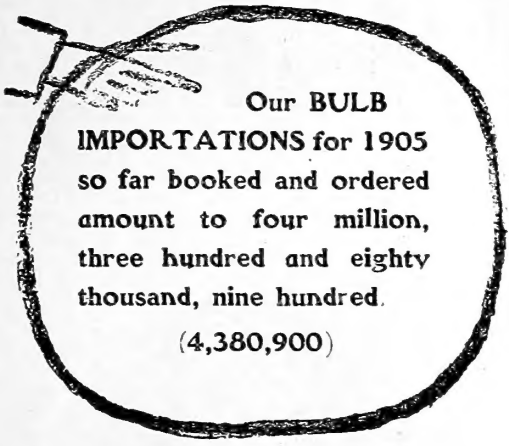

Testimonial from the City Forester and Landscape Gardener of Philadelphia

Office of Bureau of City Property, City Hall,
Philadelphia, May 10, 1905.

Gentlemen: It affords me a great deal of pleasure, and I may add gratification to once AGAIN bear testimony to the excellency in every point of the bulbs furnished by your house for our City Squares and Parks. Our bulbous display has become one of the features of the City, and great numbers come here for the sole purpose of examining and admiring the spring treat, as so many term it, copying the designs and the names of varieties of bulbs used. I congratulate you on continued success in obtaining the best stocks.

Yours truly,

JNO. C. LEWIS, City Forester and Landscape Gardener.

INDEX TO CONTENTS OF THIS CATALOGUE

BULBS		PLANTS		MISCELLANEOUS	
	PAGE		PAGE		PAGE
Amaryllis.....	11	Araucaria.....	40	Insecticides (all kinds).....	32
Aconite.....	11	Areca.....	40	Knives.....	29
Autumn Crocus (Colchicum).....	11	Asparagus.....	40	Leaf Rack.....	26
Anomatheca (Scarlet Freesia).....	11	Asparagus.....	40	Lopping Shears.....	29
Anemone (Wind Flower).....	11	Blackberry.....	33	Labels (Pot).....	33
Allium.....	11	Cycas.....	40	Leaf Mould.....	30
Astilbe (see Spirea).....	15	Carnation.....	39	Mole Traps.....	29
Bleeding Heart (Dielytra).....	13	Currant.....	38	Mats (Hot Bed).....	29
Begonias.....	11	Cocos Palms.....	40	Mastica.....	28
Buttercups (see Ranunculus).....	15	Ferns.....	21 40	Machine.....	28
Chionodoxa (Glory of Snow).....	11	Fern Ball.....	21	Moss (all kinds).....	30
Colchicum (Autumn Crocus).....	11	Fruit Trees.....	38	Nozzles.....	26-34
Crown Imperials.....	11	Gooseberry.....	38	Orchid Baskets.....	27
Crocus.....	12	Grape Vines.....	38	Orchid Pans.....	27
Calla Lily, all varieties.....	12	Kentia Palms.....	40	Pencil Indelible.....	33
Chinese Lily.....	12	Latania.....	40	Poultry Supplies.....	35
Daffodils (Narcissus).....	7, 8, 9	Osage Orange.....	37	Pebbles.....	12
Dielytra (Bleeding Heart).....	13	Privet.....	37	Pots.....	27
Freesias.....	13	Raspberry.....	38	Plant Tubs.....	27
Scarlet (see Anomatheca).....	11	Rubber.....	40	Pot Hangers.....	27
Gladolus.....	13	Strawberry.....	37	Pruning Saws.....	29
Gloxinias.....	13	Violet.....	39	Pumps.....	34
Hyacinths, First Size Named.....	2, 3			Pruning Shears.....	35
Second Size Named.....	3			Pot Brackets.....	34
Dutch Unnamed.....	4			Plant Stands.....	28
Grape.....	4			Putty Bulb.....	28
French Roman.....	4			Plant Bed Cloth.....	28
Miniature or Dutch Roman.....	4			Peat.....	30
Ixias.....	14			Propagating Sand.....	30
Iris, all varieties.....	13			Paper for Celery.....	30
Jonquils.....	7			Plant Stakes.....	33
Lilium Harrisii.....	10			Pincers for Glazing Points.....	28
Candidum.....	10			Rakes.....	26
Longiflorum.....	10			Rolling Stands.....	35
Giganteum.....	10			Raffia.....	30
Auratum.....	10			Root Cutters.....	34
Album.....	10			Saucers (Pot).....	27
Rubrum.....	10			Seed Pans.....	27
Melpomene.....	10			Shears.....	29
Tigrinum.....	10			Saws.....	29
Tenuifolium.....	10			Spray Pumps.....	34
Lily of the Valley.....	14			Stoves (Hot Water).....	35
Lachenalia.....	14			Straw Mats.....	29
Narcissus.....	7, 8, 9			Shading Cloth.....	28
Oxalis.....	14			Silkalene.....	30
Ornithogalum.....	15			Soil.....	33
Paeonies.....	15			Stakes.....	31
Ranunculus.....	15			Sulphur Blower.....	33
Snowdrops.....	15			Syringes.....	33
Scilla.....	15			Sweepers, Lawn.....	26
Sparaxis.....	15			Sieves.....	35
Spirea.....	15			Tubs.....	27, 35
Star of Bethlehem (see Ornithogalum).....	15			Thermometers.....	29
Tulips.....	5			Tree Pruners.....	29
Single, Early.....	6			Twemlow's Putty.....	28
Double.....	7			Tobacco Stems.....	30
Late.....	5			Trellis.....	33
				Tongs for Lehman Coal.....	34
				Torches.....	35
				Twine.....	30
				Vases.....	27
				Watering Pots.....	26
				Wheel Barrows.....	26
				Wagon Heaters.....	31
				Wire.....	33

SEEDS, Etc.

Flower.....	16-21
Farm.....	22
Grass.....	23, 24
Mushroom Spawn.....	24
Vegetable.....	25

MICHELL'S HYACINTHS

STRICTLY FIRST SIZE NAMED,

Which produce the largest and most perfect flower spikes. Adapted for forcing in water or in soil. Most of these varieties here offered have won first prizes at the Horticultural exhibitions.

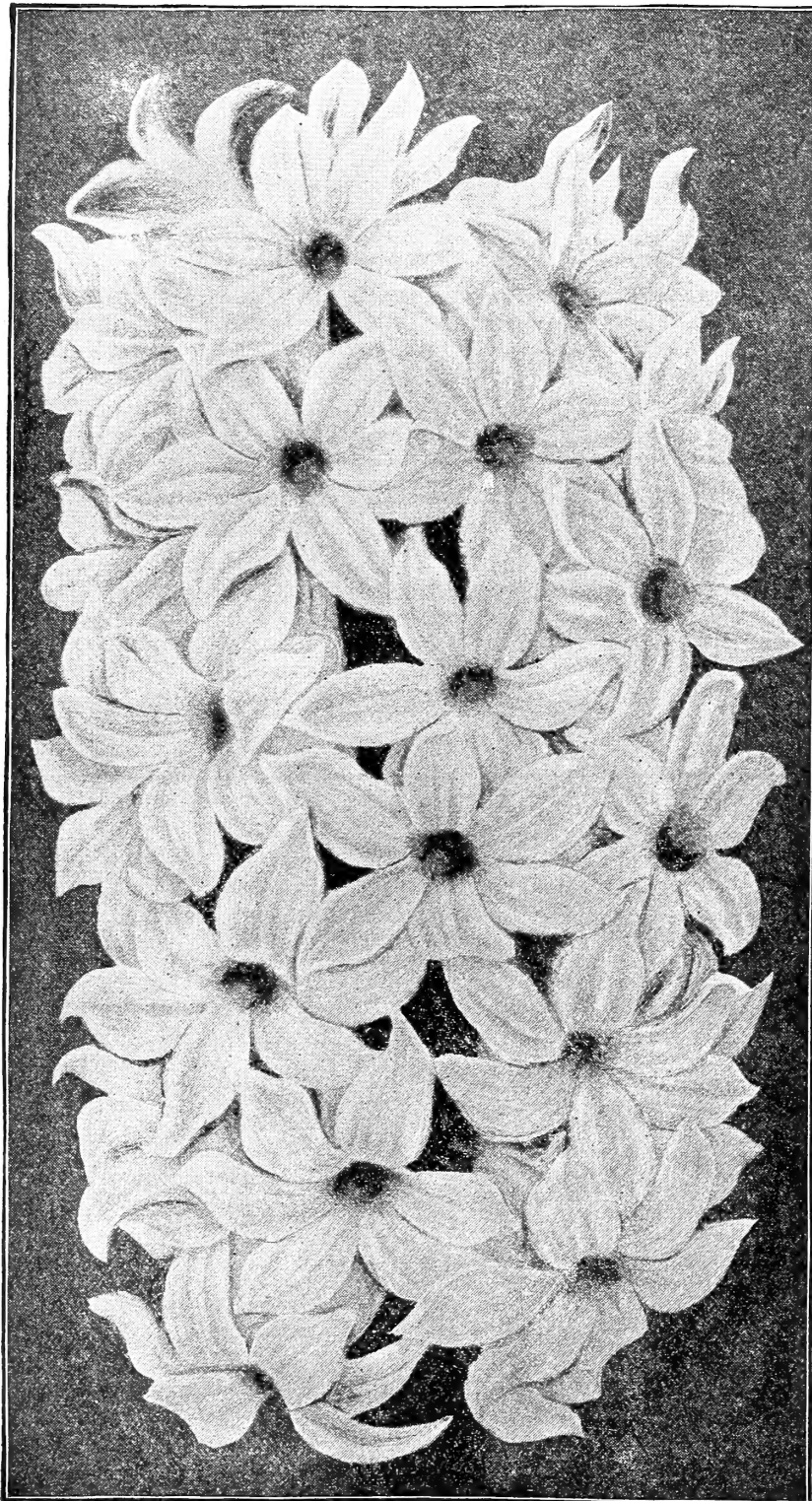

Michell's First Size Named Single Hyacinth.

HYACINTH GLASSES.

Belgian, in all colors, 18 cts. each; per doz., \$1.75.
Tye or Low Pattern, 18 cts. each; per doz., \$1.75.

TUBES FOR BELGIAN HYACINTH GLASSES.

10 cts. each; per doz., \$1.10.

DIRECTIONS FOR GROWING HYACINTHS IN WATER.

There is much pleasure derived from growing Hyacinths in water; select good, large bulbs (single flowering preferred) and place them in the glasses, allowing the water just to touch them, place them in the dark until thoroughly rooted, changing the water every ten days (a small piece of charcoal in the bottom of glass prevents the water from fouling). It is advisable to use tubes in order to prevent the bulb from getting handled, so that when the water is changed, the bulb may be lifted out with tube.

SINGLE RED VARIETIES.

	Each	Per doz.	Per 100
Amy. Rich	\$0.10	\$1.00	\$7.00
Roi des Belges. Bright scarlet10	1.00	7.00
General Pelissier. Rich Crimson, . .	.10	1.00	7.00
Robert Steiger. Crimson10	1.00	7.00
Koh-i-Noor. Semi Double. Bright, very fine10	1.00	7.50

SINGLE PINK VARIETIES.

Baron von Thuyl. Rosy10	1.00	7.00
Moreno. Extra fine12	1.20	8.00
Gertrude. Bright10	1.00	7.00
Gigantea. Light10	1.00	7.00
Lord Macauley. Bright10	1.00	7.00
Maria Cornelia. Rose, very Early, . .	.12	1.20	8.00
Norma. Flesh color10	1.00	7.00
Rosea Maxima. One of the finest12	1.20	8.00

SINGLE WHITE VARIETIES.

Alba Superbissima. Pure white10	1.10	7.50
Baroness von Thuyl. Pure white, very early10	1.00	7.00
Grandeur a'Merveille. Blush10	1.00	7.00
La Innocence. Pure extra fine12	1.20	8.00
La Grandesse. Pure white12	1.25	9.00
Mad Vander Hoop. Pure white, compact10	1.10	7.50
Queen of the Netherlands. Extra fine spike, pure white12	1.20	8.00

SINGLE BLUE VARIETIES.

Blue Mourant. Deep Blue10	1.00	7.00
Chas. Dickens. Porcelain10	1.00	7.00
Czar Peter. Rich porcelain blue, extra large spike12	1.20	8.00
Grand Maitre. Bright10	1.00	7.25
King of the Blues. The best bright blue10	1.00	7.00
Haydn. Best Violet, good spike10	1.00	7.00
Leonidas. Light, large10	1.00	7.00
Queen of the Blues. Light, extra large spike10	1.00	7.00

SINGLE YELLOW VARIETIES.

Hermann. Orange10	1.00	7.00
Ida. Bright yellow12	1.20	8.00
King of the Yellows.12	1.20	8.00
La Citroniere. Lemon10	1.00	7.00

A single bulb mailed free. For mailing 1 doz. add 15c. to price for postage.



The Hyacinths bought of you last fall proved Magnificent Specimens.
 Mrs. W. H. Edwards.
 Smith's Mills, Pa.

6 Bulbs of any one variety at dozen rates; 25 at 100 rates, 250 at 1000 rates.

Hyacinth growing in water, roots contained in a tube.

FIRST SIZE NAMED HYACINTHS—Continued.

DOUBLE RED AND PINK VARIETIES.

	Each	Per Doz.	Per 100
Bouquet Royal. Pink	\$.10	\$1.00	\$6.75
Bouquet Tendre. Dark red, large	.10	1.00	7.00
Czar Nicholas. Pink	.10	1.00	7.00
Lord Wellington. Pink, large truss	.10	1.00	7.00
Prince of Orange. Dark pink	.10	1.00	7.25

DOUBLE WHITE VARIETIES.

Flevo. Pure, fine truss	.10	1.00	7.00
La Tour de Auvergne. Pure white perfect spike	.10	1.00	7.00
La Virginite. Cream	.10	1.00	7.00
Prince of Waterloo. Pure white, extra large	.10	1.00	7.00

DOUBLE BLUE VARIETIES.

Blocksberg. Porcelain, large bells and spike	.10	1.00	7.00
Garrick. Deep, very good	.10	1.00	7.00
Mignon Van Dryfhout. Light blue, large bulb and spike	.10	1.00	7.00
Rembrandt. Porcelain, a grand sort	.10	1.00	7.00

DOUBLE YELLOW VARIETIES.

Bouquet de Orange	.10	1.00	7.00
Goethe. Rich yellow	.10	1.10	7.50

Single Bulbs mailed free. (Add 10c. per dozen for mailing.)

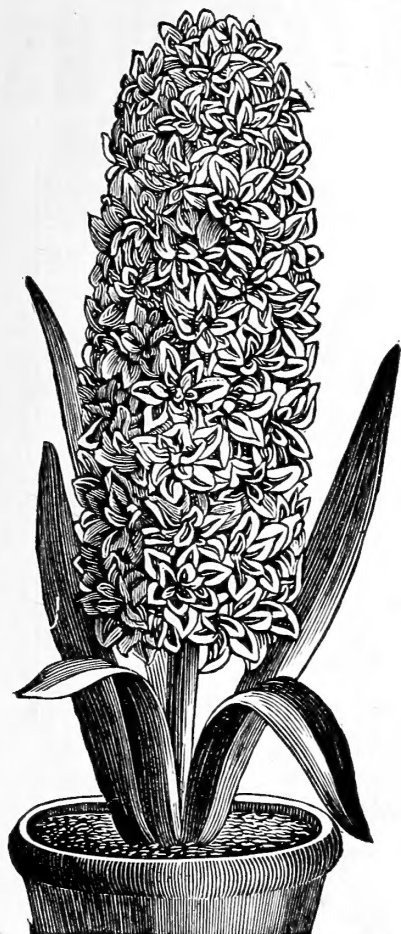

Double Hyacinth

SECOND SIZE NAMED HYACINTHS (First Quality)

FOR FORCING AND HIGH CLASS BEDDING.

These Hyacinths produce vastly superior results as compared with the ordinary bedding sorts. The price is just a little higher to justify the extra care taken in the production and harvesting of this stock. Our bulbs are extra fine and anyone will be well repaid by planting them.

SINGLE RED VARIETIES.

	Each	Per Doz.	Per 100	Per 1000
Koh-i-Noor (Semi-double). Bright	\$.08	\$0.80	\$5.50	\$50.00
Queen of Hyacinths. Scarlet	.07	.75	5.50	48.00
Robert Steiger. Crimson, compact truss	.07	.75	5.50	48.00
Roi des Belges. Bright scarlet, very fine	.07	.75	5.50	48.00

SINGLE PINK VARIETIES.

Baron von Thuyl. Light rose, fine spikes	.07	.75	5.50	48.00
Chas. Dickens. Light, large spike	.07	.75	5.50	48.00
Gertrude. Bright, very compact	.07	.75	5.50	48.00
Gigantea. Light, flesh color	.07	.75	5.50	48.00
Lord Macauley. Bright carmine	.07	.75	5.50	48.00
Moreno. Light, large	.07	.75	5.50	48.00
Rosea Maxima. One of the finest pinks	.08	.80	5.50	50.00

SINGLE WHITE VARIETIES.

Alba Superbissima. Pure white, good truss	.08	.80	5.50	52.50
Baroness von Thuyl. Pure white, fine for forcing	.08	.80	5.50	52.50
Grandeur a Merveille. Blush white, large spike	.08	.80	5.50	50.00
La Grandesse. Pure white, the finest	.08	.85	6.00	55.00
La Innocence. Pure, very fine	.08	.80	5.50	52.50
Mad. Van der Hoop. Pure, large bells	.08	.80	5.50	50.00
Queen of the Netherlands. Pure (extra)	.08	.80	5.50	52.50

SINGLE BLUE VARIETIES.

Baron von Thuyl. Deep blue, large spike	.07	.75	5.50	48.00
Blue Mourant. Deep blue	.07	.75	5.50	48.00
Chas. Dickens. Porcelain	.07	.75	5.50	50.00
Czar Peter. Porcelain (extra fine)	.08	.85	5.50	52.50
Grand Maitre. Bright (very rich), large truss	.07	.75	5.50	50.00
King of the Blues. Bright	.07	.75	5.50	50.00
Leonidas. Light	.07	.75	5.50	50.00

SINGLE YELLOW VARIETIES.

Herman. Orange	.08	.75	5.50	50.00
Ida. Bright, the best yellow	.08	.75	5.50	50.00

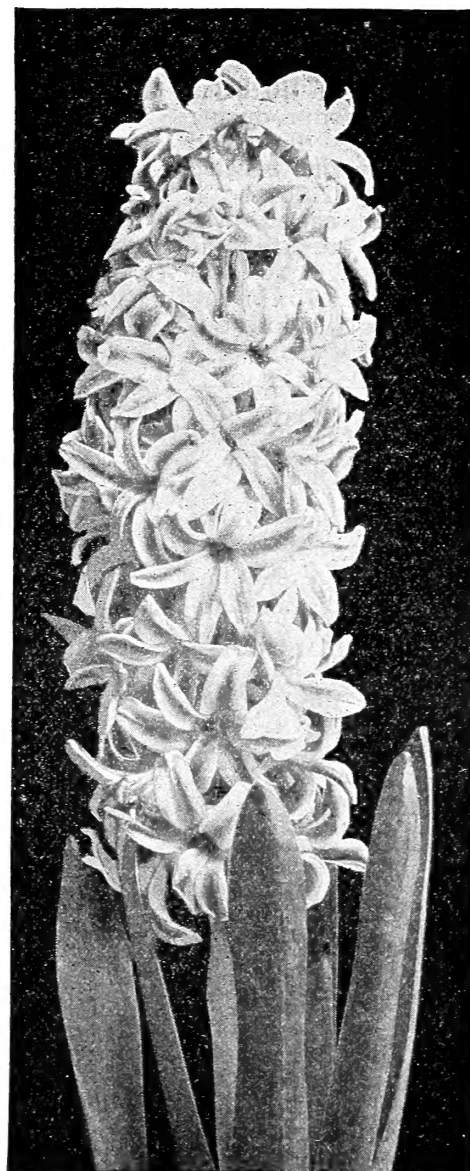

Single Second Size Named Hyacinth

In sending you this order allow me to congratulate you on the FINE HYACINTHS, TULIPS and DAFFODILS you sold me last fall. My gardens were the handsomest in the neighborhood, and it has been a pleasure for me to hear the many pleasing comments made on the flowering bulbs.

W. W. MATOS.

SWARTHMORE, PA.

6 Bulbs of any one variety at dozen rates; 25 at 100 rates; 250 at 1000 rates.

HYACINTHS—CONTINUED.

FRENCH ROMAN HYACINTHS.

Roman Hyacinths afford a continuous supply of bloom from early winter until late in spring if forced successfully. They are very fragrant. The blooms are suitable for most any kind of cut-flower work; they also look very attractive if planted in boxes or pots and used for window decoration. They are not hardy, consequently will not do for outdoor planting.

	Each	Doz.	100	1,000
First Size, Pure White	\$0 05	\$0 45	\$3 25	\$28 00
Mammoth Size, Pure White	06	60	4 00	33 50
Giant Size, Pure White	07	75	5 00	43 00
Pink, Light	05	50	3 25	28 00
Pink, Dark	04	40	3 00	26 00
Blue	05	40	2 75	26 00
Italian. White. Larger spikes, blooming later than the French	05	45	3 00	28 00

If Roman Hyacinths are wanted by mail, please add 10c. per doz. for postage.

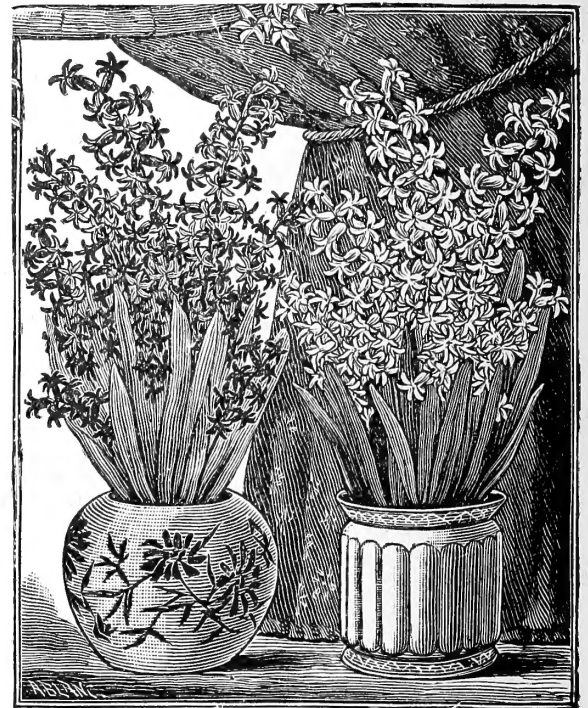

French Roman Hyacinths.

DUTCH OR MINIATURE ROMAN HYACINTHS.

Excellent for growing in pots, pans or boxes, blooming freely and early. They may be planted close together, either in pans or pots, or in the open ground. Culture is the same as for other Dutch hyacinths.

	Each	Per doz.	Per 100
Red. Named sorts, our selection	\$0 05	\$0 45	\$3 00
White " " " "	05	50	3 25
Pink " " " "	04	40	2 75
Blue " " " "	04	40	2 75

Please notice that these are the named varieties, which are far superior to the separate color grade usually offered.

SPECIAL OFFER.

We will furnish 110 bulbs of hyacinths for producing the opposite illustrated bed, in superior bedding grade, for \$2.85, or if second size named hyacinths are preferred, as offered on page 3, we will furnish for \$5.75, in any assortment of colors, our selection of varieties.

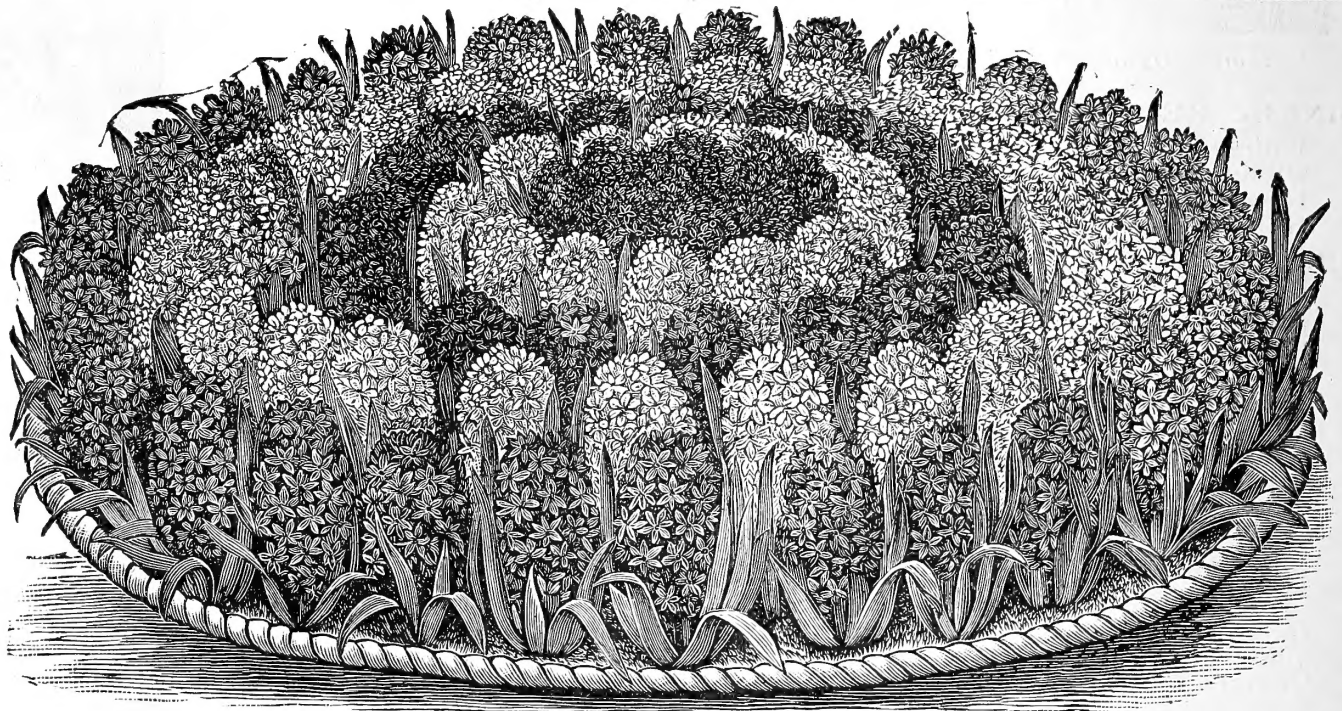

Michell's Superior Bedding Hyacinths.

GRAPE HYACINTHS.

An early Spring blooming bulb for outdoor and house culture, resembling a bunch of grapes in appearance.

	Per Doz.	Per 100	Per 1000
White	\$0.20	\$1.00	\$7.50
Blue	.15	.70	5.50

Michell's Superior Unnamed Hyacinths

(In Separate Colors). Very desirable for bedding, also for growing in water or pots. These bulbs are the best quality, but not as large as the named varieties.

SINGLE HYACINTHS (Unnamed)

	Each	Per doz.	Per 100	Per 1000
Red. All shades, including pink	\$0 05	\$0 45	\$2 85	\$26 00
White. All shades, including pure white	05	45	2 85	26 00
Blue. All shades, including purple	05	45	2 85	26 00
Yellow. All shades	05	45	2 85	26 00
Pink	05	45	2 85	26 00
Dark Red	05	45	2 85	26 00
Pure White	05	45	2 85	26 00
Blush White	05	45	2 85	26 00
Light Blue	05	45	2 85	26 00
Dark Blue and Purple	05	45	2 85	26 00
Mixed. All colors	05	40	2 75	25 00

DOUBLE HYACINTHS (Unnamed)

	Each	Per doz.	Per 100	Per 1,000
Red. All shades	\$0 05	\$0 50	\$2 90	\$27 50
Pink	05	50	2 90	27 50
White. All shades	05	50	2 90	27 50
Pure White	05	50	2 90	27 50
Blue. All shades	05	50	2 90	27 50
Yellow	05	50	2 90	27 50
Mixed. All colors	05	45	2 80	27 00

SEE CULTURAL DIRECTIONS FOR BULBS ON THE FIRST INSIDE COVER PAGE OF CATALOGUE.

MICHELL'S LATE FLOWERING TULIPS

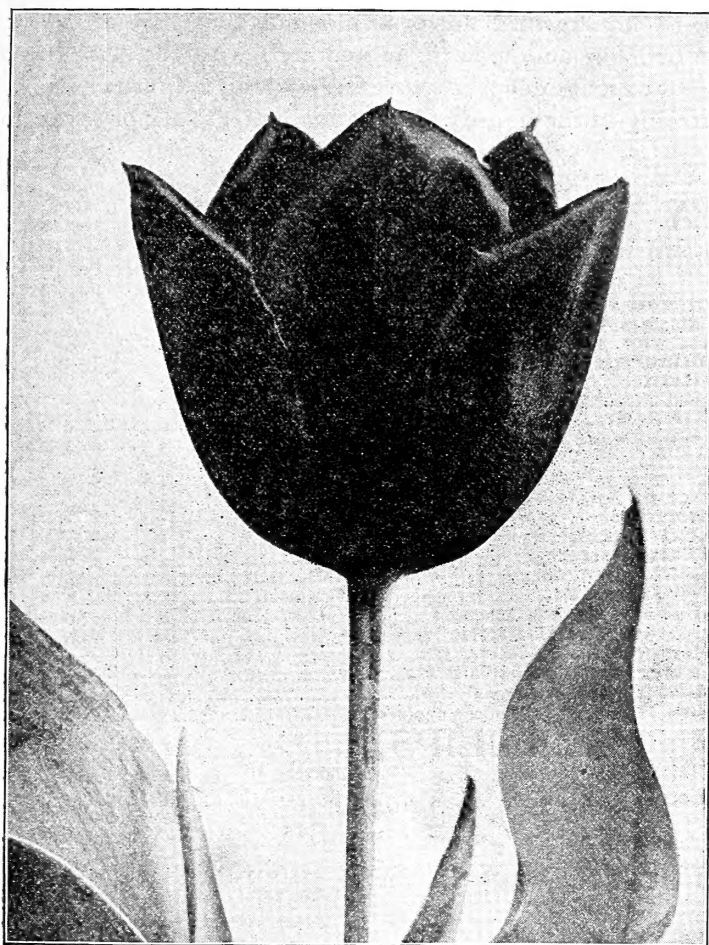

Tulip Gesneriana Scarlet (One-half Natural Size).

Few, if any, flowering bulbs have created such admiration, or met with such favor as the late flowering tulips. Their real value has only become known in latter years. It is remarkable with what prominence and brilliancy they stand out after other tulips have long faded away. They usually are at their best the latter part of May. The long slender stems, sometimes two feet, according to variety, on which the flower is supported, elevate them to a height that will permit them to be recognized from a distance; the odorous scent which they impart to the air is a grand characteristic; our list embraces the most desirable kinds, and we offer them in collections below to be within the reach of means of all flower lovers.

SINGLE LATE TULIPS IN SEPARATE VARIETIES

	Each	Per Doz.	Per 100	Per 1000
Bouton D'Or. Immense yellow flower; stem long and stout	\$0.03	\$0.25	\$1.60	\$13.50
Gesneriana Rosea. Of a brilliant rose shade, an elegant companion to the above03	.25	1.50	12.50
Gesneriana Spathulata. The true Gesneriana tulip with the blue-black centre, of a dazzling scarlet color; it can be seen at a great distance04	.30	1.75	16.00
Greigii (<i>Queen of Tulips</i>). A handsome type of a brilliant orange color with a yellow and black centre15	1.50	10.00	
Picotee (<i>Maiden's Blush</i>). This is one of the finest of the class of late tulips of a pure white, with brilliant rose edging, large flower on stout stem04	.40	3.00	25.00

Those TULIP BULBS I got from you are certainly SHOWING OFF FINE
SOMERVILLE, N. J. W. E. SIDDELL.

SINGLE LATE TULIPS IN MIXTURE

	Each	Doz.	100	1000
Bybloemen. A mixture of white with grounds of scarlet, pink, scarlet and crimson markings	\$0.03	\$0.25	\$1.50	\$12.50
Bizarres. Yellow ground stripes and markings of red, white and orange03	.20	1.35	11.00
Darwins. The Darwins embrace most every imaginable color, the effect in sunlight is gorgeous indeed04	.35	2.00	17.50
Parrots. Sometimes called Dragon Tulips from the fact of their possessing a very irregular cut or fringed edge, exquisitely fragrant; our mixture embraces a fine range of colors. Our bulbs are extra large and sure to bloom03	.20	1.15	9.50
Superfine Mixture or Cottage Garden Mixture. All colors and varieties04	.30	2.00	16.00

DOUBLE LATE TULIPS

	Each	Doz.	100	1000
Paeony Red. A brilliant red variety, of good substance, good keeper	\$0.04	\$0.35	\$1.75	\$13.00
Yellow Rose. Of a rich golden yellow, very fragrant, showy03	.25	1.50	12.00
Choicest Mixed. All colors03	.20	1.25	9.50

The BULBS I received of you last Fall GAVE SPLENDID SATISFACTION. I shall want quite a number this Fall and will place the order with you.
CANTON, OHIO. J. M. JOHNSON.

No.	Price
1 consists of 12 each of all the late named and mixed sorts (except Greigii) offered on this page. Single and Double (144 bulbs)	\$3.00
2 consists of 25 each of all the late named and mixed sorts (except Greigii) offered on this page. Single and Double (300 bulbs)	4.75
3 consists of 50 each of all the late named and mixed sorts (except Greigii) offered on this page. Single and Double (600 bulbs)	9.25
4 consists of 100 each of all the late named and mixed sorts (except Greigii) offered on this page. Single and Double (1200 bulbs)	16.00

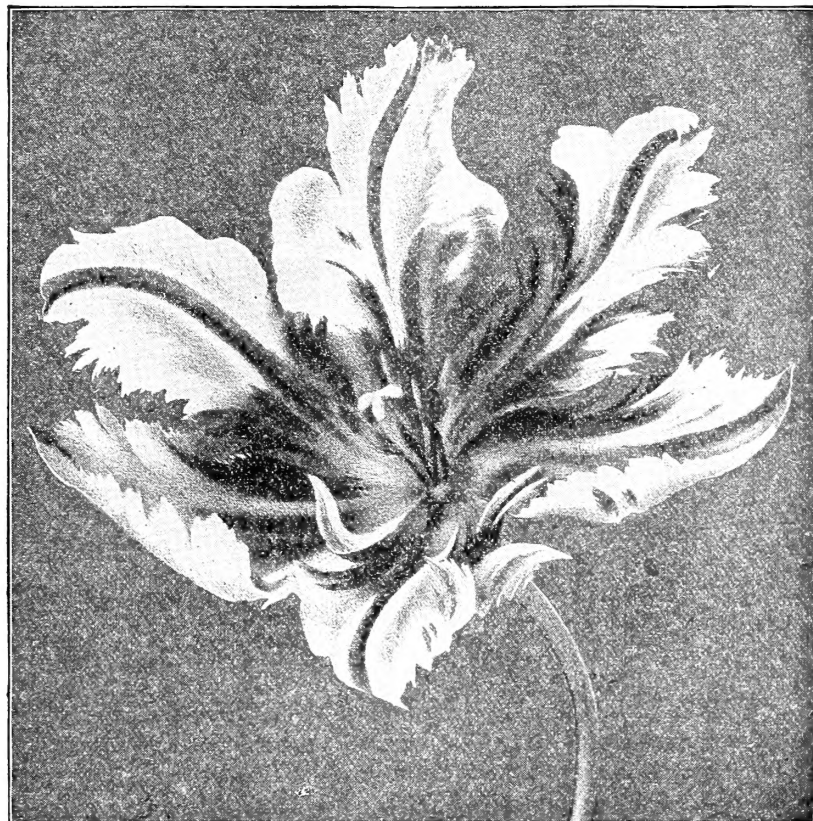

Parrot or Dragon Tulip.

6 BULBS OF ANY ONE VARIETY AT DOZEN RATES; 25 AT 100 RATES; 250 AT 1000 RATES.

TULIPS EARLY SINGLE TULIPS

Strictly True to Name and Color

NOTHING is more beautiful than a bed of tulips in the spring. They are the showiest flower in bloom at that time of the year. They should be planted in beds of any design, made of a good portion of loam and manure mixed well with the soil; the distance apart should be about four inches. The bulbs must be planted about four inches deep. A covering of long manure or straw for over winter is very beneficial for the bed. Tulips are also excellent for growing in the house; four or five bulbs to six or seven inch pots, or they can be forced in the greenhouse with good results.

NAMED VARIETIES OF EARLY SINGLE TULIPS.

Height in inches		Per doz.	Per 100	Per 1000	Height in inches		Per doz.	Per 100	Per 1000
8	Artus. Bright red	\$0.25	\$1.35	\$12.00	8	Jagt von Delft. White	\$0.25	\$1.40	\$11.00
8	Adeline Patti. Rosy Red	.35	2.00	18.50	9	Joost van Vondel. Bright pink, white stripes	.25	1.75	14.00
10	Belle Alliance. Scarlet, large	.40	2.50	22.00	9	Joost van Vondel. Pure white, very large, new	.15	5.00	37.50
10	Canary Bird. Clear yellow	.30	1.75	15.00	9	L'Immaculee. Pure white	.20	1.25	10.50
9	Cardinal's Hat. Dark scarlet	.25	1.25	10.00	9	La Reine. (Queen Victoria). Blush white, very good	.20	1.25	9.50
10	Chrysolora. Golden yellow, large	.25	1.35	11.00	9	Ophir de Or. Mammoth yellow	.40	2.50	20.00
9	Couleur de Cardinal. Red	.45	3.25	30.00	12	Pottebakker. Yellow, large	.35	2.00	17.00
8	Cottage Maid. White, large pink border	.25	1.50	12.50	12	" White, large	.30	2.00	17.00
9	Colour Ponceau. Cherry red	.30	1.50	12.00	12	" Scarlet	.35	2.25	19.50
9	Crimson King. Bright crimson	.30	1.50	12.50	10	Prince of Austria. Red	.45	3.00	28.00
7	Duc van Thol. Scarlet	.25	1.50	12.00	10	Proserpine. Very large, glossy, brilliant pink	.45	3.25	30.00
7	" " White	.35	2.25	18.00	9	Rachel Ruish. Pink	.25	1.25	11.00
7	" " Yellow	.35	2.25	21.00	9	Rose Grisdellin. Bright pink	.30	2.00	17.00
7	" " Crimson	.25	1.35	11.00	9	Rose Mundt (Huickman). Pink	.20	1.50	12.00
7	" " Pink	.40	2.25	21.00	9	Silver Standard. White, striped with crimson	.30	2.00	16.00
7	" " Red, yellow edge	.25	1.50	11.50	10	Verboom. Bright rich scarlet	.40	2.50	22.50
7	" " Gold striped	.25	1.50	12.50	9	Vermilton Brilliant. Brilliant scarlet	.45	3.00	27.50
10	Duchesse de Parma. Red, yellow border	.25	1.20	10.00	9	Waterloo. Large scarlet	.40	2.50	22.50
9	Grand Master of Malta. Crimson and white	.35	2.25	20.00	9	Wouwerman. Violet, large	.40	2.50	22.50
15	Keizer Kroon. Red, with broad yellow edge	.30	1.75	15.00	10	Yellow Prince. Large flower	.25	1.50	12.00
8	Gold Finch. Fine golden yellow	.35	2.25	16.00	9	White Hawk. One of the choicest	.45	2.50	22.00

MIXTURES OF EARLY SINGLE TULIPS.

Michell's Superfine. All brightest colors and largest flowering. Extra choice	Per doz. \$0.20	Per 100 \$1.10	Per 1000 \$8.00
Fine Mixed. Very good quality	.15	.75	6.50

UNNAMED SINGLE TULIPS.—Separate Colors.

Red, White, Pink, Yellow.
Per doz., 20 cts.; per 100, \$1.25; per 1000, \$10.00.

This beautiful bed of Tulips, = \$4.00.

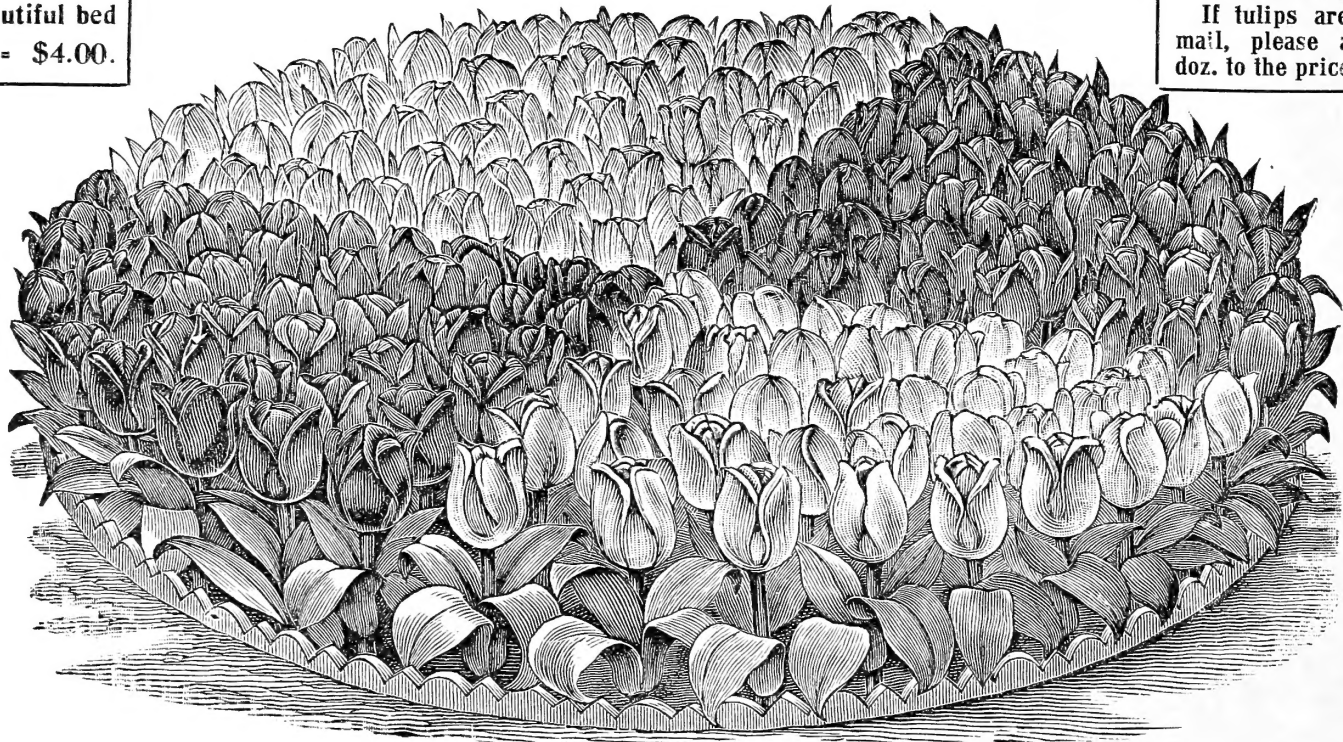

NOTICE.
If tulips are desired by mail, please add 5c. per doz. to the price for postage.

Practical Bed of Tulips.

A very "Effective and Practical Bed" of Single Tulips.

Everybody should have one of these effective beds at this small cost. Eight feet in diameter or twenty-four feet in circumference, requires 250 bulbs, planted five inches apart. 125 Chrysolora, yellow, and 125 Pottebakker Scarlet. **PRICE FOR THE 250 BULBS, \$4.00.** Any other color may be used in their place at cost ranging according to varieties used. Ask us for special price and other suggestions on different design Tulip Beds.

MICHELL'S SUPERB TULIPS

DOUBLE VARIETIES

Height in inches		Each	Per doz.	Per 100	Per 1000
9	Coronne d'Or. Pure yellow, fine forcer.....	\$1.06	\$2.60	\$4.00	\$35.00
6	Duc van Thol. Red and yellow02	.20	1.15	9.00
9	Duke of York. Red with white edge.....	.03	.25	1.50	12.40
9	Gloria Solis. Red, yellow border03	.25	1.60	14.00
9	Imperator Rubrorum. Brilliant scarlet, fine forcer05	.40	2.85	26.50
9	La Candeur. Pure white, excellent forcer...	.03	.25	1.60	13.00
9	Le Blason. Pink04	.35	2.00	17.50
9	Murillo. Pink, best for forcing04	.40	2.60	23.00
8	Rex Rubrorum. Scarlet01	.30	2.00	17.00
9	Rose Blanche. Pure white03	.25	1.40	11.00
9	Salvator Rosa. Extra fine pink, forcer07	.60	4.25	37.50
8	Titian. Red and yellow.....	.04	.30	1.85	16.00
8	Tournesol. Red, yellow border, good forcer04	.35	2.10	18.50
8	Tournesol. Yellow, fine forcer.....	.05	.45	3.40	30.00
8	Yellow Rose. Pure Yellow.....	.03	.25	1.50	12.00

EARLY DOUBLE TULIPS IN MIXTURE

Our mixtures of tulips are carefully made so as to insure perfect harmony in color and evenness of bloom and growth. The largest bulbs are used for this purpose and our customers can positively rely upon getting entire satisfaction.

	Each	Per doz.	Per 100	Per 1000
Mitchell's Early. Fine mixed.....	\$0.02	\$0.15	\$0.85	\$ 7.50
Mitchell's Early. Superfine mixed03	.25	1.00	9.00

EARLY DOUBLE TULIPS (in Separate Colors)

These are intended to be used where no special effect is to be carried out. They are composed of named sorts thrown together in separate colors. They produce splendid results at a nominal cost. The named varieties should however be used where special effect or designs are wanted.

	Each	Per doz.	Per 100	Per 1000
Red	\$0.03	\$0.20	\$1.40	\$12.00
Pink03	.20	1.40	12.00
White03	.20	1.40	12.00
Yellow03	.20	1.40	12.00

Single bulbs of Tulips mailed free; add 5c. per dozen for postage, if desired by mail.

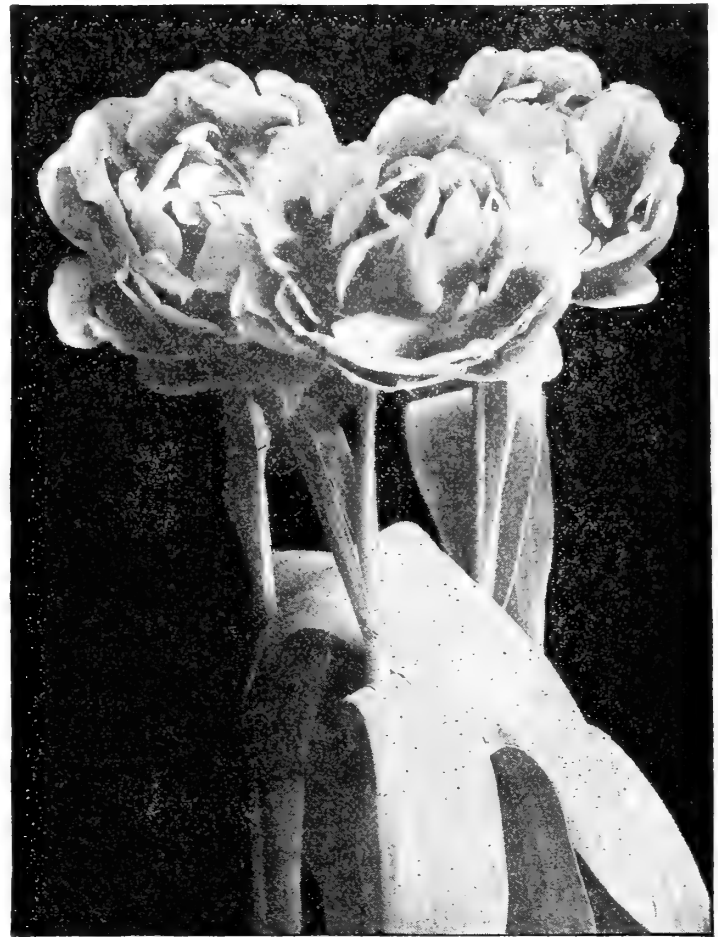

Double Tulip Tournesol (Red and Yellow)

HARDY NARCISSUS

(For outdoor planting)

The Narcissus or Daffodil planted outside, when established and thoroughly acclimated, yields abundant returns for the care and money expended on them. They form dense clumps and bloom most profusely. The failure of Narcissus to flower the first year, when planted outside, is attributed to the fact of their necessity of first becoming thoroughly accustomed to the climate and soil, they rarely fail to give good results the second year. Most of the double and single sorts are perfectly hardy, and need not be disturbed oftener than once in three or four years, and not then unless they have become too much crowded by offsets. Plant in the Fall in good garden soil about three or four inches deep, and four to six inches apart.

NARCISSUS IN MIXTURE

All large flowering bulbs.

	Each	Doz.	Per 100	Per 1000
Single, all varieties	\$0.02	\$0.18	\$1.00	\$7.75
Double,02	.20	1.00	8.25

If desired by mail add 5c. per doz. to price quoted, for postage.



Single Jonquils.



JONQUILS (Sweet Scented)

These flowers when in bloom are very attractive imparting a very sweet odor to the surrounding atmosphere; they are hardy and the bulbs, when planted outside, increase from year to year.

	Each	Per doz.	Per 100	Per 1000
Single Yellow. Very sweet scented.....	\$0.02	\$0.15	\$0.75	\$ 6.25
Double Yellow04	.35	2.50	20.00
Campernelle Phylogine Rugulosus. Large single yellow, excellent for forcing; an improvement on the old Campernelle.....	.02	.20	1.25	9.50
Campernelle. Yellow.....	.02	.15	1.00	7.25

SEE ALSO PAGES 8 AND 9 FOR OTHER NARCISSUS

6 BULBS AT DOZEN RATES; 25 AT 100 RATES; 250 AT 1000 RATES.

NARCISSUS—CONTINUED.

Single Narcissus

(Daffodils)

Ard Righ, or Irish King. Rich yellow trumpet, very early. Each, 6c.; per doz., 65c.; per 100, \$4.00; \$30.00 per 1000.

Empress Bicolor. Perianth snow-white, trumpet rich yellow; valuable for cutting. A good companion to Emperor. Each, 6c.; per doz., 60c.; per 100, \$4.00; \$35.00 per 1000.

Emperor. (See cut). One of the finest daffodils in cultivation, flower of the richest yellow, trumpet of immense size; the petals of the perianth measure $3\frac{1}{2}$ inches across. Each, 6c.; per doz., 60c.; per 100, \$4.00; \$35.00 per 1000.

Barrii Conspicuis. Sulphur perianth, broad cup marked with scarlet, very desirable. Each, 4c.; per doz., 30c.; per 100, \$2.00; \$18.00 per 1000.

Bicolor Grandee. A grand trumpet variety, golden yellow with white petals, late flowering. Each, 5c.; per doz., 50c.; per 100, \$3.50; \$30.00 per 1000.

Campernelle. A large flowering Jonquil, producing an abundance of yellow flowers, fragrant. Each, 2c.; per doz., 15c.; per 100, \$1.00; \$7.25 per 1000.

Campernelle Rugulosus. An improvement on the above variety, producing larger flowers. Each, 2c.; per doz., 20c.; per 100, \$1.25; \$9.25 per 1000.

Cynosure. A favorite cup variety, perianth primrose, yellow centre stained scarlet. Each, 3c.; per doz., 25c.; per 100, \$1.50; \$12.00 per 1000.

Giant Princeps. Large golden yellow trumpet. Each, 3c.; per doz., 25c.; per 100, \$1.40; \$11.00 per 1000.

Golden Spur. One of the grandest daffodils, with extra large, bold, rich yellow flowers; foliage very broad and striking. It is of unusual robust habit and unsurpassed for gardens, pots or forcing. Each, 6c.; per doz., 60c.; per 100, \$4.00; \$32.50 per 1000.

Hoop Petticoat (Bulbocodium). Of rich golden yellow color. Bears from six to twelve flowers to each bulb. Three to six bulbs may be placed in a six-inch pot. A dry and sheltered situation suits it best when planted in the open ground. Each, 6c.; per doz., 65c.; per 100, \$4.25; \$35.00 per 1000.

Henry Irving. A golden yellow trumpet sort with deeper yellow perianth or petals; most desirable. Each, 5c.; per doz., 50c.; per 100, \$3.75; \$32.50 per 1000.

Horsfieldi Bicolor. Very large, perianth white, trumpet golden yellow; one of the finest types. Each, 5c.; per doz., 50c.; per 100, \$3.25; \$30.00 per 1000.

Stella Incomparabilis. White star-shaped flower, with distinct yellow trumpet. Each, 3c.; per doz., 20c.; per 100, \$1.25; \$9.00 per 1000.

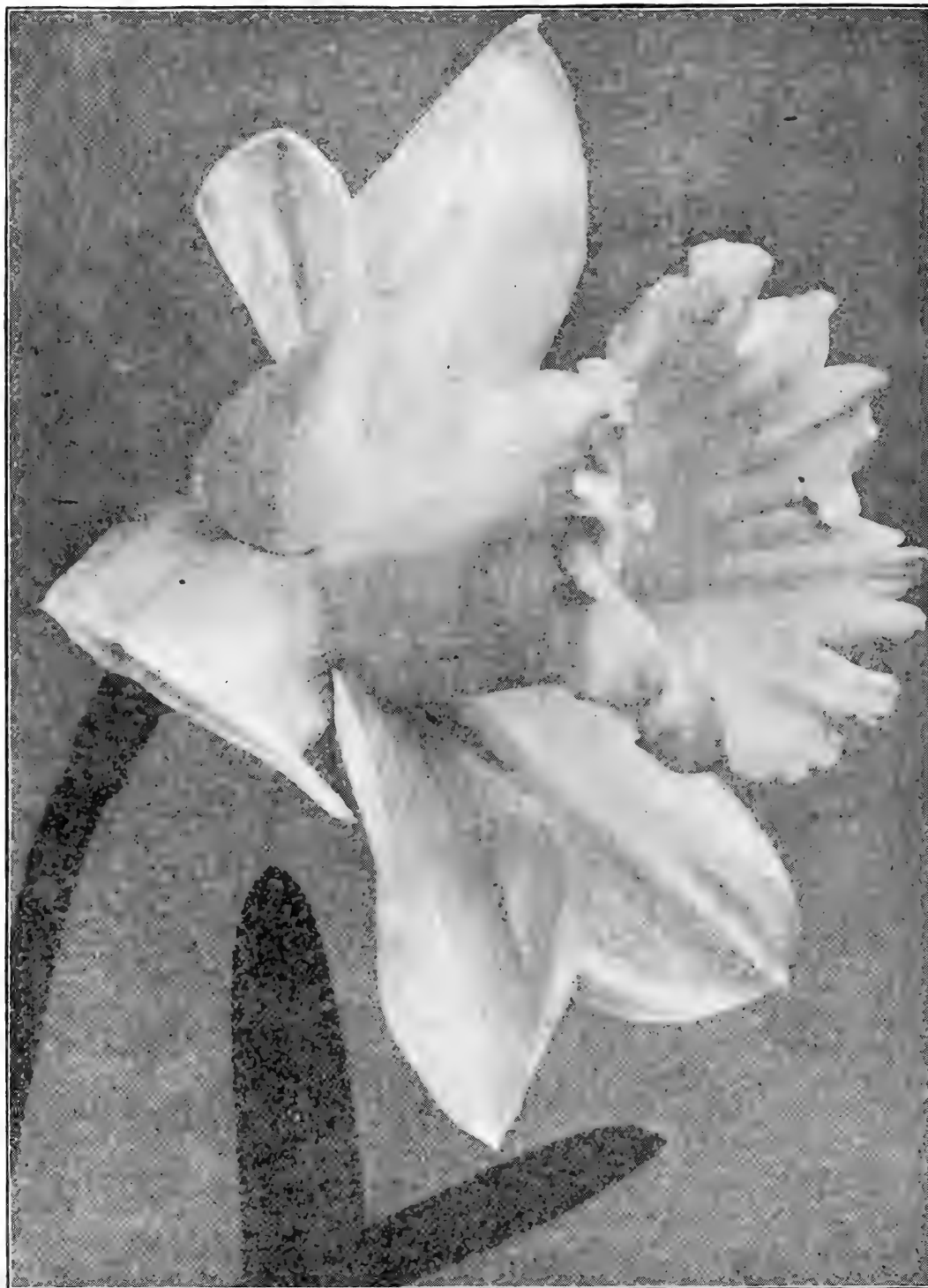

Narcissus Emperor (The Grand Single Daffodil)

Trumpet Major (Holland Grown). A large yellow favorite; fine for forcing or bedding. Each, 3c.; per doz., 25c.; per 100, \$1.50; \$12.00 per 1000.

Trumpet Major (French Grown). Particularly adapted for early forcing, coming into bloom considerably earlier than the Dutch grown bulbs, otherwise the flower is the same. Each, 5c.; per doz., 50c.; per 100, \$2.25; \$20.00 per 1000.

Sir Watkin. A giant cup variety, centre deep yellow tinged with orange, petals sulphur yellow; a very fine sort. Each, 6c.; per doz., 60c.; per 100, \$4.50; \$37.50 per 1000.

Single Mixed. All varieties and colors. Each, 2c.; per doz., 18c.; per 100, \$1.00; \$7.75 per 1000.

See also Pages 7 and 9 for other Varieties of Narcissus.

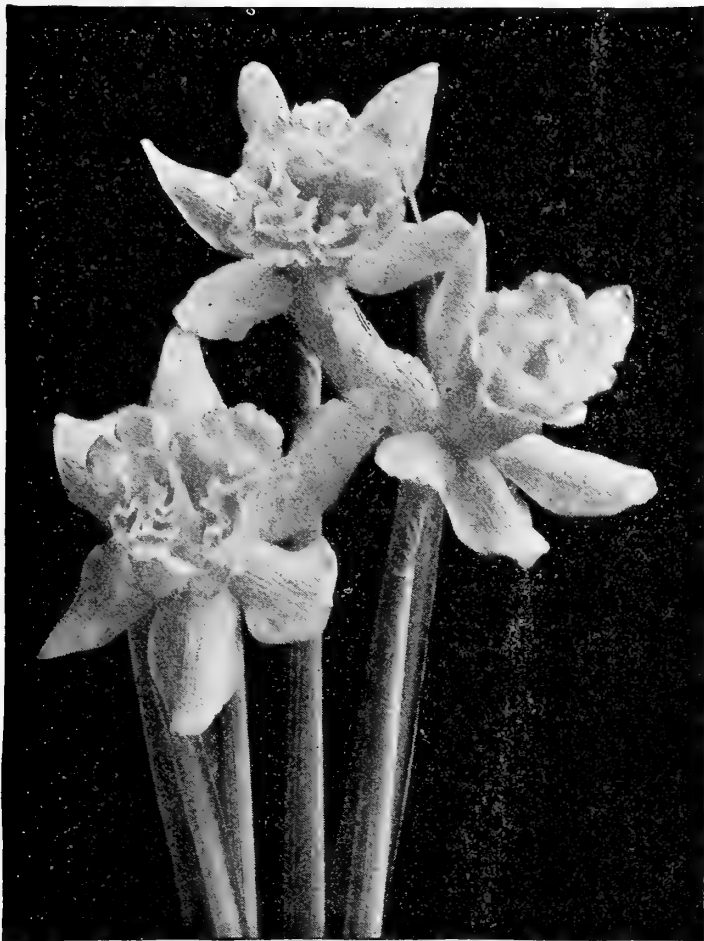

Narcissus Von Sion.

NARCISSUS—CONTINUED.

Double Varieties.

	Each	Per doz.	Per 100	Per 1000
Von Sion. Extra fine Holland-grown bulbs. The color of the flower is a bright yellow, devoid of the green tips often found in the cheaper stock. Very fine for forcing or bedding	\$.03	\$0.30	\$2.00	\$17.50
Von Sion. Extra large, two-nosed bulbs. Will average 190 blooms from 100 bulbs	.04	.40	2.60	22.00
Von Sion. Monster size bulbs. Very choice. Our stock of this favorite variety is extra fine.	.06	.65	4.00	35.00
Alba Plena Odorata. (<i>Double White Daffodil</i>). Deliciously fragrant. Does not force satisfactorily	.03	.20	1.20	9.00
Incomparable Double. (<i>Butter</i>). An old-fashioned type used principally for outdoor planting. Orange suffused yellow	.02	.20	1.00	9.00
Sulphur Phoenix. White suffused yellow. Is classed among the finest of double varieties	.06	.60	3.75	30.00
Orange Phoenix. (<i>Eggs and Bacon</i>). Light yellow with orange centre. Good for forcing or bedding	.04	.30	2.00	15.00
Mixed. All colors. Fine for outside massing.	.02	.20	1.00	8.25

Polyanthus Varieties.

The Polyanthus Narcissus are a very interesting class. They may be grown in water or soil with equal success. If grown in water treat similar to Chinese Lilies, and if in soil like other varieties of Narcissus used for forcing. They are not hardy.

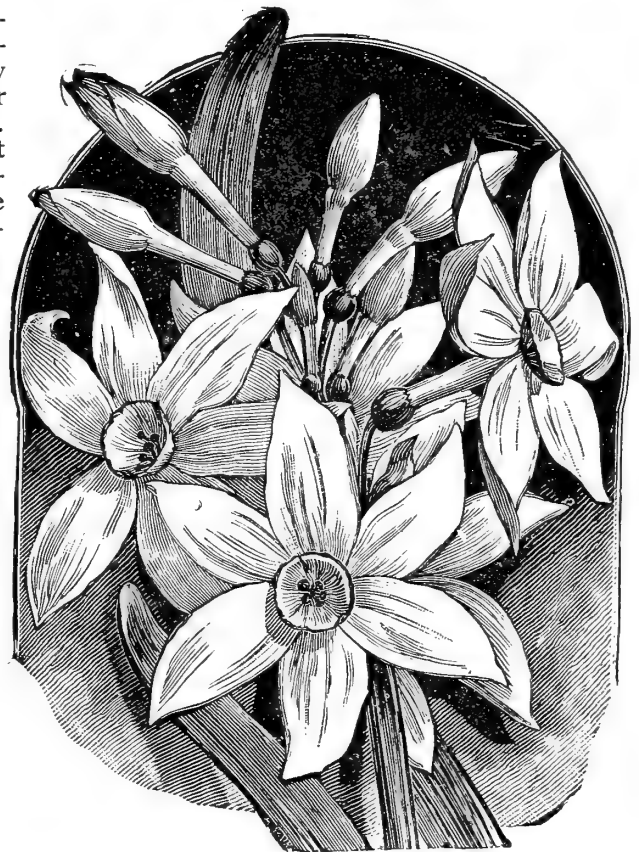

Narcissus Paper White Multiflora.

POLYANTHUS NARCISSUS.

	Each	Per doz.	Per 100	Per 1000
Double Roman. White suffused yellow. Very fragrant.	\$.04	\$0.30	\$1.50	\$12.00
Gloriosa. A desirable sort for forcing. Sulphur yellow.	.04	.40	2.50	20.00
Grand Monarque. White and Yellow	.05	.40	2.50	20.00
Grand Soleil d'Or. A yellow flower, reddish cup	.04	.40	2.25	20.00
Paper White Grandiflora Multiflora. Flowers larger than the Grandiflora. Extra choice	.05	.40	2.50	20.00
Paper White Grandiflora. Very large flowering, the favorite forcing variety, superior to the old sort	.04	.30	1.75	15.00
Polyanthus Narcissus. Choice mixed, of all sorts	.04	.30	1.75	15.00

Hardy Poets Narcissus.

Poeticus. (*Pheasant's Eye*). Fragrant white flowers with orange cup. Giant bulbs. Each, 2c.; per doz., 15c.; per 100, 70c.; per 1000, \$5.00.

Poeticus Ornatus. Similar to Poeticus, but larger and four weeks earlier. Magnificent cut flowers. Excellent for forcing. Each, 2c.; per doz., 20c.; per 100, \$1.20; per 1000, \$10.00.

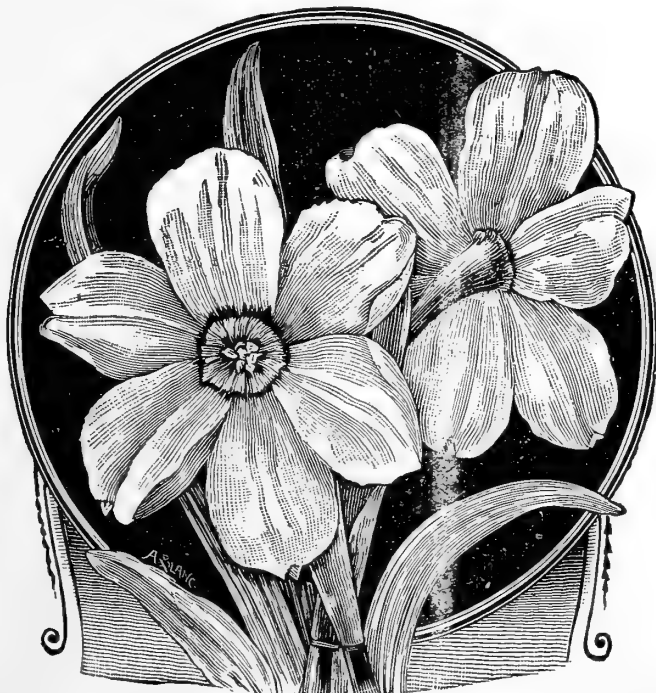

Narcissus Poeticus.

COLLECTIONS OF NARCISSUS—SINGLE VARIETIES.

3 each of 17 varieties offered on page 8—	51 bulbs	\$.170	(Post paid, \$1.85)
6 " " 17 " " " " " " " "	8-102 " "	3.25	
12 " " 17 " " " " " " " "	8-204 " "	6.25	
25 " " 17 " " " " " " " "	8-425 " "	11.25	

DOUBLE VARIETIES.

3 each of 5 varieties offered on this page—	15 bulbs	\$.35	(Post paid, \$0.45)
6 " " 5 " " " " " " " "	30 " "	.65	
12 " " 5 " " " " " " " "	60 " "	1.20	
25 " " 5 " " " " " " " "	125 " "	2.25	
50 " " 5 " " " " " " " "	250 " "	4.25	

POLYANTHUS VARIETIES.

3 each of 7 varieties offered on this page—	21 bulbs	\$.55	(Post paid, \$0.65)
6 " " 7 " " " " " " " "	42 " "	1.10	
12 " " 7 " " " " " " " "	84 " "	2.00	
25 " " 7 " " " " " " " "	175 " "	3.50	
50 " " 7 " " " " " " " "	350 " "	6.25	

See also Narcissus offered on pages 7 and 8.

6 Bulbs of any one variety at dozen rates; 25 at 100 rates; 250 at 1000 rates.

EASTER LILY.

Michell's Superior Lily Bulbs

EASTER IN 1906 COMES APRIL 15TH.

LILIUM HARRISII (True Bermuda Easter Lily)

Grown and Selected Especially for Us. Strictly Free from Disease.

MICHELL'S SPECIAL STOCK

Size of bulb	Each	Per doz.	Per 100
5 to 7 inches circum.....	\$0.10	\$0.90	\$ 6.00
7 to 9 inches circum.....	.20	2.00	12.50
9 to 11 inches circum.....	.35	3.50	25.00
11 to 13 inches circum. (Monster bulbs).....	.65	6.50	50.00

REGULAR STOCK

Size of bulb	Average No. of blooms	Each	Per doz.	Per 100
5 to 7 inches circum.....	5	\$0.08	\$0.75	\$ 5.00
7 to 9 inches circum.....	8	.15	1.50	11.50
9 to 11 inches circum.....	12	.25	2.50	20.00
11 to 13 inches circum.....	15	.50	5.00	40.00

LILIUM TENNUIFOLIUM (Coral Lily)

Color: a beautiful scarlet; growing about 1 ft. high..... Each \$0.20 Per doz. \$2.00



Elmira, N. Y. March 9, '05
 The LILY BULBS I had from you last fall certainly proved immense. I had plants with 18 flowers on. Enclosed find my order of Bulbs. J. B. RUDY.
 GARDENER TO HON J. S. FASSETT.

JAPANESE EASTER LILIES (Ready in October)

Many private gardeners now use very extensively the Japanese Easter Lily Bulbs. They are generally entirely free from disease, requiring just a little bit more forcing, to bring into flower, than the regular *Lilium Harrisii*.

LILIUM LONGIFLORUM MULTIFLORUM (Japan)

MICHELL'S SPECIAL STOCK (Free Flowering Type).

Size of bulbs	Each	Per doz.	Per 100
7 to 9 inches circum.....	\$0.12	\$1.25	\$ 7.00
9 to 10 inches circum.....	.20	1.75	10.00
10 to 12 inches circum. (Mammoth size).....	.30	3.00	15.00

LILIUM LONGIFLORUM (Japanese Easter Lily)

Size of bulbs	Each	Per doz.	Per 100
7 to 9 inches circum.....	\$0.10	\$1.00	\$ 6.00
9 to 10 inches circum.....	.15	1.50	9.00
10 to 12 inches circum. (Mammoth size).....	.20	2.00	12.50

LILIUM LONGIFLORUM GIGANTEUM (Japan)

(Mammoth Flowering Species).

Size of bulbs	Each	Per doz.	Per 100
7 to 9 inches circum.....	\$0.15	\$1.50	\$ 9.00
9 to 10 inches circum.....	.20	2.00	12.50

HARDY JAPAN LILIES (Ready in October)

	Each	Per doz.	Per 100
Auratum. (Golden Banded Japan.) White, dotted with brown spots, with a yellow streak in the centre of each petal; extra large bulbs.....	\$0.25	\$2.50	\$16.00
Auratum. Very fine blooming bulbs.....	.15	1.50	10.00
Lancifolium Speciosum Album. Pure white, extra large bulbs.....	.20	2.00	15.00
Lancifolium Speciosum Album. Fine blooming bulbs.....	.15	1.25	9.00
Lancifolium Speciosum Rubrum or Roseum. Pink. Very large bulbs.....	.15	1.50	10.00
Melpomene. Very large. Rich crimson.....	.15	1.50	10.00
Tigrinum. Single. Orange, spotted brown.....	.10	.80	5.00
Tigrinum. Double. Orange, spotted brown.....	.15	1.30	8.25

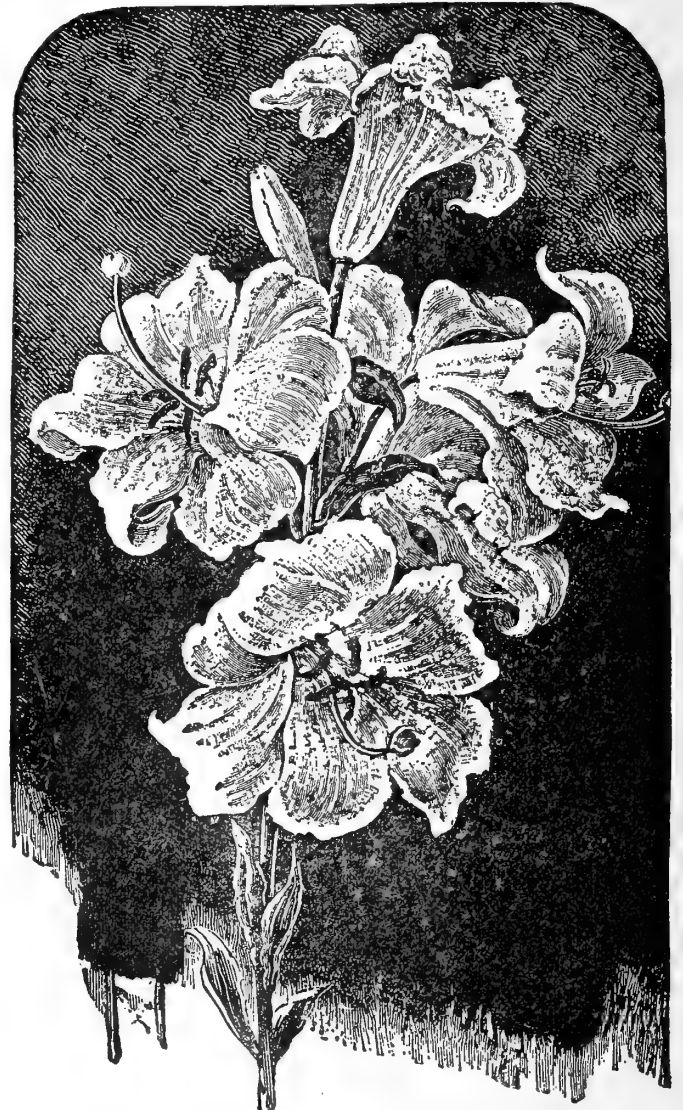

Lilium Candidum

LILIUM CANDIDUM

(Annunciation or St. Joseph's Lily)

A hardy variety, pure white in color, fragrant, blooming in June.

	Each	Per doz.	Per 100
Large bulbs.....	\$0.10	\$1.00	\$ 6.50
Extra large bulbs.....	.15	1.50	9.00

ACONITE (*Eranthis Hyemalis*)

In early Spring the golden-yellow blossoms of Winter Aconite look charming and form a striking contrast to the pure white snowdrop. Height, 6 to 8 inches. Each, 3c.; per doz., 20c.; \$1.00 per 100.



Single Anemone

ANEMONES (*See Cut*)

Suitable for pot or border culture; when planted in masses are most effective; succeed best in a light, rich, well-drained loam. Plant in October or November. Cover with leaves, straw or long manure on approach of Winter. For pot culture fill pots with any rich porous compost, with good drainage, planting four bulbs in a six-inch pot; place in cold frame or any moderately cool situation, giving very little water until plants appear, then remove to greenhouse or sitting room window.

	Each	Per Doz.	Per 100
Double Mixed. All colors	\$0.03	\$0.25	\$1.50
Single. Scarlet03	.20	1.00
Single Mixed. All colors03	.20	1.00
Fulgens. Scarlet Windflower04	.30	2.00
Double White04	.35	2.25

ALLIUM NEAPOLITANUM

Excellent for winter flowering, extensively forced for cut flowers, pure white with green stamens, borne in large loose umbels. Height, 15 to 18 inches. Per doz., 20c.; per 100, \$1.00; \$7.50 per 1000.



Allium

ANOMATHECA CRUENTA

(Scarlet Freesia.) (Ready in October.)

A very pretty species of bulbs for indoor blooming, resembling very much Freesias from which they partially derive the name. It may also be planted outdoors and will endure the winter with slight protection. Flowers rosy scarlet, dotted crimson on petals. Per doz., 20c.; \$1.25 per 100.

AMARYLLIS

- Belladonna Major.** Bright pink. Each, 15c.; per doz., \$1.50.
- Formosissima** (*Jacobæan Lily*). Crimson, blooming early in the summer. Each, 10c.; per doz., \$1.00.
- Hybrids of Vittata.** Large bulbs. Each, 50c.; per doz., \$5.00.
- Johnsoni.** Very large flower, rich crimson-scarlet color, striped with white. Each, 35c.; per doz., \$3.50.
- Treatiæ Alba.** Pure white, blossoms the entire summer. Each, 5c.; per doz., 40c.; per 100, \$3.00.
- Treatiæ Rosea.** Bright rose. Each, 5c.; per doz., 40c.; \$3.00 per 100.



Fancy Giant Amaryllis

	Each	Per Doz.
Giant Flowering Crimson	\$1.00	\$10.00
" " Orange-red	1.00	10.00
" " White, red stripes	1.00	10.00
" " Red, white stripes	1.00	10.00

CHIONODOXA

(*Glory of the Snow*)

A most exquisite early spring flowering bulb, thoroughly hardy, and will thrive well in any soil.

Lucillia. Flowers brilliant sky-blue color with white centre. 2c. each; per doz., 15c.; \$1.00 per 100; per 1000, \$8.00.

Sardensis. Beautiful deep blue flowers. Per doz., 15c.; per 100, \$1.00; per 1000, \$8.00.

Gigantea. A very distinct species with very large lavender blue flowers with white centre. 3c. each; per doz., 25c.; \$1.50 per 100; \$11.00 per 1000.

BEGONIAS—Tuberous Rooted. (*Ready in November*)

These bulbs are most satisfactory for window, garden, greenhouse or conservatory blooming. The bulbs when received should be potted, well watered and placed in a dark warm place until thoroughly rooted, when they may be brought to the light. Begonias thrive best in a warm, shaded place.

	SINGLE			DOUBLE		
	Each	Per Doz.	Per 100	Each	Per Doz.	Per 100
Crimson	\$0.10	\$1.00	\$6.00	\$0.15	\$1.50	\$10.00
Orange10	1.00	6.00	.15	1.50	10.00
Pink10	1.00	6.00	.15	1.50	10.00
Scarlet10	1.00	6.00	.15	1.50	10.00
White10	1.00	6.00	.15	1.50	10.00
Yellow10	1.00	6.00	.15	1.50	10.00
Mixed07	.70	5.00	.12	1.20	8.50

NEW FRILLED TUBEROUS ROOTED SINGLE BEGONIA (*Ready in October*)

The latest improvement in Begonias—they are really magnificent. The flowers are very large, 5 to 6 inches in diameter, and beautifully ruffled and frilled.

Mixed, all colors, 25c. each; per doz., \$2.50; \$18.00 per 100.



Begonia

CROWN IMPERIALS

	Each	Per Doz.	Per 100
Single Yellow	\$0.15	\$1.50	\$8.00
Single Red15	1.50	8.00
Single Mixed. All colors10	1.00	7.50
Double Red25	2.50	17.50

COLCHICUM

Autumnale (*Hardy Giant Flowering Crocus*).

A very interesting bulb; blooming in the autumn without the foliage, which follows in the spring. Flowers are all shades of purple and rose. Strong bulbs, 5c. each; per doz., 50c.; \$3.75 per 100.



White Calla Lily.

CALLA LILIES.

Callas require a good rich soil and plenty of warmth to make them thrive. It is undoubtedly one of the easiest culture bulbs in existence. The white or Lily of Nile Calla requires plenty of moisture constantly. The black variety requires very little until it has made considerable start. The bulbs should be potted when received and put in a dark place until thoroughly rooted, when they may be brought to the light.

WHITE CALLA. Flower pure waxy white, leaves dark green.

	Each	Per Doz.	Per 100
Monster Bulbs, specially large	\$0 40	\$4 00	\$30 00
Mammoth "	25	2 50	16 00
First Size "	15	1 50	10 00
Second Size "	10	1 00	7 50

SPOTTED CALLA. (Ready in October). Foliage green mottled white, flower pure white 10 1 00 6 00

BLACK CALLA. (Ready in October). Foliage a rich green. Flower very large and of a purplish black color. 15 1 25 8 50

LITTLE GEM CALLA. A miniature type, very similar to the regular white calla but much smaller and dwarfer in every way 10 1 00 7 00

YELLOW CALLA. (Elliottiana). An entirely distinct golden yellow variety, otherwise very much like the common white sort 1 00 11 00

Single bulbs of Callas mailed without extra cost. For a dozen add 15c. to the price quoted, for postage.



Chinese Sacred Lily.

CHINESE SACRED LILY. (Ready in October.)

The Chinese Lily or Narcissus is too well known to require much description. The flowers are borne in clusters, as the illustration represents, and are deliciously fragrant. Color white, with a yellow centre. Price, Mammoth bulbs, 10c. each; 3 for 25c.; 90c. per doz.; per basket of 30 bulbs, \$2.00.

NEW GOLDEN CHINESE LILY.

This variety is very similar in every way to the above, excepting that the bulbs are considerably smaller and the flowers are of a rich golden yellow. Treatment, same as the regular variety. Delightfully fragrant.

Price 5c. each; per doz. 50c.; \$3.50 per 100.

Pebbles for planting Chinese Lily Bulbs, clean and uniform in size, 5c. per quart, 25c. for 6 quarts; 30c. per peck; per bushel, \$1.00.

Bowls for Chinese Lilies. A large selection of **Glass, Stone,** and **Japanese Ware,** at all prices.

See also page 9 for other Narcissus suitable for growing in water.



Michell's Giant Named Crocus.

CROCUS.

Of the first flowers to appear in the Spring the Crocus leads. We especially recommend, for fine effect, the planting of the named varieties, which will produce vastly superior results to the other unnamed sorts.

MICHELL'S GIANT NAMED VARIETIES.

	Per doz.	Per 100	Per 1000
Baron von Brunow. Deep blue	\$0 15	\$0 65	\$6 00
Cloth of Gold. Rich yellow, brown veins	15	65	6 00
Cloth of Silver. Silvery white, striped lilac	15	65	6 00
Mont Blanc. Pure white	15	65	6 00
Purpurea Grandiflora. Fine purple	15	65	6 00
Sir Walter Scott. White, striped purple	15	65	6 00
Giant Yellow. Immense size	15	80	7 00

EXTRA LARGE CROCUS IN SEPARATE COLORS.

	Per doz.	Per 100	Per 1000
Blue and Purple	\$0 10	\$0 40	\$3 50
White	10	40	3 50
Striped	10	40	3 50
Yellow Mammoth	12	60	5 50
Yellow. Regular size	10	40	3 50
Mixed. All colors	10	35	3 00

Dozen lots of Crocus will be mailed free if 100 are desired; by mail please add 10 cents postage.

SEE ALSO COLCHICUM OR AUTUMN CROCUS, PAGE 11.

6 Bulbs of any one variety at dozen rates; 25 at 100 rates; 250 at 1000 rates.



DIELYTRA SPECTABILIS (Bleeding Heart)

Ready in November

One of our popular garden border perennials, blooming very early in the Spring. The flowers are borne on long racemes of a beautiful pink and white color. Strong roots, 15c. each (by mail, 20c.); per doz. \$1.50; \$11.00 per 100.

FREESIA

A beautiful white, fragrant flower. They make very successful house blooming bulbs; a very satisfactory cut flower, desirable for growing in pots or pans.

	Each	Per doz.	Per 100	Per 1000
Refracta Alba. First Size Bulbs...	\$0.02	\$0.15	\$0.90	\$7.00
" " Mammoth "03	.25	1.50	10.00
" " Monster "05	.35	2.00	15.00

FREESIA PURITY. Fisher's Original Stock. A magnificent **snowy, glistening white**, of very large size, and great length and strength of stem; produces trusses of eight to eleven flowers. Stems can be cut two feet long. Three to four strong blooming shoots are produced from each bulb *in addition* to the main stalk. No **greenhouse** or conservatory should be without this glorious Freesia. **Price**, each 10c.; \$1.00 per doz.; per 100, \$6.00.

LEICHTLINI. Large, pure yellow, fragrant variety; good contrast to the white sort. **Price**, each 3c.; 25c. per doz.; per 100, \$1.50; \$10.00 per 1000.

SCARLET FREESIA. (See Anomatheca, page 11.)

GLADIOLUS

For Winter Forcing. Ready in November.

"May." The finest forcing large-flowering variety; produces a large spike of nearly pure white flowers. 50 cts. per doz.; per 100, \$3.00.

The Bride. A lovely, pure white gladiolus. Six bulbs can be planted in a six-inch pot. Each 2 cts.; per doz., 20 cts.; per 100, \$1.15.

Bride. (Pink.) A type like the above, but pink in color. Very handsome. Per doz., 25 cts.; per 100, \$1.50.

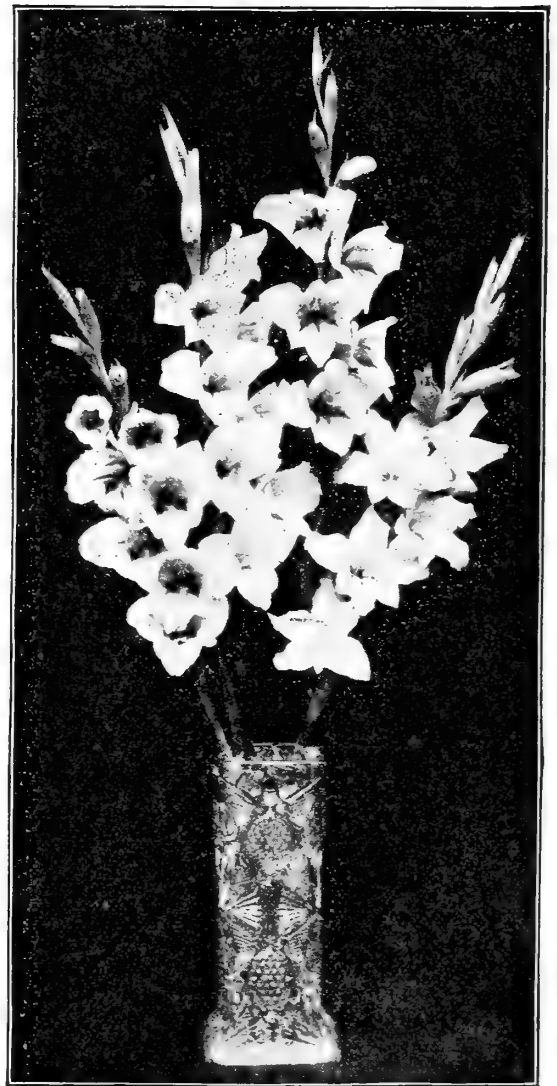

Bride Gladiolus

GLOXINIAS (Ready in November)

Our strain of this indispensable winter flowering bulb is the finest to be had. The bulbs should be treated similar to begonias, excepting that they delight in a very warm place, and entire seclusion from the sun. Only strong bulbs sent out by us.

	Each	Per doz.	Per 100		Each	Per doz.	Per 100
Scarlet and Red ..	\$0.15	\$1.50	\$7.00	Spotted and Tigered..	\$0.15	\$1.50	\$7.00
Blue15	1.50	7.00	White15	1.50	7.00
Bordered Scarlet..	.15	1.50	7.00	Choicest Mixed.....	.10	1.00	6.00
" Blue.....	.15	1.50	7.00				

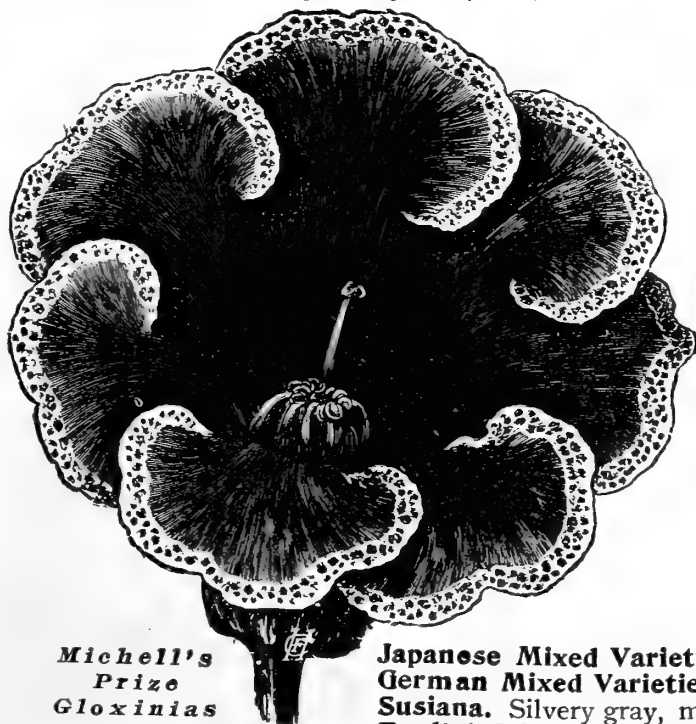

Michell's Prize Gloxinias

TESTIMONIAL

I am pleased to tell you of the fine show of **Gloxinias** and **Begonias** from the bulbs you supplied. They have been admired by all who have seen them. **The colors are grand; the assortment splendid.** **J. CURNOW**
Gardener to **Akron, O.**
C. B. Raymond, Esq.

IRIS

A bed of Iris in bloom is truly a wonderful sight. They bloom consecutively; the Germanica or German Iris coming first, being followed by the Spanish, English and Japanese. The Spanish varieties may be successfully forced in the house, when treated similar to tulips desired for forcing. The Japanese make an especially fine show, and a bed of them will yield a magnificent display. Plant in the fall, in well drained soil.

	Each	Per doz.	Per 100
Japanese Mixed Varieties . .	\$0.15	\$1.50	\$10.00
German Mixed Varieties . .	.10	1.00	6.50
Susiana. Silvery gray, mottled	.15	1.50	10.00
English Mixed. Large flowered	.03	.25	1.75
Spanish Mixed. Orchid flowering	.02	.12	.75

Spanish Iris Named Varieties.

	Per doz.	100	1000
Blanche Superbe. Pure white	\$0.15	\$1.00	\$8.00
Alex Von Humboldt. Light blue	.15	1.00	8.00
Jaune Brilliant. Pure yellow	.15	1.00	8.00

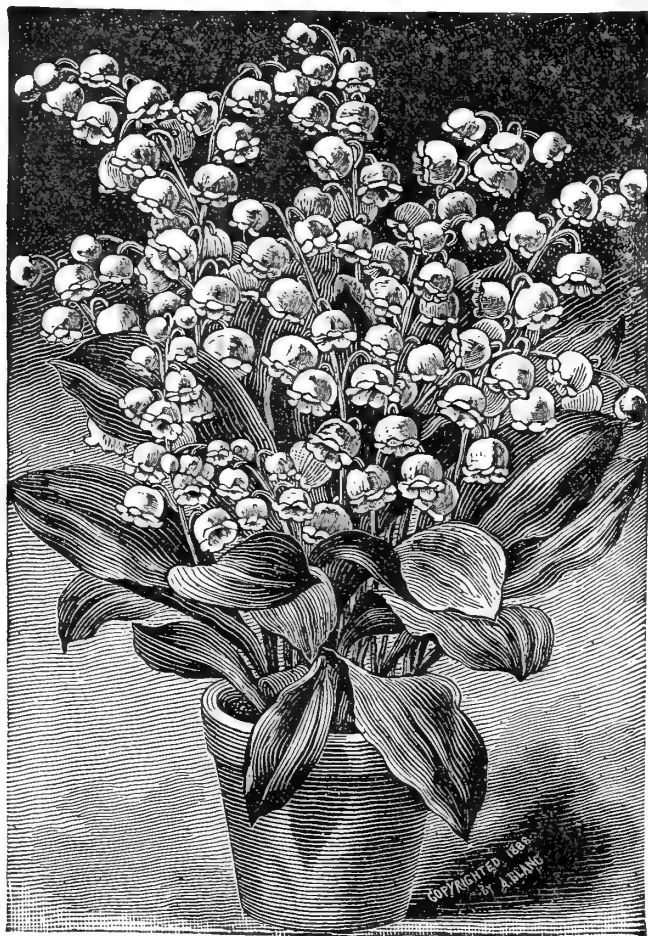

Lily of the Valley (Michell's Russian.)
LILY OF THE VALLEY.

Ready in November.

It is now a most popular plant for forcing, which is easily done by planting the pips in pots, from 6 to 12 in each, watering freely.

MONSTER OR EXCELSIOR XXX. This grade is the finest imported to this country. Produces very long, heavy flower spikes. Per doz., 40c.; per 100, \$3.00; \$5.50 for 200; per 1000, \$18.00.

"BERLIN" A brand especially selected. Will produce good spikes. Per doz., 25c.; per 25, 40c.; per 100, \$1.50; per 1000, \$12.00.

DUTCH. Recommended for outdoor blooming particularly. Per bunch of 25 roots, 35c.; per 100, \$1.25; per 1000, \$11.00.

COLD STORAGE. For forcing at any time. Orders booked for 100 or more for shipment about every two weeks. Price about \$2.50 per 100.

CLUMPS. Large undivided clumps for massing or making beds of out-of-doors. 25c. per clump; per doz. clumps, \$2.50; per 100 clumps, \$18.00. (Clumps of Valley are not mailable.)

LACHENALIA PENDULA.

Desirable for planting in hanging basket, making a grand show; a rich vermilion color. 15c. each; per doz., \$1.50; per 100, \$10.00.

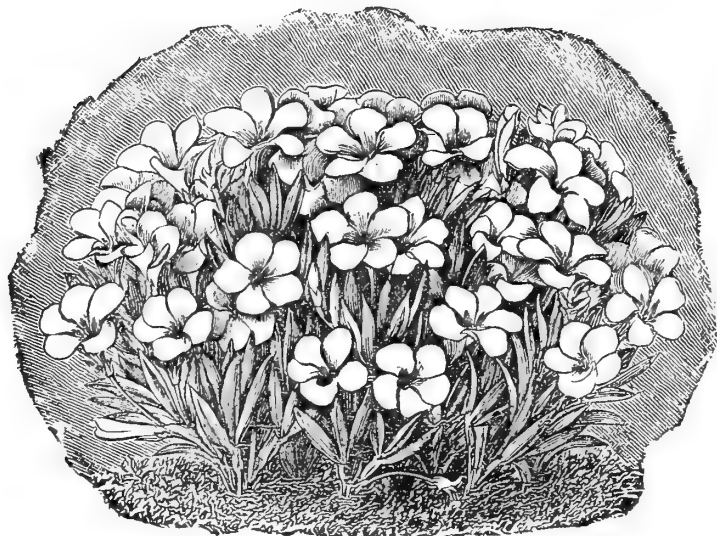

Oxalis Grand Duchess.

IXIAS.

This bulb produces a very pretty flower. They are half hardy, requiring a well drained soil and winter protection. The flowers in the mixture range in various shades of all colors.

MIXED. 12c. per doz.; per 100, 75c.; \$5.00 per 1000.

CRATEROIDES. Fiery scarlet. 25c. per doz.; per 100, \$1.50; \$12.00 per 1000.



OXALIS (Bermuda Buttercup).

An unrivalled winter-flowering pot plant, of the easiest culture, succeeding with everybody. One of the finest winter-flowering plants for pot culture. Place in a dark, cool position for a few weeks to root thoroughly, and remove to a sunny situation in the window or conservatory, and the great profusion of bloom for weeks will astonish and delight you. The flowers are of the purest bright buttercup yellow.

Large bulbs.....10c. for 3; per doz., 25c.; per 100, \$1.50.
Mammoth bulbs..... 5c. each; per doz., 50c.; per 100, \$3.00.

BOWEI. Flowers large, most brilliant rose color, in great profusion. 10c. for 4; per doz., 25c.; per 100, \$1.50.

PINK. 10c. for 4; per doz., 25c.; per 100, \$1.50.

WHITE. 10c. for 4; per doz., 25c.; per 100, \$1.50.

YELLOW. 10c. for 4; per doz., 25c.; per 100, \$1.50.

VERSICOLOR. Red, violet and white. 10c. for 4; per doz., 25c.; per 100, \$1.50.

MIXED. All colors. 10c. for 6; per doz., 15c.; per 100, \$1.00.

DOUBLE YELLOW. 10c. for 4; per doz., 25c.; per 100, \$1.50.

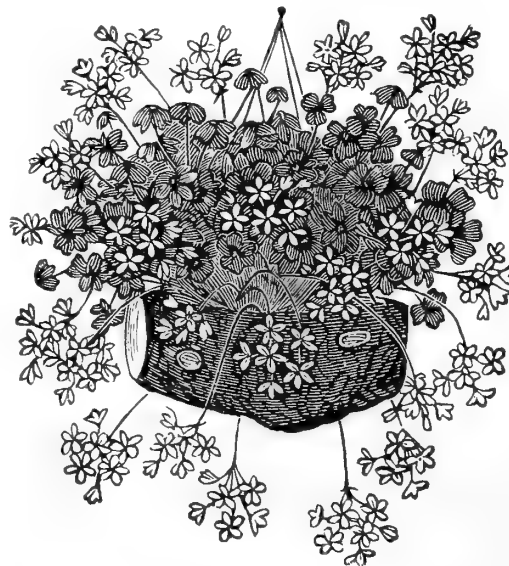

Oxalis Bowei.

OXALIS (Grand Duchess).

A new, compact, growing sort; very desirable as a pot plant.

See Illustration Opposite.

White.....3 for 10c. per doz., \$0.30; per 100, \$2.00
Pink.....3 for 10c. " .30; " 2.00
Lavender.....3 for 10c. " .30; " 2.00

ORNITHOGALUM ARABICUM

(Star of Bethlehem.)

A hardy white flowering bulb, particularly adapted for outside. 5c. each; per doz., 40c.; \$2.50 per 100.



SCILLA SIBERICA (SQUILLS.)

Hardy, pretty blue flowers, for the house or garden. Per doz., 25 cts.; \$1.40 per 100; \$11.00 per 1000.

SPARAXIS.

A beautiful class of bulbs, allied to the Ixias and requiring the same treatment, producing spikes of the most exquisite flowers. Mixed varieties. Per doz., 15 cts.; 75 cts. per 100.

PÆONIES.

Ready in November.

Extra fine large clumps, will bloom next Spring

Double, Pink.....	Each, \$.25	\$2.50 per doz.
Double, White.....	“ .25	2.50 “
Double, Red.....	“ .25	2.50 “
Double, Mixed Colors.....	“ .25	2.25 “
Tenuifolia. Finest scarlet, feathery foliage.....	“ .25	2.50 “



Japanese Paeonies.

These are a very beautiful and distinct species, flowering quite early.

	Each	Per doz.
Red30c.	\$3.00
White30c.	3.00
Pink.....	.30c.	3.00

Ranunculus or Buttercups.

Turban, or Turkish. Very double and distinctly marked. Finest mixed, per doz., 15 c's.; 75 cts. per 100.

Persian. Finest mixed, per doz., 15 cts.; 75 cts. per 100.

Ranunculus.



SNOWDROPS.

Set about two or three inches deep, and one inch apart in clumps or triple rows (if planted singly they are not conspicuous).

Single.....	per doz., \$.15	\$0.75 per 100	\$6.00 per 1000
Elwee's Giant.....	“ .15	.75 “	6.00 “
Double.....	“ .25	1.50 “	12.50 “



New Spirea "Gladstone"

SPIREA (Astilbe). READY IN NOVEMBER.

LARGE, STRONG, HEALTHY CLUMPS.

	Each	Per doz.	Per 100
"Gladstone"—New. (See illustration). The handsomest of all Spireas; was awarded silver medals wherever exhibited. Each plant produces from 25 to 40 spikes of snow-white flowers.....	\$0.25	\$2.25	\$12.50
Japonica10	1.00	6.00
Compacta Multiflora. Superior to Japonica, of more compact habit, flowers more freely and closer; foliage, beautiful dark green12	1.25	9.00
Astilboides Floribunda. An improvement on the common Astilboides; large, pure white plumes, with bright green foliage12	1.25	7.00
Washington (New).....	.25	2.25	16.00
Palmata. The red flowering variety15	1.50	8.00
Superba. A grand new white variety.....	.25	2.50	18.00

Note.—Spireas are not available.

6 Bulbs of any one variety at dozen rates; 25 at 100 rates; 250 at 1000 rates.

MICHELL'S CHOICE FLOWER SEEDS For Autumn AND Winter Sowing

For the convenience of our customers, and to facilitate the filling of orders, we have affixed numbers to all varieties of Flower Seeds, and in ordering it is only necessary to give the quantity wanted, and the number; but care should be taken to give the correct number, as a mistake in this would result in getting the wrong variety.

ACHILLEA

- 20 **Ptarmica Plena.** Hardy perennial; useful for cut flowers and for cemetery decoration; double white flowers....(Large pkt., \$0.30) Pkt. \$0 10

AGONITUM (Monk's Hood or Wolf's Bane)

- 25 **Napellus.** Hardy perennial, producing curious, hood-shaped blue and white flowers; 4 feet. (Large pkt., \$0.20) 05

ALYSSUM

- 70 **Carpet of Snow.** Dwarf and compact; flowers white; 4 inches....\$0.15 per ¼ oz.; oz. \$0.50 05
- 71 **Little Gem.** Dwarf, profuse bloomer; white; 4 inches.....\$0.15 per ¼ oz.; oz. \$0.50 05
- 72 **Saxatile Compactum** (Basket of Gold). Showy golden yellow flowers; hardy perennial; 1 foot.....(Large pkt., \$0.15) 05
- 73 **Sweet.** Fragrant, white flowers; 6 in..oz. \$0.25 05

ANEMONE (Windflower)

A very pleasing hardy perennial, easily grown from seed, and producing large flowers.

- 105 **Coronaria Mixed.** 2 feet... (Large Pkt., \$0.15) \$0 05
- 106 **Queen Charlotte.** A beautiful variety; large, semi-double pink flowers; 3 feet..... 25
- 107 **St. Brigid or Poppy.** Very pretty and perfectly hardy; flowers embrace all the rainbow shades and also black and white, and are of a very large size; 2 feet.. (Large pkt., \$0.30) 15



Aquilegia (Columbine)

AQUILEGIA (Columbine)

Hardy perennials of easy cultivation, blooming from May to August. Suitable for herbaceous borders and groups among shrubs.

- 130 **Chrysantha** (Golden Spurred). Bright golden yellow flowers; 3 feet.... (Large pkt., \$0.25) \$0 10
- 131 **Chrysantha Alba** (White Spurred). A beautiful pure white variety.... (Large pkt., \$0.30) 10
- 132 **Cœrulea** (Rocky Mountain Columbine). Violet-blue and white; 2 feet.... (Large pkt., \$0.30) 10
- 134 **Single Mixed.** All colors; 2 feet....oz., \$0.35 05
- 135 **Double Mixed.** All colors; 2 feet....oz., .35 05

ASPERULA

- 165 **Odorata** (Sweet Woodruff). Pretty hardy perennial with fragrant leaves and stems; flowers white; 1 foot.....¼ oz., \$0.20 05

ASTER (Michaelmas Daisy)

- 328 **Perennial Mixed.** Hardy herbaceous plants bearing single flowers.. (Large pkt., \$0.25) 10

ANTIRRHINUM (Snapdragon)

A showy and useful plant, and is fast becoming one of our most popular flowers; useful for beds or borders, and is also extensively grown under glass for cutting during the winter.

- 110 **Dwarf Firefly.** Scarlet; 1 foot (L'ge pkt., \$0.15) Pkt. \$0 10
- 112 **Dwarf Mixed.** Choicest colors; 1 foot.oz., \$0.50 05
- 114 **Giant Scarlet.** 2 feet.....(Large pkt., \$0.20) 10
- 115 **Giant White.** 2 feet.....(Large pkt., .20) 10
- 116 **Giant Yellow.** 2 feet.....(Large pkt., .20) 10
- 120 **Queen of the North.** A fine variety; forms a large plant, densely covered with large, white flowers; excellent for beds or pot culture; 1 foot.....¼ oz., \$0.25 10
- 122 **Tall Mixed.** Extra fine; 2 feet.....oz., .40 05
- 123 **Imported Collection.** 10 dwarf varieties..... 40
- 124 **Imported Collection.** 10 tall varieties..... 40

AURICULA (Primula Auricula)

- 410 **Choice Mixed.** A well-known half hardy perennial; flowers of many beautiful colors; 6 inches 10

BROWALLIA

Elegant, free flowering plants; blooms finely in the winter if sown in July or August; 18 inches.

- 500 **Elata Cœrulea Grandiflora.** Large sky-blue flowers..... (Large pkt., \$0.15) \$0 05
- 502 **Speciosa Major.** A new large flowering variety, of the most brilliant ultramarine blue; especially desirable as a pot plant for winter and early spring flowering. (L'ge pkt., \$0.25) 10

GALCEOLARIA

An ornamental plant, and a universal favorite for decorating the greenhouse or conservatory; produces a mass of beautiful pocket-like flowers. Our strains of Calceolaria have a wide reputation as to large size, rich and varied colors of the flowers.

- 515 **Hybrida Grandiflora, Tall Mixed.** Large flowering, rich, self-colored flowers saved from a choice collection; 18 in... (Large pkt., \$0.60) \$0 25
- 516 **Hybrida Grandiflora Pumila Compacta.** Of dwarf, compact growth, producing immense trusses of large, brilliant self-colored and spotted flowers; 1 foot... (Large pkt., \$0.60) 25
- 517 **James' Superb Strain.** A robust grower, producing very large and beautiful flowers; 18 inches 50
- 518 **Rugosa Mixed** (Shrubby). Small flowering varieties for bedding; of the finest colors; 1 ft. 50
- 519 **Sutton's Perfection.** Mixed...Per original pkt. 90

CAMPANULA (Canterbury Bell or Bell Flower)

These are well worthy a place in every garden, bearing a great profusion of attractive bell-shaped flowers.

- 545 **Cup and Saucer** (Calycanthema). Pure white flowers, resembling a cup and saucer; hardy biennial, 2½ feet..... (Large pkt., \$0.25) \$0 10
- 546 **Cup and Saucer.** Mixed ... (Large pkt., .20) 10
- 547 **Persicifolia Grandiflora Blue.** An elegant hardy perennial, bearing large cup-shaped flowers; 2 to 3 feet..... (Large pkt., \$0.25) 15
- 548 **Persicifolia Grandiflora White.** Same as above, except in color..... (Large pkt., \$0.25) 15
- 549 **Pyramidalis** (Chimney Bell Flower). Stately hardy perennial, either for garden or pot culture; mixed, blue and white flowers; 3 feet (Large pkt., \$0.20) 05
- 550 **Single Mixed.** Large bell-shaped flowers, hardy biennial; 2 to 3 feet..... (Large pkt., \$0.10) 05
- 551 **Double Mixed.** All colors.. (Large pkt., .15) 05

FLOWER SEEDS—Continued

CANDYTUFT (Iberis)

- 570 **Sempervirens.** Hardy perennial, profuse Pkt.
bloomer; pure white; 1 foot.... $\frac{1}{4}$ oz. \$0.25 \$0 10

CARNATION

Desirable for greenhouse culture in winter and for the garden in summer.

- 600 **Early Vienna.** Early flowering, double, extra fine; all colors mixed; 1 foot
(Large pkt. \$0.25) \$0 10
602 **Finest German.** Double, mixed colors; seed saved from flowers of the finest quality.
(Large pkt. \$0.50) 25
610 **Choice Mixed.** Double; all colors
(Large pkt. \$0.40) 10

Marguerite Carnations

The Marguerite Carnations are the earliest to bloom, and produce large, double, sweet-scented flowers. Being half-hardy perennials, if they are slightly protected during the winter they will flower profusely the next summer; 1 foot.

- 604 **Excelsior.** Extra large flowering
(Large pkt. \$0.30) \$0 15
606 **White.** Large flowers.....(Large pkt. .30) 10
608 **Yellow.** Very fine.....(Large pkt. .50) 10
609 **Choice Mixed.** All colors...(Large pkt. .20) 10

CINERARIA

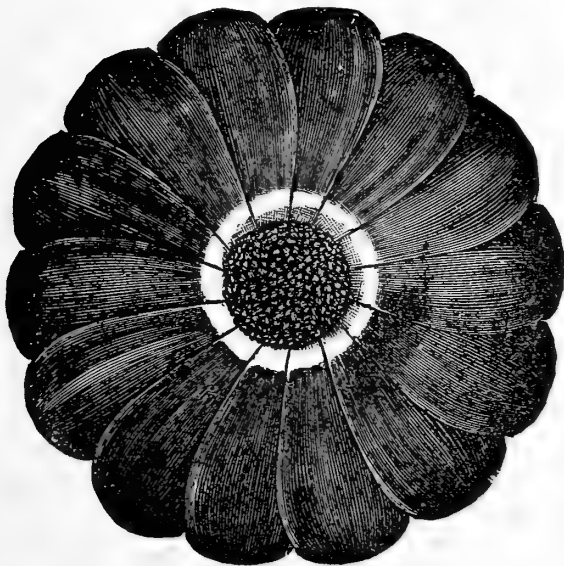

Michell's Giant Cineraria

One of the most ornamental plants for conservatory or house decoration; seed may be sown from May to September for a succession. **Michell's Grandiflora Prize Strain** is the best procurable, producing immense trusses of the largest flowers.

- 691 **Grandiflora Prize Dwarf.** Mixed colors; plants of dwarf habit....(Large pkt. \$0.60) \$0 35
693 **Grandiflora Prize Medium Tall.** Mixed colors; desirable as a decorative plant
(Large pkt. \$0.60) 35
695 **Hybrida.** Choice mixed....(Large pkt. .50) 25
697 **Double Flowering.** Mixed colors
(Large pkt. \$0.60) 35
699 **James' Giant Strain.** A superb variety; mixed colors 50
703 **Stellata** (Sutton's). Desirable as a pot plant, or for cutting; medium sized star-like flowers 75
705 **Stellata Hybrida.** Of graceful and vigorous habit, producing a profusion of elegant flowers 1 00
707 **Sutton's Superb.** Mixed colors; extra fine... 60

COREOPSIS

One of the finest hardy plants, producing showy flowers in great abundance from June till frost; excellent for cutting; 2 feet.

- 540 **Lanceolata Grandiflora.** Large golden yellow flowersoz. \$0.60 \$0 10
541 **California Sunbeams.** This variety is larger than the old-fashioned types, flowers beautifully formed; various shades of yellow and brown.....(Large pkt. \$0.20) 10

CYCLAMEN

Beautiful plants for the window or greenhouse; with mottled leaves and rich colored flowers.

- 780 **Giganteum Album.** White....100 seeds \$1.25 Pkt. \$0 35
782 **Giganteum Roseum.** Pink....100 seeds 1.25 35
784 **Giganteum Rubrum.** Red....100 seeds 1.25 35
786 **Giganteum White** with carmine eye
100 seeds \$1.25 35
788 **Giganteum Mixed.**.....100 seeds 1.00 25
802 **Papilio** (Butterfly). The edges of the flowers are beautifully fringed, or waved; mixed.. 40
804 **Persicum.** Choice mixed..(Large pkt. \$0.30) 10
806 **Sutton's Giant.** Choicest mixed .Per orig. pkt. 1 00

DAISY (Bellis Perennis)

Beautiful spring flowering perennials, easily raised from seed; 4 inches.

- 855 **Giant White.** Large, double (Large pkt. \$0.40) \$0 15
857 **Giant Mixed.** Double, extra large.
(Large pkt. \$0.40) 15
859 **Longfellow.** Large double pink (L'e pkt. .30) 10
860 **Snowball.** Double pure white (L'ge pkt. .30) 10
861 **Double Mixed.** Very choice (Large pkt. .30) 10

DELPHINIUM (Perennial Larkspur)

Handsome hardy perennial plants for the herbaceous border and shrubbery, producing a profusion of splendid spikes of flowers throughout the summer.

- 873 **Cashmerianum.** Large, dark blue flowers; 18 inches.....(Large pkt. \$0.40) \$0 10
875 **Chinense Grandiflorum.** Large, bright blue; 2 feet.....Oz. \$0.60 10
876 **Elatum** (Bee Larkspur). Rich blue with dark centre.....(Large pkt. \$0.20) 10
877 **Formosum.** Rich blue, with white centre
oz. \$0.75 10
879 **Nudicaule.** Compact growth, spikes of scarlet flowers; 18 inches.....(Large pkt. \$0.40) 10
881 **Zalil.** Beautiful sulphur yellow (L'ge pkt. .40) 10
883 **Hybridum Mixed.** Choice single.....oz. \$0.50 10

DIANTHUS (Pinks)

Hardy garden varieties; excellent for beds and borders; very fragrant.

- 917 **Erfurt.** A new sort recently introduced; blooms very early; very fragrant; choice mixed.... \$0 15
919 **Clove Scented.** Double and semi-double varieties, in beautiful colors..(Large pkt. \$0.40) 10
921 **Pheasant's Eye.** Single white; fringed flowers with dark centre.....oz. \$0.40 05
923 **Double Scotch.** A choice variety of colors; fragrant.....(Large pkt. \$0.40) 15

DICTAMNUS (Gas Plant)

- 925 **Fraxinella.** Hardy perennial, with fragrant foliage, and red flowers; 2 $\frac{1}{2}$ feet....oz. \$0.40 \$0 10

DIGITALIS (Foxglove)

A handsome hardy perennial; either for borders or in groups among shrubs; 3 feet.

- 930 **Gloxiniæflora.** Gloxinia shaped flowers; all colors; mixed.....oz. \$0.40 \$0 05
932 **Monstrosa** (Mammoth Foxglove). The tall spikes are surmounted by one monstrous flower; all colors mixed (Large pkt. \$0.25) 10

EUPATORIUM

- 975 **Fraseri.** A fine hardy perennial; clusters of white flowers.....(Large pkt. \$0.20) 10

GAILLARDIA (Blanket Flower)

Splendid showy plants for beds or borders.

- 1020 **Grandiflora Compacta.** Hardy perennial, a compact variety, bearing long stemmed flowers; choice mixed colors..... $\frac{1}{4}$ oz. \$0.25 \$0 10
1022 **Grandiflora Superba.** Hardy perennial; splendid mixed varieties; 2 feet.... $\frac{1}{4}$ oz. \$0.20 10

GYPSOPHILA (Baby's Breath)

- 1105 **Paniculata.** Free flowering hardy perennial; flowers in graceful sprays of white; fine for bouquets; 2 feet.....oz. \$0.35 05

FLOWER SEEDS—Continued

HEUCHERA (Alum Root)

1125 **SANGUINEA**. Hardy perennial; crimson flowers; excellent for cutting; 1 foot
 (Large pkt. \$0.30) Pkt. \$0 10

HIBISCUS (Marshmallow)

Showy, ornamental perennial plants, for mixed beds or shrubby borders, having large sized, beautiful colored flowers.

1130 **CRIMSON EYE**. Large white flowers with crimson centre..... $\frac{1}{4}$ oz. \$0.20 \$0 10
 1132 **GOLDEN BOWL**. Giant yellow with maroon centre; 3 feet..... $\frac{1}{4}$ oz. \$0.25 10
 1134 **PALUSTRIS**. Large pink flowers; 3 feet
 $\frac{1}{4}$ oz. \$0.20 05

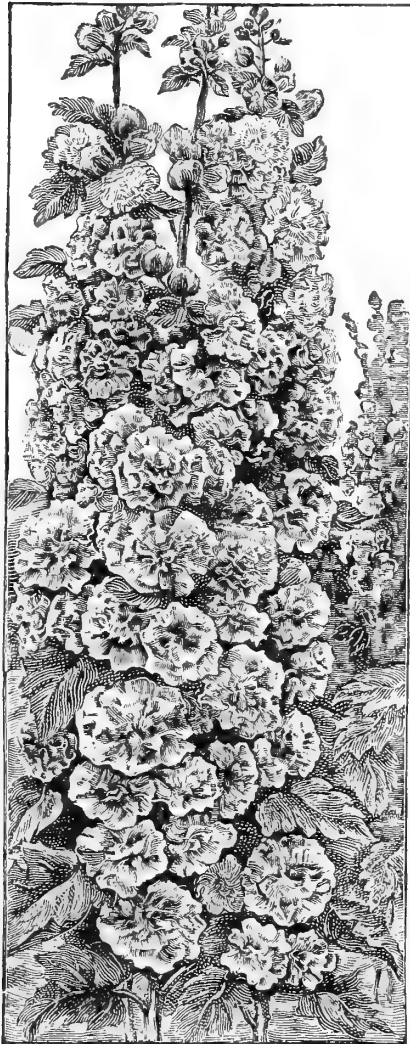

Chater's Double Hollyhock

HOLLYHOCK

One of the most popular and desirable of hardy perennial plants; 6 to 7 feet.

1146 **ALLEGHENY**. Semi-double; mammoth flowers, having the edges of the petals finely fringed and lacinated; mixed colors. $\frac{1}{4}$ oz., \$0.50 (L'ge pkt. \$0.25) Pkt. \$0.10.

CHATER'S IMPROVED DOUBLE HOLLYHOCK

Our strain of this is the best that can be procured; seeds saved from the most double flowers.

1149 **PINK**. Oz. \$1.25 (Large pkt. \$0.25), Pkt. \$0.10.
 1151 **RED**. Oz. \$1.25 (Large pkt. \$0.25), Pkt. \$0.10.
 1153 **SALMON**. Oz. \$1.25 (Large pkt. \$0.25), Pkt. \$0.10.
 1155 **WHITE**. Oz. \$1.25 (Large pkt. \$0.25), Pkt. \$0.10.
 1157 **YELLOW**. Oz. \$1.25 (Large pkt. \$0.25), Pkt. \$0.10.
 1159 **CHOICE MIXED**. Oz. \$1.00 (Large pkt. \$0.20), Pkt. \$0.10.
 1160 **SINGLE MIXED**. Oz. \$1.00, $\frac{1}{4}$ oz. \$0.30, Pkt. \$0.10.
 1161 **IMPORTED COLLECTION**. 6 colors, \$0.40.
 1163 **IMPORTED COLLECTION**. 12 colors, \$0.75.

LATHYRUS LATIFOLIUS

(Everlasting or Perennial Pea)

Free flowering, hardy perennial climbers, bearing beautiful pea-shaped flowers.

1210 **CRIMSON**. Brilliant.....oz. \$0.40 \$0 10
 1212 **PINK BEAUTY**. Bright, rosy-pink.....oz. .40 10
 1214 **WHITE**oz. .40 10
 1216 **CHOICE MIXED**. All colors.....oz. .30 05

LAVENDER (Lavendula Vera)

1220 Hardy perennial; long spikes of fragrant blue flowers; 18 inches.....oz. \$0.30 05

LOBELIA

1237 **CARDINALIS** (Cardinal Flower). Hardy perennial; brilliant scarlet flowers; 3 feet
 (Large pkt. \$0.50) 10

LYCHNIS

1285 **CHALCEDONICA**. Fine scarlet flowers, 2 feet
 oz. \$0.30 05
 1287 **HAAGEANA**. Brilliant orange, scarlet, crimson, etc., in mixture; 1 foot..... $\frac{1}{4}$ oz. \$0.25 10

LUPINUS (Lupin)

A useful annual flower, for cutting and house decoration; very free flowering; seeds sown in greenhouse during the late summer and fall months will produce an abundance of bloom for Christmas and winter season; 2 to 3 feet.
 1265 **BLUE**. 1269 **RED**. 1273 **WHITE**.
 1267 **PINK**. 1271 **SCARLET, White Tipped**. 1275 **YELLOW**.
 Each of the above colors, oz., \$0.30; pkt., \$0.10.
 1277 **MIXED**. All colors, oz., \$0.20; pkt., \$0.05.

MIGNONETTE (Reseda)

One of our most popular annuals; prized for its delicious fragrance; sowings may be made at intervals for a succession of bloom; also valuable for growing in pots for winter and spring flowering.

1340 **ALLEN'S DEFIANCE**. Grown under favorable conditions the spikes will attain a length of 12 to 15 inches; deliciously fragrant...oz. \$0.60 Pkt. \$0 10
 1341 **ALLEN'S DEFIANCE** (Special). Indoor grown seed; extra choice; originators' stock (Half-size pkt. \$0.50) 1 00
 1343 **BIRD'S MAMMOTH**. Large spikes of reddish flowers; excellent for pots or open ground oz. \$0.50 10
 1345 **BISMARCK**. Spikes of immense size, compact, strong grower.....(Large pkt. \$0.25) 10
 1349 **GOLDEN MACHET**. Large spikes; yellow.oz. \$0.50 10
 1352 **GOLIATH**. One of the finest varieties; giant spikes of brilliant red flowers; very fragrant (Large pkt. \$0.25) 10
 1353 **GRANDIFLORA**. Large flowering.....oz. \$0.25 05
 1355 **MACHET**. One of the best sorts for pot culture; spikes of reddish-tinted flowers....oz. \$0.60 10
 1357 **MILES' SPIRAL**. Flowers whitish.....oz. \$0.25 05
 1363 **SUTTON'S GIANT**. Large; reddish-buff..... 25
 1367 **IMPORTED COLLECTION**. 10 varieties..... 50

MYOSOTIS (Forget-Me-Not)

Neat and beautiful little plants with star-shaped flowers; succeeds best in a moist, shady situation; perennial.

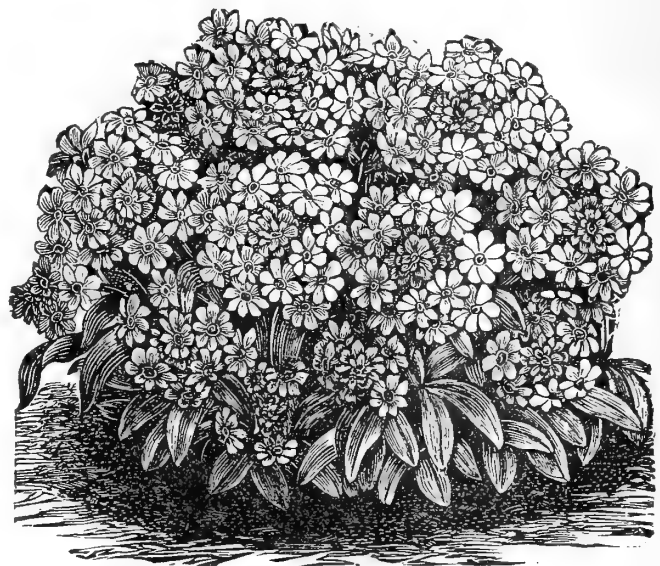

Myosotis (Forget-Me-Not)

1390 **ALPESTRIS COERULEA**. Bright blue; 6 inches (Large pkt. \$0.15) \$0 10
 1391 **ALPESTRIS VICTORIA**. Of bushy habit; bearing large bright blue flowers. (Large pkt. \$0.25) 10
 1393 **DISSITIFLORA**. Compact; rich blue; 6 inches (Large pkt. \$0.30) 10
 1395 **ELIZA FANROBERT**. Large flowering; bright blue; 6 inches.....(Large pkt. \$0.20) 10
 1399 **GRANDIFLORA ALBA**. Large white flowers; 6 inches.....(Large pkt. \$0.20) 10
 1401 **PALUSTRIS**. The true Forget-Me-Not; bright blue flowers; 6 inches.....(Large pkt. \$0.30) 10
 1403 **PALUSTRISSEMPERFLORENS**. Dwarf; blooms from spring until autumn; blue; 6 inches (Large pkt. \$0.25) 10
 1407 **CHOICE MIXED**..... $\frac{1}{4}$ oz. \$0.25 05

MICHELL'S PANSIES, ETC.

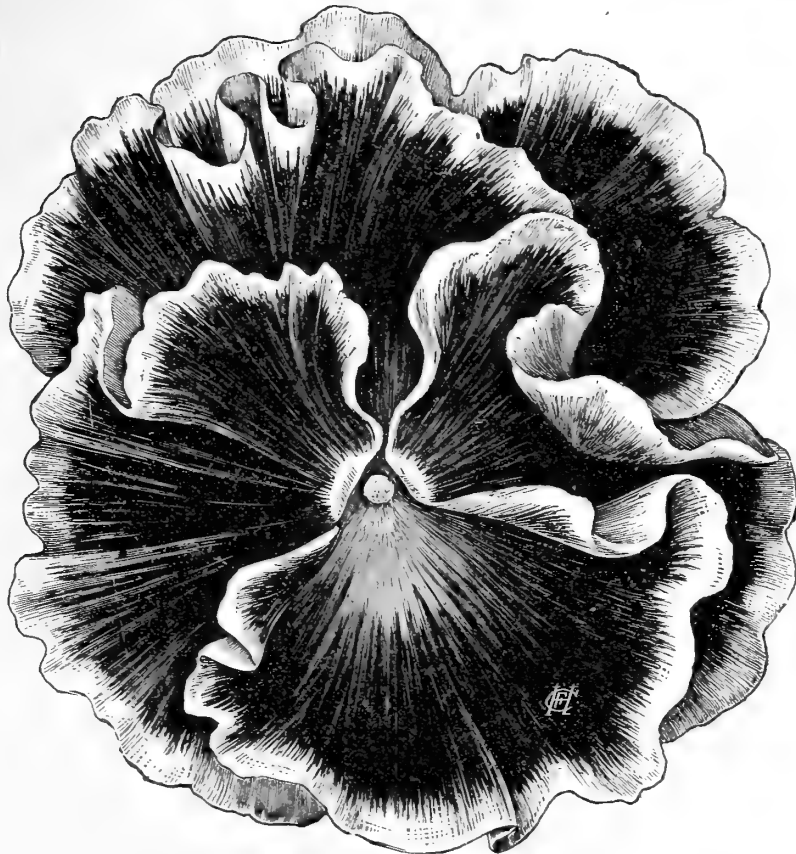

Pansy. *Michell's Giant Exhibition*

MICHELL'S GIANT PANSIES

Separate Colors

A strain secured from the leading Pansy specialists, and not to be compared with the ordinary Giant Trimardeau, as the flowers are of much heavier texture.

			Pkt.
1535	Giant Prize Azure Blue. Violet blue.	1/8 oz. \$0.65	\$0 15
1537	" Black Blue	1/8 oz. .65	15
1539	" Emperor William	1/8 oz. .65	15
1541	" Hortensia Red	1/8 oz. .65	15
1543	" King of the Blacks	1/8 oz. .65	15
1545	" Lord Beaconsfield	1/8 oz. .65	15
1549	" Peacock. Upper petals beautiful blue, lower petals deep claret with white margin	1/8 oz. \$1.00	15
1551	" Snow Queen. White	1/8 oz. .65	15
1553	" Striped and Mottled	1/8 oz. .65	15
1557	" White with dark eye	1/8 oz. .65	15
1559	" Pure Yellow	1/8 oz. .65	15
1561	" Yellow with dark eye	1/8 oz. .65	15

SPECIAL OFFER. We will send 6 packets of any of the above varieties of Giant Pansies for 75c.; or the entire 12 pkts. for \$1.40.

PANSIES (Other Sorts)

1565	Belgian Striped	oz. \$1.00 (Large pkt. \$0.25)	\$0 10
1567	Emperor William	oz. 1.00 (Large pkt. .25)	10
1569	Faust (King of the Blacks). Almost black	oz. \$1.00 (Large pkt. \$0.25)	10
1571	Gold Margined	oz. 1.00 (Large pkt. .25)	10
1573	Havana Brown	oz. 1.00 (Large pkt. .25)	10
1575	Lord Beaconsfield	oz. 1.00 (Large pkt. .25)	10
1577	Mahogany Colored	oz. 1.00 (Large pkt. .25)	10
1579	Silver Edged	oz. 1.00 (Large pkt. .25)	10
1581	Snow Queen. White	oz. 1.00 (Large pkt. .25)	10
1583	White with eye	oz. 1.00 (Large pkt. .25)	10
1585	Yellow Gem. Pure yellow	oz. \$1.00 (Large pkt. \$0.25)	10
1587	Yellow with eye	oz. 1.00 (Large pkt. .25)	10

SPECIAL OFFER. We will send 6 packets of any of the above varieties of regular sorts of Pansies for 50c.; or the entire 12 packets for 90c.

PANSIES IN MIXTURES

1595	Michell's Giant Exhibition. A strain which we have secured from the leading pansy specialists in Germany and France. It can be relied upon to produce flowers of immense size, very heavy texture, and of the most brilliant colors. Per oz., \$6.00; \$1.00 per 1/8 oz.	(Large pkt. \$0.50)	Pkt. \$0 25
1597	Bugnot, Odier and Cassier. A superb mixture of giant blotched varieties	1/8 oz. \$1.00	25
1599	Giant Trimardeau. Very large flowering; all colors mixed	1/4 oz. \$0.60 (Large pkt. \$0.30)	10
1600	Mad. Perret. A new strain, early flowering, fragrant, a great diversity of colors, especially rich in red shades	1/8 oz. \$1.00	25
1601	Masterpiece. New giant curled	1/8 oz. 1.00	25
1603	Non Plus Ultra. Beautiful colors	1/8 oz. 1.00	25
1605	Odier or Blotched	1/8 oz. .75	15
1607	Parisian Large Stained	1/8 oz. .75	15
1609	Finest English Mixed	oz. \$1.50 (Large pkt. .25)	10
1611	Very Fine Mixed	oz. .75 (Large pkt. .20)	05
1613	Imported Collection. 6 colors		40
1614	Imported Collection. 12 colors		75

PHLOX (Hardy)

1725	Decussata. A fine herbaceous perennial for beds and borders; mixed colors, 3 feet	(Large pkt. \$0.25)	\$0 10
------	--	---------------------	--------



Poppy. *Oriental Hybrid*

POPPY (Perennial)

1780	Giant Orange	(Large pkt. \$0.15)	\$0 10
1782	Giant Scarlet (Bracteatum)	(Large pkt. .15)	10
1784	Iceland, Single Mixed. Colors range from white and yellow to deep orange scarlet	(Large pkt. \$0.15)	10
1786	Iceland, Double Mixed. 1 foot. (L'ge pkt. .25)		10
1788	Oriental Hybrids. Beautiful flowers often measuring 6 inches across; of many colors	(Large pkt. \$0.25)	10
1790	Imported Collection. 8 varieties		40

PYRETHRUM

Hardy perennials; fine for borders; very desirable for cutting; 1 1/2 to 2 feet.			
1862	Roseum. Bright rose color	(Large pkt. \$0.25)	\$0 10
1866	Uliginosum. Large, single white flowers	(Large pkt. \$0.25)	10
1868	Hybridum Single Mixed	(Large pkt. .25)	10
1869	Hybridum Double Mixed	(Large pkt. .50)	25

FLOWER SEEDS—Continued



Michell's Prize Primula

PRIMULA

CHINESE FRINGED PRIMROSE

The seed we offer is of the very choicest strain secured from a leading Primula specialist, and our customers may rely upon it to be the very best.

- 1805 **Alba Magnifica.** Very large white flowers with yellow eye.....(Large pkt. \$0.60) \$0 40
- 1806 **Chiswick Red.** Brilliant red. (Large pkt. .60) 40
- 1807 **Holborn Blue.**..... (Large pkt. .60) 40
- 1809 **Kermesina Splendens.** Crimson with yellow eye(Large pkt. \$0.60) 25
- 1811 **Rosy Morn.** Delicate pink.. (Large pkt. .60) 25
- 1813 **Stellata** (Sutton's). Excellent pot plant, or for cutting; mixed.....Per original pkt. 1 25
- 1815 **Fern Leaved.** Mixed(Large pkt. \$0.60) 25
- 1817 **Williams' Superb Strain.**.....(Large pkt. .60) 40
- 1819 **Michell's Prize Mixture.** This mixture contains only the very finest sorts selected from the best strains.....(Large pkt. \$0.60) 25
- 1821 **Double White.** Elegantly fringed..... 50
- 1823 **Double Mixed.** All colors..... 50
- 1825 **Imported Collection.** 8 varieties..... 75

PRIMULA OBCONICA GRANDIFLORA

- 1828 **Compacta.** (New) Excellent 25
- 1830 **Fimbriata.** Flowers fringed (Large pkt. \$0.50) 15
- 1832 **Kermesina.** Red; very fine.. (Large pkt. .40) 20
- 1834 **Rosea.** Pink.....(Large pkt. .30) 15
- 1836 **White.** Pure white, shading occasionally to lilac(Large pkt. \$0.30) 15
- 1838 **Hybrida Mixed.** Various colors. (L'ge pkt. .30) 15

PRIMULA—OTHER VARIETIES

- 1840 **Cortusoides Sieboldii.** Hardy perennial variety; should have slight protection during the winter; also fine for pots; mixed colors (Large pkt. \$0.50) 15
- 1842 **Floribunda.** Fragrant, yellow. (L'ge pkt. .50) 25
- 1844 **Forbesi** (Baby Primrose). Free flowering; fine for pots; color rosy lilac. (Large pkt. \$0.50) 25
- 1846 **Veris** (English Cowslip). Hardy perennial; fragrant; mixed(Large pkt. \$0.20) 10
- 1848 **Vulgaris** (English Primrose). The common hardy English variety; canary yellow (Large pkt. \$0.30) 10

RUDBECKIA (Cone Flower)

- 1902 **Newmani.** Hardy perennial; yellow flowers with black centre.....(Large pkt. \$0.40) 10

SCABIOSA (Mourning Bride)

- 1950 **Caucasica.** Fine hardy perennial; flowers lilac blue; 3 feet.....(Large pkt. \$0.30) 10



Michell's Stocks

STOCKS (Gilliflower)

The seed we offer is from pot-grown plants and will produce 80 per cent. large double flowers; 1 to 1½ feet.

LARGE FLOWERING DWARF TEN WEEK Pkt.

- 2010 **Blood Red.** 1/8 oz. \$0.50, (Large pkt. \$0.25) \$0 10
- 2012 **Light Blue** 1/8 oz. .50, (Large pkt. .25) 10
- 2014 **Pink** 1/8 oz. .50, (Large pkt. .25) 10
- 2016 **Purple** 1/8 oz. .50, (Large pkt. .25) 10
- 2018 **White** 1/8 oz. .50, (Large pkt. .25) 10
- 2020 **Yellow** 1/8 oz. .50, (Large pkt. .25) 10
- 2022 **Choice Mixed** 1/8 oz. .50, (Large pkt. .25) 10
- 2023 **Imported Collection.** Large flowering; 8 varieties. 50

VARIOUS STOCKS

- 2025 **Wallflower Leaved.** Choice mixed 1/8 oz. \$0.50, (Large pkt. \$0.25) 10
- 2035 **Beauty of Nice.** A winter flowering variety; grows 2 to 2½ feet high, with spikes 1 foot in length, around which are a number of side shoots covered with fragrant flowers; color, a delicate shade of pink..... 25
- 2037 **Brompton or Winter.** Mixed. (Large pkt. \$0.30) 10
- 2039 **Excelsior.** Immense spikes of fragrant white flowersPer original pkt. 1 00
- 2043 **Princess Alice** (Cut and Come Again). Perpetual blooming; throws out numerous side branches, all bearing clusters of double white fragrant blooms; fine for cutting; 2 feet 1/8 oz. \$0.50, (Large pkt. \$0.30) 10
- 2045 **Snowflake.** A dwarf variety with large double, snow-white flowers.....(Large pkt. \$0.30) 15

STOKESIA (Cornflower Aster)

- 2055 **Cyanea.** A hardy perennial, each plant bearing 20 to 30 lavender-blue flowers, resembling cornflowers; 2 feet.....(Large pkt. \$0.30) 15

SWEET WILLIAM (Dianthus Barbatus)

- 2310 **Auricula Flowered.** A beautiful class of "eyed" single varieties, all colors mixed....oz. \$0.30 05
- 2312 **Single Mixed.** All colorsoz. .25 05
- 2314 **Double Mixed.** Finest colorsoz. .60 10

VINCA (Madagascar Periwinkle)

- 2375 **Alba.** White with rose eye.. (Large pkt. \$0.20) 10
- 2376 **Alba Pura.** Pure white..... (Large pkt. .20) 10
- 2377 **Rosea.** Rose with dark eye.. (Large pkt. .20) 10
- 2378 **Mixed** 1/4 oz. \$0.25 10

WALLFLOWER

- 2404 **Double Mixed.** All colors ... (Large pkt. .30) 10
- 2406 **Paris Extra Early.** A single variety, flowering first year from seed; mixed (L'ge pkt. \$0.20) 10
- 2408 **Single Mixed** All colors.....oz. \$0.30 05

MICHELL'S SWEET PEAS

For a complete list see page 59 of our General Catalogue for 1905. THE VARIETIES HERE OFFERED ARE THE CREAM OF THE LARGE FLOWERING VARIETIES. For early flowering, we advise planting in Autumn.

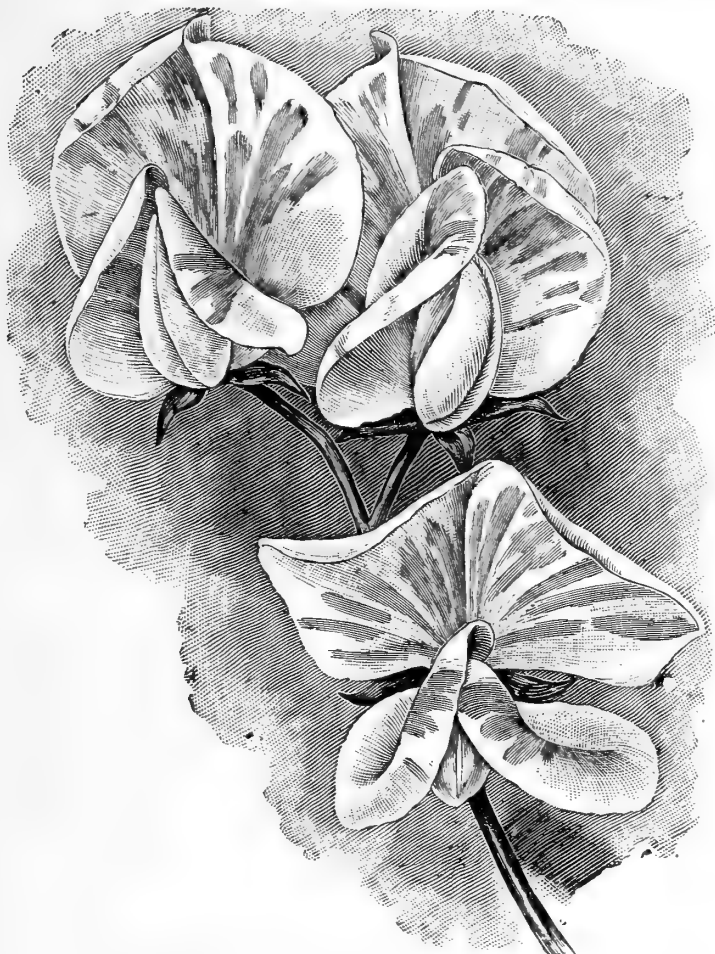

For complete list of Named Sweet Peas see page 59 of our Spring Catalogue.

Selected Named Varieties.

- Blanche Burpee.** Large pure white and of graceful form.
Blanche Ferry. Standard bright carmine rose, wings white tinged with pink.
Blanche Ferry. Extra Early. Same as above, but two weeks earlier.
Captain of the Blues. Standard purplish mauve, wings blue.
Countess of Radnor. Mauve standard, lavender wings, fine form.
Earliest of All. Standard rosy pink, wings creamy white, extra early.
Emily Henderson. Large pure white, early and profuse bloomer.
Hon. Mrs. E. Kenyon. A beautiful primrose color, one of the largest and best.
Katherine Tracy. Soft, but brilliant pink, very attractive.
Lady Grisel Hamilton. Standard light lavender, with azure blue wings.
Lord Kenyon. Self colored, bright rose pink, a fine large flower.
Lovely. Soft shell pink, large and extra fine.
Mars. Bright crimson scarlet, self colored.
Miss Willmott. Rich, deep orange pink, very large.
Mont Blanc. Large size, pure white, the earliest of all.
Mrs. Eckford. Primrose yellow, of large size and fine form.
Navy Blue. Dark indigo blue and violet, the best blue.
Othello. Very dark maroon, of fine form and large size.
Prince of Wales. Rose crimson, self-colored, of very large size.
Sadie Burpee. One of the largest whites.
Salopian. (Sunproof). The largest and best crimson scarlet.

Prices for any of the above named Sweet Peas.

5 cts. per pkt.; per oz., 10 cts.; 25 cts. per ¼ lb.; per lb., 75 cts.

SWEET PEAS IN MIXTURE

All of the Mixtures offered below have been made up by ourselves and cannot fail to give entire satisfaction.

MICHELL'S MAGNIFICENT MIXTURE.

This mixture is composed of all large flowering varieties in light colors, including many shades of pink, red, white, lavender, primrose, as well as striped, mottled, etc. The finest mixture obtainable and is sure to produce many new colors and shades.

Price, 5 cts. per pkt.; per oz., 15 cts.; 25 cts. per ¼ lb.; per lb., 80 cts.

MICHELL'S GILT EDGE MIXTURE.

ECKFORD'S LARGE FLOWERING.

Cannot fail to give entire satisfaction; contains the large flowering varieties in a wide range of colors. Price, 5 cts. per pkt.; per oz., 10 cts.; 20 cts. per ¼ lb.; per lb., 60 cts.

Michell's Booklet, "HOW TO GROW SWEET PEAS," free with all orders if asked for.

FERN BALLS

Ready in December.

Though not a novelty, the Fern Ball still holds its place among the collections of plants and ferns in conservatories, and even in the dwelling room. It is easily succeeded with. Cultural directions sent with each ball if asked for. See illustration of Fern Ball in foliage on rear inside cover page.

Price, Dormant Fern Balls, 40 cts. each; per doz., \$4.00; by mail, 50 cts. each.

" Started " " 60 cts. " " " 6.00.

Started Fern Balls cannot be sent by mail.

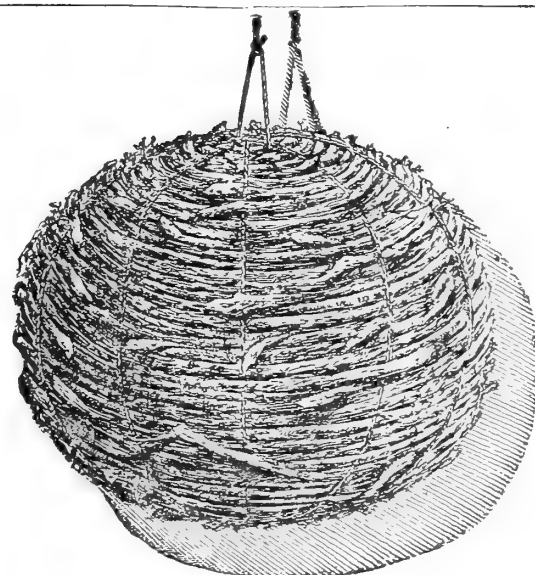

Dormant Japanese Fern Ball.

BE SURE AND ORDER ONE OF THE COLLECTIONS OF LATE TULIPS OFFERED ON PAGE 5.

FARM SEEDS OF CHOICEST QUALITY

PRICES SUBJECT TO MARKET CHANGES.

Our Farm Seeds are all carefully selected with a view of furnishing absolutely pure seed. Gentleman and commercial farmers may depend upon us for very best of quality.

CLOVERS. (All varieties, 60 lbs. per Bu.)

Add 18c. for each Two Bushel Sack (returnable).

	Per lb.	Per bu.	5 bushel lots Per bu.
Red. Finest re-cleaned seeds; free from dodder, etc. Sow 20 lbs. per acre	\$0.18	\$8.75	\$8.65
Crimson. Choicest Delaware grown seed. Sow 20 lbs. per acre	.12	5.75	5.65
Alfalfa. Our stock is Utah grown, the finest Alfalfa region. Sow 30 lbs per acre	.18	8.75	8.65
Alsike. Western grown; fine for mixing in Timothy. Sow 20 lbs. per acre	.18	8.75	8.65
White Dutch. Most desirable for lawn work, best grade. Sow 15 lbs. per acre	.25	13.20	13.00

TIMOTHY SEED.

Add 18c. for each Two Bushel Sack (returnable).

We are one of the largest handlers of **choice re-cleaned Timothy Seed** in the city. Our stock can be depended upon to be clean and free from fowl seed of any kind. Sow 1/2 bushel per acre, or with wheat 1 1/2 pecks. Price: \$2.10 per bu.; 5 bu. at \$2.05 per bu.; 10 bu. at \$2.00 per bu. (45 lbs. per bu.)

SPECIAL PRICE ON LARGER QUANTITIES.

SEED RYE.

Add 18c. for each Two Bushel Sack (returnable).

Penna. White Winter. This variety is a splendid yielder, large grain, stiff straw of fine quality. Sow 1 1/2 to 2 bushel per acre. Price: \$1.20 per bu.; 5 bu. at \$1.15 per bu.; 10 bu. at \$1.10 per bu. (56 lbs. per bu.)

SPECIAL PRICE ON LARGER QUANTITY.

DWARF ESSEX RAPE.

A highly valued farm plant; can be sown as late as September, and in a few weeks' time is suitable to turn pigs or sheep into. Sow 10 lbs. per acre if broadcast, or 6 lbs. in drills. 10c. per lb. (by mail, 18c.); 90c. for 10 lbs.; 50 lbs., \$3.25; \$6.25 per 100 lbs.



Crimson Clover.

CHOICE SEED WHEAT.

Our Seed Wheat is principally grown on the farms or estates of gentleman farmers who bear in mind the most important point in wheat growing, that is, well fertilized ground. Most of the wheat offered here has been engaged by us and has a record of having yielded from 36 to 40 bushels per acre. Sow 1 1/2 to 2 bushels per acre (60 lbs. per bushel).

Fultz-Mediterranean. A hybrid variety, a cross between the old reliable *Fultz* and the *Red Mediterranean (Bald)*. 50c. per peck; per bu., \$1.60; 5 bu. at \$1.55 per bu.; 10 bu. at \$1.50 per bu.

Fultz. A white bald variety, a big yielder of seed; straw very stiff. 50c. per peck; per bu., \$1.50; 5 bu. at \$1.45 per bu.; 10 bu. at \$1.40 per bu.

Dietz Longberry (Bearded). One of our best red wheats, largely in demand by millers. 50c. per peck; per bu., \$1.60; 5 bu. at \$1.50 per bu.; 10 bu. at \$1.45 per bu.

Jones Winter Fife (Bald). Very prolific, hardy red variety, long grain heads, fine straw. 50c. per peck; per bu., \$1.60; 5 bu. at \$1.55 per bu.

WE CAN ALSO FURNISH ALL OTHER VARIETIES OF WHEAT
SAMPLES AND PRICES ON LARGER QUANTITIES QUOTED.

WINTER VETCHES (*Vicia Villosa*).

Frequently called sand or hairy Vetch. Sow with rye for a nurse crop, 1/2 to 1 bushel per acre (60 lbs. per bu.) 15c. per lb. (by mail, 23c.); per bu., \$7.25.

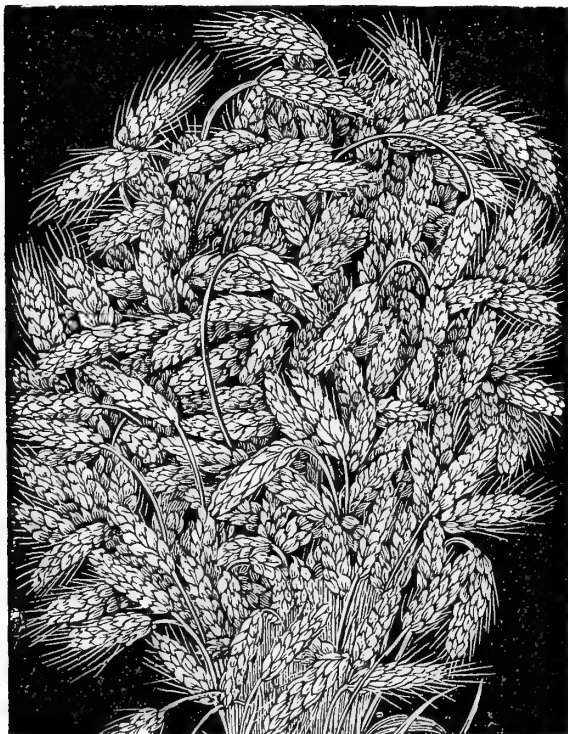

Dietz Longberry Wheat.

WE CAN ALSO FURNISH ALL OTHER VARIETIES OF FARM SEEDS.
WRITE FOR PRICES AND SAMPLES.

LAWN and PASTURE GRASS SEED

Our stock embraces the finest qualities of the various sorts. Any special mixture, for special purpose, compounded to order. Sow Grass Seed in summer, and with the aid of an occasional sprinkling a most beautiful lawn can be obtained before winter. Grass starts well in summer, as weeds and other obnoxious growth do not thrive at that time.

Michell's Non-Superior Evergreen Lawn Grass Seed. (20 lbs. per bushel.) Too well known to need description. The best lawn grass seed that exists for general use. Prices: Per qt., 25c.; 40c. for 2 qts.; 4 qts., 65c.; \$1.00 per pk.; per bu. of 20 lbs., \$4.00 (5 bu. lots at \$3.75 per bu.) (10 bu., \$3.50 per bu.) (50 bu., \$3.25 per bu.)

Michell's Shaded Lawn Grass Mixture. (20 lbs. per bushel.) Difficulty is frequently experienced in establishing a lawn where shade and other trees exist. This has been entirely overcome by the introduction of this fine formula. Prices: Per qt., 25c.; 40c. for 2 qts.; 4 qts., 65c.; \$1.00 per pk.; per bu. of 20 lbs., \$4.00 (5 bu. lots at \$3.65 per bu.) (10 bu., \$3.50 per bu.) (50 bu., \$3.25 per bu.)

Fairmount Park Lawn Seed. (15 lbs. per bushel.) A very fine mixture indeed. Prices: Per qt., 20c.; 35c. for 2 qts.; 4 qts., 50c.; 75c. per pk.; per bu. of 15 lbs., \$2.75 (5 bu. lots at \$2.50 per bu.) (10 bu., \$2.30 per bu.) (50 bu., \$2.20 per bu.)

Evergreen Grass with no Clover. (20 lbs. per bushel.) Many people do not like white clover in a lawn. Price: Per qt., 25c.; 40c. for 2 qts.; 4 qts., 65c.; \$1.00 per pk.; per bu. of 20 lbs., \$4.00 (5 bu. lots at \$3.65 per bu.) (10 bu., \$3.50 per bu.) (50 bu., \$3.25 per bu.)

Michell's Seashore Formula Grass Seed Mixture. (20 lbs. per bushel.) The salt atmosphere plays havoc with the seashore lawn, and unless the proper formula of seed is sown, trouble is sure to come. Prices: Per qt., 25c.; 40c. for 2 qts.; 4 qts., 65c.; \$1.00 per pk.; per bu. of 20 lbs., \$4.00 (5 bu. lots at \$3.65 per bu.) (10 bu., \$3.50 per bu.) (50 bu., \$3.25 per bu.)

Michell's Terrace or Embankment Grass Seed Mixture. (20 lbs. per bushel.) A serious problem that always confronts the gardener after a rainstorm is the replacing of washed-out places in the terraced lawn. Prices: Per qt., 25c.; 40c. for 2 qts.; 4 qts., 65c.; \$1.00 per pk.; per bu. of 20 lbs., \$4.00 (5 bu. lots at \$3.65 per bu.) (10 bu., \$3.50 per bu.) (50 bu., \$3.25 per bu.)

Michell's Golf Course Grass Seed Mixture. (15 lbs. per bushel.) There's no dread of defeat on the fair greens or links where this seed is sown. Prices: Per qt., 20c.; 35c. for 2 qts.; 4 qts., 50c.; 70c. per pk.; per bu. of 15 lbs., \$2.50 (5 bu. lots at \$2.25 per bu.) (10 bu., \$2.15 per bu.) (50 bu., \$2.00 per bu.)



VIEWS

1. Michell's Evergreen Lawn Seed.
2. Michell's Shaded Lawn Seed.
3. Michell's Pasture Grass Seed.



Michell's Putting Greens Mixture. (20 lbs. per bushel.) Made up especially from such grasses as will grow very short. Prices: Per qt., 25c.; 40c. for 2 qts.; 4 qts., 65c.; \$1.00 per pk.; per bu. of 20 lbs., \$4.00 (5 bu. lots at \$3.65 per bu.) (10 bu., \$3.50 per bu.) (50 bu., \$3.25 per bu.)

Lawn Tennis and Polo Grass Seed Mixture (Michell's). (20 lbs. per bushel.) The game can be enjoyed much better when the proper grass (where grass is still used on tennis courts) is under foot. Prices: Per qt., 25c.; 40c. for 2 qts.; 4 qts., 65c.; \$1.00 per pk.; per bu. of 20 lbs., \$4.00 (5 bu.

lots at \$3.65 per bu.) (10 bu., \$3.50 per bu.) (50 bu., \$3.25 per bu.)

GRASS MIXTURES FOR FIELDS

Michell's Permanent Pasture and Hay Grass Mixture. (20 lbs. per bushel.) A composition of varieties of grasses best suited to the purpose named. Prices: Per qt., 20c.; 50c. for 4 qts.; per pk., 85c.; \$3.00 per bu. of 20 lbs. (5 bu. lots at \$2.75 per bu.) (10 bu., \$2.60 per bu.) (50 bu., \$2.40 per bu.)

Exposition or Quick Growth Mixture. (15 lbs. per bushel.) Prices: Per qt., 20c.; 30c. for 2 qts.; per pk., 65c.; \$2.25 per bu.

MICHELL'S GRASS SEEDS ARE RENOWNED FOR PURITY AND QUALITY

MICHELL'S GRASS SEEDS

GRASSES IN SEPARATE VARIETIES

If wanted by mail add 8c. per lb. to prices quoted.

	Lb.	Bu.	100 Lbs.		Lb.	Bu.	100 Lbs.
Awnless-Brome Grass (<i>Bromus inermis</i>). A valuable grass for light, dry soils. Will stand long droughts and produce heavy growths where other grasses frequently fail. Forty lbs. to the acre. Bu. (14 lbs.)	\$0.20	\$2.50	\$12.50	Herd or Red Top Grass. Very popular for field use. Bu. (10 lbs.)	\$0.15	\$1.00	\$8.00
Blue Grass (Kentucky). Extra fancy cleaned. One of the most valuable sorts for lawn purposes, and as a pasture grass is indispensable. This grade is best for sowing lawns. Sow 3 to 5 bu. per acre for lawn; for pasture sow 2½ bu. Bu. (14 lbs.) Qt. 15c.20	1.75	12.00	Italian Rye Grass. An annual quick in maturing. Bu. (22 lbs.)12	2.25	8.50
Creeping Bent Grass (<i>Agrostis stolonifera</i>). Excellent for lawns, succeeds well in all locations, makes a low velvety growth. Bu. (20 lbs.)25	4.50	20.00	Meadow Fescue. English Blue Grass. An excellent grass for permanent pasture or hay. Bu. (22 lbs.)20	3.25	14.00
Canadian Blue Grass. Adapted especially to high, dry situations. Fine for permanent pasture. Bu. (14 lbs.)15	1.60	9.50	Meadow Foxtail. An elegant pasture grass. Bu. (7 lbs.)30	1.90	23.00
Crested Dogtail. An excellent grass for hard, dry soils, valuable for pastures or lawns, 25 lbs. to acre. Bu. (21 lbs.)35	6.00	25.00	Natural Green Grass. Largely used on lawn and field. Bu. (14 lbs.)20	2.00	12.00
English Rye Grass (Perennial Rye). Fine for an immediate effect. Bu. (24 lbs.)18	2.00	8.00	Orchard Grass. For pasture, sowing under orchards or shady places. Bu. (14 lbs.)20	2.25	13.00
Fancy Herd or Red Top. Extra re-cleaned seed, free from chaff. Bu. (32 lbs.)20	4.50	12.50	Rhode Island Bent Grass (<i>Agrostis Canina</i>). Resembles Herds Grass, forming a fine turf even on thin soils. Doing especially well in salt atmospheres. The only Lawn Grass used at Newport. Sow forty lbs. to the acre. Bu. (15 lbs.)30	4.00	25.00
Hard Fescue. Thrives well in dry situations, where many other grasses fail; 30 lbs. to the acre. Bu. (12 lbs)25	2.75	17.00	Sheep's Fescue (<i>Festuca Ovina</i>). Sow forty lbs. to the acre. Bu. (12 lbs.)20	2.25	16.00
				Sweet Vernal (Perennial). Very fragrant. Five lbs., \$2.5065		
				Sweet Vernal (Annual) Five lbs., \$1.0025		
				Timothy Seed. Prime10	2 10	
				Wood Meadow Grass (<i>Poa Nemoralis</i>). Particularly adapted for pleasure grounds and lawns; will grow under trees where few other grasses can exist. Bu. (14 lbs.)35	4.25	27.50

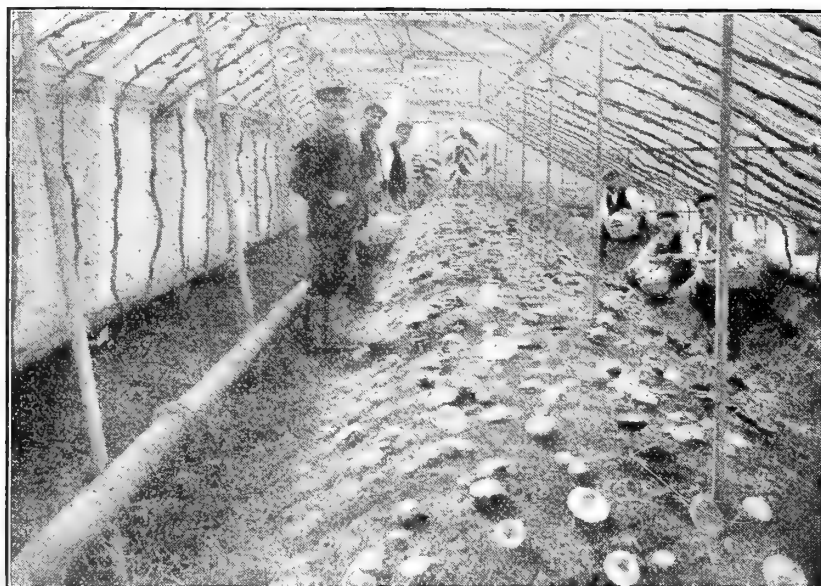

Mushrooms from Michell's English Superior Mushroom Spawn

MICHELL'S MUSHROOM SPAWN

We are the largest importers of mushroom spawn in Philadelphia. We receive during the making season shipments every two weeks, thus insuring our patrons fresh spawn, whereby good results can be obtained. Our English Spawn is hard to equal, being made by one of the most reputable manufacturers in England.

PRICES:

Per brick	\$ 0.15	Per 100 lbs.	\$ 8.00
Per brick, postpaid.25	Per 250 lbs.	17.50
12 bricks	1.60	Per 1000 lbs.	60.00
25 lbs.	2.50		

Books on Growing Mushrooms

Pamphlet (gratis for a postal card asking for it)	
Robinson's Book (postpaid)	\$0.50
Falconer's Book	1.00

TESTIMONIAL

I had another record-breaking mushroom bed which bore 4 months. Some of the mushrooms weighed ¼ lb. each. Of course the spawn was from you. Mr. Dick concluded he had never seen such a crop.

Gardener to Col. S. B. Dick, Esq.,
Meadville, Pa

JAS. DOGGETT, Jr.

PURE CULTURE MUSHROOM SPAWN

We have made arrangements to represent the most experienced and reliable maker of Pure Culture Spawn. This brand of spawn is the result of careful and scientific experimenting, being produced in an entirely different manner than the English, the brick of compost being inoculated by the tissues or fibres of finest selected mushrooms and allowed to go through a process of developing in manure before inserting in the bricks at the time of manufacturing. It has promised big returns, having been tested thoroughly and pronounced a perfect success. The spawn is claimed to produce larger, whiter and more abundantly fine quality of mushrooms.

Prices of Pure Culture Spawn:

Per brick	\$0.30	10 bricks	\$2.20
Per brick, postp'd45	25 bricks.	5.00
6 bricks.	1.25	50 bricks.	9.00

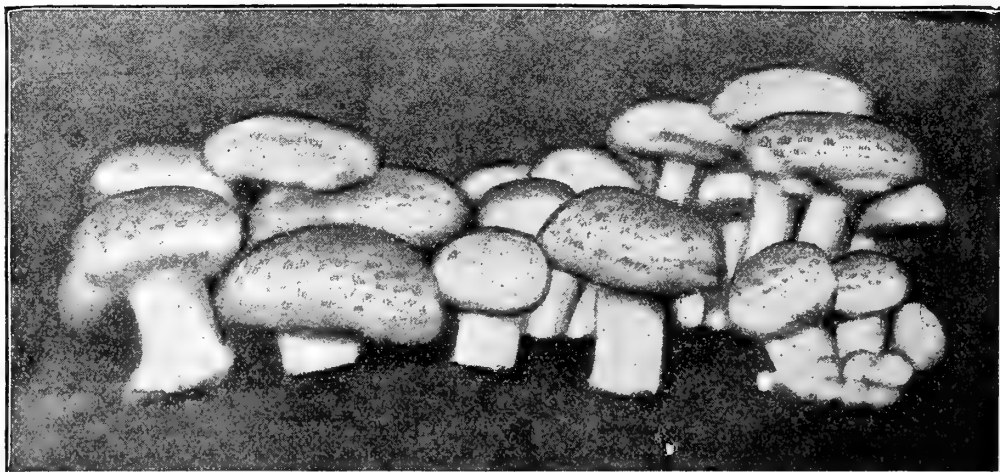

Mushrooms from Michell's Pure Culture Mushroom Spawn.

VEGETABLE SEEDS FOR FALL SOWING.

ASPARAGUS ROOTS.

FOR AUTUMN PLANTING—READY IN OCTOBER.

Barr's Mammoth and Conover's Colossal. Extra strong two-year-old roots. Per 100, 75 cts.; per 500, \$3.00; per 1000, \$5.00.

Columbian Mammoth White. 80 cts. per 100; per 1000, \$5.00.

BEETS.

Eclipse. Per pkt., 5 cts.; per oz., 10 cts.; per $\frac{1}{4}$ lb., 20 cts.; per lb., 60 cts.

Crimson Globe. Per pkt., 5 cts.; per oz., 10 cts.; per $\frac{1}{4}$ lb., 30 cts.; per lb., 80 cts.

Crosby's Egyptian. Per pkt., 5 cts.; per oz., 10 cts.; per $\frac{1}{4}$ lb., 25 cts.; per lb., 75 cts.

BEANS—For Forcing.



EMPEROR WILLIAM FORCING BEAN.

Emperor William

Fine, Green Pod.

60 cts. per qt.

Sion House.

Improved. One of the best and most desirable. 60 cts. per qt.

CABBAGE

Early Jersey Wakefield.

The best for early use; of excellent quality, good size and sure to head; extra fine selected stock. Per pkt., 10 cts.; per oz., 30 cts.; per $\frac{1}{4}$ lb., \$1.00.

Henderson's Early Summer. A second early sort with large solid heads, coming in a few days later than the Wakefield. Per pkt., 10 cts.; per oz., 25 cts.; per $\frac{1}{4}$ lb., 75 cts.

Large Jersey Wakefield. Per pkt., 10 cts.; per oz., 30 cts.; per $\frac{1}{4}$ lb., \$1.00.

CAULIFLOWER.

Sow for early use about middle of September or October in a bed of rich earth; transplant in frames, cover with sashes and shutters during severe weather, giving light and air every mild day.

Early Snowstorm. The earliest and best of all for forcing; must be kept growing constantly; will not stand a check at any period of its growth. Per pkt., 25 cts.; per $\frac{1}{4}$ oz., \$1.50.

Selected Dwarf Erfurt. Per pkt., 20 cts.; per $\frac{1}{4}$ oz., 75 cts.

Lenormand's Short Stem. Per pkt., 10 cts.; per oz., 65 cts.

Veitch's Autumn Giant. Per pkt., 10 cts.; per oz., 65 cts.

Snowball. Per pkt., 20 cts.; per $\frac{1}{4}$ oz., 75 cts.

Algier's Giant. Per pkt., 10 cts.; per oz., 75 cts.

CARROT.

Early Short Horn or French Forcing. Per pkt., 5 cts.; per oz., 10 cts.; per $\frac{1}{4}$ lb., 30 cts.; per lb., \$1.00.

CUCUMBER—English Prize.

Sow the seeds in small pots about the middle of January; when they have grown to three leaves plant in prepared hill of rich, loose soil in the centre of a sash.

Rochford's Market. Per pkt., 20 cts.

Marquis of Lorne. Per pkt., 20 cts.

Tender and True. Per pkt., 20 cts.

Long Gun (Pierson's). The best of all. Per pkt., 20 cts.

Telegraph. Per pkt., 20 cts.

Covent Garden. Per pkt., 20 cts.

Sion House. Per pkt., 20 cts.

ALSO ALL OTHER VARIETIES.

CORN SALAD—Fetticus.

Large Seeded. Best garden sort. For Winter and early Spring use, sow in drills in August and September. Per pkt., 5 cts.; per oz., 10 cts.; per $\frac{1}{4}$ lb., 20 cts.; per lb., 60 cts.

KALE.

For early use sow in September. Protect in Winter with straw or litter.

Dwarf Green Curled German. Leaves green, finely fringed. Per pkt., 5 cts.; per oz., 10 cts.; per $\frac{1}{4}$ lb., 25 cts.; per lb., 75 cts.

Imperial Long Standing. A first-class curled sort. Per pkt., 5 cts.; per oz., 10 cts.; per $\frac{1}{4}$ lb., 25 cts.; per lb., 75 cts.

LETTUCE. (A few leading sorts for forcing.)

"All-Right" Spring and Autumn. (Michell's). Pkt., 10c.; oz., 25c.; $\frac{1}{4}$ lb., 75c.; lb., \$2.50.

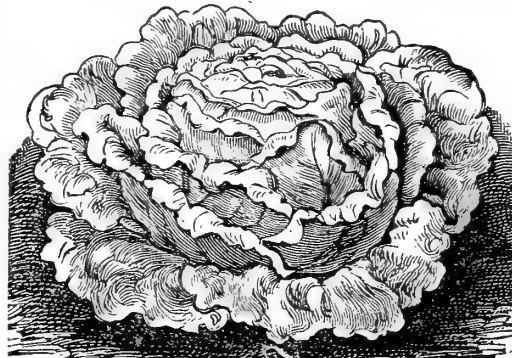

ALL-RIGHT LETTUCE.

Big Boston. Pkt., 5c.; oz., 20c.; $\frac{1}{4}$ lb., 65c.; lb., \$2.00.

Forcing Emperor.

Pkt., 5c.; oz., 20c., $\frac{1}{4}$ lb., 50c.; lb., \$1.75

Early Tennisball.

Pkt., 5c.; oz., 15c.; $\frac{1}{4}$ lb., 40c.; lb., \$1.25.

Boston Market.

Pkt., 5c.; oz., 15c.; $\frac{1}{4}$ lb., 40c.; lb., \$1.50.

Early Dutch Butter, Spotted. Pkt.

5c.; oz., 20c.; $\frac{1}{4}$ lb., 50c.; lb., \$1.50.

MUSK MELONS.

FOR FORCING.

We offer two of the best English sorts, deliciously sweet and fragrant. Fruit should be supported in net if vines are growing with suspended fruit.

Blenheim Orange.

25 cts. per pkt.

Windsor Castle.

25 cts. per pkt.

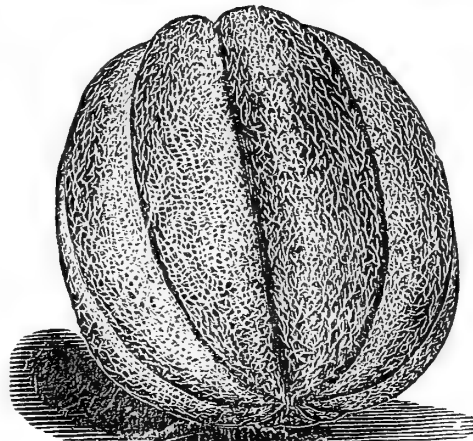

BLENHIM ORANGE.

PARSLEY.

Double Curled Covent Garden. Pkt., 5 cts.; oz., 10 cts.; $\frac{1}{4}$ lb., 30 cts.; lb., \$1.00.

RADISH.

Cardinal or Scarlet Globe. One of the very best for forcing. Pkt., 5 cts.; oz., 10 cts.; $\frac{1}{4}$ lb., 25 cts.; lb., 80 cts.

Round Red Forcing, or Button. Pkt., 5 cts.; oz., 10 cts.; $\frac{1}{4}$ lb., 25 cts.; lb., 75 cts.

Round White Forcing. Pkt., 5 cts.; oz., 10 cts.; $\frac{1}{4}$ lb., 25 cts.; lb., 75 cts.

Fireball. Pkt., 5 cts.; oz., 10 cts.; $\frac{1}{4}$ lb., 25 cts.; lb., 75 cts.

Early French Breakfast. Pkt., 5 cts.; oz., 10 cts.; $\frac{1}{4}$ lb., 25 cts.; lb., 70 cts.

White Box. (Philadelphia). Pkt., 5 cts.; oz., 10 cts.; $\frac{1}{4}$ lb., 25 cts.; lb., 70 cts.

White Box. (Felton's Private Stock). Pkt., 5 cts.; oz., 15 cts.; $\frac{1}{4}$ lb., 30 cts.; lb., \$1.00.

SPINACH.

Victoria. A new variety; dark green leaves; long standing. We can recommend this very highly. Oz., 5 cts.; $\frac{1}{4}$ lb., 15 cts.; lb., 35c.; \$1.50 for 5 lbs.

Bloomsdale Round-seeded Savoy. The best for family purposes. Oz., 5 cts.; $\frac{1}{4}$ lb., 15 cts.; lb., 35c.; 5 lbs., \$1.50.

Long Standing Round-seeded. Oz., 5 cts.; $\frac{1}{4}$ lb., 15 cts.; lb., 35c.; 5 lbs., \$1.50.

Prickly Seeded. Oz., 5 cts.; $\frac{1}{4}$ lb., 15 cts.; lb., 35 cts.

TOMATO—For Forcing.

Sutton's Best of All. Original true stock. Pkt. 40 cts.

Sutton's Eclipse. Original true stock. Pkt., 40 cts.

Lorillard. Pkt., 10 cts.; oz., 30 cts.

Frogmore. An old English variety. 25 cts. per pkt.

Stone. Pkt., 10 cts.; oz., 25 cts.

Mayflower. Pkt., 10 cts.; oz., 30 cts.

ALSO ALL OTHER VARIETIES.

RUBBER HOSE.

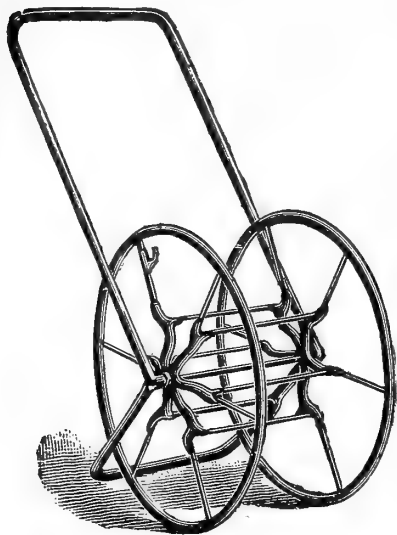

WIRTS' IRON HOSE REEL.

This is an extensive branch of our business. The very large quantity we handle enables us to supply our customers the best hose at lower prices than sold for elsewhere.

We couple our hose free.

	Per foot
Red Cross Brand 3/4 in.	7 1/2c.
Standard Brand. 3/4 in.	11c.
Micell's Reliable Brand. 3/4 in., 3 ply, with our guarantee	13c.
Chicago Electric (New) 3/4 in., 4 ply, " "	16c.
Wire Wrapped 3-Ply 3/4 in.	17c.
"Cyclone." 1/2 in.	11c.

Wirts' All Iron HOSE REELS Very Durable

No. 10. Holds 75 feet	\$2.75
No. 20. Holds 100 feet	3.00
No. 30. Holds 250 feet	5.00
Sylph Reel. Holds 200 feet	2.25
Champion Reel. Holds 100 feet	.85

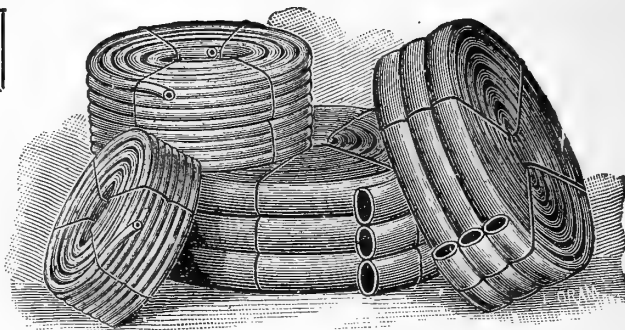

MICHELL'S GUARANTEED HOSE.

GALVANIZED WATERING CANS.

The best and most durable watering pot made. Each has two roses—one fine and one coarse.

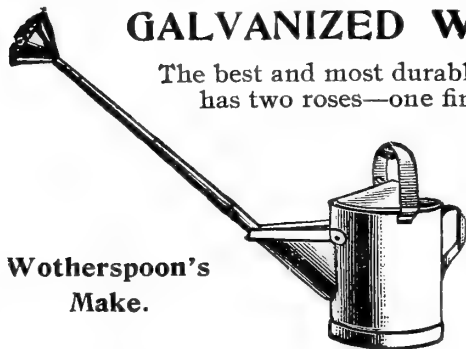

Wotherspoon's Make.

	Round	Oval
4 quart	\$1.60	
6 "	1.85	\$2.10
8 "	2.00	2.35
10 "	2.25	2.60
12 "	2.60	2.85
16 "	3.15	

Galvanized Iron Clad Watering Cans	
4 quart, ea.	\$0.40
6 " "	.50
8 " "	.60
10 quart, ea.	\$0.65
12 " "	.75
16 " "	.95

The Iron Clad watering can have but one rose each.

MODEL LAWN SWEEPER.

Just what is wanted on every private place, very neat and substantial in construction; sweeps a swath 20 in. wide, has box for carrying the rubbish swept up which can be readily emptied in a moment. Price, \$11.00 each.

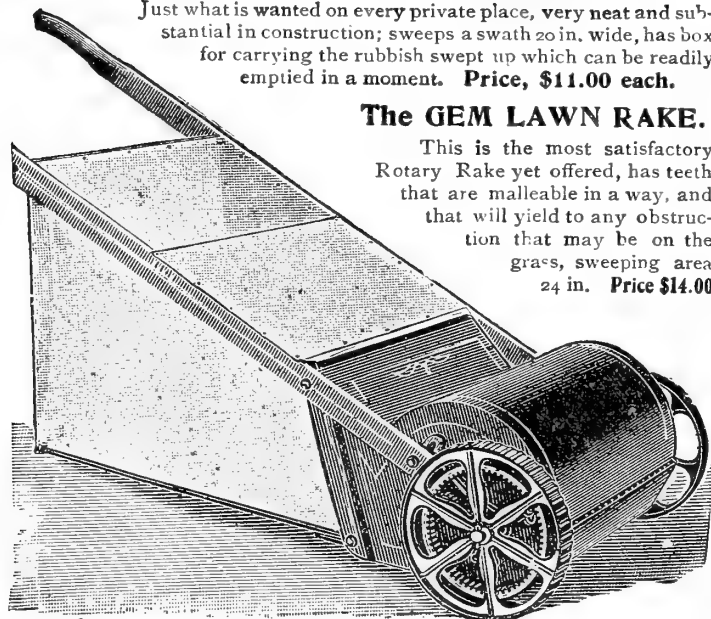

Model Lawn Sweeper.

The GEM LAWN RAKE.

This is the most satisfactory Rotary Rake yet offered, has teeth that are malleable in a way, and that will yield to any obstruction that may be on the grass, sweeping area 24 in. Price \$14.00.

LAWN RAKES.

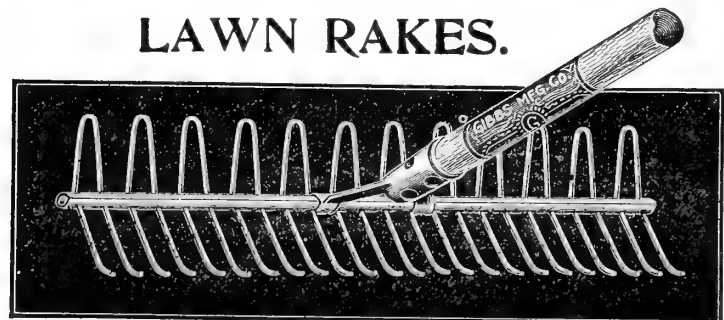

GIBBS' RAKE.

Lawn King 50 teeth, 4 feet long	\$1.00	Automatic, 22 teeth	\$.60
" " 38 " "	.75	" " 26 " "	.70
" " 26 " "	.50	" " 38 " "	1.00
" " 22 " "	.40	Regular Wooden Lawn and Straw Rakes, each	.35
Gibbs' 24 in., 50c.; 48 in., \$1.00		Coldwell	Each, .50

HOSE NOZZLES, 25c., 35c., 40c. each



Boston Spray Nozzle.

Made of Copper.

Fine or coarse spray 50c. each

LEAF RACK.

Light and durable. Can be easily folded and detached and the truck used with water barrel.

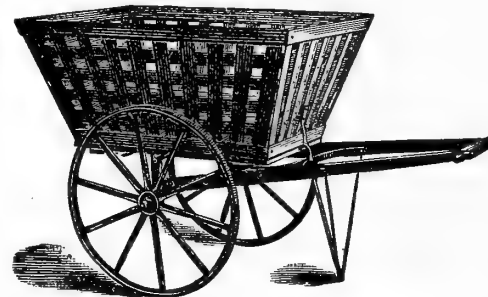

1 1/2 in. wheel	\$ 9.75
2 1/2 in. " "	10.50
3 1/2 in. " "	11.25

Leaf Rack only \$4.25.

EASTERN GARDEN BARROW

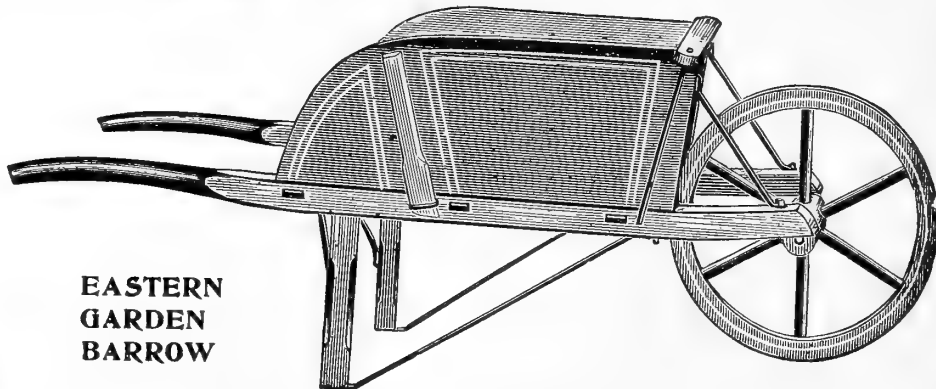

WHEEL BARROWS.

Strong and Light Running.

Eastern, No. 4—Broad (3 inch) tire	\$4.00	Jacobs, No. 2	\$3.25
" " 5— " " "	4.50	" " 3	3.75
Boys, extra strong	each, 3.00	" " "	4.25
Special Greenhouse	" 5.00	Canal Side Dump	2.50

Warren Automatic Self-Cleaning Rake, 75c. each.
Ole Olsen, 75c. each.
Ames, 16 teeth, 55c. each.
" 24 teeth, 70c. each.

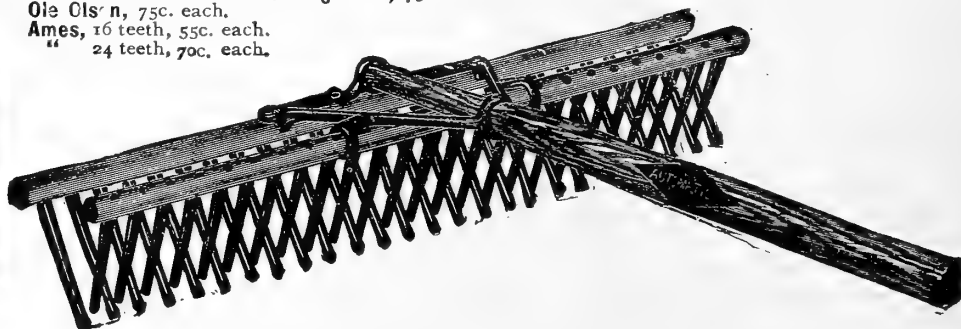

Automatic Self-Cleaning Rake.

FLOWER POTS, PLANT TUBS, ETC.



Standard Flower Pots.

Full inside measurement, height and width.

No charge for barrels or packing.

6 supplied at dozen rates. 50 supplied at 100 rates.

500 supplied at 1000 rates.

Size, inches height and width inside	Per doz.	Per 100	Per 1000	Size, inches height and width inside	Each	Per doz.	Per 100	Per 1000
2	\$.07	\$.50	\$3.96	5 1/2	\$.41	\$3.13	\$24.75	
2 1/4	.08	.56	4.45	6	\$.05	49	3.75	29.70
2 1/2	.09	.69	5.45	6 1/2	.07	62	4.80	44.00
3	.11	.88	6.93	7	.08	78	6.00	55.00
3 1/2	.14	1.06	8.41	8	.11	1.09	8.40	77.00
4	.18	1.38	10.89	9	.16	1.56	12.00	110.00
4 1/4	.20	1.56	12.37	10	.22	2.11	16.20	148.50
4 1/2	.24	1.88	14.85	11	.29	2.81	21.60	
5	.32	2.50	19.80	12	.40	3.90	30.00	
We can also supply the Hand Made Pots.				14	.80	7.80	60.00	
				16	1.50	16.50		

"NEPONSET" Flower Pots.

(Water-Proof Paper.)

Used principally for shipping plants and for temporary potting.

Size	Per doz.	Per 100	Per 1000
2 1/4	\$.08	\$.25	\$ 2.20
2 1/2	.10	.30	2.40
3	.12	.45	3.90
3 1/2	.18	.60	5.15
4	.20	.80	6.90
4 1/2	.25	1.20	10.35
5	.30	1.65	14.55

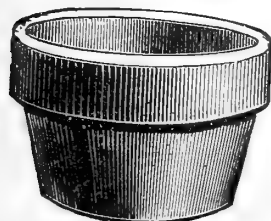

Bulb Pans.

(Earthenware).

Diameter	Each	Per doz.	Per 100
6 in.	\$.07	\$.68	\$3.75
7 "	.08	.78	4.80
8 "	.10	.98	6.00
9 "	.15	1.30	8.40
10 "	.20	1.63	10.80
12 "	.25	2.28	15.00
14 "	.50	4.55	30.00
16 "	.90	7.80	60.00
28 "	1.25	11.70	90.00

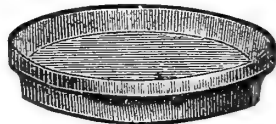

Pot Stands or Saucers.

Each	Per doz.	Per 100
4 in.	2c	\$.15
5 "	3 "	.18
6 "	4 "	.24
7 "	5 "	.31
8 "	6 "	.47
9 "	8 "	.62
10 "	9 "	.78
11 "	11 "	.94
12 "	15 "	1.17
14 "	25 "	1.95

SEED PANS (Earthenware).

6 in. each 20c. \$2.00 doz. 10 in. each 30c. \$3.00 doz.
8 " " 25 " 2.50 " 12 " " 40 " 3.50 "

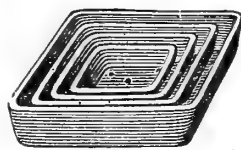

FERN PANS.

Width	Height	Each	Per Doz.	Per 100
4 in.	1 1/4 in.	\$.04	\$.31	\$1.65
4 1/4 "	2 1/8 "	.05	.33	2.20
5 1/4 "	2 1/4 "	.06	.41	2.75
6 1/4 "	2 3/4 "	.07	.49	3.30
7 "	2 7/8 "	.09	.55	3.85
8 "	3 1/8 "	.11	.79	5.50
9 "	3 1/4 "	.15	.95	6.60

PLANT TUBS OF FIBRE

Unbreakable, cannot Rot
Mahogany Green Enamel
Finish. Each Finish. Each
12 1/2 inch. \$0.90 10 in. with Saucer, \$0.80
13 1/2 " 1.10 12 " " " 1.00
19 " 1.75 14 " " " 1.60
21 1/2 " 2.00

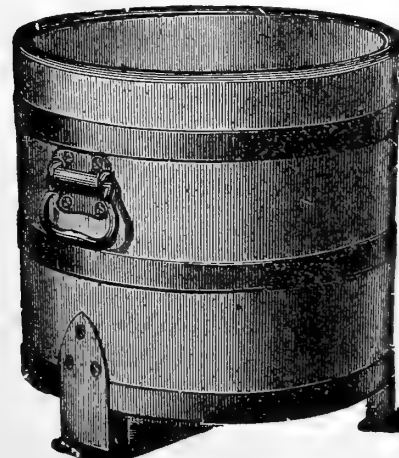

Improved White Cedar Plant Tub

Made of white cedar, bound with extra heavy iron hoops. Drop handles of special pattern, serving as hooks. Substantial iron feet of original design. Removable perforated bottoms, painted green outside and brown inside

No.	Outside diam.	Length of stave	Price
0	27 in.	24 in.	\$5.00
1	25 "	22 "	4.50
2	23 "	20 "	4.00
3	21 "	18 "	3.50
4	19 1/2 in.	16 "	2.75
5	18 "	14 "	2.50
6	16 1/2 "	13 "	2.00
7	15 "	12 "	1.75
8	12 "	10 "	1.50

Cedar Plant Tub.

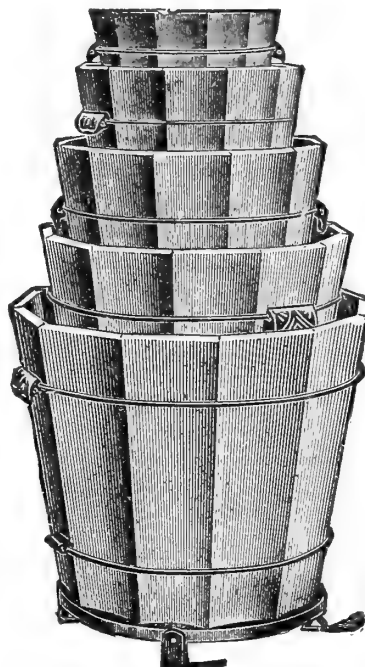

Columbia Tub.

NOTICE. Diameters of Tubs are Outside Measurements.

Columbia Plant Tubs.

12 in. diam. x 11 in. high.	\$1.00
15 " " x 14 " "	1.50
18 " " x 16 " "	2.00
21 " " x 18 " "	2.50
24 " " x 20 " "	3.00

"Excelsior" Plant Tubs.

Made of cypress, painted green, iron feet.
No. 1, 13 in. diam., 11 in. staves, price, \$1.00
No. 2, 14 1/2 " " 13 " " " 1.35
No. 3, 16 " " 15 " " " 1.60
No. 4, 20 " " 18 " " " 2.50
No. 5, 24 " " 21 " " " 3.00

CUT FLOWER VASES

Made of Wood Fibre. Unbreakable

No.	Diam. in. inside	Depth in. inside	Each	Per doz.
0	8	13	\$.45	\$4.80
1	5 1/2	10	.40	4.20
2	4 1/2	9	.35	3.60
3	4	6	.30	3.00
4	3	4 1/2	.25	2.40
00	9	21	.90	9.00
11	5	18	.60	6.00
22	4 1/2	15	.45	4.80
33	4	12	.40	4.20
44	3	9	.35	3.60
000	9	29	1.75	18.00

Flower Pot Saucers—Made of Wood Fibre.

UNBREAKABLE.

WATERPROOF.

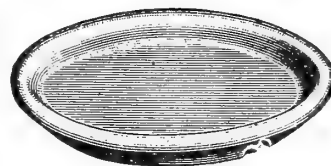

Size	Each	Per doz.	Per 100.
4 in.	8c.	\$.90	\$7.13
5 in.	9c.	.95	7.37
6 in.	10c.	.96	7.60
7 in.	11c.	1.04	8.36
8 in.	12c.	1.14	8.93
9 in.	13c.	1.26	9.88
10 in.	14c.	1.32	10.45
12 in.	15c.	1.56	12.35
14 in.	16c.	2.04	16.15
16 in.	30c.	3.60	28.50
18 in.	35c.	4.20	33.25

ROLLING STANDS.

For Heavy Plants and Palms. Made of Indurated Fibre Ware.

Will not soak or rust. Casters have ball bearings. Every heavy plant sold needs one to save carpets and floors.

Size	Pot.	Will Fit Tub. No.	Each	Doz.
12 in.	10 in.	No. 8	\$.50	\$5.70
14 in.	12 "	" 8	.60	6.84
16 in.	14 "	" 8	.75	8.55
18 in.	16 "	" 7-6	.85	9.50
20 in.	" "	5	1.00	11.40
22 in.	" "	4	1.20	14.25

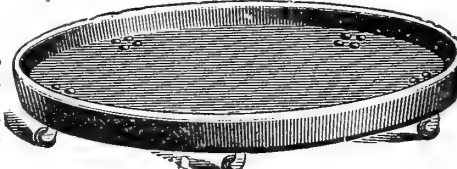

Pot Hangers.

The best device for lifting plants in and out of jardineres; also for suspending plants, such as Asparagus Sprengeri, Ferns, etc.

- No. 1. 40 cts. per doz. for 3 to 5 inch pots.
- No. 2. 50 cts. per doz. for 6 and 7 inch pots.
- No. 3. 60 cts. per doz. for 8 to 10 inch pots.

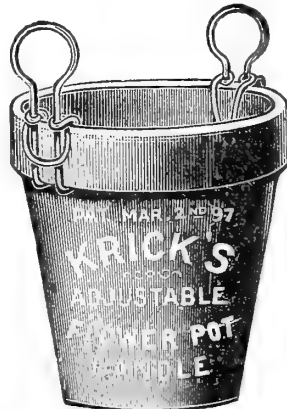

Wood Orchid Baskets.

Size	Each	Per doz.
6 in.	\$.30	\$3.50
8 "	.40	4.25
10 "	.50	5.00
12 "	.60	6.50

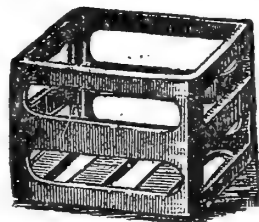

Orchid Baskets (Earthenware.)

Size	Each	Per doz.	Size	Each	Per doz.
Square, 4 in.	\$.15	\$1.35	Round, 6 in.,	\$.20	\$1.80
" 6 "	.25	2.25	" 8 "	.30	2.50
" 7 "	.30	3.00	" 10 "	.40	3.60

Cork Bark—for Orchids, 30 cts. per lb.

The New
Patent
"Superior"
Enameled
Iron Plant
Stands.



The New "Superior" Iron Plant Stand showing a Palm in TILTING Position.

This is the very best and only stand that fills a long felt want. You can tilt and set your plants at any angle desired to produce the proper decorative effect.

Height	Size of Plates	Price	Height	Size of Plates	Price
12 inch	5x7	\$0.85	36 inch	8x10½	\$1.55
18 "	5x7	.95	36 "	8x12	1.65
18 "	8x10½	1.05	42 "	8x10½	1.75
24 "	8x10½	1.15	42 "	8x12	1.80
24 "	8x12	1.25	48 "	8x12	1.85
30 "	8x10½	1.35	60 "	8x12	1.95
30 "	8x12	1.45	72 "	8x12	2.05

"STAR" IRON PLANT STANDS.

Somewhat similar to the above, excepting that they are not fitted with the tilting device, and are finished in black varnish.

12 inches high	\$0.70	30 inches high	\$1.15
18 " "	.80	36 " "	1.40
24 " "	.95	42 " "	1.55

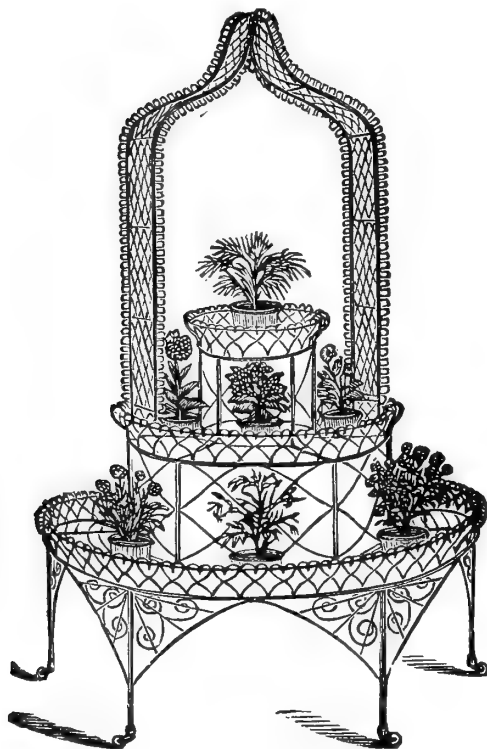

WIRE
Plant Stands.

Painted green and bronzed. Without Arch.

1 step	\$2.00
2 "	2.75
3 "	3.75
3 " ½ round with Arch	5.00

WOODEN
Plant Stands.

Very neat and durable.

3 shelves	each, \$1.25
4 " "	1.75

PEERLESS GLAZING POINTS.

(See Cut)

These are made of steel wire and galvanized. No rights and lefts. Per box of 1000, 60c.; 5000 lots at 55c. per 1000. Pincers for driving, 50c.

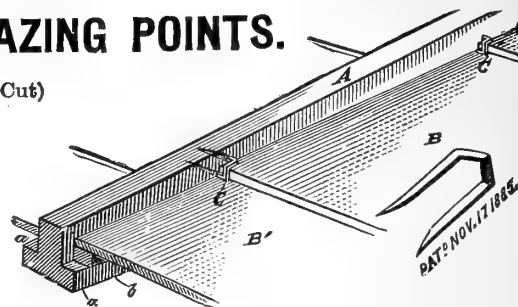

- Siebert's Popular Glazing Points. 40c. per lb.
- Bruen Glazing Points. 45c. per lb.
- Michell's New T Points. 90c. per lb.
- Zinc Nails. 20c. per lb.
- Brass Peerless Points. \$1.00 per 1000.

HOT BED SASH.

Special price will be quoted on quantities, also on glazed and painted complete sash. Price fluctuates; ask for same before purchasing elsewhere. 3 ft. 2 in. x 6 ft. 2 in., unglazed, about \$1.40 each.

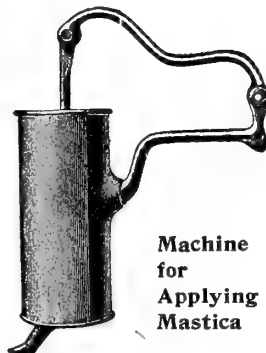

Machine for Applying Mastica

For Glazing Greenhouses, new or old. Per gallon, \$1.25; ½ gallon, 70c.; 5 gallons, \$5.75.

MASTICA.

MACHINES FOR APPLYING MASTICA.

Each \$1.25

TWEMLOW'S ENGLISH PUTTY.

For Glazing.

16 pound can	\$1.25
50 " kit	3.75
80 " kit	6.00



PUTTY BULBS.

Used for applying Putty when Glazing.

Each \$1.00

STEEL WHEEL GLASS CUTTERS (Very Good).

Single wheel, 15c. each; 6 wheel, 30c. each.

UNIVERSAL GLAZIERS' DIAMOND.

Hold the Diamond against the ruler. Place it so that the Diamond and Guide Wheel rest on the glass, Wheel towards you. Press on it gradually, until it makes a singing sound, not a harsh noise. Draw over the glass slowly and uniformly; never cut twice in the same place.

- Ebony handle \$3.00
- Cocoa handle with extra large diamond 4.00

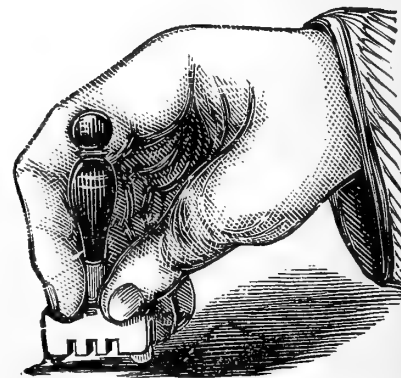

PLANT BED CLOTH.



A Substitute for Glass Sash on Hot-beds and Cold Frames.

- Light Grade.** Mostly used for shading greenhouses. Per yard, 4c.; by the piece of 68 yards, 3½c. yard.
- Medium Grade.** The best for general purposes. Yard, 8c.; by the piece of 50 yards, 7c. yard.
- Heavy Grade.** Water-proof and advised for protecting and dense shading. Per yard, 10½c.; by the piece of 40 yards, 10c. per yard.

MISCELLANEOUS SUPPLIES

HOT BED MATS.



Palmer's Burlap—Frost Proof.

Made expressly for Winter covering of hot beds and cold frames.

Indestructible, Cheap and Warm. Will not harbor mice or vermin. Easy handling. Have now been in practical use for

years. Costing less than half as much as old-fashioned straw mats and entirely taking their place.

Size 76 x 76 inches, fully covering two regular size hot bed sash, \$1.10 each; \$12.00 per doz.

Size 40 x 76 inches, fully covering one hot bed sash, 75 cts. each; \$8.50 per doz.

Duck and Burlap, 40 x 76 inches, \$1.15 each; \$12.75 per doz.

" " " 76 x 76 " 1.50 " 16.50 "

We can supply these mats any length desired, as follows:

Duck and Burlap, 76 inches wide, at 25 cts. per running foot.

Plain Burlap, at 18 cts. per running foot. 76 inches wide.

Straw Mats. For covering hot beds and frames. 3 x 6 feet, \$1.00 each, \$10.00 per doz.; 6 x 6 feet, \$1.40 each, \$15.50 per doz.

THERMOMETERS.

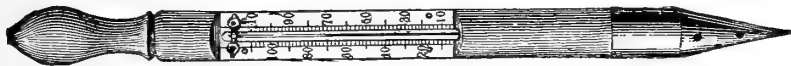

Mushroom and Hot-bed Thermometer, best quality, Brass Tip. \$1.25 and \$1.50 each.

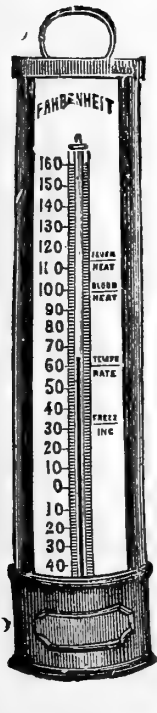

	Each	Per doz.
Guaranteed Three Point Tested, 8 ins.,	\$0.50	\$5.00
" " " 10 "	.65	6.50
Standard Tin Case 7 "	.15	1.50
" " " 8 "	.20	2.00
" " " 10 "	.25	2.50
" " " 12 "	.30	3.00

Maximum and Minimum Thermometers.

Registering the coldest and warmest temperature. 8 inch, each, \$2.50; 10 inch, each, \$3.00.



Disston's Pole Pruner

Price, \$1.00.

PRICES.

4 feet \$0.75	10 feet \$1.15
6 "85	12 " 1.25
8 " 1.00	14 " 1.50

PRUNING SAWS—Disston's Make.

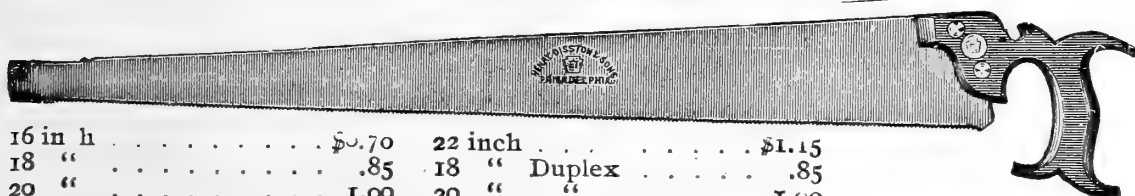

16 in h \$0.70	22 inch \$1.15
18 "85	18 " Duplex85
20 " 1.00	20 " " 1.00

Rattan

Hot Bed Mats.

Very Durable.

Each mat covers two ordinary frames, 3 x 6 feet.

One size only.

Each \$2.00

Per doz. 21.00

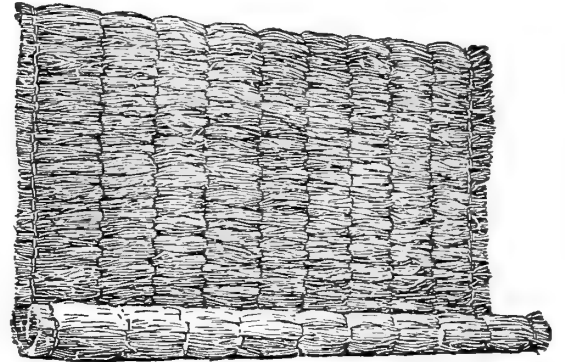

Rattan Mat.

MOLE

TRAPS.

Our list of these embraces the very best makes, sure to catch moles.

Out-o'-Sight.

Each \$1.00

Olmsted's.

Each \$1.50

Enterprise.

Each \$1.70

Perfection.

Each \$2.00

Reddick's.

Each \$1.00

English Mole

Traps.

Each \$0.35

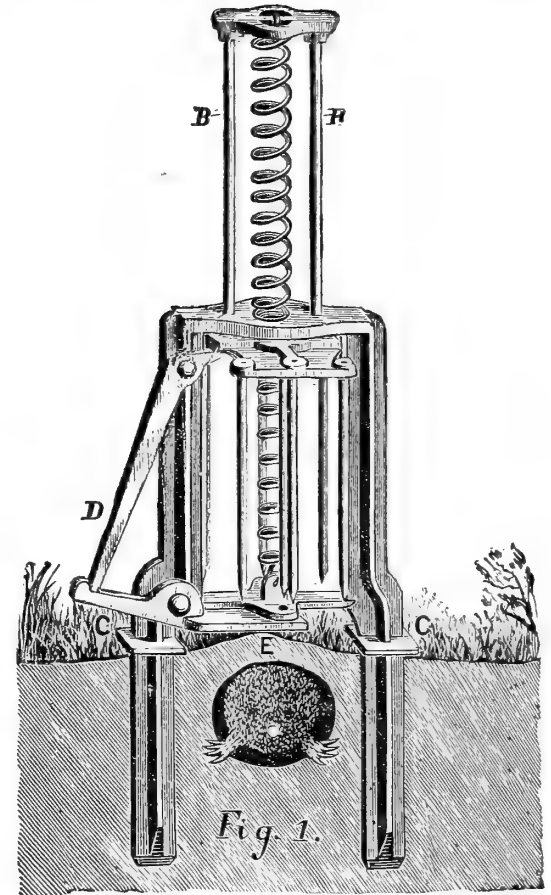

Fig. 1.

Olmsted Mole Trap.

Pruning Shears, Saws and Knives.

German Hand Pruning Shears.

Steel blades, coiled steel spring, which cannot drop out. A large assortment. 60 cts. to \$1.35 each. Extra springs, 10 cts. each.

Hedge Knives. \$1.00 each.

American Hand Pruning Shears.

Price, 35 cts. per pair.

Hedge Shears. Best quality. 8 inches,

\$1.50; 9 inches, \$1.75; 10 inches, \$2.00. With fly nut, 50 cts. extra.

Pruning and Budding

Knives. A large assortment. 50c. to \$1.25 each.

Pruning Gloves. Best quality

buckskin. \$1.25 pair.

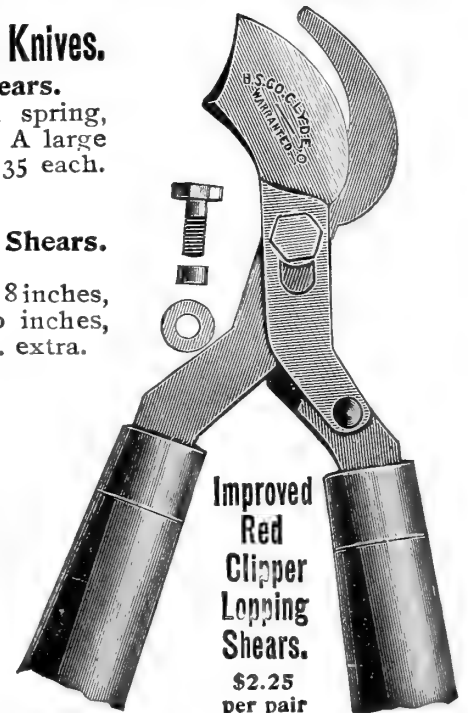

Improved Red Clipper Lopping Shears. \$2.25 per pair

SUNDRIES.

Charcoal (Lump). 25c. per peck; per bush., 85c.; \$2.00 per bbl.
 Grafting Wax. Finest quality, with directions; lb., 25c.
 Moss (Green). Per barrel, \$1.75.
 Moss (Green Sheet). Per barrel, \$2.75.
 Moss (Sphagnum), Green. Per bbl., \$1.50.
 Moss Sphagnum (Dry). Per barrel bale, \$1.00.
 Peat (Jersey) Best quality. Per barrel, \$1.25.
 Tobacco Stems (Fresh Havana). \$2.00 per large bale.
 Prepared Soil for Potting. Per bush., 50c., per bbl., \$1.25.

Orchid Peat (Lapp's). Per barrel, \$2.00.
 Propagating Sand. Extra clean. Per barrel, \$1.50.
 Wax Paper. 30 cts. per lb.; 5 lbs., \$1.25.
 Tin Foil. 15 cts. per lb.; 2 lbs. for 25 cts.
 Tar Twine. For tying mats, fodder, etc. Per ball, 15 cts.
 Leaf Mould. Similar to peat. \$1.50 per barrel.
 Binder Twine. 5 lb. ball, 75 cts.
 Paper for Covering Celery (Outdoors). Roll, \$1.00

CIDER MILLS PRESSES, ETC.

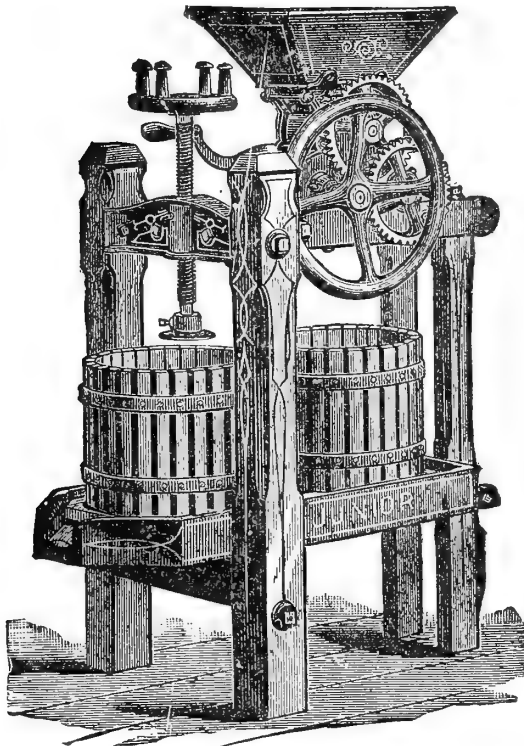

CIDER MILLS.

"Buckeye Junior." For cider making; also for pressing berries, grapes, etc. \$12.00
 "Buckeye Medium" 16.00
 "Buckeye Senior." Capacity five barrels per day 22.00
 Senior Press. Fitted up for power use 25.00

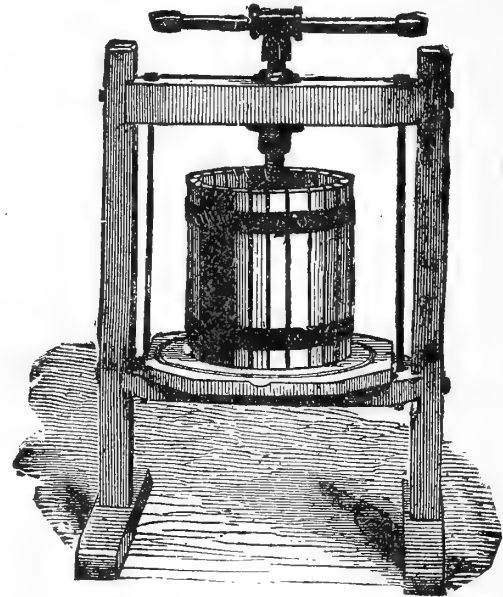

BERRY PRESSES

MADE EXTRA STRONG.

No. 1	each,	\$4.00
" 2	"	5.00
" 2½	"	5.75
" 3	"	6.25

BERRY CRUSHER. Price, \$3.00

FRUIT PICKERS.

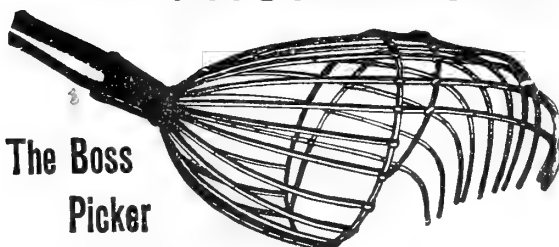

The Boss
Picker

	Each
Universal	\$1.00
Lees	.75
Plumley	1.00
Boss	.35
American	.25

TYING MATERIALS.

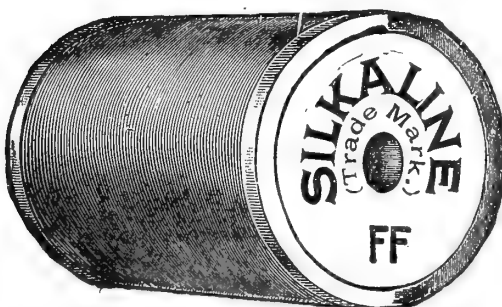

Green Silkaline. The best material for tying; does not fade; is very strong and durable. 20 cts. per spool, \$1.50 per lb.
 Raffle. Natural color. 20 cts. per lb.; 5 lbs., 90 cts.
 Colored Raffle. All colors, for fancy work, etc. 50 cts. per lb.

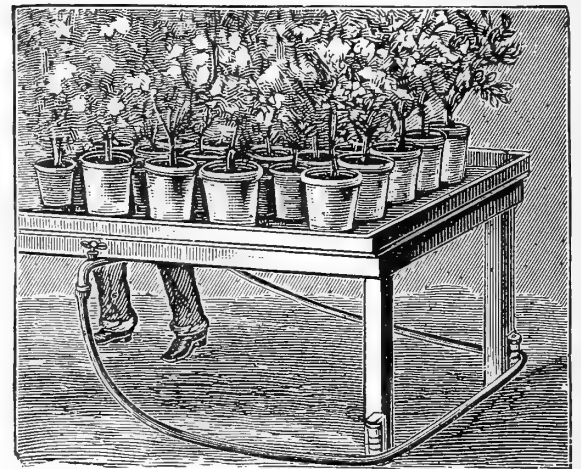
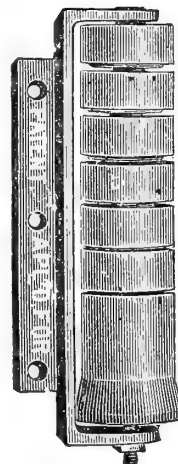

SCHUCK'S HOSE PROTECTOR.

DOUBLES THE LIFE OF YOUR HOSE.

Price 30 cts. each; per doz., \$3.00

HIGH GRADE FERTILIZERS

Prices on Some Sorts Vary During the Year. SOLD WITH OUR GUARANTEE.

Highest Quality.

Ashes (Canada Unleached Hardwood). These contain all of the fertilizing elements except nitrogen. 5 lbs., 20c.; 35c. per 10 lbs.; 25 lbs. 60c.; 85c. per 50 lbs.; per 100 lbs. \$1.50; bbl. of 250 lbs. \$2.50; ton of 2000 lbs. \$18.00. Apply about 1000 lbs. to the acre.

THE COST OF WOOD ASHES can be reduced \$3.00 per ton by customers giving us their order two weeks ahead, to enable us to ship it direct from Canada to the customer. Special rate on application.

Bone Meal **Michell's Strictly Pure and Fresh.** In fertilization nothing takes precedence in importance over animal bones, because they furnish the soil with the essential requisite of nitrogen as well as phosphoric acid. The most substantial fertilizer for lawns and plants is **Michell's Bone Meal.** It keeps on feeding the soil for fully ten months. 3 lb. bag 15c.; 5 lb. bag 25c.; 10 lbs. 40c.; 25 lbs. 75c.; 50 lbs. for \$1.10; 100 lbs. \$2.00; sack of 200 lbs. \$3.50; ton \$30.00.

Blaker's "Odorless" Lawn Dressing. One of the best fertilizers, supplying just what every worn-out lawn requires. Per 100 lbs. \$3.00. F. O. B. Factory only. Special price will be quoted on larger quantities.

Bone Flour **Pure.** Ground perfectly fine; excellent for pot plants or beds where an immediate effect is wanted. 5 lbs. 25c.; 10 lbs. 45c.; 25 lbs. \$1.00; 50 lbs. \$1.50; 100 lbs. \$2.50; bag or bbl. of 200 lbs. \$4.50; ton \$40.00.

Blood. (Dried.) Very rich in nitrogen. 5 lbs. 30c.; 10 lbs. 50c.; 25 lbs. \$1.00; 50 lbs. \$1.85; 100 lbs. \$3.50.

Bowker's Plant Food. Made especially for plants growing in conservatory or house. Clean, free from offensive odor. Full directions with each package. Package 15c. and 25c.; by mail 25c. and 40c.

Clay's Fertilizer Imported manure, especially recommended for flowers or vegetables, to bring the highest perfection. Should be used in potting soil, and spread on staging of greenhouses planted with flowering plants. Per lb. 15c.; 5 lbs. 60c.; 10 lbs. \$1.10; 28 lbs. \$2.00; \$6.50 per cwt. (112 lbs.)

Cotton Seed Meal. 5 lbs. 25c.; 10 lbs. 40c.; 25 lbs. 85c.; 50 lbs. \$1.50; 100 lbs. \$2.50; 200 lbs. \$4.00; per ton, \$33.00.

Flora Cola A powerful liquid fertilizer for house plants. 25c. per bottle.

Guano **Pure Peruvian.** 1½ lb. box 15c.; 3½ lb. box 25c.; 10 lbs. 50c.; 100 lbs. \$2.50; per ton \$40.00.

Guano **Potato, Corn and Truck. Sharpless and Carpenter's Brand.** Guaranteed analysis: Actual Potash, 6 to 8 per cent; Ammonia 1½ to 2½ per cent.; available Phos. Acid, 6 to 8 per cent., in original sacks only. Price \$3.50 per sack of 200 lbs.; \$30.00 per ton.

Horn Shavings A very valuable and rich fertilizer, especially for roses, chrysanthemums, etc. 10c. per lb.; 5 lbs. for 40c.; 25 lbs. \$1.75; \$5.00 per 100 lbs.

Thomson's Flower and Vegetable Manure. This is one of the very best fertilizers, introduced from England, and can be highly recommended to any one wishing an immediate effect in forcing. Highest testimonials from those who have tested its merits. Put up in original bags. 28 lbs. (¼ cwt.), \$1.75; 56 lbs. (½ cwt.), \$3.25; \$6.25 per cwt.

Imperial Liquid Plant Food. One of the best and most reliable plant fertilizers now on the market. Highest testimonials received from all who are using it now. 55 oz., \$1.00; 7 lbs., \$1.60; 20 lbs., \$4.00 (F. O. B. Factory).

"Jadoo" Liquid A popular fertilizer in liquid form. Specially adapted for feeding house plants. 15c. per bottle.

Kainit. (Pure). Apply at the rate of 1000 lbs. per acre, 5 lbs. 20c.; 10 lbs. 35c.; 25 lbs. 50c.; \$1.25 per 100 lbs.; per 200-lb. sack, \$2.00; \$15.00 per ton.

Land Plaster (Nova Scotia). A valuable top dressing. It also purifies and sweetens worn out, sour soils. Used also extensively for mixing with Paris Green for destroying insects. 5 lbs. 15c.; 25 lbs. 30c.; 40c. for 50 lbs., 100 lbs. 75c., \$1.50 per bbl. (300 lbs.), ton \$9.00.

Lawn Dressing (Michell's Odorless). Very rich in fertilizing ingredients. Makes your lawn green, bright and durable. 5 lbs. for 30c.; 25 lbs. \$1.00; \$1.75 per 50-lb. bag; per 100 lbs. \$3.00; \$5.00 per 200 lbs; per ton \$40.00.

Manure We can supply at short notice, strictly first-class, clean, short or long manure. Our large sales these past three years prove that we send out a choice article. In car-load lots only at \$1.25 per ton. Special price will be quoted on larger quantities.

Michell's Plant Food Very effective, clean and easily applied. 15c per pkg.; 4 pkgs. 50c.

Mapes Celebrated Fertilizers. Prices quoted here are f. o. b. Phila. It is, however, more advantageous to the customer to have them shipped direct from Mapes' factory as the price will be 25c. less per sack, and \$2.00 less per ton than prices herewith quoted, only paying one freight charge.

	Sack of 200 lbs.	Ton of 2000 lbs.
Potato Manure	\$4.50	\$39.00
Corn manure	4.25	36.00
Cabbage and cauliflower manure	4.25	38.00
Fruit and vine manure	4.25	39.00
Grass and grain spring top dressing	4.25	40.00
Complete manure, for general use	4.25	38.00
Complete manure, for heavy soils	4.50	39.00
Complete manure, for light soils	4.50	41.00
Vegetable manure, for all soils	4.50	41.00
Early vegetable and truck manure	4.50	41.00

Muriate of Potash Lb. 10c., 5 lbs. 35c., 10 lbs. 50c., 50 lbs. \$1.75, 100 lbs. \$3.25.

Nitrate OF SODA. For all crops. Contains the largest percentage of nitrogen; equal to 19 per cent. of ammonia. It is very quick in action, and hastens maturity of crops fully two weeks. *Should not be applied until the plants are above the ground,* when 100 to 150 lbs. per acre should be sown with other fertilizers, or mixed with phosphates. Lb. 10c., 5 lb. 30c., 10 lb. 50c., 25 lbs. \$1.00, 50 lbs. \$2.00, 100 lbs. \$3.50, 200 lbs. \$6.25; per ton, \$57.50.

Poudrette Per lb. 10c. (26c. by mail); 5 lbs. 20c.; 35c. per 10 lbs.; 25 lbs. 60c.; \$1.00 per 50 lbs.; \$1.50 per 100 lbs.; per 200 lb. sack \$2.50; \$8.00 per 1000 lbs.; \$15.00 per full ton.

Phosphate **Baugh's Celebrated Double Eagle Brand.** 50 lbs. \$1.00; \$1.75 for 100 lbs.; \$3.00 per 200 lb. sack; \$25.00 per ton.

Phosphate. Super High Grade. Analysis; Ammonia 4 to 6 per cent.; bone phosphate 24 per cent.; available phos. acid 6 to 8 per cent.; sulph. potash 1 to 2 per cent. It stands without a rival as the largest crop producer. Apply 400 lbs. per acre. 5 lbs. 20c.; 10 lbs. 35c.; 25 lbs. 60c.; 100 lbs. \$1.75; 200 lbs. \$3.25; per ton \$28.00.

Potato Manure (Baugh's). Very high grade. Guaranteed (from factory only). \$3.50 per 200 lb. sack; per ton \$30.00.

Soot Imported Scotch. Per lb. 10c.; per 5 lbs. 35c.; \$1.25 for 25 lbs.; 100 lbs. \$4.00.

Salt (Agricultural Brand). For topdressing lawns or asparagus beds. Apply early in spring, at rate of 800 to 1000 lbs. per acre. 25 lbs. 30c.; \$1.00 per 100 lbs.; 200 lbs. \$1.50; ton \$9.50.

Sheep Manure **Pure, Fresh Pulverized.** One of the richest general fertilizers. **Michell's XX Brand,** Pkg. 15c.; 5 lbs. 25c.; 10 lbs. 40c.; 25 lbs. \$1.00; 50 lbs. \$1.50; \$2.25 per 100 lbs.; \$32.00 per ton.

Sulphate of Ammonia Lb. 10c.; 35c per 5 lbs.; 10 lb. for 60c.; 50 lb. for \$2.50, 100 pounds for \$4.50.

Tobacco Stems Largely used for covering lawns during the winter. 5c. lb.; 5 lb. for 20c.; barrel \$1.00; \$2.00 per large bale; per half ton \$6.00; \$11.00 per ton.

IT WILL PAY YOU TO LET US ESTIMATE ON THE LARGE ORDER OF FERTILIZERS

INSECT DESTROYERS, ETC.

Aphis Punk. (*Nikoteen.*) Especially designed for use in private places and in houses without convenient furnaces for heating irons necessary for vaporizing **Nikoteen** or Tobacco Extract. The Punk is lighted with a match and allowed to burn, which it does without flaming, at the same time giving off dense white fumes of nicotine that kills aphis and thrip very effectively. Per box 60c. Per twelve boxes \$6.50.

Ant Exterminator. Very effectual for destroying ants in gardens and lawns. Per ¼ lb. 20c., 40c. per ½ lb., per lb. 75c.

Alcohol. For nicotinic lamps. Per quart 65c.

Bowker's Bodlime. Stops canker worms, caterpillars and all creeping insects from crawling up trees. Superior to all other articles heretofore on the market. 5 lbs. 90c., \$1.35 10 lbs., 25 lbs. \$2.75.

Bordeaux Mixture. For black rot, downy mildew, and anthracnose of grape, potato blight, potato rot, leaf blight of cherry, pear, quince and other fungus diseases. Per lb. box 20c., 75c. 5 lbs., makes 25 gallons spray, 10 lbs. \$1.25 makes 50 gallons spray, \$2.50 25-lb. box makes 125 gallons.

Bordeaux Mixture. In liquid form. Per qt. 40c., \$1.00 per gallon.

Bug Death. Now largely used instead of Paris Green, safer, just as effectual and acts as a fertilizer as well as an insecticide. Price, 1 lb. 15c., 35c. for 3 lbs., 5 lbs. 50c., \$1.00 for 12½ lbs., 100 lbs. \$7.00. (Special Shaker 25c.)

Copperdine. For black rot, carnation rust, and anthracnose of the grape, pear, leaf blight, apple scab and powdery mildew. One gallon can (makes 100 gallons wash), per qt. 50c., \$1.50 per gal.

Copper Soap. (Permol). Positive cure for mildew, rust and all fungus. Per can 75c. Dilute 1 part soap to 30 parts water.

Dalmation or Persian Powder. Pure, ¼ lb. 15c., 40c. lb., 5 lbs. \$1.50.

Fir Tree Oil. For destroying insects, such as mealy bug, red spider, scale, thrip, green fly, etc. Full directions with each can. ½ pt. 50c., 75c. per pt., per qt. \$1.50, \$2.75 per ½ gal., per gal. \$5.00.

Fir Tree Oil Soap. ½ lb. 25c., 75c. for 2 lbs.

Fostite. Prevents mildew. 5 lbs. 60c., \$2.50 25 lbs.

Good's Caustic Potash Whale Oil Soap. Per lb., 20c., 75c. per 5 lbs., 25 lbs. for \$1.75, \$3.00 per 50 lbs., 100 lbs. for \$5.00.

Grape Dust. Best remedy for mildew. 5-lb. pkg. 30c., \$5.00 100-lb. keg.

Hellebore. For destroying rose slugs. Per lb. 25c., \$1.00 5 lbs., 10 lbs. \$1.85.

Horicum. A salt, sulphur and lime solution made by Hammond. For San Jose Scale. 35c. per qt., per gal. \$1.00.

Hustler Insecticide. A new remedy for mealy bug, and soft scale, excellent for washing palms, spraying roses, etc.; in paste form and is diluted in water. Price, per ½-lb. can 15c., \$1.00 for 5 lbs.

Kerosene Emulsion. (Paste). For plant lice of any kind, cabbage worms, scale, insects on pear and other trees. 1 lb. 15c., 60c. 5-lb. can, makes 50 gallons of spray, 25-lb. can \$2.50 makes 250 gallons of spray.

Kerosene Emulsion. (Liquid). Per qt. 40c., \$1.00 per gal.

Kerosene Soap (Permol). Per pkg. 15c., 25c. per lb., 10-lb. pails \$1.75, \$3.75 25 lbs.

Lemon Oil. Will destroy mealy bug, scale, thrip, red spider, etc. Per ½ pt., 25c., 40c. per pt., per qt. 75c., \$1.25 per ½ gal., per gal. \$2.00, \$9.00 per 5-gal. keg. Dilute 1 part oil to 30 parts of water.

London Purple. Cheaper and less dangerous than Paris Green. Lb. 25c., \$1.10 5 lbs. Special price on larger quantity.

Nicotinic Acid. A powerful insecticide for evaporizing. ¼ pt. 75c., \$1.25 per ½ pt., per pt. \$2.50, \$4.50 per qt., \$15.00 per gallon. Lamps for Nicotinic acid evaporating 50c. each.

Nico Fume. An improvement on Aphis Punk; elegant reports from florists who have used it. Positive death to red spider and aphis. Put up in air tight metal packages. Price, per box 75c., \$3.50 for 144 sheets, 288 sheets for \$6.50

Nico Fume. (Liquid). Similar in effect to the above; used for vaporizing where more convenient to use in this form. Per ¼ pint 50c., \$1.50 per pint.

Nikoteen. For spraying and vaporizing. Per pt. \$1.50.

Noxall. (Michell's). The best article to be used as a spray for insects. Similar to Disparene. Per lb. can 30c.

Nicosol. A very promising nicotine preparation for green fly, aphis and other greenhouse pests; can be sprayed or vaporized.

No. 1 can, enough to fumigate 40,000 cubic feet of space, \$2.25.

No. 2 can, enough to fumigate 20,000 cubic feet of space, \$1.25.

Paris Green (Pure). Lb. 30c., \$1.40 5 lbs., 14-lb. buckets \$3.50.

Persian Insect Powder. Fresh and pure. Per ¼ lb. 15c. 40c. per lb.

Rose Leaf Extract of Tobacco. Per qt 50c., \$1.25 per gal. 5 gal. \$4.25.

Salt, Sulphur and Lime. For spraying for San Jose Scale.

Concentrated, . . . per gallon, \$1.50; per ½ gallon, 80c.

Partly diluted, . . . per gallon, 60; \$2.50 per 5 gallons.

Seal Oil Soap. 1-lb. can 25c., \$2.20 for 10 lbs., 30-lb. cans 20c. per lb.

Slug Shot. Canister with perforated top 15c., 25c. 5 lbs., 10 lbs. 50c., \$4.25 100 lbs. Bulk in barrels weighing about 225 lbs. (¾ c. per lb. F. O. B. factory) 4c. per lb. F. O. B. Phila.

Sulphur. A preventive and cure for mildew. Lb. 7c., 30c. 5 lbs., 25 lbs. for \$1.25.

Sulphate of Copper. For spraying. Per lb. 10c., 90c. per 10 lbs., 25 lbs. \$2.00.

Tobacco Dust. Cheaper than snuff and quite as effectual. Sure remedy for green fly. Per lb. 10c., 25c. 5-lb. pkg., 100 lbs. \$3.50.

Tobacco Soap. (Pinner's.) For destroying insects, parasites and their eggs, infesting either plants or animals. ½ lb. 20c., 40c. lb.

Tobacco Stems, Fresh. For fumigating. Lb. 5c., \$1.00 bbl., per large bale \$2.00, \$6.00 per ½ ton, per ton \$11.00.

Tobakine Fumigating Paper. Per box 60c., \$6.50 per doz. boxes.

Tobakine Fumigating Liquid. ¼ pt. 60c., \$1.10 per ½ pt., per pt. \$2.00.

Tobakine Fumigating Powder. Used as a substitute for tobacco stems. 5 lbs. 25c., 45c. for 10 lbs., 25 lbs. \$1.00.

Tobakine Fumigating Dusting Powder. Claimed to be superior to tobacco dust. 5 lbs. 25c., 45c. for 10 lbs., 25 lbs. \$1.00

Whale Oil Soap. For destroying and preventing insects on plants, trees, vines, etc., for washing down the bark of trees, grape vines, etc. With directions, per ½ lb. 10c., 15c. per lb., per 5 lbs. 50c., 90c. per 10 lbs., per 25 lbs. \$1.75.

Worm Eradicator. The best article for destroying worms. Per bottle 50c., \$1.00 and \$3.00.

Sulpho Tobacco Soap. Especially adapted to be used for the window garden. Works in the greenhouse just as well. Easily prepared for use. Very effective. 4 oz. 10c. (postpaid 14c.), 8 oz. 20c., (postpaid 25c.)



Kilo-Scale is now one of our foremost remedies for combating with the dread San Jose scale. It does the work quickly and thoroughly. Whole orchards destined to destruction have been saved by it. A trial will convince. Price 45c. per qt., per gal. \$1.50, 5 and 10 gal. cans at \$1.25 per gal; per barrel (50 gals.) \$45.00. One gallon makes 20 to 25 gallons of solution.

BELLOWS

For Applying the Insect Destroyers

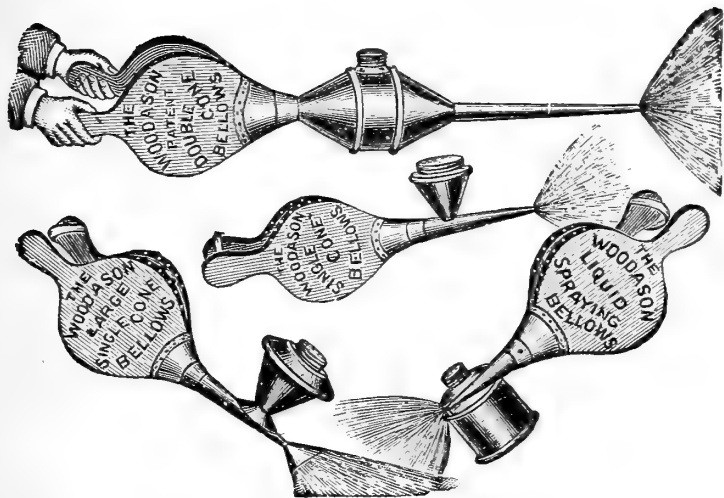

Large Double Cone.....each, \$3.00 | Liquid Spraying...each, \$1.50 and \$2.00
 Large Single Cone..... " 2.00 | Sulphur Bellows.....each, 1.50
 Small Single Cone..... " 1.00 | Houchin's Single Cone60

SYRINGES

Deakin's Brass Garden Syringes



No. A. 1 stream and spray hose, 12 x 1 inches\$2.20
 No. B. 1 " " " " 13 x 1 1/4 " 3.00
 No. C. 1 " " " " 14 x 1 1/2 " 3.50
 No. 2. 1 " " 2 roses, 13 1/2 x 1 1/8 " 4.25
 No. 5. 1 " " " " 18 x 1 1/2 " 6.25
 No. H. 18 inches long, 1 1/2 inches in diameter 2.25
 No. H. 18 " " " " " with movable spray..... 2.50

LEWIS BRASS SYRINGE, \$1.50

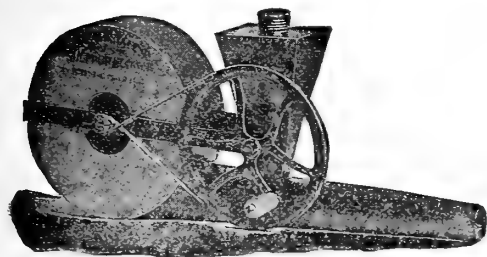

**"PEERLESS" SULPHUR
 AND
 INSECTICIDE BLOWER.**

This is the most satisfactory distributor of Sulphur and other Insecticides in powder form. Will never wear out.

Satisfaction guaranteed.

Price \$4.50.

WOODEN CUT FLOWER BOXES

For carrying or sending cut flowers. In sets of three boxes, one lid to each set, each box forming a lid for the other.

30 inch, per set \$3.95 | 42 inch, per set \$5.00
 36 inch, per set 4.50 | 48 inch, per set 5.55

PAPER BOXES

A few of the leading sizes, most any other size furnished to order.

lg. wide	deep	Per doz.	Per 100
18 x 6 x 3 1/2 inches		\$.45	\$3.50
21 x 7 x 3 1/2 inches		.50	3.80
24 x 8 x 4 inches		.60	4.75
28 x 8 x 5 inches		.90	7.20

WAX PAPER

30 cts. per pound; 5 pounds for \$1.25

Fumigators.

Perfection, No. 1, holds 1 pk. of stems.....\$3.00
Perfection, No. 2, holds 1/2 bush. of stems..... 3.50
Perfection, No. 3, holds 3/4 bush. of stems..... 4.00
Perfection, No. 5, holds 1 bush. of stems..... 5.50
Eureka, No. 1, height 12 in., for a house 10 x 20 ft... 1.20
Eureka, No. 2, height 16 in., for a house 12 x 40 ft... 1.75
Eureka, No. 3, height 20 in., for a house 15 x 100 ft... 2.25
Eureka, No. 4, height 24 in., for a house 20 x 100 ft... 3.25
Tobacco Stems (Fresh). For fumigating. 5 lbs. for 25 cts.; \$1.00 per bbl; \$2.00 per bale of 250 lbs.; \$11.00 per ton. 1/2 ton, \$6.00.

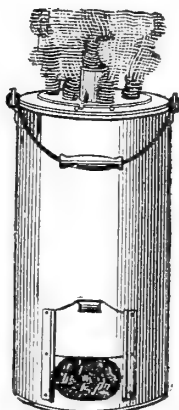

Perfection Fumigator.

PLANT STAKES

PAINTED STAKES

	Doz.	100		Doz.	100
1 1/2 ft. Tapering green.....	\$0.17	\$1.00	3 ft. heavy, rose or dahlia,	\$0.75	\$4.85
2 " " " " " " " " " " " "	.28	1.70	3 1/2 " " " " " " " " " " " "	.88	5.68
2 1/2 " " " " " " " " " " " "	.39	2.40	4 " " " " " " " " " " " "	1.10	6.50
3 " " " " " " " " " " " "	.51	3.20	5 " " " " " " " " " " " "	1.25	8.15
3 1/2 " " " " " " " " " " " "	.75	4.80	6 " " " " " " " " " " " "	1.55	9.80
4 " " " " " " " " " " " "	.88	5.60			

BAMBOO OR CANE STAKES

SOUTHERN..... 25c. per doz.; per 100, \$1.00; 250 for \$2.00; \$7.00 per 1000
JAPANESE..... per doz., 25c; per 100, \$1.00; per 1000, \$7.00

GALVANIZED STEEL PLANT STAKES

No. 10 Wire			No. 8 Wire—Galvanized Stakes.		
	Per doz.	Per 100	Per doz.	Per 100	Per 1000
2 ft. long.....	\$0.12	\$0.60	4 ft. long.....	\$0.25	\$1.25
2 1/2 " " " " " " " " " " " "	.15	.75	4 1/2 " " " " " " " " " " " "	.30	1.35
3 " " " " " " " " " " " "	.18	.90	5 " " " " " " " " " " " "	.35	1.50
3 1/2 " " " " " " " " " " " "	.22	1.10	6 " " " " " " " " " " " "	.40	1.75

HYACINTH OR MATCH STAKES

	Per doz.	Per 100	Per 1000		Per doz.	Per 100	Per 1000
12 inches long.....	\$0.05	\$0.20	\$1.25	18 inches long.....	\$0.08	\$0.30	\$1.75

UNPAINTED STAKES OR DOWELS

	Doz.	100	1000
36 in. long, 1/4 in diameter	\$0.15	\$0.60	\$1.50
36 " " " " " " " " " " " "	.15	.75	5.00
36 " " " " " " " " " " " "	.20	1.00	7.50
42 " " " " " " " " " " " "	.20	.80	5.75
42 " " " " " " " " " " " "	.20	.75	6.00
42 " " " " " " " " " " " "	.25	1.10	9.00

GALVANIZED WIRE IN ROLLS

No.	Per lb.	Per Roll, 12 lbs.	No.	Per lb.	Per Roll, 12 lbs.
16	\$.10	\$0.85	20	\$.13	\$1.15
18	.11	1.00	22	.14	1.20
19	.12	1.10	24	.15	1.25

TRELLISES

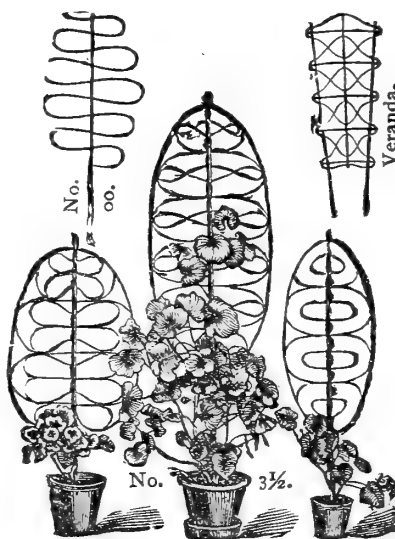

For training vines. Each 15c. to \$1.50.

Painted Pot Labels

	100	1000		100	1000
3 1/2 inch. \$0.10	\$0.75	6 inch. \$0.25	\$1.50		
4 " " .12	.85	8 " " .35	3.25		
4 1/2 " " .15	1.00	10 " " .50	4.50		
5 " " .20	1.25	12 " " .75	6.00		

Painted Tree Labels

	Per 100	Per 1000
Iron Wired	15c.	\$1.00
Copper Wired.....	20c.	1.25
" " painted..	25c.	1.50

Indelible Marking Pencil, 10 cts. each.

Indestructible Copper Labels. Made of copper thin and pliable; can be written on with a pencil, which indents the copper, leaving a permanent impression. Per doz., 20c.; \$1.00 per 100.

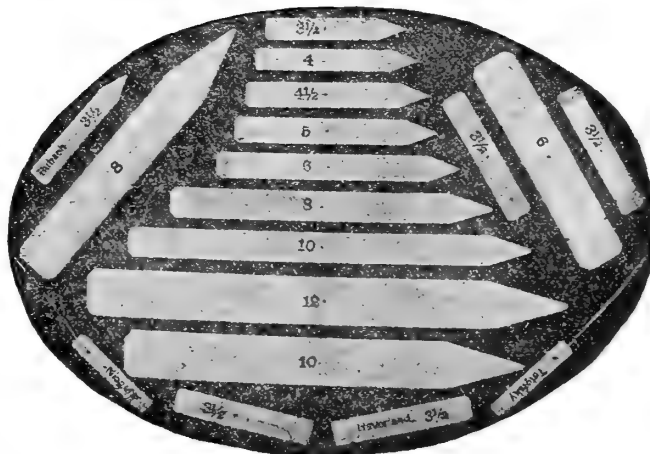

Painted Pot and Tree Labels

DODGE'S EVERLASTING GLASS LABELS. Will never wear out. Sample mailed free on application. 50c. per doz.; \$3.50 per 100.

SEASONABLE NEEDS

DEMING'S BARREL SPRAY PUMP



Deming's Barrel Spray Pump.

This pump is one of the very best sprayers on the market. Fitted with brass cylinders. Will not corrode or rust.

PUMP only, no hose or nozzle, \$7.00.

OUTFIT A—Pump with 12½ feet hose, fitted with either a Bordeaux or Vermorel nozzle and pole connection for reaching into trees, \$9.50.

OUTFIT B—Pump with two 12½ foot sections of hose, two Bordeaux or Vermorel nozzles and pole connections, \$11.50. Barrels with trunions ready to mount on truck, \$2.50 each.

Truck Barrel and Pump Outfit A complete with trucks as below :

1½ inch tire truck..... \$17.00 | 2½ inch tire truck..... \$17.75 | 3½ inch truck, complete.....\$18.75

BUCKET FORCE PUMPS FOR SPRAYING

Success (see Cut). Made of brass, fitted with 3½ feet of hose, with a "Bordeaux" nozzle attached. Price, \$4.00.

Perfect Success. Similar to the above, but with an attachment for fastening to a bucket. Price, \$5.00. **Hose.** 7 foot sections with couplings for extending the length, suitable for either the Success or Perfect Success Pump. Price, \$1.25.

Acme Force Pumps. Very durable. Made of brass. Price, \$4.50 each.



Success Pump. Showing it in bucket.



Vermorel Nozzle.

Extra Nozzles

for Deming's Bucket or Barrel Pumps.



Vermorel and Bordeaux.....75c. each
(Postpaid, 80c.)

The above are fitted for regular 3/8 inch couplings. For 3/4 inch attachments add 25c. to the above price.

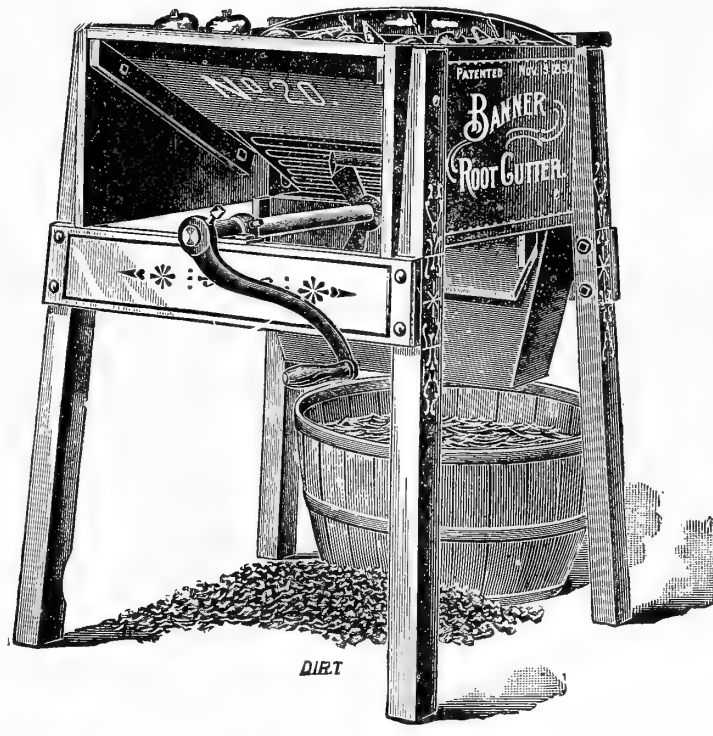

DIRT

ROOT CUTTERS

These are a necessity on every stock and poultry farm in winter, the milk and egg yield can be greatly increased by means of green food in winter in the form of roots.

No. 7. Banner , for Poultry and Sheep.....	Each \$5 00
No. 16. " ".....	12.00
No. 20. " (see Cut).....	8 50
Ames	12.00

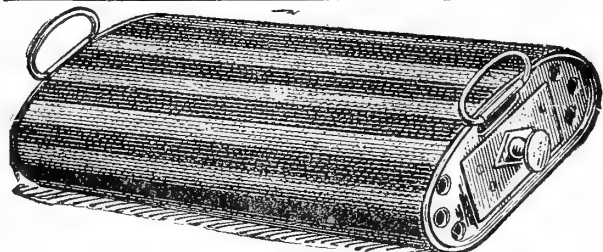

No. 5 Heater.

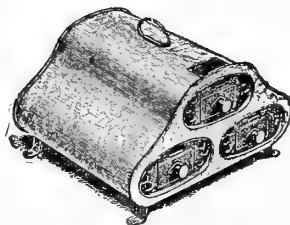

No. 10 Heater.

These heaters have proved themselves very efficient for the work they are designed. They will keep the temperature above freezing in most any ordinary closed vehicle during the severest weather. Fine for automobiles. Made of heavy sheet iron, white metal ends.

No. 5. Single drawer, 14 inches long.....	\$2.75
No. 5 B. Same as above, but covered with Brussels carpet.....	3.00
No. 5 C. Same as No. 5, but covered with Velvet carpet.....	3.25
No. 7 B. 20 inches long, Brass ends, covered with Brussels carpet.....	4.50
No. 7 C. 20 inches long, Brass ends, covered with Velvet carpet.....	5.00
No. 10. Three drawers, 14 inches long.....	7.25

Coal for Lehman Heaters, 75 cents per doz. bricks; per 100, \$6.00.
Tongs for Handling Hot Coals, 25 cents.

Wagon, Carriage and Automobile Heaters

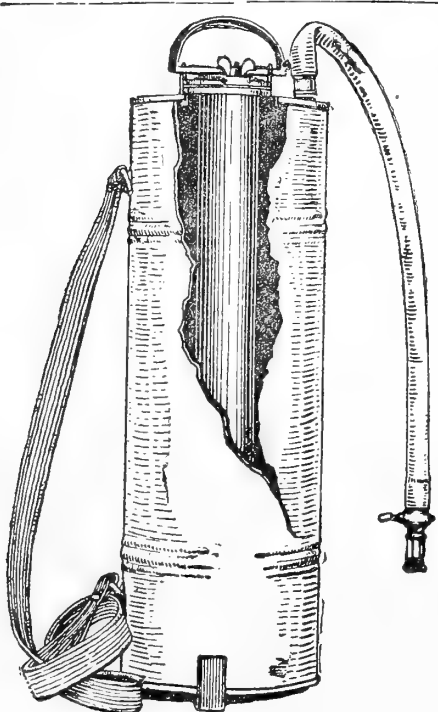

The Auto Spray.

This machine is now used in every orchard, garden and nursery throughout the country, it is simply the most durable and best compressed air sprayer offered. The maker of them is so confident of their merits that he guarantees every machine.

Brass, complete with hose and nozzle..... \$6.00

Galvanized Iron, complete with hose and nozzle..... 4.00

EXTENSION PIPES, 2 Feet Long.

Brass..... 30c. each. **Galvanized Iron**..... 25c. each.

AUTO-POP ATTACHMENT, which permits the operator to control the flow of liquid at the nozzle by a mere pressure of the thumb, \$1.00 extra per machine.

Pot Brackets

Pot Brackets solve completely the problem where to put plants in winter. They can easily be fastened to frames and other places in a few moments. They are substantial in make and very ornamental.

Jones' Pot Bracket
(see Cut.)

These are made of spun metal and can easily be mailed.

No. 1. Holds 5 in. pot. Each, 30c.; per doz., \$3.00.

No. 2. Holds 6 in. pot. Each, 35c.; per doz., \$3.50.

No. 3. Holds 7 in. pot. Each, 40c.; per doz., \$4.00.

If single brackets desired by mail, add 15c. to price of each bracket.

Japanned Bronze Bracket

Small, for Pot 4 to 5 in. Each, 35c.; per doz., \$3.50.

Medium, for Pot 6 in. Each, 50c.; per doz., \$5.50.

Large Double, for 2 Pots. Each, 75c.; per doz., \$7.50.

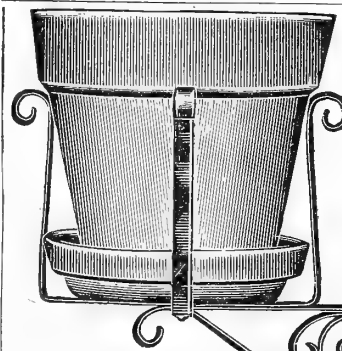

Pot Brackets

THE AUTO SPRAY

This machine is now used in every orchard, garden and nursery throughout the country, it is simply the most durable and best compressed air sprayer offered. The maker of them is so confident of their merits that he guarantees every machine.

Brass, complete with hose and nozzle..... \$6.00

Galvanized Iron, complete with hose and nozzle..... 4.00

EXTENSION PIPES, 2 Feet Long.

Brass..... 30c. each. **Galvanized Iron**..... 25c. each.

AUTO-POP ATTACHMENT, which permits the operator to control the flow of liquid at the nozzle by a mere pressure of the thumb, \$1.00 extra per machine.



It's So Easy

Rolling Saucers for Plant Tubs

ROLLING SAUCERS.

(See Illustration)

FOR LARGE PLANTS IN POTS AND TUBS

For transporting heavy flower pots and tubs, without lifting. (See cut.) These are made of Papier Mache, and are absolutely faultless. They are light, substantial and waterproof. The heaviest plant can easily be moved by a child. Every saucer fitted with ball bearing casters, which allows them to be moved in any direction.

PRICES.

Size	Pot	Tab	Each	Doz.
12 in.	10 in.	No. 8	\$0 70	\$ 5 70
14 in.	12 "	" 8	60	6 84
16 in.	14 "	" 8	75	8 55
18 in.	16 "	" 7-6	85	9 50
20 in.		" 5	1 00	11 40
22 in.		" 4	1 20	14 25

GREEN ENAMEL FIBRE TUBS—(PAPIER MACHE.)

Indestructible, and will take the place of a jardiniere, having a heavy coat of green gloss enamel, which renders them very ornamental.

PRICES

Complete with Saucers.

10 inch, 80c., 12 inch, \$1.00, 14 inch, \$1 60.

See, also, page 27 for a large line of Papier Mache Ware.

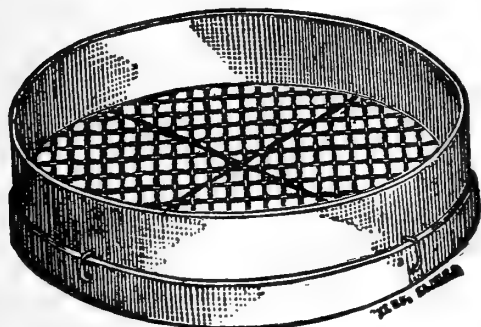

SIEVES—For Soil and Sand.

16 inch, Galvanized	\$0 45
18 " "	55
20 " "	65
20 " Foundry Wire, very heavy	75

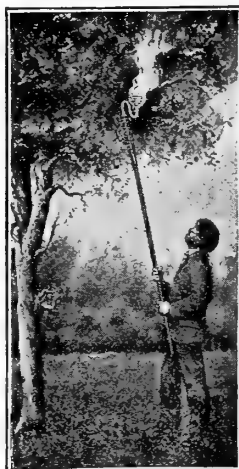

Asbestos Torch.

TORCHES

For Burning Out Caterpillars In Trees, etc.

Limbs infested with caterpillars and other insects may be burned out very easily.

Asbestos Torch, price 35c. by mail, 45c. Reservoir Torch, price 25c. by mail, 35c.

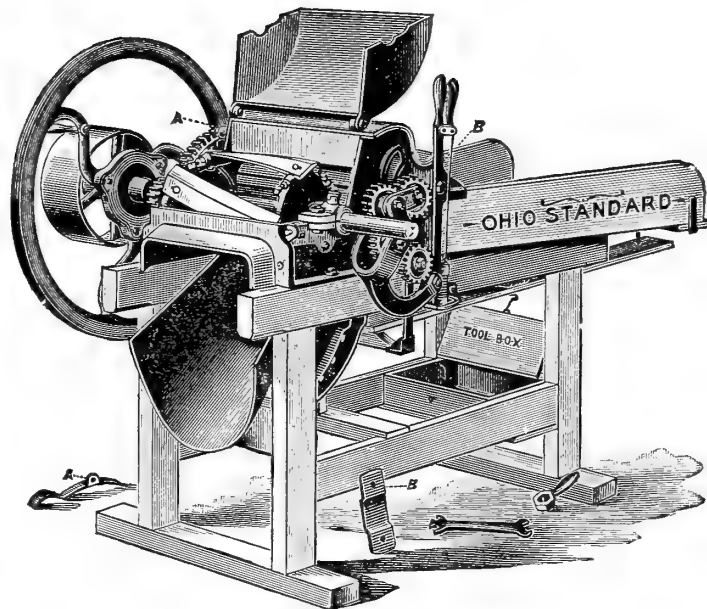

Ohio Hay Cutter.

OHIO HAY AND FEED CUTTER.

This is considered the finest machine in the market for cutting hay ensilage, etc. We can furnish it with one or two knives. Single knife, \$12.00; two knives, \$16.50.

HOT WATER STOVES

FOR HEATING GREENHOUSES, CONSERVATORIES, HENNERIES, ETC.

IMPROVED HOT WATER HEATER.

No. 0. Capable of heating 150 feet 1 in. pipe	price, \$12.50
No. 1. " " " 200 " " "	15 50
No. 2. " " " 400 " " "	22.50

IDEAL JR. WATER STOVE.

	No. 0	No. 10	No. 11	No. 12
Direct square feet of radiation	60	125	155	175
Capacity of tank in gallons	80	165	200	225
Price	\$19.50	\$26.70	\$29.40	\$31.80

Descriptive circular of each mailed, if interested.



Improved Hot Water Stove.

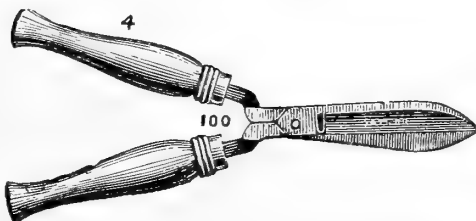

HEDGE SHEARS. BEST ENGLISH MAKE.

8 in. plain, \$1.50; 8 in. fly nut, \$2.00; 9 in. plain, \$1.75; 9 in. fly nut \$2.25; 10 in. plain, \$2.00, 10 in. fly nut, \$2.50.



PRUNING SHEARS.

A Few of the Most Popular.

French, small	\$1 25
" large	1 50
Wiss, 8 in.	1 75
Henckle, 7 in.	1 10
" 8 "	1 35
" 9 "	1 50
Hessenbruch, 8 in.	1 00
German, 8 in.	60
American, 8 in.	30

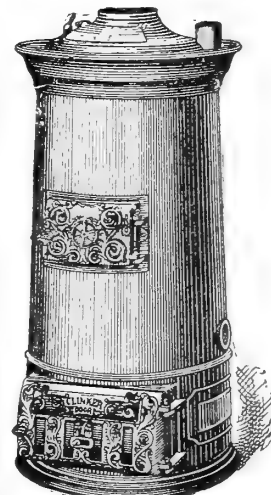

Ideal Hot Water Stove.

HIGH GRADE POULTRY SUPPLIES, Etc.

We have omitted the prices of some foods in larger quantities, as prices, especially of grains, fluctuate continually. Write for prices on larger quantities.

FOODS

Animal Meal. (Bowker's). 5 lbs. 20c., 10 lbs. 40c., 25 lbs. 75c., 50 lbs. \$1.20, 100 lbs. \$2.25.
Barley. Per qt. 10c.
Bone (Granulated). The use of ground bone tends to keep fowls in good health, and materially aids laying hens. 5 lb. pkge. 20c., 25 lbs. 75c., 50 lbs. \$1.25, 100 lbs. \$2.50.
Buckwheat. For pigeons and young poultry. Per qt. 10c., peck 35c.
Clover Meal (Alfalfa). Best quality, 5 lbs. 20c., 25 lbs. 75c., 50 lbs. \$1.25, 100 lbs. \$2.00.
Charcoal (Ground). A little ground charcoal mixed with the soft feed in the morning, once or twice a week, keeps them healthy. 1 lb. 8c., 5 lbs. 35c., 10 lbs. 60c., 25 lbs. \$1.25, 100 lbs. \$4.00.
Charcoal (Pulverized). Same price as ground charcoal; used for stock feeding.
Cut Clover Hay. Excellent food for winter and early spring. 5 lbs. 20c., 10 lbs. 35c., 50 lb. bag \$1.10, 100 lbs. \$2.00.
Chick Manna, or Food for Little Chicks. Specially prepared for little chicks when first hatched. Should be the first and only food, and continued for 10 or 12 days before feeding anything else. Directions for feeding on each package. 1 lb. pkge. 10c., by mail, 25c.; 5 lb. pkge. 40c., 15 lbs. \$1.10, 60 lb. box, bulk \$4.20.
Chick Food. (Michell's). 5 lbs. 25c., 10 lbs. 40c., 25 lbs. 75c., 50 lbs. \$1.50, 100 lbs. \$2.50.
Chick Food. (Steinmesch). 5 lbs. 25c., 10 lbs. 40c., 25 lbs. 75c., 100 lbs. \$2.50.
Cracklings. Similar to Poultry Meat. 50 lb. cakes only, 3½c. lb.
Dried Blood. A great egg producer. 5 lbs. 30c., 10 lbs. 50c., 25 lbs. \$1.00, 100 lbs. \$3.50.
"H. O." Poultry Food. 5 lbs. 20c., 25 lbs. 75c., 100 lbs. \$2.25, *per ½ ton \$20.00, *per ton \$37.00. (*From factory prepaid.)
Hemp Seed. Used largely for feeding birds and pigeons. Per qt. 12c., peck 50c., bush. \$1.75.
Hulled Oats. 5 lbs. 20c., 10 lbs. 35c., 25 lbs. 75c., 100 lbs. \$2.35.

Imperial Egg Food. For making hens lay winter and summer. Keeps the fowls in the best condition. 26 oz. pkge. 25c.
Kaffir Corn. Excellent poultry food. Qt. 10c.
Linseed Meal. (New process). 5 lbs. 30c., 10 lbs. 55c., 25 lbs. \$1.15, 100 lbs. \$4.00.
Meat for Poultry (Prepared). This is prepared with great care. It is the finest thing we know of to cause hens to lay during the winter; extremely profitable to feed. 5 lbs. 25c., 10 lbs. 40c., 50 lbs. \$1.50, 100 lbs. \$2.50, 500 lbs. \$12.00, per ton \$44.00.
Milk (Granulated). 5 lbs. 30c., 10 lbs. 50c., 25 lbs. \$1.00, 50 lbs. \$1.75, 100 lbs. \$3.00.
Mash Food (Early Breakfast). 5 lbs. 20c., 10 lbs. 35c., 25 lbs. 75c., 100 lbs. \$2.50.
Mica Crystal. For digestion. 5 lbs. 15c., 10 lbs. 20c., 25 lbs. 35c., 100 lbs. 85c. Three grades—fine, coarse and medium.
Oyster Shell (Fresh Ground). The finest article to feed for shell making. 5 lbs. 10c., 25 lb. bag 25c., 100 lbs. 75c., ½ ton \$5.50, per ton \$10.00.
Peas (Canada Field). Per qt. 10c.
Pratt's Food. Will make hens lay all the year, and is excellent for feeding to young chicks. For large fowls mix one ounce with the food for fifteen or twenty. For fifteen or twenty chicks give one-half ounce every other day. 1½ lb. pkge. 25c., 5 lb. pkge. 60c., 12 lb. bag \$1.25, 25 lb. bag \$2.50.
Pratt's Horse and Cattle Food. 5 lb. pkge. 50c., 12 lb. bag 75c., 25 lbs. \$1.50, 50 lbs. \$3.00.
Rice (Broken). For young chicks. Lb. 6c., 10 lbs. 55c., 25 lbs. \$1.25, 100 lbs. \$5.00.
Rust's Egg Producer. 1 lb. 25c., 2½ lbs. 50c., 6 lbs. \$1.00, 10 lbs. \$1.50, 25 lbs. \$3.50.
Rust's Havens Condition Powder. Per pkge. 25c., large size 50c., 5 lb. box \$1.00, 8 lb. box \$1.50, 20 lb. box \$3.50.
Sheridan's Condition Powder. 4 oz. pkge. 25c., 2¼ lb. can \$1.00, six 2¼ lb. cans \$5.00.
Sunflower Seed. Qt. 10c., 4 qts. for 30c.

Remedies and Preventatives

Death to Lice. (Lambert's). 10c., 25c., 50c., \$1.00 per pkge.
Death to Lice Ointment. (Lambert's). 10c., 25c. per box.
Death to Lice. (Slack's). 25c. per pkge.
Gape Cure. (Michell's). 15c., 25c., 40c. per bottle.
Gape Cure. (Madoc). 20c., 35c. per can.
Germozone (Disinfectant). 12 oz., 50c.
Hen Tonic. 15c., 25c., 40c. per bottle.
Lice Killer Liquid. (Lee's). 35c. per qt., 60c. per ½ gal., \$1.00 per gal., 5 gal. for \$4.00.
Lice Killer Liquid. (Rust's). 35c. per qt., 60c. per ½ gal., \$1.00 per gal.
Multum in Parvo Powder. 20c., 35c. per pkge.
Roup Preparation. 20c., 40c. per pkge.
Roup Pills. (Rust's). 25c. per box, 250 for \$1.00.
Roup Cure. (Conkey's). 50c. and \$1.00 per box.
Spongia (for Roup). 15c., 25c., 40c. per bottle.
Standard Oil of Tar (Disinfectant). Used by U. S. Government. 35c. per qt., 60c. per ½ gal., \$1.00 per gal.
Thymo Cresol (Disinfectant). 35c. per bottle.
Tobacco Stems. 5 lbs. 20c., \$1.00 per barrel.
Tobacco Dust. 5 lbs. 25c.
Vero Insect Powder. 16c. per ¼ lb., 30c. per ½ lb.

NEST EGGS

	Each	Per Doz.
Knox (Medicated)	6c.	60c.
Medicated	5c.	30c.
Porcelain	3c.	25c.
Wooden. (Coxe's)	3c.	25c.



STANERT'S REVOLVING Chicken Holder

To Kill Chickens on

The holder is made of malleable iron and will last a lifetime. Simplifies the operation and, if you kill many fowls you should have a number of them.

Price: 50c. each; per doz., \$4.50.

BOOKS ON POULTRY AND PIGEONS. Price per Copy

Poultry Craft. (The best book of its kind).	\$1.50
Winter Eggs—How to Get Them. (Robinson).	.25
Capons for Profit. New Edition. (Greiner).	.50
Profits in Poultry	1.00
Money in Squabs	.50
Diseases of Poultry. (Salmon).	.50

Ask for our new **POULTRY CATALOGUE**—the most Complete List of its kind.

STRAWBERRY PLANTS, Etc.

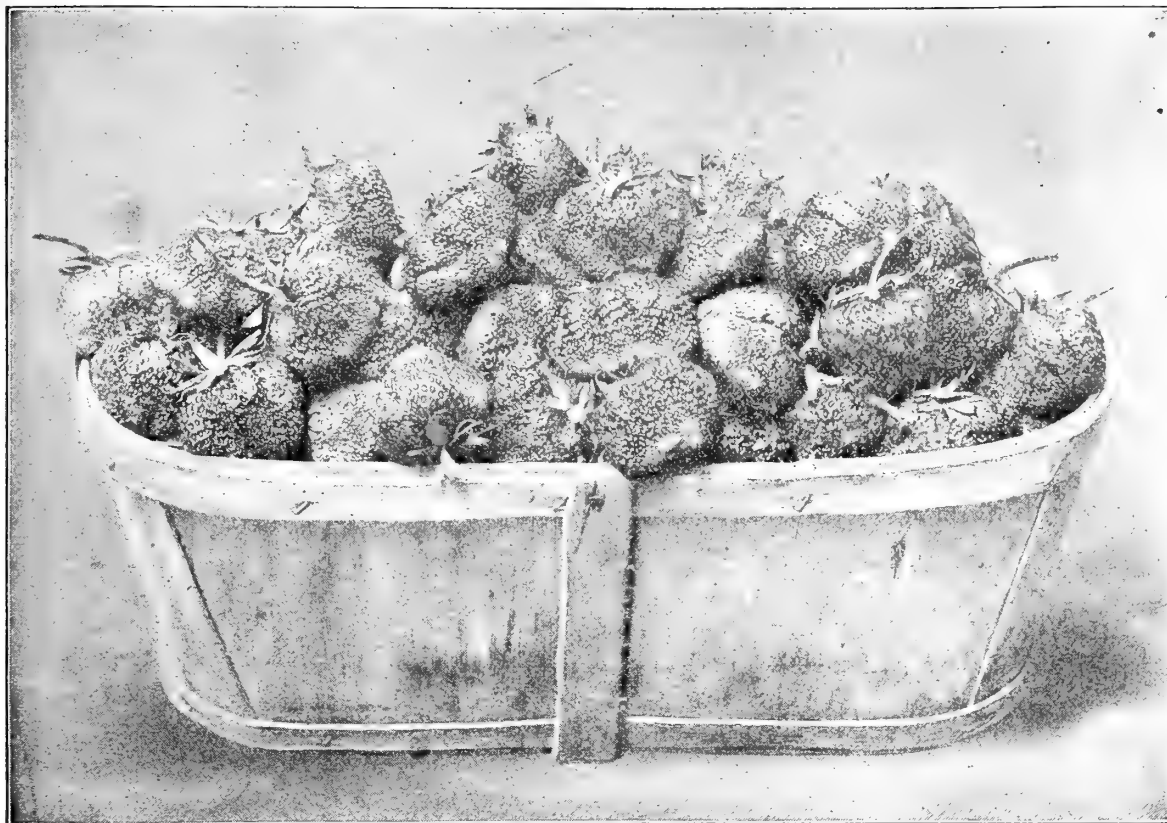

The Great "New Berry", Michell's Abundance.

Brandywine. Late, Perfect. *The finest of all late fruiting sorts; it has not a single defect. Fruit extra large, heart-shaped; color, bright, rich red.*

Bismarck. Early, Perfect. A seedling from Bubach and resembles its parent in every way. It is enormously prolific.

Bubach. Mid-season, Pistillate. One of the best and most profitable; an old favorite.

Cumberland Triumph. Early to mid-Summer. An excellent variety for the home garden.

Gandy. Late, Perfect. One of the best berries for market. Fruit solid, of fine flavor.

William Belt. Mid-season, Perfect. For size, beauty and fine quality it is one of the very best. Ten of the largest fill a quart box.

Sharpless. Mid-season, Perfect. An old favorite with many. Fine color, good quality.

Clyde. Early to mid-season, Perfect. Exceedingly productive, of fine quality. A top-dressing of stable manure in Winter will stimulate greater foliage growth. Few strawberries succeed as well as the Clyde.

Gladstone. Mid-season, Perfect. The fruit, which is borne in great clusters, is of largest size and beauty; unexcelled in quality.

Glen Mary. Mid-season to late. Imperfect. Its roots are enormous, enabling it to ripen its great crop of monster berries in the driest season. Never failed to produce a large crop of fruit.

Marshall. Early, Perfect. This is one of the finest berries. It is the earliest of all the very large varieties and it usually matures all its fruit. Berry is dark, glossy red, and of fine quality.

Michell's Early. Early, Perfect. A very strong growing, extra early variety; worthy of a place in all gardens.

Nick Ohmer. Mid-season, Perfect. The berries are a giant among strawberries, conical in form. Rich crimson, firm and solid, excellent in quality.

PRICES:

(Except where noted)

POT GROWN—Per doz., 60c.; per 100, \$3.00; per 1000, \$25.00.

LAYER PLANTS—Per doz., 25c.; per 100, \$1.00; per 1000, \$6.00.

MICHELL'S ABUNDANCE STRAWBERRY.

One of the finest varieties for general crop; will produce more berries in the space allotted to its growth than any sort in existence; ripens very evenly and up to the stem.

PRICES:

POT GROWN—Per doz., 75c.; per 100, \$4.00; per 1000, \$30.00.

LAYER PLANTS—Per doz., 35c.; per 100, \$1.50; per 1000, \$10.00.

HEDGE PLANTS.

CALIFORNIA PRIVET.

Large Stock, Strong Plants.

Exceedingly beautiful, nearly evergreen hedge plants. Very vigorous and hardy; leaves deep green, bright and very glossy. Especially adapted for hedges at the seashore; very easily transplanted. Beware of spurious kinds of privet which are being offered for the above and which are not nearly so desirable. Ours are the genuine California, or Japan Privet (*Ligustrum Ovalifolium*). Most of them have been transplanted and are furnished with an abundance of fine fibrous roots, are well branched and are sure to give satisfaction.

	Per 100	Per 1000
1 and 2 year old, 12 to 18 inch.....	\$3.50	\$30.00
2 year old, 18 to 24 inch.....	4.00	35.00
2 year old, 24 to 30 inch.....	4.50	40.00

Also larger sizes quoted on application.

Osage Orange. 1 year old, per 100, 75c.; per 1000, \$5.00. 2 years old, per 100, \$1.00; per 1000, \$7.50.

Hemlock Spruce. 1 to 2 ft. high, per doz., \$6.00; per 100, \$40.00. 2 to 2½ ft. high, per doz., \$7.50; per 100, \$55.00.

Norway Spruce. 12 to 18 inches high, per doz., \$3.00; per 100, \$20.00. 2 to 2½ ft. high, per doz., \$6.00; per 100, \$40.00.

American Arbor Vitae. 18 to 24 inches high, per doz., \$3.00; per 100, \$20.00. 3 to 3½ ft. high, per doz., \$7.00; per 100, \$50.00.

Althea (Hibiscus). 1 to 2 ft. high, per doz., \$1.50; per 100, \$10.00. 3 to 4 ft. high, per doz., \$3.50; per 100, \$25.00.

Berberis (Thunbergii). 1 to 1½ ft. high, per doz., \$2.00; per 100, \$12.00. 1½ to 2 ft. high, per doz., \$2.25; per 100, \$16.00. 2 to 2½ ft. high, per doz., \$3.50; per 100, \$25.00.

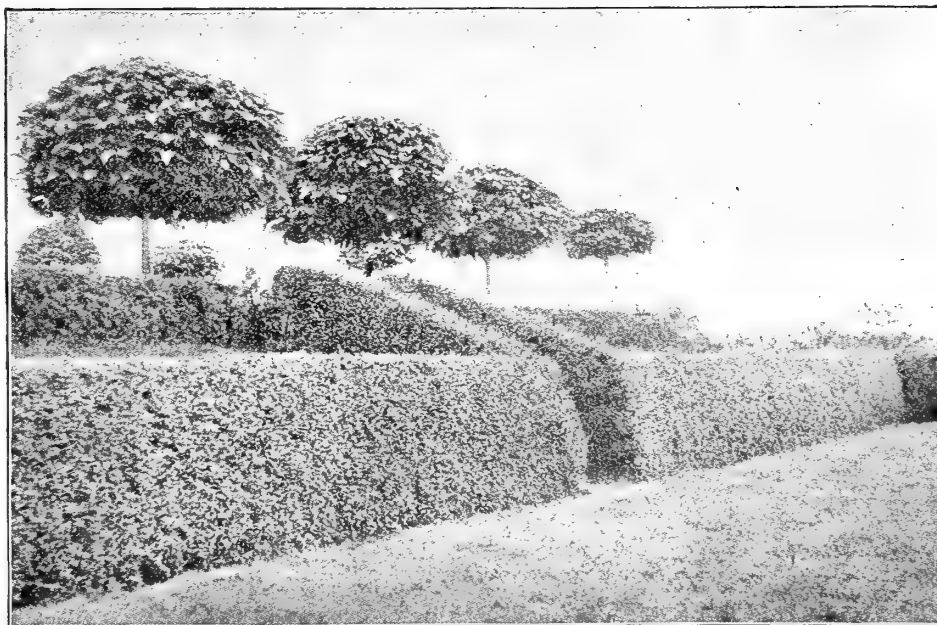

A Hedge of California Privet (Catalpa Trees in the rear).

FRUIT TREES, BUSHES, VINES, ETC.

Strong, Sturdy Stock Only, Shipping Season April 1st to about November 1st.



Blackberries

Blackberries

Plant in good rich soil, in rows five feet apart, and three or four feet apart in the row. After the fruiting season or in early spring, cut out all the dead wood. Should be planted early, before the buds start. A good top dressing of stable manure, applied annually, produces large crops. Keep the ground clean and well worked.

- Erie.** An excellent early berry; ripens its entire crop at once. Berries good size, black, firm, sweet and of good quality. Per doz. 60c., per 100 \$3.00.
- Kittatinny.** Large, juicy, sweet and excellent; hardy and productive. Considered the best and most profitable late berry. Per doz. 60c., per 100 \$3.00.
- Wilson's Junior.** Of large size, unsurpassed productiveness, fine flavor and early. The largest and best early blackberry yet introduced. Per doz. 60c., per 100 \$3.00.

Raspberries

Plant in rows five to six feet apart, two to four feet apart in the row. Cut the tops off within a few inches of the ground when planted. Pinch the vigorous young shoots several times during the summer, they will then grow stout enough to stand without staking.

- Brandywine.** Large; bright red; hardy and productive; an old variety, extensively grown. Per doz. 50c., per 100 \$2.50.
- Cuthbert.** Large, firm, deep rich crimson, of excellent quality; perfectly hardy and very productive. Per doz. 50c., per 100 \$2.50.
- Philadelphia.** Dark crimson; hardy and productive. Per doz. 50c., per 100 \$2.50.
- Golden Queen.** The best yellow variety. Per doz. 50c., per 100 \$2.50.
- Gregg.** A large black variety; fruit firm, of excellent quality and a good shipper. Per doz. 50c., per 100 \$2.50.
- Japanese, or Wineberry.** Large clusters of red berries, excellent for jelly or preserving. Per doz. \$1.00, per 100 \$6.00.
- Strawberry Raspberry.** A raspberry in the form of the strawberry, growing about 18 inches high; fruit, bright scarlet. Per doz. \$1.50, per 100 \$6.00.



Raspberries

Currants

Currants should be planted in good soil, which must be kept rich and well worked. Sprinkle ashes around the roots occasionally, to keep the borers away. The currant worm may be destroyed by sprinkling the bushes with powdered white hellebore while they are wet with dew. Where it has been applied, the fruit should not be used without first being washed.

- Black Naples.** Vigorous and productive; used for jelly and jams and highly profitable for market in some sections. Two years, per doz. \$1.00, per 100 \$6.00.
- Fay's Prolific.** Color rich red. Per doz. \$1.50, per 100 \$7.50.
- Red Dutch.** Medium size; in large bunches, the old and well-known currant of the garden. Per doz. \$1.00, per 100 \$6.00.
- Red Cherry.** Large. Per doz. \$1.00, per 100 \$6.00.
- White Grape.** The best white variety; large, sweet. Per doz. \$1.00, per 100 \$6.00.

Hardy Grape Vines

- Catawba.** A very good keeper; red, sweet and rich, with pleasant flavor. Does best against buildings.
- Concord.** One of the most profitable of all hardy grapes. Bunch and berry large; black, juicy and sweet.
- Delaware.** Light red, very sweet.
- Duchess.** Medium size; greenish white; excellent quality.
- Martha (White Concord).** Large, pale yellow; strongly resembles the Concord in all points except in color: hardy and vigorous.
- Floore's Early.** Bunch and berry round and large; black.
- Niagara.** Bunches very large and very compact; berries large, light greenish white, skin thin but tough, and does not crack.
- Pocklington.** Golden yellow.
- Worden.** Large, Black.
- Salem.** Large; bright reddish brown; fine rich aromatic flavor.
- Price of any of the above varieties:
Strong two year old Vines, 25c. each, per doz. \$2.50
Extra strong three year old Vines, 50c. each, per doz. \$5.00.

Gooseberries

Treatment same as for Currants.

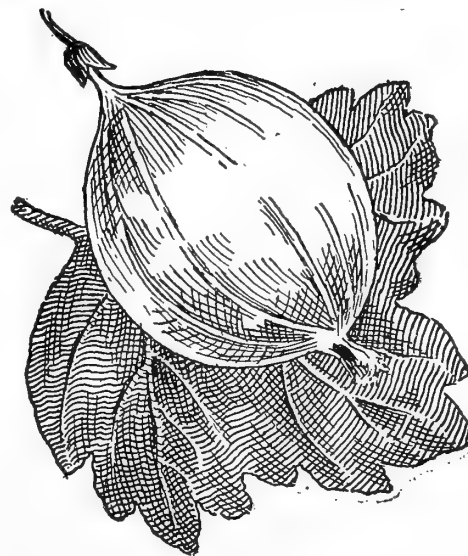

Gooseberries

- Downing.** Large pale green; soft, juicy and good for family use. Per doz. \$1.00, per 100 \$6.00.
- Houghton's Seedling.** Pale red. Per doz. \$1.00, per 100 \$6.00.
- Industry.** Although a foreign sort, it has done admirably, being a vigorous grower and an immense yielder, and showing no signs of mildew. Color dark red. Each 20c., per doz. \$1.75, per 100 \$10.00.

- APPLES**—Baldwin, Early Harvest, Maiden Blush. Each 75c., per doz. \$8.00.
- APRICOTS**—Acme, Rowan. Each 50c., per doz. \$5.00.
- CHERRIES**—Black Tartar, Gov. Wood. Each \$1.00, per doz. \$10.00.
- PEACHES**—Crawfords Early, Elberta. Each 30c., per doz. \$3.00.
- PLUMS**—(European) Bradshaw, Reine Claude, Each \$1.00, doz. \$10.00.
- “ (Japan) Abundance Burbank. Each 75c., per doz. \$8.00.
- PEARS**—Bartlett, Kieffer, Seckel. Each \$1.00, per doz. \$10.00.
- QUINCE**—Meeches Champion. Each 50c., per doz. \$5.00.

The above Trees are all 2 years old, except where noted. We can furnish smaller Trees at lower prices.

SEND FOR COMPLETE CATALOGUE ON TREES AND SHRUBS. "MAILED FREE."

PLANTS, Etc.



VIOLETS.

EXTRA SELECTED CLUMPS.

For planting in frames and greenhouses; in fine, healthy condition, free from rust and disease. Grown by specialists.

SINGLE VARIETIES.

La France. Very large. One of the very best. \$2.00 per doz.; \$12.00 per 100.

Luxonne. The very best large single blue variety. It is of a beautiful rich soft violet color, with strong stout stems from 9 to 12 inches long, very fragrant. \$1.50 per doz.; \$12.00 per 100.

Princess of Wales. \$1.50 per doz.; \$12.00 per 100.

California. One of the largest single blue violets in cultivation. Strong clumps per doz., \$1.50; per 100, \$11.00.

DOUBLE VARIETIES.

Lady Hume Campbell. The best double blue. Field clumps per doz., \$1.50; per 100, \$12.00.

Double Russian. Dark blue. Per doz., \$1.50; per 100, \$12.00.

Swanley Double White. Strong clumps. Per doz., \$1.50; per 100, \$12.00.

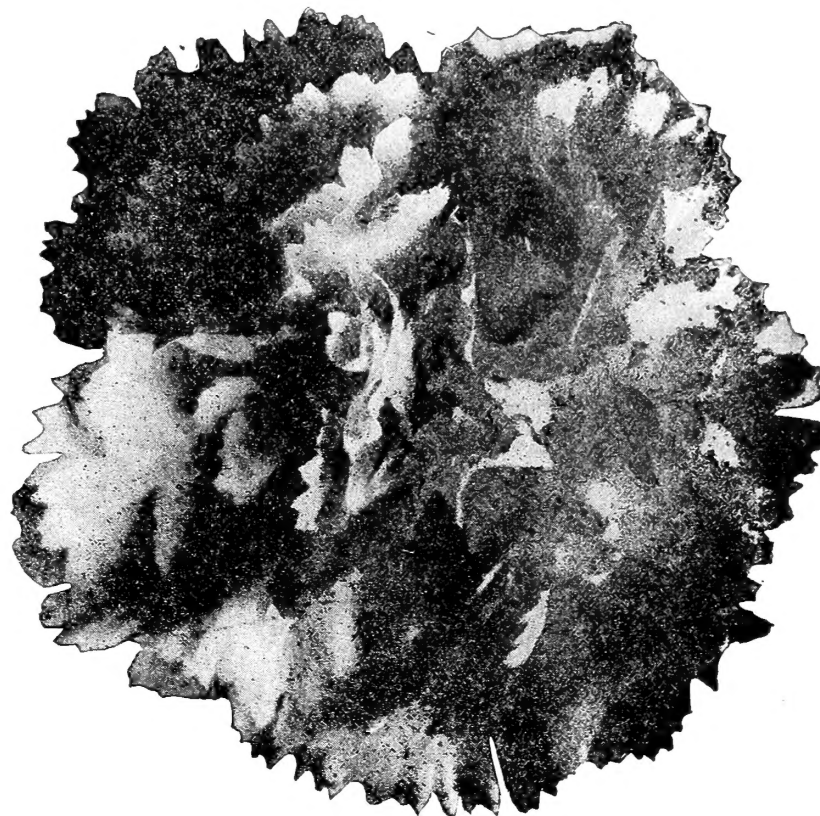

SELECTED CARNATIONS.

FOR WINTER BLOOMING.

Grown especially for us. Plants clean and free from disease. Large strong clumps.

PRICES:

Per doz., \$2.00. Per 50, \$6.50. Per 100, \$12.00.

WHITE

Vesper, May Naylor, Lillian Pond, The Queen, Queen Louise, Flora Hill, Gov. Wolcott, Norway, White Cloud, Boston Market, Lady Bountiful, Fred Burki.

PINK

Lawson, Joost, Crocker, Genevieve Lord, Marquis, Melba, Enchantress, Fiancee, Fair Maid, Nelson Fisher.

RED AND SCARLET VARIETIES

Crane, Roosevelt, Estelle, Adonis, America, Maceo, Challenger, Harry Fenn, Cardinal.

VARIEGATED AND YELLOW VARIETIES

Amarzindy, Bradt, Prosperity, Gold Nugget, Golden Beauty, Sunbird.

CARNATION SUPPORTS.

"Model."

	Doz.	100	1000
2 rings	\$0.45	\$3.00	\$27.50
3 "	.55	3.50	32.50

CARNATION BANDS.

Don't throw away bursted calyx carnation blooms. To the grower of this favorite winter flower this band is invaluable. Can be readily and quickly adjusted; almost invisible when on the flower; will not injure the most delicate flower.

PRICES:

7,000	\$0.75
4,500	.50
2,000	.25
1,000	.15

Postpaid to any address in the United States.

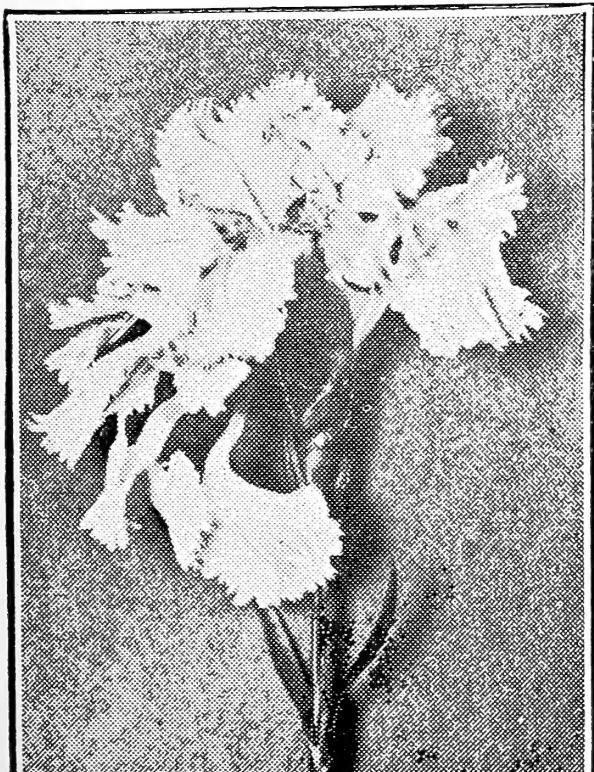

Cut showing Bursted Carnation without our Carnation Band.

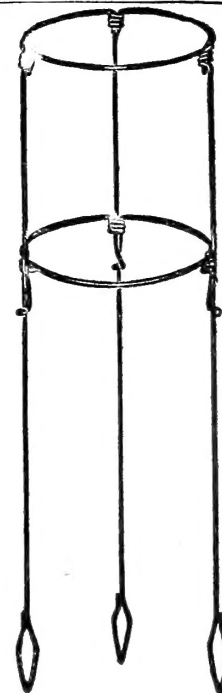

"Model" Two Ring Carnation Support.

KILLS

Sulpho-Tobacco Soap.

INSECTS

PALMS AND DECORATIVE HOUSE PLANTS



ARAUCARIA (Norfolk Island Pine)

One of the most beautiful decorative plants. Easily kept in the house.

	Each	Doz.
6 inches high.....	\$0.75	\$7.50
8 " "	1.00	10.00
12 " "	1.50	15.00
15 to 18 inches high.....	2.00	21.00



FICUS ELASTICA (Rubber Plant)

	Each	Each	
12 inches high.....	\$0.50	18 inches high.....\$1.00	
15 " "75	24 " "	1.50

PALMS

Grown in cool greenhouses, preferable and more satisfactory than those grown in hothouses.

KENTIAS

	Each
15 inches high, 5 to 6 leaves.....	\$1.00
20 " " 6 to 7 "	1.50
24 to 30 inches high, 6 to 7 leaves	2.00

Also larger sizes, from \$2.50 to \$5.00 each.

LATANIAS (Fan Leaved Palm)

	Each
5 to 6 leaves, 15 inches high.....	\$0.50
6 well-developed leaves, 15 inches high	1.00
6 to 7 well-developed leaves, 20 inches high..	1.50

Also larger sizes, from \$2.00 to \$5.00 each.



CYCAS REVOLUTA. (Sago Palm)

A very fine, hardy house plant, 75c. to \$5.00 each

Cocos Weddeliana Palm

Very graceful fine foliage, especially adapted for planting in Fern Dishes.

	Each	Doz.
3-inch pots, 12 inches high	\$0.25	\$2.50
4 " " 16 " "50	5.00

Special Price will be quoted on larger quantities.

Areca Lutescens Palms

	Leaves	Height	Each	Doz.
3-inch pots, 4 to 5, 12 to 15 inches...			\$0.25	\$2.50
4 " " 5 to 6, 15 to 18 " "50	5.00
5 " " 6 to 7, 18 to 21 " "			1.00	10.00
6 " " 7 to 8, 24 to 26 " "			2.00	21.00

Asparagus Sprengerii Plants

	Each	Doz.	Per 100
3-inch pots	\$0.15	\$1.50	\$10.00
4 " "25	2.75	22.50

FERNS

Desirable Varieties Special for Filling Fern Dishes or Pans.



BOSTON FERNS

	Each	Doz.
Young Plants.....	\$0.25	\$2.50
Strong Plants.....	.50	5.00
Large Plants, 6-in. Pots...	1.00	10.00

Specimen Plants.....\$2.00 to \$5.00 each

FERNS

2½ inch Pots.
\$1.00 per doz.
7.00 per 100.
3 inch Pots.
\$1.25 per doz.
9.00 per 100.

Winter Decorations for the Home and Conservatory



Michell's Giant Cyclamen Plants

Produced from our own strain of seed in the brightest colors.

30 cents each; per dozen, \$3.00



Asparagus Plumosa

A very sturdy house plant. Desirable for growing in fern dishes.

15 cents each; per dozen, \$1.25



Japanese Fern Ball

Japanese Fern Balls, new importation; ready in December.

Dormant Fern Balls	- -	40 cents each
Started Fern Balls	- -	75 cents each



JARDINIERES

Our stock of Fancy Jardiniere is exclusive; the most original designs and patterns can be obtained here, suitable for all sizes of pots. The prices are low—as little as 25 cents, as high as \$10. Call and examine our stock before purchasing elsewhere.



Fern Dish Planted with Michell's Long-Keeping Ferns

FERN DISHES AND FERNERIES

The amount of satisfaction derived from a fern dish is remarkable. Planted with hardy ferns, the kind we select especially for that purpose, they stand the abuse of any room. The dishes, empty, with an inside liner, can be had at 60 cents to \$3.00 each. Prices for filling fern dishes, from 75 cents to \$1.50, according to size of dish and assortment of plants.



MICHELL'S GRASS SEED AS SOWN AROUND HORTICULTURAL HALL AND OTHER BUILDINGS AT ST. LOUIS EXPOSITION.

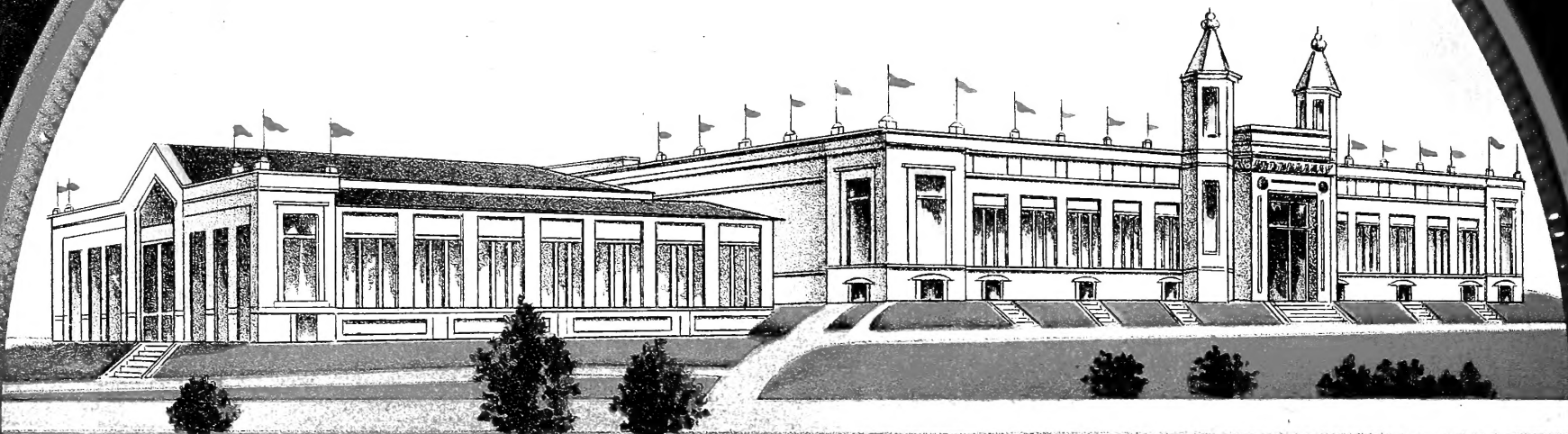

SOW
**MICHELL'S EVERGREEN
LAWN GRASS SEED**
IN SEPTEMBER OR OCTOBER
AND OBTAIN A SUPERB LAWN
FREE FROM WEEDS IN 6 TO 8 WEEKS.

From the Leading Landscape Architect in Philadelphia
TESTIMONIAL
Your lawn seed produces wonderful results. Sown about two weeks it will have to be mowed now. It excels by far any I have ever used. The nine acres that were seeded look as fine and as green as could be. You certainly can challenge the whole world on grass seed.
May 11, 1905.

TESTIMONIAL
Your grass seed has made a great hit at Chestnut Hill. I wish you could come to see it. Engineers, architects and estate owners agree that it is the best growth for newly planted grass seed they have ever seen. I've been asked numerous times where I bought the seed and could not help but tell them. I find I always get the best money can buy from you.
Chestnut Hill,
June 13, 1904.
J. F. MOLLOY,
Landscape Engineer.