

Historic, Archive Document

Do not assume content reflects current scientific knowledge, policies, or practices.

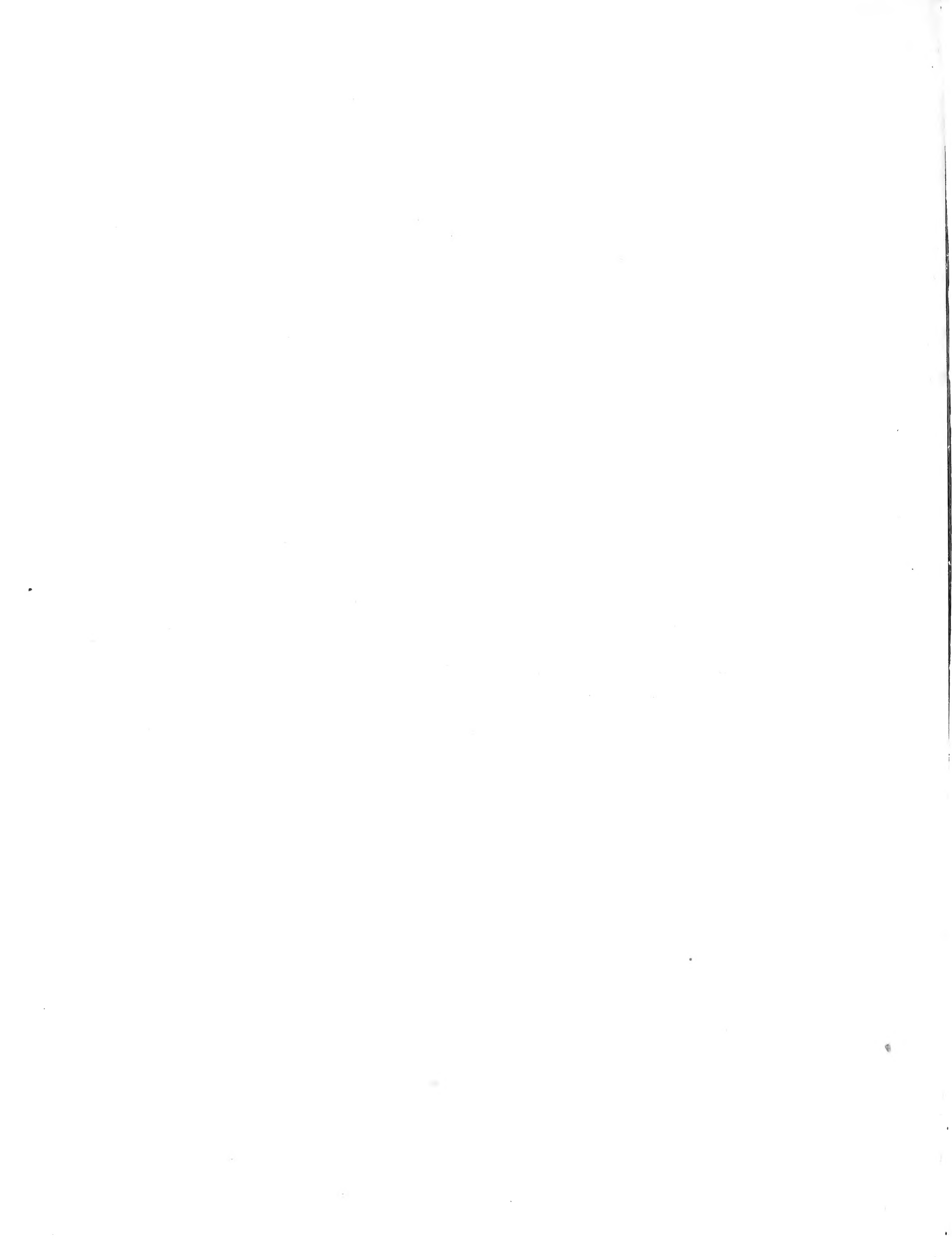



A well matured *Lilium Harrisii* Bulb

A Newspaper Clipping from the *Philadelphia Press*, Oct. 29, '04

PLANTING 100,000 BULBS

Gardeners Arranging Floral Treat for Philadelphia Next Spring.

City Forester Lewis began yesterday his preparations for a floral treat in the larger city squares next springtime.

A force of gardeners was set to work planting the 100,000 bulbs of tulips, hyacinths and narcissus.

The main displays will be in Independence and Logan Squares, but there will be beds in all the Philadelphia Public Parks.

Henry F. Michell & Co., 1018 Market St., have had the City's contract for Bulbs for five years. Bids are awarded on merit of previous years display and lowest prices. This firm supplies a number of the principal parks throughout the country, also many of the largest private gardens and estates. The dependability of color, luxurious flowering qualities of the Michell importations has given this firm an enviable position and ranks it as one of the largest importers of bulbs in America.

P. S. We have again been awarded the contract for furnishing the city with bulbs for this autumn delivery for next springs display.

Henry F. Michell Co.

BULBS Supplies SEEDS Plants

1018 Market Street,
Philadelphia, Pa.

HENRY F. MICHELL, Pres
FRED'K J. MICHELL, Vice-Pres.

... TELEPHONES ...
BELL - - - FILBERT 39-73
- - - - - 39-74
KEYSTONE - - RACE 19-33

MICHELL'S

JULY AND AUGUST, 1905



WHOLESALE



Catalogue and Price List

of BULBS

and Seasonable Supplies

TESTIMONIAL on PANSY SEED.

The Pansy seed I had from you this spring produced the finest plants and largest flowers ever seen on the market at Easton.

Easton, Pa.

E. A. S.

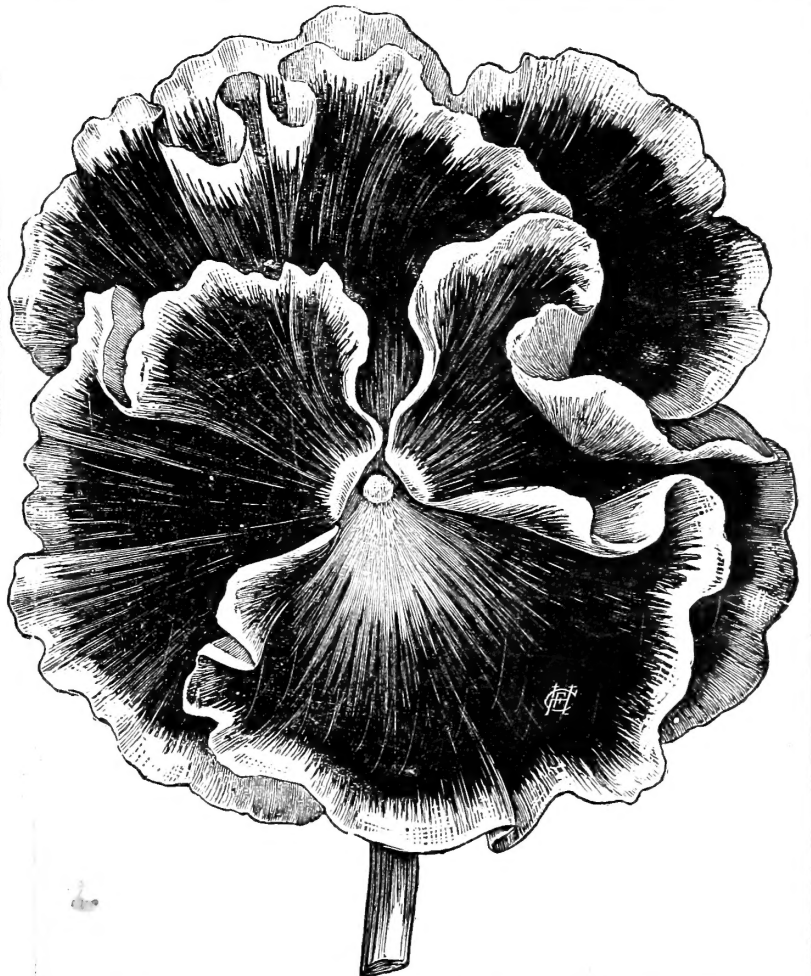

A single bloom of Michell's Giant Exhibition Pansy

BULBS.

*Easter Sunday in
1906 is April 15th*

The prices quoted herein are as near correct at present as they may be safely quoted. **REMEMBER**, however, they are only approximate. **PLACE YOUR ORDER NOW.** It will be filled with choicest stock and billed at lowest possible prices which are current in September. **ALL PRICES INCLUDE OCEAN FREIGHT, DUTY, CUSTOM HOUSE EXPENSES, PACKING AND DELIVERY** f. o. b. Philadelphia steamships, freight lines, etc. **ALL BULBS** are unpacked and carefully examined after arrival before orders are filled.

TIME of DELIVERY of various Bulbs is approximately as follows, viz.: **Harrisii, Bermuda Longiflorum, Freesias, Callas**, about July 15th. **Roman Hyacinths, Paper White Narcissus, Liliun Candidum**, about August 15th. **Dutch Narcissus, Hyacinths, Tulips and Miscellaneous Bulbs**, about September 10th. **Japanese Lilies, Bride Gladioli, Spirea, Dielytra, Paeonies, etc.**, about November 10th. **Lily of the Valley**, about December 1st.

EASTER LILY BULBS

MICHELL'S SPECIAL BRAND EASTER LILY BULBS are far superior to the usual grade of stock imported. They are especially grown for us by the most reliable grower whose stock we can always rely upon. Thus we can insure you of getting bulbs as free from disease as it is possible to get them. We lay special stress on our **SPECIAL BRAND** (not only by name, but by actual test). Every florist who has grown them pronounced them absolutely dependable.



Liliun Harrisii

LILIUM HARRISII MICHELL'S SPECIAL BRAND Ready about July 15th

Produced by special selection of only the finest looking and best matured bulbs. No blind ones. There is usually a limited supply of these and we advise all wishing to book their orders for some of this grade to place it at once.

Size	Number of Bulbs in each Case	Price per Doz.	Price per 100	Price per 1000
5 to 7 inches	400	\$0 75	\$4 50	\$42 50
7 to 9 "	200	1 50	8 75	82 50
9 to 11 "	100	2 75	18 50	180 00

LILIUM HARRISII REGULAR SELECTED BRAND

Our Lilies have given unequalled satisfaction where they have been grown in comparison with other Lily stocks. Being heavy importers of this indispensable Easter Flowering Bulb, we are in a position to furnish the best quality at the price of some inferior grades frequently offered.

Size	Number of Bulbs in each Case	Price per Doz.	Price per 100	Price per 1000
5 to 7 inches	400	\$0 65	\$4 00	\$36 50
7 to 9 "	200	1 25	8 00	75 00
9 to 11 "	100	2 25	17 00	165 00
11 to 13 "	50	4 50	32 50	310 00

Bermuda Liliun Longiflorum

Many florists still continue to grow a few of these. We have arranged for a quantity sufficient to supply the wants of our trade.

Prices on Bermuda Liliun Longiflorum are same as on the Regular Brand Liliun Harrisii.

TESTIMONIAL.
Enclosed please find check for balance of my account and please book my order for 3 cases of Liliun Harrisii. I have had them in market since January. They were fine. I hope you will send me as good next year. S. N. P.
Toledo, Ohio, April 4, '05



TESTIMONIAL.
The LILY BULBS I had from you last fall certainly proved immense. I had Lilies with 18 flowers on. Enclosed find my order of Bulbs. J. B. R.
Elmira, N. Y., March 9, '05.

LILIES, (Continued)

SPECIAL NOTICE—We would draw your particular attention to our Special Stock or Brand of Japanese Lilies. You will be well repaid by planting them; the slight advance in cost is trifling compared with the general results you will obtain.

LILIAM LONGIFLORUM (Japanese)

MICHELL'S OWN SPECIAL BRAND

This is the strain which has produced such surprisingly good Easter Lilies for the past years. Hardly a bulb fails to give a free flowering perfect plant.

Sizes	Bulbs in each Case	Price Per Doz.	Price Per 100	Price Per 1000
6 to 8 inches.....	400.....	\$0 50	\$3 25	\$30 00
7 to 9 ".....	300.....	75	5 00	44 00
9 to 10 ".....	200.....	1 25	7 75	74 00
10 to 12 ".....	150.....	1 75	12 00	110 00

LILIAM LONGIFLORUM (Japanese)

(Ready about October 15th)

Those who have planted our Japan Longiflorums declare them to be the cleanest, healthiest and most vigorous plants they have ever grown. We have already booked a great many orders for Fall delivery. There will be no disappointments next Easter if you plant our stock.

Sizes	Bulbs in each Case	Price Per Doz.	Price Per 100	Price Per 1000
7 to 9 inches.....	300.....	\$0 65	\$4 25	\$39 00
9 to 10 ".....	200.....	1 10	7 25	69 00
10 to 12 ".....	150.....	1 50	10 50	100 00

Lilium Longiflorum Giganteum

(Ready about October 15th)

MAJESTIC FLOWERING JAPANESE

This variety is now coming into great prominence on account of its mammoth flowers. The plants are of a robust growth, decked with a good green colored foliage presenting a handsome appearance.

Sizes	Bulbs in each Case	Price Per Doz.	Price Per 100	Price Per 1000
7 to 9 inches.....	300.....	\$0 85	\$5 75	\$55 00
9 to 10 ".....	200.....	1 50	9 75	95 00

Testimonials

Winston, N. C.

I was more than pleased with the bulbs and appreciate your kindness in sending such good material. Enclosed please find P. O. money order in payment of my account.

Mrs. H. L.

Feb. 6, 1905.

Baltimore, Md.

Your bulbs were fine which we purchased from you. We think you deserve the check enclosed.

E. & U.

Jan. 9, 1905.

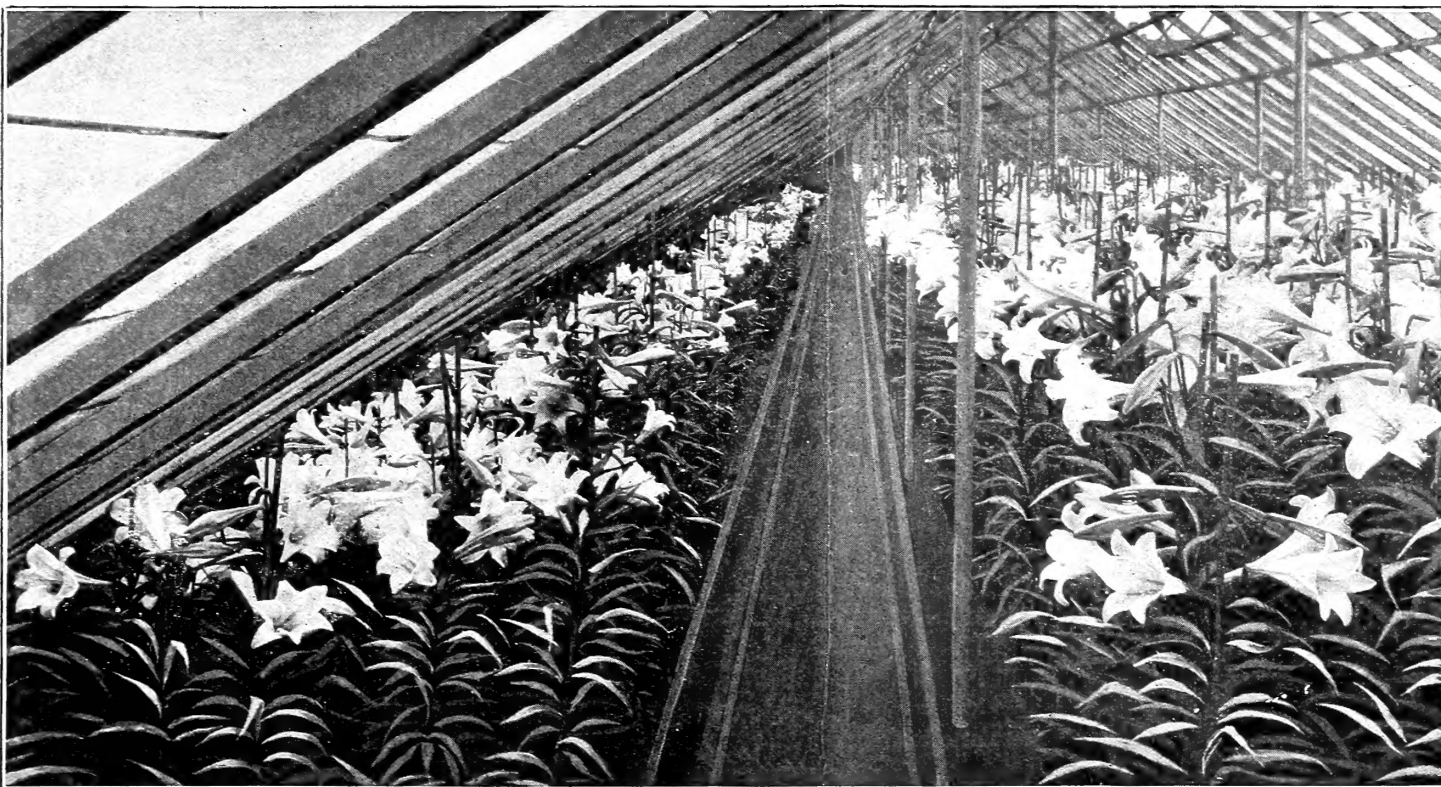

Photograph of a house of MULTIFLORUM MICHELL'S SPECIAL BRAND JAPANESE EASTER LILIES taken at one of the prominent Philadelphia growers establishments.

TESTIMONIALS

A few words from customers direct will tell you more at one glance than we could with hours of convincing argument.

I received the *Bulbs* all right and they are in *fine condition*.

A. H. L.

Wilmington, Del.

I received the *Bulbs* in good condition and *am well pleased with them*. Please find enclosed a check which pays for them.

Allentown, Pa. T. B.

Enclosed please find check in payment of our bill of bulbs. Our order for next season will be ready soon, and we will mail it to you. *Thanking you for sending us such good stock last season.* E. & Co.

Wilkesbarre, Pa.

I wish you could see the growth coming on our *Harrisii*. It is the *healthiest growth* on a patch of lilies *I ever saw*. Every bulb came up and we cannot detect one with disease. *They came from your house.* B. Floral Co.

Mansfield, Ohio.

I am pleased to report what that 85% of my *Harrisii Lily* bought of you are doing fine.

Oswego, N. Y. W. D. S

I wish to thank you for the *fine lot of lily bulbs* you sent me, the plants are certainly looking very fine and very little disease amongst them.

Wheeling, W. Va. M. L. H.

6 Bulbs of any one Variety at Dozen Rates, 25 at 100 Rates, 250 at 1000 Rates.

LILIUM CANDIDUM (Ready about August 15th)

ST. JOSEPH'S OR ANNUNCIATION LILY

Are now largely used by florists for forcing; they are very satisfactory for this purpose, producing magnificent white flowers on well decked plants.

	Per doz.	per 100	per 1000
Regular Size	\$0 65	\$4 00	\$37 50
Monster Bulbs	80	4 75	42 50

WHITE CALLA LILIES (Ready about July 15th)

Our stock of these bulbs is carefully harvested and properly matured, thus insuring all bulbs being sure bloomers.

	Inches in Circumference	Price per doz.	Price per 100	Price per 1000
Mammoth Size, 6 to 7½.....		\$1 40	\$10 00	\$95 00
Extra Selected, 5 to 6		1 20	8 50	80 00
First Size, 4½ to 5½.....		85	6 00	55 00
Second Size, 3½ to 4½.....		60	4 75	45 00
Third Size, 3 to 4		50	4 00	35 00

BLACK CALLA LILY. (Ready in October)

Green foliage, with a darkish flower; good strong bulbs; sure to bloom. Price, 80c. per doz.; \$6.00 per 100.

SPOTTED FOLIAGE CALLA. (Ready in October)

The flower is pure white, much like the regular Calla; the leaves are light green, spotted with white. Price 50c. per doz.; \$4.00 per 100.

LITTLE GEM CALLA LILY

A plant of very dwarf growth; foliage small and of a good green color; produces flowers white in color.

Per doz., 50c.; per 100, \$3.00; per 1000, \$27.50.

ROMAN HYACINTHS French grown for Early Forcing

(Ready about August 15th)

Our stock of French Roman Hyacinths is an exclusive one. The bulbs are fully matured. They are carefully packed and evenly graded as to size, so that when you order a certain size you do not get anything smaller.

	Per doz.	Per 100	Per 1000
First Size, White, 11 to 12 ctm.....	\$0 35	\$2 25	\$19 00
Selected Size, White, 12 to 15 ctm.....	40	2 50	23 50
Extra Selected Size, White, 13 to 15 ctm.....	50	3 15	30 00
Pink. Light, 12 to 15 ctm.....	40	2 75	26 50
Pink. Dark, 12 to 15 ctm.....	35	2 50	22 50
Blue. 12 to 15 ctm.....	35	2 50	22 50
Italian (later than French). 12 to 15 ctm.....	40	2 60	24 00

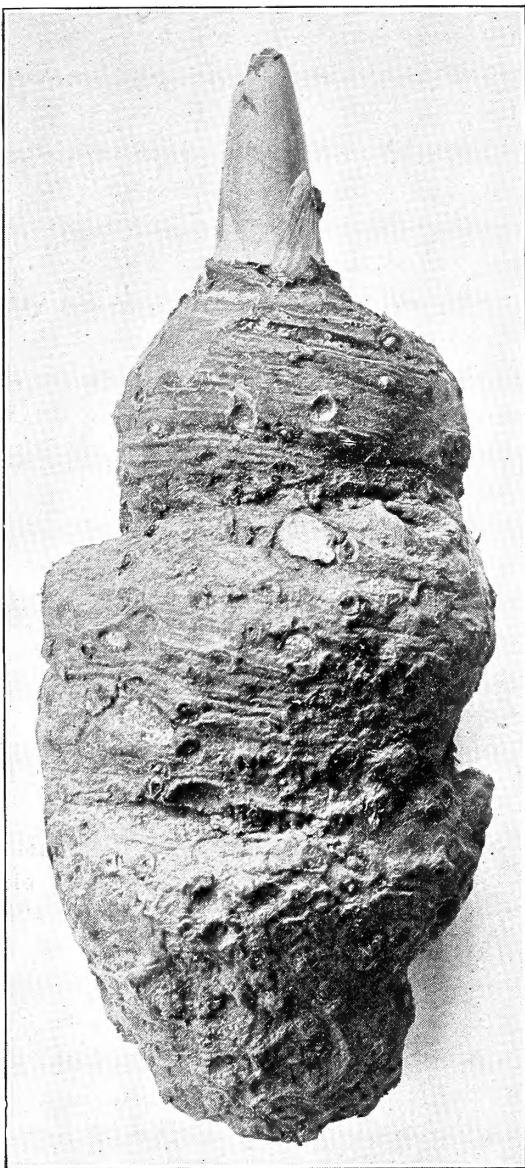

CALLA LILY BULB

Dutch Roman or Miniature Hyacinths

Named Varieties. Large Bulbs

Dutch Roman Hyacinths are largely used for growing in pans, pots and boxes. They force satisfactorily, and owing to the ready demand, are quite salable. Do not waste time and money planting unnamed sorts when the better varieties may be had at so moderate a cost.



Dutch Roman Hyacinths

	Per Doz.	Per 100	Per 1000
Baroness van Thuyll Pure white.....	35	\$2 10	\$19 00
Chas. Dickens. Deep pink	30	2 00	18 50
Chas. Dickens. Light blue	30	2 00	18 50
Gen. Pelissier. Dark red	30	2 00	18 50
Gertrude. Deep pink	30	2 00	18 50
Gigantea. Light pink	30	2 00	18 50
Grand Maitre. Rich porcelain	30	2 00	18 50
King of the Blues. Deep blue.....	30	2 00	18 50
La Grandesse. Pure white	40	2 50	22 00
Mad. Vander Hoop. Pure white.....	35	2 40	21 00

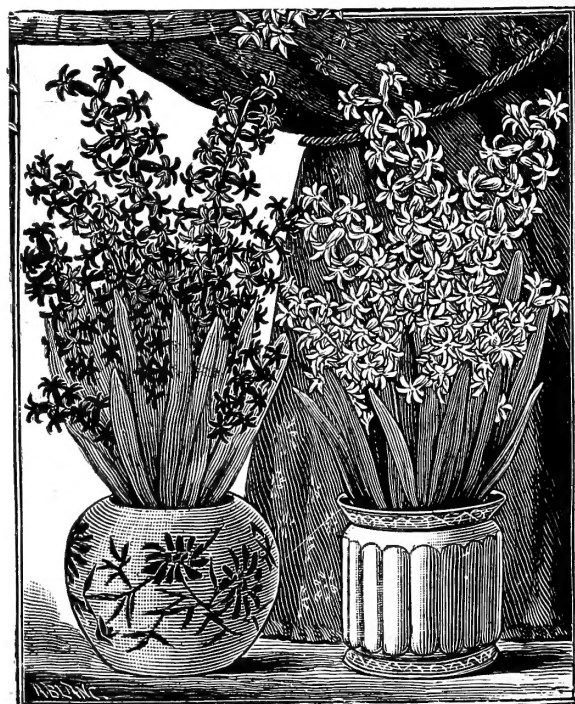

French Roman Hyacinths

6 Bulbs of any one Variety at Dozen Rates; 25 at 100 Rates; 250 at 1000 Rates.

DUTCH HYACINTHS

STRICTLY FIRST SIZE NAMED

Our list of Hyacinths embraces the very best varieties, satisfactory forcers and those with immense trusses or spikes. It pays to plant first size named Hyacinths for the best trade. They always find a ready market at a good price.

SINGLE VARIETIES.

	Per doz.	Per 100	Per 1000
RED.			
Amy. Dark.....	\$0 75	\$5 50	\$54 00
Gen. Pelissier. Crimson.....	80	6 00	58 50
Koh-i-noor, fine. Semi-double light.....	85	6 50	59 50
Robt. Steiger. Crimson.....	80	6 00	58 00
Roi des Belges. Deep.....	80	6 00	58 50
PINK.			
Baron von Thuyll. Light.....	80	6 00	58 50
Gertrude. Bright.....	80	6 00	58 50
Gigantea. Flesh.....	80	6 00	58 50
Lord Macaulley. Bright.....	80	6 00	58 50
Moreno. Light Rose.....	90	7 00	67 50
Maria Cornelia. Rose, fine early.....	85	6 50	62 50
Norma. Flesh, early.....	80	5 60	58 50
Rosea Maxima. Very fine rose.....	90	7 00	67 50
WHITE.			
Alba Superbissima. Pure.....	85	6 50	64 00
Baroness van Thuyll. Pure.....	80	6 00	58 50
Grandeur A'Merveille. Blush.....	80	6 00	58 50
La Grandesse. Pure.....	1 10	8 00	77 50
La Innocence. Pure.....	1 00	7 00	68 50
Madame Vander Hoop. Pure.....	90	6 65	66 00
Queen of the Netherlands. Pure.....	1 00	7 00	68 50
BLUE.			
Blue Mourant. Deep.....	80	6 00	58 50
Chas. Dickens. Light Porcelain.....	80	6 00	58 50
Czar Peter. Porcelain.....	1 00	7 00	68 50
Grand Maitre. Bright.....	80	6 00	58 50
Haydn. Violet Bright.....	80	6 00	58 50
King of the Blues. Deep.....	80	6 00	58 50
Leonidas. Light.....	80	6 00	58 50
Queen of the Blues. Porcelain.....	90	6 50	62 50
YELLOW.			
Hermann. Orange.....	80	6 00	58 50
Ida. Lemon.....	80	6 00	58 50
King of the Yellows. Orange.....	80	6 00	58 50
La Citroniere. Lemon.....	80	6 00	58 50
DOUBLE VARIETIES. RED AND ROSE.			
Bouquet Royale. Rose, red centre.....	80	6 00	58 50
Bouquet Tendre. Dark, carmine red.....	80	6 00	58 50
Czar Nicholas. Delicate Pink.....	80	6 00	58 50
Lord Wellington. Rose.....	80	6 00	58 50
Prince of Orange. Light Red.....	80	6 00	58 50
WHITE.			
Flevo. Pure White.....	80	6 00	58 50
La Tour d'Auvergne. Pure White, early.....	80	6 00	58 50
La Virginite. Rose, White.....	80	6 00	58 50
Prince of Waterloo. Pure White, fine.....	80	6 00	58 50
BLUE.			
Blocksberg. Light Blue.....	80	6 00	58 50
Garrick. Blue, darker centre.....	80	6 00	58 50
Mignon von Dryhout. Light Blue.....	80	6 00	58 50
Rembrandt. Bright.....	80	6 00	58 50
YELLOW.			
Bouquet Orange. Orange Yellow.....	80	6 00	58 50
Goethe. Citron.....	80	6 00	58 50

GRAPE HYACINTHS

White.....	15	60	4 50
Blue.....	10	40	3 25

SECOND SIZE NAMED OR FANCY HYACINTHS ESPECIALLY SELECTED FOR FLORISTS USE

These Hyacinths are a fine selection of named varieties that produce highly satisfactory results. We have included only such sorts that produce large spikes. Second size named Hyacinths pay much better than ordinary mixed color Hyacinths. They are also best for bedding for fine effect.

	Per doz.	Per 100	Per 1000
SINGLE PINK.			
Baron van Thuyll. Light.....	\$0 60	\$4 25	\$41 50
Chas. Dickens. Rose.....	60	4 25	41 50
Gertrude. Bright.....	60	4 25	41 50
Gigantea. Flesh.....	60	4 25	41 50
Lord Macaulley. Bright.....	60	4 25	41 50
Moreno. Light Rose.....	60	4 25	41 50
Rosea Maxima. Rose, fine....	60	4 25	41 50
SINGLE RED.			
Koh-i-noor. Light, semi-double	60	4 25	41 50
Roi des Belges. Deep.....	60	4 25	41 50
Queen of Hyacinths. Scarlet	60	4 25	41 50
Robert Steiger. Crimson....	60	4 25	41 50

	Per doz.	Per 100	Per 1000
SINGLE WHITE.			
Alba Superbissima. Pure....	60	4 25	41 50
Baroness van Thuyll. Pure..	60	4 25	41 50
La Innocence. Pure.....	70	4 50	44 00
La Grandesse. Pure.....	70	4 50	44 00
Madam Vander Hoop. Pure..	60	4 25	41 50
Queen of the Netherlands. Pure	60	4 25	41 50
Grandeur A'Merveille. Blush	60	4 25	41 50
SINGLE BLUE.			
Blue Mourant. Deep.....	60	4 25	41 50
Baron van Thuyll. Deep....	60	4 25	41 50
Chas. Dickens. Light.....	60	4 25	41 50
Czar Peter. Lt. Porcelain, fine	70	4 50	44 00
Grand Maitre. Deep Porcelain	60	4 25	41 50
King of the Blues. Deep,			
extra large.....	60	4 25	41 50
Leonidas. Bright Porcelain...	60	4 25	41 50
SINGLE YELLOW.			
Hermann. Orange.....	60	4 25	41 50
Ida. Lemon.....	60	4 25	41 50

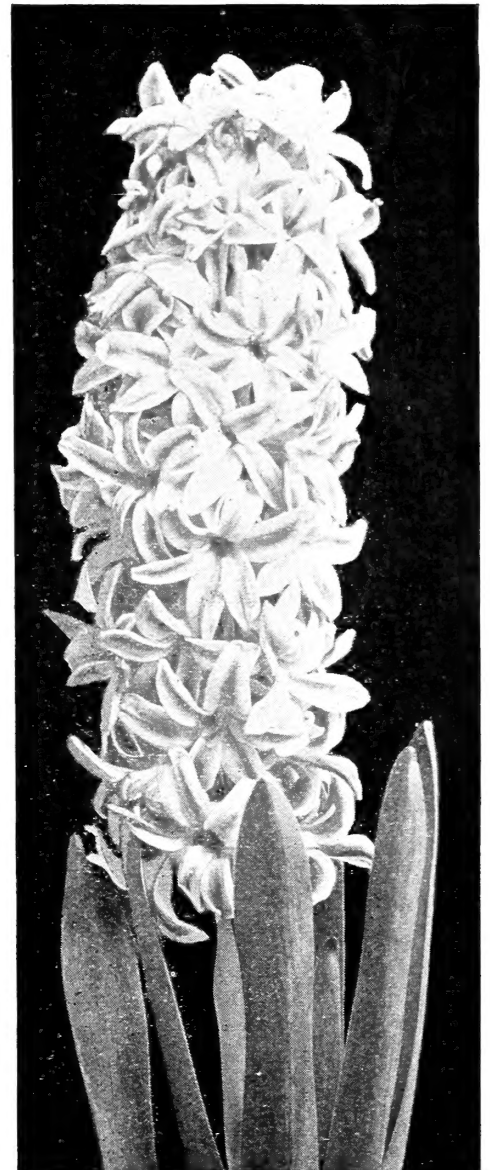

Named Hyacinth 1/3 actual size

TESTIMONIAL.

I enclose check to balance my account. The bulbs were **VERY SATISFACTORY.** I shall send another order soon. A. H. M. Oswego, N. Y., Jan. 5th, '05.

Michell's Fancy BEDDING HYACINTHS

In separate Colors for Bedding and Forcing.

Our Separate Color Hyacinths should not be compared with cheaper stock frequently offered, only the large size grades are imported by us.

	Per doz.	Per 100	Per 1000
Single Red, all shades	\$0 40	\$2 50	\$23 00
“ Pink	40	2 50	23 00
“ Deep Red	40	2 50	23 00
“ White, all shades	40	2 50	23 00
“ Pure White	40	2 50	23 00
“ Blush White	40	2 50	23 00
“ Blue, all shades	40	2 50	23 00
“ Light Blue	40	2 50	23 00
“ Deep Blue	40	2 50	23 00
“ Yellow, all shades	40	2 50	23 00
“ All Colors, Mixed	85	2 35	23 00
Double Red, all shades	45	2 60	24 00
“ Pink, all shades	45	2 60	24 00
“ White, all shades	45	2 60	24 00
“ Pure White	45	2 60	24 00
“ Blue, all shades	45	2 60	24 00
“ Yellow	45	2 60	24 00
“ Mixed, All Colors	40	2 50	23 00

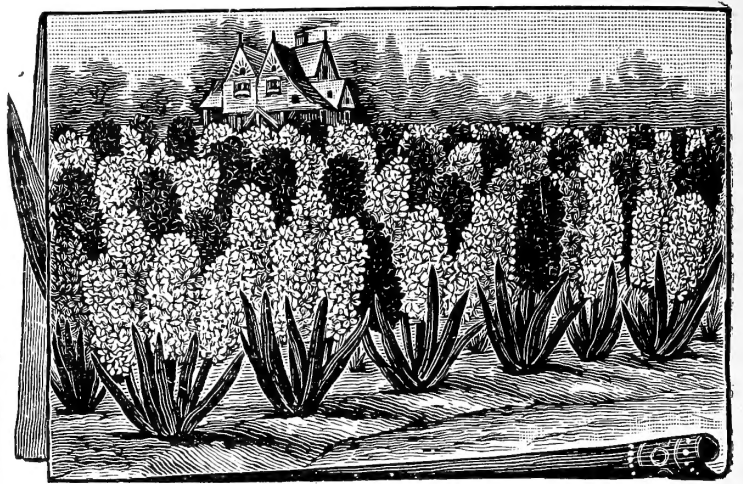

MICHELL'S BEDDING HYACINTHS

NARCISSUS or DAFFODILS

POLYANTHUS VARIETIES

Varieties flanked * are ready about August 15th, others about September 10

	Per doz.	Per 100	Per 1000
*Paper White	\$0 15	\$0 85	\$ 7 50
*Paper White Grandifl. ra. Largest bulbs	20	1 10	9 50
*Paper White Multiflora. (Improved type of the above sort)	25	1 50	13 50
Ask for special price on large quantities of Narcissus Paper white Grandiflora			
*Double Roman. White and Yellow	20	1 00	8 75
Gloriosa. Sulphur Yellow	30	1 85	17 00
*Grand Soleil d'Or. White and yellow	30	1 70	16 00
*Grand Monarque. White and Yellow	25	1 60	14 50
Mixed. All Sorts	20	1 20	10 00

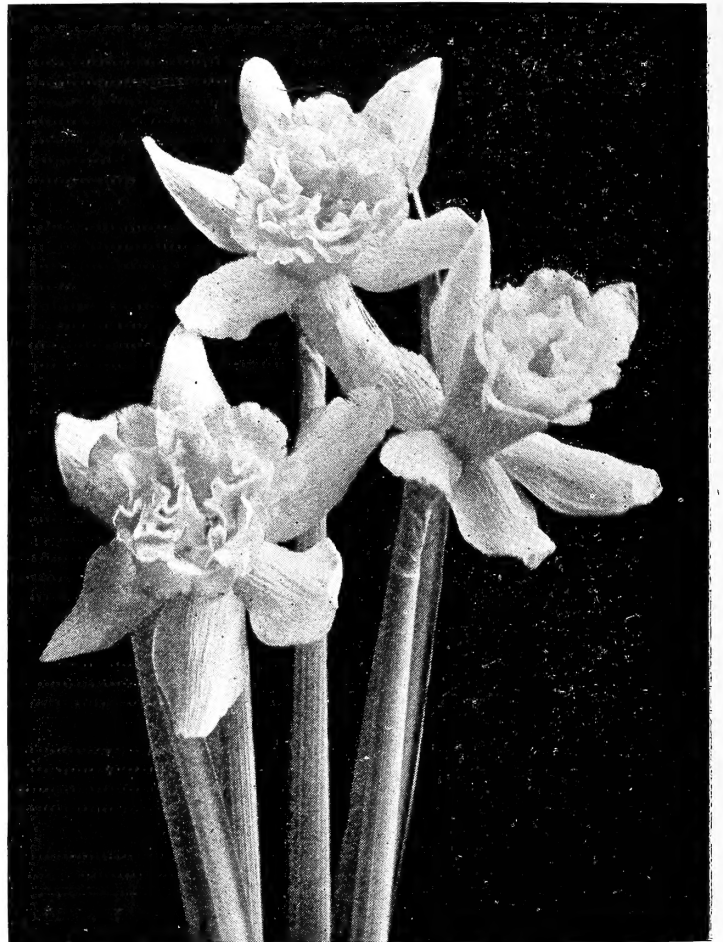

NARCISSUS VON SION (True Stock)

NARCISSUS, (Continued)

DOUBLE VARIETIES

	Per Doz.	Per 100	Per 1000
Alba Plena Odorata. White	\$0 12	\$0 60	\$ 4 75
Incomparable. Yellow	15	80	6 75
Orange Phoenix. Yellow	18	1 00	8 00
Sulphur Phoenix. White Suffused Yellow	35	2 25	20 00
Von Sion. Yellow, strictly first size	25	1 50	13 00
“ “ “ second size	20	1 25	10 50
“ “ “ mammoth 2 flowering	30	2 00	19 00
“ “ “ monster 3 to 4 flowers	45	3 25	30 00
Mixed. All Colors	15	75	6 50

SINGLE VARIETIES

Ard. Righ. Yellow	30	2 10	19 00
Bicolor Grandee. White with Yellow trumpet	30	1 75	16 00
Barrii Conspic. Yellow, Orange scarlet cup	20	1 10	9 00
Campernelle Rugulosus Yellow	12	75	6 00
Campernelle. Yellow	10	50	4 25
Cynosure. Yellow, Orange scarlet cup	10	65	5 50
Emperor. Yellow	30	1 75	16 00
Empress. Yellow and White	35	2 10	19 50
Giant Princeps. Yellow	15	85	7 00
Golden Spur. Yellow	30	1 85	16 75
Henry Irving. Deep Yellow	25	1 75	16 00
Hoop Petticoat. Yellow	40	3 00	28 00
Horsfieldi. Yellow and white	25	1 75	16 00
Incomparable Stella. Yellow and White	12	65	5 50
Pæticus. White, Red Eye	10	50	4 00
“ Ornatus. White	12	65	5 50
Sir Watkin. Sulphur Yellow and Orange	30	1 75	16 00
Trumpet Major (Dutch Grown). Yellow	18	1 00	8 50
“ (French Grown Extra). The French Trumpet Majors are adapted for early forcing	30	1 60	14 50
Mixed. All colors	12	70	5 75

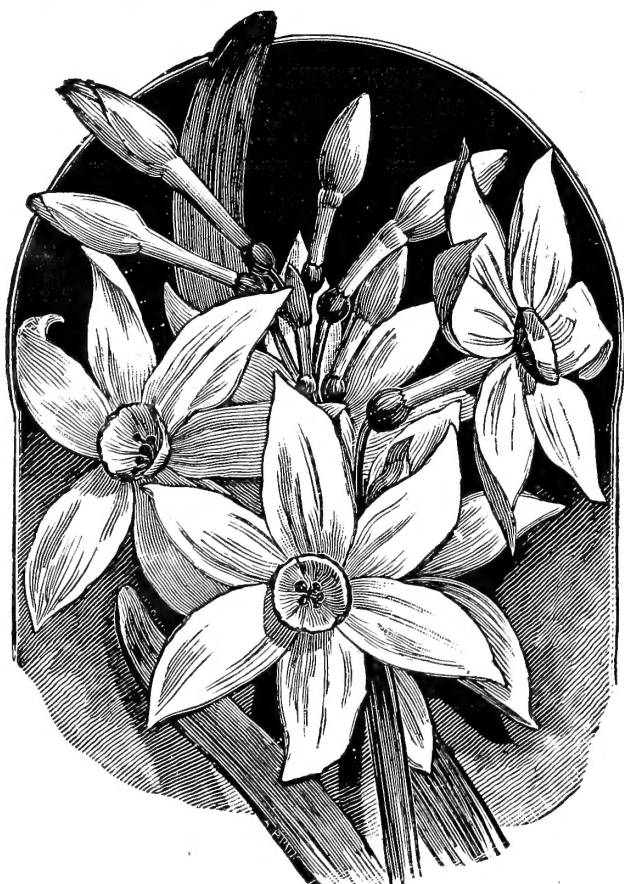

NARCISSUS PAPER WHITE MULTIFLORA

DO NOT fail to include in your order some French Major Narcissus for early blooming. Do not compare our bulbs of these with those offered at low prices the quality we offer is the best and largest size bulbs.

6 Bulbs of any one variety at doz. rates; 25 at 100 rates; 250 at 1000 rates

TULIPS FORCING AND BEDDING

True to Color and Name. All Strictly First Size Bulbs.

EARLY SINGLE VARIETIES

	Per Doz.	Per 100	Per 1000
Adeline Patti. Rosy Crimson.....	\$0 30	\$1 75	\$16 00
Artus. Scarlet.....	20	1 20	10 50
Belle Alliance. The best scarlet.....	35	2 10	19 00
Canary Bird. Light Yellow.....	20	1 10	9 50
Cardinal's Hat. Scarlet.....	15	85	7 50
Chrysolora. Yellow; bedding.....	15	95	8 50
Cottage Maid. Pink and White.....	15	95	8 50
Coulour de Cardinal. Scarlet; forcing.....	40	2 75	26 50
Coulour Ponceau. Cherry and White.....	15	85	7 50
Crimson King.....	20	1 20	10 00
Duchesse de Parma. Red and Yellow.....	15	90	7 75
Duc Van Thol. Scarlet.....	20	1 15	10 00
" " Yellow.....	30	2 00	18 00
" " Crimson.....	15	90	8 00
" " White.....	30	1 60	14 00
" " Pink.....	35	2 00	19 00
" " Gold Striped.....	15	1 00	9 00
" " Red and Yellow.....	15	1 00	9 00
Gold Finch. One of the Finest Yellows.....	25	1 40	12 50
Grand Master of Malta. Red and White.....	30	2 00	18 00
Jagt Von Delft. Pure White.....	15	85	7 50
Joost Van Vondel. Red striped with White.....	20	1 25	11 50
" " White The very best.....	45	3 25	30 00
Kaiserkroon. Red and Gold.....	20	1 25	12 00
La Reine. Blush White.....	15	80	7 00
L'Immaculee. Pure White.....	15	80	7 00
Ophir d'Or. Large Yellow.....	25	1 40	13 00
Pottebakker. Yellow.....	25	1 35	12 25
" " White.....	25	1 35	12 50
" " Scarlet.....	30	1 65	15 50
Prince of Austria. Large Red.....	40	2 65	25 00
Procerpine. Bright Pink; large.....	40	2 65	25 00
Rachel Ruisch. Pink.....	20	1 00	9 00
Rose Grisdelin. Pink.....	25	1 35	12 50
Rose Mundi. Bright Pink.....	15	85	7 50
Silver Standard. White, crimson stripe.....	25	1 50	14 00
Yellow Prince.....	15	90	8 25
Vermilion Brilliant. Richest Scarlet.....	40	2 65	25 00
Verboom. Bright Scarlet.....	30	1 80	17 00
Wouwerman. Purple Violet.....	30	1 75	16 50
White Hawk (New Extra Fine).....	30	1 75	16 50

EARLY TULIPS IN SEPARATE COLORS

	Per Doz.	Per 100	Per 1000
Single Red Mixed.....	\$0 15	\$0 90	\$7 50
" " White.....	15	90	7 50
" " Pink.....	15	90	7 50
" " Yellow.....	15	90	7 50
Double Red.....	20	1 15	10 00
" " White.....	20	1 15	10 00
" " Pink.....	20	1 15	10 00
" " Yellow.....	20	1 15	10 00



Early Double Tulip. Tournesol, Red and Yellow

6 Bulbs of any one variety at dozen rates; 25 at 100 rates; 250 at 1000 rates.

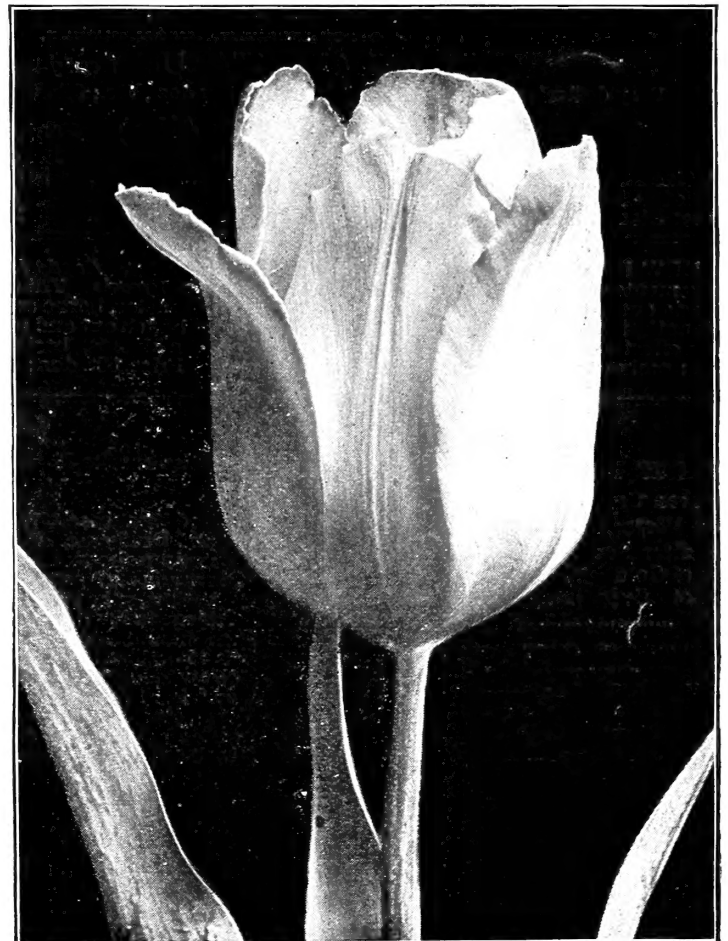

Early Single Tulip. Yellow Prince

EARLY DOUBLE TULIPS

	Per Doz.	Per 100	Per 1000
Coronne d'Or. Rich Yellow.....	40	2 75	26 00
Duc Van Thol. Red and Yellow.....	12	75	7 00
Duke of York. Red, with white edge.....	15	90	8 50
Gloria Solis. Red with yellow border.....	20	1 25	11 50
Imperator Rubrorum. Scarlet; fine forcer.....	35	2 35	22 50
La Candeur. Pure White.....	20	1 25	11 50
Le Blazon. Pink.....	25	1 50	13 50
Murillo. Pink; forcing.....	30	1 90	18 00
Rex Rubrorum. Scarlet.....	25	1 50	13 50
Rose Blanche. Pure White.....	15	95	8 50
Salvator Rose. Pink.....	45	3 10	29 00
Tournesol. Red and Yellow.....	30	1 65	15 50
" " Yellow.....	35	2 40	22 50
Titian. Red and Yellow.....	20	1 30	12 00
Yellow Rose.....	15	85	7 50

EARLY TULIPS IN MIXTURE

	Per Doz.	Per 100	Per 1000
Single Fine Mixed. All colors.....	\$0 10	\$0 60	\$5 25
Single Superfine Mixed. All colors.....	15	75	6 75
Double Fine Mixed. All colors.....	12	70	6 00
Double Superfine Mixed. All colors.....	15	85	8 00

LATE FLOWERING TULIPS

SINGLE AND DOUBLE

	Per Doz.	Per 100	Per 1000
Bouton d'Or. Single yellow.....	\$0 20	\$1 10	\$9 50
Bizarres. Single mixed.....	15	85	7 00
Bybloemen. Single mixed.....	15	1 00	9 00
Darwin. Single mixed.....	20	1 25	12 00
Gesneriana (True Spathulata). Single scarlet.....	25	1 5	12 00
Gesneriana. Single Pink.....	20	1 20	11 00
Picotee (Maiden's Blush). Single white, pink edge.....	25	1 50	14 00
Parrot. Choicest mixed.....	15	85	7 00
Paeony Red, double.....	20	1 10	9 00
Double Mixed.....	15	90	8 00

ANOTHER LETTER

FROM A CUSTOMER READS AS FOLLOWS, viz.:
 In sending you this order let me congratulate you on the fine *Hyacinths*, *Tulips* and *Daffodils* you sold last fall. My flower beds this spring were the handsomest in the neighborhood, and it has been a pleasure to me to hear the many pleasing comments passed. W. W. M., Swarthmore, Pa.

MISCELLANEOUS BULBS

ALLIUM NEAPOLITANUM Ready in August

Very desirable white flowers for forcing, Per doz., 10c.; 50c. per 100; per 1000, \$4 50.

FREESIAS (Refracta Alba) Ready in July

	Per doz.	Per 100	Per 1000
First Size.....	\$0 10	\$0 50	\$4 00
Mammoth Size.....	15	75	6 00
Monster Size.....	20	1 00	9 00

NEW FREESIA "Purity" (Fisher's Own Growing. Ready in July. We made early arrangements with the originator of this valuable new Freesia. This variety exceeds by far any Freesia ever offered; it is of a *snowy glistening* white color, borne on stout wiry stems, two feet in length, it is said by those who have seen it that a bunch cut and placed in water will give the same effect as roses or carnations, so gigantic are the blooms, besides the main stalk it throws up a number of side shoots well covered with buds. Price, 50c. doz.; per 100 \$3.25; \$30.00 per 1000.



NEW FREESIA "Purity"

CROCUS

	Per 100	Per 1000
LARGE BULBS		
Purplea Grandiflora. Blue	45	\$3 50
Queen Victoria. White.....	45	3 50
Sir Walter Scott. Striped...	45	3 50
Cloth of Gold. Yellow.....	45	3 50
Cloth of Silver. Striped.....	45	3 50
White.....	25	2 00
Blue.....	25	2 00
Striped.....	25	2 00
Yellow. Regular Size.....	30	2 75
" Mammoth bulbs.....	60	5 50
" Monster bulbs.....	95	8 50
Mixed. All colors.....	25	2 00

OXALIS

Varieties marked * ready in July, balance in Sept.

	Per doz.	Per 100	Per 1000
*Grand Duchesse. White.....	\$0 20	\$1 25	\$10 00
*Grand Duchesse. Pink.....	20	1 25	10 00
*Grand Duchesse. Lavender..	20	1 25	10 00
*Bermuda Buttercup. Large yellow, very popular, extra large bulbs.....	18	1 00	8 00
Pink.....	15	60	5 00
White.....	15	75	6 50
Yellow.....	15	75	5 50
Bowenii. Finest Pink variety..	15	1 00	8 00
Versicolor.....	15	75	5 50
Double Yellow.....	15	85	7 50
Mixed. All colors.....	10	50	4 50

GLADIOLUS Ready in November

	Doz.	100	1000
The Bride. A pure white sort used extensively for forcing.....	\$0 12	\$0 75	\$6 00
Pink Bride. Similar in character to the above, but different in color.....	12	75	6 00

CHOICE NAMED SORTS

Augusta. The finest white variety.....	\$0 60	\$4 00	\$39 00
Brenchleyensis. Vermilion scarlet.....	20	1 00	8 00
Canary Bird. Exquisite.....	1 25	9 00	87 50
Eugene Scribe. Rich pink.....	85	6 50	60 00
Fatma. White striped and blotched with salmon.....	75	6 00	57 50
May. White penciled crimson, excellent for forcing.....	30	1 75	15 00
Shakespeare. White, shaded carmine, blotched pink.....	75	6 00	50 00

SEPARATE COLORS

Pink Shades.....	25	1 25	12 00
Scarlet and Crimson.....	20	1 00	9 00
White and Light Colors.....	30	1 75	15 00
Yellow Shades.....	35	2 50	23 00

MIXTURES

Childsii. Mammoth flowering species.....	30	2 00	18 00
Extra Choice. All colors.....	15	1 00	9 00
Fine Mixed. All colors.....	12	90	8 00
Groff's New Hybrids. Extra fine.....	95	2 50	22 00
Lemoines. Butterfly varieties.....	20	1 50	12 00



SPIREA FLORIBUNDA SPIREA OR ASTILBE

(Ready in November)

Selected strong clumps with plenty of Flowering Spikes

	Per doz.	100	1000
Japonica.....	\$0 70	\$1 00	\$8 00
Compacta Multiflora strong clumps.....	80	4 50	42 00
Astilboides Floribunda.....	80	4 50	42 00
Washington, Extra large and very free blooming. The finest of all Spireas.....	1 50	9 50	90 00
Gladstone A handsome species. Very large.....	1 50	9 50	90 00

LILY OF THE VALLEY

(Ready in November)

Our Lily of the Valley has given satisfaction wherever grown. We buy it direct from the grower and by contracting for the growing of immense quantities are thus enabled to deliver a superior stock for the least cost.

	Per 100	Per 1000	Per Case 2500
Michell's Berlin 3-year-old pips.....	\$1 25	\$10 75	\$25 00
" Hamburg. (late).....	1 15	10 00	24 00
" Russian. (Mammoth size spikes and flowers).....	1 50	14 00	
\$25 00 per case of 2000 pips			
Clumps for out-door planting, \$2 01 per doz.; per 100, \$15 00.			

Cold Storage Valley

We have arranged for quantity of high-grade pips in Cold Storage, ready for delivery at any time. Place your order at once. Price upon application.



Michell's Russian Lily of the Valley

For a more complete list of miscellaneous bulbs, see our September Wholesale Catalogue mailed to all of our Florist customers or to any one in the trade upon request.

6 Bulbs of any one Variety at Dozen Rates; 25 at 100 Rates; 250 at 1000 Rate

VEGETABLE SEEDS

SUITABLE FOR SUMMER AND AUTUMN SOWING

	Qt.	4 Qts.	Peck	Bu.
BEANS. Improved Red Valentine..	\$0 20	\$0 75	\$1 40	\$5 50
Mohawk (6 weeks).....	20	70	1 20	4 25
Early Long Yellow..... (6 wks)	20	70	1 25	4 75
Golden Wax (Rust Proof) Imp'd	30	1 10	2 20	8 00
Black German Wax.....	30	1 00	1 85	7 00
Vardwell's Kidney Wax.....	35	1 25	2 40	8 00

(Also all other varieties.)

	¼ lb.	Lb.	5 lbs.	Bu.
BEET. Arlington Blood Turnip..	\$0 15	\$0 50	\$2 25	\$7 00
Bastian's Half Long.....	15	40	1 75	5 00
Crimson Globe	20	65	2 75	7 50
Crosby's Egyptian	20	60	2 50	7 50
Eclipse Extra Early.....	15	50	2 25	7 00
Edmand's Selected Turnip.....	15	40	1 75	5 50
Lentz Turnip (True).....	15	40	1 75	4 50

(Also all other varieties.)

	Qt.	4 Qts.	Peck	Bush.
CORN—SWEET OR SUGAR.				
Crosby's Ex. Early.....	\$0 20	\$0 70	\$1 20	\$4 00
Stabler Ex. Early.....	20	70	1 20	4 00
Adams' Ex. Early.....	15	55	90	3 25
Early Evergreen	20	70	1 20	4 00

(Also all other varieties.)

	Oz.	¼ lb.	Lb.
CORN SALAD. (Large 5 lbs. \$1.75).....	\$0 05	\$0 15	\$0 40

	Oz.	¼ lb.	Lb.
ENDIVE. Green Curled.....	\$0 15	\$0 35	\$1 25
White Curled, self blanching.....	15	35	1 25
Giant Fringed	15	50	1 75
Broad Leaved Batavian.....	15	35	1 25

	Oz.	¼ lb.	Lb.
KALE. Green Curled German.....	\$0 07	\$0 20	\$0 65
Imperial, Long-standing (5 lbs. \$2.50)...	07	20	60
Siberian	07	20	60

LETTUCE.

	Oz.	¼ lb.	Lb.
"All Right," Spring and Autumn (Michell's)	\$0 20	\$0 60	\$2 00
Black Seeded Simpson.....	12	30	1 00
Boston Market (White Seeded).....	10	30	1 00
Big Boston	15	40	1 30
Deacon	10	30	1 00
Dutch Butter, Spotted (Improved).....	15	35	1 25
Hanson Improved	10	30	1 00
Matchless (New)	25	75	2 50
Mammoth Salamander (True).....	15	40	1 50
Paris or Kingsholm Cos (Romaine)....	10	35	1 25
Royal Cabbage, Summer Drumhead....	10	35	1 10
Salamander	10	30	1 00
White Butter, or Early Cabbage.....	10	30	1 00
White Russian Summer.....	25	70	2 50
Wonderful	15	40	1 50

(Also all other varieties.)

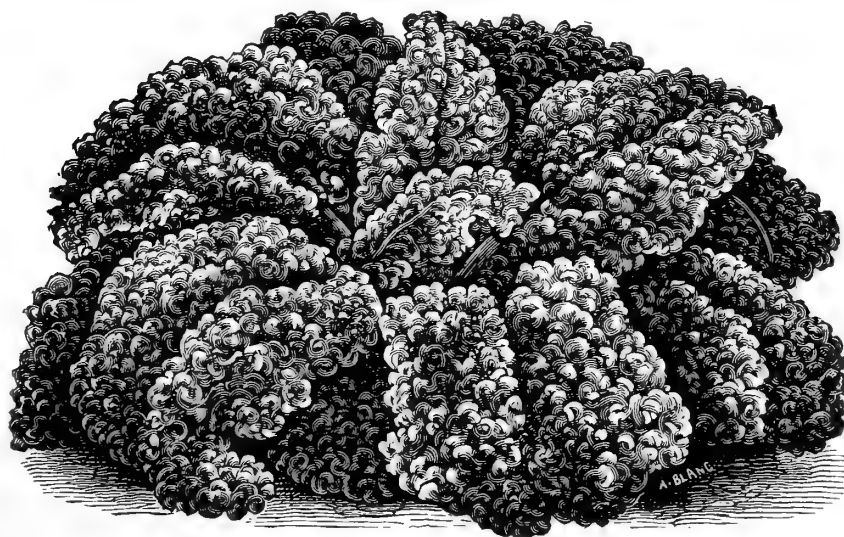

Michell's Bloomsdale Spinach (home grown)

SPINACH.

	¼ lb.	Lb.	10 lbs.	Bu.
Long Standing	\$0 08	\$0 20	\$1 80	\$6 00
Belgian Evergreen (L'g Standing)	10	25	1 80	6 50
Victoria (Long Standing).....	08	20	1 80	6 00
Bloomsdale	08	20	1 80	6 00
New Zealand (7c. per oz.).....	20	75	6 50	



A Yield of Mushrooms from Michell's Pure Culture Spawn

PURE CULTURE MUSHROOM SPAWN (See cut)

Made in America, and after years of careful experimenting, it has finally been pronounced faultless. We have arranged to represent the most reliable of American Spawn makers and are now booking orders for delivery commencing about July 15th. Pure culture spawn is claimed to be far superior to the English, from the fact that it produces much heavier crops and comes into bearing two weeks sooner.

Prices—\$1.75 per dozen bricks; per 25, \$3.00; per 100, \$10.50; per 250, \$25.00; per 1000, \$97.50.

MUSHROOM SPAWN. Michell's English Brand. Per brick, 15c.; per doz. bricks, \$1.50; per 100 lbs., \$6.00; per 1000 lbs., \$55.00. (250 lbs or over at 1000 lb. rates.)

PARSLEY.

	Oz.	¼ lb.	Lb.
Covent Garden, Curled, Extra.....	\$0 07	\$0 20	\$0 75
Extra Curled (Perpetual).....	07	20	60

Notice.—Pecks of Peas at Bushel Rates.

PEAS.

	Qt.	4 qts.	Bu.
Advancer (McLean's) (Medium Early)	\$0 20	\$0 70	\$5 00
Alaska Extra Early.....	20	60	4 00
Abundance (Bliss) (Medium Early)....	20	70	4 75
Blue Beauty (Medium Early).....	25	80	5 40
Daniel O'Rourke, Improved (Ex. Early)	20	60	4 00
Eureka, Extra Early (True).....	20	70	5 00
Heroine (Medium Early).....	25	85	5 60
Michell's Dandy Extra Early.....	25	80	5 40
Premium Gem (Extra Early).....	25	90	6 35

(Also all other varieties.)

RADISH.

	Oz.	¼ lb.	Lb.
Beckert's Chartier (True).....	\$0 07	\$0 15	\$0 50
Cincinnati Market (Long Scarlet).....	07	15	45
Cardinal Globe	07	20	70
Early French Breakfast.....	07	15	50
Fireball	07	15	60
Golden Olive Shaped.....	07	15	55
Golden Globe, Dresden.....	07	15	55
Long Scarlet, Short Top.....	07	15	50
Long White Lady Finger.....	07	15	50
Scarlet Forcing or Button.....	07	20	60
White Box	07	15	45
White Box (Felton's).....	10	25	75
White Strasburg, Half Long.....	07	15	50
White Delicacy, Half Long.....	07	20	70
White Summer, Turnip-shaped.....	07	15	50
Yellow Summer, Turnip-shaped.....	07	15	50

TURNIP.

	Oz.	¼ lb.	Lb.
Purple Top White Globe (5 lbs., \$1.50)...	\$0 05	\$0 15	\$0 35
Cow Horn	05	15	45
Purple Top Flat, Strap Leaved (5 lbs. \$1.50)	05	12	35
White Flat Dutch, Strap Leaved.....	05	12	35
Snow Ball, Extra Early (White).....	07	15	50
Extra Early Purple Top Munich.....	07	20	65
Yellow Aberdeen	05	12	35
Early White Egg.....	05	12	40
Yellow, or Amber Globe.....	05	12	40
Improved, Yel. Purple Top Ruta-Baga..	05	15	40
Fry's Private Stock Purple	10	25	75

For a complete list of Vegetable Seeds see our general Wholesale Catalogue

MICHELL'S CELEBRATED FLOWER SEEDS

Especially Selected for Florists' Trade for Summer and Early Fall Sowing

ACHILLEA.		Trade Pkt	Oz.
Ptarmica Plena.	Hardy perennial, double white.	\$0 30	\$2 50

ACONITUM (Monk's Hood.)			
Napellus.	Hardy perennial, blue and white.	\$0 20	\$0 65

ALYSSUM.			
Carpet of Snow.	Of dwarf, creeping habit.	\$0 10	\$0 35
Little Gem (True).	Very dwarf, best for pot culture	10	35
We have made arrangements for the true Dwarf Little Gem Alyssum, which our customers can rely upon as being extremely dwarf.			
Sweet.	White trailing (¼ lb. 40c.)	10	15
Saxatile Compactum.	Hardy perennial, yellow.	15	30

AMPELOPSIS.			
Veitchi (Japanese Ivy)	(per lb., \$1.50)	\$0 10	\$0 15

ANTIRRHINUM (Snapdragon.)			
Dwarf Firefly.	Scarlet.	\$0 15	\$0 35
Dwarf Mixed		15	40
Giant Scarlet		20	60
Giant White		20	60
Giant Yellow		20	60
Queen of the North.	Large pure white.	15	50
Tall Mixed		10	25

AQUILEGIA (Columbine.)			
Chrysantha.	Yellow	\$0 25	\$1 00
"	Alba. White	30	1 50
Coerulea.	Blue	30	2 25
Single Mixed		10	20
Double Mixed		10	20

TESTIMONIAL ON SNAPDRAGON.



ASPARAGUS PLUMOSA

Perkins Hill, Akron, O.
 Please find herewith another order for Bulbs and Seeds. I hope you will give it the same attention as you have done in the past. There is one thing I would like to give you great credit for, that is your Antirrhinum (Snapdragon). I have had the finest lot that ever I saw in my greenhouses, and have been admired by every one who saw them.
 Very respectfully,
 J. CURNOW,
 Gardener for
 C. B. RAYMOND, Esq.

Our Asparagus Seed is all new crop greenhouse grown seed, and not mixed with surplus old crop seed.

ASPARAGUS.			
Plumosus Nanus.	Home-grown. New Seed.		
Just received. Per 100 seeds, 35c; \$2.50 per 1,000 seeds.			
Sprengeri.	New crop. Per 100 seeds, 15c; 25c. per 250 seeds; 1,000 seeds, 75c.; \$3 00 per 5,000 seeds.		

ASTER.		Trade pkt.	Oz.
Perennial Mixed		\$0 25	\$1 00

AURICULA.			
Primula Auricula.	Mixed.	\$0 50	

BROWALLIA.			
Elata. Blue		\$0 15	\$0 40
Speciosa Major.	Most desirable variety as a pot plant; flowers very large; rich blue.	25	

CALCEOLARIA.		½ Trade pkt.	Trade pkt.
Hybrida Grandiflora.	Choice mixed.	\$0 60	\$1 00
Hybrida Grandiflora Compacta.	Mixed.	60	1 00
James' Superb Strain.	Superfine mixed.	60	1 00
Rugosa (Shrubby).	Mixed (per small pkt., 34c.)	60	1 00

CAMPANULA (Canterbury Bells).		Trade pkt.	Oz.
Calycanthema Cup and Saucer.	White.	\$0 25	\$1 25
"	" " Mixed	20	75
Media.	Single mixed.	10	20
"	Double mixed	15	60
Persicifolia Grandiflora.	Blue	25	
"	" White	25	
Pyramidalis (Chimney Bell Flower).	Mixed.	20	60

CANDYTUFT (Iberis).			
Crimson		\$0 10	\$0 15
Empress Mammoth.	Best for cut flowers (lb. \$2)	10	25
Little Prince.	Dwarf, large spikes, pure white	15	40
Pink		10	20
Purple		10	15
Sempervirens.	Hardy, perennial, white.	15	50
Tom Thumb.	White, very dwarf.	10	20
White Rocket.	Pure white (lb., 60c.)	05	10
Mixed.	All colors.	05	10

CARNATION.			
Early Vienna.	Mixed.	\$0 25	\$1 50
Finest German Mixed.		50	
Marguerite.	Choicest mixed, all colors.	20	75
"	Excelsior. Extra large, mixed.	30	2 25
"	Snowflake. White	30	1 25
"	Yellow	50	
Choice Mixed		40	2 00



CINERARIA. MICHELL'S GIANT STRAIN

CINERARIA.			
The Cineraria seed offered by us is the best procurable. Immense trusses of the largest flowers are produced. Have been awarded numerous First Prizes.			
Grandiflora Prize Dwarf.	Mixed.	½ Trade pkt.	Trade pkt.
"	" Medium Tall. Mixed.	\$0 60	\$1 00
James' Giant Strain.	Mixed.	60	1 00
Hybrida Choice.	Mixed.	30	50
Double Mixed		60	1 00
Sutton's Stellata (Star Cineraria).	Orig. pkt. 60c.		
Stellata Hybrida.	Original pkt. \$1.00.		

COREOPSIS		Trade pkt.	Oz.
Lanceolata Grandiflora.	Extra large yellow flowers	\$0 15	\$0 50
California Sunbeams.	Flowers large; various shades of yellow and brown	20	75



Cyclamen Giganteum

CYCLAMEN GIGANTEUM

Grown by one of the leading growers in Europe, who has a world-wide reputation for this strain.

	100 Seeds	1000 Seeds
Giganteum Album. White	\$0 75	\$6 00
" Roseum. Pink	75	6 00
" Rubrum. Red	75	6 00
" White with Red Eye	75	6 00
" Mixed	60	5 00
Papilio (Butterfly). Mixed	1 50	
Persicum. Choice mixed	30	2 00

DAISY, DOUBLE (Bellis Perennis)

Giant White	\$0 40	\$3 00
" Mixed	40	2 50
Longfellow. Red	30	2 50
Snowball. White	30	2 50
Mixed	30	2 00

DELPHINIUM (Perennial Larkspur)

Cashmerianum. Large dark blue	\$0 40	\$2 00
Chinense. Bright blue	15	40
Formosum. Rich blue	15	50
Nudicaule. Scarlet	40	2 00
Zalil. Sulphur yellow	40	2 00
Hybridum. Single mixed	10	25

DIGITALIS (Fox Glove)

Gloxiniaeflora. Mixed	\$0 10	\$0 25
Monstrosa. Mixed	25	1 00

DRACAENA

Australis. Broad leaved	\$0 20	\$0 60
Indivisa. Narrow foliage	15	35
Adiantum (Maiden Hair). Mixed	\$0 30	

GAILLARDIA

	Trade pkt.	Oz.
Grandiflora Compacta. Perennial mixed	\$0 20	\$0 60
" Superba. Perennial mixed	15	40

GYPSOPHILA

Paniculata (Baby's Breath). Perennial; white	\$0 10	\$0 20
--	--------	--------

HELIANTHUS (Sunflower)

Golden Bouquet. Perennial. Single Yellow	\$0 20	\$0 75
Red Perennial (New), 20c. per pkt.		

HEUCHERA (Alum Root)

Sanguinea. Hardy perennial, crimson flowers	\$0 30	\$2 00
---	--------	--------

HOLLYHOCK

Allegheny Semi-Double Fringed, Mixed	\$0 25	\$1 00
Chater's Double Pink	25	1 00
" " Red	25	1 00
" " Salmon	25	1 00
" " White	25	1 00
" " Yellow	25	1 00
" " Mixed	20	75
Single Mixed	15	50

LATHYRUS LATIFOLIUS

(Everlasting or Perennial Pea.)

	Trade pkt.	Oz.
Crimson. Brilliant	10	\$0 20
Pink Beauty. Bright rosy pink	10	20
White	10	20
Choice Mixed	10	15

LOBELIA

Cardinalis (Cardinal Flower). Perennial, scarlet, \$0 50

LUPINUS

These are among the most useful of our annual flowers for cutting and house decoration; very free flowering; seeds sown in greenhouse during the late summer and fall months, will produce an abundance of bloom for Christmas and winter season.

	Trade pkt.	Oz.
Blue	\$0 10	\$0 20
Pink	10	20
Red	10	20
Scarlet, white tipped	10	20
White	10	20
Yellow	10	30
Mixed	10	15

LYCHNIS

Chalcedonica. Scarlet	\$0 10	\$0 20
Haageana Hybrida. Mixed	15	60



Photograph showing spikes produced from ALLEN'S DEFIANCE MIGNONETTE

MIGNONETTE

MICHELL'S COLOSSAL. A new variety, producing an unusual number of spikes of immense size, the actual flower spikes measuring from 8 to 12 inches in length; a heavy and continuous cropper. Price, per 500 seeds, 30c.; 50c. per 1,000 seeds; per 1/8 oz., \$1.25.

Allen's Defiance. Originator's stock. ets), 1/2 size pkt., 50c.; full size pkt., \$1.00.

	Trade pkt.	Oz.
Allen's Defiance. Large flowering, true	\$0 15	\$0 40
Bird's Mammoth. Very large spikes	10	30
Bismarck. Very large, best for pot culture	25	1 50
Golden Machet. Yellow	10	30
Golden Queen. Yellow flowers	10	30
Goliath. Giant spikes	25	2 00
Grandiflora. Large flowering	10	15
Machet. Improved selected	15	40
Miles' Hybrid Spiral. A good outdoor sort	10	15
Parson's White	10	25
Sweet Scented	10	15



TESTIMONIAL ON MICHELL'S PANSY SEED.

Wilmington, California.

I take this opportunity of letting you know of the success I had with your Giant Exhibition Pansy Seed. I have grown pansies for years, but in all my experience none have equalled yours. The Flower Seed obtained from you surpassed my expectations by far.

Yours,
C. A. BRAZEE, Florist.

MICHELL'S PANSIES

NOTE—Please do not compare our GIANT PRIZE PANSY with the ordinary Giant Trimardeau. The seed we offer will produce flowers of much heavier texture.

GIANT SORTS IN SEPARATE COLORS

	Trade pkt.	Oz.
Giant Prize Azure Blue.....	\$0 40	\$2 00
" " Black Blue	40	2 00
" " Emperor William. Ultramarine blue	40	2 00
" " Golden Queen. Pure yellow.....	40	2 00
" " Hortensia Red	40	2 00
" " King of the Blacks.....	40	2 00
" " Lord Beaconsfield. Purple violet..	40	2 00
" " Peacock. Blue, claret and white..	50	5 00
" " Snow Queen. Pure white.....	40	2 00
" " Striped and Mottled.....	40	2 00
" " White with Eye.....	40	2 00
" " Yellow with Eye.....	40	2 00

REGULAR SORTS IN SEPARATE COLORS

Belgian Striped	\$0 25	\$0 75
Emperor William. Ultramarine blue.....	25	75
Faust or King of the Blacks.....	25	75
Gold Margined. Purple, golden edge.....	25	75
Havana Brown	25	75
Lord Beaconsfield. Purple violet.....	25	75
Mahogany Colored	25	75
Silver Edged. Purple, silver edge.....	25	75
Snow Queen. Pure white.....	25	75
Yellow with Eye.....	25	75
Yellow Gem. Pure yellow.....	25	75
White with Eye.....	25	75

PANSIES IN MIXTURES

Michell's Giant Exhibition. A strain which we have secured from one of the leading pansy specialists in Germany to which we added the cream of the Paris strain, also the choicest to be had from Scotland. It can be relied upon to give flowers of immense size, very heavy texture, and of the most brilliant colors. Per trade pkt., 50c.; 75c. per 1/8 oz.; per oz., \$5.00.

	Trade pkt.	Oz.
Bugnot, Odier and Cassier. A superb mixture..	\$0 50	\$5 00
Giant Trimardeau. Very large flowering.....	30	1 25
Mad. Perret. A new strain; profuse bloomer; fragrant, and noted as an early blooming variety, of many fine shades of color, and especially rich in red shades.....	50	4 00
Masterpiece. New Giant, curled.....	50	5 00
Non Plus Ultra. Giant blotched varieties.....	50	4 00
Odier or Blotched. A beautiful strain.....	40	2 50
Parisian, Large Stained. Large flowering.....	40	2 00
Finest English. Large flowering.....	25	75
Very Fine Mixed.....	15	50

MUSA ENSETE (Abyssinian Banana)

Fresh stock. Per 10 seeds, 20c.; 25 seeds, 40c.; 100 seeds, \$1.25.

MYOSOTIS (Forget-me-Not)

	Trade pkt.	Oz.
Alpestris. Blue	\$0 15	\$0 50
" Victoria. Very large blue.....	25	75
Dissitiflora. Blue	30	2 00
Eliza Fanrobert. Blue, fine for pots.....	20	60
Fair Maiden. Rich pink, erect growing.....	30	1 50
Grandiflora Alba. White.....	20	75
Oblongata Perfecta. Long stemmed, dark blue	25	1 50
Palustris. True Forget-Me-Not.....	30	1 50
Palustris Semperflorens. Blooms all summer..	25	1 50
Royal Blue. Erect growing.....	30	1 75

PHLOX

Decussata. Hardy perennial. Choicest mixed. \$0 25 \$1 25

POPPY (Perennial)

Giant Scarlet	15	40
" Yellow	15	60
Iceland. Single mixed.....	15	50
Oriental Hybrids. Mixed colors.....	25	1 25



Chinese Primrose (Primula Sinensis Fimbriata)

PRIMULA (Primrose)

We have a very choice strain from a Leading Primula Specialist, and florists may rely upon this to be the very best. Size of flowers very large. Beautifully fringed and of the brightest colors.

	½ Trade Pkt.	Trade Pkt.
Alba Magnifica. White.....	\$0 60	\$1 00
Chiswick Red. Brilliant red.....	60	1 00
Holborn Blue	60	1 00
Kermesina Splendens. Crimson.....	60	1 00
Rosy Morn. Pink.....	60	1 00
Stellata (Sutton's Star). Original pkt., \$1.25.		
Fern Leaved. Mixed colors.....	60	1 00
Michell's Choicest European Mixture contains only the very finest sorts selected from the best strains. (Per 1-16 oz., \$2.00).....	60	1 00
William's Superb Strain. Mixed.....	60	1 00
Double White	60	1 00
" Mixed	60	1 00

PRIMULA OBCONICA

	Trade Pkt.
Grandiflora Fimbriata. Mixed	\$0 50
" Kermesina. Red	40
" Rosea. Pink	30
" White	30
" Hybrida. Mixed	30
" Compacta. Excellent. 17c. per pkt.	

PRIMULA (Other Varieties)

Buttercup. New yellow, very popular.....	\$0 50
Cortusoides Sieboldii. Mixed colors.....	50
Floribunda. Yellow	50
Forbesi. (Baby Primrose).....	50
Veris. (Cowslip) Mixed.....	15
Vulgaris. (English Yellow Primrose).....	30

POLYANTHUS (Primula Elatior)

English. Single mixed.....	\$0 25
Gold Laced. Very showy.....	50

PYRETHRUM

	Trade Pkt.	Oz.
Hybridum. Single mixed.....	\$0 20	60
" Double mixed	50	
Roseum. Pink	20	75
Uliginosum. (Giant White Daisy).....	25	

RUDBECKIA (Cone Flower)

Newmanni. Hardy, perennial, yellow.....	\$0 40	\$2 00
---	--------	--------

SCABIOSA

Caucasica. One of the handsomest, especially valuable for cutting, the blooms lasting a long time in water; lilac blue; 3 feet.....	\$0 30	\$1 60
---	--------	--------

SMILAX SEED, NEW CROP

Per trade pkt., 10c.; 25c. per oz.; ¼ lb., 80c.; \$2.50 lb.



Michell's Stocks

MICHELL'S STOCKS

LARGE FLOWERING DWARF TEN WEEKS

	½ Trade Pkt.	Trade Pkt.	Oz.
Blood Red	\$0 25	\$0 40	\$2 50
Light Blue	25	40	2 50
Pink	25	40	2 50
Purple Violet	25	40	2 50
White	25	40	2 50
Yellow	25	40	2 50
Mixed	25	40	2 00

STOCKS (Other Varieties)

Wallflower Leaved. Choice mixed.....\$0 25 \$0 40 \$2 25
 "Beauty of Nice." The plant attains a height of 2 to 2½ feet, and throws a gigantic flower spike one foot in length; around the stem the plant sends out a number of long side shoots covered with large fragrant flowers; color, a delicate shade of pink. Price, per pkt., 20c.; 50c. per 3 pkts.

Queen Alexandra. A new variety of the same type as Beauty of Nice, color, delicate, rosy lilac. Per pkt., 20c.; 50c. per 3 pkts.

Excelsior. Large pure white. Original pkt., \$1.00.

	½ Trade Pkt.	Trade Pkt.	Oz.
Princess Alice. (Cut-and-Come-Again.)			
White	\$0 30	\$0 50	\$2 50
Snowflake. Dwarf forcing, pure white..	30	50	
Winter or Brompton. Mixed.....	30	50	3 00

STOKESIA (Cornflower Aster)

Cyanea. A hardy perennial, each plant bearing 20 to 30 lavender-blue flowers, excellent for cutting

SWEET WILLIAM (Dianthus Barbatus)

	Trade Pkt.	Oz.
Auricula Flowered. Single mixed.....	\$0 10	\$0 20
Single Mixed. All colors.....	10	15
Double Mixed. All colors.....	15	50

VINCA

Alba. White with rose centre.....	\$0 20	\$0 60
Alba Pura. Pure white.....	20	60
Rosea. Pink	20	60
Mixed	15	50

WALLFLOWER

Double Mixed	\$0 30	\$2 00
Single Mixed	10	15

GLAZING MATERIALS, ETC.

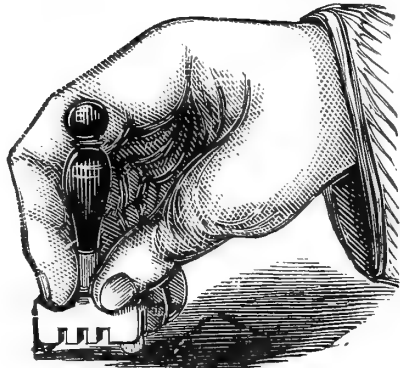

DIAMOND GLASS CUTTER

UNIVERSAL GLAZIER'S DIAMOND

Last forever.

	Each.
Ebony Handle	\$2 50
Cocoa Handle, extra large diamond	3 75

OTHER GLASS CUTTERS

Steel Wheel, each.....	\$0 15
Per doz. 1 25 75c. for 6.	
Steel, 6 Wheel, adjustable, each...	30



Putty Distributor

Scollay's Putty Distributor

The best appliance for distributing putty. One day's work by the old method of glazing can easily be done in four hours by the use of the distributor.

Price, each	\$0 85
By mail	95

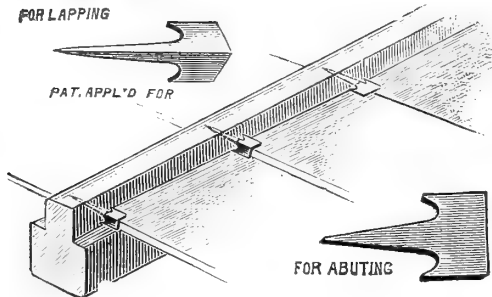

MICHELL'S T GLAZING POINT

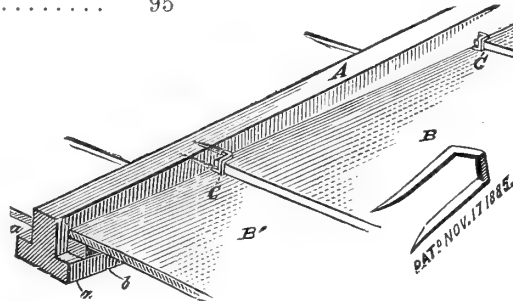

PEERLESS GLAZING POINT

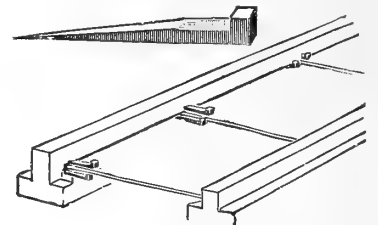

SIEBERT'S GLAZING POINT

GLAZING POINTS

Peerless (see cut), galvanized, per 1000, 60c.; 5000 lots at 55c. per 1000. Brass, \$1.00 per 1000. Pincers for driving the above, 50c.	
Siebert's Points, 2 sizes, 5/8 inch and 7/8 inch (see cut)	\$0 40
10-lb. lots for \$3.50.	
Model Point	Per lb. 45
Zinc Nails	20
Michell's T Point (see cut)	75

Oiled Muslin or Plant Bed Cloth



	Per Yd.	Yds.	Per Piece	Piece
Light	4c.	60		3 1/2 c.
Medium	8c.	60		7c.
Heavy	10 1/2 c.	40		10c.

SCHUCK'S HOSE PROTECTOR

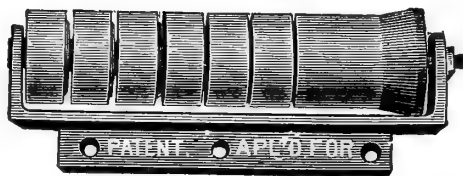

HOSE PROTECTOR

Just the proper thing. Lengthens the life of your hose by a year. Easily attached to greenhouse bench.
Each, 25c.; per doz., \$2.50.

RUBBER SPRINKLER



	Straight Neck.
Small	50c.
Large	75c.
	Crook Neck.
Small	50c.
Large	75c.

ZEMENTINE

For Shading Glass. Far superior to whitewash and more easily prepared. Price, 15c. per 2-lb. pkg.; 10 lbs. for 70c.

Hammond's Greenhouse White Paint

The manufacturer claims this paint is superior in quality and lower in price than any other material of the same character. It is largely used now in place of the ordinary grade of white lead on account of its durability.

Price, per gallon	\$1 50
5 gallons for	7 25
10 "	14 00
50 "	62 50

TYING MATERIALS

GREEN SILKALINE.

For stringing Smilax and Asparagus. Fast color and will not fade; very strong and will not break. Coarse and fine, put up on 2 oz. spools, 8 in a box, 16 oz. of Silkline guaranteed.

Price, per lb. (8 spools)	\$1 25
" " Spool	20

GREEN LINEN (substitute for Silkline), very similar to the above, fast color. Per lb., 65; 5 lbs. for \$3.00.

TWINES.

Jute, 2, 3, 5-ply, 12c. per lb.
Bouquet Linen, 35c. per lb.; 3 lbs. for \$1.00. (Also all other brands.)

RAFFEA.

Fresh and strong, long and fibrous. Price 20c. per lb.; 10 lbs. for \$1.25; \$10.00 per 100 lbs.

MICHELL'S SUMMER SPECIALTIES

FOR FLORISTS

RAFFEA

**Fine Quality Just Received Long and Fibrous
Natural Color**

15c per lb.; 10 lbs., \$1.25; \$10.00 per 100 lbs.
9¼c per lb. in bale lots of about 225 lbs.

In Colors For fancy decoration work
Black, Brown, Blue, Green, Red, Orange, Yellow and Pink.
40c per lb.; 5 lbs. at 38c per lb.; 10 lbs., \$3.50.

GLAZING MATERIAL

Mastica is a substitute for putty, **does not harden**, easily applied.
1 gallon does 300 running Feet.

PRICE: \$1.25 per gallon; 5 gallons, \$5.75; \$11.00 for 10 gallons.

Mastica Machines (for applying Putty, Mastica, etc.) \$1.25.

Twemlow's Putty is made after an old English formula similar to Mastica, preferred by many to the above, exceeds the old fashioned putty in value.

PRICE: \$1.25 per gallon (16 lbs.); 50 lb. Kit, \$3.75; 80 lb. Kit for \$6.00; 25 gallons (½ barrel), \$28.75; \$55.00 per barrel

GLAZING POINTS

Our Stock embraces all of the Leading Makes

Peerless (Improved Van Reyper), Nos. 1 and 2 for single thick, No 2½ for double thick glass. (**Galvanized**), 60c. per 1000; 5000 for \$2.75. **Brass**, \$1.00 per 1000; 5000 for \$4.50.

Pincers for driving Peerless Points, 50c. per pair.

Siebert's Galvanized, with a special head, ⅝ inches (1100 to the lb.), ⅞ inches (900 to the lb.)

PRICE: 40c. per lb.; 10 lbs. for \$3.50.

Michell's (T). The new point that received honorable mention at the convention S. A. F. 75c. per lb. (about 1100 points); 10 lbs., \$6.50.

Glazing or Zinc Shoe Nails. Preferred by many of the old time gardeners to the more modern kind. 20c. per lb.; 10 lb. \$1.75.

Model or Bruen Point. Made with an idea to hold the glass in its place which it does well. 45c. per lb. of about 1100 points.

NOTE. Samples of any of the above points mailed free for examination.

HENRY F. MICHELL CO.

1018 Market Street, Philadelphia.

SEEDS

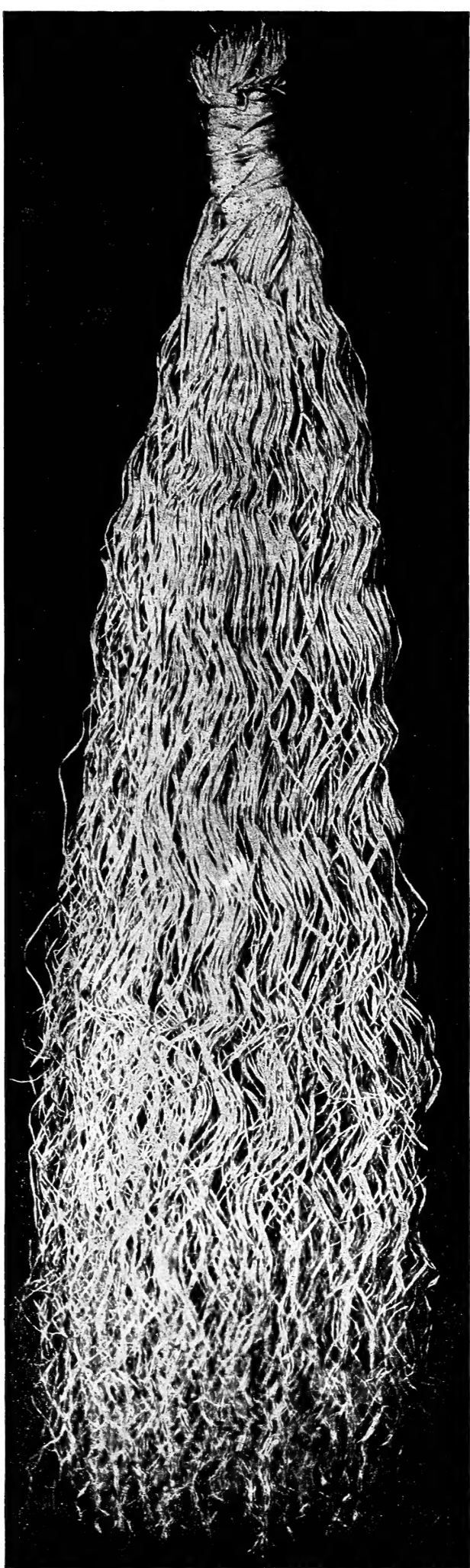

Michell's Superior Flower Seeds

(For Summer Sowing)
For Florists



An Average Size Bloom of Michell's Giant Size Cineraria.

MICHELL'S CINERARIA

The Cineraria seed offered by us is the best procurable. Immense trusses of the largest flowers are produced. It has been awarded numerous First Prizes.

Michell's Grandiflora Prize Dwarf, mixed
 " " Med. Tall, "
 James' Giant Strain. Mixed
 Hybrida Choice Mixed
 Double Mixed
 Sutton's Stellata (Star Cineraria), Orig. pkt. 60c.
 Stellata Hybrida. Original pkt. \$1 00 .

	1/2 Trade Pkt.	Trade Pkt.
Michell's Grandiflora Prize Dwarf, mixed	60	1 00
" " Med. Tall, "	60	1 00
James' Giant Strain. Mixed	60	1 00
Hybrida Choice Mixed	30	50
Double Mixed	60	1 00

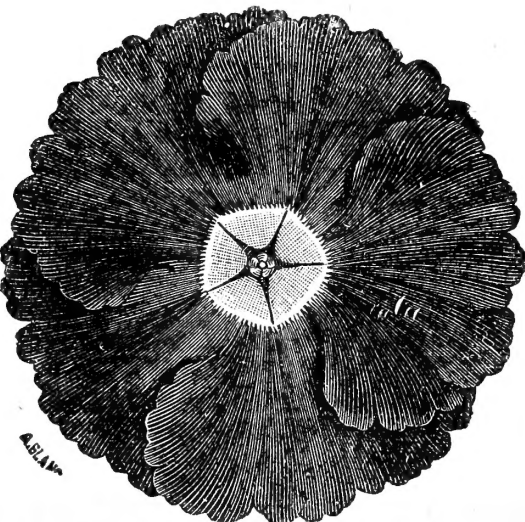

An Average Bloom of Michell's Choicest Mixture Primula.

PRIMULA SEED

Michell's Choicest Mixture

The cream of varieties properly blended.

Price (small pkt 17c.); 60c. per 1/2 trade pkt, per trade pkt. \$1, \$2 per 1-16 ounce.

PANSY SEED MIXTURE

	For size of bloom and color, also its distinct markings, cannot be excelled (1/8 oz., 75c.) . . .	Per Trade Pkt.	Per Oz.
Michell's Giant Exhibition		50	5 00
Bugnot, Odier and Cassier. A superb mixture		50	5 00
Giant Trimardeau. Very large flowering		30	1 25
Mad Perret. Especially rich in red shades		50	5 00
Masterpiece. New Giant, curled		50	5 00
Non Plus Ultra. Giant blotched varieties		50	4 00
Odier or Blotched. A beautiful strain		40	2 50
Parisian, Large Stained. Large flowering		40	2 00
Finest English. Large Flowering		25	1 00
Very Fine Mixed		20	75

For separate varieties of Pansy see Page 12 of accompanying catalogue.



Michell's Giant Exhibition Pansy.

TESTIMONIAL

Please send me at once the following list of **Pansy Seed**. Last season I grew with yours some pansies, seed of which I obtained from a very prominent house at \$10 per oz Yours at \$5 per oz. was far superior as it contained finer blooms.

COLLEGE HILL, CINCINNATI, OHIO.

G. C.

For other varieties and mixtures Primula see Page 13 of accompanying catalogue.

TESTIMONIAL ON MICHELL'S PRIMULA SEED

I want to say a word about your mixture of **Primula Seed**. Some of the flowers measure 2 inches across. The variety of color is the best I ever saw.

MOORESTOWN, N. J.

H. O.

SUNDRY NEEDS FOR THE FLORIST

CARNATION SUPPORTS

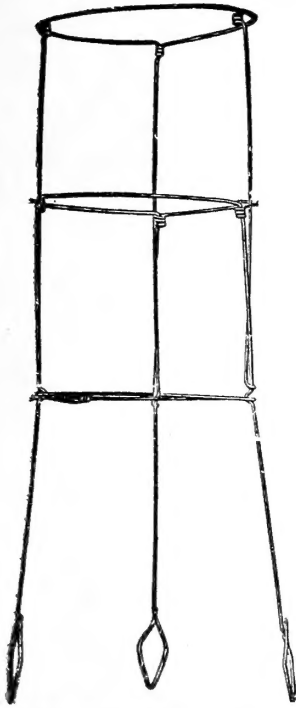

"Model" Three Ring

"MODEL"

The most practical support, now in use by nearly all the largest Carnation growers in this country. Sufficient additional blooms are obtained in one season to pay more than the cost of these supports.

"P. BRUEN MAKE"

F. O. B. Phila.

	Per 100	Per 1000
2 ring.....	\$2 75	\$25 00
3 ring.....	3 00	27 50

F. O. B. Factory

	Per 100	Per 1000
2 ring.....	\$2 50	\$22 50
3 ring.....	2 75	25 00

"IGOE" MAKE

F. O. B. Factory Only

	Price per 1000
2 ring.....	\$21 00
3 ring.....	23 50

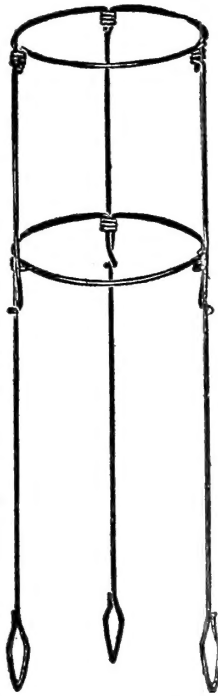

"Model" Two Ring

PLANT STAKES

No. 10 STEEL WIRE GALVANIZED STAKES

	Per 100	Per 1000		Per 100	Per 1000
2 feet long.....	\$0 45	\$4 08	4 1/2 feet long.....	\$1 00	\$ 9 20
2 1/2 " " " " " "	55	5 11	5 " " " " " "	1 12	10 23
3 " " " " " "	65	6 15	5 1/2 " " " " " "	1 20	11 27
3 1/2 " " " " " "	78	7 18	6 " " " " " "	1 30	12 25
4 " " " " " "	88	8 16	6 1/2 " " " " " "	1 40	13 28

No. 8 STEEL WIRE GALVANIZED STAKES

	Per 100	Per 1000		Per 100	Per 1000
2 feet long.....	\$0 55	\$5 25	4 feet long.....	\$1 10	\$10 00
2 1/2 " " " " " "	70	6 50	4 1/2 " " " " " "	1 25	11 50
3 " " " " " "	80	7 50	5 " " " " " "	1 40	13 00
3 1/2 " " " " " "	95	9 00	6 " " " " " "	1 60	15 50

Green Painted Tapering Plant Stakes

Size	1 1/2 ft.	2 ft.	2 1/2 ft.	3 ft.	3 1/2 ft.	4 ft.	5 ft.
Per doz.....	\$0 14	\$0 24	\$0 35	\$0 46	\$0 57	\$0 68	\$0 80
Per 100.....	90	1 55	2 20	2 90	3 60	4 35	5 10

Green Painted Heavy or Dahlia Stakes

Size	3 ft.	3 1/2 ft.	4 ft.	5 ft.	6 ft.
Per doz.....	\$0 68	\$0 80	\$0 95	\$1 15	\$1 40
Per 100.....	4 40	5 17	5 90	7 40	8 90

WHEELBARROWS

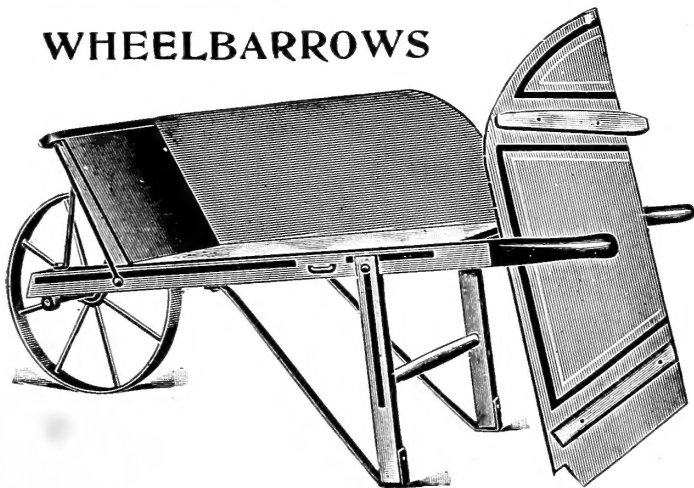

FLORISTS' WHEELBARROW (See Cut)

This is a very narrow barrow designed for use in aisles of a greenhouse. Box measures inside 14 in. in front, 17 in. in back and 12 in. deep. Handles 4 ft. 8 in. long. Spread of handles at hand-hold 20 in., which is extreme width of barrow. Furnished with 18-in. diameter wheel. Nicely painted and striped. Price, each, \$4.50.

OTHER MAKES OF WHEELBARROWS

Jacobs, No. 2, each.....	\$3 00	Eastern No. 4—3-inch tire, each	\$3 75
Jacobs, No. 3, each.....	3 25	Eastern No. 5—3-inch tire, each	4 25
Jacobs, No. 4, each.....	3 75	Boys'.....	2 75
		Canal (Dump).....	2 00

RUBBER HOSE FOR FLORISTS

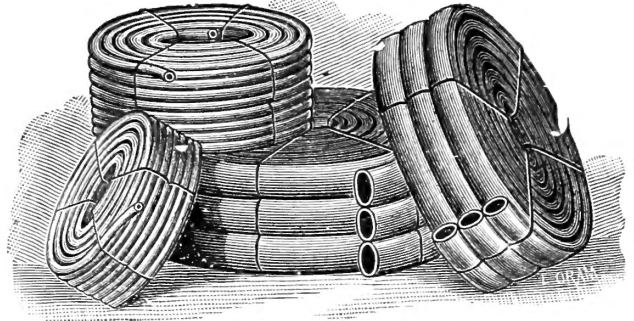

	Per foot
Standard Brand. 3/4 inch.....	\$0 10 1/2
Extra Standard Brand. 3/4 in., 3-ply.....	12
" " " " 3/4 " 4-ply.....	14 1/2
Chicago Electric.....	15
Bull-Dog, 7-ply.....	15
Wire Wrapped, 3-ply, 3/4 inch.....	13

HOSE MENDERS

HUDSON'S HOSE MENDERS. Complete outfit of six Menders with Pliers, 55c.; by mail, 70c. **Separate Menders,** 42c. per doz. **Separate Bands,** 15c. per doz.
HOSE MENDERS (Woodason's Iron). 1/2 inch, each 5c.; doz., 45c.; 3/4 inch, each 5c.; doz., 50c. **Cooper's all Brass,** per doz., 75c. (1/2 and 3/4 in.)
HOSE BANDS (Caldwell's) per doz., 15c. **Sherman,** per doz., 40c.

PLANT STAKES

HYACINTH STAKES (Wood)

DYED GREEN

	Per 100	Per 1000
12 inch.....	\$0 15	\$0 85
18 inch.....	20	1 25
CANE STAKES. Southern.....	75	6 00
" " Japanese. Very thin, 6 ft. long, 100,	75c.;	
500 for \$3.00; per 1000, \$5.50; 2500 for \$12.50.		

UNPAINTED STAKES OR DOWELS (Wood)

	Per 100	Per 1000		Per 100	Per 1000
36 in. long, 3-16 in. diam.	\$0 60	\$4 50	42 in. long, 3-16 in diam.	\$0 65	\$5 50
36 " " 5-16 " " "	55	4 50	42 " " 1/4 " " "	65	5 50
36 " " 3/8 " " "	70	6 00	42 " " 5-16 " " "	65	5 50
36 " " 1/2 " " "	60	4 50	42 " " 3/8 " " "	65	5 25
36 " " 3/4 " " "	50	4 00	42 " " 1/2 " " "	85	7 50

We can supply these Dowels, dyed green, 50c. per 1000 additional.

GALVANIZED WIRE (Prices Subject to Change)

For Supporting Plant Stakes

No. 16, per roll of 12 lbs.....	\$0 75
No. 18, " " " " " " " "	80
No. 19, " " " " " " " "	80
No. 20, " " " " " " " "	90
No. 22, " " " " " " " "	1 05
No. 24, " " " " " " " "	1 20

ANNEALED WIRE

No.	16	18	20	22	24
Per stone of 12 lbs.....	\$0 50	\$0 55	\$0 60	\$0 70	\$0 75

Prices on wire subject to change.

MISCELLANEOUS SUNDRIES

	Per Bbl.
Peat (Jersey).....	\$1 15
" (Orchid).....	1 75
Moss, Dry (Sphagnum) Barrel Bales (70c. if called for)	
85c. if shipped or delivered.	
Moss, Dry (Sphagnum) in 5 bbl. bales, \$2.50 per bale.	
" Green (Lump), if called for \$1.25, (if shipped).....	1 50
" Green (Sheet).....	2 25
" Green or Live Sphagnum.....	1 25
Tin Foil. Per lb., 10c.; 10 lbs., 95c.	

MICHELL'S PURE BONE MEAL

For Florists

Strictly free from acid; will not injure the most delicate plant. Price, \$1.75 per 100 lbs.; 200 lbs., \$3.25; \$29.00 per ton. We also carry a full line of **Fertilizers** and **Insecticides**. See general wholesale catalogue for price.

PLANT TUBS, POTS, ETC.

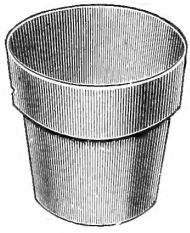

BEST QUALITY Standard Flower Pots

Full Inside Measurement

P. S.—The prices on Clay Flower Pots only are subject to discount of 10 per cent. for cash with order, or if paid within 30 days.

Size	100	1000	7 inch	Doz.	100	1000
1 3/4 inch	\$0 35	\$3 15	8 inch	\$0 68	\$5 00	\$50 00
2 "	40	3 60	9 "	95	7 00	70 00
2 1/2 "	55	4 95	10 "	1 35	10 00	100 00
2 3/4 "	60	5 63	11 "	1 85	13 50	135 00
3 "	70	6 30				
3 1/2 "	85	7 65				
	Doz.		11 inch	\$0 25	\$4 40	\$18 00
4 inch	\$0 15	1 10	12 "	35	3 40	25 00
4 1/2 "	18	1 25	13 "	45	4 80	37 50
4 3/4 "	22	1 50	14 "	50		
5 "	28	2 00	15 "	75		
5 1/2 "	35	2 50	16 "	1 10		
6 "	42	3 00	18 "	1 65		
6 1/2 "	55	4 00	20 "	2 20		

"NEPONSET" PAPER FLOWER POTS

They are the cheapest flower pots on the market. Made from the well-known NEPONSET WATER-PROOF FABRIC, and for lightness, cleanliness and cheapness have no equal. Especially valuable for shipping plants by express.

These prices are net, no discount

Size	100	1000	Weight per 1000 pots	Size	100	1000	Weight per 1000 pots
2 1/4 "	\$0 25	\$2 00	20 pounds	4 "	\$0 80	\$6 90	33 pounds
2 1/2 "	30	2 40	23 "	5 "	1 20	10 35	56 "
3 "	45	3 90	33 "	6 "	1 65	14 55	74 "
3 1/2 "	60	5 15	44 "				

Not less than Original Crates at 1000 Rates

BULB PANS (Earthenware)

Size	Each	Doz.	100	1000
6 inch	\$0 05	\$0 50	\$3 00	\$29 00
7 "	07	60	4 00	38 75
8 "	08	75	5 00	48 50
9 "	11	1 00	7 00	68 50
10 "	14	1 25	9 00	88 00
12 "	20	1 75	12 50	115 00
14 "	35	3 50	25 00	235 00
16 "	60	6 00	50 00	480 00
18 "	85	9 00	75 00	730 00

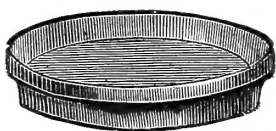
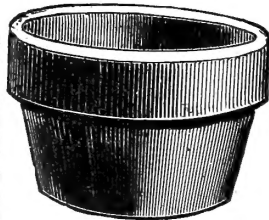

FLOWER POT SAUCERS

(Earthenware)

Size	Doz.	100	9 inch	Doz.	100
4 inch	\$0 13	\$0 90	10 "	\$0 55	\$4 00
5 "	16	1 12	11 "	67	5 00
6 "	23	1 50	12 "	80	6 00
7 "	27	2 00	14 "	1 00	7 50
8 "	40	3 00		1 65	12 50

AZALEA POTS

Width	Height	Each	Doz.	100
6 inch	5 inch	\$0 05	\$0 46	\$3 52
7 "	6 "	08	70	5 65
8 "	7 "	10	1 00	7 95
10 "	8 "	20	1 90	15 25

FERN DISH LINERS

Width	Height	Each	Doz.	100
7 inch	1 1/2 inch	\$0 08	\$0 75	\$4 50

POT HANGERS

The best device for lifting plants in and out of jardinières; also for suspending plants, such as Asparagus Sprengerii, Ferns, etc.

- No. 1. 30c. per doz. for 3 to 5 in. pots
- No. 2. 40c. per doz. for 6 to 7 in. pots
- No. 3. 50c. per doz. for 8 to 10 in. pots

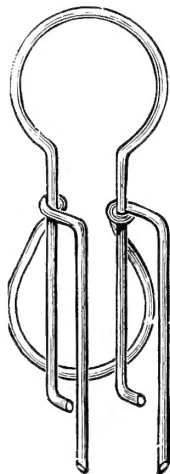

Pot Hanger

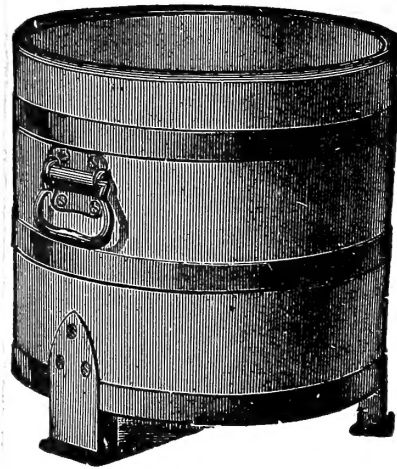

White Cedar Tub

Improved White Cedar Plant Tub

Measurements are Outside Dimensions

No.	Diam.	Length of Stave	Price
0	27 inch	24 inch	\$4 50
1	25 "	22 "	4 05
2	23 "	21 "	3 60
3	21 "	18 "	3 15
4	19 1/2 "	16 "	2 50
5	18 "	14 "	2 25
6	16 1/2 "	13 "	1 80
7	15 "	11 "	1 58
8	12 "	10 "	1 35

Excelsior Plant Tub

Measurements are Outside Dimensions

No.	Diam.	Length	Price
1	13 inch	11 inch	\$0 90
2	14 1/2 "	13 "	1 22
3	16 "	15 "	1 44
4	20 "	18 "	2 25
5	24 "	21 "	2 70

Improved Columbia Plant Tub

Measurements are Outside Dimensions

12 inch diameter	\$0 90 each
15 "	1 35 "
18 "	1 80 "
21 "	2 25 "
24 "	2 70 "

Square Plant Tub

Painted Green Very Practical Measurements are Outside Dimensions

No.	Diam.	Length	Price
1	12 1/2 inch	12 inch	\$0 68
2	14 "	12 "	90
3	16 "	12 1/2 "	1 12

FERN PANS

EARTHENWARE

Width	Height	Each	Doz.	100
4 in.	1 1/2 in.	\$0 03	\$0 27	\$1 45
4 1/2 "	2 1/8 "	04	30	1 95
5 1/2 "	2 1/4 "	05	37	2 48
6 1/2 "	2 1/2 "	06	45	2 97
7 "	2 3/8 "	08	49	3 47
8 "	3 1/8 "	09	72	4 95
9 "	3 1/2 "	13	86	5 40

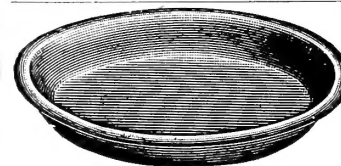
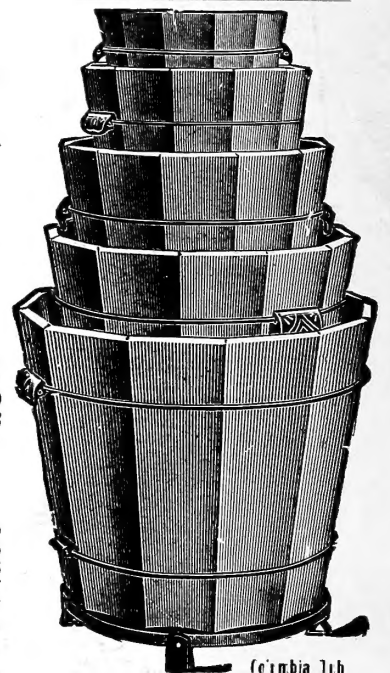

Flower Pot Saucers

Made of Wood Fibre

Unbreakable. Are not porous, and will protect woodwork, tables, etc., on which plants are to stand.

Size	Doz.	100	9 inch	Doz.	100
4 inch	\$0 81	\$6 42	10 "	\$1 14	\$8 90
5 "	84	6 64	11 "	1 19	9 41
6 "	87	6 84	12 "	1 41	11 12
7 "	94	7 53	14 "	each 16c.	1 84
8 "	1 03	8 04	16 "	27c.	3 24
			18 "	32c.	3 78

Rolling Stands

For Heavy Plants and Palms Made of Indurated Fibre Ware

Will not soak or rust. Casters have ball bearings. Every heavy plant sold needs one to save carpets and floors.

Size	Each	Doz.	Size	Each	Doz.
12 inch	\$0 45	\$5 13	18 inch	\$0 77	\$8 65
14 "	54	6 16	20 "	90	10 26
16 "	68	7 70	22 "	1 13	12 83

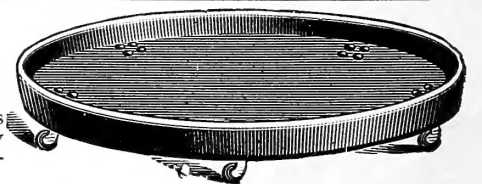

POT LABELS (Painted)

3 1/2 inch	per 1000, \$0 60	6 inch	100	1000
4 "	65	8 "	\$0 15	\$1 25
4 1/2 "	70	10 "	85	\$3 00
5 "	90	12 "	45	4 00
			60	5 50

TREE LABELS. Notched

Copper wired (unpainted).....\$1 00 Painted.....\$1 25

WIRED TOOTH PICKS. Great labor savers, used in making up funeral and other designs. \$1.50 per box of 10,000