

## **Historic, Archive Document**

Do not assume content reflects current scientific knowledge, policies, or practices.

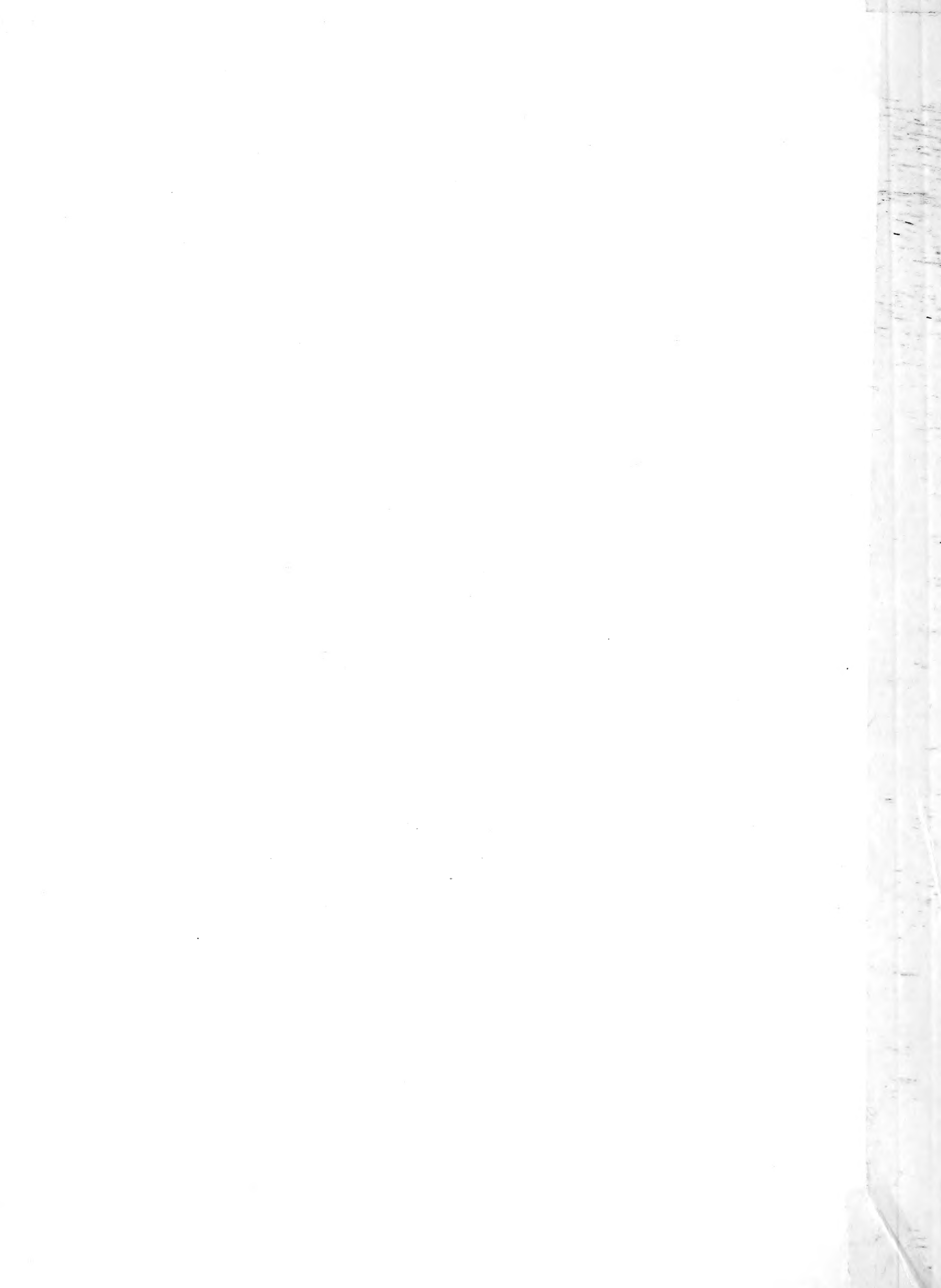

*MS*

# SEEDS 1910 BULBS GARDEN TOOLS

LIBRARY  
U. S. D. Department of Agriculture  
Washington, D. C.



LONG ISLAND  
BEAUTY

M. A. BRUNJES & SON  
1581 MYRTLE AVE.  
BROOKLYN. N. Y.

# Read Carefully Before Ordering

**HOW TO ORDER.** We advise placing your order early. Please use order sheets found in front part of every catalogue, carefully filling out blank spaces at top for shipping directions. Be sure to sign your NAME and give Post Office and State. To avoid mistakes do not write letters on same sheet as orders. If you do not receive your seeds in a reasonable time after ordering them, write again, telling what was ordered, amount of money sent, etc. When goods are to be shipped by freight or express, give plain shipping directions; otherwise we will use our best judgment in the matter. If you want only a few packages, do not hesitate to send for them. We take as much pains to send them promptly as we do large orders.

**SEND CASH WITH THE ORDER.** This can be done either in the form of a Money Order, Bank Draft, Express Order, or Registered Letter. Remittances sent in any other way are entirely at the senders' risk. Small amounts may be sent in postage stamps.

**EXPRESS AND FREIGHT ORDERS.** When orders are received to be shipped by express or freight, the purchaser must pay the charges.

**SEEDS BY MAIL.** Orders for packets or ounces will be sent by mail, postage free, at prices given. For larger quantities, by mail, include in your remittance 8 cents per pound or 15 cents per quart, for Beans and Peas, and 10 cents for Corn, to cover postage.

**SIGN YOUR NAME.** Name and address should be written as plainly as possible and care exercised to have Post Office, County and State in Full. If your express office or freight depot has a different name from your post office, give that also. This is very important, as we cannot send goods if we do not know where to send them.

**DELIVERIES.** We deliver by our own teams to express offices, railroad and boat lines, for shipment to out-of-town points.

**MARKET-GARDENERS,** or other large planters, requiring larger quantities of seeds than are here offered are invited to write us for Special Prices, and must be sure to name **varieties** and **quantities** they will want.

## INDEX

	Page		Page		Page		Page
Abronia	37	Candytuft	41	Garlic	18	Phlox	55
Abutilon	37	Cannas	41, 61	Gilia	46	Physalis	55
Achillea	37	Canterbury Bells	41	Gladioli	2, 63	Poppies	4, 53, 54
Aconitum	37	Caraway	32	Globe Amaranth	46	Portulaca	54
Acroclinium	37	Cardoon	13	Godetia	46	Potatoes	24
Adlumia	37	Carnations	42	Gourds	46	Primula	55
Adonis	37	Carrot	13	Grass Seeds	35	Pumpkin	27
Ageratum	37	Castor Oil Plant	32	Grasses	36	Pumps	66
Agrostemma	37	Catnip	32	Helianthus	47	Pyrethrum	54
Alyssum	37	Cauliflower	1, 12	Helichrysum	47	Radish	28
Amaranthus	39	Celery	13, 14	Heliotrope	47	Rape	36
Amaryllis	60	Celery	13, 14	Herbs	32	Ricinus	56
Ammobium	39	Celosia	42	Hollyhock	47	Rhubarb	29
Ampelopsis	39	Centaura	42	Horehound	32	Rosemary	32
Anagallis	39	Centrosema	42	Humulus	47	Rue	32
Anchusa	39	Cerastium	42	Hyacinthus	63	Ruta Baga	31
Anemone	39	Chervil	14	Hypericum	47	Rye	36
Anise	32	Chicory	14	Hyssop	32	Saffron	32
Antirrhinum	40	Chives	14	Ice Plant	47	Sage	32
Aquilegia	39	Crysanthemum	42, 43	Insecticides	65	Salpiglossis	56
Arabis	39	Cineraria	43	Impatiens Sultani	47	Salsify	29
Arctotis	39	Cinnamon Vine	69	Ipomoea	47	Salvia	56
Armeria	39	Citriodora	58	Kale	18	Sanvitalia	56
Artichoke	5	Clarkia	43	Kohl Rabi	18	Savory	32
Asparagus	6	Clematis	43	Lantana	48	Scabiosa	56
Asp. Plumosus	40	Clianthus	43	Larkspur	48	Schizanthus	56
Asp. Sprengeri	40	Cleome	43	Lavender	32	Scorzonera	29
Asperula	39	Clover	36	Leek	20	Sea Kale	29
Asters	3, 38, 39	Cobæa	43	Lettuce	19, 20	Sedum	56
Astilbe	39	Coccinea	43	Lilies	64	Senecio	56
Auricula	39	Cockscomb	43	Lily of the Valley	63	Sensitive Plant	56
Balloon Vine	40	Coleus	44	Linum	48	Silene	56
Balm	32	Collards	12	Lobelia	48	Smilax	56
Balsam	40	Convolvulus	44	Lupinus	48	Solanum	56
Bartonia Aurea	40	Coriander	32	Lychnis	48	Sorrel	30
Basil, Sweet	32	Corn	1, 15, 16, 34	Madeira Vine	64	Spinach	2, 29
Beans		Corn Salad	16	Marjoram, Pot	32	Sprayers	66
Bush, Lima	6	Corydalis	44	Marjoram, Sweet	32	Squash	30
English, or Broad	6	Cosmos	3, 44	Marigold	48	Stocks	4, 57
Dwarf, or Bush	7, 8	Cowslip	44	Martynia	24	Stokesia Cyanea	57
Pole or Running	8, 9	Cress	16	Marvel of Peru (Four O'Clocks)	48	Sunflower	36
Soja	36	Cucumber	17	Matricaria	49	Sweet Peas	4, 52
Beet	9, 10	Cuphea	44	Maurandia	49	Sweet Sultan	56
Mangel Wurzel	10	Cyclamen	44	Mignonette	49	Sweet William	57
Sugar	10	Cypress Vine	44	Millet	36	Swiss Chard	30
Begonia	3, 40, 60	Dahlias	2, 44, 62	Mimulus	49	Tansy	32
Bellis	40	Dandelion	17	Mina Lobata	49	Thunbergia	58
Bene	32	Datura	44	Momordica	49	Thyme	32
Bird Seed	36	Delphinium	45	Mushroom Spawn	22	Tobacco Seed	30
Borage	10	Dianthus	45	Musk Melons	21	Tomato	31
Borecole, or Kale	10	Digitalis	46	Mustard	20	Tools and Implements	67-76
Brachycome	40	Dill	17	Myosotis	49	Torenia	58
Broccoll	10	Dolichos	46	Nasturtiums	20, 50	Tropæolum	58
Browallia	40	Echeveria	46	Nemophila	50	Tuberoses	64
Brussels Sprouts	10	Egg Plant	2, 17	Nicotiana	49	Turnip	32
Buckwheat	36	Edelweiss	46	Nigella	49	Vegetable Plants	33
Bulbs and Roots	60	Endive	18	Okra	24	Verbena	4, 58
Cabbage	1, 11, 12	Eschscholtzia	46	Onion Seed	23	Vinca	58
Cacalia	40	Euphorbia	46	Onion Sets	24	Violet	58
Caladium	60	Eutoca	46	Oxalis	52, 64	Virginian Stock	58
Calampells	41	Farm Seed	36	Pansies	3, 51	Wallflower	59
Calandrinia	40	Farm Tools	67-76	Parsley	25	Water Melons	22
Calceolaria	41	Fennel	18, 22	Parsnip	25	Wheat	36
Calendula	40	Fenzlia	46	Peas	26, 27, 36	Wormwood	32
Calla Lily	60	Fertilizers	65	Pepper	25	Xeranthemum	59
Calliopsis	41	Flowering Plants	33	Petunias	3, 52	Zinnias	59
Callirhoe	40	Gaillardia	46	Phaseolus	55		
Campanula	41						





# M. H. BRUNJES & SON'S

## Vegetable Seed Novelties and Specialties

### Cauliflower

#### ERFURT DWARF EARLIEST

In this variety we offer a strain of Cauliflower of the highest quality and one that is certain to withstand the test of the most critical grower. It is not only superior for forcing but succeeds just as well in the open ground, and may be depended upon to form large, handsome, pure white heads of delicious flavor. Per pkt. 50c., oz. \$5.00.

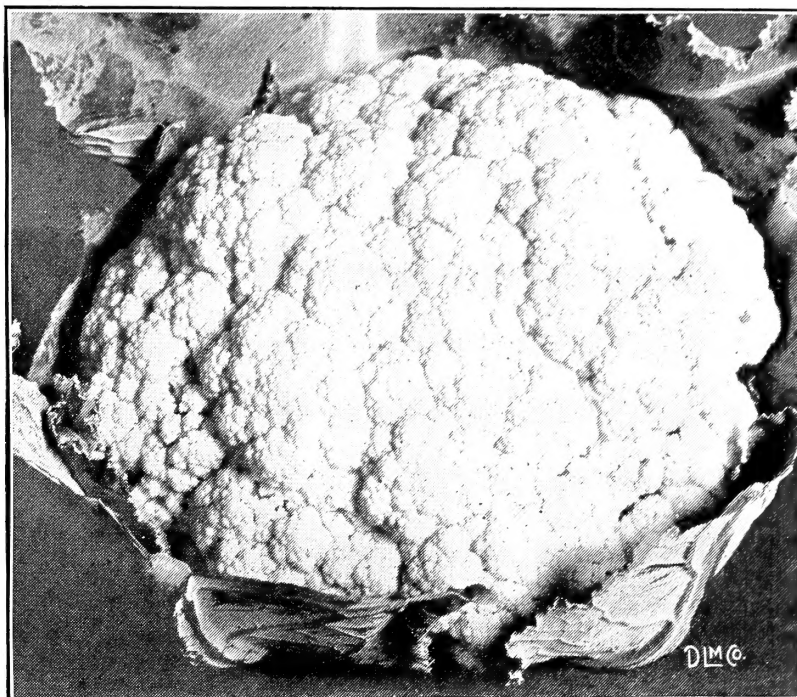

Cauliflower, Erfurt Dwarf Earliest

### Cabbage

#### GIANT ZITTAU

Owing to their fine flavor, the red Cabbages are rapidly becoming popular. The large, solid heads of this splendid variety are dark red and of excellent quality. Per pkt. 10c., oz. 30c., ¼ lb. \$1.00.



Holmes' Delicious Early Sweet Corn

### Two of Our Long Island Specialties

Our strains of Long Island Cabbage are noted for their trueness to type, uniform size, sure heading qualities, and superior flavor. Utmost care is taken in the selection of every head, and only the very best and most perfect specimens are saved for our seed.

#### LONG ISLAND FLAT DUTCH

A selected strain, superior for early or late planting, and well recommended for its exceptionally fine head, not exceedingly large, but very solid. It is a favorite and largely planted on Long Island by market gardeners. Per pkt. 10c., oz. 65c., ¼ lb. \$2.00, lb. \$8.00.

#### LONG ISLAND SAVOY

The finest of all Savoy Cabbage. Highly esteemed for its round, deep, uniform heads which are very large, beautifully curled and unsurpassed in quality. An excellent keeper. Per pkt. 10c., oz. 65c., ¼ lb. \$2.00, lb. \$8.00.

### Holmes' Delicious Early Sweet Corn

The earliest Sweet Corn in cultivation, ripening in 55 days from time of planting. The stalks grow from 5 to 6 feet high and are very productive, each bearing 2 and sometimes 3 good marketable ears. The ears measure 7 to 9 inches in length, 12-rowed and well filled with large, deep grains of delicious flavor. The seed may be planted a little earlier than most varieties and the hills should be further apart.

Price by mail, postpaid, pkt. 15c., pt. 40c., qt. 75c.; by express, not prepaid, ½ pk. \$2.50, pk. \$4.00.

# Vegetable Seed Novelties and Specialties—Continued

## Egg Plant BLACK BEAUTY

Although this variety is not quite so large as the well known New York Improved Purple, it matures from a week to ten days earlier. The fruits have thick flesh and are very attractive in appearance, being of a rich, glossy, purplish black color. Plants are of strong, stock growth and very productive. Per pkt. 10c., oz. 50c.,  $\frac{1}{4}$  lb. \$1.50.

## Spinach TRIUMPH

A well recommended sort of Long Standing Spinach, which is not only good for spring and summer use, but for fall sowing as well. The leaves are large, thick and of the choicest quality. Per pkt. 5c., oz. 10c.,  $\frac{1}{4}$  lb. 20c., lb. 50c.

## Seven Choice Dahlias

**DAVID JOHNSON.** (Show.) A very fine Dahlia of the show type with large, round, full-centered flowers of a beautiful salmon rose color. Each 10c., per doz. \$1.00.

**ETHEL.** (Show.) Pure yellow, each petal having a distinct white tip. A soft and pleasing combination of colors. Each 10c., per doz. \$1.00.



Dahlia, Ethel Schmidt

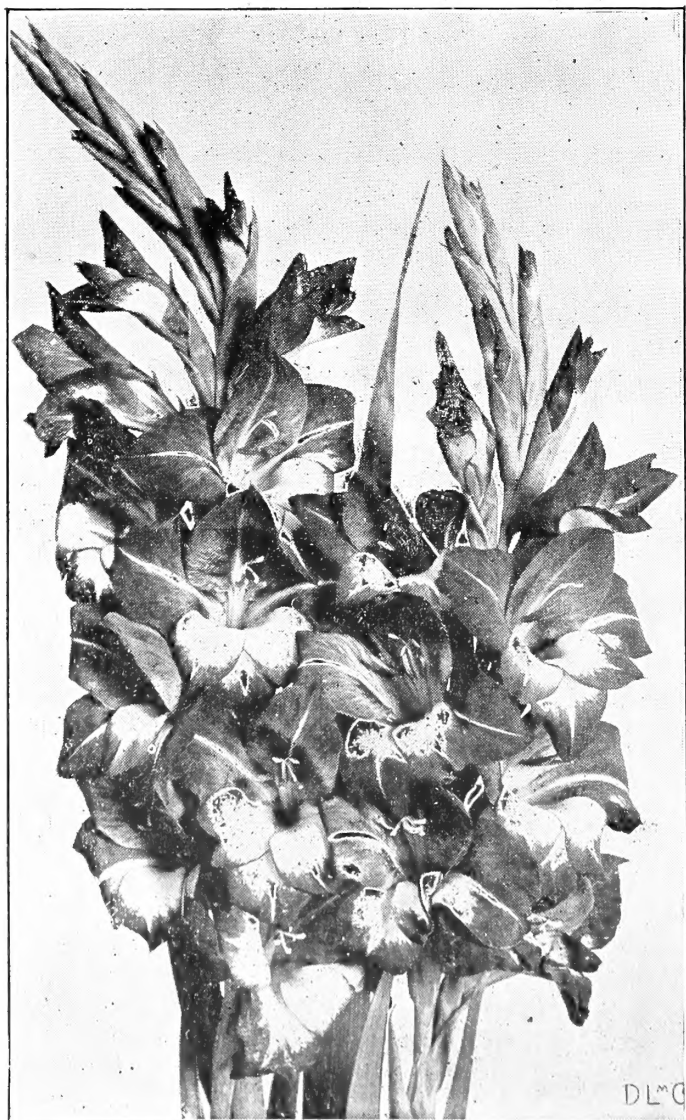

Gladiolus

**ETHEL SCHMIDT.** When making a selection of Dahlias be sure this beautiful new fancy variety is included. The magnificent, full flowers are pure white, flushed pink, dotted and penciled crimson. Each 25c., per doz. \$2.50.

**JACK ROSE.** The grand, new Decorative Dahlia has the rich dazzling crimson color of the famous General Jacqueminot Rose. The blooms are of perfect form, from 5 to 7 inches in diameter, and borne freely on long, stout stems. Plants compact. Each 25c., per doz. \$2.50.

**MRS. GEO. STEVENSON.** (Cactus.) The long-stemmed, brilliant yellow flowers are of large size and produced in great profusion. Each 10c., per doz. \$1.00.

**MRS. J. P. MACE.** One of the daintiest blush pink Cactus Dahlias, unsurpassed for cutting. Each 15c., per doz. \$1.50.

**SOUVENIR DE GUSTAVE DOUZON.** (Decorative.) The largest flowering variety of all, blooming early and continuing until frost. Blooms of rich scarlet often measure 8 and 9 inches across. Each 15c., per doz. \$1.50.

## Five Splendid Gladioli

**GIANT PINK.** A strong grower, having large pink flowers with a dark red marking in the throat. Each 10c., per doz. \$1.00.

**MEADOWVALE.** Large spikes of pure white flowers with slight crimson marking in throat and a faint tinge of pink on lower petals. Each 10c., per doz. \$1.00.

**MEPHISTOPHELES.** The dark red flowers, of large size, are stained in a most striking manner with black and yellow. Each 10c., per doz. \$1.00.

**MRS. FRANCIS KING.** An attractive variety, with light scarlet, wide open flowers of immense size and which are formed on long stems. Each 5c., per doz. 50c.

**SNOWBANK.** A favorite variety with flowers of snowy white, excepting a slight stain of red at the base. Each 7c., per doz. 75c.

For complete list of Dahlias and Gladioli, see pages 62-63.



# M. H. BRUNJES & SON'S Flower Seed Novelties and Specialties

## Four Ideal Asters VICK'S ROSE KING

This superb new Aster is a mate to the prize-winning variety, Violet King. The beautiful, brilliant rose-colored flowers are the size of a saucer and borne on stems frequently two feet in length. The stiff, strong petals are so formed as to completely cover the crown and their remarkable lasting qualities render it a most valuable sort for cutting. Per pkt. 25c., 2 for 40c.

### VIOLET KING

Owing to its immense size and beautiful soft violet-colored flowers, this sterling sort became a favorite at once. Plants of branching growth with long, stiff stems and gracefully formed, full-centered flowers. Pkt. 10c.,  $\frac{1}{4}$  oz. 75c.

### SUNRISE

When in bloom the plants of this variety present a striking appearance. The quilled petals, of a very delicate pink color, form charming, oval-shaped Asters about 4 inches in diameter. Pkt. 25c., 2 pkts 40c.

### HERCULES

Tremendously large, pure white flowers of the Giant Comet order, often measuring 6 and 7 inches in diameter. Pkt. 20c., 3 pkts 50c.

One pkt. each of the above four varieties, 65c.

## BEGONIA (Fibrous Rooted)

The Begonia is one of the leading and most popular summer flowering plants for bedding, and from June until late fall is an endless mass of bloom.

**SEMPERFLORENS ERFORDIA.** An unusually free blooming variety of sturdy, branching growth, with glossy, dark green foliage and bright rosy carmine flowers. Per pkt. 25c.

**GRACILIS LUMINOSA.** The flowers of this superior bedding sort are of large size, fiery dark scarlet color, and together with the reddish brown leaves, form a very attractive plant. Per pkt. 20c.

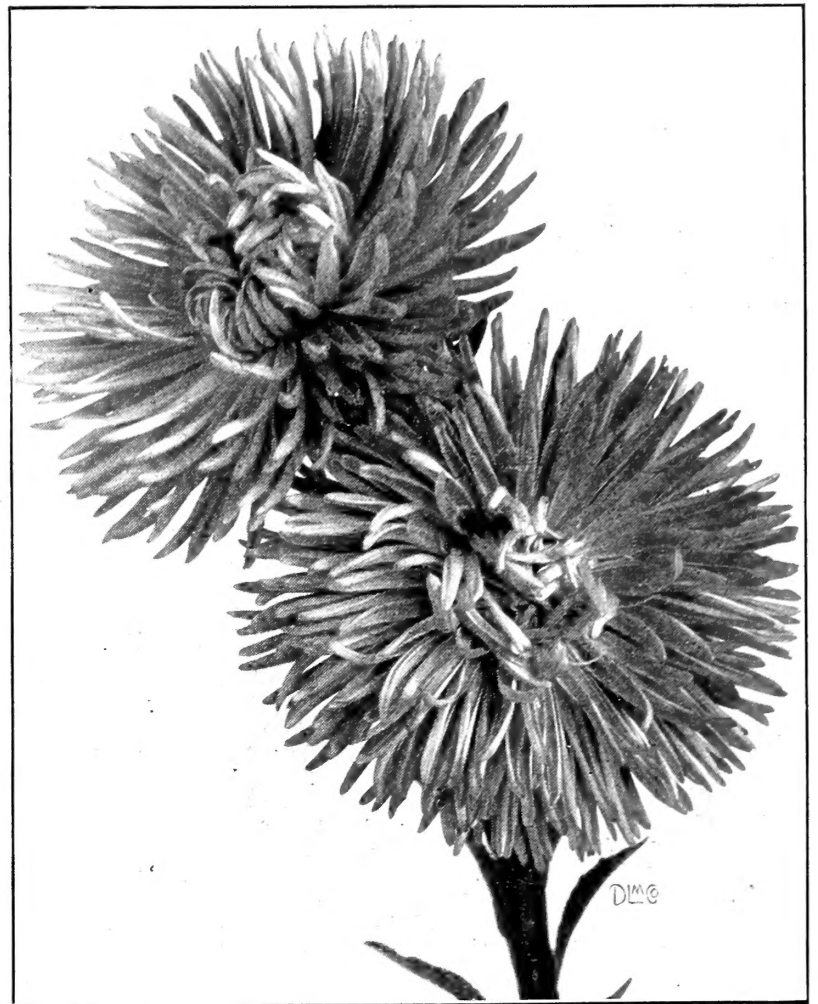

Aster, Rose King

## Masterpiece Pansy GOLDEN QUEEN

A new variety of compact growth, having flowers of immense size and rich golden yellow color, with three large black blotches on the lower petals. The finely frilled petals greatly add to the beauty of the flower. Per pkt. 25c.

## Cosmos LADY LENOX

This is a great improvement on all the other varieties of Cosmos. The plants are of vigorous growth, attaining a height of 6 to 7 feet, while the flowers, of a pretty shell pink color, measure 4 to 5 inches in diameter. Per pkt. 10c.,  $\frac{1}{4}$  oz. 25c.

## GIANT PETUNIAS

These giant-flowering Petunias, with their wonderful range of colors, large tinged throats and massive blooms, are admirably adapted for the garden, window box or exhibition.

**GIANT CRIMSON.** Rich velvety color. Per pkt. 25c.

**GIANT ROSE.** An exquisite shade of rosy pink. Per pkt. 25c.

**GIANT WHITE.** Extra large pure white flowers. Pkt. 25c.

**GIANT YELLOW THROATED.** The throats of this variety are delicately veined and penciled with yellow. Per pkt. 25c.

**GIANT MIXED.** Includes many fancy color combinations. Per pkt. 25c.

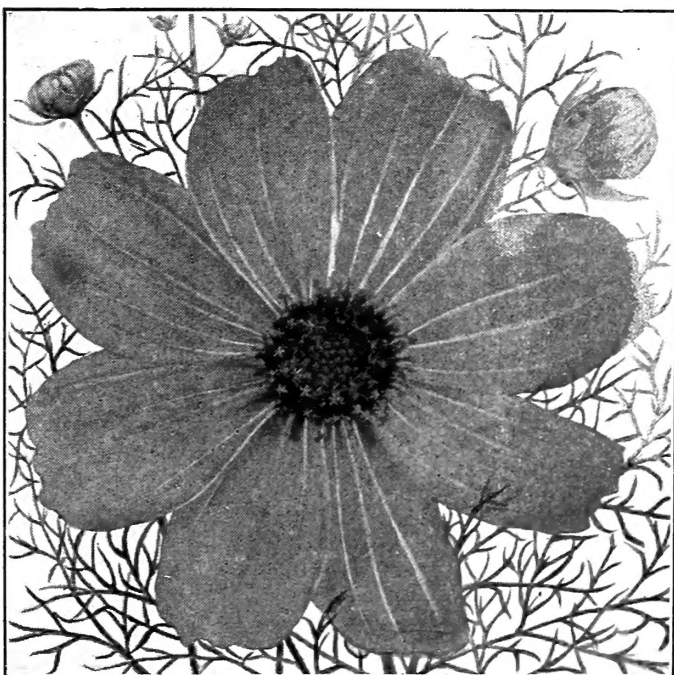

Cosmos, Lady Lenox

# Flower Seed Novelties and Specialties—Continued

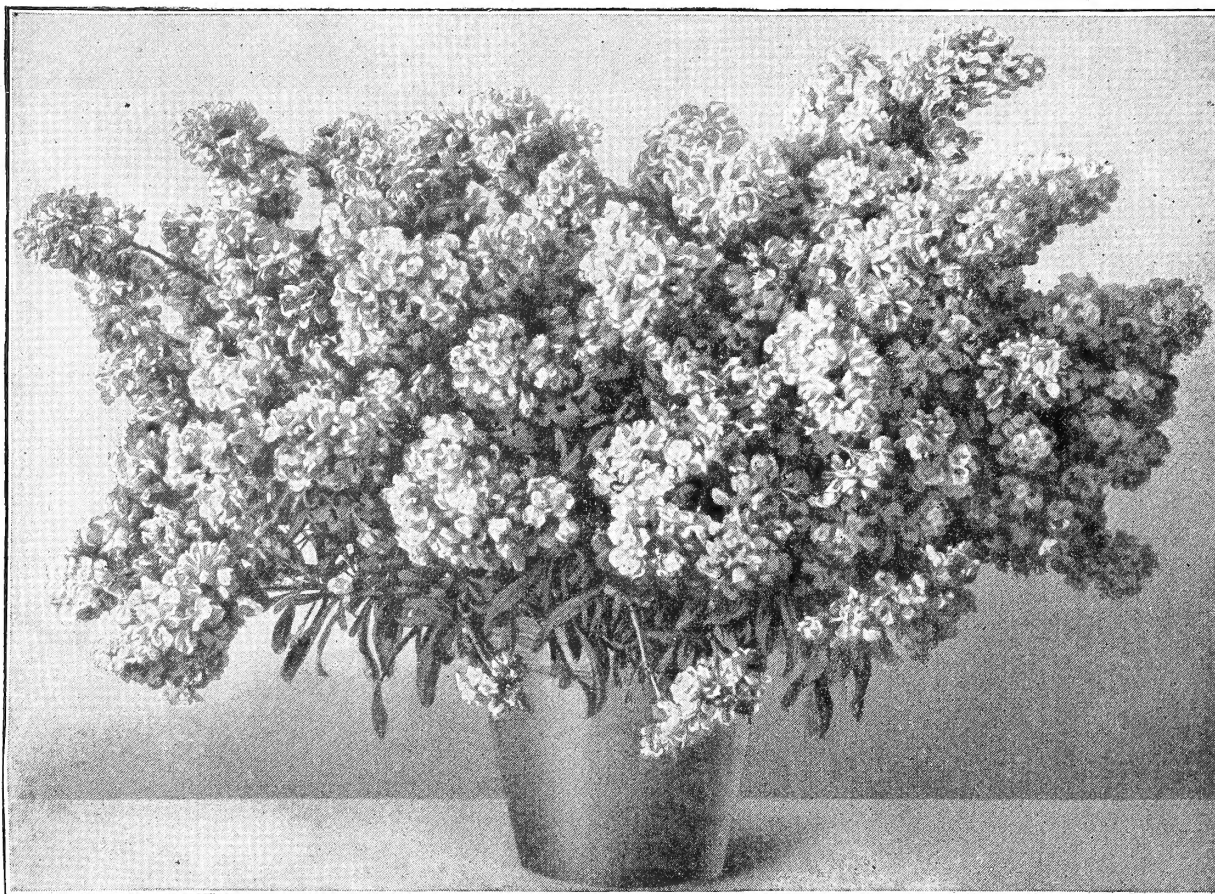

Stock, Abundance

the illustration. The plants, measuring 2 feet across each way, are of branching habit, the center stem dividing off into many side shoots which form magnificent spikes of bloom. Seed produces from 50 to 60 per cent. double flowering plants, which are excellent for pots, bedding and cutting. Per pkt. 25c.

## Poppy Charles Darwin

Single annual Poppies have long been popular with many and the introducing of this new variety will be found a great addition to the list. The flowers have a dense wreath of white anthers while the dark purple petals are marked with a large velvety black spot. 2½ ft. Per. pkt. 15c.

## Stock, Giant Nice Abundance

The special feature of this grand novelty is not the beautiful rosy carmine color of its flowers, but the phenomenal profusion of bloom, as may be seen by

## Mammoth Verbena, Rose Queen

An effective bedding plant with immense umbels of brilliant rosy pink flowers. This is undoubtedly the most perfect and largest of all Verbenas, the individual flowers measuring 1 to 1¼ inches across. Per pkt. 25c.

## Orchid-Flowered Sweet Peas

The Spencer or Orchid-flowered type of this favorite flower is steadily increasing in popularity. The showy, fragrant flowers, all of them of giant size and measuring up to 2 inches across, are gracefully formed on long, stout stems, each bearing 3 and often 4 blossoms. A novel and very pleasing feature of this type is the frilled, wavy petals, so distinct from the old standard sorts.

**CAPTAIN OF THE BLUES SPENCER.** Very large and attractive; standard purple, wings light blue. Per pkt. 10c., oz. 30c., ¼ lb. \$1.00.

**COUNTESS SPENCER.** Bright clear pink, extra large. Per pkt. 5c., oz. 15c., ¼ lb. 35c., lb. \$1.25.

**E. J. CASTLE.** Carmine rose with veins of deeper rose. Per pkt. 10c., oz. 20c., ¼ lb. 50c.

**FLORENCE MORSE SPENCER.** Delicate blush with pink edge; four blossoms to the stem. Per pkt. 10c., oz. 25c., ¼ lb. 75c.

**FRANK DOLBY.** Beautiful lavender blue. Per pkt. 10c., oz. 20c., ¼ lb. 50c., lb. \$1.75.

**GLADYS UNWIN.** Splendid for cutting, soft light pink; blooms freely. Per pkt. 5c., oz. 15c., ¼ lb. 35c., lb. \$1.25.

**HELEN LEWIS (Orange Countess).** A magnificent giant-flowered orange pink. Per pkt. 5c., oz. 15c., ¼ lb. 35c., lb. \$1.25.

**LOVELY SPENCER.** A dainty, soft, shell pink, shading almost white at the edge. Per pkt. 10c., oz. 30c., ¼ lb. \$1.00.

**MRS. ALFRED WATKINS.** Flowers borne on long stems and of a pale pink color. Per pkt. 10c., oz. 20c., ¼ lb. 50c., lb. \$1.75.

**NORA UNWIN.** Pure white, giant-ruffled flowers; a superb variety. Per pkt. 10c., oz. 20c., ¼ lb. 50c., lb. \$1.75.

**PRIMROSE SPENCER.** Clear primrose; a charming mate to white Spencer. Per pkt. 10c., oz. 25c., ¼ lb. 75c.



Sweet Pea, Countess Spencer

**WHITE SPENCER.** This grand variety is of the largest size, purest white and delightfully fragrant. Per pkt. 10c., oz. 25c., ¼ lb. 75c.

For complete list of Sweet Peas see page 52.



# GENERAL LIST OF CHOICE VEGETABLE SEEDS

M. H. BRUNJES & SON give no warranty, express or implied, as to the description, quality, productiveness or any other matter of any seeds, bulbs, or plants they send out and they will not be in any way responsible for the crop. If the purchaser does not accept the goods on these terms, they are at once to be returned.—M. H. B. & SON.

When seeds are ordered by mail Postage must be added to catalogue prices at the rate of 8 cents per pound for Seeds, 15 cents per quart for Peas and Beans, and 10 cents per quart for Corn.

## ARTICHOKE

*One ounce will produce 500 plants*

To secure globes the first year sow the seed in hotbeds during February and in May transplant in rows three feet apart and two feet apart in the row, selecting a bed of deep, rich and rather moist soil. Seed may also be sown outdoors in May, but will not mature until the second year. In winter protect the crowns with a covering of leaves or straw.

**Large Globe.** Heads light green, thick and fleshy. Per pkt. 10c., oz. 30c.

**Jerusalem.** Unlike the above, the roots when pickled are the edible portion of this variety, but it is mainly grown for

feeding stock. Plant the tubers in rows four feet apart and one foot apart in the row, cultivating same as potatoes. *Five bushels will plant one acre.*

**Large Tubers,** Per qt. 25c., pk. \$1.25, bush. \$4.00.

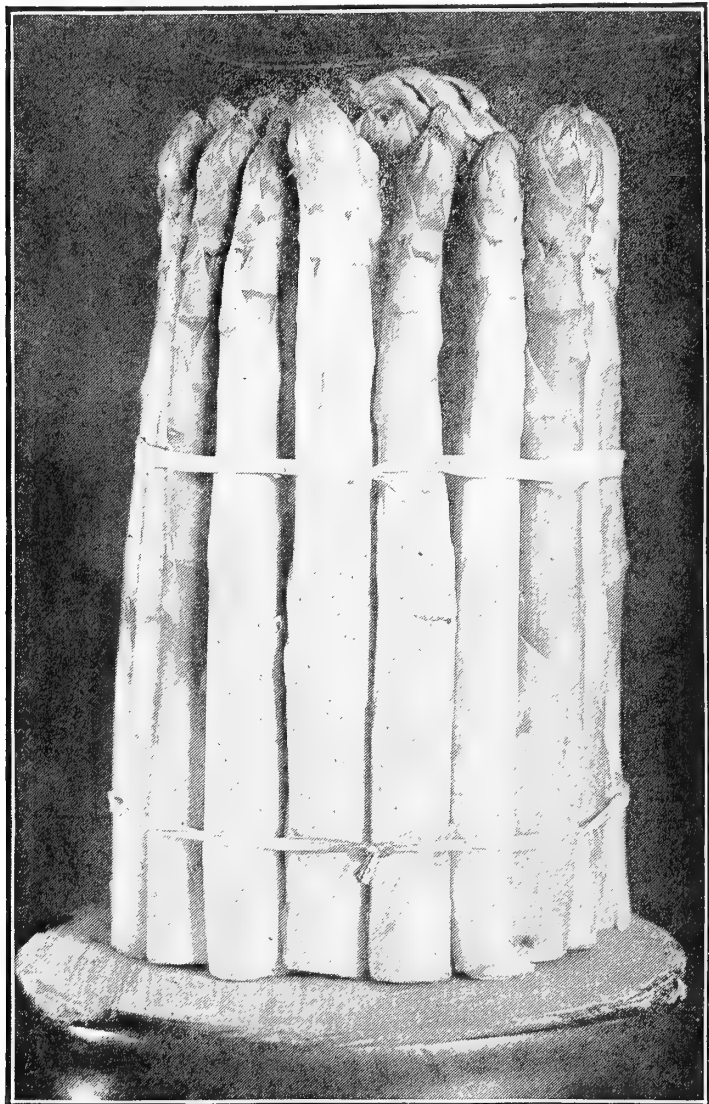

Asparagus

## ASPARAGUS

*One ounce will sow about 50 feet of drill; 1 pound will produce enough plants for 1 acre.*

Sow the seed outdoors about April or May in drills one foot apart and two inches deep. When well developed, plants should be thinned out to two inches apart and the following spring, or preferably when two years old, transplanted to permanent beds of sandy soil that has been thoroughly dug and well enriched with manure. Set plants twelve inches apart in trenches eighteen inches wide and after carefully spreading the roots cover to depth of four inches; and the second row three or four feet from the first. Cultivate frequently and add a top dressing of well rotted manure or wood ashes in the fall. Cutting should not take place until roots are four years old.

**The Palmetto.** An early sort with light green shoots uniform in size and good quality. Pkt. 5c., oz. 10c.,  $\frac{1}{4}$  lb. 20c., lb. 60c.

**Conover's Colossal.** One of the best for general use. Large tender stalks especially desirable for canning. Pkt. 5c., oz. 10c.,  $\frac{1}{4}$  lb. 20c., lb. 60c.

## ASPARAGUS ROOTS

*A bed twelve by thirty-two feet requires 100 roots.*

Results are obtained two years earlier by planting roots.

**The Palmetto.** Strong two-year-old roots. Per 100 \$1.00, per 1000 \$6.00.

**Colossal.** Strong two-year-old roots. Per 100 \$1.00, per 1000 \$6.00.

## BEANS, English or Broad

**Broad Windsor.** A distinct variety that requires early planting, in the open ground, either in February or March, to obtain best satisfaction. They are not affected by cold weather. Per pt. 20c., qt. 35c.

## BEANS, Bush Lima

*One quart will plant 100 feet of drill.*

After the soil becomes warm and dry, plant in drills two feet apart and one foot apart in the row about two inches deep.

**Burpee's Bush Lima.** Plants vary from eighteen to twenty-four inches in height, somewhat spreading and yielding long flat pods, about four inches long, containing three or four beans of delicious flavor. Per pt. 20c., qt. 35c., pk. \$2.00.

**Dreer's Bush Lima.** Large thick pods well filled with sweet tender beans and maturing a trifle later than Burpee's. Per pt. 20c., qt. 35c., pk. \$2.25.

**Fordhook Bush Lima.** The pods of this wonderful new bush Lima are not only double the size of the well known Dreer's or Kumerle, but are thicker and produced in greater abundance from 4 to 6 days earlier. Each pod contains on an average 4 extra large beans of delicious flavor. The plants form erect bushes 20 to 30 inches high. Per pt. 25c., qt. 45c., pk. \$2.75.

**Burpee Improved Bush Lima.** This is the finest Bush Lima that has ever been introduced. The pods are of enormous size, containing from 3 to 5 beans (more containing 5 than 3) which are not only larger than those of the old variety, but are nearly twice as thick. In quality it is of the best. The bushes when fully grown measure  $2\frac{1}{2}$  feet in height and 24 inches across the top. It is about one week earlier than Burpee's Bush Lima. Per pt. 25c., qt. 45c., pk. \$2.75.

Be sure you have included in your order some  
of the two last named Bush Limas.

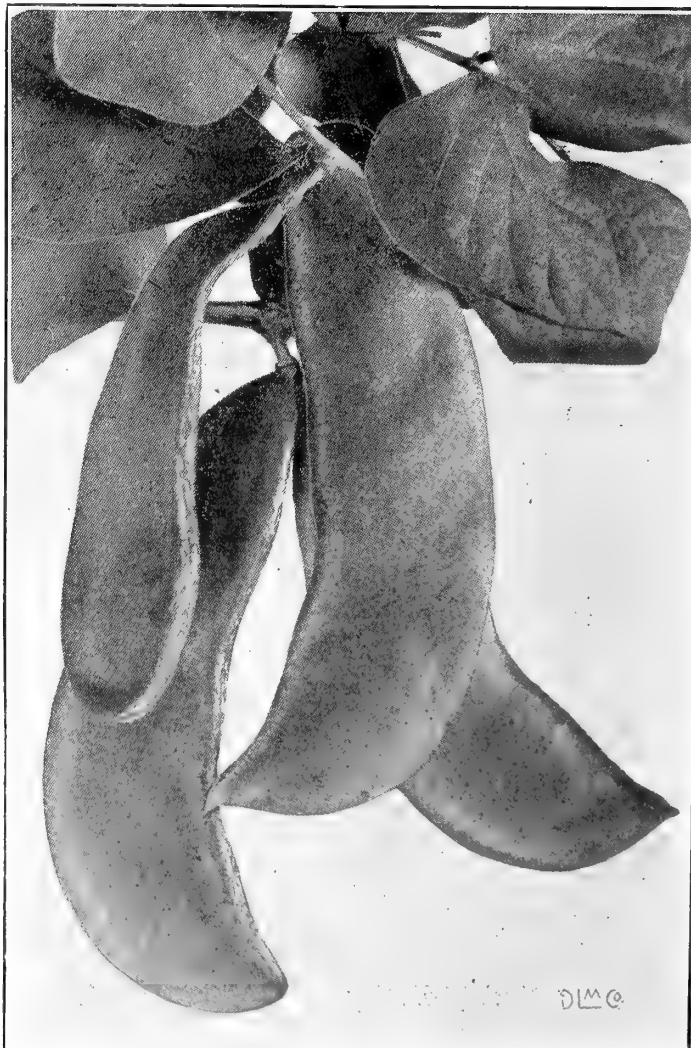

Beans, Burpee's Bush Lima

## BEANS

The seed should not be planted before the ground becomes light and warm, in favorable seasons usually about the first of May. The soil should be rich and mellow, and the seeds scattered about 3 inches apart in drills 2 feet apart, and covered about 2 inches deep. Successive sowings made at intervals of about two weeks until August 15th, will give a plentiful supply of beans all season. One quart of seed will sow 100 feet of drill; 2 bushels will sow an acre.

For Beans sent by mail add postage at the rate of 8c.

per pt., 15c. per qt.

### BEANS, Bush (Green Podded)

**Bountiful.** A valuable sort, equally good for market or private garden; bearing continuously for several weeks. The beans are uniform in size, flat, solid, stringless and retain their tenderness even when past maturity. Per pt. 15c., qt. 25c., pk. \$1.50.

**Black Valentine.** Has very long handsome round pods, and being immensely productive places this variety as one of the most profitable for the market gardener. It is very early but can not compare with the best in quality. Per pt. 15c., qt. 30c., pk. \$2.00.

**Dwarf Horticultural.** A standard variety used extensively for shelling. When fully matured the large flat beans are yellow, splashed with crimson. Per pt. 15c., qt. 25c., pk. \$1.50.

**Earliest Red Valentine.** One of the popular early snap Beans with round, fleshy pods about 5 inches in length; very brittle, tender and of fine quality. Per pt. 15c., qt. 25c., pk. \$1.50.

**Extra Early Refugee.** Matures two weeks earlier than Refugee or 1000 to 1. The plant grows similar to the Refugee, but the round podded light green beans are somewhat smaller. Per pt. 15c., qt. 25c., \$1.50.

**Giant Stringless Green Pod.** The round dark green pods, giant in size, are absolutely stringless and unsurpassed in tenderness. For the garden, there are few that will give better satisfaction. Per pt. 15c., qt. 30c., pk. \$2.00.

**Hodson Green Pod.** Similar in growth to the Hodson Wax, and like that variety it is enormously productive, while the vines are rarely if ever affected by blight. Has exceedingly long pods, averaging 7 inches in length, flat, very showy but quite stringy; late in maturity. Per pt. 15c., qt. 25c., pk. \$1.50.

**Longfellow.** The pods of this Bean are about 6 inches long, pale soft green, straight and round, of delicious flavor; extremely early and a most abundant bearer. Per pt. 15c., qt. 30c., pk. \$2.00.

**Long Six Weeks.** Valuable on account of its extra earliness and productiveness. The pods are long and flat, and of good quality as long as they are tender. Per pt. 15c., qt. 25c., pk. \$1.50.

**Refugee or Thousand to One.** Although it will give equally good results if planted early, this Bean has become a

favorite for sowing during July and used in the fall for pickling. The round straight pods are uniform in size, light colored and of the best quality. Per pt. 15c., qt. 25c., pk. \$1.50.

**Stringless Green Pod.** An ideal variety having round, slightly curved, fleshy and exceedingly tender pods. Matures a few days earlier than the Giant sort. Per pt. 15c., qt. 30c., pk. \$2.00.

**White Navy or Boston Pea Bean.** Yields large quantities of white shell beans, which are used for baking. Per pt. 15c., qt. 25c., pk. \$1.25.

### BEANS, Bush (Wax Podded)

**Currie's Rust-Proof Black Wax.** Valuable for general use, being early, hardy, and a heavy yielder. Extra long flat pods of fine color, and not apt to rust. Per pt. 15c., qt. 25c., pk. \$1.50.

**Davis White Kidney Wax.** Pods remarkably long, straight and handsome, waxy white color; enormously productive; seed white. Per pt. 15c., qt. 30c., pk. \$2.00.

**Hodson Wax.** In growth of vine and productiveness this variety exceeds any other wax-podded Bean. The long flat pods, slightly curved, are of handsome appearance and usually free from rust. Per pt. 15c., qt. 30c., pk. \$2.00.

**Improved Golden Wax.** Small plants of erect growth bearing flat pods about 5 inches in length, of excellent quality. An early and reliable variety recommended for home use. Per pt. 15c., qt. 25c., pk. \$1.50.

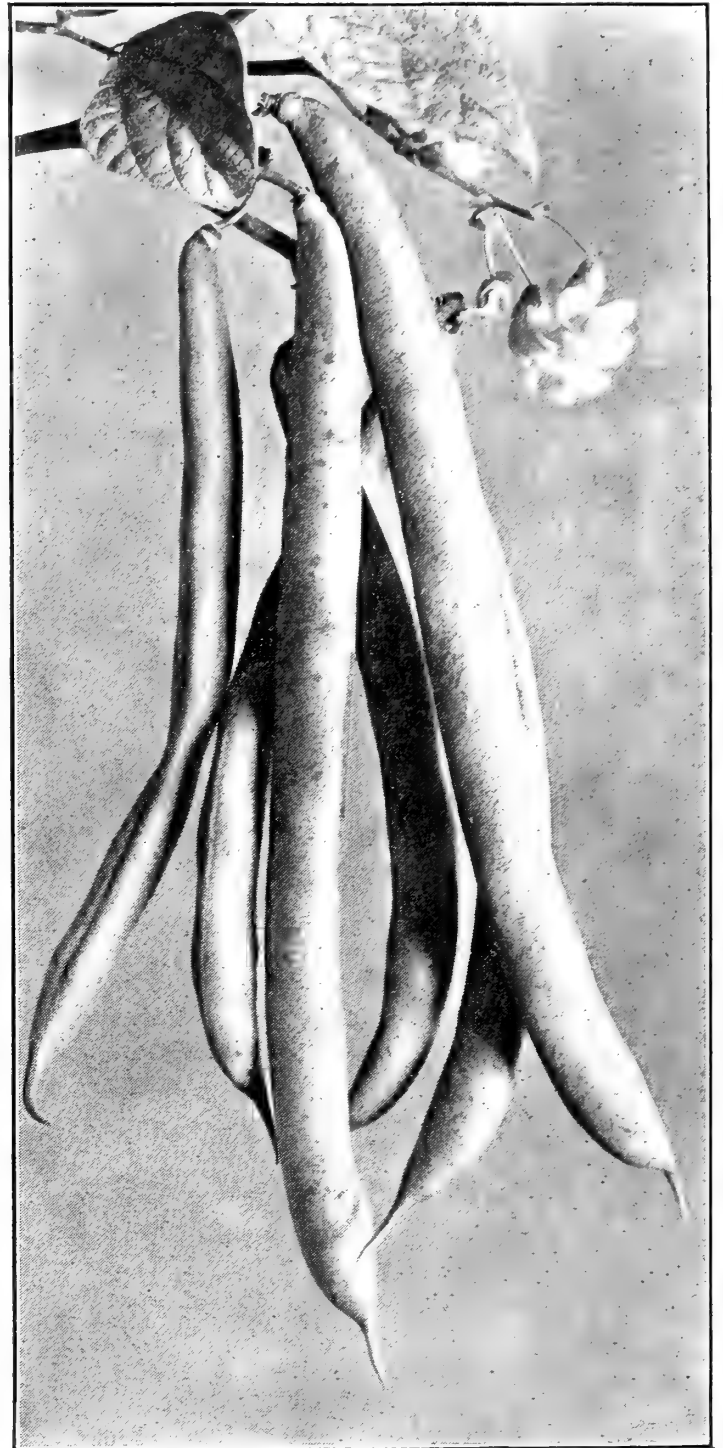

Beans, Bountiful

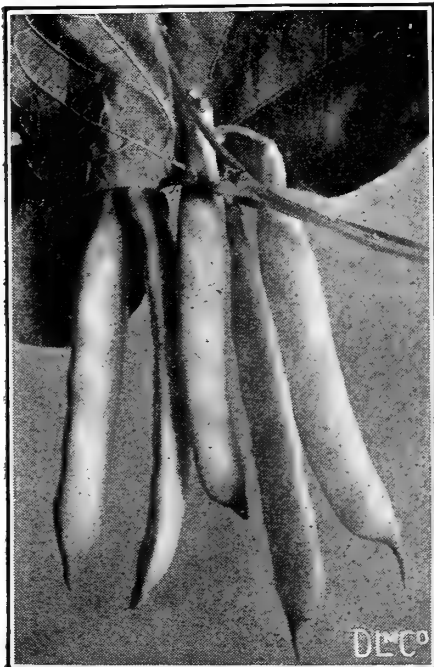

Beans, Improved Golden Wax

Packets of all Varieties of Beans, 10c. each, Postpaid.

## BEANS, Pole or Running

*One quart will plant 100 to 150 hills*

### Green and Wax Podded

As Pole Beans, especially the Limas, are more sensitive to cold, they should not be planted until warm weather, about May 15th. For best results poles 8 to 10 feet long should be set 4 feet apart each way before planting. Plant 5 to 6 seeds, two inches deep, around each pole and after the plants are well started, thin out, leaving but 3 or 4 of the strongest. The bearing season of the pole varieties will be found to be longer and the pods considerably larger than those of the bush sorts.

**Early Golden Cluster Wax.** The best wax podded Pole Bean. The pods, borne in clusters, are of large size, flat, brittle and continue to bear for a long time. Per pt. 20c., qt. 35c., pk. \$2.25.

**Dutch Case Knife.** Very large, flat, green-podded bean about 8 inches in length. It is mainly used for shelling, when it is equally good either green or dry. Per pt. 15c., qt. 30c., pk. \$2.00.

**Horticultural Cranberry.** The large dark green podded beans are of the finest quality. When fully matured they become splashed with purplish red and may then be used for shelling. Per pt. 20c., qt. 35c., pk. \$2.00.

**Lazy Wife.** A desirable variety of late maturity, having broad, flat, fleshy pods of light green color and excellent quality. It may also be used as a shell bean, each pod containing 6 to 8 white beans which are almost as broad as long. Per pt. 20c., qt. 35c., pk. \$2.00.

**Old Homestead or Kentucky Wonder.** This is decidedly the best of all green-podded Pole Beans. The vines are of good climbing habit and heavy yielders of long, almost round pods, 8 to 10 inches in length, of the very best quality. An early and well recommended sort for the home garden. Per pt. 20c., qt. 35c., pk. \$2.00.

**Scarlet Runner.** Generally known as an ornamental climber, with bright scarlet flowers, but the beans may also be used in the green state. Per pt. 20c., qt. 35c., pk. \$2.50.

**White Dutch Runner.** Similar to the above, but with white flowers. Per pt. 20c., qt. 35c., pk. \$2.50.

**Yard Long.** The pods are 2½ to 3 ft. in length, round and thick as a pencil; seed small. Per pkt. 10 cts.

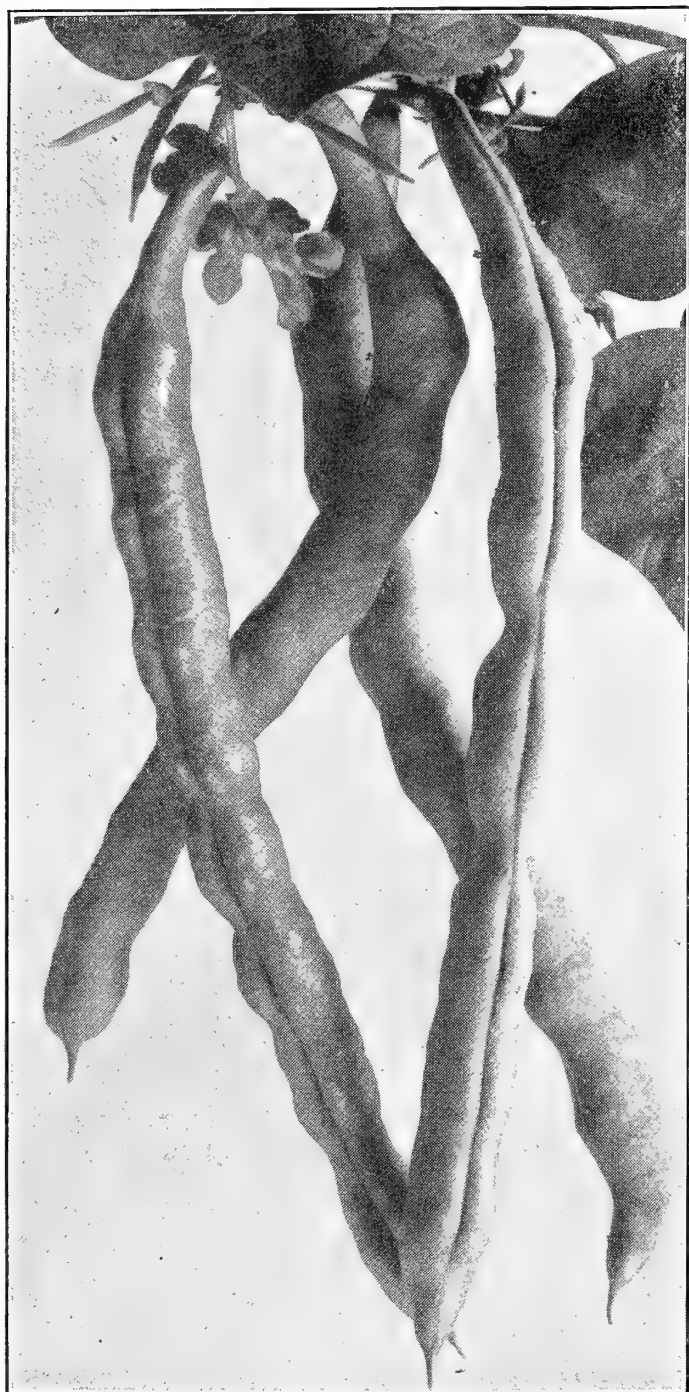

Beans, Old Homestead

#### BEANS, WAX PODDED—Continued

**Pencil Pod Black Wax.** This is an exceptionally fine sort for the private garden. The pencil-like pods are round, slender, entirely free from strings, brittle and of a beautiful yellow color. Medium early and equal to the best in quality. Per pt. 15c., qt. 30c., pk. \$2.00.

**Prolific Black Wax.** A selected strain, yielding round, tender beans of medium size and superior quality; somewhat shorter but thicker than Pencil Pod Black Wax. Per pt. 15c., qt. 25c., pk. \$1.50.

**Round Pod Kidney Wax.** All the best qualities that make a garden favorite are combined in this Bean. It is very early, wonderfully productive, and the waxy-like pods, never stringy, possess the most delicious flavor. Per pt. 15c., qt. 30c., pk. \$2.00.

**Stringless Refugee Wax.** Popular for either early or late planting. Plants are large, spreading and heavy yielders of round fleshy podded beans. Per pt. 15c., qt. 25c., pk. \$1.50.

**Valentine Wax.** A very early and desirable Bean of good quality, with round waxy pods of medium length. Per pt. 15c., qt. 30c., pk. \$2.00.

**Wardwell's Kidney Wax.** The pods of this variety are almost 6 inches long, straight, flat and solid. It is medium early, maturing a little later than improved Golden Wax, very productive and largely grown in all sections. Per pt. 15c., qt. 30c., pk. \$2.00.

TRY  
OUR  
LAWN  
GRASS

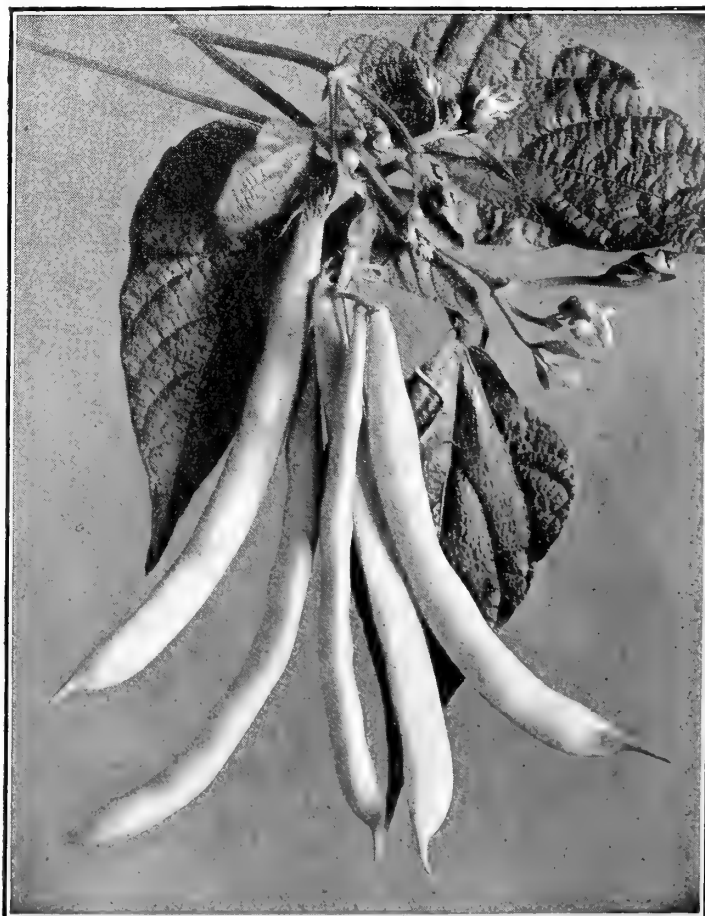

Beans, Hodson Wax—See page 7

# BEANS

One quart will plant 100 hills

## POLE LIMA

For Culture see page 8

**Challenger Lima.** This is to-day and always has been a favorite market sort; thick podded, a good yielder and matures early. Per pt. 20c., qt. 35c., pk. \$2.25.

**Dreer's Improved Lima.** A fine early variety, very productive and of superior quality. Pods very thick, about 4 to 5 inches in length and generally contain about 4 to 5 seeds. Per pt. 20c., qt. 35c., pk. \$2.25.

**Early Leviathan.** The earliest of all Pole Limas and therefore one of the most reliable, either for the market or private garden. The long straight pods contain from 3 to 5 large beans, unsurpassed in flavor, and are borne in large clusters continuously until late in the season. Per pt. 20c., qt. 35c., pk. \$2.50.

**Ford's Mammoth Podded.** Where size of pod is the first consideration, this variety leads the list. Vines are unusually vigorous, enormously productive and of good climbing habit, while the pods, giant in size, are well filled with delicious beans. Per pt. 20c., qt. 35c., pk. \$2.50.

**Ideal.** One of the newer introductions, somewhat similar but superior to the King of the Garden Lima. It is a most excellent sort and certain to become popular when fully known. The straight flat pods, uniform in size, are fully 6 to 8 inches in length, handsome, attractive, deep green in color and borne continuously until frost. Per pt. 20c., qt. 35c., pk. \$2.50.

**Large White Lima.** Vines dark green, of vigorous growth and good climbing habit. Its large flat tender beans of superb quality make this variety especially desirable for home use. Per pt. 20c., qt. 35c., pk. \$2.25.

# BEET

One ounce will sow 100 feet of drill

Best results are obtained by using a light soil that has been well enriched with manure. Sow in drills 1 foot apart and 1 inch deep, as soon as the ground is in working condition, and for succession every two weeks until August. When the plants are well advanced thin out to 4 or 5 inches apart.

**Crosby's Extra Early Egyptian.** This is an improved strain of the Egyptian, probably the quickest growing, earliest and best known of table Beets. In shape it is broad at the top, tapering quickly to a small tap root. In color it is deep blood red, and in quality unsurpassed for flavor and fine grain. Per pkt. 5c., oz. 10c., 1/4 lb. 20c., lb. 60c.

**Columbia.** Round and smooth, with deep red flesh, early and very tender. Per pkt. 5c., oz. 10c., 1/4 lb. 20c., lb. 50c.

## Golden Globe.

This is one of the finest Beets yet introduced. Roots are not large, but very handsome. Round and a clean, smooth surface. Per pkt. 5c., oz. 10c., 1/4 lb. 20c., lb. 60c.

## Detroit Dark Red Turnip.

This variety should not be too highly recommended. It is not only one of the best for market but for home use as well. The root is globular in shape, very smooth, of a blood-red color and uniform size. Per pkt. 5c., oz. 10c., 1/4 lb. 20c., lb. 60c.

## Sowing's Early Blood Turnip.

A good variety for main crop. Keeps well. Like Edmand's, but lighter color. Per pkt. 5c., oz. 10c., 1/4 lb. 20c., lb. 50c.

## Early Egyptian.

A favorite among gardeners for frame and early outdoor culture. It is flat shaped, of the darkest color, with small, deep green leaves and tap-root. When young, very sweet and tender. Per pkt. 5c., oz. 10c., 1/4 lb. 20c., lb. 50c.

## Early Eclipse.

Splendid globular shaped roots, the flesh of which is not of the darkest, but very sweet. Matures early. Per pkt. 5c., oz. 10c., 1/4 lb. 20c., lb. 50c.

## Edmand's Early Blood Turnip.

A valuable Beet for late planting. Medium in size, good color, with sweet, juicy flesh. Per pkt. 5c., oz. 10c., 1/4 lb. 20c., lb. 50c.

## Improved Blood Turnip.

A remarkably fine Beet of the darkest color, highest in quality and desirable for early or late crops. Per pkt. 5c., oz. 10c., 1/4 lb. 20c., lb. 60c.

## Long Smooth Blood.

An excellent sort for winter use. It is of medium size, dark color and with few side roots. Per pkt. 5c., oz. 10c., 1/4 lb. 20c., lb. 60c.

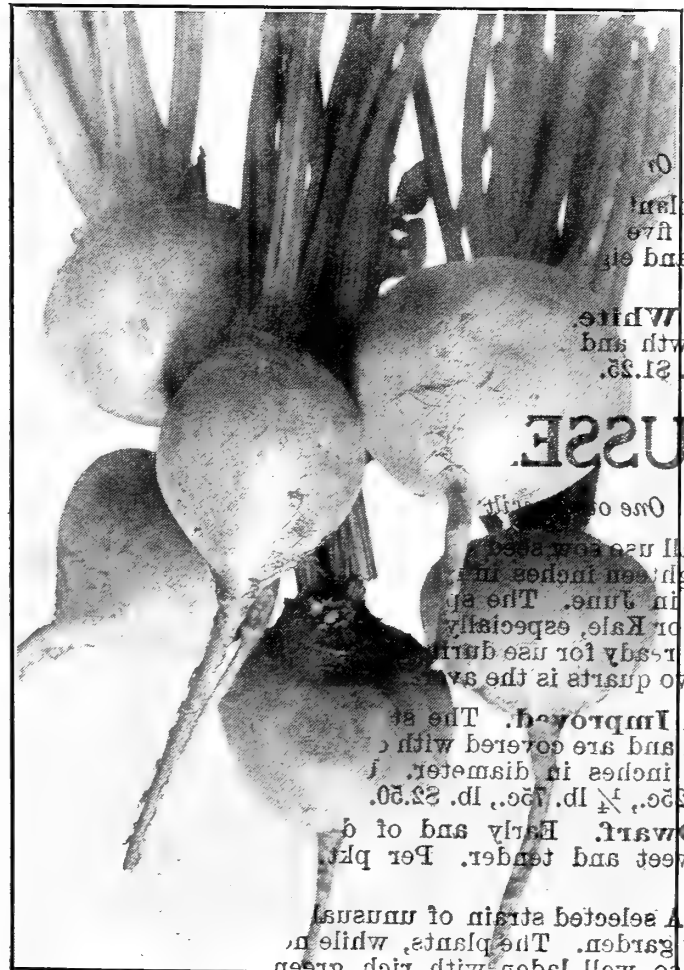

# BRUSSELS

Beet Columbia Globe Per pkt. 5c., oz. 10c., 1/4 lb. 20c., lb. 50c.

BEET—  
Early Model. An extremely color with rather short tops and of fine flavor. Superior for sowing. Per pkt. 5c., oz. 10c., 1/4 lb. 20c., lb. 50c.  
Uniform in size, light tender. Per pkt. 5c., oz. 10c., 1/4 lb. 20c., lb. 50c.  
Swiss Giant. For description and

# MAMMOTH

Invaluable for feeding stock from two feet apart, allowing the plant to grow in the row.  
A standard sort. This enormous quantity of long straight roots. The most largely grown of all Mammoth Long Pod. Per lb. 15c., lb. 35c.  
Large globe-shaped; flesh yellow, suited to light or shallow soils. Per lb. 15c., lb. 35c.  
The popular yellow variety. Unusually large quantities to the acre. Medium golden yellow color and good keeper. Per oz. 5c., lb. 35c.

# SUGAR BEET

Lane's Imperial. The flesh is pure white and large percentage of sugar. In every respect a fine variety for feeding cattle. Per oz. 5c., lb. 35c.

# BORECOLE

For description and price see page 18.

Beans, Early Leviathan

Brussels sprouts

## BEET—Continued

**Early Model.** An extremely early Beet of deep, blood red color with rather short tops and perfect, globe-shaped roots of fine flavor. Superior for frames as well as for outside sowing. Per pkt. 5c., oz. 15c.,  $\frac{1}{4}$  lb. 30c., lb. 90c.

**Lentz Early.** Uniform in size, light colored but sweet and tender. Per pkt. 5c., oz. 10c.,  $\frac{1}{4}$  lb. 20c., lb. 50c.

**Swiss Chard.** For description and price see page 30.

## MANGEL-WURZEL

*Six pounds will sow one acre.*

Invaluable for feeding stock. The rows should be not less than two feet apart, allowing the plants to stand six inches apart in the row.

**Mammoth Long Red.** A standard sort yielding an enormous quantity of long, straight roots. This is undoubtedly the most largely grown of all Mangels. Per oz. 5c.,  $\frac{1}{4}$  lb. 15c., lb. 35c.

**Yellow Globe.** Large globe-shaped; flesh white tinged yellow. Suited to light or shallow soils. Per oz. 5c.,  $\frac{1}{4}$  lb. 15c., lb. 35c.

**Golden Tankard.** The popular yellow variety, yielding unusually large quantities to the acre. Medium early, golden yellow color and good keeper. Per oz. 5c.,  $\frac{1}{4}$  lb. 15c., lb. 35c.

## SUGAR BEET

**Lane's Imperial.** The flesh is pure white and contains large percentage of sugar. In every respect a most profitable variety for feeding cattle. Per oz. 5c.,  $\frac{1}{4}$  lb. 15c., lb. 35c.

## BORECOLE

For description and price see Kale, page 18.

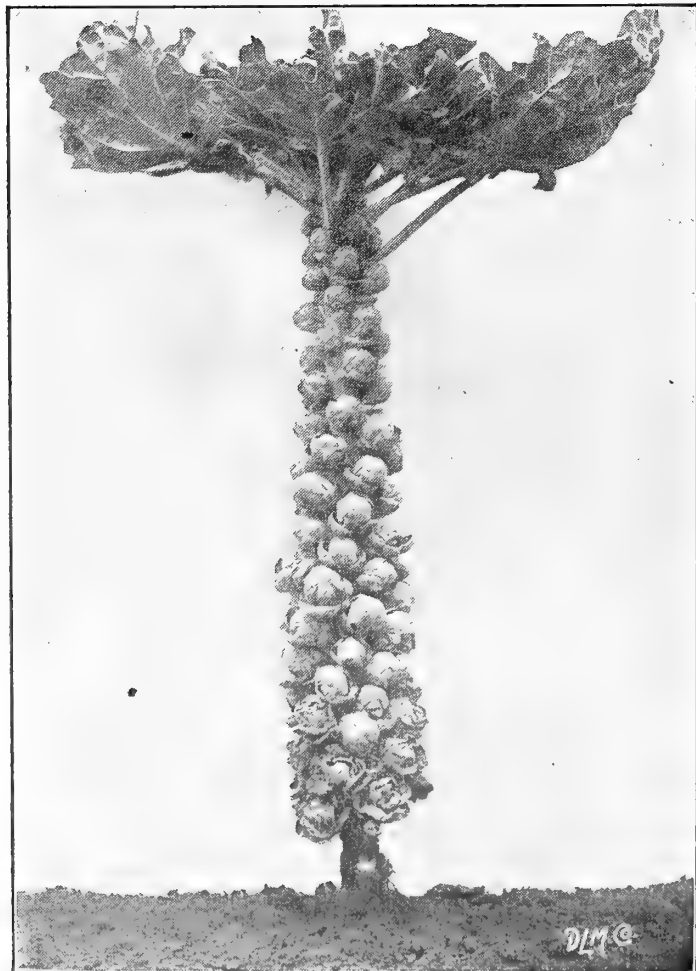

Brussels Sprouts

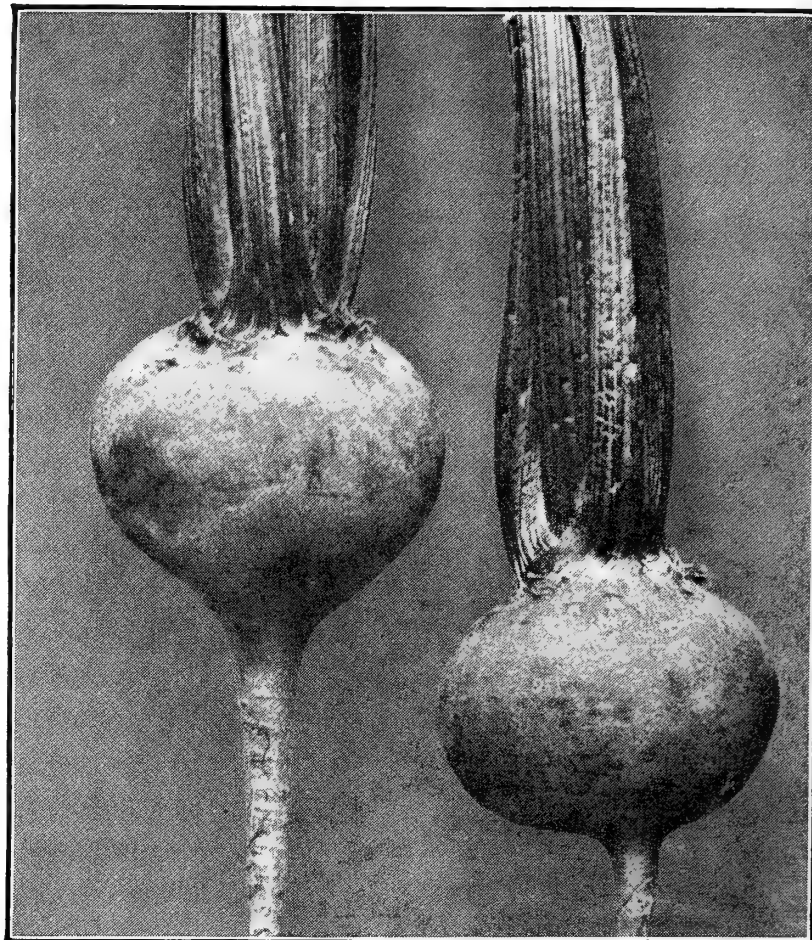

Beet, Improved Blood Turnip

## BORAGE

The leaves have a cucumber-like odor, and are used as a salad. Sow the seed in drills one foot apart from April until August and when well advanced thin out to three inches in the row. As it soon runs to seed, make sowings every two weeks for a succession. Per pkt. 5c., oz. 15c.,  $\frac{1}{4}$  lb. 35c., lb. \$1.00.

## BROCCOLI

*One ounce will produce 3,000 plants.*

Start the plants in hotbeds during February or outside in May and when five inches high transplant in rows two and one-half feet apart and eighteen inches in the row. Cultivate same as for Cabbage.

**Early Large White.** Similar to Cauliflower in appearance, but of taller growth and heads not quite so compact. Per pkt. 10c., oz. 40c.,  $\frac{1}{4}$  lb. \$1.25.

## BRUSSELS SPROUTS

*One ounce will produce 3,000 plants.*

For early fall use sow seed outdoors in May and during July set plants every eighteen inches in rows two feet apart. Later sowings may be made in June. The sprouts are far superior in flavor to either Cabbage or Kale, especially after a hard frost, and from June sowings will be ready for use during the early part of October. Between one to two quarts is the average yield of one plant.

**Long Island Improved.** The stems of this variety grow about two feet high and are covered with cabbage-like sprouts about one and one-half inches in diameter. Unsurpassed in quality. Per pkt. 10c., oz. 25c.,  $\frac{1}{4}$  lb. 75c., lb. \$2.50.

**Improved Dwarf.** Early and of dwarf habit, but the heads are large, sweet and tender. Per pkt. 5c., oz. 20c.,  $\frac{1}{4}$  lb. 50c., lb. \$1.50.

**Matchless.** A selected strain of unusual merit and well worth a trial in every garden. The plants, while not only strong and vigorous, are also well laden with rich, green sprouts of the finest flavor. Per pkt. 5c., oz. 20c.,  $\frac{1}{4}$  lb. 50c., lb. \$1.75.





Cabbage, Early Jersey Wakefield

## CABBAGE

*One ounce will produce  
3,000 plants.*

Almost any soil, whether a light sandy loam or heavy clay, if properly prepared, will be suitable to growing Cabbage, but a rich loam with a gravelly sub-soil is undoubtedly the best. Plants of the earlier varieties should be started in February and from then until June for a succession. To obtain strong stocky plants, the seedlings should be transplanted at least once before the final planting, when they are set from one to two feet apart in rows two to three feet apart according to the variety. Insects are quite troublesome to plants grown in the open ground. Therefore, after sowing, sprinkle a small quantity of Tobacco Dust over the seed and also keep the young plants well covered until ready for planting. Thorough cultivation is necessary for best results.

**All-Head Early.** The heads are large, round, flat, very solid and uniform in size. It is a good keeper, of fine quality, and almost certain to head under any favorable conditions. Per pkt. 5c., oz. 30c.,  $\frac{1}{4}$  lb. \$1.00, lb. \$3.50.

**All Seasons.** One of the best second early sorts, but will also give equal satisfaction for late or intermediate planting. A dry hot summer does not affect it from forming large solid heads, which in sweetness and tenderness may be classed with the best. Per pkt. 5c., oz. 25c.,  $\frac{1}{4}$  lb. 75c., lb. \$2.50.

**Autumn King** Very late in maturing. Heads flat with few outer leaves, extremely hard and remarkable for its great size and weight; an excellent keeper. Per pkt. 5c., oz. 25c.,  $\frac{1}{4}$  lb. 75c., lb. \$2.50.

**Charleston Wakefield.** Although a few days later than the Early Jersey Wakefield it is larger, less pointed and equally good in quality. Invaluable for gardens where close planting is usually necessary. Per pkt. 5c., oz. 30c.,  $\frac{1}{4}$  lb. \$1.00, lb. \$3.00.

**Danish Ballhead or Hollander.** An excellent Cabbage for winter use, having round, medium size heads, as solid as a rock, which remain in splendid condition until spring. Very hardy, of compact growth and withstands the cold better than any other variety. Superior for shipping. Per pkt. 5c., oz. 30c.,  $\frac{1}{4}$  lb. \$1.00, lb. \$3.00.

**Early Jersey Wakefield.** Extra early, with thick outer leaves and hard conical-shaped heads, that are equal to any in quality. Per pkt. 5c., oz. 30c.,  $\frac{1}{4}$  lb. \$1.00, lb. \$3.00.

**Early Spring.** The earliest flat headed variety, which is ready for use about one week later than Jersey Wakefield but matures more even and also produces far more Cabbage to the acre. The heads, of medium to large size, form close to the ground, and have few, very smooth, dark green outside leaves. Per pkt. 5c., oz. 35c.,  $\frac{1}{4}$  lb. \$1.25, lb. \$4.00.

**Glory of Enkhuisen.** A medium early Cabbage with large ball-shaped heads, thin-ribbed but hard and solid. Per pkt. 5c., oz. 30c.,  $\frac{1}{4}$  lb. \$1.00, lb. \$3.00.



Cabbage, Early Spring

**CABBAGE—Continued**

**Improved Early Summer.** Early and sure heading variety. Heads light green in color, firm, of good quality and seldom burst. Per pkt. 5c., oz. 25c.,  $\frac{1}{4}$  lb. 75c., lb. \$2.50.

**Long Island Flat Dutch.** A selected strain, superior for early or late planting, and well recommended for its exceptionally fine head, not exceedingly large, but very solid. It is a favorite and largely planted on Long Island by market gardeners. Per pkt. 10c., oz. 65c.,  $\frac{1}{4}$  lb. \$2.00, lb. \$8.00.

**Premium Flat Dutch.** An esteemed late Cabbage that is well suited for winter storing. Heads are hard, perfect in shape, and attain large size. Per pkt. 5c., oz. 20c.,  $\frac{1}{4}$  lb. 60c., lb. \$2.00.

**Succession.** In every respect a model variety. It may be planted at all seasons but will give best results when used as a second early or intermediate sort. A sure header, of medium size, and finest quality. Per pkt. 5c., oz. 30c.,  $\frac{1}{4}$  lb. \$1.00, lb. \$3.00.

**SAVOY CABBAGE**

**Early Dwarf Ulm Savoy.** An early, sure heading sort with solid heads of medium size but very sweet and tender. Per pkt. 5c., oz. 20c.,  $\frac{1}{4}$  lb. 60c., lb. \$2.00.

**American Drumhead Savoy.** One of the best Savoy Cabbages for general use with fine curled dark green leaves and large firm heads of good quality. Per pkt. 5c., oz. 25c.,  $\frac{1}{4}$  lb. 75c., lb. \$2.50.

**Perfection Drumhead Savoy.** Splendid for late planting. The heads are large, solid and keep well through winter. Per pkt. 5c., oz. 25c.,  $\frac{1}{4}$  lb. 75c., lb. \$2.50.

**Long Island Savoy.** The finest of all Savoy Cabbage. Highly esteemed for its round, deep, uniform heads which are very large, beautifully curled and unsurpassed in quality. An excellent keeper. Per pkt. 10c., oz. 65c.,  $\frac{1}{4}$  lb. \$2.00, lb. \$8.00.

Cabbage Plants, see page 33.

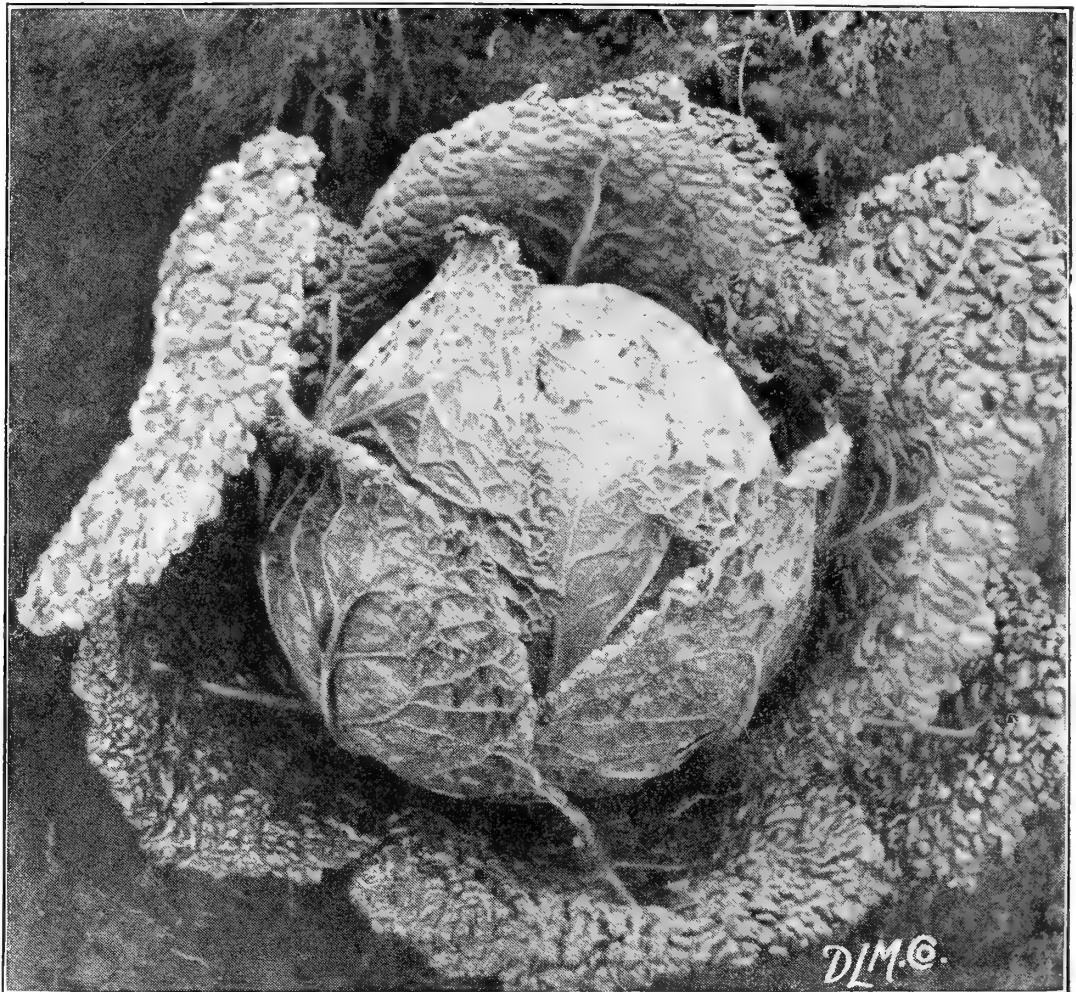

Cabbage, American Drumhead Savoy

**RED CABBAGE**

**Mammoth Rock Red.** An exceedingly fine strain, both for market or garden use, which may be depended upon to form solid heads equal to any for size and deep red color. Per pkt. 5c., oz. 30c.,  $\frac{1}{4}$  lb. \$1.00, lb. \$3.00.

**Large Red Drumhead.** A very good variety having round dark red heads, solid and excellent for pickling. Per pkt. 5c., oz. 25c.,  $\frac{1}{4}$  lb. 75c., lb. \$2.50.

**CAULIFLOWER** *One ounce for 2,000 plants.*

There is little difference regarding the cultural directions between the Cabbage and Cauliflower, only that the latter requires richer soil and more careful attention. When the heads begin to form it is necessary to tie the leaves loosely over the head to prevent bleaching.



Cauliflower, Erfurt Dwarf Earliest

**Erfurt Dwarf Earliest.** In this variety we offer a strain of Cauliflower of the highest quality and one that is certain to withstand the test of the most critical grower. It is not only superior for forcing but succeeds just as well in the open ground, and may be depended upon to form large, handsome, pure white heads of delicious flavor. Per pkt. 50c., oz. \$5.00.

**Early Snowball.** A sure header, somewhat earlier than the Extra Early Dwarf Erfurt; plants compact in growth with few small outer leaves, which allows close planting. Splendid for the private garden where space is often limited. Per pkt. 25c., oz. \$2.50.

**Extra Early Dwarf Erfurt.** An early well known favorite, especially recommended to all desiring a Cauliflower of medium, uniform size. Per pkt. 25c., oz. \$2.50.

**COLLARDS**

*One ounce for 3,000 Plants.*

A variety of Cabbage forming only a mass of leaves instead of a solid head, but which is esteemed most highly and extensively grown in the South. Sow seed about the same as Cabbage and later transplant one foot apart in rows two and a half feet apart. Sowings are made in the South from January to May and again in early fall.

**True Georgia** (Southern Creole). Vigorous and productive, growing from four to six feet high. Per pkt. 5c., oz. 10c.,  $\frac{1}{4}$  lb. 30c., lb. \$1.00.

## CARROT

One ounce to  
100 feet of row.

A light, loamy soil that has been well manured the previous year is preferred for growing Carrots, although good crops may also be obtained from ordinary garden soil. For early use seed may be sown in hotbeds from January until March, and in the open ground as soon as the weather becomes warm and settled, usually in April. Sow seed one-half inch deep in rows fifteen inches apart, and later thin to five inches in the row. Keep soil between the rows well hoed and free from weeds. From July 1st to 15th sow for winter crops.

**Parisian Forcing.** Extremely early, of small size but very sweet, tender and beautiful orange red color. Per pkt. 5c., oz. 15c.,  $\frac{1}{4}$  lb. 40c., lb. \$1.25.

**Chantenay.** An ideal, medium early, stump-rooted Carrot; smooth and uniform in shape, averaging five inches in length with thick heavy shoulders, rather large tops and deep orange color. Per pkt. 5c., oz. 10c.,  $\frac{1}{4}$  lb. 25c., lb. 75c.

**Danvers Half-Long (Stump-Rooted).** Owing to its enormous yield, this variety is the best and most profitable for main crop, and especially desirable for feeding cattle. It is somewhat longer, thicker and a better keeper than the Chantenay. Per pkt. 5c., oz. 10c.,  $\frac{1}{4}$  lb. 25c., lb. 75c.

**Guerande, or Oxheart.** A short, thick Carrot not exceeding four inches in length and about the same in width which does quite well on hard, heavy soils where the longer varieties are useless. Per pkt. 5c., oz. 10c.,  $\frac{1}{4}$  lb. 25c., lb. 75c.

**Half-Long Nantes (Stump-Rooted).** This favorite first early sort has a rich reddish color, is equal to any in sweetness and one we recommend for the home garden. Per pkt. 5c., oz. 10c.,  $\frac{1}{4}$  lb. 25c., lb. 75c.

**Improved Danvers Half-Long.** An improved type of the Danvers Half-Long. The roots are smooth, bright orange and of handsome appearance. Per pkt. 5c., oz. 10c.,  $\frac{1}{4}$  lb. 30c., lb. 90c.



Carrots, Chantenay

**Intermediate (St. Valery).** Matures earlier than Long Orange Improved; has shorter and broader roots which gradually taper to a point. Per Pkt. 5c., oz. 10c.,  $\frac{1}{4}$  lb. 25c., lb. 75c.

**Long Orange Improved.** The longest and latest of all Carrots; unsurpassed for its keeping qualities. Per pkt. 5c., oz. 10c.,  $\frac{1}{4}$  lb. 25c., lb. 75c.

**New York Market.** It is stump-rooted, about six inches long and very productive. Per pkt. 5c., oz. 10c.,  $\frac{1}{4}$  lb. 30c., lb. 90c.

**Rubicon.** Similar to the above in shape, with medium size tops and of the finest quality. Per pkt. 5c., oz. 10c.,  $\frac{1}{4}$  lb. 30c., lb. 90c.

## CARDOON

An esteemed celery-like vegetable, the stalks of which are blanched and used for flavoring soups or stews. Sow during April or May in drills 12 inches apart, later thinning to 6 inches in the row. Leave roots in ground until following spring, then transplant into trenches two and a half feet apart and one foot in the row, where they remain for several years.

**Large Solid.** Grows about three and a half feet high. Per pkt. 5c., oz. 25c.,  $\frac{1}{4}$  lb. 75c., lb. \$2.50.

## CELERY

One ounce will produce  
5,000 plants.

During April or May sow seed  $\frac{1}{4}$  inch deep in drills either in the open ground or cold frame, keeping the soil well moist until seed germinates. When the plants are about two inches high thinning out is necessary and then after attaining a height of five inches they are ready to be transplanted, usually in July, to final beds of very rich soil. Set plants every six inches in rows three feet apart. Keep space between rows cultivated and free from weeds. For early use begin blanching in September by drawing up the soil to within a few inches of the top and firm well around the plants. Select every other row for early use, thus giving the remaining Celery more room for late blanching.

**Golden Self-Blanching.** This early self-bleaching Celery compares with any in quality and with little banking the handsome solid stalks as well as the heart become a rich golden yellow. Pkt. 10c., oz. 60c.,  $\frac{1}{4}$  lb. \$2.00, lb. \$6.00.

**Golden Rose.** There is little difference between this and the preceding, but the golden stalks are slightly tinted with rose. Per pkt. 10c., oz. 30c.,  $\frac{1}{4}$  lb. 85c., lb. \$3.00.

**Evans' Triumph.** One of the best late sorts, growing rather large but uniform in size; the inner stalks blanch white. Per pkt. 5c., oz. 20c.,  $\frac{1}{4}$  lb. 60c., lb. \$2.00.

**French's Success.** An addition to the green Celery, of compact growth, possessing the finest flavor and recommended for its keeping qualities. Per pkt. 5c., oz. 30c.,  $\frac{1}{4}$  lb. \$1.00, lb. \$3.00.

**Schumacher.** A reliable variety with comparatively large stalks, solid but crisp and tender. Per pkt. 5c., oz. 20c.,  $\frac{1}{4}$  lb. 60c., lb. \$2.00.

**Kalamazoo.** It is of dwarf, compact growth, deep green color, but blanches readily and stands shipping well. Per pkt. 5c., oz. 20c.,  $\frac{1}{4}$  lb. 60c., lb. \$2.00.

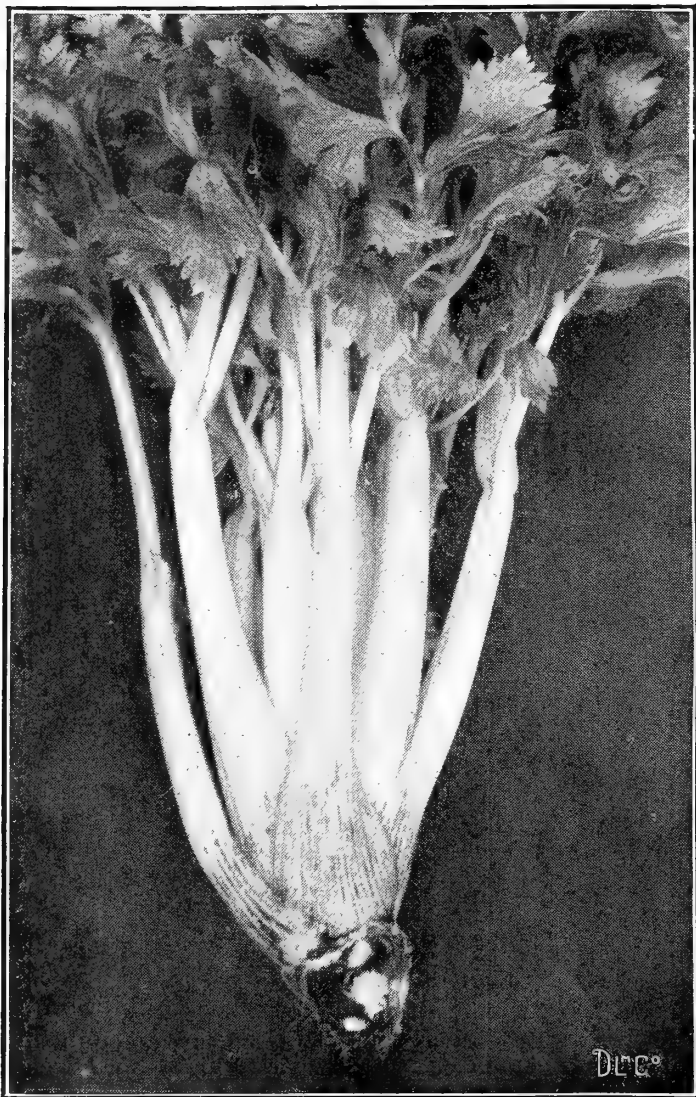

Celery, Golden Self-Blanching

## CELERIAC, Or Turnip-Rooted Celery

This vegetable is grown principally for its bulb-like roots, the flavor of which is highly esteemed in soups and stews. For early use first sowings are made in frames the beginning of March but outdoor sowings during April and May are recommended if roots are desired for winter. Like Celery, sow seed  $\frac{1}{4}$  inch deep in drills 10 inches apart and when plants are stocky transplant to beds of rich deep soil, 6 inches apart in rows  $1\frac{1}{4}$  feet apart. Cultivate thoroughly and remove but little of the greens until the bulb is of good size.

**Large Smooth Prague.** The finest of all Celeriac. Roots measure from 2 to 4 inches in diameter, round, smooth and comparatively few side roots. Pkt. 5c., oz. 20c.,  $\frac{1}{4}$  lb. 60c., lb. \$2.00.

Plants, see page 33.

## CHERVIL

The Chervil resembles the Parsley and is highly esteemed for flavoring and garnishing dishes of meats and vegetables. Seed may be sown early in spring, but when the plants are quite large they should be transplanted about 10 inches apart.

**Curled.** The leaves when young are superior to parsley and prized for their delicious flavor. Per pkt 5c., oz. 10c.,  $\frac{1}{4}$  lb. 30c., lb. \$1.00.

## CHICORY

The seed may be sown in drills 1 foot apart as early in the spring as the ground can be worked. When the plants are 3 to 4 inches high they should be thinned out so that each plant stands 5 inches apart.

**Witloof.** The leaves are generally blanched, and in this way make an excellent salad. Per pkt. 5c., oz. 10c.,  $\frac{1}{4}$  lb. 30c., lb. \$1.00.

## CHIVES

The green tops which have a peculiar onion-like flavor are used for salads and also in soup. Plants are perfectly hardy, Per pkt. 10c.

## CELERY--Continued

**Boston Market.** Distinct from all other varieties. Plants grow very bushy with innumerable side shoots, which form many small instead of one large head. Withstands continuous cutting and like the Soup or Cutting is excellent for soup greens. Per Pkt. 5c., oz. 20c.,  $\frac{1}{4}$  lb. 60c., lb. \$2.00.

**Columbia.** Words of highest praise have been received from growers of this new Celery. Stalks thick and stocky, well shaped and when blanched resemble the Golden Self-Blanching, Pkt. 10c., oz. 40c.,  $\frac{1}{4}$  lb. \$1.25, lb. \$4.00.

**Dwarf Golden Heart.** Fine for market or garden, excellent keeper, very solid, and the heart is a golden yellow when blanched. Per pkt. 5c., oz. 20c.,  $\frac{1}{4}$  lb. 60c., lb. \$2.00.

**Fin de Siecle.** Grows to a large size and will keep solid and crisp throughout the winter. Per pkt. 5c., oz. 20c.,  $\frac{1}{4}$  lb. 60c., lb. \$2.00.

**Giant Pascal.** A most desirable early winter variety having broad stringless stalks which blanch quickly to a beautiful creamy white. Per pkt. 5c., oz., 20c.,  $\frac{1}{4}$  lb. 60c., lb. \$2.00.

**Perfection Heartwell.** An excellent Celery of rather tall growth with a golden yellow heart, and round thick stalks of the finest flavor. Per pkt. 5c., oz. 20c.,  $\frac{1}{4}$  lb. 60c., lb. \$2.00.

**Soup, or Cutting Celery.** This variety is adapted to sowing thick in rows and cutting when three or four inches high, to use for soup flavoring. It can be cut repeatedly and will furnish a succession throughout the season. Per pkt. 5c., oz. 15c.,  $\frac{1}{4}$  lb. 40c., lb. \$1.25.

**White Plume.** A variety especially adapted to cultivation by amateurs, as its inner stalks and leaves are naturally white, and do not require blanching by the old process of high banking. By simply tying up the stalks and drawing up the soil with the hoe, the work of blanching is complete. It is tender, crisp and of good flavor. Per pkt. 5c., oz. 25c.,  $\frac{1}{4}$  lb. 75c., lb. \$2.50.

**Winter Queen.** As a winter keeping Celery there are few that can compare with this superior variety. It is not only noted for its good keeping qualities, but also for the thick, heavy stalks, almost all heart, which blanch to a creamy white and possess that rich nutty flavor so much desired in Celery. Per pkt. 5c., oz. 20c.,  $\frac{1}{4}$  lb. 60c., lb. \$2.00.

Plants, see page 33.

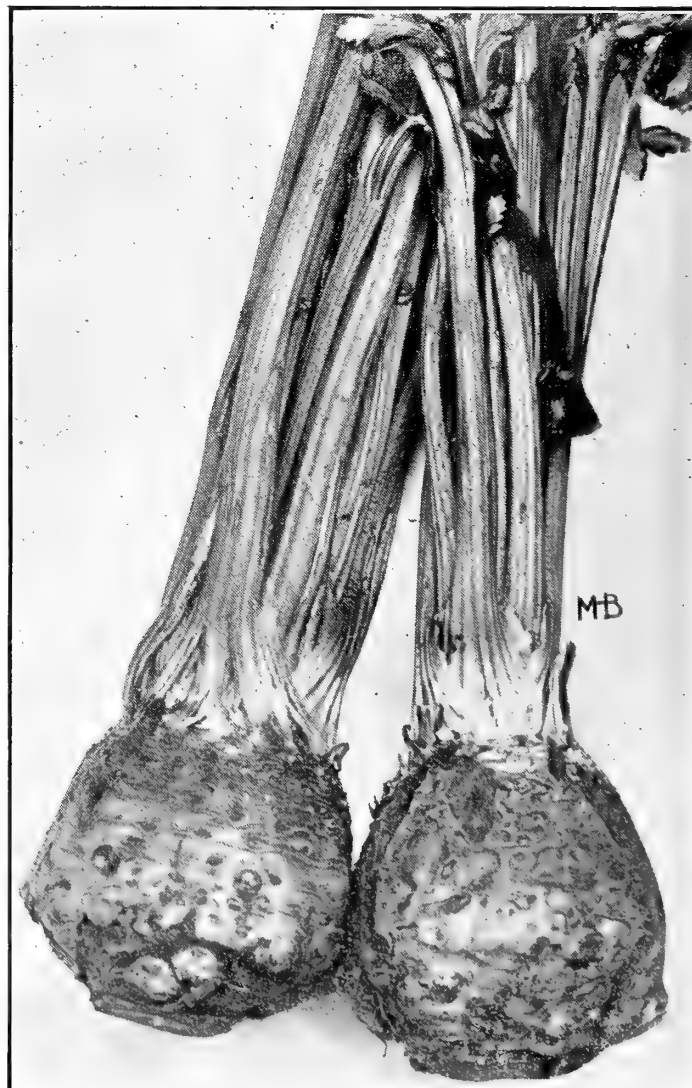

Celeriac, Large Smooth Prague

# CORN, SWEET OR SUGAR

A deep, rich soil is best adapted to growing Corn. As it is quite sensitive to cold, planting should be withheld until the ground becomes warm and mellow, usually early in May. Plant in hills from 2 to 3 feet apart according to the variety, dropping about 5 kernels in each, and cover one inch; later thin to 3 plants to a hill. Cultivate thoroughly between the rows and keep the soil hoed well up to the plants. For a continuous supply during the season, plantings should be made every few weeks until the latter part of July.

Add 5c. per pint, 10c. per quart, if to be sent by mail.

*One quart will plant 200 hills; 8 quarts for one acre in hills.*

**Country Gentleman.** Quite late in ripening. The long, deep grained kernels, formed irregularly on the small white cobs, are the sweetest of any variety in cultivation. Per pt. 15c., qt. 25c., pk. \$1.50.

**Early Champion.** One of the best medium early varieties. Ears are large, well formed with clear white, sweet kernels and can be highly recommended for the market or garden. Per pt. 15c., qt. 25c., pk. \$1.50.

**Early Evergreen.** From a week to 10 days earlier than Stowell's Evergreen, with somewhat shorter ears but otherwise possessing all the good qualities of that famous corn. Per pt. 15c., qt. 25c., pk. \$1.50.

**Early Mammoth.** A popular sugar corn of great merit; earlier than the late Mammoth, and far better adapted for the private garden. The ears, of fine quality, are long but not very thick. Per pt. 15c., qt. 25c., pk. \$1.50.

**Golden Bantam.** May be planted at least a week earlier and will mature before most all other sweet corn. The stalks grow about 4 feet high, each producing 2 or more ears measuring from 5 to 7 inches in length. When ready for use the kernels are bright golden yellow, deliciously sweet, richly flavored, and remain tender for some time after ripening. Per pt. 15c., qt. 25c., pk. \$1.50.

**Kendel's Early Giant.** A valuable early sweet corn. The ears grow to a tremendous size, measuring 8 to 10 inches long, and having 10 to 14 rows on each cob, the majority having 12 rows; kernels pure white, sweet, tender. Per pt. 15c., qt. 25c., pk. \$1.50.

**Long Island Beauty.** This variety is considered by many as the best of the second early sorts. The ears, of excellent quality, are shorter but thicker than Early Mammoth and ripen about a week earlier. Per pt. 15c., qt. 25c., pk. \$1.50.

**Mammoth White Cory.** An extra large corn, considering its extreme earliness. The stalks generally grow 4 feet high, each one usually bearing 2 ears of good quality. Per pt. 15c., qt. 25c., pk. \$1.50.

**Mammoth Late.** Mainly planted by market gardeners. The stalks grow very high and bear the largest ears of any sweet corn. Per pt. 15c., qt. 25c., pk. \$1.50.

**Metropolitan.** A remarkably fine, vigorous growing sort with good-sized ears, maturing shortly after Mammoth White Cory. Per pt. 15c., qt. 25c., pk. \$1.50.

**Peep-O'-Day.** Of dwarf, compact habit, very early, immensely productive, and withstands close planting. Ears of medium size, sweet and tender. Per pt. 15c., qt. 25c., pk. \$1.50.

**Perry's Hybrid.** Popular among the market gardeners as an intermediate sort. A fine corn for the table, with ears of good length, very sweet, and maturing after the smaller eared varieties. Per pt. 15c., qt. 25c., pk. \$1.50.

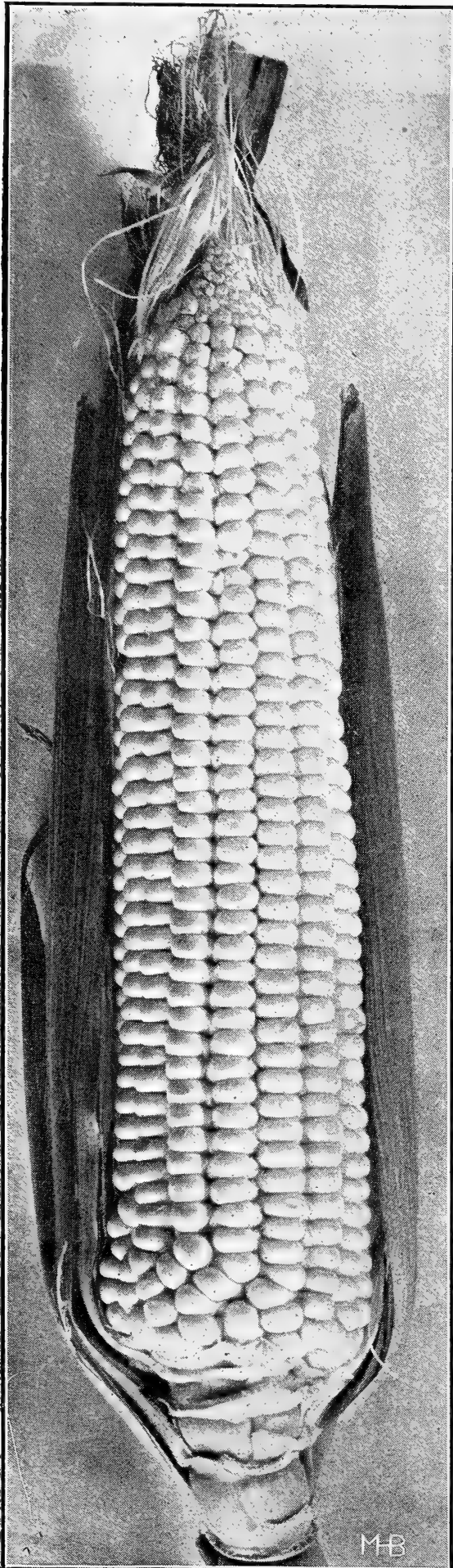

Corn, Long Island Beauty

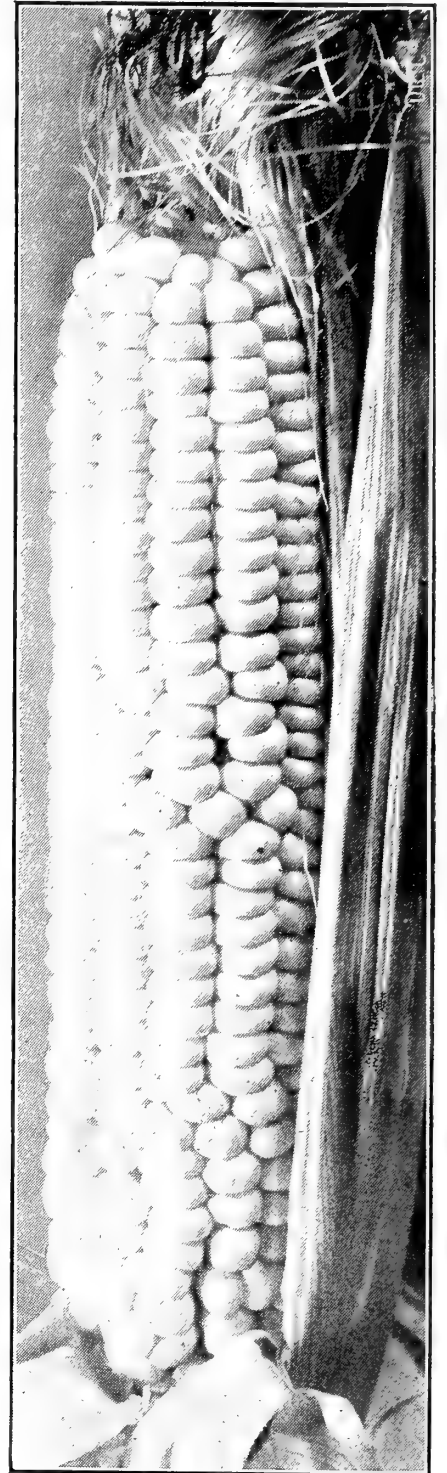

Corn, Mammoth White Cory

Packets of all Varieties of Sweet Corn, 10c. each, Postpaid

CORN, SWEET OR SUGAR—Continued

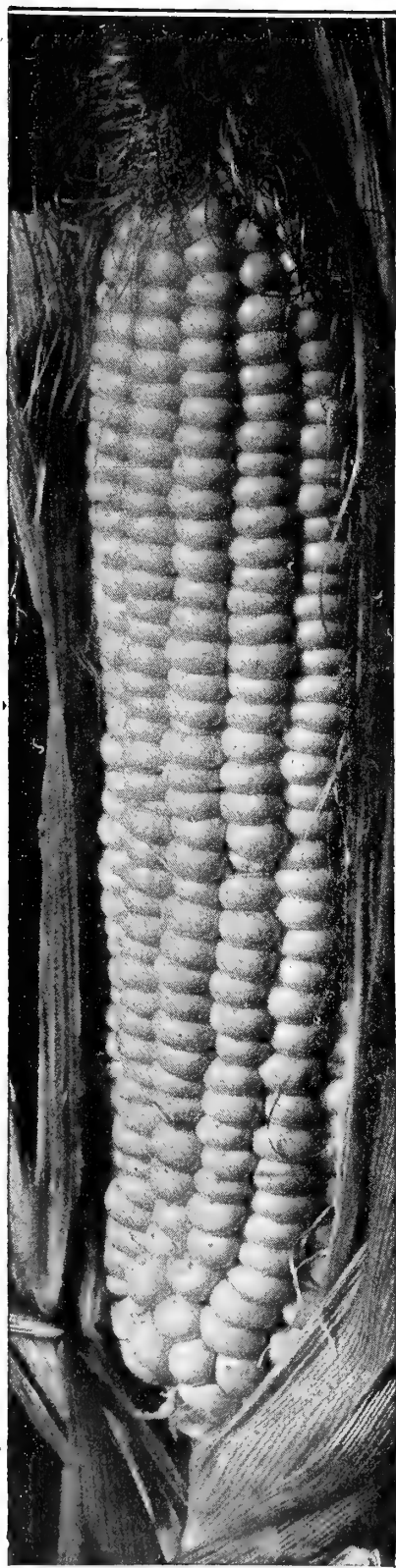

Corn, Stowell's Evergreen

**Potter's Excelsior (Squantum).** The ears of this grand sugar corn are large and well filled with 12 rows of deep, snowy white kernels. Its sweetness and delicious flavor afford it a place with the best garden varieties. Per pt. 15c., qt. 25c., pk. \$1.50.

**Premo.** As an early variety (and there are many of them) few surpass this one for the home table. Although of rapid growth, ripening in about 60 days, the ears are extra large and of fine quality. Per pt. 15c., qt. 25c., pk. \$1.50.

**Red Cob Cory.** Resembles the Mammoth White Cory, but matures a trifle earlier and has red cobs. Per pt. 15c., qt. 25c., pk. \$1.50.

**Stowell's Evergreen.** The well known late sort and one of the best and most largely planted for general use. The large, thick ears are well filled to the end and remain in condition for cooking longer than most varieties. Per pt. 15c., qt. 25c., pk. \$1.50.

**White Evergreen.** This may readily be called a White Stowell's Evergreen. Though similar to that variety in size, it is ready for picking a few days earlier, while its most valuable feature lies in the pure whiteness of the long, slender grains. Per pt. 15c., qt. 25c., pk. \$1.50.

**White Pop Corn.** (Ears.) Per lb. 10c., 100 lbs. \$8.00.

**Sweet Fodder Corn.** Per pk. \$1.00, bush. \$3.00.

FIELD CORN, See page 34

## CRESS, or Peppergrass

*One ounce will sow 150 ft. of drill*

The seed should be sown early in the spring on rich ground, quite thickly, in shallow drills, about 1 foot apart. For succession sow every 10 days, as it soon runs to seed.

**Extra Curled.** The leaves, which have a peculiar taste, are used as a salad. Per pkt. 5c., oz. 10c., ¼ lb. 20c., lb. 60c.

## WATER-CRESS

Requires a moist situation, or, better still, a running stream where seed may be sown along the banks in spring. It can be cut the second year.

**Common.** Per pkt. 10c., oz. 30c., ¼ lb. \$1.00.

**True Erfurt.** Superior to the above and of a milder flavor. Per pkt. 10c., oz. 40c., ¼ lb. \$1.25.

## CORN SALAD, or Fetticus

*One ounce will sow 75 ft. of drill*

This small green salad may be had all through the winter months providing same is given a slight covering of coarse litter or straw. Seed should be sown quite thickly, in August and September, in drills 10 inches apart.

**Large Seeded.** The best variety. Per pkt. 5c., oz. 10c., ¼ lb. 25c., lb. 65c.

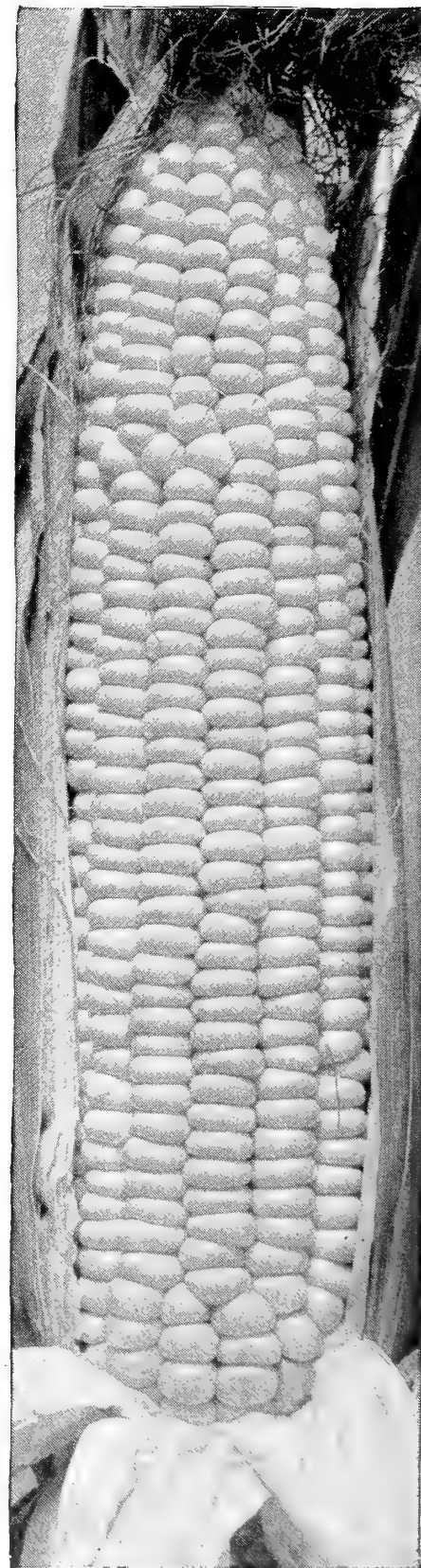

Corn, Potter's Excelsior

Rely upon us for your seeds and you will be satisfied.



Corn Salad, Large Seeded

## CABBAGE

Long Island Flat Dutch  
and  
Long Island Savoy  
head the list in their  
respective classes.



Cucumber

## CUCUMBER

One ounce will  
plant 50 hills.

After danger from frost is over, usually early in May, sow seed one-half inch deep in hills not less than four feet apart, dropping about twelve seeds in each hill. Later, when plants are well started, thin out, leaving only five or six of the strongest to every hill. A rich soil that has been well manured is most profitable for Cucumbers. Sow seed for pickles from June to July.

**Bennett's White Spine.** A superior strain well recommended for table use. Fruits are uniform in shape, rich green color and particularly fine in quality. Per pkt. 5c., oz. 10c.,  $\frac{1}{4}$  lb. 30c., lb. \$1.00.

**Cool and Crisp.** An excellent Cucumber for slicing, but when small is equally good for pickling. Flesh pure white, tender and crisp. Per pkt. 5c., oz. 10c.,  $\frac{1}{4}$  lb. 30c., lb. \$1.00.

**Cumberland.** The fruits although long and slender are uniformly straight, skin dark green, with many small white spines. Suitable for pickles or slicing. Per pkt. 5c., oz. 10c.,  $\frac{1}{4}$  lb. 30c., lb. \$1.00.

**Davis Perfect.** A type of white spine which is certain to meet with favor either for forcing or open ground culture. It is a handsome, extra long Cucumber, delightfully flavored, and retains its deep glossy green color until near maturity. Per pkt. 5c., oz. 15c.,  $\frac{1}{4}$  lb. 40c., lb. \$1.50.

**Early White Spine.** For general crop this variety may well be relied upon both for quantity and quality. Medium size, beautiful color and keeps in good condition long after pickling. Per pkt. 5c., oz. 10c.,  $\frac{1}{4}$  lb. 30c., lb. \$1.00.

**Evergreen White Spine.** Matures somewhat later than the Early White Spine, but exceeds it in length; equally productive and darker in color. Per pkt. 5c., oz. 10c.,  $\frac{1}{4}$  lb. 30c., lb. \$1.00.

**Green Prolific, or Boston Pickling.** Fruits are small, bright green, very smooth and yield an unusually large number of pickles to the acre. Per pkt. 5c., oz. 10c.,  $\frac{1}{4}$  lb. 30c., lb. \$1.00.

**Improved Long Green.** Grows from ten to twelve inches long, thick, dark green and one of the best flavored. At maturity the fruits become rich yellow and are then esteemed for making mustard cucumbers. Per pkt. 5c., oz. 10c.,  $\frac{1}{4}$  lb. 30c., lb. \$1.00.

**Japanese Climbing.** A distinct variety which may be trained to a pole or trellis and bearing throughout the summer extra long, smooth, well flavored Cucumbers. Per pkt. 5c., oz. 15c.,  $\frac{1}{4}$  lb. 35c., lb. \$1.25.

**West India Gherkin.** The smallest of all, not exceeding two inches in length, oval shaped, prickly and very tender when young. Used only for pickling. Per pkt. 5c., oz. 15c.,  $\frac{1}{4}$  lb. 35c., lb. \$1.25.

## ENGLISH FORCING CUCUMBERS

**Lockies' Perfection**, per pkt. 25c.; **Duke of Edinburgh**, per pkt. 25c.; **Rollison's Telegraph**, per pkt. 25c.

## DANDELION

One ounce will sow  
100 feet of drill.

This is one of the earliest spring vegetables. When small the leaves are very tender and esteemed for making salad. Sow the seed in spring when soil has become warm in rows twelve inches apart and one quarter inch deep. It remains over winter and is ready for cutting the following spring.

**French (Common).** Per pkt. 5c., oz. 20c.,  $\frac{1}{4}$  lb. 50c., lb. \$1.75.

## DILL

From May 15th to June 15th sow seed one-half inch deep in drills one and one-half feet apart. Unless the plants stand very thick, it is not necessary to thin out, but keep soil cultivated and free from weeds.

**Common.** Of dwarf growth and highly esteemed as a flavor for pickles. Per pkt. 5c., oz. 10c.,  $\frac{1}{4}$  lb. 25c., lb. 75c.

**Mammoth.** A large, vigorous growing sort attaining a height of four to five feet. Per pkt. 10c., oz. 20c.,  $\frac{1}{4}$  lb. 60c., lb. \$2.00.

## EGG PLANT

One ounce will produce  
1,000 plants.

As the seed germinates slowly, sow during February and early March in a hotbed or greenhouse. Plants are very sensitive and should be protected even from a slight frost. Transplant to the open ground in early June, setting plants two and a half feet apart each way.

**New York Improved Purple.** Large, handsome, spineless fruits possessing a rich purple color. Plants usually yield six fruits. Per pkt. 10c., oz. 50c.,  $\frac{1}{4}$  lb. \$1.50, lb. \$5.50.

For Plants, see page 33.



Egg Plant, New York Improved Purple

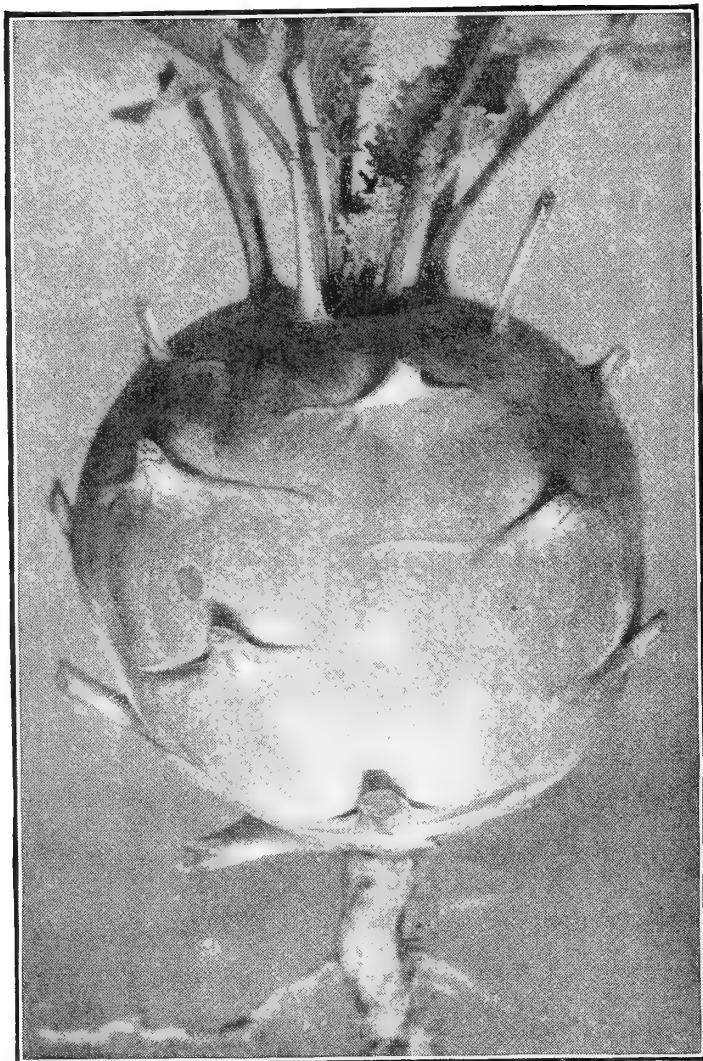

Kohl-Rabi

## KALE OR BORECOLE One ounce will produce 3,000 plants.

This vegetable may be had almost at all seasons of the year, but it does not reach perfection until the winter months. For summer use sowings are made in April, while for winter greens June is the best month. Sow in drills one quarter inch deep, and later reset plants two feet apart each way.

**Dwarf Green Curled Scotch.** Noted for its extreme hardiness, dwarf, compact habit and extra fine curled leaves. Per pkt. 5c., oz. 10c.,  $\frac{1}{4}$  lb. 25c., lb. 80c.

**Tall Green Curled Scotch.** Heads are formed on stalks two and a half feet high; color bright green and leaves exceedingly curly. Per pkt. 5c., oz. 10c.,  $\frac{1}{4}$  lb. 25c., lb. 75c.

**Dwarf Brown.** Similar in growth to the Dwarf Green Curled Scotch. The leaves are purple in color, tender and preferred by many to that variety. Per pkt. 5c., oz. 15c.,  $\frac{1}{4}$  lb. 30c., lb. \$1.00.

**Siberian, or Sprouts.** This variety is sown during August in drills one foot apart, where it remains until the following spring. Per pkt. 5c., oz. 10c.,  $\frac{1}{4}$  lb. 25c., lb. 80c.

## KOHL RABI One ounce will sow 200 feet of drill.

The bulb-like portion of this vegetable is of delicate flavor, especially when small, and cooked similar to white turnips. For early use sow seed outdoors during April and from then on for succession in drills fifteen inches apart; later thin out to six inches in the row.

**Early White Vienna (Frames).** A short-leaved variety which succeeds well in frames but may also be sown in the open ground. Per pkt. 5c., oz. 30c.,  $\frac{1}{4}$  lb. \$1.00, lb. \$3.00.

**Early Purple Vienna.** Leaves and bulbs are rich purple in color but the flesh is tender and of fine quality. Per pkt. 5c., oz. 30c.,  $\frac{1}{4}$  lb. \$1.00, lb. \$3.00.

**Early White Vienna.** Excellent for sowing outside. The leaves grow somewhat larger than the Early White Vienna for frames. Per pkt. 5c., oz. 30c.,  $\frac{1}{4}$  lb. \$1.00, lb. \$3.00.

Kohl Rabi Plants, see page 33.

## ENDIVE

*One ounce will sow 200 feet of drill.*

Sow seed one-half inch deep in rows twelve inches apart from May 15th until the middle of August. After the plants are well advanced they should be transplanted in rows fifteen inches apart and twelve inches apart in the row, thus securing larger heads than if only thinned out. When nearly full grown draw the leaves together and tie at the top to blanch the heart.

**Large Green Curled (Chicory).** Leaves are quite broad, beautifully curled, deeply lacinated and form large flat heads which bleach readily to a creamy white. Per pkt. 5c., oz. 15c.,  $\frac{1}{4}$  lb. 40c., lb. \$1.50.

**White Curled.** An ideal variety for the private garden. Leaves very tender, especially striking in appearance and bleach somewhat easier than the above. Per pkt. 5c., oz. 15c.,  $\frac{1}{4}$  lb. 40c., lb. \$1.50.

**Broad-Leaved Batavian (Escarolle.)** An excellent strain with thick, broad leaves, slightly curled, bright green at first but when blanched the heart becomes white and crisp. Per pkt. 5c., oz. 15c.,  $\frac{1}{4}$  lb. 40c., lb. \$1.50.

## FENNEL

For succession sow from June 15th to July 15th in rows one and a half to two feet apart, and later thin out to five inches in the row. Earlier sowings frequently run to seed.

**Florence, or Naples.** Grows about two feet high, forming an oval-shaped bulb just above the ground. Has a peculiar, still very sweet, Celery-like taste. Per pkt. 5c., oz. 15c.,  $\frac{1}{4}$  lb. 35c., lb. \$1.10.

## GARLIC

*One pound will plant 10 feet of drill.*

Plant sets every four inches in rows ten inches apart. After the tops turn yellow gather the bulbs and store in a dry place like onions.

**Garlic Sets.** Per lb. 30c.

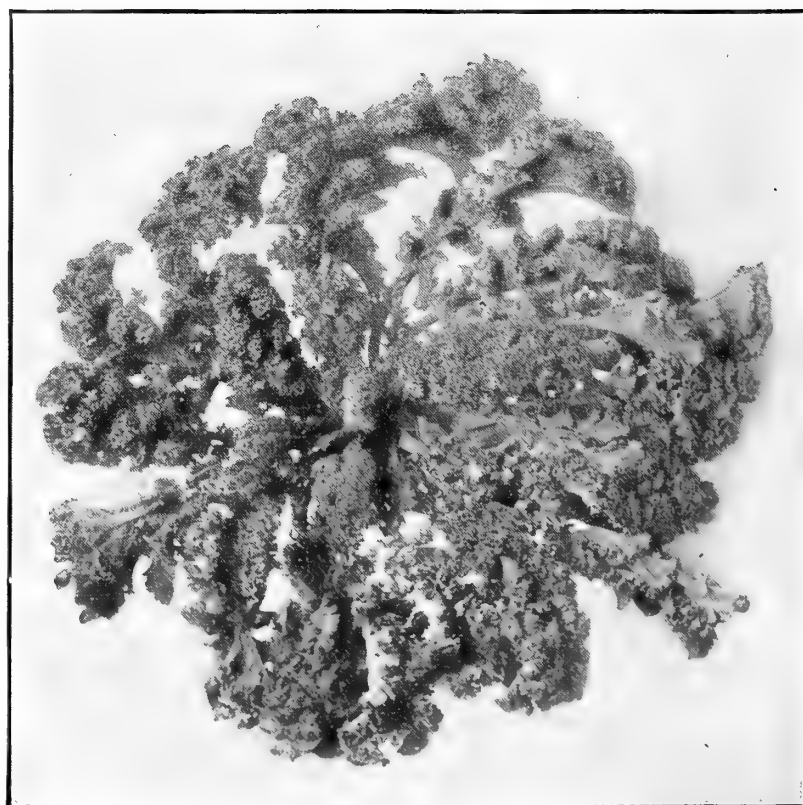

Kale, Dwarf Green Curled Scotch



# LETTUCE

One ounce will sow  
200 feet of drill

Early Lettuce may be had by sowing seed in hotbeds during February or March and transplanting to the open ground in May. Seed is sown outdoors from April to August in drills 12 inches apart and later thinned out to ten inches in the row. Select a rich moist soil if possible, as the quality of Lettuce depends largely upon how quickly it grows.

**All Seasons.** Well adapted for growing in summer for which it is principally used. Globular shaped, well blanching heads which stand long before running to seed. Per pkt. 5c., oz. 15c.,  $\frac{1}{4}$  lb. 40c., lb. \$1.25.

**Big Boston.** A favorite with market gardeners for early spring and fall sowing. The large-sized heads are light green in color slightly tinged with brown. Per pkt. 5c., oz. 20c.,  $\frac{1}{4}$  lb. 50c., lb. \$1.50.

**Black Seeded Simpson.** The plants form a mass of long leaves, exceedingly tender and crisp, light green shading almost white. Fine for summer use. Per pkt. 5c., oz. 15c.,  $\frac{1}{4}$  lb. 40c., lb. \$1.25.

**Boston Market** (White Seeded Tennisball). An early, medium-sized Lettuce suited to growing in frames and also for forcing. Per pkt. 5c., oz. 15c.,  $\frac{1}{4}$  lb. 40c., lb. \$1.25.

**Brown Dutch.** Well adapted to Southern culture, especially in the fall months when it may be treated as a winter Lettuce. Pkt. 5c., oz. 15c.,  $\frac{1}{4}$  lb. 40c., lb. \$1.25.

**California Cream Butter.** Its soft, thick leaves form large, globular shaped heads of a rich cream yellow, very solid and sweet buttery flavor. Per pkt. 5c., oz. 15c.,  $\frac{1}{4}$  lb. 40c., lb. \$1.25.

**Deacon.** A fine summer variety of easy culture, not extra large but has a well blanching, golden heart of excellent quality. Pkt. 5c., oz. 15c.,  $\frac{1}{4}$  lb. 40c., lb. \$1.25.

**Defiance.** A firm heading Lettuce of medium size, good quality and stands long before going to seed. Per pkt. 5c., oz. 15c.,  $\frac{1}{4}$  lb. 40c., lb. \$1.25.

**Early Curled Simpson.** It is not only very early but one of the best of the loose leaf varieties. Its bright green, curly leaves are exceedingly tender and possess a rich, delicate flavor. Per pkt. 5c., oz. 15c.,  $\frac{1}{4}$  lb. 40c., lb. \$1.25.

**Golden Queen.** Splendid for early spring or fall sowing but not suitable for summer. Small, hard, compact heads, of very light green color and buttery flavor. Per pkt. 5c., oz. 15c.,  $\frac{1}{4}$  lb. 40c., lb. \$1.25.

**Grand Rapids.** A non-heading sort used extensively for growing in hothouses, where it matures quickly. Per pkt. 5c., oz. 15c.,  $\frac{1}{4}$  lb. 40c., lb. \$1.25.



Lettuce, Big Boston

**Hanson.** Succeeds in almost any soil and forms large solid heads, somewhat crumpled, at all seasons of the year. Recommended for private gardens. Pkt. 5c., oz. 15c.,  $\frac{1}{4}$  lb. 40c., lb. \$1.25.

**Hubbard's Market.** A large, cabbage-heading Lettuce grown in all sections and at all seasons. The soft, light green leaves are broad, thick and never brownish in any part. Pkt. 5c., oz. 15c.,  $\frac{1}{4}$  lb. 40c., lb. \$1.25.

**Iceberg.** The leaves of this lettuce are beautifully curled at the edges, crisp, brittle and of a bright green color. Very solid, well blanching heads. Per pkt. 5c., oz. 15c.,  $\frac{1}{4}$  lb. 40c., lb. \$1.25.

**Long Island Winter.** Owing to its extreme hardiness it is best adapted to growing in cold frames during the winter, but may also be planted outdoors in early spring. Per pkt. 5c., oz. 20c.,  $\frac{1}{4}$  lb. 60c., lb. \$2.00.

**Mammoth Black Seeded Butter.** The immense-sized heads present an attractive appearance, while in quality it compares with any. Per pkt. 5c., oz. 20c.,  $\frac{1}{4}$  lb. 50c., lb. \$1.50.

**Market Gardener's Private Stock.** An excellent summer Lettuce, the heart of which is well blanching, very tender and crisp. Per pkt. 5c., oz. 15c.,  $\frac{1}{4}$  lb. 40c., lb. \$1.25.

**Maximum, or Immensity.** This handsome, mammoth headed sort is gradually coming into favor both for summer and fall planting. It is similar to California Cream Butter in shape and color but of much larger size. Per pkt. 5c., oz. 20c.,  $\frac{1}{4}$  lb. 40c., lb. \$1.25.

**May King.** One of the leading varieties for forcing or early outdoor planting. It is of quick growth, fine flavored and little affected by unfavorable weather. Per pkt. 5c., oz. 20c.,  $\frac{1}{4}$  lb. 50c., lb. \$1.50.

**New York, or Wonderful.** The broad, dark green leaves are beautifully curled and fringed at the edges, while the heads are large, solid and very tender. Per pkt. 5c., oz. 15c.,  $\frac{1}{4}$  lb. 40c., lb. \$1.25.

**Prizehead.** For those who prefer a leaf Lettuce, Prizehead will be found a most reliable variety. Leaves large and spreading, somewhat ruffled and exceptionally tender. Easily grown. Per pkt. 5c., oz. 15c.,  $\frac{1}{4}$  lb. 40c., lb. \$1.25.

**Salamander.** A superb and undoubtedly the most popular of all summer Lettuce. Heads are well formed, compact, light green in color and unsurpassed in quality. Per pkt. 5c., oz. 15c.,  $\frac{1}{4}$  lb. 40c., lb. \$1.25.



Lettuce, California Cream Butter

## LETTUCE—Continued

**Tennisball Black Seeded.** Comparatively few possess the good qualities of this sort, which may be planted at all seasons, but is especially desirable during the warm weather. Heart blanches readily and has a rich buttery flavor. Per pkt. 5c., oz. 15c.,  $\frac{1}{4}$  lb. 40c., lb. \$1.25.

**Unrivalled.** Similar in almost every way to Big Boston, except that the color is solid green without any tinge of brown whatever. Per pkt. 5c., oz. 20c.,  $\frac{1}{4}$  lb. 50c., lb. \$1.50.

**Yellow Seeded Butter.** An ideal Lettuce for the home garden. The leaves tightly overlap each other, forming a solid head which is tender, crisp and of excellent quality. Per pkt. 5c., oz. 15c.,  $\frac{1}{4}$  lb. 40c., lb. \$1.25.

**Lettuce Plants.** See page 33.

## ROMAINE OR COS VARIETIES

**Eclipse Cos.** Dwarf in growth and matures very early. Leaves grow upright, are crisp and very tender. Per pkt. 5c., oz. 20c.,  $\frac{1}{4}$  lb. 50c., lb. \$1.50.

**Mammoth White Cos.** Forms very large oblong heads well rounded at the top, light green in color and of excellent quality. Per pkt. 5c., oz. 20c.,  $\frac{1}{4}$  lb. 50c., lb. \$1.50.

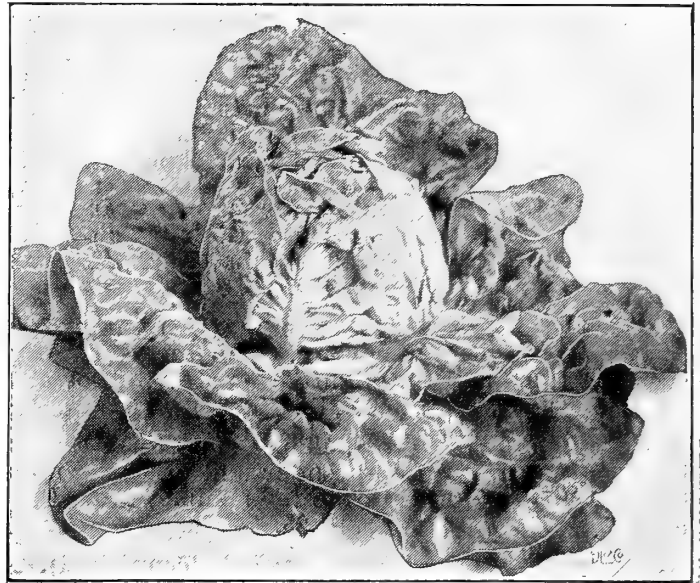

Lettuce, Maximum

**Paris White Cos.** This variety is becoming more popular every year. The outer leaves are dark green, while the inner ones closely overlap each other, forming a handsome, well blanched head of creamy white. Per pkt. 5c., oz. 15c.,  $\frac{1}{4}$  lb. 40c., lb. \$1.25.

## LEEK

*One ounce will sow 200 feet of drill.*

One of the three vegetables principally used for flavoring soup. Both for summer and winter use sow seed during April and May in drills  $\frac{1}{2}$  inch deep and when quite strong, usually the early part of July, transplant in rows 12 inches apart and 5 inches apart in the row. Plants should be slightly trimmed before setting out.

**Large American Flag.** The best variety for the home garden. Early, very large and withstands considerable cold weather, though it is mostly grown for summer and early fall. Per pkt. 5c., oz. 15c.,  $\frac{1}{4}$  lb. 40c., lb. \$1.25.

**Winter.** Can be left to stand outdoors during the winter and will remain in fine condition until the following spring. Very solid and firm but not quite as large as the preceding. Pkt. 5c., oz. 20c.,  $\frac{1}{4}$  lb. 50c., lb. \$1.50.



Lettuce, Cos or Romaine

## MUSTARD

*One ounce will sow 75 feet of drill.*

The leaves impart a sharp, pungent flavor to salads and are also highly esteemed when cooked like Spinach. For a succession, sow seed  $\frac{1}{2}$  inch deep, in drills 8 inches apart, every few weeks from early spring until September.

**Giant Southern Curled.** Leaves are large, finely curled and form a good substitute for spinach. Pkt. 5c., oz. 10c.,  $\frac{1}{4}$  lb. 25c., lb. 75c.

**White English.** The best for salad; grows rapidly. Oz. 5c.,  $\frac{1}{4}$  lb. 15c., lb. 40c.

## NASTURTIUM

*One ounce will sow 20 feet of drill.*

Although the Nasturtium is grown principally for its flowers, the green seeds when pickled may be used as a substitute for Capers. Sow the seed one inch deep, usually about the beginning of May.

**Tail Mixed.** Requires the support of a trellis or fence. Per pkt. 5c., oz. 15c.,  $\frac{1}{4}$  lb. 35c., lb. \$1.25.

**Dwarf Mixed.** Per pkt. 5c., oz. 15c.,  $\frac{1}{4}$  lb. 35c., lb. \$1.25.

For an early, flat, green podded Bush Bean of the highest quality, try Bountiful

Give  
Our Novelties  
a Trial

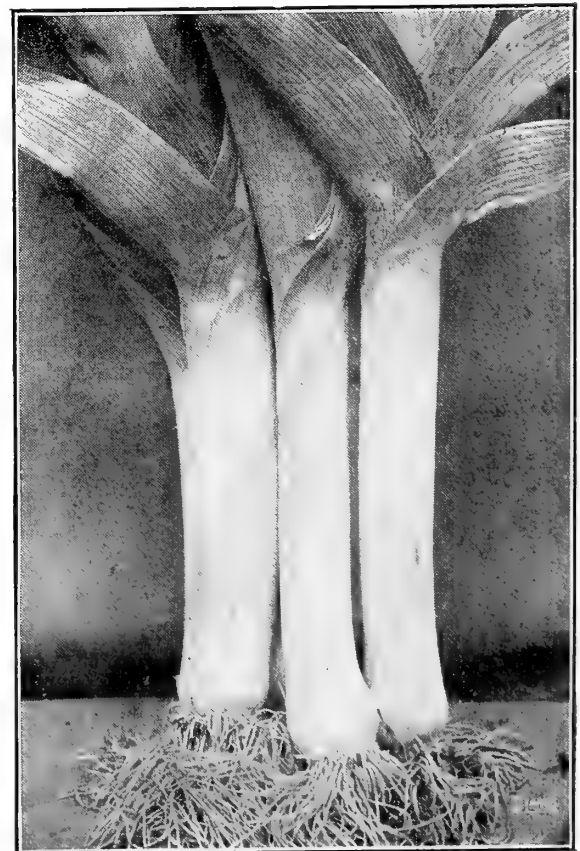

Leek, Large American Flag

# MUSKMELON

One ounce will  
plant 60 hills

A light, rich soil is preferred for growing melons. In May, when the soil has become warm and dry, plant 8 to 10 seeds  $\frac{1}{2}$  inch deep in hills 5 to 6 ft. apart each way. Before planting add a quantity of well rotted manure to each hill and mix thoroughly. Like Cucumbers and Squash, the young plants should be protected from insects and for this purpose a dusting of tobacco dust is advisable. As soon as the plants begin crowding and after the danger from insects is past, remove all but three plants to a hill. The side runners should be pinched back to insure fruiting. Spray at intervals with Bordeaux Mixture, to which a small quantity of Arsenate of Lead has been added.

**Acme, or Baltimore.** Can be recommended as one of the best green fleshed varieties. The melons are oval shaped, not extra large but very sweet and of delicious flavor. Per pkt. 5c., oz. 20c.,  $\frac{1}{4}$  lb. 50c., lb. \$1.50.

**Bay View.** Late in maturing but of very large size.

The fruit is oblong in shape and heavily ribbed; flesh light green. Per pkt. 5c., oz. 20c.,  $\frac{1}{4}$  lb. 50c., lb. \$1.50.



Muskmelon, Emerald Gem

**Long Island Beauty.** For a large, early maturing melon, Long Island Beauty should not be overlooked. In shape it is round, with well flattened ends, dense netted skin, and sweet, juicy, green flesh. Per pkt. 5c., oz. 20c.,  $\frac{1}{4}$  lb. 50c., lb. \$1.50.

**Miller's Cream, or Osage.** Oval in shape, medium size, with solid thick orange flesh of superb quality. Fine market sort. Per pkt. 5c., oz. 20c.,  $\frac{1}{4}$  lb. 50c., lb. \$1.75.

**Paul Rose.** About the same size and shape as the Rocky Ford or Netted Gem. The flesh is very thick, leaving a small seed cavity; deep orange color, firm and sweet. Per pkt. 5c., oz. 20c.,  $\frac{1}{4}$  lb. 50c., lb. \$1.75.

**Rocky Ford.** One of the finest basket melons in cultivation, and undoubtedly the most largely planted. Vines vigorous and continuous bearers; oval fruit having thick, green flesh of excellent quality. Splendid either for the private gardener or shipper. Per pkt. 5c., oz. 15c.,  $\frac{1}{4}$  lb. 40c., lb. \$1.25.

**Tip Top.** This superior variety is attractive in appearance, very productive, and nearly round. The yellow flesh, ripening close to the rind, is of the most delicious flavor. Per pkt. 10c., oz. 25c.,  $\frac{1}{4}$  lb. 75c., lb. \$2.50.



Muskmelon, Extra Early Hackensack

**Burrell's Gem.** An ideal variety for the garden and especially desirable for shipping. Medium size, averaging 2 to 2 $\frac{1}{4}$  pounds each, oval in shape, with thin hard rind and dark green, closely netted skin. The unusually thick, salmon-red flesh is fine grained and possesses that rich spicy flavor. Per pkt. 5c., oz. 20c.,  $\frac{1}{4}$  lb. 50c., lb. \$1.50.

**Emerald Gem.** A favorite early sort of the finest quality. The small globular shaped melons are smooth and dark green, while the flesh, of salmon color, almost ripens to the rind and is the sweetest of any. Per pkt. 5c., oz. 20c.,  $\frac{1}{4}$  lb. 60c., lb. \$2.00.

**Extra Early Hackensack.** This is a popular green fleshed variety with large, heavily netted fruit. Good for shipping. Per pkt. 5c., oz. 15c.,  $\frac{1}{4}$  lb. 40c., lb. \$1.25.

**Hoodoo.** This grand new melon is highly recommended either for the home table or for shipping. It is uniform in size, nearly round, heavily netted, while the flesh is very thick, exceedingly sweet, and rich orange in color. Per pkt. 10c., oz. 25c.,  $\frac{1}{4}$  lb. 75c., lb. \$2.50.

**Jenny Lind.** An extremely early, green fleshed variety of small size, round and of excellent flavor. Per pkt. 5c., oz. 15c.,  $\frac{1}{4}$  lb. 40c., lb. \$1.25.



Muskmelon, Rocky Ford

## WATERMELONS

*One ounce will plant 40 hills*

Culture similar to that of Muskmelon, excepting the hills should be 8 to 10 feet apart.

**Alabama Sweet.** Popular among the Southern growers. Long and very large, with dark green rind and bright red flesh of excellent quality. Per pkt. 5c., oz. 10c.,  $\frac{1}{4}$  lb. 25c., lb. 75c.

**Black Boulder.** A well recommended extra large, very productive variety having dark green skin; unsurpassed for shipping. Per pkt. 5c., oz. 10c.,  $\frac{1}{4}$  lb. 25c., lb. 80c.

**Dixie.** A good shipping Melon of medium size, oblong shape and rich scarlet flesh; skin dark green, striped a lighter shade. Per pkt. 5c., oz. 10c.,  $\frac{1}{4}$  lb. 20c., lb. 60c.

**Halbert Honey.** Especially desirable for home gardens or nearby markets. Ripens well up to the thin rind and is remarkably sweet and tender. Per pkt. 5c., oz. 10c.,  $\frac{1}{4}$  lb. 30c., lb. \$1.00.

**Harris' Earliest.** An early, oval shaped variety with deliciously sweet flesh, dark and light green striped skin. Per pkt. 5c., oz. 10c.,  $\frac{1}{4}$  lb. 30c., lb. \$1.00.

**Iceberg.** One of the best for shipping. Of thick oval shape and very dark green skin, while the flesh, of superb quality, is of the deepest red. Per pkt. 5c., oz. 10c.,  $\frac{1}{4}$  lb. 20c., lb. 60c.



Watermelon, Black Boulder

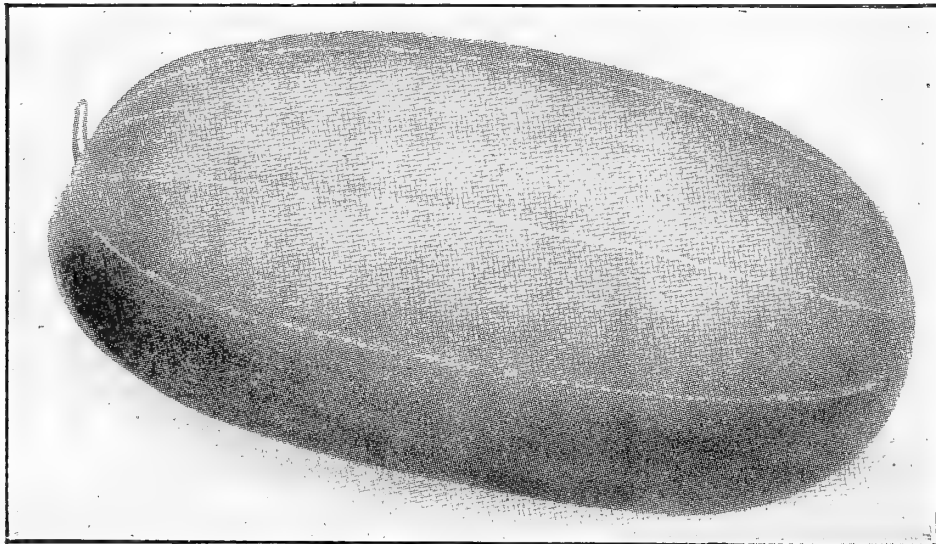

Watermelon, Kleckley Sweets

**Kleckley Sweets.** Medium to large size, oval in shape and unsurpassed for its sweet, sugary flavor. An exceptionally fine variety for the private garden. Per pkt. 5c., oz. 10c.,  $\frac{1}{4}$  lb. 25c., lb. 85c.

**Kolb's Gem.** Very large and owing to its hard, firm rind it is used extensively for shipping. Per pkt. 5c., oz. 10c.,  $\frac{1}{4}$  lb. 20c., lb. 60c.

**Sweetheart.** The fruit is light green striped darker, oval and uniform in shape, having rich red flesh of delicious melting flavor. Per pkt. 5c., oz. 10c.,  $\frac{1}{4}$  lb. 20c., lb. 60c.

### Citron for Preserving

**Red Seed.** Round and smooth, flesh white, used only for preserving. Per pkt. 5c., oz. 10c.,  $\frac{1}{4}$  lb. 20c., lb. 60c.

**Green Seed.** Used for the same purpose as the preceding. Per pkt. 5c., oz. 10c.,  $\frac{1}{4}$  lb. 20c., lb. 60c.

## MUSHROOM SPAWN

*Ten pounds will spawn 10 feet square*

To grow Mushrooms does not necessarily require any special house, as a cellar, shed or even under greenhouse benches will answer the purpose. Of course, conditions must be such that an even temperature of 50 to 65 degrees can be maintained. Secure some fresh horse manure, not too coarse, and also a quantity of good rich soil. To one part of soil add two or three of manure and when thoroughly mixed form into beds three feet wide, and from 10 to 12 inches deep, pounding it together as you proceed. The bed will soon become very hot and not until temperature recedes to 80 or 90 degrees is it ready for the spawn. Make holes 8 to 10 inches apart and large enough to admit the spawn, which is broken into pieces about the size of a hen's egg and covered one and a half inches. After remaining in this condition from 8 to 10 days cover the bed with 2 inches of fresh soil and after firming with the back of a spade cover with 4 inches of salt hay or straw. It takes about 2 months before the first mushrooms appear. When watering, the water should be 95 degrees.

A 14-page pamphlet, "How to Grow Mushrooms," postpaid for 10c.

**English Spawn.** (In bricks.) Per lb. 15c., 8 lbs. \$1.00.

**Pure Culture.** Per brick 25c., postpaid 40c. By express: 10 bricks \$2.00, 50 bricks \$8.00.

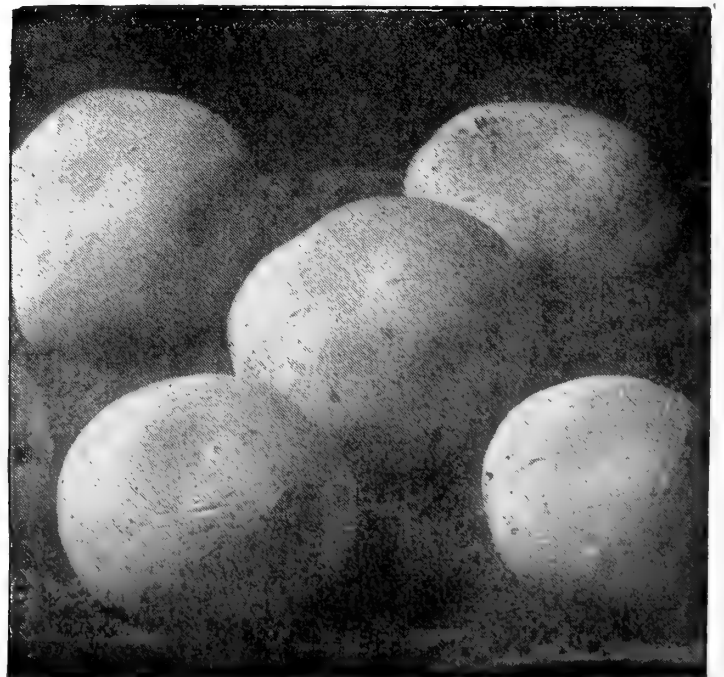

Mushrooms

# ONION One ounce for 100 feet of drill

A rich loamy soil, preferably one that has been liberally manured the previous season, is best suited to growing Onions. Just as soon as the soil is in working condition, usually in April, sow seed  $\frac{1}{2}$  inch deep in drills 12 inches apart, and later thin out the plants to 4 inches apart in the row. Hoe frequently and also give occasional weeding.

**Adriatic Barletta.** The small round snow-white bulbs mature very early and are prized for pickling. Per pkt. 5c., oz. 20c.,  $\frac{1}{4}$  lb. 60c., lb. \$2.00.

**Australian Brown.** This variety possesses wonderful keeping qualities. The Onions are rich brown in color, solid and of mild flavor. Per pkt. 5c., oz. 15c.,  $\frac{1}{4}$  lb. 50c., lb. \$1.75.

**Ailsa Craig.** An exceptionally large Onion and one of the finest for exhibiting. It is oval shaped, slightly pointed at each end, with pale straw colored skin and solid white flesh. To obtain extra large specimens, sow seed in hotbeds during February and transplant to the open ground in April. Per pkt. 10c., oz. 30c.,  $\frac{1}{4}$  lb. \$1.00, lb. \$3.50.

**Hardy White Winter.** The seed should be sown during the latter part of August or beginning of September and the plants left standing over winter. In this way, pure white, flat shaped Onions of medium size may be had from 3 to 4 week earlier than seed sown in spring. Per pkt. 5c., oz. 25c.,  $\frac{1}{4}$  lb. 75c., lb. \$2.50.

**Large Red Wethersfield.** Splendid deep red sort and fine keeper. Grows to a large size, flat but thick, with purplish white flesh of rather sharp flavor. Per pkt. 5c., oz. 15c.,  $\frac{1}{4}$  lb. 50c., lb. \$1.75.

**Mammoth Silver King.** This is the largest of all white Onions and though not recommended for shipping, it is desirable for the home garden. Flat shaped, and mild, tender, silvery-white flesh. Per pkt. 5c., oz. 20c.,  $\frac{1}{4}$  lb. 60c., lb. \$2.00.

**Prizetaker.** A very popular variety of enormous size, single bulbs often weighing from 2 to 4 pounds. Handsome, globular formed Onions with bright yellow skin and fined grained flesh of the purest white. An immense cropper. Per pkt. 5c., oz. 20c.,  $\frac{1}{4}$  lb. 60c., lb. \$2.00.

**Southport Red Globe.** Matures late, globe shaped, short necked and dark red in color. Flesh tender and of excellent quality. Per pkt., 5c., oz. 15c.,  $\frac{1}{4}$  lb. 50c., lb. \$1.75.

**Southport White Globe.** Owing to its beautiful white skin, uniform size and attractive appearance, it has become a favorite with all. A good keeper and abundant yielder, with firm, mild flesh. Per pkt. 5c., oz. 25c.,  $\frac{1}{4}$  lb. 85c., lb. \$3.00.

**Southport Yellow Globe.** Large Onion of globular form, almost round, and rich yellow color. It matures about the same time as Southport Red Globe and has flesh of the same high quality. Excellent keeper. Per pkt. 5c., oz. 15c.,  $\frac{1}{4}$  lb. 50c., lb. \$1.75.

**White Portugal, or American Silverskin.** Market gardeners find this an exceptionally fine, flat variety of good size and the purest white, but it is also popular for the home table. A good keeper with sweet mild flesh. Per pkt. 5c., oz. 25c.,  $\frac{1}{4}$  lb. 75c., lb. \$2.50.

**White Scallion.** Similar in growth to the Leek, growing straight and not forming any bulb. Sow the seed during August and they will be ready for the table in early spring. Used only in the green state. Per pkt. 5c., oz. 15c.,  $\frac{1}{4}$  lb. 50c., lb. \$1.50.

**White Bunch.** The small, flat Onions are pure white and highly relished when pickled. Market gardeners find this a valuable variety for bunching, as it ripens very early. Per pkt. 5c., oz. 20c.,  $\frac{1}{4}$  lb. 60c., lb. \$2.00.

**Yellow Globe Danvers.** Especially recommended as one of the best yellow sorts, and there are many who will have no other. In shape it is nearly round with light brown colored skin and solid white flesh. It is noted for its productiveness and superior keeping qualities. Per pkt. 5c., oz. 15c.,  $\frac{1}{4}$  lb. 50c., lb. \$1.50.



Onion, Prizetaker



Onion, Southport White Globe

## ONION SETS

By planting sets, Onions may be had much earlier than from spring sown seed. To obtain large Onions, sets should be planted 3 to 4 inches apart, in rows one foot apart, as soon as the frost is out of the ground.

**White Sets**..... per qt. 20c., 1/2 pk. 75c., 1 pk. \$1.25  
**Red** " " " " 20c., 1/2 pk. 75c., 1 pk. 1.25  
**Yellow** " " " " 20c., 1/2 pk. 75c., 1 pk. 1.25

**Egyptian or Top Onion.** Produces small bulbs on top of stalks which are planted in autumn and used in the spring as scallions.

Sets. Ready in August. Per qt. 20c., 1/2 pk. 60c., 1 pk. \$1.00.

**Onion Sets: If wanted in larger quantities, write for prices. If wanted by mail, add 10c. per qt. for postage**

## OKRA, or Gumbo

*One ounce will sow 40 feet of drill*

Extensively grown in the South. The green pods are used in soups. Sow during May in drills 3 feet apart and later thin out to 10 inches in the row.

**White Velvet.** Pods are round, smooth, white and tender. Per pkt. 5c., oz. 10c., 1/4 lb. 20c., lb. 65c.

**Perkin's Mammoth Long Pod.** Wonderfully productive; immense, deep green pods, slim, but retaining their tenderness longer than most sorts. Per pkt. 5c., oz. 10c., 1/4 lb. 20c., lb. 65c.



Onion Sets

## MARTYNIA

*One ounce will plant 150 hills*

Spreading plants growing about 2 feet high and bearing seed pods which are esteemed for pickling when young. Plant seed during April and May in hills 3 feet apart each way.

**Proboscidea.** Per pkt. 5c., oz. 30c., 1/4 lb. \$1.00.

## POTATOES

*Ten bushels cut tubers will plant one acre*

Planting may commence as early in the spring as the ground can be worked. Place one piece every 12 inches in rows 2 1/2 feet apart, covering about 4 inches. When cutting the seed care should be taken that at least one good eye, or two small ones, is allowed to each piece.

**Bovee.** Similar to the Early Rose in color but matures earlier and is more productive. Grows to a good size and is a fine cooker.



Okra, White Velvet

### POTATOES—Continued

**Early Ohio.** A splendid early variety, having flesh colored skin and white flesh of superb quality.

**Early Rose.** One of the most popular for the home garden.

**Green Mountain.** This well known late Potato is grown extensively on Long Island and succeeds in almost any soil. In flavor and keeping qualities it ranks with the best.

**Rural New Yorker No. 2.** Oblong in shape, uniformly large, smooth, and has very white skin and flesh. A heavy yielder.

We will be pleased to quote our lowest price on the above listed varieties.



Potatoes, Early Rose

## PARSNIP

One ounce for 200 feet of drill

Parsnips require a deep, rich, mellow soil, and should be sown in drills one and one-half feet apart and one-half inch deep as soon as the ground can be worked in spring. Thin plants to six inches apart in the row and cultivate frequently.

**Hollow Crown.** An excellent strain, having long smooth roots of the purest white and finest flavor. Per pkt. 5c., oz. 10c.,  $\frac{1}{4}$  lb. 20c., lb. 50c.

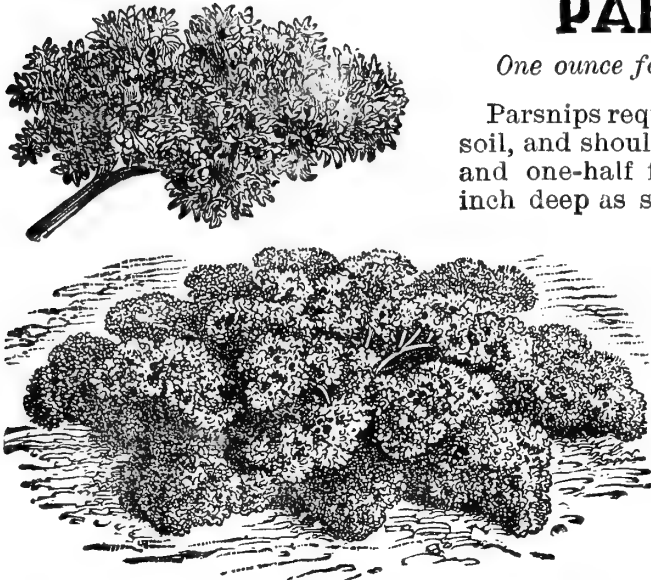

Parsley, Extra Double Curled

## PARSLEY

One ounce will sow 100 feet of drill

As the seed is slow in germinating it should be sown as early in spring as possible in drills 1 foot apart and  $\frac{1}{2}$  inch deep. When the plants are well advanced thin out to 6 inches apart in the row. By making a second sowing, under glass, in July or August a supply can be had throughout the winter.

**Extra Double Curled.** The best strain for general use. Leaves are deeply curled, very dark green in color, and unequalled for flavoring and garnishing. Per pkt. 5c., oz. 10c.,  $\frac{1}{4}$  lb. 20c., lb. 60c.

**Champion Moss Curled.** A fine curly variety, resembling the above in appearance, but of more rapid growth. Per pkt. 5c., oz. 10c.,  $\frac{1}{4}$  lb. 20c., lb. 60c.

**Plain.** Although the leaves are not curled, they have an excellent flavor and therefore preferred by many. Per pkt. 5c., oz. 10c.,  $\frac{1}{4}$  lb. 20c., lb. 60c.

**Turnip-Rooted, or Hamburg.** The roots, which resemble small Parsnips, are valuable for flavoring soups, while the leaves, similar to those of Celery, may also be used for the same purpose as the roots. Per pkt. 5c., oz. 10c.,  $\frac{1}{4}$  lb. 20c., lb. 60c.

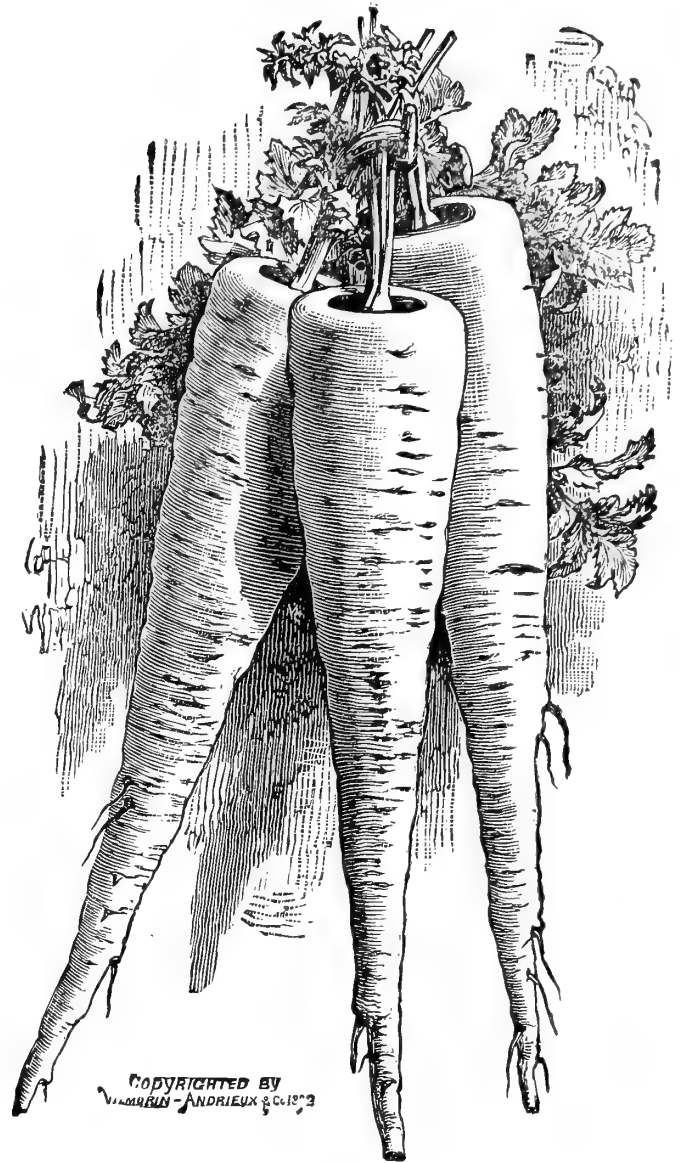

Parsnip, Hollow Crown

## PEPPER

One ounce will produce 2,000 plants

Peppers should be started in a hot-bed during March or April. The latter part of May transplant to the open ground in rows two feet apart and eighteen inches in the row.

**Large Bell or Bull-Nose.** Plant of vigorous growth, producing large thick peppers of mild flavor. Per pkt. 5c., oz. 25c.,  $\frac{1}{4}$  lb. 75c., lb. \$2.50.

**Procopp's Giant.** The scarlet fruit of this variety is long, quite fleshy and of very sharp flavor. Per pkt. 5c., oz. 25c.,  $\frac{1}{4}$  lb. 75c., lb. \$2.50.

**Sweet Mountain, or Spanish Mammoth.** Resembles the Large Bell in appearance, but is larger in size and of milder flavor. The young peppers are bright green, but gradually change to a rich red when fully matured. Per pkt. 5c., oz. 25c.,  $\frac{1}{4}$  lb. 75c., lb. \$2.50.

**Chinese Giant.** An unusually large sweet pepper, about twice the size of Bull-Nose, but a little later in maturing. The flesh is quite thick, very mild and of a bright red color. Plants 2 feet high and very productive. Per pkt. 10c., oz. 50c.,  $\frac{1}{4}$  lb. \$1.50, lb. \$5.00.

**Golden Dawn.** An early variety of medium size, golden yellow color, and mild flavor. Per pkt. 5c., oz. 25c.,  $\frac{1}{4}$  lb. 75c., lb. \$2.50.

**Long Red Cayenne.** The bright scarlet pods varying from 3 to 4 inches in length are very pungent. Per pkt. 5c., oz. 25c.,  $\frac{1}{4}$  lb. 75c., lb. \$2.50.

**Chili.** A late maturing variety with small red fruit which is used extensively for pepper sauce. Per pkt. 5c., oz. 25c.,  $\frac{1}{4}$  lb. 75c., lb. \$2.50.

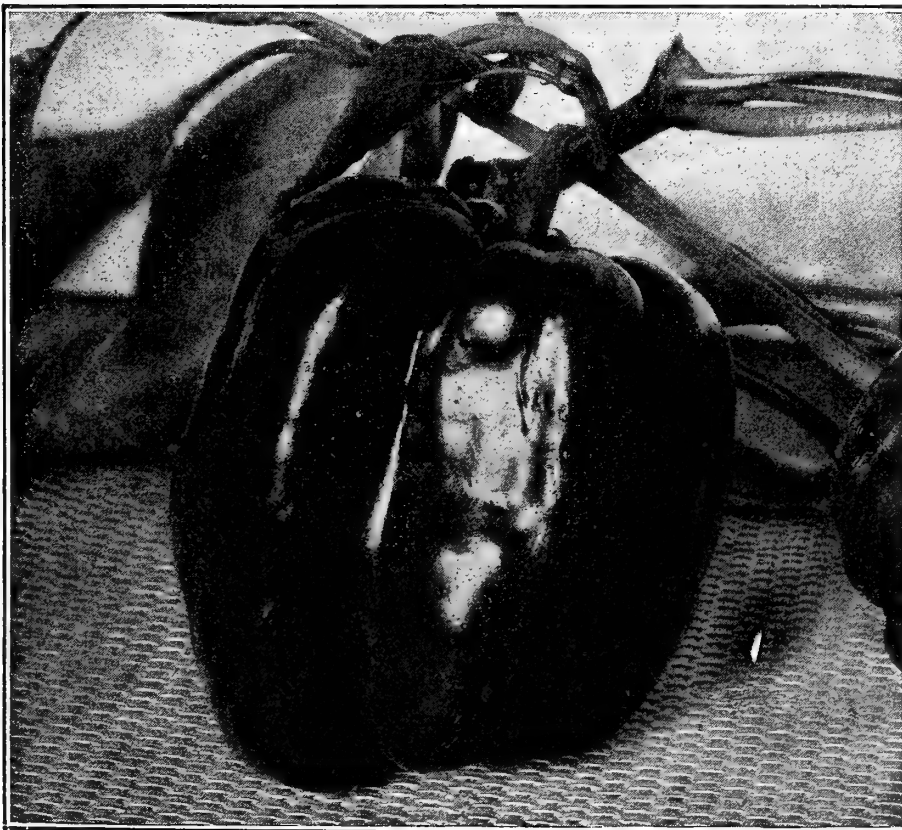

Pepper, Chinese Giant

## PEAS One quart of seed will plant about 125 feet of drill

All smooth-seeded Peas may be planted as early in spring as the soil can be prepared for them. They are very hardy, and will endure a low temperature, both before and after sprouting. By sowing for the first crop as early as practicable, and for succession at intervals of about two weeks until the first of June, a good supply of this delicious vegetable may be enjoyed through the greater part of the summer. Late sowings, however, do not yield as well as early ones, because the hot and dry weather is unfavorable to the development of the plants. The seed should be sown in drills about three inches deep and from three to four feet apart, according to the variety, taller sorts requiring more room than the dwarf ones. Dwarf Peas require a very rich soil, while tall ones thrive best in rather thin ground, which does not stimulate too luxuriant growth in the vines, to the detriment of the pods. The latter are frequently sown in double rows, with the brush or support of some kind between them. Wrinkled Peas are not so hardy as the smooth sorts, and should not be sown as early, but are superior to them in quality, more delicate in flavor, and remain longer in season.

If wanted by mail, add 10c. per pt., 15c. per qt. extra.

### EXTRA EARLY

**Alaska.** Popular among market gardeners for an early crop. The pods are medium size, dark green in color and ripen almost at one time. Per pt. 15c., qt. 25c., pk. \$1.75.

**Ameer.** The vines of this variety grow about 3 feet high and are heavy bearers. The pods, 3 inches long, mature shortly after Alaska and are well filled with sweet, tender peas. Per pt. 15c., qt. 30c., pk. \$2.00.

**Improved Daniel O'Rourke.** A smooth seeded Pea resembling First of All. Per pt. 15c., qt. 25c., pk. \$1.75.

**First of All.** An extremely early variety of vigorous growth, usually attaining a height of two and one-half feet and bearing small podded peas of fair quality. Per pt. 15c., qt. 25c., pk. \$1.75.

**Surprise.** In addition to its earliness, being one of the first wrinkled varieties to mature, it is a heavy cropper and its pods, 2½ inches long, are well filled with luscious peas. Height 2 feet. Per pt. 15c., qt. 30c., pk. \$2.00.

**Nott's Excelsior.** One of the best dwarf early wrinkled Peas. It grows about 14 inches high, very productive, and the pods 3 inches long, generally contain 6 or 7 large, sweet peas of the finest quality.

Well recommended for home use. Per pt. 15c., qt. 25c., pk. \$1.75.

**Premium Gem.** The round pods, 2½ inches long, are borne on short bushes, which are well suited to small gardens. Per pt. 15c., qt. 25c., pk. \$1.75.

**American Wonder.** Dwarfier and a trifle earlier than the preceding, but not quite so productive. The peas are sweet, tender and of delicious flavor. Per pt. 15c., qt. 25c., pk. \$1.75.

**Sutton's Excelsior.** This Pea is a great improvement over the other dwarf early varieties. It is a very heavy cropper and the large, handsome pods, uniform in size, are well filled with immense peas of unsurpassed quality. Height 15 inches. Per pt. 15c., qt. 30c., pk. \$2.00.

**Gradus.** One of the most popular wrinkled sorts. Even though it matures a short time later than the extra earlies, the pods, fully as long as those of the well-known Telephone, contain very large peas that are unexcelled for sweetness. A superior variety for the market or private garden. Per pt. 20c., qt. 35c., pk. \$2.25.

**Thomas Laxton.** An exceptionally fine variety, growing three feet in height and yielding large podded peas, four to five inches in length, of the finest flavor. Per pt. 20c., qt. 35c., pk. \$2.00.

### LATE, or MAIN CROP

**Abundance.** A splendid second early sort, growing about 1½ feet high and bearing abundantly medium-sized pods, each containing 6 to 8 large peas of good quality. Per pt. 15c., qt. 25c., pk. \$1.75.

**Everbearing.** Of spreading habit, and therefore the seed should be sown about 5 inches apart. The large podded peas are tender and of superb flavor. Per pt. 15c., qt. 25c., pk. \$1.75.

**Alderman.** The largest podded of all Peas, even larger than the Duke of Albany, and also much darker in color. The vines, four feet in height, are vigorous, robust and decidedly heavy yielders. Per pt. 15c., qt. 30c., pk. \$1.75.



Pea, Sutton's Excelsior

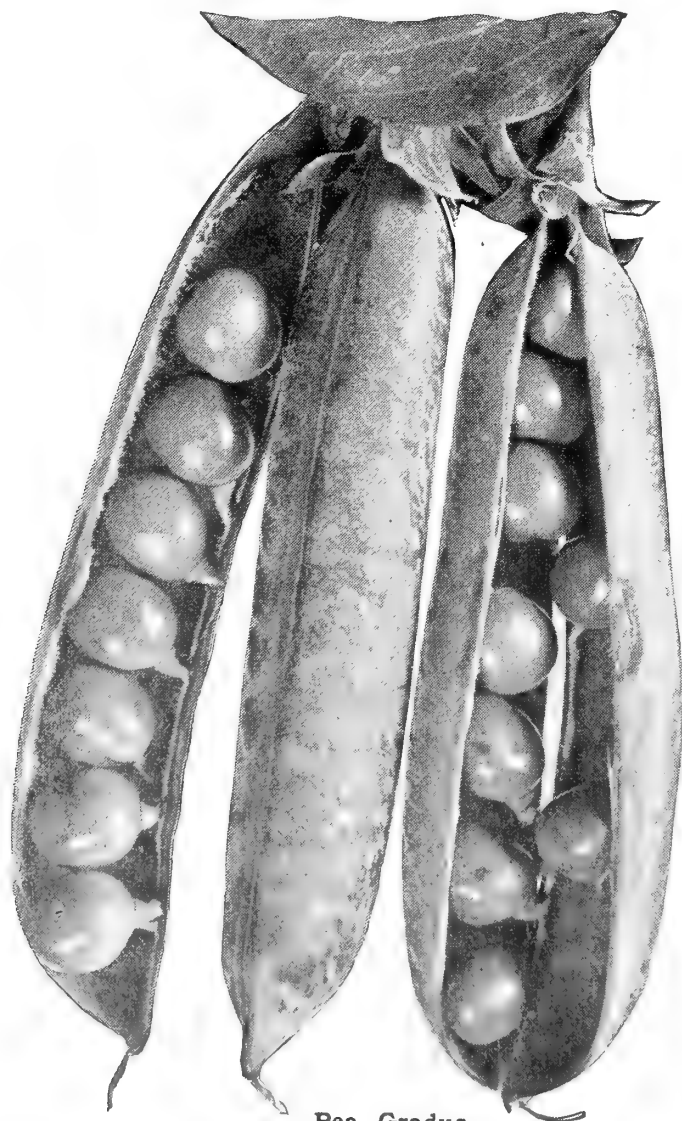

Pea, Gradus



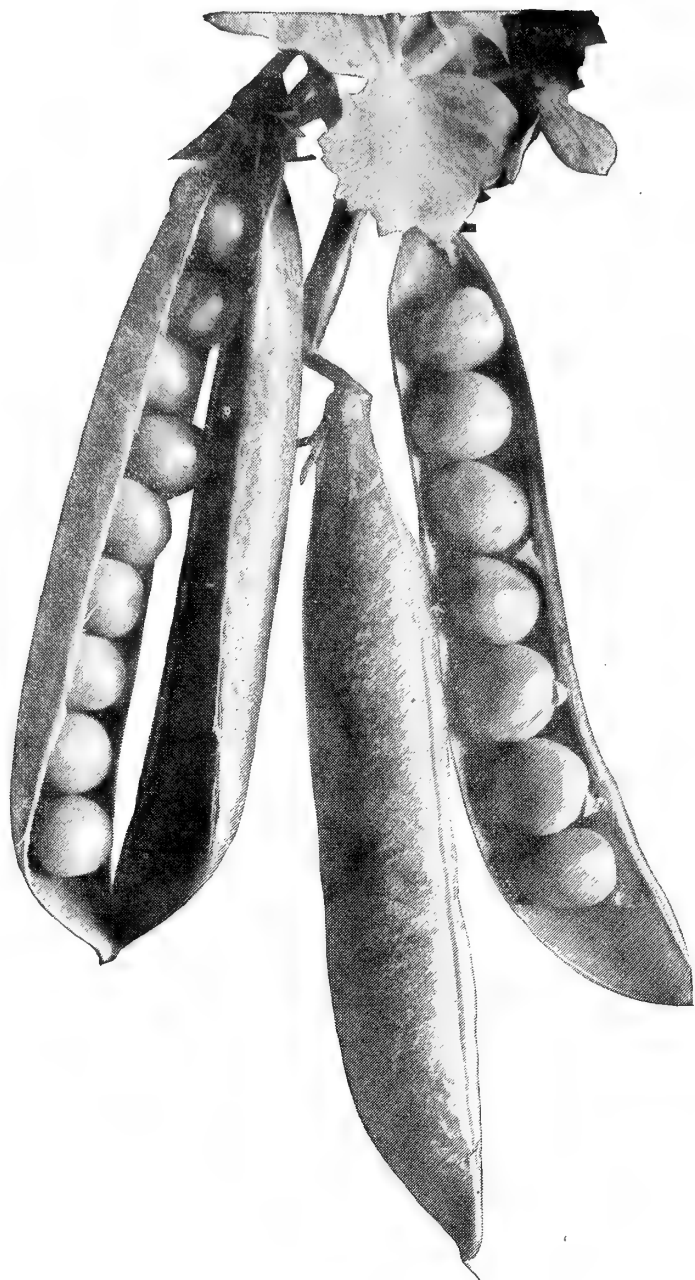

Pea, Telephone

**Large Sweet Cheese.** Specimens of this sort are usually about 2 feet in diameter and one third as thick. The skin is creamy yellow, while the flesh is unsurpassed for making pies. Per pkt. 5c., oz. 10c.,  $\frac{1}{4}$  lb. 20c., lb. 50c.

**Large Tours.** Grows to a large size. The fruit is oblong in shape and often weighs from 75 to 100 pounds. Per pkt. 5c., oz. 10c.,  $\frac{1}{4}$  lb. 20c., lb. 60c.

**Mammoth Golden Cashaw.** A queer shaped Pumpkin containing an immense quantity of sweet, tender flesh. Per pkt. 5c., oz. 10c.,  $\frac{1}{4}$  lb. 25c., lb. 75c.

**Small Sugar.** Though small, this is one of the sweetest, and is highly recommended for home use. Round, with dark orange colored skin and thick solid flesh. Per pkt. 5c., oz. 10c.,  $\frac{1}{4}$  lb. 20c., lb. 65c.

**Winter Luxury.** Vines productive, bearing medium-sized fruit with finely netted skin of russet yellow color. A superior winter variety of the finest quality. Per pkt. 5c., oz. 10c.,  $\frac{1}{4}$  lb. 20c., lb. 65c.

## PEAS—Continued

### LATE, OR MAIN CROP

**Telephone.** For general planting this tall growing variety is undoubtedly the most popular among market gardeners. The pods, four to four and one-half inches long, are light green in color and filled with large, sweet, tender peas. Per pt. 15c., qt. 30c., pk. \$1.75.

**Champion of England.** A standard Pea; vines grow  $4\frac{1}{2}$  feet high and bear medium-sized pods of peas of good quality. Per pt. 15c., qt. 25c., pk. \$1.50.

**Duke of Albany.** Immense pods, on style of Telephone; a very superior Pea of quick growth; pods dark green, well filled. Height 4 ft. Per pt. 15c., qt. 30c., pk. \$1.75.

**Dwarf Telephone.** An ideal dwarf wrinkled Pea, maturing earlier than the late tall growing kinds. A remarkably fine variety for the private garden, as its vines never exceed two feet in height and the peas are of excellent flavor. Per pt. 15c., qt. 30c., pk. \$2.00.

**Long Island Mammoth.** Very popular with market gardeners who want a large, handsome pod of a deep green color. Per pt. 15c., qt. 25c., pk. \$1.50.

**Tall Melting Sugar.** The pods as well as the peas of this variety are edible and both very sweet. Per pt. 20c., qt. 35c.

Packets of all varieties of Peas, 10c. each, postpaid.

## PUMPKIN

*One ounce will plant 50 hills.*

Pumpkins are usually raised in the cornfield. When the Corn is about  $1\frac{1}{2}$  feet high, or after it receives its last cultivation, the seed is sown, dropping 3 seeds in every third hill. The seed may also be sown after May 15th, in hills 8 feet apart, placing about 6 seeds in each hill and later thin out to four plants.

**King of the Mammoths (Jumbo).** This is indeed a mammoth variety. The pumpkins are from 2 to 3 feet in diameter, orange yellow in color, flat shaped, and have thick, bright yellow flesh of excellent quality. Per pkt. 5c., oz. 15c.,  $\frac{1}{4}$  lb. 40c., lb. \$1.25.

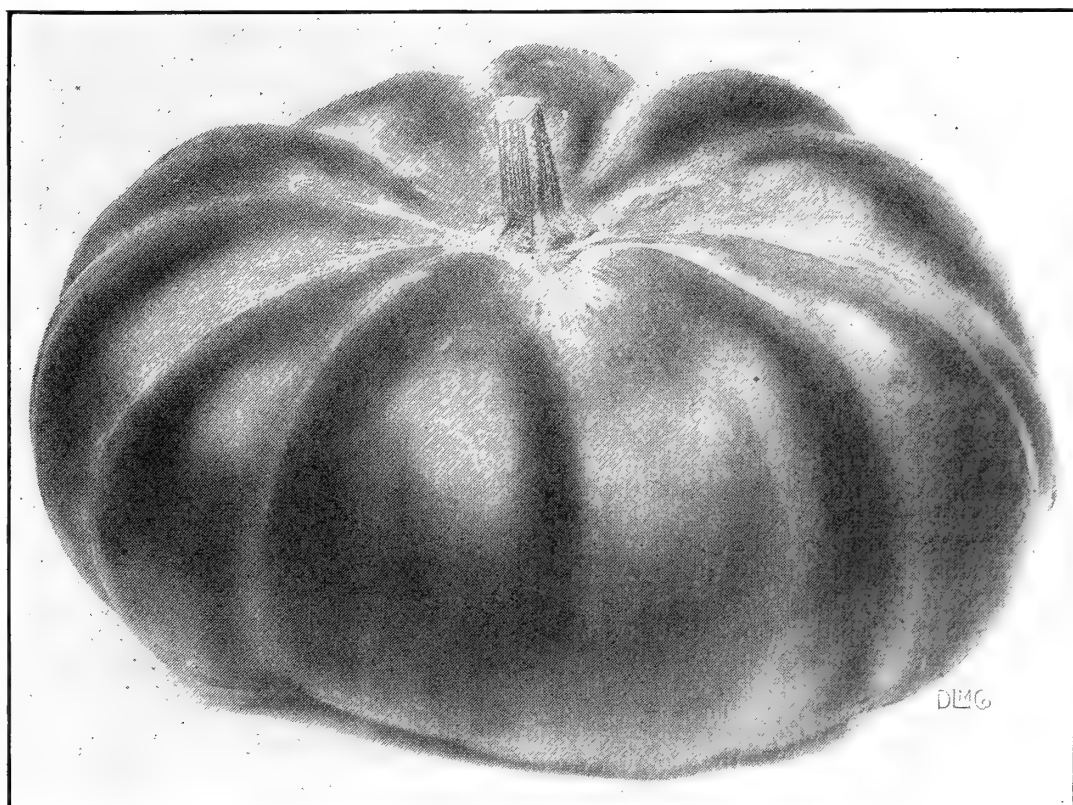

Pumpkin, Large Cheese

**RADISH**

*One ounce will sow  
100 feet of drill.*

For early use select only forcing varieties and sow in hotbeds or under glass any time from January until March. Begin sowing outdoors as soon as the soil is in working condition, usually early in April, selecting if possible a light, sandy loam. Although seed of the monthly Radishes may be sown broadcast the summer and winter sorts should be sown in drills twelve to eighteen inches apart, but not before May 15th, as earlier sowings will most likely run to seed. For winter sow from July 15th to August 15th in drills eighteen inches apart, later thinning out to six inches apart.

**Crimson Giant.** A forcing variety of unusual size, but better adapted to outdoor culture. It is solid, crisp and tender. Per pkt. 5c., oz. 15c.,  $\frac{1}{4}$  lb. 25c., lb. 85c.

**Earliest Carmine Forcing.** An extra early, olive shaped, deep red Radish with rather small tops, maturing in about twenty days. Per pkt. 5c., oz. 10c.,  $\frac{1}{4}$  lb. 25c., lb. 75c.



Radish, Early White Turnip

**Early Round Dark Red.** All that its name implies as well as being of rapid growth and handsome appearance. Per pkt. 5c., oz. 10c.,  $\frac{1}{4}$  lb. 20c., lb. 65c.

**Non Plus Ultra.** Especially desirable during the warm summer months owing to its earliness, short top, and rarely becoming pithy. Per pkt. 5c., oz. 10c.,  $\frac{1}{4}$  lb. 25c., lb. 75c.

**Scarlet Globe Forcing.** Popular everywhere either for forcing or outside sowing. Its brilliant color, uniform shape, and crisp, white flesh make it a favorite with all. Per pkt. 5c., oz. 10c.,  $\frac{1}{4}$  lb. 25c., lb. 75c.

**Scarlet Turnip, White Tipped, Forcing.** A splendid variety, medium to small in size, round and very solid. Color rich scarlet slightly tipped with white. Per pkt. 5c., oz. 10c.,  $\frac{1}{4}$  lb. 20c., lb. 60c.

**Early Scarlet Turnip.** One of the standard sorts for general sowing. Roots are turnip shaped, dark red and of fine quality. Per pkt. 5c., oz. 10c.,  $\frac{1}{4}$  lb. 20c., lb. 60c.

**French Breakfast.** This well known Radish is olive shaped, bright scarlet with the exception of the white tip. Per pkt. 5c., oz. 10c.,  $\frac{1}{4}$  lb. 20c., lb. 65c.

**Early Scarlet Turnip, White Tipped.** An exceptionally fine strain so largely grown by market gardeners. Its color is of the deepest scarlet with a prominent white tip; superb flavor. Per pkt. 5c., oz. 10c.,  $\frac{1}{4}$  lb. 20c., lb. 60c.

**Early White Turnip.** Preferred by many to the red sorts. Flesh clear white, tender and sweet. Per pkt. 5c., oz. 10c.,  $\frac{1}{4}$  lb. 20c., lb. 65c.

**Chartier.** Roots are red with a white tip, slender and remain solid and crisp until of large size. Per pkt. 5c., oz. 10c.,  $\frac{1}{4}$  lb. 20c., lb. 65c.

**Iceberg.** One of the earliest and purest of all long, white varieties. For crispness and tenderness it is unsurpassed. Per pkt. 5c., oz. 10c.,  $\frac{1}{4}$  lb. 25c., lb. 75c.

**Long Scarlet Short Top.** A long, smooth, tapering Radish somewhat smaller but brighter in color than Chartier. Per pkt. 5c., oz. 10c.,  $\frac{1}{4}$  lb. 20c., lb. 65c.

**Long White Vienna (Lady Finger).** The skin and flesh are both pure white and of excellent quality. Per pkt. 5c., oz. 10c.,  $\frac{1}{4}$  lb. 20c., lb. 65c.

**Early Golden Yellow Oval.** Grows from three to four inches long, oval shaped, perfectly solid, and skin bright yellow. Per pkt. 5c., oz. 10c.,  $\frac{1}{4}$  lb. 25c., lb. 75c.

**Giant White Stuttgart.** Splendid for summer use; one of the best for slicing. Pkt. 5c., oz. 10c.,  $\frac{1}{4}$  lb. 20c., lb. 65c.

**White Summer Turnip.** An approved variety for the home garden. The Radish is round, quite large and decidedly crisp. Per pkt. 5c., oz. 10c.,  $\frac{1}{4}$  lb. 20c., lb. 60c.

**Yellow Summer.** The same as the preceding except in color. Per pkt. 5c., oz. 10c.,  $\frac{1}{4}$  lb. 20c., lb. 60c.

**White Strasburg.** Handsome, long roots of delicate flavor when small but remaining in good condition until maturity. Per pkt. 5c., oz. 10c.,  $\frac{1}{4}$  lb. 20c., lb. 65c.

**Half-Long Black.** Highly recommended as the best sort for winter. In color it is more of a gray than black and grows to an extremely large size. Per pkt. 5c., oz. 10c.,  $\frac{1}{4}$  lb. 25c., lb. 80c.

**Round Black Spanish.** Pkt. 5c., oz. 10c.,  $\frac{1}{4}$  lb. 20c., lb. 65c.

**Rose China Winter. (Scarlet China).** A rose colored variety of fine quality; flesh white. Per pkt. 5c., oz. 10c.,  $\frac{1}{4}$  lb. 25c., lb. 75c.



Radish, Scarlet Globe

## SPINACH One ounce will sow 50 feet of drill.

First sowings should be made as soon as the ground is open in spring. Sow seed half inch deep in drills one foot apart and every two weeks thereafter for succession. Sowings made during September usually grow large enough to winter over and with little protection afford Spinach very early the following spring. A rich soil is essential to obtain best results.

**Bloomsdale Savoy-Leaved.** The popular fall Spinach so largely grown for market. Grows upright, the leaves being crumpled, dark green and very thick. Per oz. 5c.,  $\frac{1}{4}$  lb. 15c., lb. 35c.

**Early Giant Thick-Leaved.** A quick growing sort and one of the best for wintering over. It is of large size, rich green color and excellent quality. Per oz. 5c.,  $\frac{1}{4}$  lb. 15c., lb. 35c.

**Improved Thick-Leaved.** This handsome strain of Spinach is especially useful for spring and summer sowing. Per oz. 5c.,  $\frac{1}{4}$  lb. 15c., lb. 35c.

**Long Season.** Leaves are decidedly dark green in color, very broad, thick and fleshy. It resists the summer heat remarkably well, in fact better than all others, and remains a long time in condition for use before going to seed. Per pkt. 5c., oz. 10c.,  $\frac{1}{4}$  lb. 20c., lb. 50c.

**Long-Standing.** Succeeds well at almost all seasons and though rather slow growing it is a very fine, large, dark green leaved Spinach. Per oz. 5c.,  $\frac{1}{4}$  lb. 15c., lb. 35c.

**New Zealand.** Distinct from the ordinary Spinach in appearance. The plants are more spreading in growth with small very dark green leaves, which may be had throughout the hot summer months. Sow seed outdoors during May, dropping about 3 seeds in hills two feet apart each way. Per pkt. 5c., oz. 10c.,  $\frac{1}{4}$  lb. 30c., lb. \$1.00.

**Round Thick-Leaved.** One of the best and most desirable for the home garden either for early or late planting. The round, slightly crumpled leaves are both tender and of good quality. Per oz. 5c.,  $\frac{1}{4}$  lb. 15c., lb. 35c.

**Victoria.** A favorite for early summer. It is one of the darkest in color and with exception of the heart, the leaves are comparatively smooth. Per oz. 5c.,  $\frac{1}{4}$  lb. 15c., lb. 35c.

**Viroflay.** Matures very early. The leaves are pointed, bright green, and when large should be cut as it soon runs to seed. Per oz. 5c.,  $\frac{1}{4}$  lb. 15c., lb. 35c.

## RHUBARB

Should be sown during April or May in drills one foot apart covering the seed about one half inch. Later thin out the seedlings to four inches apart and in the fall transplant to permanent beds of well enriched soil, setting plants not less than three feet apart. They will be in condition for use the following year. Per pkt. 5c., oz. 15c.,  $\frac{1}{4}$  lb., 40c.

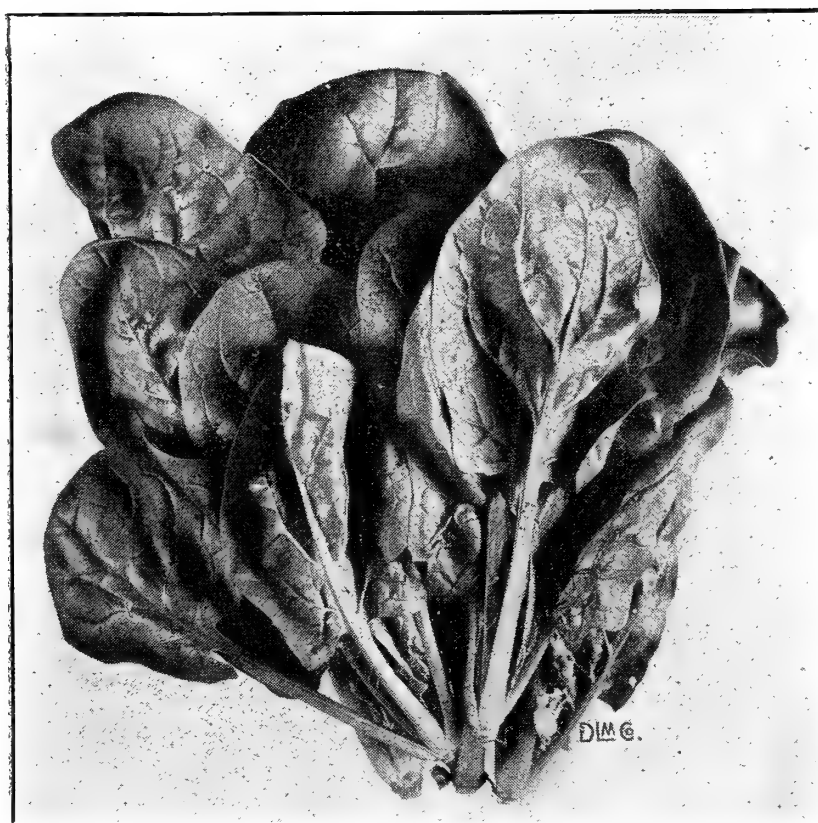

Spinach Victoria



Salsify, Mammoth Sandwich Island

## SALSIFY, or OYSTER PLANT

*One ounce will sow 75 feet of drill.*

This vegetable is best grown in a rich, deep but loose soil. Sow seed about one inch deep from April to June 15th in drills twelve inches apart. Later thin out to four inches in the row. They are usually ready for use in September but become more delicate in flavor after a light frost.

**Mammoth Sandwich Island.** The roots are white, extra long, straight and very tender. Per pkt. 5c., oz. 15c.,  $\frac{1}{4}$  lb. 40c., lb. \$1.25.

## SCORZONERA, or Black Oyster Plant

Should not be sown before May 15th, but otherwise is cultivated the same as Salsify. The roots are black.

**Long Black.** Per pkt. 5c., oz. 20c.,  $\frac{1}{4}$  lb. 60c., lb. \$2.00.

## SEA-KALE One ounce will sow 100 feet of drill.

As soon as the ground can be worked sow the seed in drills three feet apart and cover two inches. When plants are advanced thin out to six inches and cultivate during summer. During the winter or the following spring the process of blanching should begin. Per pkt. 10c., oz. 30c.,  $\frac{1}{4}$  lb. \$1.00.



Squash, Early Prolific Orange Marrow

**Hubbard.** A superior dark green winter variety. Grows very large and is one of the finest for table use. Per pkt. 5c., oz. 15c.,  $\frac{1}{4}$  lb. 35c., lb. \$1.00.

**Mammoth Summer Crookneck.** The largest and most desirable Crookneck Squash. Skin is well warted and of a beautiful golden color. Per pkt. 5c., oz. 15c.,  $\frac{1}{4}$  lb. 30c., lb. 90c.

**Mammoth White Bush Scalloped.** An early sort of bush habit. The fruits are uniformly large, pure white and of good quality. Per pkt. 5c., oz. 15c.,  $\frac{1}{4}$  lb. 30c., lb. 90c.

**Vegetable Marrow.** A favorite English sort about 9 inches in length and 5 inches in diameter, the flesh of which is white and very tender. Per pkt. 5c., oz. 15c.,  $\frac{1}{4}$  lb. 35c., lb. \$1.00.

## SORREL

*One ounce will sow 150 feet of drill.*

Seed sown during April in drills 12 inches apart and  $\frac{1}{2}$  inch deep will be in condition for cutting about July. For early spring use, a sowing should be made in August. The roots are hardy and if not disturbed will remain for several years.

**Large-Leaved French.** Per pkt. 5c., oz. 15c.,  $\frac{1}{4}$  lb. 35c., lb. \$1.00.

## SWISS CHARD, or Spinach Beet

*One ounce will sow 100 feet of drill.*

No matter how small the garden a place should be reserved for this vegetable. The leaves grow quite high and when broken off and cooked like Spinach are preferred by many to the latter. By using the outer leaves new ones will always form. Sow seed early in spring in rows 15 inches apart and later thin out to 6 inches in the row. Per pkt. 5c., oz. 10c.,  $\frac{1}{4}$  lb. 20c., lb. 50c.

## TOBACCO

*One ounce will produce plants for 1 acre.*

**Connecticut Seed Leaf.** Per pkt. 5c., oz. 25c.,  $\frac{1}{4}$  lb. 75c., lb. \$2.50.

**Imported Havana.** Per pkt. 10c., oz. 30c.,  $\frac{1}{4}$  lb. \$1.00, lb. \$3.50.

## SQUASH

*One ounce Early will plant 50 hills; 1 ounce Marrow, 25 hills.*

Not only Squash but all vine seeds should not be sown until the weather is quite warm. Early or summer varieties are planted during May in hills four feet apart; the winter sorts require from six to eight feet and are planted in July. Plant 8 or 10 seeds one inch deep in a hill, but later leave only three of the strongest plants remain. Soil should be rich and well manured.

**Boston Marrow.** This popular, oval shaped winter squash is one of the most useful for pies. Flesh rich orange, skin yellow. Per pkt. 5c., oz. 10c.,  $\frac{1}{4}$  lb. 20c., lb. 60c.

**Cocozella (Italian Vegetable Marrow.)** An esteemed Italian variety, 15 to 18 inches in length and about 4 in diameter; very dark green striped with white. Per pkt. 5c., oz. 15c.,  $\frac{1}{4}$  lb. 35c., lb. \$1.00.

**Delicious.** In color it is of the darkest green while the flesh is a beautiful orange; exceedingly dry and sweet. Medium size averaging from 5 to 10 pounds. Per pkt. 5c., oz. 15c.,  $\frac{1}{4}$  lb. 35c., lb. \$1.00.

**Early Prolific Orange Marrow.** Similar to Boston Marrow in shape but smaller in size, much earlier, and skin more reddish in color. Per pkt. 5c., oz. 15c.,  $\frac{1}{4}$  lb. 30c., lb. 90c.

**Fordhook.** The vines are vigorous and very productive, bearing small yellow fruit about 8 inches long, slightly ridged and of delicious flavor. Per pkt. 5c., oz. 15c.,  $\frac{1}{4}$  lb. 35c., lb. \$1.00.

**Golden Hubbard.** In size and shape the same as Hubbard. It is somewhat warted, golden red in color, while the flesh is fine grained, deep yellow and of extra rich flavor. Per pkt. 5c., oz. 15c.,  $\frac{1}{4}$  lb. 35c., lb. \$1.00.



Swiss Chard



Tomato, Earliana

## TOMATO

*One ounce will produce  
1,500 plants.*

For early Tomatoes start plants in hot beds during March, sowing the seed  $\frac{1}{4}$  inch deep in drills 6 inches apart. They should be replanted at least once in the frames before the final planting outdoors in May, after all danger of frost is past. It is unwise to set plants closer than 3 to 4 feet apart each way, as the vines grow vigorously and soon cover the entire space. In gardens where space is limited and only a few plants grown, we recommend the use of galvanized tomato supports.

**Acme.** Matures early, is purple red in color, smooth and very productive. Per pkt. 5c., oz. 25c.,  $\frac{1}{4}$  lb. 75c., lb. \$2.00.

**Coreless.** A recent introduction the fruit of which is almost round. In color it is bright red, ripening well up to the stem. Very productive, Tomatoes of large size and delicious flavor, form in clusters every short distance. Per pkt. 10c.

**Dwarf Champion.** Grows very dwarf and compact. Fruit purple slightly tinged with pink, of medium size, quite solid and excellent quality. Per pkt. 5c., oz. 25c.,  $\frac{1}{4}$  lb. 75c., lb. \$2.50.

**Dwarf Stone.** In growth it is somewhat like the preceding variety. The Tomatoes are considerably larger, while the flesh is firm and heavy which makes it a first class sort for the garden. Per pkt. 5c., oz. 35c.,  $\frac{1}{4}$  lb. \$1.00, lb. \$3.00.

**Earliana.** An exceedingly early, large Tomato of bright red color, smooth, solid and uniform in size. The vines are not very large but remarkably productive. Per pkt. 5c., oz. 35c.,  $\frac{1}{4}$  lb. \$1.00, lb. \$3.00.

**Early Jewel.** This variety is somewhat larger than Earliana but matures nearly a week later. The fruit is round, very meaty and of handsome bright scarlet color. Per pkt. 5c., oz. 35c.,  $\frac{1}{4}$  lb. \$1.00, lb. \$3.00.

**Favorite.** A good dark red sort for shipping. It is medium early, globe shaped and very smooth. Per pkt. 5c., oz. 25c.,  $\frac{1}{4}$  lb. 75c., lb. \$2.00.

**Golden Queen.** Rich golden yellow, equal to the red sorts both in size and flavor. Per pkt. 5c., oz. 25c.,  $\frac{1}{4}$  lb. 75c., lb. \$2.50.

**Improved Trophy.** Although rather late it is of unusual size, deep red and an immense cropper. Per pkt. 5c., oz. 25c.,  $\frac{1}{4}$  lb. 75c., lb. \$2.50.

**Matchless.** Strong, vigorous growing plants producing large Tomatoes until frost. It ripens well, does not crack, while its color is both rich and attractive. Per pkt. 5c., oz. 25c.,  $\frac{1}{4}$  lb. 75c., lb. \$2.50.

**Paragon.** A desirable, smooth, very solid Tomato of deepest red; useful for the table and preserving. Per pkt. 5c., oz. 25c.,  $\frac{1}{4}$  lb. 75c., lb. \$2.50.

**Perfection.** Even though one of the oldest it is still preferred by many to the later introductions. Ripens medium early and is esteemed both for market and home gardens. Per pkt. 5c., oz. 25c.,  $\frac{1}{4}$  lb. 75c., lb. \$2.00.

**Ponderosa.** Immense size, single specimens often weighing from 1 to 2 pounds. Flesh very firm, containing few seeds; good for slicing. Per pkt. 10c., oz. 50c.,  $\frac{1}{4}$  lb. \$1.50.

**Stone.** Very popular for late or main crop. It is extra large, exceedingly heavy and of a handsome brilliant scarlet while the shape is round and slightly flattened. Pkt. 5c., oz. 25c.,  $\frac{1}{4}$  lb. 75c., lb. \$2.50.

**Stirling Castle.** Stands supreme as a forcing variety and especially desirable for early outdoor planting. Fruit is rather small, bright red and produced abundantly. Per pkt. 10c.

**Red Peach, Red Cherry, Yellow Plum.** Fine for preserving. Each, per pkt. 5c., oz. 25c.

**Tomato Plants,** see page 33.

## RUTA BAGA, Russian or Swede Turnip

*One ounce will sow 150 feet of drill; two pounds for one acre.*

Sow seed from middle of June to July 15th, in drills  $1\frac{1}{2}$  to 2 feet apart, later thinning the plants to 8 inches in the row. They should be pulled before severe weather and after removing the tops stored in the cellar or pit outdoors.

**Long Island Improved.** A superior variety growing to a large size, well shaped, short neck and of a bright yellow color with purple top. Per pkt. 5c., oz. 10c.,  $\frac{1}{4}$  lb. 20c., lb. 60c.

# TURNIP

One ounce will sow 150 feet of drill; two pounds will sow an acre.

For early use sow in hotbed during March, selecting either of the Milan varieties. Sowings may be made outdoors in drills 12 inches apart as soon as the ground can be worked in spring and later thin out to 5 inches in the row. For succession sow at intervals of a fortnight until the last week of July, from which time until the end of August sowings should be made for the late crops.

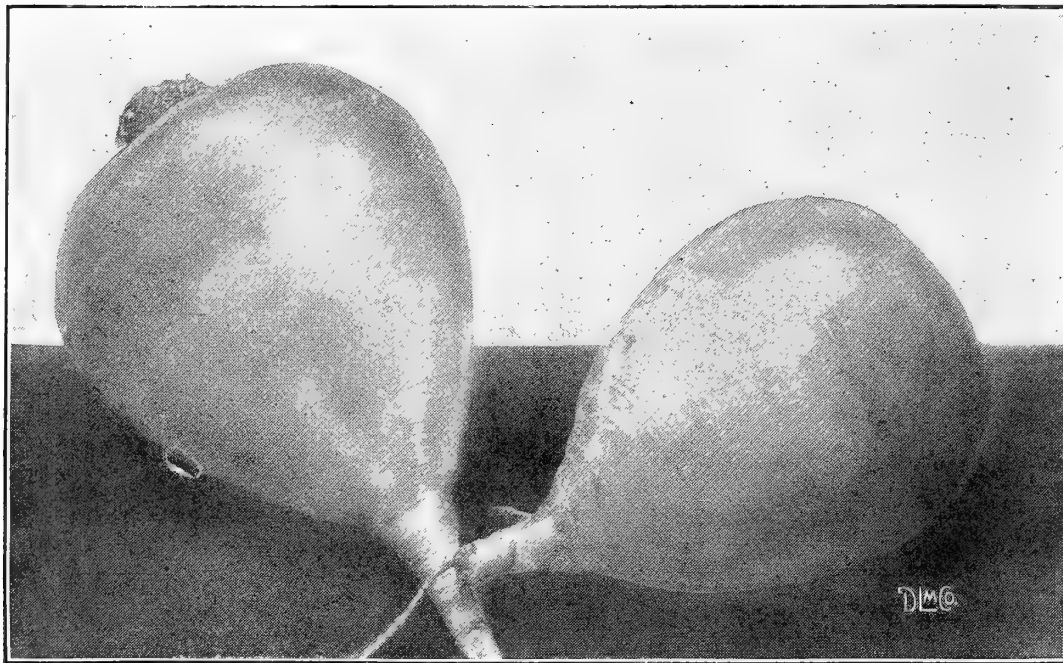

Turnip, Purple Top White Globe

**Early Snowball.** A first-class table variety with small, round, ball-shaped roots of the purest white; very tender. Per pkt. 5c., oz. 10c., 1/4 lb. 20c., lb. 60c.

**Extra Early White Milan.** Exceptionally fine for early sowing both in frames and outdoors. The bulb is smooth, flat and of medium size. Per pkt. 5c., oz. 10c., 1/4 lb. 30c., lb. 90c.

**Purple Top White Milan.** Almost identical in size and shape with the preceding but with purple crown. The flesh is white, sweet and fine flavored. Per pkt. 5c., oz. 10c., 1/4 lb. 25c., lb. 75c.

**Purple Top Strap Leaf.** A flat quick growing variety, popular either for spring or fall. Per pkt. 5c., oz. 10c., 1/4 lb. 20c., lb. 50c.

**Purple Top White Globe.** One of the best and most productive of the winter Turnips. The roots are attractive in color, globe-shaped, extra large and very solid. Per pkt. 5c., oz. 10c., 1/4 lb. 20c., lb. 50c.

**Seven Top.** The roots are of no particular use although the leaves, for which it is chiefly grown, furnish greens throughout the winter in Southern States. Per pkt. 5c., oz. 10c., 1/4 lb. 20c., lb. 50c.

**Yellow Stone.** Keeps well during winter. Color of skin and flesh is bright yellow, the latter being firm, sweet and tender. Per pkt. 5c., oz. 10c., 1/4 lb. 20c., lb. 50c.

## HERBS—Sweet, Pot and Medicinal

Do not fail to devote a small space in your garden to the cultivation of herbs. Sow during May or June in drills one foot apart covering the seed very lightly and later thin out or transplant to six inches in the row. Before in full blossom the plants should be cut, tied in small bunches and hung up in the shade to dry, after which they are placed in boxes or bottles for winter use.

	Per pkt.	Per oz.
Anise ( <i>Pimpinella anisum</i> ). Biennial.....	\$0 05	\$0 10
Balm ( <i>Melissa officinalis</i> ). Perennial.....	05	25
Basil, Sweet ( <i>Ocimum basilicum</i> ). Annual .....	05	20
Bene ( <i>Sesamum orientale</i> ). Annual .....	05	15
Caraway ( <i>Carum carai</i> ). Perennial .....	05	10
Castor Oil Plant ( <i>Ricinus communis</i> ). Annual .....	05	20
Coriander ( <i>Coriandrum sativum</i> ). Annual.....	05	10
Catnip ( <i>Nepeta cataria</i> ). Perennial.....	10	40
Fennel ( <i>Anethum feniculum</i> ). Perennial .....	05	10
Horehound ( <i>Marubium vulgare</i> ). Perennial.....	05	25
Hyssop ( <i>Hyssopus officinalis</i> ). Perennial.....	05	25
Lavender ( <i>Lavendula spica</i> ). Perennial.....	05	20
Marjoram, Sweet ( <i>Origanum marjorana</i> ). Annual....	05	20
Rosemary ( <i>Rosemarinus officinalis</i> ). Perennial.....	05	35
Rue ( <i>Ruta graveolens</i> ). Perennial.....	05	20
Saffron ( <i>Carthamus tinctorius</i> ). Annual.....	05	20
Sage ( <i>Salvia officinalis</i> ). Annual.....	05	20
Summer Savory ( <i>Satureia hortensis</i> ). Annual.....	05	15
Tansy ( <i>Tanacetum vulgare</i> ). Perennial.....	05	30
Thyme, Broad-leaved ( <i>Thymus vulgare</i> ). Perennial..	05	40
Wormwood ( <i>Artemisia absinthium</i> ). Perennial.....	05	20



Rosemary



Celery Plants

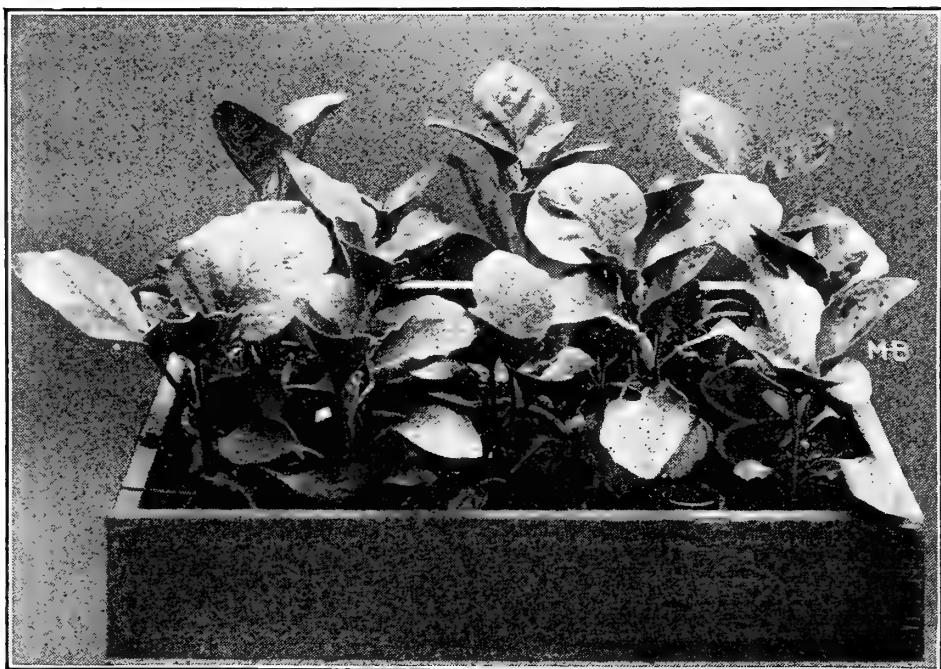

Pot-Grown Egg Plants

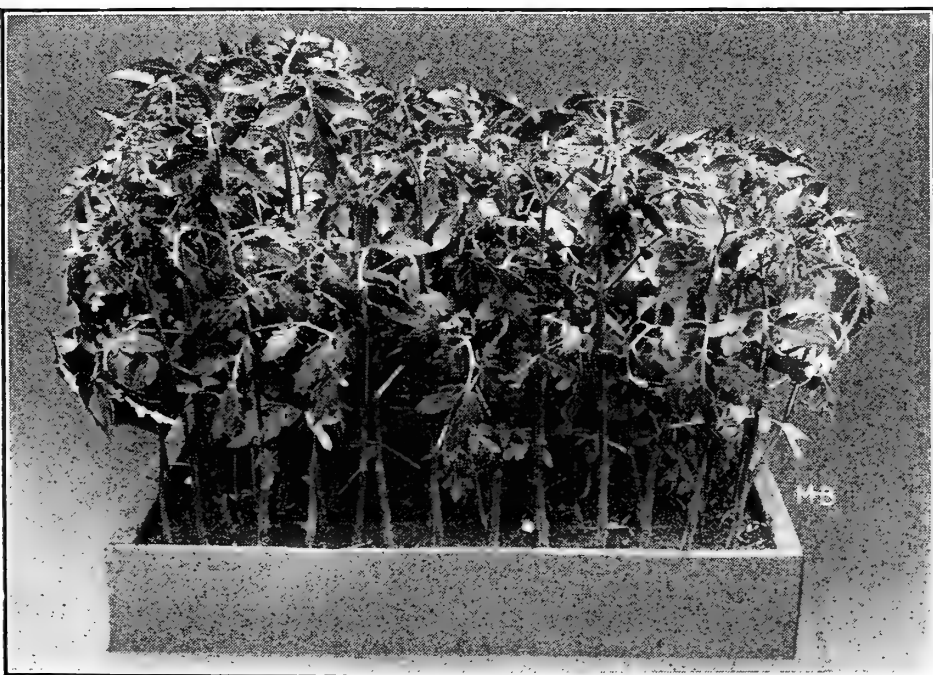

Tomato Plants

## VEGETABLE PLANTS AND ROOTS

The following list comprises some of the best varieties in each class and with the strong, transplanted plants that we offer, purchasers are almost certain of success.

If wanted by mail, add 6c. per dozen extra for postage. Egg Plants and larger quantities can be sent by express only at buyer's expense.

**Cabbage.** Ready April 20th. Charleston Wakefield, All Head Early, Succession, American Drumhead Savoy, Mammoth Rock Red. Price per doz. 15c., per 100 \$1.00, per 1000 \$6.50.

**Cauliflower.** Ready April 20th. Early Snowball. Price per doz. 20c., per 100 \$1.50.

**Celery.** Ready April 20th. Perfection Heartwell, Soup or Cutting. Price per doz. 15c., per 100 85c., per 1000 \$7.00.

**Celery.** Golden Self-Blanching. Ready in June. Price per 100 50c., per 1000 \$4.00.

**Celeriac.** Ready April 20th. Large Smooth Prague. Price per doz. 15c., per 100 85c.

**Egg Plants.** Pot Grown. Ready May 15th. New York Improved Purple. Price per doz. 50c., per 100 \$3.50.

**Kohl-Rabi.** Ready April 20th. Early White Vienna. Price per doz. 10c., per 100 70c.

**Lettuce.** Ready April 20th. Big Boston, Mammoth Black Seeded Butter. Price per doz. 10c., per 100 70c., per 1000 \$6.50.

**Pepper Plants.** Ready May 15th. Large Bell or Bull Nose. Price per doz. 20c., per 100 \$1.50.

### TOMATO (Ready April 25th)

**Ponderosa.** Price per dozen 15c., per 100 \$1.00.

**Acme, Dwarf Stone, Early Jewel, Perfection, Stone, Matchless, Golden Queen, Red Cherry, Yellow Plum.** Price per doz. 15c., per 100 80c., per 1000 \$6.50.

Our plants are grown in flats containing 100 each. Less than 100 plants will be charged at dozen rates.

**Horseradish Roots.** Ready April 1st. Per doz. 15c., 100 75c.

**Rhubarb Roots.** Ready April 1st. Each 10c., per doz. \$1.00.

**Asparagus Roots.** See page 6.

### FLOWERING PLANTS

Ready in May. By Express only, not prepaid

**Aster, Queen of the Market.** Pot grown. Rose, White, Dark Blue. Per doz. 25c., per 100 \$2.00.

**Bellis, Double Daisy, White and Pink.** Per doz. 50c., per 100 \$3.00.

**Carnations (Hardy).** Field-grown plants. Per doz. \$1.00.

**Chrysanthemums.** Pot grown. Pink, White, Yellow. 5c. each, per doz. 50c.

**Pansies. Mixed Colors.** Per doz. 50c., per 100 \$3.00.

**Sweet William.** Field-grown plants. Per doz. \$1.00.

We also have a large assortment of other bedding plants during May, such as Alyssum, Ageratum, Begonia, Geranium, Phlox, Salvia, Verbena, etc., and would be pleased to furnish prices during that month.

## FIELD CORN

*Eight quarts will plant one acre in hills; three bushels will sow one acre broadcast or half that quantity in drills.*

If wanted by mail, add 15c. per qt. extra for postage.

### DENT VARIETIES

#### CHAMPION WHITE PEARL

An extra early variety ripening in about 95 days. It is a very heavy yielder, the ears having small cobs with 14 and 16 rows of long, deep kernels of the purest white. Per qt. 15c., pk. 60c., bus. \$2.00.

#### GOLDEN BEAUTY

Highly recommended as one of the best of the yellow Dent Field Corns. The stalks grow from 8 to 10 feet high and usually mature their large sized, small cobbed ears in one hundred and fifteen days from time of planting. The ears are of handsome appearance and filled out to the tip with exceedingly large, broad grains of rich yellow color, which are excellent for grinding into meal. Per qt. 15c., pk. 60c., bus. \$2.00.

#### SNOWFLAKE WHITE DENT

A very desirable sort bearing ears from 9 to 12 inches in length and maturing in 110 to 115 days. The ears are well filled with large, smooth, snow white kernels, which when shelled, fill the measure quickly. The stalks do not grow very high but each produces from one to two good ears. Per qt. 15c., pk. 60c., bus. \$2.00.

#### IMPROVED LEAMING

Matures quite early, adapted to most all soils and is largely planted in both the Northern and Southern States. Under good conditions it will yield one hundred bushels and over per acre. The long, tapering ears have golden yellow grains, of medium size and on an average of two are produced on each stalk. The stalks of this variety will be found very good for ensilage. Per qt. 15c., pk. 60c., bus. \$2.00.

#### MASTODON EARLY

For size, this wonderful variety heads the list of all the early Dent Corns. Besides being a sure and abundant cropper, yielding as high as 175 bushels to the acre, its strong stalks and luxuriant foliage

are most valuable for ensilage. From 16 to 22 rows of deep, golden yellow and white shaded grains are formed on the small red cobs. Our customers will find this an especially good Field Corn which is almost certain to ripen even in the far Northern States. Per qt. 15c., pk. 60c., bus. \$2.00.

#### 90-DAY YELLOW DENT

To those desiring an early maturing Corn, 90-Day Yellow Dent will be found very satisfactory. Though the ears are not of the largest size, the kernels are formed very compactly on the cob and considering its extreme earliness, is a good yielder. Per qt. 15c., pk. 60c., bus. \$2.00.

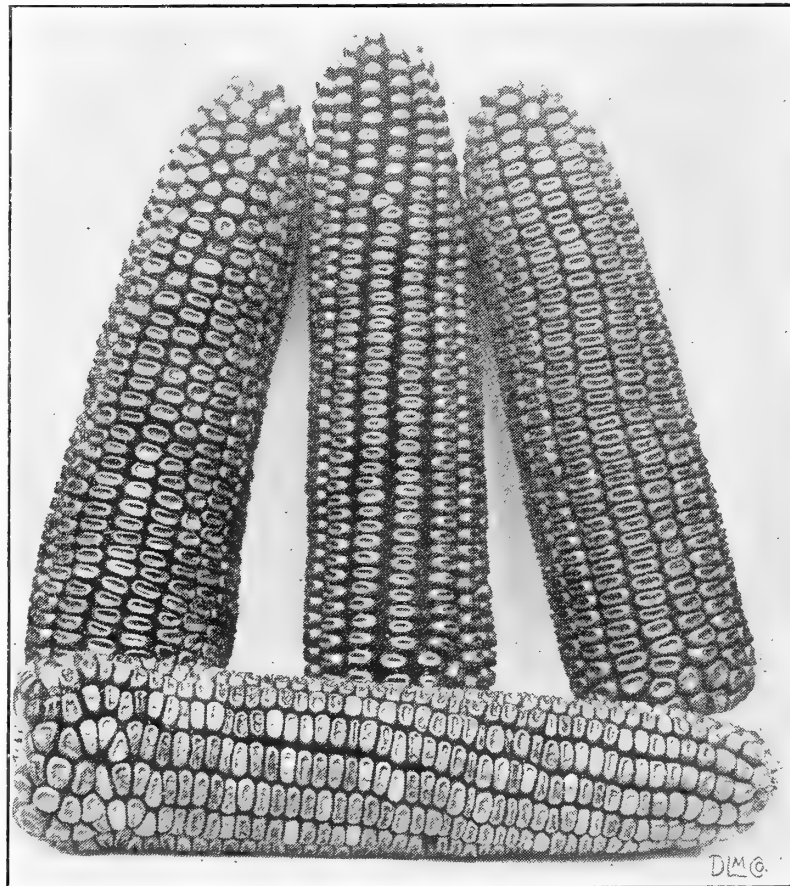

Field Corn, Golden Beauty

### FLINT VARIETIES

#### LARGE YELLOW FLINT

Ripens earlier and is much hardier than the Dent varieties. The ears are long and slender with large, very broad grains. Per qt. 15c., pk. 60c., bus. \$2.00.

#### WHITE SANFORD

Medium size ear, 8 rowed, kernels large, broad and of a silvery white color; very productive. Per qt. 15c., pk. 60c., bus. \$2.00.

**Long Island Beauty Sweet Corn is one of the best second earlies for the home garden.**



# LAWN GRASS SEED

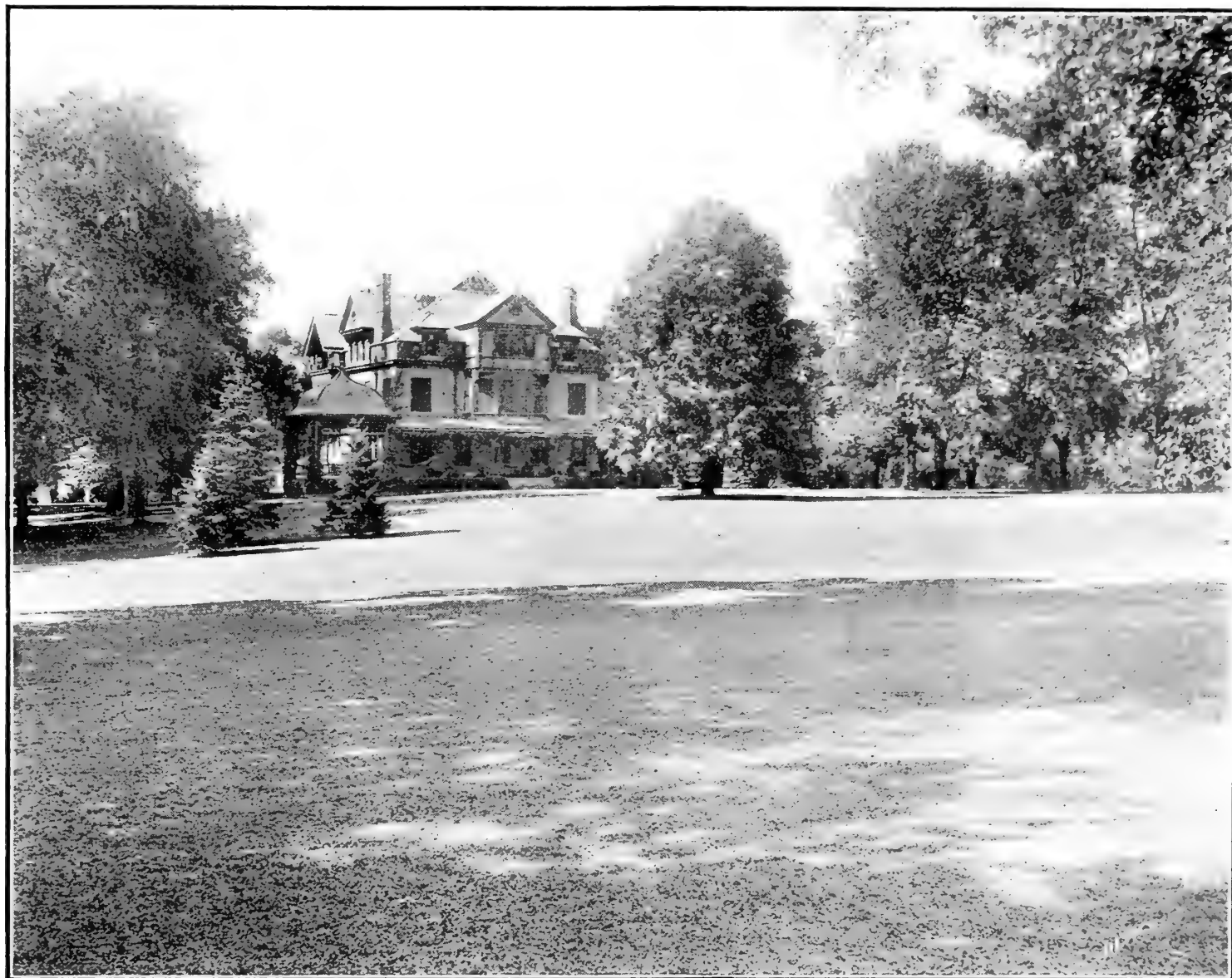

## M. H. BRUNJES & SON'S CHOICE CENTRAL PARK LAWN GRASS

(Weight, 20 lbs. per bushel)

A beautiful lawn always adds to the attractiveness of the home and we can truthfully say that many of the finest lawns have been produced from our Choice Central Park Lawn Grass Mixture. It weighs 20 pounds to the bushel and is composed of the finest dwarf evergreen grasses, which mature during different months, thus insuring a thick, rich, velvety green lawn almost through the year. Although the greater number of lawns have been made by sowing the seed in spring, usually from the end of March until July, equally good results can be obtained from fall-sown seed. In the early spring a dressing of our Lawn Invigorator, Bone Meal, or Sheep Manure is very beneficial. In making a lawn it should always be remembered to sow the seed thickly. One quart will sow 15x20 (300 square feet), 1 bushel 100x108 (10,800 square feet), 4 bushels one acre (43,560 square feet).

Price per qt. 20c., by mail, postpaid, 25c.; 2 qts. 40c., by mail, postpaid, 50c.; ½ pk. 75c., by mail, postpaid, 95c.; by express, not prepaid, pk. \$1.25; bushel (20 lbs.) \$4.50.

Full directions for making a lawn printed on each box.

## SHADY NOOK LAWN GRASS

In shady places, especially under trees, may often be seen bare spots which spoil the appearance of the balance of the lawn. For such places we can recommend this mixture, as it contains only those grasses suited for growing in shady places. Use the same quantity of seed as given above.

Price per qt. 25c., by mail, postpaid, 30c.; 2 qts. 50c., by mail, postpaid, 60c.; ½ peck 90c., by mail, postpaid, \$1.10; by express, not prepaid, pk. \$1.50; bushel (20 lbs.) \$5.00.

We feel so confident that our seeds will please you that we only ask to be favored with a trial order, to prove it is to your advantage to place your order with us.



# GENERAL LIST OF FLOWER SEEDS

The following ABBREVIATIONS are used throughout the FLOWER SEED portion of our Catalogue :

H. A.....Hardy Annuals.	H. P.....Hardy Perennials.	H. H. B.....Half-Hardy Biennials.
H. H. A.....Half-Hardy Annuals.	H. H. P.....Half-Hardy Perennials.	H. C.....Hardy Climbers.
T. A.....Tender Annuals.	H. B.....Hardy Biennials.	G. S.....Greenhouse Shrubs.

Full Directions for Sowing FLOWER SEEDS printed on each packet.

**WE PREPAY POSTAGE ON ALL FLOWER SEEDS IN PACKETS AND OUNCES.**

- ABRONIA** (Sand Verbena). A pretty trailing annual with sweet-scented verbena-like flowers, suited for hanging baskets and vases. Prefers a sandy soil.  $\frac{1}{2}$  ft.  
**Umbellata.** Rosy-lilac. ....Pkt. 5c.
- ABUTILON.** Bell-shaped perennial shrubs, of easy cultivation and valuable as a house plant in winter and for the garden in summer. 3 ft. G. S.  
**Finest Mixed Hybrids.** .....Pkt. 10c.
- ACHILLEA.** From June to October this hardy perennial, growing about  $1\frac{1}{2}$  feet high, is a mass of pure white double flowers.  
**The Pearl.** .....Pkt. 10c.
- ACONITUM.** Tall growing plants suitable for hardy borders and thriving best in shady locations. 4 ft. H. P.  
**Napellus.** Long spikes of blue hood-shaped flowers. ....Pkt. 5c.
- ACROCLINIUM.** These splendid Everlastings are pretty as garden annuals or may be gathered when the buds first open and preserved for winter. 1 ft.  
**Double Mixed.** Rose and White..... $\frac{1}{4}$  oz. 15c., pkt. 5c.
- ADLUMIA Cirrhosa** (Mountain Fringe). A hardy biennial climber with feathery-like foliage and innumerable small tube shaped flowers of a delicate rose color. Height 15 ft. Pkt. 10c.
- ADONIS Aestivalis** (Flos Adonis). The single, scarlet flowers are bright, showy and contrast well with the fine cut dark green foliage. 1 ft. H. A. .... Oz. 25c., pkt. 5c.
- Vernalis.** A perennial blooming in May; large bright yellow flowers. 1 ft. .... $\frac{1}{4}$  oz. 20c., pkt. 5c.

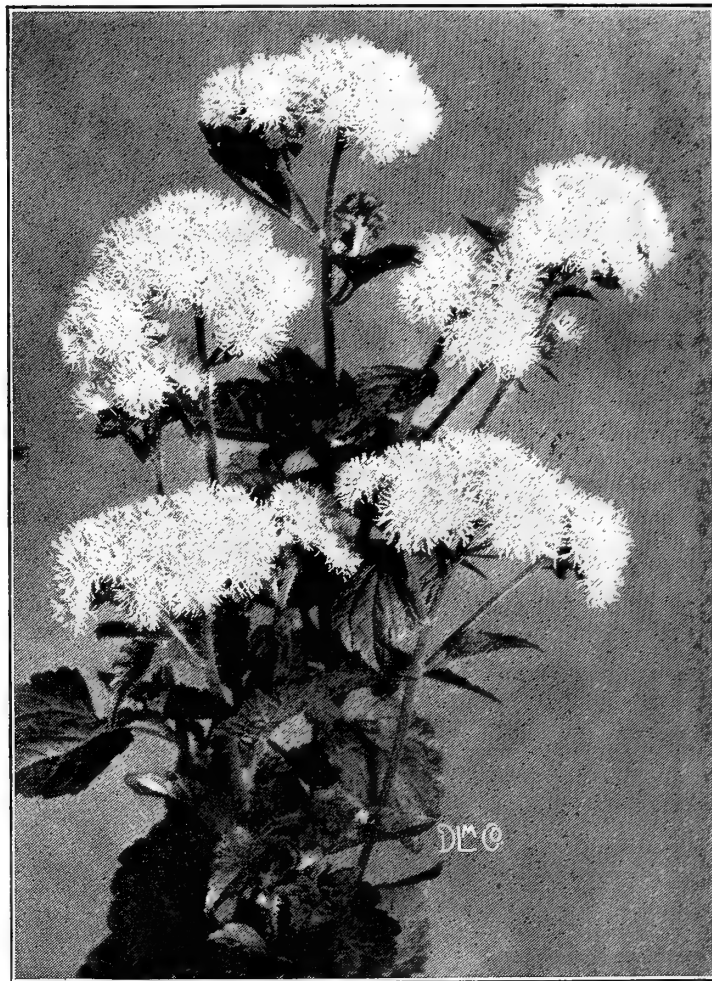

Ageratum

## AGERATUM

This everblooming annual is of the easiest culture and one of the

leading blue flowered plants whether for bordering or bedding. Its rich blue flowers are formed in

clusters and at times fairly cover the entire plant.

**Blue Perfection.** Flowers of the largest size and deepest blue. 8 inches ...  $\frac{1}{4}$  oz. 25c., pkt. 5c.

**Blue Star.** A handsome miniature variety growing only 5 inches high. Plants are one mass of bright blue flowers.....Pkt. 10c.

**Imperial Dwarf Blue.** A splendid free flowering sort. Fine for bedding. 8 inches..... $\frac{1}{4}$  oz. 20c., pkt. 5c.

**Imperial Dwarf White.** Similar to the above but having flowers of the purest white. 8 inches .....  $\frac{1}{4}$  oz. 20c., pkt. 5c.

**Little Dorrit.** Dwarf bushy plants, about 6 inches high, with beautiful azure blue flowers. Fine for pot culture.  $\frac{1}{4}$  oz 25c., pkt. 5c.

**AGROSTEMMA Cœli Rosea** (Rose of Heaven). A free blooming annual, not more than  $1\frac{1}{2}$  feet high, having bright rose colored flowers which are suitable for bouquets. .... Pkt. 5c.

**Coronaria** (Rose Campion). Effective when grown in masses and if sown early, blooms the first season. Single, dark red flowers and silvery white foliage. H. P. .... $\frac{1}{4}$  oz. 15c., pkt. 5c.

## ALYSSUM

Very desirable for edging. The seed germinates quickly and the pure white flowers begin to appear about one month later. The plants are dwarf, spreading and continue to bloom sometimes as late as November. H. A.

**Carpet of Snow.** The plants of this superb variety do not exceed 4 inches in height and are in constant bloom until the appearance of frost.....Oz. 50c., pkt. 10c.

**Little Gem.** A splendid sort growing somewhat higher than Carpet of Snow.....Oz. 40c., pkt. 5c.

**Cdoratum** (Sweet Alyssum). Very fragrant, blooms freely and its pure white flowers are fine for cutting.  $\frac{1}{2}$  ft.....Oz. 25c., pkt. 5c.

**Saxatile Compactum.** Bright golden perennial sort blooming early in the spring.....Pkt. 5c.



Sweet Alyssum

# ASTERS

The ever-increasing demand for this favorite flower surely proves its popularity both with the florist and also for the home garden. It has few superiors for cutting and ranks with the best annuals for bedding. For early flowers sow in frames during March and April, while for late flowering, seed may be sown in the open ground in May. They prefer a sunny location, rich soil and, if possible, avoid planting them on the same place two years in succession. H. H. A.

**QUEEN OF THE MARKET.** This is one of the earliest Asters grown. The plants are of branching habit and produce flowers, of rather large size and quite full to the center, which are splendid for cutting. Height 15 inches.

- |                                    |                                      |
|------------------------------------|--------------------------------------|
| Crimson... 1/4 oz. 35c., pkt. 10c. | Dark Blue... 1/4 oz. 35c., pkt. 10c. |
| Pink..... " 35c., pkt. 10c.        | Pure White " 35c., pkt. 10c.         |
| Scarlet.... " 35c., pkt. 10c.      | Bright Rose " 35c., pkt. 10c.        |
| Light Blue " 35c., pkt. 10c.       | Finest Mixed..oz. \$1., pkt. 10c.    |

**TRUFFAUT'S PÆONY PERFECTION.** A superb variety; in fact, considered one of the most perfect Asters grown. The flowers are of good size, with incurved petals, and begin blooming in August. 1 1/2 to 2 ft.

- |                               |                                    |
|-------------------------------|------------------------------------|
| Bright Rose ..... Pkt. 10c.   | Light Blue..... Pkt. 10c.          |
| Purple Violet ..... Pkt. 10c. | Snow White ..... Pkt. 10c.         |
| Dark Crimson ..... Pkt. 10c.  | Mixed..... 1/4 oz. 50c., pkt. 10c. |

**DWARF QUEEN.** The large double blooms are formed on dwarf plants about one foot high, which render them suitable either for pots or borders.

- |                             |                                    |
|-----------------------------|------------------------------------|
| Bright Rose. .... Pkt. 10c. | Dark Blue..... Pkt. 10c.           |
| Pure White..... Pkt. 10c.   | Mixed..... 1/4 oz. 50c., pkt. 10c. |

**VICTORIA.** Flowers of this remarkably fine strain are beautifully formed, extra double, and of striking appearance. The plants are of pyramidal growth, about 18 inches high, covered with blooms throughout the latter part of the summer.

- |   |
|---|
| Dark Blue..... Pkt. 10c.                  |
| Peach Blossom..... Pkt. 10c.              |
| Dark Scarlet..... Pkt. 10c.               |
| Pure White..... Pkt. 10c.                 |
| Light Blue..... Pkt. 10c.                 |
| Violet..... Pkt. 10c.                     |
| Finest Mixed..... 1/4 oz. 60c., pkt. 10c. |



Aster, Giant Branching

**GIANT COMET.** The long, wavy petals form flowers of immense size, usually 3 to 4 inches in diameter. 1 1/2 ft.

**The Bride (White passing to rose)..... Pkt. 10c.**

**Pure White..... Pkt. 10c.**

**Mixed Colors.. Pkt. 10c.**

**HOHENZOLLERN.**

The finest of all feathered or loose petaled varieties. It is early, very large and a profuse bloomer.

Pkt.

**Azure Blue..... 10c.**

**Pure White..... 10c.**

**Bright Rose... 10c.**

**Silvery Lilac... 10c.**

**Mixed. 1/4 oz. 60c., 10c.**

**GIANT BRANCH-**

**ING.** A general favorite for late blooming. The flowers are large and

handsome, gracefully formed, and borne on long, stiff stems; valuable for cutting. 2 1/2 ft.

- |  |                                   |
|--|-----------------------------------|
| Crimson... 1/4 oz. 35c., pkt. 10c.     | Purple... 1/4 oz. 35c., pkt. 10c. |
| Shell-Pink " 35c., pkt. 10c.           | White.. " 35c., pkt. 10c.         |
| Lavender " 35c., pkt. 10c.             | Rose.... " 35c., pkt. 10c.        |
| Finest Mixed.....oz. \$1.00, pkt. 10c. |                                   |

**CHINA. Finest mixed ..... Pkt. 5c.**

**DWARF VICTORIA.** A magnificent class of dwarf Asters, with immense double flowers ranging in almost every shade and color. 12 inches.

**Finest Mixed ..... 1/4 oz. 60c., pkt. 10c.**

**CROWN, OR COCARDEAU.** The white centered flowers are bordered with various brilliant colors. Very attractive. 1 1/2 ft.

**Finest Mixed ..... 1/4 oz. 50c., pkt. 10c.**

**DWARF, CHRYSANTHEMUM-FLOWERED.** One of the late-flowering Asters. It is of compact growth and blooms freely.

**Finest Mixed..... 1/4 oz. 50c., pkt. 10c.**



Aster, Truffaut's Pæony Perfection

ASTERS—Continued

- Ball or Jewel.** Splendid free flowering variety, forming compact plants, about 2 feet high, which begin blooming in August and valuable alike for bedding or cutting. The flowers are as round as a ball, with short incurved petals quite similar to the Peony Perfection.
- Finest Mixed**..... ¼ oz. 50c., pkt. 10c.
- Daybreak.** Splendid early blooming sort, having large, double, shell pink flowers, almost round, which are exceptionally fine for bouquets..... ¼ oz. 75c., pkt. 10c.
- Hercules.** Tremendously large flowers of the purest white of the Giant Comet order, often measuring six and seven inches in diameter. .... 3 pkts. 50c., pkt. 20c.
- Purity.** Another magnificent Aster, similar in growth to Daybreak but having flowers of the purest white..... ¼ oz. 75c., pkt. 10c.
- Sunrise.** When in bloom the plants of this variety present a striking appearance. The quilled petals, of a very delicate pink color, form very charming oval shaped Asters about four inches in diameter..... 2 pkts. 40c., pkt. 25c.
- Violet King.** Owing to its immense size and beautiful soft violet colored flowers, this sterling sort became a favorite at once. Plants of branching growth with long, stiff stems and gracefully formed full-centered flowers..... ¼ oz. 75c., pkt. 10c.
- One pkt. each of the above last 5 varieties, 60c.

HARDY PERENNIAL ASTER

Where once established, these handsome single perennial Asters, with their hundreds of bright dai-y-like flowers, afford a grand display, which increases in beauty year after year. 2½ ft.

Large Flowered Mixed .....Pkt. 10c.

AMARANTHUS

Ornamental foliage plants preferring a warm, dry situation. Their stately growth and brilliant colored leaves present an attractive appearance when used for back grounds or in center of beds. H. H. A.

- Caudatus** (Love-Lies-Bleeding). Plants about 3 feet high, with long drooping spikes of crimson flowers..... Pkt. 5c.
- Cruentus.** A well known variety, with dark red, feathery flowers and foliage. 2 ft..... Pkt. 5c.
- Tricolor Splendens** (Joseph's Coat). Superior to the old variety; dazzling variegated foliage..... Pkt. 5c.
- AMMOBIUM.** An annual, white flowered Everlasting; which will be found useful for bouquets. Grows about 2 feet high and prefers a light sandy soil.
- Alatum Grandiflorum**.....Pkt. 5c.

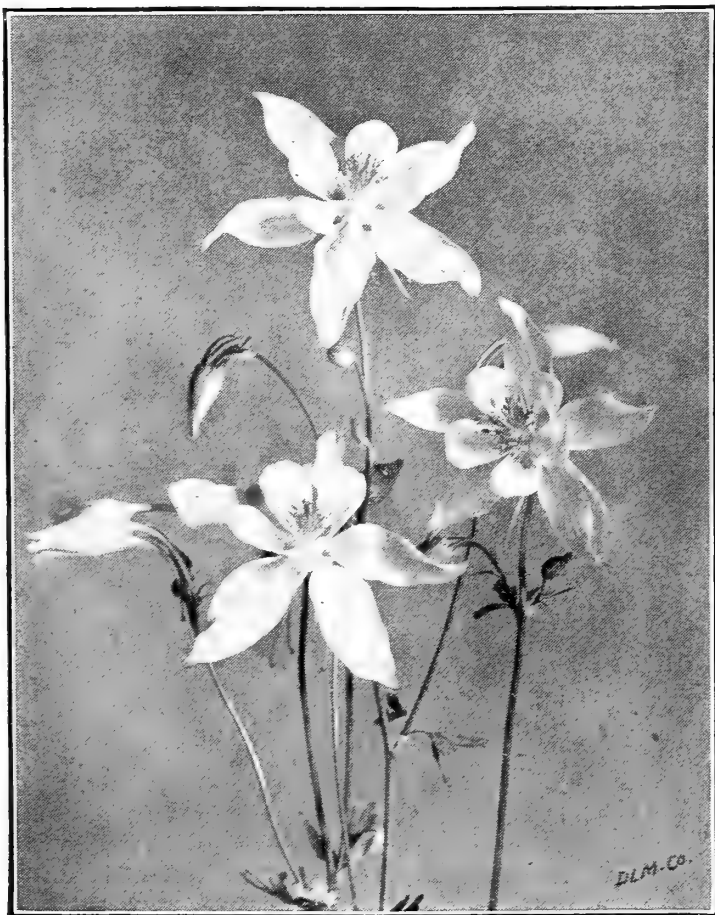

Aquilegia



Aster, Sunrise

- AMPELOPSIS Veitchii** (Japanese or Boston Ivy). The well known hardy climber so popular for covering brick or stone walls. In Autumn the deep green leaves turn to red. H. P..... Pkt. 5c.
- ANAGALLIS.** This small single flowered annual, ranging in colors of pink, red, blue and lilac, should be started early and transplanted to a sunny position outdoors in May. H. A.
- Grandiflora, Finest Mixed**.....Pkt. 5c.
- ANCHUSA Capensis.** Blue flowered annual with large Forget-Me-Not-like blossoms ... Pkt. 5c.
- Barrelieri.** Handsome hardy perennial, taller than Capensis, bearing deep blue flowers. 2 ft... Pkt. 10c.
- ANEMONE.** Early spring blooming plants with bright cup-shaped flowers. H. P. 1 ft.
- Coronaria** (Poppy Anemone). Finest mixed. .... Pkt. 5c.
- St. Brigid.** An improvement on the preceding, producing double and semi-double flowers of immense size and many colors..... Pkt. 10c.

AQUILEGIA

One of our prettiest perennials, blooming in endless profusion from May until July. The odd shaped flowers are unique in appearance and borne on slender stems well above the foliage.

- Chrysantha.** Attains a height of three feet and has beautiful golden yellow flowers..... Pkt. 5c.
- Chrysantha fl. pl.** Double, long spurred flowers of a rich golden color..... Pkt. 10c.
- Cœrulea.** A variety of striking beauty; flowers violet blue and white. 2 ft..... Pkt. 10c.
- Rose Queen.** Long spurred flowers of a soft, delicate rose or pink color with white centers and yellow anthers. A charming and very pleasing color combination. 15 inches..... Pkt. 15c.
- Single Varieties, Finest Mixed**..... Pkt. 5c.
- Double Varieties, Finest Mixed**..... Pkt. 5c.
- ARABIS Alpina.** Splendid little plants for edging, growing six inches high and covered with a mass of small white flowers early in spring. H. P..... ¼ oz. 25c., pkt. 5c.
- ARCTOTIS Grandis.** This daisy-like annual is of easiest culture, blooms continuously until frost and is splendid for cutting. Flowers white, reverse of petals pale blue. 2½ ft..... ¼ oz. 25c., pkt. 5c.
- ARMERIA Formosa** (Sea Pink). Very dwarf plants, not over six inches high, above which are borne on slender, wiry stems, many small double pink flowers. H. P. ¼ oz. 25c., pkt. 5c.
- ASPERULA Odorata** (Sweet Woodruff). White flowered perennial, thriving best in partial shade. Prized for the fragrance of its leaves, which are dried and placed among clothing. Pkt. 5c.
- ASTILBE Davidii.** Handsome tall growing plants with luxuriant foliage and graceful spikes of rosy violet flowers borne on stems nearly six feet long. H. P..... Pkt. 15c.
- AURICULA.** See Primula.



### CALLIOPSIS (Coreopsis)

Favorite free flowering annuals requiring no particular attention but thriving best in sunny locations. Sow seed early in spring where plants are to remain.

- Atrosanguinea.** Dark crimson. 2 ft. .... Pkt. 5c.
- Coronata maxima.** Showy, large yellow flowers, especially fine for cutting ..... Pkt. 5c.
- Drummondii** (Golden Wave). Compact bushes are completely covered with bright golden yellow, dark centered flowers. Very pretty border plant. 1 ft. .... 1/4 oz. 15c., pkt. 5c.
- Dwarf Mixed.** ..... Oz. 30c., pkt. 5c.
- Tall Mixed.** ..... Oz. 25c., pkt. 5c.

#### PERENNIAL VARIETIES

From early summer until fall these hardy perennials are in constant bloom and their long stemmed flowers afford excellent material for cutting.

- Grandiflora.** Bright golden yellow. 2 1/2 ft. 1/4 oz. 20c., pkt. 5c.
- Lanceolata.** Flowers large and showy, averaging 3 inches in diameter and of a rich golden color. .... 1/4 oz. 35c., pkt. 10c.
- CALAMPELIS Scabra.** Splendid half-hardy climber for covering walls, trellises, etc., with racemes of brilliant, orange colored tubular flowers and delicate foliage. 10 ft. Pkt. 10c
- CALCEOLARIA.** Gorgeous greenhouse plants with magnificent striped, mottled and self-colored flowers of striking beauty. Sow seed during June or July. H. H. B. 2 ft.
- Grandiflora, Finest Mixed.** Tigered and self colored. Pkt. 25c.

### CAMPANULA

There are quite a number of old-fashioned flowers, but this one seems to be a favorite with all. The blue and white bell shaped flowers, blooming as they do in such great profusion, always attract attention. H. P.

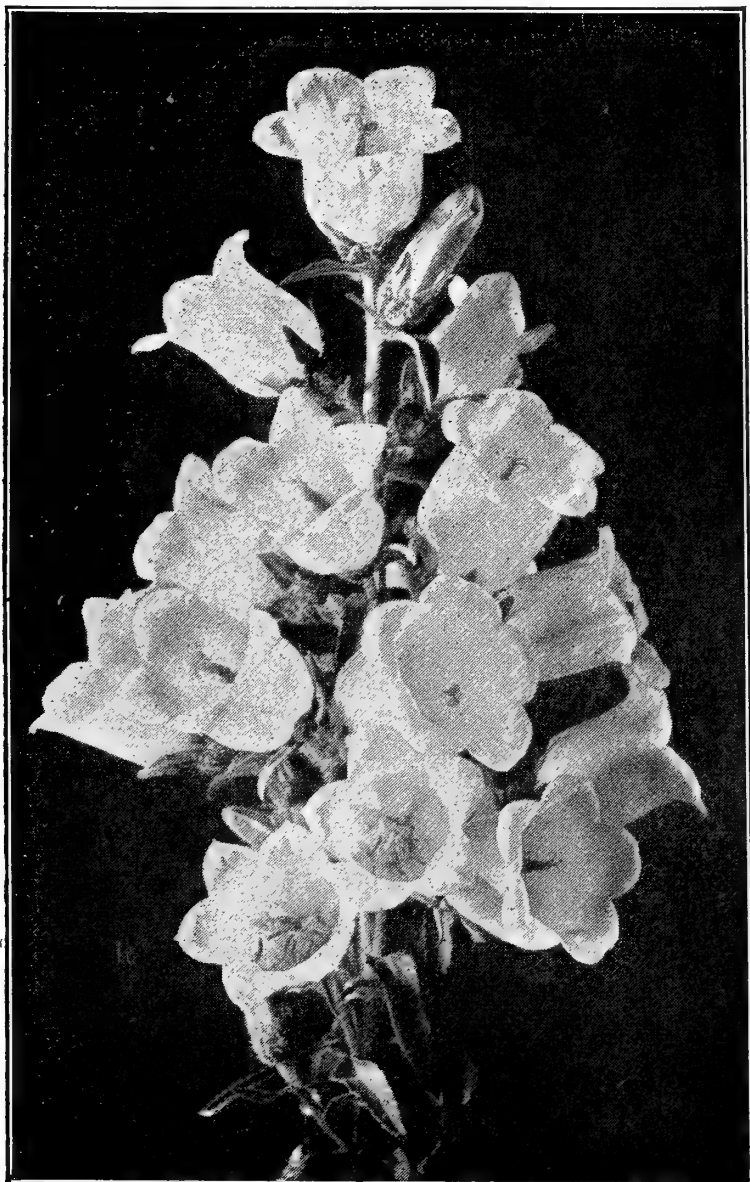

Canterbury Bells



Calliopsis Drummondii

- Carpatica.** Pretty border plants with clear blue flowers; blooms all summer. 6 inches. H. P. .... Pkt. 5c.
- Carpatica alba.** Pure white. .... Pkt. 5c.
- Persicifolia** (Peach Bells). A grand variety having large bell or cup-shaped blossoms. 2 1/2 ft.
- Finest Mixed.** Blue and white. .... Pkt. 10c.
- Pyramidalis.** The handsome showy flowers are borne on long stems about 5 feet high.
- Blue.** ..... Pkt. 5c.
- White.** ..... Pkt. 5c.
- Finest Mixed.** ..... Pkt. 5c.

### CANTERBURY BELLS (Campanula Medium)

Admirably adapted for borders, beds or massing and their countless number of beautiful flowers may be enjoyed during a long period. H. B. 2 ft.

- Single Blue.** ..... Pkt. 5c. | **Single Striped.** ..... Pkt. 5c.
- Single Rose** ..... Pkt. 5c. | **Single White.** ..... Pkt. 5c.
- Finest Single Mixed.** ..... 1/4 oz. 15c., pkt. 5c.
- Finest Double Mixed** ..... 1/4 oz. 25c., pkt. 5c.
- Calycanthema** (Cup and Saucer). Finest Mixed. .... pkt. 5c.

### CANDYTUFT

Well known hardy annual of dwarf, branching growth requiring little attention for success. Any ordinary garden soil will answer, but it demands a sunny position.

- Empress.** Best pure white variety. .... Oz. 40c., pkt. 5c.
- White Rocket.** White; prized for cutting. Oz. 25c., pkt. 5c.
- Sweet Scented.** Small white fragrant flowers. Oz. 25c., pkt. 5c.
- Little Prince.** A dwarf variety with large heads of pure white flowers; fine for pots. 1/2 ft. .... Pkt. 10c.
- Crimson.** ..... Oz. 25c., pkt. 5c.
- Carmine.** ..... Oz. 40c., pkt. 5c.
- Fine Mixed.** All colors. .... Oz. 25c., pkt. 5c.
- Dwarf Hybrids Mixed.** ..... 1/4 oz. 25c., pkt. 5c.
- Perennial** (Iberis Sempervirens). Pure White. .... Pkt. 10c.

- CANNA.** Few plants surpass the Canna for center pieces or bedding. Sow seed early indoors.
- Crozy's Large Flowering.** Fine Mixed. .... Pkt. 5c.

# CARNATIONS

Popular free blooming plants, growing from 12 to 18 inches high and bearing large, double, rich colored flowers. H. H. P.

**MARGUERITE.** Favorite variety for starting early, either in February or March, when it will bloom continuously all summer. The delightfully fragrant flowers are splendid for cutting.

- Double Red.** .....Pkt. 10c. | **Double Rose...** .....Pkt. 10c.
- Double Striped.** ....Pkt. 10c. | **Double White.....** Pkt. 10c.
- Double Golden Beauty.** Pure yellow. ....Pkt. 10c.
- Double Mixed.....** ..... $\frac{1}{4}$  oz. 40c., pkt. 10c.
- Giant Marguerite.** A giant type of the Marguerite, admired for its fragrance and producing a large percentage of double flowers. Mixed colors .....Pkt. 15c.
- Chabaud's Earliest Perpetual.** Handsome large flowered strain, equally desirable for house culture in winter or the garden in summer. Finest mixed.....Pkt. 15c.

## HARDY CARNATIONS

Sow seed of the hardy varieties during June or July and later transplant where they are to remain. This gives them ample time to develop into strong plants that will keep over winter with but slight protection.

**EARLY DWARF VIENNA.** Plants not over one foot high and often 50 flowers have been counted on one bush.

- Double Pure White.....** Pkt. 10c.



Marguerite Carnation

- Double Finest Mixed.** .... $\frac{1}{4}$  oz. 40c., pkt. 10c.
- Grenadin.** Dazzling scarlet double flowers. 1 ft.  $\frac{1}{4}$  oz. 75c., pkt. 10c.
- Choice Mixed.** 1 $\frac{1}{2}$  feet ..... $\frac{1}{4}$  oz. 50c., pkt. 10c.

**CELOSIA.** (See Cockscomb,)

## CENTAUREA

Hardy annuals, of easiest culture, bearing long-stemmed, bright-colored flowers, which are favorites both for the garden and as cut flowers. 2 feet.

### CYANUS. (Corn Flower.)

- Pure White.....** Pkt. 5c.
- Rose.....** Pkt. 5c.
- Emperor William.** Finest blue for cutting... Oz. 25c., pkt. 5c.
- Finest Mixed.** All colors..... Oz. 25c., pkt. 5c.
- Double Blue.....** Pkt. 10c.
- Double Flowered Mixed.....** Pkt. 5c.

### GIANT SWEET SULTANS

These giant Corn Flowers are indispensable for cutting and vase decoration. Their sweet-scented flowers are borne on long, stout stems and average three to four inches in diameter. 2 feet.

- ODORATA.** Light blue .....Pkt. 10c.
- Chameleon.** Yellow, changing to rose.....Pkt. 10c.
- Margaritae.** Pure white; best for cutting .. $\frac{1}{4}$  oz. 30c., pkt. 10c.
- Finest Mixed.** Includes many beautiful colors.....Pkt. 5c.
- IMPERIALIS alba.** An excellent white variety.....Pkt. 10c.
- Finest Mixed.....** Pkt. 10c.

### WHITE-LEAVED VARIETIES (Dusty Miller)

For borders and ribbon beds these white-leaved plants are very useful and exceedingly attractive. 1 foot.

- Candidissima.** Silvery white foliage..... $\frac{1}{4}$  oz. 35c., pkt. 10c.
- Gymnocarpa.** Leaves similar to the above but more finely lacinated ..... $\frac{1}{4}$  oz. 20., pkt. 5c.
- CENTROSEMA Grandiflora** (Butterfly Pea). Beautiful perennial climber with reddish violet, pea-shaped flowers which bloom in July providing the seed is sown in March. 8 to 10 feet.....Pkt. 5c.

**CERASTIUM Tomentosum** (Snow in Summer). Silvery leaved perennial forming compact bushes not over 6 inches high, which render them useful for edging and rockwork.....Pkt. 10c.

## CHRYSANTHEMUM

Splendid single and double annuals, the flowers of which are quite large and very effective in bouquets. The plants, 2 feet high, are easily raised from seed and deserve a place in every garden.

### ANNUAL VARIETIES

- Carinatum Eclipse.** Single flowers of purest yellow, with a band of deep crimson, center brown.....Pkt. 5c.
- Carinatum Single Mixed..** .....Oz. 40c., pkt. 5c.
- Carinatum Double Mixed.** .....Oz. 40c., pkt. 5c.

Chrysanthemums Continued on Page 43



Celosia Plumosa - See page 43



**CHRYSANTHEMUM - Continued**

- Morning Star.** Early profuse blooming plants with large, daisy-like flowers, borne on strong stems and of a beautiful cream yellow color. 1½ feet. .... ¼ oz. 15c., pkt. 5c.
- Evening Star.** Rich golden yellow flowers, 3 inches across; very fine for cutting. .... ¼ oz. 25c., pkt. 10c.
- Inodorum Plenissimum.** This garden gem is crowned with small double snow-white flowers until frost... Pkt. 10c.

**PERENNIAL VARIETIES**

- Frutescens** (Marguerite, or Paris Daisy). White, star-shaped flowers; a desirable pot plant for winter blooming. 1½ ft. .... Pkt. 10c.
- Shasta Daisy.** An elegant hardy perennial, about 2½ feet high, bearing long-stemmed, single, white flowers.. Pkt. 10c.

**CINERARIA**

Splendid decorative plants, for growing indoors during the winter, with a wide range of beautiful colors. The month of July is considered the best time to sow the seed, if but one sowing is to be made.

- Prize Mixed.** A magnificent strain, the flowers being of the largest size and most striking colors..... Pkt. 35c.
- Fine Mixed.** 1½ ft. .... Pkt. 25c.
- Prize Dwarf Mixed.** 10 inches..... Pkt. 35c.
- Stellata.** Small star-like flowers borne in great profusion and useful both for decorating and cutting..... Pkt. 25c.
- Maritima.** White leaved variety for edging..... Pkt. 5c.
- CLARKIA.** Showy annual growing about 2 feet high and blooming profusely throughout the summer.
  - Mixed.** Double and Single Varieties. .... Pkt. 5c.
- CLEMATIS.** Perfectly hardy and one of the most desirable climbers for covering fences, verandas and embankments. H. P. 10 ft.
  - Paniculata.** Clusters of small star-shaped, fragrant flowers of the purest white. .... Pkt. 10c.
  - Jackmanni Varieties.** The flowers of blue, purple, white, etc., are of immense size..... Pkt. 10c.
- CLEOME Pungens** (Spider Plant). An interesting plant, inasmuch as the rose colored flowers are spider-like in appearance. Of strong growth and blooms profusely throughout the summer. Sow seed indoors during March. Tender annual. 4 ft..... Pkt. 5c.
- CLIANTHUS Dampieri** (Australian Glory Pea). Brilliant scarlet pea-shaped flowers, each adorned with a large black blotch and borne in clusters of three or four. Tender perennial. Height 3 ft..... Pkt. 10c.
- COBÆA.** Very pretty, rapid climbing plant, blooming freely the first season and attains a height of 15 to 30 feet.
  - Scandens.** Purple bell-shaped flowers.. Oz. 75c., pkt. 10c.
  - Scandens Alba.** White..... Pkt. 10c.
  - Macrostemma.** Violet with green..... Pkt. 10c.

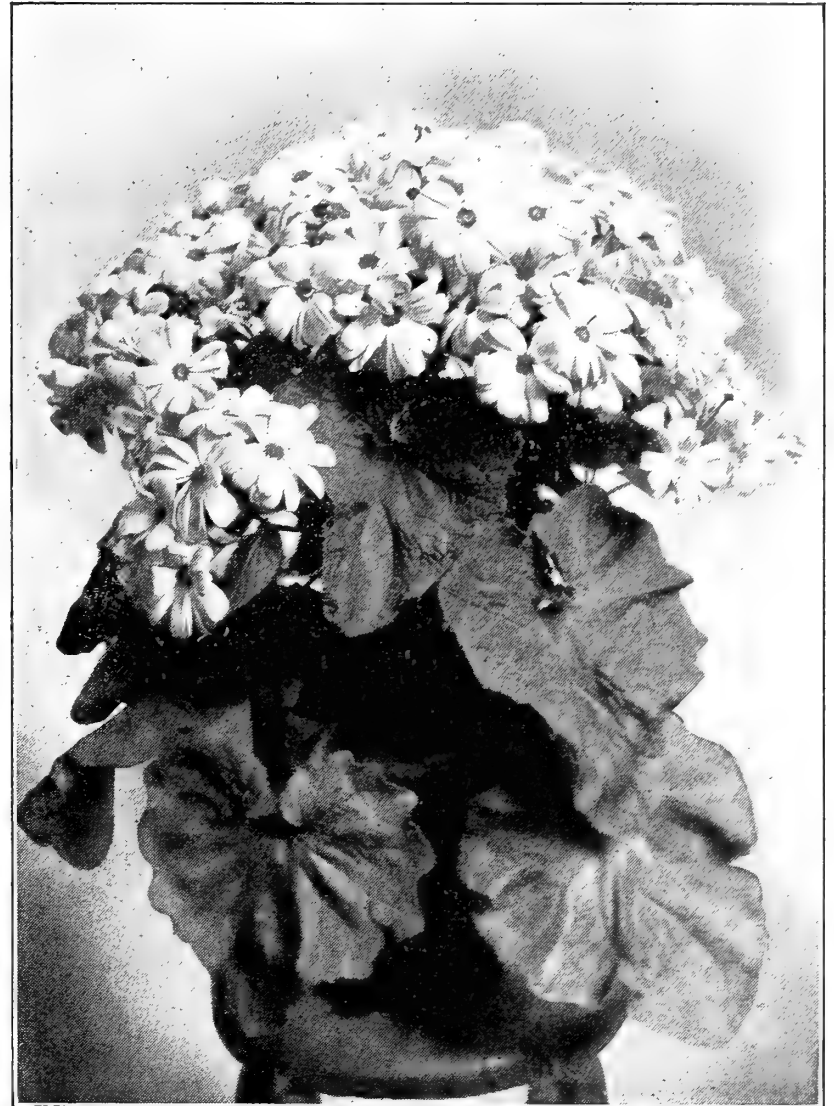

Cineraria

- COCCINEA Indica.** Annual climber with glossy ivy leaves and pure white flowers, which are later followed by rich scarlet fruits. 10 ft..... Pkt. 5c.

**COCKSCOMB (Celosia)**

Altogether a very ornamental class of plants, some with large ruffled heads, resembling a cock's comb and others with beautiful feathery-like plumes. When well grown the cristata varieties are exceedingly handsome, while few flowers are more picturesque than the brilliant feathered sorts. H. H. A.

- CRISTATA Empress.** Bright crimson combs of extraordinary size; dark foliage. 1 ft ..... Pkt. 10c.
- Glasgow Prize.** Splendid dwarf variety of immense size and rich crimson color. 1 ft..... Pkt. 10c.
- Golden Beauty.** Bright golden yellow..... Pkt. 10c.
- Queen of Dwarfs.** This little gem grows but 6 inches high; rose colored flowers..... Pkt. 10c.
- Dwarf Mixed**..... Pkt. 5c

**FEATHERED VARIETIES**

- THOMPSONI MAGNIFICA.** An exceptionally fine strain with large spikes of magnificent plumed flowers, which remain in bloom an unusually long time. They make excellent plants for bedding and their brilliant colored plumes form a striking contrast to the rich green foliage. 2 ft.
  - Crimson.** ..... Pkt. 10c.
  - Golden Yellow.** ..... Pkt. 10c.
  - Finest Mixed** ..... ¼ oz. 40c., pkt. 10c.
- PYRAMIDALIS PLUMOSA.** Decorative plants with graceful, feathery flowers. 3 feet.
  - Mixed Colors** ..... ¼ oz. 20c., pkt. 5c.

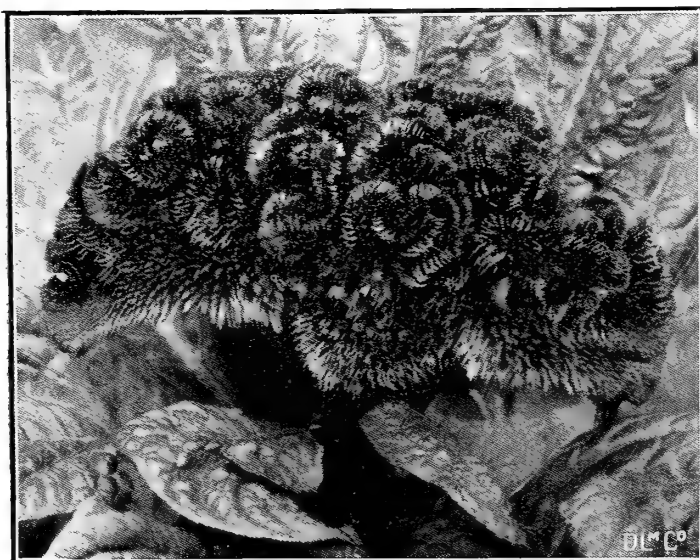

Cockscomb

**CONVOLVULUS, tricolor** (minor). Beautiful free-flowering and remarkably showy plants with exceedingly handsome, rich-colored flowers, producing in beds and mixed borders an unusually brilliant effect. H. A. 1 ft.

**Dwarf Bedding. Morning Glories.**  
Finest mixed. Pkt. 5c., oz. 25c.

**CONVOLVULUS, or Morning Glory.**  
A beautiful annual climber, of very rapid growth, attaining a height of 15 feet and blooming profusely until frost.

White.....Pkt. 5c., oz. 20c.  
Dark Blue .....Pkt. 5c., oz. 20c.  
Rose.....Pkt. 5c., oz. 20c.  
Dark Red.....Pkt. 5c., oz. 20c.  
**Climbing Varieties.** Finest mixed colors.  
Pkt. 5c., oz. 15c.

**Imperial Japanese.** These vines attain a height of from 30 to 50 feet. The colors range through reds, blues, indigo and blackish purple; from snow-white to cream and silver-gray. Some are striped, starred and spotted.

**Choice Mixed Colors.** Pkt. 5c., oz. 50c.

**COSMOS.** A charming autumn-flowering plant, with flowers borne profusely in loose clusters of variegated colors. 5 to 6 ft. Annual.

**Mammoth Perfection.** The flowers are double the size of the old variety. For cutting and vases this is one of the finest flowers grown.

Crimson.....Pkt. 10c.  
Bright Pink.....Pkt. 10c.  
Pure White.....Pkt. 10c.

**Dwarf Early-Flowering.** Seed sown in the open ground in the early part of May will produce blooming plants in August, and they will continue to flower until killed by frost in fall.

**Dwarf Early-Flowering "Dawn."** Pure white tinged with pink. 4 ft. Pkt. 10c.

**Dwarf Early-Flowering.** Mixed. Pkt. 10c.

**Klondyke.** Flowers are golden-yellow, measuring two to three inches in diameter. Should be sown early in the spring. 3 ft. Pkt. 10c.

**CORYDALIS Nobilis.** Yellow. H. P. 3/4 ft. Pkt. 10c.

**COWSLIP** (*Primula veris*). A favorite free-flowering plant; should be extensively grown for beds and borders of the spring flower-garden. H. P.

**Fine Mixed Colors.** 3/4 ft. Pkt. 5c.

**CUPHEA** (Cigar Plant). Excellent free blooming plants suitable for the conservatory or garden border.

**Platycentra.** Scarlet, black and white, *Excellent for pots.* H. H. P. 1 ft. Pkt. 10c.

**Miniata.** Deep scarlet. 1 ft. Pkt. 5c.



Cosmos

**Mammoth Perfection. Mixed**.....Pkt. 10c.

**Finest Mixed** .....Pkt. 5c.

**COLEUS.** One of the most popular ornamental foliage plants; very decorative and easily grown from seed.

**Fine Mixed**.....Pkt. 10c.

**CYCLAMEN.** Beautiful plants, well adapted for greenhouse or window gardening, with ornamental foliage and bright colored flowers. G. P. 1 ft.

**Persicum Giganteum.** Unsurpassable strain. Choice Mixed. Pkt. 25c.

**Persicum Giganteum.** A smaller variety. Fine Mixed .....Pkt. 15c.

**CYPRESS VINE** (*Ipomœa Quamoclit*). Very graceful and beautiful twining annuals, with feathery dark green foliage and star-like flowers. 20 ft.

**Crimson.** Very brilliant.....Pkt. 5c.

**White.** Beautiful and graceful.....Pkt. 5c.

**Finest Mixed Colors**.....Oz. 30c., pkt. 5c.

**DAHLIA.** The seed we offer has been saved from a superb collection of the finest varieties. Blooms the first season if sown early.

**Single Tom Thumb.** About 12 inches high by 24 inches across; flowers produced in abundance and of the most exquisite colors. Pkt. 10c.

**Double Dwarf Mixed.** An excellent class, bearing large double flowers of various colors. Pkt. 15c.

**DATURA, or Trumpet Flower.** Half-hardy annuals of rapid growth with large trumpet-shaped fragrant flowers; very showy. 3 ft.

**Golden Queen.** Double, bright yellow and very showy.....Pkt. 10c.

**Finest Mixed.** Shades of lilac, purple, yellow and white.....Pkt. 5c.



Cyclamen



Dianthus, Plumarius

**DELPHINIUM**

(Perennial Larkspur). Magnificent border plants with gorgeous spikes of bloom, varying in shade from delicate white to the richest blue. If the seed is sown early they will flower the first season. H. P.

**Elatum** (Bee Larkspur.) Blue, 5 ft. Pkt. 5c.

**Formosum.** Rich dark blue, white center. 2 ft. Pkt. 5c.

**Zalil** (Hardy Yellow Larkspur). Pure sulphur-yellow, of branching habit. 4 ft. Pkt. 10c.

**Nudicaule.** Dwarf bushy plants with bright scarlet flowers. 1½ ft. Pkt. 15c.

**Chinense.** Finest mixed 2 ft. Pkt. 5c.

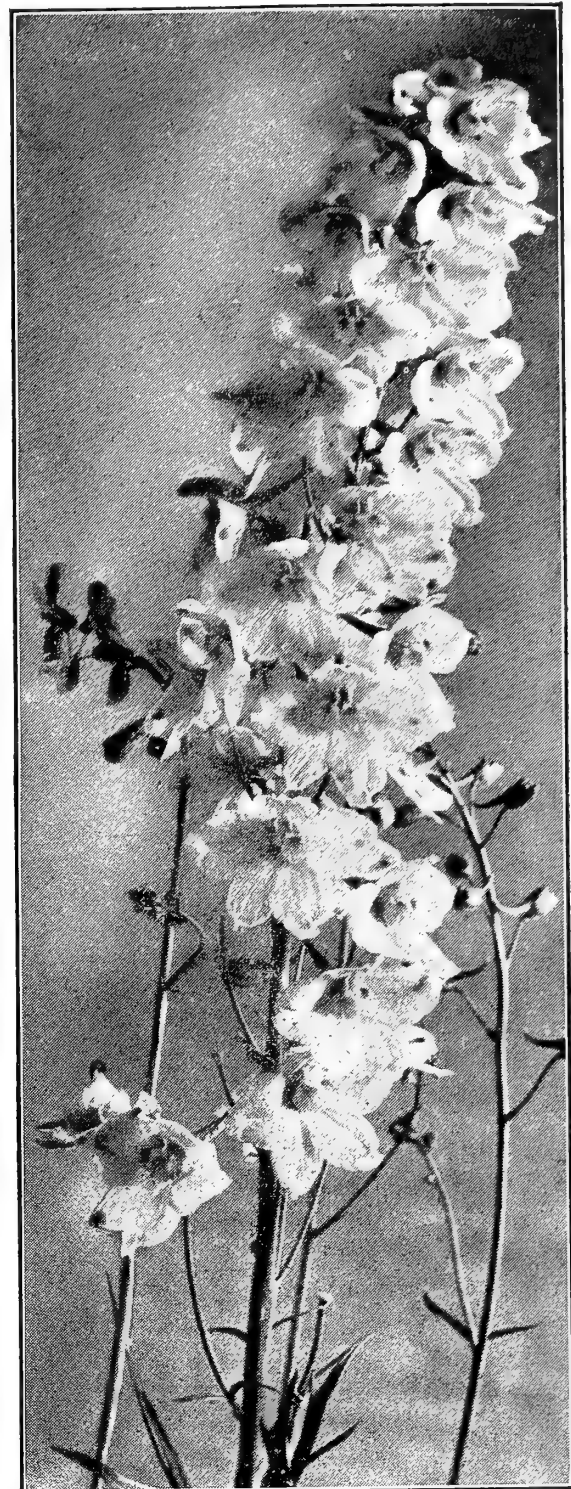

Delphinium

**Dianthus, or Pinks**

A beautiful genus, which embraces the most brilliant and rich variety of colors. They have a delicate perfume, which makes them valuable for cutting. H. A. 1 ft.

**SINGLE ANNUAL VARIETIES—**

- Chinensis** (China or Indian Pink). Brilliant colors, mixed. ½ ft. Pkt. 5c.
- Laciniatus.** A splendid fringed variety; flowers of magnificent colors. Pkt. 5c.
- The Bride** (Little Gem). Large purple flowers, white eye. Pkt. 5c.
- Crimson Belle.** Showy dark red flowers. Pkt. 5c.
- Finest Mixed, Single.** Superb colors. Oz. 40c., pkt. 5c.

**DOUBLE ANNUAL VARIETIES—**

- Chinensis alba, fl. pl.** Double white. Pkt. 5c.
- Chinensis, Double Mixed** (China Pink). Oz. 50c., pkt. 5c.
- Mourning Pink.** Giant double Crimson, fringed white. Pkt. 10c.
- Diadematus, fl. pl.** One of the finest varieties. The flowers are large and double, comprising beautiful and striking colors. Pkt. 5c.
- Fireball** (Sinensis fl. pl.). This brilliant double Chinese Pink is densely double and of a glowing, velvety red color; fine for cutting. Pkt. 10c.

**Heddewigii, fl. pl.** (Double Japan Pink). Mixed colors. Pkt. 5c.

**Heddewigii Nobilis** (Royal Pinks). Selected and improved varieties of the popular single Japan Pink, producing flowers nearly 4 in. across, of quite a new shape. The petals are somewhat undulated and twisted, each one covering half of the other, and beautifully fringed. The colors vary from white to dark red. Pkt. 10c.

**Imperialis, fl. pl.** (Double Imperial Pink). An extremely pretty variety, beautifully variegated; colors mixed. Pkt. 5c.

**Laciniatus, fl. pl.** A double fringed variety with handsome flowers; brilliant colors mixed. Pkt. 5c.

**Finest Double Mixed.** Containing a fine assortment of exquisite colors. Pkt. 5c., oz. 50c.

**HARDY DOUBLE PERENNIAL VARIETIES**

The Garden Pink is highly admired for its beautifully laced and delightfully fragrant flowers, and is esteemed above all others for decoration and bouquets. It is of easy culture and accommodating habit, growing freely and flowering profusely, either in the greenhouse or open borders. H. P.

**Plumarius Semperflorens.** (Florists' Perpetual Pinks.) Perfectly hardy. Fine mixed. Pkt. 10c.

**Gardnerianus, fl. pl.** A beautifully fringed variety, with fragrant double flowers; various colors. 1½ ft. Pkt. 5c.

**Finest Mixed Double.** Splendid colors. Pkt. 5c.

**Finest Mixed Single.** Various colors. Pkt. 5c.



Dianthus, or Double China Pinks



Gaillardia Grandiflora

**Picta Lorenziana** (or Double-Flowering). Finest mixed. Pkt. 5c. oz. 50c.  
**Hardy Perennial.** These are among our finest plants for permanent garden and border decoration, forming large clumps about 2 feet high by 2 feet through. The flowers, 3 to 4 inches across, are gracefully poised on long stems and are gorgeously colored, usually crimson or scarlet, bordered with orange, canary or someshade of yellow. As a cut flower for vases they are of unsurpassed beauty.  
**Grandiflora.** Hardy perennials, producing large, strikingly beautiful flowers. 3 ft. Pkt. 10c.  
**New Hybrids, Finest Mixed.** Pkt. 10c.

**GILIA.** These well-known and much admired dwarf plants are highly prized for their earliness, and are very effective in masses and rock-work. H. A.  
**Mixed.** White, lilac and purple.  $\frac{3}{4}$  ft. Pkt. 5c., oz. 20c.  
**GLOBE Amaranth.** Very showy annuals, with extremely pretty everlasting flowers, which are usually cut and preserved for winter bouquets.  $\frac{1}{2}$  to 2 ft. H. A.  
**Orange.** Pkt. 5c.  
**Dwarf Red, White, Pink, Finest Mixed.** Each pkt. 5c.



Godetia

**DIGITALIS** (Foxglove). Handsome plants of stately growth, especially adapted for shrubberies. H. P. 3 ft.

**Gloxiniaeflora.** Beautifully spotted, large gloxinia-shaped flowers. **Mixed.** Pkt. 5c.

**Finest Mixed Colors.** Splendid for mixed borders. Pkt. 5c.

**DOLICHOS lablab** (Hyacinth Bean). A very ornamental and rapid-growing climber, with dense foliage and handsome purple and white flowers. T. A.

**Purple, White, Mixed.** Very handsome. Each pkt. 5c.

**ESCHSCHOLTZIA** (Cali ornia Poppy). Remarkable alike for their profusion of bloom and beautiful bright colors. H. A. 1 ft.

**Californica Alba.** Creamy white. Pkt. 5c.

**Californica.** Bright yellow, rich orange center. Pkt. 5c., oz. 40c.

**Mandarin.** Bright Scarlet; inner side rich orange. Pkt. 5c.

**Golden West.** Large golden yellow. Pkt. 5c.

**Canaliculata Rosea.** Rosy yellow; fine bedder. Pkt. 5c.

**Single, or Double Mixed.** Each pkt. 5c., oz. 30c.

**ECHEVERIA Secunda.** Excellent plant for Carpet bedding with light green glaucous foliage.  $\frac{1}{4}$  ft. Pkt. 25c.

**EDELWEISS** (Leontopodium Alpinum). Dwarf hardy perennials with white star shaped flowers succeeding well in light soil and a sunny position.  $\frac{1}{2}$  ft. Pkt. 10c.

**EUPHORBIA Variegata** (Snow-on-the-Mountain). Pretty annuals with green foliage, striped with white. 2 ft. Pkt. 5c.

**EUTOCA Viscida.** Free blooming border plants with dark blue flowers, H. A. 1 ft. Pkt. 5c.

**FENZLIA Dianthiflora Rosea.** Rose colored flowers.  $\frac{1}{4}$  ft. H. A. Pkt. 10c.

**Four o'Clock.** See Marvel of Peru.

**GAILLARDIA** This is one of the most valuable annuals lately introduced. For general decorative purposes as well as for bouquets it is invaluable, its gay colored double flowers being abundantly produced without intermission, from July until frost sets in.



Eschscholtzia Californica

**Tall Finest Mixed Colors.** Very attractive in masses. Pkt. 5c.

**GODETIA.** Of all garden annuals few are as beautiful as Godetias, being exceedingly showy when grown in beds and masses; these new varieties are very compact and bushy in habit, forming oval plants about one foot high, completely enveloped with large, gorgeously colored flowers, from 2 to 3 inches across.

**Gloriosa.** Large, satiny, blood-red. Pkt. 5c.

**Duchess of Albany.** A beautiful glossy satin-white color. Pkt. 5c.

**The Bride.** White, with crimson center. Pkt. 5c.

**Finest Mixed Colors,** Pkt. 5c., oz. 30c.

**GOURDS Ornamental** (Mock Orange). A highly interesting genus, of rapid growth, with luxuriant and ornamental foliage, and bearing fruit of the most varied and fantastic forms; very desirable for trellis work. T. A.

**Chinese Loofa** (Sponge, or Dish Rag). Large yellow flowers, followed by long green fruits, which form inside a tough fibrous mass, which is used for bathing, being superior to a sponge. Pkt. 5c.

**Egg-Shaped.** A Japanese gourd, with small white fruit resembling an egg. Pkt. 5c.

**Hercules Club.** Club shaped 3 or 4 feet long. Pkt. 5c.

**Finest Mixed Varieties.** Pkt. 5c., oz. 25c.

**HELIANTHUS** (Sunflower). The following varieties are remarkable for their majestic growth, and the fine bold outline, admirably adapted for shrubberies; very effective. H. A.

**Single Varieties—**

**Macrophyllus Giganteus.** A tall variety with large yellow flowers. 10 ft. Pkt. 5c.

**Miniature Sunflower.** Of dwarf branching habit, bearing many small flowers. Orange with black center. 3 ft. Pkt. 5c.

**Double Varieties—**

**Californicus.** Magnificent large double orange flowers, 6 to 8 inches in diameter, densely double, showing no center. 5 ft. to 6 ft. high. Pkt. 5c.

**Globe of Gold.** A new dwarf double-branching sunflower, bearing flowers of a deep yellow color like globes of gold. 3 ft. Pkt. 5c. oz. 20c.

**HELICHRYSUM** (Everlasting flower). Exceedingly pretty and effective



Helichrysum

border plants, the dried flowers of which are highly prized for winter bouquets. H. A. 1 to 2 ft.

- |  |  |
|--|--|
| <b>Dwarf Double Scarlet.</b><br>Pkt. 5c. | <b>Tall Double "Fireball."</b><br>Dark red. Pkt. 5c. |
| <b>Dwarf Double White.</b><br>Pkt. 5c.   | <b>Tall Double Yellow.</b><br>Pkt. 5c.               |
| <b>Dwarf Double Mixed</b><br>Pkt. 5c.    | <b>Tall Double Mixed.</b> Pkt. 5c.                   |

**HELIOTROPE.** Deliciously fragrant plants, equally prized in the conservatory and flower garden. Plants raised from seed bloom the first season. H. H. P. 1½ ft.

- |   |           |
|---|-----------|
| <b>Dr. Livingstone.</b> Dark blue . . . . . | Pkt. 10c. |
| <b>Peruvianum.</b> Purple . . . . .         | Pkt. 10c. |
| <b>Finest Mixed Varieties</b> . . . . .     | Pkt. 10c. |

**HOLLYHOCKS.** For distant effect in large groups they are matchless; they also form a showy and effective outline in flower gardens and borders. The seed offered has been saved from exhibition flowers and cannot fail to produce superb varieties. H. P. 6 ft.

**Chater's Varieties—**

- |                                  |  |
|----------------------------------|--|
| <b>Double White.</b> Pkt. 10c.   | <b>Double Pink.</b> Pkt. 10c.              |
| <b>Double Yellow.</b> Pkt. 10c.  | <b>Double Violet Lila c.</b><br>Pkt. 10c.  |
| <b>Double Crimson.</b> Pkt. 10c. | <b>Chater's Double Mixed.</b><br>Pkt. 10c. |
| <b>Double Scarlet.</b> Pkt. 10c. |  |
| <b>Double Finest Mixed,</b>      | Pkt. 5c.                                   |

**Everblooming Hollyhocks—**

A new class blooming the first season from seed if sown during March or April. The flowers are large and of many colors.

- |   |           |
|---|-----------|
| <b>Double Annual Finest Mixed</b> . . . . . | Pkt. 10c. |
| <b>Single Annual Finest Mixed</b> . . . . . | Pkt. 5c.  |

**Mammoth Allegheny—**

A variety with enormous fringed flowers often five inches in diameter. Fine mixed. Pkt. 10c.

**HUMULUS JAPONICUS** (Japanese Hop). Splendid annual climber of fast growth and very ornamental. 12 ft. Pkt. 5c.

**Japonicus Follis Variegatis.** A variegated form of the preceding; leaves rich green, blotched and marbled with creamy white. 10 ft. Pkt. 10c.

**HYPERICUM ELEGANS** (St. John's Wort). For planting under trees; flowers yellow, very showy. H. P. 1 ft. Pkt. 5c.

**ICE PLANT** (Mesembryanthemum Crystallinum). A pretty little trailing plant of dwarf habit, suitable for rock-work and flower borders. The leaves are covered with crystal-like icy globules, extensively employed in garnishing. H. H. A. Pkt. 5c.

**IPOMOEA.** Quick growing summer climbers. For covering arbors, walls, trellises, etc., they are unsurpassed. H. A.

**Coccinea** (Star Ipomoea). Small scarlet flowers, blooming in dense profusion. 8 ft. Pkt. 5c.

**Noctiflora** (Moonflower). One of the most beautiful and rapid-growing climbers now cultivated. At night and during dull days the plant is covered with large, pure white fragrant flowers, 5 to 6 inches in diameter. H. A. 20 ft. Pkt. 10c.

**Mixed Varieties.** Pkt. 5c.

**IMPATIENS SULTANI.** Well adapted for window culture; producing abundantly flowers of a bright rose color. 1½ ft. Pkt. 15c.

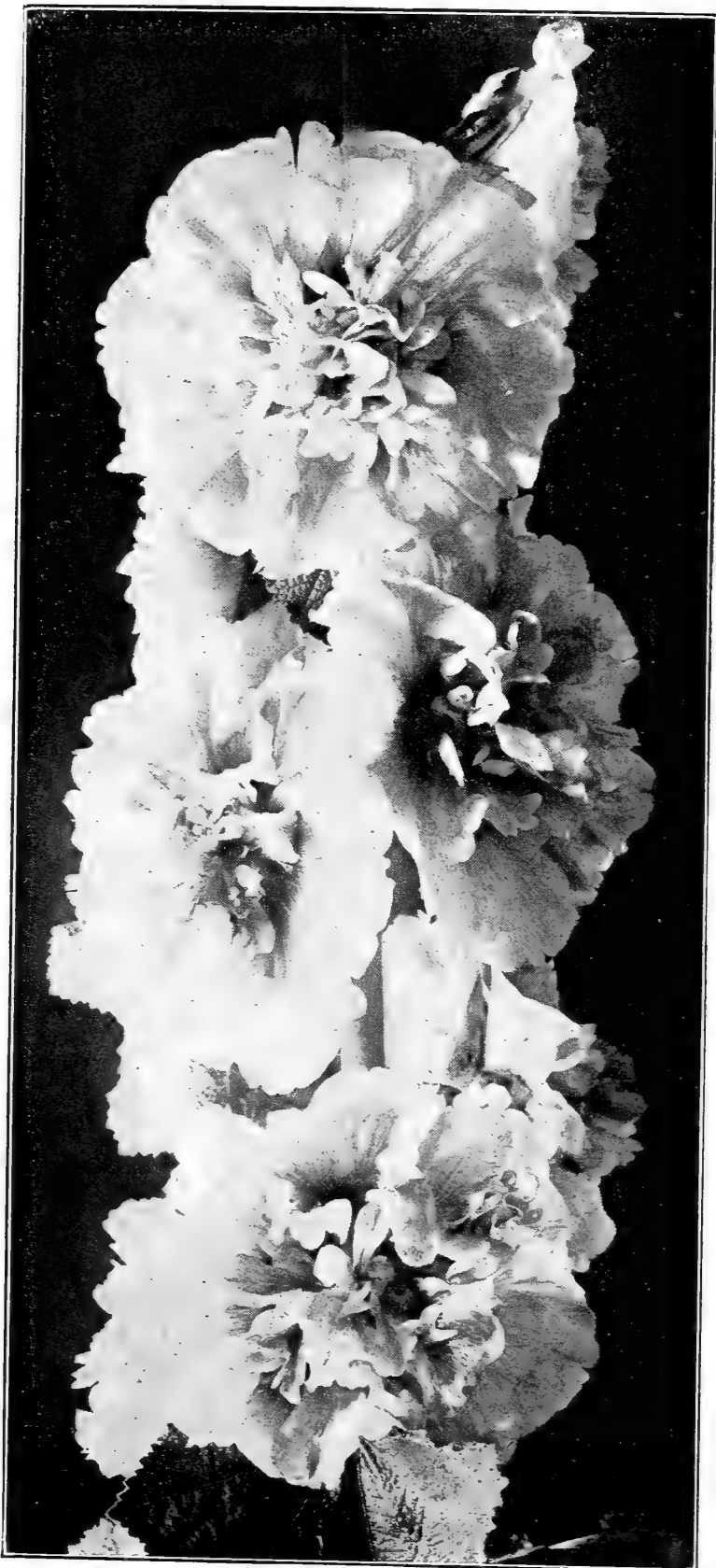

Hollyhocks

**LANTANA.** A splendid bedding plant, also beautiful in pots. No plant presents a greater variety of colors and changing hues. H. H. P. 1 ft.

**Hybrida Nana Compacta.** Finest mixed varieties.....Pkt. 5c.

**LARKSPUR.** Elegant plants, producing in great variety of form and colors some of the most beautiful flowers in cultivation. H. A. 1 ft.

- Double Dwarf Rocket. Azure Blue**.....Pkt. 5c.
- “ “ “ **Pure White** .....Pkt. 5c.
- “ “ “ **Apple Blossom Pink**.....Pkt. 5c.
- “ “ “ **Finest Mixed Colors**.....Pkt. 5c.
- “ **Stock-Flowered.** Tall branching habit, fine for cutting. 2 ft.
- “ “ “ **Lustrous Carmine**.....Pkt. 5c.
- “ “ “ **Dark Blue**.....Pkt. 5c.
- “ “ “ **Pure White**.....Pkt. 5c.
- “ “ “ **Finest Mixed**.....Pkt. 5c.
- “ **Tall Rocket. Finest Mixed.** All colors. 1½ ft.....Pkt. 5c.
- “ “ **Emperor.** Compact bushes bearing 40 to 50 flowers on a single plant.
- “ “ “ **Finest Mixed.** 2 ft.....Pkt. 5c.

**LINUM.** One of the handsomest annuals ever introduced; for brilliancy of color and duration of bloom it is unsurpassed. H. A. 1 ft.

**Grandiflorum Coccineum.** Brilliant scarlet.....Pkt. 5c.

**Flavum.** Beautiful golden yellow. H. P.....Pkt. 5c.

**LOBELIA.** An invaluable class of plants for bedding, edging or ribbon gardening. *Lobelia gracilis* should be particularly noted for its value in hanging baskets, while the *Erecta* varieties are extensively used for bedding purposes. H. H. A. ½ ft.

**Erinus Speciosa.** Deep blue, fine for bedding..... Pkt. 5c.

“ **Gracilis.** Pale blue, spreading habit; very effective in pots..... Pkt. 5c.

“ **Barnard's Perpetual.** Deep blue with white eye..... Pkt. 10c.

**Erecta Crystal Palace Compacta.** Intense blue..... Pkt. 10c.

“ **Empéror William (Blue King).** Sky blue; compact..... Pkt. 5c.

“ **Duplex.** Double blue; distinct..... Pkt. 10c.

“ **White Lady.** Large white flowered variety..... Pkt. 5c.

“ **Finest Mixed Varieties**..... Pkt. 5c.

**Cardinalis Hybrida (Cardinal flower).** Splendid perennials of various shades of scarlet and crimson. 2 ft..... Pkt. 10c.

**LYCHNIS** Profuse-blooming hardy perennials, remarkable for the brilliancy of their flowers; excellent for mixed borders and for cutting. Finest Mixed, 2 ft. Pkt. 5c.

**LUPINUS.** A splendid genus of handsome and ornamental garden plants with long, graceful flower spikes of rich and varied colors. H. A.

**Perennial Varieties.** Mixed colors.....Pkt. 5c.

**Annual Varieties.** Mixed colors.....Pkt. 5c.

**MARIGOLD.** In late summer, when bedding and other plants are past their prime, marigolds produce a wealth of color that is simply invaluable. Although the plants are not quite hardy, they can be easily raised without glass by deferring the sowing until spring frosts have ceased to be dangerous. The African varieties produce large self-colored blossoms on tall plants; the French are smaller, some of the varieties being elegantly striped and spotted. H. H. A. 1 ft.

**African Eldorado.** The colors run through all shades of yellow, from very light primrose to the deepest orange. Very double. 3 ft. Pkt. 5c.

**African Double Dwarf Orange.** 1½ ft.....Pkt. 5c.

“ “ “ **Light Yellow.** 1½ ft..... Pkt. 5c.

“ “ “ **Mixed.** 1½ ft.....Oz. 50c. Pkt. 5c.

**French Double Dwarf Gold-Striped.** Large flowers, regularly striped with chestnut brown on a bright yellow ground. This is one of the best for bedding. 1 ft. Pkt. 5c.

**French Double Dwarf Dark Brown.** A very rich shade. 1 ft. Pkt. 5c.

**French Double Dwarf Orange.** A garden favorite. 1 ft. Pkt. 5c.

“ “ “ **Yellow and Brown.** 1 ft.....Pkt. 5c.

“ “ “ **Light Yellow.** 1 ft.....Pkt. 5c.

“ “ “ **Lilliput, Yellow and Brown.** 1 ft.

An excellent variety ..... Pkt. 5c.

“ “ “ **Mixed**.....Oz. 50c. Pkt. 5c.

**MARVEL OF PERU (Four O'Clocks).** Handsome border plants remarkable for their compact growth, rich glossy leaves, profusion of bloom, and diversity of color in flower and foliage. 2 ft. H. A.

**Finest Mixed.** Brilliant colors.....Oz. 20c. Pkt. 5c.

**Tom Thumb.** Mixed. 1 ft.....Oz. 30c. Pkt. 5c.



Lobelia, Emperor William



Marigold, Dwarf Double African

**MATRICARIA** (Feverfew). Half hardy perennials, blooming the first year from seed, with large heads of showy flowers; splendid for cutting.

**Grandiflora. fl. pl** Large, double pure white flowers.  $1\frac{1}{4}$  ft Pkt. 5c

**MIGNONETTE** The mignonette is universally esteemed for its delicate perfume and singularly pretty spikes of bloom. If well thinned out at an early stage, the growth of flower and foliage will be greatly facilitated H. A.

**Allen's Defiance.** This mignonette, when grown under favorable conditions, produces spikes from 12 to 15 in. long; the individual florets are of remarkable size. Pkt. 10c., oz. 75c.

**Golden Queen.** A distinct variety of mignonette, with spikes of golden-yellow blossoms. Pkt. 5c., oz. 40c.

**Large-Flowered Pyramidal.** A distinct and improved variety, of robust, pyramidal growth and large flowers. Pkt. 5c., oz. 40c.

**Machet.** Dwarf and vigorous plants of pyramidal growth and thick green leaves with long and broad spikes of deliciously scented red flowers. Pkt. 10c., oz. 75c.

**Miles' Hybrid Spiral.** Dwarf and branching, with spikes often attaining a length of from 8 to 10 in. Pkt. 5c., oz. 35c

**Goliath.** This is an excellent mignonette with large trusses of flowers and dark green foliage. Fine for forcing. Pkt. 10c.

**Large-Flowering Sweet-Scented.**  $\frac{1}{2}$  ft. Pkt. 5c., oz. 15c.

**MIMULUS** (Monkey Flower). Handsome, profuse-blooming plants, with flowers of singular form and brilliant colors, rich and beautifully marked. H. H. P.

**Cardinalis.** Scarlet; very striking. 1 ft. Pkt 10c

**Duplex Mixed.** Flowers are borne in pairs. Pkt. 15c.

**Moschatus** (Musk Plant). Valuable for pots and window boxes  $\frac{1}{2}$  ft. Pkt. 5c.

**Finest Mixed Varieties.** Pkt. 5c.

**MINA Lobata.** Handsome, half-hardy climbing annual of rapid growth; bearing twin-like racemes of flowers which in the bud are orange-red, but open orange yellow and soon turn to creamy white. 20 ft. Pkt. 10c.

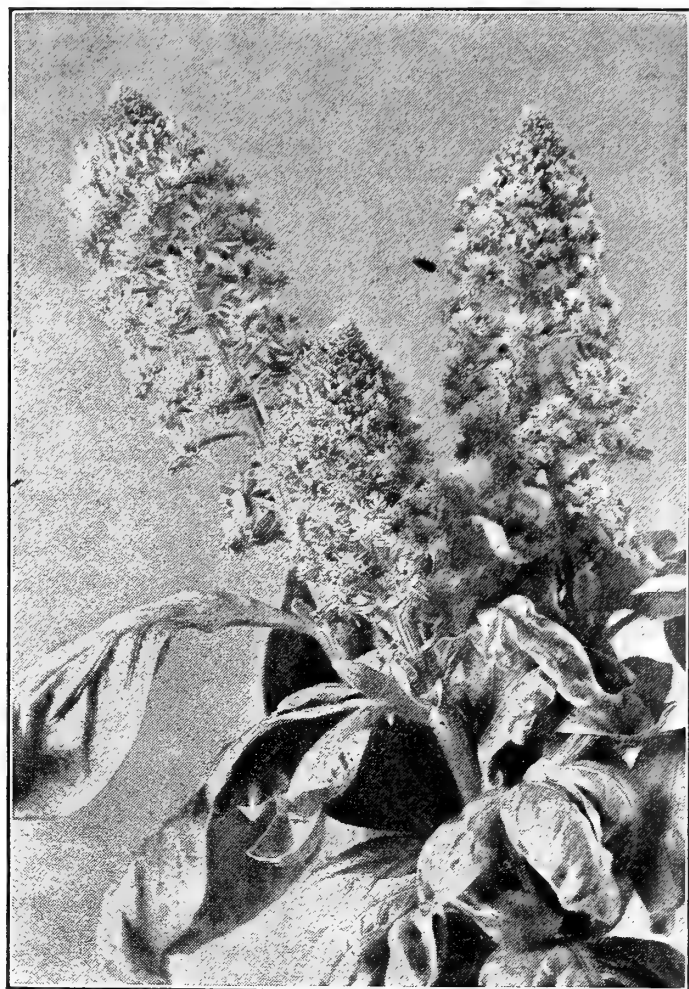

Mignonette Machet

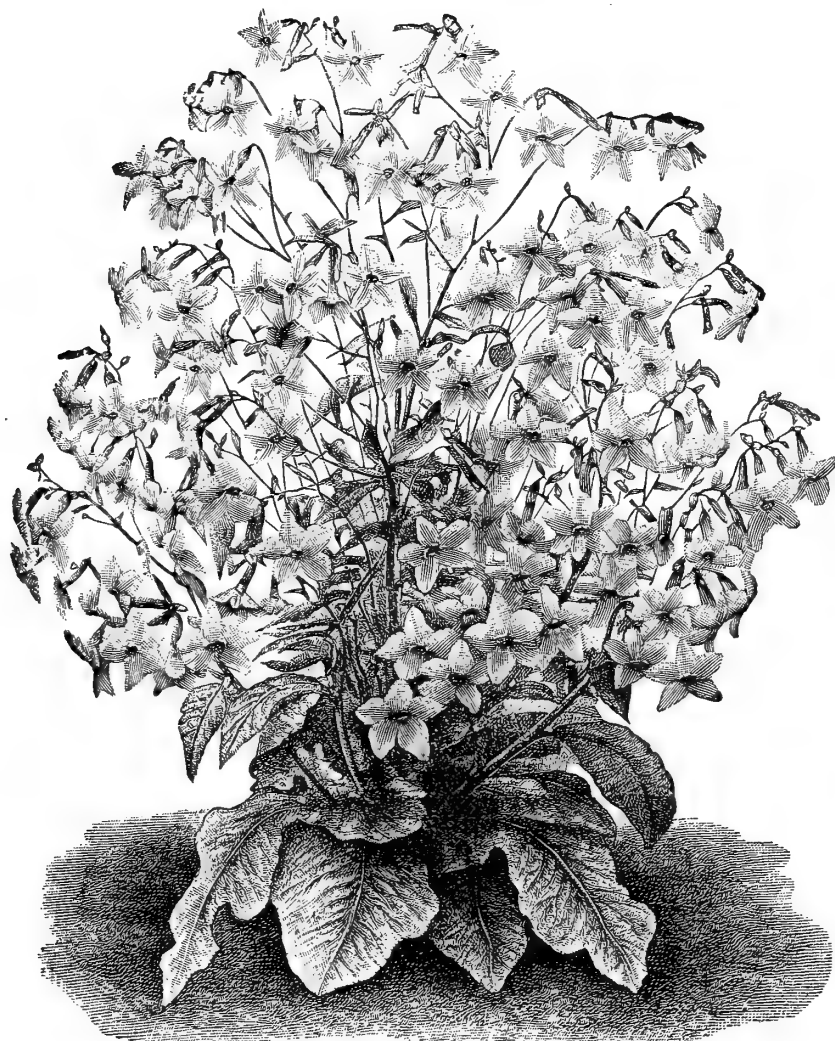

Nicotiana Sanderae

**MOMORDICA.** Trailing plants, with curious and ornamental foliage and remarkable fruit. H. H. A.

**Balsamina** (Balsam Apple). Orange fruit, 10 ft. Pkt. 5c.

**Charantia** (Balsam Pear). Copper-colored scarlet fruit. 10 ft. Pkt. 5c.

**MAURANDIA.** Beautiful climbers for hanging baskets, vases and trellises, blooming the first year if sown early. H. H. P. 10 ft.

**Fine Mixed.** Pkt. 10c.

**MYOSOTIS** (Forget-Me-Not). These beautiful little plants are too well-known to need recommendation. H. P.

**Alpestris Alba.** White, a very attractive variety.  $\frac{1}{2}$  ft. Pkt. 5c.

**Alpestris Blue.**  $\frac{1}{2}$  ft. Pkt 5c.

**Dissitiflora.** Large sky blue flowers; very early. 6 to 12 in. Pkt. 10c.

**Palustris.** Blue, adapted for moist situations.  $\frac{1}{2}$  ft. Pkt. 10c.

**Semperflorens.** Perpetual-flowering. Flowers from early spring to autumn. 6 in. Pkt. 10c.

**Victoria.** Azure blue, remaining in bloom a long time. 6 in. Pkt. 10c., oz. \$1.50.

**Finest Mixed Varieties.** Pkt. 5c., oz. 75c.

**NICOTIANA Affinis.** Splendid annual, producing clusters of long white tube-shaped flowers, fragrant toward evening. 3 ft. Pkt. 5c.

**Colossea.** Magnificent foliage plant, the young leaves at first tinted with red. It soon attains a height of 5 or 6 ft., with leaves often 2 ft. in length and a foot in width. Excellent for foliage beds Pkt. 10c.

**Sanderae.** A hardy annual of compact growth with bright sweet scented carmine flowers. 2 ft. Pkt. 10c.

**NIGELLA** (Love-in-a-Mist). Beautiful border plants, with prettily cut foliage and curiously formed flowers H. A. 1 ft.

**Damascena** (Devil-in-a-Bush). Mixed, double. Pkt. 5c.

**Hispanica** (Love-in-a-Mist). Mixed, single. Pkt. 5c.

**NASTURTIUMS**

**TOM THUMB, OR DWARF VARIETIES**

When planted in beds or masses, the brilliant effect of these splendid flowers is scarcely surpassed by any of our finest bedding plants. H. A. 1 ft.

	Per oz.	Per pkt.
<b>Aurora.</b> Salmon Rose.....	\$0 15	\$0 05
<b>Beauty.</b> Yellow and scarlet.....	15	5
<b>Chameleon.</b> Blotched crimson, bronze and yellow..	20	5
<b>Crystal Palace Gem.</b> Sulphur, spotted maroon....	15	5
<b>Empress of India.</b> Deep crimson, dark-leaved.....	20	5
<b>Golden King.</b> Fine deep yellow.....	15	5
<b>King of Tom Thumb.</b> Intense scarlet, dark leaved.	20	5
<b>King Theodore.</b> Dark maroon; dark foliage.....	20	5
<b>Lady Bird.</b> Orange-yellow, red spots.....	20	5
<b>Luteum.</b> Yellow.....	15	5
<b>Purpureum.</b> Dark crimson.....	15	5
<b>Pearl.</b> Creamy white.....	15	5
<b>Prince Henry.</b> Light yellow, marbled scarlet.....	15	5
<b>Ruby King.</b> Rosy scarlet, dark foliage.....	15	5
<b>Rose.</b> Fine shade.....	15	5
<b>Scarlet.</b> A very brilliant color.....	15	5
<b>Vesuvius.</b> Beautiful salmon red.....	15	5
<b>Finest Mixed Tom Thumb Varieties.....</b>	15	5

¼ lb. 35c., lb. \$1.25.

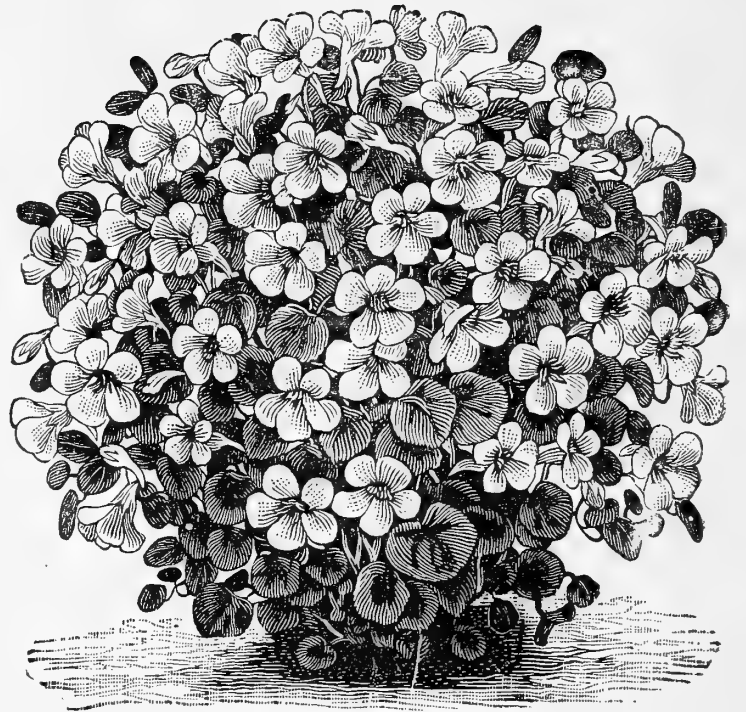

Nasturtium, Dwarf

**TALL OR CLIMBING VARIETIES**

A well-known ornamental, profuse flowering plant, adapted for rock work, banks, covering trellises or rustic work; the seeds, if pickled young, are an excellent substitute for capers. H. A. 10 feet.



Nasturtium, Tall

	Per oz.	Per pkt.
<b>Atropurpureum.</b> Dark crimson.....	\$0 15	\$0 05
<b>Dunnett's Orange.</b> (Sunlight) bright orange....	15	5
<b>Hemisphericum.</b> Straw color, with rosy scarlet blotches.....	15	5
<b>Heinemanni.</b> Chocolate color.....	15	5
<b>King Theodore,</b> Velvety dark crimson, dark foliage.....	15	5
<b>Pearl.</b> White.....	15	5
<b>Prince Henry.</b> Yellow, marbled scarlet.....	15	5
<b>Regelianum.</b> Purplish violet.....	15	5
<b>Scheurmani Coccineum.</b> Scarlet striped.....	15	5
<b>Scarlet.</b> Bright color.....	15	5
<b>Schulzi.</b> Scarlet, darkest-leaved.....	15	5
<b>Vesuvius.</b> Salmon, dark-leaved.....	15	5
<b>Von Moltke.</b> Bluish rose.....	15	5
<b>Yellow.</b> Clear pure yellow.....	15	5
<b>Finest Mixed.</b> ¼ lb. 35c., lb. \$1.25.....	15	5

**Lobb's Nasturtium.** (*Tropæolum Lobbianum.*) They are excellent for window boxes, vases, hanging baskets and rockeries. 8 ft.

**Finest Mixed.** All colors of Lobbianum. Pkt. 5c., oz. 20c.

**Madam Gunther's Hybrids.** Shades of rose, salmon, brightest red, pale yellow, either as self colors or spotted and striped. The foliage is mostly dark and contrasts very effectively with the rich colors.

**Choice Mixed Colors.** Pkt. 5c., oz. 20c.

**NEMOPHILA.** A genus of exceedingly beautiful dwarf-growing plants. Their height and habit of growing being so uniform and the colors so varied and striking, they never fail to produce a pleasing effect. H. A. ¾ ft.

**Maculata.** White, violet blotches. Very pretty..... Pkt. 5c.

**Insignis Marginata.** Blue flowers bordered white..... Pkt. 5c.

**Insignis.** Sky blue flowers with white center..... Pkt. 5c.

**Fine Mixed.** All colors..... Oz. 25c., pkt. 5c.



# PANSIES

The Pansy has become one of our most popular plants for bedding and may be seen in bloom almost the year round, but it is during May they appear at their best. To have them bloom in May, the seed should be sown during July or August, so that it may develop into strong plants for remaining outdoors over winter, with a slight protection. For later flowers sow seed in early spring.

## SUPERB MIXTURES

**GIANT BEAUTIES.** A superior mixture containing only those sorts which are noted for their richness of color, perfect form and immense-sized blooms. Especially recommended for either early spring or late summer sowing. Pkt. 25c., 1/8 oz. \$1.00.

**MASTERPIECE.** One of the larger-flowering Pansies; distinct from all others, in that the petals are beautifully frilled or ruffled, giving the flowers a unique, though very fascinating appearance. In color, they range chiefly through the darker shades. Pkt. 20c., 1/8 oz. 75c.

**BUGNOT'S SUPERB BLOTCHED.** Splendid strain with large well-formed flowers, many of them handsomely blotched, marked and veined in the most striking manner and rarest colors. Pkt. 25c.

**ORCHID-FLOWERED.** A distinct variety embracing some of the most beautiful colored flowers heretofore unknown in Pansies. The light delicate tinted flowers, of medium size, are really novel in appearance and when planted with darker shades the contrast is very effective. Pkt. 20c., 1/8 oz. 75c.

**GIANT PARISIAN.** Somewhat lighter colored than the Giant Trimardeau and particularly recommended to those desiring a bright, showy mixture. Flowers mostly five blotched. Pkt. 15c., 1/4 oz. \$1.00.

**FRENCH MIXED.** Comprises many beautiful colors. Pkt. 10c., oz. \$2.00.

**GIANT TRIMARDEAU.** Plants of this type are of strong, compact growth, free bloomers and withstand unfavorable weather remarkably well. Flowers are of largest size, usually stained or blotched, and in an endless range of colors. Pkt. 10c., oz. \$2.50.

**MME. PERRET.** The flowers of this variety are mainly of the red, rose and wine shades. Pkt. 10c.

**FINE MIXED.** All colors. Oz. \$1.00, pkt. 5c.

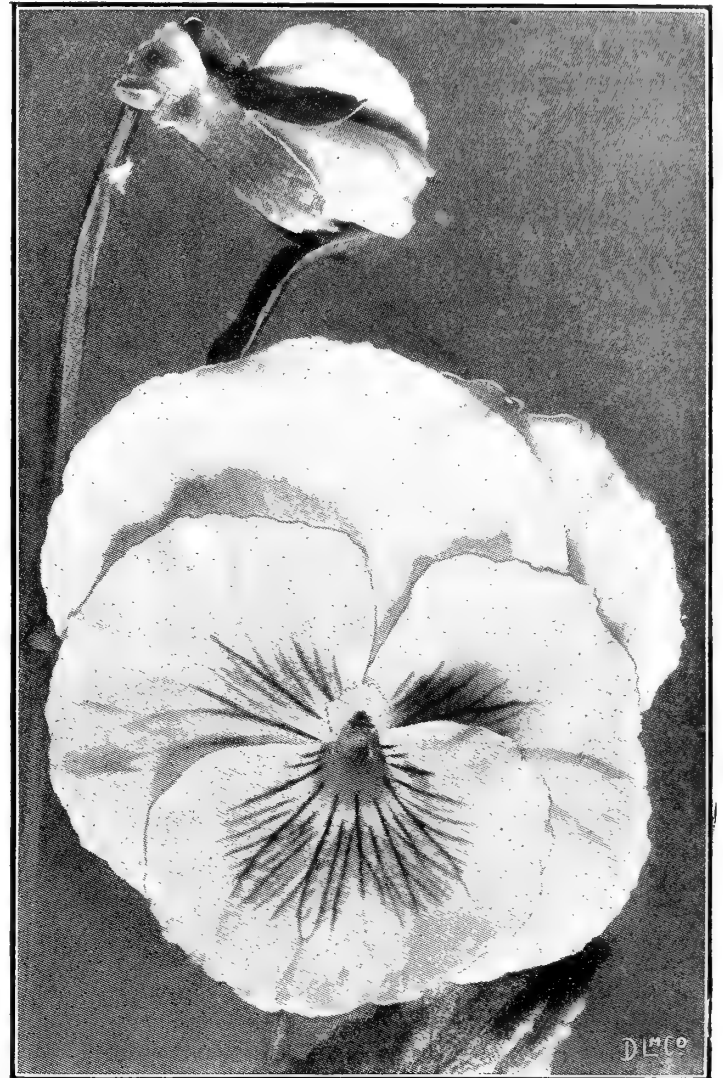

Pansy, Giant Beauty

## GIANT SEPARATE COLORS

	Per pkt.		Per pkt.
<b>ANDROMEDA.</b> Soft rosy color, tinted lavender, with darker veining; wavy petals.....	\$0.15	<b>MAUVE QUEEN.</b> Charming new Pansy of a delicate mauve color with a large blotch of carmine on lower petals.....	\$0.10
<b>EMPEROR FRANZ JOSEPH.</b> Giant flowers of pure white, each petal being blotched with violet blue.....	.15	<b>PURPLE.</b> One of the best dark varieties..	.10
<b>EMPEROR WILLIAM.</b> Bright corn-flower blue with dark eye.....	.10	<b>RUBY KING.</b> Brilliant red shades.....	.10
<b>FIRE KING.</b> Golden yellow, upper petals purple .....	.10	<b>SNOWFLAKE.</b> Especially fine for bedding; snow white flowers.....	.10
<b>GOLDEN QUEEN.</b> Pure yellow.....	.10	<b>STRIPED.</b> Of striking beauty. Flowers well formed and striped with pretty colors.....	.10
<b>GOLDEN YELLOW.</b> Center stained with black; large and very showy.....	.10	<b>VIOLET BLUE.</b> A splendid variety.....	.10
<b>LORD BEACONSFIELD.</b> Rich, velvety purple-violet, shaded white at the top. Unsurpassed for bedding.....	.10	<b>WHITE, STAINED PURPLE.</b> An exceedingly attractive variety of the Giant Trimardeau type.....	.10

## TUFTED PANSIES

(Viola Cornuta)

Though somewhat smaller than the above, the flowers are produced in greater abundance and remain in bloom until early fall. The culture is the same as for Pansies. **Choice mixed.** Pkt. 10c.

# SWEET PEAS

## EXTRA SELECTED VARIETIES

This flower is too popular and well known to require any description, as it is a favorite with all. We have listed below only those varieties that to our knowledge will give the best results and which we consider superior in their respective classes.

Although the sweet pea does well in almost any soil, still one that is very rich and rather moist suits it best. Very early in spring sow the seed quite thickly in drills two inches deep and later thin out the plants to six inches apart in the row. When the plants are about five inches high it is necessary to place a trellis or brush along the rows for their support.

The flowers should be picked frequently, before the seed pods form, otherwise the plants will soon stop flowering.

We prepay postage on packets, ounces and ¼ lbs., but if 1 lb. is ordered 8c. must be added for mailing.

All 5c. per packet, except where prices are given.

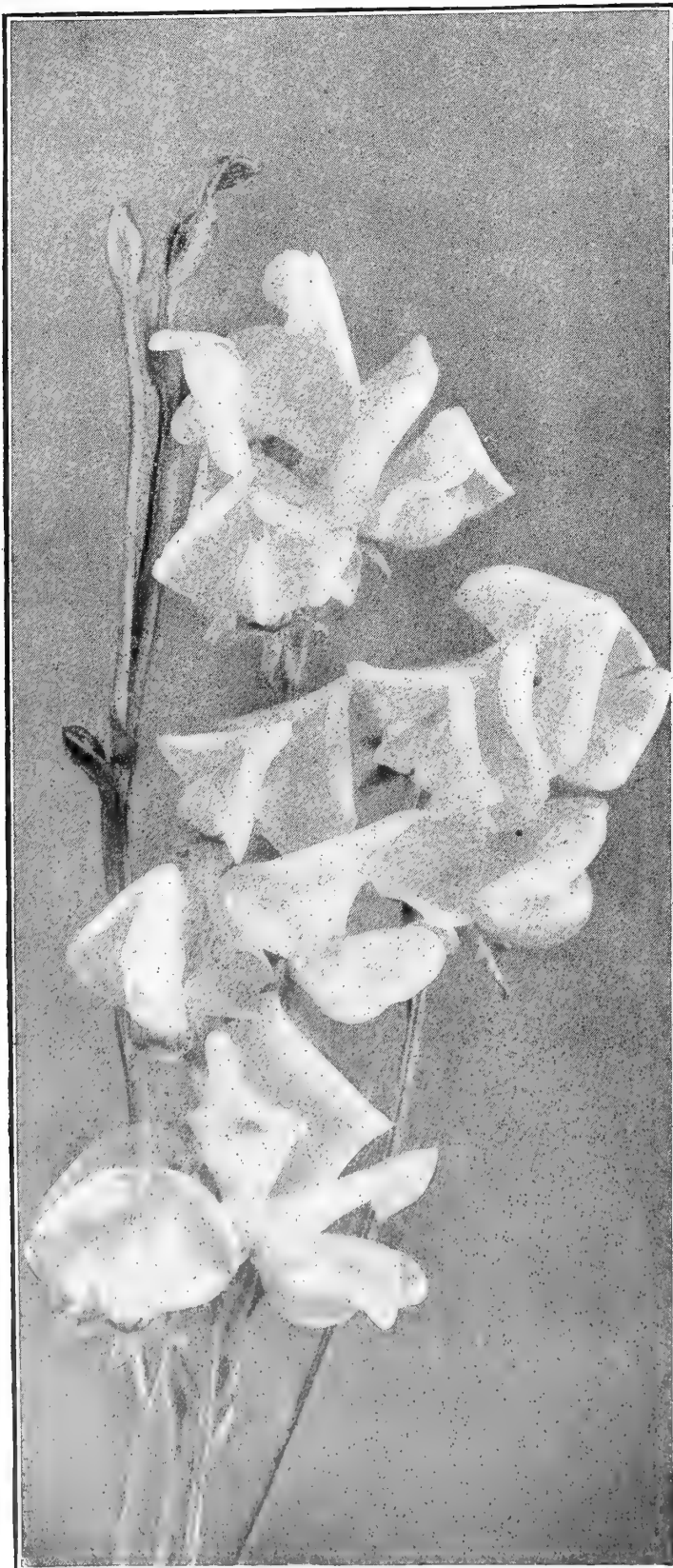

Sweet Pea

	Per oz.	Per ¼ lb.	Per lb.
<b>America.</b> Deep red striped on white ground....	\$0 10	\$0 25	\$0 65
<b>Apple Blossom.</b> Standard pink, wings white shaded pink.....	10	25	65
<b>Aurora.</b> Orange rose, striped on white, very large flower.....	10	25	65
<b>Blanche Burpee.</b> Pure white of medium size.	10	25	65
<b>Blanche Ferry.</b> Extra early; pink and white; excellent for cutting.....	10	25	65
<b>Boreatton.</b> Clear dark maroon.....	10	25	65
<b>Captain of the Blues.</b> Purple standard, wings blue tinged purple.....	10	25	65
<b>Countess of Radnor.</b> Beautiful light lavender.	10	25	65
<b>Countess Spencer.</b> Giant bright pink shaded deeper at edges. Petals wavy and very attractive	15	35	1 25
<b>Dorothy Eckford.</b> One of the best pure whites	10	25	65
<b>Dorothy Tennant.</b> Large rosy purple.....	10	25	65
<b>Earliest of All.</b> A very early pink and white..	10	25	65
<b>Emily Henderson.</b> Pure white, free flowering	10	25	65
<b>Flora Norton.</b> Bright clear blue; showy.....	10	25	65
<b>Frank Dolby.</b> Giant flowered light lavender blue..... Pkt. 10c.	20	50	1 75
<b>Gladys Unwin.</b> Giant light pink usually having four blossoms on long stout stems.....	15	35	1 25
<b>Gorgeous.</b> Beautiful orange tinged rose.....	10	25	65
<b>Helen Pierce.</b> Pure white mottled with bright blue. Flowers are marked similar to gloxinia ..	15	35	1 25
<b>Helen Lewis.</b> Superb orange pink; very large with wavy petals.....	15	35	1 25
<b>Henry Eckford.</b> Nearly a clear orange, splendid.....	10	25	65
<b>Hon. Mrs. E. Kenyon.</b> The best clear primrose yellow.....	10	25	65
<b>John Ingman.</b> Rosy carmine, wavy edges....	15	35	1 25
<b>Katherine Tracy.</b> Soft pink; fine for cutting.	10	25	65
<b>King Edward VII.</b> A bright crimson scarlet, extra large.....	10	25	65
<b>Lady Grisel Hamilton.</b> Light lavender; lovely shade.....	10	25	65
<b>Lottie Eckford.</b> White shaded lilac and blue	10	25	65
<b>Miss Willmott.</b> Brilliant orange pink.....	10	25	65
<b>Mont Blanc.</b> An early flowering pure white....	10	25	65
<b>Navy Blue.</b> Deep indigo blue shaded with violet.....	10	25	65
<b>Nora Unwin.</b> A superior white with giant ruffled flowers gracefully formed on long stems..... Pkt. 10c.	20	50	1 75
<b>Othello.</b> Dark Maroon.....	10	25	65
<b>Prima Donna.</b> Fine bright pink; four blossoms on a stem.....	10	25	65
<b>Prince Edward of York.</b> Crimson scarlet..	10	25	65
<b>Salopian.</b> A bright rich scarlet.....	10	25	65

**Veribest Mixed.** In making up this mixture we have used only the choicest named varieties, including many recent introductions, in such proportions as will insure a most striking effect. Per pkt. 5c., oz. 15c., ¼ lb. 35c., ½ lb. 65c., lb. \$1.25.

**Eckford's Mixed.** Special care has been taken in selecting the different varieties for this mixture and we feel sure same will give satisfaction. Per pkt. 5c., oz. 10c., ¼ lb. 20c., ½ lb. 30c., lb. 50c.

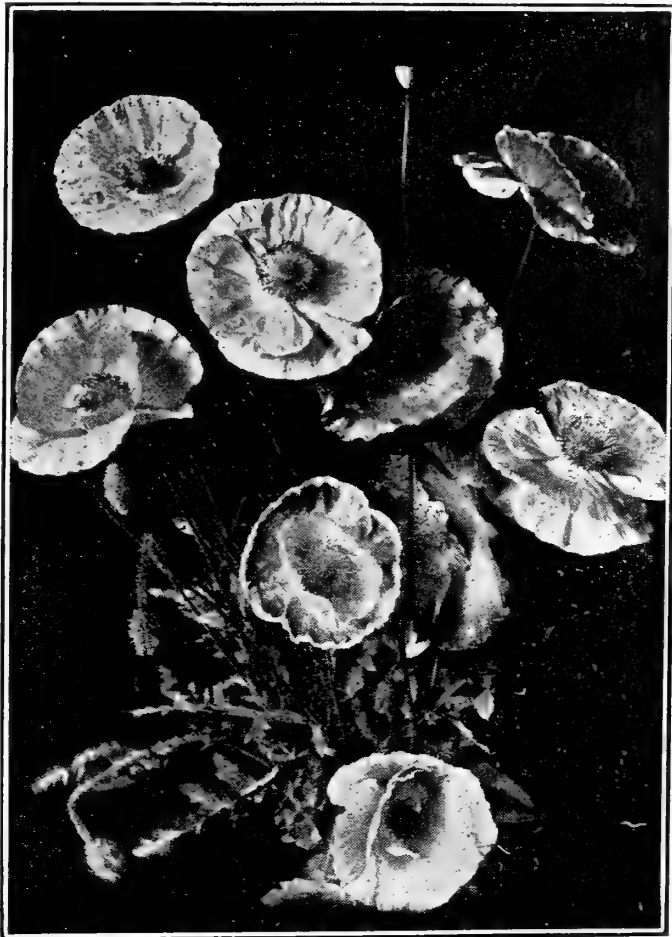

Poppy Shirley

**OXALIS.** A splendid class of plants, with brilliantly colored flowers and dark foliage; suitable either for greenhouse decoration, rock-work or rustic baskets out-of-doors. H. H. P.

**Rosea.** Delicate rose, forming a pretty plant when in bloom. 1/2 ft. Pkt. 10c.

**Tropaeoloides.** Deep yellow, with fine, compact, brown foliage. 1/2 ft. Pkt. 10c.

**Valdiviana.** Fragrant yellow. Pkt. 10c.

**PETUNIA.** A highly ornamental and profuse-flowering garden favorite, equally effective for the decoration of the greenhouse and sitting-room window or planted out in beds or borders. Annuals.

**Single Varieties—**

**Giants of California.** The large fringed flowers range from the most delicate to the deepest shades. A superb strain for bedding.

**Choice Mixed.** Pkt. 25c.

**Large-Flowered.** A plain-edged variety with enormous flowers; remarkable for their brilliant colors.

**Finest Mixed.** Pkt. 25c.

**Striped and Blotched.** Very attractive flowers with star-shaped blotches. Pkt. 10c.

**Compacta Brilliant.** Dwarf free blooming plants and bright carmine flowers. Pkt. 10c.

**Snowball.** Pure snowy-white flowers, fine for borders. Pkt. 10c.

**Countess of Ellesmere.** Rose with white throat, pretty. Pkt. 5c.

**Kermesina.** Crimson. Pkt. 10c.

**General Dodds.** Deep, showy dark red flowers. Pkt. 10c.

**Venosa.** Veined varieties. Pkt. 5c.

**Dwarf Inimitable.** Star

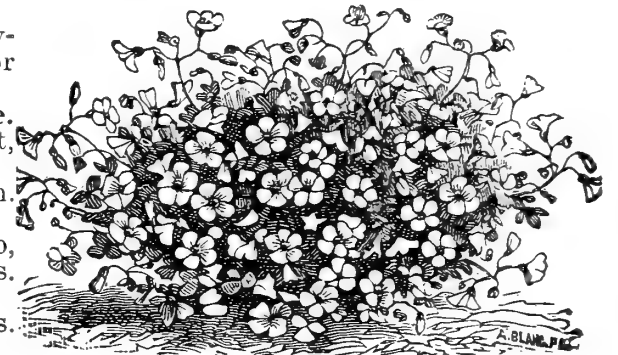

Oxalis Rosea

An exceedingly showy variety for bedding.....Pkt. 10c.  
 Oz. \$1.00, pkt. 5c.

**Double Varieties—**

**Grandiflora large-flowered Double.** The finest double variety grown; superb colors.....Pkt. 25c.

**Fringed Large-flowered Double.** Large double fringed flowers of the most charming colors.....Pkt. 25c.

**Double Striped and Blotched.** A choice mixture of beautiful striped and spotted flowers.....Pkt. 15c.

**Dwarf Double Lilliput.** Pretty, small double flowers of the most charming shades of color. Pkt. 25c.

**POPPIES.** One of the prettiest old-fashioned annuals, with large double or single flowers of almost every color imaginable, blooming profusely during the summer months. Sow the seeds where the plants are to remain as they do not stand transplanting.

**Single Annual—**

**Dwarf Shirley.** This dwarf variety of single poppies with their bright shining flowers of silky texture, are exceedingly effective in masses, and also valuable for cutting. 18 inches.

**Finest Mixed.** Pkt. 10c.

**Danebrog.** Large flowers of a brilliant scarlet, with a silver spot on each of the petals. Pkt. 5c.

**The Bride.** Large satiny-white flowers, 3 to 4 in. across; extremely handsome. 2 ft. Pkt. 5c.

**Miss Sherwood.** Large flowers with satiny-white petals shading to light rose. Pkt. 5c.

**Glaucum (Tulip Poppy).** A distinct tulip-shaped poppy of bright scarlet color. 1 ft. Pkt. 10c.

**Fine Mixed.** Brilliant colors. Pkt. 5c, oz. 25c.

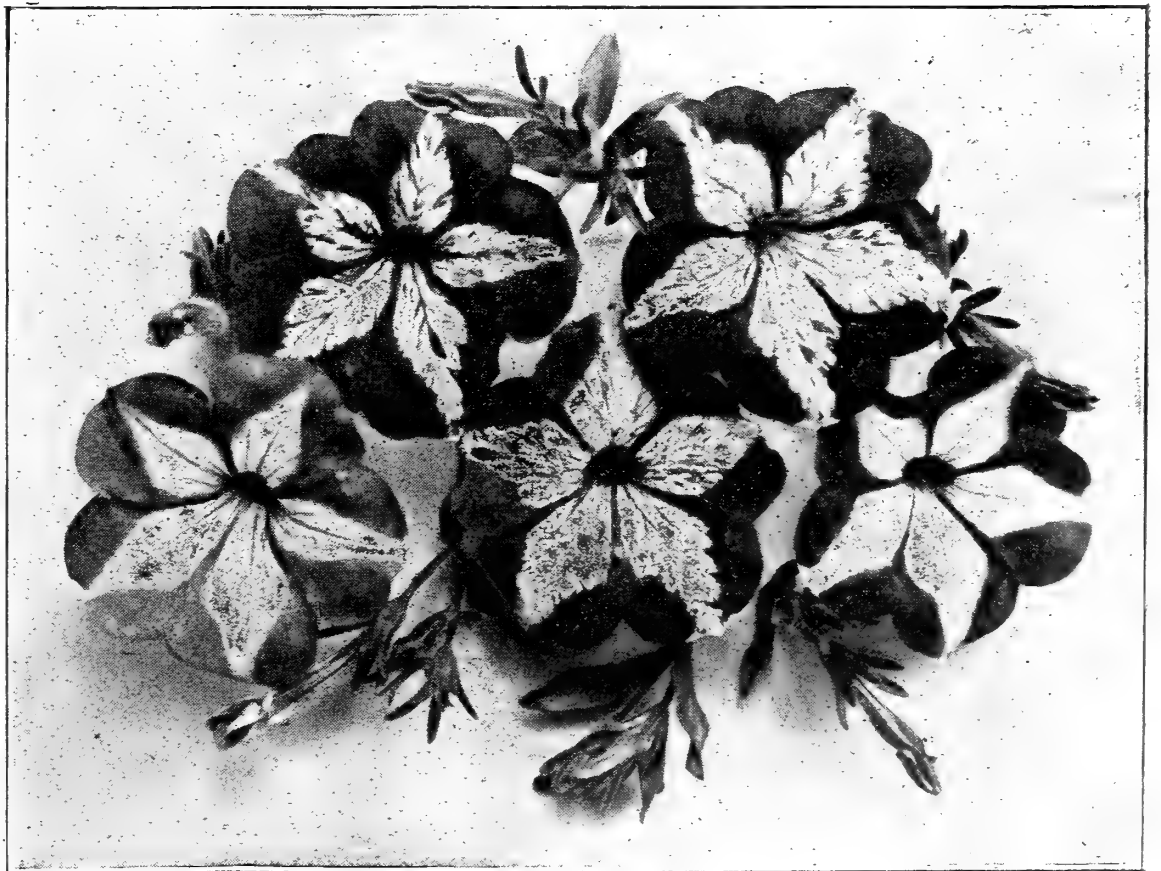

Petunia Striped and Blotched

**POPIES. Double Annual.**

**Double Carnation-Flowered.** Large double flowers with petals deeply cut and fringed. 1 ft.

- Dwarf Pure White.....Pkt. 5c.
- “ Rose .....Pkt. 5c.
- “ Crimson .....Pkt. 5c.
- “ Finest Mixed. From many varieties.....Oz. 30c. Pkt. 5c.

**Double Peony-flowered.** Peony-shaped flowers often measuring 4 to 5 inches across. 1 ft.

- Dwarf Scarlet and White.....Pkt. 5c.
- “ Dark Scarlet.....Pkt. 5c.
- “ White and Light Purple .....Pkt. 5c.
- “ Brilliant Rose .....Pkt. 5c.
- “ Finest Mixed .....Cz. 30c. Pkt. 5c.

**Mikado.** The petals are cut and fringed; the color pure white at the back, while the fringed edges are of a brilliant crimson-scarlet. Pkt. 5c.

**American Flag.** Beautiful double white flowers bordered orange scarlet. 2 ft. Pkt. 5c.

**Ariel.** New, double white flowers, shaded bright salmon and each petal with a blue blotch. 2 ft. Pkt. 10c.

**HARDY PERENNIAL POPPIES.**

**Oriente.** Exceedingly large single flowers with various shades of rose, scarlet, lilac and mauve. 3 ft.

**Finest Mixed Hybrids.** Pkt. 10c.

**Nudicaule** (Iceland Poppies). These dwarf poppies with their light green foliage and fragrant flowers make an attractive appearance when planted in beds. Bloom the first year from seed. 1 ft.

**Single Finest.** Mixed. Pkt. 10c.

**PORTULACA.** There are few flowers that make such a dazzling display of color in the bright sunshine as a bed of Portulacas. They succeed best in a light, dry soil and should have a sunny situation. Annual. 1/2 ft.



Poppy, Carnation-Flowered

**SINGLE VARIETIES**

- |  |  |
|--|--|
| Alba. Beautiful pure white.....Pkt. 5c.            | <b>Caryophylloides.</b> Rose, striped red.....Pkt. 5c. |
| Alba striata. White, striped crimson .....Pkt. 5c. | <b>Rosea.</b> Bright rose.....Pkt. 5c.                 |
| Aurea vera. Deep golden .....Pkt. 5c.              | <b>Thellusonii.</b> Splendid scarlet.....Pkt. 5c.      |
| Bedmanni. White with red center.....Pkt. 5c.       | <b>Splendens.</b> Crimson.....Pkt. 5c.                 |
| Bronze Color.....Pkt. 5c.                          | <b>Fine Mixed.</b> All colors.....Oz. 5c., Pkt. 5c.    |

**DOUBLE VARIETIES**

- |                                 |  |
|---------------------------------|--|
| Pure White.....Pkt. 15c.        | <b>Crimson.</b> Bright and showy.....Pkt. 15c. |
| Brilliant Scarlet.....Pkt. 15c. | <b>Grandiflora.</b> Finest mixed.....Pkt. 10c. |

**PYRETHRUM.** Very beautiful and exceedingly ornamental dwarf-growing plants, with yellow foliage. Excellent for edgings and ribbon beds. Hardy perennial.

**Aureum** (Golden Feather). Bright yellow foliage. Pkt. 5c.



Portulaca, Single

## PHLOX DRUMMONDI

This hardy annual, with its bright showy flowers, cannot be too highly recommended for bedding purposes or ribbon borders, as the plants remain in bloom until late in summer. The grandiflora variety if planted in rich soil attains a height of twelve to fifteen inches and affords splendid spikes of flowers for cutting.

### GRANDIFLORA VARIETIES, 1 ft.

- Alba.** Splendid pure white flowers ..... Pkt. 10c.
- Atropurpurea.** Deep purple..... Pkt. 10c.
- Crimson.** Rich, dazzling color..... Pkt. 10c.
- Rosea.** Soft rosy-pink..... Pkt. 10c.
- Scarlet.** Bright and showy; splendid for bedding ..... Pkt. 10c.
- Striped.** Many pretty colors ..... Pkt. 10c.
- Grandiflora.** Finest mixed..... Oz. 75c., pkt. 5c.

### NANA COMPACTA DWARF VARIETIES

- Defiance.** Very bright scarlet. .... Pkt. 10c.
- Fireball.** Handsome dark red ..... Pkt. 10c.
- Hortensiaeflora.** Rose ..... Pkt. 10c.
- Snowball.** Pure white ..... Pkt. 10c.
- Splendens.** Crimson, white eye..... Pkt. 10c.
- Nana compacta.** Finest mixed..... Oz. \$2.00., pkt. 10c.
- Large Flowered Cecily Phlox.** A splendid variety of dwarf, compact habit with remarkably large flowers and splendid colors. 1/2 ft. **Choice Mixed.**..... Pkt. 10c.
- Star of Quedlinburgh.** Pretty star-shaped flowers. **Finest Mixed.**..... Pkt. 10c.
- Decussata.** Hardy perennials, bearing large trusses of bright colored flowers. 2 ft. **Finest Mixed.**..... Pkt. 10c.

**PHASEOLUS Multiflorus Papilio** (Butterfly Bean). A new addition to the climbing plants and similar to the Scarlet and White Runners, so popular for garden decoration. The leaves almost disappear beneath the clusters of charming flowers which gracefully rise and fall, like butterflies, in the passing breeze. Flowers of large size with pretty, wavy, snow-white wings and rose standards. 12 ft..... Pkt. 10c.

**PHYSALIS Francheti** (Chinese Lantern Plant). A hardy perennial, about 2 feet high, blooming the first year from seed and admired for its bright colored seed pods, which are at first golden yellow but later changing to orange-scarlet. The pods are quite similar in appearance to small lanterns..... Pkt. 5c.



Phlox Drummondii

## PRIMULA (Chinese Primrose)

The Chinese Primrose is one of the favorite pot plants for winter blooming, either in the house or conservatory. The fringed, rich-colored flowers, of very large size and handsome appearance, are in constant bloom throughout the greater part of the winter. Sow the seed from April until June. 3/4 ft.

- Chinensis Fimbriata.** **Finest Fringed Mixed.** .. Pkt. 25c.
- Chinensis Stellata** (Star Primrose). Very pretty, free-blooming plants for decorative purposes, with graceful spikes of star-shaped flowers borne well above the foliage..... Pkt. 25c.
- Obconica Grandiflora.** Splendid free blooming hybrids, bearing large clusters of flowers three months after sowing. 1 ft. **Fine Mixed Hybrids**..... Pkt. 10c.
- Obconica Gigantea.** An improved strain of the above, with extra large flowers and comprising many beautiful shades and colors..... Pkt. 15c.
- Kewensis.** A new and charming acquisition to the Primula family, making very fine house plants for winter blooming. The bright yellow flowers are fragrant and produced in whorls along the full length of the stem, which adds to their beauty and attractiveness. Sow seed in early spring. 18 inches... Pkt. 25c.

### HARDY PRIMROSES

- Auricula.** This half-hardy perennial blooms profusely early in spring, affording a splendid display of richly marked flowers. **Choice Mixed**..... Pkt. 10c.
- Elatior (Polyanthus).** These well-known perennials are not perfectly hardy, but if protected in a cold frame during the winter, make excellent bedding plants for spring blooming. The beautiful, various-colored flowers are marked in the most striking manner and succeed best in partial shade. 1 ft. **Finest Mixed**..... Pkt. 10c.
- Gold Laced.** Pretty, bright colored flowers..... Pkt. 10c.
- Vulgaris (English Primrose).** Yellow; fragrant.... Pkt. 5c.



Primula Obconica

**RICINUS** (Castor Oil Bean). From seed they quickly attain gigantic proportions, and are ornamental till destroyed by frost. H. A.

**Borb niensis Arboreus.** Large and handsome green foliage. 15 ft. Pkt. 5c., oz. 20c.

**Communis** (Castor Oil Plant). Large green foliage. 6 ft. Pkt. 5c., oz. 20c.

**Cambodgensis.** The finest dark leaved variety. Foliage dark maroon with black stems. 5 ft. Pkt. 5c., oz. 25c.

**SALPIGLOSSIS.** Handsome funnel-shaped flowers of a peculiar velvety softness, useful for filling vases and table bouquets. H. H. A.

**Large-Flowering.** Finest mixed varieties, including scarlet, sky blue, yellow and black. 1½ ft. Pkt. 5c.

**Dwarf.** This plant being more compact than the above, forms elegant plants for bedding. 1 ft.

**Fine Mixed.** Pkt. 5c.

**SALVIA.** Magnificent bedding plants of the most brilliant and effective character. Laden with scarlet spikes, a bed forms a beautiful and highly attractive object. H. H. P. 2 ft.

**Clara Bedman** (Bonfire). This is the finest Salvia for bedding yet introduced. The plants grow into compact oval bushes; brilliant scarlet flowers. The spikes stand out stiff and erect, while they bear from 20 to 30 flowers each. 2½ ft. Pkt. 15c.

**Fireball.** A dwarf early blooming variety with large spikes of bright dazzling scarlet flowers. The plants while not more than two feet in height are continually ablaze with flowers from July until late in the fall. Pkt. 15c.

**Burning Bush.** Excellent for bedding or borders with magnificent scarlet flowers. Pkt. 10c.

**Splendens.** Flowers bright scarlet. 3 ft. Pkt. 10c.

**SCABIOSA, or Sweet Scabious.** A very showy, free flowering plant, producing a great profusion of beautiful and richly colored flowers. H. A.

**Dwarf Double.** Many colors, mixed. 1 ft. Pkt. 5c.

**Tall Double.** Very showy. Mixed colors. 2 ft. Pkt. 5c.

**SCHIZANTHUS** (Butterfly Flower). Elegant free-flowering hardy annuals for the garden in summer or for pot-culture in the greenhouse during winter. 1½ ft.

**Finest Mixed.** Shades of rose, scarlet, purple and white. Pkt. 5c.

**SENSITIVE PLANT.** One of the most remarkable and interesting plants in cultivation; the leaves when touched, instantly fold up.

**Minosa Pudica.** H. H. A. 1 ft. Pkt. 5c.

**SEDUM.** (Stone Crop).

**Cœruleum.** Charming little plants with bright blue flowers doing best in light soil. H. A. ¼ ft. Pkt. 10c.

**SENECIO. Jacobea.** For large beds and mixed borders the Jacobea is very effective. H. A. 1 ft. Finest mixed colors. Pkt. 5c.

**SILENE.** (Catchfly.) Free blooming hardy plants of easiest cultivation, useful for beds and borders.

**Armeria.** Mixed colors. Hardy annual. Pkt. 5c.

**Pendula.** Dwarf Rose. Excellent for spring bedding. 6 in. Pkt. 5c.

**SMILAX.** Smilax is the most useful and one of the most graceful climbers which adorn the greenhouse or conservatory. T. P. 6 ft.

**Myrsiphyllum Asparagoides.** Pkt. 10c.

**SANVITALIA.**

**Procumbens, fl. pl.** A charming dwarf annual, useful for small beds, edges or baskets; and covered all summer with bright, double yellow flowers. H. A. ½ ft. Pkt. 5c

**SOLANUM.**

**Capsicastrum** (Jerusalem Cherry). Very interesting plants for greenhouse or window decoration. Its dwarf branching habit and bright scarlet berries are very attractive. 1 ft. T. P. Pkt. 10c.

**SWEET SULTAN** (Centaurea Moschata). Hardy annuals with bright-colored flowers, on long, slender stems, which are splendid for cutting and bouquets. 1½ ft.

**Blue, White and Yellow Mixed.** Pkt. 5c.



Salpiglossis

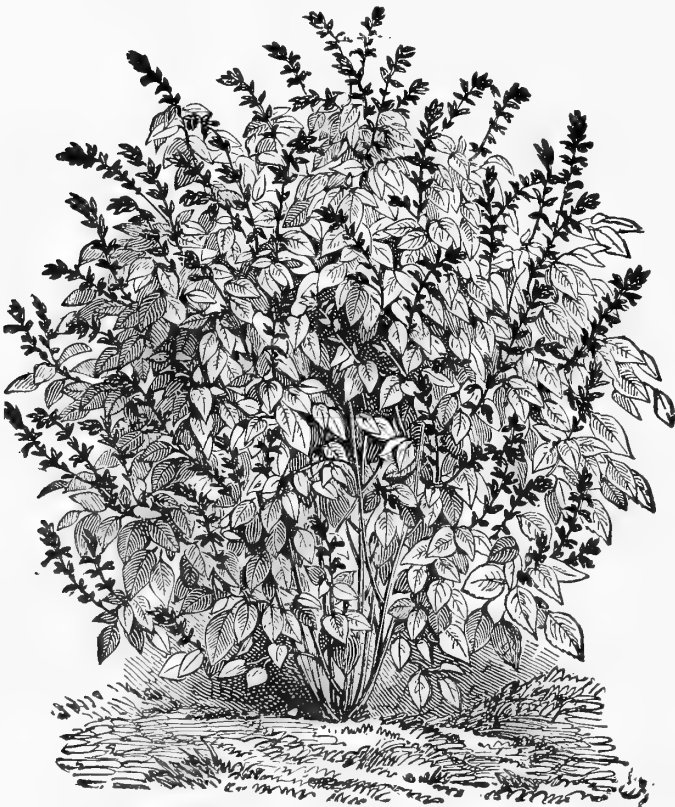

Salvia Splendens



Scabiosa

**STOCKS.** The stocks, being of easy cultivation, has grown into popular favor, either for bedding, edging or pot plants. Their handsome flower spikes of every desirable color are invaluable for cutting and bouquets. To obtain early flowers, seed should be started under glass in March or April; but for later flowers sowings may be made in the open ground in May. H. H. A. 1 1/4 ft.

**Large Flowering Double Dwarf Ten-Week.** A magnificent strain producing a large percentage of double flowers.

	Oz.	Pkt.
Pure White .....	\$3 00	\$0 10
Bright Rose.....	3 00	10
Light Blue.....	3 00	10
Crimson.....	3 00	10
Canary-Yellow.....		10
Blood-Red, very effective.....		10
Violet.....		10
Shining Purple-Carmine.....		10
Carmine. Bright and showy.....		10
Finest Mixed.....	2 50	10
<b>Large Flowering Dwarf, Pyramidal.</b>		
Finest Mixed. Excellent variety.....		10
<b>Dwarf German Ten Weeks.</b> Fine mixed..	2 00	05
<b>Dresden Perpetual</b> (Cut-and-Come-Again). Splendid free flowering Stocks of branching habit and exceedingly double flowers. A fine class for cutting.		
<b>White, Princess Alice.</b> Beautiful large spikes of clear snow-white flowers .....		Pkt. 15c.
<b>Finest Mixed.</b> All colors .....		Pkt. 10c.

**LARGE-FLOWERING EMPEROR.**

A beautiful winter blooming class, bearing profusely extra large double flowers. Seed sown in May or June make strong plants for winter flowering. H. H. B. 1 1/2 ft.

**Finest Mixed** .....

**Snowflake.** This dwarf wallflower leaved variety affords splendid spikes of pure white fragrant flowers; very early and valuable for forcing. Pkt. 15c.

**SWEET WILLIAM (Dianthus Barbatus).**

A well-known hardy biennial with large heads of extremely rich colored flowers, effective when planted in beds or borders, and also useful for cutting. Seed sown in July or August will produce flowering plants the next summer. H. B. 2 ft.

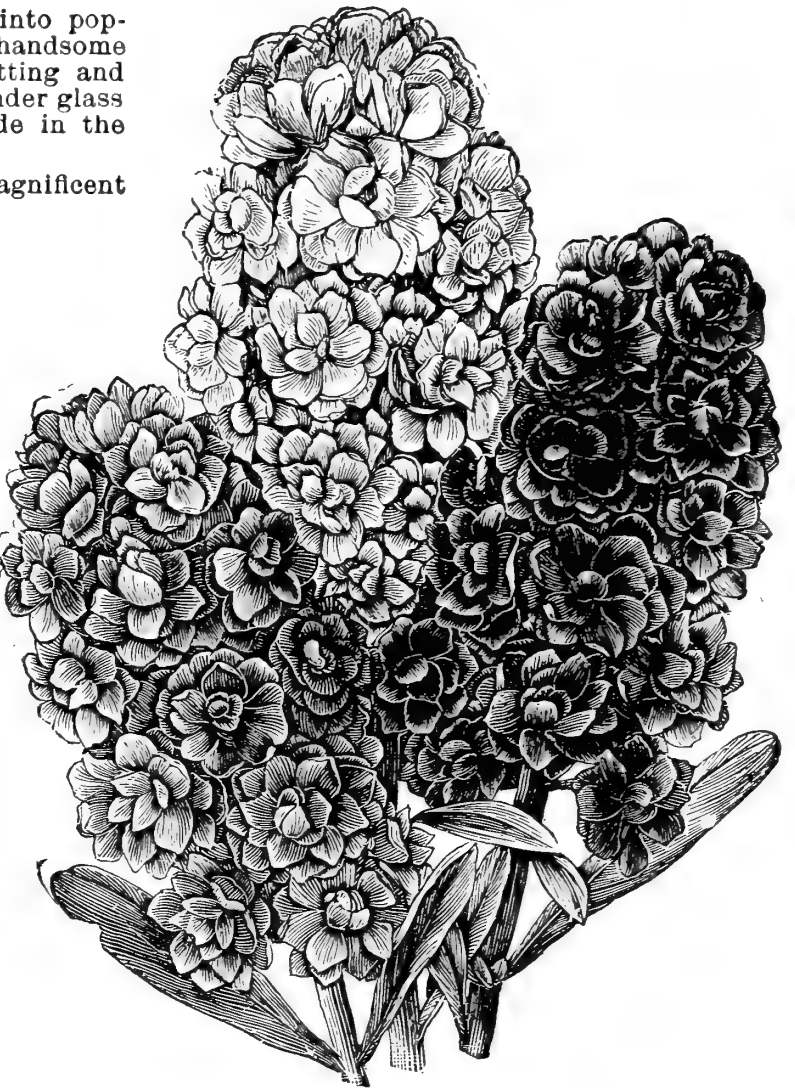

Stocks, Ten-Weeks

**Auricula-flowered.** A handsome variety, producing immense trusses of bloom .....

**Pink Beauty.** New rosy Chamois.....

**Fine Mixed Single.** All colors.....

**Double Crimson.** Very rich shade.....

**Mixed Double.** Beautiful colors .....

**Dwarf Double.** The plants are more compact than above varieties with double fragrant flowers, 12 to 15 in.

**Splendid Mixed.** All colors.....

**Dwarf Single.** Similar to the above, having pretty single flowers of various colors, 12 to 15 inches.

**Choice Mixed.** Oz. 60c., pkt. 5c.

**STOKESIA CYANEA**

(Corn-flower Aster). The pretty lavender blue flowers of this hardy perennial are splendid for cutting, and especially attractive for vase decoration. 2 ft. Pkt. 10c.



Stokesia Cyanea



Sweet William

**TORENIA Fournieri.** These tender annuals, whether planted in beds or hanging baskets, are extremely effective, with their showy antirrhinum-like flowers. If seed is sown early the plants are completely covered with flowers from July until frost. 1 ft. Fine mixed. Pkt. 10c.

**THUNBERGIA.** Beautiful, rapid-growing annual climber, thriving in a light, rich loamy soil, in warm situations in the garden and used extensively in hanging-baskets, vases, etc.; very pretty flowers in buff, white, orange, etc., with dark eyes. H. H. A. 5 ft. Finest Mixed Colors. Pkt. 5c., oz. 50c.

**TROPÆOLUM Canariense** (Canary Bird Flower). A splendid climber with curiously shaped bright yellow flowers and fine cut foliage. Blooms freely from July until frost. H. H. A. 10 ft. Pkt. 5c.

**VIOLET** (Viola).

**Odorata Semperflorens.** A well-known hardy perennial, with sweet scented blue flowers; being exceptionally pretty for borders. The seed of this variety is slow in germinating. 1/2 ft. Pkt. 10c.

**Cornuta Admiration.** This class commences to bloom in July from seeds sown the same spring, and its lovely blue flowers are produced abundantly during the whole summer. H. P. 1/2 ft. Pkt. 10c.

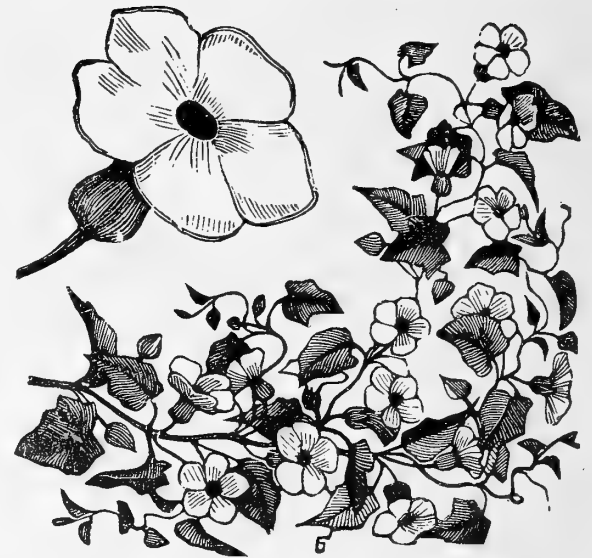

Thunbergia

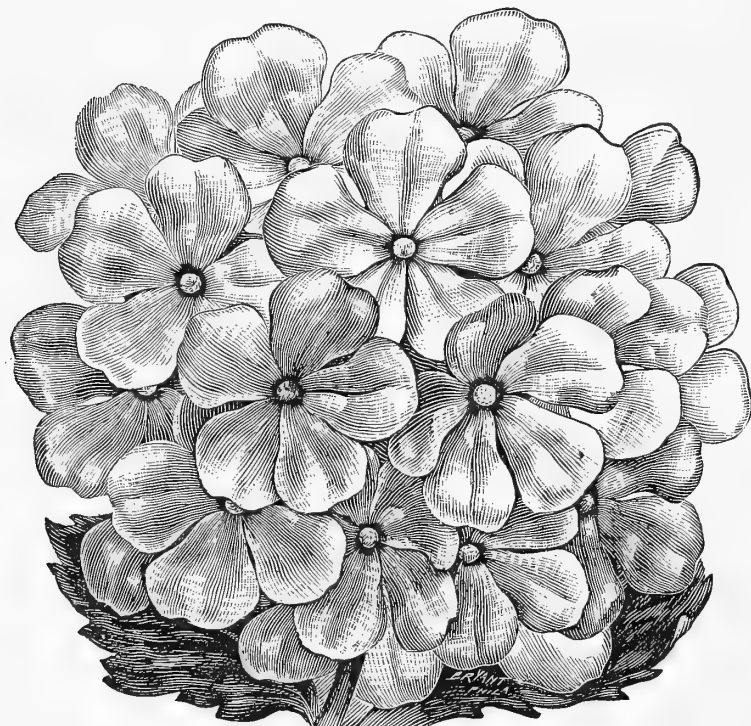

Verbena

**VIRGINIAN STOCK.** Charming dwarf free-flowering plants, extremely effective in small beds, baskets or as edgings. H. A. 1/2 ft.

Finest Mixed, red and white. Each, pkt. 5c, oz. 20c.

**VERBENA.** For effective bedding the Verbena is unequalled. The plants of trailing habit are just covered with large heads of beautiful colored flowers until late in autumn. Best results are obtained by sowing the seed early in the house or hot bed, but outdoor sowings may be made also in May. Annual. 1/2 ft.

	Pkt.
Black Blue with white eye.....	\$0.10
Candidissima. Flowers of purest white.....	.10
Cœrulea. Blue shades .....	.10
Defiance. Brilliant scarlet.....	.10
Firefly. Scarlet, with white eye.....	.10
Pink Shades. Very fine.....	.10
Purpurea. Purple.....	.10
Striata. Striped.....	.10

**Mammoth.** Flowers of this variety are very large, of dazzling colors and distinct eyes.

Choice Mixed.....Oz. \$2.00, pkt. 10c.

**Tom Thumb.** Dwarf and compact, not exceeding 6 inches in height; flowers well formed, of various beautiful colors.

Finest Mixed .....

Hybrida, Finest Mixed Varieties .....

**CITRIODORA** (Lemon Verbena). The light green leaves of this variety are sweetly scented and extensively used in bouquets. 2 ft. Pkt. 10c.

**VINCA.** Fine free blooming plants with glossy green leaves and bright rose and white flowers. They are splendid for the garden, and having long, stiff stems, make valuable cut flowers. Seed should be sown early and they will bloom the first year. H. H. P. 1 1/2 ft.

	Pkt.
Rosea. Rose.....	\$0.05
Rosea alba. White, red eye .....	.05
Alba pura. Pure white.....	.05
Finest Mixed.. .....	.05



Vinca



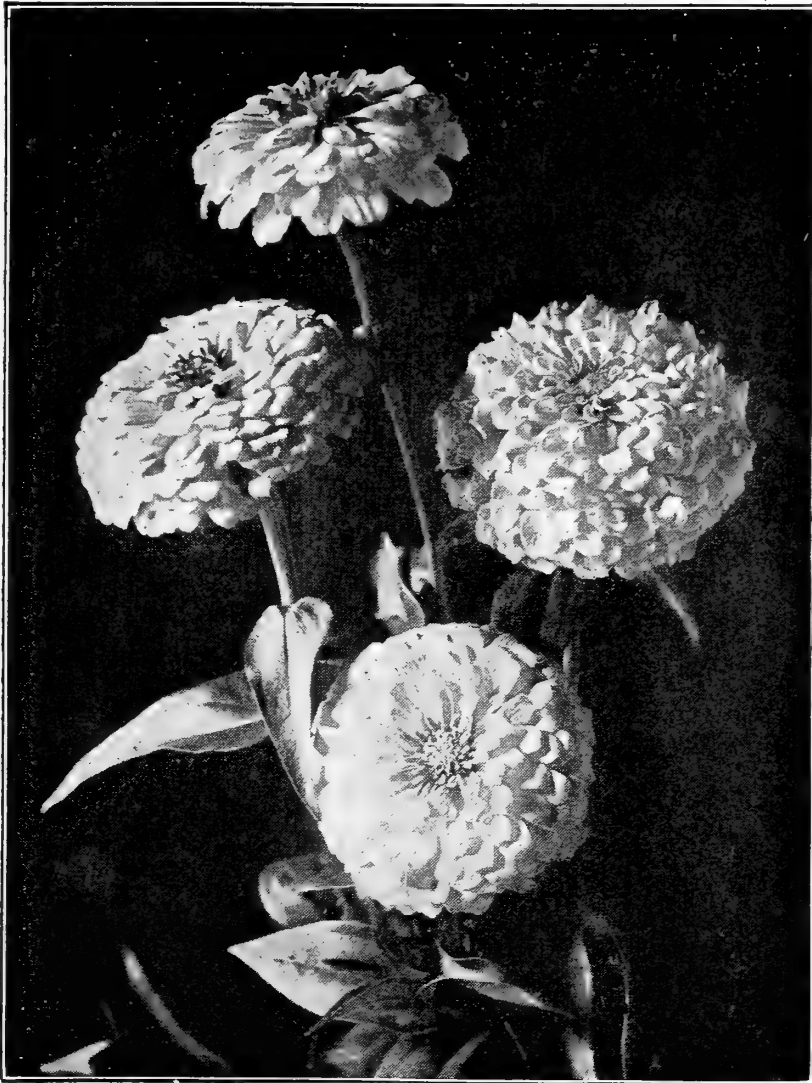

Zinnia

**LARGE-FLOWERING WALLFLOWER**

Wallflowers are highly prized for their delicious fragrance. In the spring they are indispensable for beds and groups. The large, massive, conspicuous spikes of the double German varieties have a charming effect; while the more bushy, compact growth and profuse blooming of the single varieties render them exceedingly attractive. H. P. 2 ft.

**Single Varieties.**

**Paris Earliest.** A single variety blooming the first year from seed sown early in spring, with sweet-scented yellow flowers. Pkt. 5c.

**Early Feltham.** The flowers are large of a reddish brown color. Pkt. 5c.

**Tom Thumb, Black Brown.** Dwarf compact habit with rich dark brown flowers; excellent for growing in pots during the winter months. 1 ft. Pkt. 10c.

**Dwarf Blood Red.** Effective dark red color. Pkt. 5c.

**Single Varieties, Finest Mixed.** Pkt. 5c.

**Double Varieties.**

**Dwarf Branching, Dark Brown.** Finest sort for florists, being extremely double. Pkt. 15c.

**Double Finest Mixed.** Pkt. 10c.

**XERANTHEMUM.** Very showy and pretty everlasting, valuable to cut for summer and winter bouquets. H. A. 2 ft.

**Cœrulea fl. pl.** Double purple. Pkt. 5c.

**Finest Mixed Colors.** Pkt. 5c.

**ZINNIA. (Youth and Old Age).** Of all the double flowers few equal these hardy annuals, with their profusion of bloom and everlasting flowers. Whether in beds, borders or groups the plants are continually covered with large double flowers from early summer until killed by frost. They are extremely useful to cut for bouquets.

**DWARF DOUBLE VARIETIES.**

Crimson.....Oz. 75c.	Pkt. 5c.	Golden Yellow....Oz. 75c.	Pkt. 5c.	1½ ft.	Sulphur Yellow...Oz. 75c.	Pkt. 5c.
White.....Oz. 75c.	Pkt. 5c.	Salmon.....Oz. 75c.	Pkt. 5c.		Violet.. ..Oz. 75c.	Pkt. 5c.
Scarlet.....Oz. 75c.	Pkt. 5c.	Purple.....Oz. 75c.	Pkt. 5c.		Finest Mixed.....Oz. 50c.	Pkt. 5c.

**Zebra Striped.** A pretty class having the flowers striped in a peculiar, still very attractive manner; for a showy display through the summer months a bed of this variety is unsurpassed. 1½ ft. Pkt. 10c.

**Giant Flowering.** The flowers of this variety are of enormous size and when in full bloom make a very striking appearance. 3 ft.

**Queen Victoria.** The double snow-white flowers often measure 4 inches in diameter. Pkt. 10c.

**Gold Striped Scarlet.** Unusually large bright golden flowers striped with scarlet. Pkt. 10c.

**Citron Yellow.** A handsome and exceedingly attractive color. Pkt. 10c.

**Double Giant-Flowering.** Finest mixed. Pkt. 10c.

**Curled and Crested.** The flower petals are gracefully curled and twisted. Mixed colors. Pkt. 10c.

**Tom Thumb.** The dwarf bushy plants are ablaze with small double flowers the whole summer; excellent for edges, borders and beds. 9 in.

**Finest Mixed.** Pkt. 10c.

**Lilliput.** This variety cannot be too highly recommended for borders or beds and are also very desirable for growing in pots. The pretty double flowers, while not more than an inch in diameter, are produced in the greatest profusion all summer. 1 ft.

Orange Gem .....	Pkt. 10c.
Scarlet Gem .....	Pkt. 10c.
White Gem .....	Pkt. 10c.
Finest Mixed .....	Pkt. 10c.



Zinnia, Zebra Striped

# BULBS AND ROOTS FOR SUMMER FLOWERS

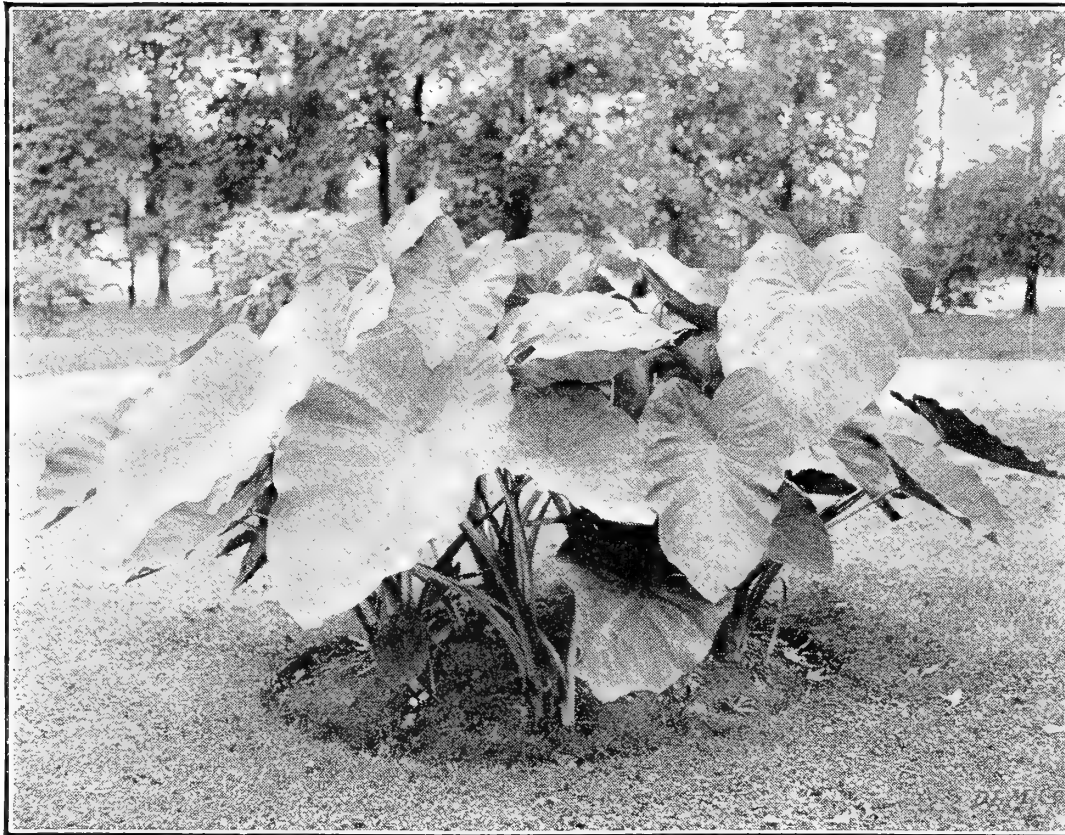

Caladium Esculentum

## CALADIUM ESCULENTUM

### Elephant's Ear

When planted in beds or borders the Caladium is very effective. The large light green leaves are of enormous dimensions, often measuring 3 feet long and 2 feet in width. Grows in any good garden soil.

**Large Bulbs.** Each 10c., per doz. \$1.00.

**Extra Large Bulbs.** Each 15c., per doz. \$1.50.

Above shipped by express only.

## FANCY-LEAVED CALADIUMS

The magnificent foliage of the fancy-leaved Caladiums is so oddly striped, spotted and veined that fancy words can hardly describe their beauty. They are indispensable as pot plants for house decoration, but also splendid for bedding purposes. Plant outside when weather is warm in places away from the direct rays of the sun.

**Price,** each 15c., per doz. \$1.75. By mail add 6c. each extra.

**Baron de Mamore.** Dark red leaves with green and white markings; forms a striking appearance.

**Henriette Bassett.** A very odd variety. Marked and veined rose with a yellow border.

**Lord Derby.** Green veins and mid-rib; transparent light rose.

**Splendidum.** Ground color rich crimson, shaded maroon, heavily veined center and edged with dark green.

**Triomphe de Exposition.** Bright crimson, slightly shaded throughout with pink, green border.

**Wilma.** Beautiful shade of pink, veined and ribbed with green.

## CALLA LILY

May be planted in pots for conservatory or house decoration and also in the garden after the weather becomes warm and settled. Flowers are pure white with a black center, while the dark green leaves are freely spotted white.

**Spotted Leaf.** Large bulbs, each 10c., per doz. \$1.00.

## CINNAMON VINE

A hardy, rapid growing climber with bright green heart-shaped leaves and small snow white cinnamon scented flowers.

**Extra large bulbs,** each 5c., per doz. 50c., postpaid 60c.

## AMARYLLIS

**Formosissima** (Jacobean Lily). Large, handsome, trumpet-shaped flowers of rich crimson scarlet, which are borne on slender stalks well above the long, narrow, dark green leaves. It may be planted in pots for house culture or in the open ground during May, blooming either in June or July. **Large bulbs** each 10c., per doz. \$1.00. By mail add 3c. each extra.

## BEGONIAS

### Tuberous-Rooted

This is one of the few plants that prefers and also thrives best in a partially shaded place. They grow easily, bloom freely and succeed well either in the open ground or as a pot plant in the conservatory or window box. The single as well as the double flowers range through the most striking colors and often measure 5 inches in diameter. Start indoors during February or March, using a rich sandy soil.

	SINGLE	Each	Doz
Scarlet .....		5c.	60c.
White.....		5c.	60c.
Yellow .....		5c.	60c.
Mixed.....		5c.	60c.

	DOUBLE	Each	Doz.
Scarlet .....		7c.	75c.
Rose .....		7c.	75c.
Orange.....		7c.	75c.
Mixed.....		7c.	75c.



Calla Lily



Bed of Cannas

## CANNAS

With new and better varieties being introduced almost every year, the Canna is becoming one of the most popular plants for bedding. The foliage is both rich and attractive, while the large handsome flowers of almost every shade and color bloom continuously from July until frost. We offer strong dormant roots of the following varieties at a very reasonable price.

By mail add 3c. each, 25c. per dozen extra

**Alsace.** The flowers at first are light yellow but gradually change to a creamy white. Green foliage. 4½ feet. Each 5c., per doz. 60c.

**Austria.** A splendid orchid flowered variety with canary yellow flowers, of extra large size, blooming profusely throughout the summer. Green foliage. 5 feet. Each 5c., per doz. 60c.

**Black Prince.** The deep green purple shaded leaves are highly ornamental and contrast well with the large spikes of maroon colored flowers. 3½ feet. Each 5c., per doz. 60c.

**Brandywine.** Magnificent dark bronze leaved Canna, growing about 5 feet high, the flowers of which are bright red. Each 5c., per doz. 60c.

**Buttercup.** The nearest approach to a clear yellow. The plants always present an attractive appearance as they are in constant bloom until frost. Green leaved, growing from 3 to 4 feet. Each 10c., per doz. \$1.00.

**Charles Henderson.** This favorite crimson variety, although growing only 3½ feet high, will be found satisfactory for bedding, either alone or with the brighter colored sorts. Green foliage. Each 5c., per doz. 60c.

**David Harum.** Plants grow from 3 to 4 feet high and produce handsome, brilliant red flowers very freely until fall. Bronze foliage. Each 5c., per doz. 60c.

**Duke of Marlborough.** A semi-dwarf green leaved Canna with exceptionally fine, dark crimson flowers. Each 5c., per doz. 60c.

**Egandale.** Although the soft, currant red flowers of this popular bronze variety are not very large, it is preferred by many because of its handsome foliage. 4 feet. Each 5c., per doz. 60c.

**Florence Vaughan.** The flowers, of unusually large size, are bright golden yellow in color, spotted with red. Plants will not exceed 5 feet in height. Green foliage. Each 5c., per doz. 60c.

**King Humbert.** Of all the varieties this one is especially striking either in groups, beds or as single specimens. The superb orangescarlet flowers are of enormous size and with the massive bronze foliage few are more effective. 5 feet. Each 10c., per doz. \$1.00.

**Louisiana.** Wherever a tall growing Canna is necessary, Louisiana should not be overlooked. The leaves in particular are very large and glossy green in color, while it is nothing unusual to see dazzling scarlet flowers measuring 6 and 7 inches in diameter. Each 10c., per doz. \$1.00.

**Mlle. Berat.** Flowers of beautiful deep pink are borne high above the bright green foliage. 4 feet. Each 5c., per doz. 60c.

**Pennsylvania.** A superior green leaved orchid flowered Canna with remarkably large, deep scarlet flowers often measuring 6 inches in diameter. Free bloomer. 6 feet. Each 10c., per doz. \$1.00.

**Queen Charlotte.** The foliage is dark green, while the crimson scarlet flowers are bordered with a broad band of bright yellow. 4 feet. Each 5c., per doz. 60c.

**Venus.** This is undoubtedly the daintiest of all Cannas. Its pretty pink flowers are slightly tinted at the edges with creamy yellow. Green foliage. 3½ feet. Each 10c., per doz. \$1.00.

# DAHLIAS

Although of easy culture Dahlias require a deep, rather rich soil, plenty of air, but best of all, sunshine. Begin planting early in May, placing the roots 3 feet apart and 4 inches below the surface. As the shoots appear all but the strongest one should be removed and even this one should be cut back, thus producing a strong, compact plant.

Our roots are extra large and can be shipped by express only.

## SHOW AND FANCY DAHLIAS

Price, except where noted, 10c. each, per dozen \$1.00.

**A. D. Livoni.** The plants, while not more than 3½ feet high, are literally covered with very full double flowers of clear soft pink. Affords splendid material for cutting.

**Arabella.** The large size flowers are pale primrose, tipped and shaded rose and lavender. Blooms early and profusely.

**Bon Ton.** A splendid variety of medium size. The petals are beautifully formed and of rich garnet color.

**Client.** Flowers of velvety crimson are borne on long stems. Large size and fine for cutting.

**Cuban Giant.** Superb deep crimson variety shaded with maroon; unusually large and free bloomer. Each 15c., per doz. \$1.50.

**Frank Smith.** A magnificent fancy Dahlia, in fact one of the best of this type. In color it is dark, purplish maroon, each petal tipped with white.

**Gettysburg.** The brightest and largest pure scarlet. Its remarkable size, striking appearance and dazzling color always attract attention. Each 15c., per doz. \$1.50.

**Keystone.** Another fancy variety with beautiful pink flowers striped and blotched crimson.

**M. D. Hallock.** Clear canary yellow; petals quilled similar to A. D. Livoni.

**Miss May Lomas.** Flowers full to the center. Pure white shaded with lavender; soft dainty color.

**Stanley.** Bright golden yellow petals, each marked with a distinct red tip. Full to the center.

**White Swan.** A free blooming pure white variety with long stems and large double flowers.

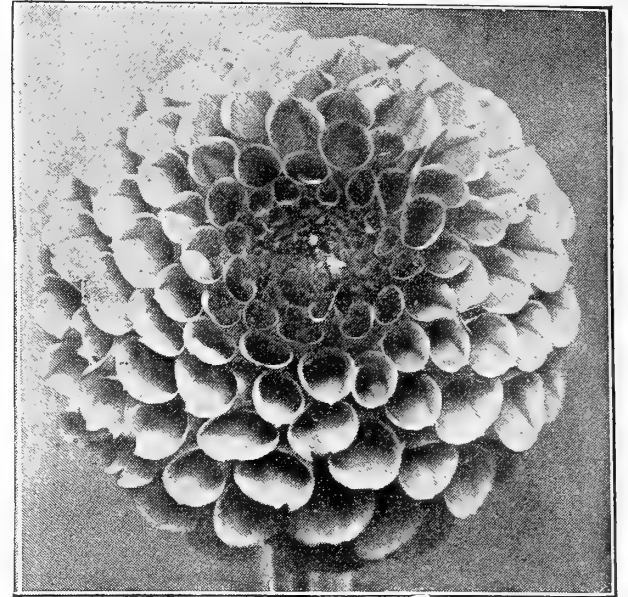

Show Dahlia

## DECORATIVE DAHLIAS

Price, except where noted, 10c. each, per dozen \$1.00.

**Baron Schroeder.** Bright purple shaded blue; a very pretty color.

**Clifford W. Bruton.** Best pure bright yellow decorative Dahlia for cutting. It is early, blooms freely, and measures 5 to 6 inches in diameter.

**Grand Duke Alexis.** A grand exhibition variety. Flowers pure white with a slight shade of lavender at the edges. Each 15c., per doz. \$1.50.

**Kaiserin Augusta Victoria.** This wonderful variety cannot be too highly recommended for cutting. Plants grow about 3 feet high and always appear to be covered with pure white flowers. Each 15c., per doz. \$1.50.

**Mrs. Roosevelt.** This is a perfect beauty. The blooms, of mammoth size, are gracefully formed on long stems. In color it is a soft delicate pink, gradually changing to white at the center. Each 15c., doz. \$1.50.

**Mrs. Winters.** A grand, pure white variety which compares favorably with the best Decorative Dahlias.

**Wm. Agnew.** Rich dazzling red flowers of fine form and exceedingly large size, often measuring 6 and 7 inches in diameter.

## CACTUS DAHLIAS

Price, 10c. each, per dozen \$1.00.

**Country Girl.** Blooms early and long. The petals are quite broad, deep golden yellow shaded with salmon, the edges almost red.

**Countess of Lonsdale.** A handsome salmon colored variety. Flowers are very large and produced in endless profusion.

**Crimson Beauty.** Its rich deep crimson flowers are certainly attractive and of unusual beauty.

**Flora.** This one is especially fine. Pure snow white flowers borne on long slender stems.

**Kriemhilde.** The most popular of all for cutting. Petals are delicate pink shading to white at the center.

**Standard Bearer.** Brilliant fiery scarlet. Blooms abundantly throughout the summer.

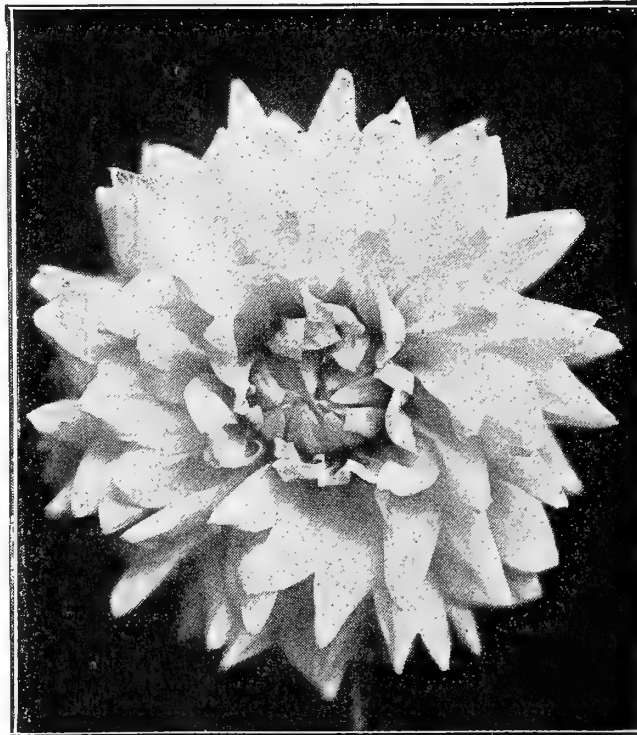

Mrs. Winters

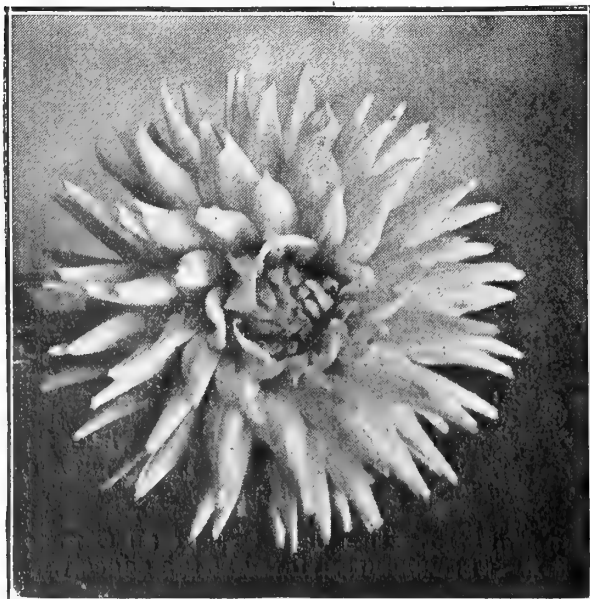

Cactus Dahlia

# GLADIOLUS

After years of careful improvement the Gladiolus is to-day one of the most beautiful of all summer flowering bulbs. Even in ordinary garden soil few will give such remarkable results with so little care. Bulbs should be planted 4 to 6 inches apart and 3 to 4 inches deep, according to the size of bulbs, from April 15th to June 15th.

*By mail add 10c. per dozen extra*

**America.** This superb variety, with its beautiful soft lavender pink flowers of large size, has become a favorite with all. Each 10c., per doz. \$1.00.

**Augusta.** Extensively used for forcing. Color pure white with blue anthers. Each 5c., per doz. 50c., per 100 \$3.00.

**Baron Hulot (Blue Jay.)** A rare and very pleasing shade of dark violet blue. Each 10c., per doz. \$1.00.

**Brenchleyensis.** The popular vermilion scarlet; bright and showy. Each 3c., per doz 30c., per 100 \$2.00.

**George Paul.** Giant flowers of deep crimson, slightly stained yellow and spotted with purple. Each 7c., per doz. 75c.

**May.** An ideal variety for cutting. Pure white flaked rosy crimson. Each 4c., per doz. 40c., per 100 \$2.50.

**Mrs. Beecher.** One of the most striking. Flowers extra large, deep rosy crimson with clear white throat. Each 7c., per doz. 75c.

**Octoroon.** A beautiful salmon-pink. Each 7c., per doz. 75c.

**Rosella.** A variety of exceptional beauty. Color light rose stained purple and white. Each 10c., per doz. \$1.00.

## MIXTURES OF GLADIOLUS

	Doz.	100
<b>White and Light</b> varieties mixed .....	\$0.40	\$2.50
<b>Scarlet and Red</b> , extra fine .....	.25	1.75
<b>Pink and Rose</b> , all shades.....	.30	2.00
<b>Yellow and Orange</b> , all shades .....	.50	3.75
<b>Striped and Variegated</b> , extra.....	.40	2.75



Gladiolus

	Doz.	100
<b>Childsii Mixed.</b> Every shade and color is included in this mixture, while the flowers are noted for their beauty as well as remarkable size .....	\$0.50	\$3.00
<b>Groff's Mixed Hybrids.</b> A superb mixture comprising every shade known in Gladiolus.....	.35	2.00
<b>Success Mixture.</b> Contains a wide range of colors and is the best mixture offered when the price is considered.....	.20	1.50

## HYACINTHUS candicans

Pure white bell-shaped flowers are suspended gracefully from the long slender spikes which grow from 3 to 4 feet high. Often 20 to 30 flowers have been counted on one stem. Very effective when planted in clumps.

**Large Bulbs.** Each 4c., per doz. 40c., postpaid 50c.

## LILY OF THE VALLEY

These should be planted outdoors in a shady position where they can remain permanently; and in early spring their pure white bell-shaped fragrant flowers are produced abundantly. The following can be had only early in spring and by express.

**Large Imported Clumps.** Each 25c., per doz. \$2.50.



Lily of the Valley

## LILIES

Lilies, with their stately growth and magnificent colored flowers, ranging from the purest white to the deepest crimson, many of them beautifully spotted, form a splendid appearance among the herbaceous border, where they should remain for years undisturbed. Plant as soon as the ground is open in spring, selecting a deep rich soil that has been enriched with well decayed manure. Set bulbs 8 inches deep, placing a handful of sand at the bottom of each. **By mail add 4c. each extra.**

**Auratum (Golden Banded Lily).** Gorgeous flowers of pure white freely spotted with crimson and has a broad band of rich yellow running through the center of each petal. Very fragrant and blooms the latter part of July. Each 20c., per dozen \$2.00.

**Philadelphicum.** Grows about 2 feet high, producing yellow and scarlet flowers, spotted purple, throughout the summer. Each 15c., per dozen \$1.50

**Longiflorum.** Splendid for indoor culture but also desirable for the hardy border. White trumpet shaped flowers blooming in July. Each 15c., per dozen \$1.50.

**Speciosum Album.** One of the hardiest garden Lilies, with fragrant flowers of purest white, blooming in August. Each 15c., per dozen \$1.50.

**Speciosum Rubrum.** Very pretty white Lilies thickly spotted with crimson. Each 15c., per dozen \$1.50.

**Tenuifolium.** This dwarf variety with its brilliant, crimson scarlet flowers blooms early in June. Each 15c., per dozen \$1.50.

**Tigrinum Splendens.** An improved Tiger Lily growing from 4 to 6 feet high. Large flowers of orange salmon with black spots. Each 10c., per dozen \$1.00.

**Tigrinum flore pleno.** A double variety of the preceding, flowering in August. Each 10c., per dozen \$1.00.

**Umbellatum.** Beautiful hardy Lily growing about 2 feet high and bearing rich dark red flowers. Each 15c., per dozen \$1.50.

**Wallacei.** Single bulbs usually send up several spikes, each having 6 to 8 handsome orange-red flowers. Height 12 inches. Each 15c., per dozen \$1.50.

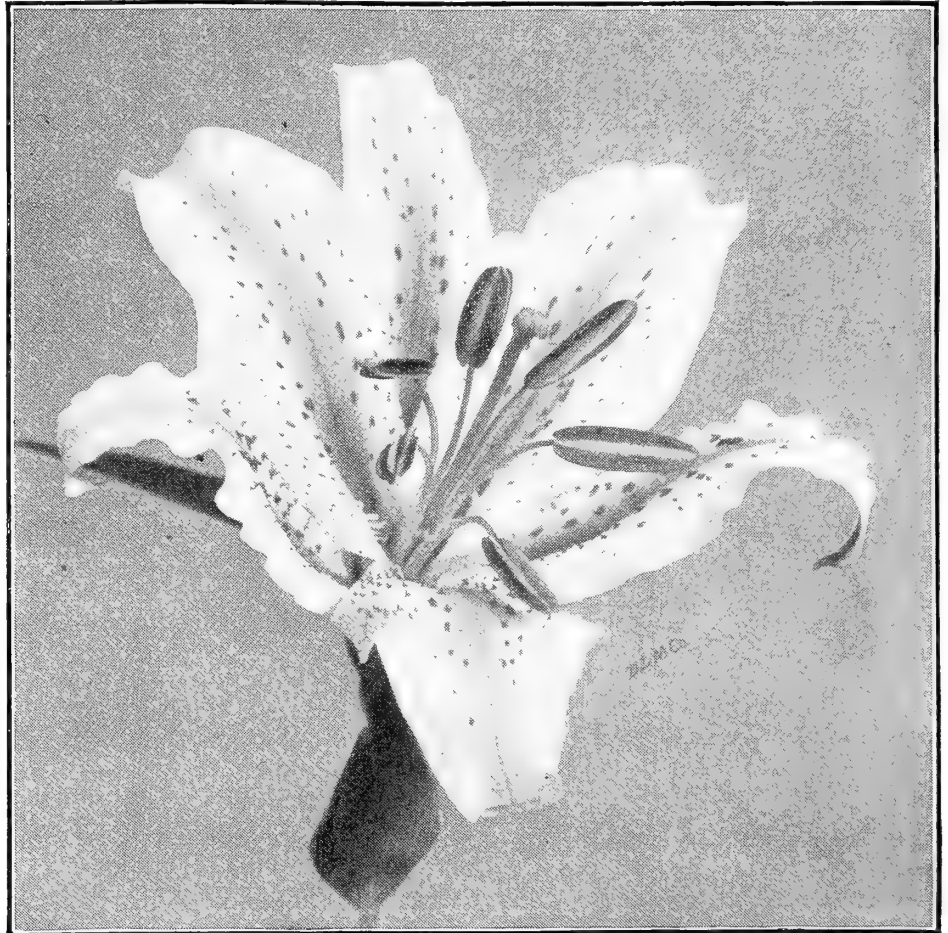

Lilium Auratum

### MADEIRA VINE

This popular, quick growing climber has thick glossy green leaves and fragrant, feathery white flowers.

**Large Bulbs.** Each 5c., dozen 50c., postpaid 60c.

### OXALIS, Summer Flowering

Pretty free flowering plants, having clover-like foliage; extensively used for bordering. Blooms early and continuously throughout the summer.

**Deppei.** Splendid white variety; plant bulbs 3 inches apart.

**Deppei Rosea.** Rosy pink; fine for hanging baskets or vases.

**Mammoth Bulbs.** Per dozen 30c. postpaid, per 100 \$1.75.

### TUBEROSE

The pure white double flowers form on long stems 3 feet high and are very fragrant. To obtain best results do not plant bulbs outdoors before May 15th.

**Double Excelsior Pearl.** Per dozen 20c., postpaid 32c.; per 100 \$1.50.

**Mammoth Bulbs.** Per dozen 35c., postpaid 55c.; per 100 \$2.50.

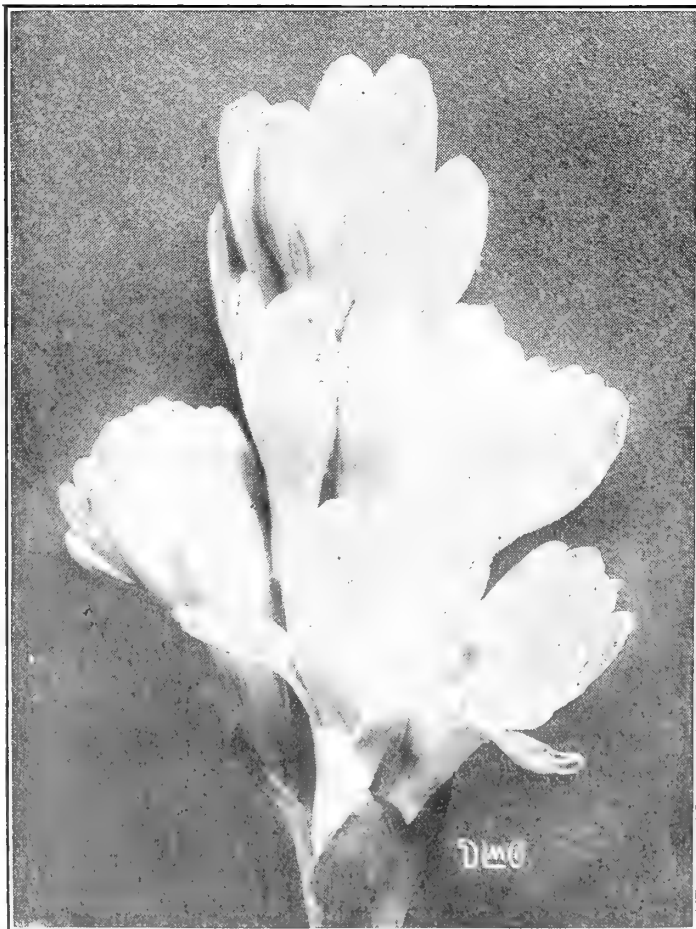

Tuberose, Excelsior Pearl

### BULBS FOR WINTER BLOOMING

We carry in stock usually during October and November a choice assortment of Hyacinths, Tulips, Crocus, Narcissi, etc. If you wish any of these write for price list.

## INSECTICIDES

Liquids and poisonous powders are not mailable and can be sent by express only.

### ANTIPEST

Very effective against ants, green fly, spider, etc. To be used when foliage is dry and sun is shining. Directions on can. Per qt. 50c., ½ gal. 75c.

### ARSENATE OF LEAD

Kills caterpillars and all leaf-eating insects. A strong poison which does not wash off or burn the tenderest foliage. Per lb. 25c., 5 lbs. 90c.

### BORDEAUX MIXTURE

For all fungous diseases such as rust, potato blight, mildew and various rots of grapes. Qt. 40c., gal. \$1.25.

### GRAPE DUST (HAMMOND'S)

Used for mildew and rust on vegetables, flowers and fruits. Per 5 lb. package 35c., 100 lb. keg \$5.50.

### HELLEBORE

Destructive against the currant worm and rose slug. Per ¼ lb. 10c., ½ lb. 15c., lb. 25c.

### HORICUM (HAMMOND'S)

A lime, sulphur and salt mixture for San José scale. Add 20 to 25 parts water. Per qt. 35c., gal. \$1.00.

### KEROSENE EMULSION

Kills lice and other soft bodied insects. Directions on can. Per qt. 40c., gal. \$1.25.

### LEMON OIL

Excellent for all house plants. Destroys red spider, caterpillar, and almost all other insects. Kills fleas on dogs and gives the hair a beautiful glossy appearance. Per ½ pt. 25c., pt. 40c., qt. 75c., ½ gal. \$1.25.

### PYROX

A combination of Arsenate of Lead and Bordeaux Mixture. Especially good for fruit trees, killing all leaf eating insects and preventing apple scab and pear blight. Spray early in Spring. Per 5 lb. can \$1.00.

## FERTILIZERS

### BONE MEAL

One of the best fertilizers for the lawn, encouraging a luxuriant dark green growth, especially if applied before a rain. Equally good either for pot plants or rose and carnation culture. Results are obtained quickly from its use. Per lb. 5c., 10 lbs. 45c., 100 lbs. \$2.75, bag (200 lbs.) \$5.00, ton (2000 lbs.) \$40.00.

### BONORA, NATURE'S PLANT FOOD

A wonderful plant food that has been used and recommended by some of the leading horticulturists.

¼ lb. package making	56 pints	.....	\$0.25
1 lb. package making	25 gallons	.....	.50
5 lb. package making	140 gallons	.....	2.50

### BOWKER'S FOOD FOR FLOWERS

The use of this fertilizer will certainly repay the user many times, both in size and number of flowers, besides giving the foliage a rich, green healthy color. A large package is sufficient for 30 plants for 6 months. Small package 15c., postpaid 25c.; large package 25c., postpaid 40c.

### NITRATE OF SODA

Should be applied only to crops above ground and as it is very strong should not be used carelessly. It acts quickly and hastens maturity of flowers, fruits and vegetables at least two weeks. Per lb. 6c., 10 lbs. 50c., 100 lbs. \$3.50, bag (200 lbs.) \$6.50.

### PARIS GREEN

Largely used to kill the potato bug. Per ½ lb. 20c., lb. 30c., 5 lbs. \$1.40, 14 lb. pails \$3.75.

### ROSE LEAF TOBACCO EXTRACT

An extract of tobacco which destroys all insects and scale on plants. Per pt. 30c., qt. 50c.

### SLUG SHOT (HAMMOND'S)

A non-poisonous insecticide used with good results for the cabbage and currant worm, rose and plant lice, etc.; also for lice on chickens. Per lb. 10c., 5 lbs. 30c., 10 lbs. 50c., 100 lbs. \$4.50.

### SULPHO-TOBACCO SOAP

Exterminates all insects on plants in the garden or greenhouse and also acts as a fertilizer. Per 3 oz. box 10c., by mail 14c.; 8 oz. box 20c., by mail 30c.

### TOBACCO DUST

A sure remedy for plants affected with lice, aphids, green fly etc. Use freely. Per lb. 5c., 10 lbs. 45c., 100 lbs. \$2.50.

### TOBACCO STEMS

For fumigating. In bales, per 100 lbs. \$1.75.

### TREE TANGLEFOOT

Prevents insects from crawling up the trunks of trees. Directions how to apply on the can. Lb. 30c., 3 lbs. 85c.

### WHALE-OIL SOAP

A reliable insecticide for general use. It is easily applied to trees, plants and vines, whether for scale or other destructive insects. Per lb. box 15c., 3 lbs. 40c.

### WEED KILLER (TARGET BRAND)

Two applications of this will keep the driveways, walks, etc., free from all weeds the entire Summer. It is not injurious to stone or pavements of any kind. Add 49 gallons of water to one gallon of Weed Killer and apply with an ordinary watering pot. Per qt. 40c., ½ gal. 65c., gal. \$1.00.

### MAPES' FERTILIZERS

These standard fertilizers have become popular everywhere, as all who have used them will do so again. They are composed mainly of ground bone and can be applied easily by machine or hand.

**Potato Manure.** Per bag (200 lbs.) \$5.00, ton (2000 lbs.) \$45.00.

**Fruit and Vine Manure.** Per bag (200 lbs.) \$5.00, ton (2000 lbs.) \$45.00.

**Vegetable, or Complete Manure.** For light soils. Per bag (200 lbs.) \$5.00, ton (2000 lbs.) \$45.00.

**Complete Manure.** (For general use.) This will be found a good substitute for stable manure, but in a more concentrated form, being 30 to 40 times stronger. Per lb. 5c., 10 lbs. 45c., 100 lbs. \$3.00, bag (200 lbs.) \$5.00, ton (2000 lbs.) \$42.00.

**Lawn Invigorator.** As a top dressing for lawns about the dwelling, in cemeteries, parks or on golf links, it will develop a strong vigorous growth throughout the season. It may be used any time in the year but preferably in early Spring. Twenty-five pounds is sufficient for a plot 10 by 100 feet. Per lb. 5c., 10 lbs. 45c., 100 lbs. \$2.75, bag (200 lbs.) \$5.00.

### SHEEP MANURE

When mixed with soil or used as a liquid fertilizer, it is very beneficial to all plant life, whether in the greenhouse or garden. Although not as quick in action as some fertilizers, it is more lasting and insures a continuous steady growth. It is both odorless and clean to handle. Per lb. 5c., 10 lbs. 45c., 100 lbs. \$2.00.

# THE "PERFECT SUCCESS" BUCKET SPRAY PUMP.

All Brass Working Parts.

Indestructible Bronze Ball Valves.

Malleable Iron Combination Foot-Rest.

This outfit is a most excellent one for ordinary use in gardens, vineyards and orchards; for washing windows and buggies, and for the application of whitewash. This new combination bucket clamp and foot-rest enables the operator to have the pump and bucket clamped together as one outfit, with the pail standing upright in a rigid position. Thus the entire outfit can be carried in one hand, a feature possessed by no other spray pump. The pump has a large air chamber and is double-acting, throwing a continuous stream either solid or in fine spray. It is provided with Bordeaux Nozzle and four feet of discharge hose.

Price complete as shown in cut, \$5.50, without Pail, \$5.00.

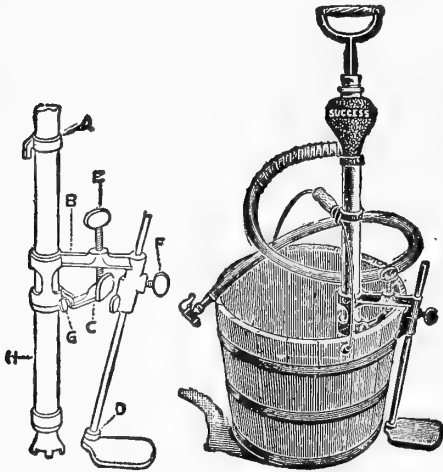

Perfect Success Spray Pump

## THE "PRIZE" BRASS SPRAY PUMP.

This Pump is what its name indicates—a prize to the possessor. For Greenhouse and Garden use and for washing windows and buggies this Pump serves a long-felt want, because it is both durable and cheap. Unlike many of the "cheap pumps" its working parts are entirely brass. It is furnished with Acme Nozzle, and will throw a fine spray or a solid stream.

Price of The "Prize" Bucket Spray Pump, with Acme Nozzle and three feet of hose, \$4.00.

## THE "SUCCESS" KNAPSACK SPRAYER.

A Knapsack and Bucket Sprayer Combined. 5-Gallon Copper Tank. Brass Pump with Bronze Ball Valves.

The improvements recently made in our Success Knapsack Sprayer entirely obviate all objections to the knapsack pattern. As now made this sprayer can be used either as a knapsack or bucket sprayer, the illustration as here given showing its use as a knapsack. To be used as a bucket sprayer the handle and lever are removed and the extra handle with which the outfit is provided is placed in position. It will be noticed that the straps used on our knapsack are made extra wide just where the weight comes upon the shoulders.

The pump may be worked with either the right or left hand, and may be readily removed from the tank by unscrewing the drip cup, which is just below the air chamber, and is made extra wide, so that any leakage around the plunger is returned into the tank and not allowed to run down the operator's back.

Price complete as shown in cut with Bordeaux Nozzle and three feet of hose \$15.00

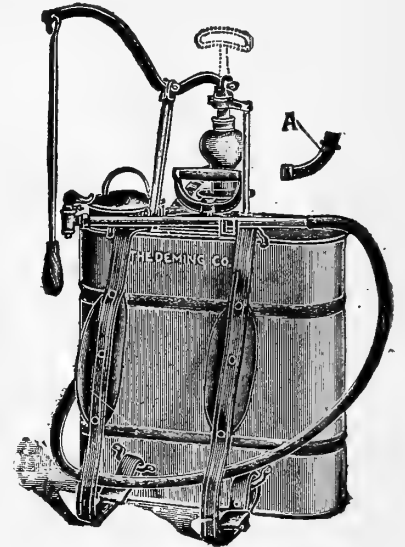

Knapsack Sprayer

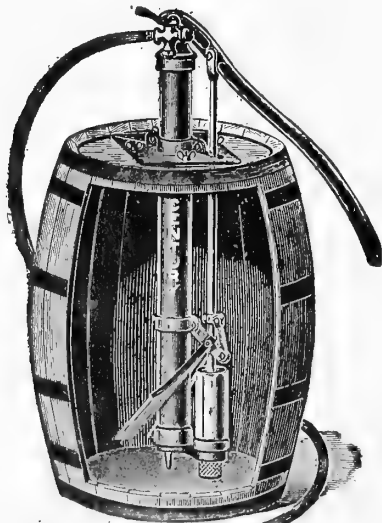

Barrel Spray Pump

## THE "CENTURY" SPRAYER.

With Submerged Brass Cylinder, Brass Ball Valves and "Everlasting" Plunger Packing.

For durability, ease of operation, free water ways and positive action generally, this pump stands in the front rank. The capacity is sufficient for all ordinary purposes. Length of stroke is 5 inches and diameter of cylinder 2 1/4 inches. The air chamber is large, and the discharge is fitted with Y for two leads of 1/2-inch hose.

The Pump is Furnished Regularly with a cast base with hook bolts to fasten same to the end of barrel. This base has a large hole with cover for filling the barrel.

Price complete as shown in cut, \$14.50.

Cart for above barrel pump, \$10.20.

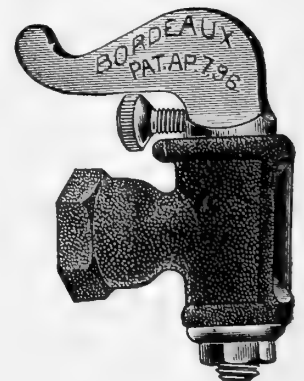

"Bordeaux" Nozzle

## THE INCOMPARABLE "BORDEAUX" SPRAY NOZZLE.

The "Bordeaux" Nozzle is the simplest and best combination spraying nozzle on the market. It throws a solid stream or a fan-shaped spray, adjustable to any fineness and is readily disengaged, throws a long distance coarser spray, or may be shut off altogether—features possessed by no other spray nozzle. Each 80 cents.



# "OLIVER" CHILLED PLOWS

Are acknowledged to be the Best General Purpose Plows manufactured, and so great is their popularity that unscrupulous parties are seeking to trade upon their good name by making and offering for sale "spurious plows and parts as genuine."

Every "Genuine Oliver" Chilled Plow has stenciled on the wood beam the inscription, "MANUFACTURED BY THE OLIVER CHILLED PLOW WORKS, SOUTH BEND, INDIANA, U. S. A."

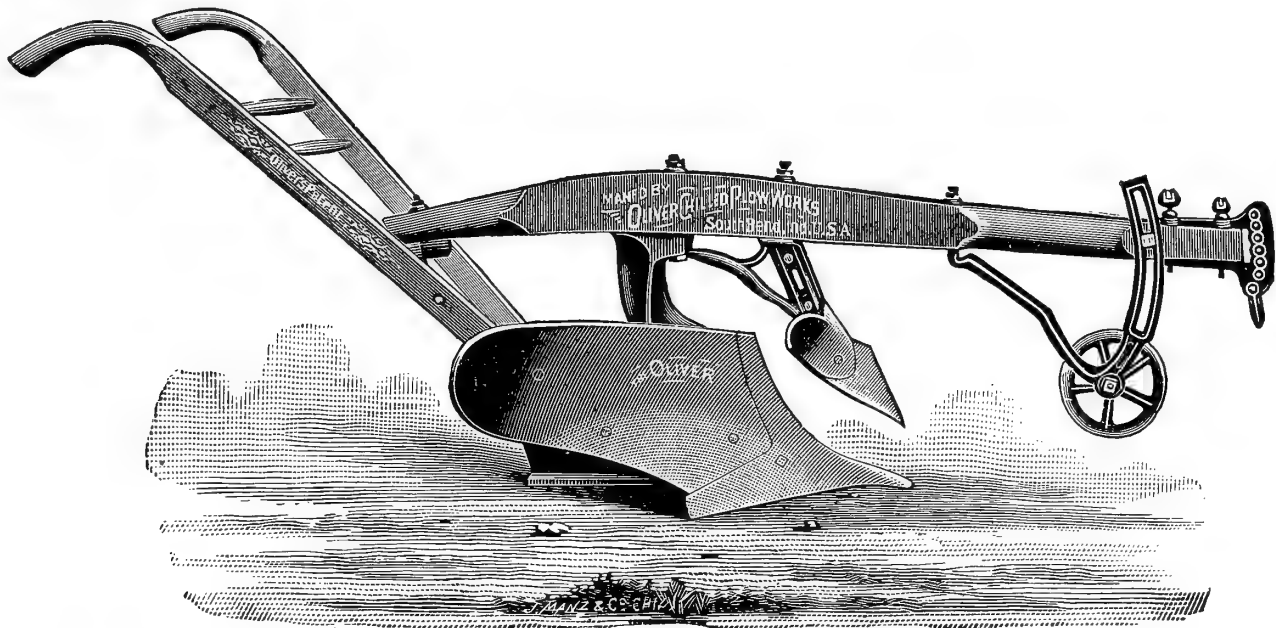

**WOOD BEAM PLOW**

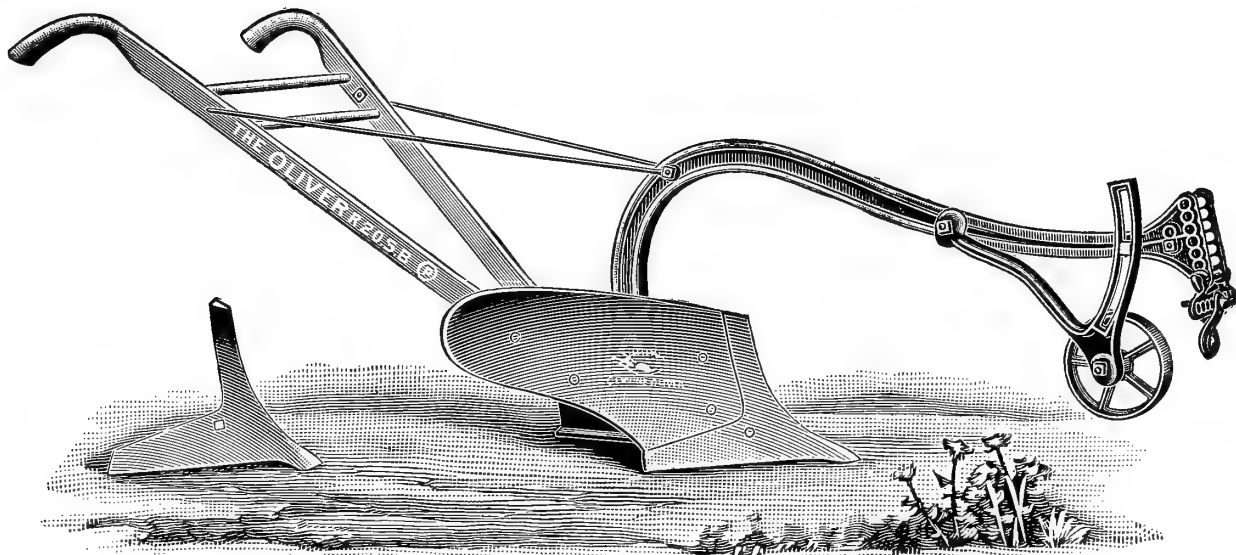

**STEEL BEAM PLOW**

No. A-1 Pony		Capacity 4 1/2 x 8 in.	Wood Beam, \$4.75	Steel Beam, \$5.75
" 10-0	Heavy,	" 5 1/2 x 11 "	" " 7 00	" " 8.00
" 19	Medium,	" 6 1/2 x 12 "	" " 9.00	" " 10.00
" 20	"	" 7 x 13 "	" " 9 50	" " 10.50

For Plows with Wheel, add \$1.00; with Jointer, add \$2.00.

In addition to the Plows above listed, we carry in stock a great variety of other styles and sizes, both in Chilled and Steel; also a full line of repairs.

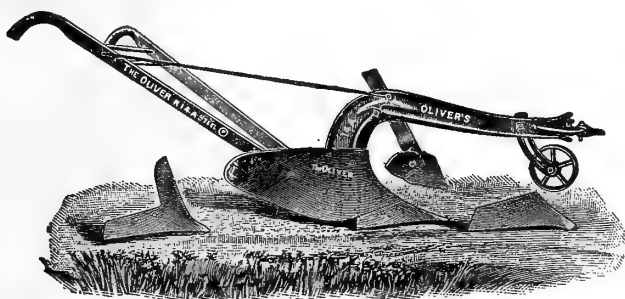

**No. 14-A Iron Beam Two Horse Plow**

Capacity 7 x 12 in., with Chilled Mould.....	\$ 9.50
" " " " Steel " .....	11.50
Add for Wheel.....	\$1.00. Jointer..... 2.00

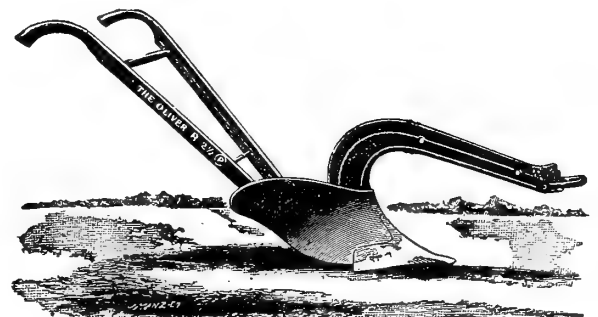

**No. 2 1/2 Iron Beam Two Horse Plow**

Capacity 6 x 12 in.....	\$7.00
Add for Wheel.....	\$1.00. Jointer..... 2.00

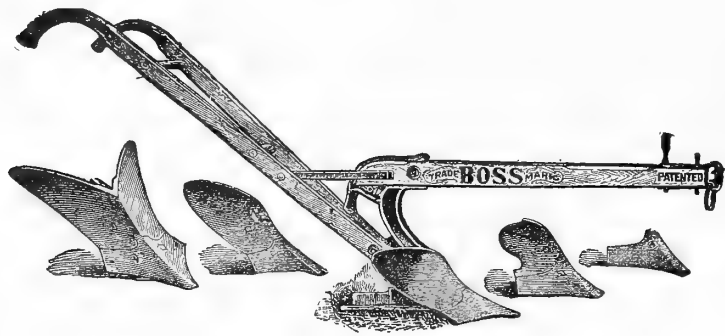

The "Boss" Combination Plow

The handiest one horse turning plow for use by market gardeners and farmers. Actually four plows in one. It can be worked as a medium and heavy one-horse plow and as a plow for operating among cabbage, strawberries, etc. \$5.00. With the double mould and share, \$6.75.

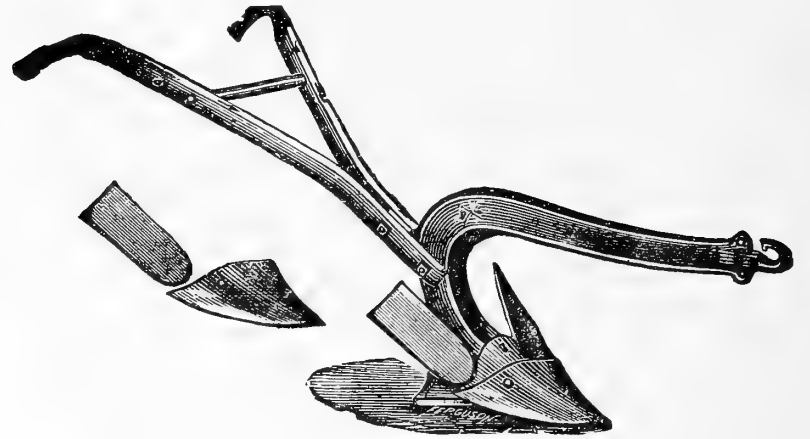

Mitchell Shovel Plow

The point and wings are of steel .....\$4.50  
 Potato Digging Attachment..... 3.00

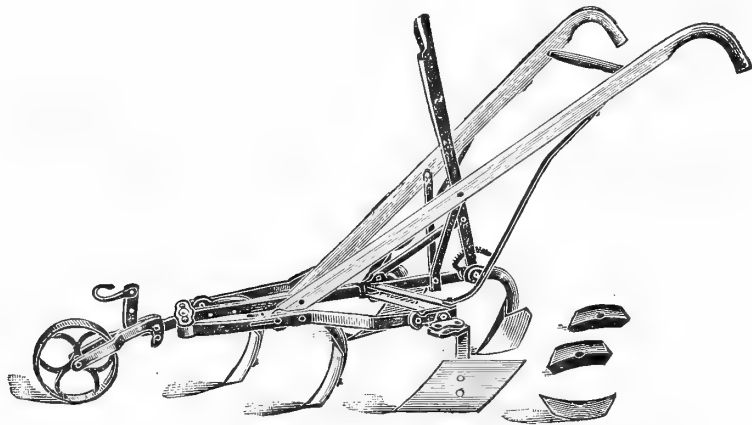

"Triumph" Steel Cultivator and Horse Hoe

Price, \$6.00

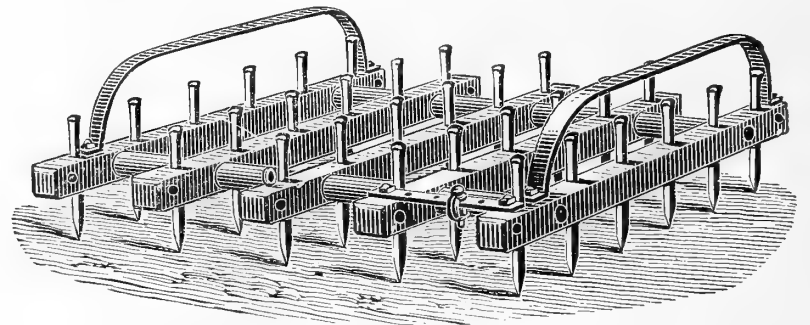

Gardener's Harrow With Runners

24 Teeth.....\$7.00  
 30 " ..... 7.50

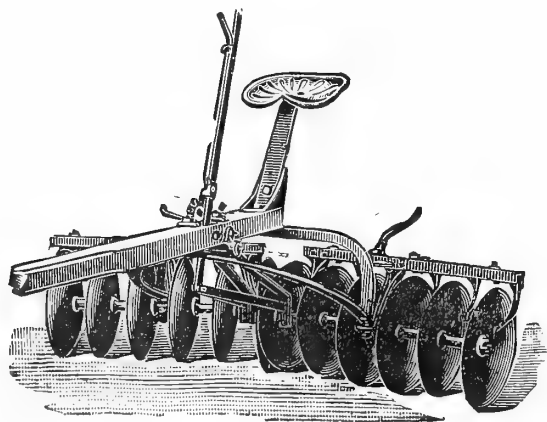

Steel Disc Smoothing Harrow

The frame measures 6. ft. 8 in. by 6 ft., and has 4 sets of rollers, having 58 discs, 8 in. diameter. Price, \$18.00.  
 Special size, 4 ft. 6 in. by 4 ft., \$17.00.

All Steel Flexible Disc Harrow

The only Disc Harrow having *independent adjustable spring pressure* upon the inner end of each gang of discs, allowing any amount of pressure to be thrown upon the inner ends of the gangs by the foot of the operator.

No. 3. 2 Horse has 12-16 in. Discs; cuts 6 ft., with Solid discs.....\$25.00  
 No. 3. 2 Horse has 12-16 in. Discs; cuts 6 ft., with cut-out discs..... 26.50  
 No. 0. 1 Horse has 6-16 in. solid discs, cuts 3 ft..... 21.00  
 Whiffletrees and Neck Yoke for 2 Horse Harrows, add..... 1.75

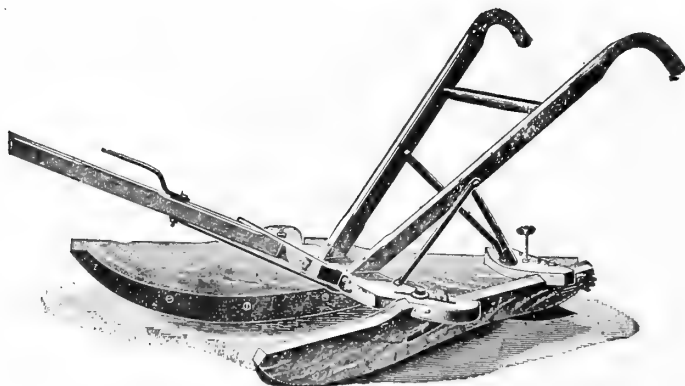

Wood Frame Potato and Pea Coverer

The sides are made adjustable. This Coverer has been in use for over 30 years, and does excellent work, \$10.00

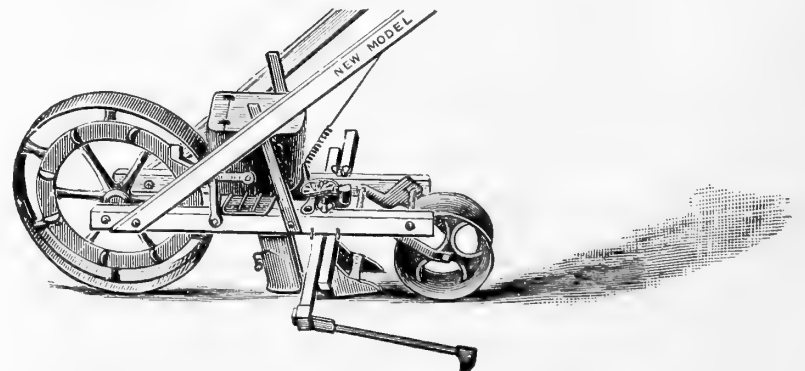

New Model Seed Drill

This is a first-class hand drill, is easily adjusted to sow accurately all kinds of small seeds, \$7.00

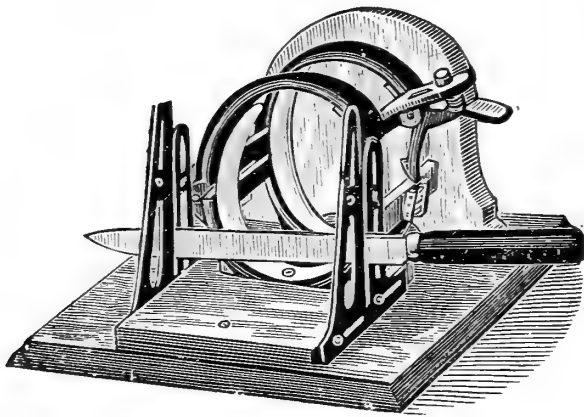

Asparagus Buncher.

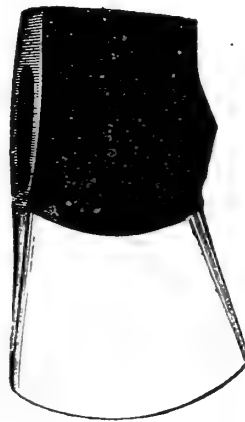

Steel Axe.

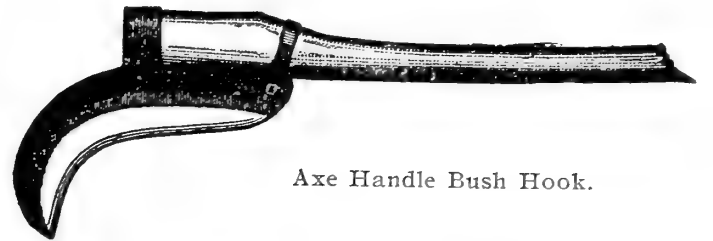

Axe Handle Bush Hook.



Asparagus Knife.

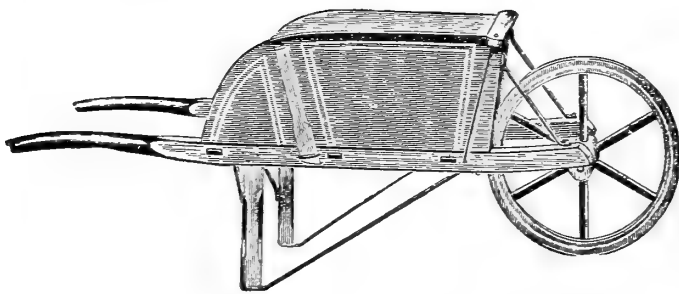

Garden Barrow.

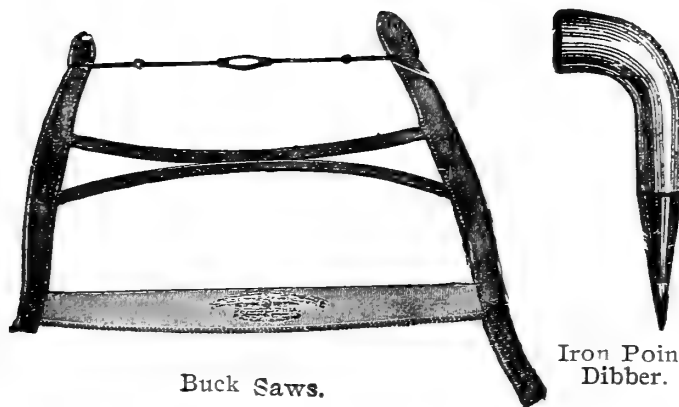

Buck Saws.

Iron Point Dibber.



Post Hole Digger.



Saw Buck.

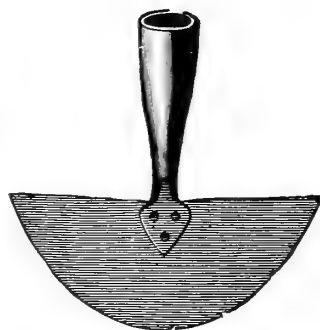

Edging Knife.

## GARDEN AND FARM TOOLS

<b>Asparagus Buncher</b> .....	Each.	\$3 00
<b>Asparagus Knife</b> .....		35
<b>Axes, Felling, With Handles</b> .....		1 25
"    "    Short Handles.....		1 00
<b>Axe Handle Bush Hook</b> .....		1 25
<b>Barrow, Regular Garden</b> , are made in five sizes, well built and nicely finished.		
No. 2. Boy's, holding 2 cubic feet.....		2 75
" 4. Medium, " 4 " ".....		3 25
" 5. Regular, " 5 " ".....		3 75
" 6. Large, " 6½" ".....		4 50
<b>Barrow, Canal, Bolted</b> .....		2 00
"    " <b>Half Bolted</b> .....		1 75
<b>Baskets, Market, 3 to bbl.</b> .....	Per doz.	\$5 00
"    "    3½ to bbl.....	"    "	5 00
"    "    4 to bbl.....	"    "	5 00
<b>Boots, Horse Lawn</b> . Made of heavy leather. Price per set of four.....		\$9 00
<b>Buck Saws</b> .....		85
<b>Saw Buck</b> .....		40
<b>Corn Hook</b> .....		30 and 35
<b>Dibbers. Medium or large</b> .....		35
"    Iron.....		40
<b>Digger, Post Hole</b> .....		1 25
<b>Edging Knives, with handle</b> .....		60
"    "    without handle.....		50
<b>Duster, Leggett Champion</b> . Each machine is furnished with 4 tubes, 6 nozzles, 2 straps and oil can; will dust two rows of potatoes at a time. Weighs about 6 lbs. Price, \$7.50.		
<b>Duster, Leggett Little Giant</b> . Same as above only smaller. Price, \$5.00.		
<b>Forks, Spading. 4 tine, Strapped</b> .....	Each	\$0 85
"    "    5 " ".....		1.00
" <b>Manure.</b> 4 " ".....		1.10
"    "    5 " ".....		1.25
"    "    6 " "    Light.....		1.25
" <b>Hay.</b> 2 " Plain L. H.....		50
"    "    3 " " ".....		60
"    "    4 " Strapped L. H.....		75
<b>Glaziers' Points, Van Reyper's</b> . Made of steel wire and galvanized. Per box, 1000, 60c. By mail.....		75



The "Warren" Hoe.

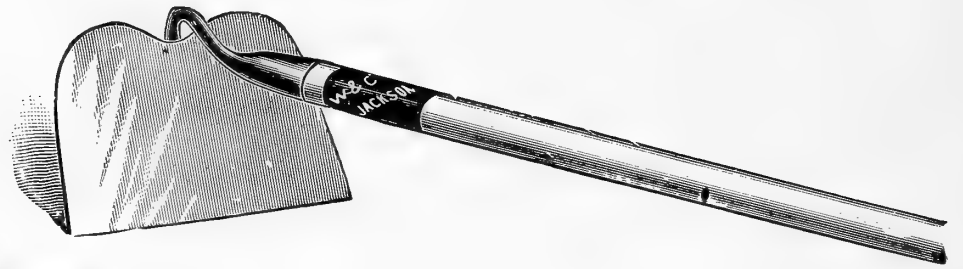

Field Hoe.

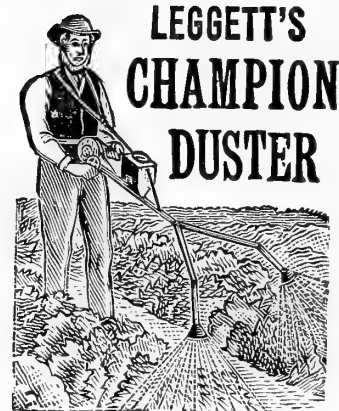

LEGGETT'S CHAMPION DUSTER

GARDEN AND FARM TOOLS—Continued

<b>Glazing Point Pincers</b> .....	Each	\$0 40			
<b>Grafting Wax</b> , For grafting cuts and bruises on trees. Per pkg., each, 10c., 20c. and .....		30			
<b>Grind Stones</b> , Mounted, No. 1.....		5 00			
“ “ “ No. 2.....		4 50			
“ “ “ No. 3.....		4 25			
“ “ Velox Iron Frame.....		5 00			
<b>Hose, Rubber</b> , in 25 and 50 foot lengths. Best quality, 3/4 inch.....	Per Ft.	15c.			
<b>Hose, Rubber</b> , Good quality, 3/4 inch.....		“ 10 & 12c.			
“ <b>Menders</b> , Cooper's. Each, 10c.....	Per Doz.	75c.			
“ <b>Couplings</b> , Common.....	Pair	10c.			
“ <b>Reel</b> , Wooden, small.....		75			
“ “ <b>Iron</b> , large, \$3.50.....	medium	3 00			
<b>Hoes, Draw</b> , Warren, Medium.....		60			
“ “ “ Large.....		70			
“ <b>Garden or Field</b> , 3 inch to 7 1/2 inch.....		45			
“ <b>Scuffle</b> , English handles, 20 cents, extra 7 in. 60c., 8 in. 65c., 9 in. 70c., 10 in.....		75			
“ “ Bradley, 6, 7 and 8 in.....		75			
<b>Hooks, Clam</b> , 4 tine, flat.....		65			
“ “ 6 tine, round.....		75			
“ <b>Potato</b> , 4 tine, flat.....		45			
“ <b>Grass</b> , American.....		35			
“ “ English.....		45			
“ “ German.....		35			
“ “ Little Giant.....		50			
“ <b>Potato</b> , flat and round tine.....		45			
“ <b>Manure</b> , 4 tine.....		50			
“ “ 5 tine.....		60			
<b>Hoe and Rake Combine</b> , 4 tine.....		40			
“ “ “ 6 tine.....		45			
“ <b>Onion</b> , two prong.....		35			
<b>Jacks, Wagon, Sampson</b> , No. 0, \$2.00; No. 1, \$2.50; No. 2.....		3 00			
“ “ <b>Leader</b> .....		1 50			
<b>Labels, Wooden, Pot and Garden</b>					
4 in., plain....	Per 100 \$0 10	Per 1000 \$0 60	4 in., painted....	Per 100 \$0 15	Per 1000 \$0 75
5 “ ....	15	75	5 “ ....	20	1 00
6 “ ....	20	1 00	5 “ ....	25	1 35
8 “ ....	50	4 00	8 “ ....	60	5 00
12 “ ....	60	5 00	12 “ ....	70	6 00
<b>Labels, Notched Tree</b> . Per 100, 10c.; per 1000.....					75
“ <b>Copper Wired</b> . “ 30c.; “ .....					2 00



Clam Hook.



Digging Fork.

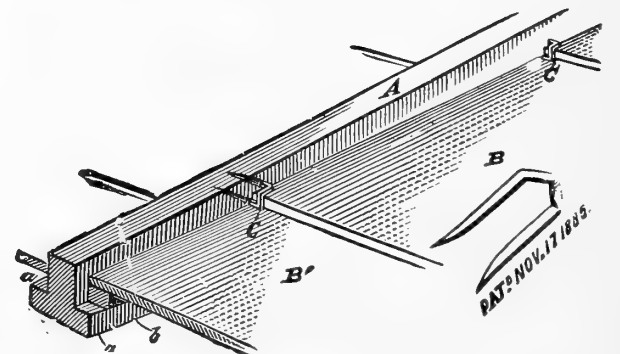

Glazier's Points.

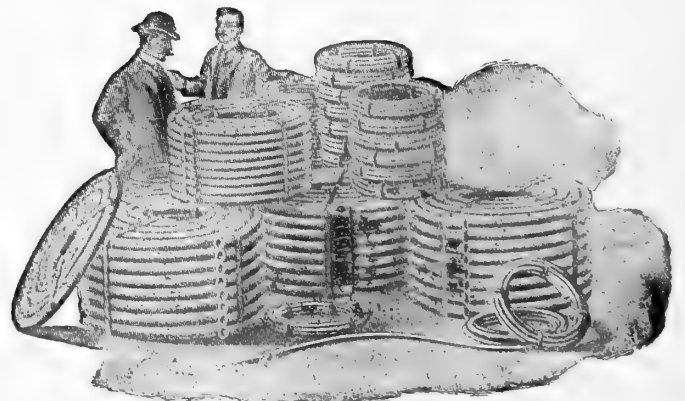

Rubber Hose.

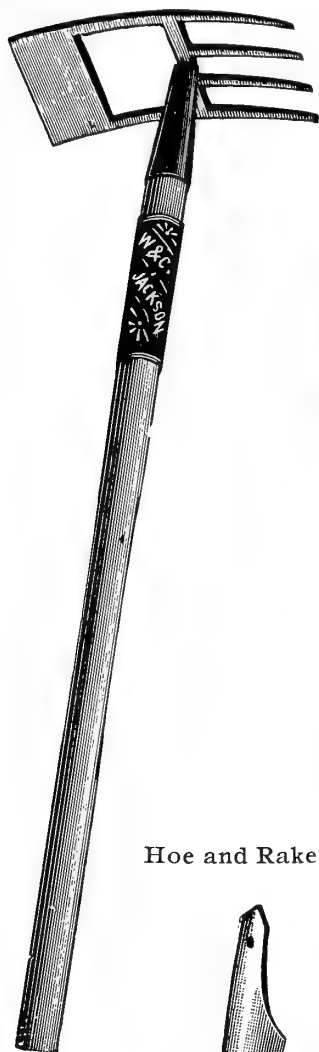

Hoe and Rake.

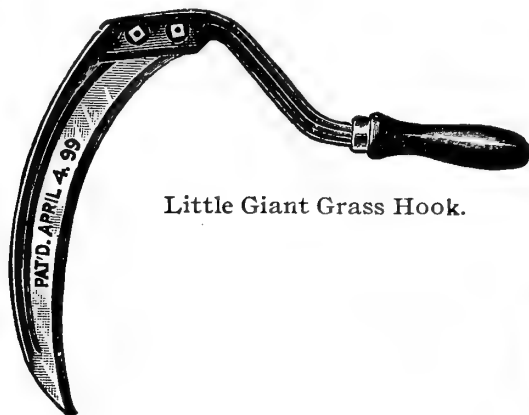

Little Giant Grass Hook.

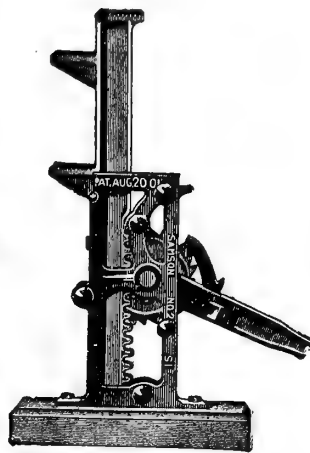

"Samson" Jack.

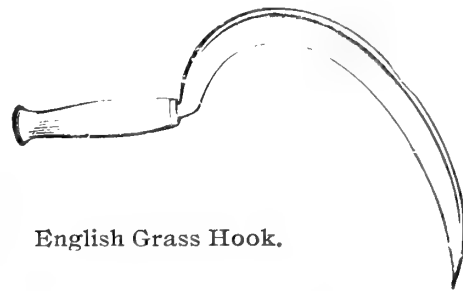

English Grass Hook.

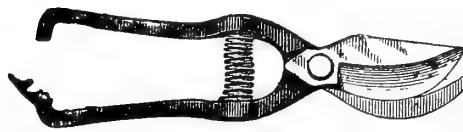

Solid Steel.

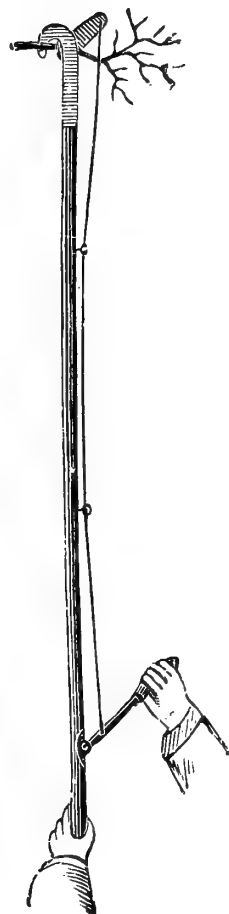

Tree Pruner.

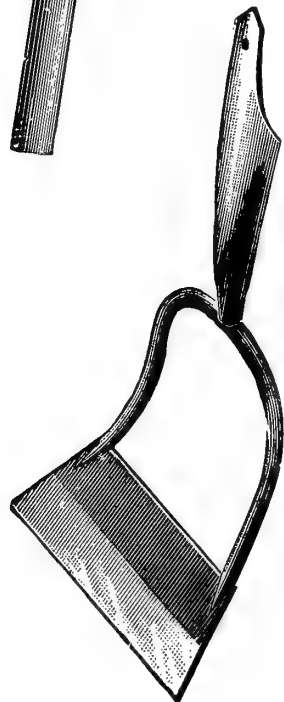

English Solid Scuffle Hoe.

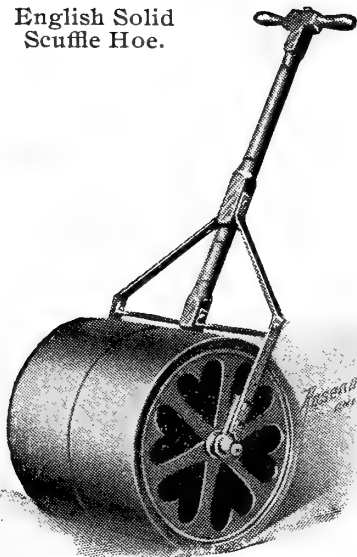

Lawn Roller.

GARDEN AND FARM TOOLS—Continued

Lanterns, Buck Eye.....	Each	\$0 85
"    B. B. Royal.....		75
"    Monarch.....		50

**Lawn or Golf Green Roller.** This new Pattern Roller is made with our Improved Wood Handle strongly braced, having counterpoise balance weights on shaft for holding the handle up when the Roller is not in use.

	Length of Rollers	Weight About	Price
2 Sections 7½ in. Face x 15 in. Diam.....	15 in.	150 lbs.	\$8 00
2 " 8 " " " 20 " " .....	16 "	225 "	11 25
2 " 10 " " " 20 " " .....	20 "	250 "	12 50
2 " 12 " " " 20 " " .....	24 "	300 "	15 00
2 " 10 " " " 24 " " .....	20 "	400 "	20 00
3 " 8 " " " 28 " " .....	24 "	500 "	26 00

**Coldwell's Imperial Lawn Mower.** The ready adjustment of the revolving cutter to the bottom knife and the sharpening of same, also its easy and noiseless running, place the Imperial ahead of all Lawn Mowers now made. High wheel, 10 in. diameter.

	Net
14 in. with Four Blades.....	\$8 00
16 " " " " .....	8 80
18 " " " " .....	9 60
20 " " " " .....	10 40

<b>Lawn Mower, Cadet.</b>	
12 in. Low Wheel.....	Net, \$2 75
14 " " " .....	" 3 00
16 " " " .....	" 3 25

<b>Lawn Sprinkler, 3 arm.....</b>	\$1 25
" " 4 " .....	3 00
" " 8 " .....	3 50
" " Water Witch.....	75

<b>Mattocks, with Handle.....</b>	1 10
<b>Mole Traps, New Model.....</b>	1 50
<b>Nozzle, Gem.....</b>	35
<b>Oyster Shell.....</b>	Per 100 lbs. 2 00
<b>Pails, Galvanized.....</b>	10 qts. 15c., 12 qts. 20
" " .....	14 " 25c., 16 " 30
" " Extra Heavy.....	16 " 50
" Wood, Army.....	35
" Oak, Heavy.....	60

**Plant Tubs Made of Cedar, Painted green, with iron hoops and drop handles, very strong.**

No. 7. Outside top diameter 17 inches, outside height 14 inches .....	each \$1.85
No. 8. Outside top diameter 16 inches, outside height 13 inches .....	" 1.60
No. 9. Outside top diameter 14 inches, outside height 12 inches .....	" 1.35

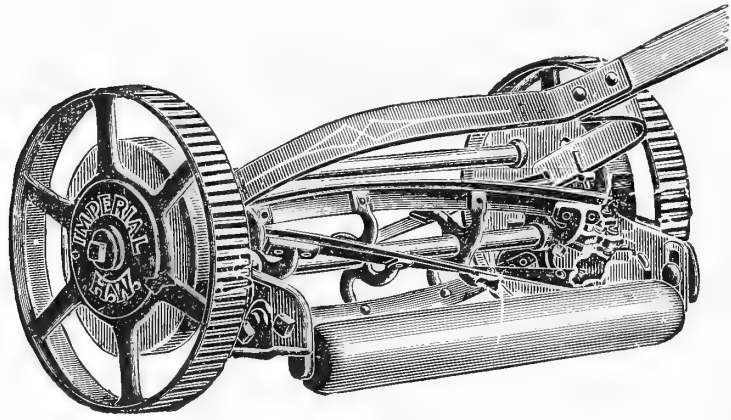

Coldwell's Imperial Lawn Mower.



Galvanized Pail.

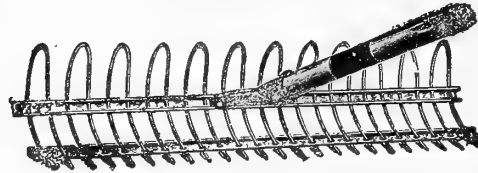

Steel Reversible Lawn Rake.

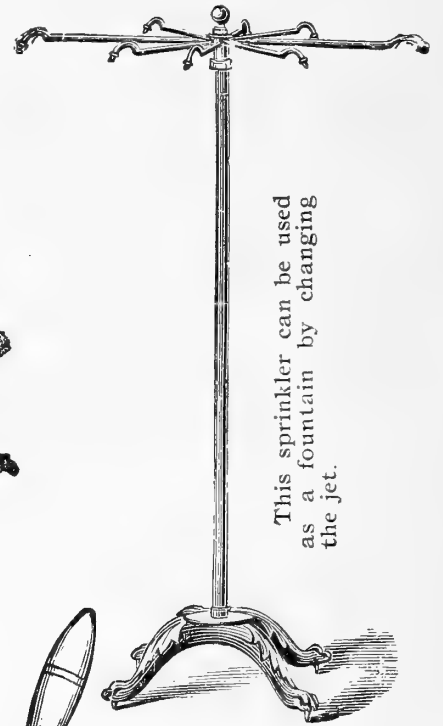

This sprinkler can be used as a fountain by changing the jet.

Portable Lawn Sprinkler.

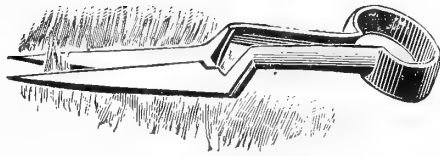

Grass Shears.

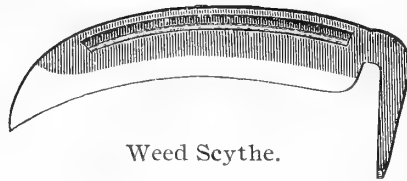

Weed Scythe.

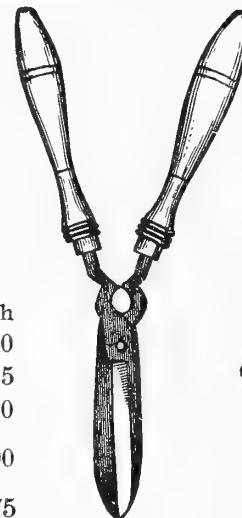

Hedge Shears.

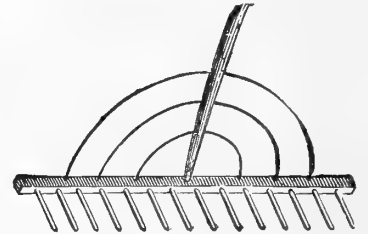

Wood Hand Rake.

GARDEN AND FARM TOOLS—Continued

<b>Pots, Watering, Japanned</b> .....	6 qts. 30c., 8 qts. 35c., 10 qts.	Each \$0 40
“ “ “ .....	12 “ 50c., 16 “	65
“ “ Galvanized.....	8 qts. 45c., 10 qts. 50c., 12 “ 65c., 16 “	80
<b>Putty Bulb, Rubber, excellent for glazing</b> .....		90
<b>Plant Sprinkler, Rubber</b> .....	50c., Large,	75
<b>Pruner, Water's Improved Tree, 10 ft.</b> (Illustration page 52) .....		1 25
“ <b>Shear, Nickel plated; extra</b> .....		85
“ “ <b>Solid Steel</b> .....		50
“ “ <b>Climax</b> .....		35
<b>Pick and Handle</b> .....	Patent, \$1.50; Railroad,	1 00
<b>Rakes, Reversible Galvanized</b> .....		50
“ <b>Steel Garden. 8 teeth, 35c.; 10 teeth, 40c.; 12 teeth, 45c.; 14 teeth, 50c.; 16 teeth, 55c.; 14 teeth, extra heavy</b> .....		85
“ <b>Wooden Hay. 3 bow, 12 teeth</b> .....		35
“ <b>Wooden Lawn, 22 teeth</b> .....		35
<b>Shears, Border. English</b> .....		2 25
“ <b>Hedge. (With notch 25c. extra)</b> .....		1 25
“ <b>Sheep or Grass. Trowel shank</b> .....		1 00
“ “ “ “ <b>Various sizes, 50c. to</b> .....		75
<b>Scythe, Lawn. English. Broad blades, 30 to 40 in.</b> .....		1 10
“ <b>Grass. American. 30 to 40 in.</b> .....		75
“ <b>Weed. American</b> .....		75
“ <b>Snaths (or handles). Patent fastening</b> .....		75
“ <b>Stones. English round Talacre</b> .....		15
“ <b>Rifle</b> .....		15
<b>Stakes or Dahlia Poles, Heavy. Round tapering, painted green. 2 ft., each 4c., per doz. 45c.; 3 ft., each 5c., per doz. 60c.; 4 ft., each 7c., per doz. 80c.; 5 ft., each 9c., per doz. \$1.00; 6 ft., each 11c., per doz. \$1.30.</b>		
<b>Spades. Ames' extra quality</b> .....		Each \$1 25
“ <b>Good quality</b> .....		1 00
“ <b>Long handled</b> .....		75
<b>Stakes, Cane, Bamboo. From 5 to 8 ft. in length. Per doz., 15c.; per 100, 75c.; per 1000, \$7.00.</b>		



Gem Nozzle.

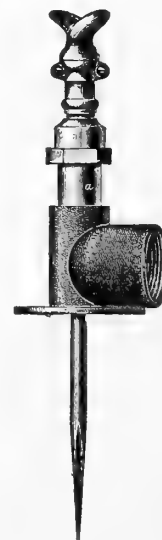

Water Witch Sprinkler.

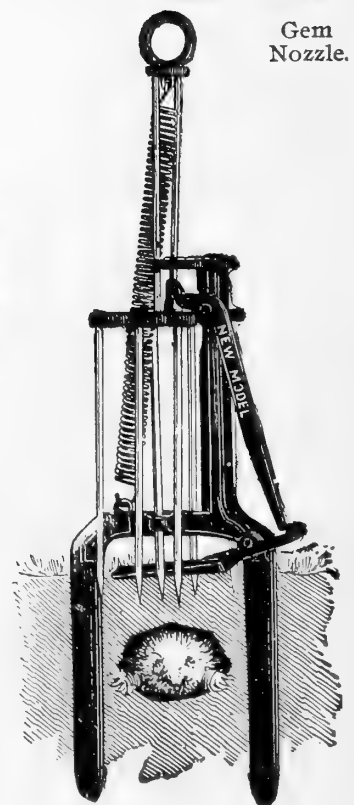

Mole Trap.



Haseltine Weeder.

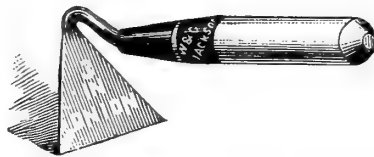

Three-Cornered Weeder.

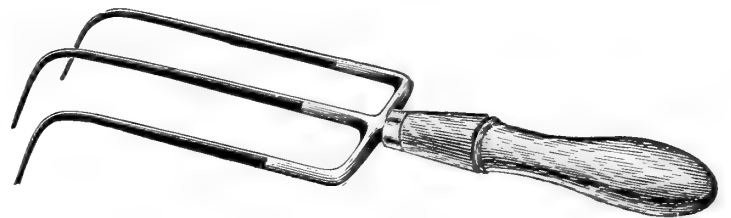

Eureka Hand Weeder.



Solid Steel Socket Shank Trowel.



Length of Barrel, 18 in. Diam. 1½ in.



Scythe Rifle.

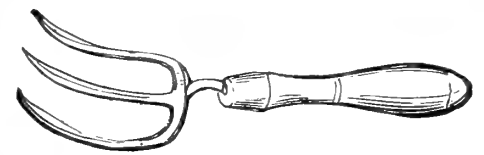

Weeding Fork.



Solid Steel Concave Shank Trowel.



Scythe Stone No. 51.

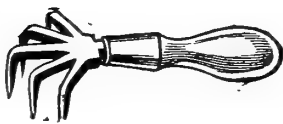

Weeder.

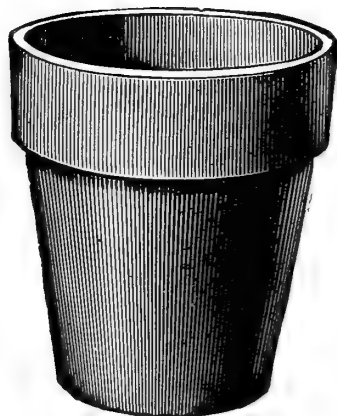

Flower Pot.

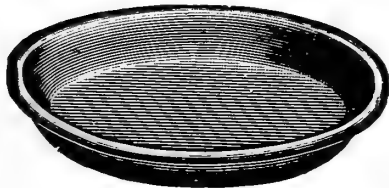

Flower Pot Saucer.

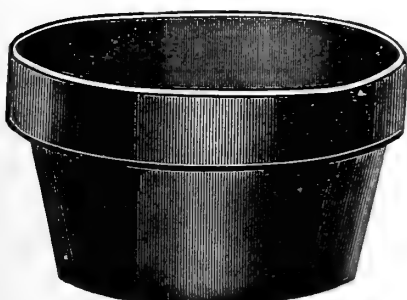

Seed Pan.

GARDEN AND FARM TOOLS—Continued

**Standard Flower Pots.** These Pots are all "Standard" shapes and sizes, and are far superior to any other Flower Pots.

Sizes.	Price. Per Doz.	Price. Per 100	Sizes.	Price. Per Doz.	Price. Per 100
2½ inch.....	\$0 15	\$1 00	8 inch.....	\$1 10	\$ 8 75
4 ".....	25	1 50	9 ".....	1 70	14 00
5 ".....	35	2 50	10 ".....	2 00	16 50
6 ".....	55	4 25	11 ".....	3 40	28 00
7 ".....	90	7 25	12 ".....	4 00	33 00

**Flower Pot Saucers.**

Sizes	Price Per Doz.	Price Per 100	Sizes.	Price. Per Doz.	Price. Per 100
4 inch.....	\$0 20	\$1 50	8 inch.....	\$0 50	\$4 00
5 ".....	25	1 80	9 ".....	65	5 25
6 ".....	35	2 75	10 ".....	75	6 00
7 ".....	40	3 25	12 ".....	1 20	9 50

**Round Seed Pans.**

Sizes.	Price. Per Doz.	Price Per 100	Sizes.	Price. Per Doz.	Price. Per 100
6 inch.....	\$0 55	\$4 50	8 inch.....	\$1 10	\$9 00
7 ".....	80	6 50	10 ".....	1 45	12 00

**Stones, Scythe, Round.....** Each \$0 15  
 " " **Flat.....** 10

**Shovels.** Ames' extra quality..... 1 25  
 " Good quality..... 1 00  
 " Round point, good quality..... 1 00  
 " Long handled..... 75

**Scoops.** No. 2, \$1.10; No. 3, \$1.15; No. 4, \$1.20; No. 5, \$1.25; No. 6, \$1.30.

**Syringes, Heavy Brass for Greenhouse and Garden.**  
 No. A. Length of barrel, 12 inches; diameter, 1 inch; one spray rose and one jet..... Each \$2 00  
 No. H. Length of barrel, 16 inches; diameter, 1½ inches; with fixed spray rose only 2 25  
 No. 2. Length of barrel, 14½ inches; diameter, 1¾ inches; two spray roses (one fine and one coarse) one jet and side attachment..... 3 50  
 No. G. Length of barrel, 16 inches; diameter, 1½ inches; one spray rose and one jet, side attachment, and angle joint for sprinkling under foliage..... 4 00  
 No. 11. Length of barrel, 18 inches; diameter, 1½ inches; two spray roses (one fine and one coarse) and one jet the same as No. 5 without the patent valve..... 4 50  
 No. 5. Length of barrel, 18 inches; diameter, 1½ inches; with patent valves, two spray roses (one fine and one coarse) one jet and side attachments..... 5 50

**Trowels.** Cast steel, 6 in..... 15 and 25  
 " Forged steel..... 40  
 " Maynards solid steel socket shanked..... 50

**Thermometers.** Wood frame, 10 inch spirit..... 35  
 " Greenhouse or conservatory, metal, 12 inch..... 1 25  
 " Mushroom or hot bed with brass tip 15 inch..... 1 25

**Weeders, Eureka.....** 25  
 " **Excelsior.....** 10  
 " **Haseltine.....** 25  
 " **Onion, 3-in.....** 25  
 " **Forks.....** 10 and 15

## GARDEN AND FARM TOOLS—Continued

**SPRINKLERS.** See also page 59.

**Aetna.** Stands 24 inches high and has 3 arms. The top is made the same as the Preston. The base is formed of 3 legs each of which terminates into a solid ball. \$1.75.

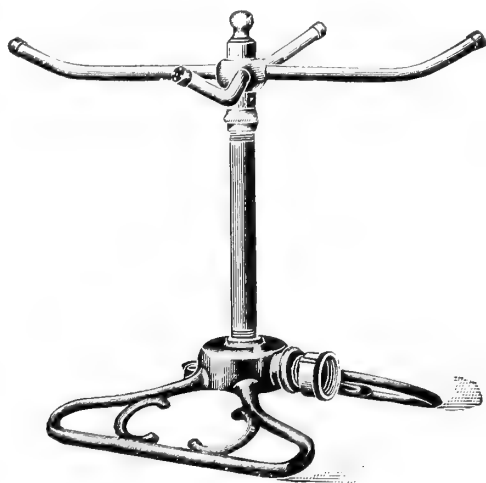

California Sprinkler

**California.** One of the most popular sprinklers, the arms of which are arranged to cover a large area. \$1.50.

**Columbia.** It is constructed on the same principle as the Preston but has 3 legs instead of the sled at the base. \$1.25.

**Cyclone.** Made exactly as the California but has only 3 arms. \$1.25.

**Preston.** An ideal sprinkler for a small garden. With the exception of the sled it is all brass, and stands about 6 inches high. \$1.00.

**Texas.** There is no difference between the Texas and the Aetna, only the former has 4 arms. \$2.00.

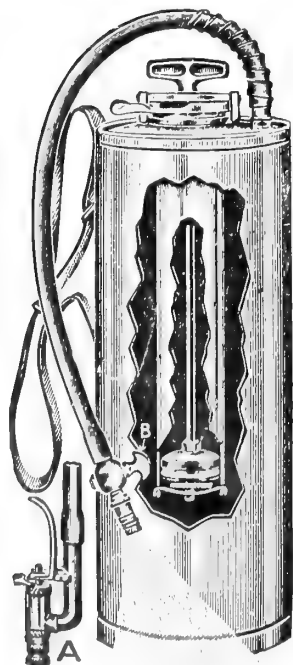

PATENTED.

Auto Spray

ARE your plants, trees or shrubs ever troubled with insects? On page 65 you will find a complete list of insecticides and remedies for all insect pests. Also a number of high grade fertilizers for plants either indoors or outside in the garden.

**SPRAYERS.** See also page 54.

**Auto Spray.** A simple but well constructed automatic sprayer used by innumerable florists, nurserymen and gardeners throughout the country. After filling the tank two-thirds full of solution, pump up air pressure, which is done in about 15 seconds, by 10 to 15 strokes of the plunger. Usually two pumpings will discharge the entire contents. The auto pop is a device for controlling the spray. Full directions given with each pump. Galvanized iron tank with auto pop, \$5.50.

Brass tank with auto pop, \$7.00.

Brass extension pipe. 2 feet long, each 45c. Copper strainer, each 80c.

**Myers' Spray Pump (Little Giant).** Has all brass working parts and withstands the use of the strongest insecticides. Will throw a straight stream 50 feet, or if a spray is desired simply change the nozzle. \$4.00.

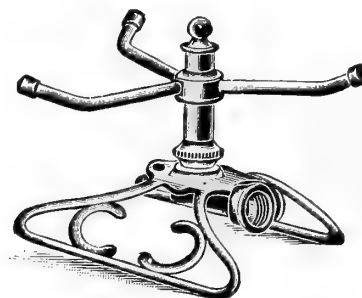

Preston Sprinkler

**Faultless Sprayer.** This will be found a very useful article by all having a small garden. Holds about a quart. Galvanized Can, Tin Tube. 75c. All Brass. \$1.00.

**Nozzle Boston.** A perforated nozzle, similar to the rose on a Philadelphia Watering Can. 50c.; by mail, 60c.

**Nozzle Daisy.** Spray and stream. 50c.

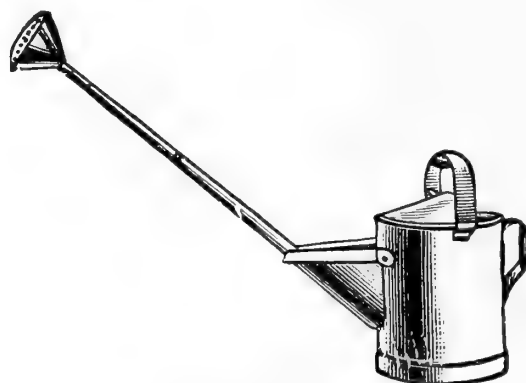

Watering Pot

**Philadelphia Watering Cans.** Extra heavy with long spout; each equipped with 2 copper-faced roses. 6 qts. \$2.00, 8 qts. \$2.25, 10 qts. \$2.50.

**French Watering Cans.** Similar to the above but oval shaped. 6 qts. \$2.25, 8 qts. \$2.50.

**Rustic Hanging Baskets.** 9 in. \$1.00, 10 in. \$1.25, 13 in. \$1.75.



# "PLANET Jr." FARM & GARDEN TOOLS

## No. 5 Hill and Drill Seeder

Price, \$13.00



This seeder is the latest and most perfect development of the hand seed drill. It sows evenly in drills, and also drops in hills, at 4, 6, 8, 12 or 24 inches apart. It is thrown out of gear instantly by moving a convenient lever; or, the flow of seed is stopped by pushing down the feed rod. No time is lost; no seed is wasted. It is quickly set to sow different kinds of seed in the exact thickness desired. It covers and rolls down light or heavy, and marks the next row clearly. 16½-inch patent steel drive wheel; hopper holds five quarts; it runs light, and sows equally well with a full hopper or a tablespoonful of seed.

The accurate hill-dropping drill, which gives a regular stand of plants with the least seed, saves its cost over and over in seed alone. We guarantee this drill to be more accurate than any other made, and to give satisfaction in every respect.

## PLANET Jr. No. 4

Combined Hill and Drill Seeder, Single Wheel Hoe, Cultivator and Plow

This admirable tool combines in a single convenient implement a capital hill-dropping seeder, a perfect drill seeder, a single wheel hoe, a cultivator, and a plow. It holds two quarts and as a seeder is like the No. 5. sowing in continuous rows, or dropping in hills at five different distances. It is thrown out of gear by simply raising the handles. The index is accurate, simple and easily set. The drill is detached and the tool frame substituted by removing but one bolt. It then becomes a single wheel hoe, garden plow or cultivator. It is useful almost every day of the season, at every stage of garden work. With this one implement the small farmer can do practically all the work in his small crops.

A set of three rakes supplied when specially ordered. Price, \$1.00.

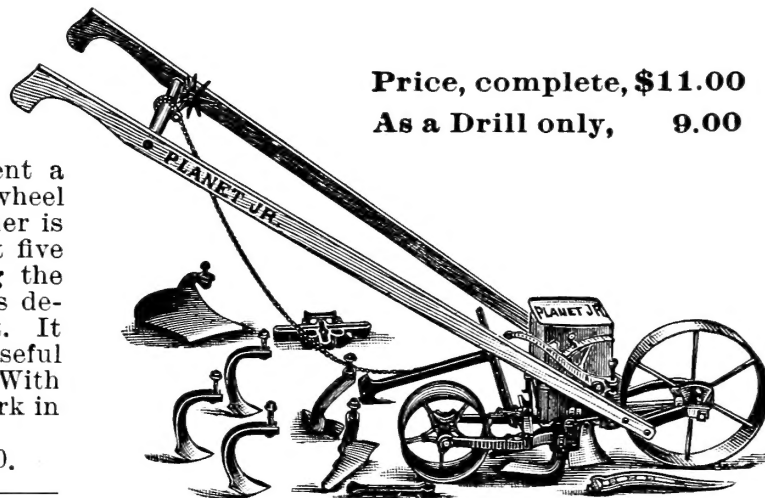

Price, complete, \$11.00

As a Drill only, 9.00

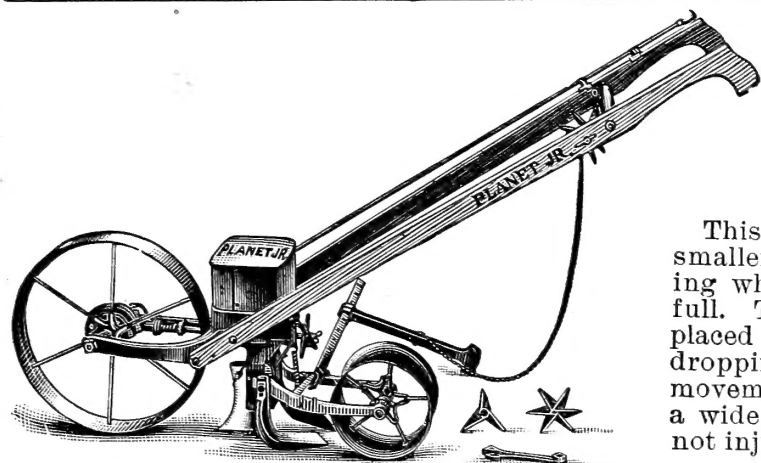

## "PLANET Jr." No. 3—HILL AND DRILL SEEDER

Price, \$10.50

This is the same tool as No. 5 seeder, and just as good, except that it is smaller in size. The hopper holds three quarts; 15-inch patent steel driving wheel, with broad face, which makes the drill run easily, even when full. The quantity of seed is regulated by an accurate index, conveniently placed at the top of the handle, and carefully graduated for either hill-dropping or drillings. The flow of seed is started or stopped by a single movement of the forefinger. The roller is broad and hollow-faced, leaving a wide, smooth track for the wheel hoe. It is extremely simple, and will not injure the most delicate seed.

## "PLANET Jr." No. 2—DRILL SEEDER

Price, \$7.50

This tool is known and used the world over, and excepting our hill and drill seeders, is the most perfect drill known. It holds three quarts, and sows in an even, regular stream, whether there is much or little in the hopper. The index contains the names of the principal seeds, and when a name appears through the slot, the drill is set right for that seed. The opening plow, being directly between the wheels, follows all irregularities of the ground. It can be set to run deep or shallow, and the seeds are deposited in a very narrow line. The machine is extremely simple, has no agitators, belts or gearing; and will not injure any seed. The best low-priced drill on the market.

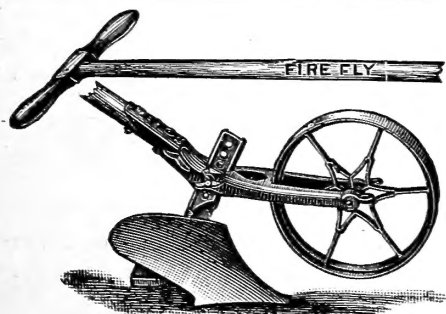
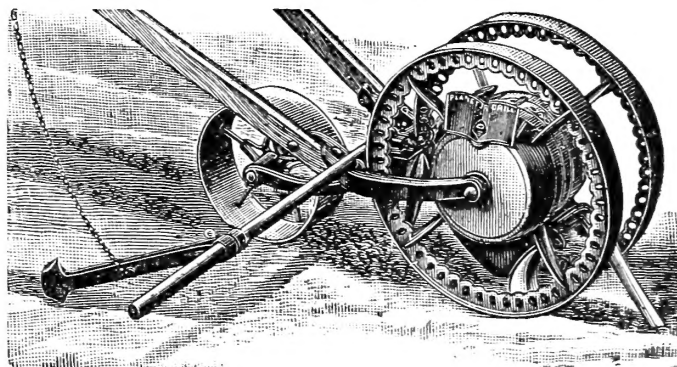

## THE "FIRE-FLY" GARDEN PLOW

Price, \$2.35

This tool is most useful in small gardens, opening furrows for manure or seeds, and covering them quickly. Chicken-raisers will find it very useful in plowing up the scratching yards. The moldboard is of tempered and polished steel; the depth is quickly changed.

"PLANET JR." FARM AND GARDEN TOOLS—Continued

"PLANET Jr." No. 11

Double Wheel Hoe, Cultivator, Rake and Plow Price, \$9.00

This perfected wheel hoe is invaluable for use in all small crops. Its variety of work is almost incredible. Changes and adjustments of the tools are made with the greatest quickness. It has 11-inch wheels, which can be set at four different distances apart; the frame is malleable, with ample room for tool adjustment and can be set three different heights. The handles are adjustable at any height, and, being attached to the arch, are undisturbed in making changes of adjustment in frame, wheels or tools. The arch is of stiff steel, unusually high; the quick change frame permits the tools to be changed without removing the nuts. Seven pairs of tools, as shown in the cut, go with the complete wheel hoe. All the blades are of tempered and polished steel.

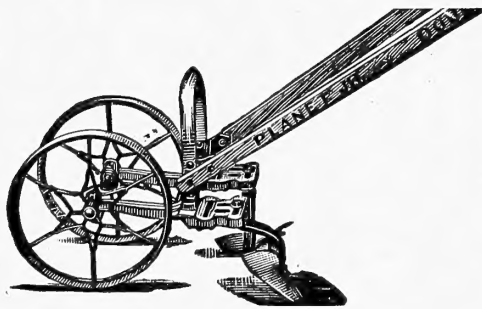

No. 13 DOUBLE WHEEL HOE Price, \$4.75

This tool is the No. 11, with 6-inch hoes only, these being the tools that are most generally useful. Any or all of the other tools shown with No. 11 may be added at any time, and are sure to fit.

"PLANET Jr." No. 16

Single Wheel Hoe, Cultivator, Rake and Plow Price, \$6.00

This latest and best single wheel hoe has a very full set of tools, several of them being of new design, such as have been found to work in the very best manner. It has 11-inch wheel, with broad face; is very light, strong and easy running. It has adjustable handles and quick-change frame. The tools are a well-shaped plow for marking out, plowing, covering, and late cultivation; a pair of 6-inch shield hoes and three all steel patent cultivator teeth; also a set of two rakes, just the thing for preparing ground for the seed drill. A practical leaf guard holds up the plants, while thorough work is being done underneath; the frame changes in height, and the wheel may be attached to the other side of the frame, when both sides of the row may be hoed at one passage.

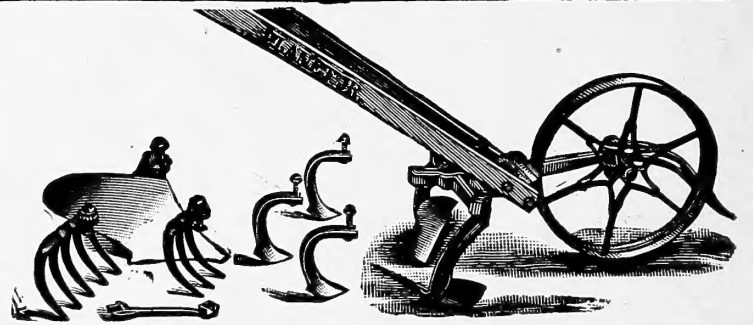

No. 18 SINGLE WHEEL HOE

Price, \$3.50

This tool has the same frame and handles as No. 16, but has one pair of 6-inch hoes only—the tools that are most constantly useful throughout the season. All the other tools can be added as needed.

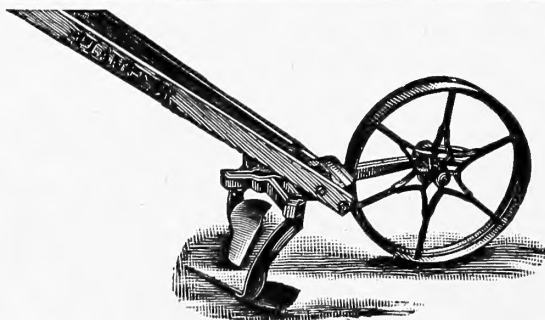

"PLANET Jr." GRASS EDGER

Price, \$6.25

Extreme neatness is the great secret of attractiveness in the grounds about a house. The Grass Edger assists wonderfully in producing this effect. It will edge straight or curved work—paths, drives, borders or flower beds—at the speed of a mile an hour. It should be the constant companion of the lawn mower. Strawberry growers will find the grass edger, with the hoe removed, a rapid and perfect tool for cutting off surplus runners.

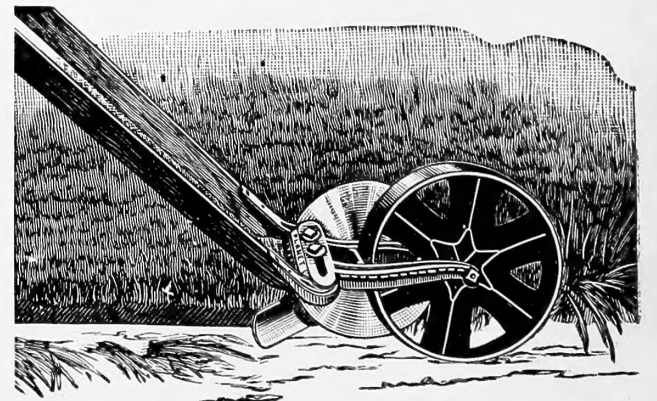

Space will not permit our showing and describing all of the "Planet Jr." tools, but we will send a fully illustrated catalogue FREE FOR THE ASKING to any who desire it, and we can supply promptly anything ordered. "Planet Jr." goods are standard machines, the best on the market. In sending your orders to us, you can rely on getting bottom prices.

"PLANET, JR." FARM AND GARDEN TOOLS.—Continued

"PLANET JR." No. 8 HORSE HOE Price, \$9.00

Probably no other cultivating machine is so widely known as the "Planet Jr." Combined Horse Hoe and Cultivator, for it is in use throughout the civilized world. It is so strongly built as to withstand incredible strain, yet it is light and easy to handle.

**The Frame** is extra long and extra high, making a tool that will not clog easily.

**The Stiff Steel Standards** are hollow with round throats; they polish quickly and free themselves readily from obstructions, and they clasp the frame and strengthen it.

**The Depth** is under perfect control by a new lever wheel and patent depth regulator, moved instantly in unison by single lever, making exact work, steadying the machine and relieving the operator.

**The Expander** is an entirely new pattern, superior to all other forms: exceedingly strong, simple, accurate and positive in all positions.

**The Handle and Braces** are also new, and the most effective and stiffest combination known, at once making the tool rigid, yet allowing every adjustment of handles *in height and sidewise*.

**The Reversible Side Hoes** patented, are an important part of the implement. As shown in the cut, they act as plows or hillers, but when turned end for end the tool becomes a genuine horse hoe, working so shallow and so close, without injury to the roots, that an immense amount of hand labor is saved.

Every part is perfected to make the tool acceptable to the intelligent farmer, who knows the best is always the cheapest. Without Depth Regulator (order as No. 7). **Price, \$9.00.**

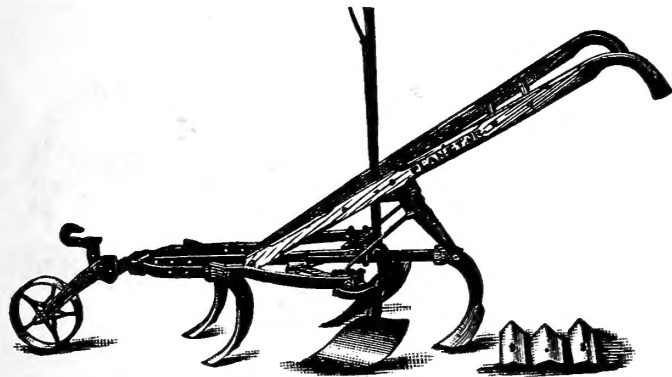
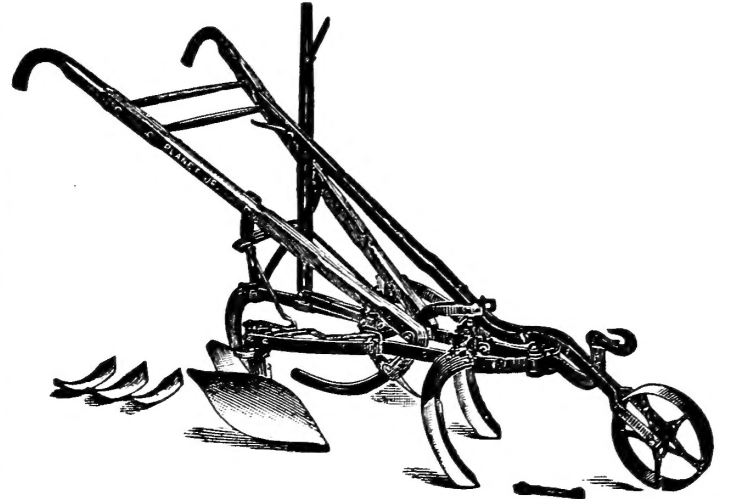

"PLANET JR." No. 9

Horse Hoe and Cultivator

Price, \$7.75

This tool is similar to the No. 8 Horse Hoe, but it has a plain wheel instead of one operating by a convenient lever. It has the same standards and teeth, and is made in other respects like the popular No. 8. It is strong and serviceable and will give full satisfaction.

"PLANET JR." TWELVE-TOOTH HARROW AND CULTIVATOR

Price, Plain, \$6.20.

Price, With Wheel, \$7.40.

Price, Complete, \$9.00

This tool has rapidly grown into favor with farmers, market gardeners and strawberry growers. It has a high frame and the chisel-shape teeth **cut an inch wide each**. It may be set with teeth trailing.

**The foot-lever pulverizer** is a capital addition for preparing ground for the seed drill or for plant setting. Hand levers regulate both width and depth **while in motion**; it contracts to 12 inches, and may be further reduced in width by taking off the outside teeth: it expands to 32 inches. It cultivates deep without throwing earth upon the plants, and the smooth round-throated teeth turn strawberry runners without injuring them. Strawberry Runner Cutter Attachment consisting of a 10-inch flat steel disc mounted on an outrigger, extra. **Price, \$1.85.**

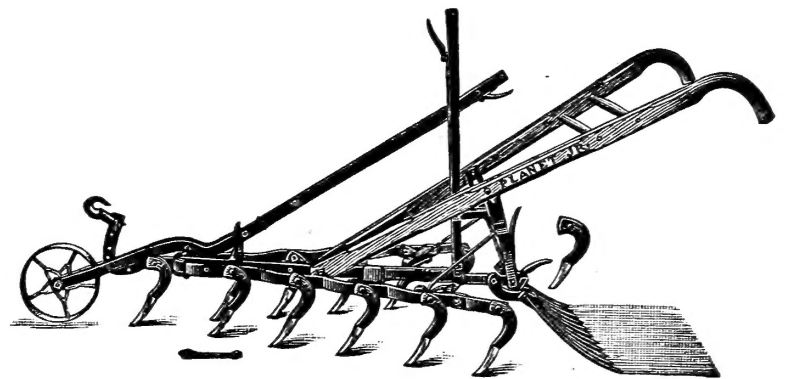

For a Rich, Green, Velvety Lawn, Sow Our  
**CHOICE CENTRAL PARK LAWN GRASS**

# SEEDS 1910 BULBS

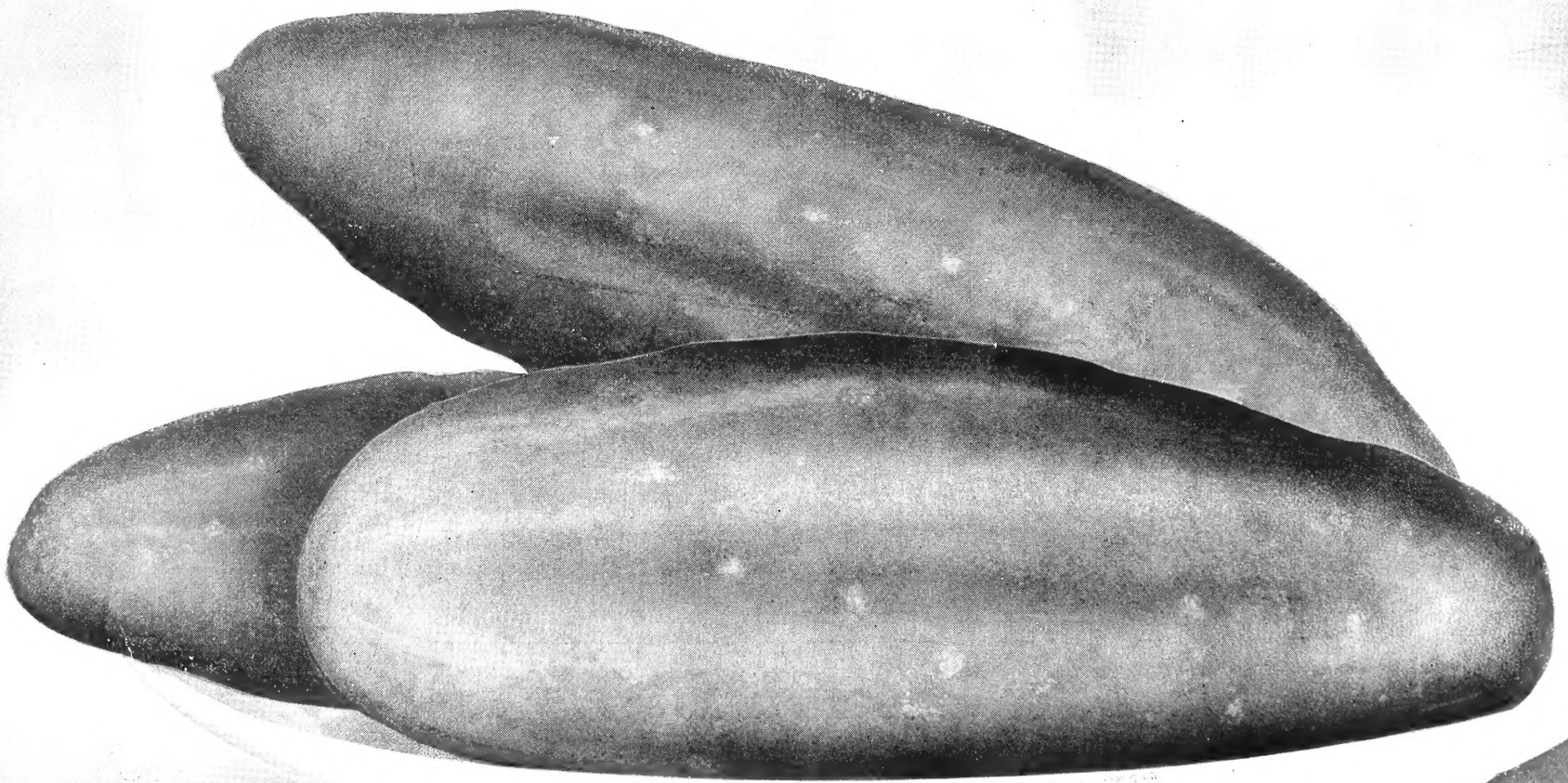

AND CRISP

M. A. BRUNJES & SON  
1581 MYRTLE AVE.  
BROOKLYN. N. Y.