

Historic, Archive Document

Do not assume content reflects current scientific knowledge, policies, or practices.

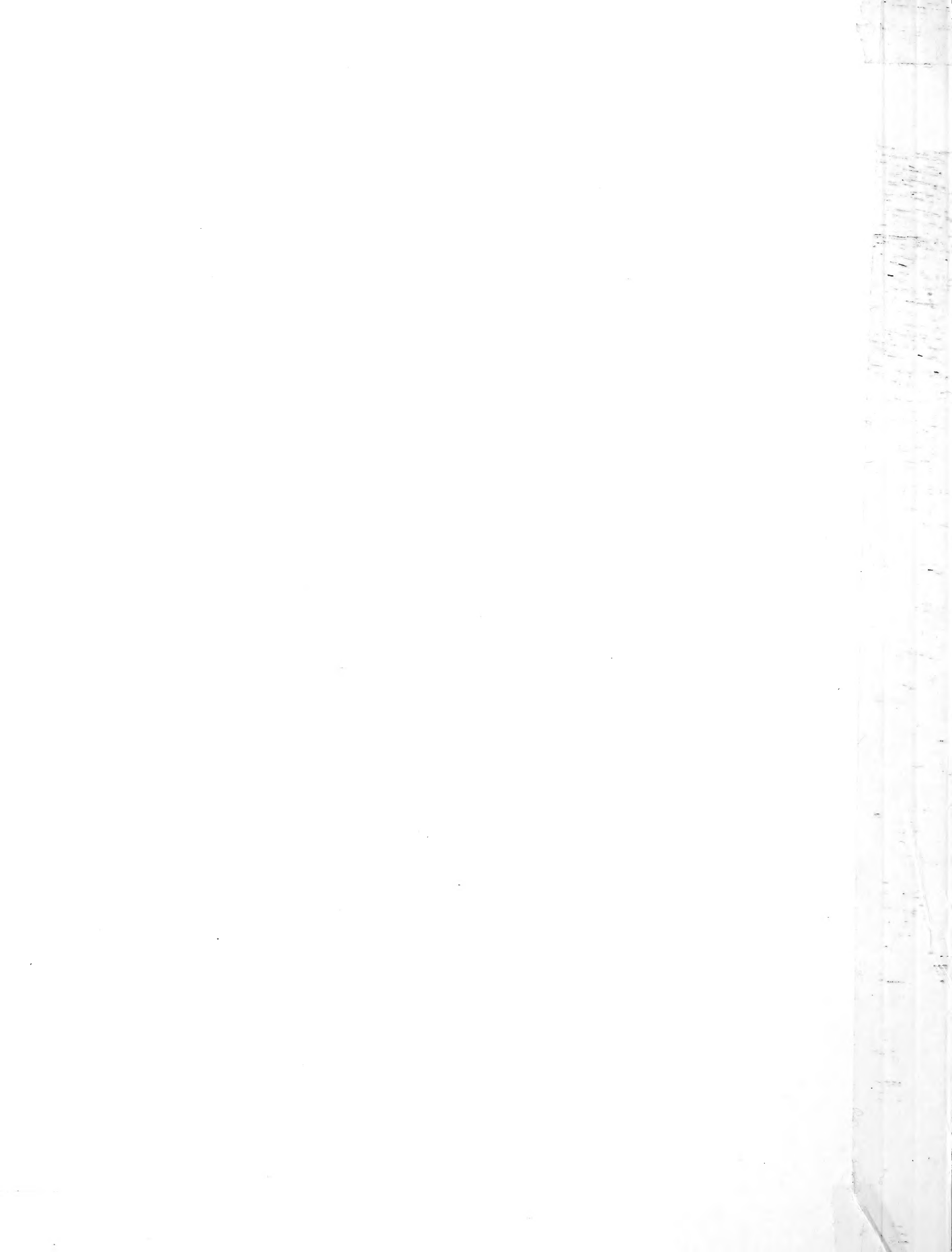

ROSS BROS. CO.

SEEDS AND AGRICULTURAL GOODS

WORCESTER MASS.

SPRING 1911



General View of Exhibits at New England Corn Show, held at Worcester, Mass., last November

The Possibilities of New England Corn

"Never has the enhanced cost of living, when due to agricultural decline, failed to end in national disaster."—J. J. Hill, President of Great Northern Railway.

The New England Corn Exposition at Worcester, last November, seems to have far excelled the wildest dream of success of its promoters. We have hoped and worked for years in our own business with faith in our grower friends that ultimately they would show the skeptics of America what New England really can do in producing this cereal.

These exhibits of the New England's best corn fulfilled their mission splendidly in educating the farmers to new ideals of corn perfection. Mr. L. B. Clore, the manager of this exposition and winner of many prizes at National shows declared that so great was its educational value that he confidently guaranteed an increase of ten bushels per acre within the next two years in the New England States. Mr. Clore said further: "It is human nature for a man to leave home with a sample of corn, thinking that he has the best on earth. However, when he brings it in competition with others he soon learns that there are some things he had not taken into consideration. He will go home and plan on improvements next year, and will put into effect the new ideas and methods suggested at the exposition."

It is difficult to fully estimate the educational value of this show, for the influence of individual corn breeders such as Brewer, Chapin, Stickney, et. al., will be felt more strongly each succeeding year. We are convinced that men of this caliber are doing a great service for the nation and we are proud to be able to give our own customers first opportunities of purchasing direct from us the personally grown and carefully selected stock of these growers. The pages following are brimful of interesting facts about the varieties of both flint and dent best suited to our own short corn-growing season. Remember that the varieties which we offer mature in 90 to 105 days and will be found safe kinds for growing in the temperature belt that extends into Northern Illinois and Wisconsin. Not only are the varieties we offer, high in protein value, but their superior grain-producing qualities have been demonstrated decisively at the recent exposition.

You may have said, New England is now producing an average of 45 bushels of corn per acre, which is greater than any other section of the country. This is true, for even with the enormous yields of many central Western states—due to their large acreage—the yields per acre are below the average of the six New England States. It has been stated that the farmer of New England who grows but 45 bushels of shelled corn per acre is dangerously near the death line and volume alone can save him. And right at this period of high cost of living, while the man who tills the soil is beginning to realize more fully a true value for his product, he must not lose sight of the fact that our national population is increasing at the rate of between two and three million stomachs a year.

With the tremendous national yield of corn in 1910, the average is still but 27.8 bushels per acre. Is it not time that our farmer friends begin this year to plant better seed corn? We mean corn that has been grown by corn-breeders who have given their lives to its careful selection and testing. This is the kind of seed corn that our customers may have confidence in, if secured from us. We realize the value of pedigreed seed—seed with a history dating back many generations of small cob, straight, deep rows, and well filled, butt and tip.

That New England has a great future in agriculture is predicted by many thoughtful men with clear visions. Our proximity to good markets with teeming populations highly appreciative of the best offerings of Ceres impels us to declare that "it is up to the farmer to make good." That he will, we have no doubt, by intensive farming and scientific methods, for we can surpass any section of America in quality and yield of corn per acre, already. The several new world records prove this statement.

To stimulate and encourage the growing of better corn for 1911, and to demonstrate the fact that the New England Flint varieties hereafter mentioned are the most satisfactory and will produce the largest yield of any Flint corns known, we offer the following cash prizes:

CASH PRIZES FOR BEST 10 EARS OF CORN

\$10 in gold for the best 10 ears of the Stickney Prize Flint Corn and \$10 in gold for the best 10 ears of the Sheffield World's Prize Corn, to be awarded at the annual October 12th Exhibition of the Worcester Horticultural Society, Horticultural Hall, Worcester, Mass.

Any one located at a distance who wishes to compete for these prizes can send his exhibits in our care, well packed, and express charges prepaid and we will see that they are taken care of and placed on exhibition. Notice of entry should be made to us not later than Sept. 15. Seed to be purchased from us or one of our regular agents. The Corn in all cases to revert to us, as we wish to make a comparison of how these varieties mature, with the view of keeping them pure and eventually producing an unequalled variety of Flint Corn.

\$50 IN GOLD FOR THE HEAVIEST YIELD OF EUREKA ENSILAGE CORN FROM ONE ACRE

To substantiate our statements that Eureka Ensilage Corn will produce more tons of best silage per acre than any other known ensilage variety, we take this opportunity to offer a prize of \$50 to the person or persons raising the heaviest acre of this variety in 1911, seed to be purchased from us or some one of our regular agents. The total yield from this acre shall be taken by cutting and weighing either the entire crop or four average square rods taken from the four quarters of the acre. The measuring, cutting and weighing to be done by three disinterested persons.

This prize to be announced at the October 12th Exhibition of the Worcester Horticultural Society, Horticultural Hall, Worcester, Mass.

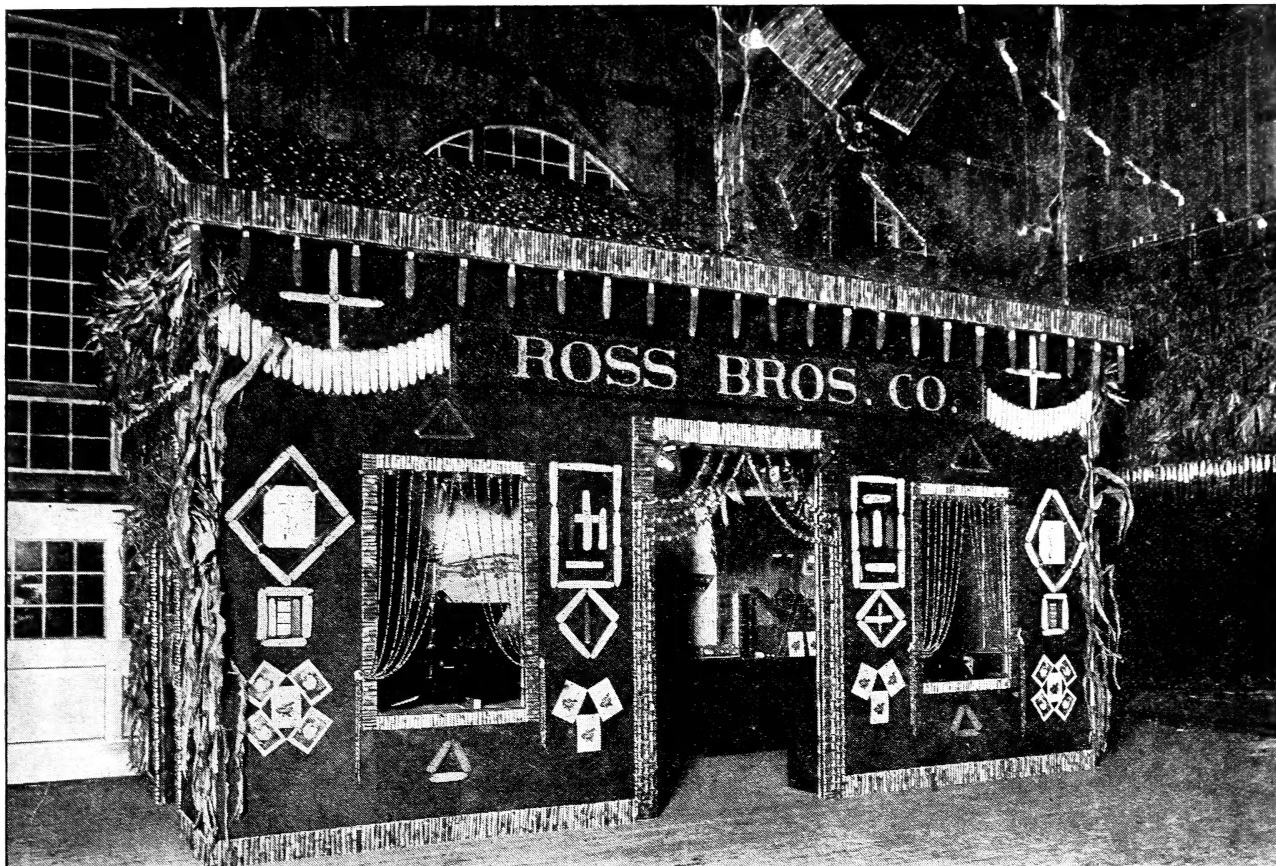

One of the principal attractions at the Corn Show was our Corn Bungalow. This building was an imitation of an Old Dutch Mill, being about 22 feet long and 15 feet wide. The roof was covered with ears of corn representing a tile roof. Thirty bushels ears of corn were used in this work. The sign on the front was unique, being made entirely of corn, the letters being covered with white corn while the background was red, and back of the sign were placed electric lights which brought out the color scheme very prominently in the evening. Every ornamentation of windows, door, gables, etc., was made from some part of corn. On the roof was an imitation of an Old Dutch Mill made entirely of corn stalks. On the interior of the building was a farm scene with a perfect model of a silo and also a model of an ensilage cutter. This was in motion, being operated by electric power. A corn planter in the other end of the building showed the method of dropping corn in hills and drills and also distributing fertilizer. Altogether, this exhibit was of considerable educational value.

About the New England Corn Show

That a very great interest in corn growing has recently been aroused was conclusively shown by the number of entries at the New England Corn Exposition held in this city last November. This was the first exhibition of its kind ever held in New England. The number and character of the exhibits and the yields reported were, to say the least, remarkable and surprising. In an address at the time Mr. Geo. T. Powell, a well-known writer and an authority said: "The quality which I have seen today, at this exhibition, in the corn, in my judgment, exceeds anything of the kind I have ever seen anywhere in the United States. I have been a judge at international expositions, at expositions in many states, and I was the first single judge at the Buffalo Exposition."

Some of the premium yields were enormous. In fact, a new world's record for the largest yield from an acre was established by a crop of yellow flint grown in Massachusetts (see description of the Sheffield World's Prize Flint)—123.8 bushels of *crib dry* shelled corn. While, as noted in the description, this crop was practically crib-dry at harvest, most crops contain at that time a considerably greater per cent of moisture, therefore, that all crops might be judged by the same standard, the conditions of the competition required that the yield should be determined by analysis at the experiment station of the state in which the crop was raised, on a water-free, or 12 per cent moisture basis, which is considered the average condition of corn fit to mill or market, known generally as "crib-dry." Other large yields of yellow flint were as follows, all of which were figured on the crib-dry basis. They are given in the order in which they were awarded premiums with the state in which the crop was raised following the number of bushels per acre. 103 $\frac{1}{4}$ bushels, Massachusetts; 95.78 bushels, Maine; 94.79 bushels, Connecticut; 89.36 bushels, Massachusetts; 86.90 bushels, Maine.

Another large yield was that of Mr. Stickney. This was not entered in the acre contest, but Mr. Stickney received, as noted in the description of this corn following, several premiums in other classes. Beyond doubt such crops are profitable, and that such crops are within the possibilities of many farmers does not appear to us a visionary view, especially when it is considered that of the above large crops two were grown in Maine, one of the most trying locations in which corn can be grown because of a short season.

If some of the specimens exhibited were representative of the crop, seed selection is a feature of corn-growing yet to be learned by many New England farmers. And here we wish to call attention to the fact that, notwithstanding the large yields reported here, and of others of which we at times hear, the average yield of the United States is but little more than it was a half century ago. In the record-breaking crop of 1906, the average yield per acre rose to 31.1 bushels, but while the total yield of 1910 was not greatly below that of 1906, the average was but 27.8 bushels, the total yield approximating that of 1906 only because of a much greater acreage.

Frankly stated, the situation is not one of which those interested in agriculture can well be very proud and shows at least a probable neglect by many farmers to avail themselves of the great assistance offered by the experiment stations in the different states in the way of advices regarding seed selection, fertilizers, rotation of crops, etc., advices based upon the results of many years' careful and costly experiment, and which, if they had been observed and followed, would undoubtedly have resulted in a much larger average yield of corn. In view of the possibilities as shown in the yields reported, there seems no longer any need of discussing the question whether it pays to raise corn, but rather that which concerns many farmers is what they need to make their crops more closely approximate those of the few successful growers. In general, the need is, of course, **better farming**. As a specific starting point, **better seed**.



Two weeks from planting



Three weeks from planting



Four weeks from planting



Five weeks from planting

Corn for Ensilage. The Eureka. The Best

Grows the tallest and is the most leafy. Will produce more good material for the silo than any other

The Eureka is a very tall and especially leafy variety of Southern corn. It originated in Virginia, over twenty years ago, and was the result of many years' careful selection from the tallest stalks producing the most leaves. While the silo, at that time, was probably an almost unheard of thing, the need of this seemingly rather strange selection will be easily seen when it is understood that, at that time, the Southern farmer used no other hay for his working stock than the leaves of corn. These were not saved as we harvest them here by cutting the entire stalk but by stripping the blades from the stalk. Therefore it was desirable, in fact necessary, to grow the tallest variety or strain producing the greatest possible amount of foliage as well as one that produced the largest quantity of ears; therefore the selection, the Eureka, **the tallest and most leafy variety in cultivation**, and, therefore, for ensilage, **the best**.

It should be borne in mind that this selection was made also with respect to a large production of ears as well as to the largest amount of foliage, as the Southern farmer had to have grain as well as hay; in fact, the selection was doubtless made primarily for grain and secondarily for foliage. In the result we have the Eureka, which is not only the most leafy variety but in its home in the South one of the greatest grain-producing varieties. While, of course, we have known for years that the Eureka cared well, we did not really know how productive of grain it was until last October, when our Mr. W. D. Ross, president of this Company, spent several days in the South inspecting the crop of Eureka. He found that 100 bushels of ripe, sound, shelled corn to the acre was not a very rare occurrence, while in especially favorable seasons the yield was considerably more than that. This shows that there cannot be any reasonable objection made to the Eureka on the score of not producing a sufficient number of ears.

We sell other varieties of corn used for ensilage—several of them—good varieties, too. If it is considered that for the silo some variety is necessary that will produce ears nearly ripe, and the much smaller amount of foliage is a secondary matter, then evidently some of the other varieties which we offer would be of more value than the Eureka. But if the main purpose of the silo is to preserve in as nearly a natural condition as possible the largest possible amount of fresh green foliage and large fresh green ears which can be grown on the smallest possible area, then the Eureka is better—in our opinion **it's the best** in cultivation. And this is in accord with the opinions of hundred of practical farmers who, having tried it to their satisfaction, now plant nothing but the Eureka.

Pk. 60 cts., bus. \$2, bags included. Selected ears, box of 70 lbs., \$3

We never had such a growth of corn as we did last year where we planted Eureka Corn. I cut a number of stalks that measured 17½ feet to 18 feet high. The best one I found was 18 feet 3 inches and weighed twelve pounds. We planted 4½ acres and filled two silos that hold seventy-five tons each and there was enough corn left over to feed sixty cows twice a day for three weeks, so I think we must have had nearly two hundred and sixty tons of ensilage and I believe it to be the sweetest ensilage we ever had.—FRED L. POOR, Williams-town, Vt.

My Eureka seed was planted about June 1 and Sept. 14, it stood about 19 feet high and there were stalks 3½ in. through. It is earing very heavily—has from 2 to 5 ears on a stalk. One of the largest stalks weighed 22½ lbs. and had 3 large ears on it. I never saw anything like it in this country, as I used no manure on the land and only 125 lbs. of fertilizer per acre. There are farmers coming from miles around to see this and they all say they never saw anything like it. I have planted it in four different fields and it all proved about the same.—C. E. HOUSE, New Berlin, N. Y.

The set of fourteen pictures, on pages 2 and 3, show the growth of a crop of Eureka Ensilage Corn, at the Beach Farm Dairy, Coldwater, Mich. First picture taken two weeks from day Corn was planted and one taken each week after till harvest, except the 11th and 13th weeks. Corn planted 19th of June and harvest commenced in fourteen weeks and one day. The series illustrates the life history of Eureka Ensilage from planting to harvesting.



Six weeks from planting



Seven weeks from planting



Eight weeks from planting



Nine weeks from planting (10 ft. high)



Ten weeks from planting

Twelve weeks from planting

Fourteen weeks and one day (14 ft. high)

A shock of Eureka

Corn for Ensilage and Grain THE BEST SEEDS OF THE BEST STRAINS

Varieties used in the East mainly for ensilage, and elsewhere for both grain and ensilage. Prices include bags

While the dent varieties are used in the East mainly for ensilage, more attention has recently been given the type as a grain crop, and some excellent crops were grown last season in different localities in New England. Many of the exhibits at the New England Exposition were fine specimens of well-ripened grain and the premium yields were large. Some good crops were grown in the northern New England States and as noted in the description of the Brewer's Yellow Dent that variety made a remarkable record in competition with the flint type. For ensilage the varieties which we here offer are mostly those which have been cultivated in the East for this purpose or a long time, and are, including the Eureka, the best for the purpose

BREWER'S YELLOW DENT. A new acclimatized early dent variety, bred in Connecticut by Mr. N. H. Brewer who secured the first prize for the best acre of corn in the United States at the National Corn Exposition in 1908. The yield of this acre was 133½ bushels of shelled corn. The original seed was Reid's Yellow Dent, an early strain grown and bred by J. L. Reid of East Lynne, Ill., for fifty-seven years previous to its introduction in Connecticut. The variety was introduced by Mr. Brewer as one which could be successfully grown for grain in the southern part of New England. That it matured well in Connecticut last season was shown by the fact that in the Sweepstakes for best ten ears any type, and first prize for best single ear, any type, both classes open to New England. Also in competition with other dent varieties it was awarded the first prize as the best ten ears of dent. Whether or not the variety will prove, as a grain crop, to be adapted for this climate, we believe it is destined to be a popular variety for ensilage here and elsewhere, combining as it does the possibility of a large crop of grain with the certainty of a great production of ears and material for the silo. Especially to those who do not favor a large-growing variety like the Eureka this must prove a decided acquisition, for, in a large production of ears closely approaching maturity it not only surpasses the popular Leaming and Mastodon but also the smaller-growing early varieties, King of the Earliest, Pride of the North, etc., while ears and stalks are larger than of any of the latter type. If desired for growing for grain the seed grown by Mr. Brewer in Connecticut may, perhaps, be preferable; if desired mainly for ensilage, the western-grown seed is just as desirable. Seed grown by Mr. Brewer. Qt. 20 cts., qt. by mail, 35 cts., 2 qts. 30 cts., ½ pk. 50 cts., pk. 80 cts., bus. \$2.50. Western-grown seed. Pk. 60 cts., bus. \$2, 2 bus. or more, \$1.90 per bus.

KING OF THE EARLIEST. A selection from the Pride of the North. Several days earlier. Pk. 45 cts., bus. \$1.60, 2 bus. or more, \$1.55 per bushel.

WHITECAP YELLOW DENT. Nearly as early as the Pride of the North and has much larger ears. Stalks 8 to 10 feet high, with an abundance of foliage. Pk. 45 cts., bus. \$1.60, 2 bus. or more, \$1.55 per bushel.

REID'S YELLOW DENT. An early and remarkably productive variety; very popular in the West. This is the variety from which Mr. Brewer made his first selection. Also as noted, it has been very carefully bred; is remarkably uniform in type, and should be of interest to all growers in sections where the dent type is grown for grain. Valuable in this latitude for ensilage. Pk. 45 cts., bus. \$1.60, 2 bus. or more, \$1.55 per bushel.

PRIDE OF THE NORTH. One of the earliest dent varieties which has been considerably cultivated in the East for grain because of extreme earliness, and is popular, to a greater extent, for ensilage on late soils. Pk. 45 cts., bus. \$1.60, 2 bus. or more, \$1.55 per bushel.

LEAMING. A medium-early dent variety, probably more extensively used for ensilage than any other. Stalks 12 or 13 feet in height and leafy. Ears about 9 inches long, well filled with medium-sized, but deep kernels which, in sections where they ripen more closely, approach in hardness the flint type than those of any other dent sort. We offer two grades of seed. The Regular Grade is of the same high quality that we have offered for years; the Choice is from specially selected ears. Regular Grade, pk. 40 cts. bus. \$1.50, 2 bus. or more, \$1.45 per bus. Choice, or Hand picked. Pk. 50 cts., bus. \$1.70, 2 bus. or more, \$1.65 per bushel.

EARLY MASTODON. A dent variety second in popularity to the Leaming. We offer two grades. Regular Grade, pk. 45 cts., bus. \$1.60, 2 bus. or more, \$1.55 per bushel. Choice, or Hand-pick, pk. 55 cts., bus. \$1.80, 2 bus. or more, \$1.75 per bushel.

RED COB ENSILAGE. A large, tall-growing variety, popular for ensilage. Pk. 35 cts., bus. \$1.35, 2 bus. or more, \$1.25 per bushel.

SANFORD WHITE FLINT. Large strain. Popular for ensilage in northern part of New England. Pk. 45 cts., bus. \$1.75, 2 bus. or more, \$1.70 per bushel.

SWEET FODDER. Mostly evergreen and Mammoth. Pk. 75 cts., bus. \$2.50, 2 bus. or more, \$2.40 per bushel.

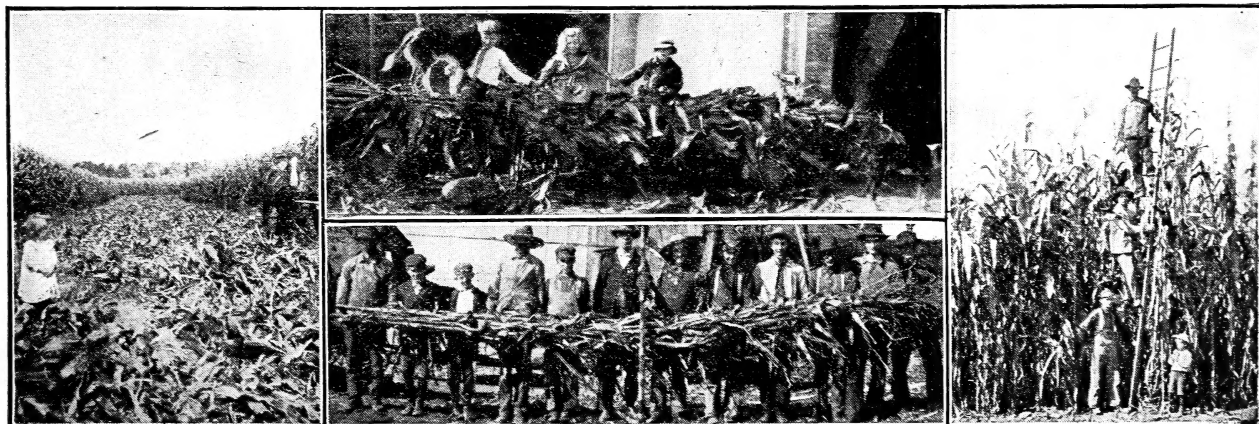

Harvesting at fourteen weeks, one day

At the ensilage cutter

Another view of the same field

CORN FOR GRAIN • The King Crop

VARIETIES FOR NEW ENGLAND AND LIKE LATITUDE. PRICES INCLUDES BAGS

It was a bright farmer who said: "I must raise more corn to feed more stock to get more farm manure with which to raise more Corn."

While previous to about ten years ago there was, perhaps much in favor of the opinion very generally held in the East that grain could be more profitably purchased than produced in the East, since then conditions in the West have been changing and with them the opinions of many farmers in this section of the country.

For many years we have given much attention to securing the best stocks of the varieties which are used in New England mainly for ensilage and elsewhere for grain. And as interest in the East has gradually created a greater demand for the varieties which can be grown for grain in the latitude of New England, we have given more and more attention to such varieties. We hope to become as widely and as favorably known as a source from which the best types and best seed of these varieties may be procured as we now are widely and favorably known regarding those grown mainly for ensilage.

It is a growing and well-founded opinion that with plants grown from seed, as with animals, parentage counts. Larger yields may well be expected from seed of strains known to have been large producers than from strains without such record. Therefore both the Sheffield and Stickney strains are worthy the attention of all corn growers in the East and quite possibly of those in other sections.

The Sheffield World's Prize Flint

An acre of this corn grown by Mr. Harry S. Chapin, of Sheffield, Massachusetts, yielded 123 8-10 bushels of "crib-dry" shelled corn, which not only secured the first prize for the largest yield on an acre at the New England Corn Exposition, but also established a new world's record.

The Sheffield World's Prize Flint is an early eight-rowed flint variety which was brought from Vermont to Sheffield as long ago as 1867, and has been grown in that town on some farms every year since, but it is only recently that Mr. Chapin commenced its cultivation.

The ears are thicker and the color darker but otherwise resemble the Improved Canada, being of about the same length and having the same desirable compact form and well capped tip, and are uniformly true to type.

The kernels are much larger than the Improved Canada, in fact are larger than any of this type which we have ever seen. In trials made by Mr. Chapin, it was found that it required only 63 pounds of ears to make a bushel (56 pounds) of shelled corn. As may be seen, this is even a larger proportion of corn to cob than was noted with the Stickney corn, and of that the proportion of corn is considerably more than is usual with most flint strains.

Concerning its time of ripening Mr. Chapin says that while he has never grown the Improved Canada and could not therefore give an opinion of the comparative time of maturity, he has grown the Longfellow and this corn ripens at least two weeks earlier than that variety. It is therefore evident that it matures about with, or soon after, the Improved Canada, and is much like it in habit of growth. Of the crop in question Mr. Chapin says, it was not planted until June 4 and was cut September 27 and 28, which he says was at least ten days later than the average farmer would have cut the same field, but was quite certain that it paid him to let it stand.

The condition of the corn at harvest time was remarkable. For while analysis shows that most crops contain at that time a large per cent of moisture, this was shown by analysis to be practically crib-dry.

While doubtless the large yield was, in a measure, due to heavy manuring, thorough preparation of the soil and good cultivation, the character of the strain was an important factor—the unusually large proportion of corn to cob and the fact that it was difficult to find a stalk that did not have one good well-matured ear while much the larger proportion of stalks had two.

As shown by the following letter we have secured the entire portion suitable for seed of Mr. Chapin's crop. Judging by the inquiries received by him at the time of this writing the demand for this corn is going to be large; we therefore advise early orders.

Qt. 20 cts., by mail, 35 cts.; 2 qts. 35 cts., $\frac{1}{2}$ pk. 60 cts., pk. \$1, bus. \$3.50. Selected ears, bus. (70 lbs.) \$4, $\frac{1}{2}$ bus. \$2.25, pk. \$1.25.

"After Mr. Ross had looked over my crop of Sheffield World's Prize Flint corn that won first prize at the New England Corn Exposition last month, in the acre contest, I concluded to accept his offer for my entire crop for seed purposes, as I am sure that your firm can dispose of it so as to reach a larger number of growers, who will be anxious to try this splendid variety the coming season, than it would be possible for me to do."—HARRY S. CHAPIN.

I have sown the Eureka for two years. The first year I sowed three acres, rows three feet apart and eight quarts per acre. At harvest time this corn stood 18 feet high with Gold Mine variety on one side 8 feet high and Pride of the North on the other side 10 feet high, and all had the same treatment. Eureka gave me more than double the other varieties. These three acres raised by me in 1909 was the only Eureka in this section but it drew attention from all sides so that this year I not only ordered for 25 acres for myself but let my friends and neighbors have 50 bushels beside. Now in this section it was very wet at planting time so nearly every farmer had to replant his corn, unless he sowed Eureka, as Eureka will not rot under any condition I have ever met, and I never sow over 8 quarts per acre. My corn this year averaged 16 feet with some going as tall as 18 feet. Five stalks with roots on, but free from dirt, weighed 85 pounds and with them I took first prize for the best five stalks of Ensilage corn. I could have easily carried off first prize at the New York State Fair had I exhibited them. I weighed the corn that came off from one acre and to my surprise it weighed between 36 and 37 tons and this acre was sown after the middle of June. It goes without saying that I am very much pleased with the Eureka and I expect to sow 25 acres in 1911, and from the outlook now my neighbors will oblige me to order at least 100 bushels for them.—MILES J. PECK, Cortland, N. Y.

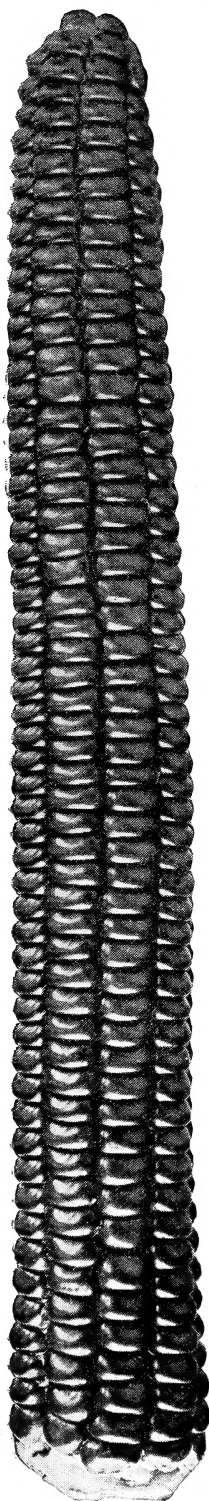

LONGFELLOW

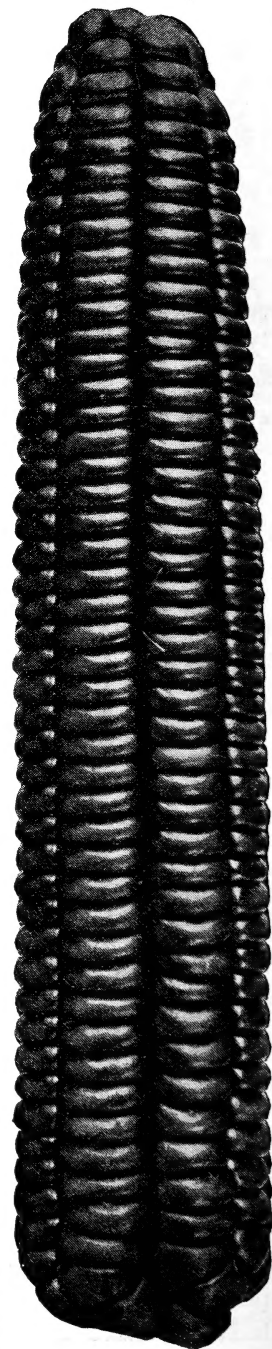

SHEFFIELD WORLD'S PRIZE

Stickney's Yellow Prize Flint

A prize-winning Massachusetts strain which attracted more attention at the New England Corn Exposition than any other of the many varieties or strains exhibited

This corn won at the National Corn Show, in 1909, the first prize for best ten ears of flint corn grown in the eastern zone, which comprises all the states east of Ohio and Kentucky. And while it was not entered in the acre contest there was no other corn exhibited at the New England Exposition which attracted so much attention. This was especially true of the prize-winning trace of 70 ears of which the remark was often made: "The finest trace of corn I ever saw."

In the classes in which Mr. Stickney competed he was awarded the following premiums: The sweepstakes for the best single ear of flint; the Sweepstakes for the best ten stalks exhibit of flint; the first prize best ten ears of flint; the first prize for the the best 70 ears of flint; the first for the best single ear in its class; and the first for best ten stalk exhibit in its class; a special premium of \$25 from a Vermont Creamery Package Company and a gratuity of \$100 from a Massachusetts Fertilizer Company for the largest field and yield. This field measured nine acres and the yield was \$19½ bushels of shelled corn at harvest time—an average of over 91 bushels per acre.

The ears of this strain are of a distinctly different type from the Sheffield World's Prize Flint, being much longer, averaging about 12 inches. They are somewhat thicker than the Longfellow and while generally eight-rowed, there is, as with many strains of New England flint corn of the large-eared type, occasionally one that is twelve-rowed, which is not a serious objection. While the ears, as has been mentioned, are rather thicker than the Longfellow, the cob is not large. By shelling several bushels of ears it was found that 70 lbs. of ears would make 60 lbs. of shelled corn, which is a considerable proportion of corn than the usual estimated proportion—56 lbs. The ears are of about the same height as the Longfellow. The crop matures a little earlier. Qt. 20 cts., by mail, 35 cts.; 2 qts. 30 cts., ½pk. 50 cts., pk. 90c., bus. \$3. Selected ears, bus. (70 lbs.) \$4, ½bus. \$2.25, pk. \$1.25.

Early Canada. IMPROVED STRAIN

The earliest of the eight-rowed yellow flint varieties in general cultivation in New England. Ears about 8½ inches long. Remarkably even and well-filled with the cob completely covered at the tip like the original Canada Cap. Stalks are small and very often bear two good ears and while the variety is, perhaps, especially desirable for light soils of only medium fertility, it is often grown by some farmers on their best land with very satisfactory results. Matures in favorable seasons in about 90 days. It is hardly necessary to say that for late planting or for cold, clayey soils, not well adapted for corn, this is the variety to use. Pk. 60 cts., bus. \$2.10, 2 bus. or more, \$2 per bus. Choice selected ears of our own growing, bus. of 70 lbs. \$3, ½bus. \$1.60, pk. 90 cts.

Longfellow

This, for a long time, has been very popular in southern New England. Ears are eight-rowed and of remarkable length—12 to 14 inches, with occasionally one 15 inches. Stalks are considerably taller than the Improved Canada, but not so large but that they make excellent and easily handled dry stover. When well-grown, owing to the long ear and occasional twin ears, the Longfellow is a very productive variety. Though two ears to the stalk are, of course, desirable, we prefer to give more attention to securing a well-formed and well-ripened ear of typical length rather than to select for breeding stock from stalks bearing two ears if at the sacrifice of any of above mentioned qualities. The Longfellow is safe for planting in the latitude of Massachusetts, and in favorable seasons has yielded large crops farther north. Pk. 60 cts., bus. \$2.10, 2 bus. or more, \$2 per bus. Choice selected ears of our own growing, bus. of 70 lbs. \$3, ½bus. \$1.60, pk. 90 cts.

Sanford White Flint RHODE ISLAND STRAIN

An eight-rowed white flint variety which is much the most popular in Rhode Island. As grown there the ear is, with the exception of color, much like the Improved Canada; not quite as large but having the same even rows and as well filled at the tip. The stalks are larger and considerably more leafy than the Canada, which is doubtless the reason of its popularity for ensilage in the northern part of New England. The strain however, more largely grown for ensilage, seed of which is grown in the West and listed on page three, is distinctly different. The stalks grow considerably taller and the ear is much longer and later in maturing. This, the Rhode Island type, ripens about with the Improved Canada and like that is desirable for soils of medium fertility. Choice Rhode Island grown seed. Pk. 60 cts., bus. \$2.10, 2 bus. or more \$2 per bushel.

Small quantities of field corn are sometimes desired for trial. Where not otherwise priced any variety postpaid, pt. 18 cts., qt. 30 cts.; by express, pt. 10 cts., qt. 15 cts.

We commenced to raise Eureka corn 7 or 8 years ago, and although we have tried many other kinds, we have never found any that would make any showing when compared with the Eureka; in fact, we raise no crop on our farm that produces either the gross or net profit that the Eureka does, and we have raised alfalfa the same length of time with good success, getting an average crop of 5 tons per acre. I am sure I should not have been able to make the net profit on the farm of \$30 per acre (120 acres) selling nothing but the product of 50 cows at an average price of 5 cts. per quart, without Eureka. Our crop of corn this year was badly damaged by the drought, but even then Eureka proved its worth, 33 acres filling our two silos, each of which is 20 ft. in diameter and 42 ft. high—enough ensilage to feed our 60 cows and 30 heifers, a full feed for 365 days.—C. J. ANGEVINE, Coldwater, Mich

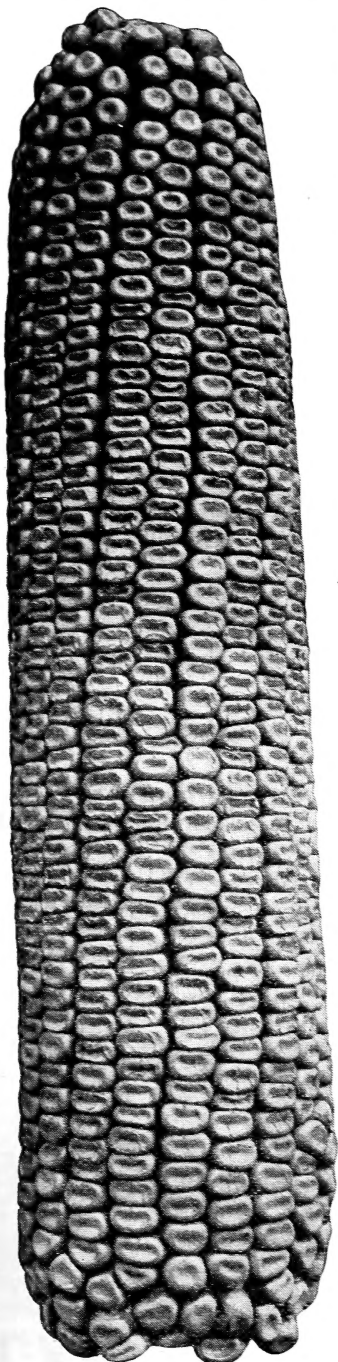

BREWER'S YELLOW DENT

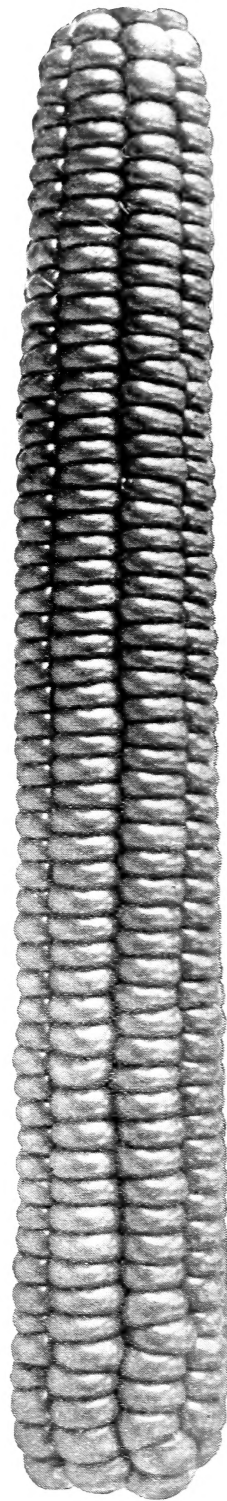

STICKNEY'S

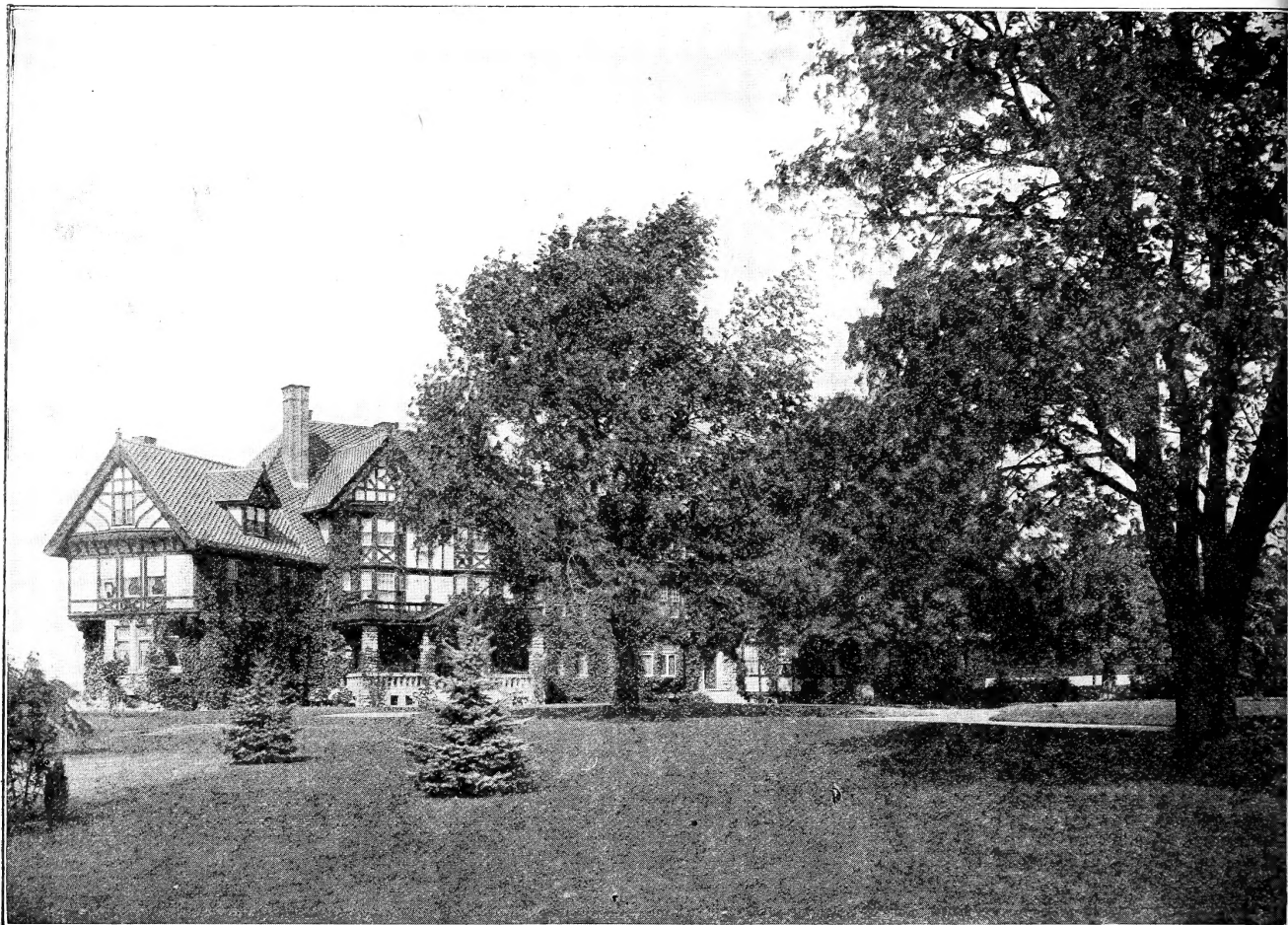

The Worcester Lawn Grass Seed

PRODUCES QUICKLY AFTER SOWING A LUXURIANT VELVETY GROWTH OF RICH VERDURE. EVENTUALLY A FIRM, DURABLE SWARD WHICH, WITH PROPER CARE, WILL LAST INDEFINITELY

The **Worcester Lawn Grass Seed** is a mixture of the grasses which, on account of their fine, even growth, are adapted to the lawn. Each has also some feature peculiar to itself which meets some requirement and makes it, therefore, a desirable component. The varieties combined in well-balanced proportions make a mixture which, if sown on the average soil properly prepared will produce in a few weeks after sowing a luxuriant verdure; also, each succeeding season, a continuous thick growth from early in the spring until the ground freezes, which, though soft and velvety, will bear frequent cutting and constant trampling, and will eventually form a close, firm, durable turf, which will remain in good condition permanently if given reasonable care. This mixture is vastly superior to any single variety for this purpose, because none alone is adequate, mainly because no variety is at its best growth the entire season, and as well because several, though desirable as components, have objectionable features when sown alone. Such features are, however, very largely or entirely overcome when used in proper proportions in a mixture. This is especially true of Kentucky Blue Grass, often recommended to be used alone, as it seldom grows well after the first of July, and does not hold its color in hot, dry weather. Also, it is of slow growth, generally requiring three years to make a firm turf. It is, however, one of the best sod-forming grasses, permanent, the growth fine and even, and is a necessary component of a complete mixture.

In quality of seeds also this mixture is of the best, being composed of the highest grades of native and imported varieties. It is much heavier than many mixtures offered, weighing 28 pounds or over to the measured bushel.

We advise a minimum sowing of 65 pounds to the acre, but often a larger quantity would probably be preferable. 80 to 90 pounds would not be too much when the quickest possible effect is desired. A pound will sow 500 to 600 square feet.

Lb. 30 cts., if by mail, 40 cts.; 4½-lb. pkg. \$1.25, 10 lbs. \$2.50, 25 lbs. \$6, 50 lbs. or more at 23 cts. per lb., including bags

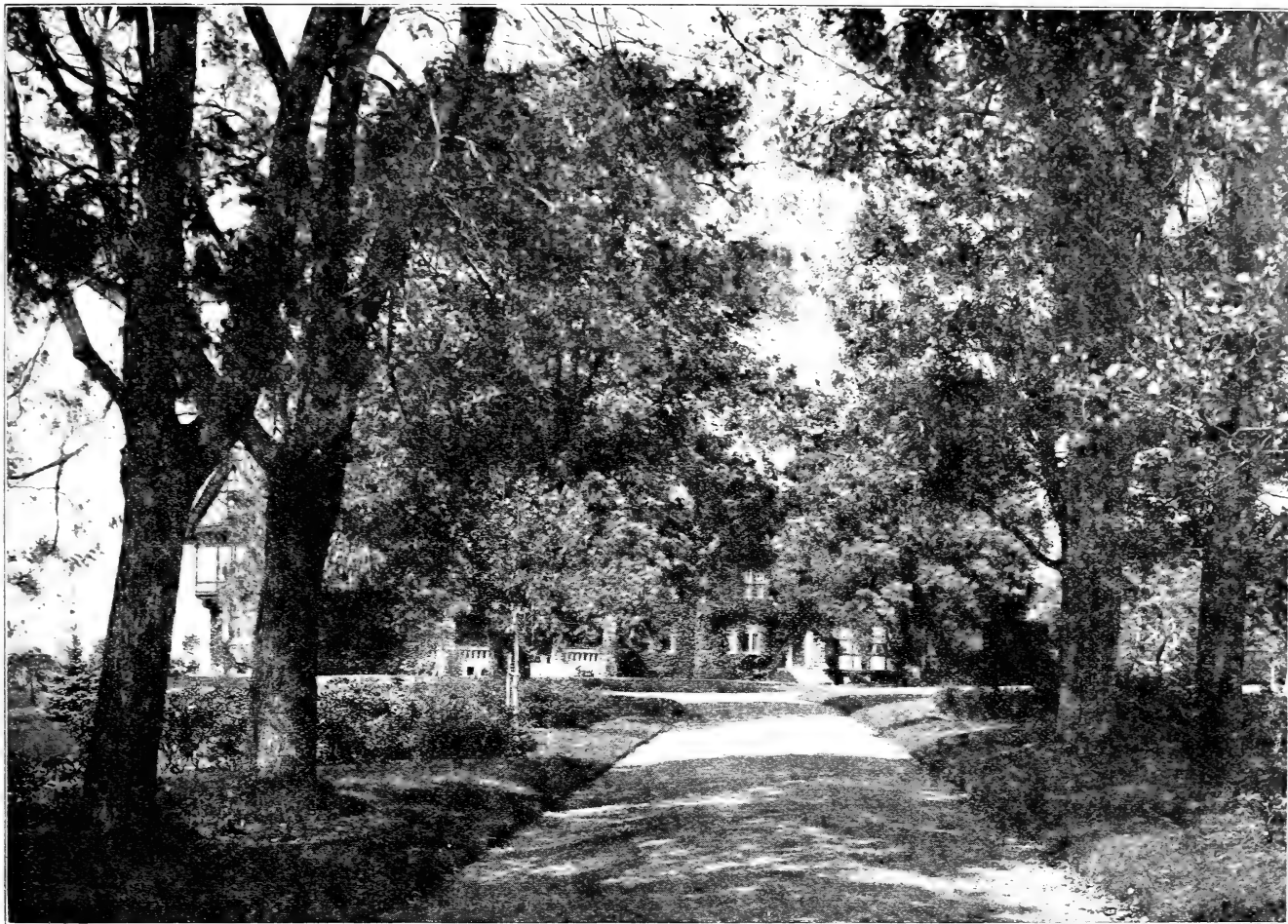

The Shady Spot Lawn Grass Seed

PRODUCES IN SHADED PLACES A FINE VELVETY GROWTH

Bare spots seriously affect the otherwise attractive appearance of many lawns, and while for renovating or filling such spots our Worcester or Park Mixtures are entirely sufficient, where such spots are caused by the shade of trees, a renovation can be better accomplished by the use of the **Shady Spot Mixture**. This is composed of varieties which thrive in shade. It includes all known varieties of this class otherwise adapted to the lawn, all of which are of dwarf habit and fine, even growth. To secure a good growth, however, the soil should be properly prepared before sowing seed. Soil that is naturally moist, which has been densely shaded, often becomes sour, which is indicated by a growth of moss and sometimes by bog grass. In such cases, the moss or grass should be removed, the soil thoroughly worked over, and an application of lime be given at the rate of one bushel to each thousand feet. If the soil is dry, and there has been no growth on it for some time, it is usually very hard and it is useless to sow seed without working it deeply and thoroughly pulverizing it. What would be preferable would be to remove some of the soil and add new soil and rotted turf, and thereby furnish humus, which soils on which nothing has grown for some time usually lack. While, if soil is well prepared, the growth will continue for some time, we do not claim the permanency for this that we do for the Worcester when used in the open exposure to the sun, as there are no grasses which, if cut often, will be as permanent in the shade as others in the open. This is especially true if the shade is very dense. We therefore advise yearly attention and applications of a small quantity of seed if growth is thin. Those who have hitherto been unable to secure a growth under trees because they have not used a special mixture, will find this of great value, and will be well repaid for any slight expense and trouble incurred in following our suggestions by the greatly improved appearance of the lawn.

Lb. 40 cts., by mail 50 cts.; 10 lbs. or over, 35 cts. per lb.

The Park Lawn Grass Seed

This mixture is prepared, as far as price will permit, on the same lines as our Worcester mixture. It is designed chiefly to meet a demand for a mixture somewhat lower in price, for sowing various large areas and the less important places about the home, but is entirely adequate for all purposes. It comprises nearly all the varieties which form our Worcester mixture, though necessarily in different proportions, and does not contain any coarse-growing varieties. Simply stated, the Park is a **good** mixture, the Worcester a **better** one. Four bushels are required for an acre of new seeding. A quart is sufficient for about 300 square feet.

Qt. 15 cts., by mail 22 cts.; 4 qts. 50 cts., pk. 90 cts., bus. (20 lbs.) \$3.35, including bags

General List of Vegetable Seeds

While we invite a comparison of our prices with those of any reliable dealer, we wish to lay much the greater emphasis on the fact that "quality" is the paramount feature considered in what we have to offer.

FREE DELIVERY.—We deliver postpaid to any post-office in the United States all seeds quoted by the packet, half-ounce, ounce and quarter-pound at catalog quotations for such quantities. All vegetables and flower seeds quoted by the pound at "postpaid price," and also beans, sweet corn and peas by the half-pint, pint and quart when quoted "postpaid." Where postpaid price is not given, quotations are net at our store, and such as grass seeds, field and ensilage corn, and a few other farm seeds, require an additional remittance for postage, if desired in small quantities by mail, at the rate of 8 cts. per pound for grass seeds, and others sold by weight, and 15 cts. per quart for field and ensilage corn, or others sold by measure. Customers will save themselves from possible delay and disappointment, and us from much inconvenience, if, when making order they will note carefully the difference between the postpaid and by express or freight prices, and order and remit accordingly.

BAGS.—Hereafter we shall make no charge for bags, boxes or barrels used in filling orders for seeds at prices quoted in this catalog.

HOW TO ORDER.—Remittances, etc., for first order, always use the attached Order Blank. In any event give first your post-office address, which is sufficient for orders to be sent by mail. State plainly if goods are to be sent by express or by freight, and to what point if different from post-office.

DO NOT ORDER LARGE, HEAVY LOTS OF SEEDS SENT BY EXPRESS unless you are certain that you are willing to pay the express charges which, even with the reduction now made on such shipments by the express companies, are much more than freight charges.

But do not order a few pounds of seeds sent by freight which could be sent as cheaply, more safely, and which would reach you much sooner if sent by express.

REMITTANCES for small orders may be made in postage stamps, but if stamps are used, care should be taken that they are not moistened by handling. Enclosing in oiled paper is much the safer way to send them.

FOR LARGER ORDER, remittances should be made by Express Money Order, P. O. Money Order, Bank Draft or Registered Letter, all of which are inexpensive and absolutely safe.

C. O. D. ORDERS.—In no case will C. O. D. orders be accepted unless 25 per cent of the amount is sent with the order. If possible to do otherwise, do not order goods to be sent in this way. It is much preferable, when not convenient to remit with order, to give the order to an express company. The goods will generally arrive sooner, and the express companies make no extra charge for this service, as they do for collecting and returning money.

IT IS OUR CONSTANT ENDEAVOR to ship all orders promptly, and to use all possible precaution to prevent mistakes, but, for various reasons, slight delay in shipping is sometimes unavoidable, and mistakes will sometimes occur. Orders are very generally acknowledged, always, if for any reason they cannot be filled at once, and the reason given. If, after a reasonable time has elapsed, the goods have not been received, nor either acknowledgement of order or notification of shipment, it may be assumed that the order has miscarried or been overlooked. In such event we should be notified and the order repeated, when we will at once endeavor to trace the order, and, having found it, give it precedence in filling and shipping over all others. All mistakes of whatever nature will be promptly and cheerfully rectified as soon as brought to our notice.

WHAT WE GUARANTEE.—That all seeds sold by us shall be as represented; should they prove otherwise, we will refill the order gratis; but, we give no warranty, express or implied, as to description, purity, productiveness or any other matter of any seeds, bulbs, or plants we send out, and we will not be in any way responsible for the crop. No officer, agent or employee of this company is authorized to make any warranty whatsoever. If the purchaser does not accept the goods on these terms, they are at once to be returned and the money paid will be refunded.

Special Offer to Purchasers of Seeds in Packets Only

| | |
|---|--------|
| For 50 cts. seeds in packets may be selected amounting to | \$0 65 |
| For \$1 seeds in packets may be selected amounting to | 1 35 |
| For \$2 seeds in packets may be selected amounting to | 3 00 |

DO NOT ORDER SEEDS IN BULK EXPECTING THIS WILL APPLY

ASPARAGUS

An ounce will sow about 60 feet of drill, and produce 200 or more plants

To grow asparagus from seed, sow as early as ground can be worked. Make the soil rich and sow in drills one foot apart and an inch or more deep. If the bed has good care, the roots may as well be transplanted to the permanent bed early the following spring as to wait another year, as is generally done. In fact, careful and extended experiment at some of the stations has shown that strong, vigorous roots of one year's growth are preferable to two year old because they do not, for years, produce as many small stalks. The soil should be thoroughly and as deeply worked as possible and can hardly be made too rich. In the field, the rows should be from four to six feet apart, but in the garden where the cultivation is to be done by hand the rows may be as close as two feet apart. Make broad trenches 8 inches deep, and if the roots are well spread, the crown will be 6 inches below the level. Cover with but an inch of soil at time of setting, filling the trench gradually as the plants grow. The plants should have frequent cultivation and yearly heavy applications of manure or fertilizer. The third year from setting, two or three cuttings may be made; after that, all that are possible until time for early peas.

CONOVER'S COLOSSAL. A standard variety. Postpaid, pkt. 5 cts. oz. 10 cts., 2 ozs. 15 cts., ½ lb. 25 cts., lb. 70 cts.; by express, lb. 60 cts.

COLUMBIAN MAMMOTH WHITE. Large stalks; clear white until 3 or 4 inches high. Postpaid, pkt. 5 cts., oz. 10 cts., 2 ozs. 15 cts., ½ lb. 25 cts. lb. 85 cts.; by express, lb. 75 cts.

PALMETTO. Early and productive. Postpaid, pkt. 5 cts., oz. 10 cts., 2 ozs. 15 cts., ½ lb. 25 cts., lb. 85 cts.; by express, lb. 75 cts.

ASPARAGUS ROOTS

The three varieties at uniform price. Postpaid, 50 for 65 cts.; by express, 100, 75 cts., 1,000, \$5.50.

BRUSSELS SPROUTS

A very hardy plant of the cabbage family, growing from 2 to 3 feet high, producing from the sides of the stalk numerous small heads about 2 inches in diameter. Sow about the middle of May, and treat generally as directed for cabbage.

IMPROVED HALF-DWARF. Pkt. 5 cts., ¼ oz. 10 cts., oz. 15 cts., 2 ozs. 25 cts., ½ lb. 40 cts.



CONOVER'S COLOSSAL ASPARAGUS

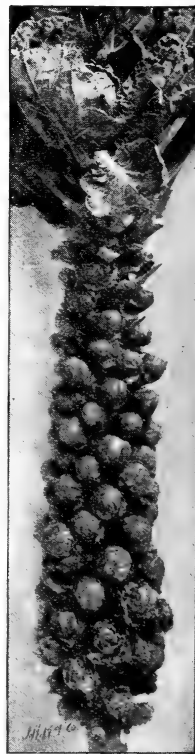

BRUSSELS SPROUTS

General Farm Books.

| | |
|---|--------|
| Soils, by Burkelt—Their Properties, Improvement, Management, Crop Growing and Feeding | \$1 25 |
| First Principles of Soil Fertility, Vivian | 1 00 |
| The Physical Properties of Soils, McColl | 50 |

BEANS

Beans succeed best in warm, light soil of at least average fertility. In this latitude it is not usually safe to plant much earlier than the middle of May. If planting is made earlier and is followed by especially wet or cold weather, the planter should not blame the seedsman if beans fail to germinate. Plant the dwarf varieties in drills 2 or 3 feet apart, about 2 inches deep, and thin plants to 4 to 6 inches apart. Give frequent, shallow cultivation until time of blossoming.

DWARF, or BUSH BEANS

A quart will plant about 100 feet of drill, $1\frac{1}{2}$ bushel will plant an acre. All quotations include bags

Green-Podded Varieties

Of the following varieties, the first four are used for snap or string beans, rarely for shelling. The other three mainly for green shell beans, but are sometimes used when dry. The Horticultural type, on account of its highly colored attractive pods, is the popular one for market throughout New England.

- BOUNTIFUL.** Vine unusually thrifty, rarely affected by blight; bears early, profusely and for a long time. Pods large, flat but thick and meaty, stringless and tender. Postpaid, $\frac{1}{2}$ pt. 14 cts., pt. 26 cts., qt. 45 cts.; by express, $\frac{1}{2}$ pt. 10 cts., pt. 18 cts., qt. 30 cts., 2 qts. 55 cts., $\frac{1}{2}$ pk. 90 cts., pk. \$1.65, bus. \$6.
- EARLY RED VALENTINE.** An old favorite. Vine hardy and productive; pods round, of medium length, thick, tender and of fine flavor. Postpaid, $\frac{1}{2}$ pt. 14 cts., pt. 23 cts., qt. 40 cts.; by express, $\frac{1}{2}$ pt. 10 cts., pt. 15 cts., qt. 25 cts., 2 qts. 45 cts., $\frac{1}{2}$ pk. 80 cts., pk. \$1.50, bus. \$5.75.
- LONG YELLOW SIX WEEKS.** Early and productive; pods flat. Postpaid, $\frac{1}{2}$ pt. 14 cts., pt. 23 cts., qt. 40 cts., by express, $\frac{1}{2}$ pt. 10 cts., pt. 15 cts., qt. 25 cts., 2 qts. 45 cts., $\frac{1}{2}$ pk. 80 cts., pk. \$1.50, bus. \$5.75.
- MAMMOTH GREEN-POD STRINGLESS.** Vine vigorous and extremely productive. Pods long, nearly round, meaty and stringless. Postpaid, $\frac{1}{2}$ pt. 14 cts., pt. 26 cts., qt. 45 cts.; by express, $\frac{1}{2}$ pt. 10 cts., pt. 18 cts., qt. 30 cts., 2 qts. 55 cts., $\frac{1}{2}$ pk. 90 cts., pk. \$1.65, bus. \$6.
- LOW'S CHAMPION.** Vine of rank vigorous habit seldom affected by blight or mildew; productive; pods large and well filled. Beans large, oval, red, of finest quality. Postpaid, $\frac{1}{2}$ pt. 14 cts., pt. 26 cts., qt. 45 cts.; by express, $\frac{1}{2}$ pt. 10 cts., pt. 18 cts., qt. 30 cts., 2 qts. 55 cts., $\frac{1}{2}$ pk. 90 cts., pk. \$1.65, bus. \$6.
- DWARF HORTICULTURAL.** Pods thick, broad, of medium length, yellowish green splashed with red when at the stage of fitness for green shell beans and are then very attractive. Beans are large, oval, easily shelled and of fine quality. Postpaid, $\frac{1}{2}$ pt. 14 cts., pt. 26 cts., qt. 45 cts.; by express, $\frac{1}{2}$ pt. 10 cts., pt. 18 cts., qt. 30 cts., 2 qts. 55 cts., $\frac{1}{2}$ pk. 90 cts., pk. \$1.60, bush. \$6.
- GODDARD, or BOSTON FAVORITE.** Vine very large, vigorous and productive. Pods long, larger than the Dwarf Horticultural, similar in color and marking. Beans large, kidney-shaped, of excellent quality. Postpaid, $\frac{1}{2}$ pt. 14 cts., pt. 26 cts., qt. 45 cts.; by express, $\frac{1}{2}$ pt. 10 cts., pt. 18 cts., qt. 30 cts., 2 qts. 55 cts., $\frac{1}{2}$ pk. 90 cts., pk. \$1.60, bus. \$6.

DWARF WAX, or BUTTER BEANS

- BURPEE'S WHITE WAX.** A new white-seeded variety combining quality, productiveness and attractiveness to a degree that makes it superior to other white-seeded wax sorts. Postpaid, $\frac{1}{2}$ pt. 18 cts., pt. 30 cts., qt. 50 cts.; by express, $\frac{1}{2}$ pt. 14 cts., pt. 22 cts., qt. 35 cts., 2 qts. 65 cts., $\frac{1}{2}$ pk. \$1.10, pk. \$2.
- NEW KIDNEY WAX.** An improvement on that excellent variety, Wardwell's Kidney Wax; more productive, less liable to rust or blight, while equal in quality. Pods are flat but very thick, 6 to 7 inches long, entirely free from strings and tough fiber. Postpaid, $\frac{1}{2}$ pt. 18 cts., pt. 30 cts., qt. 50 cts.; by express, $\frac{1}{2}$ pt. 14 cts., pt. 22 cts., qt. 35 cts., 2 qts. 65 cts., $\frac{1}{2}$ pk. \$1.10, pk. \$2.
- HODSON WAX.** A new and distinct variety, about two weeks later than others but surpassing most others in its combination of large, handsome pods, good quality and immunity from rust. It is also above the average in productiveness. Postpaid, $\frac{1}{2}$ pt. 14 cts., pt. 26 cts., qt. 45 cts.; by express, $\frac{1}{2}$ pt. 10 cts., pt. 18 cts., qt. 30 cts., 2 qts. 55 cts., $\frac{1}{2}$ pk. 90 cts., pk. \$1.65, bus. \$6.
- BLACK WAX, Prolific Strain.** The best strain of this old and well-known variety. Postpaid, $\frac{1}{2}$ pt. 14 cts., pt. 26 cts., qt. 45 cts.; by express, $\frac{1}{2}$ pt. 10 cts., pt. 18 cts., qt. 30 cts., 2 qts. 55 cts., $\frac{1}{2}$ pk. 90 cts., pk. \$1.65, bus. \$6.

CURRIE'S RUST-PROOF WAX. Pods flat, long, nearly straight, of good quality. Postpaid, $\frac{1}{2}$ pt. 14 cts., pt. 26 cts., qt. 45 cts.; by express, $\frac{1}{2}$ pt. 10 cts., pt. 18 cts., qt. 30 cts., 2 qts. 55 cts., $\frac{1}{2}$ pk. 90 cts., pk. \$1.65, bus. \$6.

DETROIT WAX. Pods flat, broad, of medium length. Desirable on account of its hardness and productiveness. Postpaid, $\frac{1}{2}$ pt. 14 cts., pt. 23 cts., qt. 40 cts.; by express, $\frac{1}{2}$ pt. 10 cts., pt. 15 cts., qt. 25 cts., 2 qts. 45 cts., $\frac{1}{2}$ pk. 80 cts., pk. \$1.50, bus. \$5.75.

DAVIS' WAX. Vine hardy and productive. Pods flat, extra long, always straight; clear, waxy white and unsurpassed in attractiveness. Postpaid, $\frac{1}{2}$ pt. 14 cts., pt. 26 cts., qt. 45 cts.; by express, $\frac{1}{2}$ pt. 10 cts., pt. 18 cts., qt. 30 cts., 2 qts. 55 cts., $\frac{1}{2}$ pk. 90 cts., pk. \$1.65, bus. \$6.

GOLDEN WAX. An old, well-known and popular variety of excellent quality. Pods flat, long, golden yellow. Early and productive. Postpaid, $\frac{1}{2}$ pt. 14 cts., pt. 26 cts., qt. 45 cts.; by express, $\frac{1}{2}$ pt. 10 cts., pt. 18 cts., qt. 30 cts., 2 qts. 55 cts., $\frac{1}{2}$ pk. 90 cts., pk. \$1.65, bus. \$6.

GOLDEN-EYED WAX. Next to Horticultural Wax in its freedom from rust, and superior to that in quality though not equal to most others in the list. Pods of good length, flat, straight waxy yellow and attractive. Popular with market-gardeners. Postpaid, $\frac{1}{2}$ pt. 14 cts., pt. 26 cts., qt. 45 cts.; by express or freight, $\frac{1}{2}$ pt. 10 cts., pt. 18 cts., qt. 30 cts., 2 qts. 55 cts., $\frac{1}{2}$ pk. 90 cts., pk. \$1.65, bus. \$6.

HORTICULTURAL WAX. Has been proved by several years' trial to be entirely immune from rust and blight in the most unfavorable seasons. And while this immunity is attained at sacrifice of quality, the variety has become popular with many gardeners because of the certainty of securing a crop and as well because the plant bears early and abundantly and pods are of good size and attractive. Postpaid, $\frac{1}{2}$ pt. 14 cts., pt. 28 cts., qt. 50 cts.; by express, or freight, $\frac{1}{2}$ pt. 10 cts., pt. 20 cts., qt. 35 cts., 2 qts. 65c., $\frac{1}{2}$ pk. \$1.10, pk. \$1.90, bus. \$7.

WARDWELL'S KIDNEY WAX. Deservedly a popular variety maturing a little later than the Golden Wax. Pods are creamy white, very attractive and not surpassed in quality. Postpaid, $\frac{1}{2}$ pt. 14 cts., pt. 26 cts., qt. 45 cts.; by express, $\frac{1}{2}$ pt. 10 cts., pt. 18 cts., qt. 30 cts., 2 qts. 55 cts., $\frac{1}{2}$ pk. 90 cts., pk. \$1.65, bus. \$6.

ROUND-POD KIDNEY WAX. Of unsurpassed quality. One of the best for the home garden and very desirable for market where round-podded varieties are popular. Pods are long, very white and wax-like; uniformly perfect in shape and vine is very productive. Postpaid, $\frac{1}{2}$ pt. 14c., pt. 28c., qt. 50c.; by express, $\frac{1}{2}$ pt. 10 cts., pt. 20c., qt. 35c., 2 qts. 60c., $\frac{1}{2}$ pk. \$1.80, bus. \$6.75.

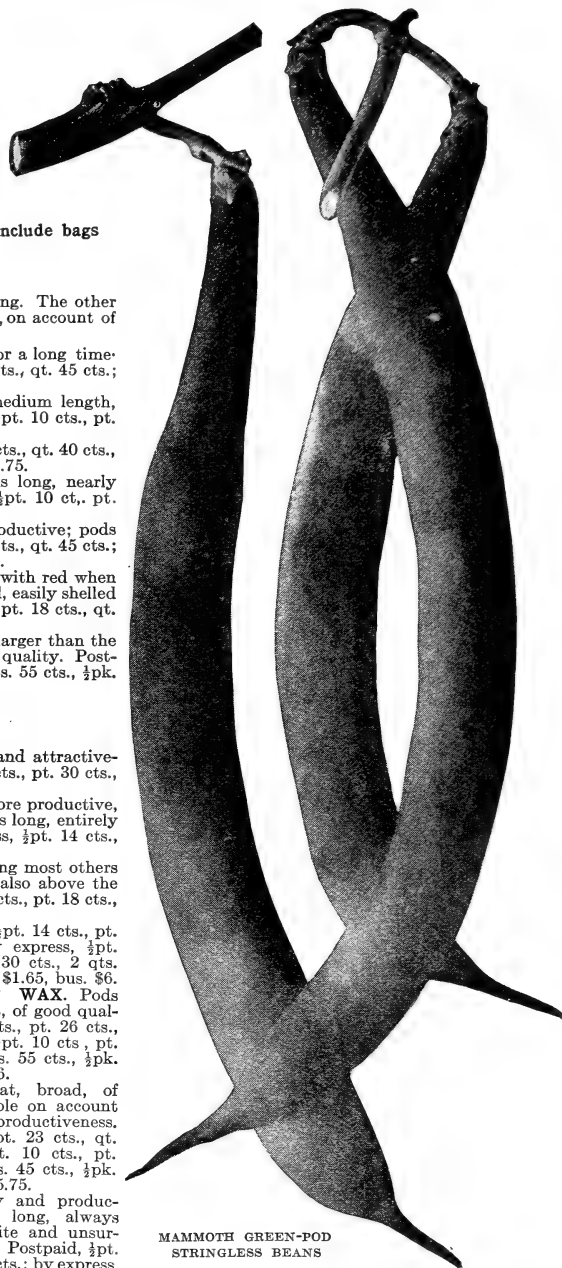

MAMMOTH GREEN-POD
STRINGLESS BEANS



BURPEE'S WHITE WAX BEANS

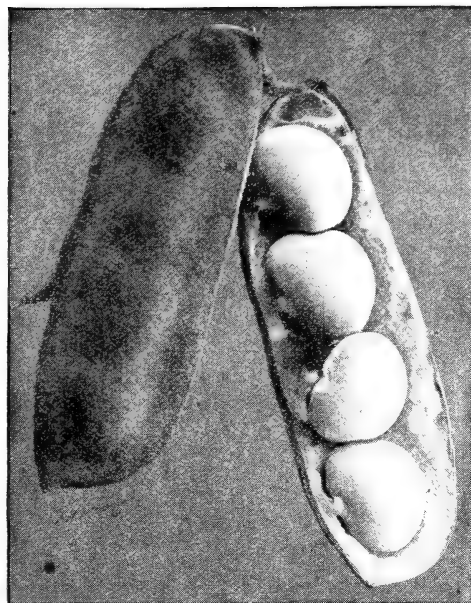

BUSH LIMA BEAN

DWARF LIMA BEANS

Lima Beans are more tender than others and should not be planted until settled warm weather, in this latitude, not before May 20; generally May 25 would be better and, in especially backward seasons peculiar to New England, probably as good results would be obtained—and perhaps better—by deferring planting until June 1. They require warm land, and it is useless to plant them on any other. Plants of this dwarf class should not stand nearer than 1 foot in the row and rows should be 3 to 3½ feet apart for best results.

HENDERSON'S BUSH LIMA. A bush form of the Sieva Lima; beans small but vine is productive and bears early. Postpaid, ½ pt. 14 cts., pt. 28 cts., qt. 50 cts.; by express, ½ pt. 10 cts., pt. 20 cts., qt. 35 cts., 2 qts. 65 cts., ½ pk. \$1.10, pk. \$2.

BURPEE'S BUSH LIMA. A bush form of the Large Lima which it closely resembles and approaches in size. Very popular. Postpaid, ½ pt. 14 cts., pt. 28 cts., qt. 50 cts.; by express, ½ pt. 10 cts., pt. 20 cts., qt. 35 cts., 2 qts. 65 cts., ½ pk. \$1.10, pk. \$2.

BURPEE'S NEW IMPROVED BUSH LIMA. This new strain bears uniformly larger pods and beans than the preceding. The plant is of more vigorous and erect growth and more productive. Postpaid, ½ pt. 19 cts., pt. 33 cts., qt. 60 cts.; by express, ½ pt. 15c., pt. 25c., qt. 45c., 2 qts. 80c., ½ pk. \$1.40, pk. \$2.50.

DREER'S BUSH LIMA. A dwarf form of the Dreer's Pole Lima; beans are of distinct form being much thicker than other Limas. Postpaid, ½ pt. 14 cts., pt. 28 cts., qt. 50 cts.; by express, ½ pt. 10 cts., pt. 20 cts., qt. 35 cts., 2 qts. 65 cts., ½ pk. \$1.10, pk. \$2.

FORDHOOK BUSH LIMA. An improved form of the Dreer's Bush Lima; beans and pods are of the same thick form but both are larger. The plant is of stronger and more erect growth, bears earlier and yields a larger crop. A valuable variety; ½ pt. 18 cts., pt. 30 cts., qt. 55 cts.; by express, ½ pt. 14 cts., pt. 23 cts., qt. 40 cts., 2 qts. 75 cts., ½ pk. \$1.30, pk. \$2.25.

POLE OR RUNNING BEANS

Pole Beans are more sensitive to wet and extremes of temperature than the dwarf varieties; and should not be planted much, if any, before the Lima. Poles should be set in rows about 4 feet apart, preferably running north and south, allowing about 3 feet between the poles in the row. The safer way is to plant six to eight beans around each pole and thin to three or four plants. Beans should be about 2 inches below the surface and are more generally pressed into the soil, eye down, instead of dropped and covered, as they come up a little sooner planted in this way. Like the dwarf beans they require frequent shallow cultivation.

KENTUCKY WONDER, or OLD HOMESTEAD. Pods are borne in large clusters, are of unusual length, nearly round, silvery green; when young crisp, entirely stringless, of fine texture and flavor. Vine bears early and is very productive. Used only as a string bean. Postpaid, ½ pt. 10 cts., pt. 20 cts., qt. 35 cts., 2 qts. 65 cts., ½ pk. \$1.10, pk. \$1.85.

14 cts., pt. 28 cts., qt. 50 cts.; by express or freight, ½ pt. 10 cts., pt. 20 cts., qt. 35 cts., 2 qts. 65 cts., ½ pk. \$1.10, pk. \$1.75.

GOLDEN CLUSTER WAX. Pods long, broad, thick and fleshy; borne in clusters, creamy white to golden yellow; of best quality. Postpaid, ½ pt. 16 cts., pt. 28 cts., qt. 55 cts.; by express, ½ pt. 12 cts., pt. 20 cts., qt. 40 cts., 2 qts. 75 cts., ½ pk. \$1.25, pk. \$2.25.

INDIAN CHIEF, or POLE BLACK WAX. Pods short, broad, flat, fleshy, creamy white, of average quality and remain in good condition a long time. Postpaid, ½ pt. 14 cts., pt. 26 cts., qt. 50 cts.; by express, ½ pt. 10 cts., pt. 18 cts., qt. 35 cts., 2 qts. 65 cts., ½ pk. \$1.10, pk. \$1.75.

DUTCH CASEKNIFE. A favorite with those who prefer white shell beans; beans of medium size, but pods are very long, the yield therefore large. Postpaid, ½ pt. 14 cts., pt. 26 cts., qt. 45 cts.; by express ½ pt. 10 cts., pt. 18 cts., qt. 30 cts., 2 qts. 55 cts., ½ pk. 95 cts., pk. \$1.65.

LONDON HORTICULTURAL, or SPECKLED CRANBERRY. Pods short, broad, yellowish green, streaked with bright red. Beans in general appearance identical with Dwarf Horticultural, of about the same size, more nearly round; of the best quality. Postpaid, ½ pt. 14 cts., pt. 28 cts., qt. 50 cts.; by express, ½ pt. 10 cts., pt. 20 cts., qt. 35 cts., 2 qts. 65 cts., ½ pk. \$1.10, pk. \$1.75.

WORCESTER MAMMOTH HORTICULTURAL. Resembles the preceding but pods and beans are much larger. Also the pods being more highly colored are more attractive, which greatly increases the value of the variety for market. The vine is vigorous and very productive and the beans have not attained their size at any sacrifice of quality. Postpaid, ½ pt. 19 cts., pt. 36 cts., qt. 65 cts.; by express, ½ pt. 15 cts., pt. 28 cts., qt. 50 cts., 2 qts. 90 cts., ½ pk. \$1.60, pk. \$3.

GOLDEN CARMINE HORTICULTURAL. A strain of the preceding which has the additional merits of being an excellent string bean and as a shell bean of being a week or more earlier. The pods and beans are nearly if not quite as large and beans are equal in quality. Pods, when at the stage suitable for string beans, are light waxy yellow; when ready for shelling, golden yellow, splashed with bright carmine; at both stages very attractive. Postpaid, ½ pt. 19 cts., pt. 36 cts., qt. 65 cts.; by express, ½ pt. 15 cts., pt. 28 cts., qt. 50 cts., 2 qts. 90 cts., ½ pk. \$1.60, pk. \$3.

SCARLET RUNNER. Largely grown as an ornamental climber, of rapid growth, flowers dazzling scarlet. Postpaid, ½ pt. 5 cts., ½ pt. 14 cts., pt. 28 cts., qt. 50 cts.; by express, ½ pt. 10 cts., pt. 20 cts., qt. 35 cts., 2 qts. 65 cts.



KENTUCKY WONDER BEAN

POLE OR RUNNING LIMA BEANS

A quart will plant about 100 hills

Postpaid, ½ pt. 14 cts., pt. 28 cts., qt. 50 cts.; by express, ½ pt. 10 cts., pt. 20 cts., qt. 35 cts., 2 qts. 65 cts., ½ pk. \$1.10, pk. \$1.90

SEIBERT'S EARLY LIMA. The earliest variety. Pods short, thin, easily opened. Contain but three or four beans, but beans are large and vine is very prolific.

LARGE LIMA. An old standard variety. Pods long, broad, thin, borne in clusters. Beans large, not surpassed in quality.

KING OF THE GARDEN LIMA. Earlier than Large Lima and pods are longer.

CHALLENGER, or DREER'S IMPROVED LIMA. Distinct; pods are short but very thick, beans also much thicker than others. Medium early and productive.

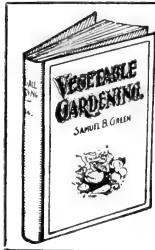

VEGETABLE GARDENING. By Prof. Samuel B. Green, a prominent authority on the growing of vegetables for home use and the market. Treats on tillage, implements, seed-growing greenhouses, insects and how to destroy them; complete classification of vegetables with instructions for growing. A complete, practical guide to gardeners. 256 pages. Illustrated. Paper, 50 cts.; cloth, \$1, postpaid.

BEAN CULTURE. By Glen C. Sevey. The only thorough and comprehensive book treating on the planting, raising and marketing of Beans. New and highly valuable methods of cultivation and care are described. Postpaid, 50 cents.

BEET

An ounce will sow about 50 feet of drill
5 or 6 pounds required for an acre

The Beet thrives best in deep, rich, but rather light soil. Sow in drills about 15 inches apart and 1 inch deep. Make the soil firm over the seed. This is very important, especially if soil is at all dry. By omitting to do it good seed often fails to germinate, and the seedsman is generally blamed for the failure. For early use, sow as soon as the ground can be worked; for fall use, in May; for winter, from the 20th of June to the middle of July, according to the variety. Thin plants to 4 or 5 inches apart. Give frequent shallow cultivation.

Unless otherwise noted, all prices on this page are postpaid. If by express or purchased at counter, 10 cts. will be deducted from price per pound

EARLY EGYPTIAN. The earliest variety; roots flat; deep crimson; top small; pkt. 5 cts., oz. 10 cts., 2 ozs. 15 cts., $\frac{1}{2}$ lb. 20 cts., lb. 60 cts.

CROSBY'S EARLY EGYPTIAN. An improved form of the preceding; roots much thicker and more regular. Nearly as early and of better quality. The most popular early variety for market throughout New England, if not elsewhere, and is now being considerably used for last sowing. Pkt. 5 cts., oz. 10 cts., 2 ozs. 15 cts., $\frac{1}{2}$ lb. 25 cts., lb. 75 cts.

CROSBY'S EARLY EGYPTIAN EXTRA-SELECTED STRAIN. From roots of our own growing and selection. For several years we have given this especial attention and have largely succeeded in eliminating the light-colored, coarse-fleshed specimens peculiar to the Egyptian. Roots are more uniform in shape and tops are more even in growth and a little smaller. We confidently recommend it to market-gardeners as an unsurpassed strain. Pkt. 5 cts., oz. 12 cts., 2 ozs. 20 cts., $\frac{1}{2}$ lb. 30 cts., lb. \$1.10.

BASTIAN'S EARLY. Roots too light-colored to be popular for market, but of the finest flavor. Very tender and sweet. Pkt. 5 cts., oz. 10 cts., 2 ozs. 15 cts., $\frac{1}{2}$ lb. 20 cts., lb. 60 cts.

EARLY ECLIPSE. An early globe-shaped variety of good quality and deep color. Pkt. 5 cts., oz. 10 cts., 2 ozs. 15 cts., $\frac{1}{2}$ lb. 20 cts., lb. 60 cts.

CRIMSON GLOBE. Roots perfectly globular, one of the earliest of this shape; of fine dark color; seldom grows over-large. Pkt. 5 cts., oz. 10 cts., 2 ozs. 15 cts., $\frac{1}{2}$ lb. 20 cts., lb. 70 cts.

ARLINGTON FAVORITE. Resembles the Dewing's, but is earlier, of medium size, good quality and rich color. Pkt. 5 cts., oz. 10 cts., 2 ozs. 15 cts., $\frac{1}{2}$ lb. 20 cts., lb. 60 cts.

EDMAND'S BLOOD TURNIP. A standard variety used for both second-early and main crop. Of good quality and keeps well. Pkt. 5 cts., oz. 10 cts., 2 ozs. 15 cts., $\frac{1}{2}$ lb. 20 cts., lb. 60 cts.

DEWING'S BLOOD TURNIP. One of the leading main-crop varieties. Pkt. 5 cts., oz. 10 cts., 2 ozs. 15 cts., $\frac{1}{2}$ lb. 20 cts., lb. 60 cts.

DETROIT DARK RED. A superior second-early and main-crop variety rapidly growing in favor for late planting. Of this we offer a selected strain proved by repeated trials to be greatly superior to the seed generally offered. Roots globular inclining slightly to ovoid, very smooth with small tap-root; skin dark blood-red, flesh deep-red zoned with deeper shade; of finest texture and keep well. Tops uniformly small and grow upright so that the rows may be close together. Should, and probably eventually will, largely displace the preceding two, now popular varieties, for late planting. Pkt. 5 cts., oz. 10 cts., 2 oz. 15 cts., $\frac{1}{2}$ lb. 25 cts., lb. 80 cts.

SWISS CHARD, or SILVER SEA KALE BEET. Used for greens only. Until recently but little used in this country but for the the last few years has rapidly increased in favor. Much superior to other beets for greens. Of very rank growth, plants should be thinned to about one foot apart. When the plants have attained full size, the stems and midribs are sometimes cooked and served like asparagus. Pkt. 5 cts., oz. 10 cts., 2 ozs. 15 cts., $\frac{1}{2}$ lb. 20 cts., lb. 65 cts.

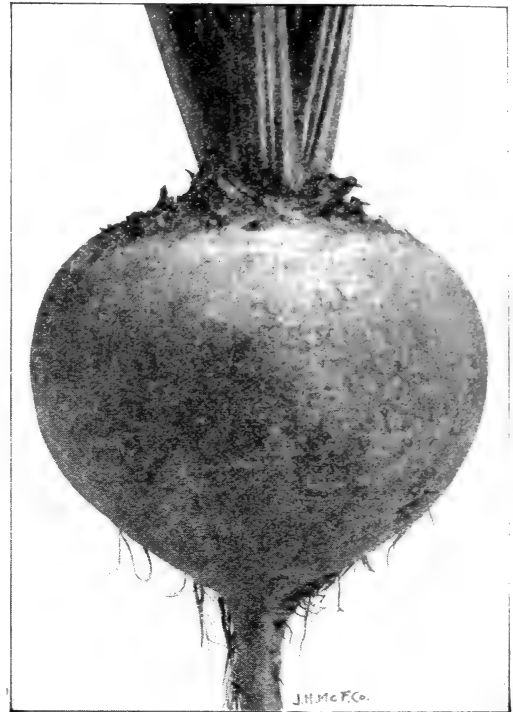

DETROIT BLOOD TURNIP BEET

SUGAR BEET AND MANGEL-WURZEL

These are used for stock-feeding only. Seed should be sown in rows 2 feet apart and plants thinned to stand from 10 to 15 inches apart in the row according to the size of variety. Seed of the Mangel-Wurzel Beet seldom germinates as well as that of the table varieties, and therefore should be sown more thickly—six to eight pounds to the acre.

Oz. 10 cts., $\frac{1}{2}$ lb. 15 cts., $\frac{1}{2}$ lb. 25 cts., lb. 45 cts.; by express or freight, $\frac{1}{2}$ lb. 20 cts., lb. 35 cts., 5 lbs. and over, 30 cts. per lb.

LANE'S SUGAR BEET. A standard variety for stock-feeding.

GOLDEN TANKARD. Top and neck very small; root ovoid, large; flesh yellow, zoned with white; an excellent sort.

MAMMOTH LONG RED MANGEL. Mammoth size; skin light red, flesh white and rose. Grows well out of ground.

NORBITON GIANT LONG RED. Similar to the preceding; has smaller top and neck; flesh scarlet.

ORANGE GLOBE. Top small, root medium-sized; skin deep orange-yellow, flesh white. Grows almost out of the ground; good for shallow ground; easy to harvest.

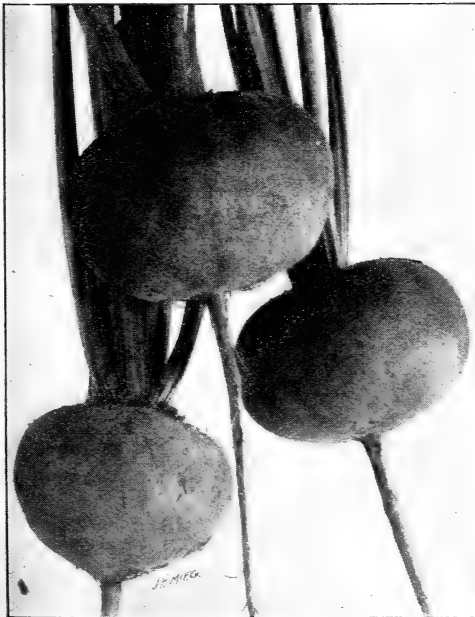

CROSBY'S EARLY EGYPTIAN BEET

FARM BLACKSMITHING. A complete treatise on Blacksmithing, by J. M. Drew, written for farmers who want a workshop where they can profitably spend stormy days. Illustrated, 100 pp. Price, 12mo., cloth, 50 cents.



STANDARD BLACKSMITHING, Horse-shoeing and Wagon-making, by J. G. Holstrom, author of Modern Blacksmithing, gives practical instructions, by a successful blacksmith. The latest and most complete book on the subject published. Thoroughly illustrated. Price, 12mo., cloth, \$1.

CABBAGE, CAULIFLOWER AND ALLIED VEGETABLES, by Allen. A competent guide. 50 cents.

RHUBARB CULTURE. Morse. Dark forcing and field culture. 50 cents.

CELERY CULTURE. 50 cents.

CABBAGE

An ounce will produce
about 2,000 plants

The Cabbage will thrive on any good garden soil but is more successfully grown on deep, strong loam, and new soil is much preferable, as on old land the roots are more liable to be affected by the disease called club-root. Especially should land be avoided upon which, within two years, cabbage, cauliflower, turnips or radishes have been grown.

For the earliest crop seed is usually sown in February or March in hotbeds with only moderate bottom heat, and the plants hardened by gradually exposing them to the night air and transplanted as early as the ground is in suitable condition.

Seed of the second-early, autumn and winter varieties may be sown in the open ground. If a second crop is desired to follow closely the early crop, seed of some second-early sort should be sown as soon as ground can be worked. For later crops, successive sowings may be made, in this latitude, until about the middle of June, possibly some later, the time depending somewhat on the nature and condition of the soil, the season, and more on the variety, such kinds as All Seasons and Volga requiring considerably less time than the Danish Ballhead. Some growers prefer to sow the late varieties in hills where the crop is to be grown, thinning to one plant at first hoeing, but more often seed is sown in beds and transplanted.

All prices on this page are postpaid; by express or at counter in quantities of $\frac{1}{2}$ lb. or more, 10 cts. will be deducted from price per lb.

EARLY JERSEY WAKEFIELD. The standard early variety. Head conical. Pkt. 5 cts., $\frac{1}{2}$ oz. 15 cts., oz. 25 cts., 2 ozs. 45 cts., $\frac{1}{4}$ lb. 75 cts., lb. \$2.50.

CHARLESTON EARLY WAKEFIELD. Larger than the Jersey Wakefield, a few days later. Pkt. 5 cts., $\frac{1}{2}$ oz. 15 cts., oz. 25 cts., 2 ozs. 45 cts., $\frac{1}{4}$ lb. 75 cts., lb. \$2.50.

EARLY SPRING. The earliest flat-headed variety, maturing soon after the Jersey Wakefield but much larger. Pkt. 5c., $\frac{1}{2}$ oz. 15c., oz. 25c., 2 ozs. 45c., $\frac{1}{4}$ lb. 75c., lb. \$2.50.

HENDERSON'S EARLY SUMMER. An early large-heading sort. Head flat or slightly conical, remains on stump longer without bursting than most early kinds. Pkt. 5 cts., $\frac{1}{2}$ oz. 12 cts., oz. 20 cts., 2 ozs. 35 cts., $\frac{1}{4}$ lb. 60 cts., lb. \$2.10.

GLORY OF ENKHUIZEN. A comparatively new variety from Holland which has been sufficiently cultivated in this country to prove it of great merit. Head large, nearly round, very solid and matures earlier than All Seasons. Pkt. 5 cts., $\frac{1}{2}$ oz. 18 cts., oz. 30 cts., 2 ozs. 55 cts., $\frac{1}{4}$ lb. 90 cts., lb. \$3.

ALL SEASONS. For reliability in heading not surpassed by any other variety, and few, if any, equal it in ability to stand the hot sun and dry weather and when mature to remain in the field so long without bursting. Head as large as most of the later sorts, round, usually slightly flattened, solid and of the finest quality. Extensively grown for both second-early and main crop. Pkt. 5 cts., $\frac{1}{2}$ oz. 12 cts., oz. 20 cts., 2 ozs. 35 cts., $\frac{1}{4}$ lb. 60 cts., lb. \$2.10.

EARLY WINNINGSTADT. Head large, conical, hard and keeps well. Plant very hardy and sure to head. Pkt. 5 cts., $\frac{1}{2}$ oz. 10 cts., oz. 15 cts., 2 ozs. 25c., $\frac{1}{4}$ lb. 45 cts., lb. \$1.75.

FOTTLER'S BRUNSWICK. An early large drumhead which has been in New England one of the most popular second-early varieties. Head flat, solid, keeps well and of good quality. Pkt. 5 cts., $\frac{1}{2}$ oz. 15 cts., oz. 25 cts., 2 ozs. 45 cts., $\frac{1}{4}$ lb. 75 cts., lb. \$2.50.

PREMIUM FLAT DUTCH. An old standard late variety. Head large, flat and solid. Pkt. 5 cts., $\frac{1}{2}$ oz. 12 cts., oz. 20 cts., 2 ozs. 35 cts., $\frac{1}{4}$ lb. 60c., lb. \$2.10.



GLORY OF ENKHUIZEN CABBAGE

SUREHEAD. Of the Flat Dutch type, but head is thicker. Remarkable for its uniformity and certainty to head. Pkt. 5 cts., $\frac{1}{2}$ oz. 12 cts., oz. 20 cts., 2 ozs. 35 cts., $\frac{1}{4}$ lb. 60 cts., lb. \$2.10.

WARREN STONE MASON. An improved strain of the old Stone Mason. Previous to the introduction of the Danish Ballhead probably the most popular variety in New England for main crop. Earlier and more nearly round than the old strain, of medium size, hard, solid and of excellent quality. Reliable and keeps well. Pkt. 5 cts., $\frac{1}{2}$ oz. 15 cts., oz. 25 cts., 2 ozs. 45 cts., $\frac{1}{4}$ lb. 70 cts., lb. \$2.40.

VOLGA. A very hardy variety, originally from Russia; very uniform and reliable in heading. Head larger than any of the preceding but matures so quickly that seed can safely be sown considerably later than of other winter sorts. Though not desirable in this climate as a second-early it is especially valuable for fall and winter; round solid head, not as heavy as Danish Ballhead but larger, far superior in quality and keeps as well. Pkt. 5 cts., $\frac{1}{2}$ oz. 15 cts., oz. 25 cts., 2 ozs. 45 cts., $\frac{1}{4}$ lb. 75 cts., lb. \$2.50.

AUTUMN KING or WORLD BEATER. One of the largest hard-heading varieties, thick flattened head, solid and keeps remarkably well but requires rich, strong soil and a long season to fully develop. Pkt. 5 cts., $\frac{1}{2}$ oz. 15 cts., oz. 25 cts., 2 oz. 45 cts., $\frac{1}{4}$ lb. 75 cts., lb. \$2.50.

DANISH BALLHEAD. The most popular late variety for market. Head of medium size, round, extremely hard, heavier by at least one-fourth than any other sort and unsurpassed in keeping. Plant very hardy, vigorous, longer-stemmed and requires a longer season than our native varieties.

Not as desirable for the home garden as most others in the list. We offer an unsurpassed strain from one of the leading growers in Denmark. Pkt. 5 cts., $\frac{1}{2}$ oz. 18 cts., oz. 30 cts., 2 ozs. 50 cts., $\frac{1}{4}$ lb. 85 cts., lb. \$3.

MARBLEHEAD MAMMOTH. On rich land with good cultivation heads attain an enormous size; large crops have been grown of which heads averaged 30 pounds, while specimens weighed twice that. The best of all for stock and poultry. Requires a long season. Pkt. 5 cts., $\frac{1}{2}$ oz. 12 cts., oz. 20 cts., 2 ozs. 35 cts., $\frac{1}{4}$ lb. 60 cts., lb. \$2.10.

AMERICAN IMPROVED SAVOY. The best of the Savoy type, which should be more largely grown. Pkt. 5 cts., $\frac{1}{2}$ oz. 12 cts., oz. 20 cts., 2 ozs. 35 cts., $\frac{1}{4}$ lb. 60 cts., lb. \$2.10.

MAMMOTH ROCK RED. Head larger and more solid than Red Drumhead; reliable in heading. Pkt. 5 cts., $\frac{1}{2}$ oz. 15 cts., oz. 25 cts., 2 ozs. 45 cts., $\frac{1}{4}$ lb. 75 cts., lb. \$2.50.

DANISH STONEHEAD. A new red variety claimed by the grower in Denmark to be "the largest, most solid and compact of all red varieties; sure-heading and tender; the heads do not crack, and even in late spring, when all other varieties have burst, the heads of the 'Danish Stonehead' keep hard and sound." Pkt. 10 cts., $\frac{1}{2}$ oz. 30 cts., oz. 50 cts., 2 ozs. 90 cts., $\frac{1}{4}$ lb. \$1.50.

HOW TO GROW CABBAGES.

A fine new booklet that gives instructions how to grow Cabbages from seed-time until harvest. Written by J. H. Gregory, a recognized authority on this subject. Postpaid, 40c.



DANISH BALLHEAD CABBAGE

CARROT

An ounce will sow about 150 feet of drill; 3 pounds to the acre

The Carrot thrives best in a light sandy soil, free from stones, well enriched and deeply and thoroughly worked. Make the top surface fine and smooth by raking. Sow in drills 14 inches apart and half an inch deep and thin plants to 3 or 4 inches apart. Sow from the middle of May to the middle of April.

EARLY SCARLET HORN. A small early variety used by market-gardeners for bunching. Pkt. 5 cts., oz. 10 cts., 2 ozs. 15 cts., $\frac{1}{2}$ lb. 25 cts., lb. \$1.

CHANTENAY. In earliness intermediate between the preceding and the Danvers. About 5 inches long, thick at top, tapering slightly but uniformly stump-rooted. Of fine color and good quality. Pkt. 5 cts., oz. 10 cts., 2 ozs. 15 cts., $\frac{1}{2}$ lb. 25 cts., lb. \$1.

DANVERS. The most popular variety for market on account of its attractive form and largely grown for stock. A little longer than the Chantenay, not as thick, smooth, deep orange. Pkt. 5 cts., oz. 10 cts., 2 ozs. 15 cts., $\frac{1}{2}$ lb. 25 cts., lb. \$1.

GUERANDE, or OXHEART. Roots short and very thick, four inches or more in diameter, tapering to about two inches at the bottom. Excellent for either table use or stock, and especially desirable for stiff, hard soils. Pkt. 5 cts., oz. 10c., 2 ozs. 15 cts., $\frac{1}{2}$ lb. 25 cts., lb. 90 cts.

RUBICON. Earlier and larger than the Danvers; thick, lacking attractive form; is not used for market but will produce a greater weight than the Danvers and is more easily harvested than the Long Orange. Pkt. 5 cts., oz. 10 cts., 2 ozs. 15 cts., $\frac{1}{2}$ lb. 25 cts., lb. \$1.

INTERMEDIATE HALF-LONG. Thicker at the top, a little longer than the Danvers and point-rooted. Of good color. Pkt. 5 cts., oz. 10 cts., 2 ozs. 15 cts., $\frac{1}{2}$ lb. 25 cts., lb. 90 cts.

ST. VALERY. Sometimes called the Point-rooted Danvers, but is rather more like the Long Orange. Very attractive in form, of rich dark color and finest quality. Pkt. 5 cts., oz. 10 cts., 2 ozs. 20 cts., $\frac{1}{2}$ lb. 25 cts., lb. 90 cts.

LONG ORANGE. A standard variety grown mainly for stock. Pkt. 5 cts., oz. 10 cts., 2 ozs. 15 cts., $\frac{1}{2}$ lb. 25 cts., lb. 80 cts.

LARGE WHITE BELGIAN. Grows one-third out of ground. The portion above ground is green, that below white; large and rather coarse. Used only for stock. Pkt. 5 cts., oz. 10 cts., 2 ozs. 15 cts., $\frac{1}{2}$ lb. 25 cts., lb. 75 cts.

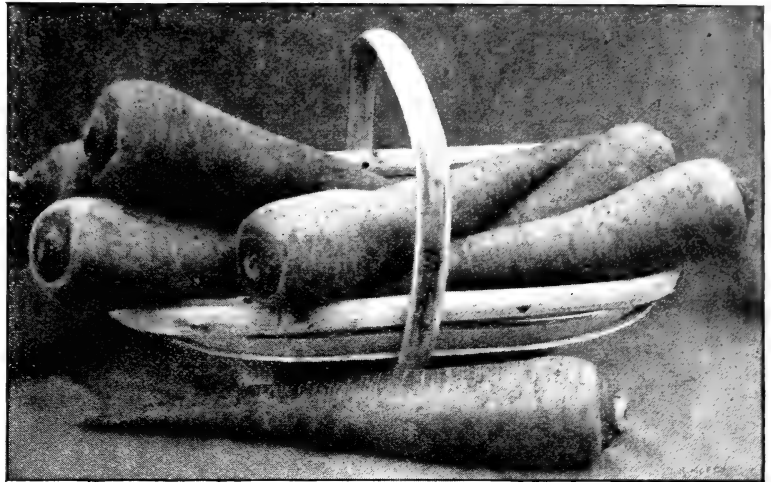

DANVERS HALF-LONG CARROTS

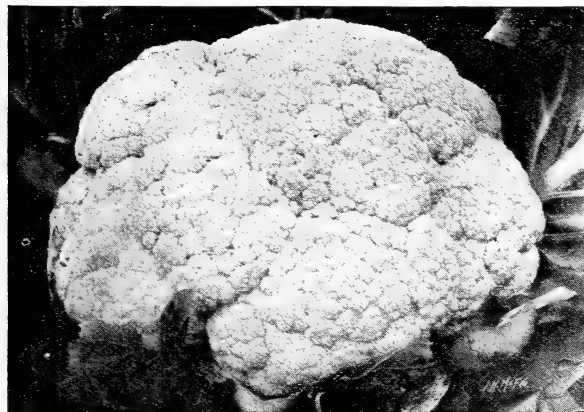

EARLY SNOWBALL CAULIFLOWER

CAULIFLOWER

An ounce will produce about 2,000 plants

In general, the Cauliflower requires about the same treatment as the cabbage; moist land is, however, more essential and heavier manuring and more frequent cultivation aid to a greater extent the full development of the plant. In this climate the plant heads well only in the cool fall months. Seed should therefore be sown as for late cabbage, from the middle of May to middle of June, the late varieties, however, requiring a little more time than most sorts of late cabbage.

EARLY SNOWBALL. The earliest and surest to head. Probably more largely used than all others combined. We offer an unsurpassed strain from one of the leading growers in Denmark. Pkt. 20 cts., $\frac{1}{2}$ oz. 65 cts., $\frac{3}{4}$ oz. \$1.25, oz. \$2.25, $\frac{1}{2}$ lb. \$7.50.

DANISH GIANT, or DRY WEATHER. About ten days to two weeks later than the Snowball. Of dwarf growth, producing large, hard and snow-white heads, fully protected by foliage. As indicated by the name, especially fit for dry and hot climates; sure to head when all other sorts fail. Pkt. 20 cts., $\frac{1}{2}$ oz. 65c., $\frac{3}{4}$ oz. \$1.25, oz. \$2.25, $\frac{1}{2}$ lb. \$7.50.

EARLY LONDON. Matures soon after the Snowball. Pkt. 5 cts., $\frac{3}{4}$ oz. 25 cts., oz. 45 cts., 2 ozs. 75 cts., $\frac{1}{2}$ lb. \$1.25.

LARGE ALGIERS. A late sort; one of the surest of this class to head. Of fine quality. Pkt. 10 cts., $\frac{3}{4}$ oz. 40 cts., oz. 75 cts., $\frac{1}{2}$ lb. \$2.25.

CORN SALAD, FETTICUS, or LAMB'S LETTUCE

A hardy, rapid-growing plant, often used in winter as a substitute for lettuce and is sometimes cooked and used like spinach. It does not thrive in hot weather and if sown in the spring it should be very early and on extremely rich soil. It will then be ready for use in four to six weeks. It, however, succeeds best when sown in August or September. If sown in the former, it will be ready for use in the late fall. If left in the ground during winter, it should, on the approach of cold weather, be protected with straw or litter. Pkt. 5 cts., oz. 10 cts., 2 ozs. 15 cts., $\frac{1}{2}$ lb. 25 cts.

CRESS, CURLED, or PEPPER GRASS

A small pungent salad plant, much liked by some with lettuce. Like all salad plants it should be grown on rich ground. Seed may be sown early in the spring, but if desired through the summer repeated sowings will be necessary. Pkt. 5 cts., oz. 10 cts., 2 ozs. 15 cts., $\frac{1}{2}$ lb. 20 cts.

CHERVIL, CURLED

A hardy annual, used for flavoring and garnishing, and deserving of more general use for the latter purpose. It is thought by some to exceed even parsley in beauty and its use at least would afford a pleasing variation. Seed should be sown early in the spring and when plants are well-rooted, transplant to 1 foot apart. The leaves will be ready for use in seven to ten weeks from planting. Pkt. 5 cts., oz. 15 cts., 2 ozs. 25 cts., $\frac{1}{2}$ lb. 40 cts.

DANDELION

An ounce will sow 200 feet of drill. Two pounds to the acre

Sow early in the spring in rich soil in drills 15 to 18 inches apart, cover lightly but make the earth firm. Thin to 5 inches apart in row. Cultivate frequently through the summer. Plants ready for cutting the following spring.

CULTIVATED, or FRENCH COMMON. A greatly improved strain of the common Dandelion. Pkt. 5 cts., $\frac{3}{4}$ oz. 12 cts., oz. 20 cts., 2 ozs. 35 cts., $\frac{1}{2}$ lb. 60 cts., lb. \$2.25.

IMPROVED THICK LEAVED. Pkt. 10 cts., $\frac{3}{4}$ oz. 25 cts., oz. 40 cts., 2 ozs. 70 cts., $\frac{1}{2}$ lb. \$1.25, lb. \$4.50.

ASPARAGUS CULTURE. A special book that gives the most practical methods of raising, cultivating, harvesting, marketing, forcing and canning Asparagus. This authoritative, up-to-date book, postpaid, 50 cts.

All prices on this page are postpaid. By express or at counter, in quantities of one-half pound or more, prices are 10 cents per pound less than quoted.

Vacant Government Lands.

A book listing and describing all homestead land in the United States, and tells how 160 and 320 acres can be procured free, by entry. 25 cents.



PARIS GOLDEN SELF-BLANCHING CELERY

CELERY

An ounce will produce from
3,000 to 4,000 plants

CULTURE.—The seed of Celery being of slow germination, it requires about three months from sowing until the seedlings are at the right stage for setting in permanent situations. The time of sowing therefore depends upon whether the plants are desired for early or late planting. For early use, seed may be sown inside in shallow boxes or in a coldframe, in either case where there is but little heat. The seed being very fine, care should be taken that it be but slightly covered with soil, which should always be kept moist, until the seed germinates nearly wet, and never after allowed to become dry. When about 2 inches high, the seedlings should be transplanted into other frames from 2 to 3 inches apart, to start a new growth of roots and to make them stocky. When 4 inches high, they will be made more stocky if about an inch of the leaves is shorn off the plants. After being transplanted, the plants should be set in permanent situation as soon as new roots have formed. Allowing them to remain in the frame too long will often cause them to run to seed. This, however, is more liable to occur with early plantings than with late.

Celery thrives best on moist, peaty soils, but is often successfully grown on somewhat sandy soil, artificially watered or irrigated. It is more often grown as a second crop than a main crop, but in either case requires heavy enriching.

For early use, the plants may be set as early as the middle of June; for later use, from that time until the first of August, and if plants are strong and healthy, and soil is especially adapted to Celery, good results are often secured when set as late as the middle of August; the result, however, depending considerably on the season. The old method of setting plants in a trench is now little used, largely because of the self-blanching habit of the variety most grown, and as well because it has been found that level culture requires much less labor and answers as well. The plants are set at various distances apart, sometimes 6 and sometimes 12 inches apart, in rows $2\frac{1}{2}$ to 3 feet apart. Early self-blanching varieties and the late green varieties are often set in alternate rows; boards being used to blanch the early crop, and when these are removed, there is ample room for banking the late with earth.

Another method is to set in beds about 5 feet wide, with plants 6 or 7 inches apart each way, boards being used on the outside of the bed only, the dense growth of the closely set plants serving to make them self-blanching. This method requires frequent applications of fertilizer, copious watering and intensive cultivation and, while the product may quickly be sufficiently blanched as far as attractive appearance is concerned, and the method, therefore, a profitable one when growing for market, neither this nor any other method produces Celery of as fine flavor and quality as by banking with earth.

The early self-blanching varieties can often be blanched in two weeks if weather is warm. Later in the fall, when colder, it takes from three to four weeks, while the late green varieties require a much longer time; in fact, these are seldom made fit for use in the garden or field, but are only partially blanched (almost always by banking with earth) in the field, and the blanching completed in the cellar or pit where stored, the time required there depending on the temperature.

In storing for winter use, the plants are packed closely together, generally on earth, and sometimes with earth about the roots, and if desired to be kept as long as possible the temperature is kept just above the freezing point. Celery for storing should not be handled when wet, not should it be allowed to wilt.

It may be well to mention that, to some extent, seed is now being sown in the field where it is designed to have it grow, sometimes, if sown early, in alternate rows of early and late sorts, and, if a late variety, in crops of radish, onion sets, spinach, etc., a space being left, when such crops were planted for this purpose. This practice seems to be increasing.

GOLDEN SELF-BLANCHING, or PARIS GOLDEN. The most popular variety for market; probably more largely grown than all others combined. Of vigorous growth, easily blanched, and of excellent quality for one of this class. We offer headquarters seed of proved quality. Pkt. 10 cts., $\frac{1}{2}$ oz. 30 cts., oz. 50 cts., 2 ozs. 90 cts., $\frac{1}{2}$ lb. \$1.50.

WHITE PLUME. The earliest and most easily blanched of all varieties; requires little banking to make it fit for market, belonging to the self-blanching class. A desirable variety for early fall use, but does not keep well; very showy and beautiful, but not more so than the Golden Self-blanching, and not equal to that in several other respects. Pkt. 5 cts., $\frac{1}{2}$ oz. 12 cts., oz. 20 cts., 2 ozs. 35 cts., $\frac{1}{2}$ lb. 60 cts.

BOSTON MARKET. An old variety of superior quality. At one time more largely grown than any other and is yet in some sections grown to some extent. Of low, spreading habit, dark green and glossy; forms a number of secondary heads instead of a single large one. Grown mainly for winter use. Pkt. 5 cts., $\frac{1}{2}$ oz. 12 cts., oz. 20 cts., 2 ozs. 35 cts., $\frac{1}{2}$ lb. 60 cts.

GIANT PASCAL. This is a green-leaved variety which was developed from the Golden Self-blanching. It is much larger, a better keeper and of superior flavor. It grows about 2 feet high, has very broad and thick stalks,

which are stringless. Peculiarly sweet, nutty flavor, blanches quickly. Pkt. 5 cts., $\frac{1}{2}$ oz. 12 cts., oz. 20 cts., 2 ozs. 35 cts., $\frac{1}{2}$ lb. 60 cts.

WINTER QUEEN. Of medium height, but stout thick and heavy, with a larger amount of heart than most other sorts. Of fine quality, more easily handled than the Giant Pascal, and an excellent keeper. One of the best for late winter use. Pkt. 5 cts., $\frac{1}{2}$ oz. 12 cts., oz. 20 cts., 2 ozs. 35 cts., $\frac{1}{2}$ lb. 60 cts.

CELERICAC, or TURNIP-ROOTED CELERY

Sow seed and treat in first stages of growth as directed for celery. Set in rows 2 feet apart and 6 inches apart in the row. As the roots only are used, no banking is necessary. When roots have reached a size of 2 inches in diameter they are ready for use. These are boiled, sliced and eaten with vinegar. To keep through winter, roots should be packed in moist sand or earth.

LARGE SMOOTH PRAGUE. An improved sort, with nearly round roots, which have but few side roots. Pkt. 5 cts., oz. 15 cts.

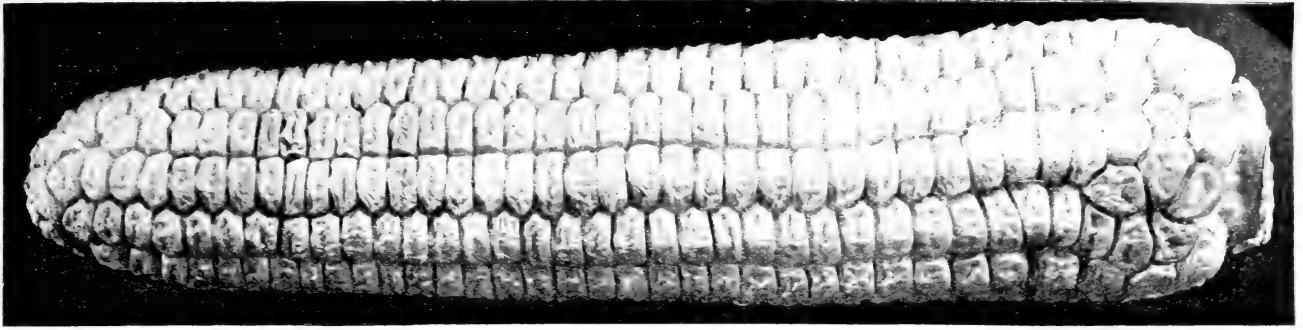

GOLDEN BANTAM SWEET CORN

SWEET CORN

A quart will plant about 200 hills,
12 to 16 quarts to the acre

Sweet Corn should not be planted until ground is warm, and cannot usually be safely planted in this latitude much before the middle of May. The small, early varieties may be planted in the garden as closely as 2½ by 2 feet, but in the field, are generally planted 3 by 2 or 2½ feet. In the small garden, however, a more economical use of space can be made and the product secured a little earlier by making the rows several feet apart, planting in the intervening space any early, low-growing crop like radish, spinach, or lettuce, and following this with a second crop of cucumbers for pickles, winter squash, celery or turnips, the corn ripening in time for the removal of the stalks before they greatly interfere with the growth of the second crop. The later and larger varieties require more room. Corn thrives best on warm, rich soil and succeeds only when given frequent but shallow cultivation. But three stalks are allowed to grow to a hill.

Prices at counter are the same as by express. All prices include bags

PEEP-O'-DAY. The earliest; productive. Stalks 3½ to 4½ feet high. Ears twelve-rowed, about 6 inches in length. Kernels white, sweet and of good size. Postpaid, ½ pt. 13 cts., pt. 23 cts., qt. 40 cts.; by express, ½ pt. 10 cts., pt. 18 cts., qt. 30 cts., 2 qts. 50 cts., ½ pk. 85 cts., pk. \$1.40, bus. \$5.

EARLY RED CORY. The most popular early variety. Ears 6 inches long; kernels broad, from reddish amber to nearly white; cobs mostly red. Postpaid, ½ pt. 13 cts., pt. 20 cts., qt. 35 cts.; by express, ½ pt. 10 cts., pt. 15 cts., qt. 25 cts., 2 qts. 40 cts., ½ pk. 70 cts., pk. \$1.15, bus. \$4.

EXTRA-EARLY RED CORY. Does not differ from the preceding except in earliness. Is ready for market a few days sooner than either the Red Cory or First of All, and for this reason we no longer offer the latter. Postpaid, ½ pt. 13 cts., pt. 23 cts., qt. 40 cts.; by express, ½ pt. 10 cts., pt. 18 cts., qt. 30 cts., 2 qts. 50 cts., ½ pk. 85 cts., pk. \$1.40, bus. \$5.

EARLY WHITE CORY. A selection from the Red Cory, both kernels and cob white; otherwise identical. Postpaid, ½ pt. 13 cts., pt. 20 cts., qt. 35 cts.; by express, ½ pt. 10 cts., pt. 15 cts., qt. 25 cts., 2 qts. 45 cts., ½ pk. 75 cts., pk. \$1.25, bus. \$4.50.

MAMMOTH WHITE CORY. Differs from the White Cory in having considerably larger ears, and in that they are twelve-rowed. Ripens nearly as early and is thought by some to be of better quality. Postpaid, ½ pt. 13 cts., pt. 20 cts., qt. 35 cts.; by express, ½ pt. 10 cts., pt. 15 cts., qt. 25 cts., 2 qts. 40 cts., ½ pk. 70 cts., pk. \$1.15, bus. \$4.

GOLDEN BANTAM. Surpasses in sweetness all others, remains in good condition longer, retains its rich flavor, sweetness and tenderness to maturity. Ears 5 to 7 inches long, eight-rowed; kernels broad, golden yellow. Stalks about 4 feet high, sturdy and productive. Postpaid, ½ pt. 13 cts., pt. 23 cts., qt. 40 cts.; by express, ½ pt. 10 cts., pt. 18 cts., qt. 30 cts., 2 qts. 50 cts., ½ pk. 85 cts., pk. \$1.40, bus. \$5.

QUINCY MARKET. One of the sweetest early varieties. The ears closely resemble the Crosby, but are larger and mature earlier. Postpaid, ½ pt. 13 cts., pt. 20 cts., qt. 35 cts.; by express, ½ pt. 10 cts., pt. 15 cts., qt. 25 cts., 2 qts. 45 cts., ½ pk. 75 cts., pk. \$1.25, bus. \$4.50.

EARLY CROSBY. New England Strain. This has been for years the most popular second-early strain in New England, and is largely grown elsewhere. Ears are intermediate in size between those of the first-early sorts and the Kendel's Early Giant, especially attractive and distinct, having rather small, almost square, kernels packed so closely on the cob that there is no space between the rows, as with other varieties; has always twelve or more rows and tip is completely covered. Not only an unusually attractive ear, but of a size preferred by many, and corn is of superior quality. Postpaid, ½ pt. 13 cts., pt. 20c., qt. 35 cts., by express, ½ pt. 10 cts., pt. 15 cts., qt. 25 cts., 2 qts. 45 cts., ½ pk. 75 cts., pk. \$1.25, bus. \$4.50.

KENDEL'S EARLY GIANT. A second-early variety, following closely the small-eared, early kinds, but having ears of sufficient size to warrant its use for main-crop, usually twelve-rowed. Of good quality; productive. Postpaid, ½ pt. 13 cts., pt. 20 cts., qt. 35 cts.; by express, ½ pt. 10 cts., pt. 15 cts., qt. 25 cts., 2 qts. 40 cts., ½ pk. 70 cts., pk. \$1.15, bus. \$4.

EARLY CHAMPION. Ready for use about the same time as Kendel's Early Giant. Ears as large or larger, ten- or twelve-rowed; kernels deep, pure white, sweet and tender. Postpaid, ½ pt. 13 cts., pt. 20 cts., qt. 35 cts.; by express, ½ pt. 10 cts., pt. 15 cts., qt. 25 cts., 2 qts. 40 cts., ½ pk. 70 cts., pk. \$1.15, bus. \$4.

METROPOLITAN. A new second-early sort, maturing closely to the preceding; rather distinct in growth, having especially strong stalks with numerous narrow, very dark green leaves. Ears 9 inches long, ten- or twelve-rowed. Well filled with large, deep kernels of excellent quality. Postpaid, ½ pt. 13 cts., pt. 20 cts., qt. 35 cts.; by express, ½ pt. 10 cts., pt. 15 cts., qt. 25 cts., 2 qts. 40 cts., ½ pk. 70 cts., pk. \$1.15, bus. \$4.

POTTER'S EXCELSIOR, or SQUANTUM. A popular midsummer variety. Ears of medium size, twelve-rowed, very sweet and tender. Postpaid, ½ pt. 13 cts., pt. 20 cts., qt. 35 cts.; by express, ½ pt. 10 cts., pt. 15 cts., qt. 25 cts., 2 qts. 40 cts., ½ pk. 70 cts., pk. \$1.15, bus. \$4.

BLACK MEXICAN. A popular variety; until the introduction of the Golden Bantam, the sweetest of all. Ears of medium size; kernels large, when ripe bluish black, but at proper stage for cooking, the color shows but little if at all. Postpaid, ½ pt. 13 cts., pt. 20 cts., qt. 35 cts.; by express, ½ pt. 10 cts., pt. 15 cts., qt. 25 cts., 2 qts. 40 cts., ½ pk. 70 cts., pk. \$1.15, bus. \$4.

MARBLEHEAD MAMMOTH. Ears of the largest size, having twelve to sixteen rows of kernels of more than average size, sweet and tender. Preferred by some to Evergreen for fodder and matures its crop earlier. Postpaid, ½ pt. 13 cts., pt. 20 cts., qt. 35 cts.; by express, ½ pt. 10 cts., pt. 15 cts., qt. 25 cts., 2 qts. 40 cts., ½ pk. 65 cts., pk. \$1, bus. \$3.75.

COUNTRY GENTLEMAN. Medium size, with irregular rows of very deep and slender kernels and small cob. Sweet and tender, not surpassed in quality by any other variety with white kernels. Plant very productive, often yielding three and sometimes four good ears. Plant liberally, as the kernels, being much shriveled, seldom germinate so well as those of the regular type. Ready for use a little before the Stowell's Evergreen, Postpaid, ½ pt. 13 cts., pt. 20 cts., qt. 35 cts.; by express, ½ pt. 10 cts., pt. 15 cts., qt. 25 cts., 2 qts. 45 cts., ½ pk. 80 cts., pk. \$1.25, bus. \$4.50.

FERRY'S EARLY EVERGREEN. Ears large, with sixteen to twenty rows. Equal in quality to the Stowell's Evergreen; one to two weeks earlier. Postpaid, ½ pt. 13 cts., pt. 20 cts., qt. 35 cts.; by express, ½ pt. 10 cts., pt. 15 cts., qt. 25 cts., 2 qts. 40 cts., ½ pk. 80 cts., pk. \$1.25, bus. \$4.50.

STOWELL'S EVERGREEN. Standard late. Ears large, kernels shriveled; very deep. Postpaid, ½ pt. 13 cts., pt. 20 cts., qt. 35c.; by express, ½ pt. 10 cts., pt. 15 cts., qt. 25 cts., 2 qts. 40c., ½ pk. 70 cts., pk. \$1.15, bus. \$4.



EARLY CROSBY SWEET CORN

THE BOOK OF CORN. A complete treatise upon the culture, marketing and uses of Maize in America and elsewhere. \$1.50.

MARKET-GARDENING. Landreth. \$1.

CUCUMBER

An ounce will plant about 50 hills. $1\frac{1}{2}$ to 2 pounds to the acre

The Cucumber requires well-enriched soil, and should not be planted until settled warm weather, in this latitude, seldom before the middle of May. Plant the early small kinds in hills $3\frac{1}{2}$ to 4 feet apart, the larger varieties 5 to 6 feet. Make the hills broad; use 15 to 20 seed to the hill, dropping them well apart. Cover with not over an inch of earth, and firm this well with the hoe. If the young plants are attacked by the striped bugs or other insects, dust frequently with air-slaked lime, soot or ashes mixed with road dust, taking care that too much is not used at one time. When all danger from bugs is past thin to three plants to the hill. Give frequent shallow cultivation as long as vines will permit.

The prices on this page are postpaid. By express or at counter in quantities of $\frac{1}{2}$ lb. or more, they are 10 cts. per lb. less than as quoted

EARLY RUSSIAN. The earliest and hardiest variety. Fruit 3 to 4 inches long. Vine vigorous and productive. Pkt. 5 cts., oz. 15 cts., 2 ozs. 25 cts., $\frac{1}{2}$ lb. 40 cts., lb. \$1.25.

EARLY CLUSTER. Early and productive. Fruit small, dark green, borne in pairs or clusters largely near the root. Pkt. 5 cts., oz. 15 cts., 2 ozs. 25 cts., $\frac{1}{2}$ lb. 40 cts., lb. \$1.25.

EARLY FRAME, or SHORT GREEN. Fruit straight, smaller at the ends, bright green, a little later than the early Cluster. Pkt. 5 cts., oz. 15 cts., 2 ozs. 25 cts., $\frac{1}{2}$ lb. 40 cts., lb. \$1.25.

EARLY WHITE SPINE. Deservedly the most popular type. Fruit uniformly large, straight and attractive; dark green, lighter at blossom end with a few white spines; flesh tender and of fine flavor. Pkt. 5 cts., oz. 15 cts., 2 ozs. 25 cts., $\frac{1}{2}$ lb. 40 cts., lb. \$1.25.

EXTRA LONG, or EVERGREEN WHITE SPINE. A distinct and superior strain of this popular type. Fruit long, cylindrical, dark green, crisp and tender. Vine productive and comes into bearing soon after the Early White Spine. Popular with market-gardeners. Pkt. 5 cts., oz. 15 cts., 2 ozs. 25c., $\frac{1}{2}$ lb. 40 cts., lb. \$1.35.

NICHOL'S MEDIUM GREEN. Fruit thicker than White Spine and full at both ends; light green; attractive and of fine quality. Pkt. 5 cts., oz. 15c., 2 ozs. 25 cts., $\frac{1}{2}$ lb. 40 cts., lb. \$1.25.

EMERALD. Fruit straight, symmetrical and entirely spineless. Color very dark green which it retains until ripe; of excellent quality; attractive and popular for shipping because it holds color so long. Vine productive; season medium to late. Pkt. 5 cts., oz. 15 cts., 2 ozs. 25 cts., $\frac{1}{2}$ lb. 40 cts., lb. \$1.35.

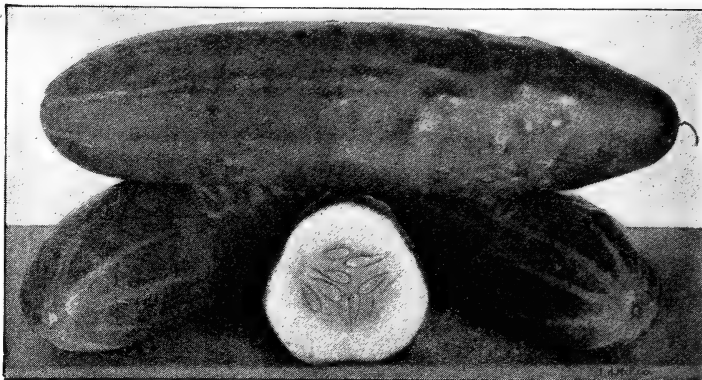

DAVIS PERFECT CUCUMBER

DAVIS' PERFECT. New. Fruit long, slim, symmetrical; rich dark green; holds color until nearly ripe. Very attractive and of finest quality. One of the best for shipping. Vine especially vigorous and large. Pkt. 10 cts., oz. 20 cts., 2 ozs. 35 cts., $\frac{1}{2}$ lb. 60 cts., lb. \$1.60.

LONG GREEN. An old standard sort yet very popular for home gardens, but little used for market. Fruit 10 to 12 inches long; very firm and crisp. On this account often used for pickles and is the best of all when ripe for for making sweet pickles. Pkt. 5 cts., oz. 15 cts., 2 ozs. 25 cts., $\frac{1}{2}$ lb. 40 cts., lb. \$1.35.

CUMBERLAND. A distinct variety of the White Spine type. Vine vigorous, very productive and continues in bearing much longer than most sorts. Fruit large, symmetrical, dark green, thickly set with small white spines; of best quality. Pkt. 5 cts., oz. 15 cts., 2 ozs. 25 cts., $\frac{1}{2}$ lb. 40 cts., lb. \$1.25.

JAPANESE CLIMBING. Vine very vigorous, with especially strong, grasping tendrils. Fruit of good size and quality. Pkt. 5 cts., oz. 15 cts., 2 ozs. 25 cts., $\frac{1}{2}$ lb. 40 cts., lb. \$1.25.

BOSTON PICKLING. A favorite for pickling. Pkt. 5 cts., oz. 12 cts., 2 ozs. 20 cts., $\frac{1}{2}$ lb. 35 cts., lb. \$1.10.

EGGPLANT An ounce will produce 150 plants

The Eggplant, like all sub-tropical plants, requires, for both germination of seed and vigorous growth of plant, a high temperature. The seed is slow in germinating, and should be sown about the first of April. When the young plants show two rough leaves, transplant to 3 or 4 inches apart, and when settled warm weather comes, set in rich, warm soil, $2\frac{1}{2}$ to 3 feet apart each way.

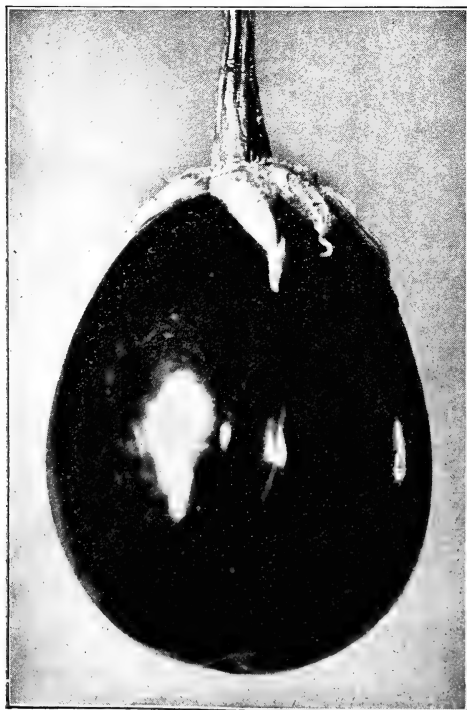

IMPROVED NEW YORK EGGPLANT

BLACK PEKIN. An early variety, nearly round, large, smooth, black and glossy. Plants prolific, leaves purplish black. Pkt. 5 cts., $\frac{1}{2}$ oz. 15 cts., oz. 25 cts., 2 ozs. 45 cts., $\frac{1}{2}$ lb. 75 cts.

NEW YORK IMPROVED. (Spineless.) The favorite variety. Fruit of largest size, oval, rich purple and finest quality. Plant large, spreading and very productive; foliage light green. Pkt. 10 cts., $\frac{1}{2}$ oz. 20 cts., oz. 35 cts., 2 ozs. 60 cts., $\frac{1}{2}$ lb. \$1.

ENDIVE An ounce will sow 150 feet of drill, producing from 2,000 to 2,500 plants

Endive, like lettuce, may be grown at any season, but is more generally used in the fall. For early use, sow in April, for later, until July, in drills 18 inches apart, or in beds for transplanting, plants should stand 10 to 12 inches apart in the row. When nearly full-grown, tie the outer leaves over the center to blanch the heart, or blanch with boards placed on each side as with celery.

MOSS CURLED. Of dense growth and finely curled. Pkt. 5 cts., $\frac{1}{2}$ oz. 10 cts., oz. 15 cts., 2 ozs. 25 cts., $\frac{1}{2}$ lb. 40 cts.

LARGE GREEN CURLED. Of larger growth, not so much curled as preceding. Pkt. 5 cts., $\frac{1}{2}$ oz. 10 cts., oz. 15 cts., 2 ozs. 25 cts., $\frac{1}{2}$ lb. 40 cts.

KALE, or BORECOLE An ounce will produce 2,000 plants

For early use, sow in May and transplant in June, and treat generally as for cabbage.

DWARF CURLED SCOTCH. A standard variety. Pkt. 5 cts., oz. 10 cts., 2 ozs. 15 cts., $\frac{1}{2}$ lb. 25 cts., lb. 75 cts.

KOHLRABI An ounce will sow about 200 feet of drill

This vegetable is intermediate between the cabbage and turnip. The edible part is an enlargement of the stem and should be used when half-grown, as when full-grown it is tough and fibrous. Sow in drills 18 inches apart and thin plants to 6 or 8 inches apart.

EARLY WHITE VIENNA. Pkt. 5 cts., $\frac{1}{2}$ oz. 10 cts., oz. 15 cts., $\frac{1}{2}$ lb. 50 cts.

EARLY PURPLE VIENNA. Pkt. 5 cts., $\frac{1}{2}$ oz. 10 cts., oz. 15 cts., $\frac{1}{2}$ lb. 50 cts.

LEEK

AMERICAN BROAD FLAG. The standard variety. Pkt. 5 cts., $\frac{1}{2}$ oz. 10 cts., oz. 15 cts., 2 ozs. 25 cts., $\frac{1}{2}$ lb. 40 cts., lb. \$1.25.

LETTUCE

An ounce will produce from
3,000 to 4,000 plants

Lettuce thrives on nearly all soils, but because the growth should at all times be rapid to insure crispness and best flavor, the soil should be richly enriched and well worked before planting. Lettuce being quite hardy, seed may generally be sown as soon as ground can be fitted, as, while prolonged or continued freezing will kill the plants, they are but little injured by an ordinary frost. Seed may also be sown in the hotbed in gentle heat, and the plants, if well hardened by having been often exposed to the air, may usually be set in the open ground very soon after the time suggested for sowing seed outdoors. The early-heading varieties may be grown in rows from 14 to 18 inches apart, with the plants about 5 inches apart in the row. The early loose-leaved varieties require a little more space, and the large summer varieties still more. The seed requires a light covering with earth, and if soil is well firmed, will germinate in a few days.

Except where otherwise noted, pkt. 5 cts., ½oz. 10 cts., oz. 15 cts., 2 ozs. 25 cts., ¼lb. 40 cts., lb. \$1.25 postpaid. If desired by express or purchased at counter, 10 cts. may be deducted from lb. price

WHITE-SEEDED TENNISBALL, or BOSTON MARKET. An old and popular variety for forcing; heads small and compact. Not suitable for outdoor planting.

BELMONT FORCING. Like the preceding, this is a plain-leaved variety, resembling it in general appearance, but is larger. It forms a compact head and is, like the Tennisball, almost certain to head, making it a desirable and profitable variety for forcing.

MAY KING. A new, very hardy variety of foreign origin, which, owing to its hardiness, earliness and large size for a variety of this class, is coming rapidly into favor here, both for outdoor planting and for forcing. Forms compact heads nearly, if not quite, as early as White-seeded Tennisball. Pkt. 5 cts., ½oz. 12 cts., oz. 20 cts., 2 ozs. 35 cts., ¼lb. 60c.

BLACK-SEEDED TENNISBALL. More extensively grown in New England than any other variety, both for first outdoor crop and for main crop, the medium-sized heads being the size most liked by gardeners, while its compact form allows it to be grown more closely together than others. Leaves plain, thick, dark green; blanches to a rich creamy white inside.

BIG BOSTON. Although much larger than either, this resembles the White-seeded Tennisball and Belmont, and like them, is of the type popular with market-gardeners here and with most shippers. It is very desirable for those gardeners requiring a large-heading variety for forcing, and for growing in coldframes, and heads well very early in spring outdoors. It does not head well in midsummer, but is especially valuable for fall use, every plant being almost certain to head. Though the heads are large, having only a few outer leaves, the plants may be set more closely than other large varieties. Leaves broad, smooth, thin and hard, outer leaves light green; a large proportion of the inner ones or head blanching to creamy white; of fine quality, crisp and tender.

EARLY CURLED SIMPSON. (White-seeded.) An old variety, with broad, often frilled, very curly light green leaves; sweet, tender, of fine flavor.

BLACK-SEEDED SIMPSON. Much larger than the preceding, but not so much curled. Forms a large, loose cluster of leaves rather than a head; leaves light yellowish green.

EARLY CURLED SILESIA. An old, standard sort, very popular for home gardens.

BOSTON FINE CURLED. Beautifully curled, excellent for garnishing, but of rather poor quality.

DEACON. One of the most popular summer varieties, forming heads a little above medium size, which, although not so large as some of this class are nevertheless very solid, of excellent quality and flavor, and which remain fit for use a long time. The outer leaves are few and are of a deep green, the inner portion blanching to a beautiful cream-yellow.

CRISP AS ICE. A midsummer variety, surpassing all of this class in crispness, tenderness and fine flavor. Forms large, solid heads, with leaves crimped and curled, those outside being variegated dark green and bronze, the inner portion blanching to a rich creamy yellow. Pkt. 5 cts., ½oz. 10 cts., oz. 15 cts., ¼lb. 50 cts.

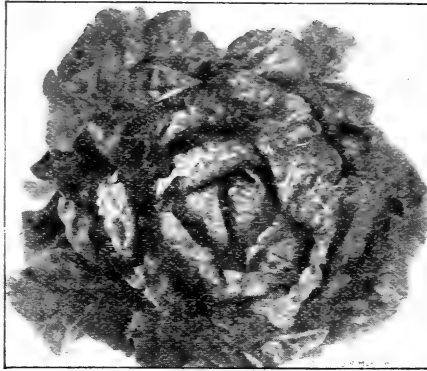

MAY KING LETTUCE

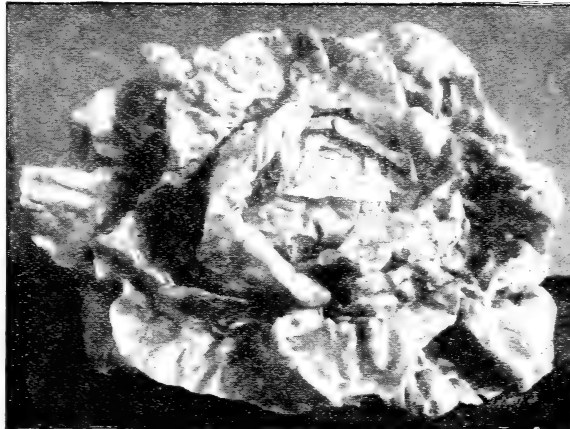

CRISP AS ICE LETTUCE



BIG BOSTON LETTUCE

PRIZE HEAD. A large, loose-leaved variety, which has been very popular for home use. Leaves very thin, crimped, bright green tinged with brownish red; sweet, tender and of good flavor, but not equal to Crisp as Ice.

HANSON. An old variety of great merit. Forms a large, flat, cabbage-like head, very slow to run to seed. The outer leaves are bright green, with veins of lighter shade, inner leaves white, usually curved and twisted at the base. A very attractive variety of excellent quality and extensively grown for home use.

NEW YORK MARKET. One of the largest varieties in cultivation. The heads are very solid with but little tendency to run to seed. It blanches itself naturally, is crisp, tender and of excellent flavor, and always free from bitterness.

MARTYNIA

The seed-pods when young and tender make excellent pickles, but should be gathered when less than half grown. Pkt. 5 cts., ½oz. 20 cts., oz. 35 cts., 2 ozs. 60 cts., ¼lb. \$1.

MUSHROOMS

Cultural directions, to be of any value, would be too lengthy to give here, but we offer the very helpful little book "Mushroom Culture and Pure Culture Spawn," which not only gives the latest methods of culture of Mushrooms, but also how best to prepare them for market, and several recipes for cooking them. 15 cts., postpaid.

LAMBERT'S PURE CULTURE SPAWN. This will produce Mushrooms of a specific variety, selected with reference to size, color and yield, and eliminates absolutely any danger of poisonous specimens. Standard bricks, weighing from 1½ to 1¾ pounds, of the variety most largely cultivated. 25c., postpaid, 35c.; 5 bricks by express, \$1.

MUSTARD

Used mainly for salads but is sometimes boiled for greens. Sow as early as ground can be worked in drills eighteen inches apart and one-half inch deep. If desired throughout the season successive sowings should be made about every three weeks.

WHITE, or YELLOW. The common variety. The seeds are often used to flavor pickles. Pkt. 5 cts., oz. 10 cts., ¼lb. 15 cts., lb. 40 cts.

SOUTHERN GIANT CURLED. Large light green leaves, much crumpled at the edge. The best for salads. Pkt. 5 cts., oz. 10 cts., 2 ozs. 15 cts., ¼lb. 20 cts., lb. 65 cts.

Farmer's Cyclopedia of Agriculture

By Wilcox & Smith. Agricultural science and practice on farm, orchard and garden, feeding and diseases of farm animals. \$3.50.

ANIMAL BREEDING. Shaw. \$1.50.

"AGRICULTURE FOR YOUNG FOLKS." Wilson & Wilson. An elementary book for beginners, a perfect guide to amateurs. \$1.

"SOILING CROPS AND THE SOIL." Shaw. Cultivating and harvesting, building and filling silos, use of ensilage. \$1.50.

MUSKMELON

An ounce will plant about 50 hills. 1½ to 2 pounds are required for an acre

The Muskmelon succeeds best in warm, rich soil. Plant when all danger of frost is past in broad hills 4 to 5 feet apart, 10 or more seeds to each hill. Cover with one inch of soil and firm well with the hoe. If young plants are attacked by insects, dust them with air-slaked lime or ashes mixed with twice as much road dust. Use this frequently but sparingly, as a large quantity at one time is liable to injure the plants. When all danger from insects is past, thin to three plants to the hill.

All prices on this page are postpaid. By express or at counter, in quantities of one-half pound or more, they are 10 cts. per pound less than quoted

COSMOPOLITAN. Of medium size, nearly round, has no ribs; light green, covered with silver-gray netting; flesh green, firm, sweet and of fine flavor. Pkt. 5 cts., oz. 15 cts., 2 ozs. 25 cts., ¼lb. 40 cts., lb. \$1.25.

EMERALD GEM. Small to medium size; skin deep green, generally smooth; flesh thick, rich salmon, not surpassed in richness and flavor. But few varieties are so nearly certain to produce uniformly good melons. Pkt. 5 cts., oz. 15 cts., 2 ozs. 25 cts., ¼lb. 40 cts., lb. \$1.35.

ROCKY FORD. More largely grown than any other of the small or basket melons. Oval, slightly ribbed, densely covered with fine netting; flesh green; thick and of rich flavor. Pkt. 5 cts., oz. 15 cts., 2 ozs. 25 cts., ¼lb. 40 cts., lb. \$1.25.

ADMIRAL TOGO. A new variety similar in appearance to the Rocky Ford having the same dense netting and of the same shape and size, but with orange flesh. The flesh is unusually thick and of rich flavor, and the variety combines to a remarkable degree superior quality with the desired firmness for shipping. Pkt. 5 cts., oz. 15 cts., 2 ozs. 25 cts., ¼lb. 45 cts., lb. \$1.75.

PAUL ROSE, or PETOSKY. The product of crossing the Osage and the Netted Gem. Resembles the latter but is a little larger, and flesh is rich orange. Very sweet and high flavored. Pkt. 5 cts., oz. 15 cts., 2 ozs. 25 cts., ¼lb. 40 cts., lb. \$1.25.

IMPROVED GREEN NUTMEG. Large, round, flattened at both ends. Ribbed and covered with coarse netting; flesh thick and of fine flavor. Pkt. 5 cts., oz. 12 cts., 2 ozs. 20 cts., ¼lb. 35 cts., lb. \$1.10.

EXTRA-EARLY HACKENSACK. Above medium size, nearly round; flesh green, a little coarse but juicy, sweet and of good flavor. Pkt. 5 cts., oz. 15 cts., 2 ozs. 25 cts., ¼lb. 40 cts., lb. \$1.25.

SURPRISE. Of medium size, oval, lightly ribbed, netted in patches; skin yellowish white; flesh deep salmon, of good quality. Vine hardy, productive and bears early. Pkt. 5 cts., oz. 15 cts., 2 ozs. 25 cts., ¼lb. 40 cts., lb. \$1.25.

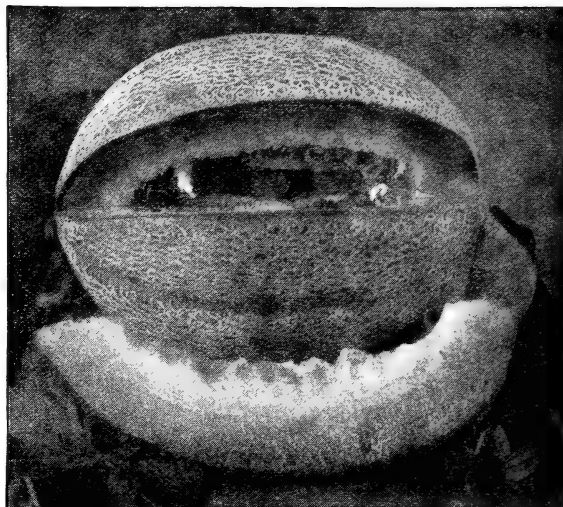

ROCKY FORD MUSKMELON

OSAGE, or IMPROVED MILLER'S CREAM. Of medium size, oval, dark green, shallow netting; flesh deep salmon, thick, very firm, sweet and of rich flavor. Pkt. 5 cts., oz. 18 cts., 2 ozs. 30 cts., ¼lb. 50 cts., lb. \$1.75.

BAY VIEW. Of largest size, Long, deeply ribbed, covered with coarse netting; flesh green, thick and of finest flavor. Vine extremely hardy. Late but safe in maturing its fruit in this latitude. The quality of Bay View warrants its careful growth. Pkt. 5 cts., oz. 15 cts., 2 ozs. 25 cts., ¼lb. 45 cts., lb. \$1.50.

WATERMELON

An ounce will plant about 30 hills.
4 pounds to the acre

COLE'S EARLY. Small but very early; of fine quality and sure to mature in any latitude where melons can be grown. Pkt. 5 cts., oz. 10 cts., 2 ozs. 15c., ¼lb. 25 cts., lb. 75 cts.

HARRIS' EARLIEST. A new extra-early variety, large and of exceptional fine quality. Slightly oval, mottled in stripes of light and dark green. Flesh bright red. One of the most desirable for planting in the North. Pkt. 5c. oz. 12 cts., 2 oz. 20 cts., ¼lb. 35 cts., lb. \$1.25

PHINNEY'S EARLY. A standard early variety of medium size, oval, marbled light and dark green; flesh pink, sweet and crisp. Pkt. 5 cts., oz. 10 cts., 2 ozs. 15 cts., ¼lb. 75 cts.

PEERLESS, or ICE CREAM. Of medium size, oval, dark green; flesh scarlet, very sweet. Pkt. 5 cts., oz. 10 cts., 2 ozs. 15 cts., ¼lb. 25 cts., lb. 75 cts.

MOUNTAIN SWEET. An old favorite, early, productive and of good quality. Fruit long, dark green; flesh scarlet. Pkt. 5 cts., oz. 10 cts., 2 ozs. 15 cts., ¼lb. 25 cts., lb. 75 cts.

SWEETHEART. Large, oval, very heavy; rind thin but firm, mottled light and very light green; flesh bright red, tender, melting and sweet. Retains its good qualities for a long time after ripening. Pkt. 5 cts., oz. 10 cts., 2 ozs. 15 cts., ¼lb. 25 cts., lb. 85 cts.

KLECKLEY'S SWEET, or MONTE CRISTO. One of the sweetest; above medium size; dark green; rind thin; flesh bright red. Pkt. 5 cts., oz. 10 cts., 2 ozs. 15 cts., ¼lb. 85 cts.

CUBAN QUEEN. Large, round or slightly oval, striped light and dark green; rind thin but firm; flesh bright red, solid, crisp and sweet. Pkt. 5 cts., oz. 10 cts., 2 ozs. 15 cts., ¼lb. 25 cts., lb. 75 cts.

KOLB'S GEM. Of the largest size, round or slightly oval, striped light and dark green; flesh bright red, a little coarse but tender and sweet. Pkt. 5 cts., oz. 10 cts., 2 ozs. 15 cts., ¼lb. 25 cts., lb. 75 cts.

CITRON. For preserving only. Pkt. 5 cts., oz. 10 cts., 2 ozs. 15 cts., ¼lb. 25 cts., lb. 85 cts.

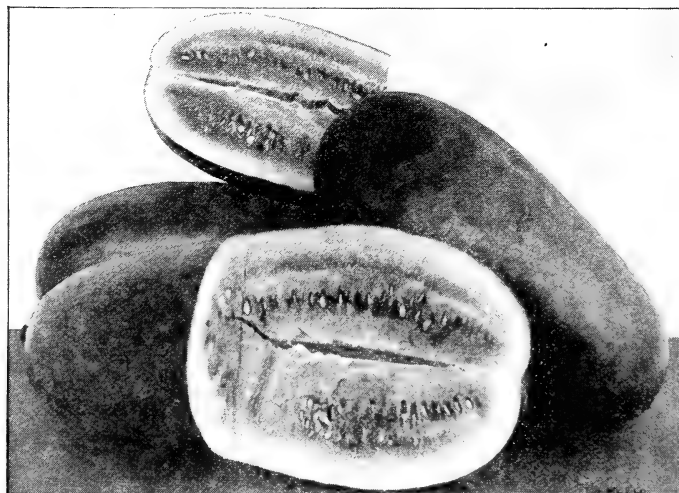

KLECKLEY'S SWEETS WATERMELONS

OKRA, or GUMBO

The young seed-pods are used in soups or stewed and served like asparagus. Much esteemed in the South. In the North requires an especially warm location and probably best result would be obtained by sowing seed in the hotbed. Set plants in rows two feet or more apart and about a foot apart in the row. The seeds are a long time in germinating.

DWARF GREEN. Early and productive; best for northern cultivation. Pkt. 5 cts., oz. 10 cts., ¼lb. 25 cts.

Grasses, How to Grow Them.

Shaw. All varieties, cultivation, care, development and use. \$1.50.

Clovers, and How to Grow

Them. Shaw. Treats on growth, cultivation and treatment of Clover. \$1.

The Forage and Fiber Crops in America.

By Hunt. An abundance of new and scientific thought for practical men. \$1.75.





YELLOW GLOBE DANVERS ONIONS

ONION

An ounce will sow about 100 feet of drill.
4 to 5 pounds to the acre

The Onion usually thrives best on old, rich land but can be profitably grown only on such as has been kept free from weeds. It stable manure is used it should be either well rotted or plowed into the soil the previous fall. As manure always contains more or less weed seeds many large growers now use nothing but commercial fertilizer. The soil should be worked until manure or fertilizer is thoroughly mixed with it and the surface made fine and even by raking. Sow as early as ground can be prepared in rows 12 to 14 inches apart, one-half inch deep and make soil firm. Keep free from weeds, especially at first, for if the weeds once get ahead of the young plants it is almost useless to continue cultivation—the land would better be plowed and replanted with some other crop.

Except where quoted in 5-lb. lots, all prices for Onion Seed are postpaid, and are subject to a discount of 10 cts. from the lb. price if sent by express or purchased at counter. Special quotations made for larger quantities

YELLOW GLOBE DANVERS. Of globular form but differs from the Southport type in being slightly flattened at both top and bottom; ripens earlier and in unfavorable seasons is more nearly free from scallions. Pkt. 5 cts., $\frac{1}{2}$ oz. 10 cts., oz. 15 cts., 2 ozs. 25 cts., $\frac{1}{4}$ lb. 40 cts., lb. \$1.50, 5 lbs. \$1.30 per lb.

YELLOW GLOBE DANVERS. Extra Selected. Eastern grown seed. A superior strain grown from carefully selected bulbs; of perfect form, unusually small neck, skin of rich deep color; firm and heavy and unsurpassed for shipping or storing. Pkt. 5 cts., $\frac{1}{2}$ oz. 12 cts., oz. 20 cts., 2 ozs. 35 cts., $\frac{1}{4}$ lb. 55 cts., lb. \$1.85, 5 lbs. \$1.65 per lb.

SOUTHPORT YELLOW GLOBE. Bulbs nearly spherical, slightly elongated; does not mature quite so early as our Selected strain of Yellow Globe Danvers; a little more inclined to grow stiff-necked on some soils or in unfavorable seasons, but when well-grown bring the highest price, especially in New York markets. Pkt. 5 cts., $\frac{1}{2}$ oz. 12 cts., oz. 20 cts., 2 ozs. 35 cts., $\frac{1}{4}$ lb. 55 cts., lb. \$1.85, 5 lbs. \$1.65 per lb.

SOUTHPORT RED GLOBE. Identical in form with the preceding; rich deep red, above medium size; an excellent keeper and one of the most attractive of all. Pkt. 5 cts., $\frac{1}{2}$ oz. 12 cts., oz. 20 cts., 2 ozs. 35 cts., $\frac{1}{4}$ lb. 55 cts., lb. \$1.85, 5 lbs. \$1.65 per lb.

SOUTHPORT WHITE GLOBE. Of true globe shape. Later than White Portugal; keeps better and like all globular varieties a greater weight can be obtained on the same area. Pkt. 10 cts., $\frac{1}{2}$ oz. 18 cts., oz. 30 cts., 2 ozs. 55 cts., $\frac{1}{4}$ lb. 90 cts., lb. \$3.

EXTRA-EARLY RED FLAT. The earliest red variety; of medium size. Pkt. 5 cts., $\frac{1}{2}$ oz. 10 cts., oz. 15 cts., 2 ozs. 25 cts., $\frac{1}{4}$ lb. 40 cts., lb. \$1.50.

LARGE RED WETHERSFIELD. The standard red variety. Bulb large, flattened but thick; skin deep purplish-red. The best of all for light soils. Pkt. 5 cts., $\frac{1}{2}$ oz. 10 cts., oz. 18 cts., 2 ozs. 30 cts., $\frac{1}{4}$ lb. 50 cts., lb. \$1.85, 5 lbs. \$1.65 per lb.

PRIZETAKER. Of the largest size, form nearly globular; skin thin, light straw-color; flesh white, mild and tender. Quite certain to bottom, but rather late and not a good keeper but is successfully grown when started early in hotbed and transplanted. Pkt. 5 cts., $\frac{1}{2}$ oz. 12 cts., oz. 20 cts., 2 ozs. 35 cts., $\frac{1}{4}$ lb. 60 cts., lb. \$2.

ONION SETS

If by mail, add 10 cts. per quart to prices. Prices for larger quantities than here quoted, given on application

Onion Sets require rich soil and, with the exception of the Egyptian, early planting. Rows should be the same distance apart as suggested for Onions grown from seed, and sets should be planted from 2 to 4 inches apart, and only lightly covered with earth, the top of set just below the surface with any growth it may have made above. Culture same as of Onions from seed. White and yellow sets are grown from seed sown very thickly; the crop from sets is used both when half-grown and when mature. Potato Onions and Shallots, are propagated by division of the large bulb into several smaller ones, the first growing as large as Onions from seed; the latter are much smaller, but are favorites with some because of their peculiar flavor and are used both in the green state and when dry. Egyptian sets are borne in clusters at the top of a tall seed-stem; once planted they will live for years, but are usually treated as annuals; form a bulbous root rather than a bulb; used green and should be planted in the fall.

EITHER WHITE OR YELLOW. Qt. 20 cts., $\frac{1}{2}$ pk. 60 cts., pk. \$1.

POTATO ONIONS. Qt. 20 cts., $\frac{1}{2}$ pk. 65 cts., pk. \$1.25.

SHALLOTS. Qt. 20 cts., $\frac{1}{2}$ pk. 60 cts., pk. \$1.15.

EGYPTIAN, OR PERENNIAL TREE. Ready in September. Qt. 20 cts., $\frac{1}{2}$ pk. 50 cts., pk. 90 cts.

PEAS

Of the early smooth varieties, 1 quart will plant 150 feet of drill. Of the wrinkled sorts, a quart will plant about 100 feet, 1 $\frac{1}{4}$ to 1 $\frac{1}{2}$ bushels will plant an acre

Though light, warm soil is desirable for the extra-early sorts, Peas generally succeed better on that which is moderately heavy. The early smooth Peas are very hardy and may be planted as soon as frost is out of the ground and are sometimes planted in the fall. The wrinkled varieties are somewhat more tender and seed is more liable to rot if planted as early. Plant the early and dwarf varieties in drills 2 $\frac{1}{2}$ feet apart and 3 or 4 inches deep, but cover with but one inch of soil and fill trench gradually as plants grow. Plan the taller and later varieties in rows 3 to 4 feet apart and 5 or 6 inches deep, covering as already suggested

Prices at counter are same as by express. All prices include bags. With the exception of Alaska, First and Best and Black-eyed Marrowfat, all varieties have wrinkled seeds

The total crop of 1910 of all varieties of peas was the poorest for at least over thirty years. And not only in this country is the shortage an unprecedented one, but in all sections of the world where seed peas are grown extremely unfavorable conditions seem to have prevailed so that the total product of the world is far below the needs. This is especially true of some of the varieties in greatest demand. Prices, therefore, rule high but even at the extreme prices which must be quoted stocks of many varieties will, without doubt, be exhausted early in the season. Orders should therefore be placed early to make certain of their being filled.

DWARF EARLY VARIETIES

AMERICAN WONDER. A well-known and popular variety of very dwarf habit; the earliest of the dwarf varieties. Postpaid, $\frac{1}{2}$ pt. 16 cts., pt. 30 cts., qt. 55 cts.; by express, $\frac{1}{2}$ pt. 12 cts., pt. 22 cts., qt. 40 cts., 2 qts. 75 cts. $\frac{1}{2}$ pk. \$1.40, pk. \$2.50, bus. \$9.50.

NOTT'S EXCELSIOR. The most popular of the dwarf varieties. Vine larger and more productive than the American Wonder and bears earlier than Premium Gem. Postpaid, $\frac{1}{2}$ pt. 19 cts., pt. 33 cts., qt. 60 cts.; by express, $\frac{1}{2}$ pt. 15 cts., pt. 25 cts., qt. 45 cts., 2 qts. 80 cts., $\frac{1}{2}$ pk. \$1.40, pk. \$2.70, bus. \$10.

PREMIUM GEM. An improved strain of Little Gem. Vine not quite so tall, more even in growth and more productive. Postpaid, $\frac{1}{2}$ pt. 14 cts., pt. 26 cts., qt. 50 cts.; by express, $\frac{1}{2}$ pt. 10 cts., pt. 18 cts., qt. 35 cts., 2 qts. 65 cts., $\frac{1}{2}$ pk. \$1.20, pk. \$2.25, bus. \$8.50.

SUTTON'S EXCELSIOR. The best of the dwarf varieties. The vine is of more vigorous growth than the Nott's Excelsior, a little taller, fully as productive and matures its crop nearly as early, while both pods and peas are decidedly larger. In quality equal to any of the preceding, all of which compare favorably with the larger and later sorts. Postpaid, $\frac{1}{2}$ pt. 19 cts., pt. 33 cts., qt. 60 cts.; by express, $\frac{1}{2}$ pt. 15c., pt. 25 cts., qt. 45 cts., 2 qts. 80 cts., $\frac{1}{2}$ pk. \$1.50, pk. \$2.90, bus. \$11.

EXTRA-EARLY VARIETIES OF TALLER GROWTH

ALASKA, or EARLIEST OF ALL. Very popular with market-gardeners due to its uniformity in ripening. Nearly the whole crop can be gathered at one picking. Vine about 2 $\frac{1}{2}$ feet high; bears abundantly pods which, though small, are always well filled. Postpaid, $\frac{1}{2}$ pt. 14 cts., pt. 25 cts., qt. 45 cts.; by express $\frac{1}{2}$ pt. 10 cts., pt. 17 cts., qt. 30 cts., 2 qts. 55 cts., $\frac{1}{2}$ pk. \$1, pk. \$1.90, bus. \$7.25.

FIRST AND BEST. Matures closely to Alaska; both peas and pods larger. Prices same as Alaska.

GRADUS. A remarkable variety, combining earliness with peas of largest size and best quality. Matures soon after Nott's Excelsior. Vine resembles the Telephone but is only 3 to 3 $\frac{1}{2}$ feet high, on rich land; productive. Pods 4 inches long, straight, slightly curved at end, light green, well filled. Postpaid, $\frac{1}{2}$ pt. 19c., pt. 36c., qt. 65c.; by express, $\frac{1}{2}$ pt. 15c., pt. 28c., qt. 50c., 2 qts. 90c., $\frac{1}{2}$ pk. \$1.60, pk. \$3, bus. \$11.50.

THOMAS LAXTON. Vine of about the same height as the Gradus of similar habit but much darker, harder and more productive. More attractive and better filled with peas as large and equal in quality. Postpaid, $\frac{1}{2}$ pt. 19 cts., pt. 36 cts., qt. 65 cts.; by express, $\frac{1}{2}$ pt. 15 cts., pt. 28 cts., qt. 50 cts., 2 qts. 90 cts., $\frac{1}{2}$ pk. \$1.60, pk. \$3, bus. \$11.50.

SECOND-EARLY MEDIUM AND LATE VARIETIES

ADVANCER. An old popular second-early sort. Vine about 2 $\frac{1}{2}$ feet high, vigorous and productive. Pods of medium size, broad, well filled. Peas rather under medium size but of finest quality. Postpaid, $\frac{1}{2}$ pt. 14 cts., pt. 26 cts., qt. 50 cts.; by express, $\frac{1}{2}$ pt. 10 cts., pt. 18 cts., qt. 35 cts., 2 qts. 65 cts., $\frac{1}{2}$ pk. \$1.20, pk. \$2.25, bus. \$8.50.

YORKSHIRE HERO. Vine 26 to 30 inches, stout and branching, hardy and productive. Pods 3 to 3 $\frac{1}{4}$ inches long, broad, well-filled with peas of largest size, mealy, and of the richest flavor. Postpaid, $\frac{1}{2}$ pt. 14 cts., pt. 25 cts., qt. 45 cts.; by express, $\frac{1}{2}$ pt. 10 cts., pt. 17 cts., qt. 30 cts., 2 qts. 55 cts., $\frac{1}{2}$ pk. \$1, pk. \$1.90, bus. \$7.25.

EVERBEARING. In all respects very similar to, if not identical with, Yorkshire Hero. Postpaid, $\frac{1}{2}$ pt. 14 cts., pt. 25 cts., qt. 45 cts.; by express, $\frac{1}{2}$ pt. 10 cts., pt. 17 cts., qt. 30 cts., 2 qts. 55 cts., $\frac{1}{2}$ pk. \$1, pk. \$1.90, bus. \$7.25.

DWARF CHAMPION. A new variety, claimed to be equal in quality to Champion of England. Both peas and pod are considerably larger and vine is only about 3 feet high. Postpaid, $\frac{1}{2}$ pt. 14 cts., pt. 26 cts., qt. 50 cts.; by express, $\frac{1}{2}$ pt. 10 cts., pt. 18 cts., qt. 35 cts., 2 qts. 65 cts., $\frac{1}{2}$ pk. \$1.20, pk. \$2.25, bus. \$8.50.

IMPROVED STRATAGEM. Vine 24 to 28 inches, of vigorous habit, with good culture, productive. Pods 3 $\frac{1}{2}$ to 4 inches, broad, attractive, well-filled. Peas extra large and of finest quality. Unfortunately, inclined to sport; however, has, in a great measure, been overcome in the improved strain we offer. Postpaid, $\frac{1}{2}$ pt. 14 cts., pt. 26 cts., qt. 50 cts.; by express, $\frac{1}{2}$ pt. 10 cts., pt. 18 cts., qt. 35 cts., 2 qts. 65 cts., $\frac{1}{2}$ pk. \$1.20, pk. \$2.25, bus. \$8.50.

TELEPHONE. Extensively grown. Vine 3 $\frac{1}{2}$ to 4 ft. On good soil, productive. Pods large. Peas above medium size, of best quality. Postpaid, $\frac{1}{2}$ pt. 18 cts., pt. 30 cts., qt. 55 cts.; by express, $\frac{1}{2}$ pt. 14 cts., pt. 22 cts., qt. 40 cts., 2 qts. 75 cts., $\frac{1}{2}$ pk. \$1.40, pk. \$2.60, bus. \$10.

ADMIRAL DEWEY. Productive variety, growing 3 $\frac{1}{2}$ feet, pods of the largest size, dark green, well filled with large peas of unsurpassed quality. Postpaid, $\frac{1}{2}$ pt. 18 cts., pt. 30 cts., qt. 55 cts.; by express, $\frac{1}{2}$ pt. 14 cts., pt. 22 cts., qt. 40c., 2 qts. 75c., $\frac{1}{2}$ pk. \$1.40, pk. \$2.60, bus. \$10.

CHAMPION OF ENGLAND. Vine 4 $\frac{1}{2}$ to 5 feet high, productive. Pods 2 $\frac{1}{2}$ to 3 inches long, broad, well filled. Peas of medium size, much shriveled of unsurpassed quality. Postpaid, $\frac{1}{2}$ pt. 14 cts., pt. 26 cts., qt. 50 cts.; by express, $\frac{1}{2}$ pt. 10 cts., pt. 18 cts., qt. 35 cts., 2 qts. 65 cts., $\frac{1}{2}$ pk. \$1.20, pk. \$2.25, bus. \$8.50.

BLACK-EYED MARROWFAT. An old variety. Peas large but like all smooth peas, much inferior in quality, to the wrinkled sorts. Postpaid, $\frac{1}{2}$ pt. 14 cts., pt. 23 cts., qt. 40 cts.; by express, $\frac{1}{2}$ pt. 10 cts., pt. 15 cts., qt. 25 cts., 2 qts. 40 cts., $\frac{1}{2}$ pk. 65 cts., pk. \$1.15, bus. \$4.50.



THOMAS LAXTON PEAS

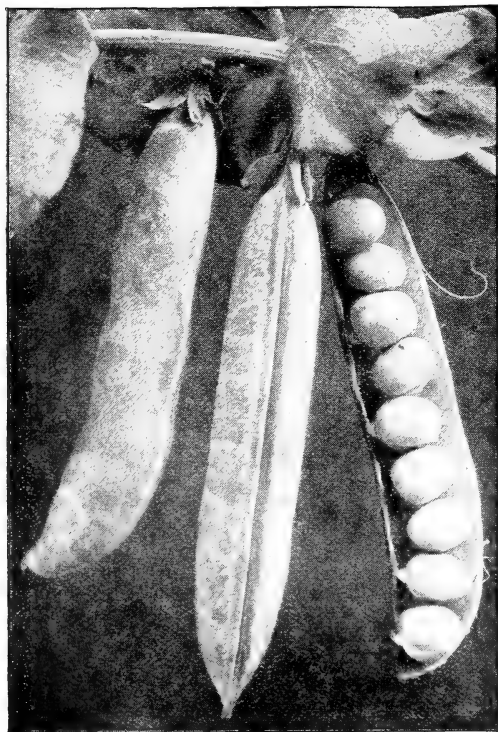

TELEPHONE PEAS



HOLLOW CROWN PARSNIPS

LONG RED CAYENNE. Fruit very slim, pointed, about 4 inches long and, when ripe, bright red. Extremely pungent.

RED CHILI. Used for making pepper-sauce. Pods bright, red, slender, about 2 inches long and very pungent. Requires a long season; seed should be sown early in hotbed.

Each of above, pkt. 5 cts., ½oz. 15 cts., oz. 25 cts., 2 ozs. 40 cts., ¼lb. 75 cts.

GIANT CRIMSON. The first to mature of the extra-large varieties and surpassed by none in evenness of size and shape. The fruit's average heavier than any other large Peppers as the flesh is unusually thick. When matured the color is deep crimson, flavor very mild. The plant grows upright, is vigorous, larger than the Chinese Giant and more productive. Pkt. 10 cts., ½oz. 25 cts., oz. 40 cts., ¼lb. \$1.25.

PUMPKIN

One ounce will plant
12 to 18 hills

SMALL SUGAR. The popular variety in New England for pies; fine-grained and sweet. Pkt. 5 cts., oz. 10 cts., 2 ozs. 15 cts., ¼lb. 25 cts., lb. 85 cts.

LARGE CHEESE, or KENTUCKY FIELD. Shape flat, skin of a rich cream color when ripe, flesh tender and of fine quality. Pkt. 5 cts., oz. 10 cts., 2 ozs. 15 cts., ¼lb. 25 cts., lb. 85 cts.

MAMMOTH TOURS. One of the largest in cultivation; good for feeding stock. Pkt. 5 cts., oz. 15 cts., 2 ozs. 25 cts., ¼lb. 40 cts., lb. \$1.25.

CONNECTICUT FIELD. The standard variety for feeding stock. Pkt. 5 cts., ¼lb. 15 cts., lb. 60 cts.

GOLDEN OBLONG. Pumpkins from 15 to 20 inches long and 8 to 10 inches in diameter; skin rich golden yellow, thin, but unusually tough. Flesh light golden yellow, of fine quality. Keeps nearly as well as the hard-shell squashes. Pkt. 5 cts., oz. 15 cts., 2 ozs. 25 cts., ¼lb. 40 cts., lb. \$1.50.

QUAKER PIE. Fruits broad, pear-shaped to slightly oval; skin rich cream-buff; flesh fine-grained and of rich flavor. Pkt. 5 cts., oz. 15 cts., 2 ozs. 25 cts., ¼lb. 40 cts., lb. \$1.50.

JUMBO, or KING OF THE MAMMOTHS. The largest of all Pumpkins. Skin orange-salmon, flesh bright yellow, very thick, fine grained and of excellent quality for pies. Pkt. 5 cts., oz. 15 cts., 2 ozs. 25 cts., ¼lb. 40 cts., lb. \$1.25.

Garden Insects frequently destroy large percentages of a year's crop and oftentimes totally ruin certain patches. Professor Green has made a very thorough study of these pests and their habits, and gives many valuable remedies in his book, "Vegetable Gardening," which we will send, postpaid, anywhere for 50 cents. 256 pages.

Propagation of Plants.

Crossing species and varieties, how plants are multiplied, by Fuller. \$1.50.

How Crops Grow. Johnson. Chemical composition, structure and life of plants. \$1.50.

PARSNIP

An ounce will sow 100 feet of drill; 6 pounds are required for an acre

The Parsnip thrives on any soil which is deep, mellow and moderately rich, but best on that which is rather light or sandy. Avoid the use of fresh manure, as roots are more inclined to be coarse, spongy and ill-shaped. Seed germinates slowly, should be sown early and immediately after ground is prepared—that is, before the soil has become dry. Sow in rows 18 inches apart, cover with one-half inch of soil and make firm by rolling or with back of hoe. Thin plants to three inches or more apart.

All prices on this page are postpaid and are subject to a discount of 10 cents from the pound price if seeds are sent by express or purchased at counter

ARLINGTON LONG SMOOTH. Roots very long and smooth, with full crown; desirable for deep soils and, owing to the full crown, is less liable to rot if left in the ground through the winter than the Hollow Crown.

HOLLOW CROWN. Roots of medium length, thicker at the top or shoulder than the preceding; succeeds better on shallow or stiff soil; crown slightly depressed; does not, on this account, keep so well in the ground through the winter as the Arlington Long Smooth, but is more easily harvested and more extensively grown.

Of each variety we offer a choice selected strain. Pkt. 5 cts., oz. 10 cts., 2 ozs. 15 cts., ¼lb. 20 cts., lb. 60 cts.

PEPPER

An ounce will produce from 1,500 to 2,000 plants

The Pepper requires deep, rich, warm soil. Sow in hotbed or in the house early in April and transplant to open ground about the first of June. Set in rows 2½ feet apart and about 2 feet apart in the row. A liberal application of any fertilizer rich in nitrogen, made when plants are set in the open ground, or at first hoeing, will greatly assist the growth of the plants, increase the productiveness and improve the quality of the fruit.

LARGE BELL, or BULL NOSE. Large, bell-shaped, thick-fleshed and less pungent than some other sorts. Good for filling.

SWEET MOUNTAIN. Fruit very large, often 8 inches long by 2 in diameter. Flesh thick, sweet and mild.

RUBY KING. Large. Four to six inches long, symmetrical; very mild and sweet.

SQUASH, or TOMATO-SHAPED. Fruit flat or tomato-shaped, and somewhat ribbed, flesh thick and slightly more pungent than other large sorts, early and sure to mature.



RUBY KING PEPPER



GOLDEN OBLONG PUMPKINS

Choice Northern-Grown POTATOES

**PROGRESSIVE FARMERS CHANGE SEED OFTEN
BECAUSE IT PAYS**

EXTRA-EARLY VARIETIES

- EARLY BOVEE.** Resembles the Queen; of good size, few small tubers, of best quality. Pk. 45 cts., bus. \$1.50, bbl. \$3.50.
- EARLY SIX WEEKS.** Of good quality, even when hardly full grown; keeps well; form round, slightly inclined to oblong; color light red or rose. Pk. 45 cts., bus. \$1.50, bbl. \$3.50.
- EARLY HARVEST.** An early white variety of finest quality. Vine unusually vigorous and productive. Pk. 45 cts., bus. \$1.50, bbl. \$3.50.
- EARLY NORTHER.** Closely resembles the Rose, but of better form. Popular. Pk. 45 cts., bus. \$1.50, bbl. \$3.50.
- IRISH COBLER.** Large and of excellent quality; round to oblong. By far the most popular early white variety. Vine very stocky; withstands drought better than other early sorts; productive. Pk. 45 cts., bus. \$1.50, bbl. \$3.50.
- BURPEE'S EXTRA-EARLY.** One of the earliest varieties, producing larger and finer tubers than many of the extra-earlies. Tubers oblong, with white or pale brownish skin; few and shallow eyes; quality of the best. Pk. 45 cts., bus. \$1.50, bbl. \$3.50.
- CLARK'S NO. 1.** An old favorite of excellent quality. Resembles the Rose. Pk. 45 cts., bus. \$1.50, bbl. \$3.50.
- EARLY ROSE.** The standard with which new early varieties are compared. Pk. 45 cts., bus. \$1.50, bbl. \$3.50.
- NEW QUEEN.** A very popular sort. Closely resembles the Beauty of Hebron, but is considerably earlier. A heavy yielder, and of excellent quality. Pk. 45 cts., bus. \$1.50, bbl. \$3.50.
- BEAUTY OF HEBRON.** One of the most popular varieties; productive, early and of excellent quality. Pk. 45 cts., bus. \$1.50, bbl. \$3.50.

HARDWOOD LANDS. Explains the use and value of stump and cut-over lands, for profitable farming purposes. 25 cents.



GOLD COIN POTATO

HYBRIDIZED POTATO SEED

We imagine but few of our readers much under fifty years of age have ever seen a potato ball, as but few of the many varieties introduced and cultivated in the last half century have usually borne seed. So for the interest of those who are not familiar with this product of the potato we may say that while it is customary to speak of the Potato itself as seed the seed proper is produced inside of balls about one and a quarter inch in diameter, borne at the top of the vine on a string-like stem as shown in the illustration. These are hard and green until near the time the tubers mature, becoming soft and turning yellowish as they ripen. Inside are the many small seeds. Growing Potatoes from seed is a very interesting experiment and may prove a very profitable one as new creations find a ready market and generally at a high price. The seed here offered is the product of many hybridizations of the best new and old varieties, not only those cultivated in this country but selections from nearly every section of the world where the Potato is grown, a large portion of it coming from Mr. Burbank, the world-renowned hybridizer. The multitude of diversified varieties which will be produced from this seed will be surprising, and that varieties of great value may be among them is not at all improbable. The chance is well worth striving for. Cultural directions on each packet. Pkt. 15 cts., 2 pkts. 25 cts., 10 pkts. \$1. Special discount on seeds in pkts. does not apply to this except on single pkt. price.

Farm Machinery and Farm Motors. Davidson & Chase. An indispensable book for present-day, practical farming. Net, \$2

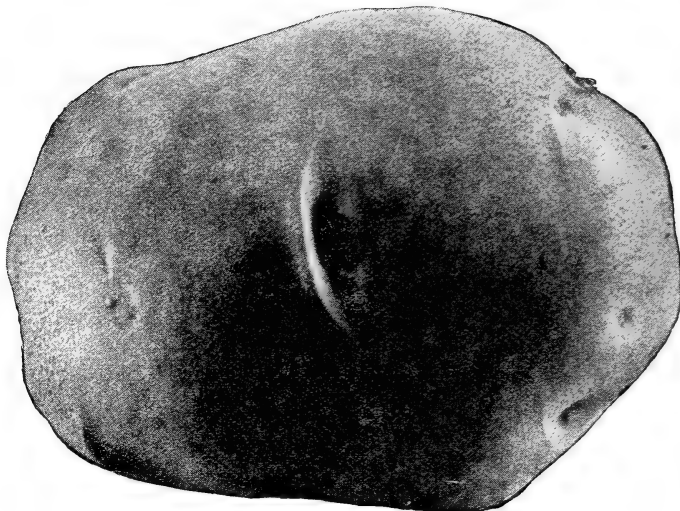

CARMAN NO. 3 POTATO

SECOND-EARLY, or MEDIUM

- SPAULDING'S NO. 4.** In color resembles the Rose, somewhat similar in shape, but inclines to oblong. Uniform in size, of good quality; seldom rots. Has a record of 479 bushels to the acre, and in a comparative test proved the heaviest yielder of 190 varieties. Pk. 45c., bus. \$1.50, bbl. \$3.50.
- DELAWARE.** Succeeds well in all soils. A valuable combination of size, yield and quality. White throughout. Shape oblong. Pk. 45 cts., bus. \$1.50, bbl. \$3.50.
- PROLIFIC ROSE.** One of the heaviest yielders of all the Rose seedlings. A little later than the Early Rose; shape similar, color the same, except that the seed end is nearer red. Pk. 45 cts., bus. \$1.50, bbl. \$3.50.

LATE, or MAIN CROP

- GREEN MOUNTAIN.** Of flat, oval form; white, smooth and attractive. Ripens slowly and keeps well; of excellent quality. Very productive. Pk. 40 cts., bus. \$1.40, bbl. \$3.25.
- GOOD TIMES.** A new and very productive variety. Tubers are very attractive, never prongy or ill-shaped. Vine of vigorous growth, heavier than the Green Mountain; rust-proof. Pk. 45 cts., bus. \$1.50, bbl. \$3.50.
- CARMEN NO. 1.** Shape round or globular, skin white, shallow eyes; not inclined to rot in field or cellar; of excellent quality. Late in ripening, but yields large crops of fine marketable potatoes. Pk. 45c., bus. \$1.50, bbl. \$3.50.
- RURAL NEW YORKER NO. 2.** Very large and smooth; in form oblong, inclined to round; skin and flesh white. Of superior quality. A large cropper. Pk. 45 cts., bus. \$1.50, bbl. \$3.50.
- CARMEN NO. 3.** A handsome round, white variety of the best quality; large; almost no small tubers. Claimed by the introducer to outyield any Potato of its class. Vines large and vigorous, not troubled by bugs or blight as much as those of other sorts. Pk. 45 cts., bus. \$1.50, bbl. \$3.50.
- VERMONT GOLD COIN.** This Potato is claimed by the introducers to be "the hardiest, most vigorous in growth, most productive and the best in table quality of all potatoes; it has proved to be absolutely unequalled for main crop." Reports in general very largely substantiate these claims. The tubers are of a desirable size, not over-large like those of some varieties noted for their remarkable yield; in form slightly oblong, rather, broad and quite thick and have small eyes; the skin is smooth, thin and glossy and of a light golden tint, sufficient in coloring to make the variety distinct from the white-skinned varieties. The flesh is pure white and, when cooked, is remarkably dry and mealy. The tubers grow closely together in the hill, are easily dug and, not being extra-large, the great yield is because of a remarkably even production of a large number of tubers, uniform in size, in each hill. The vine, as claimed, is of luxuriant growth and resists blight remarkably. The combination of desirable features will undoubtedly place the Gold Coin in the front rank of main-crop varieties. Pk. 45 cts., bus. \$1.50, bbl. \$3.50.

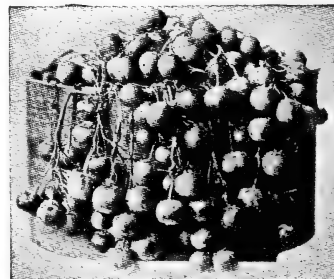

POTATO SEED BALLS

RADISH

An ounce will sow
100 feet of drill

Radishes are now grown the entire year, and may be sown when desired in hotbeds with moderate heat, either in rows 6 inches apart or broadcast. Soil should be light and rich, preferably new soil and fine rotted turf and commercial fertilizer. Seed may be sown outside very early, as soon as ground can be worked, in rows 6 to 12 inches apart, as desired, and one-half inch deep. For our own use, we prefer that plants shall be thick, commencing to use roots when twice the size of a large pea and only thinning when plants are so crowded as to prevent the formation of roots of a size suitable for use. Grown in this way and used from the size noted to that of a small marble roots are tender and crisp and never have the thick skin, so generally a feature of those found in our markets. If desired for some time, seed should be sown at intervals of two to three weeks. As with the hotbed, soil should be light and rich, if possible, that which has recently been in grass. Avoid the use of both fresh manure and soil on which either radishes, turnips or cabbage were grown the previous year. Commercial fertilizers are much preferable and especially is nitrate of soda valuable in stimulating rapid growth, without which radishes are tough and stringy.

Prices of all varieties, postpaid, pkt. 5 cts., oz. 10 cts., 2 ozs. 15 cts., ¼lb. 25 cts., lb. 85 cts.; by express or at counter, lb. 75 cts., 5 lbs. or over at 60 cts. per lb.

NEW RADISH, CRIMSON GIANT FORCING. This new Radish, combining both earliness and great size; while well suited for forcing is equally adapted for outdoor cultivation. While it grows much larger than other forcing varieties, it does not become pithy under glass nor outdoors, even when twice as large and a week older. When full grown it has a circumference of 5 to 6 inches and weighs from 1½ to 2 ounces. Color a beautiful crimson-carmine. The roots vary somewhat in shape, some being round while others incline to oval.

EARLY SCARLET TURNIP. A small, round variety, with small tops; quick grower. Popular for forcing and outdoors. Deep scarlet.

EARLY SCARLET TURNIP, WHITE-TIPPED. Root nearly round, slightly flattened at bottom; bright scarlet with tip of clear white, early and attractive; suitable for forcing and outside planting.

ROSY GEM. A selected strain of the preceding with tops small; a very early radish.

NON PLUS ULTRA, or DEEP SCARLET FORCING. One of the earliest; tops very small, specially suited for forcing. Color deep rich red; form globular.

SCARLET GLOBE. The shape of this when first large enough for use is oval, in later stages of growth more nearly globular. Brilliant red, which it holds long after pulling. Tops are a little larger than those of some varieties, but it is largely used for forcing because it is seldom pithy, excelling, in this respect, any other variety, either when planted under glass or outdoors.

FRENCH BREAKFAST. A stump-rooted radish; about 3 inches long. Bright scarlet, tipped white. An old favorite, for home garden.

EARLY LONG SCARLET, SHORT-TOP. One of the most popular Radish, but has been largely displaced by the round varieties. Six to 8 inches long; ready to pull in twenty-five to thirty days from sowing.

WOOD'S EARLY FRAME. Similar to Long Scarlet, but shorter of more brilliant color and slightly thicker at top, matures quicker and is more largely used for forcing.

WHITE STRASBURG. A fine summer variety, growing about 4 inches long and 2 inches thick. Pure white.

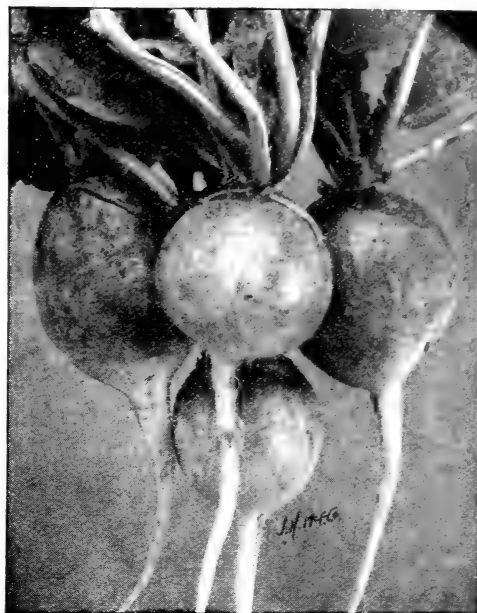

SCARLET GLOBE RADISHES

CHARTER, or SHEPHERD. A long variety, distinct, and one of the hand-somest. Color red at the top, shading through pink in the middle to white at the tip. Attains a very large size before being unfit for use. Too large to be used for forcing, but a desirable variety for outdoor growing.

LONG BLACK SPANISH WINTER. One of the hardiest and best for winter use.

CHINESE ROSE WINTER. A popular winter variety. Roots cylindrical, slightly larger at the bottom, terminating abruptly. Grows about one-half above ground. Color of upper part scarlet, shading to rose in lower portion. Six to 8 inches long.

SALSIFY, or VEGETABLE OYSTER

An ounce will sow
50 feet of drill

Sow early and deeper than parsnip, otherwise culture is the same and, like that, roots, if desired, may be left in the ground through the winter, but should be dug very early in the spring, as they deteriorate rapidly after growth commences.

MAMMOTH SANDWICH ISLAND. Larger, of stronger growth, and less liable to grow prongy than the old Long White. Pkt. 5 cts., oz. 15 cts., 2 ozs. 25 cts., ¼lb. 30 cts., lb. \$1; by express, lb. 90 cts.

SPINACH

An ounce will sow 50 feet of drill,
14 to 16 pounds to the acre

Spinach thrives only on rich land—the richer the better. For earlier use, sow in August or September, in drills 12 to 14 inches apart, covering seed 1 inch. Plants should stand 2 inches or more apart. Protect with a light covering of leaves or straw, which should be removed at first signs of a new growth in spring. For later or early summer use, sow as early as ground can be worked in the spring. The entire crop should be cut before hot weather, as after that the leaves become tough, stringy and of poor flavor.

All varieties, except where price is stated, postpaid, pkt. 5 cts., oz. 10 cts., ¼lb. 15 cts., lb. 35 cts.; by express, lb. 25 cts., 5 lbs. \$1, 100 lbs. \$15

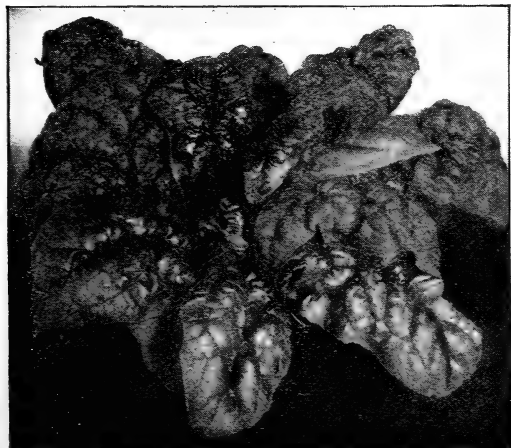

EARLY GIANT THICK-LEAVED SPINACH

ROUND THICK-LEAVED. Leaves large, thick, fleshy and slightly crumpled. Extensively grown, and used for both spring and fall sowing.

EARLY GIANT THICK-LEAVED. Leaves very large and thick, deep green, attaining a size suitable for use earlier than the preceding and plant grows to a larger size before running to seed.

LONG STANDING. A variety which matures early and remains in condition for use longer than most others. Leaves smooth, rich, dark green.

VICTORIA. Leaves large, thick, very dark green, slightly curled in the center. A little later than Long Standing, but surpasses it in the desirable feature of remaining in condition for use for a long time. Especially desirable for spring sowing.

SAVOY-LEAVED, or BLOOMSDALE. The earliest variety and used almost entirely for fall sowing, as it runs quickly to seed in warm weather. Leaves of medium size, dark green, pointed, and crimped. Postpaid, pkt. 5 cts., oz. 10 cts., ¼lb. 15 cts., lb. 40 cts.; by express, lb. 30 cts., 5 lbs. \$1.25.

NEW ZEALAND. This is a plant of a different genus, entirely distinct from the common Spinach. It makes a much larger plant, thrives during hot weather, grows on all soils, rich or poor, and may be cut nearly all summer, new shoots growing when others are cut. As it takes a long time for the seed to germinate, it is preferable to sow in heat and transplant as plants will then reach a size from which the shoots can be cut much earlier than if sown in the open ground, but, as the plant is hardy or half-hardy, and it requires much less care, seed is probably more often sown outdoors. Plants should stand not closer than 3 feet apart each way. Postpaid, pkt. 5 cts., oz. 10 cts., 2 ozs. 18 cts., ¼lb. 30 cts., lb. \$1; by express, lb. 90 cts.

LONG SEASON. A new variety claimed to surpass all others in its ability to withstand hot weather without running to seed. Leaves very dark green, much crumpled, thick, tender and succulent. Postpaid, pkt. 5 cts., oz. 10 cts., 2 ozs. 15 cts., ¼lb. 20 cts., lb. 60 cts.; by express, lb. 50 cts., 5 lbs. \$2.

SQUASH

An ounce of small-seeded varieties will plant 30 to 40 hills; of the larger-seeded varieties, 12 to 15 hills

The Squash is very tender and should not be planted until all danger of frost and cold nights is passed. It thrives best in warm soil which can hardly be made too rich; manure should be worked well into the soil over the entire area, and hills should have a liberal quantity of that which is well rotted. To avoid borers it is more or less the custom to plant as late as possible and is often done as late as the middle of June; in such case, an application of commercial fertilizer or nitrate of soda greatly hastens the first growth. The early bush varieties are generally planted in hills about 5 feet apart and the running varieties about 10. Thin to three plants to the hill.

All prices on this page are postpaid and are subject to a discount of 10 cents from pound price if sent by express or purchased at counter

MAMMOTH WHITE BUSH SCALOP. An improvement on the old variety, larger, pure white and superior in quality. Pkt. 5 cts., oz. 10 cts., 2 ozs. 15 cts., 1/2 lb. 25 cts., lb. 90 cts.

EARLY SUMMER CROOKNECK. For early planting the Crookneck type is used in New England to almost the exclusion of any other. This, while much smaller than the Mammoth Crookneck, is yet largely grown, many considering it of better flavor. Pkt. 5 cts., oz. 10 cts., 2 ozs. 15 cts., 1/2 lb. 25 cts., lb. 85 cts.

MAMMOTH SUMMER CROOKNECK. Vine larger and of more vigorous growth than the Summer Crookneck and fruit is twice as large, and deeper colored. Its large size and attractive appearance have made it popular with market-gardeners. Pkt. 5 cts., oz. 10 cts., 2 ozs. 18 cts., 1/2 lb. 30 cts., lb. \$1.

FORDHOOK. An early running variety, suited for either summer or winter use. Fruit small, oblong, 8 to 10 inches in length, with smooth, thin skin, bright yellow; flesh straw-yellow, dry, sweet and of fine flavor. Excellent for baking or for pies; a remarkable keeper. Pkt. 5 cts., oz. 10 cts., 2 ozs. 18 cts., 1/2 lb. 30c., lb. \$1.

THE FAXON. A very desirable variety for the home garden, very productive, of medium size (five or six pounds), fine-grained, dry, sweet, a good keeper, uniform in shape, but varied in color. This variation in color is a distinct feature of the squash.

Pkt. 5 cts., oz. 10 cts., 2 ozs. 15c., 1/2 lb. 25 cts., lb. 90 cts.

PROLIFIC MARROW (Dunlap's).

The earliest fall variety; from a week to ten days earlier than any other Marrow. Color deep orange. Skin considerably pitted. Not so thick-meated as the Orange Marrow, nor quite equal in quality, but especially desirable on account of its earliness, and also because it is very prolific. Pkt. 5 cts., oz. 10 cts., 2 ozs. 15 cts., 1/2 lb. 25 cts., lb. 85c.

ORANGE MARROW. An early variety, much like the Prolific Marrow in color and pitting, but is more nearly round, later, much thicker-meated, and of better quality. Pkt. 5 cts., oz. 10 cts., 2 ozs. 15 cts., 1/2 lb. 25 cts., lb. 85 cts.

BOSTON MARROW. This grows larger than either of the preceding, but is not of so deep color. Skin thin, yellow, with pinkish tint. Desirable for pies, not so dry as the Hubbard. Pkt. 5 cts., oz. 10 cts., 2 ozs. 15 cts., 1/2 lb. 25 cts., lb. 85 cts.

ESSEX HYBRID. A cross of the Hubbard and Old Turban, partaking somewhat of the features of both. Like the Hubbard, it is hard-shelled. In color it is like the Turban, and in form somewhat resembles it, but an improvement. Pkt. 5 cts., oz. 10 cts., 2 ozs. 15 cts., 1/2 lb. 25 cts., lb. 85c.

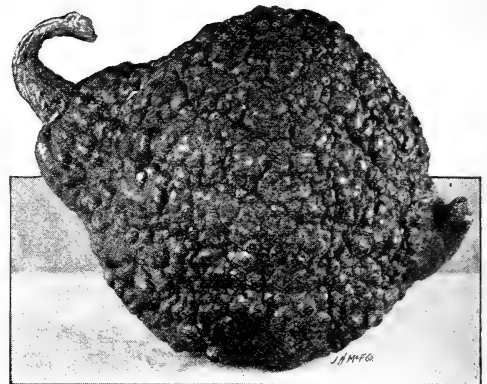

HUBBARD SQUASH

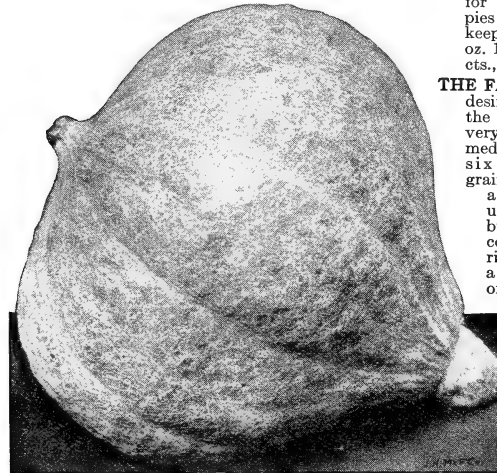

ORANGE MARROW SQUASH



GOLDEN HUBBARD SQUASH

BAY STATE. Similar in shape to the Essex Hybrid; shell slate-color and harder and flesh is dryer than of that variety. Of excellent flavor and very solid. Pkt. 5 cts., oz. 10 cts., 2 ozs. 15 cts., 1/2 lb. 25 cts., lb. 85 cts.

GOLDEN HUBBARD. A distinct sort, of the shape and general character of the Hubbard, but a little smaller, earlier to mature, and a rich orange-red instead of the dark olive-green of the old Hubbard, while the flesh, which is thick, is a little deeper colored, of fully as good quality, fine-grained and dry. Pkt. 5 cts., oz. 10c., 2 ozs. 18 cts., 1/2 lb. 30 cts., lb. \$1.

DELICIOUS. This new Squash, the product of years of careful selection and crossing, in color is almost uniformly of a green shade, with occasionally a blue specimen, it being just about as pure in this respect as the original Hubbard. In size it also closely follows the Hubbard when introduced which weighed between five and ten pounds. The flesh is dark orange, and but few varieties, if any, surpass it in thickness, and none in its combination of fineness of grain, dryness, sweetness and rich flavor. It is a fall and winter Squash, excellent at all seasons, but, like the old Hubbard, does not acquire its best quality until winter. Pkt. 5 cts., oz. 12 cts., 2 ozs. 20 cts., 1/2 lb. 35 cts., lb. \$1.25.

HUBBARD. A well-known and favorite winter variety more largely grown than any other. We offer a choice strain, considered by some of our customers to be superior to the popular Chicago Hubbard. Pkt. 5 cts., oz. 12 cts., 2 oz. 20 cts., 1/2 lb. 35 cts., lb. \$1.25.

CHICAGO, or WARTED HUBBARD. A selection of the Hubbard, with thickly warted shell. Equal in quality to that and generally considered to be of more attractive appearance. Of this also we offer a carefully selected strain, unsurpassed by any we have ever seen. Pkt. 5 cts., oz. 12 cts., 2 ozs. 20 cts., 1/2 lb. 35 cts., lb. \$1.25.

GOLDEN BRONZE. A cross of the Bay State and Boston Marrow. In form the same as the last-named, with stem and blossom end precisely like that variety; also, having the peculiar wrinkled appearance of the skin like the Boston Marrow. Very uniform in size, and weighs about nine pounds. Skin dark grayish green with bronze on upper surface when ripe. Flesh bright yellow, fine-grained, very sweet and of fine flavor. Matures early but keeps well, and the vine is very productive. Pkt. 5 cts., oz. 12 cts., 2 ozs. 20 cts., 1/2 lb. 35 cts., lb. \$1.25.

MARBLEHEAD. Form oval; shell hard slate-colored. Dry, of delicious flavor, and a good keeper. Pkt. 5 cts., oz. 10 cts., 2 ozs. 15 cts., 1/2 lb. 20 cts., lb. 75c.

MAMMOTH CHILI. The largest variety, attaining under special cultivation an enormous size. Pkt. 10 cts., oz. 20 cts., 1/2 lb. 60 cts.



Poultry Books That Are Right

A complete, descriptive circular sent on request
Poultry Manual. For plain and fancy breeders. 25 cents.

Poultry Houses, Coops and Equipments, complete plans up-to-date. 25 cents.

Chicks, Hatching and Rearing— cold facts well stated. 25 cts.

Egg Money; How to increase it—Hundreds of Plans. 25c.

Turkeys, Ducks and Geese. Their care, raising and marketing. 50 cts.

Simple Poultry Remedies. A doctor book for the poultry yard. 25 cts.

Single books, mailed postpaid, at above prices; entire set, six books, postpaid, \$1.50.

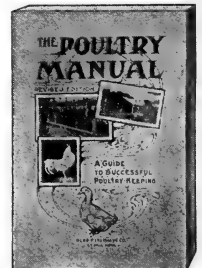

TOMATO

An ounce will produce about 2,000 plants

The Tomato succeeds best in light, warm soil, of medium fertility. Strong and rich soil tends to an overgrowth of vine, and if such is the only available soil, the vines would better be trained to stakes and pruned. And this method is an excellent one for any soil, as the fruits are kept from the ground by pruning, are more open to the sun and ripen earlier, and the vitality, otherwise exhausted in unnecessary growth, is utilized in forming fruits of larger size, more nearly perfect in shape and of better quality. If this plan is adopted, select, when plant is about 10 inches high, the strongest branch and pinch off all others except this and the main stem. Care should be taken that the fruiting stems are not pinched off. Such, however, can soon be distinguished, as the buds form early. As the two stems grow, they should be tied at intervals of 8 or 10 inches to a stake driven deeply into the ground and which should be at least 6 feet high, as all varieties, except those of dwarf habit, will grow about as tall as this, and the most vigorous often much taller. The side branches, which continue to start should be trimmed off. Seed should be sown in the hotbed or in the house in boxes, from six to eight weeks before time to set plants in the open ground, which, in this latitude, is usually close to the first of June. When the plants have attained four leaves, transplant into the cold-frame, or, if seeds were sown in the house, into shallow boxes, allowing about four inches between the plants. Strong, stocky plants at time of setting can be obtained only by an unchecked growth, especially in the first stages, and plenty of air at all times. The dwarf sorts should be set in rows about 3½ feet apart, and 2½ feet apart in the row; the stronger growing varieties in rows 4 or 5 feet apart and at a proportionate distance in the row, unless intended to be staked and pruned, when they may be set somewhat closer.

EARLIANA. An extra-early variety, much superior in smoothness and solidity to any of the older, extra-early sorts, and larger. Vine of rather slender habit, hardy and productive. Fruit deep red; borne in clusters. Pkt. 5 cts., ¼ oz. 18 cts., oz. 30 cts., 2 ozs. 50 cts., ¼ lb. 90 cts.

JUNE PINK. Practically a pink Earliana, the plant being identical in habit and bearing at the same time, while the fruits are the same except in color. Valuable for market-gardeners. Pkt. 10 cts., ¼ oz. 20 cts., oz. 35 cts., 2 ozs. 60 cts., ¼ lb. \$1.10.

ACME. An old, early variety, yet popular with many growers. Fruit of good size, always round and smooth, seldom cracks, and of best quality; bright pink. Vine large and productive, bears first fruits very early and continues in bearing until frost. Pkt. 5 cts., ¼ oz. 15 cts., oz. 25 cts., 2 ozs. 40 cts., ¼ lb. 75 cts.

BEAUTY. The best of its color for main crop. Fruit deep purplish-pink, the largest of all the perfectly smooth tomatoes, and not surpassed in quality. Vine large, vigorous and a heavy bearer. Pkt. 5 cts., ¼ oz. 15 cts., oz. 25 cts., 2 ozs. 40 cts., ¼ lb. 75 cts.

CHALK'S EARLY JEWEL. Fruit above medium size, or large; deep, smooth, solid, and of finest flavor; bright red. Vine vigorous and remarkably productive. One of the best of its color and time of ripening. About ten days later than Earliana. Pkt. 5 cts., ¼ oz. 15 cts., oz. 25 cts., 2 ozs. 40 cts., ¼ lb. 75c.

IMPERIAL. Fruit large and very attractive, resembling the Beauty; is not quite so large, but ripens a little earlier, is always smooth and not surpassed in quality. Vine vigorous and remarkably productive. Pkt. 5 cts., ¼ oz. 15 cts., oz. 25 cts., 2 ozs. 40 cts., ¼ lb. 75c.

PERFECTION. Until the Stone was introduced, the standard red Tomato and yet largely grown. Fruit medium to large, round and smooth and of superior quality. Pkt. 5 cts., ¼ oz. 15 cts., oz. 25 cts., 2 ozs. 40 cts., ¼ lb. 75c.

STONE. A large, very solid and heavy red-fruited sort of exceptional firmness. One of the best varieties for shipping and not surpassed for main crop by any other of its color. Pkt. 5c., ¼ oz. 15c., oz. 25c., 2 ozs. 40c., ¼ lb. 75c.



DWARF CHAMPION TOMATOES



CHALK'S EARLY JEWEL TOMATO

LIVINGSTON'S GLOBE. A new variety of merit. Fruit mostly very large, mainly elongated or globe-shaped. Smooth, solid and of best quality. Vine vigorous and productive, and bears earlier than most main-crop varieties. Pkt. 10 cts., ¼ oz. 18 cts., oz. 30 cts., 2 ozs. 50 cts., ¼ lb. 90 cts.

DWARF CHAMPION. Vine dwarf and compact and of erect habit; early and productive. Fruit of medium size, smaller toward the end of the season. Purplish pink. Pkt. 5 cts., ¼ oz. 15 cts., oz. 25 cts., 2 ozs. 40 cts., ¼ lb. 75 cts.

DWARF STONE. Vine similar in habit to Dwarf Champion, but more vigorous and more productive. Does not bear so early, but fruits are much larger and more uniform in size. Were it not that the color of the Dwarf Champion is preferred by many, this would displace it entirely. As it is, it is rapidly growing in favor. Bright red. Pkt. 5 cts., ¼ oz. 18 cts., oz. 30 cts., 2 ozs. 50c., ¼ lb. 90 cts.

GOLDEN QUEEN. A very attractive variety. Fruit large, smooth, solid and we think of richer flavor than any of the standard varieties. Should be more largely grown for home use. Pkt. 5 cts., ¼ oz. 15 cts., oz. 25 cts.

RED PEAR. Fruit bright red, rather small, distinctly pear-shaped; of rich flavor and used largely for preserving. The stock we offer is the true pear-shaped, not the large red plum often sold for it. Pkt. 5 cts.

YELLOW PEAR. Identical with Red Pear, except in color. Clear rich yellow. Pkt. 5 cts.

YELLOW PLUM. Small, plum-shaped fruit of rich flavor. Desirable for preserving, and pickling. Pkt. 5 cts.

YELLOW HUSK, STRAWBERRY, or GROUND CHERRY. Fruit about the size of a small cherry, borne in husks; of very rich flavor; used only for preserves. Plant also distinct. Pkt. 5 cts.

HERBS, SWEET OR POT AND MEDICINAL

| | Pkt. | Oz. | | Pkt. | Oz. |
|-----------|--------|--------|----------------|--------|--------|
| CARAWAY | \$0 05 | \$0 10 | SAGE | \$0 05 | \$0 20 |
| CATNIP | 05 | 40 | SUMMER SAVORY | 05 | 20 |
| CORIANDER | 05 | 10 | SWEET MARJORAM | 05 | 20 |
| DILL | 05 | 15 | THYME | 05 | 40 |
| FENNEL | 05 | 15 | | | |

TOBACCO

CONNECTICUT SEED LEAF. Pkt. 5 cts., oz. 25 cts.
 HAVANA. Pkt. 10 cts., oz. 40 cts.

Systematic Pomology. Waugh. Treating on the descriptive nomenclature and classification of fruits. \$1.

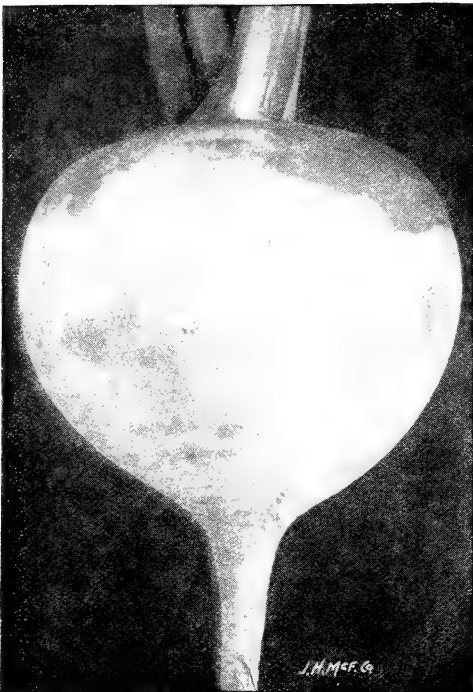

PURPLE-TOP WHITE GLOBE

TURNIP

An ounce will sow 150 feet of drill If sown in drills one pound is required for an acre ; if sown broadcast less seed is sufficient if sown evenly

Turnips thrive in well-enriched, medium to light soil, succeeding best on land that was shortly before in grass, enriched at time of sowing with a liberal application of commercial fertilizer. They should not be grown on the same land two years in succession nor should they follow a crop of cabbage or radish. For early use seed should be sown as soon as ground can be prepared so that the roots will be of sufficient size before hot weather which makes them tough and stringy. At best, early turnips are not very satisfactory. The main need for early varieties is for especially late planting, while for a long time it was held that July 25 was the latest date at which Turnips could profitably be sown, more seed is now sown after that than before, and good roots are often obtained from seed sown as late as September 1. The roots are much sweeter if they do not attain their size until after several hard frosts. The above regarding the time of sowing applies only to the English or common Turnips, the Swedes or Rutabagas, requiring a longer season, should be sown not later than July 15. The rows of the English varieties should be from 1½ to 2 feet apart and plants thinned to 4 to 7 inches, according to variety and its top-growth. These varieties are often sown broadcast and too often too much seed is used; a half-pound is sufficient for an acre if sown evenly. The Swedish varieties require more space; rows should be at least 2½ feet apart and plants should not be nearer than 10 inches. Seed of this class should never be sown broadcast.

All prices on this page are postpaid, and are subject to a discount of 10 cts. from pound prices if to be sent by express or purchased at counter

EARLY WHITE MILAN. Roots flat, smooth and symmetrical; pure white. Top very small, upright and compact, permitting close planting. The earliest and much the best of any extra-early white variety. Pkt. 5 cts., oz. 10 cts., 2 ozs. 15 cts., ¼lb. 25 cts., lb. 90 cts.

EARLY PURPLE-TOP MILAN. Differs from the preceding in that the roots are not quite so thick and are purple on top. Pkt. 5 cts., oz. 10 cts., 2 ozs. 15 cts., ¼lb. 25 cts., lb. 90 cts.

EARLY PURPLE-TOP FLAT. A well-known variety and very extensively grown. Roots smooth, white, with the upper portion purplish red. Pkt. 5 cts., oz. 10 cts., 2 ozs. 15 cts., ¼lb. 20 cts., lb. 60 cts.

EARLY SNOWBALL. Pure white, round, of medium size. Ready for the table six weeks after planting. Of fine quality. Pkt. 5 cts., oz. 10 cts., 2 ozs. 15 cts., ¼lb. 20 cts., lb. 75 cts.

EARLY PURPLE-TOP WHITE GLOBE. One of the handsomest varieties, the upper portion of the root being a purplish red, the lower pure white. A rapid grower, attaining a marketable size sooner than other large globular varieties. Of the best quality and an excellent keeper. Owing to its strong growth, should be more severely thinned than other early varieties. Pkt. 5 cts., oz. 10 cts., 2 ozs. 15 cts., ¼lb. 20 cts., lb. 70 cts.

WHITE EGG. More extensively grown than any other variety. White, egg-shaped, smooth and symmetrical, of medium size; flesh firm, sweet and mild. Pkt. 5 cts., oz. 10 cts., 2 ozs. 15 cts., ¼lb. 20 cts., lb. 60 cts.

GOLDEN BALL, or ORANGE JELLY. Of globular form, medium size, skin rich orange; flesh pale amber, very fine-grained, mild and sweet. One of the most attractive, of the best quality and keeps well. Pkt. 5 cts., oz. 10 cts., 2 ozs. 15 cts., ¼lb. 20 cts., lb. 60 cts.

YELLOW GLOBE. The standard yellow variety. The form is round, slightly flattened. Largely grown for stock and, to some extent, for market. An excellent keeper. Pkt. 5 cts., oz. 10 cts., 2 ozs. 15 cts., ¼lb. 20 cts., lb. 60 cts.

COW HORN, or LONG WHITE. Root long, slightly crooked and grows nearly half above ground. Clear white, except a little green at top. Though more largely used for feeding stock, it is a fine table variety, being tender, and of mild flavor. Of very rapid growth. Pkt. 5 cts., oz. 10 cts., 2 ozs. 15 cts., ¼lb. 20 cts., lb. 70 cts.

Swedish, Russian or Rutabaga

SWEET GERMAN. An old variety yet largely grown, mainly for table use. Sweet and mild. Pkt. 5 cts., oz. 10 cts., 2 ozs. 15 cts., ¼lb. 20 cts., lb. 60 cts.,

WHITE FRENCH, or ROCK. Also an old and popular sort. Roots a little longer than Sweet German, but does not otherwise differ. Valuable for table or feeding. Pkt. 5 cts., oz. 10 cts., 2 ozs. 15 cts., ¼lb. 20 cts., lb. 60 cts.

BUDLONG. Originated in Rhode Island by Mr. Budlong, a very extensive grower of Rutabagas. Earlier and more nearly round than other white varieties of this class. Pkt. 5 cts., oz. 10 cts., 2 ozs. 15 cts., ¼lb. 20 cts., lb. 60 cts.

BREADSTONE. An early variety, white, faintly colored at top; of medium size, tender, mild and sweet. Pkt. 5 cts., oz. 10 cts., 2 ozs. 15 cts., ¼lb. 20 cts., lb. 60 cts.,

SHAMROCK. A popular English Yellow Swede. A decided favorite with our local trade. Has short neck, shape oblong. Pkt. 5 cts., oz. 10 cts., 2 ozs. 15 cts., ¼lb. 20 cts., lb. 60 cts.

LONG ISLAND IMPROVED. This is undoubtedly the finest variety of Purple-Top. Rutabaga. It grows much larger than other American varieties; is, therefore, desirable for stock, but equally desirable for the table and market, as it is tender and sweet, and of very attractive appearance. Pkt. 5 cts., oz. 10 cts., 2 ozs. 15 cts., ¼lb. 20 cts., lb. 60 cts.



LONG ISLAND IMPROVED SWEDE

Popular Fruit Growing. By Samuel B. Green. An authentic book treating on the practical methods of fruit growing, from planting to marketing. It covers the subject of insects and the best methods of destruction, winter protection, grafting, pruning and every other phase of interest to the practical fruit-grower, including small fruits. A valuable book for only \$1, postpaid.

Amateur Fruit Growing. This is a splendid guide for all those who have not made a study of fruit growing and wish to follow a course of instruction that will insure successful results. This book deals with only the common practices and the simple methods of fruit-culture. An excellent book for the amateur. Plain, straightforward fruit-talk. 25 cents.

Grain and Miscellaneous Seeds for Forage Crops

While we shall endeavor to maintain throughout the season the prices on this page, all quotations are subject to change without notice if the market changes greatly. All prices include bags

BARLEY

For grain, 2 bushels to the acre; for forage, 3 bushels 48 lbs. to the bushel

CHEVALIER. A two-rowed variety. Heads a little longer than the six-rowed varieties and the grain is larger, plump, extra-heavy and in favorable seasons nearly white. On account of its attractive appearance and fine quality, the grain brings the highest price, while the variety is extensively grown for green forage. Pk. 50 cts., bus. \$1.85, 2 bus. \$3.60, bags included.

MANSURY. A six-rowed variety, largely grown for forage. Pk. 40 cts., bus. \$1.55, 2 bus. \$3, bags included.

BEARDLESS. Free from beards common to all varieties except the New White Hull-less. While very productive of grain, the variety is used in this section only for forage, and for this purpose its use is rapidly increasing. The grain, while it germinates well, is always light in weight and the least attractive of any. Pk. 50 cts., bus. \$1.70, 2 bus. \$3.30, bags included.

NEW WHITE HULL-LESS. This valuable new variety is not only hull-less but beardless. Very early and extremely productive, yielding well on poor soils and enormously on good land. Not only one of the best for grain but also for forage and hay. Pk. 60 cts., bus. \$2, 2 bus. \$3.90, bags included.

BUCKWHEAT

For grain, 1 bushel to the acre; for soiling, 1 1/2 bushel. 48 lbs. to the bushel

JAPANESE. By far the best variety. Earlier, yields better and grain is larger than that of other kinds. Pk. 45 cts., bus. \$1.60, 2 bus. \$3, bags included.

SILVER HULL. Kernels not so large as Japanese but larger than common buckwheat, and the plant produces more while they make more nearly white flour. Pk. 45 cts., bus. \$1.60, 2 bus. \$3, bags included.

OATS

For grain, 2 1/2 bushels to the acre; for forage, 1 to 1 1/2 bushel. 32 pounds to the bushel

AMERICAN. Selected heavy and well cleaned. Pk. 25 cts., bus. 75 cts., 2 1/2 bus. \$1.80, 10 bus. \$6.75, bags included.

LONG'S WHITE-TARTAR. Claimed to be the earliest, heaviest and most prolific domestic grown Oat in cultivation, and suitable for all soils. The straw is long and stout, and does not easily lodge. The heads are from 8 to 10 1/2 inches in length, while the kernels are very large, plump and heavy. Pk. 35 cts., bus. \$1.25, 2 1/2 bus. \$3, 10 bus. \$11.50, bags included.

CANADIAN CLUSTER. A strong-growing variety producing a tall, stiff straw and a fine large head. Not inclined to rust. Grain large, plump and heavy, usually weighing 40 pounds or more to the measured bushel. Pk. 35 cts., bus. \$1.25, 2 1/2 bus. \$3, 10 bus. \$11.50, bags included.

RYE

For grain, 1 bus. to the acre; for forage or soiling 1 1/2 bus. 56 lbs. to the bus. Prices include bags

SPRING. Pk. 50 cts., bus. \$1.85, 2 bus. \$3.60.

WINTER. Pk. 40 cts., bus. \$1.35, 2 bus. \$2.60.

WHEAT

1 to 1 1/2 bus. to the acre. 60 lbs. to the bus. Prices include bags

SPRING. Pk. 60 cts., bus. \$2, 2 bus. \$3.90.

WINTER. Rapidly increasing in favor as an early forage crop. Pk. 50 cts., bus. \$1.75, 2 bus. \$3.40.

PEAS, CANADA FIELD

1 1/2 bushel to the acre; with oats, 1 bushel. 60 pounds to the bushel

Extensively planted for green forage, generally with oats, but sometimes with barley. Also sown alone for plowing into the soil and for making into hay. Pk. 60 cts., bus. \$2, 2 bus. \$3.85, 10 bus. \$18.50, bags included.

VETCHES

One bushel to the acre; with oats or rye, 1/2 bus.; 60 pounds to the bushel

SPRING VETCH, or SPRING TARE. Used for the same purposes as Canada peas. Lb. 10 cts., lb. by mail, 20 cts.; 10 lbs. 85 cts., 25 lbs. \$1.80, bus. \$3.85, 100 lbs. \$6.25, bags included.

WINTER, SAND, or HAIRY VETCH. This thrives on poor, sandy soil and will produce enormous crops of green forage or hay. It is perfectly hardy, may be sown in either spring or fall and is one of the best cover crops. Reports

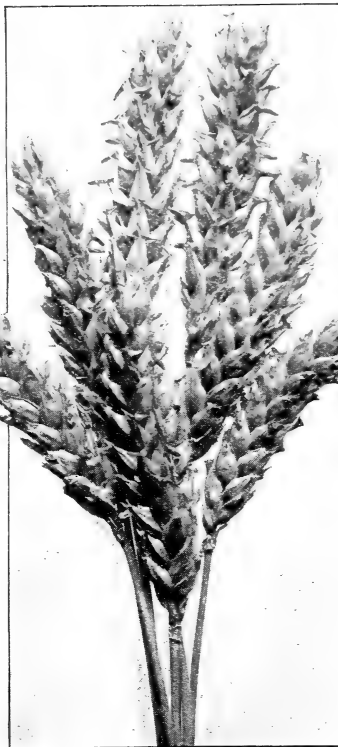

BARLEY

Winter, Sand, or Hairy Vetch, continued from several Agricultural Stations and large growers show that there is nothing superior if equal to this as a nitrogen-gatherer and humus-producer. Lb. 15 cts., lb. by mail, 25 cts.; 10 lbs. \$1.40, 25 lbs. \$3.35, bus. \$7.50, 100 lbs. \$12, bags included.

COW-PEAS

This is not only an excellent forage plant, but a great soil-enricher as well, and has been rightly termed the "poor man's bank," as, in common with all leguminous plants, it increases the fertility of the soil upon which it grows. Seed may be planted in drills or broadcast; the amount varying from eight quarts to two bushels per acre, less, of course, being required if sown in drills 18 to 30 inches apart than when broadcast. While there are a number of varieties, we have not thought it necessary to offer more than two. Of these, the Whip-poorwill is here used much in excess of the other.

CLAY. Pk. \$1, bus. (60 lbs.) \$3.75.

WHIPPOORWILL. Pk. \$1, bus. \$3.65, bags included.

SOY, or SOJA BEAN

1/2 to 3/4 bushel to the acre in drills 2 1/2 to 3 feet apart

This is another valuable legume, growing in favor for forage and ensilage, often succeeding well on land too light for clover.

MEDIUM EARLY YELLOW. Pk. \$1, bus. (60 lbs.) \$3.50.

MEDIUM EARLY GREEN. Pk. \$1.15, bus. \$4.25, bags included.

DWARF ESSEX RAPE

Used both for green manuring and for pasturing sheep and hogs, and is considered by many to be the cheapest feed for these animals and to leave the land in an improved condition after the crop has been eaten by them. Sow as soon as frost is out of the ground; the crop will be ready for pasturing in about six weeks. Sow in drills, 2 1/2 feet apart; it will require about three pounds per acre, broadcast about double that quantity. Lb. 12 cts., lb. by mail, 25 cts.; 10 lbs. \$1, 25 lbs. or over, 9 cts. per lb.

Books on Farm Crops

FORAGE CROPS OTHER THAN GRASSES—Shaw. How to cultivate, harvest, and use them. \$1.

THE CEREALS IN AMERICA—Hunt. A book of intense interest to every farmer. \$1.75.

ALFALFA—Coburn. History, cultivation and merits; its use as forage and fertilizer. \$2.



FIELD OF OATS

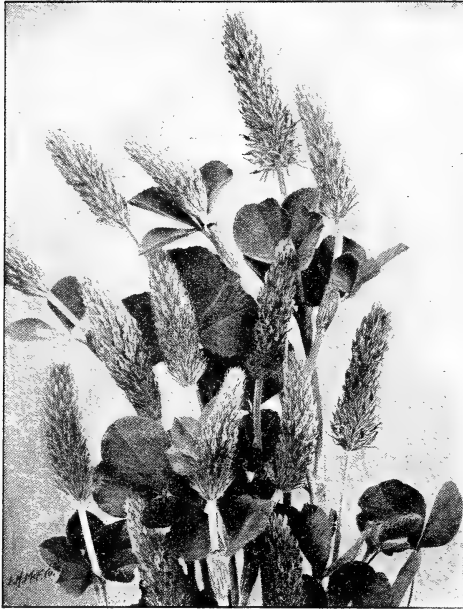

CRIMSON CLOVER



TIMOTHY



RED-TOP GRASS

Grass Seeds of the Highest Grade

With the exception of Red-Top and Timothy, of which other grades are offered, the seeds of all varieties of grasses are of the grade known as "fancy"—the highest grade obtainable and as nearly pure and free from weed seeds as the greatest care and most improved machinery can make it. This should be remembered when comparing prices.

Prices of all Grass Seeds subject to market changes. If desired by mail, add 8 cts. per lb. to prices quoted. Prices include bags or sacks. Unless otherwise noted, 25 lbs. at 100-lb. rate

AWNLESS BROME GRASS (*Bromus inermis*). A hardy and productive grass, thriving on very dry and poor soil, where most other grasses would not grow. Lb. 18 cts., 10 lbs. \$1.65, 100 lbs. \$15.

CANADA BLUE GRASS (*Poa compressa*). Thrives on poor, dry soil, and also on hardy, clayey ground; withstands extremes of drought or wetness; bears trampling well and remains green till winter. A valuable grass for pastures. Lb. 22 cts., 10 lbs. \$2, 100 lbs. \$19.

CREeping BENT. (*Agrostis stolonifera*). Of rapid growth, fine texture and spreading habit. Forms a very close and permanent sod. Especially valuable for lawns. Lb. 30 cts., 10 lbs. \$2.75, 100 lbs. \$25.

CRESTED DOG'S-TAIL (*Cynosurus cristatus*). Thrives best on moist, rich soil, but accommodates itself to nearly all soils. Grows well in the shade. Valuable in moderate quantity for permanent pasture and lawns. Lb. 35c., 10 lbs. \$3.25, 100 lbs. \$30.

ENGLISH, or PERENNIAL RYE GRASS (*Lolium perenne*). Of rapid growth and productive; produces a strong growth in four or five weeks. Made into hay it is rather hard, but is very nutritious and is much relished by cattle and horses. Lb. 12 cts., 10 lbs. \$1, 100 lbs. \$9.

PERENNIAL RYE GRASS. Selected Dwarf. A selected short-seeded strain, suitable for the lawn. Makes a fine green turf in a few weeks. Lb. 14 cts., 10 lbs. \$1.25, 100 lbs. \$10.

FINE-LEAVED, or SLENDER FESCUE (*Festuca angustifolia*). A very fine-bladed grass, valuable for lawns; grows well in the shade and in dry, inferior soils. Is very hardy, lasts long and bears grazing well. Lb. 38 cts., 10 lbs. \$3.50, 100 lbs. \$34.

HARD FESCUE (*Festuca duriuscula*). A variety of Sheep's Fescue, of dwarf habit; like that, thrives on poor soil and is very hardy. Lb. 25 cts., 10 lbs., \$2.40, 100 lbs. \$22.

ITALIAN RYE GRASS (*Lolium italicum*). Thrives on a variety of soils, producing early and large crops. Though a perennial, it is short-lived and generally treated as an annual. Valuable for soiling. Sown in the fall, will produce a large crop of hay the following season. Lb. 12 cts., 10 lbs. \$1, 100 lbs. \$9.

KENTUCKY BLUE GRASS (*Poa pratensis*). One of the most valuable grasses for pasture and lawn, requires some time to become established but lasts indefinitely on congenial soils. Lb. 30 cts., 10 lbs. \$2.85, 100 lbs. \$27.

MEADOW FESCUE (*Festuca pratensis*). Largely used for both temporary and permanent mowing mixtures. Though at once productive, it does not reach its full production for two or three years, when it surpasses most other grasses. Succeeds best on cool, moist soil, rich in organic matter. Lb. 40 cts., 10 lbs. \$3.75, 100 lbs. \$36.

MEADOW FOXTAIL (*Alopecurus pratensis*). One of the best pasture grasses; makes an earlier growth than any other variety, thrives best in low, moist land, but grows well on high, light soil and bears extreme summer heat without burning. Lb. 35 cts., 10 lbs. \$3.20, 100 lbs. \$30.

ORCHARD GRASS (*Dactylis glomerata*). One of the most nutritious and valuable grasses, early, hardy and permanent and thrives in all soils and situations. Bears frequent mowing and constant cropping, and is very productive. Should be included in liberal proportions in most mixtures for both mowing and pastures. Lb. 25 cts., 10 lbs. \$2.35, 100 lbs. \$21.50.

RED, or CREEPING FESCUE (*Festuca rubra*). A creeping-rooted grass thriving in dry, poor soils. Forms a close, firm turf and is valuable for shaded lawns. Also valuable for gravelly banks and exposed hillsides. Lb. 30 cts., 10 lbs. \$2.75, 100 lbs. \$26.

RED-TOP (*Agrostis vulgaris*). Next to Timothy the most largely used grass; succeeds best on moist soil, but thrives well on a variety of soils, and is valuable for permanent mowing, pastures and lawns. **Re-cleaned, or Fancy.**

Worcester Grade. Lb. 23 cts., 10 lbs. \$2.10, 100 lbs. \$20.

Prime Grade. Lb. 21 cts., 10 lbs. \$1.90, 100 lbs. \$18.

RHODE ISLAND BENT (*Agrostis Canina*). Of fine growth, forming a close and permanent sod. One of the best lawn grasses and desirable for pasture mixtures. Lb. 28 cts., 10 lbs. \$2.65, 100 lbs. \$25.

ROUGH-STALKED MEADOW GRASS (*Poa trivialis*). Thrives on moist, rich land. Valuable for both meadows and pastures, but should be used only in mixtures. Especially desirable for shaded lawns. Lb. 40 cts., 10 lbs. \$3.75, 100 lbs. \$35.

SHEEP'S FESCUE (*Festuca ovina*). Of dwarf but thick growth; thrives on dry uplands and in poor, sandy or gravelly soils where other grasses would fail. Valuable for pasture mixtures. Lb. 25 cts., 10 lbs. \$2.40, 100 lbs. \$22.

SWEET VERNAL (*Anthoxanthum odoratum*). Used in small quantity in both meadow and pasture mixtures on account of its pleasing fragrance, and is especially desirable for the pasture because of its both early and late growth. True perennial. Lb. 75 cts.

TALL MEADOW FESCUE (*Festuca elatior*). On strong, moist, or clayey soils, very productive and permanent. Very nutritious, readily eaten by all stock; should form a part of all meadow and pasture mixtures for moist soil. Lb. 40 cts., 10 lbs. \$3.75, 100 lbs. \$36.

TALL MEADOW OAT GRASS (*Avena elatior*). A very hardy species, making an early and luxuriant growth and continuing to grow until late in the fall and is, therefore, especially desirable for pastures. It makes good hay and, when used for soiling, can be cut several times in the season. Lb. 27 cts., 10 lbs. \$2.40, 100 lbs. \$22.

TIMOTHY (*Phleum pratense*). More largely used than any other grass but often when other varieties would be more profitable. 45 lbs. to the bus.

Worcester Grade. Heavy, re-cleaned seed, guaranteed 99 per cent pure. Lb. 18 cts., 10 lbs. \$1.50, ½ bus. \$3.10, bus. \$6, 2½ bus. or more, \$5.90 per bus., bags included.

Prime Grade. Lb. 17 cts., 10 lbs. \$1.40, ½ bus. \$2.90, bus. \$5.60, 2½ bus. or more \$5.50 per bus., bags included.

GRASS SEEDS, continued

VARIOUS-LEAVED FESCUE (*Festuca heterophylla*). Of early growth and permanent, thriving best in cold, moist land, rich in humus and potash. Grows well in the shade. Valuable in mixtures for permanent mowing, pastures and shaded lawns. Lb. 30 cts., 10 lbs. \$2.75, 100 lbs. \$25.

WOOD MEADOW GRASS (*Poa nemoralis*). A very early, hardy and permanent species, valuable for shaded lawns and permanent pasture mixtures. Lb. 70 cts., 10 lbs. \$6.50.

For mixtures for mowing and pastures see next page; for lawn mixtures see pages 6 and 7.

CLOVERS (Bags included)

Clover, Like all Other Legumes, Enriches the Land on Which it Grows

MEDIUM RED (*Trifolium pratense*). The well-known Red Clover. Lb. 23c.; 10 to 50 lbs., 21 cts. per lb.; 50 lbs. or more, 20 cts. per lb.

MAMMOTH, or PEA VINE (*Trifolium pratense* var.). A variety of the preceding of larger growth. Lb. 24 cts.; 10 to 50 lbs., 22 cts. per lb.; 50 lbs. or more, 21 cts. per lb.

ALSIKE, or SWEDISH (*Trifolium hybridum*). Hardy, productive, fragrant; succeeds best on stiff, cold soils. Lb. 23 cts.; 10 to 50 lbs., 21 cts. per lb.; 50 lbs. or more, 20 cts. per lb.

WHITE (*Trifolium repens*). Used in nearly all mixtures for lawns and valuable for pastures. Lb. 35 cts., 5 lbs. \$1.60, 10 lbs. \$3, 25 lbs. or more 29 cts. per lb.

CRIMSON (*Trifolium incarnatum*). An annual used for soiling and for plowing under to enrich the soil. Lb. 21 cts.; 10 to 50 lbs., 19 cts. per lb.; 50 lbs. or more, 18 cts. per lb.

ALFALFA (*Medicago sativa*). Within the last two years some good crops of Alfalfa have been grown in New England. It seems to be the consensus of opinion of the successful growers that it requires well-drained land and an abundant application of lime previous to sowing, and that August is the best time to sow. 20 to 25 pounds to the acre. Lb. 26 cts.; 10 to 50 lbs., 24 cts. per lb.; 50 lbs. or more, 23 cts. per lb.



MEDIUM RED CLOVER



JAPANESE, OR BARNYARD MILLET

MILLETS (Prices include bags)

HUNGARIAN GRASS (*Panicum Germanicum*). Used extensively for forage and to some extent for hay. Withstands drought well, succeeds on ordinary soil, and on rich land two crops may be grown the same season. One bushel, (48 lbs.) to the acre. Pk. 50 cts., 1/2 bus. 90 cts., bus. \$1.70, 2 1/2 bus. or more, \$1.60 per bus.

GERMAN, or GOLDEN (*Setaria Italica*). Of stronger, and taller growth than the preceding and requires richer land. Has an abundant foliage; is, therefore, an excellent forage crop and makes a coarse, rather harsh hay, but which is readily eaten by all kinds of stock if cut at the proper time. 50 lbs. to the bushel, 1/4 to 1 bushel to the acre. Pk. 50 cts., 1/2 bus. 95 cts., bus. \$1.80, 2 1/2 bus. or more, \$1.70 per bus.

SIBERIAN, or RUSSIAN. Resembles Hungarian but plant is somewhat larger and rather more leafy; matures about the same time. It is said to stand drought better than any other millet, and also, that when made into hay it is preferred by stock to any other. 50 lbs. to the bushel. 1/4 to 1 bushel to the acre. Pk. 50 cts., 1/2 bus. 95 cts., bus. \$1.80, 2 1/2 bus. or more, \$1.70 per bus.

JAPANESE, or BARNYARD. (*Panicum Crus Galli*). A very popular forage plant of very rank growth, from 6 to 7 feet high, with much larger leaves than any of the preceding. Like all coarse-growing plants it needs abundant plant-food and, when given this on good soil, the yield is immense. While its use has been largely confined to soiling purposes, it may be used for ensilage and is, when cut at the proper stage and made into hay, readily eaten by both cattle and horses. It may be sown from May 15 to July. 15 pounds to the acre. Lb. 10 cts., 10 lbs. 75 cts., 25 lbs. \$1.50, 50 lbs. or more, 5 cts. per lb.

VEGETABLE GARDENING BOOKS

- GARDENING FOR PROFIT. Henderson.....\$1 50
- GARDENING FOR PLEASURE. Henderson..... 1 50
- GARDENING FOR YOUNG AND OLD. Henderson 1 00



MIXTURES OF GRASS SEEDS

Prices include bags
or sacks

For Meadows and Pastures

It seems to us to be beyond dispute that a thicker growth, therefore larger yield, may be obtained by sowing a mixture of many varieties than by the use of one or a few. Many of the grasses of fine growth are rich in nutritive quality and of heavy bottom growth, but their scanty top growth makes them unsuitable for sowing alone. Combined, however, with those of coarser and taller growth, they fill the interstices, restraining the rank growth of the latter, making them thereby more tender, and greatly increasing the total yield, the whole producing not only a larger yield and much heavier aftermath at once, but, if properly combined, for many years.

We are confident that a trial of any of the following mixtures will prove that each, for the purpose indicated, is superior in various respects to the common method of seeding with timothy and red-top. For though each of these is a very excellent and a necessary grass, used alone or together, they are inadequate for the largest production and most permanent results, and, in some locations or soils, entirely unsuited.

With these mixtures we advise a sowing of from four to eight pounds of clovers, according to the nature of the soil and mixture; on soil known to be especially adapted for clover, the maximum quantity might, perhaps, be profitably increased. The quantity most advisable can be determined better by the individual farmer than by us. For general advice, we would suggest that for soils of medium texture and moisture, two pounds of medium Red or Mammoth to one of Alsike would be a good proportion. For moist soils, just the reverse—two of Alsike to one of Medium or Mammoth. White Clover would better be used to some extent with all pasture mixtures and Alsike with those for medium and moist soils. The great value of clover as a soil-enricher, as well as its value for feeding, makes it well worth while to try it to some extent on light soils. It is our opinion that the clovers would more often thrive on light land if used in connection with a mixture of several grasses than when used with timothy alone, because the more dense growth of the mixture would serve to shade and cool the soil. We cannot include clover seeds in our mixtures, because, on account of their greater weight, they should be sown alone, and also, because, in this latitude, they should not be sown much later than August.

Mixture for Mowing for Medium Soil

On soil which is of average natural fertility and neither unusually dry nor wet, well enriched before sowing and regularly top-dressed, in short, on soil which will produce good timothy hay, this mixture will produce at first cutting a larger crop and a much heavier aftermath of hay, which, though not like timothy, salable in cities for feeding horses, is, nevertheless, superior for feeding to both cattle and horses, because richer in nutriment, and more readily eaten because more tender; that is, if seed is used in sufficient quantity and crop is harvested at proper time. And not only will the product be greater at first, but, if properly treated, the land will continue in productive condition for many years. Forty pounds to the acre. Lb. 20 cts.; 10 to 40 lbs. 18 cts. per lb.; 40 lbs. or more, 17 cts. per lb.

Mixture for Permanent Mowing for Moist Soil

It should be understood that by moist soil we do not mean that which is swampy, but rather such as is often termed "natural grass land," because more nearly wet than many soils which, though not so well adapted for grass as a heavier and moister soil, will yet produce good crops of hay. On land moist, cool, heavy and rich, this mixture will produce enormous crops for an almost indefinite period. It differs from the preceding in that, while it contains most of the species and varieties which form that mixture (but in different proportions), it also contains grasses which thrive on, in fact require strong and moist soil. 35 to 40 pounds to the acre. Lb. 20 cts.; 10 to 40 lbs., 18 cts. per lb.; 40 lbs. or more, 17 cts. per lb.

Mixture for Permanent Mowing for Dry Soil

While dry land is not the ideal soil for a grass crop, much larger crops can be obtained with this mixture than with timothy and red-top, because it contains, in large proportions, varieties which thrive on dry soil and of which some succeed on soil where both the former would utterly fail. 40 to 50 pounds to the acre. Lb. 20 cts.; 10 to 40 lbs., 18½ cts. per lb., 40 lbs. or more, 17½ cts. per lb.

Mixture for Permanent Pasture for Medium Soil

Though many farmers so rotate their crops that the permanency of their mowing fields is not of great consideration, such as regularly pasture their herds, invariably desire that the pasture shall be permanently productive when once seeded. Aside from permanency, an important requisite is that of continual growth from early spring until fall. And as many varieties as possible should be used which bear constant trampling and continued close grazing. This mixture is prepared with these ends in view. 40 to 50 pounds to the acre. Lb. 20 cts.; 10 to 40 lbs., 18½ cts. per lb.; 40 lbs. or more, 17½ cts. per lb.

Mixture for Permanent Pasture for Moist Soil

Moist and strong land is not only the ideal soil for mowing, but is as well the best for the pasture, and for this purpose a mixture is, perhaps, even more necessary than for the mowing field. Like the preceding, this mixture is prepared to meet the requirements of continual growth and permanent productiveness, and contains, in large proportions, the grasses which are at their best on moist soil. 40 pounds to the acre. Lb. 20 cts.; 10 to 40 lbs., 18½ cts. per lb.; 40 lbs. or more, 17½ cts. per lb.

Permanent Pasture Mixture for Dry Hilly Lands

In no situation are timothy and red-top so unsuitable for seeding as in a dry, hilly pasture, for both require strong, rather moist land to thrive for any length of time. This mixture is composed of grasses which thrive on light soil, endure long drought and bear, without injury, constant cropping. 40 pounds to the acre. Lb. 20 cts.; 10 to 40 lbs., 18½ cts. per lb.; 40 lbs. or more, 18 cts. per lb.

Flower Seeds

The smallest yard in Japan is made attractive and pretty by a wonderful arrangement of walks, trees, shrubs and flowerers. Surely there is not a single home in America that should be without at least a small garden of flowers. With this wonderful selection of the best standard sorts offered in this book, and at a trifling expense, a succession and profusion of bloom can easily be obtained.

ANNUALS attain full growth from seed, flower and die in one year.

HARDY ANNUALS can usually be sown as soon as the ground is worked in spring.

BIENNIALS grow from seed one year, bloom and die the next, though some varieties bloom the first season when sown early.

PERENNIALS live for a number of years, blooming annually after the first season, although some kinds will flower the same year if sown early.

HALF-HARDY varieties of **BIENNIALS** and **PERENNIALS** require winter protection of plants.

How to Order

When ordering, always give catalogue variety number; and while it is not necessary to give name it often serves to indicate more fully what the customer desires, as in the event of the number and name differing, we always send the variety indicated by the name as probably the one desired.

All Flower Seeds by the packet, fraction of an ounce, ounce and quarter-pound, sent postpaid at prices quoted. In larger quantities, by the half-pound and pound, they will be sent at option of the customer, either by mail, postpaid, or by express at customer's expense, as per quotations.

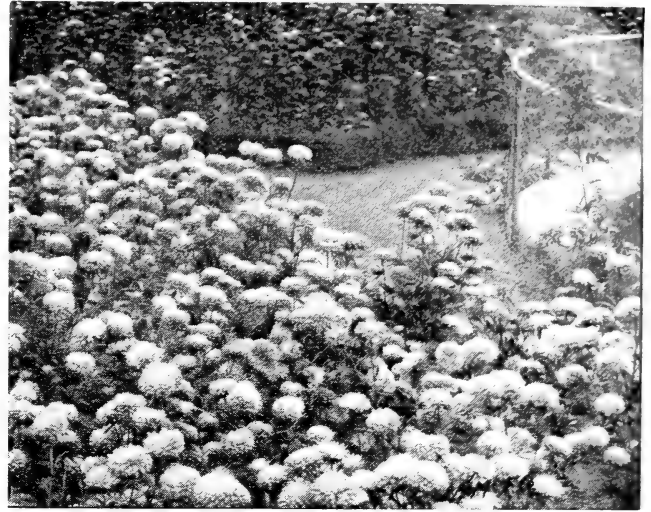

A BED OF ASTERS ALWAYS GIVES SATISFACTION

ASTERS

Our Aster seeds were procured from the most noted American and European growers, who grow fine seeds of unsurpassed quality. This popular annual thrives in nearly all soils if well enriched. Seed may be sown in the open ground early in the spring, in this latitude usually by the last of April. The first week in May is early enough, as plants from seed sown then will usually be through blooming before frost. Good blooming plants are often grown from seed sown as late as the middle of June, but when sown so late as this, the early varieties are preferable and the plants should be grown in rich soil, with the best of care.



GIANT BRANCHING ASTERS

- 1 **QUEEN OF THE EARLIES**, or **EARLIEST PARIS WHITE**. One of the earliest white Asters; stems long; fine for cutting. Pkt. 5 cts., $\frac{1}{8}$ oz. 20 cts., $\frac{1}{4}$ oz. 35 cts., oz. \$1.
- 2 **QUEEN OF THE MARKET**. A very early-blooming strain, which, though plant is only $1\frac{1}{4}$ feet high, bears from ten to fifteen well-formed, medium-sized flowers on long stems. Much used by florists.
- 3 **White**. 5 **Rose**. 6 **Light Blue**. 9 **Mixed Colors**. Each, Pkt. 5 cts., $\frac{1}{8}$ oz. 20 cts., $\frac{1}{4}$ oz. 35 cts., oz. \$1.25.
- 15 **EARLY SNOWDRIFT**. An extra-early variety. Plant of slender growth, having but few and narrow leaves, bearing in profusion on long, upright stems, large, pure white flowers of very feathery and graceful appearance, and always full and double. Of American origin. Originator's stock, pkt. 15 cts.
- 20 **Daybreak**. Flowers very large and full, and borne on long stems, the color a beautiful shell-pink. The plant blooms early and profusely, and is of strong and compact habit. Very popular. 2 feet. Pkt. 10 cts., $\frac{1}{8}$ oz. 40 cts., oz. \$2.75.
- 21 **Purity**. Pure white. A desirable companion to Daybreak. Identical in form of flower and general habit. Blooms at the same time. Pkt. 10 cts., $\frac{1}{8}$ oz. 50 cts., oz. \$3.50.
- 23 **Lavender Daybreak**. New. Soft, clear lavender. Pkt. 15 cts.
- 24 **TRUFFAUT'S PEONY-FLOWERED PERFECTION**. Very extensively cultivated and a favorite. Plants are large, of compact form and bear freely large flowers, having incurved petals, like those of the peony; very double and beautiful.
- 26 **White**. 27 **Crimson**. 28 **Light Blue**. Each, pkt. 10 cts., $\frac{1}{8}$ oz. 50 cts., oz. \$3.
- 32 **Mixed Colors**. A wide range of colors. Pkt. 10 cts., $\frac{1}{8}$ oz. 45 cts., oz. \$2.
- JEWEL**, or **BALL**. A selection from the Peony Perfection, but entirely distinct. The flowers are about $2\frac{1}{2}$ inches in diameter, have short, incurved petals and are as round as a ball. They are borne on long stems, are excellent for cutting and afford a novel and pleasing effect in contrast with other types. $1\frac{1}{2}$ feet.
- 36 **Mixed Colors**. Pkt. 10 cts., $\frac{1}{8}$ oz. 40 cts.
- 40 **SUNLIGHT**. Flowers 3 to 4 inches in diameter, of peony form. Clear sulphur-yellow, a color not common among Asters. 2 feet. Pkt. 10 cts.
- VICTORIA**. Considered for a long time one of the finest types, and improved in recent years. The flowers are large, double, imbricated, having petals which curve outward like those of the show dahlia. Bears freely beautiful long-stemmed flowers.
- 55 **White**. 56 **Dark Scarlet**. 57 **Peach-Blossom Pink**. 58 **Dark Crimson**. 59 **Light Blue**. Each, pkt. 10 cts., $\frac{1}{8}$ oz. 50 cts.
- 62 **Mixed Colors**. A superb mixture. Pkt. 10 cts., $\frac{1}{8}$ oz. 45 cts., oz. \$3.
- WASHINGTON** (Giant Victoria). Flowers similar to Victoria, but larger; much used for exhibition. 2 feet.
- 65 **Mixed Colors**. Pkt. 10 cts., $\frac{1}{8}$ oz. 45 cts., oz. \$3.
- GIANT BRANCHING COMET**. Distinct and valuable; flowers resemble the Japanese chrysanthemum. Not only larger, but petals are longer and somewhat broader than the old Comet section. The plant is of vigorous, luxuriant growth and produces freely its long-stemmed, graceful flowers. $1\frac{1}{2}$ to 2 feet.
- 70 **White**. 71 **Light Yellow**. 72 **Azure-Blue**. 73 **Rose**. 74 **Light Blue and White**. 75 **Crimson**. 76 **Rose and White**. Each, pkt. 10 cts., $\frac{1}{8}$ oz. 50 cts.
- 80 **Mixed Colors**. Many colors and shades. Pkt. 10 cts., $\frac{1}{8}$ oz. 45 cts., oz. \$3.
- 81 **MIKADO PINK**. The premier of shell-pink Asters. Following is the description of the originators: "In type, Mikado Pink belongs to the Comet class. Petals are narrow, very long and gracefully reflexed. In color it is a most exquisite shade of shell-pink. Strong-growing, free-branching, long-stemmed plants. In growth these plants are unusually vigorous for their type. It is not uncommon to find plants with a dozen long, strong, graceful stems each crowned with flowers from $4\frac{1}{2}$ to 6 inches in diameter. Pkt. 20 cts.
- 82 **MIKADO WHITE**. Similar in every respect to Mikado Pink except color, the flowers having the same deep, fluffy form, and the plant the branching habit ascribed to the above. Blooms at the same season. Each is the best of its color in the Comet class. Pkt. 15 cts.

GOLD MINE IN THE FRONT YARD.

By C. S. HARRISON. A valuable book explaining cultivation and care of flowers grown at home (in the front yard), for home use or for profit. Price, \$1.



COMET ASTERS

a single packet secure a choice selection of the most desirable varieties. Pkt. 10 cts., $\frac{1}{2}$ oz. 40 cts., $\frac{1}{4}$ oz. 65 cts., oz. \$2.25.

- 125 **Good Mixed.** Our own mixture of many tall and double varieties; a wide range of colors. Pkt. 5 cts., $\frac{1}{2}$ oz. 20 cts., $\frac{1}{4}$ oz. 35 cts., oz. \$1.

Abronia

A beautiful little trailing plant, bearing freely in the autumn months verberna-like fragrant flowers. Sow in the house and transplant, or very early in the open ground. Hardy annual.

- 130 **Arenaria.** Yellow. Pkt. 5 cts.
131 **Umbellata.** Rose, white eye. Pkt. 5 cts.

Achillea

- 135 **Ptarmica, The Pearl.** One of the best white, hardy perennials in cultivation, bearing profusely and continuously from June until frost beautiful small white, double flowers; useful for cutting. Easily grown from seed. Desirable and often used in cemeteries. 2 feet. Pkt. 15 cts.

Acroclinium

EVERLASTING FLOWER

A half-hardy annual, bearing attractive white and rose-colored single and double flowers chiefly used when dried for winter bouquets and wreaths; for this purpose, flowers should be cut before fully expanded. $1\frac{1}{4}$ feet.

- 139 **Light Rose and Pure White, Mixed.** Pkt. 5 cts.

Adlumia

- 140 **Cirrhosa (Mountain Fringe; Allegheny Vine).** A beautiful hardy, climbing biennial, which usually self-sows. The feathery foliage resembles that of the maidenhair fern. Of rapid growth and produces, in great profusion, small, tube-shaped pink blossoms. Of the easiest culture. Desirable for covering trellises, stumps, etc. 10 to 15 feet. Pkt. 5 cts.

BOOKS ABOUT FLOWERS

Phlox Manual, Peony Manual, Iris Manual. All about them. 25 cts. each.

ASTERS, continued

HOHENZOLLERN. A remarkable new strain of the Giant Comet type. The flowers are considerably larger and the petals are more curled. They are borne on long stems and are very graceful; of enormous size, closely resembling chrysanthemums. Of robust branching habit, and blooms earlier than the Giant Comet. $2\frac{1}{2}$ feet.

- 85 **White.** 86 **Light Blue.** 87 **Rose.** Pkt. 10 cts., $\frac{1}{2}$ oz. 50 cts.

- 90 **Mixed Colors.** Pkt. 10 cts., $\frac{1}{2}$ oz. 45 cts., oz. \$3.

OSTRICH FEATHER. Of the Comet type, but distinct, the petals being more curled and twisted, giving the flower a distinctive feathery appearance. The flowers are large and full and among the best for cutting. The plant is of branching habit and remarkably profuse in bloom.

- 102 **Mixed Colors.** Pkt. 10 cts., $\frac{1}{2}$ oz. 45 cts.

104 **Lavender Gem.** Of the Ostrich Feather type. Flowers large and remarkably free from single and semi-double specimens. The feathery effect is increased in a large proportion of the flowers by long, partly tubular florets, irregularly cut and slashed. The color is an exquisite shade of lavender, which deepens with age. The plant branches close to the ground and blooms profusely and very early. 2 feet. Pkt. 10 cts., $\frac{1}{2}$ oz. 50 cts.

AMERICAN BRANCHING. A superior late-blooming strain of American origin. The flowers are of the largest size, borne on long, graceful stems, often 15 or more inches in length, are exceedingly beautiful and unsurpassed for cutting. The plants are of extra-large and strong growth, and bloom profusely. $2\frac{1}{2}$ feet.

- 108 **White.** 109 **Pink.** 110 **Lavender.** 111 **Crimson.** 112 **Purple.** Each, pkt. 10 cts., $\frac{1}{2}$ oz. 35 cts., $\frac{1}{4}$ oz. 60 cts., oz. \$2.

- 116 **Mixed Colors.** Pkt. 10 cts., $\frac{1}{2}$ oz. 30 cts., $\frac{1}{4}$ oz. 50 cts., oz. \$1.75.

117 **VIOLET KING.** A new variety of American origin, in habit similar to the American Branching. The flowers are entirely distinct from any other, petals somewhat resemble those of the quilled sorts, but are much larger, those in the center being curiously twisted, curled and incurved, completely covering the crown. In shape and size, round, full and very large, often 4 and 5 inches in diameter; color soft violet-lilac. Pkt. 10 cts., $\frac{1}{2}$ oz. 40 cts., $\frac{1}{4}$ oz. 75 cts.

118 **SEMPE'S BRANCHING. (Mary Semple.)** Distinct in form and color from above. A beautiful shell-pink; large. Pkt. 10 cts., $\frac{1}{2}$ oz. 30 cts., $\frac{1}{4}$ oz. 50 cts.

119 **CARDINAL.** One of the best bedding Asters. In color entirely distinct; deep vivid cardinal. Begins blooming freely from first to middle of August; flowers of good size and form. Pkt. 15 cts., $\frac{1}{2}$ oz. 50 cts.

BETTERIDGE'S QUILLED (Reid's Improved). Flowers small, very double, with finely quilled or tube-shaped petals. $1\frac{1}{2}$ feet.

- 120 **Mixed Colors.** Pkt. 5 cts., $\frac{1}{2}$ oz. 20 cts.

124 **WORCESTER MIXTURE.** Our own mixture of the leading choice varieties. It includes

every color and shade known among Asters, and will afford, especially if purchased in bulk, the greatest diversity of both color and type. Purchasers of

every color and shade known among Asters, and will afford,

especially if purchased in bulk,

the greatest diversity of both

color and type. Purchasers of

every color and shade known

among Asters, and will afford,

especially if purchased in bulk,

the greatest diversity of both

color and type. Purchasers of

every color and shade known

among Asters, and will afford,

especially if purchased in bulk,

the greatest diversity of both

color and type. Purchasers of

every color and shade known

among Asters, and will afford,

especially if purchased in bulk,

the greatest diversity of both

color and type. Purchasers of

every color and shade known

among Asters, and will afford,

especially if purchased in bulk,

the greatest diversity of both

color and type. Purchasers of

every color and shade known

among Asters, and will afford,

especially if purchased in bulk,

the greatest diversity of both

color and type. Purchasers of

every color and shade known

among Asters, and will afford,

especially if purchased in bulk,

the greatest diversity of both

color and type. Purchasers of

every color and shade known

among Asters, and will afford,

especially if purchased in bulk,

the greatest diversity of both

color and type. Purchasers of

every color and shade known

among Asters, and will afford,

especially if purchased in bulk,

the greatest diversity of both

color and type. Purchasers of

every color and shade known

among Asters, and will afford,

especially if purchased in bulk,

the greatest diversity of both

color and type. Purchasers of

every color and shade known

among Asters, and will afford,

especially if purchased in bulk,

the greatest diversity of both

color and type. Purchasers of



GIANT HOHENZOLLERN ASTERS

WHEN ORDERING FLOWER SEEDS ALWAYS GIVE NUMBER PRECEDING VARIETIES

Agrostemma

Pretty, free-blooming plants of easy culture, especially desirable for dry situations. Excellent for cutting. Blooms the first season.

- 160 *Coeli-rosa* (Rose of Heaven). Rose, white center. Hardy annual. 1½ feet. Pkt. 5 cts.
- 161 *Coronaria* (Rose Campion). One of the earliest hardy perennials. 1½ feet. Mixed colors, pkt. 5 cts.

Alyssum

A well-known favorite hardy annual, blooming profusely the entire season. Excellent for edgings. No other white flower is so well adapted for a densely low carpet, or as borders and ribbons in garden work. Extremely fragrant, and frequently used for bouquets. Of easiest culture. Sure to make a good display. Sow seed early in April.

- 166 *Sweet Alyssum*. Fragrant, white. 1 foot. Pkt. 5 cts., ¼oz. 15 cts., oz. 25 cts.
- 167 *Little Gem*. Of spreading habit, forming compact masses of bloom, often a foot or more in diameter. White, fragrant. 1½ feet. Pkt. 5 cts., ¼oz. 25 cts., oz. 40 cts.
- 168 *Carpet of Snow*. Of very dwarf habit; white, fragrant. 4 inches. Pkt. 5 cts., ½oz. 30 cts., oz. 50 cts.
- 170 *Saxatile compactum*. Hardy perennial, bearing in great profusion in early spring golden yellow flowers. Desirable for rockwork or for massing. 1 foot. Pkt. 5 cts., ¼oz. 20 cts., ½oz. 35 cts., oz. 60 cts.

Amaranthus

Brilliantly colored foliage, and bearing peculiarly formed flowers. While in rich soil the plants and leaves are much larger, the colors are seldom as brilliant as when grown on rather poor soil. Of easiest culture. Give plenty room to develop.

- 175 *Caudatus* (Love-Lies-Bleeding). Long, drooping flower; blood-red. Half-hardy annual. 3 feet. Pkt. 5 cts.
- 176 *Cruentus* (Prince's Feather). Spikes of dark red flowers. Half-hardy annual. 3 feet. Pkt. 5 cts.
- 177 *Salicifolius* (Fountain Plant). Long, gracefully undulated foliage, beautifully variegated, varying from green to bronze, banded and tipped with carmine. Tender annual. 3 feet. Pkt. 5 cts.
- 178 *Tricolor splendens* (Joseph's Coat). Red, yellow and green foliage. One of the most beautiful of ornamental-leaved plants. Hardy annual. 2 feet. Pkt. 5 cts.

Ampelopsis

- 182 *Veitchii* (Boston Ivy; Japan Ivy). The well-known, popular climbing vine, so often seen on walls of churches, school-houses, etc. Grows rapidly and clings to the smoothest surface. Ornamental the entire season, the dark green glossy leaves changing in the autumn to beautiful shades of scarlet, crimson and orange. Easily grown from seed. Entirely hardy except in the far North. Stands the dust and smoke of cities exceedingly well. Pkt. 10 cts., ¼oz. 15 cts., oz. 25 cts.

Anemone. Windflower

A hardy garden perennial, usually treated like bulbous plants, the roots requiring about the same treatment as bulbs of the tulip and hyacinth. These are easily grown from seed sown early in the spring in rich, rather light loam. When tops are dead, the roots, which are solid, flattened masses, resembling dried ginger, should be lifted and stored in an airy, dry place where it is said they will keep for two years. The Anemone makes a good pot plant and has the desirable feature that it can be planted and brought into bloom at almost any time of the year. Roots should preferably be planted outdoors early in the spring, and, when past blooming, again lifted and stored as above directed. Select, if possible, a location partially shaded, and water profusely during blooming period if soil is especially dry. Fine, large flowers for bouquets.

- 188 *Coronaria*. Single; mixed colors. The well-known Poppy-flowered Anemone. 1 foot. Pkt. 5 cts.
- 189 *Coronaria, St. Brigid*. An improved strain, bearing larger and more brilliant flowers, and remaining in bloom longer. 1 foot. Pkt. 10 cts.



ALYSSUM. JUST RIGHT FOR EDGING A BED

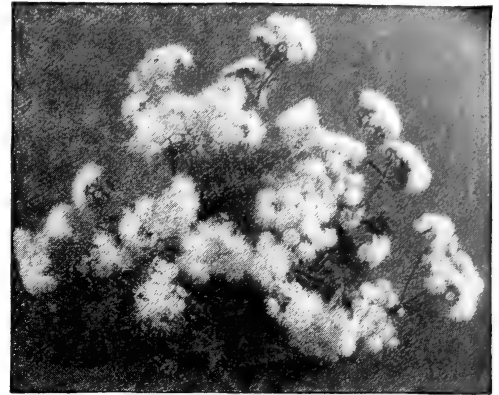

AGERATUM. FOR BORDERS (see page 32)

Anthemis tinctoria

(Hardy Golden Marguerite)

A beautiful hardy perennial of easy culture, bearing all summer golden yellow, daisy-like flowers, excellent for cutting. Plants bushy and should stand at least 2 feet apart. Height 2 feet.

- 192 *Keiwayi*. Pkt. 5 cts., ¼oz. 15 cts., oz. 25 cts.

Antirrhinum. Snapdragon

A favorite, half-hardy perennial, blooming profusely the first season from seed. Sow in a sunny bed. Fine for cutting. Treated as an annual.

- 194 *Tall Varieties*. Mixed colors. 2 feet. Pkt. 5 cts., ¼oz. 20 cts., oz. 50 cts.
- 195 *Grandiflorum*. Giant varieties. Mixed colors. 2½ feet. Pkt. 10 cts., ¼oz. 25 cts., oz. 75 cts.
- 196 *Dwarf Varieties*. Mixed colors. 1 foot. Pkt. 5 cts., ¼oz. 25 cts., oz. 75 cts.

Aquilegia. Columbine

Well-known hardy perennials, bearing in great profusion, through May and June, exquisite flowers greatly varied in coloring. Of easy culture, thriving best in well-drained soil, and growing well in partial shade. For planting among shrubbery or for naturalizing in the edges of woods, few hardy plants equal this old favorite. 1 to 3 feet.

- 200 *Single, Mixed Colors*. Pkt. 5 cts., ¼oz. 15 cts., oz. 40 cts.
- 202 *Double, Mixed Colors*. Pkt. 5 cts., ¼oz. 15 cts., oz. 40 cts.

Arabis

- 209 *Alpina* (Rock Cress). A pretty little hardy perennial, thriving in dry soil, and one of the earliest to bloom. Flowers white and deliciously fragrant; resembles Sweet Alyssum. The plant is covered with bloom and is excellent for rockwork and edgings. 6 inches. Pkt. 10 cts.

Arctotis

- 210 *Grandis* (African Lilac Daisy). A beautiful new annual from Africa, of luxuriant, branching growth, bearing freely from July until frost. Large, long-stemmed daisy-like flowers about 3 inches across; pure white on upper surface, reverse side of pale lilac. Pkt. 10 cts., ¼oz. 20 cts., ½oz. 30 cts.

Aristolochia

- 215 *Sipho* (Dutchman's Pipe). A hardy perennial vine of rapid growth, with large, glossy heart-shaped leaves, bearing curious yellowish-brown blossoms, somewhat resembling a pipe. 15 to 20 feet. Pkt. 15 cts.

Asperula

- 220 *Odorata* (Sweet Woodruff). A hardy perennial, blooming freely and continuously in rather moist soil and a partially shaded location. The flowers are white, but the plant is largely grown for its fragrant leaves and stems, which are used when dried for the same purposes as those of lavender. 1 foot. Pkt. 5 cts.

FLOWER BOOKS

- BULBS AND TUBEROUS-ROOTED PLANTS. C. L. Allen. \$1.50.
- PRACTICAL FLORICULTURE. Peter Henderson. \$1.50.
- GREENHOUSE CONSTRUCTION. L. R. Taft. \$1.50.
- GREENHOUSE MANAGEMENT. L. R. Taft. \$1.50.
- HOME FLORICULTURE. Eben E. Rexford. \$1.
- PARSONS ON THE ROSE. Samuel R. Parsons. \$1.



BALSAM

Balsam

This old favorite annual, sometimes known as Lady's Slipper, has been continually improved for several years, the flowers of some strains now closely rivaling in size and beauty those of the Camellia. Requires rich soil, full exposure to the sun and plenty of water, to be grown to perfection, but is otherwise of easy culture. We offer seed of the most improved types, which will, with favorable conditions, produce a large proportion of double flowers. 2 feet.

- 225 **Improved Camellia-Flowered, Mixed Colors.** Double flowers of the finest type and a wide range of beautiful colors. Pkt. 10 cts., $\frac{1}{2}$ oz. 25 cts., oz. 75 cts.
 226 **New Double White (Alba perfecta).** Extra-fine. Pkt. 10 cts., $\frac{1}{2}$ oz. 25 cts., oz. 75 cts.
 227 **Double Dark Red.** Beautiful rich color. Pkt. 10 cts., $\frac{1}{2}$ oz. 25 cts., oz. 75 cts.
 230 **Choice Mixed.** Double flowers of many colors. Pkt. 5 cts., $\frac{1}{2}$ oz. 15 cts., oz. 50 cts.

Balloon Vine. Love-in-a-Puff

(*Cardiospermum halicacabum*)

- 235 A tender annual climber of rapid growth, bearing small, white flowers, followed by curious inflated seed-vessels, somewhat resembling a balloon. 10 to 15 feet. Pkt. 5 cts.

Beans, Ornamental Varieties

The Scarlet and White Runner Beans are deservedly popular as ornamental climbers, as but few plants grow so rapidly, and none is more easily grown. The former is largely grown alone for ornament, but all are very attractive. The Butterfly is a very pleasing novelty, having large flowers, which are white with salmon-rose standard, followed by pods that equal in edible qualities those of the standard garden sorts. The beans of the White Runner are used in some localities as green shell beans; Scarlet are also edible, but seldom used. All should be treated as directed for Pole Beans.

- 240 **Scarlet Runner.** Pkt. 5 cts.
 241 **White Runner.** Pkt. 5 cts.
 242 **Butterfly.** New; charming white and rose. Pkt. 10 cts.
 For larger quantities, see list of vegetable seeds.

Bellis perennis. English Double Daisy

A perennial plant, bearing in early spring small double white or rose-colored flowers. It succeeds best here in a rich, loamy soil, partially shaded. It is generally classed as hardy, but really needs a slight protection through the winter. 4 inches.

- 245 **Mixed Colors.** Pkt. 10 cts., $\frac{1}{2}$ oz. 50 cts.

Brachycome. Swan River Daisy

A free-flowering plant of dwarf, compact growth, bearing in great profusion beautiful single blue or white flowers. Effective as edgings or in beds, and suitable for rustic baskets or pot culture. Half-hardy annual. 1 foot.

- 250 **Mixed Colors.** Pkt. 5 cts.

Browallia

A beautiful free-blooming half-hardy annual. Seed may be sown in the open ground when warm, but preferably should be sown early in the house or hotbed, and, if possible, repotted once or twice. The plants will then bloom early and be covered throughout the summer with their beautiful blue and white flowers. For beds, borders or pots few equal it. $1\frac{1}{2}$ feet.

- 251 **Blue and White, Mixed.** Pkt. 5 cts.

Calendula. Pot Marigold

A very free-blooming hardy annual of easy culture. Grows well in nearly all soils. Flowers double, borne on stiff stems, and are cut to some extent, but the plant is more desirable for bedding. 1 to $1\frac{1}{2}$ feet.

- 255 **Meteor.** Yellow, striped orange. Pkt. 5 cts., $\frac{1}{2}$ oz. 10 cts., oz. 15 cts.
 256 **Orange Giant.** Extra large; orange. Pkt. 5 cts., $\frac{1}{2}$ oz. 15 cts., oz. 25 cts.
 257 **Prince of Orange.** Orange, striped light yellow. Pkt. 5 cts., $\frac{1}{2}$ oz. 15 cts., oz. 25 cts.
 258 **Sulphur Crown.** Sulphur-yellow. Pkt. 5 cts., $\frac{1}{2}$ oz. 15 cts., oz. 25 cts.
 259 **Mixed Varieties.** Above and other varieties, mixed. Pkt. 5 cts., $\frac{1}{2}$ oz. 10 cts., oz. 15 cts.

Calliopsis

Well-known, profuse-flowering hardy annuals of the easiest culture. The mixed colors represent the type more commonly known. The named sorts resemble in habit, foliage and flower the perennial type, generally known as Coreopsis.

- 260 **Mixed Colors.** $1\frac{1}{2}$ to 2 feet. Pkt. 5 cts., $\frac{1}{2}$ oz. 15 cts., oz. 25 cts.
 261 **Coronata maxima.** Yellow; extra large. $1\frac{1}{2}$ feet. Pkt. 5 cts., $\frac{1}{2}$ oz. 15 cts.
 262 **Golden Wave (Drummondii).** Golden yellow, with small dark center. $1\frac{1}{2}$ feet. Pkt. 5 cts., $\frac{1}{2}$ oz. 15 cts.
 263 **Ray of Gold.** New, yellow, with purplish brown center. 6 to 8 inches. Pkt. 5 cts., $\frac{1}{2}$ oz. 15 cts.

Canterbury Bells. (*Campanula medium*)

Well-known, beautiful, hardy biennials. Like all of this class, may be sown where they are to remain any time after midsummer, or in beds in the spring for transplanting. The Calycanthema (Cup-and-Saucer) class is so named because of the broadening of the calyx into a saucer-shaped secondary flower. In permanent situations, plants should stand 18 to 20 inches apart. All varieties succeed best in a rich, rather sandy, well-drained soil.

- 267 **Prize Mixture.** A superb mixture of all classes, single, double and cup-and-saucer. Pkt. 10 cts., $\frac{1}{2}$ oz. 20 cts.
 268 **Single, Mixed Colors.** Pkt. 5 cts., $\frac{1}{2}$ oz. 15 cts.
 269 **Double, Mixed Colors.** Pkt. 5 cts., $\frac{1}{2}$ oz. 15 cts.
 272 **Calycanthema (Cup-and-Saucer).** Mixed colors. Pkt. 10 cts., $\frac{1}{2}$ oz. 20 cts.



ANTIRRHINUM (see page 33)

Canary-Bird. (*Tropeolum Canariensis*)

275 A rapid-growing, half-hardy annual climber, bearing curiously formed yellow flowers. Blooms until frost. Fine for shady places. 10 to 15 feet. Pkt. 5 cts., $\frac{1}{2}$ oz. 15 cts.

Candytuft. Iberis

Popular hardy annual, growing in any soil, requiring but little care, and by repeated sowings may be had in bloom all summer. 6 inches to 1 foot.

276 **Carmine.** Pkt. 5 cts., $\frac{1}{2}$ oz. 15 cts., oz. 25 cts.

277 **Dark Crimson** (Dunnett's). Pkt. 5 cts., $\frac{1}{2}$ oz. 15 cts., oz. 25 cts.

278 **Empress.** Large trusses; pure white. Pkt. 5 cts., $\frac{1}{2}$ oz. 20 cts., oz. 35 cts.

279 **Giant Hyacinth-flowered.** Heads of immense size, resembling the hyacinth. White. Generally considered superior to Empress. Pkt. 5 cts., $\frac{1}{2}$ oz. 25 cts., oz. 40 cts.

280 **Mixed Colors.** Pkt. 5 cts., $\frac{1}{2}$ oz. 10 cts., oz. 15 cts.

281 **Queen of Italy.** New. Of dwarf, bushy habit. Large, pink flowers; fine. 6 inches. Pkt. 5 cts., $\frac{1}{2}$ oz. 25 cts., oz. 40 cts.

282 **Dwarf Hybrids.** Mixed colors. Of dwarf habit, but flowers are large. Pkt. 5 cts., $\frac{1}{2}$ oz. 20 cts., oz. 35 cts.

283 **White Fragrant.** Pkt. 5 cts., $\frac{1}{2}$ oz. 10 cts., oz. 15 cts.

Carnation

Well-known and very popular half-hardy perennial, which, until the introduction of the Marguerite class, was mainly grown by the florist in the greenhouse and occasionally by the amateur in pots in the house. The Marguerite class, including the original and later introductions of similar type, are treated as annuals, blooming in about four months from seed, which may be sown in the open ground early in the spring, usually by May 1, but preferably earlier in the house, and plants set in the open about the middle of May as this greatly lengthens the period of blooming. By cutting off the flower-stems early in the fall and potting the plants, they will bloom freely through the winter if kept in a cool room. The Carnation requires a rich soil, and, in such, the plants should stand about 12 inches apart.



CARNATION



CANTERBURY BELLS

286 **Marguerite Improved Semi-Dwarf.** An improved strain, blooming four months after sowing. Flowers are larger, a greater proportion double and the variety of colors much greater than those of the original. Pkt. 10 cts., $\frac{1}{2}$ oz. 20 cts., $\frac{1}{4}$ oz. 35 cts.

287 **Marguerite Giants.** Flowers approach in form, size, fragrance and beauty those grown by the florist. Great variety of color. Blooms four months after sowing. Pkt. 10 cts., $\frac{1}{2}$ oz. 30 cts., $\frac{1}{4}$ oz. 50 cts.

288 **Chaubaud's Giant Perpetual.** A new strain remarkable for its combination of earliness with the continuity of bloom and perfection of flowers of the perpetual type. Blooms in four or five months after sowing. Flowers large, a high percentage double. Deliciously fragrant and greatly varied in coloring. Pkt. 15 cts.

290 **Dwarf Vienna.** Blooms early the second summer from seed. The hardiest sort, said to stand the winter with a slight protection. Flowers large, double, fragrant and of varied colors. Pkt. 10 cts., $\frac{1}{2}$ oz. 25 cts.

292 **Double Fine Mixed.** A choice strain of the regular type, blooming the second year from sowing. Most desirable for house culture. Pkt. 10 cts.

Castor Bean. Ricinus

Well-known tender annual; tall, stately, majestic plants of very rapid growth, with palm-like leaves of glossy green, brown or bronze hue; very effective for lawns, planted singly or in groups. 6 to 15 feet.

295 **Borboniensis.** Large, showy foliage of purplish hue. 15 feet. Pkt. 5 cts., $\frac{1}{2}$ oz. 12 cts., oz. 20 cts.

296 **Cambodgensis.** Stalks and stems nearly black; leaves large, of a deep bronze-maroon. 6 feet. Pkt. 5 cts., $\frac{1}{2}$ oz. 15 cts., oz. 25 cts.

297 **Sanguineus** (Tricolor). Stalks blood-red, foliage reddish bronze, with scarlet seed-pods. 6 feet. Pkt. 5 cts., $\frac{1}{2}$ oz. 12 cts., oz. 20 cts.

298 **Zanzibarensis.** A comparatively new class, with gigantic leaves, ranging in color from light green to deep bronze. 10 to 15 feet. Mixed varieties. Pkt. 5 cts., $\frac{1}{2}$ oz. 12 cts., oz. 20 cts.

300 **All Varieties Mixed.** Pkt. 5 cts., $\frac{1}{2}$ oz. 10 cts., oz. 15 cts.

Cockscomb (*Celosia cristata*)

Popular free-blooming, half-hardy annual, bearing flowers of comb-like form, the recently improved strains producing under best cultivation heads of enormous size. Grown either by itself or combined with other plants, the Cockscomb makes a striking and effective display. While seed may be, and more generally is, sown in the open ground, for best results it should be sown early in the house, and the young plants transplanted into small pots in which they should remain until they show signs of blooming, when they should be shifted to a permanent location. The Cockscomb requires good rich soil, ample room and plenty of moisture to fully develop its flowers.

305 **Glasgow Prize.** Crimson; dark foliage. 9 inches. Pkt. 10 cts., $\frac{1}{2}$ oz. 30 cts.

306 **Golden Yellow.** 9 inches. Pkt. 10 cts., $\frac{1}{2}$ oz. 30 cts.

307 **Mixed.** Pkt. 5 cts., $\frac{1}{2}$ oz. 20 cts.

310 **Dwarf, Extra-Choice, Mixed.** Includes all the latest introductions and colors of the Cockscomb. Pkt. 10 cts., $\frac{1}{2}$ oz. 50 cts

Feathered Celosia (*Celosia plumosa*)

Often used for winter bouquets, and for this purpose should be cut before fully ripe and dried in the house. The class requires the same treatment as the preceding. Half-hardy annual. 1 to $1\frac{1}{2}$ feet.

311 **Thompson's Superb.** Graceful, feathery plumes of rich crimson, which contrast beautifully with the purplish bronze foliage. Pkt. 5 cts., $\frac{1}{2}$ oz. 15 cts., $\frac{1}{4}$ oz. 25 cts.

312 **Golden Plume.** Golden yellow. Pkt. 5 cts., $\frac{1}{2}$ oz. 15 cts., $\frac{1}{4}$ oz. 25 cts.

313 **Thompsoni magnifica.** A splendid strain, large plumes ranging from clear yellow to darkest red. Pkt. 10 cts., $\frac{1}{2}$ oz. 20 cts., $\frac{1}{4}$ oz. 35 cts.

316 **Choice Mixed.** Pkt. 5 cts., $\frac{1}{2}$ oz. 15 cts., oz. 40 cts.

Centaurea

To this family belong the well-known annuals, Bachelor's Button and Sweet Sultan, and also the plants known as Dusty Millers.

- CYANUS (Bachelor's Button, or Cornflower). Popular hardy annual of the easiest culture, blooming quickly after seed is sown and for a considerable time if flowers are kept well cut. 2 feet.
- 318 Single and Double, Mixed. Pkt. 5 cts., $\frac{1}{2}$ oz. 15 cts., oz. 25 cts.
- 319 White. 320 Blue. Each, pkt. 5 cts., $\frac{1}{2}$ oz. 15 cts., oz. 25 cts.
- 320 Moschata (Common Sweet Sultan). Mixed colors. Pkt. 5 cts.
- 322 Suaveolens (Yellow Sweet Sultan). Pkt. 5 cts.
- IMPERIALIS (Royal Sweet Sultan). A new and greatly improved type of Sweet Sultan. Both the plants and flowers are much larger than the common. The flowers are borne on long, stiff stems, and will last for several days after cutting. They are very fragrant and colors delicate and beautiful.
- 323 Blue. 324 White. Each, pkt. 10 cts.
- 325 Mixed Colors. Pkt. 5 cts., $\frac{1}{2}$ oz. 15 cts.
- WHITE-LEAVED CENTAUREAS (Dusty Miller). Half-hardy perennials, which are grown annually from seed for their foliage only. Used with other foliage and flowering bedding plants.
- 326 Candidissima. Deeply cut silvery white foliage, densely covered with white hairs. 1 foot. Pkt. 10c.
- 327 Gynocarpa. Silvery white foliage; of graceful drooping habit. 1 $\frac{1}{2}$ feet. Pkt. 10 cts.

Chrysanthemum, Annual Varieties

- Free-flowering plants of branching habit, with rich, finely cut and very ornamental dark green foliage, bearing on long stems daisy-like flowers of bright and varied colorings. These colorings, on the single varieties, are usually in distinct rings and look, on the flat petals, as though they were painted on. Both grow freely from seed, are of easy culture, very desirable for cutting, and are effective bedding plants. They should be given plenty of room, from 2 to 2 $\frac{1}{2}$ feet, and will bloom more freely on soil of medium fertility. Hardy annual. 1 to 1 $\frac{1}{2}$ feet.
- 330 Single (Painted Daisies). Mixed colors. Pkt. 5 cts., $\frac{1}{2}$ oz. 15 cts., oz. 25 cts.
- 333 Double (Marguerites). Mixed colors. Pkt. 5 cts., $\frac{1}{2}$ oz. 15 cts., oz. 40 cts.

Clarkia

A pretty hardy annual from California; much improved in recent years. Blooms profusely in either sun or partial shade. Colors rose, salmon-pink, purple and white. 1 foot.

- 338 Single and Double Mixed. Pkt. 5 cts., $\frac{1}{2}$ oz. 15 cts.

Cobaea

245 Scandens (Climbing Cobaea). A beautiful, rapid-growing, half-hardy perennial climber, blooming the first year from seed, bearing large, bell-shaped flowers, at first green, but changing to a beautiful deep violet-blue. A clean porch climber, free from insects. Sow early in the house and pot the plants, as this greatly lengthens the period of bloom, and the plants will make a much greater growth. Seed germinates more readily if pushed into the ground edgewise and barely covered. 20 to 30 feet. Pkt. 10 cts.

COCKSCOMB. See Celosia.

Coleus

Popular ornamental foliage plants, usually propagated by cuttings, but easily grown from seed, from which many new varieties may be expected, affording an interesting experiment to the amateur. Sow in heat in March or April and transplant to open ground about the first of June. For borders of geranium or canna beds and in carpet-bedding, very useful. Grows rapidly.

- 350 Choice Hybrids, Mixed. From a large collection; of greatly diverse shades and markings. Pkt. 10 cts.
- 351 New Large-leaved Varieties, Mixed. Saved from new varieties with very large and richly variegated foliage. Pkt. 25 cts.



COREOPSIS

Collinsia

A free-flowering hardy annual from California, of easiest culture and great beauty. Seed preferably should be sown in the fall, as the plants will bloom much earlier than from seed sown in the spring. It may, however, be sown in the spring, if desired. 1 foot. 353 Mixed Colors. Pkt. 5 cts.

COLUMBINE. See Aquilegia.

Convolvulus Minor (Dwarf Morning-Glory)

Half-hardy annual of trailing habit, growing about 1 foot high and covering a space of 2 feet, and bearing abundantly bell-shaped flowers similar to those of the tall sort. Flowers open on clear days about noon and remain open until evening, are pure white and of many shades of blue and red.

- 356 Mixed Colors. Pkt. 5 cts., $\frac{1}{2}$ oz. 10 cts., oz. 15 cts.

Coreopsis

For Annual Varieties, see Calliopsis

- 358 Lanceolata grandiflora. A beautiful, hardy perennial, blooming profusely the first season from seed sown early and continuously until frost. The flowers are a rich golden yellow, often 3 inches in diameter, borne on fine long stems, and are very desirable for cutting. Of easiest culture, growing anywhere. Pkt. 5 cts., $\frac{1}{2}$ oz. 20 cts., oz. 60 cts.

Cosmos

A rapid-growing, graceful plant, with beautiful, feathery foliage, bearing flowers which resemble the single dahlia; a very hardy annual of strong, vigorous habit, growing about 5 feet high in ordinary soil and often 8 feet in very rich. It is seldom given room enough; plants should not stand closer than 2 $\frac{1}{2}$ feet apart, and, in rich soil, a greater distance. Cosmos makes a most desirable background for many other plants, its beautiful, finely cut foliage alone making it well worth the growing for this purpose. Its value, however, is greatly increased by its lovely flowers,—white, pink, crimson or rosy purple,—borne in great profusion on long stems, rising above the foliage in an especially graceful manner, equally graceful in appearance when arranged in a vase with sufficient foliage. For this purpose but few other flowers are so desirable, and none can be had so late in the season, as, owing to the great hardiness of the plant, it bears fine flowers even after the first light frosts have come. Topping the plants when half grown will induce earlier flowering, and they will also bloom earlier and more profusely if grown on rather light and not too rich soil.

- 360 Mammoth Perfection. Mixed colors. Flowers of mammoth size; rather late in flowering; seed should therefore be sown as early as possible, in the house in March, or, as the plant is especially hardy, in the open ground in a sheltered spot in April. Pkt. 5 cts., $\frac{1}{2}$ oz. 15 cts.

- 361 Dwarf Early-Flowering. This, while flowers are not so large as the Mammoth, is growing in favor because of its earliness. If seed is sown in open ground in early spring, plants will begin to bloom the last of July and continue until November, making it, therefore, especially desirable in northern latitudes. 4 feet. Mixed colors, pkt. 5 cts., $\frac{1}{2}$ oz. 20 cts.

Cucumber Vine

- 365 Wild (*Echinocystis lobata*). One of the most rapid-growing of all annual climbers, and blooms early in the season, and continuously until fall. Of the easiest culture, growing wild in the West from self-sown seed. One of the most desirable annual climbers for quickly covering any unsightly object; growing 30 feet, and covered with small, white, fragrant flowers, followed by an abundance of prickly but ornamental seed-pods, it at all times presents a striking and effective appearance. Seed may be sown either in the fall or spring. Pkt. 5 cts., $\frac{1}{2}$ oz. 15 cts., oz. 25 cts.

Cypress Vine Ipomoea Quamoclit

- A popular climbing vine, with delicate fern-like foliage, bearing in abundance small, star-shaped, rose, scarlet or white flowers. Of easy culture. Half-hardy annual. 10 to 12 feet. 370 Mixed Colors. Pkt. 5 cts., $\frac{1}{2}$ oz. 15 cts., oz. 25 cts.

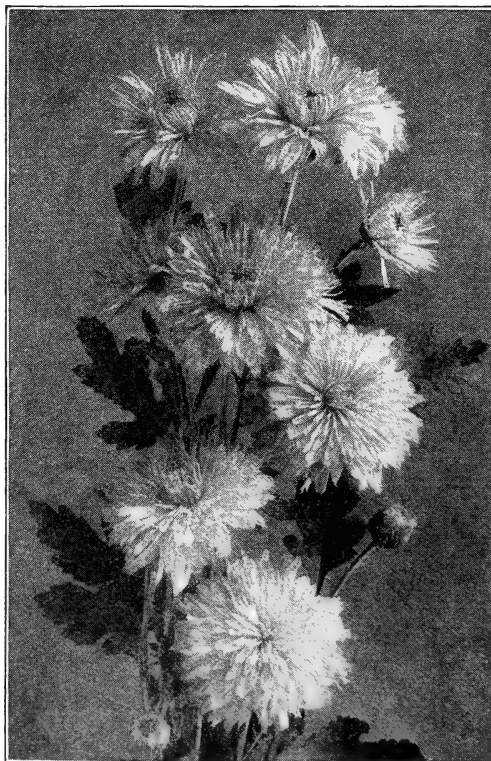

CHRYSANTHEMUM

Dahlia

The growing of the double varieties from seed is always more or less of an experiment, but fine flowers of the single type can be easily secured from seed the first season. If seed of the double sorts is sown in March and the young plants set in the open ground as soon as danger of frost is past, some of the plants, perhaps half, will bloom the first season. The single varieties however, will all bloom the first season from seed sown in the open ground as late as the first week in June. An earlier planting is, however, preferable. Tender perennial. The tubers formed each season should be stored in a frost-proof cellar.

371 **Single, Mixed Colors.** Pkt. 5 cts., ½ oz., 20 cts., oz. 50 cts.

372 **Special Mixture of Giant-Flowered Single Varieties.** Comprises seed from noted German, English and Holland growers, and includes the Giant Perfection, and Colossal strains, and Hornsvelt's Giant Hybrids. An unsurpassed mixture of the greatest possible diversity of colors. Pkt. 15 cts., ½ oz. 30 cts., ½ oz. 50 cts.

373 **Double, Large-Flowered.** Mixed colors. Saved from the finest show varieties. Pkt. 10 cts., ½ oz. 25 cts., ½ oz. 40 cts.

Daisy

It has always seemed to us unfortunate that the English Daisy (*Bellis perennis*) should have been given its common name, as we are quite sure that nearly every one instinctively associates with the terms daisy or daisy-like, flowers which resemble in form and habit our common field daisy. We therefore list under this head the famous Shasta Daisy and Michaelmas Daisies, and call attention to other flowers often known as Daisies, but listed elsewhere under different names.

ENGLISH. See *Bellis perennis*.

BURBANK'S SHASTA DAISY. An extremely hardy perennial, thriving in all soils, blooming more freely each season, and, when once established, for several months. Easily grown from seed and can also be increased by division of the root. The flowers are from 3 to 4 inches across, borne on very long, stiff, wiry stems, and remain in good condition for many days after being cut. Seed from the originator.

378 **Alaska.** Pure glistening white. Pkt. 15 cts.

379 **Burbank's Selected Hybrids.** A mixture of seeds saved from the best seedlings, including some with double rows of petals. Pkt. 15 cts.

MICHAELMAS DAISIES (Perennial Single Asters). Beautiful and showy hardy perennials, easily grown from seed, blooming profusely in the autumn months, and the first season if seed is sown early.

381 **Mixed Colors.** Pkt. 10 cts.

For other flowers known as Daisies see Anthemum, Brachycome and Chrysanthemum.

Delphinium Larkspur

Showy hardy annuals and perennials, thriving in nearly all soils if well enriched and open to the sun. Seed of the annual sorts, though more generally sown in the spring, should preferably be sown in autumn, as plants commence blooming much earlier. Seed of the perennial kinds may be sown in the open ground from April to October, or inside in March, and if plants are kept growing well set in the open border until June, and then some will bloom well in the autumn months. The Larkspurs are especially desirable because of their lovely blue shades, of which most gardens are in need. They should be planted in great masses in the garden. Also extremely effective in long rows bordering drives or walks through woods or natural parks, where shrubbery is available as background.

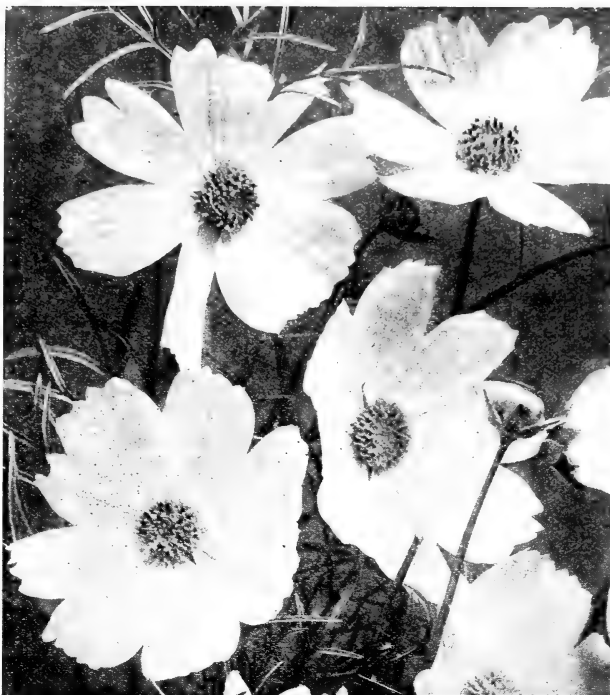

COSMOS WHEN OTHER FLOWERS ARE GONE

Japanese Pinks, have been, for a long time, very popular, and deservedly so. In diversity of rich and beautiful markings they have but few rivals, and in ease of culture, freedom of bloom, and almost certain satisfactory results, they stand close to the Nasturtium. Hardy biennials blooming the first year from seed. So easily grown from seed as to be rarely treated as biennials. Seed may be sown in the open ground any time in May. Plant 6 inches apart. 1 foot.

398 **Double China** (*D. Chinensis fl. pl.*). Small, double flowers, borne in large clusters, of many colors, mostly with white edge. Pkt. 5 cts., ½ oz. 15 cts., oz. 25 cts.

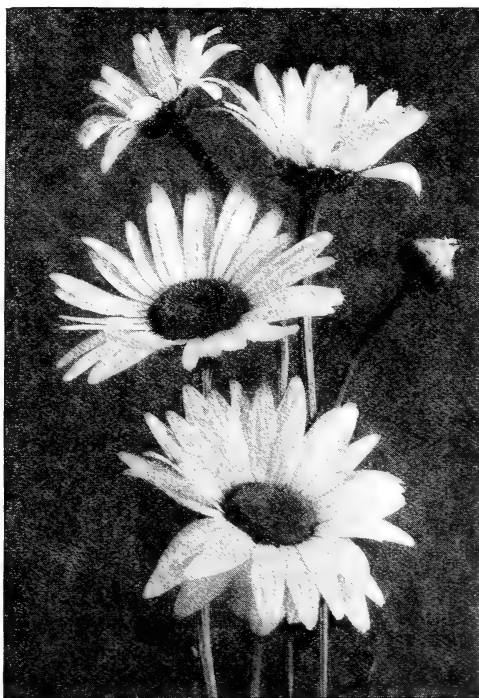

SHASTA DAISY

Annual Delphiniums

385 **Double Dwarf Rocket.** 1 foot. Mixed colors. Pkt. 5 cts., ½ oz. 15 cts., oz. 25 cts.

391 **Double Imperial Branching** (Emperor). Mixed colors. A superior strain. 2 feet. Pkt. 5 cts., ½ oz. 20 cts.

Perennials

393 **Elatum** (Bee Larkspur). Flowers have curiously folded, hairy petals in the center, which give them a fancied resemblance to a bee. Rich shades of blue, with black centers. 2½ feet. Pkt. 5 cts., ½ oz. 20 cts.

394 **Formosum.** The large flowers are deep rich blue, with white centers. 2½ feet. Pkt. 5 cts., ½ oz. 20 cts.

395 **Sibiricum hybridum.** Shades of blue. If sown early, will bloom in August. 2 feet. Pkt. 10 cts., ½ oz. 25 cts.

396 **New Hybrids.** A choice strain selected from double and single large-flowering varieties of remarkable vigor and great beauty, and blooms more profusely than others. The spikes are stiff and strong and covered with large flowers of various shades of blue, lilac and purple, often with peculiar orchid-like markings. Pkt. 15 cts.

Dianthus. Pinks

The following varieties of Dianthus, commonly known as Chinese and Japan Pinks, have been, for a long time, very popular, and deservedly so. In diversity of rich and beautiful markings they have but few rivals, and in ease of culture, freedom of bloom, and almost certain satisfactory results, they stand close to the Nasturtium. Hardy biennials blooming the first year from seed. So easily grown from seed as to be rarely treated as biennials. Seed may be sown in the open ground any time in May. Plant 6 inches apart. 1 foot.

398 **Double China** (*D. Chinensis fl. pl.*). Small, double flowers, borne in large clusters, of many colors, mostly with white edge. Pkt. 5 cts., ½ oz. 15 cts., oz. 25 cts.

399 **Heddewig's Double** (*D. Heddewigi fl. pl.*) Japan Pinks. Very large, double flowers of a wide range of color, running from white and light pink through shades of red to rich, velvety crimson and deep maroon almost black. Pkt. 5 cts., ½ oz. 25 cts.

400 **Single Mixed.** Large, single flowers, of rich and varied coloring. Pkt. 5 cts., ½ oz. 20 cts.

401 **Marvelous** (*D. mirabilis*). A novel, new strain; large, single flowers borne on stiff, straight stems; petals cut above half their length into thread-like fringe and much twisted. Of an unusually wide range of colors. Pkt. 10 cts., ½ oz. 25 cts.

402 **Princess Pink** (*D. laciniatus punctatus*). A very interesting variety; medium-sized single flowers, mottled, flaked and striped. Rarely two colors alike. Pkt. 10 cts.

403 **Double Diadem** (*D. diadematus fl. pl.*). Large, double, fringed flowers of fine, regular form and of various tints of crimson-purple to very deep purple, with white edge. Pkt. 5 cts., ½ oz. 25 cts.

404 **Double Imperial** (*D. imperialis fl. pl.*). A popular strain; fine large, double flowers of many colors. Pkt. 5 cts., ½ oz. 15 cts., ½ oz. 25 cts.

405 **Double Royal, or King's Pinks** (*D. nobilis fl. pl.*). An ideal strain, the earliest to bloom, flowers of the largest size and of remarkably bright solid or self colors. Pkt. 10 cts., ½ oz. 25 cts.

406 **Double Fringed Japan** (*D. laciniatus fl. pl.*) Large, double, fringed flowers of rich and varied coloring. Pkt. 5 cts., ½ oz. 25 cts.

407 **Fireball.** Of dwarf habit. Flowers globular, double, dark blood-red. Pkt. 5 cts., ½ oz. 25 cts.

408 **Snowball.** Very double, pure white. Excellent. Pkt. 10 cts.

Dianthus, continued

- 409 **Salmon King** (Double Salmon Queen; *D. Salmoneus fl. pl.*). New; brilliant salmon; double; distinct and attractive. Pkt. 10 cts.
- 410 **PURITY**. A new double clove-scented white Dianthus. The flowers, large and double possessing a delicious fragrance. A decided acquisition to this large family of beautiful flowers. Pkt. 10 cts.
- 415 **Worcester Mixed**. All the above and other choice strains. Unsurpassed. Pkt. 5 cts., ½ oz. 20 cts., oz. 60 cts.

Hardy Perennial Varieties**Clove or Grass Pinks; *Dianthus plumarius***

Improved forms of the old well-known Clove Pink. They grow anywhere and bloom very profusely. Flowers of many pleasing colors and deliciously fragrant. Very useful for the hardy border.

- 416 **Single** (Pheasant's Eye Pink). Mixed colors. Pkt. 5 cts., ½ oz. 15 cts.
- 417 **Double and Semi-Double**. Mixed colors. Pkt. 10 cts., ½ oz. 25 cts.
- 418 **Florist's Perpetual Pink** (*D. semperflorens*). Double and semi-double; large flowers; very fragrant and of a great diversity of colors. Blooms nearly all summer and if sown in March will generally bloom the first season. Pkt. 15 cts.
- 419 **New Dwarf Early-Flowering** (Dwarf Erfurt Clove Pink). Blooms two weeks earlier than others. Flowers double and semi-double, of spicy fragrance and rich colors. Of compact growth and marvelously profuse in bloom. Pkt. 15 cts.

Digitalis. Foxglove

Favorite hardy plant bearing in June and July tall flower spikes. Of easy culture. Well suited for background to other plants, and for naturalizing in the edges of woods. Hardy biennial or perennial. 2½ to 3 feet.

- 423 **Maculata superba** (Ivery's Spotted). A choice strain of spotted varieties. Pkt. 10 cts.
- 424 **Monstrosa**. Mixed colors. Monstrous flowers. Attractive. Pkt. 10 cts.
- 427 **Purpurea** (Common Foxglove). Mixed colors. Pkt. 5 cts.

Dolichos. Hyacinth Bean

A rapid-growing, hardy, annual climber, bearing all summer clusters of white or purplish blue flowers, followed by ornamental seed-pods. Sow in May where plants are to remain. 10 feet.

- 433 **Mixed Colors, White and Purple**. Pkt. 5 cts., oz. 10 cts.

Eschscholtzia. California Poppy

A very showy hardy annual, with beautiful, finely cut, glaucous foliage, bearing poppy-like flowers of bright colors. Of easy culture. Sow as early as soil can be worked, where plants are to remain, as they do not bear transplanting well. 1 foot.

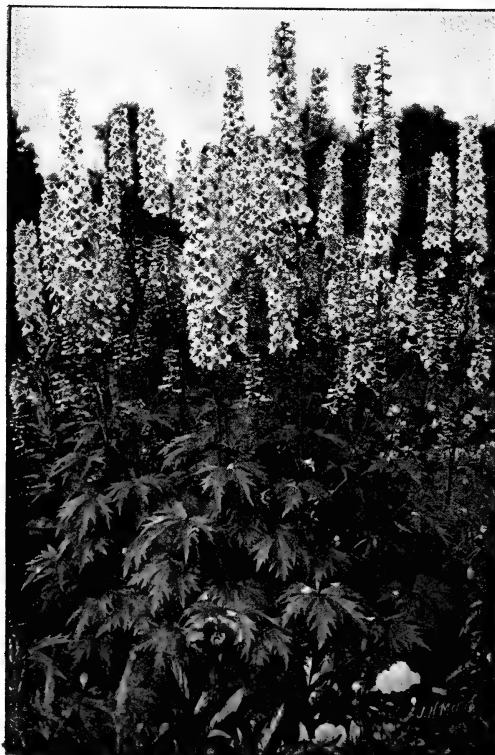

DELPHINIUMS



DIANTHUS

- 439 **Californica**. Yellow. Pkt. 5 cts.
- 440 **Mandarin**. Inner side of petals orange; outside scarlet. Pkt. 5 cts.
- 441 **Rose Cardinal**. Large, white inside, rose outside. Pkt. 5 cts.
- 442 **Mixed Colors**. Pkt. 5 cts., ½ oz. 15 cts., oz. 25 cts.
- 443 **Erecta compacta, Rose Queen**. Rose-carmine. Pkt. 5 cts.
- 446 **Erecta compacta, Dainty Queen**. A lovely new variety; pale coral-pink. Pkt. 10 cts.

Euphorbia

Ornamental foliage plants, easily grown from seed. Striking and effective appearance. Hardy annuals.

- 452 **Variegata** (Snow-on-the-Mountain). Foliage veined and margined with white. 2 feet. Pkt. 5 cts.

Forget-Me-Not. Myosotis

Favorite hardy perennials, mostly treated as annuals, nearly all blooming the first season from seed sown early in the open ground. They succeed to a degree that warrants their cultivation in average soil and open situation, but thrive better in cool, moist soil, considerably shaded. 6 inches.

- 454 **Alpestris**. Blue Alpine Forget-me-not. Pkt. 5 cts., ½ oz. 25 cts.
- 456 **Eliza Fonrobert**. Large, sky-blue, with yellow eye; much grown for cutting. Pkt. 5 cts., ½ oz. 30 cts.
- 457 **Palustris** (True Forget-me-not). Dark blue; blooms the first season. Pkt. 10 cts., ½ oz. 30c.
- 458 **Semperflorens**. Blue; blooms all season. Pkt. 10 cts., ½ oz. 30 cts.
- 459 **Distinction** (Ever-flowering). New; blue; blooms in eight to ten weeks from sowing. Pkt. 10 cts.

Four O'Clock (Mirabilis). Marvel of Peru

A well-known favorite plant, bearing freely funnel-shaped, white, red and striped flowers, which open about four o'clock in the afternoon. Will grow anywhere. Plants should be given plenty of room; about 3 feet apart. Hardy annual. 2 feet.

- 465 **Mixed Colors**. Pkt. 5 cts., ½ oz. 10 cts., oz. 15 cts.

FOXGLOVE. See Digitalis.

Gaillardia. Blanket Flower**Annual Varieties**

Very showy, free-blooming, hardy plants of easy culture. Seed germinates very slowly, and should be sown in the house in March. The flowers are very brilliant, borne on long stems. Fine for cutting. 2 feet.

- 470 **Picta**. Single; mixed colors. Pkt. 5 cts., ½ oz. 15 cts.
- 471 **Picta Lorenziana**. Double; mixed colors. Pkt. 5 cts., ½ oz. 15 cts.



BED OF GERANIUMS

Perennial Gaillardia

Hardy perennial Gaillardias thrive in nearly all soils and situations, requiring no protection and almost no care. Flowers large; with rich shades of scarlet, orange and crimson, the three often combined in one flower. Desirable for the perennial border. If sown early, will bloom the first season. 1½ to 2 feet.

478 **Newest Varieties, Mixed.** A splendid mixture; comprises all the colorings known. Pkt. 15 cts.

Geranium

Well-known, half-hardy, greenhouse perennials, easily raised from seed. Seed sown in the fall or early winter will produce flowers in June, while from that sown in March plants will not bloom until September, and from seed sown in the open ground in May or June plants for bloom in midwinter.

485 **Zonale** (Fish, or Horse-shoe Geranium). Saved from the largest and finest varieties. Pkt. 10 cts.

Globe Amaranth. Gomphrena

488 **Mixed Colors.** A tender annual plant, bearing globe-shaped, everlasting flowers, often used when dried, in winter bouquets. Blooms freely and is an excellent bedding plant. 1½ feet. Pkt. 5 cts.

Gloxinia

One of the most beautiful greenhouse perennials. May be successfully grown by an amateur. Give them a porous and well-enriched soil; a warm, moist atmosphere, and as soon as they begin to flower remove them to a cooler house, and afterward dry them off gradually, and keep them free from moisture till they again begin to grow. The seeds are small and should be sown on an even surface and but lightly covered. Moss is used for this, as for all fine seeds sown in the house, preferable to soil. If used, it should, however, be removed as soon as the seeds germinate.

489 **Splendid Mixed.** A mixture of all classes, unrivaled in richness of colors. Pkt. 25 cts.

Godetia

A showy and beautiful hardy annual, bearing freely large, delicately shaded, satiny flowers; of easy culture, blooms best in rather poor soil. Seed may be sown in the open ground, or sown in the house in March and transplanted to the open ground as soon as danger of frost is past. The plants require plenty of room. Close planting weakens them.

490 **Mixed Colors.** Includes all varieties and the latest introductions. Pkt. 5 cts., ¼oz. 15 cts., oz. 25 cts.

Gourds

Ornamental, tender annual climbers, with curiously formed and colored fruit; of very rapid growth; useful for covering unsightly objects. 10 to 20 feet.

- 491 **Apple-shaped.** Small, striped. Pkt. 5 cts.
- 492 **Dipper.** Pkt. 5 cts.
- 494 **Egg-shaped.** Pkt. 5 cts.
- 495 **Hercules' Club.** 4 feet long. Pkt. 5 cts.
- 496 **Miniature Bottle-shaped.** Pkt. 5 cts.
- 497 **Orange-shaped.** Pkt. 5 cts.
- 498 **Pear-shaped.** Green, white-striped. Pkt. 5 cts.
- 499 **Serpent.** Striped. 5 feet long. Pkt. 5 cts.
- 500 **Mixed Varieties.** Small sorts. Pkt. 5 cts., ¼oz. 10 cts., oz. 15 cts.

Gypsophila. Baby's Breath

Very graceful, free-blooming plants of easiest culture. Flowers very small, borne in loose, graceful panicles. Very largely used in bouquets with other cut-flowers such as Sweet Peas, Roses, Carnations, etc. 2 feet.

505 **Elegans grandiflora alba.** White. An improved form of the annual Gypsophila. Grown by the acre for the London and Paris flower markets. Blooms quickly after sowing; several sowings should be made. Pkt. 5 cts., ¼oz. 15 cts.

506 **Paniculata.** White. The variety more generally known as Baby's Breath. Hardy perennial. Pkt. 5 cts., ¼oz. 15 cts.

Helenium

A valuable hardy perennial, bearing in profusion in August and September long-stemmed single flowers; fine for cutting. Effective as a background.

510 **Autumnale superbum.** Deep golden yellow. 5 to 6 feet. Pkt. 10 cts. **HELIANTHUS.** See Sunflower.

Helichrysum

(**Straw Flower; Everlasting**)

One of the best everlasting flowers and an effective bedding plant, succeeding in any well-enriched soil. If flowers are desired for winter use, they should be cut just as the buds are opening. Hardy annual. 2 feet.

515 **Double** (*H. monstrosum fl. pl.*). **Mixed Colors.** Largest double flowers. Pkt. 5 cts., ¼oz. 15 cts.

Heliopsis

516 **Pitcheriana.** One of the best hardy perennials for dry soils, and its graceful flowers among the best for cutting. The plant commences to bloom early in season. The flowers are of a beautiful deep yellow, of great substance, and about 2 inches in diameter. 3 feet. Pkt. 10 cts.

Heliotrope

A well-known and favorite plant, largely grown in pots, but thriving in the open border; usually grown from cuttings, but grows readily from seed, blooming the first season if sown early. Half-hardy perennial.

518 **Mixed Colors.** All shades. Pkt. 5 cts.
519 **Large-flowering.** Mixed colors. Heads of flowers nearly double the size of the old sorts. Pkt. 10 cts.

HESPERIS. See Rocket.

Heuchera

525 **Sanguinea.** A fine hardy perennial, bearing in graceful spikes rich crimson flowers. Useful for cutting, and the plant is useful in the mixed border. 1 foot. Pkt. 10 cts.

NOTE.—"I should never consider a garden of pleasant annual flowers to be complete that did not contain some of the "everlastings," or immortelles. The colors are bright, the blooms hold long on the plant, and most of the kinds are very easy to grow."—L. H. BAILEY.



GAILLARDIA. BLOOMS ALL SUMMER

Hollyhocks

One of the oldest hardy favorites, greatly improved in recent years, flowers being larger and of better form, and plant of more sturdy growth. While the Hollyhock delights in deep, rich soil, it must be dry or well-drained, or plants will not live through the winter. Though often sown later, seeds should be sown not later than June. As young plants bloom better and are hardier, seed should be sown every year. Hollyhocks are most effective planted in long rows. Hardy perennial. 5 to 7 feet.

530 **Chater's Finest Mixed.** Choicest double varieties, a large percentage of the flowers coming double. Pkt. 10 cts., $\frac{1}{2}$ oz. 25 cts., $\frac{1}{4}$ oz. 40 cts.

531 **Double, Mixed Colors.** Pkt. 5 cts., $\frac{1}{4}$ oz. 20 cts.

532 **Allegheny.** Large, semi-double flowers beautifully fringed, of silky texture and richly colored. Pkt. 10 cts. $\frac{1}{4}$ oz. 25 cts.

534 **Everblooming Hybrids.** (Annual Hollyhock.) Double, Semi-Double and Single, Mixed. A new strain possessing all the virtues of the old-fashioned Hollyhocks, but blooming the first season from seed. Plants from seed sown inside in March or April will bloom in July, and those from seed sown in the open ground, in August, and, in both cases, continuously until frost if main stem is pinched off when 3 or 4 feet high. Pkt. 10 cts.

Humulus. Hop

Rapid-growing climbers, with attractive foliage, especially valuable because seldom injured by insects or drought. The Japanese variety is a hardy annual, and among the best for quickly covering unsightly objects. The Lupulus, or Common Hop, is a hardy perennial, easily grown from seed, and when established, of very rapid growth. Equally desirable as a screen, and has the additional feature of its large blossoms, which are not only attractive, but useful. 10 to 20 feet.

537 **Variegata.** Variegated foliage, green and white. Pkt. 5 cts.

538 **Lupulus.** The Common Hop. Pkt. 5 cts.

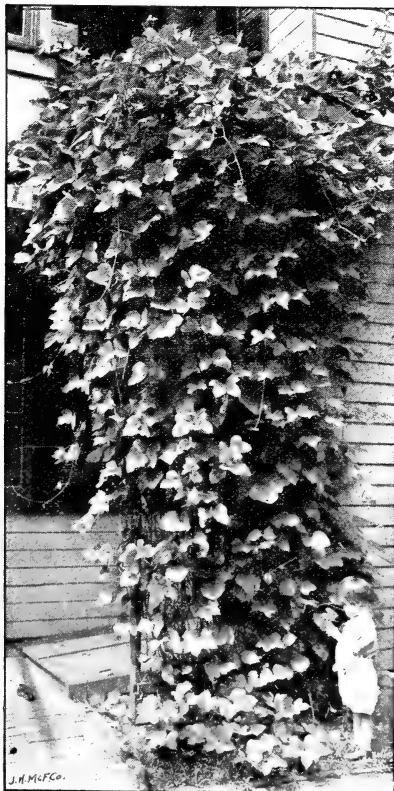

KUDZU VINE

Hunnemannia

540 **Fumariæfolia** (Giant Tall Poppy, or Bush Eschscholtzia). A valuable plant of the Poppy family, closely allied to the Eschscholtzia. A perennial, always treated as an annual, blooming by middle of July from seed sown early in May, and continually until frost. The large flowers are of a deep, rich yellow, borne on very long stems and last a remarkably long time after cutting. 2 feet. Pkt. 5 cts., $\frac{1}{4}$ oz. 20 cts.

HYACINTH BEAN. See Dolichos.

Iberis

543 **Sempervirens** (Perennial Candytuft). A desirable hardy perennial of easiest culture. Dwarf spreading habit; suitable for rockeries. Flowers pure white. Pkt. 10 cts., $\frac{1}{4}$ oz. 20 cts.

Ice Plant

(*Mesembryanthemum*)

546 **Crystallinum.** A trailing plant, with succulent stems and leaves. Excellent for hanging baskets and rockwork. Tender annual. 9 inches. Pkt. 5 cts.

Ipomoea

The *Ipomoea* family includes the well-known Morning-Glory, the Moonflower and the Cypress Vine. Rapid-growing climbers of easiest culture; bloom earlier and more profusely on rather poor soil but of higher growth and more attractive foliage when grown on rich soil. Tender annuals. 15 to 30 feet.

550 **Bona Nox** (Evening Glory). Beautiful large, violet-blue flowers which open at night. Of extremely rapid growth. Pkt. 5 cts.

551 **Coccinea** (Star Ipomoea). Small scarlet flowers, borne in profusion. Pkt. 5 cts.

552 **Setosa** (Brazilian Morning-Glory). A handsome variety of luxuriant growth, having very large, three-lobed leaves, the under side and stem being thickly set with small reddish hairs. Flowers are a pleasing rose, about 2½ inches across, of delicate satiny texture and borne in clusters, but one or two in each cluster opening at once. Pkt. 10 cts.

553 **Rubra Coerulea** (Heavenly Blue). Large, heart-shaped leaves; flowers 4 to 5 inches across, borne in clusters and in such profusion as to nearly cover the foliage; bright sky-blue. Pkt. 10 cts.

Kochia

556 **Tricophylla** (Summer Cypress). A very quick-growing annual; cultivated for its beautiful foliage, which is feathery and fine as moss. Through the summer this is bright green, but commences in early fall to gradually take on a red tinge, becoming entirely red before it dies. This brilliant coloring has given it its other two common names of Mexican Fire Plant and Burning Bush. It is often grown in rows as low hedges. Seed may be sown in the open ground about May 1. Hardy annual. 2½ feet. Pkt. 10 cts.

Kudzu Vine. Pueraria (Jack-and-the-Bean-Stalk Vine)

560 **Thunbergiana.** (*Jack-and-the-Beanstalk Vine*.) A vine of wonderfully rapid growth, when well established growing to the great height of 40 or 50 feet. Leaves are of enormous size. One of the best for forming a screen for any purpose. In the North, the plant dies to the ground in the winter, but in the South becomes woody. Hardy perennial. Pkt. 10 cts.

LARKSPUR. See Delphinium.

The amateur may have more success and less bother growing Perennials from seed sown in the open ground than from any other way. Many sorts, if sown in spring, bloom the first year from seeds as early as annuals; for instance: Gaillardia, Iceland Poppies, Chinese Larkspur, Platycodon, etc. Others do not bloom until second year.—Wm. Falconer.

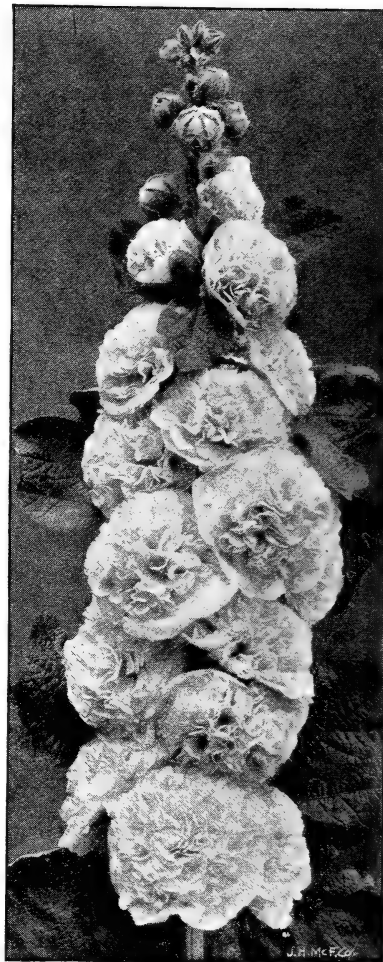

DOUBLE HOLLYHOCK

Lantana

A favorite plant of rapid growth, blooming continually through the summer; desirable for the garden or house. Tender perennials. 2 feet. 562 **Mixed Colors.** Pkt. 5 cts.

Lathyrus latifolius (Everlasting Sweet Pea)

An easily grown hardy perennial climber, bearing freely flowers somewhat similar in form to the Sweet Pea. If grown on moist soil, will bloom nearly all summer. Colors reddish purple, rose and white. 6 to 8 feet.

570 **Mixed Colors.** Pkt. 5 cts., $\frac{1}{4}$ oz. 20 cts., oz. 35 cts.

Lavender. Lavendula

575 **Vera.** A well-known hardy perennial, grown chiefly for its lasting fragrance. Pkt. 5 cts., $\frac{1}{4}$ oz. 15 cts.

Linum. Scarlet Flax

580 **Grandiflorum** (Scarlet Flax). A hardy annual of slender habit, bearing in profusion brilliant scarlet-crimson flowers. An effective bedding plant. 1 foot. Pkt. 5 cts.



AFRICAN MARIGOLD

Lobelia

Pretty little plants of easy culture, blooming profusely from June until frost. The dwarf varieties are useful for bedding and edgings; the trailing variety is excellent for hanging-baskets, vases and rock-work. Half-hardy annuals.

- 585 *Crystal Palace Compacta*. Rich blue flowers, dark foliage. Pkt. 10 cts.
 586 *White Gem*. White; dwarf; very profuse. Pkt. 10 cts.
 587 *Gracilis*. Light blue; trailing. Pkt. 5 cts.
 LOVE-IN-A-MIST. See *Nigella*.

Lupin

- 590 *Annual Varieties, Mixed*. Easily grown plants, with long, graceful spikes of pea-shaped flowers of various colors. 2 feet. Pkt. 5 cts., oz. 20 cts.
 591 *Perennial Varieties Mixed*. Hardy plants of easy culture, useful as a background in the perennial border. Mixed blue and white. 3 to 4 feet. Pkt. 5 cts., ½oz. 15 cts., oz. 25 cts.

Lychnis

Perennial plant of easy culture, blooming the first season if sown early.

- 595 *Chalcedonica* (Burning Star). Bright scarlet flowers shaped like Maltese cross. Of fine color and thrifty growth; very effective in the perennial border. 2 feet. Pkt. 5 cts.

Marigold

Favorite annual plant, blooming the entire summer; easily cultivated. The African varieties bear large yellow or orange flowers and the plants are usually tall. The French type is of dwarf habit and flowers are striped. Hardy annual. 1 to 3 feet.

- 600 *African El Dorado*. Flowers very large, extremely double, of various shades of yellow. Pkt. 5 cts., ½oz. 15 cts.
 601 *Lemon Ball*. New. The largest of all Marigolds; nearly ball-shaped; pure lemon-yellow. Pkt. 10 cts.
 602 *Orange Prince*. New. Large, rich orange. Pkt. 10 cts.
 603 *Double Mixed*. All shades of the African type. Pkt. 5 cts., ½oz. 15 cts.
 606 *French Dwarf Double, Gold Striped*. Deep brownish red, striped yellow. Pkt. 5 cts.
 607 *French Double, Mixed*. Pkt. 5 cts., ½oz. 15 cts.
 608 *Legion of Honor*. Single flower; golden yellow, with a large spot of crimson. Pkt. 5 cts.

Mignonette. *Reseda odorata*

A well-known and popular hardy annual, prized for its delightful fragrance. will come into flower in a few weeks and continue until cut down by frost.

- 615 *Grandiflora*. Improved large-flowered Sweet Mignonette. Pkt. 5 cts., ½oz. 10 cts., oz. 15 cts.
 616 *Defiance*. Large spikes and extra-large individual florets. Pkt. 5 cts., ½oz. 15 cts., oz. 50 cts.
 617 *Giant Pyramidal* (Crimson Giant). Of branching growth; large; of reddish cast. Pkt. 5 cts., ½oz. 10 cts., oz. 30 cts.
 618 *Golden Queen*. Golden yellow. Pkt. 5 cts., ½oz. 10 cts., oz. 30 cts.

Seed sown in autumn will bloom in early spring, and when sown the last of July

- 619 *Machet*. Large, thick spikes of reddish cast, of dwarf habit, dark foliage. One of the best for pots. Pkt. 5 cts., ½oz. 15 cts., oz. 40 cts.
 620 *Parson's White*. Nearly white. Pkt. 5 cts., ½oz. 15 cts., oz. 25 cts.
 621 *Victoria*. Of deep reddish cast. Pkt. 5 cts., ½oz. 10 cts., oz. 30 cts.
 625 *Mixed Varieties*. The above and other varieties. Pkt. 5 cts., ½oz. 15c., oz. 25 cts.

Mimulus

Showy, free-flowering plants of easy culture. Half-hardy perennials, blooming the first season by July, if started early in the house, and continually until October. Thrives best in moist soil and somewhat shaded location. 1 foot.

- 630 *Tigrinus* (Monkey Flower). Handsome flowers with white, sulphur or yellow ground, spotted with crimson, scarlet or pink. Pkt. 5 cts.
 631 *Moschatus* (Musk Plant). Small yellow flowers, musk-scented foliage, of trailing habit; excellent for hanging baskets. Pkt. 5 cts.

Moonflower. *Ipomoea*

635 *Grandiflora alba* (*Ipomoea noctiflora*). A very rapid-growing variety of *Ipomoea*, reaching the height of 30 feet. Large white flowers, open in the evening and on cloudy days. Germination is greatly assisted if the hard shell of the seed is filed. Plant about 1 inch deep, in moist soil, in a box or seed-pan, and set in a warm place. If soil is kept moist the seed will germinate in about two weeks. Set out the young plants as soon as all danger of frost is past, selecting a warm, sunny location. Pkt. 10 cts.

635B *Pink Hybrid Moonflower*. In color, exquisite soft lilac-pink. Of much easier cultivation than the preceding. Seeds germinate freely and plant commences to bloom profusely nearly as soon as the Morning-Glory. Vines are of most rapid growth and will cover as much or more space than any other Moonflower, having enormous leaves. Blooms very profusely and will succeed wherever the Morning-Glory will. Pkt. 10c., ½oz. 25c.

Morning-Glory. *Convolvulus major*

A well-known climbing vine of easiest culture. Hardy annual. 10 feet.

636 *Mixed Colors*. Pkt. 5 cts., ½oz. 10 cts., oz. 15 cts.

637 *Japanese Giant Morning-Glories*. The flowers of this strain are much larger than those of the common type, the range of colorings much greater, while the foliage is greatly varied and very attractive. The colors range from deepest purple through all shades of blue and red to pure white, in a great variety of beautiful blendings and markings. The vine is not so hardy nor so vigorous in its growth as the common type. Germination is assisted by soaking the seed in water for twenty-four hours before sowing. Tender annual. 3 feet. Pkt. 5 cts., ½oz. 15 cts., oz. 25 cts.

MOURNING BRIDE. See *Scabiosa*.

MUSK PLANT. See *Mimulus*.



MORNING GLORIES

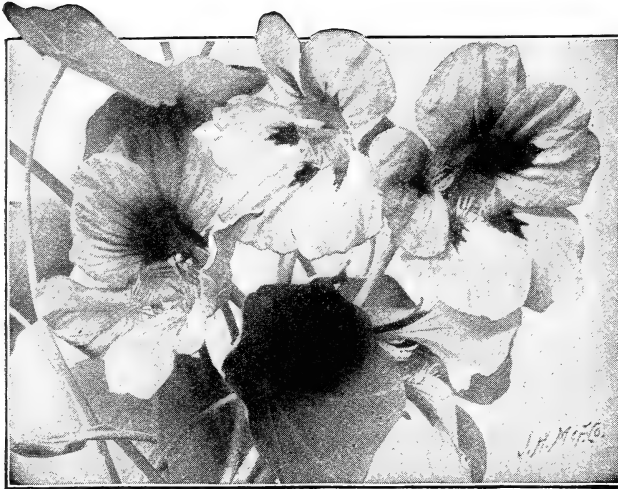

GIANT-FLOWERED TALL NASTURTIUMS—EVERBLOOMING AND BRIGHT

NASTURTIUM

So well known that no description is necessary. Among annuals, it is rivaled only by the sweet pea in popular favor, and no other plant, with so little care, produces such an abundance of graceful, beautiful flowers.

Tall Nasturtium (*Tropaeolum majus*)

- 640 **Atropurpureum**. Rich, dark crimson.
 641 **Butterfly**. Light lemon-yellow, lower petals blotched with terra-cotta-red; upper petals marked bright red.
 642 **Chameleon**. Varies in color and markings of flowers on the same plant.
 644 **Coccinea**. Bright scarlet.
 645 **Croesus**. Ground color light primrose to deep orange; upper petals blotched crimson; lower petals heavily fringed at throat and blotched brownish-red.
 646 **Dunnett's Orange**. Bright orange, blotched red.
 641 **Edward Otto**. Brownish lilac.
 650 **Golden-leaved Scarlet**. Deep scarlet; light yellowish foliage.
 652 **Heinemann**. Chocolate-color.
 654 **Hemisphaerium**. Straw-color, blotched rose.
 656 **King Theodore**. Deep crimson-maroon; dark foliage.
 658 **Luteum**. Clear light yellow.
 660 **Moonlight**. Very large, light straw color.
 662 **Pearl**. Very pale yellow, nearest approach to white.
 664 **Regelianum**. Deep crimson-violet.
 666 **Salmon Queen** (Improved Vesuvius). Rich, but soft velvety salmon; dark foliage.
 668 **Sunlight**. Giant flower; rich golden yellow.
 669 **Twilight**. Faint salmon, or buff, heavily suffused with rosy salmon. Extra-large.
 670 **Von Moltke**. Bluish rose.

Each of the preceding varieties, pkt. 5 cts., oz. 15 cts., $\frac{1}{4}$ lb. 40 cts.

- 671 **Collection of above 16 varieties**. Not subject to further discount. 50c.
 672 **Choice Mixed**. Many varieties; a wide range of colors. Pkt. 5 cts., oz. 10 cts., 2 ozs. 15 cts., $\frac{1}{4}$ lb. 25 cts., lb. 85 cts., postpaid; lb. by express or at counter, 75 cts. See, also, Worcester Mixed Tall Nasturtiums.
 673 **GIANT-FLOWERED TALL NASTURTIUMS, MIXED**. Splendid. The largest-flowered sorts, comprising several distinct named varieties and a much greater number of unnamed seedlings. The latter are the results of continual crossing by skillful hybridizers. Unsurpassed for general use, and especially desirable for competitive exhibits. Pkt. 10 cts., $\frac{1}{2}$ oz. 15 cts., oz. 25 cts., 2 ozs. 40 cts., $\frac{1}{4}$ lb. 65 cts.

Lobb's Tall Nasturtium (*Tropaeolum Lobbianum*)

By many considered better than Majus class; freer-flowering, greater profusion of bloom and brilliancy of color, although both flowers and foliage are smaller.

- 675 **Asa Gray**. Light yellow, almost white.
 677 **Black Prince**. Very dark, nearly black. Foliage dark.
 679 **Brilliant**. Dazzling scarlet.
 680 **Cardinale**. Rich, cardinal-red.
 681 **Firefly**. Deep orange, spotted red.
 683 **Giant of Battles**. Light yellow, spotted red.
 685 **Golden Queen**. Clear golden yellow.
 687 **King of the Blacks**. Deep, rich maroon; dark foliage.
 689 **Lucifer**. Deep scarlet, dark foliage.
 691 **Monsieur Colmet**. Brownish purple.
 693 **Napoleon III**. Golden yellow, spotted brown.
 695 **Regina**. Brilliant salmon, changing to deep cream.
 697 **Rudolph Virchow**. Rich carmine-rose, beautiful.

Each of these varieties, pkt. 5 cts., oz. 15 cts., 2 ozs. 25 cts., $\frac{1}{4}$ lb., 40 cts.
 698 **Collection of above 13 varieties**, no further discount, 40 cts.

TALL NASTURTIUMS, continued

- 700 **Lobbianum, Choicest Mixed**. Above and other choice varieties. Postpaid, pkt. 5 cts., oz. 12 cts., 2 ozs. 20 cts., $\frac{1}{4}$ lb. 30 cts., lb. \$1; by express or at counter, lb. 90 cts.
 701 **Madame Gunther Hybrids**. A very choice strain of the Lobbianum type, unsurpassed for diversity and richness of colors, comprising many new combinations of colors not found in any other class. The foliage is mostly dark and forms a pleasing contrast to the richly colored flowers. Pkt. 5 cts., oz. 15 cts., 2 ozs. 25 cts., $\frac{1}{4}$ lb. 40 cts.
 702 **"IVY-LEAVED."** A new type of Tall Nasturtium. An entirely distinct type of the popular flower, having leaves which resemble those of the English Ivy and flowers with narrow petals set well apart, which give them a somewhat star-like appearance. In this mixture will be found nearly all colors of the regular types. Pkt. 10 cts., $\frac{1}{2}$ oz. 15 cts., oz. 25 cts., 2 ozs. 45 cts., $\frac{1}{4}$ lb. 75 cts.
 705 **WORCESTER MIXED TALL NASTURTIUMS**. Our own mixture of many varieties, including selections from all types of Climbing Nasturtiums. Great diversity of colors, shadings and markings, including a large proportion of the more pleasing sorts. Postpaid, pkt. 5c., extra-large pkt. 10 cts., oz. 15 cts., 2 ozs. 25 cts., $\frac{1}{4}$ lb. 40 cts., lb. \$1.35; by express or at counter, lb. \$1.25.
 706 **VARIEGATED-LEAVED, or QUEEN TALL NASTURTIUMS IN MIXTURE**. Leaves are not so large as of the common Tall Nasturtium. Each leaf is variegated white, yellow, and green; flowers of medium size and borne on stems sufficiently long for cutting. Mixed colors. Includes all the named colors or varieties that have yet been offered, and several seedlings of different colors not yet named. Pkt. 10 cts., $\frac{1}{2}$ oz. 15 cts., oz. 25 cts., $\frac{1}{4}$ lb. 75 cts.

Dwarf, or Tom Thumb Nasturtiums

- 710 **Aurora**. Bright primrose, veined carmine.
 712 **Beauty**. Orange with scarlet markings.
 714 **Bronze-colored**. A very distinct and peculiar shade.
 716 **Chameleon**. Flowers of different colors or markings on the same plant.
 718 **Cloth of Gold**. Brilliant scarlet, foliage golden yellow.
 720 **Ceruleum roseum**. Rose, with bluish tinge.
 722 **Crystal Palace Gem**. Rich sulphur-yellow, spotted carmine.
 724 **Empress of India**. Dark scarlet, foliage distinct, dark purplish green.
 726 **Golden King**. Rich golden yellow.
 727 **Golden Midnight**. Flowers intense, deep maroon, almost black; a striking contrast to the light golden foliage. Pkt. 10 cts., $\frac{1}{2}$ oz. 20 cts., oz. 35c.
 728 **Golden Queen**. Both flowers and foliage yellow.
 730 **King Theodore**. Dark maroon; dark foliage.
 732 **King of Tom Thumbs**. Rich scarlet, dark foliage.
 734 **Lady Bird**. Orange-yellow, suffused red; blotched brighter red at base of petals.
 736 **Pearl**. Light cream, nearly white.
 738 **Prince Henry**. Light straw-yellow spotted and suffused with rose.
 740 **Rose**. Bright rose; small-flowered, but beautiful.
 742 **Ruby King**. Ruby-red, dark-leaved.
 743 **Spotted King**. Yellow, with brown spots.
 743b **Snow Queen**. A charming Lilliput; really the first white Nasturtium. The flowers, when first opened, are of a yellowish tinge, which soon turns to white at the edges, and, on the second day, the whole flower becomes pure white. An excellent bedding variety. Pkt. 10 cts.
 744 **Vesuvius**. Rich salmon-pink.

Each of preceding dwarf sorts, unless noted, pkt. 5 cts., oz. 15 cts., 2 ozs. 25 cts., $\frac{1}{4}$ lb. 40 cts.

- 746 **Choice Mixed**. While not equal to the Worcester Mixed, of a wide range of colors and will give very pleasing results. Postpaid, pkt. 5 cts., oz. 10 cts., 2 ozs. 15 cts., $\frac{1}{4}$ lb. 25c., lb. 85c.; by express or at counter, lb. 75c.
 747 **Worcester Mixed Dwarf Nasturtiums**. Our own preparation and can not be surpassed in range of colors, nor in quality of flowers. It includes the named varieties here listed, several novelties of merit listed elsewhere, and choice strains procured from several noted foreign growers. A superior mixture which we can recommend. Postpaid, pkt. 5 cts., extra-large pkt. 10 cts., oz. 15 cts., 2 ozs. 25 cts., $\frac{1}{4}$ lb. 40 cts., lb. \$1.35; by express or at counter, lb. \$1.25.
 748 **Queen of Tom Thumbs**. A new dwarf variety, with beautiful foliage variegated silvery white and light green. The plant does not grow over 9 inches high. The flowers are rich brilliant crimson, rather small, but show to great advantage with the beautiful foliage as a background. One of the best easily grown plants for an edging and very effective grown in masses. Pkt. 10 cts., $\frac{1}{2}$ oz. 20 cts., oz. 35 cts.
 749 **Queen of Tom Thumbs, Mixed**. We are pleased to offer this mixture, which comprises not only all named sorts, but also several unnamed seedlings of different colors. Not only have all the varieties the beautiful, marbled or variegated foliage of the original, but an additional interesting feature, that of the flowers varying in color on the same plant from light primrose and orange shades to scarlet and deep crimson, some veined and spotted with distinct colors. Pkt. 10c., $\frac{1}{2}$ oz. 20c., oz. 35c.
 750 **Dwarf Golden-Leaved Nasturtiums, in Mixture**. A mixture of seven varieties, with yellow or golden leaves, including the new Golden Midnight, recently introduced. Pkt. 10 cts., $\frac{1}{2}$ oz. 15 cts., oz. 25 cts.
 751 **Dwarf Ivy-leaved**. Like the Tall Ivy-leaved, this comprises a wide range of colors and is a charming acquisition. Pkt. 10 cts., $\frac{1}{2}$ oz. 15 cts., oz. 25 cts., 2 ozs. 45 cts., $\frac{1}{4}$ lb. 75 cts.
 752 **Lilliput Hybrids** (Queen of Holland). A new strain of the charming small-flowered type, ranging in color from pale yellow to deepest purple-maroon; blotched. Foliage mostly dark. While the flowers of the Lilliput type are small and not equal for cutting to those of the common type, the plants are superior for bedding. Pkt. 10 cts., $\frac{1}{2}$ oz. 20 cts., oz. 35 cts.

Nemophila. Love Grove

An attractive hardy annual, bearing cup-shaped flowers about an inch in diameter, usually in shades of blue and white, often spotted with brown. Succeeds in cool, shaded places, in light, but rather moist loam. 6 inches.

- 757 **Mixed Colors**. Pkt. 5 cts.

Nicotiana (Flowering Tobacco)

- Handsome, effective, half-hardy annuals, blooming profusely the entire season, and thriving in all soils. Seed may be sown early in the house, or in the open ground as soon as the soil is warm.
- 758 **Affinis**. White, star-like flowers; deliciously fragrant; expands fully in the evening. 2 to 3 feet. Pkt. 5 cts.
 - 759 **Sanderæ**. Rose-carmine; remarkably profuse in bloom. Unlike the *Affinis*, is in full bloom during the day. 3 to 3½ feet. Pkt. 10 cts.
 - 760 **Sanderæ Hybrids**. New hybrids, comprising several distinct colors or shades. Pkt. 10 cts.

Nigella Love-in-a-Mist; Lady-in-Green; Devil-in-a-Bush

A favorite hardy annual of the easiest culture. The blue or white flowers are half hidden in the abundant finely cut foliage, hence its common names. 1 to 1½ feet.

- 761 **Blue and White, Mixed**. Pkt. 5 cts.

PANSIES

Sow Pansy seed in August or September, in fresh, moist soil, cover lightly and press seeds in with a board. Keep the bed moist by watering, and, if the weather is hot and dry, by mulching with straw or by shading with cloth. The seeds will germinate in about two weeks, when the straw or cloth should be removed. In from four to six weeks, transplant to a slightly raised bed, setting the plants about 3 inches apart each way. Protect during winter with straw or leaves, and transplant to desired location early in the spring. Seed may be sown in the open ground in the spring as soon as soil can be fitted. A much earlier sowing can be made in a coldframe, but is not necessary. The ideal location is one somewhat sheltered from the wind, which has the morning sun and is shaded during the hottest part of the day. Seed sown in June in a cool place will make fine blooming plants by fall, when the weather is cool and the Pansy blooms best.

The seed which we offer of the choicest strains is of unsurpassed quality. Other strains at lower prices are of excellent quality, comprising every color and extra-large flowers.

Note that our packets of Pansy seeds are larger than usually offered, rarely containing less than 200 seeds, and more often 250 to 350.

- 770 **Bugnot's Superb Blotched**. Beautiful flowers, with broad blotches of rare shades of red bronze or brown. Of largest size, finest form and remarkable substance. Pkt. 25 cts., ½oz. 80 cts., ¼oz. \$1.40, oz. \$5.
- 771 **Cassier's Giant Blotched**. A very carefully selected strain of five-blotched varieties, remarkable for the enormous size of the flowers and the many rare combinations of shades and colors. Pkt. 25 cts., ½oz. 80 cts., ¼oz. \$1.40, oz. \$5.
- 772 **Odiar Large-flowered Blotched**. Very choice strain of three- and five-blotched varieties. Pkt. 15 cts., ½oz. 50 cts., ¼oz. 90 cts., oz. \$3.50.
- 773 **Trimardeau Giants**. Flowers of the largest size, with a dark blotch on the three lower petals. Pkt. 10 cts., ½oz. 35 cts., ¼oz. 60 cts., oz. \$2.
- 774 **Trimardeau Parisian, Large-stained**. A beautiful improved strain, mostly white ground and five-blotched varieties. Pkt. 15 cts., ½oz. 40 cts., ¼oz. 75 cts., oz. \$2.50.
- 776 **Madame Perret (Phenomenal)**. A new strain, distinctly beautiful, pink, blotched or veined with rose, crimson or purple, the upper petals either self-colored with rich wine-red or deep purple, or with a margin of white. Pkt. 15 cts., ½oz. 50 cts., ¼oz. 90 cts., oz. \$3.50.
- 778 **Masterpiece (Germania)**. Ruffled Pansies. A new strain, having ruffled and curled petals, giving the flowers the appearance of being double. Colors rich and striking. Pkt. 20 cts., ½oz. 70 cts., ¼oz. \$1.25, oz. \$4.50.
- 779 **Worcester Giant Mixed**. Our own selection of choice large-flowered strains and varieties, including a proportion of all the preceding strains, the named separate sorts, and several choice strains from different growers. Wonderful colors, shades and markings, representing nearly every type of Pansy. Pkt. 15 cts., ½oz. 60 cts., ¼oz. \$1, oz. \$3.75.
- 782 **Large-flowered Mixed**. Our own mixture of varieties. The range of colorings is excellent, and the mixture will be found very satisfactory. Pkt. 10 cts., ½oz. 30 cts., ¼oz. 50 cts., oz. \$1.75.
- 783 **English Prize Mixed**. Includes many with face-like markings, of various shades. Pkt. 5 cts., ½oz. 30 cts., oz. \$1.
- 785 **Choice Mixed**. A mixture of many varieties. Pkt. 5 cts., ½oz. 25 cts., oz. 85 cts.

Named Giant-flowered Pansies

- 786 **Giant Adonis**. Splendid light blue, with white center and dark blotches.
- 788 **Emperor William**. Ultramarine blue, with dark center.
- 790 **Freya (Silver-edged)**. Very fine.
- 792 **Golden Queen**. Pure yellow. ½oz. 50 cts.
- 794 **Indigo-Blue**. New, rich shade.
- 796 **King of the Blacks**.
- 798 **Light Blue**.
- 800 **Lord Beaconsfield**. Violet, shading to white at the top.
- 802 **Mauve Queen**. New, beautiful mauve. ½oz. 60 cts.
- 804 **Peacock**. Rich blue and purple, edged white; very striking.
- 806 **Ruby King**. Superb reddish shades. ½oz. 50 cts.
- 808 **Snowflake**. Pure white.
- 810 **Striped**. Rich, dark shades.
- 811 **Yellow**. With large, black eye.

Each of above 14 sorts, except where noted, pkt. 10 cts., ½oz. 40 cts.

Petunia

The Petunia is easily grown, and, blooming profusely all summer, is very popular for bedding. It thrives best in a warm, sunny location. Sow seed thinly where plants are to remain, in beds for transplanting, or, for early blooming, in the house in boxes. Almost invariably the weaker plants produce the finer flowers, especially of the choice strains.

- 812 **Mixed Colors**. A fine mixture of the common small-flowered type. Pkt. 5 cts., ½oz. 15 cts., ¼oz. 25 cts., oz. 75 cts.
- 814 **Finest Mixed**. A superior mixture. Pkt. 10 cts., ½oz. 20 cts., ¼oz. 30 cts., oz. \$1.

PETUNIA, continued

- 815 **Striped and Blotched, Mixed**. A choice strain. Pkt. 10 cts., ½oz. 25 cts., ¼oz. 40 cts.
- 816 **Howard's Star**. Rich shade of maroon, with five-pointed star of white. Very pretty. Pkt. 10 cts., ½oz. 40 cts.
- 817 **Dwarf Inimitable, Mixed Colors**. Dwarf, bushy plants, flowers mostly beautifully striped and blotched. Pkt. 10 cts., ½oz. 40 cts.
- 822 **Large-flowering Extra Choice, Mixed**. A superior mixture of large-flowered varieties, with beautiful markings. Pkt. 20 cts.
- 824 **Giants of California**. A superb strain. Flowers are of remarkable substance, enormous size and many are beautifully fringed. Of almost every conceivable shade; veined, striped or blotched with some contrasting shade. Plants of vigorous growth and blooms profusely. Pkt. 25 cts.

Phlox Drummondii

A well-known and very popular hardy annual, blooming profusely from July until frost, and of the easiest culture. Seed may be sown in the open ground early in the spring, either where the plants are desired to bloom, or in beds, and the young plants set in the desired location when 2 or 3 inches high. The tall sorts should stand about 12 inches apart, the dwarf about 6 inches. The plants will be more bushy and cover the ground better if pinched off while small.

- 830 **Mixed Colors**. Pkt. 5 cts., ½oz. 15 cts., oz. 50 cts.
- LARGE-FLOWERING** (*Phlox Drummondii grandiflora*). A great improvement on the common type, both heads and florets being nearly twice as large.
- 831 **Extra-Choice, Mixed Colors**. Our own mixture of the choicest and best strains from different growers. Pkt. 10 cts., ½oz. 30 cts., oz. \$1.
- 836 **Imported Collection**. Twelve colors. Pkt. 60 cts.
- DWARF** (*P. Drummondii nana compacta*). The plants of this class, growing only 6 or 8 inches high, are considered by many very desirable for bedding.
- 837 **Fireball**. Bright scarlet. Pkt. 10 cts.
- 838 **Snowball**. Pure white. Pkt. 10 cts.
- 840 **Mixed Colors**. All the choice varieties. Pkt. 10 cts., ½oz. 25 cts.
- LARGE-FLOWERING DWARF**. A new strain, combining the large heads and individual flowers of the *Grandiflora* type, with the dwarf, compact habit of the *Nana compacta*.
- 841 **Mixed Colors**. Pkt. 10 cts., ½oz. 30 cts.
- STAR, or FRINGED** (*P. Drummondii cuspidata*). A distinct class with petals partly fringed, partly toothed, and some longer than others and regularly placed, give the flowers a star-like shape. Pkt. 10 cts., ½oz. 25 cts.
- 843 **Mixed Colors**. Pkt. 10 cts., ½oz. 25 cts.
- DOUBLE**. Double and semi-double flowers. A very desirable class for cutting.
- 845 **Mixed Colors**. Pkt. 10 cts.
- HARDY PERENNIAL**. Well-known, popular herbaceous perennial, easily grown from seed.
- 847 **Choicest Mixed**. Saved from only the finest varieties. All colors. Pkt. 10 cts., ½oz. 30 cts., ¼oz. 50 cts.

PINK. See *Dianthus*.



GIANT-FLOWERED PANSY

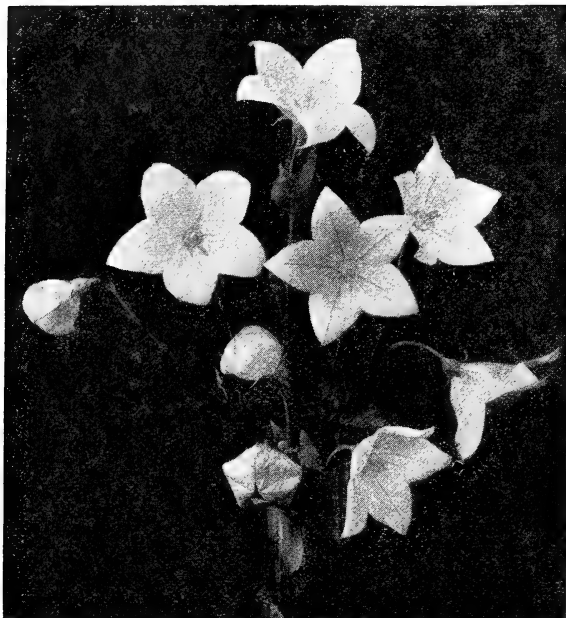

PLATYCODON

- 870 **Shirley.** A lovely strain, comprising many delicate and rich shades, ranging from pure white through pink, rose, scarlet and red to the deepest crimson, the darker shades often having a margin of white. Many of the flowers have crimped or wavy petals, all are of fine silky texture, but of good substance, and not surpassed by any for cutting. Pkt. 5 cts., $\frac{1}{2}$ oz. 15 cts.
- 872 **Shirley, Santa Rosa Strain.** Acknowledged the best and most varied strain in existence. Unusually large flowers, remarkably clear colors, including new striped, new salmon shades and new bluish ones, all mixed. Pkt. 10 cts., $\frac{1}{2}$ oz. 25 cts.
- 874 **Umbrosum.** Rich vermilion, with a spot of glistening black on each petal. Very showy. Pkt. 5 cts.

Double Annual Poppies

- 878 **Carnation-flowered, Mixed.** Fine, large, fringed flowers, of many colors. A popular class. Pkt. 5 cts., oz. 20 cts.
- 880 **Cardinal.** Very large, pure cardinal-red; deeply cut, dark green foliage; very attractive. Pkt. 5 cts.
- 882 **Golden Poppy.** Striking golden yellow foliage, and flowers in different shades of red. Pkt. 10 cts.
- 884 **Peony-flowered.** Mixed. Large, globular flowers resembling a Peony. Pkt. 5 cts., oz. 20 cts.
- 886 **Snowdrift, or Double White Fringed.** Flowers from 3 to 4 inches across, very double and finely fringed. Pure white. Pkt. 5 cts.
- 888 **Worcester Mixed.** Our own mixture of single and double annual varieties; all types and colors. Pkt. 5 cts., $\frac{1}{2}$ oz. 15 cts., oz. 50 cts.

Hardy Perennial Poppies

- ICELAND POPPIES.** Though hardy perennials, generally treated as annuals, blooming the first year, if seed is sown early. Of graceful habit, with fern-like foliage. They bloom profusely, and, if no seed-pods are allowed to form, until October.
- 890 **White, and Shades of Yellow and Orange, Mixed.** Pkt. 5 cts., $\frac{1}{2}$ oz. 20 cts.
- 891 **Burbank's Selected Strain.** A superior strain. Pkt. 10 cts., $\frac{1}{2}$ oz. 25 cts.
- ORIENTAL POPPIES.** Extremely desirable for the hardy perennial border; gorgeous blooms. Easily grown from seed sown either in late fall, or early spring. They bloom the second spring from sowing, and, though their season is short—about three weeks in June—they make a very effective display.
- 892 **Orientele.** Deep crimson flowers, with blotch of black on each petal. Pkt. 10 cts., $\frac{1}{2}$ oz. 25 cts.
- 893 **New Orientale Hybrids.** Flowers of enormous size, sometimes 6 inches or more in diameter and of many novel colors. Pkt. 15 cts.

Portulaca

Well-known tender annuals, blooming profusely all summer. Thrive in most soils and locations, but succeed best in a light, sandy soil and sunny spot, enduring any amount of dry weather. Form a dazzling display when sown in masses.

- 895 **Single Mixed.** Pkt. 5 cts., $\frac{1}{2}$ oz. 25 cts., oz. 40 cts.
- 896 **Double, Choice Mixed.** Usually from fifty to sixty per cent of the flowers will come double. Pkt. 10 cts., $\frac{1}{2}$ oz. 40 cts., $\frac{1}{2}$ oz. 65 cts.

Pyrethrum

Well-known, hardy herbaceous perennials of easy culture.

- 910 **Aureum.** (Golden Feather). Golden foliage; small, white flowers. Cultivated for its foliage alone and usually treated as an annual. 1 foot. Pkt. 5 cts.
- 913 **Roseum hybridum.** Blooms freely from June to September, bearing large-flowering, daisy-like flowers ranging from light pink to deep red, with bright yellow center; excellent for cutting. Pkt. 10 cts.

Platycodon. Chinese Bellflower

855 **Grandiflorum.** One of the best hardy perennials, and one of the easiest grown, its propagation being more easily accomplished by seed than by division of the root. It forms large clumps and is well adapted to the hardy border. Blooms from July to September. The flowers are large, steel-blue, rather more open than bell-shaped. 2 to 2 $\frac{1}{2}$ feet. Pkt. 10 cts.

Polemonium. Jacob's Ladder

857 **Ceruleum.** A hardy perennial, very popular in olden times. Easily grown from seed, preferably sown in the fall. Large heads of showy blue flowers from May to August. 2 feet. Pkt. 5 cts.

POPPY

Well-known hardy plants of quick growth, blooming profusely for a considerable time, thriving best on light, sandy loam. Seed of the annual varieties should be sown as early in the spring as possible and where desired to bloom as they do much better when they start to grow in cool weather, and are very difficult to transplant. The seed is fine and should be only slightly covered. The period of bloom will be considerably prolonged if all the flowers are cut or not allowed to form seed-pods. They will last much longer if cut just when opening.

Single Annual Poppies

- 860 **Admiral.** Large, single, peony-flowered variety, glistening white, with broad band of brilliant scarlet at the top. Pkt. 10 cts.
- 862 **Danebrog, or Danish Cross.** Brilliant scarlet with white spots at base of each petal. Pkt. 5 cts.
- 863 **Mephisto.** Beautifully fringed, usually brilliant scarlet with black spots, but varies to rose and white. Pkt. 5 cts.
- 864 **Miss Sherwood.** Fine large flower, satiny white with upper half delicate rose, a distinct and beautiful combination of unusual value. Excellent for cutting. Pkt. 10 cts.
- 866 **The Bride.** Large, pure white. Pkt. 5 cts.
- 868 **Tulip-flowered.** Bright scarlet, cup-shaped flowers. Pkt. 5 cts.

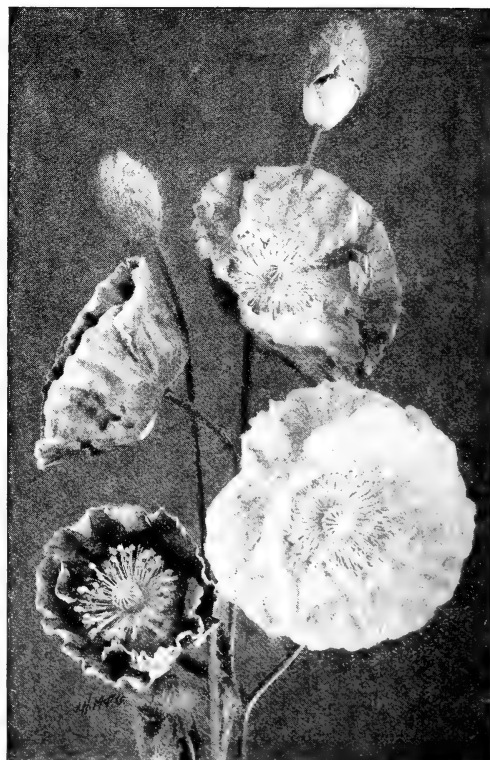

SHIRLEY POPPIES

PRIMULA**(Primrose)**

PRIMULA SINENSIS (Chinese Primrose). A beautiful winter-blooming greenhouse perennial, and one of the most pleasing for the home, blooming from December to spring. While its culture is not easy, it is by no means impossible for the amateur to raise fine, thrifty plants from seed. For early winter blooming seed should be sown the first week in April. Two sowings are advisable, but the second should not be later than the middle of May. Sow in well-drained shallow pans or boxes, using finely sifted loam, leaf mold and sand in equal parts. Cover lightly and water carefully, but well. Keep always moist and in shade, and in a temperature of about 60 degrees. In summer keep in a cool, shady location, in winter in a north window in a temperature of 45 degrees.

898 **Choicest Mixed**. Comprises the finest fringed varieties. Pkt. 35 cts.

PRIMULA OBCONICA. Easily grown. Seed sown in May will produce blooming plants by early fall. A beautiful pot plant and does well in the open ground in a cool, shady location if soil is strong, moist and rich. The treatment is about the same as of the Chinese Primrose except that the seeds should be sown in good porous soil, as they do not germinate well in leaf mold. The soil for final potting should be heavy and the plants should be kept in a temperature of from 50 to 60 degrees.

899 **Grandiflora**. Blooms profusely; white, shading to lilac. Pkt. 10 cts.

Hardy Primroses

Although known as hardy perennials, require in this climate some protection. They may be placed in a coldframe, or if protected with leaves, covered by a box, they will live through our severest winters. They are among the best of the early spring-blooming plants.

ELATIOR. (Polyanthus). Excellent for either pot or outdoor culture. Colors mostly shades of yellow, and red and yellow.

902 **Choicest Mixed**. Pkt. 10 cts.

904 **Vulgaris**. True yellow English Primrose; canary-yellow; fragrant. Pkt. 10 cts.

ROSE CAMPION. See *Agrostemma coronaria*.

ROSE OF HEAVEN. See *Agrostemma Cœli*.

RICINUS. See Castor Bean.

RESEDA. See Mignonette.

Rhodanthe

One of the finest everlasting flowers and an excellent plant for garden decoration. If flowers are gathered before they are fully expanded and dried in the shade, they will retain their color for years. Tender annual. 1 foot.

920 **Mixed Colors**. All shades of pink, rose, crimson and white. Pkt. 5 cts.

Rudbeckia**(Cone-flower)**

To this family belong the favorite plant, Golden Glow, and the well-known wild flower, Black-eyed Susan, or Yellow Ox-Eye Daisy. Both the annual and the perennials are of the easiest culture and grow in nearly all soils and situations, thriving alike in partial shade or fully exposed to the sun.

923 **Bicolor superba**. Free-blooming annual of dense, bushy growth, bearing on long stems large, bright yellow flowers with velvety brown spots at base of petals, and disc or cone of brown. Excellent for cutting. 2 feet. Pkt. 5 cts.

925 **Neumannii**. Large, golden yellow flowers, with maroon cone. Very showy; blooms for a long time. One of the best hardy perennials. 2 feet. Pkt. 15 cts.

926 **Purpurea** (Echinacea; Giant Purple Cone-Flower). Large flowers, about 4 inches in diameter, reddish purple, with large cone of brown. Hardy perennial. 3 feet. Pkt. 15 cts.



PRIMULA OBCONICA

Rocket*(Hesperis matronalis)*

Hardy perennial plant of easy culture, bearing clusters of purple or white fragrant flowers. 1½ feet.

921 **Mixed**. Pkt. 5 cts.

Salpiglossis**(Velvet Flower; Painted Tongue)**

Graceful, half-hardy annual, bearing from August to October, richly colored, funnel-shaped flowers, ranging from deepest purple to almost black and blue, through various shades of red, brown and yellow, to creamy white, usually marbled or veined with several contrasting colors. These are borne on long, slender stems, and are excellent for cutting, keeping well in water. Seed may be sown in the house the last of March or in the open ground in May. The plant succeeds best in deep, rich, rather light loam of medium moisture. 2 feet.

928 **Grandiflora**. Choicest mixed. Extra-large-flowered strain. Pkt. 5 cts., ¼oz. 20 cts.

929 **Emperor**. Mixed colors. New type, with one thick leading stem; flowers large and distinct in their beautiful veinings of gold. Pkt. 10 cts., ¼oz. 20 cts.

Salvia. Scarlet Sage

A mass of bloom from late summer until killed by frost; tender perennials, treated as an annual. Seed should be sown early indoors, or in a hotbed and the plants set out when the weather has become warm.

935 **Splendens Grandiflora**. The well-known Scarlet Sage. 3 feet. Pkt. 5 cts. and 10 cts., ¼oz. 40 cts., oz. \$1.50.

936 **Bonfire** (Clara Bedman). Compact, bushy growth, blooms earlier and more profusely. Intense scarlet. 2 feet. Pkt. 10 cts., ¼oz. 40 cts., oz. \$3.

Scabiosa. Mourning Bride

The flowers are large and double with a great variety of colors. Of easy culture and blooms freely from July until hard frost. Hardy annual. 2½ feet.

945 **Large-flowered, Mixed Colors**. Fine, large, double flowers in a wide range of colors. Pkt. 5 cts., ¼oz. 15 cts.

SCARLET RUNNER. See Beans—Ornamental varieties, page 34.

Schizanthus**(Butterfly, or Fringe Flower)**

Beautiful, dainty, half-hardy annual. Seed may be sown in the open ground, or in the house, and the plants set in the garden in May. Should be planted in a sheltered place or the plants tied to stakes as the stems are very brittle and easily broken by strong winds. An excellent house-plant. 1 to 1½ feet.

948 **Grandiflorus hybridus**. Very fine new varieties. Pkt. 10 cts.

Sensitive Plant*(Mimosa pudica)*

950 **Pudica**. Globular heads of small pink flowers. Grown chiefly for the peculiar habit of the plant, the leaves closing and drooping at the slightest touch. Tender annual. 1½ feet. Pkt. 5 cts.

Silene. Catchfly

Profuse-flowering plants of easy culture. Seed of the annual sorts may be sown in the open ground early in the spring, or in the fall if early bloom is desired.

951 **Armeria, Mixed** (Common Catchfly). Annual; blooms from July to September. White, pink and red. 1½ feet. Pkt. 5c.

953 **Pendula compacta, Single and Double**. Mixed colors. White, rose and red. Annual. Largely used for edgings. May to August. 6 inches. Pkt. 5 cts.

SNAPDRAGON. See Antirrhinum.



RUDBECKIA PURPUREA

Stock. Gilliflower

One of the most popular annuals, remarkable for its profusion of bloom brilliancy and diversity of colors and lasting quality of its flowers. Plants from seed sown inside in March or April commence to bloom in July and those from seed sown in the open ground in about ten weeks, and continue until frost. Plants grown in rich soil and well cared for produce 80 to 90 per cent of double flowers.

- DRESDEN PERPETUAL, or BRANCHING** (Cut-and-Come-Again). A perpetual blooming class of branching habit; double, fragrant flowers. 2 feet.
- 960 **Apple-Blossom Pink.** 961 **Dark Blood-Red.** 962 **Canary-Yellow.** 963 **Crimson.** 964 **Light Blue.** 965 **Violet.** 966 **Snow-White** (Princess Alice). Each of above, pkt. 10 cts., one pkt. each of the seven colors, 50 cts. (no other discount to apply); $\frac{1}{2}$ oz. 60 cts., $\frac{1}{2}$ oz. \$1.
- 967 **Choicest Mixed.** Pkt. 10 cts., $\frac{1}{2}$ oz. 50 cts., $\frac{1}{2}$ oz. 90 cts. **LARGE-FLOWERED DOUBLE TEN WEEKS.** A very choice strain, producing a very large per cent of double flowers. Fine for bedding. $\frac{1}{2}$ to 2 feet.
- 970 **Choicest Mixed.** Pkt. 10 cts., $\frac{1}{2}$ oz. 50 cts., $\frac{1}{2}$ oz. 90 cts.
- 971 **Double German Ten Weeks, Mixed Colors.** Seeds grown in the open ground instead of in pots, therefore cheaper. A good range of colors. $1\frac{1}{2}$ ft. Pkt. 5 cts., $\frac{1}{2}$ oz. 25 cts., $\frac{1}{2}$ oz. 40 cts.

Stokesia cyanea. Cornflower Aster

- 973 A beautiful hardy perennial, growing about 2 feet high and bearing from August to hard frost beautiful centaurea-like lavender-blue flowers, among the best for cutting. Pkt. 10 cts.



SWEET WILLIAM

Sunflower. Helianthus

The Sunflower grows well in all soils if fully exposed to the sun. The taller varieties make excellent backgrounds to other plants. All the varieties listed are annuals.

- 975 **Cucumerifolius** (Miniature Sunflower). Small, single flower, rich yellow. 4 feet. Pkt. 5 cts., $\frac{1}{2}$ oz. 15 cts.
- 980 **New Miniature Varieties.** Many new varieties of the miniature type of various shades of yellow and creamy white. Some are large, some have twisted petals and some black centers. Pkt. 10 cts., $\frac{1}{2}$ oz. 25 cts.
- 981 **Perkeo.** A distinct dwarf variety of the Miniature and growing only a foot high and blooming from the last of June until hard frost; is especially valuable for bedding. Pkt. 10 cts.
- 983 **Double Miniature.** Mixed. While the single flowers are more graceful, the double last longer when cut. Flowers small, double or semi-double and borne on long stems. Of various shades of yellow. 4 feet. Pkt. 10c.
- 984 **Double-Chrysanthemum-flowered.** Flowers larger than the preceding; full and double. Orange yellow. 5 feet. Pkt. 5 cts., $\frac{1}{2}$ oz. 15 cts.
- 986 **Russian Mammoth.** Very large. 7 to 9 feet. Pkt. 5 cts., oz. 10 cts.

SWEET SULTAN. See Centaurea.

Sweet William (*Dianthus barbatus*)

A splendid hardy biennial with large trusses of sweet-scented flowers produced in abundance. Seed should be sown at any time from early spring to the last of August, the late sown generally making as good plants as the early, and blooming to the full extent the following summer. $1\frac{1}{2}$ feet.

- 1300 **Single, Mixed Colors.** Pkt. 5 cts., $\frac{1}{2}$ oz. 15 cts., $\frac{1}{2}$ oz. 20 cts., oz. 30 cts.
- 1302 **Holborn Glory.** A new strain of the auricula-eyed section; both the heads and individual flowers are of the largest size and each of the latter shows a clear white eye; of an exceedingly wide range of colors. Pkt. 10 cts., $\frac{1}{2}$ oz. 20 cts.

SWEET WILLIAM, continued

- 1308 **Double, Largest-flowered.** Choicest mixed. A greatly improved strain. Pkt. 10 cts., $\frac{1}{2}$ oz. 25 cts.
- 1310 **Latifolius atrococcineus** (New Annual Everblooming). This new type is the result of a cross of the common annual pink and the Sweet William. It combines the free and continuous blooming habit of the former with the hardness of the latter, and though a biennial, blooms freely from seed the first season. Color an intense scarlet. Pkt. 10 cts.
- 1311 **Latifolius, Double.** (Annual Everblooming). **Mixed Colors.** In addition to the scarlet, this contains purple, rose and violet. Pkt. 10 cts.

Thunbergia

- 1315 An annual vine, growing about 4 feet high, bearing medium-sized flowers, white, buff or orange, with dark eye. Largely used in hanging baskets or window boxes. Pkt. 5 cts.

Verbena

Favorite annuals, thriving in nearly all soils. Useful for beds, borders, carpeting ground, and vases. Plants from seed sown in open ground in May will begin to bloom in August, and those sown inside in March will bloom from June until frost.

- 1320 **Mixed Colors.** A good strain, all colors of old type. Pkt. 5 cts., $\frac{1}{2}$ oz. 25c.
- 1321 **Mammoth Mixed Colors.** Comprises the best large-flowering sorts, of many colors. Pkt. 10 cts., $\frac{1}{2}$ oz. 40 cts.
- 1322 **Scarlet Defiance.** Large trusses of deep rich scarlet. Pkt. 10 cts.
- 1323 **Mammoth White.** Truss and florets large; fragrant. Pkt. 10 cts.
- 1324 **Italian Striped.** Large trusses and medium-sized flowers; each distinctly striped. Pkt. 10 cts.

Viola Cornuta. Tufted Pansies

Flowers are not so large as the Pansy proper, but is very desirable as it blooms profusely, and is more quickly and easily grown. Seed sown in April will produce blooming plants in June that will be covered with flowers for a long time, and, if planted in cool, moist soil, partly shaded, nearly all summer.

- 1335 **Mixed Tufted Pansies.** Finest mixture of all colors. Pkt. 10 cts., $\frac{1}{2}$ oz. 30 cts., $\frac{1}{2}$ oz. 50 cts.

Wallflower

Half-hardy perennial. A universal favorite in England. Though a fine bedding plant, is not well-known in America. It is more often grown as a pot plant and for this purpose is well adapted. The flowers are very fragrant and usually of various shades of yellow, brown and reddish brown. Seed may be sown in the open ground in the spring when warm, and, if given about 12 inches of room, will make strong stocky plants for winter bloom.

- 1340 **Single.** Mixed colors. Pkt. 5 cts.
- 1341 **Double Branching.** Mixed colors. Pkt. 10 cts.
- 1342 **Paris Extra-early.** A new single-flowered strain, blooming throughout the season from spring-sown seed. Colors light brown, brownish red, yellow and creamy white. Mixed. Pkt. 10 cts., $\frac{1}{2}$ oz. 20 cts.

WILD CUCUMBER. See Echinocystis.

Zinnia. Youth and Old Age

Old-time favorite annuals; easily grown from seed and transplanted readily. Showy flowers in profusion all summer. Fine for bedding, borders or among shrubbery.

- 1350 **Mixed Colors.** An improved strain, comprising all colors and many large flowers. 2 feet. Pkt. 5 cts., $\frac{1}{2}$ oz. 15 cts., oz. 50 cts.
- 1351 **Crimson.** 1352 **White.** 1353 **Scarlet.** 1354 **Yellow.** Each, Pkt. 5 cts., $\frac{1}{2}$ oz. 20 cts.
- 1357 **Collection of Twelve Colors.** Pkt. 50 cts.
- 1358 **Mammoth, or Giant-flowered, Mixed Colors.** Flowers of the largest size and of various colors. $2\frac{1}{2}$ feet. Pkt. 10 cts., $\frac{1}{2}$ oz. 25 cts., oz. 75 cts.
- 1360 **Curled and Crested.** A pleasing variation from the regular type, the petals being twisted, curled and crested. All colors. $2\frac{1}{2}$ feet. Pkt. 10 cts., $\frac{1}{2}$ oz. 25 cts.
- 1362 **Zebra.** Striped flowers, the colors varying on each plant. Pkt. 10 cts., $\frac{1}{2}$ oz. 25 cts.
- 1363 **Lilliput (Pompon).** Small, double flowers of many colors. Very profuse. $1\frac{1}{2}$ feet. Pkt. 10 cts., $\frac{1}{2}$ oz. 25 cts.
- 1364 **Haageana fl. pl.** (Mexican Zinnia). A distinct type with small, pretty double and semi-double flowers, which would hardly be recognized a Zinnias by those unfamiliar with the type. Of dwarf and slender growth the plant is excellent for bedding, while the deep orange flowers are good for cutting. Pkt. 10 cts.

Wild Flower Garden Mixture

1365. A mixture of many free-blooming annuals, which, once sown, require little care, and sown in this way, almost none. In fact, with the exceptions of thinning out some plants where they grow too thickly and removing an occasional weed, the bed often looks better let alone, is more in keeping with its name, and more like some lovely spots where wild plants grow. The possibilities of this mixture are great, the different seasons of blooming insuring constant succession of flowers from early in the season until hard frost, and in the height of bloom some new flower nearly every day. It affords a very easy and cheap way to quickly fill large areas or any unsightly place, and the results will surprise those who never saw a wild-flower garden; not only will the bed be attractive, but also will furnish many good flowers for cutting. To insure the greatest possible variety, the bed should be quite large. Pkt. 5 cts., $\frac{1}{2}$ oz. 15 cts., oz. 25 cts., $\frac{1}{2}$ lb. 75 cts.



STANDARD SWEET PEAS

Sweet Peas succeed best when planted very early in the spring. The soil should be at least of medium fertility and well prepared. Sow thickly in drills about 5 inches deep, but cover with but 2 inches of soil, filling the drill when plants are a few inches high. Seed may be sown in either single or double rows, the latter being preferable because more economical of space, and requiring only half as much material for support of the vines. For this purpose, poultry netting is often used, but brush is better. The season of blooming will be prolonged if all flowers are cut and seed-pods not allowed to form.

The following varieties are the best of their respective coloring. Many are of the Grandiflora or large-flowering class, others of medium size are included in the list, either because the largest and best of their shade or color, because very distinct, or because yet extremely popular.

Whenever the terms largest or best are used in descriptions, they apply to varieties in list or to any of the previous introduction, but do not include in comparison the varieties of recent introduction of the Spencer and Unwin type, the flowers of which average much larger than the older Grandiflora class.

Except where otherwise noted, all varieties at uniform price: Pkt. 5 cts., oz. 10 cts., 2 ozs. 15 cts., 1/2 lb. 20 cts., 1 lb. 35 cts., 1 lb. 60 cts., postpaid; by express or at counter, 1/2 lb. 30 cts., 1 lb. 50 cts.

- 993 **Admiration.** Pink-mauve on a ground of light primrose; wings a shade lighter than the standard, but almost self-colored. Medium size, hooded form.
- 994 **Agnes Johnson.** Pink and buff shaded and blended in the standard; wings pinkish buff. Medium size; open form.
- 995 **America.** Crimson-scarlet, striped on white; large, open form. The brightest striped variety.
- 1000 **American Queen.** Magenta-rose, self-colored, large, open form. Very bright and holds color well.
- 1005 **Apple Blossom.** Standard carmine-pink, shaded at midrib to lighter at edges; wings white, tinged and shaded with pink. Medium size; hooded form.
1010. **Aurora.** Orange-rose, striped on white; large, hooded form of the best type. Very attractive.
- 1015 **Black Knight.** Deep maroon; veining almost black. Large open form.
- 1016 **Black Michael.** Bright shining maroon, almost self-colored, the wings being only a shade lighter than the standard. A beautiful large and well-formed flower of desirable color.
- 1020 **Blanche Burpee.** Pure white, large, slightly hooded. A popular variety, but not equal to Dorothy Eckford.
- 1025 **Blanche Ferry.** Standard bright carmine-rose; wings white, tinged with pink. Medium size; open form. Most popular pink and white.
- 1030 **Countess of Lathom.** Cream-pink; self-colored. Medium size; hooded form.
- 1035 **Countess of Cadogan.** Standard opens nearly purple, but soon changes to lilac and later to blue; wings bright blue, shaded lighter at edges. Whole effect bright blue when mature. Superior in form to Navy Blue.
- 1040 **Dainty.** Pure white edged with light pink on both standard and wings, shaded lightly with light pink. Medium size; hooded form. The stems are the longest of any variety and bear, almost invariably, four flowers.
- 1045 **Dorothy Eckford.** The best pure white variety. Of the largest size and best semi-hooded form. Is similar in effect to Blanche Burpee but fully one-half larger.
- 1030 **Duke of Clarence.** Dark claret, self-colored. Large, hooded form of the best type. The lower flower on the stem is usually double.
- 1035 **Duke of Westminster.** Standard clear purple; wings purple, with tint of violet. Large, hooded form.
- 1060 **Earliest of All.** Very similar to Extra-Early Blanche Ferry, but earlier.
- 1061 **Earliest White.** It is claimed for this variety by the introducers that it will come into full bloom in forty-five days after seed is planted in the open ground. Grows only from 16 to 20 inches high, making it desirable for forcing. Flowers of good size, well formed, with stems 6 to 8 inches long. The seed is black, insuring a better stand and greater vigor and hardiness than white seed. The chief value of the variety lies in its earliness. Pkt. 5 cts., oz. 15 cts., 2 ozs. 25 cts., 1/2 lb. 40 cts., 1 lb. \$1.25.
- 1065 **Eliza Eckford.** Standard white, shaded with pink; wings white, lightly tinged with pink; medium size.
- 1070 **Emily Eckford.** Standard rose-purple; wings lilac.
- 1075 **Emily Henderson.** Pure white; large, open form, petals of more substance than other white sorts; not so graceful in form as the hooded varieties; stems very thick. Vigorous grower and blooms profusely.
- 1079 **Evelyn Byatt.** Standard rich orange-salmon, wings a trifle deeper, giving the flowers as a whole the effect of fiery orange or deep sunset color. Distinct and striking.
- 1050 **Flora Norton.** Bright, clear blue, with a faint suggestion of purple at times. Medium size; open form. More nearly blue than any other.
- 1082 **Florist Lavender.** The introducers say of it: "The most perfect and truest lavender of any type of Sweet Peas; A sport from Navy Blue; strong, vigorous grower; extra-long stems, always three and four flowers. Experts say, 'Best lavender yet.'" Pkt. 10 cts., oz. 15 cts., 2 ozs. 25 cts., 1/2 lb. 40 cts., 1 lb. \$1.25.

STANDARD SWEET PEAS, continued

- 1085 **Golden Rose.** Primrose, lightly striped and mottled with light pink; very large, semi-hooded form of the finest type; wings unusually large; both wings and standard wavy at edges.
- 1090 **Gorgeous.** Standard scarlet-orange; wings bright rose, strongly tinged with orange. Medium size; open form. Intensely bright, much more so than any of this class; very attractive, but burns in hot sun.
- 1095 **Gray Friar.** Heliotrope, marbled or dusted on white and generally showing a few stripes of violet near midrib of standard. Large, hooded form.
- 1096 **Helen Pierce.** Resembles a blue-mottled gloxiana in markings. Pure white, mottled or dotted with bright blue and faintly veined with same color, but with no suggestion of a stripe. Of good size, shell shaped; unique and especially attractive when cut and bunched by itself. Pkt. 5 cts., oz. 15 cts., 2 ozs. 25 cts., ½ lb. 35 cts., lb. \$1.
- 1097 **Henry Eckford.** Self-colored, bright, but soft flaming orange, slightly deeper at center of flower. Medium size. Unfortunately the flowers fade quickly in the bright sun, and should be cut and placed in water as soon as open. No other variety shows so well in artificial light.
- 1100 **Hon. F. Bouverie.** Standard and wings both deep pink at the base, shading to very light pink at the edges, with ground of primrose. In effect, nearly buff.
- 1101 **Horace J. Wright.** Standard dark bronze-claret; wings dark rich purple-violet. Large, fine form and a grand addition to the popular dark shades.
- 1105 **Janet Scott.** Deep, but bright pink, showing buff at top of standard, the top blossoms lighter pink and showing more buff. Large, hooded form. Distinct in both color and form.
- 1110 **Jeannie Gordon.** Standard rose, veined with deeper rose, on primrose ground; wings primrose, tinged with pink; large, hooded form.
- 1115 **Jessie Cuthbertson.** Primrose, striped with light pink; large hood.
- 1116 **John Ingman.** A seedling of Countess Spencer, which, unfortunately has reverted, only now and then a flower being wavy. Rich carmine-rose, with veins of deeper shade. Of largest size and generally four flowers to the stem, and stems are long and stiff. A grand variety, lacking only the wavy form to make it perfect. Pkt. 10 cts., oz. 20 cts. 2 ozs. 30 cts., ½ lb. 50 cts.
- 1120 **Katherine Tracy.** Standard soft pink; wings a trifle lighter; almost a self-color; medium size, open form. The standard is nearly round, and inclined to wavy edges. An attractive flower, and plant is of very vigorous growth, but usually bears but two flowers to the stem.
- 1125 **King Edward VII.** Bright red or crimson-scarlet, almost self-colored. Of largest size and open form. One of the best of this color.
- 1130 **Lady Nina Balfour.** Standard mauve, wings lavender, primrose ground, giving the blossom a pearl-gray tone quite distinct from New Countess.
- 1135 **Lady Grisel Hamilton.** The largest size and lightest shade of lavender.
- 1140 **Lady Mary Currie.** Standard crimson-orange, wings crimson, with tint of orange; above medium size; hooded form.
- 1145 **Lord Roseberry.** Bright magenta-rose, showing veins of deeper shade. Large, hooded form.
- 1150 **Lottie Eckford.** Standard white, heavily shaded with lilac; wings white, shaded with lighter lilac and both have a rim of deep blue.
- 1155 **Lovely.** Deep pink, shading to light pink at the edges. Large, hooded form. Plant vigorous, usually having four flowers to the stem.
- 1160 **Majestic.** Rose-red, self-colored, on a primrose ground. Large hood.
- 1165 **Marchioness Cholmondeley.** Standard light salmon, buff and cream; wings light buff, above medium size; hooded form.
- 1170 **Miss Wilmot.** Standard orange-pink, veined with deeper shade; wings rose, tinted orange; very large, semi-hooded form of best type. Stems long; plant vigorous. The largest and best of this shade.
- 1175 **Modesty.** White, with tint of pink a little deeper at the edges. Medium size; hooded form.
- 1180 **Mont Blanc.** Pure white; medium size and open form. Plant dwarf; very early.
- 1184 **Mrs. Collier.** Of rich primrose tint, without a trace of pink. Richer in coloring, of much better substance, larger, with long, stiff stems bearing three or four flowers; it surpasses all other primrose varieties of preceding introduction.
- 1185 **Mrs. Dugdale.** Crimson-rose, self-colored, on primrose ground; very large, semi-hooded form of a distinct shell shape—one of the best forms we have. A fine variety; distinct and attractive.
- 1190 **Mrs. George Higginson, Jr.** Light lavender, almost azure-blue and nearly free from any tint of mauve. Medium size, semi-hooded form.
- 1195 **Mrs. Jos. Chamberlain.** Flower rose, striped on white; very large hooded form.
- 1200 **Mrs. Walter Wright.** Flowers rose-purple, self-colored; very large, hooded form.
- 1205 **New Countess.** Nearly pure lavender, self-colored; medium size; hooded form.
- 1210 **Nymphæa.** The first blossoms open white, but turn pink, the bottom flower being darker than the others, the top remaining always white; large, semi-hooded form, with slightly wavy edges. Stems long and usually bear four flowers.
- 1215 **Othello.** Very dark maroon; veins almost black. Large hood.
- 1219 **Phenomenal.** A beautiful variety, white, shaded and edged with violet. Similar to Lottie Eckford, but larger and better in every way. Introduced as a variety with wavy petals, but has reverted. Pkt. 5 cts., oz. 15 cts., 2 ozs. 25 cts., ½ lb. 40 cts., lb. \$1.25.
- 1220 **Prima Donna.** Pure pink; self-colored; over medium size, hooded form. Vine vigorous; usually four flowers to the stem. Best pink sort.
- 1225 **Prince Edward of York.** Standard scarlet, with tint of crimson; wings crimson; large, open form.
- 1230 **Prince of Wales.** Rose-crimson, self-colored. Vine vigorous, usually four blossoms to the stem. The largest and finest of this shade.
- 1234 **Queen Alexandra.** A grand flower of giant size. Intense scarlet; does not burn in the sun and is by far the best of this color. Of robust habit and requires much more room than others.
- 1285 **Queen Victoria.** Light primrose, self-colored; over medium size, hooded form. Black-seeded; sure to germinate and grow vigorously.
- 1240 **Ramona.** Light pink, striped on white; over medium size; hooded form.
- 1245 **Royal Rose.** Standard crimson-pink, shading deeper at midrib; wings pink, shading lighter at edges; very large, semi-hooded form.
- 1250 **Salopian.** Pure red, self-colored; large, hooded form. Stands hot sun better than others of this color. One of the best.
- 1255 **Sensation.** Standard very light pink and buff; wings pure white; over medium size; hooded form of the best type. Nearly always four blossoms to the stem.
- 1260 **Shasta.** Pure white; very large, open form, wavy at the edges. Usually four blossoms to the stem.
- 1265 **Stella Morse.** Buff with tint of pink a little deeper at the edges; when bunched has a rich cream effect.
- 1270 **Sunset.** Primrose, striped with rose. Large, hooded form.
- 1275 **The Hon. Mrs. E. Kenyon.** Light primrose, self-colored; very large, semi-hooded form. The best of this shade.
- 1280 **Triumph.** Standard rose, heavily veined with scarlet rose; wings light crimson-pink, veined with crimson. Large, open form.
- 1285 **Venus.** Light pink and buff blended. Medium size; open form.
- 1290 **White Wonder.** Pure white; frequently produces double stems with five to nine blossoms, fully half of the flowers being double; having two or three standards. Regarded as the very best double white.

Mixtures of Sweet Peas

- 1295 **Our Best Mixed.** Our own mixture of the choicest large-flowered varieties includes the best of all the standard sorts, all the varieties of the new Giant Orchid-flowering class, including both the Countess Spencer and the Unwin types, and the new unnamed Spencer seedlings. The mixture comprises all shades, is of pleasing diversity, but is blended in carefully studied proportions, the most desirable and popular shades and colors predominating. The mixture is by far the best we ever offered, and we are quite certain that it will not be surpassed by any offered elsewhere, regardless of the price others may ask, or of the claims which may be made. Considering the liberal proportions of the new expensive sorts which the mixture contains, our price is very reasonable, and, when compared with the price at which some firms have usually offered similar (not better) mixtures, our price is very low. Postpaid, pkt. 5 cts., oz. 15 cts., 2 ozs. 25 cts., ½ lb. 35 cts., ¼ lb. 65 cts., lb. \$1.10; by express or at counter, ½ lb. 60 cts., lb. \$1.
- 1296 **Choice Mixed.** Also prepared by us; a well-blended mixture, comprising many of the large-flowering varieties of the older type, and Eckford's Large-flowering Hybrids in great variety. The mixture will compare favorably with those generally offered at a higher price, and is surpassed only by mixtures which, like our Best Mixed, contain the new orchid-flowering varieties. Postpaid, pkt. 5 cts., oz. 10 cts., 2 ozs. 15 cts., ½ lb. 20 cts., ¼ lb. 35 cts., lb. 60 cts.; by express or at counter, ½ lb. 30 cts., lb. 50 cts.
- 1297 **Cupid, or Dwarf Sweet Peas.** Plants of this class seldom grow over 6 inches high, but form a dense mass of foliage, and produce flowers of good size, in profusion, stems too short for cutting. Desirable only as a bedding plant. Choicest mixed, including nearly all colors and shades found in the tall sorts. Pkt. 5 cts., oz. 10 cts., ½ lb. 25 cts.

See, also, Mixture of Spencer Varieties and Seedlings.

Color Classification

A DUPLICATE LIST WHICH WILL AID IN SELECTING DESIRED COLORS OR SHADES

- White.** Blanche Burpee, Dorothy Eckford, Emily Henderson, Mont Blanc, Shasta, White Wonder, and Earliest White.
- Pale Yellow or Primrose, and Light Pink and Primrose.** Marchioness of Cholmondeley, Queen Victoria, Stella Morse, The Hon. Mrs. E. Kenyon, Mrs. Collier.
- Very Light Pink, or Light Blush.** Modesty, Sensation.
- Light Pink, Clear Pink and Pink and Buff.** Countess of Latham, Dainty, Eliza Eckford, Hon. F. Bouverie, Janet Scott, Katherine Tracy, Lovely, Nymphæa, Prima Donna, Venus.
- Deeper Pink.** Apple Blossom, Jeannie Gordon, Royal Rose, Triumph.
- Rose.** American Queen, Lord Roseberry, Majestic, Mrs. Dugdale, Prince of Wales, John Ingman.
- Rose and White.** Blanche Ferry, Earliest of All.
- Orange and Pink.** Gorgeous, Lady Mary Currie, Miss Wilmot, Evelyn Byatt, Henry Eckford.
- Shades of Red.** King Edward VII, Prince Edward of York, Salopian, Queen Alexandra.
- Lavender and Mauve.** Emily Eckford, Lady Grisel Hamilton, Lady Nina Balfour, Lottie Eckford, Mrs. George Higginson, Jr., Mrs. Walter Wright, New Countess, Phenomenal.
- Blue and Purple.** Countess of Cadogan, Duke of Westminster, Flora Norton, Helen Pierce.
- Very Dark Shades—Claret and Maroon.** Black Knight, Duke of Clarence, Othello, Black Michael, Horace J. Wright.
- Striped and Variegated.** America, Aurora, Golden Rose, Gray Friar, Jessie Cuthbertson, Mrs. Jos. Chamberlain, Ramona, Sunset.

COUNTESS SPENCER OR GIANT ORCHID-FLOWERED TYPE**The New Race of Sweet Peas**

Greatly surpasses in several respects all previous introductions. The most notable difference is in the beautiful form of the flowers, the tissue being so full that, unlike the older types, it can neither flatly expand nor smoothly roll, but causes both the standard and wings to wave and crinkle in a peculiarly beautiful manner. The flowers all are so uniformly of extraordinary size, averaging considerably larger than the latest introduction of the older Grandiflora type. Another remarkable and very desirable feature is that a large percentage of the flowers are borne three or four to the stem. Other desirable features are the long stems and great substance of flowers and remarkably vigorous growth and free-blooming habit of plant. The class excels in all characteristics that are desirable in the Sweet Pea and is destined to be very popular.

Though, as noted, the Spencers are very profuse in bloom, they produce but little seed. And not only does this prevent seed from being produced cheaply, but the tendency to sport and revert necessitates careful and frequent roguing; that is, taking out the vines which produce flowers not true to type, often to the extent of destroying half the crop. Pure seed, therefore, is necessarily expensive, and intending purchasers should bear this in mind in comparing prices. The seeds of the Spencer varieties which we offer, like all our Sweet Peas, are grown on contract by noted growers in California, who have themselves originated most of the Spencer varieties, and than whom there are no more skilful and reliable growers in the world. For these seeds we paid much higher prices than other growers quoted, and we have every reason to believe that the flowers will be of the true type.

APPLE-BLOSSOM SPENCER. Similar to the Apple Blossom of the older type; of fine form; petals waved and crinkled; standard finely waved at edges; large and long-stemmed. Pkt. 10 cts., ½ oz. 20 cts., oz. 35 cts.

ASTA OHN. Large flowers, waved and fluted in the standard with very large, wavy wings, lavender, suffused or tinted with mauve; superior to any other lavender. Originated by a Chinese gardener of California, an expert grower of Sweet Peas and named by him for his little daughter, Asta Ohn. Pkt. 10 cts., ½ oz. 20 cts., oz. 35 cts.

AURORA SPENCER. Enormous flowers, both wings and standard much waved or fluted; ground creamy white, beautifully flaked and mottled, rich orange-salmon. Pkt. 10 cts., ½ oz. 20 cts., oz. 35 cts.

BEATRICE SPENCER. Resembles in color and markings the old favorite, Princess Beatrice. It is fully as large as Countess Spencer, with wavy standard and large wings. The ground is white, tinted with soft pink and buff on the standard, while each wing has a blotch of brighter pink near the base. Pkt. 10 cts., ½ oz. 20 cts., oz. 35 cts.

BLACK KNIGHT SPENCER. Very dark bronze flowers.

BLANCHE FERRY SPENCER. Closely resembles the variety of the older type. Large, well waved and crinkled. Pkt. 10 cts., ½ oz. 20 cts., oz. 35 cts.

CAPTAIN OF THE BLUES SPENCER. Different from the other Spencers, with purple standard and clear blue wings. Bright and unique. Pkt. 10 cts., ½ oz. 20 cts., oz. 35 cts.

COUNTESS SPENCER. The original variety, and from which, directly or indirectly, all others of this beautiful class sprang. Soft rose, deeper at the edges, more heavily suffused in cool weather. Paradise or Enchantress is simply a fine strain of this, and, as the stock we offer of this has been re-selected and we believe cannot be surpassed, we see no reason for offering it under other names. Pkt. 10 cts., oz. 20 cts., 2 ozs. 30 cts., ½ lb. 50 cts., lb. \$1.75, postpaid; by express, lb. \$1.65.

DAINTY SPENCER. Beautifully formed, pale primrose self, changing to white, with a pink edge, more decided at the back; three and four flowers on a stem. Pkt. 10 cts., oz. 20 cts., 2 ozs. 30 cts., ½ lb. 50 cts.

FLORENCE MORSE SPENCER. Delicate blush, with pink edge; a beautiful flower of the largest size. Pkt. 10 cts., ½ oz. 15 cts., oz. 25 cts., 2 ozs. 40 cts., ½ lb. 65 cts.

FLORA NORTON SPENCER. Bright blue, with a little deeper tint of purple than the original Flora Norton. Large and both standard and wings are wavy. A grand flower. Pkt. 10 cts., ½ oz. 20 cts., oz. 35 cts.

GEORGE HERBERT. Bright rosy carmine, especially fine in artificial light. Of largest size and true wavy form, both standard and wings beautifully fluted. Four-flowered. Pkt. 10 cts., oz. 20 cts., 2 ozs. 30 cts., ½ lb. 50 cts.

HELEN LEWIS. Standard crimson-orange, wings orange-rose. The standard is reflexed, showing the distinctly fluted effect, while the wings roll and fold. Large. Pkt. 10 cts., oz. 20 cts., 2 ozs. 30 cts., ½ lb. 50 cts.

KING EDWARD VII SPENCER. Similar to King Edward VII, one of the best scarlets. Both standards and wings rich carmine-scarlet, the reverse of the wings rosy carmine. Of the largest size and waved, frilled and crinkled to a remarkable degree. Pkt. 10 cts., ½ oz. 20 cts., oz. 35 cts.

"LOVELY" SPENCER. Like its predecessor, "Lovely," this selection is all its name implies. The color is bright pink at the throat, or rather the base of both standard and wings, and shades to soft blush and almost white at the edges. Of the true Spencer type, large and wavy. Pkt. 10 cts., ½ oz. 20 cts., oz. 35 cts.

MRS. ROUTZAHN SPENCER. Ground buff or apricot, suffused with delicate pink or rose, with a decided rose edge. Of the largest size and true Spencer type. Stems unusually long; often four-flowered. One of the best. Pkt. 10 cts., ½ oz. 15 cts., oz. 25 cts.

MRS. SANKEY SPENCER. Those familiar with varieties will recognize this as a "Black-seeded White." Being black-seeded, it is easy to germinate, but, like all other black-seeded White Sweet Peas, it shows a faint tint of pink in the bud, which, however, does not show when flower is fully expanded. Pkt. 10 cts., ½ oz. 20 cts., oz. 35 cts.

MRS. WALTER WRIGHT SPENCER. Color rosy mauve, of unusual value. Pkt. 10 cts., ½ oz. 20 cts., oz. 35 cts.

OTHELLO SPENCER. A rich deep maroon color. Splendid for bouquets of this dark color. Pkt. 10 cts., ½ oz. 20 cts., oz. 35 cts.

PRINCE OF WALES SPENCER. A novel combination of bold rosy-salmon, standard (sometimes called salmon-carmine) with rosy wings; a delightful flower. Pkt. 10 cts., ½ oz. 20 cts., oz. 35 cts.

QUEEN VICTORIA SPENCER. Enormous flowers of deep primrose, suffused with rose; of good form and substance and with the true Spencer wave to the three or four flowers on a stem. Pkt. 10 cts., ½ oz. 20 cts., oz. 35 cts.

PRINCESS ALICE SPENCER. A lovely shade of lavender, claimed by the originator to be the least sportive of this class, and the best one of this shade. Pkt. 10 cts., ½ oz. 15 cts., oz. 25 cts., 2 ozs. 40 cts., ½ lb. 65 cts.

PRIMROSE SPENCER. Not so large as some of this class, but especially desirable because of its color, a pronounced primrose or creamy yellow; both standard and wings waved and crinkled, thick, strong and very long stems, always three- and sometimes four-flowered. Pkt. 10 cts., ½ oz. 15 cts., oz. 25 cts., 2 ozs. 40 cts., ½ lb. 65 cts.

RAMONA SPENCER. Like the well-known Ramona, is clear white, with soft, delicate lines and flakes of blush-pink. Standard and wings wavy and fluffy; very seldom one finds a stem with less than four blossoms, all beautifully poised. Pkt. 10 cts., ½ oz. 20 cts., oz. 35 cts.

WHITE SPENCER. Pure white. Of the largest size, has beautifully poised wings and the standard is erect and wavy. Stems often 12 inches long. Superior to any other white variety except perhaps the new Mrs. Sankey Spencer, which, though it may not outrank this in size or form, has the desirable feature of being black-seeded. Pkt. 10 cts., oz. 20 cts., 2 ozs. 35 cts., ½ lb. 65 cts.

SPENCER VARIETIES AND SEEDLINGS MIXED. This superb mixture contains not only all of the preceding named varieties, but also a considerable number of new unnamed seedlings, of which, while they may not all prove to be strictly of the Spencer type, a large percentage will be of this type. The tendency of Countess Spencer to sport is a cause of much trouble and annoyance to growers of seed, but, fortunately, it is not an unmixed evil, as it has resulted in a rapid multiplication of desirable shades and colors among them the seedlings in this mixture. Postpaid, pkt. 10 cts., oz. 20 cts., 2 ozs. 30 cts., ½ lb. 50 cts., ½ lb. 90 cts., lb. \$1.60; by express or at counter, ½ lb. 85 cts., lb. \$1.50.

"Unwin" Giant Orchid-Flowered Sweet Peas**TYPE OF NEW WAVED AND CRINKLED SORTS**

The popular Gladys Unwin, the first of this class and the parent of the other varieties following, though of different origin, is very similar in type to Countess of Spencer, having the same wavy form and crinkled edges. This and its varieties come generally true to type, though the flowers do not average quite so large.

GLADYS UNWIN. A lovely light pink, several shades lighter than Countess Spencer.

PHYLLIS UNWIN. Light rose-pink; larger than Gladys Unwin.

NORA UNWIN. White flowers have long stems and are very abundantly produced.

MRS. ALFRED WATKINS. Pale pink, slightly deeper at the edges. A large, well-expanded flower of true, wavy form and borne on very long stems.

FRANK DOLBY. Beautiful light lavender, the same shade as Lady Grisel Hamilton, but much larger, the finest lavender variety unless it be the new Asta Ohn.

E. J. CASTLE. Rich carmine-rose, with salmon shading; very striking especially in artificial light.

JOSEPHINE BARNARD. A beautiful, bold flower. In color a pure rose self, retaining this color throughout its whole period of bloom. Grows stronger in color with age, instead of fading, as is usual with other varieties. Striking upright standard, which is crinkled and waved; broad, incurved wings, flowers well placed on long stout stems, coming three or four flowers on each stem.

ST. GEORGE. Standard rich, bright orange-scarlet; very large and generally inclined to the wavy form. Wings bold and well opened, of a slightly deeper color, giving the whole flower a very brilliant appearance. An exceedingly shy seeder.

Each, pkt. 5 cts., oz. 15 cts., 2 ozs. 25 cts., ½ lb. 40 cts.

About Planting Sweet Peas in Separate Colors. We strongly advise the planting of Sweet Peas in rows of separate colors, as they are easier to gather for bouquets in solid colors, and always bring better prices for market. Named sorts can be neatly labeled with small wooden tags; this adds value to any collection.

BULBS

Begonias, Tuberos-Rooted

These are, perhaps, the most beautiful of all low-growing bedding plants, and are not, as commonly thought, of difficult growth. They require, however, a rich, mellow soil, a location shaded from the direct rays of the sun during the hottest part of the day, and plenty of water. Tubers should be started early in the house and plants set in the open ground about June 1. They will bloom soon and profusely and continuously until frost. The tubers can then be lifted and stored in dry sand in a moderately warm place.

SINGLE VARIETIES. White, Pink or Rose, Red and Yellow. Postpaid, 5 cts. each, 50 cts. per doz.

DOUBLE VARIETIES, Same Colors. Postpaid, 12 cts. each, 45 cts. for 4, \$1.25 per doz.

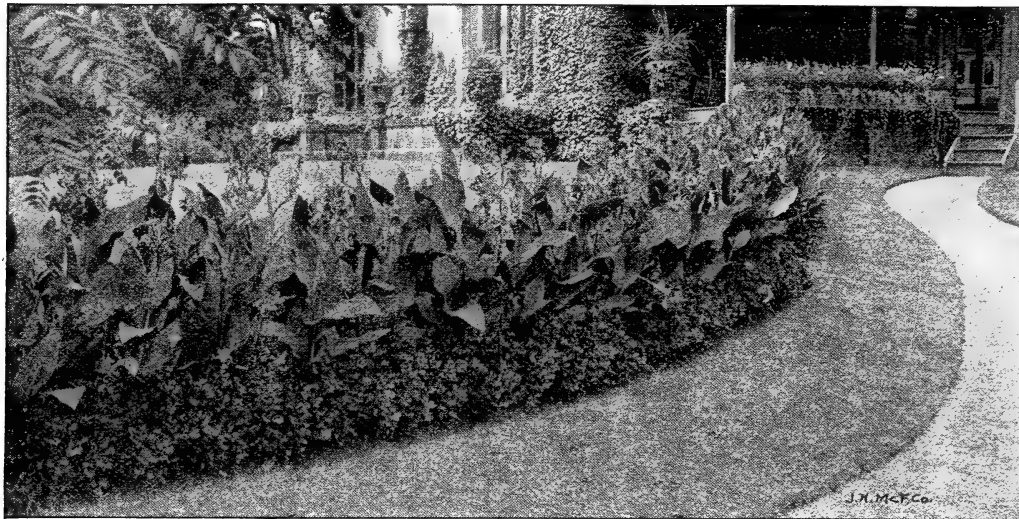

A BED OF CANNAS—SUBTROPICAL AND GORGEOUS

CANNAS

BEST STANDARD VARIETIES

Price of strong dormant roots, except where otherwise noted, 10 cts. each, \$1 per doz., postpaid; by express, 90 cts. per doz.

Except where otherwise described, all varieties have green foliage

- Alphonse Bouvier.** Brilliant crimson, deeper when fully open. 6 feet.
- Alsace.** Delicate sulphur-yellow, changing soon to creamy white. 4½ feet.
- Austria.** A fine variety of the orchid-flowered or Italian type. Canary-yellow; large, handsome foliage. 5½ feet.
- Brandywine.** Foliage luxuriant and of the darkest hue. Flowers large, intense wine-red, beautifully mottled with deep crimson; two or three petals sometimes narrowly edged with bright gold. 4 to 5 feet. 15 cts. each, \$1.35 per doz.
- Chas. Henderson.** Deep but brilliant crimson. 4 feet.
- Florence Vaughan.** Yellow, spotted with red. One of the best. 4 feet.
- Grand Rouge.** A gigantic dark-leaved variety. Very desirable for massing; bears freely bright scarlet flowers which add to its value. 7 to 8 feet.
- Italia.** Orchid-like flower; center brilliant red; wide, irregular margin of yellow. 5 feet.
- Louisiana.** Strong, vigorous grower; attains a height of 7 feet, producing a dense mass of glossy green foliage and large, vivid scarlet flowers. 15 cts. each, \$1.35 per doz.
- Luray.** Large, well-formed flowers of a very attractive rosy pink. 3½ to 4 feet.
- Madame Crozy.** A very popular variety. Crimson-scarlet, bordered with yellow; foliage broad and massive. Often blooms when a foot high. 4 feet.
- Mrs. Kate Gray.** A grand variety of the orchid-flowered type; flowers of immense size; orange-scarlet, flaked with yellow. 6 feet. 15 cts. each, \$1.35 per doz.
- Premier.** Deep crimson-red, bordered yellow. 3 feet.
- Queen Charlotte.** Bright orange-scarlet, wide edge of golden yellow. 4 feet.
- Robusta.** A popular dark-leaved variety. 7 to 8 feet.
- Shenandoah.** A splendid red or bronze-leaved sort, beautifully veined and tinted, and bears fine large trusses of salmon-pink flowers. Blooms early and abundantly. 6 feet.

Caladium Esculentum. Elephant's Ear

A very large-leaved tropical plant of rapid growth. In warm, rich, moist soil, large bulbs will send up several stalks about 5 feet high, with leaves 2½ to 3 feet long and about 20 inches wide. Very ornamental, planted either single or in groups.

Mammoth Bulbs. 25 cts. each, 65 cts. for 3, \$2.40 per doz.

Large Bulbs. 15 cts. each, 40 cts. for 3, \$1.40 per doz.

Second-Size Bulbs. 10 cts. each, 25 cts. for 3, 90 cts. per doz.

If desired by mail, add for postage 15 cts., 10 cts., and 7 cts. each, according to size.

Cinnamon Vine

A beautiful hardy climber of extremely rapid growth growing the first season from 15 to 30 feet, and, when the root becomes fully established, to a much greater length. The leaves are green, with tinge of bronze, and are very attractive. The flowers are white, borne in clusters, are of no great beauty, but of a delightful cinnamon-like fragrance. The vine dies at the end of the season, but the root is hardy, living for years and increasing in size and vigor each season. Postpaid, 5 cts., each, 25 cts. for 6, 50 cts. for 15, \$1 for 30; extra-large roots, 10 cts. each, 25 cts. for 3, 90 cts. per doz.

Madeira Vine

A rapid-growing climber, with beautiful, thick, glossy wax-like leaves, and bearing profusely in graceful feathery racemes white flowers which have a fragrance resembling nignonette. Plant when ground becomes warm. Store tubers in a cool, dry place during winter. Postpaid, 5 cts. each, 50 cts. per doz.

PEONY

THE QUEEN OF SPRING FLOWERS

This old-time favorite has again become popular, and deservedly, as, while it may have rivals blooming at other times of the year, no other plant blooming at the same time can compare with the Peony in magnificence. It is as well of the easiest culture, thriving in nearly all soils, in locations either open to the sun or in partial shade, is of the hardiest nature, requiring no protection whatever, and is never troubled by insects or disease. In fact, once planted it will largely take care of itself, the plant increasing in size and productiveness yearly. We offer strong roots of the choicest varieties.

Price, except otherwise noted, 60 cts. each, \$5 for 10, by express only

Double Varieties

- | | |
|--|---|
| Festiva maxima. White; rare and scarce. \$1 each. | Nelli Pleas. Rose. |
| Formosa Alba. White. | Phormis. Deep red. |
| Francois Ortegai. Dark crimson. | Rubra Triumph. Dark red. |
| Humei. Rose. | Zoe Calot. Rose. |
| Marie Lemoine. White. | Lutescens. White. |
| Ne Plus Ultra. Pink. | General Bertrand. Light rose. |
| Officialis alba. White. | Washington. Light red. |
| Officialis rubra. Red. | Lilacina plenissima. Flesh. |
| Queen Victoria. Blush. | Grandiflora Rosea. Light rose. |
| Tenuifolia flore pleno. Red. 75 cts. each. | Comte de Diesbach. Dark red. |
| | Louis Van Houtte. Dark red. 75c. each. |

Single Varieties

- | | |
|-------------------------|----------------------------|
| Josephine. Rose. | Mardonius. Crimson. |
| Larissa. Pink. | Medon. White. |

Tuberose

Bulbs may be started in the house for early flowers, or they may be planted in the open border, but not earlier than June in this latitude.

Excelsior Dwarf Pearl. Improved strain; plant of dwarfer habit, blooms earlier and flowers are more double than old strain. Extra-large bulbs, postpaid, 4 cts. each, 10c. for 3, 40c. per doz., 70c. for 25; by express, \$1 for 50, \$1.75 for 100. Medium-sized bulbs, postpaid, 3c. each, 10 cts. for 4, 25c. per doz., 45c. for 25; by express, \$1.35 per 100.

CANNA BEDS should be deeply spaded, and the soil mixed thoroughly with half of old rotted stable manure, for the plants are heavy feeders. Plant 18 inches apart each way. Where several varieties are used in the same bed, set the taller ones in the center and the dwarfer sorts nearer the edges. Round canna beds, 7 feet in diameter, require 19 plants; 10 feet in diameter, require 37 plants, 13 feet in diameter, require 61 plants. Pennisetum, Salvia, and Centaurea, make excellent borders for Cannas.

DAHLIAS

A Selection of Choice Varieties. The Best of the New and Old

All Dahlias are sent postpaid at prices quoted. If desired by express, 10 cts. may be deducted from dozen price

Show and Fancy Dahlias

15 cts. each, \$1.50 per doz., except where otherwise noted

SHOW DAHLIAS. include all large close-flowering varieties of a single color, and those in which the ground color is of a lighter shade than the edges or tips.

FANCY DAHLIAS include all striped, large, close-flowering varieties and those in which the ground color is darker than the edges. These varieties are, however, somewhat variable and often show but a single color.

A. D. Livoni. Shell-pink; fine. 10 cts. each, \$1 per doz.

Alice Emily. Yellow; large and full; one of the best.

Arabella. Pale primrose, shaded old rose and lavender.

Dr. J. P. Kirkland, or Cuban Giant. Dark crimson; of fine form and largest size; blooms freely. 20 cts. each, \$2 per doz.

Emily. Lavender and white; large and of finest form.

Fascination. Rose-pink, sometimes striped white; fine.

Hector. Light orange-scarlet, large and of fine form.

Imperial. Deep purplish maroon; extra-fine.

Lottie Eckford. Creamy white, striped pink and crimson.

Lucy Fawcett. Pale yellow, striped deep pink.

Margaret Bell. Light magenta; excellent.

Meteor. Bright red; very large.

Miss Dodd. Pure rather light yellow, of exquisite form and color.

Mrs. Dexter. Very large; a rich shade of salmon.

Mrs. Langtry. Cream-peach and purple; of medium size; very full; excellent.

Mrs. Saunders. Light yellow, tipped white.

Orator. Salmon-buff; large.

Pearl. White, deeply edged; rose; large.

Princess Bonnie. Light lemon; almost white; fine.

Puritan. White, striped maroon.

Statesman. Deep crimson.

Storm King. Pure white; of medium size, but blooms profusely; very desirable.

Willie Austin. Fawn; large.



SHOW DAHLIA

Cactus Dahlias of Special Merit

Except where otherwise noted, 20 cts. each, \$2 per doz.

Beatrice. Pale rose; large; a lovely variety.

Britannia. Soft salmon-pink; large; extra fine, and very profuse.

Countess of Lonsdale. A pleasing blending of salmon-pink and amber; of finest form, flowers profusely under all conditions and is perhaps the most desirable of all Cactus varieties.

Chas. Woodbridge. Rich purplish crimson; excellent.

Dainty. Lemon-yellow, tips of petals golden, base rose-pink. 25 cts. each, \$2.50 per doz.

Floradora. Wine-crimson; extra-fine. 25 cts. each, \$2.50 per doz.

General Buller. Rich velvety crimson, with white tips.

Jealousy. Clear bright yellow; extra fine. 25 cts. each, \$2.50 per doz.

Kriemhilde. Soft pink; center nearly white.

Lord Roberts. Creamy white.

Mrs. H. J. Jones. Scarlet, tipped white.

Madame de Lucca. Golden yellow, tipped orange. 25 cts. each, \$2.50 per doz.

Standard Bearer. Fiery scarlet; one of the best.

Stella. Rich vivid crimson; extra fine. 25 cts. each, \$2.50 per doz.

Vesta. Clear pink.

Viscountess Shearbroke. Reddish terra-cotta. 25 cts. each, \$2.50 per doz.

Cactus Dahlias. Choice Standard Varieties

15 cts. each, \$1.50 per doz.

Aunt Chloe. Very dark maroon, approaching black.

Bridesmaid. Rose; center pale primrose.

Cannell's Gem. Deep orange.

Capstan. Soft, brick-red, shaded apricot.

Cornucopia. Deep reddish salmon; fine.

Doctor Jameson. Deep crimson; extra fine.

Earl of Pembroke. Bright plum; profuse.

Innovation. Rich crimson, tipped pure white.

Island Queen. Light mauve.

Keyne's White. Pure white; good.

King Edward VII. Bright cherry-red.

Mary Service. Pinkish apricot or heliotrope; fine.

Mrs. Barnes. Long, twisted narrow petals, lovely clear primrose, shading to pale rosy pink.

Mrs. Bennett. Soft crimson; large; of fine form; broad, but well-curved petals.

Mrs. Charles Turner. Yellow; large.

Octopus. Nearly white, slightly tinged lavender.

Porcupine. Deep crimson, shaded darker.

Strahlein Krone. Intense cardinal-red. Rich; petals long and twisted; blooms early and profusely.

St. Catherine. Cactus; deep yellow, shaded red.

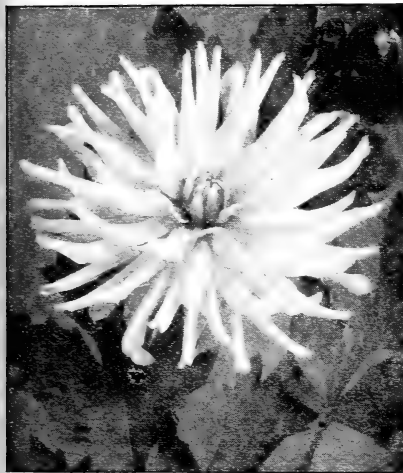

CACTUS DAHLIA

Decorative Dahlias

15 cts. each, \$1.50 per doz., unless otherwise noted

This class includes all large loose-flowering varieties which do not properly belong to the Cactus class. They are of very free-blooming habit and flowers are usually of the largest size.

Amphion. Chrome-yellow.

Beauty of Brentwood. Plum, striped darker.

Catherine Duer. A beautiful glowing red. 20 cts. each, \$2 per doz.

Clifford W. Bruton. Yellow; large and fine.

Dolly. Flesh color, tipped darker.

Grand Duke Alexis. Pure white, faintly tinged with rosy lavender at tips of petals; large, petals quilled. 20 cts. each, \$2 per doz.

Himmilische. Very deep lavender, approaching blue. 20 cts. each, \$2 per doz.

Maid of Kent. Cherry-red, usually tipped white, but variable.

Marchioness of Bute. Pure white, tipped rosy carmine.

Mme. Van den Dael. Finest soft pink. 20 cts. each, \$2 per doz.

Miss Barry. Deep purple.

Mrs. Roosevelt. The flowers of this grand variety are of enormous size, over 6 inches in diameter, always perfectly double: color a delicate blush-pink, shading to clear soft pink. Especially desirable for the largest size and a great production of perfect flowers. 35 cts. each.

Mrs. Winters. A very fine white variety. 20 cts. each, \$2 per doz.

Nymphæa (Water Lily). Shrimp-pink, shading lighter toward tip of petals.

Oban. Rosy lavender, suffused silvery fawn; extra fine.

Souvenir de Gustave Douzon. Orange-red of largest size; blooms freely. 20 cts. each, \$2 per doz.

Wm. Agnew. Rich dazzling carmine-red; large and fine.

Zulu. Very dark maroon.

Pompon, or Bouquet Dahlias

12 cts. each, \$1.25 per doz.

Small-flowered varieties; the best of all for cutting, blooming more freely and usually having extra-long stems. The flowers are of the same formation as the Show Dahlia class.

Achilles. Pale lilac, finely quilled.

Ariel. Orange-buff.

Alewine. Delicate pink, tinted lilac.

Bobby. Plum color.

Catherine. Bright yellow.

Darkness. Dark maroon.

Fairy Queen. Sulphur-yellow, edged pink.

Fashion. Bright orange.

H. C. Winters. Pale fawn.

Little Bessie. Creamy white.

May Clift. Light Maroon.

Mabel. Salmon-pink; fine.

Pure Love. Lilac.

Prince Charming. Cream tipped purple.

Snowclad. Small, white; free.

Vivid. Bright scarlet.

Mixed Dahlias

Postpaid, 90 cts. per doz., by express, 80 cts. per doz., \$1.50 for 25, \$5 per 100.

These include some of our best varieties, those of which labels have been lost and, at times, varieties of which we have a surplus. While all classes are usually included, we give no guarantee that any lot sent out will include all, nor should it be understood that customer is privileged to order those of any one class. We shall, however, endeavor to send a good assortment of colors, and are sure the mixture will be found very satisfactory.

GLADIOLI

The Gladiolus thrives in nearly all soils if well enriched and the location fully open to the sun. Bulbs may be planted by the middle of April and as late as the first of June, but for late planting large bulbs are much preferable. Plant 4 or more inches deep and from 4 to 8 inches apart, as taste suggests. To be thoroughly appreciated Gladioli should be planted in large quantities. Our own experience has been that interest increases in proportion to the area planted. For several years we have been growing our own bulbs, and are therefore in a position to know just what we have to offer; with the exceptions of the second size noted of some mixtures, all the stock offered is of first size—large, sound, healthy bulbs. Please note, however, that by first size we do not mean that all bulbs are of equal size, for some of the best varieties do not produce the largest bulbs. The second-sized bulbs which we offer are, however, in no sense inferior, but are, especially when a large quantity is desired, really preferable to the first size, because so much cheaper. All are of blooming size, and, while the spikes will not average as large the first year, the bulbs will grow to full size and be fully equal for planting the following season to those obtained by planting the larger bulbs the first. They are the size used for our own planting, and, were their value known, they would be much more largely used by customers.

Dozen and hundred prices include postage. Six sent at dozen rate, 50 at 100 rate, 250 at 1,000 rate. If desired to be sent with other articles by express, 5 cts. per doz., or 35 cts. per 100, may be deducted from prices quoted.

AMERICA. New Pink Gladiolus. This beautiful rapidly new variety is destined to increase not only because of the lovely color, large size and fine form of the flowers, but also because of the remarkably vigorous and healthy habit of the plant. The large flowers are borne on strong, thick, straight spikes, from 2 to 3 feet high, several are open at once, and all face one way. In color they are a soft, very light lavender-pink, distinct from any other Gladiolus. They are the perfection of form and no other variety surpasses this in keeping quality when cut. 10 cts. each, \$1 per doz.

Augusta. Pure white; blue anthers; tall, straight spike. One of the best of the Gandavensis type. 5 cts. each, 50 cts. per doz., \$3 per 100.

Baron Hulot (Blue Jay). A new variety of the Lemoine type, but flowers are larger and more open than most of that class. Rich deep violet, more nearly approaching blue than any other variety. 12 cts. each., \$1.25 per doz.

Brenchleyensis. Extensively used for bedding where scarlet is desired, and for planting among shrubbery. 30 cts. per doz., \$1.75 per 100.

Canary Bird. Fine, light, pure yellow flowers of medium size, borne on a straight spike of medium height. Not quite as vigorous a grower as Victory; better color. Excellent. 10 cts. each, \$1 per doz.

Giant Pink. Very large flower; dark pink, with markings of dark red in the throat. Spike long, with numerous flowers closely set and many open at once. 8 cts. each, 75 cts. per doz.

Hollandia. A new variety, which surpasses most others in length of spike and bearing an unusual number of well-arranged flowers, many of which are open at once. A lovely pink shade, tinted yellow. 10 cts. each, \$1 per doz.

Klondyke. A new and lovely variety; pale yellow, with large blotch of vivid crimson-maroon in the throat. Of medium size and form, somewhat similar to the Lemoine type, but more open and therefore more desirable. The spike, though rather slender, is wiry and straight; the foliage strong and healthy. The plant blooms early and often throws two or more spikes, which considerably lengthen the period of blooming. 10 cts. each, \$1 per doz.

May. An old, very attractive and popular variety. Fine, long spike of medium-sized flowers, nearly all of which open at once. White, much flaked and blotched with rosy crimson. 35 cts. per doz., \$2.15 per 100.

Octoroon. A beautiful old variety. Buff-pink, distinct. 8 cts. each, 75 cts. per doz.

Princes. A new giant-flowered variety. This new variety, under good cultivation, grows $\frac{3}{4}$ to 4 feet high. The flowers are of immense size, well expanded and of the desired circular form. Color rich red, with intense shadings in the throat, and white blotch across the lower petals. The spike is stiff, always straight, and notwithstanding that, like all large-flowered varieties, these seldom are over four flowers open at once, owing to its height and habit of all buds opening even to the smallest, it produces a large number of flowers. The buds open well in water, and for effective display in large vases, few varieties equal it. 12 cts. each, \$1.25 per doz.

Prophetesse. A fine new variety. Large flowers of good form; pearly white, with crimson throat. Of healthy, vigorous growth, blooms early and increases rapidly. 12 cts. each, \$1.25 per doz.

Snowbank. Pure white, except slight stain of carmine at base of petals. Flowers of medium size. A lovely variety. 10 cts. each, \$1 per doz.

Victory. Strong, straight spike with flowers of medium size, many open at the same time; delicate sulphur-yellow; lower petals shaded deep yellow. 10 cts. each, \$1 per doz.

We grow our own Gladioli and are able to offer at lower prices than are usually quoted. Remember, when comparing prices, that if ordered to go by express or purchased at counter, 5 cts. per doz. or 35 cts. per 100 is to be deducted from prices quoted

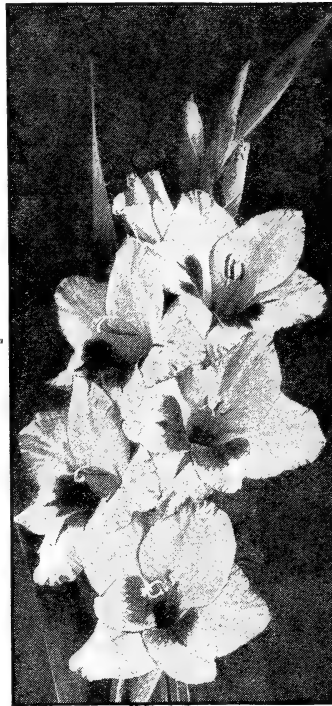

GROFF'S SILVER TROPHY STRAIN

these would become a part of this mixture. We consider it the best value we offer. 45 cts. per doz., \$2.75 per 100, \$20 per 1,000; second size, 25c. per doz., \$1.50 per 100, \$9 per 1,000.

Lemoine Hybrids

(Spotted, or Butterfly Gladioli)

A favorite with those who prefer rich and striking coloring to size. There has been, however, a great improvement made in the class and in the extra-mixed Lemoine, there are many varieties of good form which are larger than the average Gandavensis, and which approach in size the later introductions of other types.

Mixed. 25 cts. per doz., \$1.50 per 100, \$10 per 1,000.

Extra Mixed. 35 cts. per doz., \$2.10 per 100, \$14 per 1,000.

Childsi, or Giant-flowered Gladioli

A very large-flowering class of unusually vigorous growth and luxuriant foliage. The spikes are very long and thick, strong and straight. The flowers are of fine form and great substance. The range of coloring is good with the exception of the lack of a white and light sorts, and the smoky shades admired by some are more prevalent in this class than in any other, while many varieties are flaked in a manner peculiar to this class. 35 cts. per doz., \$2.10 per 100, \$14 per 1,000; second size, 20 cts. per doz., \$1.20 per 100, \$7 per 1,000.

Nanceianus

(A New Race of Giant-Flowered Gladioli)

The spikes of this new race grow taller than those of any other class, but are more like the Lemoine, rather slender and inclined to become crooked by the weight of the enormous flowers; but few white and light sorts, and but few of the soft, delicate pink and light scarlet shades approaching self-colors. The dark colors, however, surpass in richness those of any other class, as does the peculiarly beautiful mottling in the throats. These features largely counterbalance the objections mentioned and make them very desirable. 35 cts. per doz., \$2.10 per 100, \$14 per 1,000.

Choice Mixed

A mixture containing a good proportion of white and light varieties and well balanced generally. It has been our purpose to make the Choice Mixed as much like the Worcester as possible for the price, and as with that, our work has been one of constant improvement; it is of greater value now than ever before. 30 cts. per doz., \$1.85 per 100, \$12 per 1,000; second size, 20 cts. per doz., \$1.20 per 100, \$7 per 1,000.

White and Light Shades

Choice Mixed. A choice mixture of white and light varieties only. 30 cts. per doz., \$1.85 per 100, \$12 per 1,000.

Extra White and Light Mixed. A superior mixture containing the best old varieties and new hybrid seedlings. 40 cts. per doz., \$2.40 per 100, \$17 per 1,000.

Groff's Hybrid Gladioli

NOTED THE WORLD OVER FOR THEIR BEAUTY, WONDERFUL DIVERSITY AND VIGOROUS HABIT OF GROWTH

GROFF'S HYBRID SEEDLINGS. Very popular, and for the past few years have been more extensively grown than any other class. As first introduced, they lacked white and light varieties; we have, however, been able to add from time to time some of these, and the mixture, as now offered, is much superior to those generally offered under this name. 35 cts. per doz., \$2.10 per 100, \$14 per 1,000. Second size, 20 cts. per doz., \$1.20 per 100, \$7 per 1,000.

GROFF'S SILVER TROPHY, or WORLD'S BEST STRAIN. This strain, with its three sections, comprises a much greater diversity than the preceding. While Section 1 comprises varieties somewhat similar but of superior excellence, Sections 2 and 3 are especially desirable additions. Section 2 supplying a lack to which reference has been made, while in Section 3 are varieties not found in any other commercial strain.

1. Newest Reds, Scarlets and Crimson. 50 cts. per doz., \$3 per 100.

2. New White, Light and Yellow. All shades of white, cream and yellow, in many combinations, relieved by stains and blotches of rich colors in most pleasing contrast. 55 cts. per doz., \$3.50 per 100.

3. Rare Blues, in Clematis, Lilac, and Heliotrope Shades. New hybrids of Papilio Major, practically unknown. Not to be found in any other strain. 70 cts. per doz., \$4.35 per 100.

Silver Trophy Strain, mixed. A mixture of above in well-balanced proportions. 50 cts. per doz., \$3 per 100.

Worcester Mixture

Our own mixture. A large proportion of new introductions and extra-large flowers. Especial attention has been given to colors, and it will be found to be well balanced including a good proportion of white and light colors in which many mixtures are deficient. It has also been our intention to make the mixture one of the highest quality possible consistent with price, and whenever purchasing new introductions, we have always had in mind that eventually when our increase would warrant,

Hardy Perennials

We list herewith a few choice varieties of hardy plants which are suitable for either spring or early fall planting. Each is valued for its beauty, fragrance, rich coloring, unusual formation, and general usefulness in the garden.

Hollyhocks

These stately plants now find a place in every perennial garden. Especially effective planted in long rows or massed against evergreens and as backgrounds in a border. We have a good collection of extra-strong field-grown plants. **Single Mixed, Double Yellow, Double Red, Double Pink, Double White.** Each 25 cts., \$2 for 10, \$15 per 100.

Iris Germanica. German Iris; Fleur-de-Lis

Sometimes called the Orchid of the hardy garden. Wonderful markings and formations. Rare, sweet fragrance in early spring. Thrives in most all soils and locations. Foliage attractive throughout the summer. It should be one of the first plants selected for a perennial border for a new home, whether it be a cottage or a mansion.

- Duc de Nemours.** White shaded maroon; 2 feet high.
- Honorable.** Golden yellow, striped maroon; 2½ feet high.
- Madames Chereau.** White, frilled azure blue; tall; fine.
- Pallida (odoratissima).** Lavender, yellow beard; 2 to 3 feet high; fine.
- Pumila.** Straw color; odor of orange blossoms; dwarf. Fragrant; blooms in May.
- White.** White. 2 ft. high; early; one of the best.

10 cts. each, \$1 per doz., \$5 per 100. Mixed varieties. A mixture of choice varieties of our own growing. Large roots, freshly dug, by express only, 75 cts. per doz., \$1.40 for 25, \$4 per 100.

Iris Kaempferi. Japan Iris

The grandest type of the Iris family, but requiring rich, deep, moist soil. 10 in. in diameter.

- | | |
|--|---|
| <ul style="list-style-type: none"> Alba Plena. White; double. Alida. White; six petals. Blue Beard. Blue; three petals. Blue Danube. Rich blue. Blue Jay. Azure-blue; three petals. Commodore Perry. Dark red. | <ul style="list-style-type: none"> Eclairer. White; double. Gold Bond. White, yellow center; six petals. Hyde Park. Reddish purple. Mahogany. Dark red petals. Navy Blue. Dark blue; six petals. Painted Lady. White, striped pink; 3 petals. |
|--|---|
- 25 cts. each, \$2 per 10, \$15 per 100**

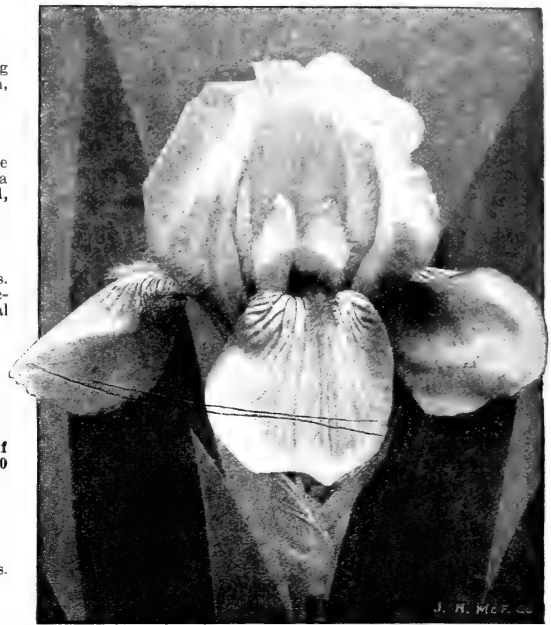

TYPE OF GERMAN IRIS (*Iris Germanica*)

Phlox

Favorites for their delightfully delicate colorings, and abundance of bloom. It is possible to have Phlox in flower from June until frost by proper selection of varieties. We offer some choice sorts.

- | | | |
|---|--|--|
| <ul style="list-style-type: none"> Bouquet Fleur. White, crimson eye. Boule de Feu. Bright red. Champs Elysees. Purple-crimsons. Caran d'Ache. Rosy crimson. Cross of Honor. Striped lilac. Coquelicot. Orange-scarlet. Epopée. Reddish violet. Eclairer. Carmine. Fiance. White. | <ul style="list-style-type: none"> Hector. Pink. Independence. White. La Candeur. White, dwarf. La Cygne. Salmon-rose, dwarf. L'Evenment. Pink. Lothair. Salmon, red eye. Le Pole au Nord. White, crimson center. Lumineux. Rose. Mad. P. Langier. Geranium-red. | <ul style="list-style-type: none"> Matador. Orange-red. Montegard. Deep crimson. Ornement. Bright. Premier Ministre. Rosy white. Queen. White. R. P. Struthers. Bright pinkish salmon. Richard Wallace. White, rose center. Thebaide. Salmon-red. Terre Neuve. Gray lilac. |
|---|--|--|
- 25 cts. each, \$2 for 10, \$18 per 100. Mixed kinds, but not named, \$15 per 100; 25 at 100 rate**

Strawberry Plants HOME-GROWN RUNNERS FOR SPRING PLANTING POTTED PLANTS FOR FALL PLANTING

The plants we offer are of our own growing, are always dug after order is received and carefully packed, insuring delivery to customer in best condition possible. Their condition will be found greatly superior to those generally received from the West or South, the latter being sold so cheaply that the necessary care in preparing them for shipping cannot be afforded. The probably different conditions could be considered when comparing prices. We offer only a few—but the best varieties, and see no reason for offering others inferior in various respects.



A POT-GROWN STRAWBERRY PLANT

- Varieties marked (p) have imperfect flowers and require to be grown with them some of the staminate (s) forms, one row in five of the latter being sufficient.
 - Brandywine.** S. A late and handsome large berry; conical in shape; dark glossy red; plant vigorous and productive.
 - Bubach.** P. A large but uniform berry of good color, one of the very best.
 - Glen Mary.** S. A good kind for the kitchen garden. Fruit conical, bright red, and fine flavor.
 - Marshall.** S. One of the best kinds for home use. Fruit large; very dark red; of delicate flavor. Would be more largely grown were it not for the fact that it is not a heavy bearer.
 - Sample.** P. One of the best market berries in cultivation. Fruit of fine color and flavor; one of the best for general crop.
 - President.** S. Berries among the largest; good for the home garden; if you want some monarch-size berries to exhibit to your friends.
 - Downing's Bride.** S. One of the best for either market or the home table; in fact, it should be in every garden. Berries of this variety bring from two to five cents per quart more than any other kind in the Worcester Markets. Fruit uniform in size, shape and color.
- Runners, \$1 per 100, \$7.50 per 1,000; potted plants, \$2.50 per 100**

Vegetable Plants

The plants that we are prepared to furnish are always of our own careful growing, and we know will give entire satisfaction, at the following prices.

- | | |
|--|---|
| <ul style="list-style-type: none"> Tomato, leading kinds, 25c. per doz., \$1.75 per 100. Lettuce, 20 cts. per doz., \$1.25 per 100. Pepper, 20 cts. per doz., \$1.50 per 100. | <ul style="list-style-type: none"> Cabbage, early kinds, 20 cts. per doz., \$1 for 100. Cabbage, late kinds, for general use, 75 cts. per 100, \$5 per 1,000. |
|--|---|

Special prices in lots of 5,000 or over

- Celery, early kinds, 25 cts. per doz., \$1.50 per 100.
- Celery, late or winter kinds, \$1 per 100, \$5 per 1,000.
- ASPARAGUS ROOTS.** All kinds listed in vegetable section; strong roots, uniform price. Post-paid, 50 for 65 cts.; by express, 100, 75 cts.; 1,000, \$5.50.
- RHUBARB ROOTS.** Large clumps, 25c. each. One-year-old roots from seed, each, 10c., per 100, \$8.

PANSY PLANTS

Best mixture of colors grown from our own seed. Per basket, 25c; by the hundred for large beds \$2

Bradley's X. L. Phosphate, Bradley's Potato Fertilizer, Bradley's Complete Fertilizer for all Crops

SPECIAL PAMPHLET DESCRIBING THEM ALL MAILED FREE ON APPLICATION

BRADLEY'S COMPLETE MANURE FOR POTATOES AND VEGETABLES.

Nitrogen, equal to ammonia, 4 to 5 per cent; available phosphoric acid, 8 to 11 per cent; total phosphoric acid, 9 to 13 per cent; potash, 7 to 8 per cent; equal to sulphate potash, 12.95 to 14.80 per cent. 100 lbs., \$2.25; ton, \$42.

BRADLEY'S X L PHOSPHATE. Nitrogen, equal to ammonia, 3 to 4 per cent; available phosphoric acid, 9 to 11 per cent; total phosphoric acid, 11 to 14 per cent; potash, 2 to 3 per cent; equal to sulphate potash, 3.70 to 5.55 per cent. 25 lbs.; 65 cts.; 50 lbs. \$1; 100 lbs., \$1.85; ton, \$35.

BRADLEY'S POTATO FERTILIZER. Nitrogen, equal to ammonia, 2.50 to 3.50 per cent; available phosphoric acid, 8 to 10 per cent; total phosphoric acid, 9 to 12 per cent; potash, 3 to 4 per cent; equal to sulphate potash, 5.55 to 7.40 per cent. 100 lbs., \$1.75; ton, \$34.

BRADLEY'S POTATO MANURE. Nitrogen, equal to ammonia, 3 to 4 per cent; available phosphoric acid, 6 to 8 per cent; total phosphoric acid, 8 to 11 per cent; potash, 5 to 6 per cent; equal to sulphate potash, 9 to 11 per cent. 100 lbs., \$1.85; ton, \$36.

BRADLEY'S COMPLETE MANURE, with 10 per cent potash. 100 lbs., \$2.15; ton, \$42.

BRADLEY'S COMPLETE MANURE FOR TOP-DRESSING.

| | |
|---------------------------------|--------------|
| Analysis | Per cent |
| Nitrogen, equal to Ammonia..... | 6.00 to 7.00 |
| Available Phosphoric Acid..... | 5.00 to 7.00 |
| Total Phosphoric Acid..... | 6.00 to 9.00 |
| Potash (K ₂ O)..... | 2.50 to 3.50 |
| Equal to Sulphate Potash..... | 4.62 to 6.46 |

100 lbs., \$2.10; ton, \$40

BRADLEY'S CORN PHOSPHATE. 100 lbs., \$1.75; ton, \$34.

| | |
|---------------------------------|---------------|
| Analysis | Per cent |
| Nitrogen, equal to Ammonia..... | 2.50 to 3.50 |
| Available Phosphoric Acid..... | 8.00 to 10.00 |
| Total Phosphoric Acid..... | 9.00 to 12.00 |
| Potash (K ₂ O)..... | 1.50 to 2.50 |
| Equal to Sulphate Potash..... | 2.77 to 4.62 |

100 lbs., \$1.75; ton, \$34

Raw Materials or Fertilizing Chemicals for Home Mixing

Farmers who understand compounding and mixing chemicals for different crops can no doubt save something in buying chemicals and mixing them on rainy days and during odd jobs, but it is a dangerous and expensive undertaking for those that do not know how, and to such we advise buying our mixed goods. We have for several years made a specialty of this branch of our trade and have the reputation of furnishing chemicals lower than many of the fertilizer companies who handle large quantities, but recommend mixed goods. The following prices are subject to change without notice. Carload buyers should ask for special prices, as many of the following are imported from other countries. We recommend large buyers to place their orders early and have the goods shipped direct from the boat; in that way a saving of from \$1 to \$2 per ton can be made. This applies especially to nitrate of soda, muriate and sulphate of potash, and slag meal. These we import in large quantities and can make shipment on arrival of boat to arrive during the month of March, and, while we cannot state at this time just the dates, we can guarantee shipment in season for spring use.

Chemicals are strictly cash goods and cannot be sold on same terms as ready-mixed fertilizers.

NITRATE OF SODA. 95 per cent purity; 19 per cent ammonia. In original bags of about 275 pounds each. 100 lbs., \$3; ton, \$50.

MURIATE OF POTASH. \$0 to \$5 per cent muriate, 50 to 55 per cent actual potash. In original bags of 224 lbs. each. 100 lbs. \$2.50; ton, \$44.

HIGH-GRADE SULPHATE OF POTASH. 90 to 95 per cent sulphate of potash, 48 to 50 per cent actual potash. In original bags, f. o. b. Worcester, 100 lbs., \$2.75; ton, \$54.

AGRICULTURAL LIME. The agricultural colleges have been experimenting for some time to ascertain the influence lime has upon the soil when used with different crops, and the results show beyond all doubt that a large majority of our common vegetables need lime. This is especially true in regard to asparagus, beets, spinach, squash, lettuce, and onions. Lime should be applied at the rate of one ton per acre. Ton, \$8. Special price in car lots for direct shipments.

ODORLESS SLAG PHOSPHATE MEAL. This is a substitute for bone or acid phosphate, and is recommended very highly by Professor Brooks of the Massachusetts Agricultural College and many of our most successful farmers. It is sold on a guarantee of 18 per cent total phosphoric acid but it varies somewhat, and should it test over 18 per cent, there is an additional charge of 60 cts. per unit. F. o. b. Boston, for shipment from boat, ton, \$14; f. o. b. Worcester, ton, \$17; 100 lbs. \$1.

DOUBLE SULPHATE OF POTASH AND MAGNESIA. 40 to 50 per cent sulphate of potash, 25 to 28 per cent actual potash. In original bags, of 224 lbs. each. 100 lbs., \$1.75; ton, \$34; f. o. b. Boston, ton, \$32.

SULPHATE OF AMMONIA. 24.75 per cent ammonia. In 200-lb. bags. 100 lbs., \$4; ton, \$71.

KAINIT. 23 to 25 per cent sulphate and muriate of potash, 12 to 13 per cent actual potash. In 200-lb. bags. 100 lbs., 90 cts.; ton, \$16; f. o. b. Boston, ton, \$14.

DISSOLVED BONE BLACK. 15 to 18 per cent soluble and available phosphoric acid. In 200-lb. bags. F. o. b. Boston, 100 lbs., \$1.35; ton, \$25.

PLAIN SUPERPHOSPHATE. 14 to 17 per cent soluble and available phosphoric acid. In 200-lb. bags. 100 lbs., \$1; ton, \$17. Special prices for car-load lots. We handle this in large quantities and can make very low prices on early shipments in large lots. We can also furnish lower grades at proportionately low prices.

DRIED BLOOD. 12 per cent ammonia. In 200-lb. bags. 100 lbs., \$3; ton, \$55.

FINE GROUND TANKAGE. 6 per cent ammonia, 30 per cent bone phosphate. In 200-lb. bags. 100 lbs., \$1.75; ton, \$33.50.

FINE GROUND TANKAGE. 9 per cent ammonia, 20 per cent bone phosphate. In 200-lb. bags. 100 lbs., \$2.40; ton, \$45.

FINE GROUND NOVA-SCOTIA PLASTER. White and fine. In 200-lb. bags. 200 lbs., \$1.10; ton, \$10.

ONONDAGA, NEW YORK, GRAY PLASTER. 200-lb. bag, 90 cts., ton, \$9.

FINE GROUND BONE. 3 to 4 per cent ammonia, 22.80 to 25.23 per cent phosphoric acid. In 200-lb. bags. 100 lbs., \$1.75; ton, \$32.

FINE GROUND BONE. 2 to 3 per cent ammonia; 22 per cent phosphoric acid. In 200-lb. bags. Ton, \$31.

TOBACCO DUST. Fine ground; for greenhouse use this is one of the best articles for dusting all kinds of plants that are affected with insects of any kind. 5 lbs., 25 cts; 50 lbs., \$1.15; 100 lbs., \$2.

DRY GROUND FISH. 9 to 10 per cent ammonia, 25 to 30 per cent bone phosphate. 100 lbs., \$2.75; ton, \$50.

CANADA HARDWOOD ASHES. We handle these in large quantities and can quote carload prices delivered at any freight station in New England. F. o. b. Worcester, ton, \$15; 100 lbs., \$1. Special price, if taken from car when in, \$14

We will mix any of the above for \$2 per ton, extra. This price applies to goods shipped from Worcester only



Odorless Lawn Fertilizer

FOR LAWNS, PARKS, CEMETERIES, GOLF LINKS, ETC.

The beauty of any lawn depends largely on two things—seed and fertilizer. Of course, it goes without saying that no amount of either of these will produce a good lawn without suitable soil, but, assuming that you have prepared your lawn with a sufficient amount of loam, you naturally expect good results by using the required amount of seed to produce, under ordinary conditions, a rich, velvety lawn, so much desired by everyone; but, no one has a right to expect a lawn to stand trampling, cutting and other abuses, without some complete fertilizer being applied each season to furnish the necessary plant-food. A fertilizer that produces a good crop of hay would not be adapted for lawns, parks and tennis courts, although many manufacturers recommend the same brand for both—this is a great mistake.

Our lawn fertilizer is especially adapted for keeping the grass green from early spring through the entire season and is acknowledged to be the standard food for grass and is used on some of the largest lawns, parks, cemeteries and private estates in New England. In mixing this, we use principally Fine Ground Bone, Muriate of Potash, Nitrate of Soda, Fine Ground Kiln-dried Sheep Manure and Tobacco Dust. This latter ingredient is found in no other fertilizer on the market. It rids the lawn of white grubs and other injurious insects, and also gives that particular green color to the grass throughout the season that every one desires. A trial will show any one the difference between this and common commercial fertilizer, sold by many as a lawn dressing. There is nothing better for new lawns than this fertilizer. For convenience, we put this up in 25-, 50- and 100-pound bags. 25 lbs. 60 cts., 50 lbs. \$1.15, 100 lbs. \$2. Special prices in 5- and 10-ton lots.

Ready-Made Fertilizer

OUR OWN BRAND

Ross Bros. Co.'s Special Mixture for all Crops

Farmers who do not thoroughly understand the compounding of chemicals will get much better results and save money by buying our special mixtures for different crops, which are mixed especially for us with latest improved machinery and by skilled men who understand the business thoroughly. Mixing chemicals or raw materials as they are commonly called is very dangerous unless the person doing the work has had experience or is a graduate of some agricultural college, and even then we doubt if it is profitable to undertake to compete with large firms who have all the up-to-date machinery for doing this work; but one thing is sure and that is, we must use more high-grade fertilizers if we want to get the best results. Our fertilizers have given excellent satisfaction in the past and we are in position to quote as low price, considering the quality of the goods, as any manufacturer.

ROSS BROS. CO.'S HIGH-GRADE POTATO AND VEGETABLE FERTILIZERS. With 10 Per Cent Potash

| GUARANTEED ANALYSIS— | | Per cent | Per cent |
|----------------------|------|---------------------------|----------|
| Nitrogen | 2.88 | Avail. Phos. Acid | 8.00 |
| Equiv. in Ammonia | 3.50 | Insol. Phos. Acid | .50 |
| Sol. Phos. Acid | 6.00 | Total Phos. Acid | 10.50 |
| Rev. Phos. Acid | 2.00 | Potash (K ₂ O) | 10.00 |

For all root-crops, such as potatoes, turnips, beets and others requiring potash. 100 lbs. \$2.10; per ton, \$40.

ROSS BROS. CO.'S CORN, GRASS AND GRAIN FERTILIZERS

This is a high-grade complete fertilizer, especially adapted for field and ensilage corn. Hungarian grass, millet and cabbage. Also for seeding down.

| GUARANTEED ANALYSIS— | | Per cent | Per cent |
|----------------------|------|---------------------------|----------|
| Nitrogen | 2.88 | Avail. Phos. Acid | 8.00 |
| Equiv. in Ammonia | 3.50 | Insol. Phos. Acid | .50 |
| Sol. Phos. Acid | 6.00 | Total Phos. Acid | 10.50 |
| Rev. Phos. Acid | 2.00 | Potash (K ₂ O) | 8.00 |

In 100-lb. bags only. 100 lbs., \$2; ton, \$38; two-ton lots, \$1 per ton discount.

ROSS BROS. CO.'S POTATO AND VEGETABLE FERTILIZERS

For all kinds of vegetables usually grown in a kitchen garden, and especially adapted for potatoes, vegetables and root-crops.

| GUARANTEED ANALYSIS | | Per cent | Per cent |
|---------------------|------|---------------------------|----------|
| Nitrogen | 1.65 | Avail. Phos. Acid | 8.00 |
| Equiv. in Ammonia | 2.00 | Insol. Phos. Acid | .50 |
| Sol. Phos. Acid | 6.00 | Total Phos. Acid | 8.50 |
| Rev. Phos. Acid | 2.00 | Potash (K ₂ O) | 5.00 |

25-lb. bags, 60 cts.; 50-lb. bags, \$1; 100-lb. bags, \$1.85; ton lots, \$35 per ton; two-ton lots, \$1 per ton discount.



Pulverized Sheep Manure

This is a pure, natural manure, and the most nutritious food for plants. Its effect is immediate, much more lasting and healthy than guano or any other manure. It is the best of all manures for mixing with the soil for greenhouse plants. It makes the richest, safest and quickest liquid manure, rivaling guano, without any deleterious effect. Instead of being put up in the natural state, as formerly, we have it kiln-dried and then finely pulverized.

5 lbs. 25 cts., 100 lbs. \$1.75, ton \$25. Special prices by the car-load

THE POTATO. Frazer. Cultivation, Harvesting, Storing, Marketing and Development. 75 cts.

Mapes Complete Fertilizers

POTATO MANURE. Ammonia 4.5 to 5 per cent; phosphoric acid, 8 to 10 per cent (soluble and available, 8 per cent); soluble potash, actual, 6 to 8 per cent; all as high-grade sulphate, and in forms free from muriates (or chlorides), magnesia, lime, etc. For Irish and sweet potatoes, also asparagus, early vegetables, tomatoes, sugar beets, sorghum and sugar cane. 100 lbs., \$2.20; ton, \$42.

CORN MANURE. Ammonia, 3.5 to 5 per cent; phosphoric acid, 12 to 13 per cent (soluble and available, 8 to 10 per cent); soluble potash, actual, 6 to 7 per cent. For sweet corn, fodder corn, Hungarian grass, millet, late turnips, late cabbage, seeding to grass. 100 lbs., \$2.10; ton, \$39.

ECONOMICAL POTATO MANURE. Ammonia, 4 to 5 per cent; phosphoric acid, 6 to 8 per cent (soluble and available, 4 to 5 per cent); soluble potash, actual, 8 to 10 per cent; all as high-grade sulphate and in forms free from muriates (or chlorides). 100 lbs., \$2; ton, \$39.

COMPLETE MANURE. For general use. Ammonia, 4 to 5 per cent; phosphoric acid, 10 to 12 per cent (soluble and available, 8 to 10 per cent); soluble potash, actual, 4 to 5 per cent. A substitute for stable manure. For use on all crops and all soils, with or without stable manure. Use broadcast; if any in hills, use sparingly. Special for oats, Hungarian grass, vegetables, melons, tomatoes and seeding with or without grain. 100 lbs., \$2.10; ton, \$40.

FRUIT AND VINE MANURE. Ammonia, 2 to 3 per cent; phosphoric acid, 7 to 9 per cent (soluble and available, 5 to 7 per cent); soluble potash, actual, 10 to 12 per cent; all as high-grade sulphate and in forms free from muriates (or chlorides). For insuring fruiting power, particularly in quality of fruits in vineyards (grapes), pears, apples, plums, strawberries and small fruits. Is slow in effect. 100 lbs., \$2.25; ton, \$44.

GRASS AND GRAIN SPRING TOP-DRESSING. Ammonia, 5 to 7 per cent; phosphoric acid, 7 to 9 per cent (soluble and available, 7 per cent); soluble potash, actual, 5 to 7 per cent. 100 lbs., \$2.25; ton, \$44.

COMPLETE MANURE, "A" Brand. Ammonia, 3 to 4 per cent; phosphoric acid, 12 to 16 per cent (soluble and available, 10 to 12 per cent); soluble potash, actual 2.5 to 3.5 per cent. Special for peas, beans, buckwheat and turnips. 100 lbs., \$1.90; ton, \$38.

COMPLETE MANURES for light soils, or Vegetable Manures for all soils. Ammonia, 6 to 8 per cent; phosphoric acid, 8 to 10 per cent (soluble and available, 6 to 8 per cent); soluble potash, actual, 6 to 8 per cent. This is a special manure for all kinds of soils for truck, early vegetables, onions, celery, tomatoes, also on light soils for oats, hops and barley. 100 lbs., \$2.25; ton, \$45.

CEREAL BRAND. Ammonia, 2 to 3 per cent; phosphoric acid, total, 8 to 10 per cent (soluble and available, 6 to 8 per cent); actual potash, 3 to 3.5 per cent. For corn, rye, buckwheat, etc. Specially adapted for use in hill or drill. 100 lbs., \$1.65; ton, \$32.

CAULIFLOWER AND CABBAGE MANURE. Ammonia, 5 to 6 per cent; phosphoric acid, 6 to 8 per cent (soluble and available, 6 per cent); soluble potash, actual, 6 to 8 per cent. 100 lbs., \$2.10; ton, \$41.

AVERAGE SOIL COMPLETE MANURE. Ammonia, 5 to 6 per cent; phosphoric acid (soluble and available, 7 to 8 per cent); soluble potash, actual, 5 to 6 per cent; all as high-grade sulphate, and in forms free from muriates (or chlorides). For onions, tomatoes, vegetables of all kinds. A substitute for stable manure. Special for tobacco on heavier soils. 100 lbs., \$2; ton, \$39.

MISCELLANEOUS BOOKS

FARM GRASSES OF THE UNITED STATES. Spillman. \$1 00
BOOK OF WHEAT. By Dondlinger, a practical manual of the wheat industry of the world. 2 00
ASPARAGUS. Hexamer. Harvesting, Marketing and Preserving, as well as Culture. 50
LANDSCAPE GARDENING. F. A. Waugh. 50

PRINCIPLES OF AMERICAN FORESTRY. Green. \$1 50
FARM WINDBREAKS AND SHELTERBELTS. " 25
EVERGREENS, HOW TO GROW THEM. C. S. Harrison 50
PRACTICAL FORESTRY. A. S. Fuller 1 50
FEEDING and MANAGEMENT of LIVE STOCK. Shaw 50
THE DAIRYMAN'S MANUAL. Stewart 1 50

Farm Implements

Cash discount on tools is allowed where cash accompanies the order, but where goods are charged, no discount will be allowed

Worcester Reversible Sulky Plow (1)

This plow works on side hill and level land; it is fitted with two steel plows mounted on wheels and easily controlled by the driver. Team raises the plow at the end. Will do better work than any hand-held plow made. Width of furrow is controlled by the feet, while the driver has both hands free. Two sets of points furnished with each plow. Price \$45. Discount for cash, \$5.

Syracuse Reversible Sulky Plow (2) STEEL MOLDBOARDS AND LANDSIDES

Will plow on sidehill or level ground and leaves no dead furrows. Throwing the plow in and out of the ground is done by the team, while the operator has control of the width of the furrow with his feet, leaving both hands free to handle the team. Two plows are used, one at a time, to turn a furrow each way. Will do satisfactory work in all kinds of soil, and of p'owing, hill or level. Weight of plow, complete, 556 lbs. We furnish two sets of points and two-horse hitch with each plow. Price, \$45. Three-horse hitch in place of two-horse, \$2 extra.

The National Reversible Sulky Plow (3)

This plow works equally well on sidehill or level land. Two plows are used, both fastened to one beam. The plows are thrown in and out of the ground with the foot, and this lever is easy to operate. A boy 12 years old can handle it easily. There are few farms in New England where a sulky plow cannot be used to advantage. Price includes extra set of points, neck-yoke and evenner. Price, \$45. Discount for cash, \$1.

The Wachusett Swivel Plow (4) THE BEST ALL-ROUND PLOW MADE

This is our latest, and, we believe, for all kinds of work, the best wood-beam swivel plow on the market. Nearly all other plows on the market at the present time have some defects, and we have been studying, for the past few years, to overcome them as far as possible, and we think we have accomplished our object in this plow. We can furnish either hardened or steel mold-boards. List price, No. 2, \$11; No. 3, \$11; No. 12, \$12.50; No. 13, \$12.50. Nos. 2 and 3 hardened moldboards; Nos. 12 and 13, steel moldboards. Discount for cash, \$1.

Diamond A, B and C Plows (5)

NEW STYLE WITH STEEL OR CHILLED MOLDBOARD

This is one of the best swivel plows made. It is furnished with steel or chilled moldboard, patent foot latch wheel, cutter and shifting clevis. All parts interchange with the '76 plow made at Castleton, Vt.

A, two-horse, wheel and cutter cuts, 5 to 7 in., 11 to 14 in. wide; weight 119 lbs., price \$13; discount, \$2.

B, two-horse, wheel and shifting cutter cuts, 4 to 6 in., 8 to 12 in., weight, 114 lbs.; price, \$12; discount, \$2.

C, one-horse, wheel only, cuts 3 to 5 in., 7 to 8 in. wide; weight, 71 lbs.; price, \$9; discount, \$1. Steel moldboard, \$1.50 extra.

Syracuse No. 60 Plow (6)

WITH STEEL CUTTER OR JOINTER, STEEL OR CHILLED MOLDBOARD

Will work on level land or sidehill. It has a patent foot latch and shifting clevis. Cuts 5 to 8 inches deep, 12 to 15 inches wide; weight, 138 lbs. There is no steel corn plow made that will equal this one. Price, steel moldboard, \$16.50; cast moldboard, \$15.50. Discount for cash, \$2.

WE FURNISH EXTRA PARTS FOR ALL THE ABOVE

We make a specialty of furnishing parties just starting in farming, poultry-keeping and fruit-growing, with a complete outfit of tools suitable for that particular work, and to such we will quote special prices. We want it distinctly understood that all tools sold by us will be as represented. We always like to hear from our customers, whether they are pleased or not—especially if they are not. Our line of heavy farm machinery is the most complete of any house in New England. Our line of spraying tools and insecticides is also very complete, and our prices are as low as first quality goods can be sold for.

DON'T MISS READING PAGE 4, IF YOU ARE INTERESTED IN CORN

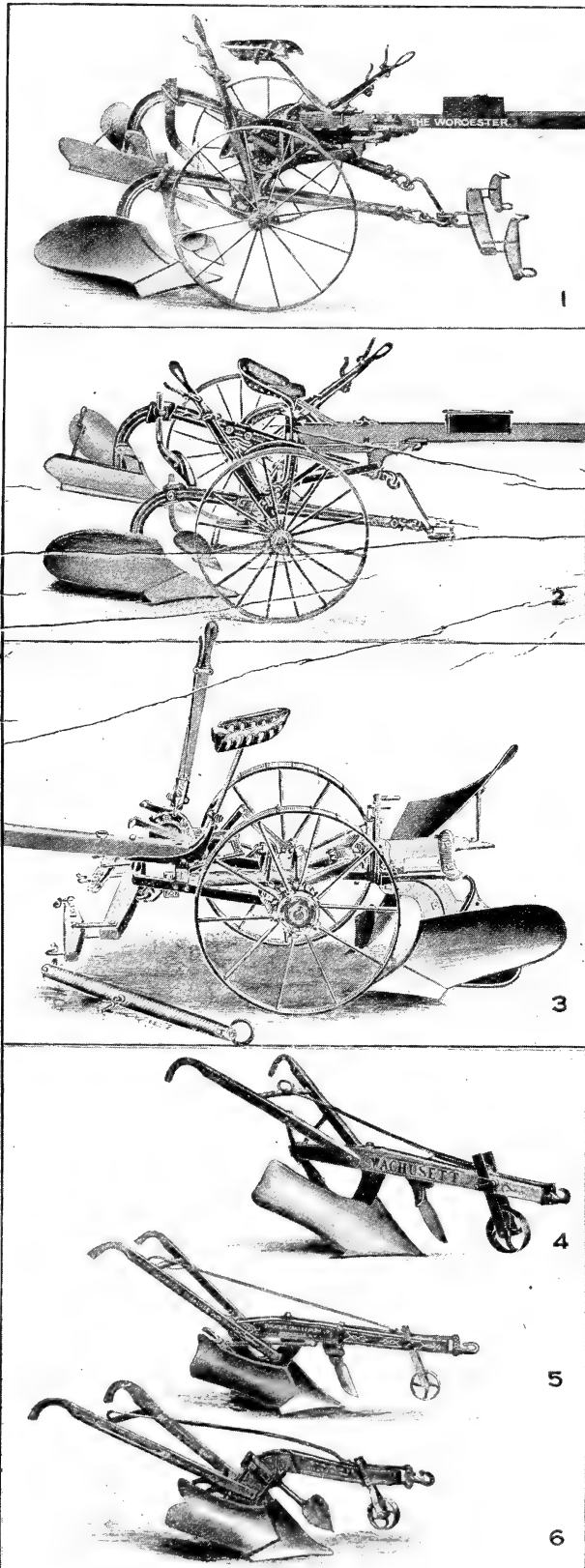

Syracuse No. 31 and 32, Two-horse Landside Plows (7)

These plows have steel moldboards and wheels, straight cutters or jointers. No. 32 is the same plow used in the double sulky, with a pair of handles and different beam put on, and no better plow was ever made. It cuts 5 to 7½ inches deep, 10 to 13 inches wide; weight, 103 lbs.; price, \$15.50. No. 31 cuts 5 to 8 inches deep, 12 to 15 inches wide; weight, 108 lbs.; price, \$16. Discount for cash for either of the above, \$2.

Syracuse No. 5 Vineyard Plow, One-Horse (8)

This plow is designed for plowing between rows of trees or vines. The handles are adjustable sideways, or up and down. The horses can walk in the furrow or on the land. This plow is also fine for garden work. Iron beams, cuts 3 to 5 inches deep, 7 to 10 inches wide; weight, 63 lbs. Price, with wheel, \$7.75. Discount for cash, 50 cts.

The Syracuse Plow No. 812 (9)

This is the latest model to be added to the Syracuse line, and has points of advantage over all old models. The leading feature is the shifting handles, which enables the operator to walk directly behind the plow when handles are set for any width furrow or for any kind of work. It has a steel truss beam, automatic jointer or cutter and shifting clevis, adjustable wheel, inclining forward or back as desired. Price, with chilled moldboard, wheel and cutter or jointer, \$16. Discount for cash, \$2.

Arlington Swivel Plow (10)

The Arlington has become a favorite in many sections. Has steel shifting lever, clevis, patent spring foot latch. Moldboards are made of patent steeled metal, and all castings are nicely polished. The beam and handles are made from selected stock, and are neatly striped and varnished. No. 30 turns a furrow 13 to 16 inches wide, 6 to 8 in. deep; weight, 135 lbs.; price, with wheel, \$13.50; with wheel and cutter, \$15; wheel and jointer, \$15.50; discount for cash, \$2; No. 29 turns a furrow 12 to 14 in. wide, 5 to 7 in. deep; weight, 123 lbs.; price, with wheel, \$12.50; wheel and cutter, \$14; wheel and jointer, \$14.50; discount for cash, \$2. No. 27 turns a furrow 8 to 11 in. wide, 4 to 6 in. deep; weight, 85 lbs.; price, with wheel, \$9; wheel and cutter, \$10; discount for cash, \$1.

Doe Cast-Iron Plow (11)

A good general-purpose plow, designed for all kinds of garden work. Wood beam, cast moldboard and point. E O, medium, one-horse, plain, \$5; E 1, large, one-horse, plain, \$6; E 2, light, two-horse, plain, \$7; E 3, medium, two-horse, plain, \$8; wheel and cutter, \$10.75; E 4, two- or three-horse, plain, \$10; wheel and cutter, \$12.75. Discount for cash, 50 cts.

Oliver Pattern Chilled Plow (12)

All parts interchange with the Oliver. This plow has a chilled moldboard, extra-high standard, which prevents clogging in weeds or trash. Will do good work at breaking for a new seed bed, and is well adapted to furrowing and rows, hilling up, and raising potatoes, or plowing out plants of any kind. A plow of this kind is very useful on any large farm as well as for the trucker. Fully up to the Oliver standard. It is our best one-horse landside plow. Price: No. A, light one-horse, \$4.50; No. B, medium one-horse, \$6; No. 10, large one-horse, \$7. Discount for cash, 50 cts. If wheel is wanted, add \$1 net to above prices.

Shovel Plow (13)

The very best of material is used in this plow, and it is one of the most practical of this form on the market. All parts are strongly reinforced. Price, \$3.50. Discount for cash, 25 cts.

Acme Pulverizing Harrow No. 23 (14)

A general purpose harrow that will crush, cut, lift, turn, smooth and level the soil to perfection in one operation. Adapted for heavy stubborn land, and also can be adjusted with levers and runners to do perfect work on lightest soil. Cuts the entire surface without disturbing the sod or trash that has been turned under by the plow. A splendid tool for orchard cultivation, or for anywhere that roots must not be bothered. Made entirely of cast steel and wrought iron, and practically indestructible. No. 23, regular size, two-horse, made in two sections, price \$17. Discount for cash, \$1.

No. H, One-Horse Acme Harrow (Not shown)

Has eight coulters, crushing spurs and seat; works 4 feet 4 inches wide; weight 90 lbs. Price, \$14. Discount for cash, 50 cts.

No. G, One-Horse Acme Cultivator (Not shown)

Has six coulters; cuts 3 feet wide; has handles, but no seat. Price, \$9. Discount for cash, 50 cts.

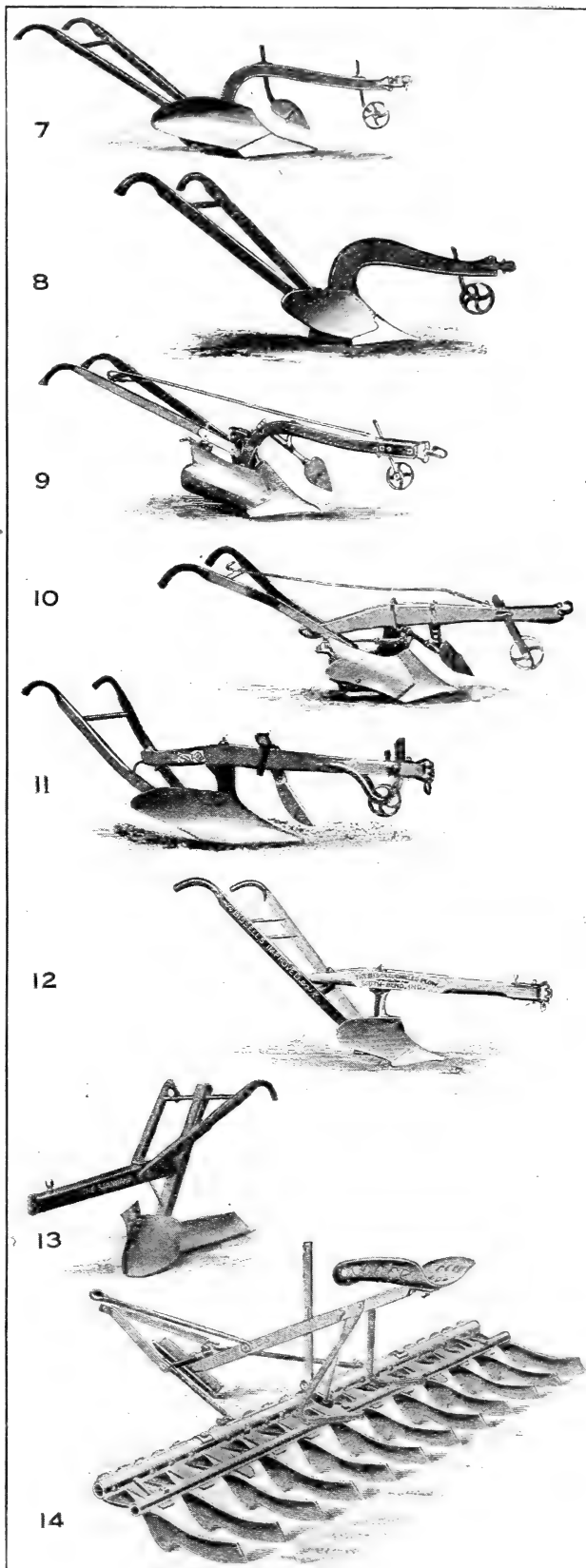

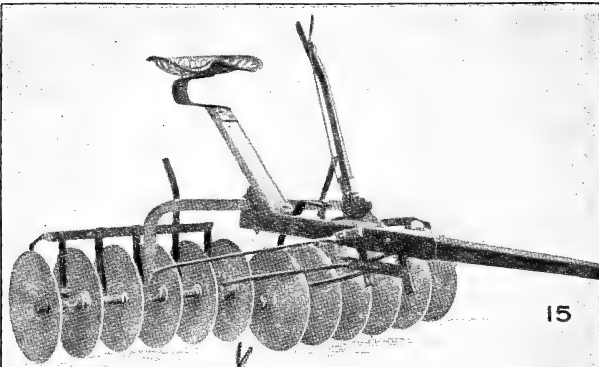

15

Eldridge Flexible Steel Disc Harrow (15)

The only disc harrow that has a steel frame made in one piece with no cast-iron standards to break. It is a perfect, flexible disc harrow, and can be taken apart in one minute, for loading or storing by simply removing two cotter pins. It runs on ball bearings. One great feature is the closeness with which the discs run together in the center. One gang travels about six inches behind the other, and the rear one cuts within an inch of the track of the front one, making it practically an overlapping harrow, and leaving no ridge. It has the easiest seat of any disc harrow made. The most perfect and durable harrow on the market. We are the exclusive selling agents, and want good agents in all unoccupied territory. 12—16 in. steel discs, complete with whiffletree, yoke and scrapers, price \$22; discount for cash, \$1.

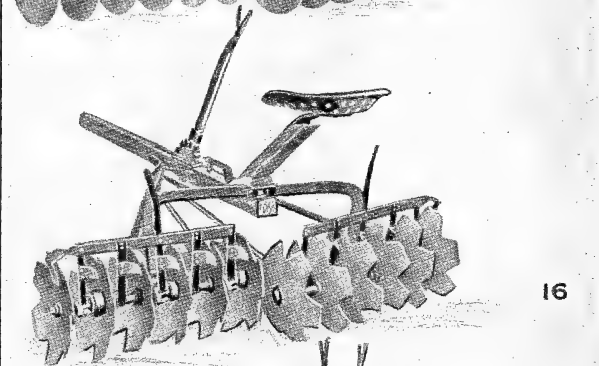

16

Eldridge Cut-out Disc Harrow (16)

For ordinary work, particularly in mild sod, we recommend a solid disc harrow, as the round disc will cut and bury grass best. But on hard, stony, rooty, or new land, the cut-out discs will dig in and do good work, even where it is impossible to plow. Lumps and trash that resist every other tool, can be brought to a good seed bed with a cut-out disc harrow. Price \$23. Discount for cash, \$1.

Reliance Disc Harrow (17)

WITH STEEL WEIGHT BOXES. 12 16-INCH STEEL DISCS

Made especially for us, and is designed for farmers who want a harrow with weight boxes, so that it can be weighted to work on very hard soil. The boxes are also handy to throw loose stones into while going over the grounds. All parts except discs are painted bright red. Price, \$22. With cut-out discs, \$1 extra. Discount for cash, \$1.

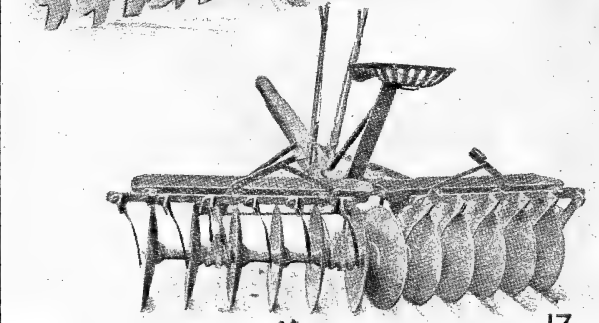

17

Chattanooga Two-way and Four-Gang Harrow (18)

WITH FLEXIBLE, DETACHABLE REAR FRAME. TWO MACHINES IN ONE

Moisture and air are necessary to allow some soils to work up fine, and by the use of the double harrow this is accomplished by reason of the front discs opening the top of the ground, exposing and turning up the soil, which is immediately recut and pulverized by the rear row of discs, leaving no ridge exposed.

The old method of preparing fields for planting requires the use of a plow or a disc harrow, a spike harrow and a roller or drag, necessitating the services of one man and three horses to each operation. One man and four horses with a Two-Way Disc Harrow will accomplish the same result better and with less than one-half the cost.

Cut discs have proven to be more penetrating than round discs, having a spading action which loosens and lifts the soil better than the solid round discs.

Has two pairs of gangs which thoroughly pulverize and level the ground in one operation. The front pair have the discs set to throw the soil outward from each side of the center, the rear discs to throw the soil inward, pulverizing at the same time. Frame is made of heavy, high-carbon steel, well braced, but flexible enough to allow turning without strain. Hard maple journals soaked in oil. Dust-proof, long-distance, self-oiling wheels on the front truck. Has proved its superiority over all others. Has twenty 16-in. discs. Price \$40. Same harrow with sixteen 16-in. discs, \$35. Discount for cash on either size, \$2. Pole, \$1 extra.

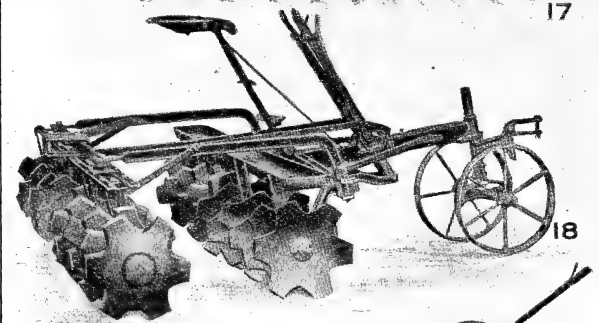

18

Meeker Smoothing Harrow (19)

This consists of a frame with four sets of rollers and 58 steel discs, which work between each other. The discs grind all lumps very fine and mash small stones below the surface better than any field roller. Regular size, 6 ft. 8 in., by 6 ft., weight, 220 lbs., price, \$20; discount for cash, \$2. Special size, 4 ft. 6 in., by 4 ft., weight 200 lbs., price \$18; discount for cash, \$2. Special size, 8 ft. by 6 ft., weight 250 lbs., price, \$25; discount for cash, \$2.

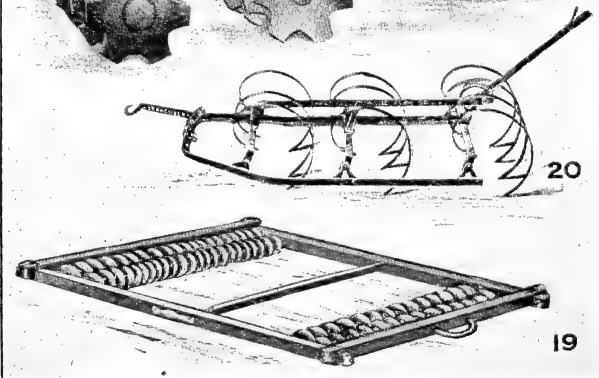

20

Syracuse One-Horse Spring Harrow (20)

Has ten spring teeth, oil-tempered, and is adapted for all kinds of work. Has given perfect satisfaction. Price, \$10. Discount for cash, 50 cts.

Our Corn pages, 1 to 5 inclusive, are unusually interesting and valuable, this year, to the wide-awake, progressive farmer. The increased value of land and the better prices secured for the products of the soil demand that better Corn seed—from the best high-yielding strains—with a pedigree for results, be planted in the Corn fields, insuring a maximum crop from each acre.

19

Quail Spring-Tooth Harrow (21)

Our best spring harrow. It is made of the very best material throughout and has two levers for raising and lowering the teeth, has wheels for traveling with the teeth up, and has non-clog frame at center, in front. Bars on which teeth are hung fasten at ends so they cannot spring out of place. Price, 15-teeth, \$17. Discount for cash, 50 cts. With seat, \$1.50 extra.

The Original Perry Spring Harrow (22)

This is the first spring-tooth harrow ever offered for sale, and it has many friends. For durability it is equal to any harrow made. The wood frame is lined with carbon steel. Bolt heads are protected. The teeth cannot get loose. Used among rocks and stumps which would soon break any other harrow to pieces. Price, 16 teeth, \$11. Discount for cash, \$1.

The Monarch Spring-tooth Lever Harrow (23)

Some users prefer a spring harrow with shoes to slide on, in place of wheels, claiming that for certain purposes and in mellow soil, the depths can be regulated better. While this has to be hauled to and from the fields on the shoes instead of wheels, it will do just as good work, and is as durable as any harrow on our list. Price, 15 teeth, \$15.50; 17 teeth, \$16.50. Discount for cash, 50 cts.

Big 5 Jr. Spike-Tooth Smoothing Harrow (24)

Designed as a leveling harrow, and for covering all kinds of grain and grass seed; also largely used for cultivating corn and potatoes just after they come up. The teeth are adjusted by means of a lever and can also be thrown up from the ground and harrow transported to and from the field on the shoes at the end. Each tooth is held in place by two bolts, while nearly all other harrows use but one. Teeth can be moved down as they wear. The entire harrow is made of steel. Price, 60 teeth, \$14; discount, \$1.50; 50 teeth, \$13; discount, for cash, \$1.

Monarch One-Horse Spring-Tooth Harrow (25)

This is the best one-horse harrow made. It has standard teeth, strong tooth-holders and a convenient handle for working around the ends. Price, \$10. Discount for cash, 50 cts.

Prout's Two-Horse Hoe (26)

Each standard has two hoes attached, and, in working, each hoe works on one side of the hills, hoeing a row at a time. The hoes operate the same as a hand hoe, moving fresh earth to plants and shoving the dry earth away from plants. The work is done much more quickly and more thoroughly, than it is done with hand hoes. With cultivators, the other horse hoes used before, only part of the soil was moved, and weeds often escaped. With this hoe the whole surface, for a distance of 2 feet more or less, on each side of the plants, is cut over, all the weeds removed. The hoes are tapering—broad at the base, narrow at the point, and the ground can be cut right up to the plant without injury to roots which run close to surface. Price, with wheels, \$25; discount for cash, \$5. Without wheels, \$23; discount for cash, \$5.

No. 72 Planet Jr., Two-Row Pivot Wheel Cultivator, Plow, Furrower and Ridger (27)

COMPLETE WITH FOURTEEN SPRING TRIP STANDARDS

Planet Jr. tools are too well known to need extended descriptions. This double cultivator is just as good for its purpose as the smaller tools are for theirs. The equipment complete consists of fourteen cultivator teeth, four reversible plows, two 7-in. shovels, four plant guards, lever-adjustable gangs and spring trip standards for stony land. Packed weight, 569 lbs. Price, \$61.25. Discount for cash, 5 per cent.

WILLIAM R. WYMAN, Skowhegan, Me., writes Nov. 18, 1909: "I purchased one of your No. 72 Two-Row Riding Cultivators equipped with spring trip standards, and I am very glad to say that it is well named, as it does twice the work of any other make of riding cultivator."

S. H. BEAL, Cornville, Me., writes Nov. 18, 1909: "I purchased of you, last January, one of your No. 72 Two-Row Riding Cultivators equipped with fourteen spring trip standards, and have used it with the greatest success in my corn and potatoes. My land is stony and the machine has stood the work well."

M. W. CAYFORD, Skowhegan, Me., writes Nov. 18, 1909: "Six years ago I purchased of you one No. 72 Two-Row Riding Cultivator equipped with regular pin brake standards, and have used it continuously during the cultivating season in my corn, potatoes and orchard, and have cultivated as high as ten acres per day in potatoes. My land is very stony, and up to the present time it has not cost me one cent except for sharpening teeth. It has cultivated twice as much as my neighbors can do with a single-row machine in the same length of time. I am highly pleased with it and have induced several neighbors to purchase one."

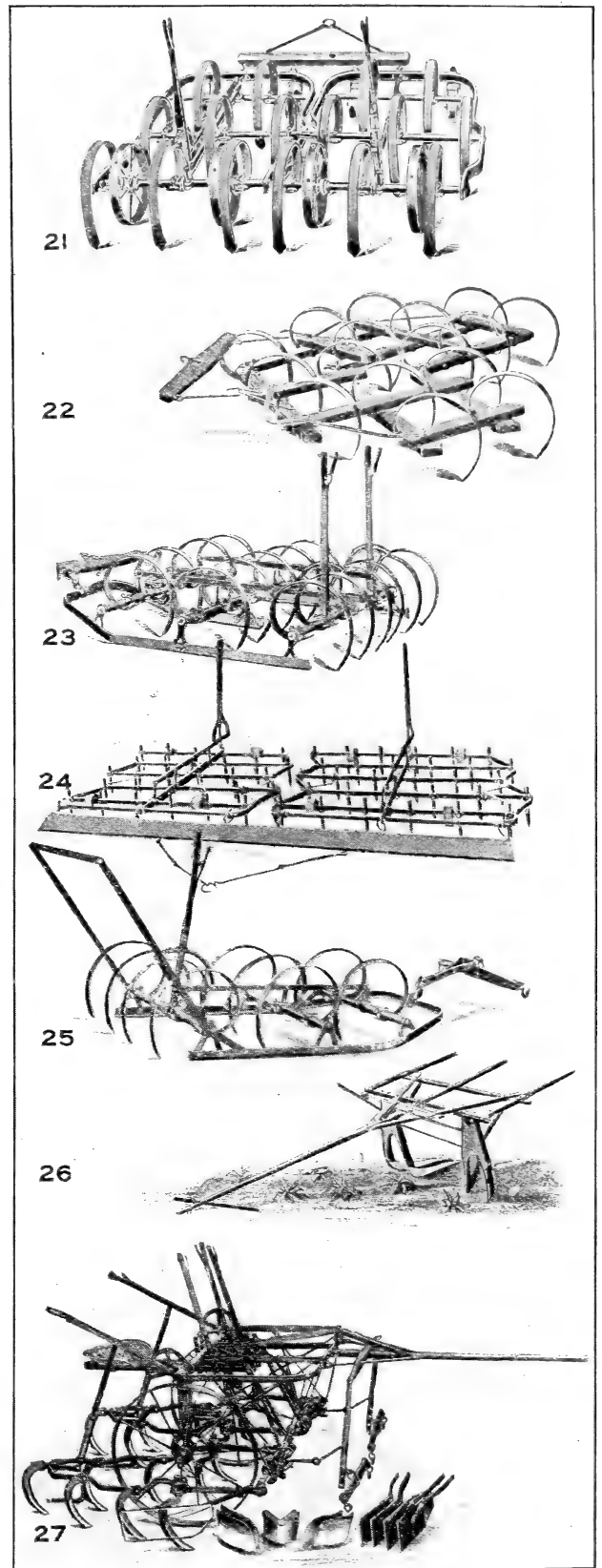

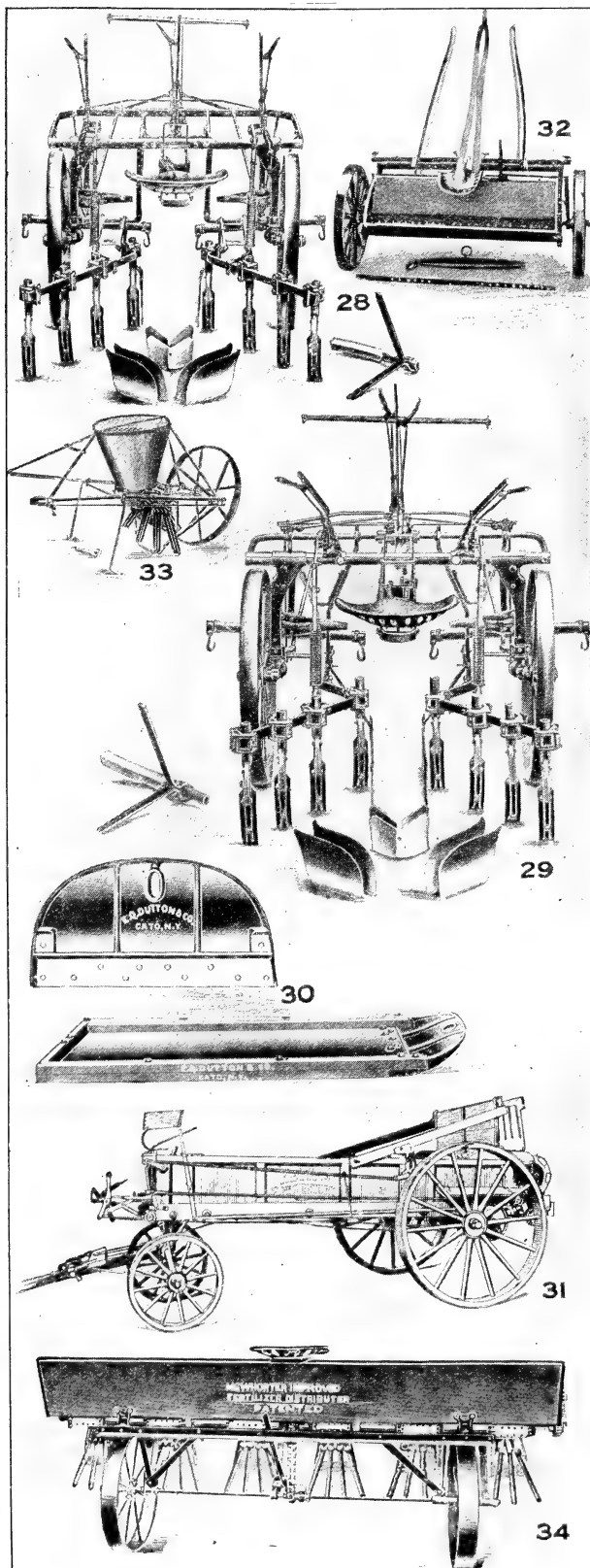

No. 75 Planet Jr., Two-Horse Pivot Wheel Cultivator, Plow, Furrower and Ridger (28)

COMPLETE WITH SPRING TRIP STANDARDS

A most practical machine, made in the best manner, and consisting of eight cultivator teeth, two 6-in. plows, two 7-in. plows, two 7-in. shovels, two plant shields and spring trip standards for stony land. Packed weight, 506 lbs. Price, \$47.50. Discount for cash, 5 per cent.

No. 76 Planet Jr., Pivot Wheel Riding Cultivator, Plow, Furrower and Ridger (29)

COMPLETE WITH SPRING TRIP STANDARDS

Weight, 507 lbs. Equipment: eight cultivator teeth, two 6-in. plows, two 7-in. plows, two 7-in. shovels, two plant shields. The central lever operates the hinged tongue, regulating the depth of the front teeth and leveling the machine; the same lever moves the gangs of teeth instantly, either closer to or farther from the row, as desired, while the team is in motion.

With the addition of the extra tooth and standard, as shown in the cut, a nine-tooth riding harrow can be made. This extra tooth fits in the center, working the ground which is left for the row when used as a cultivator. No farmer can afford to be without one of these Planet Jr. Riding Cultivators. This applies to both the No. 75 and No. 76. Price, \$51. Discount for cash, 5%.

J. B. BEROW, Cullman, Ala., writes April 23, 1908: "The Planet Jr. No. 72 Cultivator works beautifully, as all the tools we have purchased of you always do."

J. M. LUTTON & SON, Mattituck, L. I., N. Y., writes Aug. 12, 1910: "It may interest you to know that we feel very much satisfied with your Pivot Cultivator; we have used one three seasons, in which time it has probably covered a thousand acres."

J. H. GRISDALE, Agriculturist, Department of Agriculture, Dominion Experiment Farms, Ottawa, writes Dec. 11, 1909: "The No. 72 Planet Jr. Two-Row Cultivator, purchased last spring, was used throughout the cultivating season and proved to be very satisfactory indeed, since it enabled us to materially reduce the cost of cultivation in the case of both corn and roots, and did first-class work."

"Any further remarks on the No. 72 Planet Jr. Cultivator are unnecessary, but would merely add that I would like to see a lot of these machines in the country. I believe they would be found to be a profitable investment."

Cast-Iron Boat Head (30)

A simple device whereby a stone boat can be made in a few minutes by using a straight plank with the addition of the iron head. Price of head only, \$3.50; boat complete, \$7.50. Bolts for attaching, 60 cts. per set.

The Twentieth Century Manure Spreader (31)

The best spreader on the market at the present time—Mr. Kemp's improvement on his splendid old spreader. The original tight-box spreader, and the only machine that will sow commercial fertilizers, ashes, chemicals, lime, etc. Send for complete catalogue. A manure spreader costs as much, and is more used, than a binder. It is important to get one that hauls light, and which does its work evenly. This one will do those things, and no purchase should be made without studying this machine as carefully as you would a binder before buying it.

The Stevens Fertilizer Sower (32)

For sowing all kinds of commercial fertilizer, either damp or dry in drills or broadcast. Thoroughly satisfactory as a lime spreader. In meadows and orchards almost a necessity. Unequaled for top-dressing grass lands, lawns or large parks. Standard size, 5 feet 10 inches. Price, \$45. Discount for cash, \$5.

McWhorter Hand Fertilizer Sower (33)

Can be instantly changed so that the stream is divided from one into two or more streams, and thus be applied beside or on two or more rows of plants at the same time. Especially adapted for top-dressing strawberry beds and lawns. The spouts through which the fertilizer passes open and close so that a space from 4 to 30 inches wide may be covered. Price, \$11. Discount for cash, \$1.

McWhorter Improved Horse Fertilizer Distributor (34)

SET FOR BROADCASTING 8 FEET, 6 INCHES WIDE

These machines are so well balanced that when the hoppers are full there is no more weight on the horse's back than when empty. They are thoroughly and strongly made and complete in all respects, and will be found a revelation in the application of fertilizers under many conditions.

The No. 16 will broadcast the fertilizer 8 feet 6 inches wide, and be found a most convenient machine for doing furrow work, side and top dressing on rows up to 8 feet apart. It will put the fertilizer in any number of furrows or on rows that come under the width of the machine. Shipping and net weight, 420 lbs. Hopper capacity, 400 lbs. fertilizer. Price, \$48. Discount for cash with order, 5 per cent.

Farmer's Friend Seed and Fertilizer Sower (35)

Attaches to any ordinary farm wagon, and sows to perfection grass and grain seeds of all kinds in any desired quantity per acre, 50 to 100 acres a day. It also distributes all dry commercial fertilizers; ashes, land plaster, lime, etc. Has a positive force feed, and an adjustment of the holes from $\frac{1}{4}$ to $1\frac{1}{2}$ inches. The plow can be shut off from either side or altogether. It is instantly thrown in or out of gear. Price, complete to attach to wagon, \$10. Discount for cash, \$1.

Aspinwall Potato Planter No. 3 (36)

This machine plants a greater range of seed, both as to size and shape, than ever before, and handles it with the least possible friction or wear. Price, with fertilizer attachment and disc covers, \$75. Discount for cash, \$5.

Eclipse Corn Planter and Fertilizer Distributor (37)

Plants field or ensilage corn, beans, peas or beet seeds in hills, drills or checks; it will drop 6, 12, 24 or 36 inches apart. It accurately distributes from 50 to 450 lbs. as desired, of commercial fertilizer, wet or dry, in the rows of hills. Price, complete, \$21. Discount for cash, \$1.

Eclipse Two-Row Two-Horse Corn Planter (38)

The most complete, accurate, durable, and easily handled, double-row planter in the market, same construction as eclipse one-horse. Rows 36, 38, 40 and 42 inches apart. Price, \$50. Discount for cash, \$2.50.

"King of the Cornfield" (39)

CORN, BEAN AND PEA PLANTER AND FERTILIZER DISTRIBUTOR

Corn and beans may be planted at the same time in the same row, the beans half-way between the corn, or $4\frac{1}{2}$ or 9 inches from corn, as desired. The fertilizer may be put with the corn and left out of the beans. Price, \$21. Discount for cash, \$1.

Thompson's Seeder No. 5 (40)

The hopper on this seeder is made double and will do a large range of work. It sows all small seeds like clover, timothy, Hungarian, rape and flax, in any quantity from 6 to 40 quarts to the acre, and millet 3 to 24 quarts to the acre. It also sows chaffy seed like red-top, orchard grass, clean blue grass, any quantity desired to the acre; sows uniformly whole length of box, 14 feet.

This seeder is especially adapted to the requirements of the New England states. Price, \$10. Discount for cash, \$1.50.

No. 4. Grain seeder box, 10 feet, for sowing all kinds of grain. Fits on to No. 5 seeder. Price, \$5. Discount for cash, \$1.

No. 5 Seeder and No. 4 grain box. Price, \$15. Discount for cash, \$3.

Segment One-Hand Corn and Bean Planter (41)

Lightest, most accurate, strongest and most up-to-date planter on the market. Price, \$1.75. Discount for cash, 25 cts.

Automatic Hand Corn Planter (42)

Very handy for replanting and for small gardens. Price, \$2. Discount for cash, 25 cts.

Cahoon's Improved Broadcast Seed Sower (43)

Will sow all kinds of grass and grain seeds from four to eight acres per hour at a common walking gait. Price, \$3.50

The Cyclone Broadcast Seed Sower (44)

This is the cheapest and best of the hand seed sowers on the market. Will sow all grains and seeds perfectly even and any desired amount to the acre. Price, \$1.50.

The Goslee Improved Marker (45)

Adjustable tooth spreads, 2 to 4 feet. Price, \$7.50. Discount for cash, 50 cts.

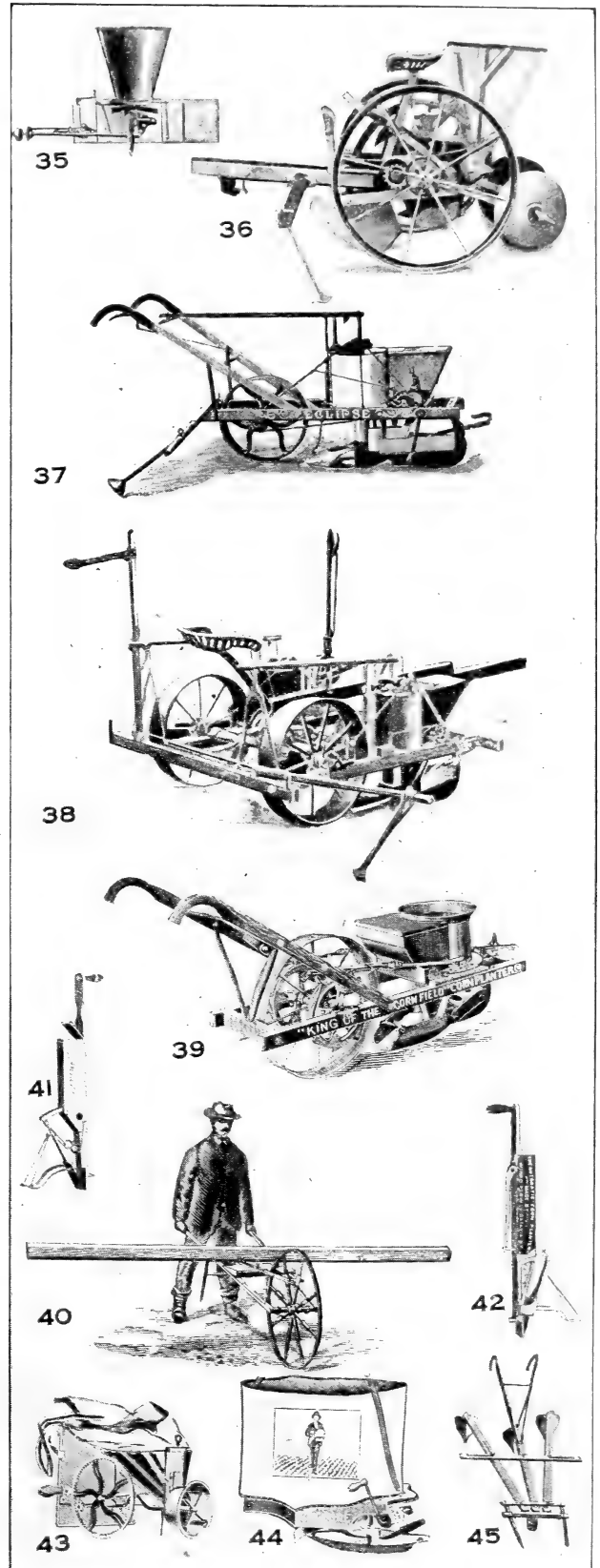

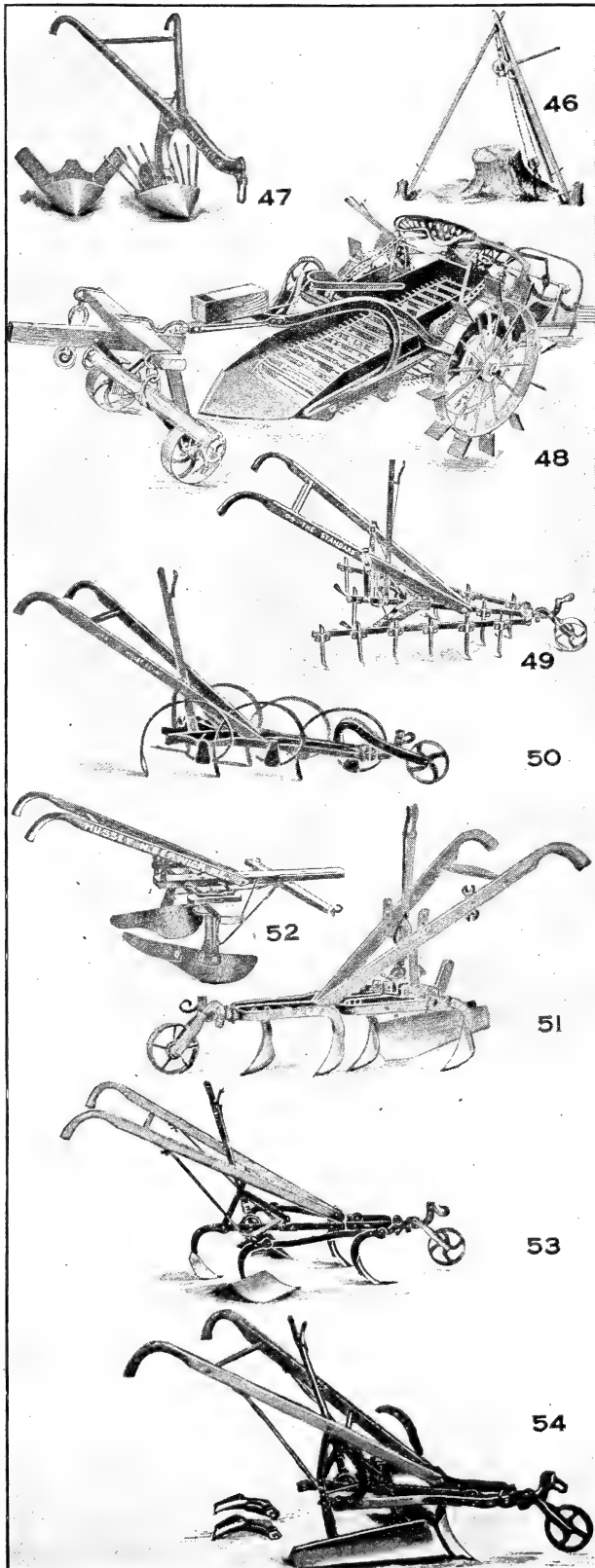
**Eureka Stump Puller and Rock Lifter (46)**

This is by far the simplest and most efficient device on market for pulling stumps, lifting stones and handling heavy bodies, and will be found very useful. Price: No. 1, weight, 22 lbs., capacity, 4 tons, \$16. No. 2. Weight 26 lbs., capacity, 6 tons, \$18. No. 3. Weight, 32 lbs., capacity, 8 tons, \$21.

The Hitchcock Potato Digger and Shovel Plow Combined (47)

An excellent and quite simple implement for digging and hilling potatoes. It is also very handy for hilling and for furrowing out. A very useful tool on any farm. Price, complete, \$10.50; without hiller, \$8.

The Worcester Potato Digger (48)

To this important implement we want to call especial attention. All parts of this digger will interchange with the Hoover, and, being like it, it will do just as good work; we claim it has better castings, and will be more durable than any other make. The crop or hill is lifted by the shovel and moves to the elevator or apron where it is partly separated. Then it is taken up by the apron rods or links and carried to the rear, being separated at the same time by the agitation of the apron. The rods are so spaced that the separated dirt falls through to the ground. From the front apron the crop falls to the rear apron where it receives a final separation and is then delivered on the ground at the rear of the machine in a narrow row, unusually convenient for picking up. The separation is thorough and the construction of the shovel and apron is such that no potatoes are cut or bruised.

The levers regulate the depth and separation and put the entire machine under control of the driver. The machine may be readily turned in a short space and is easily guided to follow the row. It is thus not only efficient but easy to operate. Price, \$100. Discount for cash, \$5.

Spike-Tooth Cultivator and Harrow (49)

This cultivator and harrow is particularly designed for cultivating between small fruits. Especially adapted to pulverize the soil and leave it smooth and level, thus conserving moisture. Price, \$6. Discount for cash, 50 cts.

Spring-Tooth Cultivator (50)

A cultivator that is especially adapted for use in stony ground. The teeth are fine, oil-tempered springs, and are alike and interchangeable; they are also adjustable for angle and depth. Has expanding lever, five spring teeth and wheel. Price, \$6.50. Discount for cash, 50 cts.

Centennial Horse Hoe (51)

Very durable horse hoe and cultivator. The expanding lever always works easily, as it has no dead centers. Price, \$8. Discount for cash, 50 cts.

New Model Horse Hoe (52)

This is undoubtedly the cheapest and best two-horse hoe yet placed on the market. It can be used for furrowing out, covering and hilling up. No farm is complete without one. Price, \$8. Discount for cash, \$1.

Steel Frame Cultivator No. 123 (53)

The reliable Steel Frame series of Cultivators meet the demand for good cultivators at a low price.

The points and standards are of the same stock as used in No. 101, but the frame is somewhat shorter and a trifle lighter. The standards are adjustable for pitch. List price, \$6. Discount for cash, 50 cts.

Steel Frame Cultivator No. 124 (54)

This tool is similar to the No. 123, but in place of the short steel hiller wing we use the long hiller, same as on No. 101. This makes a lighter tool and one that can be used for furrowing as well as hilling, and it is sold at a very low price. List price, \$7. Discount for cash, 50 cts.

On pages 72 to 77 inclusive will be found everything needed in Poultry Supplies—all the reliable Incubators, Brooders, besides the best Foods, Remedies, etc.

Steel Frame Cultivator No. 101 (55)

This Cultivator is simple, strong and easy to operate. Has no "dead centers," and no loose joints. The frame and standards of these cultivators are very strong; made of solid steel; the side bars are so curved as to make the teeth run parallel, and also to make all standards interchangeable. Has five steel plates and long steel hiller. Can be used for furrowing out or hilling. Steel frame, five teeth, wheel and lever; very strong. Price, \$8. Discount for cash, 50 cts.

Planet Jr. No. 4 Horse Hoe and Cultivator (56)

This tool is low in price, strong and simple; it has the old favorite stirrup clamp and plain expanders; they cost a trifle less than the lever. Price, \$6.75. Discount for cash, 50 cts.

Planet Jr. No. 81 Horse Hoe, Cultivator and Hiller Combined (57)

Has six 3-in. cultivator teeth, two 6-in. plows and a 12-in. furrowing tooth, making an admirable equipment, for all widths of cultivation and for hilling crops up to 4 feet apart. It has a cultivator tooth central in front, which increases the steadiness of the tool. This is followed by a group of teeth, adjustable for width by means of a convenient lever expander. Intermediate between these and the rear tooth is a pair of teeth 13 inches apart, not adjustable for width.

The lever expander is the latest design, permitting the operator to change the width of the outside teeth a fraction of an inch or more, without stopping the horse. The lever-wheel is a new design, operated without the hand-piece and wire for releasing the pin. Price, \$10. Discount for cash, 50 cts.

Planet Jr. 12-Tooth Harrow, Cultivator and Pulverizer (58)

This thorough-working and convenient tool has grown in favor among strawberry growers, market-gardeners, truckers and farmers. This is because the 12-inch chisel-shaped teeth do such capital work, without throwing earth on small plants. Price, with pulverizer and two levers as shown, \$9; without pulverizer, \$7.40; with plain wheel and no pulverizer, expanding lever, \$6.90. Discount for cash, 50 cts.

Planet Jr. No. 7 Horse Hoe and Cultivator (59)

This Horse Hoe is No. 8 without depth regulator, and a slightly different lever wheel. Price, \$8.50. Discount for cash, 50 cts.

Planet Jr. No. 9 Horse Hoe and Cultivator (60)

This admirable tool is identical with the No. 8, except that it has a plain instead of a lever wheel. It has the high frame, patented hollow steel standards, patent lever Star wheel, new lever expander, and new hollow steel wheel arms. Price, \$7.75. Discount for cash, 50 cts.

Planet Jr. No. 8 Horse Hoe (61)

This is the latest pattern Horse Hoe and Cultivator. It has a lever for raising and lowering the wheel; also one for expanding and contracting. The wheel lever also governs the depth of the rear end by means of a shoe, which is a great advantage in sandy ground. Price, \$9. Discount for cash, 50 cts.

BEE KEEPERS' SUPPLIES

We wish to announce to our patrons that we have added a line of Bee Keepers' Supplies, which includes all the necessary articles used by Bee Keepers throughout the country who are in this business either for pleasure or for profit. We handle the Falconer line exclusively, which is second to none.

If you are especially interested in Bee Keeper's Supplies we should be pleased to have you, whether you order anything else from our catalogue or not, send us your name which will be included in our list of Bee Customers. You will receive a special catalogue which gives a full description of the articles we are able to furnish, and also will send you a Premium List, which includes many handy novelties which are included with orders amounting from \$2.50 up.

BURTON J. WALRATH, Bryceville, Fla., writes Oct. 27, 1909: "I have your No. 8 Horse Hoe. It is a fine tool and I would not try to farm without one if they cost twice what they do."

S. M. CATHCART, Rehoboth, Ala., writes July 31, 1910: "Think I shall need two more of your horse hoes and cultivators next year. Your No. 8 Horse Hoe and Cultivator is the best tool that I have ever cultivated cotton and corn with in my life. It does perfectly fine level work and, the best of all, you can set it to run the exact depth you want, and that is the main thing in cultivating crops—have tools that you can run shallow to avoid cutting lateral roots. More crops are ruined by being cultivated too deep than anything else, especially in our hot, southern country."

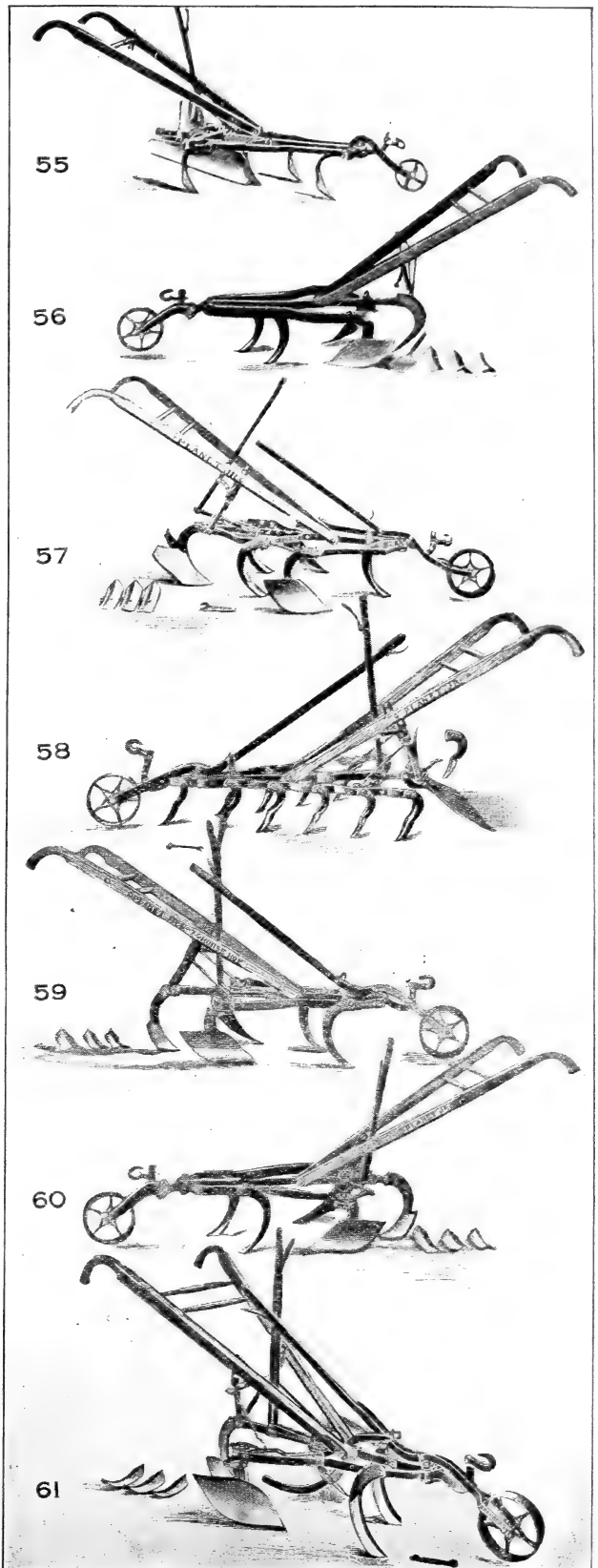

GARDEN TOOLS AND APPLIANCES

The Planet Jr. Family

The Planet Jr. Garden Tools are so well known that extended descriptions are not necessary. Their ever-increasing popularity, due to the fact of their excellence and practicability, is sufficient evidence of their worth. We carry a complete line of these tools, and will be glad to send a full catalogue of them upon request. When cash is sent with order, all goods on this page are sent prepaid.

No. 3 Planet Jr. Hill and Drill Seeder (62)

Drops in hills or drills, sows equally well whether sowing with full hopper or with a single ounce of seed. A favorite among onion-growers, market-gardeners and seedsmen. Fifteen-inch steel driving wheel. Holds three quarts. Weight, packed, 46 lbs.

No. 4 Planet Jr. Combined Hill and Drill Seeder, Wheel Hoe, Cultivator and Plow (63)

Steel driving wheel. Weight, packed, 47 lbs. Seed hopper holds 2½ quarts. Equipped with one pair of 4½-inch hoes. Three cultivator teeth, one garden plow, one leaf-guard; or sold as drill only. Price complete, \$11; plain drill, \$9.

No. 25 Planet Jr. Combined Hill and Drill Seeder and Double Wheel Hoe, Cultivator and Plow (64)

Eleven and one-fourth-inch wheels. Seed hopper holds 2½ quarts. Weight, packed, 59 lbs. It combines in a most practical way the Planet Jr. No. 4 Drill and No. 12 Double Wheel Hoe. Equipped with one pair of 6-inch hoes, two pairs of cultivator teeth, two plows, two leaf-guards. Net price, \$13.50.

No. 6 Planet Jr. Hill and Drill Seeder, Wheel Hoe, Cultivator and Plow Combined (65)

Price, complete, \$13.50. As a hill and drill seeder only, \$11.00. Packed weight, 64 lbs. Equipment: Two 6-inch hoes, three improved steel cultivator teeth, large garden plow: improved double leaf guard.

No. 16 Planet Jr. Single Wheel Hoe, Cultivator, Rake and Plow (66)

Packed weight, 29 lbs. Two 6-inch hoes, three cultivator teeth, one 7-inch rake, one 4-inch rake, one large garden plow, one leaf guard. Net price, \$5.85.

No. 17 Planet Jr. Single Wheel Hoe (67)

Packed weight, 26 lbs. One pair of 6-inch hoes, three steel cultivator teeth. One large garden plow. Price, No. 17, \$5; No. 17½, \$4.50; No. 18, \$3.50. No. 17½ is same as No. 17, less the plow. No. 18 is same as No. 17, with hoes only.

No. 18½ Planet Jr. Single Wheel Disc Hoe (68)

This simple and comprehensive tool is identical with No. 18 Single Wheel Hoe, except that two sets of three discs each take the place of the pair of hoes, and it has a leaf-lifter. The discs are adjustable for depth. These discs can be attached to any No. 18 Hoe. Net price, \$4.75.

WALTER L. HOTOPP, Jersey City, N. J., writes April 27, 1909: "Have bought a Planet Jr. No. 4. Very well satisfied with same; do not see how I could have gotten along without it."

C. D. MOWRY, Killingly, Conn., writes June 13, 1910: "I have used one of your No. 6 Combined Seeders and Cultivators. It is strong, practical, light and as efficient a machine as can be made. I consider one man can do the work of ten or more, cultivating or in any other capacity. It does about as thorough work as can be done."

A. L. DEERING, President Maine Agricultural Club, University of Maine, Orono, Me., writes July 27, 1910: "Your Planet Jr. Drill Seeder has been in use here at the State College for several years now and has given perfect satisfaction; it was also on exhibition on the modern farming train that traversed the state in June, and many inquiries were made regarding the durability, cost and the advisability of purchasing such a machine, all of which questions were most satisfactorily answered for you."

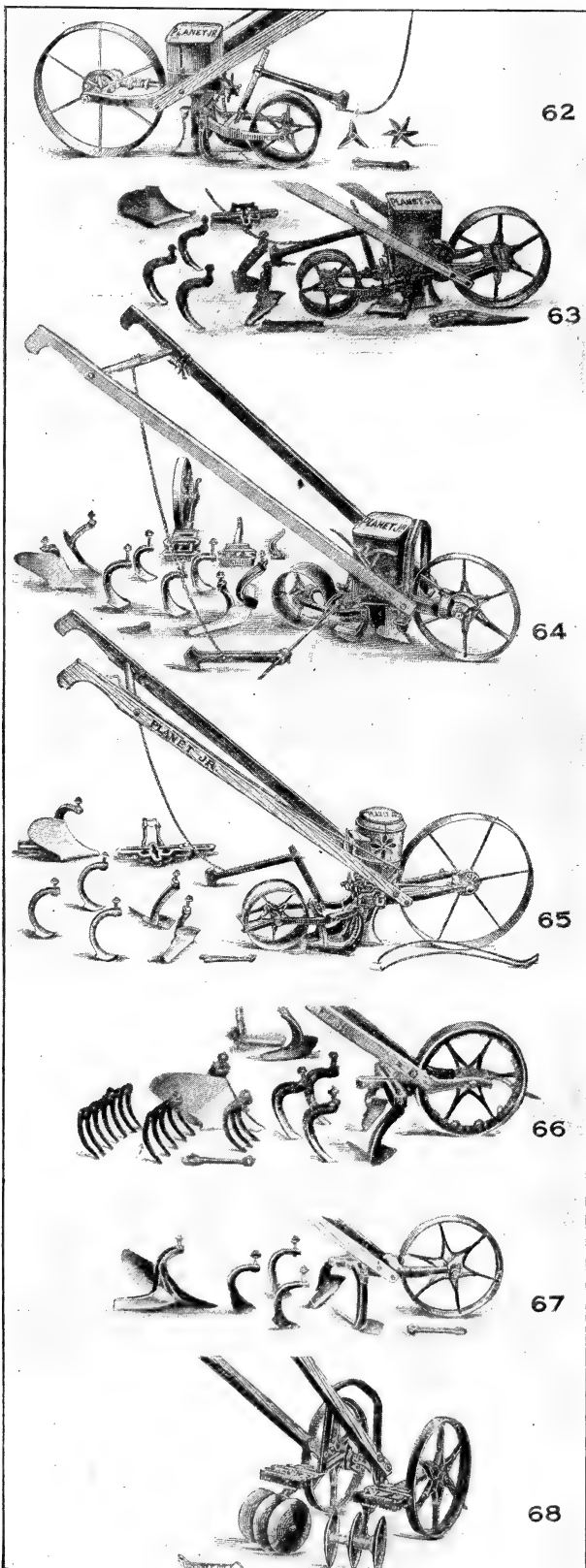

WHEEL HOES

Are companion implements to the seeder, but usually pay for themselves more quickly. Indeed, many people who can scarcely be recommended to invest in a seeder, may be very properly advised to buy a wheel hoe. No one who has even a small family vegetable garden can afford to be without a Planet Jr. Wheel Hoe, if his time is at all valuable. If you have never used any of these tools, rest assured that the saving and satisfaction are enormous. They will do all they are recommended to do: Hoeing, cultivating or plowing both sides of a row at once or all the space between two rows at one passage, at the speed of a moderate walk. By using these labor-saving tools, growers may safely plant and easily cultivate four times the acreage that they otherwise could do.

No. 11 Planet Jr. Double Wheel Hoe (69)

Packed weight, 37 lbs. One pair 6-inch hoes, oil-tempered, one pair 4½-inch hoes, oil-tempered; two pairs hollow steel cultivator teeth, one pair of plows; two 3-tooth rakes; two 5-tooth rakes; two leaf-lifters. Net price, \$9.

No. 12 Planet Jr. Double Wheel Hoe (70)

Packed weight, 32 lbs. One pair of 6-inch hoes, two pairs of hollow steel cultivator teeth, one pair of plows, one pair of leaf-lifters. Net price, \$7.50.

No. 13 Planet Jr. Double Wheel Hoe (71)

Planet, Jr. Double Wheel Hoe. Net Price, \$4.75. Packed weight, 28 lbs.

Planet Jr. Celery Hiller (72)

This tool is used largely by celery growers for banking celery in the fall. We can furnish both single or double; the single is used mostly and will do the work of five men. Price, double, \$16; single, \$13. Discount for cash, 50 cts.

Fire-Fly Plow (73)

This tool is invaluable for those who have small gardens. The moldboard is tempered and polished steel. The depth may be changed very quickly. Price, \$2.35.

Norcross Improved Hand Garden Cultivator (74)

A very handy garden tool. Price, \$1.

Sunnyside Hoe (75)

Used by many of the leading small-fruit growers. Price, 50 cts.

Arlington Slide Hoe (76)

Used by nearly all of the large market-gardeners. Made in three sizes. Price, 8-in., \$1.50; 9-in., \$1.65; 10-in., \$1.75.

Dunham All-Steel Two-Horse Land Roller (77)

With solid steel head. Cannot break and will not fill with gravel and stones. The most durable roller made.

The Dunham Steel Land Roller, with New Steel Brackets, will not break or bend. These brackets are supplied with a removable babbit metal journal boxing and are equipped with a large oil chamber that requires attention but once a year. These features together with the lathe-turned journal make a bearing that will wear for years. The drums are made of heavy plates of high carbon steel, guaranteed not to dent. The shafts are 1½ inches in diameter. Heavy angle steel frames, easy riding, double leaf seat spring, seat so adjusted as to counteract the weight of tongue on horses' necks. All of these are valuable features and should be on the Roller you buy, for you want the best. No. 6—6 feet, 24-inch diameter, \$28. No. 7—7 feet, 24-inch diameter, \$30. No. 8—8 feet, 24-inch diameter, \$32. Discount for cash, \$2. All rollers have three sections.

Dunham All-Steel One-Horse Land Roller (78)

Similar in construction and quality to the two-horse roller, and the best for lawns and truck farms. Price, \$28. Discount for cash, \$2.

Keystone Adjustable Weeder (79)

Expands to 7 feet; can be closed to 3 feet. Used for leveling. Price, \$10, with round teeth; with flat teeth, \$11. Discount for cash, 5 per cent.

The Hallock Straight Frame Weeder (not shown)

Price, \$10; discount for cash, 50 cts.

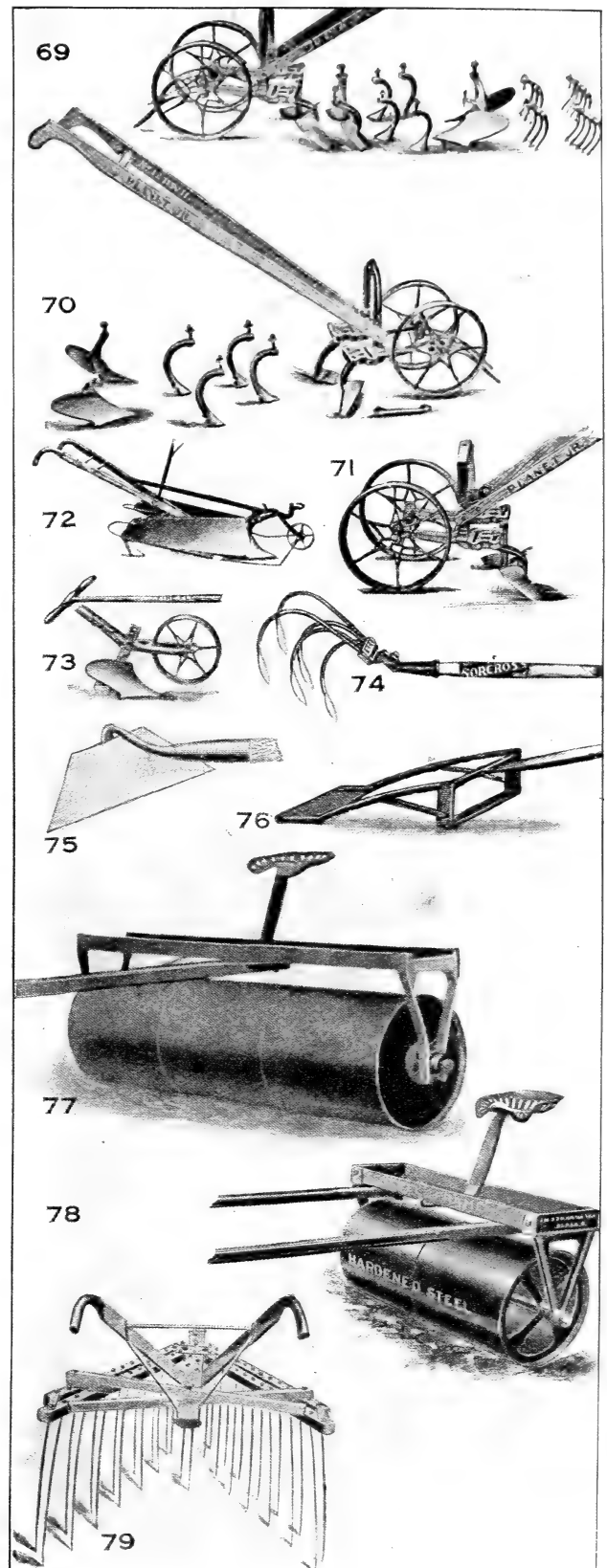

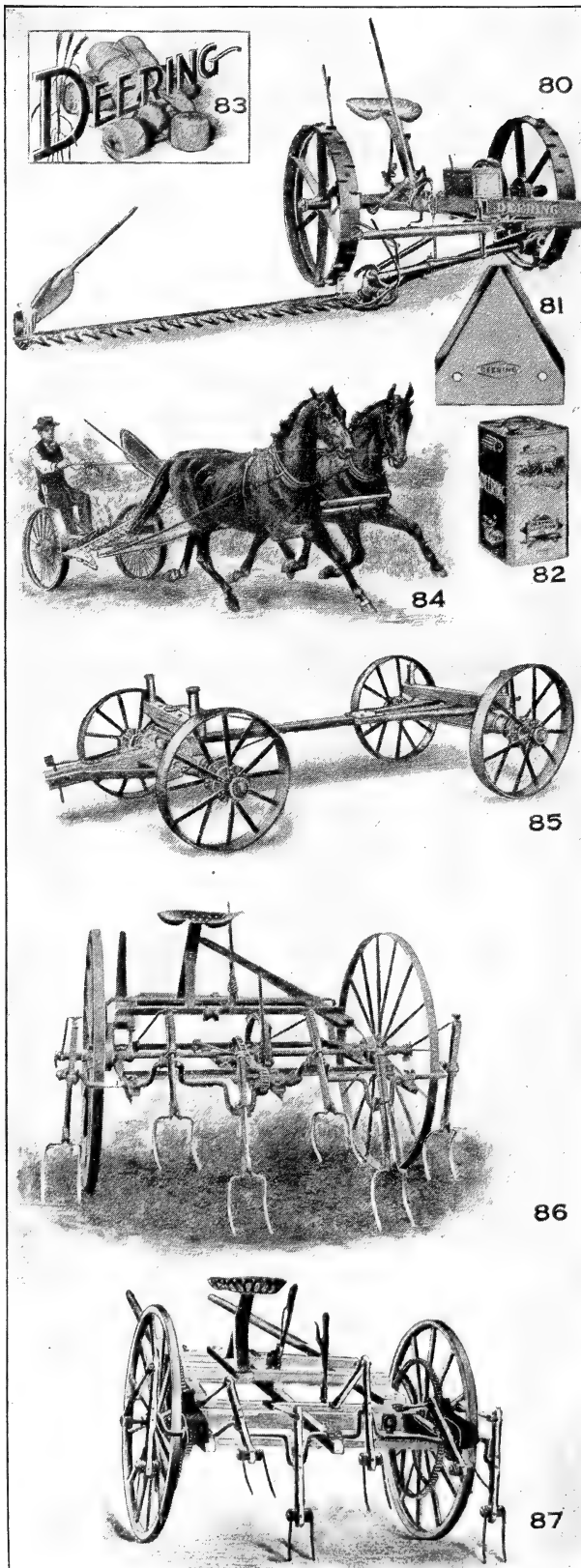

Deering Ideal Mower (80)

This machine runs on ball and roller bearings and is without doubt the lightest and stillest running machine ever made. Combines the three necessary features: good capacity, durability and absence of side draft. Frame is cast in one piece and gears so placed that the entire mechanism is well balanced. The best mower on the market. We will gladly mail catalogue describing it fully. Price, 4 feet (for one horse), \$40; discount for cash, \$2. 4½ feet (two horses), \$45; discount for cash, \$2.25. 5 ft. (two horses), \$45; discount for cash, \$2.25. 6 feet (two horses), \$49; discount for cash, \$2.45.

Mowing Machine Sections (81)

We are able to offer this year mowing machine sections put up in the latest improved styles, that is each box will contain 25 sections with 50 rivets, all that is necessary to rivet to the knife bar. All the sections are fully warranted and we have all sizes to fit the Deering, Buckeye, Champion, Wood, McCormick or Osborne, machines. We think the trade will fully appreciate this new departure in having all the sections come complete with the rivets rather than make two separate purchases, and we are able to sell these sections at a price less than the common sections which we have sold heretofore. Give size when ordering or send old one for pattern. Price, \$1 per box of 25 sections, which includes rivets.

Deering Machine Oil (82)

Made specially for mowing machines. Price, 2-quart can, 40 cts.; 4-qt. can, 75 cts.

Deering Binder Twine (83)

Put up in 5-lb. balls. Price, 15 cts. per lb; 5-lb. balls, 65 cts.; 100 lbs., \$12.

Adriance Mower No. 8 Gear Drive (84)

The simplest, best proportioned and most convenient, as well as the lightest in draft. Price, 4 ft. (one-horse), \$40; discount for cash, \$2. 4½ ft. (two-horse), \$45; discount for cash, \$2.25. 5 ft. (two-horse), \$45; discount for cash, \$2.25.

We are transfer agents for Adriance, Platt Co., and have in stock a full line of extras. Send us your orders for repairs.

Farm Wagons with Metal Wheels (85)

These wagons are built throughout of well-selected hardwood, durable and strong. The axle is 4 x 5 inches, and fitted with cast skeins. The bolsters are furnished with hollow iron stakes, as shown in cut. The reach is 9 feet, 5 inches long, and is adjustable. The wheels, which are the life of any wagon, are made of steel throughout, with the exception of the box, which is cast-iron, and is the most durable wheel made, size 28-inch front, 32-inch rear, and 4-inch tire. There is no body furnished. One of these wagons should be on every farm. They make the best ensilage wagons possible. Price, \$40. Discount for cash, \$2.

The Monarch Steel Hay Tedder (86)

As shown, is the latest thing out for a Chain-Driven Tedder. It is made of first-class steel by skilled workmen. The wheels are extra heavy channel tire with staggered steel spokes. The frame is made of continuous steel angle bars in one solid piece, no spliced corners, no bolts or rivets to get loose. It has great strength at all points. The crank shaft is made of the very best tool steel with turned bearings, and broad journal boxes. The fork arms are mad of boiler tube, and relief coil crucible steel spring is provided for each tooth. It has double seat support and separate levers for throwing in and out of gear, and for raising and lowering the teeth, both within easy reach of the driver. Has six forks and combined pole and shafts to be used with one or two horses. Price, \$32. Discount for cash, \$2.

Bay State Wood Frame Hay Tedder (87)

This is the neatest and most substantially built wood frame hay tedder on the market. It has a solid steel axle and on stony ground we recommend this to any oth r tedder as we believe a wood frame and wood wheels, if properly housed, will last longer than steel. The fork arms are made of the best hard wood. It has two levers, one throwing in and out of gear and one for raising and lowering the forks for uneven ground. It has combined pole and shafts so it can be used for either one or two horses. It is the best wood-frame hay tedder on the market, made in one size only, six forks. Price, \$30. Discount for cash, \$2.

Deering Steel Frame Rake (88)

This rake is made to supply the demand for an all-steel rake. We believe this is the best of the entire lot. It is a horse dump rake. Strength and simplicity are two features in its construction. Price, \$22. Discount for cash, \$1.

Champion Hay Rake (89)

This rake will rake green hay and aftermath better than any other rake. It has the sled runner tooth, is a self-dumping rake, and is easily operated. There are several imitations on the market. Be sure and get the **genuine**. List price, \$20. Discount for cash, \$1.

Yankee Hay Rake (90)

This is the old reliable Yankee, which needs no introduction. It is a very easy rake to operate, each tooth being independent; it will pass over large stones without breaking the teeth. It is so easy to operate that a child can handle it. List price, \$21. Discount for cash, \$1.

Deering Knife Grinder (91)

It is poor economy to operate a mower with a dull knife, for it racks the machine and worries the horses. The Deering grinder is so arranged that the emery wheel sharpens two mower sections at once and preserves the correct bevel. For grinding out nicks the degree of pressure may be regulated by a simple adjustment which enables the operator to control the action of the wheel and the pressure. The knife is firmly held in place by clamps and may be easily moved from section to section. If desired, an adjustment may be made which will enable the operator, by a rocking motion of the hand, to grind the knife the entire length without clamping it in place. This grinder may also be used as a tool grinder by substituting other stones. Clamps to the wheel; grinds any make of knife. Price, \$4.

Wilcox-King Tubular Steel Frame Grindstone (92)

WITH TWO FOOT TREADLES AND SEAT

Adjustable seat, 4 to 5 inches vertically. Stone movable forward and back on frame. Frame being slightly flexible, it adjusts itself to uneven floor or surfaces. Rigid and easily set up. Bi-treadle, with power properly applied. Hinged connection with ball bearings on crank. Ball-bearings in journals. Frame is narrow at top, making it convenient to apply power, and spread at base, giving greater rigidity. Crated complete, with face of stone protected. Price, No. 3, 60 lbs., \$5; No. 1, 100 lbs., \$5.50. Discount for cash, 50 cts.

The Hecla Oak Frame Grindstone (93)

This stone we have made for us, and it is as good a stone as money will buy. It is furnished with best Nova Scotia stone, the frame is very strong and made of oak; has both crank and foot-treadle, with trough and protector.

| Size | Price | Net | Size | Price | Net |
|--------|--------|--------|--------|---------|--------|
| 22 in. | \$8 50 | \$7 00 | 28 in. | \$10 00 | \$8 25 |
| 24 in. | 9 00 | 7 40 | 30 in. | 10 50 | 8 75 |
| 26 in. | 9 50 | 7 75 | | | |

Wilcox Mounted Grindstones (94)

This is the best low-priced grindstone on the market. The stone is best Berea Grit (Ohio), the legs are iron, which will not rot if left out during haying; the wood side-pieces are painted bright vermilion. Runs on ball-bearings, and every stone warranted to run true. No. 1 stone weighs about 100 lbs., \$5; No. 2 stone weighs about 80 lbs., \$4.50; No. 3 stone weighs about 60 lbs., \$4. Discount for cash, 50 cts.

Hager Tool Rack (95)

Designed for store or stable. Made in three styles for shovels, hoes or forks. Combination racks for stores can be used for all. Price, 50 cts. each, \$5 per doz.

When we sell three or more tools at one time we can make a lower price than that printed, but tools sold at this special price must all be taken at one time.

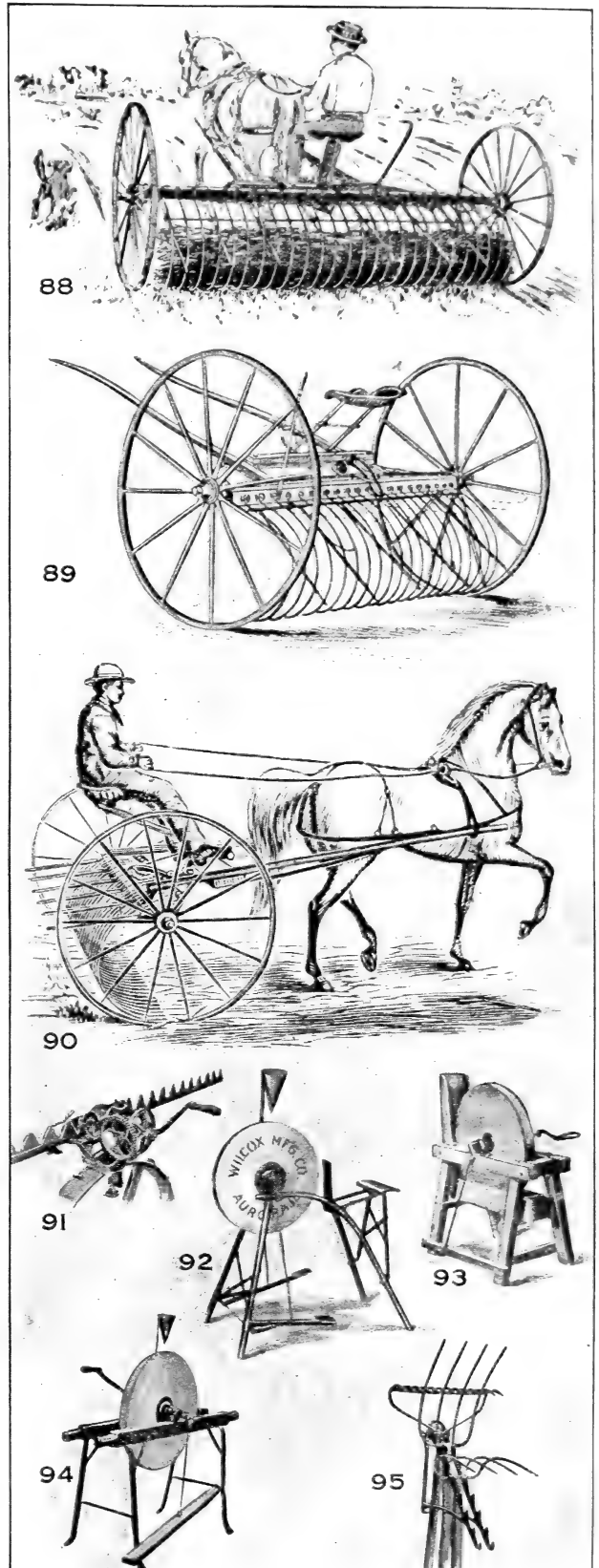

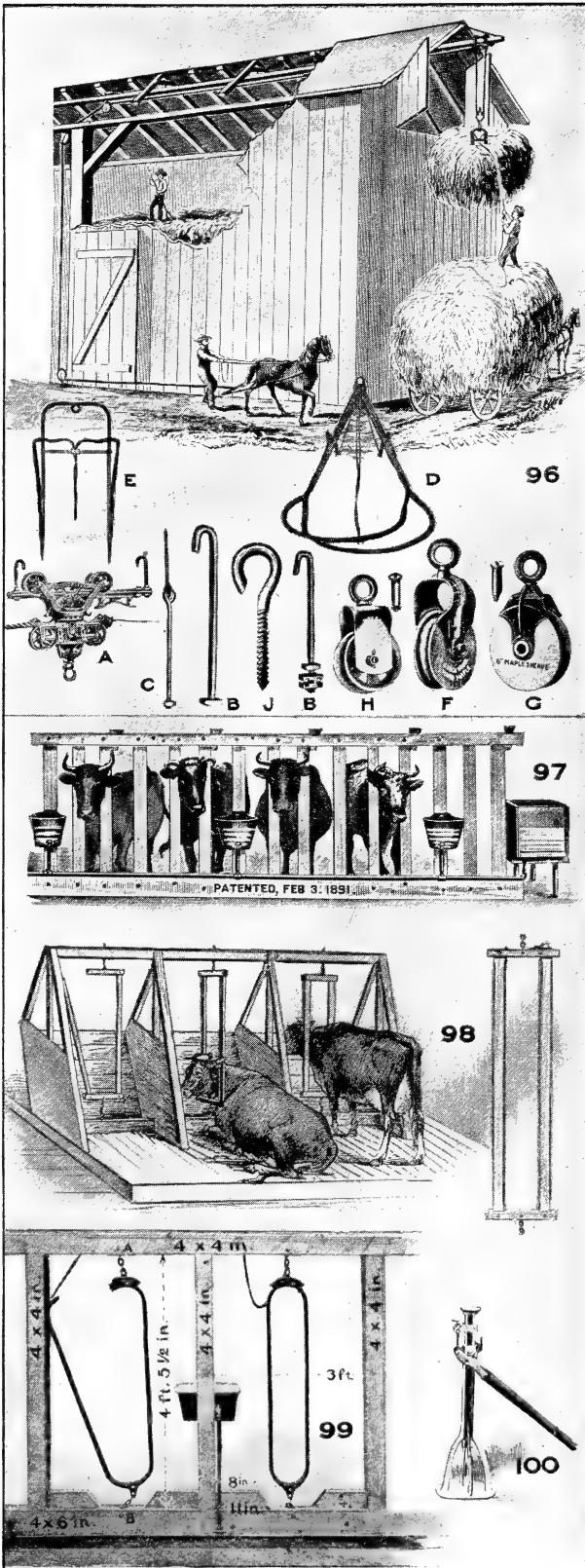

Reversible Steel Track Hay Carriers (96)

NO BARN IS COMPLETE WITHOUT ONE OF THESE RIGS

Our carriers for rod, wood or steel track are the most durable and easiest rigs to operate of any on the market. It is in all respects most practical device ever invented. Any one with a hammer and wrench can rig his barn as well as an expert carpenter. We furnish everything necessary for rigging any style of barn. If you will send us the length and height of your barn and style of ridge pole, will name you price for complete job.

| | | |
|--------------------------------|-----------|--------|
| Reversible Carrier (A) | Each | \$5 00 |
| One-way Carrier | | 5 00 |
| Wood Track Carrier | | 5 00 |
| Steel Track | per ft., | 14 |
| Steel Hanger Hooks (B) | per doz., | 1 00 |
| Malleable Iron Rafter Brackets | per doz., | 50 |
| Jointed Hanger Hooks (C) | per doz., | 1 25 |
| Four-tine Grapple Forks (D) | | 4 50 |
| Six-tine Grapple Forks | | 5 50 |
| Double Harpoon Forks (E) | | 1 25 |
| Knot-passing Pulleys (F) | | 25 |
| Common Pulleys (G) | | 20 |
| Steel Frame Pulleys (H) | | 25 |
| Rope Hitch | | 25 |
| Floor Hooks (J) | | 10 |
| Steel Grapple | | 50 |

As an estimate for the cost of rigging a barn, to those who are not familiar with this work, we give below the cost for the complete outfit for a 50-foot barn with swivel carrier to run both ways, for a barn arranged to draw up in the center. If it is intended to draw up at the end of the barn, a saving of 50 cents can be made on the carrier as a one-way carrier will answer. The following outfit includes everything complete, ready to put up. The work can be done by any man with a hammer and a wrench.

The cost of Outfit complete for 50-foot barn:

| | |
|-----------------------------------|--------|
| Swivel Carrier | \$5 00 |
| 48-ft. Steel Track | 6 70 |
| 2 doz. Jointed Hanger Hooks | 2 50 |
| 5 Pulleys | 1 00 |
| Double Harpoon Fork | 1 25 |
| 5 Floor Hooks | 50 |
| Rope Hitch | 25 |
| 24 lbs. 3/4-in. Best Manilla Rope | 3 36 |
| 50 feet 3/8-in. Trip Rope | 25 |

\$20 81

From this price we allow a discount of 5% for cash with the order. If Four-tine Grapple Fork is wanted in place of the Harpoon, add \$3.25. For each additional 6 feet in length of barn add \$1.50.

Buckley's Patent Watering Device for Watering Stock in Stables (97)

WATER IN THE STABLE IS A NECESSITY

It has come to be regarded as a matter of necessity for the proper caring of stock, while in the stable, that they should have constant access to the water of suitable temperature. The Buckley process shown is the most practical method of having it. Price, plain, \$1 each, \$11 per doz.; with valve, \$1.25 each, \$14 per doz.

Warriner's Patent Chain Cattle Stanchions (98)

These fasteners are in use in a large number of stables and give universal satisfaction. The cut shows the device; a short chain secures the fastener to the top beam so that it suspends 1 1/2 inches clear of the bottom sill. It is also fastened to the bottom sill by a chain to allow it a free and easy motion and rotation, giving the cattle freedom, yet be securely fastened. It keeps them clean and gives liberty of action. Price, \$1.25 each; in dozen lots, \$1.15 each.

The Foster Steel Stanchion (99)

A FEW SPECIAL FEATURES OF FOSTER STEEL STANCHIONS

Side bars of best U-Bar Steel, castings of malleable iron. The top lock operates easily, but when closed it is impossible for cattle to open; the top lock is protected by a strong housing with flanging sides which guide side bar so it cannot fail to close in proper place, also keeps hay and straw from getting into the lock; the top and bottom chains allow cattle to turn head, and lie down and get up with perfect comfort; the stay chain is also a special convenience, holding the side bar in readiness for closing. For appearance, workmanship, durability and ease of operation these stanchions are unmatched. Price, all steel, \$1.75 each; price, all steel, wood lined, \$2 each; price, all steel, galvanized, \$3; price, all steel galvanized wood lined, \$3.25.

Eureka Wagon Jack (100)

The best jack for light wagons and carriages made. Price, \$1.25.

Revolving Harness Punch (101)

Four-tube, 50 cts.; 5-tube, 60 cts.

Harness Snap (not shown)

3 to 8 cts. each, according to size.

Hitch Weight (not shown)

15 to 25 lbs., best smooth castings, 5 cts. per lb.

Feed Bags (102)

Price, 40 cts., 60 cts., 70 cts., 80 cts. and 90 cts., according to size.

Cast Iron Feed Box (103)

Price, \$1.25.

Corner Rack (104)

Price, cast-iron, \$1.25; wrought iron, \$1.75. Wrought is much the best.

J. I. C. Stable Pail (105)

The best stable pail on the market. Made of best oak, with strap running down the side, and heavy iron bail. Price, 50 cts.

Electric Hoop Barn Pails, cedar, painted.....\$0 40

Electric Hoop Barn Pails, pine, painted..... 35

Electric Hoop House Pails, natural color..... 30

Galvanized Iron Pails, 1-qt., 25 cts.; 12-qt., 30 cts.; 14-qt., 35 cts.

Galvanized Iron Pails, heavy, 12-qt., 45 cts.; 14-qt., 50 cts.

Common Sense Calf Feeder (not shown)

The only feeder adopted by experiment stations. Easiest to operate and clean. No valves to get clogged or foul. Prevents scours. Weans perfectly. Calves take to it like a baby to the bottle. Nipples are reinforced without seams. Price, \$2.50.

Small's Calf Feeder (106)

The original calf feeder. Price, \$2.50.

The Hercules Farm Scales (not shown)

Every farm should have one of these scales either hung in the barn floor or conveniently located outside where all kinds of farm produce can be weighed. Price, with triple beam, 5-ton, \$85.

The Rich Lever Cutter (107)

The best lever cutter made. Knife always up to its place. Price, No. A, \$4.25; No. B, \$4.50; No. C, \$5.

Cattle and Horse Salt Feeders (108)

This method of feeding pure salt to stock has been adopted in the largest stables and grows in favor daily. Salt brick, 20 cts. each, \$2 per doz. Salt brick holder, 25 cts.

No. 7 Banner Root Cutter for Poultry Keepers (109)

Cuts all kinds of roots, beets, carrots, turnips, potatoes, apples, etc., leaving them as fine as shavings. Price, \$5.

The Banner Root and Vegetable Cutter (110)

The "Banner" root cutter contains features found in no other machine. It has a self-feeder; separates the dirt from the cut feed and leaves the cut food in such condition that the stock cannot choke. Price, No. 20, hand power, capacity 30 to 50 bushels an hour, \$11. Discount for cash, \$1.

Cast-Iron Hand Corn Sheller (111)

For convenience and general utility this little corn-sheller will be found one of the handiest tools imaginable. Price, \$1.50. Discount for cash, 25 cts.

The Kelly Grist Mill (112)

The best iron mill made, because it is provided with a double set of grinders or burrs, for which reason it is called the "Duplex." It is the only mill manufactured which has double or duplex grinders. It can do as much work as any other mill of double its size. It will grind any kind of grain, or corn and cob equally well, and will produce meal of any desired quality, coarse, or medium or fine. Price, No. 1, \$35; No. 2, \$45; No. 3, \$50; No. 4, \$65.

Lion Corn Sheller (113)

Made with a heavy balance wheel, steel shafts, adjustable iron hopper, with steel springs. Solid side bearings, which hold the shafts firmly in position. Price, \$12. Discount for cash, \$2.

Wisconsin Valley Corn Sheller (114)

Price, \$7.50.

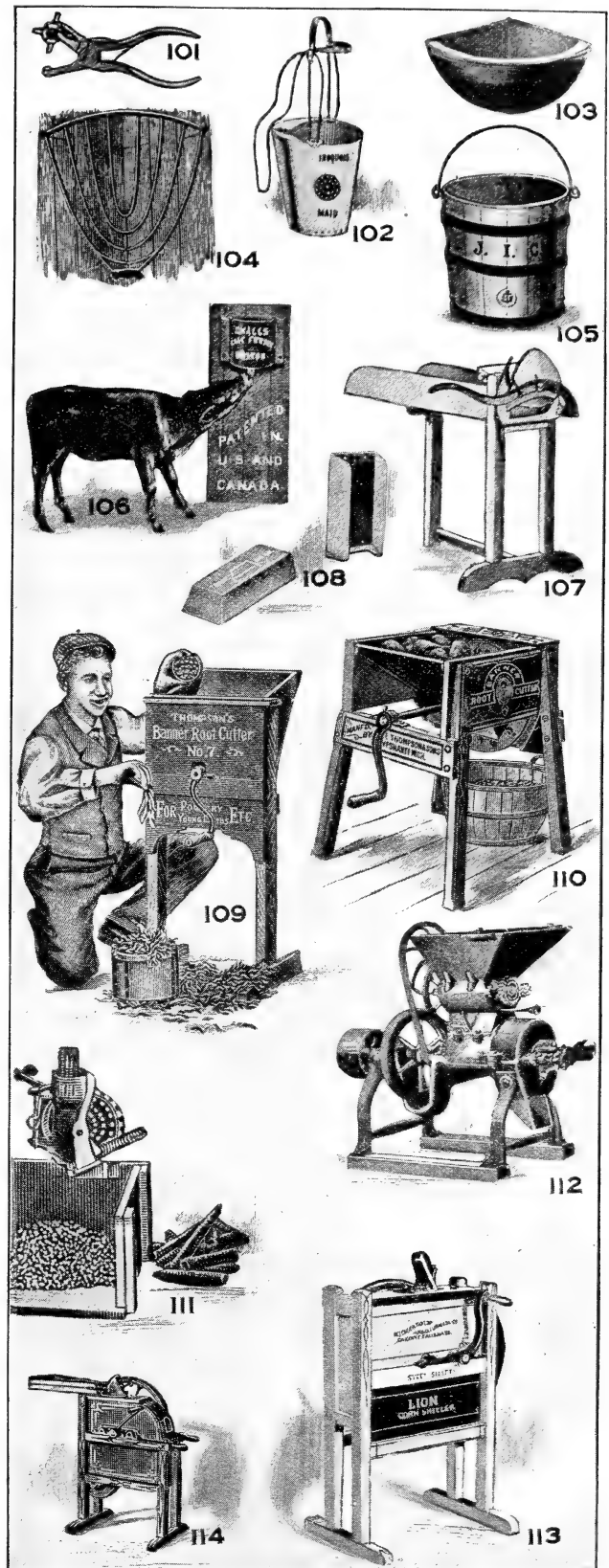

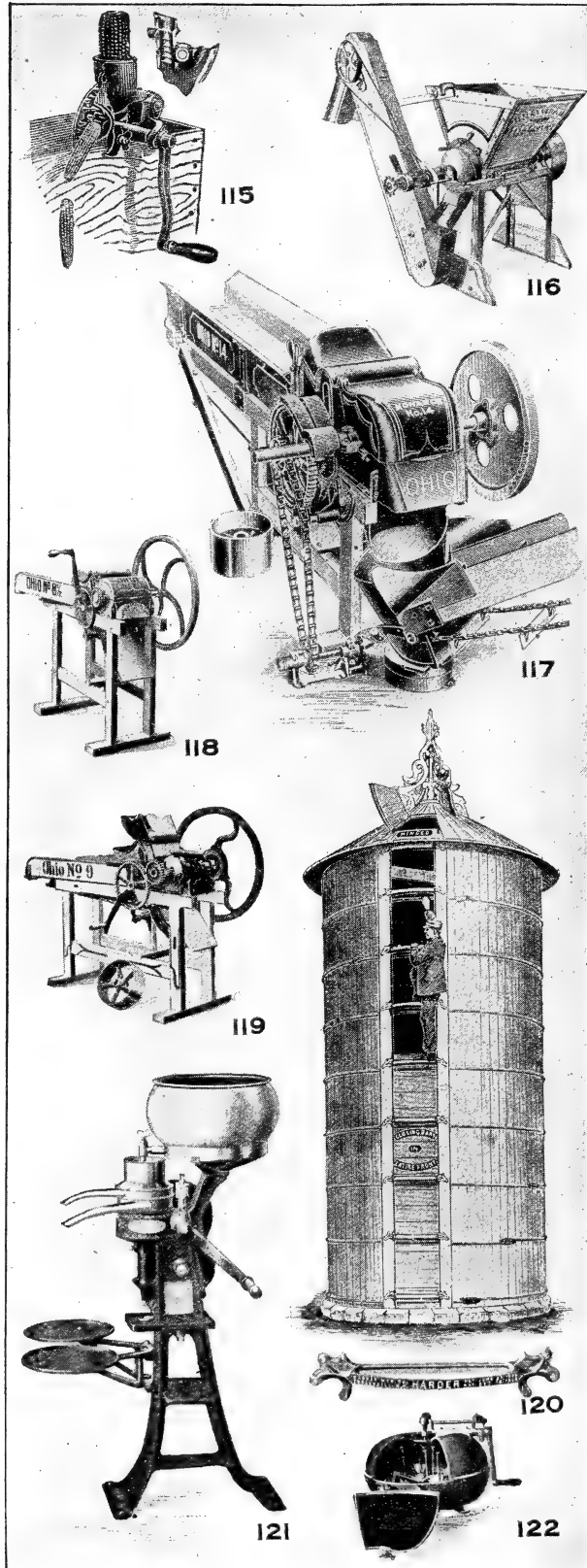

The Red Chief Corn Sheller (115)

Guaranteed to do as good work as any sheller on the market. Clamps to barrel or box; adjusts itself to any size of ear; plain, \$2; with attachment for popcorn, 25 cts. extra. Discount for cash, 25 cts.

International Feed Grinder (116)

For grinding all sorts of feed for stock, such as corn on the cob, oats, barley, Kafir corn, etc. Can be driven with two to eight horse-power. Capacity depends upon power used. With sacking elevator, the feed can be placed in sacks as ground. Price, without elevator, \$30; grinder and elevator complete, \$42.

"Ohio" Monarch Self-Feed Ensilage Cutter (117)
WITH NEW METAL BUCKET SWIVEL CARRIER AND TRAVELING FEED TABLES.

(Complete catalogue mailed free)

| No. | Length of Cut inches | Weight lbs. | 4 knives, no shredder blades | 4 shredder blades, no knives |
|---|-------------------------|----------------|------------------------------------|------------------------------------|
| 12 | 2, 3, 4 and 1 | 1000 | \$95 00 | \$98 00 |
| 14 | 2, 3, 4 and 1 | 1050 | 120 00 | 124 00 |
| 17 | 2, 3, 4 and 1 | 1100 | 155 00 | 160 00 |
| 19 | 2, 3, 4 and 1 | 1150 | 200 00 | 205 00 |
| 22 | 2, 3, 4 and 1 | 1200 | 250 00 | 256 00 |
| 12-ft. Swivel Carrier for Nos. 12, 14, and 17 (315 lbs.)..... \$45 00 | | | | |
| 12-ft. Swivel Carrier for Nos. 19 and 22 (480 lbs.)..... 55 00 | | | | |
| Carrier over 12 ft. for Nos. 12, 14, and 17, per ft. (10 lbs.)..... 1 70 | | | | |
| Carrier over 12 ft. for Nos. 19 and 22, per ft. (14 lbs.)..... 2 25 | | | | |
| Wood Cover with hooks and eyes to fasten, per ft., for Nos. 12, 14, and 17..... 25 | | | | |
| Wood Cover with hooks and eyes to fasten, per ft., for Nos. 19 and 22..... 35 | | | | |
| Extra Gears to cut 4 inches long, with two knives..... 5 50 | | | | |
| Cutting Knives, each, for No. 12, \$1.75; No. 14, \$2; No. 17, \$2.50; No. 19, \$2.75; No. 22, \$3. | | | | |

Ask for complete catalogue.

Ohio Hand-Power Cutter Nos. 8½ and 10½ (118)

THE BEST HAND CUTTER MADE.

| No. | Knives | Knives | Length of cut | Price |
|-----|--------|--------|----------------|---------|
| 8½ | 8½ | 2 | 1, 2, 3, 4 in. | \$20 00 |
| 10½ | 10½ | 2 | 1, 2, 3, 4 in. | 25 00 |

Ohio Hand or Power Cutter No. 9 (119)

Price, No. 9, with safety fly-wheel and pulley, two knives, \$35. No. 9 with safety fly-wheel and pulley, four knives, \$40. When furnished with extended knife shaft to place fly-wheel or pulley on either side, extra, \$2.

The Harder Silo (120)

The American dairyman is too well informed to longer doubt that the profit of his business is dependent largely upon the contents of a silo, for he recognizes the fact that in order to make good he must use the returns from his farm.

The Harder silo stands in a class by itself and is the only one recommended by state and dairy authorities the country over. The rigid, strong door frame not only adds to the stability of the silo, but affords absolutely tight doors, which is necessary for all silage, and a continuous ladder. This latter feature is a valuable addition to the Harder Silo and is not used in connection with any other. It is safe, strong, rigid and affords ample room for a sure footing. The mill work and general construction of all these silos is perfect. Every stave, no matter whether for an 8- or 25-foot silo, is built for that particular silo and has just the correct bevel with a heavy half-inch tongue and groove. As every piece is marked, there is no trouble whatever in putting up one of these silos.

Send for complete price-list.

Improved De Laval Cream Separators (121)

THE STANDARD SEPARATOR. A MONEY-MAKER FOR ANY FARMER.

De Laval Cream Separators are guaranteed to be as represented and to fulfill all the claims made for them, being sold subject to the guarantee of their unqualified superiority in every material feature of separator practicability, inclusive of the production of a greater value of cream and of a greater quantity of butter of better quality than is possible through the use of any other separator or creaming system.

| | |
|---|---------|
| Improved No. 4, actual capacity, 135 lbs. per hour, no stool..... | \$40 00 |
| With stool..... | 45 00 |
| Improved No. 6, actual capacity, 225 lbs. per hour, no stool..... | 50 00 |
| With stool..... | 55 00 |
| Improved No. 10, actual capacity, 335 lbs. per hour..... | 65 00 |
| Improved No. 12, actual capacity, 450 lbs. per hour..... | 75 00 |
| Improved No. 15, actual capacity, 675 lbs. per hour..... | 90 00 |
| Improved No. 17, actual capacity, 900 lbs. per hour..... | 110 00 |
| Improved No. 19, steam turbine, actual capacity, 675 lbs. per hour..... | 100 00 |
| Improved No. 20, steam turbine, actual capacity, 900 lbs. per hour..... | 125 00 |

5 per cent discount for cash with order. Send for complete catalog.

20th Century Babcock Hand Milk Tester (122)

Complete with glassware.

| | Price | Discount | | Price | Discount |
|----------------|--------|----------|----------------|---------|----------|
| 6-bottle..... | \$9 00 | \$0 45 | 12-bottle..... | \$14 00 | \$1 00 |
| 8-bottle..... | 10 00 | 50 | 24-bottle..... | 25 00 | 1 25 |
| 10-bottle..... | 12 00 | 75 | | | |

Hero Barrel Churn (123)

This churn is made of the best oak timber, has patent adjusting fastener for cover.

| List Price | | Net | | List Price | | Net | |
|------------------------|--------|--------|------------------------|------------|--------|-----|--|
| No. 0, 6 gallons..... | \$8 00 | \$4 00 | No. 4, 25 gallons..... | \$14 00 | \$7 00 | | |
| No. 1, 10 gallons..... | 9 00 | 4 50 | No. 5, 35 gallons..... | 16 00 | 8 00 | | |
| No. 2, 15 gallons..... | 10 00 | 5 00 | No. 6, 45 gallons..... | 23 00 | 11 50 | | |
| No. 3, 20 gallons..... | 11 00 | 5 50 | No. 7, 60 gallons..... | 26 00 | 13 00 | | |

Stoddard Churn (124)

Made by hand of kiln-dried oak. It will last for years. Discount for cash, 10%.

| List Price | | Net | | List Price | | Net | |
|------------------------|--------|-----|----------------------------|------------|--|-----|--|
| No. 0, 8 gallons..... | \$7 00 | | No. 4, 25 gallons..... | \$12 00 | | | |
| No. 1, 10 gallons..... | 8 00 | | No. 5, 35 gallons..... | 14 00 | | | |
| No. 2, 15 gallons..... | 9 00 | | No. 5 1/2, 45 gallons..... | 22 00 | | | |
| No. 3, 20 gallons..... | 10 00 | | No. 6, 60 gallons..... | 26 00 | | | |

FLAT WIRE BOTTLE-CARRIER. (125.) For milk-peddlers. Price, six 1-qt. bottle-carrier, 75 cts.

WIRE BOTTLE-CARRIER. (126.) Price, six 1-qt. bottle-carrier, 75 cts.; four 1-qt., 2-pt. bottle-carrier, 75 cts.; four 1-qt. bottle-carrier, 60 cts.

Combination Butter Print (127)

Cut represents No. 6 print.

| No. | Cakes | Capacity | Each Cake | Mold | Each cake | Price. |
|--------|--------|------------|-----------|----------------|-------------------|--------|
| 1..... | 3..... | 1 1/2 lbs. | 8 ozs. | 10 x 3 1/2 in. | 3 1/2 x 3 1/2 in. | \$3 50 |
| 2..... | 4..... | 2 lbs. | 8 ozs. | 11 x 3 1/2 in. | 3 1/2 x 2 1/2 in. | 3 75 |
| 3..... | 4..... | 2 lbs. | 4 ozs. | 12 x 3 in. | 3 x 3 in. | 3 75 |
| 4..... | 4..... | 1 lb. | 4 ozs. | 4 1/2 x 5 in. | 2 1/2 x 2 1/2 in. | 3 50 |
| 5..... | 4..... | 1 lb. | 4 ozs. | 10 x 2 1/2 in. | 2 1/2 x 2 1/2 in. | 3 75 |
| 6..... | 8..... | 2 lbs. | 4 ozs. | 10 x 4 1/2 in. | 2 1/2 x 2 1/2 in. | 4 50 |
| 7..... | 6..... | 1 1/2 lbs. | 4 ozs. | 10 x 3 1/2 in. | 3 1/2 x 1 1/2 in. | 4 25 |

BLANCHARD BUTTER MOLD. (128.) Same size as No. 4 Combination. Price, 1/2-lb., 60 cts.; 1-lb., 75 cts.; 2-lbs., \$1.25. Initial engraved, 25c. extra.

THE HEALTH MILK BOTTLE CAPS. (129.) Will fit any standard milk bottle. Convenient. Price, 40 cts. per 1,000; \$1.75 per 5,000; in 10,000 lots, 33 cts. per 1,000. Common round caps, 25 cts. per 1,000, \$1.15 for 5,000.

FLIPPER CAPS. Not creased. 30 cts. per 1,000; \$1.25 for 5,000.

THE R. B. MILK BOTTLE. (130.) Stamped "This bottle to be washed and returned." Price, 2 qts., \$1.50 per doz., \$16 per gross; 1 1/2 qt., \$1.25 per doz., \$13 per gross; 1 qt., 70 cts. per doz., \$7 per gross; 1 pt., 60 cts. per doz., \$6 per gross; 3/4 pt. 50 cts. per doz., \$5 per gross.

DAIRY SCALE. (131.) 30 lbs. by tenths or ounces. Gives weight of milk independent of pail. Price, \$3.

COMMON SENSE MILK PAIL. (132.) Made of extra-heavy tin. The strainer can be removed to clean or repair. Price, \$1.25.

GEM COMBINATION MILK BUCKET, WITH REMOVABLE STRAINER. (133.) Made of the best IX tin, with steel strainer frame. Price, 10 qts., 60 cts. each; 12 qts., 70 cts. each; 14 qts., 80 cts. each.

STERILAC DAIRY PAIL. (134.) Protected by patent rights. The only pail made that will keep milk clean. Price, \$2.50 each.

THE IDEAL MILK COOLER. (135.) Price, No. 2, for 10 to 15 cows, \$6; No. 3, for 25 to 40 cows, \$7. Discount for cash, \$1.

THE GENUINE WYANDOTTE CLEANER. Always bears the trademark Indian with drawn bow and arrow enclosed in a circle. If you want clean milking utensils use Wyandotte Cleaner. Prices: 5-lb. bag, 25 cts., 80-lb. keg, \$3.20, 280-lb. bbl, \$8.40.

Blanchard Churn (136)

| | | | |
|------------------------------|--------|-------------------------------|------------------------|
| No. 3, churns 2 gallons..... | \$6 00 | No. 6, churns 12 gallons..... | \$10 00 |
| No. 4, churns 4 gallons..... | 7 00 | No. 7, churns 16 gallons..... | 12 00 |
| No. 5, churns 8 gallons..... | 8 00 | | Discount for cash, 5%. |

Varnished Cylinder Churns (137)

| List Price | | Discount | | List Price | | Discount | |
|------------|--------|----------|------------|------------|--------|----------|--|
| No. 1..... | \$2 50 | \$0 50 | No. 3..... | \$3 50 | \$0 50 | | |
| No. 2..... | 3 00 | 50 | No. 4..... | 4 00 | 1 00 | | |

Cedar, same as above, 25 cts. extra.

BLANCHARD PRINT BUTTER CARRIER. (138.) Trays are made to fit butter molded in the Blanchard or Combination No. 6 molds. Prices, 16-lb., \$2.10 each; 24-lb., \$2.35; 32-lb., \$2.60; 40-lb., \$2.85. Fitted with ice-box, 75 cts. extra.

BUTTER BOXES. (139.) Holds 5 pounds. Price, per doz., all papered, 90 cts. Round, five-pound boxes at 60 cts. per dozen.

Waters Butter Worker (140)

| Capacity | | Price | | Discount | | Capacity | | Price | | Discount | |
|-------------------------|--------|--------|--------------------------|----------|--------|----------|--|-------|--|----------|--|
| No. 0, 1 to 15 lbs..... | \$7 00 | \$1 00 | No. 3, 5 to 50 lbs..... | \$10 00 | \$1 50 | | | | | | |
| No. 1, 5 to 30 lbs..... | 8 00 | 1 00 | No. 4, 10 to 80 lbs..... | 12 00 | 1 50 | | | | | | |
| No. 2, 5 to 40 lbs..... | 9 00 | 1 25 | | | | | | | | | |

Davis Swing Churn (141)

Extra for tilting frame, \$1. Price-list, complete with folding frame as shown:

| | | | |
|-----------------------------|--------|-----------------------------|------------------------|
| Size No. 1, 4 gallons..... | \$7 00 | Size No. 6, 17 gallons..... | \$18 00 |
| Size No. 2, 5 gallons..... | 8 00 | Size No. 7, 30 gallons..... | 25 00 |
| Size No. 3, 8 gallons..... | 10 00 | Size No. 8, 40 gallons..... | 30 00 |
| Size No. 4, 10 gallons..... | 12 00 | Size No. 9, 50 gallons..... | 35 00 |
| Size No. 5, 13 gallons..... | 15 00 | | Discount for cash, 5%. |

FARMERS' SCALES. (142.) 1/2 oz. to 240 lbs. Price, single beam, \$3.50; double beam, \$4.

FAIRBANKS' DAIRY SCALES. (143.) Net price, \$9.

LACTOMETER (144a), for testing gravity of milk. Price, 65 cts. each.

COMMON DAIRY THERMOMETER (144b), graduated for dairy use. 25c.

FLOATING DAIRY THERMOMETER (144c), with bulb always upright. Price, 50 cts., postpaid.



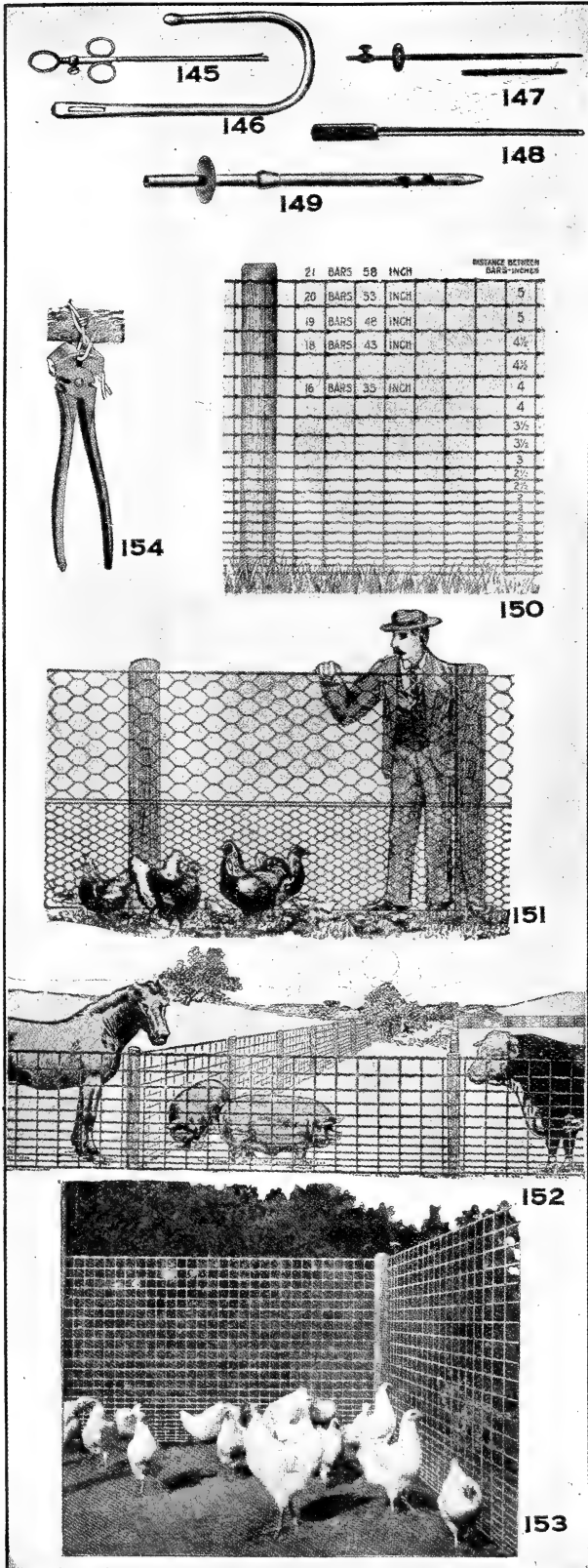

Lead Probe or Sound (145)
For the treatment of stricture and obstructed teats of cows, also for enlarging the opening in cows' teats. Made in three sizes: small, medium and large. Postpaid, 25 cts. each. Directions for using lead probe mailed with each one.

Pilling's Three-Ring Stricture Cutter (146)
Price \$3, postpaid.

Pilling's Plain Teat Slitter (147)
Illustration shows instrument both open for cutting and closed for inserting. Price, plated, \$1.50, postpaid.

Pilling's Improved Instruments for Opening Obstructed Teats (148)

There has been a demand for some simple remedy for this purpose, which we think is now filled by this little instrument, being highly endorsed by some of the best veterinary surgeons of the country for its very successful, and, at the same time, harmless and simple use, so that any person of average intelligence can use it with perfect safety. We send it securely packed in neat box, with full instructions; postpaid, 75 cts.

Milking Tubes for Sore and Obstructed Teats and Hard-Milking Cows (149)

Directions.—The long, rounded end of the tube is inserted in the orifice of the teat, when the milk will flow without the use of the hands. It is best to wet the tube with a drop of milk or water before using. Remove tube when milk ceases to flow. If, in some cases, the obstruction is further up the teat than can be passed by the regular length, you should have a longer tube, and as it can be made any length, this answers for all purposes. German-silver plated, 2½ in., 3 in., 3½ in.; all sizes, 25 cts. each, postpaid.

Parchment Paper (not shown)
For wrapping butter. Cut 8 x 11, 9 x 12, 12 x 12 or in 9 x 12 in. rolls, per lb. 20 cts., per 100 lbs. \$15.

American Poultry and Rabbit Fence (150)
The most durable poultry fence on the market. Just as effective as our other styles and three times as strong. Close at bottom to stop little chicks. Has the hinge joint, and tension curve, amply providing for expansion and contraction and for uneven ground.

| Design | Height | List price per rod | Net cash price per roll of 10 rods. |
|----------|--------|--------------------|-------------------------------------|
| No. 2158 | 58 | \$1.19 | \$4.50 |
| No. 2053 | 53 | 1.13 | 4.25 |
| No. 1948 | 48 | 1.07 | 4.00 |

Galvanized Poultry Netting (151)

| Height | Mesh | No. 19 | No. 20 |
|--------|-------|--------|--------|
| 1 ft. | 2-in. | \$0.80 | \$0.70 |
| 1½ ft. | 2-in. | 1.15 | 1.05 |
| 2 ft. | 2-in. | 1.55 | 1.35 |
| 2½ ft. | 2-in. | 1.90 | 1.70 |
| 3 ft. | 2-in. | 2.30 | 2.00 |
| 4 ft. | 2-in. | 3.05 | 2.70 |
| 5 ft. | 2-in. | 3.85 | 3.40 |
| 6 ft. | 2-in. | 4.60 | 4.05 |
| 1 ft. | 1-in. | 2.00 | 1.65 |
| 1½ ft. | 1-in. | 2.95 | 2.50 |
| 2 ft. | 1-in. | 3.95 | 3.35 |
| 2½ ft. | 1-in. | 4.95 | 4.20 |
| 3 ft. | 1-in. | 5.95 | 5.00 |

American Field and Hog Fences (152)
The strongest and most durable-made fence on the market and should take the place of every rod of barb wire. It makes a far more durable fence than barb wire, and does not injure the stock. It is harmless, and will stop cattle, horses, sheep, dogs and pigs. It makes practically an everlasting fence if properly put up. Shipped in 10- and 20-rod rolls only.

| Per rod | Per roll |
|----------|----------|
| 949 x 12 | \$0.33 |
| 949 x 6 | .41 |
| 845 x 12 | .30 |
| 845 x 6 | .38 |
| 934 x 6 | .38 |
| 635 x 12 | .25 |
| 635 x 6 | .30 |

5-lb. bundle No. 8 brace wire, 25 cts.

Excelsior Poultry Fence (153)
Graduated for little chicks and also for poultry. Made of No. 19 wire and galvanized after weaving, making it very strong.

| Height inches | Number of horizontal wires | Approximate lbs. per 10-rod roll | Price rod net | Price roll net |
|---------------|----------------------------|----------------------------------|---------------|----------------|
| 48 | 19 | 33 | \$0.83 | \$3.25 |
| 60 | 22 | 38 | .96 | 3.60 |
| 72 | 25 | 43 | 1.08 | 4.05 |

The American Fence Tool (154)
The best, and most useful all-round fence tool. It is a hammer, staple- and nail-puller wire-cutter and splicing-tongs combined. The tool is drop-forged from tool-steel, highly and skilfully tempered. We guarantee each tool to be just as represented. Price, \$1.

Mann's New Open-Cylinder Bone Cutters (155)

When it can be had green, cut bone should be fed during the winter months; we carry a stock of best selling sizes. Net cash price list. No discount from these prices.

- No. 5C (with crank handle). Closed cylinder.....\$6 00
- No. 5B (with balance wheel). Closed cylinder..... 8 00
- No. 5BM (with balance wheel and iron stand). Closed cylinder..... 10 40
- No. 7 (with balance wheel)..... 12 00
- No. 9 (Standard bone-cutter, iron stand)..... 18 40
- No. 11 Combination power cutter..... 26 00
- Clover Cutter (with balance wheel)..... 8 00
- Clover Cutter (with balance wheel and iron stand)..... 10 00
- Mortar (perforated cast-iron)..... 3 00
- Swinging Feed Tray (18 in., 27 in., 36 in. long).....\$1, \$1.25 and 1 50

MANN'S CLOVER CUTTER. (156.)

- Clover Cutter (with balance wheel).....\$8 00
- Clover Cutter (with balance wheel and iron stand)..... 10 00

SILVER'S "NEW MODEL" CLOVER CUTTER. (157.) Made only of iron and steel from entirely new patterns. Length over all, 28½ inches. Price, with four 7-inch knives, weight K. D., 60 lbs., \$10; discount for cash, \$1.

HUMPHREY GREEN BONE VEGETABLE CUTTER. (158.) Price, No. 1 (hand power), \$12; No. 2½ (hand and power), \$15. 5 per cent discount for cash.

Sefton Live-Chick Box (159)

This is the latest up-to-date box for shipping little chicks. The box is made of corrugated board and is shipped flat, but it can be easily set up ready for use. The dead air cells protect the little chicks from cold. Made in 3 sizes, 25-, 50- and 100-chick size.

| | Weight | Size | Doz. boxes |
|-----------------|---------|--------------|------------|
| 25 chicks..... | 6½ lbs. | 12 x 6 x 5 | \$1 50 |
| 50 chicks..... | 14 lbs. | 12 x 12 x 5 | 2 00 |
| 100 chicks..... | 22 lbs. | 24 x 12 x 15 | 3 15 |

THE EMPIRE COOP. (160.) Length of sections, 4 feet. Each compartment, 22 x 24 x 26 feet. Price, \$1.35 per foot. We can furnish other sizes for pigeons and bantams.

EMPIRE SHIPPING COOP. (161.) The Empire coop for shipping exhibition birds is without doubt the best one on the market; the lid is locked by simply turning the rod one quarter around and no key is required. These coops can be shipped knocked down if desired. Price, single coop, 12 x 22 x 25, \$5 cts.; trio coop, 22 x 22 x 25, \$1.10. Pen size, 22 x 22 x 25, \$1.25 each.

EYRIE SHIPPING COOP. (162.) This coop is especially adapted for use in shipping fancy fowls. The tops and bottoms are made of wood, the body is made from extra-heavy corrugated paper. Price, No. C, 12 x 22 x 22, each 50 cts., doz., \$4.50. We can furnish other sizes.

Rosco Rubber Roofing (163)

This is the very best quality of Asphalt Rubber Roofing, made especially for us under our own name, and guaranteed to be superior to any similar roofing on the market. Instead of being sold as a high-priced specialty, it is sold as a staple article at a much lower price than others of the same grade. Samples will be sent upon request.

Put up in rolls of 108 and 216 square feet, but no charge is made for the extra 8 or 16 feet. The 108-ft. size is what is known as one "square," or half-roll, or 100 feet when laid. The 216 feet size is a full roll, or 200 square feet when laid. Inside of each roll is packed cement for laying. We guarantee Rosco Rubber Roofing 1-ply for five years; the 2-ply for seven years, and the 3-ply for ten years. For 108 square feet, 1-ply, \$3.25; 2-ply, \$3.25; 3-ply, \$4. Discount: On single rolls, 25 per cent; on five rolls, 25 per cent and 5 per cent; on ten rolls, 25 per cent and 10 per cent. Don't pay list prices when you can get at least one-fourth off.

GALVANIZED WARE FOR THE POULTRY HOUSE is always the cheapest in the end, as it will not break, and stands cold weather. We have all of the reliable brands.

BOSTON DRY FOOD HOPPER. (164.) Made of galvanized iron and it is almost indestructible. The best dry-mash feeder made. Prices, A, \$1; B, \$1.90; C, 90 cts.; D, \$1.

HOUGHTON'S WIRE EGG TURNER. (165.) Made for the use of all poultry breeders, large and small, to hold and turn eggs which are to be used for hatching. See illustration 165. Price, 1008-egg size, \$8.50; 504-egg size, \$5.50; 336-egg size, \$4.25.

E. H. M. FOUNTAIN. (166.) 1-qt., 25 cts.; 2-qt., 30 cts.; 4-qt., 35 cts.; 8-qt., 50 cts.

SANITARY FOUNTAIN. (167.) 1-gal. Galvanized iron, 50 cts.; 2-gal. galvanized iron, 85 cts.

No. 8 LEADER DRINKING FOUNTAIN. (168.) ½-gal. galvanized iron, 35 cts.; 1-gal. galvanized iron, 50 cts.

No. 7 AUNTIE DRINKING FOUNTAIN. (169.) ½-gal. galvanized iron, 35 cts.; 1-gal. galvanized iron, 50 cts.

OUR FAVORITE DRINKING FOUNTAIN. (170.) 1-gal. only, price, 50 cts. (Galvanized iron.)

No. 1 FEEDER. (171.) Galvanized iron. 3-qt., 50 cts.

W. R. FOUNTAIN. (172.) Price, 2-qt., 25 cts.; 4-qt., 35 cts.; 8-qt., 50 cts.

DAVIS' FOOD AND WATER FOUNTAIN. (173.) Can be used for either water, feed, grit, shells or bone. It is the only fountain adapted to use any glass bottle. Price, 25 cts.; with glass bottle, 30 cts.

LATHROP'S CHICK FEED AND WATER DEVICE. (174.) Patented April 8, 1902. Operates grain, water and soft feed. Keeps it clean until all is consumed. Price, 25 cts. each, \$2.50 per doz.

STANDARD FOUNTAIN. (175.) Made of aluminum. We furnish only the bottom, which we send by mail. Fits any Mason jar. Each, 30 cts., post-paid.



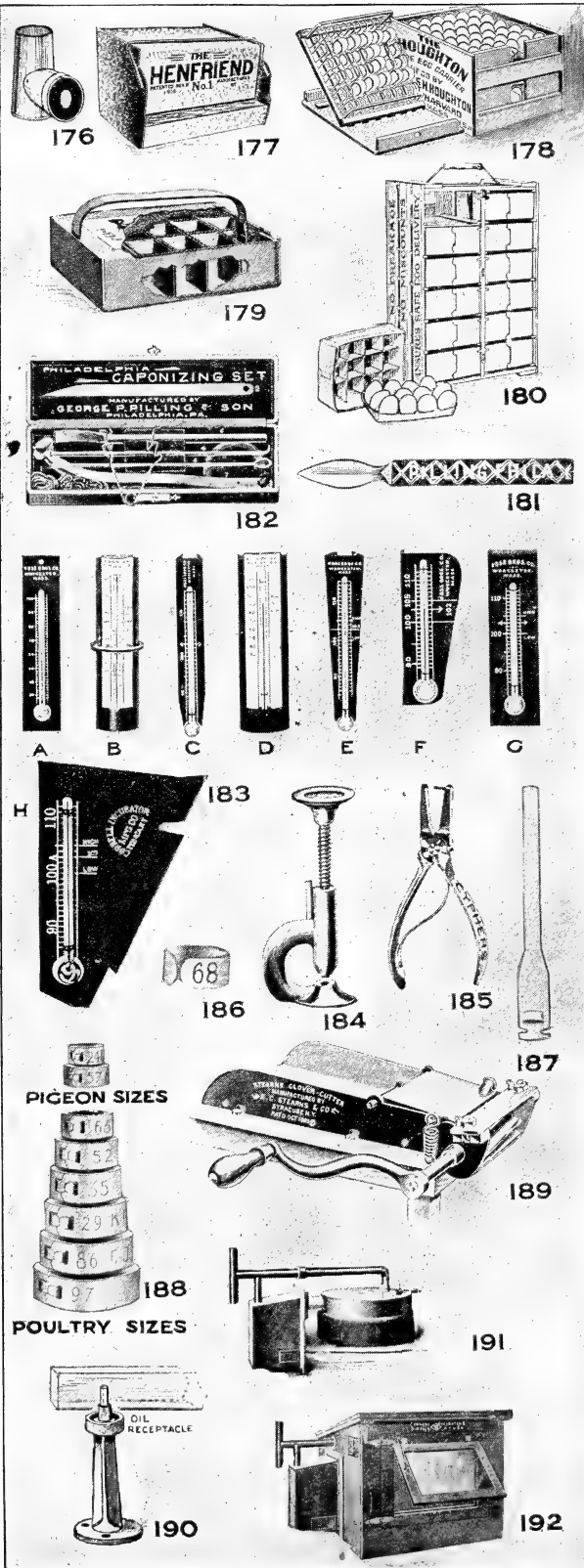

X-Ray Egg-Tester (176)

The most practical egg-tester made, and is equal to any high-priced appliance. Price, 25 cts.; 30 cts., postpaid.

Hen Friend Drinking Fountain (177)

Made of the best quality of galvanized steel. Price, No. 1, 35 cts.; No. 2, 50 cts.; No. 3, 75 cts. each.

Wire Egg Carrier (178)

The latest and best invention for handling eggs.

| Capacity | Each | Capacity | Each |
|----------|--------|----------|--------|
| 6 doz. | \$1 00 | 25 doz. | \$2 00 |
| 9 doz. | 1 25 | 30 doz. | 2 25 |
| 15 doz. | 1 50 | 36 doz. | 2 50 |
| 20 doz. | 1 75 | | |

Erie Egg Box (179)

The best carrier for shipping setting eggs. Price, No. 1, for one setting, \$1.35 per doz. No. 2, for 2 settings, \$2 per doz.

The Farmer's Modern Egg-Crate (180)

Consists of a substantial carrying crate to carry 8, 12, and 18 one-dozen-egg carriers. The carrying crates are very substantially constructed of white wood. The individual carriers are made of strong, tough jute boards with separate compartments for each egg, thus eliminating all chance of breakage. Can be used either as an egg-turner or as a carrier.

| | |
|-----------------|--------|
| 8-doz. carrier | \$1 00 |
| 12-doz. carrier | 1 25 |
| 18-doz. carrier | 2 00 |

French Poultry Killing Knife (181)

Made of finely-tempered instrument steel with nickeled handle; will last a lifetime. Sent postpaid on receipt of 50 cts.

Pilling's Caponizing Tools (182)

Price, complete with instructions, \$2.50. In velvet-lined case as per engraving, \$2.75, postpaid. We send book, "Complete Guide for Caponizing," with every set.

Incubator and Brooder Thermometers (183)

Every one warranted accurate, and will be mailed postpaid at prices named:

| | | | |
|----------------------------|----|----------------------|--------|
| A, Brooder Thermometer | 30 | E, Ertel Incubator | \$0 50 |
| B, Peep-o'-Day Brooder | 40 | F, Cypher Incubator | 60 |
| C, Prairie State Incubator | 50 | G, Regular Incubator | 50 |
| D, Brooder Thermometer | 30 | H, Cornell Incubator | 60 |

Philadelphia Poultry Marker (184)

Price, 25 cts. each, postpaid.

Cyphers' Perfect Marker (185)

Made especially for marking chicks; makes a good clean cut and does not mutilate the web. Price, 50 cts. each.

Open Pigeon Bands (186)

Made from aluminum with rounded edges. We furnish them numbered from 1 to 100. Price, 10 cts. per doz., 65 cts. per 100, postpaid.

Aluminum Leg Bands (187)

Made of one piece; two sizes; will fit any fowl; impossible to lose. In ordering, give breed. Price, 10 cts. per doz., 65 cts. per 100.

Double-Clinch Leg Bands (188)

These superior leg bands provide the only proper means of marking birds. Price, 10 cts. per doz., 65 cts. per 100, postpaid.

Stearns Clover Cutter (189)

Fastens to any table or bench. Price, \$3.

The Coolidge Roost Bracket (190)

This is a simple but effective device for preventing lice from getting on the roost. The cut explains how it is done. Price, 25 cts. each.

Cyphers Style A Outdoor Brooder (192)

Formerly Known as the Storm King

Is recommended for use of poultry raisers who feel that they do not wish to invest in the larger-sized and more costly three-apartment outdoor brooders. The 1911 Style A is equipped with the Cypher Fire-Proof Brooder Heater and Standard Adaptable Hover, and bears the Fire Underwriters "Inspected Brooder" label. It employs top heat exclusively, thus giving the chicks free use of all space underneath the hover. It is self-ventilating and self-regulating.

INSURABLE STANDARD CYPHERS INCUBATORS AND BROODERS (193)

Cyphers Incubator Company is the first to manufacture incubators and brooders that meet the requirements of the associated fire insurance interests, and is the first company to be granted labels by the Fire Underwriters, covering inspected and insurable incubators and brooders built in conformity with the specifications of their expert engineers. Labels have been issued to Cyphers Incubator Company for Incubators and Brooders.

Cyphers Incubators are standard machines, and the fire-proof lamp used on both the incubators and brooders enables any one to operate one of these machines without additional expense for insurance.

The electric machines are also very handy for those who are so situated that they have electricity, as it requires only a 16-candle-power current to run them. They are absolutely safe and reliable, and require no attention except turning the eggs once a day.

| | Eggs | Price |
|--|------|---------|
| No. 0 Incubator, without nursery drawers | 70 | \$15 00 |
| No. 1 Incubator, without nursery drawers | 144 | 22 00 |
| No. 2 Incubator, with nursery drawers | 244 | 32 00 |
| No. 3 incubator, with nursery drawers | 390 | 38 00 |
| Farm-Economy Incubator | 110 | 12 00 |
| No. 1 Electrobator | 60 | 16 00 |
| No. 2 Electrobator | 120 | 20 00 |
| Electric Hover, without inclosure | | 10 00 |
| Electric Hover, with inclosure | | 12 50 |
| Inclosure for Electric Hover | | 2 50 |
| Electrohen | 25 | 25 00 |
| Electric Toy Incubator and Brooder combined | 25 | 8 50 |
| No. 0 Electroplane | | 8 00 |
| No. 1 Electroplane | | 10 00 |
| No. 2 Electroplane | | 18 00 |
| Electric Brooder, complete | | 14 00 |
| Adaptal Hover (see illustration 191) | | 8 50 |
| Style A Outdoor Brooder (see illustration 192) | | 12 50 |
| Style B Outdoor Brooder (see illustration 194) | | 16 50 |
| Style C Outdoor Brooder | | 18 50 |
| Style D Outdoor Brooder | | 11 50 |

Complete catalogue, giving description and valuable information in regard to this complete line, will be mailed free on application.

CORNELL INCUBATORS AND PEEP-O'-DAY BROODERS

Cornell Incubators (195)

It is impossible for us, in the small space at our disposal, to give anything like a complete description of this line, but will mail free a complete catalogue describing them fully. The table top is one of the most important improvements on any incubator made. The regulator is inside, out of danger, and leaves the top free to use in turning and testing eggs. The door on the Cornell is entirely original and is found in no other make. It is practically two doors in one without that inconvenience; both are opened as one door. Each section is insulated with felt, making it a positive fit and practically air-tight. The lamp solves the moisture problem beyond a doubt. Get the catalogue.

| | |
|---------------------|---------|
| No. 0, 60-egg size | \$16 00 |
| No. 1, 128-egg size | 20 00 |
| No. 2, 232-egg size | 29 00 |
| No. 3, 364-egg size | 37 00 |

Peep-o'-Day Brooder No. 2 (196)

This is the most popular brooder on the market and is our largest seller. Dimensions are as follows: Five feet long, 3 ft. wide and 2 ft. high. Hover, 2 ft. in diameter, with a special brooder thermometer and the latest improved lamp, which will burn from thirty to forty hours. Weight, 120 lbs., Price, \$12.

Peep-o'-Day Brooder No. 3 (Not shown)

Similar to No. 2, but smaller. Dimensions, 4 feet long, 26 inches wide; weight, 75 lbs. Price, \$8.50.

Peep-o'-Day Brooder and Colony House No. 8 (197)

This brooder is built throughout of selected tongued and grooved 1-inch pine, is 6 feet long and 3 feet deep in the clear. It is the most roomy and airy brooder constructed. Price, \$20.

The Oxford Colony House (198)

These houses we have made for us by a reliable firm nearby, and, can make shipment in about ten days from date of order. We can furnish any other size wanted at proportionate prices. You can buy one of these portable houses as cheap as you can build, and if you move you can take it with you.

| Feet | Stock | Floor | 3 nests | 6 nests | |
|------------|-----------|---------|---------|---------|--------|
| 5 x 7 | 9-16 in. | \$20 00 | \$3 00 | \$0 50 | \$1 00 |
| 5 to 7 ft. | 13-16 in. | 25 00 | 3 00 | 50 | 1 00 |
| 6 x 8 | 9-16 in. | 22 00 | 4 00 | 50 | 1 00 |
| 6 x 8 | 13-16 in. | 28 00 | 4 00 | 50 | 1 00 |
| 8 x 12 | 9-16 in. | 29 00 | 5 00 | 50 | 1 00 |
| 8 x 12 | 13-16 in. | 38 00 | 7 00 | 50 | 1 00 |

50 cts. discount for cash with order.

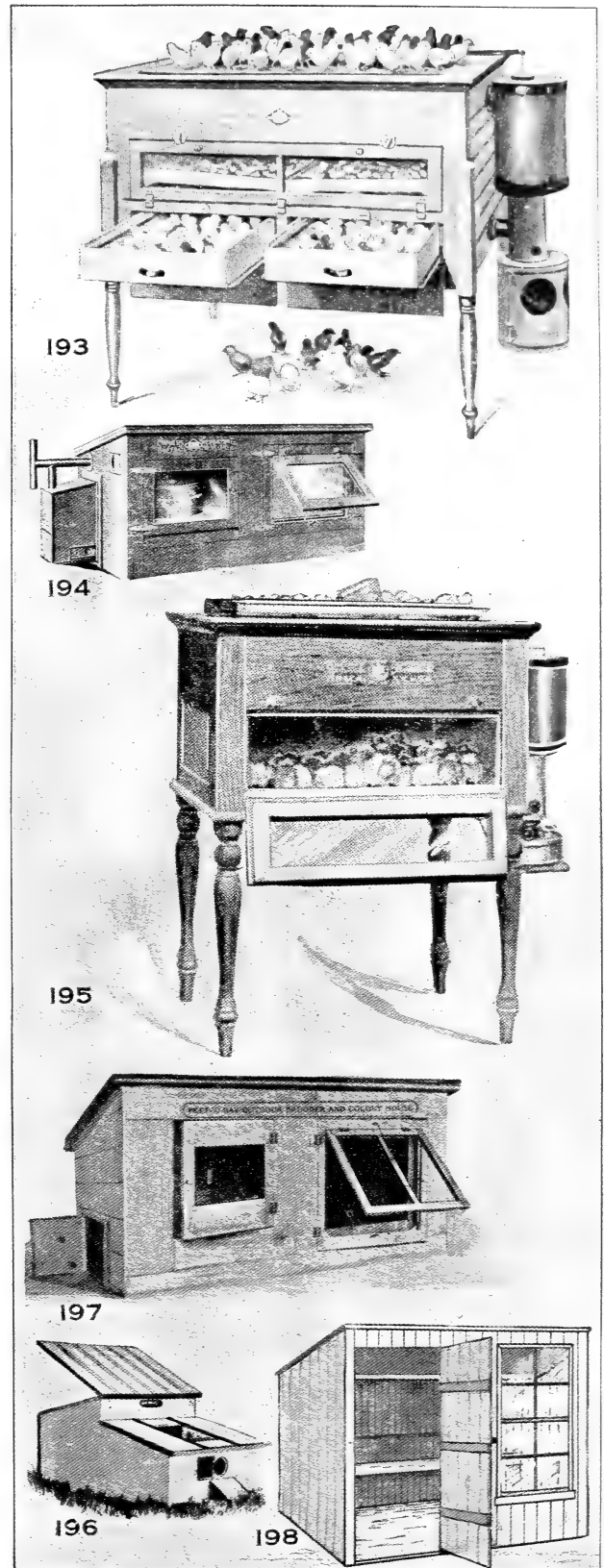

SEND FOR SPECIAL BEE SUPPLY CATALOG

WYANDOTTE EVER READY BRAND

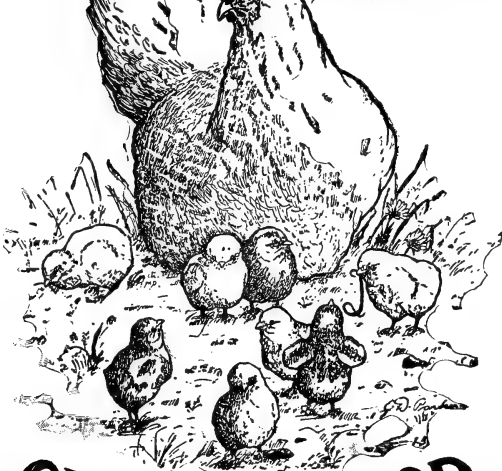

CHICKEN FOOD

TRADE MARK REGISTERED.

Poultry Foods and Condition Powders

PRATT'S POULTRY AND CATTLE FOOD. We have sold Pratt's Foods for several years and always found them reliable and can recommend them with confidence to our customers. To get the best results they should be fed regularly. They keep the poultry in good condition, and are indispensable in the stable. They keep cows and horses in the pink of condition. **Poultry Food**, small size, 25 cts., large size, 60 cts.; 12-lb. bag, \$1.25; 25-lb. bag, \$2.50. **Horse, Cattle and Hog Food**, 12-lb. bag, 75 cts.; 25-lb. bag, \$1.50.



WYANDOTTE CHICK FOOD. Our Wyandotte Chick Food is scientifically prepared to meet the chick requirement, and it is not thrown together, as many of the cheap foods on the market are, but it is made of the choicest materials that money will buy. It is not loaded down with grit and oyster shells, so as to sell at a low price. Quality is first in our minds. It is the safest feed to give young chickens. Feeding it regularly will prevent all the ailments to which they are liable and, having a good start for the first few months, they will mature much earlier and in better condition for laying or the market than they would in the ordinary way. We do not use any waste material. We are not in the milling business, and, therefore, have no refuse to dispose of. We buy only the choicest cereals and imported bird millets that we can get; to these we add the very best oatmeal and fine cracked charcoal, all of which, combined, makes a food just fitted to produce strong and vigorous chickens.

Directions.—Little chickens, like old hens, need exercise, and there is no danger of over-working them. Throw some of our chick-food in the litter on the floor and let them scratch for it, but do not throw it on the ground where it will get damp, for in that way it will become sour. Feed a little at a time and keep them hungry. You will find that when they are fed in this manner, they will grow much faster than where the feed is before them so they can get it without any exercise. After they are four to six weeks old, feed can be kept before them all the time. 25-lb. bags, 75 cts.; 50-lb. bags, \$1.35; 100-lb. bags, \$2.50; 500-lb. bags, \$11.25.

WYANDOTTE CHICK GROWER. This is designed to follow Wyandotte Food. It contains practically the same properties as Wyandotte, only larger, and is just the food to feed chicks after they have reached the age where they do not need a little chick food. This will carry them through to maturity without any other grain. Skimmed milk (if it can be had) and beef scraps should also be fed, and plenty of fresh, clean water. 100 lbs., \$2.50; 500 lbs., \$11.25.

DR. HESS' STOCK FOOD. Milk makes the money, but Dr. Hess' Stock Food makes the milk. We guarantee Dr. Hess' Stock Food to increase the bone, muscle and milk producing value of your hay, grain etc., sufficient to cover its cost many times over, besides keeping animals free from disease. 2½-lb. pkg., 25 cts.; 7-lb. pkg., 50 cts.; 25-lb. pail, \$1.60; 12-lb. sack, 75c.; 100-lb. sack, \$5.

DR. HESS' POULTRY PAN-A-CE-A. 1½-lb. pkg., 25 cts.; 5-lb. pkg., 60 cts.; 12-lb. pkg., \$1.25; 25-lb. pail, \$2.50.

KAFFIR CORN. This is probably one of the best as well as one of the cheapest foods for hens, chickens or pigeons. It is about the size of a very small pea, and is fast taking the place of other grains for poultry food. 100 lbs., \$1.75.

MILK ALBUMEN. This food is in reality skimmed milk in dry form, without the sugar, and is even better than fresh skimmed milk. It will keep for any length of time without any odor. 100 lbs., \$2.75.

CANADA FIELD PEAS. For pigeons and parrots. Lb. 5c.; 100 lbs., \$3.50.

PARROT FOOD. A mixture of whole seeds, especially designed for parrots. Lb. 10 cts.; 3 lbs., 25 cts.

DRY GROUND FISH. For poultry. This is a great egg-producer, and takes the place of beef scraps, which are so hard to get at the present time. The price is also much lower than scrap. 100 lbs., \$2.75.

CRACKED CHARCOAL. Fine for small chicks. 8-lb. bag, 25 cts.; 100 lbs. \$1.75. For poultry, same price.

OLD-FASHIONED BEEF SCRAPS. These scraps are ground fresh for us, and do not contain any oyster shell or tankage, but are good fresh bone and meat. 100 lbs., \$2.50.



- 

100 Lbs. WHITE KAFFIR CORN
ROSS BROS. CO. WORCESTER, MASS.
- 

100 lbs. MILK ALBUMEN
Protein 43 per cent.
Fat 8 per cent.
Price 100 lbs. \$2.50
- 

2 BUSH. CANADA FIELD PEAS
ROSS BROS. CO. WORCESTER, MASS.
- 

50 Lbs. MIXED PARROT FOOD
ROSS BROS. CO. WORCESTER, MASS.
- 

100 Lbs. DRY GROUND FISH
ROSS BROS. CO. WORCESTER, MASS.
- 

50 Lbs. CRACKED CHARCOAL
ROSS BROS. CO. WORCESTER, MASS.
- 

100 Lbs. OLD-FASHIONED BEEF SCRAPS
ROSS BROS. CO. WORCESTER, MASS.
- 

100 Lbs. MEAT MEAL FOR POULTRY
ROSS BROS. CO. WORCESTER, MASS.
- 

50 Lbs. SHREDDED ALFALFA FOR POULTRY
ROSS BROS. CO. WORCESTER, MASS.



POULTRY MEAL. Is finely ground meat and blood, and is preferred by many to Beef Scraps, as it may be mixed with wet feed and prevents waste. 100 lbs., \$2.

SHERIDAN'S ALFALFA. This is the latest and best food for all kinds of poultry. It is alfalfa, pure as can be had, finely ground, and should be mixed with other kinds of feed, and, being very light, it makes a very nutritious food and is also an egg-producer. 100 lbs., \$1.75.

MICO-SPAR CUBICAL GRIT. Cracked in three sizes. No. 2 for poultry No. 3, for pigeons; No. 4 for small chicks. 100 lbs., 75 cts.

GRANULATED BONE. Fresh cracked bone, without any meat, will keep for any length of time. Should always be kept in a box where the hens can get to it. 100 lbs., \$2.25.

CRUSHED OYSTER SHELLS. For poultry or chicks. 100 lbs., 75 cts.

KOW-KURE. Prevents and cures abortion and barrenness. Increases the flow of milk. It is for cows only. 50 cts. and \$1.

COW TONE. For same purpose as Kow-Kure. Considered by some as preferable to it. 50 cts. and \$1.

COW RELIEF. Cures caked bags and sore teats. Should be in every stable. \$1.

CALF CORDIAL. Sure cure for scours and other similar complaints. 50 cts.

PIGEON FOOD. A mixture of Kaffir corn, wheat, etc. Lb., 10c.; 100 lbs. \$2.75.

HEMP SEED. For birds or chickens. Lb., 10 cts.; 100 lbs., 75 cts.

CANARY SEED. Lb., 10 cts.; 100 lbs., 75 cts.

PADDY, or UNHULLED RICE. Lb., 10 cts.; 3 lbs., 25 cts.

SHERIDAN'S CONDITION POWDERS. These goods are known in every town and need no recommendations from us. Large size, regular \$1 size, our price, 80 cts.; small size, 20 cts.

DOLE'S HORSE, CATTLE AND POULTRY FOOD. This is one of the best foods for milch cows to increase the flow of milk and keep the animal in condition. Once tried, always used. Large box, 75 cts.

GLASS NEST EGGS. 5 cts. each, 30 cts. per doz.

KNOX MEDICATED NEST EGG. Drives away lice and mites. 5 cts. each, 50 cts. per doz.

MILFORD GRANITE GRIT. Two sizes for poultry and chicks. 100 lbs., 75c.

GREEN CUT BONE IN SEASON. We can furnish this in 50- and 100-lb. lots at \$3 per 100 lbs.

FINE CRACKED BONE. For small chicks; made from best selected white bones, finely cracked and screened. 8 lbs., 25 cts.; 50 lbs., \$1.40; 100 lbs., \$2.50.

EDIBLE BONE MEAL. For cattle. 10 lbs., 30 cts.; 100 lbs., \$2.50.

WYANDOTTE SCRATCH FOOD. As its name signifies, this is a scratch food, consisting mostly of whole grains such as wheat, oats, barley, corn, buckwheat, sunflower, Kaffir corn, millet, charcoal and scraps. It is the result of a large number of experiments and is mixed in the right proportions to produce bone, muscle and eggs, especially the latter. It contains no oyster shells or grit. It is free from waste material, and fowls will always find something tempting for which to scratch. A small amount of this thrown into the litter after they have gone to roost at night, will start them to work early in the morning. The profitable poultry keeper must feed for results. Simply because a feed looks good to the naked eye is no sign it will produce eggs. Our E. D. S. has been tested and has proven itself as being all that we claim for it—a complete egg-producing feed. 100 lbs., \$2; 500 lbs., \$9.50. No charge for bags.

WYANDOTTE MASH. In extreme cold weather we recommend feeding hot mash just before night. At other times, it can be fed either wet or dry, at any time during the day. This is a highly nutritious balanced ration for laying hens. It is sold under a guarantee to contain not less than 12 per cent protein and 3.50 per cent fat. It is different from most mashes on the market in that it contains medicinal properties as well as those for producing eggs. It contains those grains that are high in egg-making qualities, and feeding this mash once a day will keep the flock in a healthy condition. Laying hens should never be overfed with warm mash, especially in the morning. It has a tendency to make them stupid and inactive. While this is equal to many of the high-priced patent foods on the market, we sell it at a price within the reach of all. 100 lbs., \$2; 500 lbs., \$9.50.

Seeds and Cereals for Chick Food

While we believe that much better results can be obtained by using our regular prepared foods, we are in position to furnish anything in the line of chick or bird feeds at bottom prices. We import in large quantities and we buy in this country in carload lots and handle nothing but the best.

| | | |
|------------------------------|---------|---------|
| Imported Bird Millets..... | 10 lbs. | 100 lbs |
| Mixed American Millets..... | \$0 30 | \$2 50 |
| Steel-Cut Oatmeal..... | 25 | 2 00 |
| Canary Seed..... | 60 | 3 00 |
| | 80 | 7 00 |
| Hemp Seed..... | 75 | 6 50 |
| Rape Seed..... | 75 | 6 00 |
| Russian Sunflower Seed..... | 60 | 5 50 |
| Fine Cracked Peas..... | 50 | 3 50 |
| Fine Cracked Corn..... | 25 | 1 75 |
| Paddy, or Unhulled Rice..... | 80 | 8 00 |



In 100-lb. lots, bags, 20 cts. extra
CONKEY'S ROUP CURE. Cures roup in all its forms. It is simply put in drinking-water and the chicken takes its own medicine. 50 cts. and \$1.

CONKEY'S LICE POWDER. Kills lice and other pests on poultry, horses and cattle. 50c.

CONKEY'S LIQUID LICE KILLER. Qt., 35 cts.; 2 qts., 60 cts.
CONKEY'S CHOLERA CURE. This can be given in the drinking-water as fowls will drink when they will not eat. 50 cts.

CONKEY'S HEALING SALVE. This is an ointment possessing curative powers, is good for chicken-pox, scaly legs and for healing all sorts of wounds. Price, 50 cts.

THE EUREKA FLY-KILLER. Protects cattle and horses from fly pests and vermin. Sure preventive, perfectly harmless, easily applied and inexpensive. Eureka Fly-Killer is a sure preventive that kills and drives away the worst of all pests—the Texas, buffalo and horn flies. It was born of a necessity; it meets an existing demand for an article of its kind, and that it meets it well and perfectly satisfactorily is attested by the numerous and grateful testimonials from farmers who have used it. Gal. 75 cts.

LAMBERT'S DEATH TO LICE. As its name implies, it is sure death to lice on hens and chickens. It is harmless to human and animal life. Should be used on setting hens; it will not injure the eggs or harm the youngest chick. 15-oz. size, 25 cts.; 48-oz. size, 50 cts.; 100-oz. size, \$1.

LEE'S LICE KILLER is a liquid preparation; comes in tin cans; highly recommended. Qt., 35 cts.; 2 qts., 60 cts.; 4 qts., \$1.

DR. HESS' INSTANT LOUSE KILLER. Kills lice. Put up in round can with perforated top ready for use in one- and three-pound packages. The large size is the cheaper. You get three pounds for 60 cts., and, with the handle, it is just as convenient as the smaller size. Large size, 60 cts.; small size, 25 cts.

DR. HESS' HEALING POWDER. A great anti-septic powder. Cures galls and open wounds. 4-oz. box, 25 cts.

PRATT'S LOUSE KILLER. Put up in one-pound size. It kills the lice. 25c.
ROSS' ROUP CURE. A powder which is a positive cure for roup in its worst stages. Simply put a little in the drinking-water and the hens take their own medicine without any trouble whatever. We guarantee a cure or money refunded. Two sizes—small, 40 cts.; large, 75 cts., postpaid.

WYANDOTTE LICE POWDER. Kills lice on poultry and animals of all kinds. Lb., 25 cts.; 3 lbs., 50 cts.

WYANDOTTE LIQUID LICE KILLER. Qt., 35 cts.; 2 qts., 60 cts.; gal., \$1.



Dr. Daniels' Veterinary Medicines

All reliable, and should be in every stable for cases of emergency.

| | | |
|----------------------------------|-------------|--------|
| Colic Cure..... | Each | \$1 00 |
| Cough, Cold and Fever Drops..... | 50 cts. and | 1 00 |
| Horse Renovator..... | | 50 |
| Wander-Worker Liniment..... | | 50 |
| Worm Killer..... | | 50 |
| Absorbent Blister..... | 50 cts. and | 1 00 |
| Oster-Cocus..... | 25 cts. and | 50 |
| Liniment Powder..... | | 50 |
| Hoof-Grower and Softener..... | | 50 |
| Gall Cura..... | 25 cts. and | 50 |

INSECTICIDES

SLUG-SHOT. A fine powder used for potato bugs and other insects. Recommended for cabbage worms. 5- and 10-lb. packages, per lb., 5 cts.

PINE TAR. Used in the stable for cuts and bruises. Pint cans, 15 cts.

SCALECIDE. A petroleum oil that mixes at once with cold water in any proportion and stays mixed. It is not necessary to use an extra tank or barrel and no hot water should be used. Can be prepared in an instant, adding one gallon of Scalecide for every fifteen or twenty gallons of water. Qt. can, 40 cts.; gal. can, \$1; 5-gal. can, \$3.25; half-bbl. (30-gal. tin), \$15; bbl. (50 gals.), \$25.

TREE TANGLEFOOT

A perfect safeguard for trees against gipsy, brown-tail and tussock moth canker worms, ants and all creeping things. It will remain sticky about three months, fully exposed to the weather. Lb.-cans, 30 cts.; 3-lb. can, 85 cts.; 10-lb.-can, \$2.65; 20-lb. can, \$4.80.

GRAFTING WAX. ½lb., 10 cts.; ¼lb., 15 cts.; lb., 25 cts.

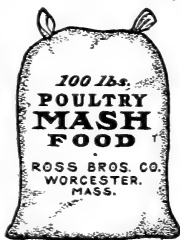



Pat. March 16 and Nov. 9, 1897
Pat. in Canada, Nov. 2, 1897
and January 25, 1900

Bug Death

We can say to our customers that we give Bug Death our fullest endorsement. While the first cost to kill the bugs on an acre of potatoes is rather more than that of arsenical insecticides, the results at harvesting time are entirely satisfactory, and where practical tests have been made, the extra yield of marketable potatoes has more than paid the entire expense. It is non-poisonous, which makes it perfectly safe to use on all plants or vines.

Very beneficial results are obtained by using Bordeaux Mixture in connection with Bug Death, and they can be mixed and sprayed on the vines at the same time. Put up in packages as follows:

1-lb. package.....\$0 15
3-lb. package..... 35
5-lb. package..... 50
12½-lb. package..... 1 00
100-lb. package..... 7 50

WHALE OIL SOAP. For destroying insects on plants, etc.; in small boxes. Lb., 15 cts.; 5 lbs., 60 cts.

PARIS GREEN. A poisonous, insoluble powder for preventing the ravages of potato bugs, codling moth, caterpillars, slugs and bugs. Mix one pound to 100 pounds of plaster, or 200 gallons of water. May be used clear with the Leggett Gun. Lb., 30 cts.; ½ lb., 18 cts.; ¼ lb., 10 cts.

COAL TAR. In quart tin boxes. For tarring corn to prevent crows from pulling it. Per pt., 15 cts.; qt., 25 cts.

HELLEBORE. Sure death to the currant worm. Lb., 25 cts.; ½ lb., 15 cts.; ¼ lb., 10 cts.

ARSENATE OF LEAD. The best insecticide known for leaf-eating insects because it kills quickly. Trees or plants sprayed with arsenate of lead and water are quickly freed from their insect pests. It cannot injure the most delicate foliage. Respraying after rains is the bane of the fruit-grower's life. Arsenate of lead dries on the leaves into a varnish-like film, which is not affected by dew or rain. One thorough spraying will protect the foliage for an entire season. 1-lb. glass jars, 20 cts.; 5-lb. glass pails, at 18 cts. per lb.; 10-lb. glass pails, at 16 cts. per lb.; 20-lb. wooden pails, at 15 cts. per lb.; 50-lb. wooden pails, at 13 cts. per lb.; 100-lb. wooden kegs, at 12 cts. per lb.

DRY BORDEAUX POWDER. For preventing blight on grapes, potatoes and other crops that are subject to rust, mildew and black rot; applied dry with bellows. Lb., 15 cts.; 5 lbs., 75 cts.

DRY BORDEAUX MIXTURE AND PARIS GREEN. It kills potato bugs and all plant-eating pests, prevents blight and rust, keeps potato and tomato vines and other foliage in a green and vigorous condition. In one and three-pound boxes, lb. 25 cts.

BORDEAUX MIXTURE. (Liquid.) This mixture is put up in one-gallon patent cans. Retail for \$1. One gallon will make 50 gallons by the addition of 49 gallons of water. Gallon cans, \$1.

TOBACCO STEMS. Indispensable for fumigating greenhouses and conservatories; for destroying aphids, should be dampened before using, and use a small handful on some dry shavings, and light it. 100 lbs., \$2.

TOBACCO DUST. Kills green- and black-fly, etc., if dusted on when the plants are moist. Also good to mix in the soil to destroy ground insects 5 lbs., 25 cts.; 50 lbs., \$1.15; 100 lbs., \$2.

Herbicide

The most effectual, practical and economical weed-exterminator known. It does the work at one-twentieth part the cost of any other method, and is also far more convenient to use than any other material. One man does the work easily on the roads, which used to need several men at a heavy expense. It completely destroys all weeds wherever applied, and by its effect on the ground prevents a growth of fresh ones, thus saving an immense amount of labor in hoeing, rolling and re-rolling.

Herbicide is warranted not injurious to marble or stonework of any kind, and it leaves the gravel paths and roads clean and bright. It can be applied in the spring, summer or fall to do its killing and preventive work.

Its application is easy, being in liquid form, and only requiring to be mixed with water and applied with a watering can or watering-cart. Five gallons mixed with one hundred gallons of water will make a very strong treating liquid which will effectually destroy all vegetable growths and will cover an area of from 150 to 200 square yards. Qt., 50 cts.; 2 qts., 80 cts.; in 5-gal. kegs, sufficient to make 100 gals. of liquid, \$5.50; in 10-gal. kegs, sufficient to make 200 gals., \$10; in 25-gal. casks, sufficient to make 540 gals. \$24.

Carbolineum

Of the numerous preservative compounds on the market, Avenarius Carbolineum stands alone as time-tried and thoroughly tested. It is the only superficial preservative method that has been used the world over and demonstrated its value in the thirty years past. It is the only one that has received recognition and met with the approbation of engineers of Europe and America—the only preparation favorably reported along with the reliable but expensive and inconvenient Creosoting and Burnetizing processes. Gal. can, \$1.25.

Reade's Electric Worm Eradicator

For the instantaneous extermination of worms and bugs of every size and kind which are found at the roots of trees, plants, shrubs, flowers, fruits and vegetables in greenhouses, orchards, fruit-gardens, vineries, flower-beds, lawns and walks, without damage to fruit, flowers or grass. The most effective method of destroying obnoxious pests, such as rose-bugs, aster-beetles, cut-worms, borers in trees, and many other insects is to destroy the larvae, which are in the ground. This can positively be done by a thorough application of Electric Worm Eradicator at the roots of trees, plants, flowers, vegetables, etc. It will be found exceedingly effective, being highly concentrated, one gallon being sufficient to make 120 gallons of fluid for use by the addition of water.

After the application of the Electric Worm Eradicator, the worms will immediately rise to the surface of the ground or flower bed, and in a few minutes will die. Cut-worms do not come to the surface, but die in the ground.

This scientific and unique preparation is specially valuable to fruit-, vegetable-, tomato- and mushroom-growers, nurserymen, florists and gardeners, as by its use it entirely prevents the ravages of worms.

The use of this preparation saves valuable trees from destruction by killing worms which are at the roots. Borers in trees are also destroyed by the use of the Electric Worm Eradicator.

We strongly recommend Electric Worm Eradicator for ridding greenhouses, grounds, etc., of ants, wood-lice and centipedes, etc.

It is perfectly odorless and will keep any length of time. Electric Worm Eradicator is most effective when used early in the morning or late in the evening. Small bottle, 50 cts.; large bottles, \$2; case of six bottles, \$10; keg, containing 1 gal., \$4; keg, containing 5 gals., \$17.50; f. o. b. New York City.

Sterlingworth Weed Killer

A most efficient destroyer of weeds, put up in powder form, one-pound package of which, added to 15 gallons of water and applied with a sprinkler, is sufficient to kill all kinds of weeds and grasses on two or three square yards of walk. Lb. pkt., 50 cts.; 3 lbs., \$1.25; 5 lbs., \$2.

Haw's Ant Destroyer

Guaranteed to drive ants from any lawn. Put up in powder form and used by scattering on the ant-hills. The ants never come back. 15 cts.

Readeana Rose-Bug Exterminator

A positive killer of rose-bugs, green-fly, scale, mealy-bug, blight, red spider, thrip, maggots, mites, mildew, mold, and a large variety of other insects including black ants and other pests that infest grape-vines, plants and flowers, without any possibility of harming or discoloring the shrubs, plants, flowers, etc. It readily mixes with water, and is adapted to the conservatory, greenhouse, vinery, flower and kitchen garden or orchard and hop gardens. For cleansing, brightening and beautifying foliage it has no equal.

The advantage of this preparation over others is that, besides being a powerful destroyer of insects, it is harmless to flowers, plants, etc., and therefore can be left on the flowers or plants, so as to kill successive arrivals of insects.

It is highly concentrated and is diluted with water according to the purpose. Full directions for use with each package. It keeps any length of time. Small bottle, 50 cts.; large bottles, \$2; case of six bottles, \$10; keg, containing one gallon, \$4; keg containing five gals., \$17.50, f. o. b. New York City.

Nikoteen

Is the most powerful known insecticide and is more economical and convenient than crude tobacco. It is highly concentrated and made from dark Kentucky tobacco. Price, per can, 75 cts.

Germ-a-thol

Is the greatest disinfectant, deodorizer, detergent (cleaner), insecticide, bactericide and antiseptic, and is needed by housekeepers, cleaners, janitors, hotel proprietors, doctors, nurses, gardeners, laundrymen, poultrymen, horse men, sheep-raisers, and by every one seeking health, comfort and cleanliness. Price, 25 cts., 50 cts., and 75 cts.

How and When to Spray

We are always willing to give any information we can in answer to this question, but nearly every agricultural college in the country publishes and mails free bulletins, giving valuable information on this subject, and these can be had by simply asking for them. A great deal of harm has been done by parties using the wrong material or not applying it in the proper quantity.

Never use scalecide to destroy anything except scales, and don't use Paris green or any other poison expecting it will destroy scales. Nothing but an oil will have any effect on any of the different varieties of scale.

Spraying pays, if you do it right, but it should not be done in a haphazard way.

Any one looking for a good paying business will find it a good investment to buy one of our No. 260 Spraying Outfits, illustrated on page 75. This can be mounted on any common wagon, and a person can earn at least \$10 per day going out spraying.

EVERYTHING FOR THE GARDEN AND GREENHOUSE

Shears

LAWN. (199.) With wheel. Price, \$2.75.
LAWN. (200.) Plain, \$2.25; with two wheels, \$3.
GRASS. (201.) Price 25 cts., and 50 cts.
HEDGE. (202.) Price 9-in., plain, \$1.25; 9-in. notched, for large limbs, \$1.40.

Weeders

SECOR. (203.) Price, 10 cts. **LANG'S. (204.)** Price, 25 cts.
GARDEN TROWEL. (205.) Price, 6-in., steel, 20 cts.; heavy steel, 40 cts.

Garden Sets (206)

| | |
|----------------------------|----------------------------|
| No. 1, 3 pieces.....\$0 10 | No. 4, 4 pieces.....\$0 50 |
| No. 2, 3 pieces.....15 | No. 5, 4 pieces.....1 25 |
| No. 3, 3 pieces.....25 | |

Hoes (not shown)

| | |
|-----------------------------------|--------------------------------|
| 7½-8 in., Field Socket.....\$0 50 | 9 in., Meadow Shank.....\$0 50 |
| 7½-8 in., Field Shank.....45 | 9½ in., Meadow Shank.....50 |
| 8 in., Meadow Socket.....55 | 9 in., R. I. Socket.....55 |
| 8½ in., Meadow Socket.....55 | Ladies'.....40 |
| 9 in., Meadow Socket.....55 | Boys'.....45 |
| 9½ in., Meadow Socket.....55 | Square Top Onion.....45 |
| 8 in., Meadow Shank.....50 | 9 in., Mortar.....70 |
| 8½ in., Meadow Shank.....50 | 10 in., Mortar.....75 |

Spading Forks (not shown)

| | |
|--|---------------------------------------|
| 4-tine, iron, D handle, plain...\$0 75 | 4-tine, long handle, strapped. \$0 80 |
| 4-tine, wood, D handle, plain.. 85 | 5-tine, iron, D handle.....1 10 |
| 4-tine, iron, D handle, strap'd. 80 | 5-tine, wood, D handle, strap'd 1 15 |
| 4-tine, wood, D handle, strap'd. 90 | |

Watering Pots (207)

| | |
|-----------------|------------------|
| 4-qt.....\$0 40 | 10-qt.....\$0 60 |
| 6-qt.....50 | 12-qt.....70 |
| 8-qt.....55 | 16-qt.....75 |

RAKES. (208.) Price, 12-tooth, iron, 30 cts., steel, 50 cts. 14-tooth, iron 35 cts.; steel, 55 cts. 16-tooth, iron, 40 cts.; steel, 60 cts. XX, 3 bow bent 40 cts. X, 3-bow bent, 30 cts. Lawn rake, 28 teeth, steel box, XX, 50 cts. Ex. No. 1, 3-bow, bent, 40 cts.

HOTBED SASH. (209.) Price, regular size, 3 x 6 ft., 1½ in., with sides projecting, glazed with double thick glass, \$3.25 each. In lots of 6, \$3.15 each. In lots of 25, \$3 each. Special price by the 100.

Hotbed Mats (not shown). Invaluable as a protector from frosts.

Special prices by the dozen

| | |
|--------------------------|-------------------------------------|
| Straw, 6 x 6.....\$1 50 | Duck and Burlap, 40 x 76.....\$1 15 |
| Straw, 3 x 6.....85 | Duck and Burlap, 76 x 76.....1 75 |
| Burlap, 40 x 76.....85 | Duck both sides, 40 x 76.....1 25 |
| Burlap, 76 x 76.....1 40 | Duck both sides, 76 x 76.....2 00 |

HOTBED THERMOMETERS. (210.) Price, \$1.50 each.

GOODALE'S ASPARAGUS KNIFE. (211.) Best asparagus knife. Made of best steel, strong and rigid. Price, 40 cts.; postage 10 cts. extra.

ASPARAGUS BUNCHER. (212.) Price, \$1.75.

Veranda Trellis (213)

| | | | | | | | |
|-------|--------|--------|--------|--------|--------|--------|-------|
| High | Wide | Each | Doz. | High | Wide | Each | Doz. |
| 5 ft. | 18 in. | \$0 85 | \$9 00 | 9 ft. | 20 in. | \$1 60 | 18 00 |
| 6 ft. | 18 in. | 1 00 | 11 00 | 10 ft. | 20 in. | 1 85 | 21 00 |
| 7 ft. | 18 in. | 1 15 | 13 00 | 11 ft. | 20 in. | 2 15 | 25 00 |
| 8 ft. | 18 in. | 1 35 | 15 00 | 12 ft. | 20 in. | 2 50 | 28 00 |

WIRE TREE GUARD. (214.) Made of extra-heavy wire. Price, \$1 each.

NURSERYMEN'S STAKES. (215.) 16 x 2 in. Extra quality. No paint. 4 cts. each, \$2.50 per 100.

PLANT STICKS. (216.) For pot or garden use. Square, painted green.

| | | | |
|--------------------------|--------|--------------------------|--------|
| Each | 100 | Each | 100 |
| 1½-ft. sticks.....\$0 02 | \$1 00 | 2½-ft. sticks.....\$0 06 | \$4 50 |
| 2-ft. sticks.....02 | 1 50 | 4-ft. sticks.....07 | 5 50 |
| 2½-ft. sticks.....03 | 2 00 | 5-ft. sticks.....08 | 7 50 |
| 3-ft. sticks.....05 | 4 00 | 6-ft. sticks.....10 | 9 00 |

FLOWER BED GUARDS. (215.) Price, 16-in., 10 cts. per running foot; 22-in., 12 cts. per running foot.

COPPER BRASS HOSE MENDER. (216.) Made of thin brass tubing. Price, 10 cts. each, postpaid; 75 cts. per doz.

RUBBER AND COTTON HOSE. (217.) Prices per foot: Bull Dog, 7-ply, ½ in., 14 cts.; ¾ in., 16 cts.; Tiger, 6-ply, ½ in., 11 cts.; ¾ in., 13 cts.; Leader, 5-ply, ½ in., 9 cts.; ¾ in., 11 cts.; Cotton, ½ in., 12 cts.; ¾ in., 14 cts.

BOSTON STEEL HOSE REEL. (218.) Holds 100 ft. hose. Price, \$1.75.

ECLIPSE HOSE REEL. (219.) Price, 75 cts.

TUBULAR METAL HOSE REEL. (220.) The most durable reel made. Holds 100 feet of hose. Price, \$3.50.

"BOSTON" SPRAY NOZZLE. (221.) Will throw a coarse or a fine spray, a large or a small, solid stream. Price, 35 cts.

STEARNS REVERSIBLE LAWN SPRINKLER. (222.) Will throw coarse or fine spray either in wide or narrow spaces. Price, 75 cts.

Lanterns. Will give a good light and are absolutely safe to carry.
 No. 2, Cold Blast. (223A.) Price, 90 cts.
 No. 15, Dash. (223B.) 75 cts.; No. 2, Dash, \$1; Cold Blast Dash, \$1.15.
 No. 0, Side Spring. (224A.) 50 cts.; No. 2, Side Spring, 75 cts.
 No. 0, Clipper. (224B.) 50 cts.; No. 2, Clipper, 75 cts.
 Milkmen's and Doctors' Driving Lanterns. No 18, Jap., \$2.50; No. 18, Nickel, \$3.
 Lantern Globes, No. 0, 10 cts. each; No. 2, 10c. each; Bull's Eye, 15c. each.

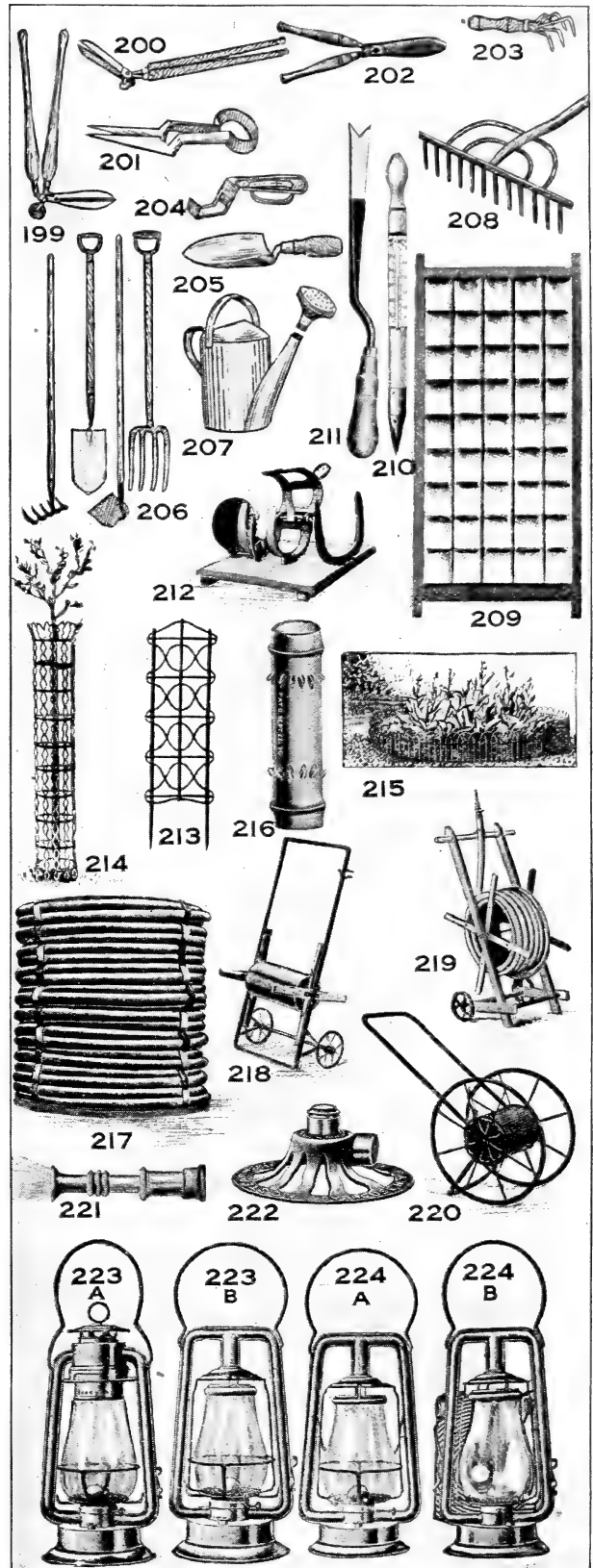

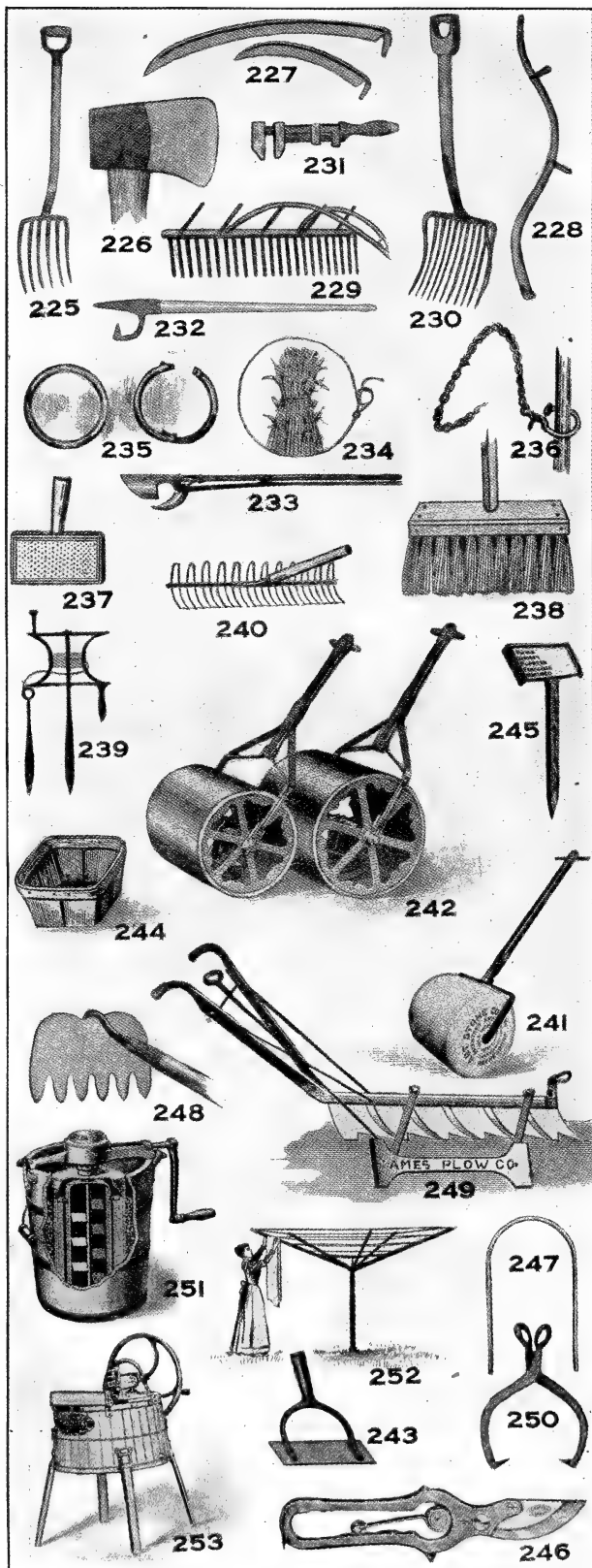

Manure Forks (225)

- 4-tine, long handle, strapped...\$0 75
- 4-tine, iron, D handle, strap'd. 80
- 5-tine, iron, D handle, plain... 95
- 5-tine, wood, handle, plain... 1 05
- 5-tine, long handle, strapped... 95
- 5-tine, iron, D handle, strap'd. 1 00
- 5-tine, wood, D handle, str'p...\$1 10
- 6-tine, iron, D handle, plain... 1 05
- 6-tine, wood, D handle, plain... 1 15
- 6-tine, long handle, strapped... 1 10
- 6-tine, iron, D handle, strap'd. 1 10
- 6-tine, wood, D handle, strp'd. 1 25

AXES. (226.) All made of best steel. Foster, 75 cts.; Black Jacket, \$1; Hickory King, \$1.25; Bradley, \$1.10.

SCYTHES. (227.) Clipper, 75 cts.; Foster, 90 cts.; all steel, 85 cts.; Black Hawk, \$1.

SCYTHE SNATHS. (228.) Cherry, \$1; Ash, 75 cts.

DRAG RAKE. (229.) For raking scatterings, 75 cts.

COKE FORK. (230.) For handling all light materials. 12-tine, \$1.75; 14-tine, \$2; 16-tine, \$2.25.

Agricultural Wrenches (231)

| Plain handle | | With knife handle | |
|--------------|--------|-------------------|--------|
| 6-in..... | \$0 20 | 6-in..... | \$0 60 |
| 8-in..... | 25 | 8-in..... | 70 |
| 10-in..... | 30 | 10-in..... | 80 |
| 12-in..... | 35 | 12-in..... | 90 |

CANT-HOOKS. (232.) For rolling logs and poles. With 3 or 3 1/2 ft. handles, \$1.25.

GIBB'S POST HOLE DIGGER. (233.) \$1.50 each.

HOLD-FAST CORN TIES. (234.) Price, \$1.25 per 100.

BULL RINGS. (235.) Price, copper, 2 1/2-in., 20 cts.; 3 in., 25 cts. postpaid. Cannon metal, heavy, 3 in., \$1.25.

CATTLE CARD. (237.) Price, No. 1, large leather, bound, 12 cts.; No. 2, large leather, not bound, 10 cts.; No. 3, small leather, bound, 10 cts.; No. 4, small leather, not bound, 8 cts.

COW TIE. (236.) 3 ft., 25 cts.; 3 1/2 ft., 30 cts.; 4 ft., 35 cts.; 4 1/2 ft., 40 cts.

RATTAN BRUSH BROOM. (238.) Prices, 5-row, 14 in., 50 cts.; 5-row, 16 in., 55 cts.; 6-row, 16 in., 60 cts.

GARDEN LINE REELS. (239.) For 200 feet of line, 50 cts.; for 300 feet, 75 cts.

QUEEN LAWN RAKE. (240.) All metal. Price, 40 cts.

Favorite Lawn Roller (241)

MADE OF REINFORCED CONCRETE

| | Diameter | Length | Weight | Price |
|--------------------|----------|----------|----------|--------|
| No. 3, Lawn..... | 15 in. | 200 lbs. | 200 lbs. | \$6 00 |
| No. 4, Lawn..... | 20 in. | 15 in. | 300 lbs. | 9 50 |
| No. 5, Garden..... | 20 in. | 30 in. | 600 lbs. | 20 00 |

L. R. Lawn Roller (242)

Surface perfectly smooth, edges beveled. Can furnish other sizes.

| | List price | Net price |
|---------------------------|------------|-----------|
| No. 7, 2-section, 20 x 20 | 215 lbs. | \$14 00 |
| No. 8, 2-section, 20 x 24 | 245 lbs. | \$10 00 |
| | | 15 00 |

SCUFFLE HOE AND HANDLE. (243.) 6-in., 45 cts.; 7-in., 50 cts.; 8-in., 55 cts.; 9-in., 60 cts.

BERRY BASKETS. (244.) All white, \$4 per 1,000; second grade, \$3.50 per 1,000, 10,000 lots, 25 cts. per 1,000 less. Close corner (for blueberries), \$4 per 1,000; oval pints, \$3.75 per 1,000; pansy baskets, \$13 per 1,000.

GALVANIZED IRON LABEL HOLDER. (245.) 15c. each; \$1.50 per doz.

FRENCH PRUNING SHEARS. (246.) Price, \$1.

Cypress Plant Tubs

| No. | Diam. | High | Each | No. | Diam. | High | Each |
|-------|------------|------------|--------|-------|--------|--------|--------|
| No. 1 | 13 1/2 in. | 11 1/2 in. | \$1 25 | No. 4 | 20 in. | 18 in. | \$2 25 |
| No. 2 | 14 in. | 13 1/2 in. | 1 50 | No. 5 | 24 in. | 20 in. | 3 00 |
| No. 3 | 16 in. | 15 1/2 in. | 1 75 | No. 6 | 28 in. | 22 in. | 4 50 |

WIRE WICKETS. (247.) Heavy, 55 cts. per doz.; light, 35 cts. per doz.

BOOTHBAY TOOTHED HOE. (248.) Price, 65 cts.

Ice Plow, Red, White and Blue (249)

- 7 1/2 in. with Improved Clearing Tooth and 22-in. swing guide.....\$25 00
- 9 in., with Improved Clearing Tooth, and 22-in. swing guide..... 28 00
- 10 1/2 in., with Improved Clearing Tooth and no guide..... 30 00
- Adjustable Swing Guide, for marking 16, 18, 20 and 22 in. extra..... 1 50
- Swing Guide, for marking, extra..... 5 00

ICE TONGS. (250.) Boston Patent Swell Handle. Price, 16 1/2 in., \$1.25 24-in., \$1.50.

White Mountain Ice-Cream Freezer (251)

| | Net price | Net Price |
|-----------|-----------|------------------|
| 2-qt..... | \$2 00 | 10-qt.....\$5 50 |
| 3-qt..... | 2 25 | 12-qt..... 7 00 |
| 4-qt..... | 2 65 | 15-qt..... 8 50 |
| 6-qt..... | 3 25 | 20-qt..... 10 75 |
| 8-qt..... | 4 50 | 25-qt..... 13 50 |

OUR SPECIAL OUTDOOR DRIER. (252.) Made of best stock; cotton line. 110-ft. line, \$3.50; 150-ft. line, \$4. Above includes box to go into the ground.

MAJESTIC ROTARY WASHERS. (253.) Ball bearings and balance fly-wheel almost make it run itself. Price, \$7. Discount for cash, 50 cts.

LA FRANCE APPROVED FIRE EXTINGUISHER. (254.) Every farmer should have one or more of these. Protects buildings and reduces insurance. Capacity, three gallons. Price, \$1. Discount for cash, \$1.

Easy Opener Pocket Knife (255)

An American-made knife with hand-forged blades of the best razor steel, tested and warranted. Order one and see how good a knife it is. You can return it if you are not satisfied. Price, 55 cts., postpaid. By express, with other goods, 50 cts. We carry a large line of America-made pocket knives, all of which are warranted.

- NO. 41. HOUSE BAR. (256.) \$2.50.
- NO. 45. STARTING BAR. (257.) \$3.50.
- NO. 43. SPLITTING FORK. (258.) \$4.25.
- NO. 15. ICE SAW. (259.) 4-ft., \$3; 4½-ft., \$3.25; 5-ft., \$3.50.
- NO. 39. BREAKING BAR. (260.) \$3.25.
- NO. 44. CALKING BAR. (261.) \$2.50.
- NO. 47. SOCKET PACKING CHISEL. (262.) \$3.25.
- NO. 135. ICE BREAKER. (263.) \$3.50.
- COLUMBIA REVOLVING LAWN SPRINKLER. (264.) Price, \$1.25.
- NIAGARA LAWN SPRINKLER. (265.) One of the best. Price, 75 cts.

Arctic Lawn Swing, With or Without Awning (266)

As a swing this affords the most comfortable lounging you can think of. The backs of the chairs are adjustable, and can be set up straight or inclined at as great an angle as you wish. Two-passenger. Price, with awning, \$7; without awning, \$6. Four-passenger, no awning, \$9. If not set up, 50 cts. less.

Cleveland Lawn Weeder (267)

The curved edge of the blade enters and loosens the soil, pressure on the lever then causes the toothed jaw to grasp the plant, and a slight pull suffices to dislodge it without disturbing the surrounding soil. Price, \$1.

Neponset Flower Pots (268)

| No. in crate | Size | Packed for shipment | Per 100 | 1,000 |
|--------------|-------------|---------------------|---------|--------|
| 1,000 | 2½-in. pots | 20 lbs. | \$0 25 | \$2 20 |
| 1,000 | 2½-in. pots | 23 lbs. | 30 | 2 40 |
| 1,000 | 3-in. pots | 33 lbs. | 45 | 3 90 |
| 1,000 | 3½-in. pots | 44 lbs. | 60 | 5 15 |
| 500 | 4-in. pots | 38 lbs. | 80 | 6 90 |
| 500 | 5-in. pots | 56 lbs. | 1 20 | 10 35 |
| 500 | 6-in. pots | 74 lbs. | 1 65 | 14 55 |

Not less than original crates at 1,000 rate. Samples by mail.

List of Pans, Standard Flower Pots and Saucers with Rims (269)

| Inside measurement, width and depth equal. | | | |
|--|-----------|---------|-----------|
| Size | Per 1,000 | | Per 1,000 |
| 1½-in. | \$7 00 | | \$11 00 |
| 2-in. | 8 00 | | 12 50 |
| 2½-in. | 9 00 | | 14 00 |
| Size | Pots | Saucers | P & S |
| 4-in. | \$2 20 | \$1 80 | \$4 00 |
| 5-in. | 4 00 | 2 25 | 6 25 |
| 6-in. | 6 00 | 3 00 | 9 00 |
| 7-in. | 10 00 | 4 00 | 14 00 |
| 8-in. | 14 00 | 6 00 | 20 00 |
| 9-in. | 20 00 | 8 00 | 28 00 |
| 10-in. | 27 00 | 10 00 | 37 00 |
| 11-in. | 36 00 | 12 00 | 48 00 |
| Size | Pots | Saucers | P & S |
| 12-in. | \$50 00 | \$15 00 | \$65 00 |
| 13-in. | 75 00 | 20 00 | 95 00 |
| Size | Each | Each | Each |
| 14-in. | \$1 00 | \$0 25 | \$1 25 |
| 15-in. | 1 50 | 30 | 1 80 |
| 16-in. | 2 00 | 35 | 2 35 |
| 18-in. | 3 00 | 50 | 3 50 |

Round Seed Pans (270)

| Size | Per 100 | Size | Per 100 |
|-------|---------|--------|---------|
| 6-in. | \$6 00 | 10-in. | \$18 00 |
| 7-in. | 8 00 | 12-in. | 35 00 |
| 8-in. | 10 00 | 14-in. | 75 00 |
| 9-in. | 14 00 | | |

500-lots, 20 per cent discount from list; 1,000-lots, 40 per cent discount from list.

RAFFIA. (271.) Price, 18 cts. per lb.; in 5-lb. lots, 15 cts. per lb.

Knollwood Ball-Bearing High-Wheel Spade-Handle Lawn Mower (272)

A 20-inch machine of this make runs as easy as a 12-inch of the old style. We offer our customers this machine as a guaranteed article, one that we have tested ourselves during the past seven years. Runs on ball-bearings. The balls used are of the very best quality and will last for years. They are enclosed in steel cups, which protect them from wear. The main axle is steel and lathe-fitted, and is adjusted as nicely as any high-priced piece of machinery. The machine has a 9-inch wheel, four knives of the best quality of steel, and, last but not least, a handle that is made to fit your hand. Price, 14-in., \$7; 16-in., \$7.25; 18-in., \$7.50; 20-in., \$7.75.

Rossmoyne Style C. Lawn Mower (273)

This machine has four knives and high, 9-in. wheels. It runs on ball-bearings of the same quality as those used in other machines. It is a first-class, medium-priced mower. All the parts are fitted on a lathe, and we warrant every machine we sell. Net prices, 12-in., \$5; 14-in., \$5.25; 16-in., \$5.50; 18-in., \$5.75; 20-in., \$6.

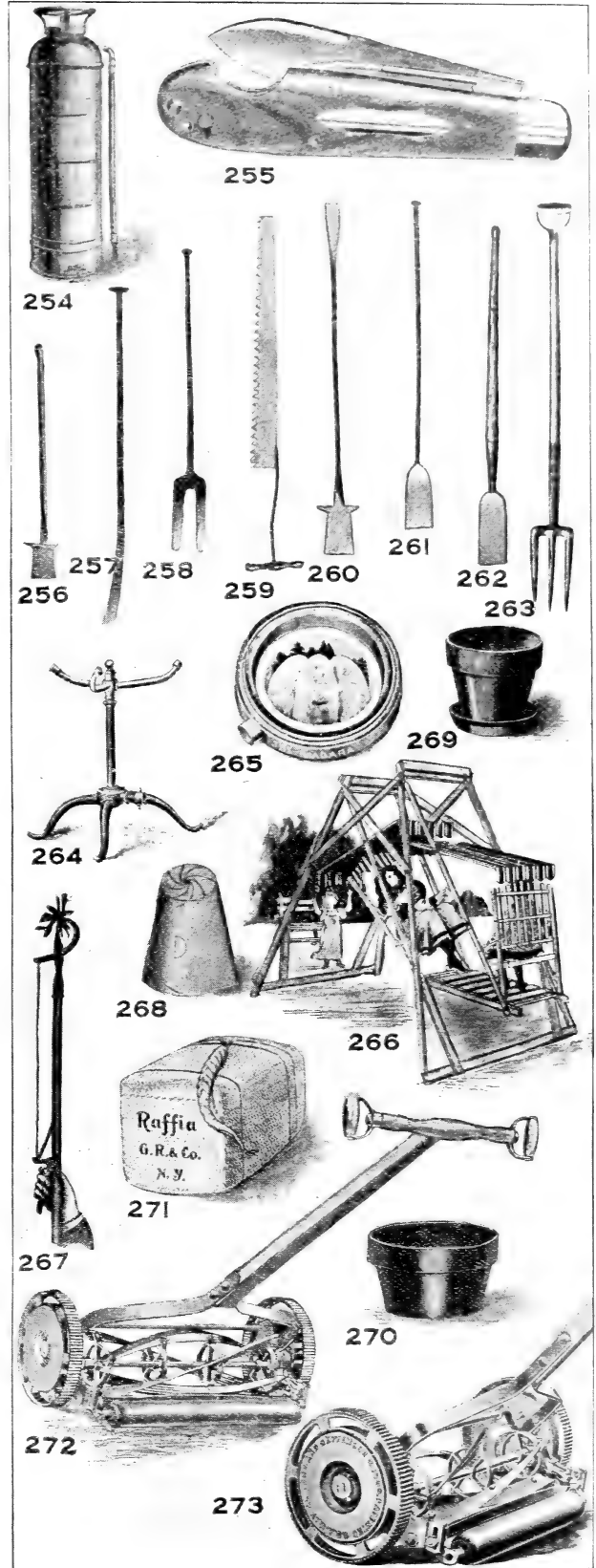

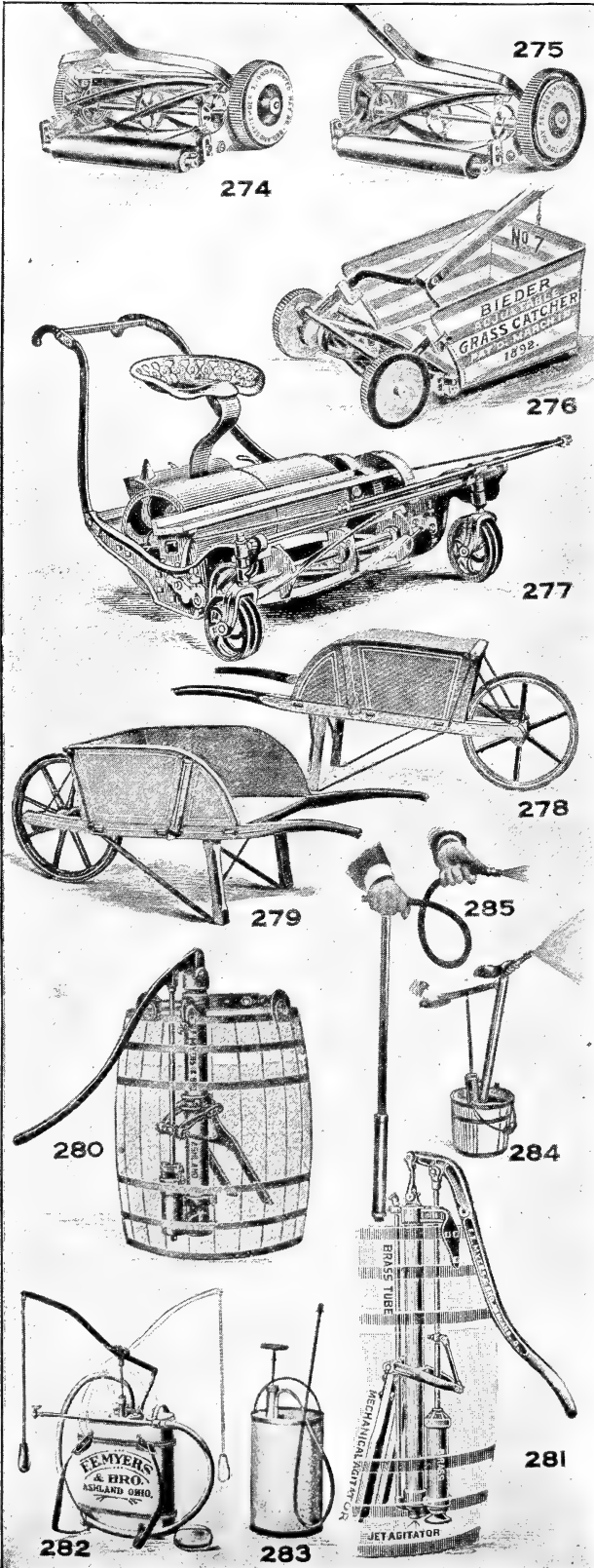

Royal Golf Mower (274)

It has five revolving knives, running at high speed, and cuts very close to the ground. Price (two sizes only), 16-in., \$7; 18-in., \$7.50.

The Little Giant Lawn Mower (275)

Preferred by many to the higher grade styles. 8-in. wheel. Net prices 12-in., \$2.75; 14-in., \$3; 16-in., \$3.25; 18-in., \$3.50.

Bieder Adjustable Grass Catcher (276)

No. 7 fits all low-wheel mowers 18 inches and smaller. Price, 75 cts. No. 13 fits all high-wheel mowers, 24 inches and smaller. Net price, \$1.

New Excelsior Horse Lawn Mower (277)

Especially built for large lawns. Has a side-draft attachment that permits the horse to walk only on the cut grass. Price, 25-in. cut, without seat or shafts, \$65; 30-in. cut, with seat and shafts, \$110; 35-inch cut, with seat and shafts, \$135. Discount, 40 per cent. Cash with order, 5 per cent extra.

We make a specialty of sharpening Lawn Mowers. Called for and delivered promptly in the city. Price, \$1.

Beekman Garden Barrow (278)

Prices, No. 2, boys' size, \$3; No. 4, medium size, for garden, \$3.25; No. 6, large size, for farmers, \$3.50.

Lawn or Garden Wheelbarrow (279)

Made entirely of oak, and has a high wheel, with eight spokes. No. 4, price, \$4.25.

The O. K. Spray Pump (280)

For hot and cold mixtures, with extension pipe, single, double or triple nozzles. This style of pump is designed for ordinary orchard use, and can be readily attached to any size of barrel in a minute's time. Price, without barrel, \$13.

| | |
|---|--------|
| Brass Y Connections, fitted for 1/4-in. pipe..... | \$1 00 |
| Pipe extensions, 8-ft..... | 60 |
| Hose Reducers, fitted for 3/4-in. or 1/2-in. hose and 1/4-in. pipe..... | 25 |
| Brass Male Ends, fitted for 1/4-in. hose and 1/4-in. pipe..... | 30 |
| Brass Female Ends, fitted as above..... | 30 |
| Brass Hose Couplings, complete for 1/4-in. hose..... | 20 |
| Brass Hose Couplings, complete for 1/2-in. hose..... | 20 |
| Galvanized Steel Hose Clamps..... | 10 |

No. 305 Brass Spray Pump (281)

The construction of this pump is the very best possible, and we believe it is unequalled for the money. Bronze ball valve, with brass seat, the plunger is brass, with hemp packing, and it will handle hot, cold or any caustic mixture. Cylinder and discharge pipes are brass. The air-chamber is 30 inches long. Uniform and constant stream; pump sets inside the barrel, entirely submerged. Complete, including barrel, extension pipe, nozzle, mechanical agitator and 25 feet of hose all ready for work. There are lots of higher-priced pumps on the market than this one, but none better or more practical for general use. We have sold hundreds of them and they always give satisfaction, but we will gladly refund the money paid for one of these pumps if it should not prove satisfactory in every way. Price, complete, \$12. Without hose, \$10.

Knapsack Spray Pump, No. 331 (282)

FOR ORCHARD, VINEYARD OR GENERAL USE

The tank of this pump holds five gallons, is fitted with strainer, which can be removed. Operator can use it the same as a tank with bucket pump. Price, \$10.

No. 18 Lightning Tank Whitewasher (283)

For whitewashing hen-houses, stables, etc. The pump is fitted with hose and pipe, and has a nozzle that is guaranteed to spray whitewash without clogging. Price, \$5. Discount for cash, 25 cts.

Daisy Tin Force Pump (284)

This is a good low-priced force pump; used for sprinkling vines and shrubs also used for whitewashing and other similar uses. Made of tin and has two nozzles. Price, \$1.

Junior Hand Spray Pump (285)

This pump requires no fastening of any kind, holds itself down and works anywhere and everywhere. All the operator need do is to press the plunger down. It rises of itself, all upward stroke being made by a brass spring, forcing the cylinder apart. Will pump from a pail, barrel, tank, spring or creek. Weighs only four pounds and is ready for instant use everywhere. Will throw three sizes of solid continuous streams and two sizes of fine, round spray. Price, \$3. Discount for cash, 25 cts.

SEND FOR SPECIAL BEE SUPPLY CATALOG

The Rochester Self-Operating Sprayer (286)

The air enters the sprayer through the valve at bottom of pump, thoroughly agitating and mixing the contents of sprayer. The compressed air, being powerful, forces the liquid out through the outlet pipe, making either a fine spray or a solid, continuous stream as desired. This size machine holds from 3 to 4 gallons. Made of galvanized iron or brass. Price: galvanized iron, style G, \$5; brass, \$6.50. Discount for cash, 50 cts.

Brass Elbow (287)

Used for turning nozzle upward and spraying under side of low-growing plants. Price, 40 cts.

Brass Extension Pipe (288)

Brass pipe with quarter-inch standard cut threads, needed for elevating the nozzle in tree spraying, whitewashing, etc. Several can be screwed together when desired. Price, 3 ft. long, 40 cts.

The Spring Hose-Cock (288½)

A slight pressure of the thumb starts the spray. Remove it and the spray stops instantly. Under the old way of using an ordinary stop-cock and continuous spray more than half the solution was wasted. It fell in open spaces between foliage and was lost. With this new Spring Hose-Cock you use only enough fluid to do each branch, plant or vine. Price, \$1 each.

The Auto-Spray Pump No. 1 (289)

The "Auto-Spray" No. 1, works automatically for six to fifteen minutes, according to the nozzle opening. It may be charged in fifteen seconds by a few strokes of the plunger, and two pumpings will usually discharge the entire contents. Simply fill two-thirds full of solution and pump up air pressure. Diameter, 7 inches; height, 2 feet; capacity, 4 gallons; weight, empty, 8 lbs.; Price with stop-cock, \$8.50; discount for cash, 10 per cent.

AUTO HOSE COCK NO. 1. (290.) Price, \$1.25.

TWO ROW ATTACHMENT. (291.) Price, \$1.50.

TWO FOOT BRASS EXTENSION. (292.) Price, 50 cts.

BRASS ELBOW. (293.) Price, 50 cts.

Little Giant Brass Spray Pump (294)

For washing windows and sprinkling lawns where there is no water pressure. Has foot rest, best hose and spray nozzle. See illustration No. 269. Price, \$3.50. Discount for cash, 50 cts.

Rubber Atomizers (295)

Useful for sprinkling house plants and also for spraying hellebore and Bug Death. Either style of neck. Small size, 50 cts.; large size, \$1.

The Acme Atomizer (296)

Used largely for spraying cattle, with the different mixtures on the market, to keep off the flies; spraying Paris green and other insecticides on potato vines, shrubs, small trees, house plants, live stock and poultry. Price, tin, 50 cts., with brass cup, 75 cts.

The Handy Atomizer (297)

Used for same purpose as the Acme, only has a larger capacity. Price, with tin cup, 45 cts.; with brass cup, 75 cts.

Acme Powder Gun (298)

A simple, practical implement for the extermination of potato bugs and all kinds of insects, flies, etc., the pests of house and garden. Net price, single, \$1; double, \$1.50.

Improved Little Giant Duster (299)

Distributes all kinds of powder. Price, \$6.

The Brownie Duster (300)

Particularly useful for indoor, as well as outdoor work, wherever a dry powder is required. Price, \$4.

Champion Paris Green, or Dry Powder Gun (301)

For distributing dry insecticides and fungicides. Sure, rapid, safe, strong and cheap. Price, \$8. Discount for cash, 50 cts.

Dickey's Bug Death Duster (302)

The best as well as the cheapest shaker on the market. Price, 25 cts.

Pruning Saws (303)

The best hand-pruning saws ever made, either pull or push. Price, curved, two edges, 16-in., 60 cts.; 18-in., 75 cts. Straight, 16-in., 50 cts.; 18-in., 60 cts. One edge, 18-in., 60 cts.

Waters' Improved Tree Pruner (304)

| | | | |
|------------|--------|------------|--------|
| 4-ft..... | \$0 75 | 12-ft..... | \$0 95 |
| 6-ft..... | 80 | 14-ft..... | 1 20 |
| 8-ft..... | 85 | 16-ft..... | 1 25 |
| 10-ft..... | 90 | | |

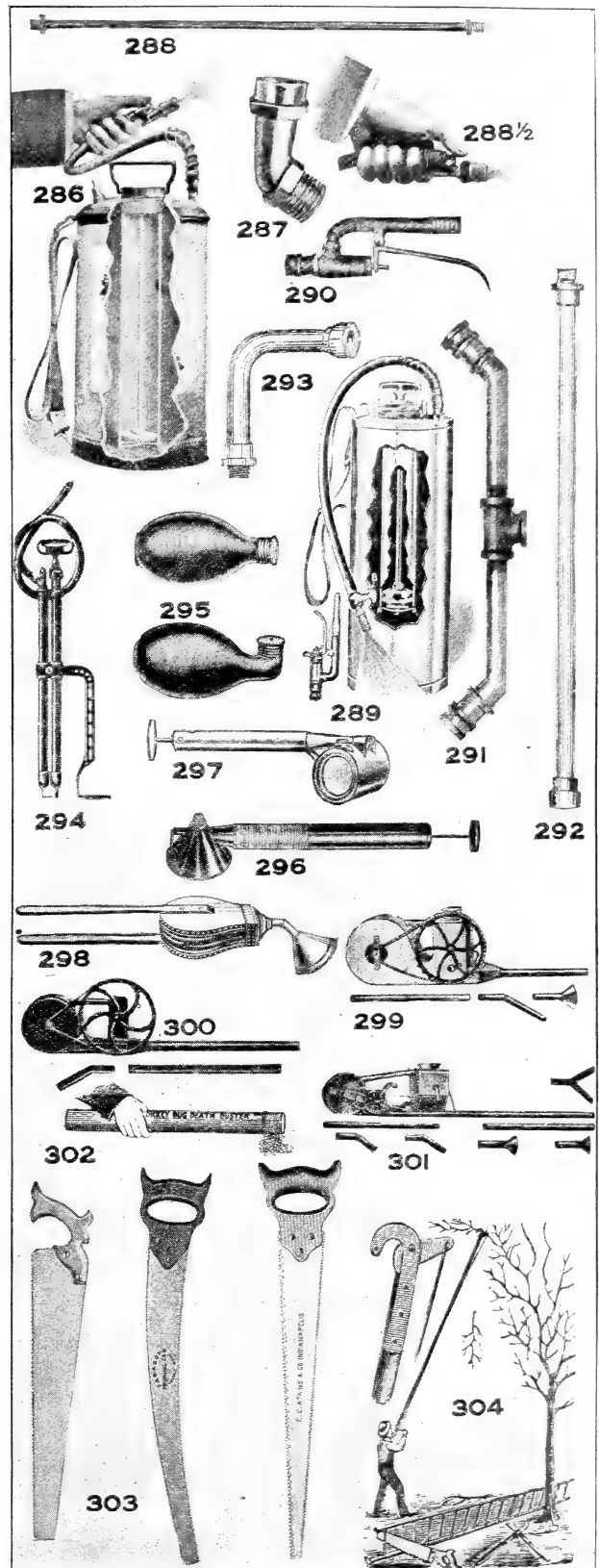

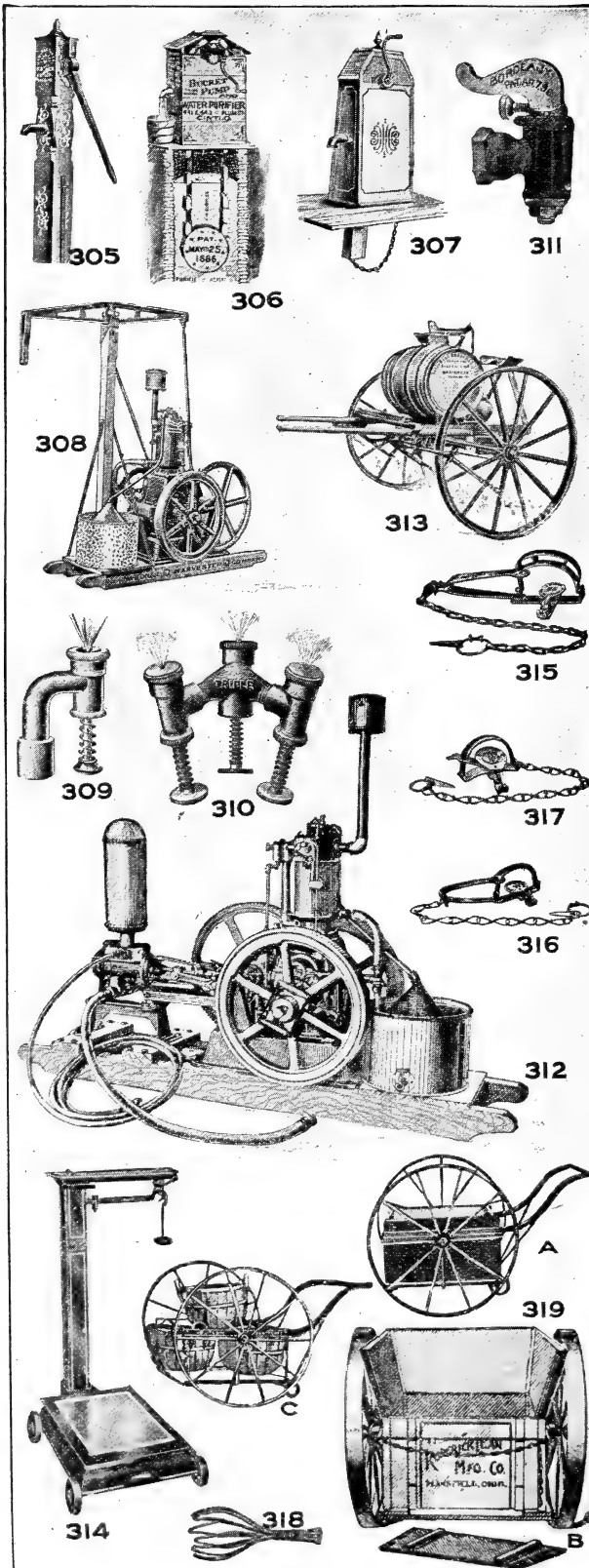

Furber Wood Pumps (305)

6 x 6 for house use. 7 x 7 for stock. 6 x 6 in. Stock, 3 1/2-in. bore for general use.

| | | | |
|-----------------------|----------|-------------------------|----------|
| Porcelain-lined | Un-lined | Porcelain-lined | Un-lined |
| 7-ft. long.....\$7 60 | \$6 10 | 12-ft. long.....\$10 60 | \$9 10 |
| 8-ft. long.....8 20 | 6 70 | 14-ft. long.....11 80 | 10 30 |
| 10-ft. long.....9 40 | 7 90 | 16-ft. long.....13 00 | 11 50 |

Use 4 x 4-inch pipe for above pumps. Price, 21 cts. per foot. Couplings and bands for the above, 50 cts. each.

7x7 in. stock, 4-in. bore—7 ft. long, porcelain-lined, \$9.75; unlined, \$8. 8 ft. long, porcelain-lined, \$10.75; unlined, \$9.

Use 4 1/2 x 4 1/2-inch pipe, 29 cts. per foot. Couplings and bands for the above, 60 cts. each, 25 per cent discount from list.

The Bucket Pump (306)

We will guarantee it to purify any well in five days, or we will refund the money. Price \$10 for the first ten feet of well. Each additional foot of well 50 cts. Discount for well less than 20 feet, 10 per cent; 20 feet and over, 20 per cent discount. Cash with order, 5 per cent extra. Wells over 40 feet deep require extra-heavy fixtures for which there is an extra charge of \$1.

Rubber Bucket Chain Pumps (307)

They are the best cheap pumps. Price, Curbs, \$2.50 each. Chain (3 ft. to 10 lb.), 10 cts. per lb. Wood Tubing, 10 cts. per ft. Rubber Buckets, 15 cts. each.

Famous Pumping Engine, Two-Horse Power (308)

Two-horse power vertical. Galvanized gasolene tank in base. Galvanized cooling tank. Substantial wooden base. Batteries, wrenches, lubricator and oil-cans. Price, as shown, \$135; discount for cash, 5 per cent.

IMPROVED VERMOREL NOZZLE WITH DEGORGER. (309.) Price, 85 cts.

TRIPLE VERMOREL NOZZLE. (310.) Price, \$2.

DOUBLE VERMOREL NOZZLE. (311.) Price, \$1.75.

BORDEAUX SPRAY AND SOLID STREAM NOZZLE. (311.) Especially recommended for use in connection with the Bordeaux mixture. Price, 85 cts.

Famous Spraying Engine and Double Acting Spray Pump (312)

TWO-HORSE POWER VERTICAL, WATER-COOLED

Revolutions per minute, 400. Diameter of fly-wheel, 24 inches. Face of fly-wheel, 2 1/2 inches. Capacity of gasolene tank, 2 1/2 gallons. Length of skids, 87 inches. Width of skids, 18 1/2 inches. Double-acting sprayer. Pump can be easily attached. Hose can be attached at either or both ends. Price, of engine and pump, as shown, \$175. Five per cent for cash.

Aspinwall Four-Row Sprayer (313)

Wider range of adjustment than any other sprayer on the market. Nozzles in front by which vines may be sprayed to the ends of rows; popular and successful. Compact and working parts easily accessible. Price, \$55; discount for cash, \$2.

American Scale (314)

The best medium-priced scale on the market. The pillars, caps and platform boards are of the best hardwood, finished in natural color. Every scale is carefully sealed to United States standard weights by competent workmen.

| Capacity | Beam graduated | Size of platform | Price |
|----------|----------------------|------------------|---------|
| 600 | 50 lbs. by 1/2 lbs. | 16 x 25..... | \$18 00 |
| 800 | 50 lbs. by 1/2 lbs. | 16 x 26..... | 20 00 |
| 1,000 | 100 lbs. by 1/2 lbs. | 17 x 26..... | 22 00 |
| 1,250 | 100 lbs. by 1/2 lbs. | 18 x 26..... | 27 00 |
| 1,500 | 100 lbs. by 1/2 lbs. | 19 x 28..... | 32 00 |

NEWHOUSE DOUBLE JAW TRAP. (315.) Double jaws prevent gnawing out. If you catch him you are sure to hold him. Best steel chain. Price, No. 91, 35 cts. each, \$3.50 per doz.; No. 31 1/2, 50 cts. each, \$5.75 per doz.

VICTOR TRAP. (316.) This is similar to the above, but has single jaws and is less expensive. Each trap has steel wire chain.

| | | | |
|------------------|--------|----------------------|--------|
| Each | Doz. | Each | Doz. |
| No. 0.....\$0 12 | \$1 20 | No. 1 1/2.....\$0 25 | \$2 50 |
| No. 1.....15 | 1 65 | No. 2.....30 | 3 30 |

JUMP TRAP. (317.) These traps are light in weight and easy to carry around. They lie very flat and are easily secreted.

| | | | |
|------------------|--------|----------------------|--------|
| Each | Doz. | Each | Doz. |
| No. 0.....\$0 15 | \$1 65 | No. 1 1/2.....\$0 25 | \$2 75 |
| No. 1.....20 | 2 00 | No. 2.....35 | 3 75 |

OUT-OF-SIGHT MOUSE AND RAT TRAP. (Not shown.) Best Rat-trap made. For rats, 20 cts.; for mice, 10 cts. Postpaid.

PEERLESS FRUIT-PICKERS. (318.) Price, 25 cts.

Butler Carts (319)

A.—Indispensable for the business man. Platform hangs low; rides level. Price, \$8.

B.—Sides and ends 12 inches high, extend upward and outward from the regular cart box. Capacity, 21 1/2 cu. ft., or about 14 bushels. Price, \$14.

C.—This can be used continuously around the farm, garden or house. Box 26 in. long, 25 in. wide, 15 in. deep inside. Capacity, 11 cu. ft. Price, \$9.50.

Economy Boilers (320)

No farmer can afford to be without a farm boiler or large kettle of some kind. The Economy, shown in the cut, is the cheapest of any on the market. Prices 33-gal., list \$14, net, \$9.75; 48-gal., list, \$16; net, \$11.50; 65-gal., list, \$20; net \$14.50. Other sizes furnished if desired.

National Cider Mill, Farmers' Size (321)

The grinding arrangement works in such a manner that the cells of the fruit are all broken and fine pomace produces more cider from a given quantity of apples than can be made by other mills. List price, \$26.50; net price, \$25.

Medium Farm Mill (322)

This is a good-sized mill for farmers' use. It is built with iron beam and heavy gearing and is perfectly adjustable for all kinds of fruit. Price, \$17. Discount for cash, \$1.50.

The Iamit Cider Mill (323)

The Iamit is a mill and press combined. It will grind apples, and you don't have to poke them into the discs. It cuts and scrapes the apples, thereby breaking all the cells. It will grind at the rate of one-half bushel per minute. Price, \$9. Discount for cash, 50 cts.

National Cider Mill, Family Size (324)

Especially adapted for family use, being light, strong and convenient. It is exactly the same in principle as the Farmers' Mill, only of smaller size and sold at a less price. The mill will pay for itself in one season, by gathering the windfalls, and making them into cider for vinegar and for market. This is just the size for that purpose. Two curbs, list price, \$18.50; net price, \$17.

Junior Cider Mill (325)

It runs very easily and is well worth the difference in price over the Iamit, as it has two curbs and a grinder of larger capacity. Price, \$17.50. Discount for cash, \$3.

Wine and Lard Presses (326)

Seven sizes adapted for all uses.

| No. | Curb Inside | Screw | Price |
|--------------------|-------------|--------|--------|
| No. 1 | 10½ x 8½ | 1 in. | \$5 25 |
| No. 2 | 12½ x 12 | 1½ in. | 6 50 |
| No. 3 | 15 x 13 | 1½ in. | 9 50 |
| No. 3½, iron beam | 16 x 15 | 2 in. | 15 25 |
| No. 4, iron beam | 17 x 16 | 2 in. | 22 50 |
| No. 4, iron geared | 17 x 16 | 2 in. | 27 00 |
| No. 5, iron geared | 20 x 18 | 2½ in. | 36 00 |

Famous Sawing Outfits (327)

STEEL TRUCK (Mounted with 6-Horse Power Famous Horizontal Engine)

The Famous sawing outfit consists of a Famous engine mounted on a portable steel saw truck which carries a saw. This makes a very convenient outfit as it may be readily transported to any desirable location, and when sawing is done it can be quickly moved.

The steel saw truck is the same for three sizes of Famous saw outfits—3-, 4- and 6-horse power. This steel-truck includes a tilting table wood saw frame, belt-tightener, seat and seat-springs, doubletree and neckyoke. The truck is very substantial and neat-appearing so that the Famous outfit is one of the most attractive on the market.

Prices: Mounted as shown (327) with 6. H. P. Famous Engine—

| | |
|----------------------|----------|
| Including 20-in. saw | \$402 00 |
| Including 22-in. saw | 403 00 |
| Including 24-in. saw | 404 00 |
| Including 26-in. saw | 405 00 |
| Including 28-in. saw | 406 00 |

Liberal discount for cash. Can furnish 4 H. P. or 8 H. P. engine if wanted.

International Famous Gasolene Engines on Skids (327½)

Made in all sizes for all kinds of work

The development of the gas engine is the result of the necessity for a power which is more convenient, practical, adaptable and economical than hand-, horse-, wind-, water-, steam- or electrical-power. Although the prevailing impression in the mind of the general public is that the internal combustion engine is a comparatively recent invention, quite the opposite is actually the case, for internal combustion engines were introduced almost 100 years before steam engines. With the introduction of steam, however, the efforts of scientific men and inventors were directed to the development and application of this power, with the result that the development of the internal combustion engine was allowed to remain practically at a standstill. It was not until 1860 that the first really practical internal combustion engine was brought out. Since then its advancement has been remarkably rapid and today the I H C Gasolene engine stands at the head of them all. Never take chances in buying a cheap engine—though you may save a few dollars at purchase, the cost will be greater in the long run.

Prices:

| | |
|--|----------|
| 6 H. P. Famous, with skids | \$345 00 |
| 8 H. P. Stationary or Famous, less skids | 385 00 |
| 8 H. P. Famous, with skids | 415 00 |
| 8 H. P. Hoisting, with drum | 700 00 |
| 10 H. P. Stationary | 500 00 |
| 12 H. P. Stationary | 590 00 |
| 15 H. P. Stationary | 700 00 |
| 20 H. P. Stationary | 890 00 |
| 25 H. P. Stationary | 1250 00 |

Above prices include any size Plain Pulley required.

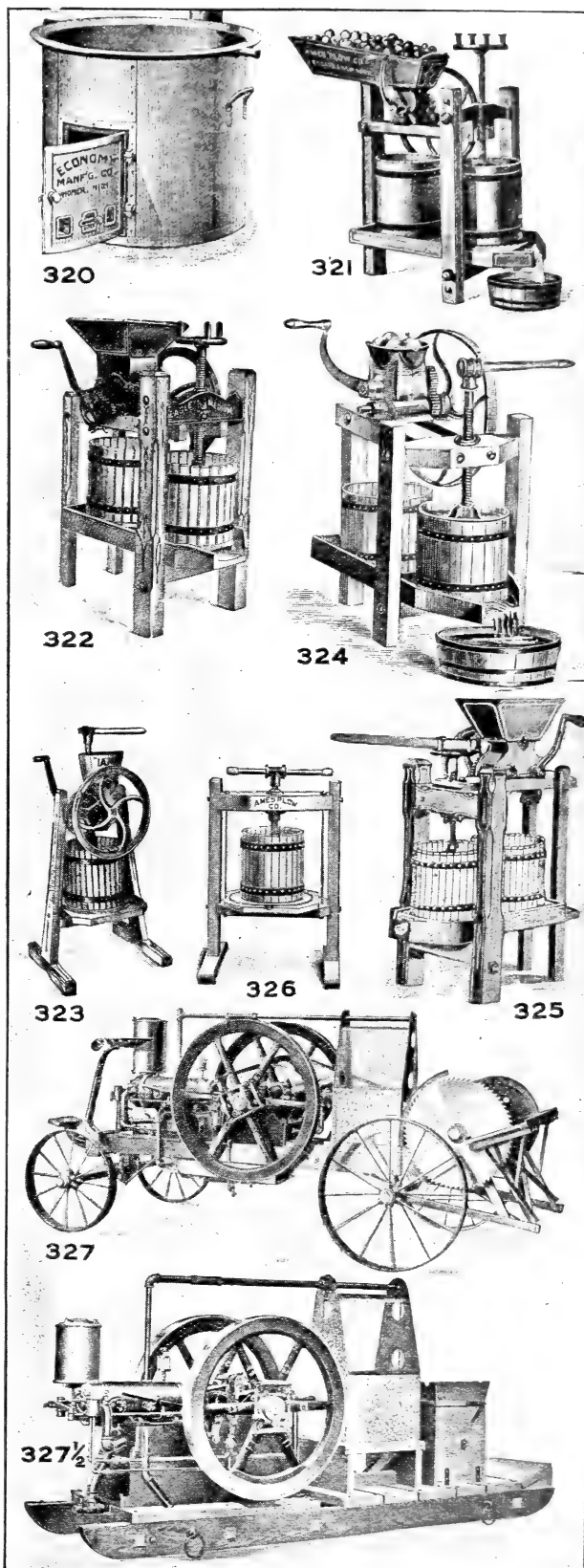

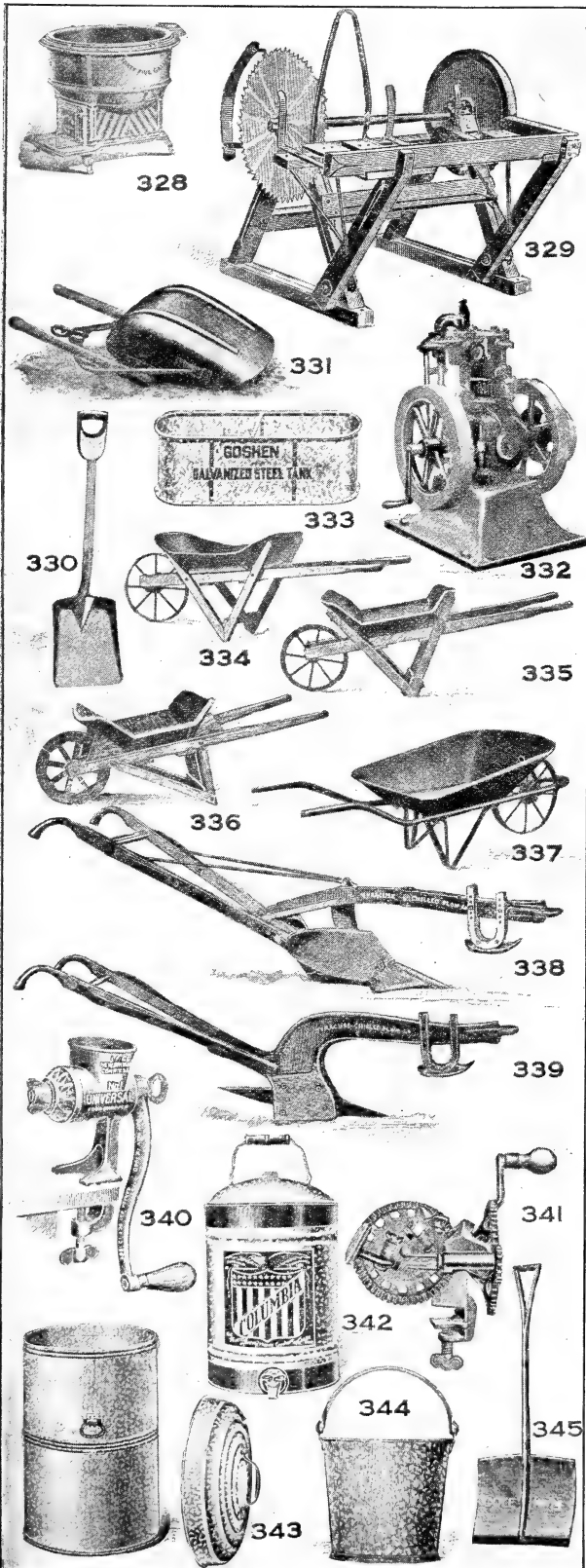

Peckham Caldrons (328)

An indispensable article on any farm. Seven sizes.
 Style 15 gal. 22 gal. 30 gal. 45 gal. 60 gal. 90 gal. 120 gal.
 ½ bbl. ¾ bbl. 1 bbl. 1½ bbl. 2 bbl. 3 bbl. 4 bbl.
 Furnace and Caldron, wood.....\$12 25 \$15 25 \$18 75 \$21 75 \$25 00 \$44 00 \$57 50
 Caldron..... 3 50 4 50 5 25 7 00 8 00 15 00 21 50
 Cover, extra..... 1 25 1 75 2 00 2 25 2 50 4 00 5 50

Ross Tilting Table Wood and Pole Saws (329)

All saws are made to drop wood on right-hand side unless otherwise ordered.
Tilting Table Wood Saws. Prices: 20-in., \$40; 22-in., \$42.50; 24-in., \$45; 2½-in., \$47.50; 28-in., \$50. Discount, 40 per cent; 5 per cent, cash with order.
Tilting Table Pole Saws. Prices: 20-in., \$47.50; 22-in., \$50; 24-in., \$52.50; 26-in., \$55; 28-in., \$57.50; Discount, 40 per cent; 5 per cent, cash with order.
 Ask for price on Sliding Table Saws.

Shovels (330)

The following are all Ames' Make.

| | Each | Doz. |
|--|--------|---------|
| No. 2, Ames' Special D handle, square..... | \$1 15 | \$12 00 |
| No. 2, Ames' Special, D handle, round..... | 1 15 | 12 50 |
| No. 2, Our Best, D handle, square..... | 90 | 8 00 |
| No. 2, Our Best, D handle, round..... | 90 | 8 25 |
| No. 3, Our Best, D handle, square..... | 95 | 8 25 |
| No. 3, Our Best, D handle, round..... | 95 | 8 50 |
| No. 2, Sunnyside, D handle, square..... | 80 | 7 50 |
| No. 2, Sunnyside, D handle, round..... | 85 | 7 75 |
| For Nos. 3, 4, 5 and 6, add 5 cts. each | | |
| No. 2, Champion Strapped Back, D handle, square..... | 65 | 7 00 |
| No. 2, Champion Strapped Back, D handle, round..... | 65 | 7 00 |
| Black finish, 25 cts. per dozen less. | | |
| Steel Bars 14, 16, 18 and 20 lbs., per lb., 5 cts. | | |

Boss Steel Scraper, with Runners (331) Pressed Steel Bowl

| | | | |
|------------------------------------|---------|-----------------------------------|--------|
| No. 0 carries 10 ft. of earth..... | \$14 00 | No. 3 carries 3 ft. of earth..... | \$6 00 |
| No. 1 carries 7 ft. of earth..... | 7 00 | No. 0 Riveted bowl..... | 10 00 |
| No. 2 carries 5 ft. of earth..... | 6 50 | | |

Greendale Gasolene Engine (332)

This engine has the simplest and most effective self-starter of any gasolene engine made. It starts instantly, without any exertion on the part of the operator. No mechanical parts to wear out, and always ready for use. It also has an automatic friction pulley, very simple and substantially made. With this pulley, the engine is free to start, but takes up the load gradually. The Greendale is made here in Worcester, by thoroughly reliable parties. It has been well tested and we can recommend it with perfect confidence to our customers as being a first-class machine.

| Horse-power | Price | Discount | Horse-power | Price | Discount |
|-------------|----------|----------|-------------|----------|----------|
| 3½ | \$175 00 | \$17 50 | 7 | \$300 00 | \$30 00 |
| 5 | 250 00 | 25 00 | 15 | 445 00 | 45 00 |

At these prices, we furnish a man to set up and start.

Goshen Round- and Square-End Steel Tanks (333)

For stock or towers. Send for complete price-list. We can also furnish any size or style of tank, either set up or flat. Send for complete list with discount.

| No. | Width | Height | Length | Capacity | Price |
|-----|--------|--------|--------|-----------|--------|
| 101 | 2 ft. | 2 ft. | 4 ft. | 3½ bbls. | \$7 00 |
| 102 | 2 ft. | 2 ft. | 5 ft. | 4½ bbls. | 8 70 |
| 103 | 2 ft. | 2 ft. | 6 ft. | 5½ bbls. | 10 25 |
| 104 | 2 ft. | 2 ft. | 7 ft. | 6½ bbls. | 11 25 |
| 105 | 2 ft. | 2 ft. | 8 ft. | 7½ bbls. | 12 25 |
| 106 | 2 ft. | 2 ft. | 10 ft. | 9½ bbls. | 15 00 |
| 107 | 2 ft. | 2½ ft. | 8 ft. | 9½ bbls. | 14 00 |
| 108 | 2½ ft. | 2 ft. | 8 ft. | 9½ bbls. | 13 00 |
| 109 | 2½ ft. | 2 ft. | 10 ft. | 12 bbls. | 16 80 |
| 110 | 2½ ft. | 2½ ft. | 8 ft. | 12 bbls. | 15 00 |
| 111 | 3 ft. | 2 ft. | 8 ft. | 11½ bbls. | 14 00 |
| 112 | 3 ft. | 2 ft. | 10 ft. | 14 bbls. | 17 50 |
| 113 | 3 ft. | 2½ ft. | 8 ft. | 14 bbls. | 16 00 |
| 114 | 3 ft. | 2½ ft. | 10 ft. | 18 bbls. | 20 00 |
| 115 | 3 ft. | 3 ft. | 10 ft. | 21 bbls. | 23 75 |
| 116 | 4 ft. | 2 ft. | 8 ft. | 15 bbls. | 18 00 |
| 117 | 4 ft. | 2 ft. | 10 ft. | 19 bbls. | 21 50 |
| 118 | 4 ft. | 2 ft. | 12 ft. | 22 bbls. | 25 75 |
| 119 | 4 ft. | 2 ft. | 14 ft. | 26 bbls. | 29 50 |
| 120 | 4 ft. | 2 ft. | 16 ft. | 30 bbls. | 34 00 |
| 121 | 4 ft. | 2½ ft. | 8 ft. | 17 bbls. | 20 00 |
| 122 | 4 ft. | 2½ ft. | 10 ft. | 24 bbls. | 24 00 |
| 123 | 4 ft. | 2½ ft. | 16 ft. | 38 bbls. | 38 00 |

KLONDIKE STEEL TRAY BARROW. (334.) The tray is one piece of sheet steel. Legs all bolted and made of best material; steel wheel and steel tray. Price, \$2.75 each.

COMMON BOLTED DUMP BARROW. (335.) The legs and braces are bolted, has a good wood wheel, with iron-bound hub, and, with the exception of our Contractor's Favorite, is the best dump made. Price, \$1.75 ea., \$19 per doz.

DUMP OR CONTRACTOR'S FAVORITE BARROW. (336.) Without doubt the strongest and most durable dump barrow on the market. Either wood or steel wheel. Price, wood wheel, \$2 each, \$22 per doz.; steel wheel, \$2.15 each, \$23 per doz.

TUBULAR STEEL BARROW. (337.) Tubular steel barrow, with pressed steel bowl, and steel frame; double braced and made for heavy work. 3 cu. ft. Price, \$5 each.

CONTRACTOR'S ROAD PLOW NO. 99. (338.) Price, \$35; discount, 20 per cent.

CONTRACTOR'S PAVEMENT PLOW No. 98. (339.) Price, \$25; discount, 20 per cent.

Universal Chopper (340)

| | |
|--|--------|
| No. 0, Small Family..... | \$1 00 |
| No. 1, Medium Family..... | 1 25 |
| No. 2, Large Family..... | 1 50 |
| No. 3, Extra Large Family, or Hotel..... | 1 75 |
| No. 344, Meat Market Internal Back Geared..... | 5 50 |

We also carry a full line of Enterprise Choppers.

ROCKING TABLE APPLE PARER. (341.) No kitchen complete without this handy article. 65 cts. each.

Oil Cans (342)

| | |
|-----------------------------------|--------|
| Home Rule, 5-gal. Pump can..... | \$1 15 |
| Climax, 5-gal. pump can..... | 1 00 |
| Banner, 5-gal. faucet can..... | 85 |
| Columbia, 5-gal. faucet can..... | 75 |
| Quaker, 5-gal. faucet can..... | 65 |
| Worcester, 1-gal. faucet can..... | 20 |

GALVANIZED ASH CANS. (343.) A galvanized, never-rust ash can or garbage can and cover is a necessity. Our No. 5 can is almost indestructible. Can with cover (18 x 26 in.), \$2.50.

Galvanized Iron Pails (344)

We have two grades of galvanized pails. These never-rust pails are strong sellers.

| | | | |
|-------------------------|--------|-------------------------|--------|
| Light grade, 10-qt..... | \$0 25 | Heavy grade, 12-qt..... | \$0 40 |
| Light grade, 12-qt..... | 30 | Heavy grade, 14-qt..... | 45 |
| Light grade, 14-qt..... | 35 | | |

SNOW SHOVELS. (345) All styles and sizes. Boys', 10 cts. and 15 cts. Men's, 25 cts., and 50 cts.

The Hustler Ash Sieve (346)

Rightly named, for it does the work in half the time with no dust or noise and with very little work.

| | |
|---|--------|
| No. 1 Family size..... | \$4 25 |
| No. 2 Large furnace size..... | 6 00 |
| No. 1 Complete with galvanized ash can..... | 6 00 |

Children's Carts (347)

We carry all styles and sizes. Small enough for the little tot to one that will carry half a ton; from 50 cts. each to \$6.

Sleds (348)

Sleds for boys and girls, 50 cts. to \$2.10.

Children's sleighs and sled boxes.

A full line of the famous Flexible Flyers—the sled that steers—the fastest on the hill.

Wood Saws (349)

| | |
|--|--------|
| No. 102, 32-in., Simonds Best Saw, blade 2 gauges thinner on back, warranted in every way..... | \$1 15 |
| No. 103, 32-in., dark hardwood frame..... | 85 |
| No. 104, Natural finish..... | 1 00 |
| No. 04..... | 50 |

Horse Brushes (350)

Horse Brushes from 50 cts. to \$4 each.

Cut shows No. 194. Warranted brush, \$3.

MANE BRUSHES. (351.) From 25 cts. to \$1 each.

BUSH HOOK. (352.) A bush hook or chopper fitted with 36-in. handle that is almost indispensable for cleaning up small bushes, etc., around the walls and other inaccessible places. Bill Hooks similar to bush hooks only very short iron handle. Bill Hook, \$1.10; Bush Hook, \$1.

BAG HOLDER. (353.) Patent Bag Holder and Funnel Combined. Is the simplest and most convenient arrangement for holding bags when being filled with grain or anything ever put in bags. \$3.50 each.

AXLE GREASE. (354.) Snowflake Grease, once used always used. Convenient and handy. 1-qt. can, 25 cts. each. 2-qt. can, 40 cts. each; 4-qt. can, 75 cts. each.

Grass Hooks (355)

| | |
|--------------------------------|--------|
| Nolins Socket Grass Hook..... | \$0 25 |
| Nolins Shank Grass Hook..... | 30 |
| Nolins Concave Grass Hook..... | 50 |

BROOMS. (356.) We have a No. 9 Heavy Barn Broom made specially for durability, 75 cts. each.

A full line of house brooms from 30 cts. to 60 cts. each.

HOG TROUGHS. (357.) Shape case iron hog troughs and nearly the price of wood troughs and will never wear out. 4 ft., \$2.10 each; 5 ft., \$2.50 each.

Baskets

| | |
|---|--------|
| 4-bus. Hickory Strapped Splint Basket..... | \$3 00 |
| 3-bus. Hickory Strapped Splint Basket..... | 2 50 |
| 2-bus. Hickory Strapped Splint Basket..... | 1 50 |
| 1½-bus. Hickory Strapped Splint Basket..... | 1 25 |
| 1-bus. Hickory Strapped Splint Basket..... | 75 |
| 1-bus. Hickory Splint Basket..... | 65 |
| ¼-bus. Plain (Drop handle) Basket..... | 45 |
| ¼-bus. Plain (Drop handle) Basket..... | 35 |

Covered Lunch Baskets from small size No. 7 at 30 cts. each, to No. 1, large size, 65 cts.

Market Baskets (see cut).

| | |
|--|--------|
| No. 1, 6 x 11 x 18 (rattan strapped)..... | \$0 30 |
| No. 2, 6½ x 12 x 20 (rattan strapped)..... | 35 |
| No. 3, 7 x 11 x 22 (rattan strapped)..... | 40 |
| No. 4, 7½ x 14 x 24 (rattan strapped)..... | 45 |

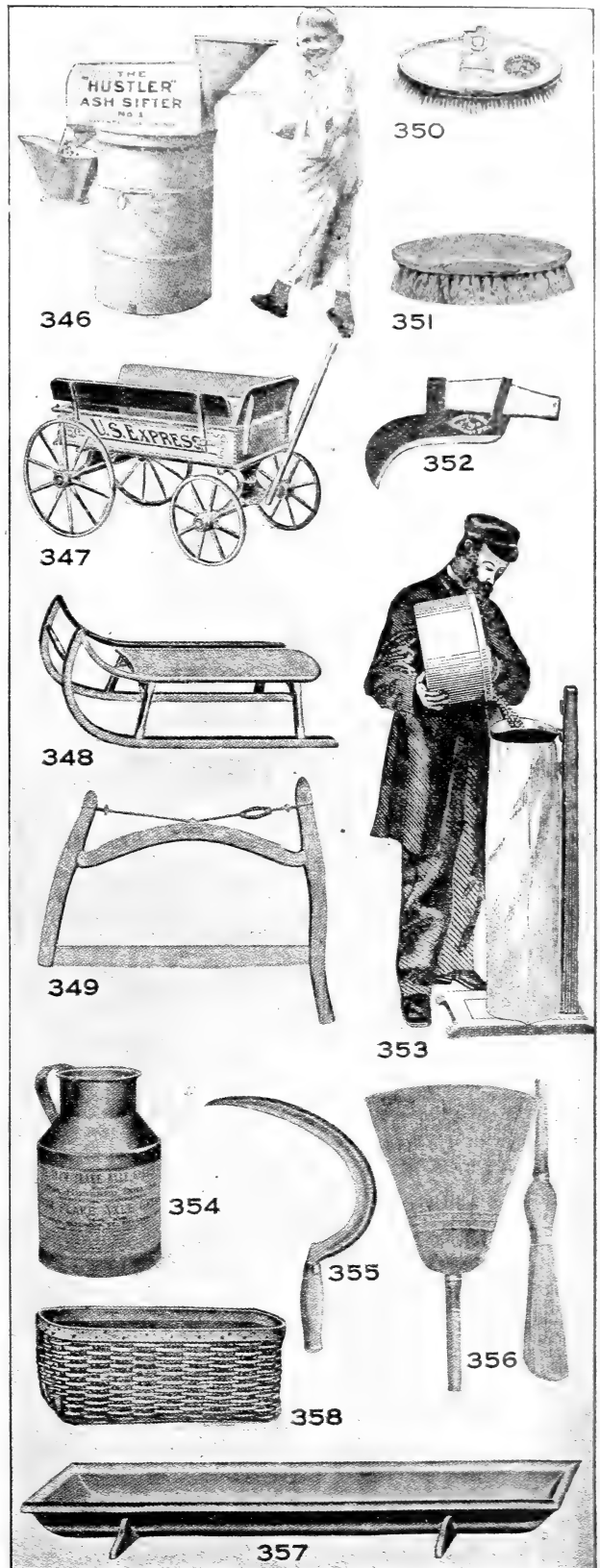

INDEX. Farm, Garden and Flower Seeds, Bulbs and Plants

| PAGE | PAGE | PAGE | PAGE |
|----------------------------------|-------------------------|--|---------------------------|
| Abronia.....32 | Canterbury Bells.....34 | Forage Crops.....27 | Lobelia.....41 |
| Achillea.....32 | Carnation.....35 | Forget-me-not.....38 | Love-in-a-Puff.....34 |
| Acroelinium.....32 | Carrot.....13 | Four O'Clock.....38 | Lupin.....41 |
| Adlumia.....32 | Castor Bean.....35 | Foxglove.....38 | Lychnis.....41 |
| Adonis.....32 | Cauliflower.....13 | Garlandia.....38, 39 | Madeira Vine.....50 |
| Ageratum.....32 | Celery.....14 | Geranium.....39 | Mangel-Wurzels.....11 |
| Agrostemma.....33 | Celery.....14 | Gilliflower.....46 | Marigold.....34, 41 |
| Alyssum.....33 | Celosis.....35 | Gladioli.....52 | Martynia.....17 |
| Amarantus.....33 | Centaurea.....36 | Globe Amaranth.....39 | Mesembryanthemum.....40 |
| Ampelopsis.....33 | Chervil.....13 | Gloxinia.....39 | Mignonette.....41 |
| Anemone.....33 | Chrysanthemums.....36 | Godetia.....39 | Millets.....29 |
| Anthesis.....33 | Cinnamon Vine.....50 | Gomphrena.....39 | Minimus.....41 |
| Antirrhinum.....33 | Clarkia.....36 | Gourds.....39 | Moonflower.....41 |
| Aquilegia.....33 | Clovers.....29 | Grass Seeds.....28, 29, 30 | Morning Glory.....36, 41 |
| Arabis.....33 | Cobaea.....36 | Gumbo.....18 | Mushrooms.....17 |
| Arctotis.....33 | Cockscomb.....35 | Gypsophila.....39 | Muskmelon.....18 |
| Aristolochia.....33 | Coleus.....36 | Helanium.....39 | Mustard.....17 |
| Asparagus.....8 | Collinsia.....36 | Helianthus.....46 | Myosotis.....38 |
| Asperula.....33 | Columbine.....33 | Helichrysum.....39 | Nasturtium.....42 |
| Asters.....31, 32 | Convolvulus.....36, 41 | Heliopsis.....39 | Nemophila.....42 |
| Baby's Breath.....39 | Coreopsis.....36 | Heliotrope.....39 | Nicotiana.....43 |
| Balloon Vine.....34 | Corn.....2-5 | Herbs, Sweet, Pot or Medi- cinal.....25 | Nigella.....43 |
| Balsam.....34 | Corn Salad.....13 | Heuchera.....39 | Oats.....27 |
| Barley.....27 | Corn, Sweet.....15 | Hollyhocks.....40, 53 | Okra.....18 |
| Beans.....9, 10 | Cosmos.....36 | Hop.....40 | Onion.....19 |
| Beans, Ornamental.....34 | Cow-peas.....27 | Humulus.....40 | Pansies.....43 |
| Beans, Soy or Soja.....27 | Cress.....13 | Hunnemannia.....40 | Pansy Plants.....53 |
| Beets.....11 | Cucumber.....16 | Iberis.....35, 40 | Parsonip.....21 |
| Begonias, Tuberous-rooted.....50 | Cucumber Vine.....36 | Ice Plant.....40 | Peas.....20 |
| Bellis.....34 | Cyprus Vine.....36 | Ipomoea.....36, 40, 41 | Peas, Canada Field.....27 |
| Borecole.....16 | Dahlias.....37, 51 | Iris.....53 | Peony.....50 |
| Brachycome.....34 | Daisy.....34, 37 | Kale.....16 | Pepper.....21 |
| Browallia.....34 | Dandelion.....13 | Kochia.....40 | Pepper Grass.....13 |
| Brussels Sprouts.....8 | Delphinium.....37 | Kohlrabi.....16 | Perennials.....53 |
| Buckwheat.....27 | Dianthus.....37, 38, 46 | Kudzu Vine.....40 | Petunia.....43 |
| Bulbs.....50-53 | Digitalis.....38 | Lantana.....40 | Phlox.....43, 53 |
| Cabbage.....12 | Dolichos.....38 | Larkspur.....37 | Pinks.....37, 38 |
| Caladium.....50 | Eggplant.....16 | Lathyrus.....40 | Platyocodon.....44 |
| Calendula.....34 | Endive.....16 | Lavender.....40 | Polemonium.....44 |
| Calliopsis.....34 | Echscholtzia.....38 | Lawn Grass Seed.....6, 7 | Poppy.....38, 44 |
| Campanula.....34 | Euphorbia.....38 | Leek.....16 | Portulaca.....44 |
| Canary-bird Flower.....35 | Fetticuis.....13 | Lettuce.....17 | Potatoes, Seed.....22 |
| Candytuft.....35, 40 | Flax, Scarlet.....40 | Linum.....40 | Primula.....45 |
| Cannas.....50 | Flower Seeds.....31-49 | | Pueraria.....40 |

Implements, Tools, Insecticides, Fertilizers and General Farm Requisites

| | | | | |
|------------------------------------|--------------------------------|--------------------------------|-----------------------------------|--|
| American Field Fence.....72 | Cutter, Ensilage.....70 | Hooks, Grass.....87 | Pots, Watering.....79 | Snap, Harness.....69 |
| Arsenate of Lead.....78 | Lever.....69 | Hopper, Food.....73 | Poultry Food.....76, 77 | Snaths.....80 |
| Atomizers.....83 | Power.....70 | Hose.....79 | Fountains.....73 | Soap, Whale Oil.....78 |
| Axes.....80 | Root.....69 | Hose, Poultry.....75 | Meal.....77 | Sowers, Fertilizer.....60 |
| Bags, Feed.....69 | Diggers, Post Hole.....80 | Ice Tools.....80 | Presses, Wine and Lard.....85 | Seed.....61 |
| Bands, Leg.....74 | Drills, Seed.....64 | Incubators.....75 | Print, Butter.....71 | Sprayers.....82, 84 |
| Baskets, Berry.....80 | Dryers, Clothes.....80 | Insecticides.....77, 78 | Probe, Lead.....72 | Spreaders.....60 |
| Baskets.....87 | Dusters.....83 | Instruments, Veterinary.....72 | Pruners.....83 | Sprinklers.....79, 81 |
| Boilers.....85 | Eggs, Nest.....77 | Jacks, Wagon.....68 | Pullers, Stump.....62 | Stanchions.....68 |
| Bone, Granulated.....77 | Engine, Gasoline.....85, 86 | Knife, Poultry Killing.....74 | Pump, Spray.....82, 83, 84 | Sticks, Plant.....79 |
| Bordeaux, Dry and Liquid.....78 | Extinguishers, Fire.....81 | Knives.....81 | Well.....84 | Stone Boat and Head.....60 |
| Bottles, Milk.....71 | Feeders, Calf.....69 | Asparagus.....79 | Punch, Harness.....69 | Swings.....81 |
| Box, Egg.....74 | Chick.....73 | Kow Kure.....77 | Rack, Corner.....69 | Tanglefoot, Tree.....77 |
| Boxes, Butter.....71 | Salt.....69 | Lactometer.....71 | Tool.....67 | Tanks.....86 |
| Box, Feed.....69 | Fence, Poultry.....72 | Lanterns.....79 | Raffia.....81 | Tar, Coal.....78 |
| Box, Live Chickens.....73 | Field.....72 | Lice Killers.....77 | Rakes, Hand.....79, 80 | Tedders.....66 |
| Bracket, Roost.....74 | Fertilizer.....54, 55 | Litter, Rock.....62 | Horse.....67 | Testers.....70, 74 |
| Brooders.....75 | Lawn.....54 | Marker, Row.....61 | Rape Seed.....27 | Thermometers.....71, 74, 79 |
| Brooms.....80, 87 | Pulverized Sheep Manure.....55 | Marker Poultry.....74 | Reels, Garden Line.....80 | Ties.....80 |
| Brushes, Horse.....87 | Fire Extinguishers.....81 | Mats, Hotbed.....79 | Hose.....79 | Timothy.....28 |
| Bug Death.....78 | Fish, Dry Ground.....77 | Mender, Hose.....79 | Rice, Unhulled.....77 | Tobacco Dust, Soap and Stems.....78 |
| Buncher, Asparagus.....79 | Fly Killer.....77 | Mills, Cider.....85 | Rings, Bull.....80 | Tongs.....80 |
| Caldrons.....86 | Food, Wyandotte Chick.....77 | Mold, Butter.....71 | Rollers.....65 | Tools, Ice.....88 |
| Calf Cordial.....77 | Scratch.....77 | Mowers.....66 | Lawn.....80 | Tools, Fence.....72 |
| Cans, Ash.....87 | Mash.....77 | Lawn.....81, 82 | Netting.....72 | Tools, Fece.....72 |
| Caponizing Tools.....74 | Forage Seeds.....27 | Nozzles.....79, 84 | Nozzles.....79, 84 | Trafs.....84 |
| Caps, Bottle.....71 | Forks.....79, 80 | Oil, Machine.....66 | Oyster Shells.....77 | Trellis.....79 |
| Cards, Cattle.....80 | Fountain, Poultry.....73 | Paddy.....77 | Pail, Stable.....69 | Troughs, Hog.....87 |
| Carriers, Bottle.....71 | Freezers.....80 | Pails.....71, 86 | Pans, Seed.....81 | Trowel.....72 |
| Carriers, Butter.....71 | Grass Catcher.....82 | Pars, Apple.....87 | Paris Green.....78 | Tubes, Milking.....72 |
| Carriers, Egg.....73 | Grinder, Knife.....67 | Paris Food.....76 | Parrot Food.....76 | Tubs, Plant.....80 |
| Carriers, Hay.....68 | Grinders, International.....70 | Peas, Canada Field.....76 | Cracked.....77 | Turner, Egg.....73 |
| Carts, Butler.....68 | Gristmill, Kelley.....69 | Pickers, Fruit.....84 | Pilling's Caponizing Tools.....74 | Twine, Binder.....66 |
| Charcoal, Cracked.....76 | Grit.....77 | Planer, Jr. Tools.....64, 65 | Planters.....61 | Veterinary Instruments.....77 |
| Chemicals.....54 | Guard, Flower Bed.....79 | Plows.....56, 57, 65, 86 | Plows, Ice.....80 | Wagon, Handy.....66 |
| Chopper.....87 | Guard Tree.....79 | Potatoes.....22 | Potato.....62 | Ware, Galvanized.....73 |
| Churns.....71 | Harrows.....57-59 | Potatoes.....22 | Potato.....62 | Washers.....80 |
| Colony House.....74 | Heaters, Tank.....86 | Sleds.....87 | | Watering Device.....68 |
| Cooler, Milk.....71 | Hellebore.....78 | | | Watering Pots.....79 |
| Coops.....73 | Hemp Seed.....77 | | | Weeders.....65, 79, 81 |
| Corn, Cracked.....77 | Hiller, Celery.....65 | | | Weight, Hitch.....69 |
| Corn, Kafir.....76 | Hoes, Hand.....65, 79, 80 | | | Wheelbarrows.....82, 86 |
| Cow Tone.....77 | Horse.....59, 62, 63 | | | Whitewashers.....82 |
| Crate, Egg.....74 | Hooks, Cant.....80 | | | Wickets.....80 |
| Cultivators.....59, 60, 62, 63, 65 | | | | Workers, Butter.....71 |
| Cutters, Horse.....73 | | | | Wrench.....80 |
| Clover.....73, 74 | | | | |

I AM OFTEN ASKED "WHAT IS THE BEST POULTRY BOOK?"
Here it is! *Brigham's* "Progressive Poultry Culture"

P I wish all my friends to have this book. It is
Scientific and Practical, Helpful and Sensible



CASH COUPON

ROSS BROS.

VALUE 50 CENTS



AGAIN THE INQUIRY IS: "WHAT IS THE BEST POULTRY PAPER?"

Here is the
Answer --

N. E. Poultry Journal

It is absolutely
all right!

Use this Coupon and get the Best Book (\$1.50) and One Year's Subscription to
the Best Paper (\$.50) all for the price of the Book. *Do it now!* (OVER)



ROSS BROS. CO., Seedsmen, Worcester, Mass.

I enclose \$1.50 and wish to take advantage of the Combination Offer detailed on the other side of this Coupon. Please send me Dr. Brigham's new book

PROGRESSIVE POULTRY CULTURE

*And enter my name for One Year's Subscription (\$.50) to
NEW ENGLAND POULTRY JOURNAL*

Name

P. O.

State

THIS CERTIFICATE IS WORTH 25 CENTS

25

PUBLISHERS
OF THE

FARM WORLD

CHICAGO,
ILLINOIS.

25

SEND US NAMES OF A FEW OF YOUR FRIENDS
WHO MIGHT LIKE TO SEE THE FARM WORLD.

Enclose TWENTY-FIVE CENTS for which send me
THE FARM WORLD regularly EACH MONTH for TWO YEARS.

It is understood that if I do not admit it to be as good
in every respect as any other farm paper I know of
(no matter at what price) that you will return the
25 cents to me at any time without question upon
my request to do so.

Name _____ R. F. D. No. _____

P. O. _____ State _____

CANADIAN SUBSCRIPTIONS 20 CENTS EXTRA. ENCLOSE COIN OR STAMPS AND
THIS CERTIFICATE IN A STRONG ENVELOPE ADDRESSED TO THE FARM WORLD, CHICAGO, ILL.

25

OUR PREMIUM LIST TO CLUB RAISERS WOULD INTEREST YOU

25

THE OFFER BELOW MAKES THIS CERTIFICATE WORTH 25 CENTS

A BARGAIN FOR YOU

Knowing its excellence and that our friends would like to receive into their homes a paper that we can highly recommend, we have made arrangements with the VICKERY & HILL PUBLISHING CO., publishers of THE FARM WORLD, to send it for TWO YEARS at a special rate to you of twenty-five cents if you use this certificate.

THE FARM WORLD is filled with more practical, original, human interest reading matter than any other farm paper published.

It always goes to its readers with clean pages. It inserts no medical, liquor or fraudulent advertising. It has from 20 to 25 well edited departments each issue. It is a helper, counselor and friend to the farmer in every part of the United States. It is full of optimism, progress and confidence, and intensely interesting, and instructive to every member of his family.

Mail this certificate with 25 cents direct to THE FARM WORLD, Chicago, Ill.

ROSS BROS. CO., Worcester, Mass.

9025-CHICAGO

READ THE PUBLISHERS AGREEMENT ON OTHER SIDE



From
Town
State



ROSS BRO'S Co.,
Worcester,
Mass.

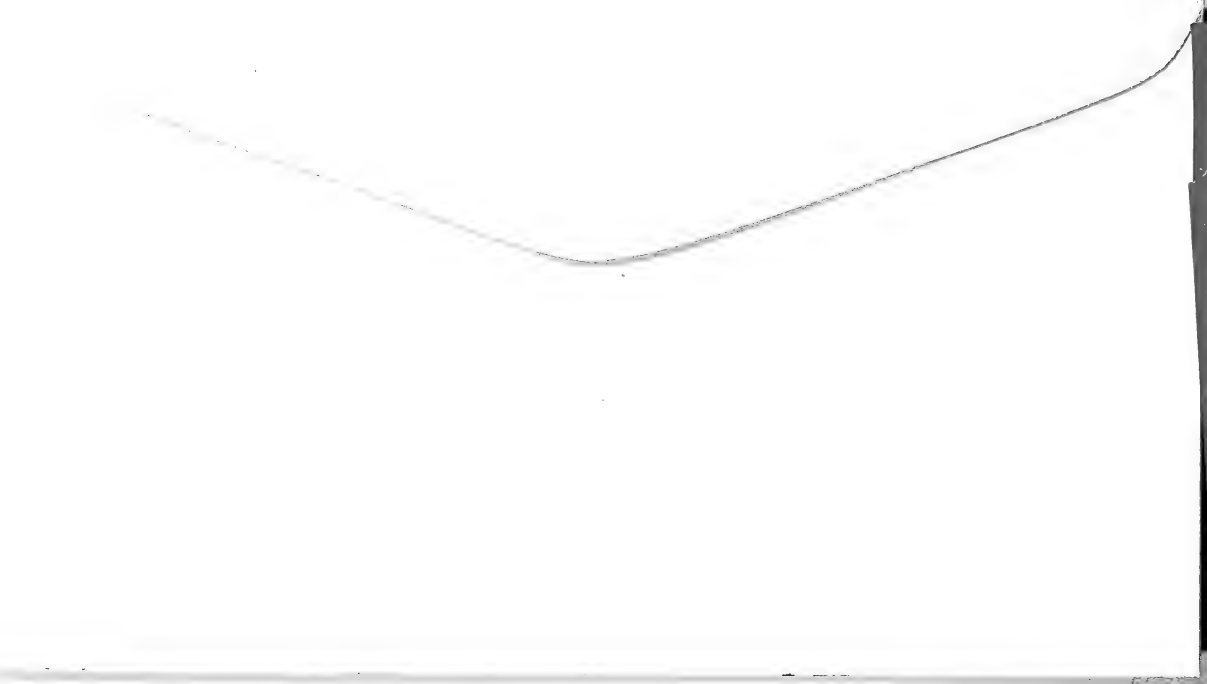

THE WESTERN STAR

ROSES

PLACE
POSTAGE
STAMP
HERE

James C. [unclear]

From _____

Address _____

A

EVERY HOME IN AMERICA SHOULD HAVE AT LEAST ONE ROSE.

COMPLETE FLOWER GARDEN FOR ONLY \$1.25.

ORDER A FEW FOR YOUR FRIENDS

HAVE YOU ORDERED GRASS SEED, PRUNING SHEARS, PLANT FOOD, INSECTICIDES? (See Page 129)

REFER TO PAGE 118 OF 1911 SPRING CATALOG

Or a New Self-Watering Flower Box.

GLANCE THROUGH OUR CATALOG AGAIN BEFORE YOU SEAL THIS.

ORDER SHEET FOR ROSES AND PLANTS

The
Conard & Jones Co.

“West Grove Floral Nurseries”
 WEST GROVE, PA.

PLEASE DO NOT WRITE HERE

Name (Very plain) _____
 P. O. Box or Street _____ R. F. D. No. () _____
 Post Office _____
 County _____ State _____
 Express Office (If different from P. O.) _____

PLEASE READ “Information for Purchasers,” on page 8, before you order, to prevent misunderstanding.

Date, _____ 1911

AMOUNT ENCLOSED

NOTE If you wish orders held until a certain time please write the date here
 (otherwise goods will be forwarded just as soon as stock is ready or when we think the season suitable for planting outside in your locality.)

§ _____
 (State whether Cash, Draft, P. O. Order, Express Money Order or Stamps.)

State whether by **MAIL** or **EXPRESS**

We deliver free to any Post Office or Express Office in the United States or its possessions, everything ordered from this catalog at our “postpaid” or “prepaid” rates; (regarding Canadian and Foreign Shipments, see page 8).
 *Goods offered “by Express” (unless otherwise stated) we do not deliver free, but send with Express Charges collect, unless you remit enough with your order to cover cost of transportation, as per schedule foot of page 8.

| QUANTITY | Please keep your Plant Orders separate from your Seed and Bulb Orders. ARTICLES WANTED For ordering Special Offers, please see and use next page of Order Sheet. | Page in Catalog | PRICE |
|----------|---|-----------------|-------|
| 7 | <i>Cover Page Combination Offer 11a</i> | 11 | |
| | | | |
| | | | |
| | | | |
| | | | |
| | | | |
| | | | |
| | | | |
| | | | |
| | | | |
| | | | |
| | | | |
| | | | |
| | | | |
| | | | |
| | | | |
| | | | |
| | | | |
| | | | |
| | | | |
| | | | |

*Add here amount to prepay express charges on 2-year-old plants. See schedule at foot of page 8.

IF ANY ITEM IS OUT OF STOCK **May We Substitute?** _____ Yes or No **Amount carried over** _____

ORDER SHEET FOR SEEDS AND BULBS

The Conard & Jones Co.

West Grove, Pa.

Name (Very plain) _____
P. O. Box or Street _____ **R. F. D. No.** () _____

Post Office _____

County _____ **State** _____

Express Office (If different from P. O.) _____

PLEASE READ "Information for Purchasers," on page 8, before you order, to prevent misunderstanding.

Date, _____ **1911**

AMOUNT ENCLOSED

NOTE All seed and bulb orders will be forwarded as soon as possible after we receive them, as the purchaser can keep this stock safely until planting time.

Seed orders are all sent by mail, postpaid.
 Bulb orders are mailed postpaid also, unless bulbs are ordered by the hundred at express price.
 See shipping instructions for plants on plant order sheet.

\$ _____
 (State whether Cash, Draft, P. O. Order, Express Money Order or Stamps.)

We deliver free to any Post Office or Express Office in the United States or its possessions, everything ordered from this catalog at our "postpaid" or "prepaid" rates; (regarding Canadian and Foreign Shipments, see p. 8) *Goods offered "by Express" (unless otherwise stated) we do not deliver free, but send with Express Charges collect, unless you remit enough with your order to cover cost of transportation, as per schedule foot of page 8.

| QUANTITY | Catalog Number | ARTICLES WANTED <small>Please use this sheet for your Seed and Bulb Orders only.</small> | Page in Catalog | PRICE |
|----------|----------------|---|-----------------|-------|
| | | | | |
| | | | | |
| | | | | |
| | | | | |
| | | | | |
| | | | | |
| | | | | |
| | | | | |
| | | | | |
| | | | | |
| | | | | |
| | | | | |
| | | | | |
| | | | | |
| | | | | |
| | | | | |
| | | | | |
| | | | | |
| | | | | |
| | | | | |
| | | | | |

IF ANY ITEM IS OUT OF STOCK **May We Substitute?** Yes No **Amount carried over**

30 DAYS' FREE TRIAL

Our new Self-Watering Flower Boxes any size you wish for Window Box, Porch Box or Hanging Basket. Prices, \$1.00 and up, and we can furnish plants to make them a thing of beauty and a joy for years. (The sub-irrigation principle makes them a splendid thing in which to start your seeds indoors.) See sizes and prices pages 76 and 130 and send for one so you can see for yourself their value. (See page 130, or circular on request.)

THEY ARE GUARANTEED NOT TO LEAK

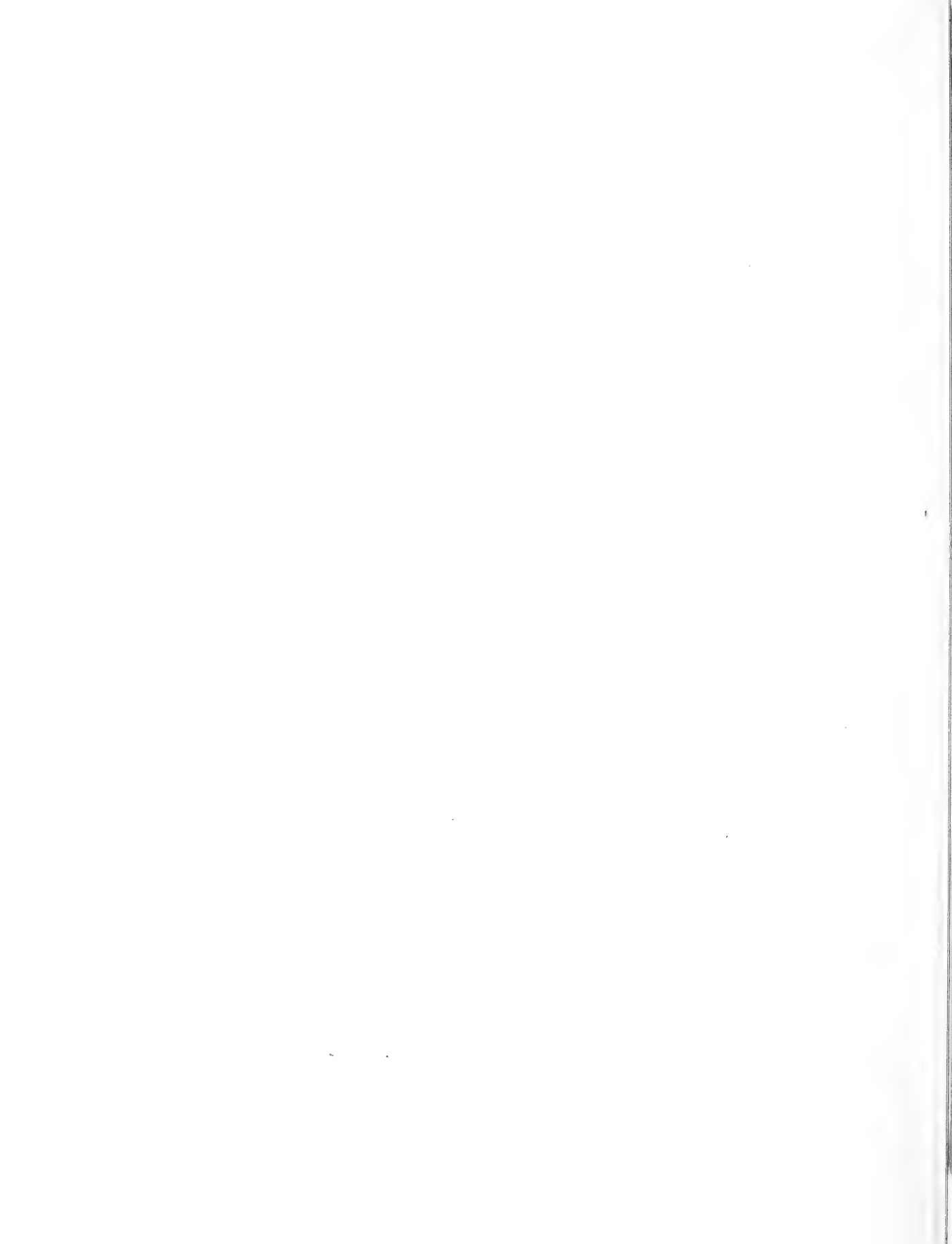

ORDER SHEET FOR SPECIAL OFFERS

You are almost sure to want some of these special value collections, which for your convenience in ordering we have numbered (see catalog). These are money-saving sets. Please order by number and carry out price as shown below.

| QUANTITY | Amount brought over | \$ | |
|-----------------------------------|---------------------|--------------------|--|
| | OFFER NUMBER | Page in Catalog | |
| " | " | | |
| " | " | | |
| | | | |
| | | | |
| | | | |
| | | | |
| | | | |
| | | | |
| | | | |
| | | | |
| | | | |
| | | | |
| | | | |
| | | | |
| | | | |
| | | | |
| | | | |
| | | | |
| | | | |
| | | | |
| | | | |
| | | | |
| | | | |
| | | | |
| | | | |
| TOTAL FOR ROSES AND PLANTS | | | |

WYANDOTTES FROM PRIZE-WINNING STOCK

WHITE, BUFF AND COLUMBIAN EGGS FOR SETTING



With eggs at 50 cents per dozen for six months of the year, every one with facilities should keep poultry, and certainly no farmer can afford to neglect this important branch of farming; both poultry and eggs are bringing good prices and there is always a ready market. With the help of an incubator and brooder, and feeding our foods, the cost of raising poultry is reduced to a minimum; one of the leading breeds and, in our opinion, the best general-purpose breed, is the Wyandotte. They are good winter layers and will bring the highest price in any market. The White Wyandotte cockerel at the head of our best pen won first prize at the Worcester Poultry show last winter, the only show where he was exhibited, as we do not make a practice of following the shows. Our Buff and Columbian Wyandottes are from the best stock in New England.



| | Setting of 13 eggs | Two settings | For incubator 100 |
|---------------------------------|--------------------|--------------|-------------------|
| WHITE WYANDOTTES, from best pen | \$3 00 | \$5 00 | |
| " " " " from utility pen | 2 00 | 3 50 | \$6 00 |
| BUFF WYANDOTTES | 2 00 | 3 50 | |
| COLUMBIAN WYANDOTTES | 2 00 | 3 50 | 6 00 |

DAY-OLD CHICKS

Parties who have no proper place for operating an incubator can buy their chicks and brooder of us, and in that way can get an early start. We have arranged with reliable parties to supply us this coming season, and, while we cannot count the chicks until they are hatched, we feel confident that we can supply the demand, if our customers will place their orders early, but we must fill them in the order in which they are received. Orders will be booked at any time for future



delivery, and we earnestly request our customers to order three weeks in advance, if possible.

We can furnish the following chicks: White Plymouth Rocks, Rhode Island Reds, White Wyandottes. Price for March delivery, \$18 per 100; April and May delivery, \$15 per 100. Special price by the 1,000. To start beginners in the business, we will sell, after April 1, one No. 3 Peep O'Day brooder, regular price, \$8.50, and 50 chicks for \$15.

Number of feet of drill which can be sown, or number of plants produced from a given quantity of seed

Asparagus. 1 oz., 60 feet of drill, 200 to 300 plants
Beans, Dwarf. 1 qt., 100 feet of drill.
Beans, Pole. 1 qt., 150 hills.
Beet. 1 oz., 50 feet of drill.
Cabbage. 1 oz., 2,500 to 3,000 plants.
Cauliflower. 1 oz., 2,500 to 3,000 plants
Celery. 1 oz., 3,000 to 4,000 plants.
Corn. 1 qt., 200 hills.
Corn Salad. 1 oz., 100 feet of drill.
Cress. 1 oz., 150 feet of drill.
Cucumber. 1 oz., 50 hills.
Dandelion. 1 oz., 200 feet of drill.
Eggplant. 1 oz., 1,000 plants.
Endive. 1 oz., 150 feet of drill.

Kale. 1 oz., 200 feet of drill.
Kohlrabi. 1 oz., 200 feet of drill.
Leek. 1 oz., 100 feet of drill.
Lettuce. 1 oz., 3,000 to 4,000 plants
Martyria. 1 oz., 50 feet of drill.
Melon, Musk. 1 oz., 60 hills.
Melon, Water. 1 oz., 30 hills.
Mustard. 1 oz., 40 feet of drill.
Nasturtium. 1 oz., 50 feet of drill.
Onion. 1 oz., 100 feet of drill.
Onion Sets. 1 qt., 50 feet of drill.
Parsley. 1 oz., 100 feet of drill.
Parsnip. 1 oz., 100 feet of drill.
Pepper. 1 oz., 1,500 to 2,000 plants.

Peas, small-seeded varieties. 1 qt., 150 feet of drill, 1 1/2 bushels per acre.
Peas, large wrinkled. 1 qt., 100 feet of drill, 1 1/2 bushels per acre.
Pumpkins 1 oz., 12 to 18 hills.
Radish. 1 oz., 100 feet of drill.
Salsify. 1 oz., 50 feet of drill.
Spinach. 1 oz., 50 feet of drill.
Squash, Summer. 1 oz., 30 to 40 hills.
Squash, Winter. 1 oz., 12 to 15 hills, 3 to 4 pounds per acre.
Tomato. 1 oz., 2,000 plants.
Turnip. 1 oz., 150 feet of drill.

Weight per bushel of Grass, Grain and Field Seeds, and quantities required per acre

Several varieties of grasses following are unsuitable for growing alone (see descriptions in general list); the quantities indicated may, however, aid in determining the amount required when used in mixtures.

| GRASS SEEDS— | Per bus. | Per acre |
|--------------------------------|----------|------------|
| Creeping Bent | 15 lbs. | 30 lbs. |
| Crested Dog's-Tail | 30 " | 30 " |
| Blue Grass, Canada | 14 " | 40 " |
| Blue Grass, Kentucky | 14 " | 40 to 50 " |
| Fine-leaved, or Slender Fescue | 22 " | 35 " |
| Hard Fescue | 20 " | 30 " |
| Italian Rye Grass | 22 " | 30 " |
| Meadow Fescue | 16 " | 30 " |
| Meadow Foxtail | 9 " | 40 to 50 " |
| Orchard Grass | 14 " | 40 to 50 " |
| Red, or Creeping Fescue | 24 " | 30 " |
| Red-Top, Common | 14 " | 50 to 60 " |
| Red-Top Extra Clean | 36 " | 50 " |
| Rhode Island Bent | 14 " | 50 " |
| Rough-stalked Meadow | 26 " | 20 " |
| Sheep's Fescue | 16 " | 35 " |

| GRASS SEEDS, continued | Per bus. | Per acre |
|------------------------|----------|------------|
| Tall Fescue | 22 lbs. | 40 lbs. |
| Tall Meadow Oat | 12 " | 50 " |
| Timothy | 45 " | 25 to 40 " |
| Various-leaved Fescue | 15 " | 40 " |
| Wood Meadow | 19 " | 30 " |
| MILLETS— | | |
| German, or Golden | 50 " | 40 to 50 " |
| Hungarian | 48 " | 48 " |
| Japanese | 35 " | 15 " |
| Siberian | 50 " | 40 to 50 " |
| CLOVER— | | |
| Alfalfa | 60 " | 15 to 25 " |
| Alsike | 60 " | 15 " |
| Crimson | 60 " | 20 " |
| Medium Red | 60 " | 15 to 20 " |
| Mammoth | 60 " | 15 to 20 " |

| GRAIN— | Per bus. | Per acre |
|-----------|----------|--------------|
| Barley | 48 lbs. | 2 to 3 bus. |
| Buckwheat | 48 " | 1 to 1 1/2 " |
| Oats | 32 " | 2 1/2 to 3 " |
| Rye | 56 " | 1 to 1 1/2 " |
| Wheat | 60 " | 1 to 1 1/2 " |

| MISCELLANEOUS SEEDS FOR FORAGE OR GRAIN CROPS— | Per bus. | Per acre |
|--|----------|----------------|
| Corn Ensilage | 56 " | 3 to 4 " |
| Corn, Sweet Fodder | 56 " | 1 to 1 1/2 " |
| Corn, Flint | 56 " | 8 to 12 qts |
| Peas, Canada Field | 60 " | 1 to 1 1/2 bus |
| Peas, Cow | 60 " | 1 to 1 1/2 " |
| Vetches | 60 " | 1 to 1 1/2 " |
| Rape, Dwarf Essex | 56 " | 4 to 8 lbs. |

Number of Plants, Trees, etc., required to set an acre

| Distance | Number | Distance | Number | Distance | Number | Distance | Number |
|-------------------|--------|-------------------|--------|-----------|--------|-------------|--------|
| 1 x 1 ft. | 43,560 | 2 1/2 x 2 1/2 ft. | 6,970 | 4 x 4 ft. | 2,722 | 10 x 10 ft. | 434 |
| 1 1/2 x 1 1/2 ft. | 19,360 | 3 x 1 ft. | 14,520 | 5 x 5 ft. | 1,742 | 25 x 25 ft. | 302 |
| 2 x 1 ft. | 21,780 | 3 x 2 ft. | 7,260 | 6 x 6 ft. | 1,210 | 15 x 15 ft. | 194 |
| 2 x 2 ft. | 10,890 | 3 x 3 ft. | 4,840 | 8 x 8 ft. | 680 | 18 x 18 ft. | 134 |
| | | | | | | 20 x 20 ft. | 103 |
| | | | | | | 25 x 25 ft. | 70 |
| | | | | | | 30 x 30 ft. | 40 |
| | | | | | | 40 x 40 ft. | 27 |

Weight per bushel of various articles

| Lbs. | Lbs. | Lbs. | Lbs. | Lbs. | | | | | |
|---------------|------|-------------|------|---------------------------------|----|-----------------|----|--------------------------------|-----|
| Apples | 48 | Bran | 20 | Cranberries | 40 | Salt, Coarse | 50 | Potatoes | 60 |
| Apples, Dried | 22 | Corn on Ear | 70 | Irish Potatoes. Heaping measure | 60 | Sweet Potatoes. | 56 | Beef and Pork. Per barrel, net | 200 |
| Barley | 48 | Corn Meal | 50 | Onions | 54 | Turnips | 58 | Flour. Per barrel, net | 196 |
| Broom Corn | 46 | Charcoal | 22 | | | Oats | 32 | | |

ROSS BROS. CO.
WORCESTER, MASS.

FARM AND GARDEN SEEDS
FARM MACHINERY AND
FERTILIZERS

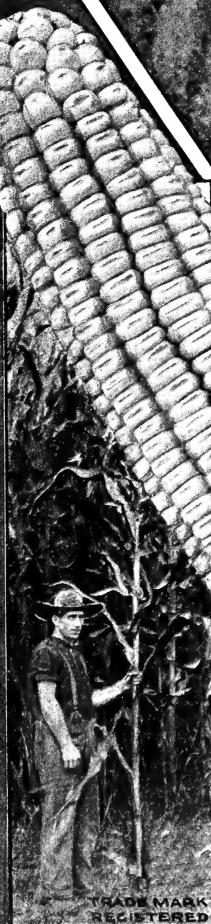

A FORTY-ACRE FIELD OF
EUREKA ENSILAGE CORN
GROWN BY L. F. GOULD
SO. FRAMINGHAM, MASS., 1910