

Historic, Archive Document

Do not assume content reflects current scientific knowledge, policies, or practices.

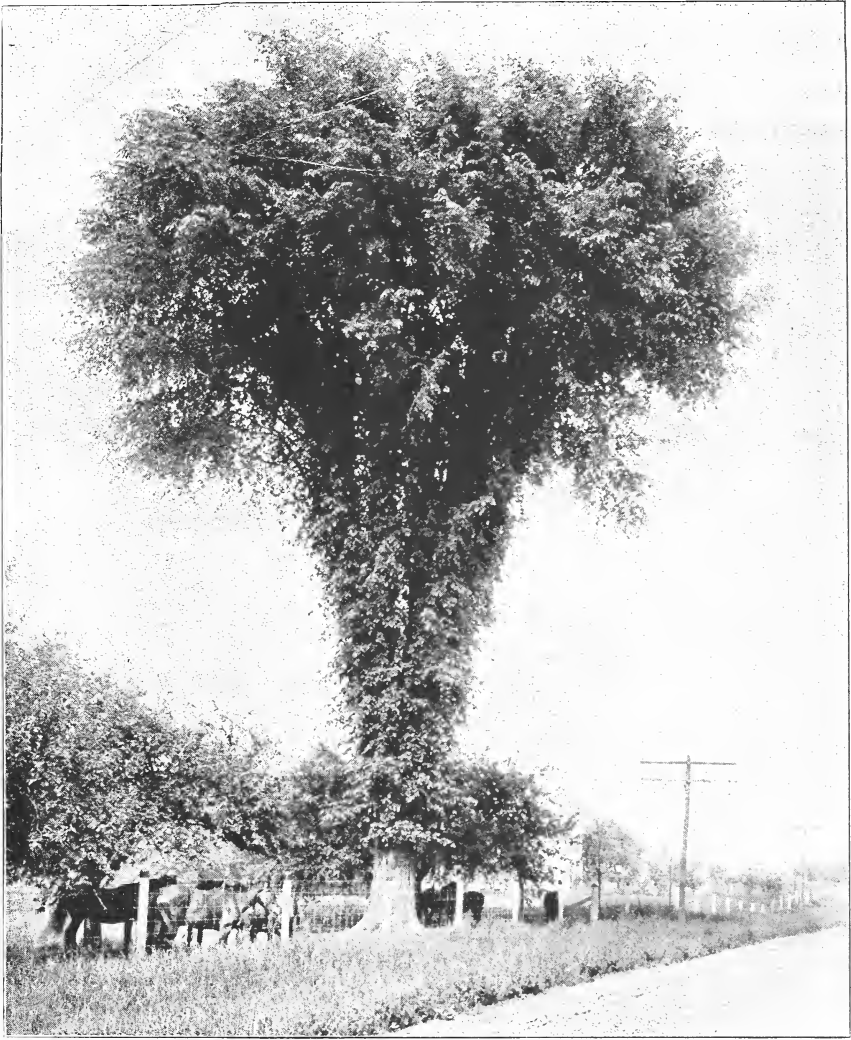



1916

1917

CATALOG
OF THE
MUNSON NURSERIES

ESTABLISHED 1876
FORTY YEARS OF RELIABLE DEALING

DENISON

TEXAS

Economic and Systematic Botany
ANSWERED NOV 7 1916

Foundations of American Grape Culture

By
T. V. MUNSON,
Denison, Texas

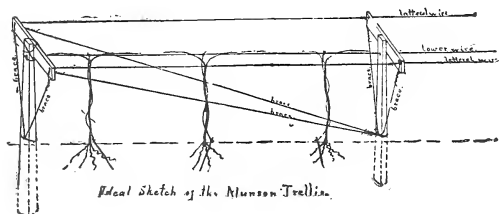

The Best Work on Grapes Published in the United States

This magnificent book is a monument that will perpetuate the memory of one who spent his noble life in the study of this fascinating subject, the Grape. It was indeed fortunate that the author put together in book form the results of his life work. Had he delayed it five years longer from the date of its publication (1908) the world would have been the loser.

This work has taken its place as the best book on grape culture in America, as is evidenced by the many highly complimentary testimonials from men who stand high in the viticultural world, as well as botanists, vineyardists, and amateur grape growers.

The book is strongly bound in buckram, with beautiful title on cover, embossed in gold. It is printed upon fine glazed paper, giving most beautiful, clear impressions of type and halftone full page engravings, 90 in number, 252 pages in all, 7½x10 inches. The book contains 8 chapters upon the different divisions of the subject, as follows: I. Botany of American Grapes. II. Breeding of Varieties of Grapes. III. Description of Varieties. IV. Adaptation of Varieties. V. How to Start a Vineyard, including Trellising, Pruning, Training, etc. VI. Protecting the Vineyard from Insects and Fungi. VII. Disposition of the Crop. VIII. The Grape for Home Adornment, Shade, Fruit and Health.

The book securely packed will be sent by parcels post or express prepaid to any part of the United States, Canada, Mexico, Cuba and Porto Rico, for \$2.00. To European countries, and other countries of the Postal Union, the book will be sent by registered mail prepaid for \$2.25.

We have put in pamphlet form Chapters V and VI of this book. These two chapters are on the Culture of the Grape. This pamphlet is furnished free to purchasers of grape vines to the amount of \$2.00 or more. See offer under "Grapes," page 18. The pamphlet alone, 20 cents; the complete book, \$2.00.

Address

T. V. MUNSON & SON
Publishers

INTRODUCTORY

To Our Numerous, Intelligent, Discriminating Customers:

It is with pleasure we hand you this our 1916-17 Catalog of THE MUNSON NURSERIES. We are grateful to our many friends and customers for their support in the past. It will be our purpose and aim to improve on the past, and we will be thankful for the continued support of all our old customers as well as many new ones.

THE FOLLOWING CAREFUL, TRUTHFUL DESCRIPTIONS are of far more value in making successful selections than would be the grandest set of pictures that could be executed. Therefore, study the descriptions, and preserve this Catalog, for it will be found a most valuable horticultural work of reference. Our methods of propagation are those pursued by the largest, most intelligent, and most successful planters of commercial orchards.

OUR VARIETIES

Our policy is to grow as few varieties of each class of fruit as will cover the entire season with suitable and choice varieties. In doing this we have retained the very best. There is not a poor or indifferent variety in our list; you can depend on that. There are many varieties so nearly alike that to retain all would be a burden upon our customers, the horticultural interests and ourselves, so in compiling our lists we have dropped all of the so-near-alike sorts except the one or two which we consider the best.

IN SOME CASES varieties heretofore included in our Catalog are omitted. Some of these are dropped, as others included are better for the same season, and of some we have no stock to offer this year; such may be inserted when we again have stock of them. Please do not order varieties not named in this Catalog.

WHILE WE HAVE A REPUTATION FOR MAKING A SPECIALTY OF GRAPES we have by no means neglected other departments or classes of fruits in our line of business. All have had the same vigilant care in testing, selecting, and propagation, so that we will be found up with the times in all things.

IN OUR EXPERIMENTAL DEPARTMENT we systematically test all new, very promising varieties as they come out, and ourselves originate numerous varieties of grapes, plums, persimmons, etc. By carefully combining the best strains and testing for a series of years in various localities, we from time to time introduce those proving superior to others in cultivation of the same season.

NO AGENTS

We employ no traveling or resident agents. We deal direct with all and each of our customers. By this method we save our customers from 25 to 80 per cent over prices agents are compelled to charge in order to maintain themselves. By our method of direct dealing our customer can order at any time as best suits him and the stock comes carefully packed in an individual bale or box direct from the nursery, and the customer is not bothered with annoyance of being solicited out of season with agents who oftentimes carry highly exaggerated pictures or samples in magnifying jars. Also our customers are not required to receive their stock on a certain "delivery day," which oftentimes comes when the customer is not prepared to receive stock or comes in the very worst of weather.

Those who claim to be our agents are frauds, and when we learn of such frauds, using our reputation to gain orders, we will publish them for protection of our customers and ourselves. Also beware of agents of other nurseries who circulate false and damaging reports about our nurseries and business, such as "they busted up," "sold out," "gone out of business," etc.

OUR CATALOG

while not large and showy as some, is nevertheless full of valuable information, and we ask its careful reading throughout. The careful, truthful, though brief, descriptions are of far more value in making successful selections than would be the grandest set of more or less exaggerated pictures. Therefore study the descriptions and preserve this Catalog.

OUR SHIPPING FACILITIES

in every direction from Denison are most excellent. We have the following railways:

Missouri, Kansas & Texas Ry., operating American Express.
Houston & Texas Central Ry., operating Wells Fargo Express.
Texas & Pacific Ry., operating Wells Fargo Express.
Frisco System, operating Wells Fargo Express.
Missouri, Oklahoma & Gulf Ry., operating Wells Fargo Express.
Texas Traction Company, operating Electric Express.

T. V. MUNSON & SON,
DENISON, TEXAS

HORICULTURAL INFORMATION

We receive many inquiries about Horticultural matters, some of which to properly answer would require several pages of letter writing and much time in searching the information with which to make answer. We are glad to give our customers all the information possible, but the questions are so numerous we find it impossible to answer all in the little time that we can spare from looking after the proper filling of our customers' orders, as we give the careful propagation and the growing of stock for our customers the first consideration. To assist our customers as much as possible we have here listed, after careful examination, the following books upon horticultural matters. We will take pleasure in ordering any of these or other horticultural and agricultural books for our customers at the publishers' prices. We do not keep the books in stock here, but same will be mailed direct to you from the publishers. By so doing we are enabled to obtain these books at a less price to our customers than if we carried them in stock. Cash must accompany the order. No discounts.

Nearly every one of these books is profusely illustrated.

FRUITS AND FRUIT CULTURE

A B C of Strawberry Culture, The. T. B. Terry	\$ 0.50
American Apple Orchard, The. F. A. Waugh.....	1.00
American Grape Growing and Wine Making. G. Husman	1.50
American Horticultural Manual. J. L. Budd and N. E. Hanson (two volumes).....	3.00
American Fruit Culturist, The. J. J. Thomas.....	2.50
American Peach Orchard. F. A. Waugh.....	1.00
Annals of Horticulture. L. H. Bailey.....	1.00
Barry's Fruit Garden.....	1.50
Beginners' Guide to Fruit Growing. F. A. Waugh75
Bush Fruits. F. W. Card.....	1.50
California Fruits and How to Grow Them. E. J. Wickson	3.00
Cape Cod Cranberries. J. Webb.....	.40
Cider Makers' Handbook, The. F. M. Trowbridge	1.00
Citrus Fruits and Their Culture. H. H. Hume	2.50
Citrus Fruits. J. E. Coit.....	2.00
Cranberry Culture. J. J. White.....	1.00
Date Growing—In the Old World and the New. P. B. Popenoe.....	2.00
Dwarf Fruit Trees. F. A. Waugh.....	.50
Farm and Garden Rule Book, The. L. H. Bailey	2.00
Field Notes on Apple Culture. L. H. Bailey.....	.75
Foundations of American Grape Culture. T. V. Munson	2.00
Fruit Growing in Arid Regions. Paddock and Whipple	1.50
Fruit Harvesting, Marketing and Storing. F. A. Waugh	1.00
Gardening for Pleasure. P. Henderson.....	1.50
Grape Culturist. A. S. Fuller.....	1.50
Grape Growers' Guide. W. Choriton.....	.75
How to Make a Fruit Garden. S. W. Fletcher.....	2.00
Making Horticulture Pay. M. G. Kains.....	1.50
Modern Strawberry Growing. A. E. Wilkinson.....	1.10
Nut Culturist, The. A. S. Fuller.....	1.50
Peach Culture. J. A. Fulton.....	1.00
Pear Culture for Profit. P. T. Quinn.....	1.00
Plums and Plum Culture. F. A. Waugh.....	1.50
Practical Fruit Grower. S. T. Maynard.....	.50
Popular Fruit Growing. S. B. Green.....	1.00
Principles of Fruit Growing, The. L. H. Bailey	1.75
Principles of Floriculture. E. A. White.....	1.75
Productive Orcharding. Fred C. Sears.....	1.50
Pruning Book, The. L. H. Bailey.....	1.50
Quince Culture. W. W. Meech.....	1.00
Small Fruit Culturist, The. A. S. Fuller.....	1.00
Strawberry Culturist. A. S. Fuller.....	.25
Successful Fruit Culture. S. T. Maynard.....	1.00
Systematic Pomology. F. A. Waugh.....	1.00
The Pecan and Its Culture. H. Harold Hume.....	1.50
Productive Orcharding. F. C. Sears.....	1.50

Plant Breeding, Propagation and Pruning

Botany. An Elementary Text Book. L. H. Bailey	1.10
New Creations in Plant Life. W. S. Harwood.....	1.75
Nursery Book, The. L. H. Bailey.....	1.50

Plant Propagation: Greenhouse and Nursery Practice. M. G. Kains.....	\$ 2.00
Plant Breeding. H. De Vries	1.50
Plant Breeding. L. H. Bailey	2.00
Principles of Plant Culture. E. S. Goff.....	1.10
Propagation of Plants. A. S. Fuller.....	1.50
Pruning Book, The. L. H. Bailey.....	1.50

Flowers and Ornamental Plants

Book of the Rose, The. A. Foster Melliar.....	1.75
Bulbs and Tuberous Rooted Plants. C. L. Allen.....	1.50
Cactus Culture for Amateurs. W. Watson.....	2.00
Chrysanthemum, The. A. Herrington.....	.50
Commercial Violet Culture. B. T. Galloway.....	1.50
Daffodils, Narcissus and How to Grow Them. A. M. Kirby.....	1.10
Familiar Flowers of Field and Garden. F. S. Matthews	1.50
Ferns and How to Grow Them. G. A. Woolson.....	1.10
Field Book of American Wild Flowers. F. S. Matthews	2.00
Flower Garden, The. J. D. Bennett.....	1.10
Garden Planning. W. S. Rogers.....	1.10
Gardening for Pleasure. P. Henderson.....	1.50
Greenhouse Construction. L. R. Taft.....	1.50
Greenhouse Management. L. R. Taft.....	1.50
Home Floriculture. E. E. Rexford.....	1.00
House Plants and How to Grow Them. P. T. Barnes	1.10
How to Make a Flower Garden.....	1.00
How to Make Money Growing Violets. G. Saltford25
Lawns and How to Grow Them. L. Barron.....	1.10
Let's Make a Flower Garden. H. Rion.....	1.35
Making Horticulture Pay. M. G. Kains.....	1.50
New Handbook of Plants. P. Henderson.....	3.00
Outdoor Rose Growing (96 fine colored illustrations). Geo. C. Thomas, Jr.....	4.00
Roses, When, Where and How to Plant. Robt. Pyle	1.00
Parsons on the Rose.....	1.00
Practical Floriculture. P. Henderson.....	1.50
Plant Culture. G. W. Oliver.....	1.50
Roses and How to Grow Them.....	1.10
Rose, Its Cultivation, Varieties, Etc., The. H. B. Ellwanger	1.25
Vines and How to Grow Them. W. C. McCullom	1.10
Water Lilies and How to Grow Them. Conard and Hus.....	.10
Window Flower Garden, The. J. J. Heinrich.....	.50
Your Plants. J. Sheehan.....	.40

Irrigation and Drainage

Drainage for Profit and Drainage for Health. G. E. Waring.....	1.00
Engineering for Land Drainage. C. G. Elliott.....	2.00
Farm Drainage. H. F. French.....	1.00
Farm Sewage. E. M. Santee.....	.50
Irrigation Farming. L. M. Wilcox.....	2.00
Irrigation for the Farm, Garden and Orchard. H. Stewart	1.00
Irrigation and Drainage. F. H. King.....	1.50
Irrigation Institutions. E. Mead.....	1.25
Land Drainage. M. Miles.....	1.00
Practical Farm Drainage. C. C. Elliott.....	1.50
Principles of Irrigation Practice. J. A. Wiltsoe	1.75
Tile Drainage. W. I. Chamberlain.....	.50

Landscape Gardening and Forestry

Hedges, Windbreaks, Shelters and Live Fences. E. P. Powell.....	.50
How to Make a Country Place. J. D. Sawyer.....	3.00
How to Plan Home Grounds. S. Parsons.....	1.00
Landscape Gardening. F. A. Waugh.....	.75
Landscape Gardening as Applied to Home Decoration. S. T. Maynard.....	1.50
Landscape Gardening. S. Parsons	2.00
Ornamental Gardening for Americans. E. A. Long	1.50
Picturesque Gardens and Ornamental Gardening. C. Henderson.....	2.00
Practical Forestry. A. S. Fuller.....	1.50
Residential Sites and Environments. J. F. Johnson	2.50

Rural Improvement. F. A. Waugh.....	\$ 1.25
The Book of Water Gardening. P. Bissett.....	2.50
The Farm Woodlot. Cheyney and Wentling.....	1.50
The Landscape Beautiful. F. A. Waugh.....	2.00

Pests, Insects, Plant Diseases and Weeds

Diseases of Cultivated Plants and Trees. G. Masee	2.25
Economic Entomology. J. B. Smith.....	2.50
Fumigation Methods. W. G. Johnson.....	1.00
Injurious Insects. W. C. O'Kane.....	2.00
Insect Pests of Farm, Garden and Orchard. E. D. Sanderson.....	3.00
Insects and Insecticides. C. M. Weed.....	1.50
Insects Injurious to Vegetables. F. H. Chittenden	1.50
Insects Injurious to Fruits. W. Saunders.....	2.00
Insects Injurious to the Household and Annoying to Man. G. W. Herrick.....	1.75
Injurious Insects to the Farm and Garden. M. Treat	1.50
Manual of Fruit Insects. Slingerland and Crosby	2.00
Spraying Crops. C. M. Weed.....	.50
Spraying of Plants, The. E. G. Lodeman.....	1.25
Weeds of the Farm and Garden. L. H. Pammel	1.50
Weeds and How to Eradicate Them. T. Shaw.....	.50

For Information on Spraying, Diseases of Trees and Plants, and all kindred subjects, write your State Agricultural Department, or Experiment Station, or Department of Agriculture, Washington, D. C., for bulletins on these subjects. They will be furnished to you free of charge and will give you the latest and best information. The National Government and most all the States maintain a department devoted to horticultural interests, and their information on spraying, diseases of trees and plants, etc., is the best to be had.

[Note—If your trees are infected with any insects or fungous diseases, send infected portion to your Experiment Station, your State Entomologist, or United States Entomologist, at Washington, D. C.] Your postmaster can give you correct address of the Experiment Station in your State.

POT PLANTS, CUT FLOWERS, FLORAL DESIGNS

We do not have for sale any Cut Flowers or Greenhouse Plants, but same can be supplied from a greenhouse adjoining the nursery. Write to C. E. Majors, florist, 1315 Mirick Ave., Denison, Texas, for information and particulars.

ADDRESSES OF HOME IMPROVERS PAID FOR

If you will send us with your order the names and postoffice addresses of six of your neighbors who own and are improving their homes, we will put in with your order, if as much as \$3 or over, articles from our list, of your own selection, to the amount of 25 cents. For 12 such addresses, when order is \$4 or more, articles to the amount of 50 cents. This order does not extend to more than twelve addresses from one customer. Be sure to put the list of names on a separate paper from that of your letter or order, as the list goes to a different department. Unless list of names is separate from order or letter, we cannot allow the extra stock.

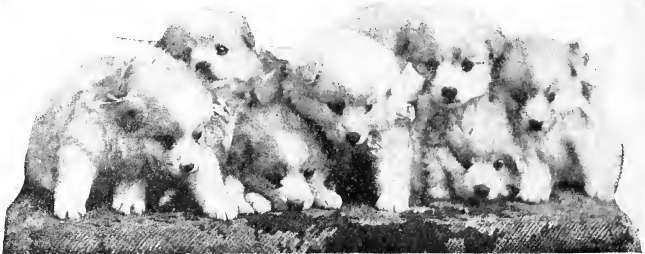

PLEASE READ THE FOLLOWING

TERMS, CONDITIONS, SHIPPING, ETC.

1. **Cash** (By Draft, Money Order, or Registered Letter) with order will secure prompt filling. No goods shipped unless **Cash** or **Satisfactory Security Accompanies** the order. If personal checks are sent, include 15 cents for collection, which amount they cost us.

2. **To Secure Goods Not Wanted Sent at Once**, send one-half the cost with the order. No reserve will be made otherwise. **Goods will be shipped "C. O. D."** only when one-half payment is sent with order, or satisfactory proof of reliability is furnished.

3. **Our Responsibility ceases** after delivery expect to find assortments broken in any nurreported immediately after receipt of goods, to admit of adjustment. A double system of checking is employed in putting up orders, so that mistakes are rare, and sometimes customers complain of an error and afterwards find it was their own mistake.

4. **Substitution.** If it is not explicitly stated in the order that no substitution is permitted in case the variety ordered is sold out, we shall consider permission to substitute granted, and then put in place of the variety ordered, always with its correct name, and one of equal or better value, unless such is not in stock, when the variety will be left unfilled and the money for it returned.

5. In order to secure what you wish, send your order early in the season, before stock is sold. Orders received late in the season may expect to find assortments broken in any nursery.

6. **Please do not order articles not named in Catalog.** We catalog only what we have for sale, and aim to sell only what we produce.

7. **Customers Will Generally Be Most Successful** in getting desirable assortments by leaving the selection, in part at least, to us, as we have much experience in testing and growing for market; but we desire everyone to have his or her choice as nearly as possible.

8. **Guarantee and Responsibility**—We send out thrifty and healthy stock, properly packed and in good condition, take railroad or express receipt "in good order," and are not responsible for losses or damages caused by delays. We do not replace trees that die under conditions over which we have no control, such as drouths, freezes, excessive rains, unsuitable soils, improper handling, and after-care. While we exercise the greatest care to have all our trees and plants true to label, and agree to replace all such as may by accident or oversight prove untrue to name, free of charge, it is mutually agreed and understood between the purchaser and ourselves that our guarantee of genuineness shall not in any case make us liable for any sum greater than originally received for such untrue trees or plants.

9. **It is to Our Own Interest** to give customers the best terms and selections possible. But we cannot prevent Drouths, Severe Winters, Early and Late Frosts, Insects and Rabbits, etc., from cutting, nor plants from dying by bad treatment in other hands, hence we never insure trees to live after leaving our possession, but we do deliver stock in good order, true to name. In case we fail in these we replace at once or refund money. After stock is accepted, we replace none that may die after planting. Unsatisfactory stock must be reported at once on receipt of same to secure adjustment.

10. **We Are Responsible to All of Our Customers**, and to them only, for the character of the goods, and to them or their forwarders—express and railway companies—we guarantee to deliver stock in good order, true to name. With such delivery our responsibility ceases.

11. **Season for Shipping and Transplanting.** We begin digging strawberry plants October 15, not earlier, and other stock November 10, and continue almost uninterruptedly to dig and ship until March 10, November, December and February being the best months in which to transplant in the South.

12. **Trees and Plants by Mail or Parcel Post.** Packages or bales of trees not measuring over 72 inches in length and girth combined can be sent by Parcel Post up to 50 pounds if within 150 miles of Denison, and up to 20 pounds for any distance. The Zone rates apply. If any of our customers desire their orders sent by Parcel Post, we will send them that way, but remittance must be made to cover cost of postage as same has to be paid in advance.

PRICES

13. Stock will be carefully and securely packed, and delivered to express or freight depot in Denison at the prices as named throughout the catalog. For quality of stock offered, these prices are quite low. You will find that it will cost you less to order at these prices and pay your own express, than to order from catalogs or agents quoting delivered prices. By actual comparison it will be seen that these prices plus the express are actually lower than prices quoted with stock delivered.

14. We formerly had two scales of prices, one a F. O. B. Denison Scale, and one a "Prepaid" Scale, giving the customer the option of either scale. But by experience we found the greatest majority of our customers preferred to order by the F. O. B. Denison Scale and pay their own express for it was cheaper than to order by the Prepaid Scale. So for this season we will only quote the one scale of prices and that will be the F. O. B. Denison Scale. If, however, anyone wishes us to prepay the express charges, we will gladly do so if money is sent for that purpose. The express charge is the same, whether sent "collect" or "prepaid."

15. **Cost of Packing** is considerable, but on all orders of \$2.00 or more we will do the packing free. On orders of less than \$2.00 add 25 cents for cost of material and time used in packing. We pack in moist moss, straw or shingle-tow, and thoroughly protect with outside packing.

16. **Prices as to Quantity.** As noted, prices are given for "each," "dozen" and "100." When 1 to 5 of a variety is ordered, remit according to the each price. When 6 to 39 of a variety is ordered, remit according to the "dozen" price. When 40 to 400 of a variety is ordered, remit according to the "thousand" price, which is 10 per cent discount from the "100" rate.

EXPRESS RATES

During the year 1914 a new system of Express Rates for Interstate shipments was put into effect by the Interstate Railway Commission, which on the whole are lower than formerly. One decided beneficial feature is that shipments are now billed through on one rate in case two or more express companies carry the shipment, and not a double charge as formerly. The Rates in Texas are fixed by the Railway Commission of Texas. Nursery Stock goes at the General Special Rate in Texas, and for Interstate shipments Nursery Stock takes Class 2 Rates. We are able to supply from this office the exact rate to any Express Office in the United States. Unless the shipment of stock be very large, we suggest the express as being more satisfactory and safer. When shipments are large we can box so they can go safely by freight. We find that charges on shipments of 300 pounds or less are as low by express as by freight, and on bales of 125 pounds or less the express is the lower. However, in making your order please give explicit directions for shipment. When such are not given we will use our best judgment, but will not be responsible for any dissatisfaction.

CARE OF TREES ON ARRIVAL

Be careful in unpacking to note everything, and immediately "heel in" in moist soil till planted, or plant at once. Never allow the roots to dry, or failure will most likely result. If the stock is received in a frozen condition, place the bales or boxes in a dark cellar or bury in earth till thawed out.

Before planting remove all broken and extra long roots with a sharp knife, cutting from below outward, not above downward. One-year-old peach or apple trees should be cut back to a naked stem 1½ to 2 feet high; leave no side branches. Two-year-old trees should have their branches cut back to their half length or more, the lower less than those above; cutting in shorter as you go upward, and leaving the leader the longest. Plant as deep as the trees stood in the nursery row, excepting dwarf pear and cherries, which should be planted sufficiently deep to cover the stock from two to three inches.

The ground should be thoroughly plowed and subsoiled at least fifteen inches deep. If to be set in land which cannot be plowed, dig holes not less than eighteen inches deep and three feet across. Then fill up with rich, mellow earth, but no fresh manure, to such a point that the tree set thereon will stand the same depth in soil, when the hole is filled, as it stood in the nursery row. Lean the tree to the south considerably and fill in among the roots carefully with mellow soil, and when completely covered an inch or two, press the soil firmly down with the foot, after which level up the hole with loose soil, which should not be tramped. If the soil is dry, pour in a bucketful or two of water before filling the hole, and when settled away, level up with loose soil. Keep the soil thoroughly pulverized about the tree, and free from weeds during the growing season. Do not water through the summer time by pouring water on top of the ground, but dig trenches around the tree and fill with water every evening until ground is thoroughly saturated below the roots; then no more watering will be needed for two weeks. Partial surface watering kills more trees than it saves. Water only in drouth, when trees show need of it.

For more detailed information on this subject and on future care of the trees, we respectfully refer you to American Fruit Culturist, or Bailey's Principles of Fruit Culture, found in the list of books.

For Information on Spraying, Diseases of Trees and Plants, and all kindred subjects, write your State Agricultural Department, or Experimental Station, or Department of Agriculture, Washington, D. C., for bulletins on these subjects. They will be furnished to you free of charge and will give you the latest and best information. The National Government and most all the States maintain a department devoted to horticultural interests, and their information on spraying, diseases of trees and plants, etc., is the best to be had.

SPRAYING UNDER THE LEAVES KILLS THE INSECTS

A Cake of Tobacco Soap free with each Sprayer

PRICE

50^c.

FOR THE
ROSE BUSHES
AND
GARDEN PLANTS

Will reach Vines
ten feet high.

Just lovely for
the flower bed.
If you like flow-
ers, you need this
Sprayer.



FOR
INDOOR
SPRAYING
UNDER
THE
LEAVES

A mist like
spray cover-
ing every
part of the plant.

THE THING LONG NEEDED

Just what mother was long looking for.

Excellent for seeds newly sown they will
not wash out to the surface.

—LOCAL AGENTS WANTED—

HAVE ONE COME WITH YOUR ORDER

APPLES

Plant Apple Trees in the South 20 feet apart north and south by 30 feet apart east and west, requiring 73 trees per acre. Best corn or cotton sandy land is suitable.

Read Bailey's Field Notes on Apple Culture, price 75 cents; or American Apple Orchard, \$1.00.

Prices

1 to 5 of a variety at "each" price.			
6 to 39 of a variety at the "dozen" rate.			
40 or more of a variety at the "hundred" rate.			
400 or more of a variety, 10 per cent discount from "hundred" rate.			
Size	Each	Dozen	100
2 to 3 feet.....	\$0.10	\$1.00	\$ 7.00
3 to 4 feet.....	.15	1.50	10.00
4 to 5 feet.....	.25	2.25	15.00

IN ORDER OF RIPENING

JUNE IN TEXAS

Early Harvest. Medium, bright straw color, tender, sub-acid; fine desert and cooking apple. Must be handled very carefully for market.

Red June. Slow, prolific; red, small; good, tart; market, table. One of the most valuable for heavy planting in the South.

Fanny. Vigorous; productive; red, large; excellent; market, table.

JULY

San Jacinto. Like a very large Red June apple, of which it appears to be seedling, coming in just as the Red June goes out. Tree vigorous and prolific; very productive. A variety of the highest merit both for market and table. Fruit hangs to the tree remarkably well and a fine keeper for an early apple.

American Summer. Medium to large; roundish conical; dull red stripes on a pale yellowish ground; rich, juicy and one of the best.

AUGUST

Bledsoe. Originated and grown extensively for many years by Judge Bledsoe, formerly of Sherman, and orchardist of note, has proved to be an apple of great merit for the Southwest, and later, over a wide range, especially so in the high, western plateau. It is large, roundish oval, sometimes angular, greenish striped and splashed with red; flesh white, sub-acid, good. Tree very vigorous and prolific. August and later.

Jonathan. Of American origin. Medium, if thinned on the tree grows larger. Roundish conical, rich bright red on light yellow ground, few minute white dots; flesh yellowish white, tender, juicy, sprightly, sub-acid, a standard of excellence in market apples. Tree has a drooping, pendant habit; very productive, and requires rich soil. Universally popular. Should be gathered in August and stored to obtain best results.

Texas Red. One of the most highly esteemed apples in East Texas; large, solid red; fine; excellent keeper.

Rome Beauty. Large, roundish, mostly covered with bright red on pale yellow ground. Tender, of good quality.

Doyle. Originated in East Texas where it is highly praised. Large, striped, with high color.

OCTOBER AND LATER

Ben Davis. Tree healthy, vigorous, an abundant bearer; fruit large, handsome, striped; flesh whitish, tender, juicy, sub-acid, only fair in quality. Popular on account of its good bearing quality.

Stayman's. (Stayman's Winesap.) Medium to large; oblate, conical; greenish yellow, mostly covered and indistinctly splashed and

mixed with dull dark red, with numerous medium gray dots; flesh yellow, firm, tender, juicy, mildly sub-acid, aromatic; quality best. Another seedling of Winesap originated in Kansas; is much larger, more beautiful in color and better in quality and equal or better keeper.

Delicious. Winter. Of peculiar and distinctive shape; brilliant dark red, shading off to golden yellow at the blossom end; flesh fine-grained, juicy, crisp and melting; flavor sweet, with a slight acid taste. Tree vigorous, thrifty and a good, dependable cropper.

Spitzenburg. Winter. In certain sections of the East succeeds splendidly and is standard in the West. Grows very finely when well fed and cared for. Medium-sized, round; dark red almost all over; firm, crisp, sub-acid, slightly aromatic. One of the richest flavored of all Apples, and very handsome. Spitzenburg can not be beaten when grown under conditions it prefers. Be sure you are in the right location.

Winesap. Medium; roundish conical form; mostly covered with red, on yellow ground; flesh fine, crisp, with a rich, high flavor. One of the best for market, dessert, or for general winter use.

Gano. Similar to Ben Davis, but deeper in color, and better in quality. Tree very hardy and vigorous. A rapid grower. An early, annual and prolific bearer. A valuable late winter apple.

Arkansas Black. Vigorous, abundant; dark red, medium; excellent market; seedling of Winesap.

Kinnaird. Strong, spreading tree, prolific; red, large; a superb Southern winter apple; the best of all Winesap seedlings. Flesh pale yellow, crisp, fine grained; of fine quality. Tree longest lived of all varieties tested with us; originated in Tennessee.

Arkansas. (Mammoth Black Twig; Paragon). Size large roundish, slightly flattened; color a dark mottled red; flesh yellow, fine-grained, with a mild, pleasant, sub-acid flavor. Tree a strong grower and abundant bearer. Large fruit and better tree than Winesap, of which it is a seedling.

CRAB APPLES

Prices: Same as Apple

Hyslop. Almost as large as Early Strawberry Apple; deep crimson; very popular on account of its large size, beauty and hardiness. Keeps well into the winter.

Whitney. Large, averaging 1½ to 2 inches in diameter, skin smooth and glossy green, striped, splashed with carmine; flesh firm, juicy and rich. Said to be a great bearer and very hardy. Tree a vigorous, handsome grower.

THE SCOTT APPLE

This is a variety that came as a stray in the orchard of Mr. J. W. Scott who lives six miles east of Denison, Texas. For more than thirty years Mr. Scott has been growing this variety and had the exclusive use of it, as he did not propagate any trees except for his own use. Realizing that this variety is too good to lose, and wishing to do mankind a favor, he has consented for its dissemination.

The apple is of same season as American Summer, that is coming in before Jonathan and after San Jacinto. It is a rich yellow skin covered nearly all over with red stripes that make it quite attractive. The market here has taken all Mr. Scott could bring in at an average of 35 to 50 cents more per bushel than the best of other varieties, and would sell when the market would be over stocked.

We only have a limited number of one-year-old trees, at 25 cents each. \$2.50 per dozen.

PEARS

Pears do well on a variety of soils—clay loam, sandy, gravelly and red soil. The soil must not be wet, should be drained, if not naturally drained. The knife is the best remedy for blight. Keep it cut off as fast as it appears. Cut back to 3 or 4 inches below where the twig or limb has blighted. Keep this up from time to time as the blight appears, and you can keep it down. We have found here and there that there is less blight where the trees are not cultivated after the second year. Plant 19 feet apart each way, requiring 135 trees per acre.

Prices

One to 5 trees of a variety at the "each" price. Six to 39 at the "dozen" rate. Forty or more at the "100" rate.

Sizes and Variety	Each	Dozen	100
Seckel, Brown Beurre, Anjou, Bartlett, 3 to 4 ft.....	\$.20	\$2.20	\$16.00
Seckel, Brown Beurre, Anjou, Bartlett, 4 to 6 ft.....	.30	3.00	20.00
Garber, Keiffer, 3 to 4 ft.....	.15	1.60	11.00
Garber, Keiffer, 4 to 6 ft.....	.20	2.00	14.00

Seckel. Small, short, pear-form; yellowish brown, with russet-red cheek; rich, juicy and melting. August.

Bartlett. Large, pear-shaped; yellow, rich, juicy and very fine. The most popular variety of its season. Early in August.

Brown Beurre. Large, brown; firm; best quality, hardy.

Beurre d'Anjou. Rather large; obtuse form; greenish yellow, dull red cheek; rich, melting, and buttery.

Garber. Equally as hardy as the Le Conte

or Kieffer, of same class of pears. The growth and appearance is very much like Kieffer; ripens one month sooner and of better quality.

Kieffer. Originated near Philadelphia. Supposed to be a seedling of Chinese Sand Pear crossed with the Bartlett. Size large, very handsome; skin yellow, with a bright vermilion cheek; very juicy, with a musky aroma; quality good when ripened to perfection. A very young and prolific bearer. As near blight-proof as Pear can be called.

APRICOTS

Plant 18 feet apart each way, requiring 135 trees per acre. Succeed best in limestone soil; bloom very early in spring. Should be treated like peaches. Very successful in most parts of the West on high ground.

Sizes	Prices	Each	Dozen	100
3 to 4 feet.....		\$.20	\$2.00	\$15.00
4 to 6 feet.....		.30	3.00	20.00

Moorpark. Large, yellowish green with brownish red on sunny side, marked with numerous dark specks, flesh bright orange, parts readily from the seed; grown largely for commercial purposes, especially for canning and drying. Tree vigorous and prolific. June.

Cluster. This valuable variety is claimed

to have never missed bearing any season since its introduction. Originated in Texas, from seed of Russian apricot.

Royal. European, large, slightly oval, dull yellow with red next the sun, flesh orange yellow with rich, vinous flavor. An important commercial variety.

PLUMS

Named in the order of ripening.

Plant 18 feet apart each way, requiring 135 trees per acre. Succeed on thinner land than peach, with more clay, and thrive where the peach will. All succeed well nearly everywhere. Read Plums and Plum Culture (Waugh), \$1.50.

Prices

One to 5 of a variety at the "each" price. Six to 39 at the "dozen" rate. Forty or more of a variety at the "100" rate.

Sizes	Each	Dozen	100
3 to 4 feet.....	\$0.20	\$2.00	\$13.00
4 to 6 feet.....	.30	3.00	20.00

Red June. Early, ripens with early peaches; medium to large; good bearer; red all over; fruit pointed and flesh yellow, and very fine in quality.

Milton. A cross of Wild Goose with some Americana variety. Better in quality than Wild Goose, nearly as large. Bright red with small white dots, very handsome. Late bloomer, but ripens early, just before Abundance. Persistent to tree after ripening. Resists rot and curculio well.

Abundance. Medium if allowed to mature as the fruit sets on tree, but large when fruit is properly thinned. As this variety is inclined to overbear, it is best that the fruit be thinned by taking at least one-half to two-thirds the fruit off when size of small marbles, the remaining fruit will be of extra size to more than make the same yield. Roundish, skin yellow, washed with purple with a bloom; flesh yellow, juicy, sub-acid with apricot flavor, quality superb.

Gonzales. Fruit very large, meaty, of brilliant red; finest of flavor; good shipper and keeper. Tree very strong and immensely productive. Very valuable.

America. A hybrid of Robinson with Abundance. Tree very thrifty, symmetrical, spreading; fruit medium to large, bright golden ground with pink cheek, dotted white; flesh firm, stone medium to large, cling. Considered one of Burbank's best productions. Very valuable.

Wickson. One of Burbank's most remarkable hybrids; between the Kelsey and Simon plums. Very large, heart shaped; dark crimson, firm, of finest quality. Blooms very early, and will succeed in localities having late springs. Nothing finer in appearance or quality is known among plums.

Burbank. Large; clear cherry red; flesh deep yellow; very sweet and agreeable flavor. Very prolific.

CHERRIES

Plant 18 feet apart each way, requiring 135 trees per acre. Require very best drouth-resisting soil. They do better on limestone or gravelly soil than sandy soils. We grow only varieties of the Duke and Morello class (Sour Cherries), as they are the only classes that will succeed in this part of the South. The Sweet Cherries (Hearts and Bigarreaus) are not successful here.

Prices

One to 5 of a variety at the "each" price. Six to 39 of a variety at the "dozen" rate. Forty or more of a variety at the "100" rate.

Sizes	Each	Dozen	100
2 to 3 feet.....	\$0.12	\$1.25	\$ 9.00
3 to 4 feet.....	.15	1.50	12.00
4 to 5 feet.....	.20	2.00	16.00

New Century. Thought to be a combination of the Morello and Duke types; originated in Grayson county, Texas, where the original has fruited very successfully for a number of years. Fruit medium to large, light red, of good quality. Tree is of the Duke type, strong, upright, foliage rather broad, and free from the mildew.

Dyehouse. About a week earlier than Early Richmond. Large, good quality, small pit. Light red.

Early Richmond (Morello or Amarelle). Medium, flattened, light pink. Tree vigorous, spreading; early. May.

English Morello. Medium, roundish, dark red, flesh and juice dark, acid. Tree dwarfish and productive. Ten days later than Early Richmond.

Baldwin. Originated in Kansas. Fruit large, round, dark but transparent red. Slightly sub-acid, but rich.

MULBERRIES

Plant 20 to 25 feet apart, requiring 109 trees per acre. Flourish in any soil or situation.

Prices

One to 5 trees of a variety at the "each" price. Six to 39 trees of a variety at the "dozen" rate. Forty or more of a variety at the "100" rate.

Sizes	Each	Dozen	100
2 to 3 feet.....	\$0.10	\$1.00	\$ 7.50
3 to 4 feet.....	.12	1.25	9.00
4 to 5 feet.....	.15	1.50	12.00
5 to 7 feet.....	.25	2.50	
6 to 8 feet, 1 to 1½ inches diameter.....	.35	3.50	
8 to 10 feet, 1½ to 2 inches diameter.....	.60	6.00	

Munson. One of the largest, most prolific and best mulberries of the Russian class. Originated by us, selected from among thousands of varieties grown from seed. The branches in fruit look like ropes of big berries. Earlier than Hicks.

Hicks Everbearing. Profuse bearer of fruit for three months; fine grower for shade; the best of all trees for the fowl yard, as the fowls greedily eat the berries. Later than Munson.

tree are nearly staminate but have rudimentary pistil, which sometimes metamorphoses and will set insignificant fruit, especially first season or two after transplanting, but after tree recovers from check of transplanting and gets into full growth, rarely any fruit sets. What fruit does set does not begin to compare in size and productiveness to the regular bearing sorts. This variety does not sprout like the non-fruited Paper Mulberry. This has a round head of compact form, well filled with leaves. The trees we grow are grafted, the same as the fruiting sorts.

Male Russian Mulberry. The flowers on this

QUINCES

Plant 10 to 12 feet apart each way. Quinces need very rich, deep, well-drained soil; they are better for careful culture.

Sizes	Each	Dozen	100
2 to 3 feet.....	\$0.15	\$1.50	\$10.00
3 to 5 feet.....	.20	1.75	11.50

Meech. Very fine and prolific; none better in growth or quality of fruit.

FIGS

Hardy in South Texas. In North Texas unprotected tops will sometimes winter kill, but when frozen tops are cut off, new shoots will come and bear fruit late in summer of same season. Like rich garden soil. Plant 10 feet apart.

Sizes	Each	Dozen	100
2 feet.....	\$0.15	\$1.50	\$12.00
3 to 4 feet.....	.25	2.50	20.00

Magnolia (Dalmatian). Large, light yellow with slightly brown cheek. Of excellent quality. Unusually productive. Fine for preserves.

Black California. Large, dark purple, very attractive.

SEEDLING PECAN TREES

These were grown from nuts of fair size and quality. They are recommended for shade trees where the fine large nut or paper shell quality is not so much desired.

Sizes	Each	Dozen	100
2 year, 12 to 20 inch.....	\$0.15	\$ 1.25	\$ 9.00
4 year, 4 to 5 feet.....	.50	5.00	
5 year, 5 to 7 feet.....	1.00	10.00	

PECAN TREES—GRAFTED VARIETIES

Gulf Coast Originations

Sizes	Prices	Each	Dozen	100
Schley, Stuart, Van Deman, 1 to 2 feet.....		\$0.50	\$ 5.00	\$40.00
Schley, Stuart, Van Deman, 2 to 3 feet.....		.75	7.50	60.00
Schley, Stuart, Van Deman, 3 to 4 feet.....		1.00	10.00	80.00

Stuart. Nuts large or very large, 1½ to 2 inches long, oblong with brownish shell, strongly marked with dark color. Shell of medium thickness and of very good cracking quality. Kernel full, plump, bright colored. In quality one of the best, the flavor being rich and sweet. A heavy bearer. Tree a strong grower, reaching an immense size, with large foliage.

Van Deman. Large to very large, from 1½ to 2½ inches long, rather slender, pointed at both ends. Color reddish brown with purplish markings. Shell of medium thickness; crack-

ing quality excellent. Kernel full and plump, bright brownish yellow; flavor sweet and good. Tree is vigorous, healthy, with large bright foliage. Altogether one of the most desirable varieties.

Schley. Size medium to large. 1½ to 1¾ inches long; oblong, somewhat flattened; light reddish brown with a few small markings of purplish brown; shell thin, separating easily from the kernel; kernel full, plump, bright yellowish brown in color; flavor rich, nutty, in quality one of the best. Tree a good grower and on the whole a very excellent variety.

Texas Originations

Prices	Each	Dozen
Texas Prolific, San Saba.....	\$1.50	\$17.50
Hollis Seedlings, 2 year, 2 foot.....	.35	3.50

San Saba Improved. A seedling of San Saba. This tree came in as a surprise, for we had about given up all hope of getting a better nut than the original; but, after discarding thousands, our patience has been rewarded. The tree bears two weeks earlier, and commences the middle of September. The nuts, a third larger than the original variety, are much brighter in color, and the tree is a stronger grower. The nuts weigh 60 to the pound. Two-year-old trees, \$1.50 each.

Texas Prolific. A seedling of San Saba; season of ripening medium. Trees of this variety are so precocious as to begin bearing the second year from the bud. The nuts are large, shapely, and of a beautiful color; the kind that is attractive. They fill up the barrel fast, and stand on their own merits. Texas Prolific is the most difficult of all varieties to propagate,

and this is why we doubt the ability of other nurseries to cut the price of the genuine stock. Trees at \$1.50 each.

The Texas Prolific and San Saba are two of the best productions of E. E. Risien of San Saba County, and for our higher altitudes we recommend them in preference to the "Coast" varieties.

Hollis or Jumbo. Discovered thirty years ago in Colorado River bottom, near San Saba, Texas. The tree is nearly 100 years old, 100 feet high, nearly 3½ feet in diameter. Has averaged 300 pounds of nuts per year for several years, selling for 50 cents per pound. These nuts have taken first prize at expositions at New Orleans, Paris, France, Chicago and St. Louis, besides many local fairs. Nuts medium large, oblong-blunt, dull yellowish brown, shell medium, full-meated, with fine separation. Flavor excellent.

PERSIMMONS

JAPANESE VARIETIES

These were introduced from Japan about seventy years ago. They are the royal fruit of Japan, their best native pomological product. Leaves are broad and burnished, the trees vary from shrubby growth of eight to ten feet high to a much larger size in different variety. Usually very prolific, often bearing at three years of age.

Sizes.	Prices	Each	Doz.	100
1 to 2 feet, grafted.....		\$0.25	\$2.50	\$17.50
2 to 3 feet, grafted.....		.35	3.50	25.00
3 to 4 feet, grafted.....		.50	5.00	40.00

The following are the best Japanese varieties and all hardy here. **Costata, Hyakume, Hyachia, Triumph, Okame** and **Dia Dia Maru**. If no particular variety is wanted, just order Japan Persimmon and we will send best assortment.

CHINESE VARIETIES

Ta-mo-pan. (Meaning in Chinese "large grindstone.") This remarkable persimmon was obtained by the Department of Agriculture collector of plants in Northern China, in the Ming Tombs Valley. It is said to endure more cold than any of the Japanese varieties. With us for three years it has been perfectly hardy. It is said to have the largest fruit of any of the known varieties, reaching as much as five inches in diameter, much flattened and with a peculiar suture extending around it equatorially. Flesh bright orange, free from astringency at all times; firm and of high quality. It promises to be hardy as far North as Kansas. It is exceedingly scarce in this country, and ours are the first trees offered for sale. We have only a few grafted on native persimmon roots, very fine trees.

Prices

3 to 4 feet.....	50 cents each
4 to 6 feet.....	75 cents each

KAWAKAMI PERSIMMON

A hybrid of one of the best Japanese with the Josephine. Fruit 2 inches in diameter. Tree hardy as far North as Illinois.

Prices

2 to 3 feet.....	40 cents each
3 to 4 feet.....	50 cents each
4 to 5 feet.....	75 cents each
6 to 7 feet, large shade tree size.....	\$1.25 each

JOSEPHINE (AMERICAN HONEY) PERSIMMON

We have a tree of the native Persimmon found wild in Missouri by Samuel Miller, and by him named Josephine, bearing profusely of large, clear honey-colored fruit of finest quality, preferred by all to even the finest Japanese kinds. The tree was moved into our grounds among the Japan varieties, and continues to fruit abundantly. It has few small seeds in comparison with most varieties. All things considered, it is the finest Persimmon known to us.

Prices

	Each	Doz.
Grafted trees with cions from original tree, 1 to 2 feet.....	\$0.35	\$3.50
Grafted trees with cions from original tree, 2 to 3 feet.....	.50	5.00
Seedling trees grown from seed of original tree, 1 year.....	.10	.90

SEEDLING NATIVE PERSIMMONS

We have grown some seedlings of the Native Persimmon, of fair quality.

These we offer 6 to 10-inch trees at 5c each, 50c per dozen; \$4 per 100.

10 to 18-inch trees at 10c each; 85c per dozen; \$6 per 100.

ELAEAGNUS LONGIPES, GOUMI

Here is a magnificent shrub, with leaves dark green above and silvery beneath, perfectly hardy, bearing a crimson, cherry-like fruit (with one small, long seed), of refreshing, tart flavor, making an immense crop every year, ripening in May here. **PRICE**, 50 cents each.

HARDY ORANGE (See under hedging plants.)

PEACHES

Directions for Cultivating. A sandy loam is best suited to the Peach, but it will adapt itself to almost any soil, provided it is well drained. Plant one-year-old trees 18x18 feet; cut the tree back to 18 to 24 inches, as it is always best to have a low-headed tree. In the spring, after the growth has started, remove all but three branches and let these be distributed so that the tree will be well balanced. For the first two years fertilize with well-decomposed barnyard manure, or a mixture of one part of cotton seed or bone meal to two parts of acid phosphate. Apply 1½ to 2 pounds to each tree. After the third year, avoid nitrogenous fertilizers and use a fertilizer containing a good percentage of bone phosphate and potash and a small percentage of nitrogen. Prune every year by cutting off one-third of the previous year's growth. The head of the tree should be broad and open, so as to allow free circulation of light and air.

Borers. Go through your orchard in March and where you find gum around the surface, clean away the dirt and, with a knife or some sharp-pointed instrument, follow up the borers and remove them; then throw around the tree a small quantity of lime and ashes. This plan, if rigidly enforced, will keep borers down, give you better fruit, and greatly extend the life of the trees.

Thinning. When a tree sets an overload, it pays to thin out the fruit, even if two-thirds of the crop has to be taken off. It relieves the tree, and the remaining fruit will grow to be large, fine flavored, and handsome, whereas if the tree is left overloaded, the fruit will be small, inferior, of poor flavor. The thinning should be done just when the young fruit is about the size of marbles, and thinned out so that the peaches will be not less than 3 to 4 inches apart on the tree. The extra price for the thinned fruit will more than pay for the fruit destroyed.

Prices

One to 5 of a variety at "each" price. Six to 39 of a variety at the "dozen" rate. Forty or more of a variety at the "100" rate.

Sizes	Each	Dozen	100
3 foot trees, ¾ to 1½ inch diameter.....	\$0.10	\$1.00	\$ 7.00
4 foot trees, ½ to ¾ inch cal.....	.15	1.50	10.00
5 foot trees, ¾ inch and up.....	.20	2.00	14.00

PERIOD I—MAY 20 TO JUNE 5

Mayflower. (North Carolina.) Red all over large, nearly free. Ripens 10 days ahead of Victor.

Early Wheeler. (E. W. Kirkpatrick, Collin Co., Tex.) Prolific. White bluish cheek, flesh white, extra firm, with true clingstone flavor. The best shipper among early varieties. Cling, 50c each; \$5 dozen.

PERIOD II—JUNE 1 to JUNE 10

Triumph. (J. D. Husted, Ga.) Productive, Skin orange yellow, nearly covered with dark crimson, more fuzzy than Alexander and resists rot better. Flesh yellow, moderately firm, free when fully ripe. Better in quality than any ripening earlier. Seed small.

Mamie Ross. (John Ross, Dallas Co., Tex.) Sure, prolific. Skin rather fuzzy, creamy white with red cheek. Flesh white, rather soft, of fair quality, semi-cling. Seed medium. Has proven a profitable market peach.

PERIOD III—JUNE 10 to JUNE 20

Carman. (J. W. Stubenrauch, Limestone Co., Tex.) Very vigorous, sure and prolific. Skin creamy, covered with stripes and splashes of crimson, rather fuzzy. Flesh of better quality than Mamie Ross. The best peach of its season. Nearly free. Seed medium. A very valuable commercial variety.

PERIOD IV—JUNE 20 to JULY 1

Family Favorite. (W. H. Locke, Fannin Co., Tex.) From Chinese Cling crossed with some other good peach. Productive. Skin quite fuzzy, clear creamy white with rich pink blush on one side. Flesh white, tint of red at stone, free, excellent quality. Seed medium. Introduced by us in 1880, and has become a valuable standard.

Riley. (Early Belle.) Large; white, with beautiful red cheek; flesh white; quality best. Prolific bearer. Ripens June 25 to July 5. The best shipping variety of its season, which makes it very valuable.

PERIOD V—JULY 1 to 15

Elberta. (S. H. Rumph, Ga.) Cross of Chinese Cling with Crawford Early. Sure and prolific. Nearly globose when fully developed, the largest specimens measuring 3x3, having

little or no tit, suture shallow, sides nearly equal. Skin little fuzzy, orange yellow, more or less covered with crimson, according to soil and exposure. Flesh firm, of fair to good quality, sometimes a little bitterish. Freestone. Seed large. The leading commercial variety.

Captain Ede. Large; yellow; excellent quality. Ripens early in July. Resembles Elberta, but better flavor.

Chinese Cling. (Originated from seed brought from Shanghai, China.) Spreading habit, healthy, not very prolific. Probably the largest peach in cultivation. Skin creamy with short fuzz, mottlings of dull red covering one-third to one-half of surface next stem. Flesh white with little red at seed, tender, very juicy, sprightly sub-acid. It is the parent of more fine commercial varieties than any other peach in cultivation, and yet not a valuable commercial variety itself.

PERIOD VI—JULY 15 to AUGUST 1

Gold Dust. (J. C. Evans, Mo.) Prolific. Tit small. Skin quite fuzzy, orange, mostly covered with bright crimson, handsome. Flesh orange, very firm, a little red at stone, best quality cling. Very pretty.

Belle (Belle of Georgia.) Very large; skin white, with red cheek; flesh white, firm, and of excellent flavor; very prolific; excellent shipper. Tree a rapid grower. July 5 to 20.

Mathew Beauty. Large light colored yellow of best buttery flavor. Skin yellow ground with red cheek, making it a very handsome appearing peach. Freestone.

Champion. Large; skin creamy white, with red cheek; flesh rich and juicy. Ripens middle to last of July.

PERIOD VII—AUGUST

Ringgold. (Wilkins, N. J.) Seedling of Heath Cling and an improvement on that variety. Productive. Skin creamy white with streaks of blush near stem end. Flesh white to the seed, of best quality and sweet Cling.

Henrietta. (Levy Late. Originated in Ky.) Tit prominent. Skin orange yellow, with crimson cheek. Flesh yellow, firm, sweet and of high quality. Cling. Very handsome.

Salway. (Thos. Rivers, England.) Skin rich yellow, covered with crimson. Flesh rich buttery yellow, fine for canning. Free.

THE STUBENRAUCH PEACHES

Many are waiting and anxious to obtain trees of Mr. Stubenrauch's Peach originations, having learned of their good qualities.

We are pleased to state that we have the rare privilege to introduce for Mr. Stubenrauch, three of his best varieties, namely, the **Frank**, **Barbara**, and **Millard**, although we have but a limited stock of each variety for this season.

The history and descriptions are given in the following letter written by Mr. J. W. Steubenrauch:

"Growing fine peaches has been with me almost a lifetime hobby. I started my first peach orchard in Texas (right where I am now), in the late 70's. Had at one time over 100 distinct varieties in bearing.

"Out of these but few possessed real merit and general value. After experimenting for a number of years with the best of those of early days, shipping them to different markets, etc., the fact became clear that unless we got more reliable bearers and get the fruit to ripen after the usual early summer glut, the business would never be a paying one. I loved the work too well to quit, and yet to keep on the way I was going would land me eventually at the poor farm. As "necessity is the mother of invention," in my case something had to be invented or else go back to raising cotton.

"Among a lot of Elberta trees along the early 90's, there was one tree superior to all the rest, growing finer fruit, more of it, and producing more regular than the average of them. The thought occurred to me then, 'Why not cross pollenate this better type with some fine later peaches, and thus get some fine seedlings that ripen intermediate?' The work was started by planting some healthy Indian seedling peaches into which were inserted buds from that fine Elberta, and buds from Bells October, a very fine high quality late yellow freestone. When these fruited the seeds from the finest specimens were planted, and when these seedlings came into fruit many of them produced fruit superior in their makeup of both parents, the large size and fine appearance of the Elberta blending with the high quality in color and flavor of the Bells October. By selecting a dozen of the best were able to cover the entire season from Elberta to September in Central Texas.

"Among this selected lot were the **Millard**, **Frank**, and **Barbara**.

"The **Millard** comes a week after the Elberta. It is an immense size, red cheek, yellow skin and flesh Clingstone. Nearly round in shape, flesh quite firm and fine grained; when fully ripe it becomes melting and really delicious, none of the bitterness as found in the Elberta.

"The **Frank** is a handsome yellow clingstone, large size, globular. Skin covered with rich red. It follows the Millard about a week and from 15 to 20 days later than Elberta. This peach has not failed to produce a crop here in twelve years.

"The **Barbara** comes in a week after the Frank. It is a high colored, yellow fleshed freestone. Round shape and of high spicy quality of the Bell, while the tree has a larger blossom of the Elberta. It is a fine canning sort. Flesh firm, bright yellow with small seed.

"One decided point in favor of these new seedlings is their regularity of bearing, much more regular than has been the case with our average old varieties."

Prices of the Stubenrauch Peaches Frank, Barbara and Millard

	Each	Doz.
One year trees, from dormant buds.....	\$1.00	\$10.00

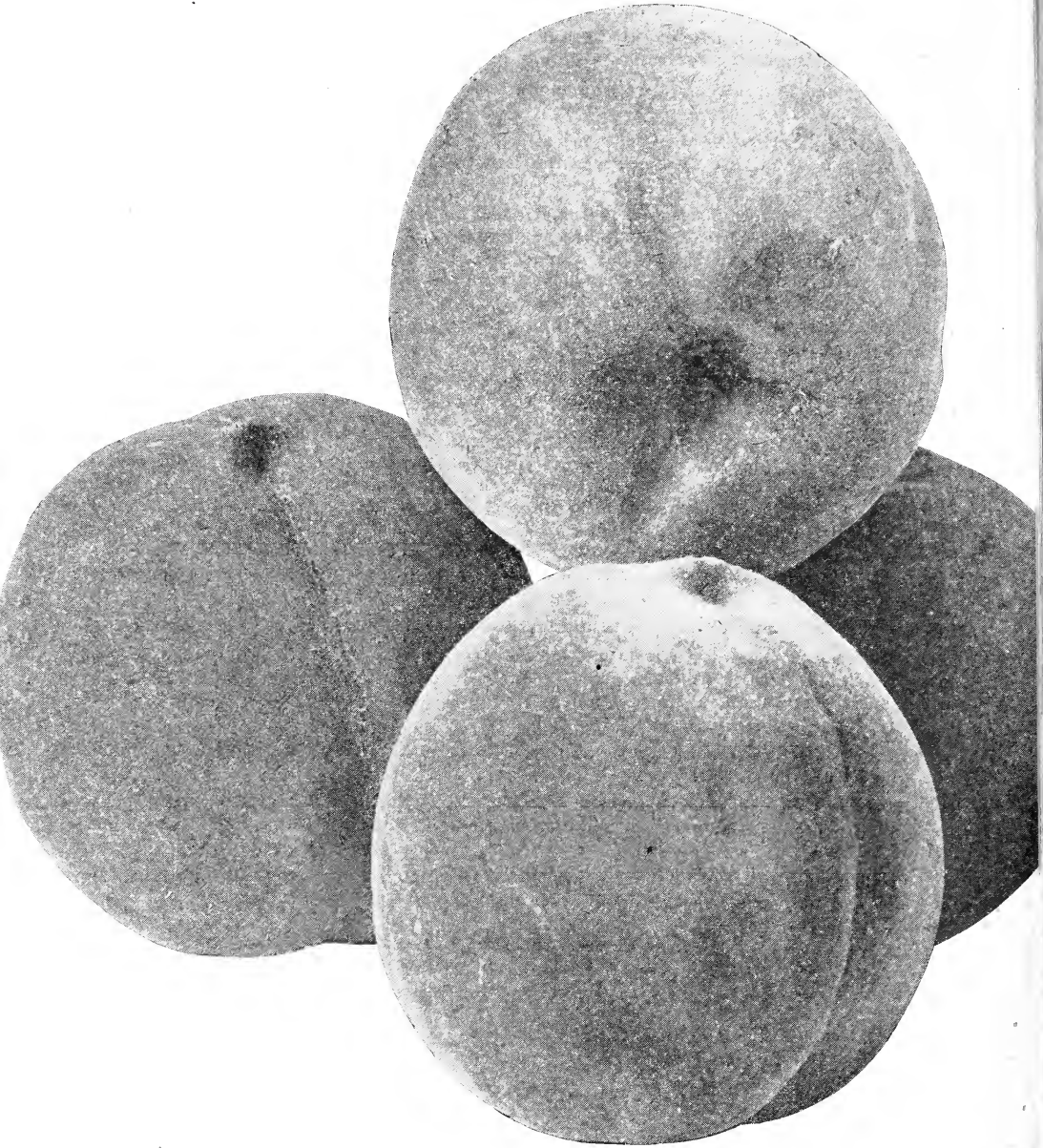

BARBARA PEACH
(Courtesy Farm & Ranch)

BLACKBERRIES

Plant 2 feet apart in rows, rows 7 feet apart, requiring 3,112 plants per acre, Succeed anywhere.

Read Fuller's Small Fruit Culturist. Price, \$1.50.

VARIETIES IN SUCCESSION

	Prices	Doz.	100	1,000
McDonald appears to be a hybrid between a blackberry and dewberry. Large and good quality. The flower being pistillate needs a staminate or perfect flowering kind nearby to pollinate; when thus pollinated it is very productive.....		\$0.50	\$2.00	\$12.00
Sorsby May. A blackberry larger than Early Harvest, and ripens about a week earlier. Very productive and a good shipper; very valuable on account of its extreme earliness.....		.50	1.50	12.00
Dallas. Very vigorous, drooping, thorny, productive, large, fine. This is proving to be a very valuable market variety.....		.35	1.50	10.00
Robison. Very vigorous, upright, prolific, uniformly very large; of best quality. Sells at the highest market price. Originated by Willard Robison, at Cisco, Texas. It has fruited here for a number of years, and has proven itself one of the most valuable varieties in cultivation. It endures the climatic hardships most excellently.....		.50	2.00	12.00

DEWBERRY

Mayes. (Austin's Improved, Austin-Mayes.) Very large, early, prolific....	.35	1.25	10.00
--	-----	------	-------

STRAWBERRIES

Plant 16 inches apart in rows, rows 3½ feet apart, requiring 9,000 plants per acre. Deep loamy, sandy soil, with clay sub-soil is preferable.

Read Fuller's Strawberry Culturist. Price, 25 cents.

Our plants are not like those handled by many growers—weak, old and mixed—but young, vigorous and pure. The very best varieties by actual test for the Southwest. Handled in the very best manner. We test nearly all varieties of any promise as they come out. The following are the cream for this climate.

The varieties are named in the order of ripening. Staminate kinds will bear alone. Pistillate varieties will require a staminate variety to be planted near them to pollinate them. S—Staminate. P—Pistillate.

Prices

	Doz.	100	1,000
All varieties, except Ettersburg.....	\$0.25	\$0.75	\$4.50

Excelsior (S). Medium size, dark red, firm, almost round. Stem short. Fine shipper and an extra early sort.

St. Louis (S). Large, light red, prolific, showy. The plant very hardy and stands drouth well, in fact plants of this variety stood drouth better than any other in same field.

Lady Thompson (S). Blunt, top-shaped medium to large, bright red, prolific but season short.

Early Ozark (S). Very large, black glossy red when well ripened, firm, of fine flavor.

Klondike (S). Peculiarly suited to great range of country over the Southwest. Large, blood red skin. Fine flavor and distinctive.

Texas (S). Dark red, round, medium size; productive; firm. Short stem.

Mellie (P). Large, ovate with neck, of Haverland type. Endures drouth well. Bright red, good shipper.

Haverland (P). Ovate or long, calyx turned back, giving appearance of neck. Light red, productive.

Aroma (S). Large, bright red, conical. One of the most valued of late sorts.

Gandy (S). An old variety, large, good color.

Evening Star (S). In Arkansas and Missouri has been found to be the largest and most productive of all late sorts; not tried in Texas. Has fine color. Plant robust.

Parker Earle (S). Berry large conical with short neck, glossy scarlet-crimson. When given hill culture on rich, well drained soil it is very productive.

Ettersburg No. 80. The Ettersburg Farms in California have originated several new varieties of strawberries, embodying the blood of two and three distinct species. We have grown here about fifteen of these varieties and find No. 80 to be the best of the lot. The plant is robust and vigorous. The berry round, large and very dark red, giving a rich color to it. The flavor is far above the ordinary strawberry in quality. We have only a limited number of plants at 75 cents per dozen.

RASPBERRIES

Plant same distance as Blackberries. Need best drouth-resisting soil, on eastern or northern slope.

	Prices	Doz.	100	1,000
F. O. B. Denison.....		\$0.50	\$2.50	\$18.00
Prepaid, in orders of \$5.00 or more.....		.60	3.00	20.00

BLACK-CAPS

Kansas. A very large excellent fruited black-cap, one of the best for a dry, hot climate.

RED VARIETIES

Cardinal. Very vigorous and prolific, dark red, very large. Originated in Kansas. Succeeding very well here. One of the most profitable varieties.

1916-1917

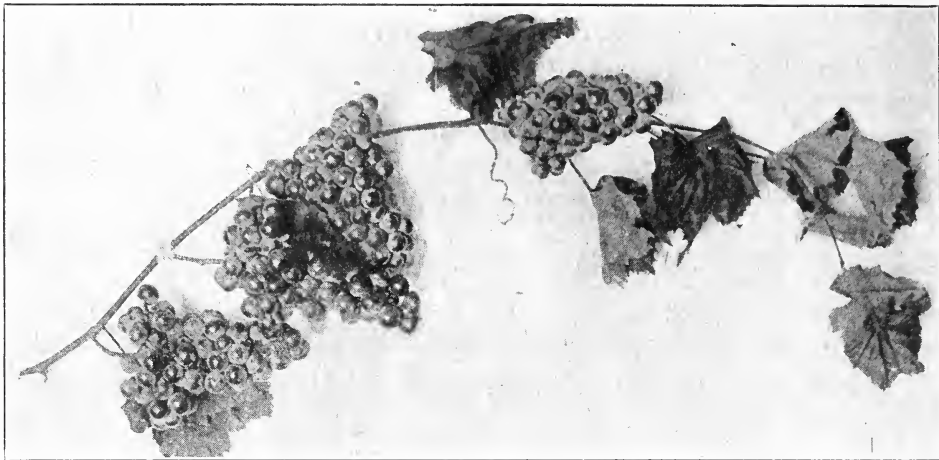

(Carman, 18 Months After Planting, by a Florida Customer)

GRAPES

.....

We Are Known the World Over
For Our Grapes

.....

It Will Be To Your Advantage To Get
Your Vines From Headquarters

.....

We Have a Very Large Stock of Well
Grown Vines

.....

Age of Vines. In all of the varieties listed, we can supply one-year vines of vigorous growth, and can supply two and three-year vines of most of the varieties. In the Price List on next page we have indicated the ages we have in stock by the small figures following the name of the variety.

Those having the figure "3" indicate that we can supply either one, two or three-year vines.

Those having the figure "2" indicate that we can supply either one or two-year-old vines, but no three-year.

Those having the figure "1" indicate that we can supply first-class one-year vines, but no two or three-year.

The age applies to the body and root of the vine, as the tops of either of the ages are only one year's growth, as each spring the old top was cut off back to the crown, so that a new top be grown, as this is the best method. In transplanting the vines (of either of the ages) the tops should be cut back by removing all the branches but two, and cut these back to two to four buds, and from the buds that are thus left the new top of next season will grow. See directions in our pamphlet on grape culture, which is sent on request to those whose orders for grape vines amount to \$2 or more.

GRAPES—Continued

PRICES

Unless one-year vines are specially ordered, we will fill all orders with two or three-year vines, if such are in stock, and fill with first-class one-year vines where we have no older vines of the variety ordered. The following prices are based on one-year vines, but we make no greater charge for the older vines. Either age will come into bearing at same time after transplanting.

1 to 5 of a variety at the "each" rate.

6 to 39 of a variety at the "dozen" rate.

40 to 400 of a variety at the "100" rate.

400 or more of a variety at the "1,000" rate.

Varieties—(Here grouped for convenience in pricing. On the following pages they are described in order of ripening.)

The Figures following the names of varieties refer to ages in stock; see page 16.

GROUP ONE			Each	Dozen	100	1,000
			\$0.10	\$0.60	\$4.00	\$35.00
Variety	Variety	Variety				
Concord ³	Delaware ³	Fern ³				
Gold Coin ³	Headlight ³					
GROUP TWO			\$0.10	\$0.85	\$6.00	\$50.00
Blondin ²	Captain ³	Catawba ³				
Cloeta ³	Columbian ³	Edna ³				
Ellen Scott ³	Herbemont ³	Last Rose ³				
Manito ³	Mericadel ²	Muench ³				
Ronalda ³	R. W. Munson ³	Xlnta ³				
GROUP THREE			\$0.15	\$1.25	\$8.00	\$70.00
Agawam ³	Albania ²	America ²				
Armalaga ³	Beacon ³	Bell ²				
Ben Hur ³	Brilliant ²	Captivator ²				
Carman ³	Champanel ²	Ericson ³				
Extra ³	Goethe ³	Hernito ²				
Jacquez ³	Ladano ³	Lindley ³				
Lomanto ²	Lukfata ³	Manson ³				
Moore Early ²	Niagara ²	President ²				
Salem ³	Valhalla ²	Wapanuka ²				
Winchell ³	Xenia ²					
GROUP FOUR			\$0.20	\$2.00	\$12.00	\$110.00
Amethyst ²	Augustina ²	Escol ¹				
Delakins ¹	Dr. Collier ¹	Hopkins ¹				
Hidalgo ¹	Husmann ³	Neva ¹				
Krause ¹	Muscat Rose ²	Rommel ¹				
Nitodal ¹	Red Giant ²	Wetumka ¹				
Salamander ¹	Sabinal ¹					
Wine King ¹	Bailey ²					

1916-1917

GRAPES—Continued

CULTURE

We have prepared a pamphlet on the culture of grapes which is re-print of Chapter V and VI from "FOUNDATIONS OF AMERICAN GRAPE CULTURE" and consists of 20 pages. This pamphlet will be sent free to all of our customers purchasing grape vines to the amount of \$2 or more, if such is requested. If the pamphlet is desired, please so request it when sending in your order. To others it will be mailed for 25 cents.

The following are good books on the grape:
 "Foundations of American Grape Culture".....\$2.00
 "American Grape Growing and Wine Making".....1.50
 "Grape Culturist," Fuller.....1.00

TO AID IN SELECTING VARIETIES FOR THE DIFFERENT REGIONS

While all of the varieties we list succeed to a greater or less degree here at Denison, Texas, on warm sandy soils with clay subsoil, there are other soils and regions where only certain varieties are successful. At the end of the description of each variety will be found capital letters indicating the regions for which they are recommended.

The letter **G** indicates for the Gulf Coast region, or 100 miles back from the Gulf north of Corpus Christi.

The letter **R** indicates those for the Rio Grande region and all south of San Antonio, and for El Paso and Pecos River regions; Arizona and California.

The letter **B** indicates those for Black Waxy and Limy soils throughout the South.

The letter **E** indicates for more or less sandy soils of East Texas and other moist regions of the Southern States north to Arkansas and Kentucky.

The letter **P** indicates for the Red Plain region of western Texas north of T. & P. Ry., western Oklahoma, Oregon and Washington.

The letter **S** indicates for the Staked Plains west of the Red Plains region; western Kansas, and eastern New Mexico.

The letter **M** indicates for the central Mississippi region, and Atlantic slope, north of Carolina to latitude of Cincinnati and St. Louis.

The letter **N** indicates for New England States, New York, and southern Ontario.

The letter **W** indicates for Wisconsin and west to Rocky Mountains.

For decided success in the moister regions, mildew and rot must be prevented by spraying.

All the varieties possessing Post-Oak Grape blood, in order to get best results in cropping, should be treated the same as Herbemont, that is, plant wide apart, as much as twelve to sixteen feet in the rows, and have long arm pruning. They do especially well upon the Munson Canopy Trellis, mentioned in Foundations of American Grape Culture, page 224. Distance apart to plant and kind of pruning required for best results are mentioned with each variety, as per following key—

"Short arm" indicates arms should be pruned after second year 2 to 3 feet long. Plant such varieties 8 feet apart in vineyard row.

"Medium arm" indicates arms should be pruned from 3 to 4½ feet long after second year, and such varieties require at least 10 feet apart in vineyard rows.

"Long arm" indicates arms should be pruned from 4½ to 6 feet long, and such varieties require at least 12 feet apart in vineyard rows.

EXPLANATION OF ABBREVIATIONS AND SIGNS USED IN THE DESCRIPTIONS OF GRAPES ON THE FOLLOWING PAGES

All bearing grapes have one of two kinds of flowers—both kinds are pistillate, but one has perfect stamens and will bear alone; the other has imperfect stamens and will require perfect stamen variety blooming at the same time planted near to render the imperfect stamen variety fruitful. Some of the best varieties are those having imperfect stamens. In the following descriptions characters are given after the name of the variety which will indicate to the reader the kind of flower and date of flowering. So in selecting mates for the imperfect stamen kinds, select those varieties with perfect stamens, blooming within three days earlier or at the same time. The perfect flowering kinds are indicated with an asterisk (*); the imperfect stamen kinds with the dagger (†). The date of flowering is indicated immediately after such sign. As all grapes bloom here in April and May, these two letters, (A) for April, and (M) for May, are used, the figures following these letters indicate the date in that month.

All dates mentioned are for Denison. While they will vary in other sections, the relative position will remain the same. This subject is fully treated in Foundations of American Grape Culture, pages 112, 131 and 212.

DESCRIBED IN ORDER OF RIPENING

The varieties are named in the following descriptions in near the order in which they ripen as it is possible to do so. There is a variation from season to season. The prices for each variety are given on page 17, and there grouped for convenience in pricing, and no attention paid to order of ripening.

(Many of the varieties are given fuller descriptions and have full page illustrations in "FOUNDATIONS OF AMERICAN GRAPE CULTURE"—Price \$2.00.

PERIOD I—LAST OF JUNE

Headlight. (†A19) Hybrid of Moyer with Brilliant. Vine slender, but more robust than Delaware, and making much longer vines, less attacked by mildew, leaves resembling those of Brilliant, but not so large; clusters small to medium, very compact, shouldered; berries clear, dark red, globular, medium or above in size, very persistent. Skin thin, tough; pulp tender, very sweet, almost equal to Delaware in quality and the finest in quality of any

American grape ripening so early. E. P. S. M. N. R. W.

"Short arm," Price Group 1, Page 17.

PERIOD II—JULY 1 to 10

Brilliant. (*A17) (Lindley x Delaware.) Growth strong. Vine endures winters anywhere up to 15 degrees below zero. Clusters large, cylindrical, or somewhat conical, often shouldered, open to compact. Berries large, globular, light to dark red, translucent, with a thin bloom, very handsome when well ripened; skin thin, rather tender, but seldom cracks;

GRAPES—Continued

pulp meaty, yet very tender, melting, and delicious, usually preferred for table and eating fresh, to Delaware. Ripens just before the Delaware and yields on an average fully twice as much. It ships about equally as well or better than Concord. R. E. P. S. M. N.
"Medium arm," Price Group 3, Page 17.

Winchell. (*A17) Sometimes confused with the Green Mountain, but the true Winchell is a distinct variety. Cluster and berry larger than Green Mountain, and of yellowish white. Green Mountain suffers easily from drouth by withering before ripening and for this reason we have dropped it.
"Short arm," Price Group 3, Page 17.

Manito. (†A20) Hybrid of America and Brilliant. Growth very similar to America, endures extremes of climate very well. Clusters long, cylindrical, rather open, with long peduncle. Very prolific; berries medium, globular, persistent, dark purple, with white specks; very distinct and unique in appearance; skin thin and tough, pulp very tender, juicy, sweet and agreeable. Ripens very early, about with Moore Early, packs beautifully and ships excellently. A very profitable market grape, also a good wine grape. E. P. S. M. N. W.
"Medium arm," Price Group 2, Page 17.

Lomanto. (*A20) Hybrid of Salado and Malaga. Vine vigorous, prolific, healthy, no rot or mildew; cluster above medium, conical, properly compact; berry very persistent, medium to large, spherical, dark purple or black, skin thin, tough; pulp melting, excellent quality; juice claret red. Valuable for limy soils and hot climate. See note under Nitodal. B. E. P. M. N.
"Medium arm," Price Group 3, Page 17.

Cloeta. (*A25) Parentage—America x R. W. Munson. Cluster large, berry large, black, handsome; skin thin, handles well; pulp tender, juicy, sprightly, far better quality than Concord. Vine very vigorous and prolific. Uses, market, table, red wine. Requires hot, dry weather to acquire high quality. E. S. M.
"Long arm," Price Group 2, Page 17.

Ladano. (†M4) Hybrid of Salado and Headlight. Vine vigorous, healthy, foliage similar to that of Headlight; cluster medium, compact; berry medium or above, dark, clear purplish-red, translucent, round; skin thin, tough; pulp tender, melting, rich, pure and sweet. Fine for hot climate and limy soils. See note under Nitodal. B. E. M. P. N.
"Long arm," Price Group 3, Page 17.

President. (*A18) Pure seedling of Herbert. Has a much better vine, which is strong, healthy, and prolific. Flower perfect. Cluster medium, compact; berry large, black, persistent, does not crack. Similar to Moore's Early and of far more value in the South than that variety. Quality excellent, much better than Concord. R. E. P. S. M. N. W.
"Medium arm," Price Group 3, Page 17.

PERIOD III—JULY 10 to 20

Captivator. (*A18) A cross of Herbert with Meladel, that is a combination of Rogers No. 14, his best black grape, Delaware, Goethe and Lindley. The growth is fairly vigorous, foliage less attacked by mildew than Delaware. Very prolific. Cluster above medium, cylindrical. Berry large, round, of a beautiful bright translucent pinkish red, no handsome grape grown. Skin thin, tough, without cracking. Pulp melting, of exceedingly delicious flavor, nothing superior. We think this grape will make a marvelous record over a very extensive region. Should prove hardy as far North as Central Illinois, Ohio, and in Massachusetts. In beauty and quality we are sure it is the finest grape yet produced in America. Ripens with Delaware. R. P. S. M. N. E.
"Medium arm," Price Group 3, Page 17.

Delaware. (*A20) Full historic description, page 143. Foundations of American Grape Culture, and illustrated on page 145, same book. Cluster medium, berry medium, bright red, juicy and of highest quality. Succeeds well in the South. Does not rot, but needs spraying to ward off Downy Mildew. E. S. M. N. B.
"Short arm," Price Group 1, Page 17.

Delakins. (*A20) A cross of Delago with Perkins, that is, a combination of Delaware, Goethe and Perkins. It has the robustness of Perkins, the handsome cluster of the Delaware, but larger, and the size and shape of the berry of the Perkins. Ripens after Delaware. G. R. E. P. S. M. N. W.
"Short arm," Price Group 4, Page 17.

Rommel. (*A18) Hybrid of Elvira and Triumph. Growth medium, endures climate better than Concord. Prolific. Slightly attacked by mildew in wet, sultry seasons, but less so than Delaware. Clusters medium to small ovate or cylindrical, often shouldered, compact, peduncle short. Berries large, globular, persistent, greenish yellow when fully ripe, skin very thin and delicate, too tender for long shipment, carries well 50 to 100 miles; very profitable for a home market grape, as it is always in demand on account of its most agreeable and fine eating qualities. Pulp melting and perfectly delicious when well ripened, but acid when under-ripe. Fruit rarely or not at all attacked by rot. R. E. P. S. M.
"Short arm," Price Group 4, Page 17.

Bell. (*A15) A hybrid of Elvira with Delaware. Vine vigorous, healthy, free from mildew and leaf folder, very hardy, a good sure producer; cluster medium cylindrical, often with a shoulder, fairly compact; berry medium, round, greenish yellow, rarely attacked with Black Rot; skin thin, sufficiently tough to prevent cracking under ordinary weather changes; pulp rather tender, juicy, very sweet and agreeably flavored; ripens just before Concord. E. P. S. M.
"Short arm," Price Group 3, Page 17.

Hernito. (*A26) A seedling of Roger's No. 44, Herbert. Vine vigorous, healthy, with foliage similar to that of Concord, endures the climate of Texas better than Concord, but more specially recommended for Northern States where something much better than Concord is desired. Flowers perfect, cluster of medium size, compact; berry very large, black. Ripens before Concord and far superior to it; much more persistent to the cluster, never cracks and hence a much better shipper. Very prolific. An improvement upon the Herbert, which was regarded as Roger's best black hybrid. Illustrated, page 159, Foundations of American Grape Culture. "Short arm," Price Group 3, Page 17.

Wapanucka. (*A22) (Rommel x Brilliant.) Growth medium to strong, equal with Concord. Cluster medium to large, cylindrical, shouldered, properly compact; peduncle short to medium. Berries large, five-eighths to seven-eighths inch in diameter, globular, persistent, rich yellowish white, translucent; skin very thin and delicate. Ripe about with Delaware. Far superior to Niagara and Green Mountain. For nearby market and table grape there is no other variety superior, if equal to it. Very prolific. R. E. P. S. M. N.
"Short arm," Price Group 3, Page 17.

Nitodal. (*A23) Salado hybridized with Malaga. Vine vigorous, healthy, cluster medium to large, conical, handsome; berry persistent, above medium, translucent, dark red; skin thin, never cracks; pulp melting, pure, fine juice pale pink. Altogether very attractive and valuable; especially in limy soils and hot climate. This grape comes out of the species *Vitis Champini* of Southwest Texas which possesses endurance against climatic hardships in the South superior to any other species. This applies as well to Lomanto, Salamander, which are also bred out of this species by two gen-

GRAPES—Continued

erations of breeding. The parent, Salado, is a hybrid of one of the best Vitis Champini varieties with Brilliant. G. R. B. E. P. S. M. N.

"Long arm," Price Group 4, Page 17.

PERIOD IV—JULY 20 to AUGUST 1

Salamander. (*M3) A combination of Salado, Delaware, and Lindley. Vine very vigorous and healthy, enduring drouth perfectly and 15 degrees below zero of cold. Prolific, of medium handsome, compact clusters of good, medium translucent red berries, having thin tough skin, melting pulp of quality about equaling Delaware. G. R. B. E. P. S. M. N.

"Medium arm," Price Group 4, Page 17.

Lukfata. (†A20) (V. Champini x Moore's Early.) Growth strong, endures heat, drouth and cold remarkably well. Succeeds in black, limy soils. Not injured by mildew. Cluster medium, ovate, sometimes shouldered, compact; berries globular, large, persistent; does not crack; pulp about same as Moore's Early, more juicy and very sweet and agreeable. B.

"Long arm," Price Group 3, Page 17.

Beacon. (*A22) Big Berry Post-Oak x Concord.) Growth medium in South Texas, becoming stronger in North Texas, to very strong in Missouri. Very prolific, of large cylindrical clusters, often shouldered, moderately compact. Berries as large or larger than Concord, black, with rather heavy white bloom, hang to cluster about equally well with Concord, but not so well as Bailey; skin a little tougher than Concord, never cracks; pulp rather more tender than Concord, very juicy, sprightly and of a very similar flavor to Concord. G. E. P. S. M.

"Long arm," Price Group 3, Page 17.

Concord. (*A18) Cluster medium to large, berry large, black with bloom. A well-known grape. Better North than South. In the South it does not ripen evenly. S. M. N.

"Medium arm," Price Group 1, Page 17.

Niagara. (*A17) Clusters large, compact; berry large, yellowish-green; skin tender; pulp juicy, better in quality than Concord, but not so good as Diamond. Needs spraying to ward off Black Rot. Better North than South, but succeeds better in the South than Concord. G. E. P. S. M. N.

"Short arm," Price Group 3, Page 17.

Ericson. (*M10) Seedling of America crossed with R. W. Munson. Cluster medium to large, compact and attractive. Berry medium, black. Skin thin and tough. Seeds small. Fine for table and wine. The vine is hardy, healthy and vigorous, and resists attacks of insects well. G. E. P. S. M.

"Medium arm," Price Group 3, Page 17.

R. W. Munson. (†A23) (Big Berry Post Oak x Triumph.) Growth strong. Clusters medium to large, cylindrical, often shouldered. Berries when well grown, medium to large, globular, persistent; black without bloom; skin never cracks; pulp tender, juicy and of a very good quality, better than Concord or Beacon. Gives good satisfaction on market. Bears heavily on long pruning and when pollinated by other erect stamened varieties flowering at same time, its own pollen not being fully adequate, although its flowers are perfect. Concord and Brilliant good pollinators for it. G. E. P. S. M.

"Long arm," Price Group 2, Page 17.

Salem. (Rogers.) (†A17) Medium cluster, large red berry, quality good.

"Short arm," Price Group 3, Page 17.

PERIOD V—AUGUST 1 to 10

Captain. (†A20) Parentage—America crossed with R. W. Munson. See description of these. Clusters very large; long cylindrical, reaching 10 to 12 inches; berry large, black with white bloom; skin thin; ships well; pulp

tender, quality much better than Concord. Exceedingly vigorous and prolific. Uses, market, table, red wine. Use Concord or Krause, as pollinators. G. P. S. M.

"Long arm," Price Group 2, Page 17.

Xlnta. (†A 22) (America x R. W. Munson.) Growth strong. Clusters large, cylindrical, shouldered, with medium peduncle, fairly compact, unless not well pollinated, then loose; flowers have reflex stamens and perfect flowering kinds should be planted near, such as Brilliant, Delaware or Gold Coin; Berries medium to large, globular, persistent, black, with little bloom; skin thin, never cracks; pulp meaty, tender and of a very agreeable, sprightly quality. Very prolific. An excellent market and wine grape. G. P. S. M. E.

"Long arm," Price Group 2, Page 17.

Mericadel. (½A26) A hybrid of America with Delaware. Vine very vigorous and very productive; cluster large, berry medium, purple, very persistent to cluster; skin thin and tough; pulp tender and meaty, of very best quality; fine for table and market. Ripens late, after Concord. Doing finely in Florida and Southeastern part of United States. Pronounced of the best quality by many who have taken part in our "grape-tasting parties." G. E. P. S. M. N.

"Medium arm," Price Group 2, Page 17.

Champanel. (*A20) (V. Champini x Worden.) Growth rampant, exceedingly resistant to heat and drouth, growing well in limy black soils. Clusters large, conical, with long peduncle, rather open. Berries globular, large, black, with white bloom, persistent; skin thin, tough; pulp tender, juicy, very sprightly, acid unless well ripened, then quite agreeable. B.

"Long arm," Price Group 3, Page 17.

Amethyst. Parentage—Delago x Brilliant. Cluster medium; berry large, clear red, with delicate bloom; skin thin and tough; pulp tender, quality the best. G. E. P. S. M. N.

"Short arm," Price Group 4, Page 17.

Dr. Collier. (*A29) Ten Dollar Prize Post-Oak and Concord Hybrid. Vine vigorous. Cluster large, conical, not very compact; berries large, globular, clear handsome red, persistent, does not drop or crack; skin thin; flesh a little pulpy, very juicy. Should be thoroughly ripe, otherwise rather acid; good quality. E. P. S. M.

"Medium arm," Price Group 4, Page 17.

Extra. (*M1) (Big Berry Post-Oak x Triumph.) Growth strong; cluster oblong to cylindrical, sometimes shouldered, moderately compact. Berries persistent, globular, medium to large, dark purple to black, with moderate bloom; skin thin, tough, never cracks; pulp tender, juicy, sprightly, agreeable, sweet. G. E. P. S. M. R.

"Long arm," Price Group 3, Page 17.

Ben Hur. (*A28) Parentage a combination of Post-Oak grape with Norton and Herbeumont. Vine very vigorous, very prolific, free from rot and mildew; cluster large; berry little under medium, black, persistent; pulp very tender, juicy, sprightly, sweet. We consider this one of the most valuable of American wine grapes. G. E. P. S. M. R.

"Long arm," Price Group 3, Page 17.

Krause. (*A20) This was produced from seed taken from sample clusters of a variety produced by Prof. E. W. Krause of Waco, Texas. Supposed to be a hybrid of Herbeumont and Niagara. Vine is vigorous, usually healthy, slightly attacked by mildew in damp seasons. Very prolific of large handsome clusters of pearly white berries of medium to large size, of fine quality. Very handsome in basket and sells at highest price. Promises to be an exceedingly valuable grape for all of the Southwest. We have named the variety in honor of Prof. Krause, who did valuable work in hybridizing grapes. Illustrated, page 150, Foundations of American Grape Culture.

"Short arm," Price Group 4, Page 17.

GRAPES—Continued

PERIOD VI—AUGUST 10 to 20

America. (#A23) (Seedling of Jaeger No. 70.) Growth very strong. Cluster conical, sufficiently compact. Berries very persistent, medium size, globular, black, with little bloom, and scattering dotted jet black, with white speck in center of dots; skin thin and tender, but does not crack; pulp melting, juicy, easily freeing the slender seeds, when fully ripe very rich in sugar; also rich in agreeable acid; possesses a very distinct, peculiar flavor, much liked by some; not "foxy," making a good combination market and wine grape. A very good port wine has been made from it without "fortifying." Very prolific with long arm pruning and when pollinized by other varieties, as it does not thoroughly pollinize itself. Beacon is a good mate. E. P. S. M.

Price Group 3, Page 17.

Bailey. (*A26) (Big Berry Post-Oak x Triumph.) Growth strong. Clusters large to very large, cylindrical or often branching, generally compact. Berries persistent, large, black, with little bloom; skin thin and tough, never cracking; pulp meaty, but not tough, juicy, sprightly, of pure very good quality, considerably above Concord. A valuable market grape, easily superseding Concord, especially in South-Central and Southwest Texas, where it has done remarkably well. G. R. P. M. S.

"Long arm," Price Group 4, Page 17.

Blondin. (*A30) Combination of Ten-Dollar-Prize-Post-Oak, Norton Virginia, and Herbermont. Cluster large, compact, shouldered; berry medium, white, translucent; skin very thin and tough; pulp very tender, juicy, sprightly, quality excellent, nearly best. Very vigorous, prolific. Late, with Triumph and Catawba in season. Very valuable as a late market and white wine grape. E. P. S. M.

"Long arm," Price Group 2, Page 17.

Valhallah. (*A20) A hybrid of Elvicand and Brilliant. A very vigorous drouth-enduring, prolific vine, well suited for black lands and will endure Missouri winters. Cluster medium; berry large, bright clear red; thin, tough skin; tender, juicy pulp of quality nearly equaling Brilliant. Hangs on perfectly; never cracks or rots. B.

"Medium arm," Price Group 3, Page 17.

Wine King. (*A26) A hybrid of Winona and America. Winona is a pure seedling of Norton Virginia, and quite an improvement on that celebrated variety, hence Wine King is a thoroughbred pure America blood of the finest wine properties and large enough in berry and cluster to make a good market grape. Cluster large, berry medium, black, very persistent. Skin thin, never cracks, pulp tender and juicy, rich and sprightly, intensely red juice. Very vigorous, prolific; free from all disease. G. E. P. S. M. R.

"Long arm," Price Group 4, Page 17.

Manson. (*A26) An exceedingly valuable white grape. A hybrid of R. W. Munson with Gold Coin, produced in 1899. Vigorous and productive; clusters large, berry above medium, of yellow color; skin thin and tough; pulp tender, quality excellent. Ripens with Triumph. E. P. S. M.

"Short arm," Price Group 3, Page 17.

PERIOD VII—AUGUST 20 to 30

Catawba. (*A13) Cluster medium, conical; berries above medium, clear dark red, globose; skin thin, tough; pulp rather tender, juicy, sprightly, with a slight Muscat flavor, not foxy. Excellent for table and wine. Does well North and fairly well South. E. P. S. M.

"Medium arm," Price Group 2, Page 17.

Ellen Scott. (*M3) Armlong hybridized with Herbermont. Vine beautiful, healthy, vigorous, prolific. Suitable to the South as far north as St. Louis and Cincinnati. Cluster

large to very large, conical. Berry large, translucent, violet covered with a delicate bloom. Skin thin and tough. Pulp tender, very juicy and sprightly, of pure high quality, reminding one of the best foreign grapes. A very handsome table and market grape. Ripens after Catawba. This grape ought to be especially valuable in West and Southwest Texas, where the European varieties will grow, and we believe will become a valuable commercial variety for those regions, as well as regions farther north and east. We anticipate for this grape a great future, and believe we have produced no grape of greater value. G. R. E. P. S. M.

"Long arm," Price Group 2, Page 17.

Armalaga. (*M2) A hybrid of Armlong (which is a hybrid of native Post-Oak grape with Black Eagle) and Malaga. The vine is vigorous and healthy. Flower perfect. Cluster large and compact. Berry large, yellowish-green, translucent, persistent to cluster. The skin is thin, tough, yet pleasant to taste, without astringency. It endures shipping as well as Tokay. In quality equal to the best foreign grapes. This promises to be very valuable in all of the drier portions of the Southwest, as it is much hardier than pure Vinifera kinds. Its fruit would be taken by anyone not acquainted with native blood as a pure foreign grape and will sell equally well with such, while the vine is immensely superior to any of the foreign. Its quality is much richer than Malaga. R. E. P. S. M.

"Medium arm," Price Group 3, Page 17.

Edna. (#M3) Hybrid of Armlong with Malaga, and similar in every way to Armalaga, although the vine is more vigorous. Clusters larger and as handsome as Armalaga. G. R. E. P. S. M.

"Long arm," Price Group 2, Page 17.

Carman. (*A26) (Post-Oak No. 1 x Triumph.) Growth vigorous; foliage never attacked by leaf folder or mildew; very prolific. Cluster large to very large, shouldered or branched, conical, very compact. Berries persistent, medium, globular, black with thin bloom; skin thin and tough, never cracking; pulp meaty, firm, yet tender when fully ripe, of pure, rich quality, much superior to Concord. G. E. P. M. "Medium arm," Price Group 3, Page 17.

Augustina. Combination of Delaware, Goethe, Brilliant. Cluster large; berry very large, translucent carmine red, very handsome; skin thin and tough; pulp meaty, tender and juicy, quality the best, with very delicious characteristic flavor. Plant 8 feet, short arm pruning. Spray. R. P. S.

Price Group 4, Page 17.

Kenia. (*A20) Parentage: Delaware, Goethe and Triumph. Clusters medium, compact, very large, white; skin thin and tough; pulp meaty, tender, highly flavored, best. Good grower, prolific Short arm pruning. E. P. M. R.

Price Group 3, Page 17.

Ronaldo. (*M4) Armlong-Malaga hybrid. Of the same general character as Armalaga, only the vine more vigorous and larger clusters. Ripens week later than Armalaga. White. G. R. E. P. S. M.

"Long arm," Price Group 2, Page 17.

Columbian. (*M10) Seedling of Isabella, and first introduced as Union Village. Cluster small; berries immensely large, purple. Quality fair. Ripens unevenly. Its extreme large berries make it a novelty for those who wish large berries to be the prime object. Fine for Jelly. E. P. S. M.

"Medium arm," Price Group 2, Page 17.

Gold Coin. (*A23) (Norton x Martha.) Growth medium. Cluster medium or above, ovate shouldered, proper degree of compactness. Berries large, globular, yellowish when fully ripe, persistent; skin thin, tough, never cracks, and rarely attacked by rot; pulp about

1916-1917

GRAPES—Continued

same consistency as Concord; very juicy and exceedingly sweet; retains a little of the Martha flavor; liked by most persons. Very handsome in the basket and markets excellently. E. M.
"Short arm," Price Group 1, Page 17.

Escol. Introduced into the United States from Palestine by General Lew Wallace. Immensely large cluster. Berries very large, ovoid, purplish black, very firm and meaty, hence a fine shipper. Does not crack. Very handsome and showy grape. Belongs to Vinifera class. R. P.
"Short arm," Price Group 4, Page 17.

Muscat Rose. A Vinifera variety and one of the most hardy of that class. Large cluster, large red berries resembling Tokay, pulp meaty, high quality. R. P.
"Short arm," Price Group 4, Page 17.

PERIOD VIII—SEPTEMBER

Grapes in this period, while ripening here the last week of August and first week in September, will hang on for several weeks without deteriorating, as the nights are cool and birds have left.

Jacques. (Le Noir, Black Spanish.) (*M2) Very prolific. Cluster rather open, but long and large. Berries small, very juicy and sprightly. Fine for red wine. Does well in Southwest Texas in semi-arid regions. In moister regions requires spraying to keep off mildew and black rot, to which it is subject. R. G. P.
"Long arm," Price Group 3, Page 17.

Herbemont. (*M4) Vine very vigorous, healthy and long lived in the South. Clusters large; berries small to medium, brownish red or translucent purple, not coloring much when in dense shade of foliage. Juicy and sprightly. Fine white or amber wine. Much subject to black rot, which will have to be kept in check by spraying. Well adapted for the South and only as far north as Kansas, as winters with

15 degrees below zero and colder will damage it. R. G. P.

"Long arm," Price Group 2, Page 17.

Muench. (*M2) A hybrid of Negosh (a Missouri Post-Oak grape found by H. Jaeger) and Herbemont. Vine very vigorous and free from all disease; clusters large to very large; berries above medium, purplish black; pulp very tender and meaty, of fine quality. Sells readily in the market, also fine for table. G. E. P. M.
"Long arm," Price Group 2, Page 17.

Fern Munson. (†M4) (Post Oak No. 1 x Catawba.) Growth very strong. Cluster medium to large with long peduncles. Berries globular, medium to large, very persistent; very dark purplish red to nearly black; skin thin, tough; pulp firm, but not tough; very juicy, sprightly, with very agreeable Catawba flavor when fully ripe; seeds leave the pulp readily. Very profitable, as it ripens when all old varieties are gone. Free from black rot. Has endured 27 degrees below zero and has borne well the following season. It endures drouth excellently. G. R. E. P. S. M.
"Long arm," Price Group 1, Page 17.

Last Rose. (†M5) A hybrid of Armlong and Jefferson. Vine vigorous, healthy and prolific. Cluster very large, compact, long peduncle, conical, with heavy shoulder. Berry medium to large, dark bright red, round. Pulp tender, of very good quality. Ripening later than the Fern Munson. Adapted to the same regions as the Ellen Scott. A very handsome market grape. G. R. E. P. M.
"Long arm," Price Group 2, Page 17.

Albania. (*M2) Parentage: Post-Oak x Norton x Herbemont. Cluster large to very large, shouldered; berry medium, translucent white; skin thin and tough; pulp very tender and juicy, sprightly, with Herbemont character, but sweeter; very vigorous and prolific; uses, late market, table and white wine. Plant 10 to 12 feet, and give long arm pruning, as described on page 226, Foundations of American Grape Culture.
Price Group 3, Page 17.

ABOUT THOSE NEW GRAPES

During the season of 1912, the late T. V. Munson saved seed of the very best combinations that were made up to that time, expecting to produce some new varieties that could excel even the best he had previously produced. His death in January, 1913, prevented him from carrying out and enjoying the results of his work. But the seedlings that he started were carefully planted in a new test vineyard and since watched. Out of some eight hundred (that were culled out of several thousand) that bore during the past three years, there are going to be about ten varieties of special merit. These have been noted, but none of them as yet named. We have a few nursery vines of them, and anyone wishing to experiment with them we offer a few vines at \$1 each. They have been designated as follows:

- | | | |
|-------------------------|-------------------------|-------------------------|
| Row 2, Post 8, Vine 1. | Row 7, Post 12, Vine 5. | Row 6, Post 7, Vine 5. |
| Row 2, Post 18, Vine 5. | Row 7, Post 8, Vine 4. | Row 8, Post 3, Vine 3. |
| Row 4, Post 13, Vine 1. | Row 2, Post 10, Vine 7. | Row 7, Post 14, Vine 4. |
| Row 5, Post 2, Vine 2. | Row 4, Post 10, Vine 5. | XXXX—\$2 each. |
| Row 5, Post 14, Vine 3. | Row 4, Post 18, Vine 1. | |
| Row 6, Post 18, Vine 4. | Row 5, Post 10, Vine 1. | |

The Row 4, Post 18, Vine 1, promises to be the latest white grape. It has a handsome cluster, fine quality and ripe after Last Rose. The XXXX is a fine bright red grape of above medium berry, solid and meaty, cluster size of Delaware. After another year's test, we will pick out about six of the very best of above, name and introduce them.

RESISTANT GRAFT STOCKS FOR GRAPES

Prices—10 cents each; \$1 per dozen; \$7 per 100.

To meet the demand of some of our customers for good Stocks, resistant to phylloxera, on which to graft more delicate varieties of Grapes, especially the Viniferas, which thereby can be made very successful in many parts of the South, especially in Southwestern Texas, we have grown a small stock of the most approved, well tested species and varieties.

Vitis Champini variety Dogridge. Well adapted for limy and sandy soils. Native of Bell County, Texas.

Vitis Doaniana variety Adobe Giant. Fine

for sandy and limy black soils. Native of Wilbarger County, Texas.

Vitis Solonis variety Australis. Specially fine for sandy soils. Native of Panhandle, Texas.

SOUTHERN MUSCADINES AND HYBRIDS

Succeed in deep rich soil throughout the South. Require much high trellis room. Plant 16 to 20 feet apart in rows. Require little or no pruning. Fruiting varieties, to render them fruitful, need male vine growing near to pollinate them.

A most excellent work on the Muscadine Grape has been published by the United States Department of Agriculture, entitled **THE MUSCADINE GRAPES** by Geo. C. Husmann and Chas. Dearing. It is a bulletin of 60 pages with numerous high grade half tones and colored plates. We have no copies of this bulletin for distribution, but if you send 25 cents to Superintendent of Documents, Government Printing Office, Washington, D. C., and ask for "Bureau of Plant Industry Bulletin No. 273, Muscadine Grapes," a copy will be sent you if still in print. Also Farmer's Bulletin, April, 1916, No. 709.

	Prices	Each	Dozen
Scuppernong, Thomas.....		\$0.25	\$2.50
San Jacinto, LaSalle.....		.35	3.50
San Rubra.....		1.00	
Male Muscadine (no vines this season.)			
Muscadine Seedlings.....		.20	2.25

Thomas. Very large black, two to five berries to cluster, not persistent. Best of the pure black muscadines. Good wine.

Scuppernong. Large, bronze, yellow, juicy, good wine. Four to six berries to cluster.

The following are hybrids of the Scuppernong made by us. The La Salle and San Jacinto being of the first generation and the others of the second generation from the Scuppernong:

La Salle. Hybrid of Muscadine and Post Oak. Large, black berry with 6 to 15 to cluster and more persistent than Thomas. Skin thin, pulp tender and better quality than Scuppernong. Earlier to ripen of this class.

San Jacinto. Berry above medium. Cluster a little more filled than La Salle, about three times the size of Scuppernong. Quality a lit-

tle better than La Salle and follows it in ripening. Very prolific. Same blood as La Salle.

Sanrubra. Hybrid of San Jacinto and Brilliant; about the same size as in San Jacinto; berry not quite so large as Scuppernong; much more persistent to cluster; skin quite thin, but never cracking; pulp melting and of best quality. Nearly as sweet as Sanalba; a great acquisition. Very vigorous and productive.

Muscadine Seedlings. These are grown from seed of La Salle, San Jacinto, and Scuppernong. The above named varieties grew near together with Albania, Armalaga and Gold Coin grapes near by. The seedlings may be pure and some may be hybrids. This cannot be determined until they fruit. Some may be staminate or male vines. We offer these seedlings only to those who wish to experiment. Some of them may prove extra ordinary.

GRAPE LEAF HOPPER

The grape leaf hopper, or "thrips," as it is sometimes called, is a small insect, active in its movements, which feeds on the under side of grape leaves. It is yellowish when young, but turns darker with age. It sucks the juices from the leaves, causing the leaves to die in spots and to turn brown. A serious leaf hopper infestation decreases the amount of sugar in the grapes to such an extent that they are of little value for the manufacture of wine, grape juice, etc. Grapes injured by leaf hoppers do not properly ripen.

REMEDY: The insect can be easily killed with "Black Leaf 40," applied when the nymphs are small and tender. One thorough spraying is usually sufficient for the season. Thoroughly wet the underside of the leaves. This is very important. See Bulletin No. 97 (page 1), U. S. Bureau of Entomology. Also No. 344, N. Y. Exp. Station, Geneva, N. Y. Also University of California, Berkeley, Cal., Bulletin No. 198.

ROSES

DIRECTIONS FOR PLANTING, PRUNING AND FERTILIZING

Any good garden soil is suitable, but should be well fertilized with decomposed stable manure. Keep the soil free from weeds and stir frequently during the summer. Mulching in fall with stable manure is beneficial. A small amount of bone meal or good fertilizer applied in summer is advisable.

WHEN PLANTING, cut off all but two or three of the strongest branches; cut these back to 3 inches. Plants thus cut back will transplant better and produce finer flowers.

PRUNING. After the first killing frost, most of the varieties should have two-thirds of the past year's growth cut off. As a general rule, the more vigorous the variety the less it should be pruned. Remove all decayed wood. Climbing Roses should have only their side branches shortened in; do not disturb the main stem.

WE FREQUENTLY receive complaints from our patrons who order late in the spring; they state the flowers produced on their roses are very inferior and do not come up to description. We would state that perfect flowers cannot be expected from plants set out late in February or March, and which produce blooms before they are well established. But if these plants are allowed to grow until the following fall, and if they receive the proper treatment, there will be no cause for complaint.

Read Henderson's Practical Floriculture. Price, \$1.50.

"HOW TO GROW ROSES." Revised and Greatly Enlarged. By Robert Pyle. A new book of 120 pages, 5x8 inches, of which 16 illustrate leading Roses in natural colors. All the necessary instructions which will be of value to the amateur are presented in clear, simple and concise form, where, when and how to plant. Fertilizers, Insecticides, Planting, Pruning, Mulching, Winter Protection, with important lists of the best Roses for every imaginable place and purpose. The Calendar of Operations alone may save you the cost of the book. Price, \$1, postpaid.

THE PRACTICAL BOOK OF OUTDOOR ROSE GROWING. By George C. Thomas, Jr. If you love roses and grow them, or desire to, you will need the explicit and authoritative instructions covering every phase of the subject in this work, the result of 15 years' close study of rose growing for the home garden. Location, ordering, planting, cultivation, etc., are all made easy with charts and text, and the 96 PERFECT REPRODUCTIONS IN FULL COLOR and some halftone plates of all kinds of roses. You will get big value in this beautiful large octavo volume, bound in handsome cloth, gold stamped, in a slip case. \$4.00 net, postage extra.

ROSES—Continued

STRONG, OPEN-GROUND, TWO-YEAR PLANTS

The following list includes the most superb varieties, both old and new. The plants are thrifty and vigorous, growing in open ground.

All these have been in bloom throughout the season, and we know them to be strictly pure and true to name and description. Our roses always give the best of satisfaction.

	Prices
Each	\$0.20
Dozen, made up of different varieties.....	2.25
Dozen, all of one or two varieties.....	2.00
Fifty, made up of different varieties.....	9.00
Fifty, not less than ten of a variety.....	8.00
Hundred, made up of different varieties.....	17.00
Hundred, not less than ten of a variety.....	15.00

EVERBLOOMING WHITE AND BLUSH

The Bride. Pure white, with tinge of pink when planted in the garden; large, full and most perfect form.

Clothilde Soupert. Vigorous, profuse bloomer, with medium, very full, white flowers, with pink center.

The Queen. Pure snow-white; sweet and fragrant; petals are thick; makes fine buds on long stems; good grower.

Antoine Revoire. Very handsome Camelia form. Outer petals almost white, gradually becoming flesh pink toward center; robust, healthy.

Kaiserin Augusta Victoria. Pure white, fragrant; fine buds and flowers on long stems; profuse; strong grower.

White Cochet. Identical in shape and habit with that splendid pink rose, Maman Cochet, except the color is white, changing to blush.

Carnot. Flesh-tinted white. Long beautiful bud, cupped, wax-like.

Fran Karl Druschki. An everywhere hardy, vigorous grower, with bright green leaves, delicately veined; splendid long buds and magnificent snow-white blooms with large saucer-shaped petals. Rightly named and deservedly a prize winner.

BUFF AND YELLOW

Etoile de Lyon. Rich, yellow, full, fragrant, pretty; profuse all summer.

Blumenschmidt. Pure citron-yellow; outer petals edged tender rose. A sport from Mademoiselle Franceska Kruger, which it resembles in form.

Marie Van Houtte. Canary-yellow, deeper center, the border of the petals tipped with bright rose; large, full and fine form, a free and continuous bloomer.

Sunburst. The color is orange-copper or golden-orange and golden-yellow; edge of petals lighter; all intense shades, extremely brilliant in effect.

Madame Jenny Gillemot. Buds long and pointed, deep saffron yellow, opening canary with dark golden shadings; blooms large, petals immense; opens very freely; a fine upright grower of branching habit. Exquisitely beautiful; very large in size; bud very long and pointed.

PINK

Catherine Mermet. Clear, shining pink with rich amber center; elegant buds and large globular flowers; handsome bush with dark green leaves. A parent of Bridesmaid and The Bride.

Madame Caroline Testout. Brilliant satiny-rose, deepening at center and bordered with silvery-rose; immense broad petals and extremely large flowers. The famous rose of Portland, Oregon.

Ophelia. A fine grower, with big, bright foliage that shows at a glance that it is a variety that will hold its flowers well. It is long-

stemmed, bushy and free branching, and a free producer of bloom. It is very fragrant and resembles Richmond in this respect. Color clear, bright pink, suffused yellow.

Duchess of Albany. (Red La France.) Two shades darker than its parent, the Pink La France, of which it is a duplicate in size, form and habit.

La France. Silvery-rose, with pink shades and satin-like petals of unsurpassable beauty; large, symmetrical and deliciously fragrant; blooms from June until frost; hardy with protection.

Franceska Kruger. Fine rich pink, creamy towards center, slightly penciled with deeper pink on outer petals. Healthy plant, great bloomer.

Maman Cochet. Rose or pink, shaded with salmon; profuse, fine bud and flower; strong grower; a very superior rose; one of the best for outdoor planting in Texas, also excellent for cut flowers.

Aurora. One of the grandest of all Hybrid Tea Roses. Color clear, bright pink, full and double to the center.

F. B. Fatzler. A most beautiful and distinct Rose of very free flowering character. The blooms are produced with great freedom on stiff stems, and are of large size and substance. The color is creamy-buff, back of petals delicate warm pink; as the petals reflex the color becomes light orange-pink, forming a most charming combination. Valuable for garden culture.

William Shean. A fine grower, throwing up long, stiff canes, crowned with large pointed flowers of purest Killarney pink, full, free, and a perpetual bloomer. Immense size, perfect form and substance. Altogether a glorious Rose.

Mlle. Cecile Bruner. Rosy pink on rich creamy white ground; a great bloomer; very satisfactory for bedding.

William R. Smith. (Charles Dingee, Jeanette Heller or Maiden's Blush; Smith, 1908.) Creamy-white with shadings of pink; a seedling from Maman Cochet and Kaiserin Augusta Victoria; beautiful in form and colors; glossy foliage; long, stiff stems; vigorous in growth; a superb summer bedder and hardy with light protection.

Paul Neyron. The largest of all Rose blooms; bright, shining pink, clear and beautiful; very double and full; finely scented; blooms first season and all summer. Grows to a great height in a single season and stems are almost thornless.

SCARLET AND CRIMSON

Meteor. Intense velvety-crimson, buds and blooms large, elegantly formed, fully double and borne on nice, long stems, with healthy, bright foliage of the deepest green. Brilliant and highly popular.

Etoile de France. (Star of France.) A brilliant shade of clear red-crimson velvet, centering to vivid cerise; large flowers on long, stiff stems; remarkably vigorous, free-blooming and hardy. Grown to some extent as a

ROSES—Continued

cut flower variety, but its chief value lies in its striking beauty as an outdoor bloomer and bedder with bronzy-green foliage.

General McArthur. (Hill, 1905.) Vivid crimson scarlet, the most beautiful shade of any garden or forcing rose offered, retaining its brilliancy when expanded to flowers of superb form, larger than Liberty or Meteor; free from mildew.

Rhea Reid. (Hill, 1908.) Described by the introducers: "Large as American Beauty (one of its parents), double as Bridesmaid, fragrant as La France, continuous as The Bride, and red as Richmond in winter. Produces a profusion of long canes and resists both mildew and black spot and makes most rapid growth."

Madame Masson. (Masson, 1856.) (H. P.) Massive, double and full flowers of intense red with crimson hue, highly perfumed; a constant and profuse bloomer, very attractive and striking.

HARDY CLIMBERS

Crimson Rambler. One of the finest climbers; magnificent trusses of deep crimson flow-

ers; makes a fine show as a climber and profuse bloomer for 2 weeks in spring.

Climbing Paul Neyron. Large flower, pink; constant. A superb variety, a fine companion for the next variety.

Climbing Meteor. A deep, double crimson climber. Constant in flower.

Climbing Augusta Victoria. Most beautiful white bud, and flower equaling in beauty the bush Kaiserin Augusta Victoria; constant.

Climbing Testout. Very strong. Light pink.

Red Dorothy Perkins. Profuse red, strong vine.

Climbing American Beauty. A seedling from American Beauty with an admixture of Wichuraiana and Tea blood. Same as its namesake in size, color and fragrance, with the addition of the climbing habit. Better blooming qualities, good foliage, and has proven hardy and withstood heat and drought. American Beauty × Marion Dingee × Wichuraiana.

SHADE AND ORNAMENTAL TREES

Many fine shade trees die the first season, after being carefully planted, from neglect of cultivation during the summer. Dig extra large holes, 4 ft. across and 2½ ft. deep. It would benefit to dynamite the bottom of the hole. In filling up roots use only good loamy moist soil. Then every two weeks during the summer cultivate the ground whether weedy or not, whether wet or dry, by digging up the soil two inches deep for a radius of four feet. Allow no Bermuda or other grass closer to the tree than four feet for two years. It will be well to mulch the trees with rakings of grass or old leaves. All these points are important. Many start to cultivate during the cool days of spring, but neglect during July and August, just the very time young set trees should have attention. See further instructions on page 6 under "Care of Trees on Arrival."

Your chief happiness lies in the growing ornaments surrounding your home. Such ornaments refine and purify. Neglect them not. Plant 20 to 25 feet on sidewalks; 25 to 30 feet apart in yards and parks.

See list of books in front part of catalog.

Elm, American White. (Ulmus Americana.) Our tall, wide spreading, native broad-leaved, white, or American Elm. The new growth long and switchy, sometimes pendant at the ends, often, however (forming the vast type), limbs gracefully upward. Attains one hundred feet or more. Indispensable in all Southern plantings.

Sizes	Each	Doz.	100
3 to 4 feet.....	\$0.10	\$1.00	\$ 7.50
4 to 5 feet.....	.15	1.60	12.50
5 to 6 feet.....	.20	2.25	17.50
6 to 8 feet.....	.30	3.00	24.00
8 to 10 feet.....	.40	4.00	32.00

Hackberry. (Celtis Occidentalis.) Perhaps the healthiest, most vigorous, most durable of our native trees, in all soils and conditions. Invaluable as street trees or as single specimens on the lawn and in grouping. We have found the hackberries, four to seven years old, transplant better than younger trees, which is very uncommon, the opposite of most trees. Plant with the view of their standing and growing for generations.

Sizes	Each	Doz.	100
3 to 4 feet.....	\$0.10	\$1.00	\$ 7.50
4 to 6 feet.....	.15	1.75	13.00
6 to 8 feet.....	.25	2.50	20.00
8 to 10 feet, 1 to 1½-inch.....	.35	3.50	28.00
8 to 10 feet, 1½ to 2-inch.....	.50	5.00	40.00
10 to 12 feet, 2 to 2½-inch.....	.75	8.00	65.00

Locust, Black. (Robinia Pseudacacia.) A well known species, largely planted throughout our country as shade and street trees, wind breaks and timber belts. Very popular in the treeless prairies, especially west of the 100th meridian. Of rapid growth, reproducing itself quickly after cutting, and the timber is very durable.

Sizes	Each	Doz.	100
3 to 4 feet.....	\$0.10	\$1.00	\$ 7.00
4 to 6 feet.....	.15	1.50	12.00
6 to 8 feet.....	.20	2.00	15.00
6 to 8 feet, 1 to 1½-inch.....	.25	2.50	20.00
8 to 10 feet, 1 to 1½-inch.....	.30	3.25	25.00
8 to 10 feet, 1½ to 2-inch.....	.40	4.50	35.00
10 feet up, 2 to 2½-inch.....	.75	8.00
10 feet up, 1½ to 3-inch.....	1.00	11.00

SHADE AND ORNAMENTAL TREES—Continued

Maple, Silver or Soft. (*Acer Dasycarpum*.) Grows best in moist, rich soil, but succeeds almost anywhere. A rapid, chaste, beautiful tree, suited to a wide range of purposes. Heads in a globular form, branching at crotch, does not have a leader like the sycamore. Leaves silvery beneath; turn scarlet in fall.

Sizes	Each	Doz.	100
3 to 4 feet.....	\$0.10	\$1.00	\$ 7.50
4 to 6 feet.....	.15	1.50	12.00
6 to 8 feet.....	.25	2.50	20.00
8 to 10 feet, 1 to 1½-inch.....	.30	3.25	25.00
8 to 10 feet, 1½ to 2-inch.....	.40	4.25	36.00
8 to 10 feet, 2 to 2½-inch.....	.65	7.50
10 feet, 2½ to 3-inch.....	1.25	13.00

Male Russian Mulberry. The flowers on this tree are nearly staminate, but have rudimentary pistil, which sometimes metamorphoses and will set insignificant fruit, especially first season or two after transplanting, but after tree recovers from check of transplanting and gets into full growth, rarely any fruit sets. What fruit does set does not begin to compare in size and productiveness to the regular bearing sorts. This variety does not sprout like the non-fruited Paper Mulberry. This has a round head of compact form, well filled with leaves. The trees we grow are grafted, the same as the fruiting sorts.

Sizes	Each	Doz.	100
One year, 3 to 4 feet.....	\$0.15	\$1.60	\$12.50
4 to 5 feet.....	.20	2.25	16.00
5 to 6 feet.....	.25	2.75	20.00
Two year, 5 to 6 feet.....	.30	3.50	27.00
6 to 8 feet.....	.35	4.00
Three year, 1½ to 1½-inch caliper, heavy.....	.50	5.00
1½ to 2 -inch caliper, heavy.....	.75	8.00

Persimmon. The persimmon makes a good shade tree, but owing to long tap root it is better to get the smaller sizes as described in the fruit section. However, if any one wishes to take the pains to transplant some 8 ft. size trees we have them from \$1 to \$2 each, according to size, from 1¼ to 2-inch caliper measure.

Poplar, Carolina. (*P. Caroliniensis*.) Considered as distinct from the Cottonwood, it differs in its strict, straight appearance, making a more upright, uniform head. A very rapid growing, effective tree, much planted throughout our country. Free from cottony blooms.

Sizes	Each	Doz.	100
4 to 5 feet.....	\$0.15	\$1.50	\$12.00
5 to 6 feet.....	.20	2.00	15.00
6 to 8 feet.....	.25	2.50	20.00
8 to 10 feet.....	.35	4.00	32.00

Sycamore. Very symmetrical, quick growing. Easy to transplant. Older trees have white underbark. Large leaves. Adapted equally well to black and sandy soils.

Sizes	Each	Doz.	100
3 to 4 feet.....	\$0.10	\$1.00	\$ 7.00
4 to 5 feet.....	.15	1.50	12.00
5 to 6 feet.....	.20	2.00	15.00
6 to 8 feet, under 1 inch.....	.25	2.50	20.00
6 to 8 feet, 1 to 1½-inch.....	.30	3.25	27.50
8 to 10 feet, 1 to 1½-inch.....	.35	4.00	32.00
8 to 10 feet, 1½ to 2-inch.....	.50	5.50	44.00
10 feet up, 2 to 2½-inch.....	.75	8.00
10 feet up, 2¼ to 2½-inch.....	1.00	10.00
10 feet up, 2½ to 3-inch.....	1.50	17.00
10 feet up, 3 to 3½-inch.....	2.00	22.00

Weeping Mulberry. Those we have are grown from cuttings hence on their own roots, and not grafted on a straight body. As the tree grows, the under limbs can be cut off and the tree will make its own body of a very pretty effect.

	Each	Doz.	100
3-year, 4 to 5 feet.....	\$0.75	\$8.00

Flowering Willow. (See under Shrubs.)

DECIDUOUS FLOWERING SHRUBS

Largely in demand for massing or grouping effects in landscapes, parks or other ornamental planting, and also as single specimens. Much depends upon the skill of the artist or planter in the proper selection, grouping or massing of Flowering Shrubs, to bring out the most pleasing and artistic effects. It is scarcely practicable to define set rules. Good soil and good culture will be amply repaid.

We have grown a large stock of shrubs to meet the growing demand which is increasing. As the Southwestern country is getting older, more attention is being paid to ornamentation of Homes, Yards, Parks, etc. To be successful, plant only those shrubs that are adapted. Do not make a mistake of planting some shrub that makes a fine show 1,000 miles away, for it may not endure the climatic conditions here. All those listed by us are fully successful in the Southwest. We can supply most of the shrubs in one, two, or three year sizes, from 6 inches to 5 feet high.

Althea, or Rose of Sharon. (*Hybiscus Syriacus*.) Altheas are among our most valuable flowering shrubs, blooming for a long time, and deserve to be in every collection. We have an assortment of distinct kinds, namely, Duchess de Brabant, purplish red; Joan de Arc, pure white, and variegated white with pink penciling.

Ages	Each	Doz.	100
1-year.....	\$0.20	\$2.00
2-year.....	.35	3.50

DECIDUOUS FLOWERING SHRUBS—Continued

Butterfly Bush. So named because the flowers attract the butterflies, and if there are many butterflies in the region, they will be swarming over the bush while in bloom. It is a strong growing shrub, with weeping branches, and at end of each branch there is a pendant of heliotrope-like flowers of heliotrope or lavender color.

Sizes	Each	Doz.	100
6 to 10 inches.....	\$0.15	\$1.50
10 to 18 inches.....	.25	2.50
3 to 5 ft., heavy.....	.60	5.00

Bush Honeysuckle. Upright with bending canes. Blooms in February with sweet white flowers.

Sizes	Each	Doz.	100
1-year.....	\$0.15	\$1.50
2-year.....	.20	2.00
3-year.....	.35	3.75

Crape Myrtle. (*Lagerstroemia*.) This is a Southern plant, much esteemed, very effective both as a single specimen or a small tree, or in groups, as a large shrub. Blooms throughout the entire summer, producing great masses of beautifully fringed flowers in immense panicles. A single tree on the lawn is most effective, or a mass of them produces a most magnificent background. The crimson is a beautiful, bright red. The light pink is very distinct. We have three colors in stock, namely, Light Pink, Improved Bright Pink, Crimson.

Sizes	Each	Doz.	100
1-year plants.....	\$0.15	\$1.60	\$12.50
2-year plants.....	.25	2.50	21.00
3-year plants.....	.40	4.50

Berberis Purpurea. (Purple Barberry.) Foliage a beautiful deep purple all the year; a splendid specimen shrub and almost indispensable in contrastive groupings.

Sizes	Each	Doz.	100
2-year, 1 to 2-foot.....	\$0.25	\$2.50

Berberis Thunbergi. (Thunberg's Barberry.) Dwarf. Inimitably neat and dense of growth, yet graceful because of its drooping branches. Yellow flowers are followed by vivid scarlet fruit, the foliage changing in fall to scarlet and gold.

Sizes	Each	Doz.	100
2-year, 10 to 18-inch.....	\$0.25	\$2.50

Deutzias. Valuable, self-sustaining shrubs which vary considerably in height and habit, but bloom alike in dainty bell or tassel-shaped flowers borne thickly in wreaths along their branches. The taller sorts are useful for specimens, groups, and the background of shrubberies; the dwarfier, for borders or for planting near the house. We have two sorts, namely:

Deutzia Crenata. Upright woody shrub that blooms early in spring, profuse and fragrant.

Light pink.

Deutzia Watsonii. (Pride of Rochester.) Double pure white.

Sizes	Each	Doz.	100
1-year.....	\$0.15	\$1.40	\$12.00
2-year.....	.25	2.50	20.00

Lilacs. (*Syringa*.) Best beloved of all the old time garden shrubs; whose flowers never fail to charm with their delicate beauty or refresh with their tender fragrance.

Sizes	Each	Doz.	100
Common White Lilac, 2-year.....	\$0.15	\$1.50	\$12.00
Common Purple Lilac, 2-year.....	.15	1.50	12.00
Rose Colored Persian Lilac.....	.25	2.50	20.00
Purple Persian Lilac.....	.25	2.50	20.00

Philadelphus Coronarius, or Mock Orange. (Improperly called *Syringa*, Sweet *Syringa*, etc.) A rather upright shrub of good appearance, bearing in April a profusion of single white flowers one inch wide, in rather dense racemes, very fragrant and effective.

Sizes	Each	Doz.	100
2 to 3 feet, 2-year.....	\$0.15	\$1.75

Philadelphus Grandiflorus. Of same habit of growth as the *Philadelphus Coronarius*, except the flowers are larger and bloom in May here.

Sizes	Each	Doz.	100
2 to 3 feet, 2-year.....	\$0.15	\$1.75

Pomegranates. Shrubs with glossy green leaves with large, waxy-like, beautiful flowers about two inches across. General hardy in North Texas, but fully hardy from Waco, Tyler and South. We have two colors: Double Salmon Pomegranate, Double Scarlet Pomegranate.

Sizes	Each	Doz.	100
1-year, 1 to 2-foot.....	\$0.15	\$1.50	\$12.00
2-year, 2 to 3-foot.....	.20	2.00	16.00

Pyrus Japonica. (Scarlet or Japan Quince, Devil's Fire.) A gorgeous sight of fiery red flowers very early in spring; in full bloom before leaves come out. Fine for single specimen, screen or hedge.

Sizes	Each	Doz.	100
1-year.....	\$0.15	\$1.40	\$11.00
2-year.....	.20	2.00	16.00

Privet. (See under Hedging Plants.)

Rhus Cotinus. (Purple Fringe.) (Smoke Tree.) A conspicuous spreading shrub or small tree with large leaves; overhung in mid-summer by cloud-like masses of light, mist-like flowers—having the appearance of smoke at a distance.

Sizes	Each	Doz.	100
2-year, 2 to 3-foot.....	\$0.25	\$2.50
2-year, 3 to 4-foot.....	.40	4.00

SALVIAS

Greggii. A new shrub found native in Southwest Texas. Blooms from early spring to late fall. Always covered with bright red flowers. Makes a neat, compact, graceful shrub 2 to 4 feet high. Endures heat well.

Sizes	Each	Doz.	100
1-year, 1 to 2-foot.....	\$0.25	\$2.75

DECIDUOUS FLOWERING SHRUBS—Continued

SPIREA

All the Spireas bloom with a riotous extravagance which makes them quite striking. Their individual style, color and habits of growth differ so markedly that a collection of varieties will ensure bloom the entire season and still evade the monotony of repetition.

Spirea Argentea. Medium growth. Spikes two to three inches long with delicate white flowers; the relative long stamens to short petals make it look fringe like. Blooms all summer.

	Each	Doz.	100
1-year	\$0.15	\$1.50
2-year20	2.00

Spirea Billardii. Strong growth. Spikes three to five inches long of closely set flowerlets of pinkish red color. Profuse and blooms all summer.

	Each	Doz.	100
1-year, 1 to 2-foot.....	\$0.15	\$1.50	\$10.00
2-year, 2 to 3-foot.....	.20	2.00	15.00
3-year, 3 to 4-foot.....	.25	2.50	20.00

Spirea Prunifolia fl. pl. (Bridal Wreath.) Plum leaved foliage; tall growing, but will prune to any desired height. Blooms early in March and is very effective with its long gracefully curving branches covered thickly their whole length with small, double white flowers.

	Each	Doz.	100
1-year	\$0.15	\$1.50	\$12.00
2-year20	2.00	16.00
3-year25	2.50

Spirea Van Houttei. Pure snow white, single flower, with dark eye in center, borne in globose clusters similar to *Reevesii* in this respect, very graceful. A complete fountain of pure white bloom in April.

	Each	Doz.	100
1-year	\$0.15	\$1.50	\$12.00
2-year20	2.00	15.00
3-year30	2.80	21.00

Mint Tree. (*Vitex Agnus Castus.*) Will grow to height of 20 feet in five to six years, but has shrub-like shape, globular in form. Leaves are deeply five fingered. Has spikes of blue flowers all summer. Foliage has mint-like fragrance.

	Each	Doz.	100
1-year	\$0.25	\$3.00
2-year40	4.00

Flowering Willow, so-called. (*Chilopsis Saligna.*) A fine tree-like shrub blooming profusely from spring or all through the summer, even in the hottest weather. Flowers purple, tubular, 1 to 2 inches long; very desirable for large yards.

	Each	Doz.	100
1-year, 2 to 3-foot.....	\$0.25	\$2.75
2-year, 3 to 5-foot.....	.40	4.50

Hardy Orange. (See under Hedging Plants.)

CLIMBING VINES

These constitute Nature's own living drapery, indispensable to "set off" the various objects of a well appointed place. They are very graceful and effective.

Climbing Roses. See list under Roses.

Honeysuckle, Chinese Evergreen. Foliage light green, dense, rapid grower; flowers white and buff. Each Doz. 100

Honeysuckle, Fuchsia Leaved. Of the coral type, vine upright, flowers red on outside of corolla with yellow inside, perpetual bloomer, very fragrant, generally evergreen, one of the best climbers. Foliage dark green. .20 2.25 17.00

Honeysuckle. (Halls.) Flowers very fragrant, white in opening, becoming buff. Very profuse, perpetual from early spring until fall; evergreen. .20 2.25 17.00

Climbing Euonymus. (*Euonymus Seboidi.*) Heretofore it has been used chiefly for ground-cover and low walls, but now it has proved its ability to climb high and preserve its character of a beautiful broad-leaved evergreen, even in the smoky city of Pittsburgh. For the first few years it clings closely to walls in a mat of small, glossy leaves, but when established it becomes more shrubby in character, throws out strong branches and has broad, glossy leaves similar to those of the Japan *Euonymus* shrub.

2-year, 1 to 2-foot..... Each Doz. 100
\$0.25 \$2.50

Trumpet Creeper. A stout, woody, handsome vine, with compound leaves and perpetual, waxy, large, tubular orange flowers in clusters; fine to ornament out-houses, tree bodies, etc., as it climbs by aerial roots. .15 1.25 10.00

Wistaria. American purple. Hardy; fine for arbors, porch screens, etc. Profuse in early spring. .15 1.40 11.00

Virginia Creeper. (*Ampelopsis quinquefolia.*) Five-lobed or fingered leaf; bright green in summer, turning scarlet in fall; completely covers dead trees, brick walls, fences. Not poisonous. .15 1.40 11.00

CONIFEROUS EVERGREENS

Much care should be exercised in transplanting Evergreens not to allow the roots to be exposed to sun or air. Our rule is to coat the roots, as soon as dug, with a puddle of earth or mud, and pack with moss.

Evergreens will be much benefited in transplanting if protected from wind and sun until they begin to take hold of their new soil. This can be done by placing barrels or boxes over them. The spring winds are specially very hard on transplanted Evergreens. Little care and good judgment will insure their success, while neglect will mean failure.

CONIFEROUS EVERGREENS—Continued

Arborvitae—Golden Compact Conical. Of compact form, globular or cone shaped. Beautiful specimens.

Sizes	Each	Doz.	100
10 to 18-inch.....	\$0.15	\$1.50	\$12.00
6 to 10-inch.....	.25	2.50	20.00
18 to 24-inch.....	.40	4.25	35.00

Arborvitae—Golden Compact Pyramidal. Of beautiful compact form, tall spear or pyramid shape. Beautiful specimens.

Sizes	Each	Doz.	100
6 to 12-inch.....	\$0.15	\$1.60	\$13.00
12 to 20-inch.....	.25	2.75	22.00
20 to 26-inch.....	.40	4.25	36.00
26 to 32-inch.....	.50	5.50	45.00

Arborvitae—Chinese. Dark green, more open in growth than the Golden, and more rapid in growth than the Golden.

Sizes	Each	Doz.	100
8 to 15-inch.....	\$0.15	\$1.50	\$12.00
15 to 24-inch.....	.25	2.50	20.00
24 to 36-inch.....	.35	3.65	28.00
3 to 4-foot.....	.50	5.00	40.00
4 to 5-foot.....	.75	8.00	60.00

Cedrus Atlantica. Of same shape as the Cedrus Deodora, but much slower grower, which makes it more desirable. Handsome bluish-green, with shorter needles than the Deodora. Have only a few specimens.

Sizes	Each	Doz.	100
4 to 5-foot.....	\$1.75	\$20.00

(None smaller in stock.)

Trailing Juniper. Dark green variety, very hardy in the South, grows low trailing on the ground. Have only a few specimens three feet in diameter..... 1.00 11.00

(None smaller in stock.)

Austrian Pine. (Pinus Austriaca.) Slower grower than the White or Yellow Pine, endures heat of the South well. Dark green.

Sizes	Each	Doz.	100
6 to 12-inch.....	\$0.15	\$1.50	\$12.00
12 to 15-inch.....	.20	2.00	15.00
15 to 21-inch.....	.25	2.50	20.00

Colorado Blue Pine. (Pinus Ponderosa.) Has long needles and very graceful. Endures climate here well.

Sizes	Each	Doz.	100
6 to 12-inch.....	\$0.15	\$1.50	\$12.00
12 to 15-inch.....	.20	2.00	15.00
15 to 21-inch.....	.25	2.50	20.00

Scotch Pine. (Pinus Sylvestris.) Dwarfish, compact habit; of lighter green than Austrian Pine. With longer needles than Austrian, but not so long as the Colorado Pine.

Sizes	Each	Doz.	100
6 to 12-inch.....	\$0.15	\$1.50	\$12.00
12 to 15-inch.....	.20	2.00	15.00
15 to 21-inch.....	.25	2.50	20.00

BROAD LEAVED EVERGREENS

These comprise such Evergreens as Magnolia, Cape Jasmine, Laurel, etc. The same precautions must be observed in transplanting as with Conifers, and it is far safer and better, in addition to these precautions, to have the leaves removed, from most kinds, when taken up, and let them put out a new set of leaves. After being carefully planted and properly watered, it is well to mulch with coarse material to prevent rapid drying out.

Cape Jessamine. A very handsome shrub of glossy evergreen leaves. Blooms in May and sometimes throughout the summer and fall, exquisitely beautiful, fragrant, camelia-like, pearly double white flowers. Hardy from Red River southward.

Sizes	Each	Doz.	100
4-year, 3 feet through.....	\$1.00	\$10.00
4-year, 2 feet through.....	.65	7.00

(Have none smaller in stock)

Magnolia Grandiflora. The grandest of all evergreens and flowering trees. Has large, glossy, bright green leaves. Succeeds throughout Texas and Oklahoma, as well as in other southern states. By clipping off all but a few of the tip leaves when taken up, and treated as in our handling, they are readily transplanted. We do not clip the leaves off unless so instructed.

Sizes	Each	Doz.	100
1-year Seedlings, 4 to 6-inch.....	\$0.15	\$1.75
6-year, 5 to 8 feet, \$2 to \$5.....			(Have no intermediate sizes in stock this season.)

Euonymus Japonica. An evergreen similar in appearance to Box, but with larger, more glossy leaves and more rapid grower than the Box. Fine for single specimens. Also makes pretty hedging plants for walks and borders, as it does not grow near so rapidly as the privets.

Sizes	Each	Doz.	100
12 to 18-inch.....	\$0.20	\$2.00	\$15.00
18 to 24-inch.....	.30	3.00	23.00

Euonymus Fulchelus. A very dwarf plant with exceedingly small leaves, scarcely ever exceeding 8 to 12 inches high.

Sizes	Each	Doz.	100
2-year, 4 to 5 inches.....	\$0.25	\$2.50

Evergreen Box, Dwarf. Used for specimens, or edging walks. Grows slowly. Will get to be 10 feet high in about 25 years' time.

Sizes	Each	Doz.	100
2-year, 3 to 6-inch.....	\$0.15	\$1.50

Holly. We only have in stock this season some very large specimen trees that would do for nearby places. Sizes, 4 to 8 feet; heavy; from \$2 to \$5 each.

HEDGING PLANTS

Amour Privet. Darker green and more nearly evergreen than California Privet. Plant more spreading than California Privet, and will endure more cold. Not so easy to root from cuttings as the California, and for this reason stock is limited.

Sizes	Each	Doz.	100
1-year, 1 to 2-foot.....	\$.10	\$1.00	\$ 7.00
2-year, 2 to 3-foot.....	.15	1.60	10.00
3-year, 4 to 5-foot.....	.25	2.75	18.00

California Privet. One of the most popular; used for screening or hedging purposes around yards and lawns; also splendid for single specimens. Nearly evergreen.

Sizes	Each	Doz.	100
1-year, 4 to 6-inch.....	\$.05	\$0.40	\$ 2.50
1-year, 6 to 12-inch.....	.10	.75	4.00
2-year, 12 to 20-inch.....	.15	1.25	5.00
3-year, 3 to 4-foot.....	.20	2.00	12.00
3-year, 4 to 5-foot.....	.30	3.00	18.00

Hardy Orange. (Citrus Trifoliata.) This has proven by test here one of the most beautiful and efficient hedges known. In three years will turn stock. Does not sprout. As tap roots go straight down, does not exhaust soil any great distance away. Has proven perfectly hardy at 15 degrees below zero. In spring is full of beautiful white flowers, and full of yellow fruit in fall. It is easily transplanted.

Sizes	Each	Doz.	100
1-year, 4 to 8-inch.....	\$.10	\$0.75	\$ 3.00
2-year, 10 to 20-inch.....	.15	1.25	7.00
3-year, 2 to 3-foot.....	.20	2.00	15.00

Euonymus Japonica. An evergreen similar in appearance to Box, but with larger, more glossy leaves and more rapid grower than the Box. Fine for single specimens. Also makes pretty hedging plants for walks and borders, as it does not grow near so rapidly as the privets.

Sizes	Each	Doz.	100
12 to 18-inch.....	\$.20	\$2.00	\$15.00
18 to 24-inch.....	.30	3.00	23.00

PERENNIALS—FOR BEDDING

HYBRID HARDY PERENNIAL HIBISCUS

By hybridizing the native species Hibiscus Moscheutos, Hibiscus Militararis, and Hibiscus Coccineus, we have obtained from the common Marsh Mallows a most remarkable lot of splendid varieties in numerous shades from pure white with crimson eye, through most delicate and rich pinks from blush to dark pink, crimson of many shades, and glowing scarlet, as though glossed with varnish. The colors all are of clear, fresh, lively shades. This group of wonderful flowers, rich enough for the garden of any king, eclipsing Cosmos and Shasta Daisies a thousand times, we have produced in a few generations of selecting and crossing. The flowers are often 8 to 12 inches in diameter and glow like suns of various colors. As soon as known, these new creations will become exceedingly popular, as the plants are of the easiest culture and are perpetual bloomers throughout the summer in the driest seasons. They grow 3 to 6 feet tall. The tops die down in the fall, but roots live for many years, sending up many stalks to flower each season. The seeds sown early in spring will produce blooming plants the latter part of the first season.

Of all the wonders produced by hybridization, none is more remarkable or strikingly beautiful for bedding in borders or in the garden than these.

In sending plants, we leave a part of the last season's (dead) top as a handle by which to lift and otherwise handle the roots. The roots should never get dry, and plant so the crown is covered up. New top will come out from same crown as indicated by the dead top.

As the plants do not come true from seed, so we do not list separate colors, but send the roots, which will bloom from Scarlet, Pink and White with variations, no two hardly alike.

	Each	Doz.	100
1-year roots.....	\$.10	\$0.90	\$6.00
2-year roots.....	.15	1.40	8.00

We have saved seed from the choicest plants, mixing the colors, which we offer at 25 cents per packet. The seed should be sown in April, about cotton planting time, in loamy, well pulverized soil, about an inch deep.

	Each	Doz.	100
Iris. A fine bedding perennial, blooming early in spring, with double flag-like flowers, in various shades of blue and purple. We have an assortment of 10 of the best German varieties.....	\$.10	\$0.70	\$4.00
Zebra Grass. The prettiest and most enduring of all grasses. Cross striped with thin lines of white. Makes soft plumes in fall.....	.10	.75	5.00
Pampas Grass. A strong growing grass, producing fine white plumes for winter decorating.....	.10	.75	4.00

CHRISTMAS TREES

We have a lot of overgrown Red Cedar and Holly from 5 to 10 feet high, from 3 to 7 feet through, which, unless much care is taken, are too large for transplanting. These can be cut off at or just under the ground and make fine Holiday trees or the greens used for decorating. Price, 50 cents to \$1 each at nursery. Packing and delivery extra.

Butler Steel Hand Cart

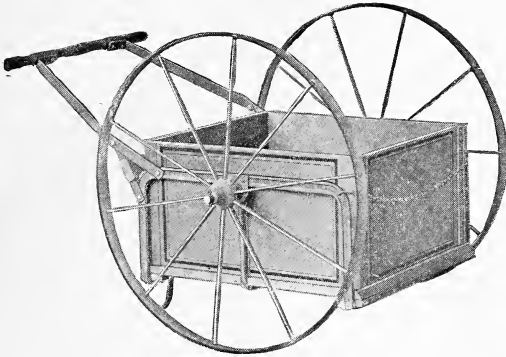

CART WITH REMOVABLE BOX

Capacity 5 bu. For general use of farmers, bakers, merchants. Serves a hundred purposes. No. 4 Cart has 2-inch tires. No. 5 Cart has 3-inch tires.

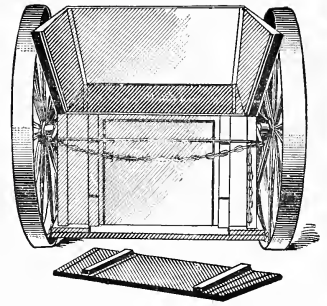

CART WITH EXTENSION HOPPER AND BOX

Shows extra hopper extending 12 in. above box, increasing capacity to about 11 bu. Cut shows wheels with 3-in. tires.

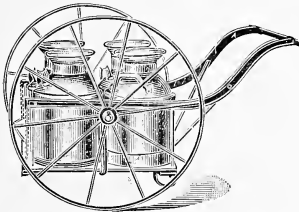

Holds four milk cans. Platform hangs low, stands level, and easily loaded or unloaded. No heavy lifting.

Of the greatest convenience in stock feeding. Can be turned and dumped without shoveling.

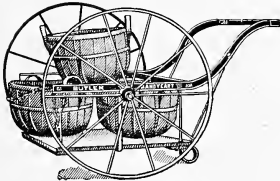
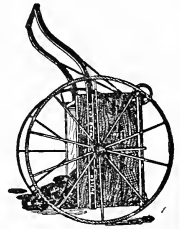

Orchardists and fruit growers find it indispensable.

Farmers save time and work in handling grain, hay, feed, potatoes, etc., etc.

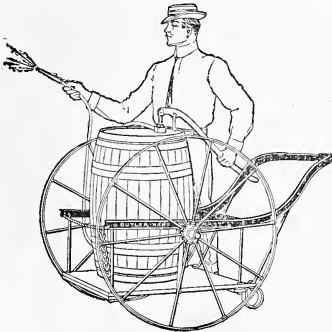
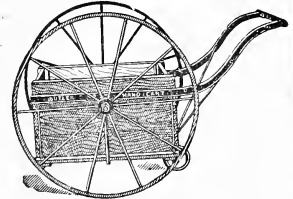

For orchard vineyard and truck garden. Equipped with spraying apparatus makes an ideal spraying outfit.

Tips forward like a truck and picks up heavy articles. Carries a heavier load and easier to handle than a wheelbarrow.

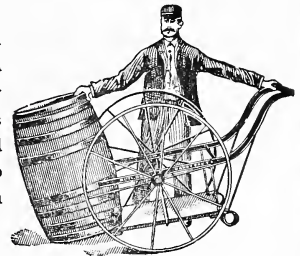

SPECIFICATIONS

WHEELS—Steel, 36 inches high with removable boxings, electric welded spokes. **TIRES**—Either 2-in. concave or 3-in. oval. **WIDTH**—Between wheels, 32 inches; from out to out hub, 40 inches. **AXLE & FRAME PARTS**—Steel. Will easily sustain a load of 500 lbs. Axle one piece entirely under platform. Bottom of cart 6 inches above ground. **PLATFORM**—Hard wood 27x31 inches. **SIDE BOARDS** Hard wood, instantly removable. **PAINTING**—Body Red neatly striped; wheels green. The only difference between the No. 4 and No. 5 Carts is in the wheels—No. 4 Cart having 2-in. concave tire wheels and No. 5 Cart 3-in. oval tire wheels.

WEIGHTS

No. 4 Without Box or Extension Hopper 2-inch Concave Tires.....	95 lbs.....
No. 5 - Without Box or Extension Hopper 3-inch Oval Tires.....	120 lbs.....
Extra Box, 25-in wide x 26-in. long x 15-in. deep.....	20 lbs.....
Extension Hopper Sides.....	20 lbs.....

Butler Steel Hand Cart

The Best General Utility Cart Built

Every farm, orchard, dairy and stock barn can use it to the best advantage. Fills the bill admirably for use on golf courses, large lawns, in the factory and for light delivery purposes. A number of large cities use the Butler Hand Cart for street cleaning purposes, by equipping it with a large can or bag holder.

The "Butler" is the original low platform cart, and used more extensively than all others. The one piece steel frame, and the patented solid steel axle extending entirely under the body give strength and solidity to the cart. Will carry a weight of 500 lbs.

Finely finished. Frame and bottom red, braces black, wheels green. (See cut.)

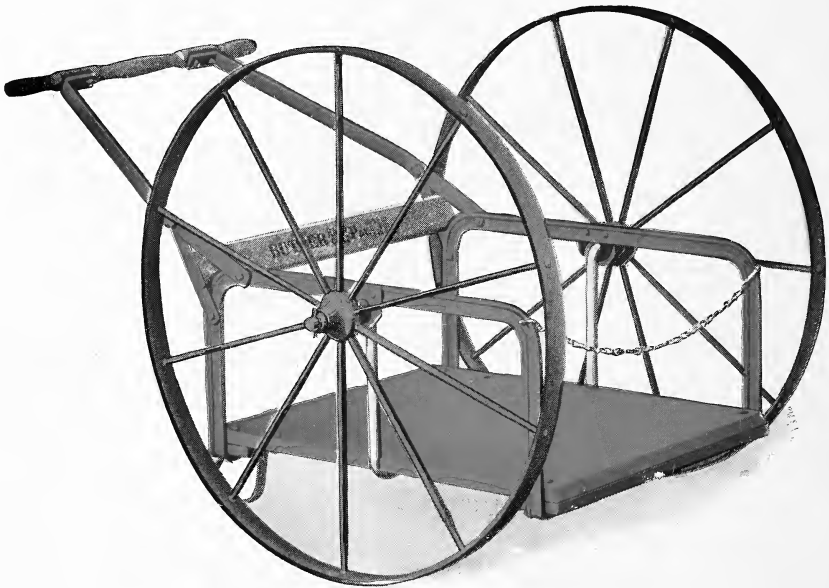

PATENTED

The Original Low Platform Cart

ITS USEFULNESS UNLIMITED

Dairymen, Farmers, Fruit Growers, Grocers, Printers, Plumbers,
Painters, Factories, Bakers, and in fact, anyone can use
the "Butler" Hand Cart to a big advantage.

T. V. MUNSON & SON,
Denison, Texas

Price of No. 4 Cart, without Box	- - - - -	\$ 8.50
Price of No. 5 Cart, without Box	- - - - -	10.00
Cart Box, extra,	- - - - -	4.50

Prices are f. o. b. depot factory in Ohio. - We will take your order.

SPRAY PUMPS AND SPRAYERS

Spraying to combat plant diseases, insects and fungus troubles has become such an important necessity we will take pleasure to assist our customers to get the best sprayers at the lowest prices.

We do not keep any sprayers in stock, but same can be sent direct from the factory to the buyer. This enables us to secure them at a less cost than if we carried in stock, as we can save the freight charge from factory to our place and also cost of keeping in stock. We are able to get them direct from the factory at a discount, and as we will be at no expense, we give our customers the benefit of the discount we are able to obtain. We describe below a few of the most popular sizes, but we can also secure other sizes to your needs.

For a complete catalog with descriptions of all kinds of sprayers, large and small, for cart and wagon, send direct to E. C. Brown Company, Rochester, New York, for such catalog. When you do so, mention that you saw the notice in our catalog.

THE AUTO-SPRAY No. 1. THE WORLD'S STANDARD COMPRESSED AIR SPRAYER.

Adapted for every variety of spraying where a hand sprayer can be used. Made in heavy brass or galvanized iron as desired, and has tank capacity of three gallons of solution. The pump is of heavy brass, 2 inches in diameter, and two or possibly three pumpings will empty the tank under higher and more constant pressure than any other knapsack sprayer. The brass tank will withstand chemical solutions, and is recommended, also the Auto-Top shut-off, which is automatic in action and operates a self-cleaning wire through the nozzle.

	Net Cash
Auto-Spray No. 1-A, brass tank, stop-cock.....	\$8.00
Auto-Spray No. 1-B, brass tank, auto-pop.....	8.50
Auto-Spray No. 1-C, galv. tank, stop-cock.....	5.00
Auto-Spray No. 1-D, galv. tank, auto-pop.....	5.50
Brass 2-inch Extensions.....	.60



THE AUTO-SPRAY No. 40. THE BEST WHITEWASH AND PAINTING MACHINE AND GENERAL PURPOSE SPRAYER EVER MANUFACTURED.

This is a strong, powerful hand sprayer with a capacity of 8 gallons of mixture. It is perfectly adapted to all-around use, for tall trees, shrubs and vines, as well as for applying whitewash or cold water paints. It is as simple as it is strong in construction. The reservoir is made of heavy galvanized steel, the pump being all brass. An agitator attached to the handle keeps the solution thoroughly mixed. Easily carried from place to place or mounted on a wagon. Absolutely the most popular for applying whitewash and paints. Furnished with complete equipment, which includes 8 feet of the best 3-ply discharge hose, 8 feet of iron extension, lever shut-off and vermored nozzle.

	Net Cash
Auto-Spray No. 40-B, galv. tank, with full equipment.....	\$12.00
Auto-Spray No. 40-A, brass tank, with full equipment.....	15.00

THE AUTO-SPRAY No. 24. BARREL SPRAYER FOR ORCHARD AND FIELD CROPS.

For those who require a barrel sprayer of exceptional durability and high pressure, this machine is specially recommended. It may be operated all day without fatigue, and is warranted to operate four nozzles if required. All working parts and valves are fully exposed and instantly get-at-able. The plunger is fitted with outside graphite packing which can be readily adjusted, and will seldom require renewing. The air chamber is large and insures a steady, constant pressure.

	Net Cash
Auto-Spray No. 24, pump only.....	\$12. 0
Mounted on barrel.....	15.00
20 feet 3-ply 1/2-inch discharge hose.....	2.88
Bamboo brass lined extension, with stop-cock and drip shield, length up to 10 feet.....	2.40
Non-Clog Atomic Nozzle, brass.....	1.00



NON-CLOG ATOMIC NOZZLE.

This nozzle is intended for use with all barrel pumps and power sprayers. It is made of cast bronze or aluminum and is fitted with standard 1/4-inch pipe thread so that it will fit all connections of standard make. It is positively the only nozzle that will not clog, despite the claims of other manufacturers. Can be adjusted by a simple mechanism to throw every gradation of spray. Each nozzle is furnished with four discs, with apertures of different size, giving the nozzle capacity of one, two, three or four vermoreds according to the disc that is used.

NON-CLOG ATOMIC NOZZLE.

	Net Cash
All brass, straight, or 45 degree angle.....	\$1.00
Aluminum, straight, or 45 degree angle.....	1.25
Brass elbow, 45 degree, furnished separate.....	.20

NON-CLOG JR.

All brass, straight, or 45 degree angle.....	\$.50
Aluminum, straight, or 45 degree angle.....	.75

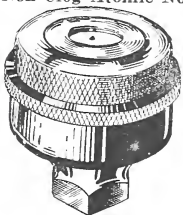
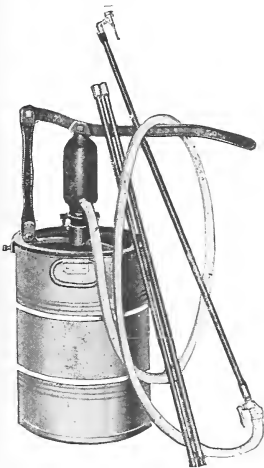

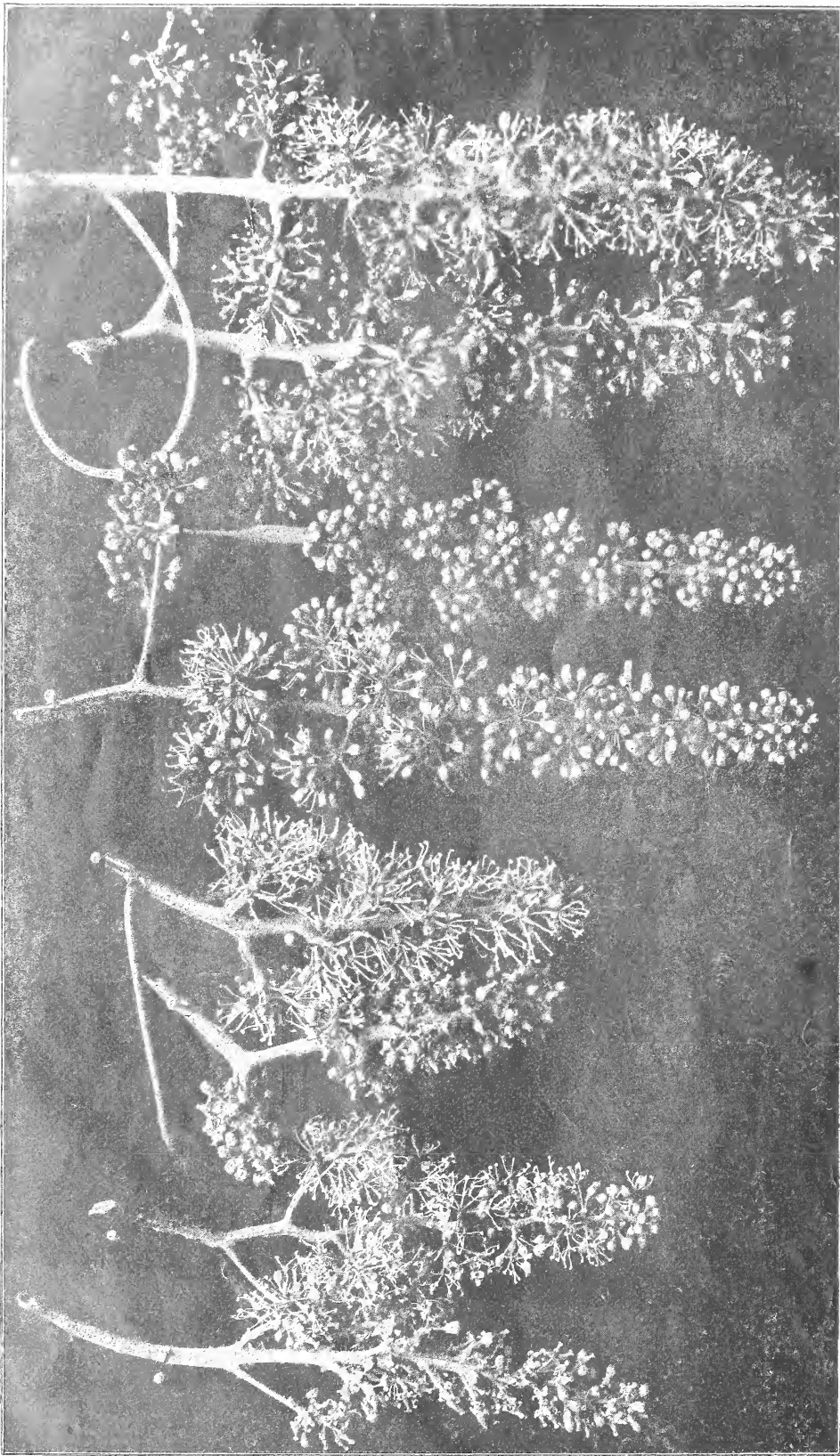

Female
(Pistillate)
Vitis rupestris.

Male.
(Staminate)
(Red Giant)
V. labrusca.

Hermaphrodite.
(Perfect)
(Concord)
V. labrusca.

Female
(Pistillate)
(In bud)
V. lancecumii.

Hermaphrodite (Perfect)
(Pense)
(Lenoir)
V. vinifera, *V. Bourquiniana*

In the descriptions of the varieties in catalog, the hermaphrodite or perfect flowers are indicated by the symbol ♀.

GRAPE FLOWERS